

Baozhong Meng · Giovanni P. Martelli
Deborah A. Golino · Marc Fuchs *Editors*

Grapevine Viruses: Molecular Biology, Diagnostics and Management

 Springer

Grapevine Viruses: Molecular Biology, Diagnostics and Management

Baozhong Meng • Giovanni P. Martelli
Deborah A. Golino • Marc Fuchs
Editors

Grapevine Viruses: Molecular Biology, Diagnostics and Management

 Springer

Editors

Baozhong Meng
Department of Molecular and Cellular
Biology
University of Guelph
Guelph, ON, Canada

Deborah A. Golino
Foundation Plant Services
University of California
Davis, CA, USA

Giovanni P. Martelli
Department of Soil, Plant and Food
Sciences
University of Bari Aldo Moro
Bari, Italy

Marc Fuchs
Section of Plant Pathology and Plant-
Microbe Biology, School of Integrative
Plant Science, New York State
Agricultural Experiment Station
Cornell University
Geneva, NY, USA

ISBN 978-3-319-57704-3

ISBN 978-3-319-57706-7 (eBook)

DOI 10.1007/978-3-319-57706-7

Library of Congress Control Number: 2017943983

© Springer International Publishing AG 2017

This work is subject to copyright. All rights are reserved by the Publisher, whether the whole or part of the material is concerned, specifically the rights of translation, reprinting, reuse of illustrations, recitation, broadcasting, reproduction on microfilms or in any other physical way, and transmission or information storage and retrieval, electronic adaptation, computer software, or by similar or dissimilar methodology now known or hereafter developed.

The use of general descriptive names, registered names, trademarks, service marks, etc. in this publication does not imply, even in the absence of a specific statement, that such names are exempt from the relevant protective laws and regulations and therefore free for general use.

The publisher, the authors and the editors are safe to assume that the advice and information in this book are believed to be true and accurate at the date of publication. Neither the publisher nor the authors or the editors give a warranty, express or implied, with respect to the material contained herein or for any errors or omissions that may have been made. The publisher remains neutral with regard to jurisdictional claims in published maps and institutional affiliations.

Printed on acid-free paper

This Springer imprint is published by Springer Nature

The registered company is Springer International Publishing AG

The registered company address is: Gewerbestrasse 11, 6330 Cham, Switzerland

Preface

Grapevine is one of the most important fruit crops throughout the world. With evidence of its cultivation in the Middle East over 8000 years ago, it is also one of the most ancient grown horticultural crops. Based on the International Organisation of Vine and Wine, in 2014 alone, grapevine was grown on 7.5 million hectares, producing 75 million metric tons of grapes. Together, the grape and wine industry represents a major economic cornerstone for many countries. Interestingly, grapevine hosts the largest number of viruses known to infect a crop plant. Since the initial identification and characterization of grapevine fanleaf virus in degenerated grapevines almost 60 years ago, nearly 70 distinct virus species that belong to a wide range of taxonomic groups (17 families and 27 genera) have been reported in grapevine. From an economic perspective, many grapevine viruses are important because they are highly pathogenic and responsible for widespread disease complexes, such as infectious degeneration, leaf roll, rugose wood, and graft incompatibility and decline, and can be of regulatory concern. More recently, emerging viruses such as grapevine red blotch-associated virus and grapevine Pinot gris virus have been identified in association with economically relevant diseases. Most of the viruses identified in grapevine infect only *Vitis* spp.

Many of the grapevine viruses have unique attributes compared to more extensively studied plant viruses that infect annual, herbaceous crop plants. Our understanding of the molecular biology, evolution, and pathological properties of the grapevine viruses in general, those involved in the aforementioned disease complexes and especially those of the families *Closteroviridae* and *Betaflexiviridae*, is very limited. Much further work is required in the years to come.

The advent and application of recombinant DNA methodologies and, more recently, of high-throughput sequencing (HTS) technologies have advanced, at an unprecedented speed, the field of grapevine virology in the past two decades. Such advances include the development and refinement of rapid and highly sensitive nucleic acid-based assays for the detection of a large number of grapevine viruses, as well as the discovery of new viruses and viral strains. Further, HTS technologies have enabled the characterization of viral communities (virome) in an infected grapevine or even a commercial vineyard. This sets the foundation for the elucidation

and understanding of the collective impact of multiple, coinfecting viruses on the grapevine host. This is very important because grapevine, as a woody perennial species, is commonly infected simultaneously with multiple viruses. Therefore, it is critical that we understand the biology of individual viruses, but we also need to understand how a certain combination of viruses interacts and exerts an even greater effect on the grapevine host.

Several books have been published on various aspects of grapevine virology in the last century. The most recent book, entitled *Graft-Transmissible Diseases of Grapevines: Handbook for Detection and Diagnosis*, by Dr. G. P. Martelli, was published in 1993. Much information has been generated since then. A new and comprehensive book on this subject, entitled *Grapevine Viruses: Molecular Biology, Diagnostics and Management*, was deemed necessary and beneficial for diverse readership communities. This book comprises four sections. Section I starts with a brief account on grapevine, a brief history of viticulture and winemaking, and an overview chapter on grapevine viruses, viroids, and the associated diseases. This is followed by 17 chapters each focusing on a specific virus or a group of related viruses and viroids. Section II includes three chapters on the methods currently in use for the detection of grapevine viruses and the diagnosis of viral diseases. In Sect. III, topics include effects of viruses and their diseases on the grapevine host, as well as on fruits and wine products, the transmission of viruses by vectors, and management strategies that are either currently used or novel strategies that are explored. The last section describes methodologies and applications of high-throughput sequencing technologies, the potential applications of viruses as beneficial vectors for protein expression and functional genomics, as well as speculations on the origin and evolution of major grapevine viruses. This book ends with a conclusion chapter that points out some future research directions in grapevine virology.

This book is intended for a broad audience, including researchers and students interested in grapevine virology, extension educators, viticulturists, vintners, service providers, and regulatory agencies, as well as diagnostic laboratories. Many of the chapters are also comprehensible to avid grape growers and nurseries that are directly impacted by viruses and the diseases they cause and have to deal with the resulting hardship. The inclusion of color photographs to illustrate typical disease symptoms caused by major grapevine viruses should render this book helpful to a wide readership.

We would like to thank the large number of authors who has participated in, and made significant contributions to, this project. Without their support, this book project would not have come to fruition. A special thank-you goes to Dr. Kenneth K. Tang, publishing editor at Springer, for his assistance with the initiation of this project. A meeting at the University of Guelph, Ontario, Canada, in June 2014 made this project possible. We also thank Ms. Mariska Van Der Stigchel, editorial assistant at Springer, for guiding us through the various technical and editorial requirements throughout this project. Finally, we are expressing our gratitude to you, the reader of this book, for your interest and curiosity. We sincerely hope the content of

the book will expand your knowledge and solicit a desire to join us in further exploring the fascinating field of grapevine virology.

Lastly, as this is the first attempt to compile such a comprehensive book, mistakes and insufficiencies are inevitable. Suggestions and constructive criticisms for further improvement are most welcome.

Guelph, ON, Canada
Bari, Italy
Davis, CA, USA
Geneva, NY, USA

Baozhong Meng
Giovanni P. Martelli
Deborah A. Golino
Marc Fuchs

Contents

Part I An Overview on Grapevine Viruses, Viroids and the Diseases They Cause	
1	The Grapevine, Viticulture, and Winemaking: A Brief Introduction 3 A.G. Reynolds
2	An Overview on Grapevine Viruses, Viroids, and the Diseases They Cause 31 G.P. Martelli
3	<i>Grapevine fanleaf virus</i> and Other Old World Nepoviruses 47 M. Digiario, T. Elbeaino, and G.P. Martelli
4	Molecular, Cellular, and Structural Biology of <i>Grapevine fanleaf virus</i> 83 C. Schmitt-Keichinger, C. Hemmer, F. Berthold, and C. Ritzenthaler
5	American Nepoviruses 109 A. Rowhani, S.D. Daubert, J.K. Uyemoto, M. Al Rwahnih, and M. Fuchs
6	<i>Grapevine leafroll-associated virus 1</i> 127 R.A. Naidu
7	<i>Grapevine leafroll-associated virus 2</i> 141 E. Angelini, N. Aboughanem-Sabanadzovic, V.V. Dolja, and B. Meng
8	<i>Grapevine leafroll-associated virus 3</i> 167 J.T. Burger, H.J. Maree, P. Gouveia, and R.A. Naidu
9	<i>Grapevine leafroll-associated virus 4</i> 197 N. Aboughanem-Sabanadzovic, V. Maliogka, and S. Sabanadzovic

10	<i>Grapevine leafroll-associated virus 7</i>	221
	M. Al Rwahnih, P. Saldarelli, and A. Rowhani	
11	Grapevine Vitiviruses	229
	A. Minafra, M. Mawassi, D. Goszczynski, and P. Saldarelli	
12	<i>Grapevine rupestris stem pitting-associated virus</i>	257
	B. Meng and A. Rowhani	
13	Viruses Involved in Graft Incompatibility and Decline	289
	A. Rowhani, J.K. Uyemoto, D.A. Golino, S.D. Daubert, and M. Al Rwahnih	
14	Grapevine Red Blotch: Molecular Biology of the Virus and Management of the Disease	303
	E. Cieniewicz, K. Perry, and M. Fuchs	
15	<i>Grapevine vein clearing virus: Diagnostics, Genome, Genetic Diversity, and Management</i>	315
	W. Qiu and J. Schoelz	
16	Grapevine fleck and similar viruses	331
	S. Sabanadzovic, N. Aboughanem-Sabanadzovic, and G.P. Martelli	
17	<i>Grapevine Pinot gris virus</i>	351
	P. Saldarelli, V. Gualandri, U. Malossini, and M. Glasa	
18	Other Grapevine Viruses of Lesser Economic Importance	365
	G.P. Martelli, D.A. Golino, and N.I. Katis	
19	Viroids Infecting the Grapevine	373
	F. Di Serio, K. Izadpanah, M. Hajizadeh, and B. Navarro	
Part II Methods for Diagnostics		
20	Biological Assays	395
	A. Rowhani, P. La Notte, J.K. Uyemoto, S.D. Daubert, and V. Savino	
21	Serological Methods for the Detection of Major Grapevine Viruses	409
	A.G. Blouin, K.M. Chooi, D. Cohen, and R.M. MacDiarmid	
22	Polymerase Chain Reaction Methods for the Detection of Grapevine Viruses and Viroids	431
	A. Rowhani, F. Osman, S.D. Daubert, M. Al Rwahnih, and P. Saldarelli	

**Part III Effects of Viral Diseases, Epidemiology
and Strategies for the Control and Management
of Viruses and Viral Diseases**

23 The Effects of Viruses and Viral Diseases on Grapes and Wine 453
F. Mannini and M. Digiario

24 Vector Transmission of Grapevine Leafroll-Associated Viruses..... 483
E. Herrbach, A. Alliaume, C.A. Prator, K.M. Daane,
M.L. Cooper, and R.P.P. Almeida

25 Ectoparasitic Nematode Vectors of Grapevine Viruses 505
P. Andret-Link, A. Marmonier, L. Belval, K. Hleibieh,
C. Ritzenthaler, and G. Demangeat

**26 Management of Grapevine Leafroll Disease
and Associated Vectors in Vineyards..... 531**
G. Pietersen, V.A. Bell, and K. Krüger

**27 Improvement of Grapevine Planting Stock Through
Sanitary Selection and Pathogen Elimination..... 561**
D.A. Golino, M. Fuchs, S. Sim, K. Farrar, and G.P. Martelli

**28 Regulatory Aspects of Grape Viruses and Virus Diseases:
Certification, Quarantine, and Harmonization..... 581**
D.A. Golino, M. Fuchs, M. Al Rwahnih, K. Farrar, A. Schmidt,
and G.P. Martelli

29 Novel Approaches for Viral Disease Management..... 599
M. Fuchs and O. Lemaire

**Part IV Metagenomics, Evolution and Biotechnological
Applications of Grapevine Viruses**

**30 High-Throughput Sequencing: Advantages Beyond
Virus Identification 625**
P. Saldarelli, A. Giampetruzzi, H.J. Maree, and M. Al Rwahnih

31 Biotechnology Applications of Grapevine Viruses 643
V.V. Dolja and B. Meng

32 Evolutionary Aspects of Grapevine Virology 659
V.V. Dolja, B. Meng, and G.P. Martelli

33 Concluding Remarks and Future Directions..... 689
G.P. Martelli

Index..... 693

Part I
**An Overview on Grapevine Viruses,
Viroids and the Diseases They Cause**

Chapter 1

The Grapevine, Viticulture, and Winemaking: A Brief Introduction

A.G. Reynolds

Abstract Grapevine is one of the longest-domesticated species with evidence of winemaking found in Anatolia dating from ca. 6000 BCE. Its spread throughout the Near East and Europe relied upon: (1) cultivar and later clonal selection and (2) vegetative propagation. Both of these processes encouraged the spread of viruses and increased the potential for infections that might result in yield reductions, compromised fruit composition, and reduced wine quality. This chapter describes how *Vitis vinifera* became a widespread crop species throughout the Near East and Europe during Neolithic, Bronze Age, Iron Ages, and thereafter and the implications that were brought by vegetative propagation of existing cultivars, new cultivars, and new clones in terms of vine vigor, yield, berry composition, and wine quality.

Keywords Neolithic • Iron age • Bronze age • Transcaucasia • Anatolia • Mesopotamia • *Vitis vinifera sylvestris*

Introduction

Grapevine (*Vitis* spp.) is among the most widely grown of fruit crops worldwide. Recent worldwide production estimates (2014) are 7.6 million hectares and 74 million metric tons (MT; OIV 2016). Its main use is for wine production (270 million hL, MhL), but grapes are also grown for fresh fruit (25 MT), raisins (5.2 MT), juice (30 MhL), vinegar, seed oils, and other products (OIV 2016). Five countries presently represent 50% of the world's vineyards (thousands of ha): Spain (1038), China (799), France (792), Italy (690), and Turkey (502) (OIV 2016; Table 1.1). Major wine-producing countries include (MhL) France (46.7), Italy (44.7), Spain (38.2), the USA (22.2), and Argentina (15.2) (OIV 2016; Table 1.1). Wine presently occupies 55% of grape usage, followed by 35% (fresh grapes), 8% (raisins), and 2% (juice, etc.) (OIV 2016).

A.G. Reynolds (✉)

Cool Climate Oenology & Viticulture Institute, Brock University,
1812 Sir Isaac Brock Way, St. Catharines, ON L2S 3A1, Canada
e-mail: areynold@brocku.ca

Table 1.1 Top grape-producing countries in the world

Country	Vineyard area (kha)	Wine production (mhL)
Spain	1038	38.2
China	799	11.2
France	792	46.7
Italy	690	44.7
Turkey	502	^a
USA	425	22.3
Argentina	228	15.2
Portugal	224	6.2
Chile	211	10.5
Romania	192	3.7
Australia	154	12.0
Moldavia	133	4.1
South Africa	132	11.3
Greece	110	2.9
Germany	102	9.2
Brazil	89	2.7
Hungary	78	2.6
Ukraine	69	2.0
Russia	47	5.4
Austria	44	2.3

Source: OIV (2016)

^aMostly table grapes and raisins

Evolution of *Vitis* spp. in the Near East and Europe

Grapevines belong to the family Vitaceae, which contains 12 genera and >700 species (Galet 2000). Most species of Vitaceae are climbing vines and include genera such as *Ampelocissus*, *Ampelopsis*, *Cayratia*, *Cissus*, *Clematicissus*, *Parthenocissus*, *Tetrastigma*, and *Vitis* (Galet 2000). It has been speculated that prior to separation of our present continents in the late Jurassic Period (165 million years ago), there existed a northern portion of the landmass, Laurasia, and a southern portion, Gondwanaland. Modern members of Vitaceae in former Laurasia mostly have chromosome number of 19 or 20 (e.g., *Vitis*, *Ampelopsis*, *Parthenocissus*), whereas those native to former Gondwanaland (e.g., *Ampelocissus*, *Cissus*, *Cayratia*) have $n = 11$ or 12. Putative early members of Vitaceae (*Cissites*, *Vitiphyllum*) likely evolved during the Cretaceous Period, and fossils have been discovered in Nebraska and Portugal (Galet 2000). Confirmed species of Vitaceae are associated with the beginning of the Tertiary Period to Early Eocene (50 million years ago) (*Ampelopsis*, *Cissus*). The first *Vitis* fossils date from the Eocene in England (*V. subglosa*) and France (*V. sezannensis*) and from the Miocene in Germany (*V. teutonica*). Fossils in Provence dated to the Early Quaternary Period include *V. ausoniae*, which resemble *V. vinifera*. Prehistoric grapevines are known in Europe from the Paleolithic/

Mesolithic periods onward (Galet 2000; Renfrew 1996). Neolithic evidence includes seeds from several locations in Switzerland and wood from Italy and Belgium. Grapevine seeds and canes from the Bronze Age were discovered in numerous locations throughout Italy, Greece, and elsewhere (Galet 2000; Renfrew 1996).

A fairly large number of *Vitis* species (≈ 60) have evolved worldwide, of which *V. vinifera* has become the most widespread for wine and table use. However, North America is considered as a major center of origin of numerous *Vitis* species. Numerous interfertile dioecious *Vitis* spp. are native to North America, Mexico, and the Caribbean (Olmo 1976). All *Vitis* species contain 19 chromosome pairs and all are capable of hybridization. Among North American species, *V. labrusca* (fox grape) has been used to develop several cultivars widely used for juice production (e.g., Concord, Niagara, Catawba), and these are widely grown in the Great Lakes region (Fig. 1.1a). Most of these cultivars are considered as *V. labruscana*, since their genetic background likely contains species other than exclusively *V. labrusca* (Cattell and Stauffer Miller 1980; Hedrick et al. 1908; Reynolds and Reisch 2015). Recently introduced wine grape hybrids, such as Frontenac, La Crescent, and Marquette, contain up to 50% *V. riparia* (Riverbank grape; Fig. 1.1b) (Hemstad 2015). Herbemont and Black Spanish cultivars, grown in Texas and other parts of the US Gulf Coast due to their resistance to Pierce's disease (*Xylella fastidiosa*), are thought to be hybrids of *V. cinerea*, *V. aestivalis*, and *V. vinifera* (Munson 1900). *V. riparia*, *V. rupestris* (Sand Grape; Fig. 1.1c), and *V. berlandieri* (mountain grape) have also been widely used for rootstock breeding and well-known rootstocks such as Couderc 3309, Millardet et de Grasset 101-14, and MdG 101-15 (*riparia* X *rupestris*), as well as Kober 5BB, 5C, and SO 4 (*berlandieri* X *riparia*). The cultivar Norton (Cynthiana), grown widely in the US Midwest, is likely a pure clone of *V. aestivalis* (Fig. 1.1d; Hedrick et al. 1908). *V. candicans* (mustang grape), native to Texas, gave rise to *V. champini* (*candicans* X *rupestris*) and was the basis for several rootstocks with phylloxera (*Daktulosphaira vitifoliae*) and salinity resistance, e.g., Couderc 1613 and C.1616 (based on *V. candicans*; Fig. 1.1e), and Salt Creek and Dog Ridge (based on *V. champini*) (Munson 1900).

A related genus, *Muscadinia*, contains one major species, *M. rotundifolia* (formerly *V. muscadinia*; Fig. 1.1f). *Muscadinia* contain 20 chromosome pairs and cannot hybridize successfully with other *Vitis* species by conventional breeding. A well-known cultivar, scuppernong, dates to the seventeenth century. Breeding programs in southern USA have led to the introduction of several cultivars (Stafne et al. 2015). *Muscadinia* cultivars are well-known as having immunity to phylloxera, and efforts have taken place to use them in rootstock breeding (Olmo 1996; Walker et al. 1985).

Eastern Asia is considered, with the Near East and North America, a major center of origin of many grape species. Liu and Liu (2015) indicate there are 37 species, one subspecies, and 10 variation species of grape in China alone. Among eastern Asian species, perhaps the best known is *V. amurensis* (Liu and Liu 2015). It is extremely cold-resistant but has no resistance to fungal diseases introduced from North America such as powdery mildew (*Uncinula necator*), downy mildew (*Plasmopara viticola*), black rot (*Guignardia bidwellii*), and phomopsis (*Phomopsis viticola*). Numerous *V. vinifera* X *V. amurensis* hybrids have been produced from crosses dating back to 1951 (Liu and Liu 2015).

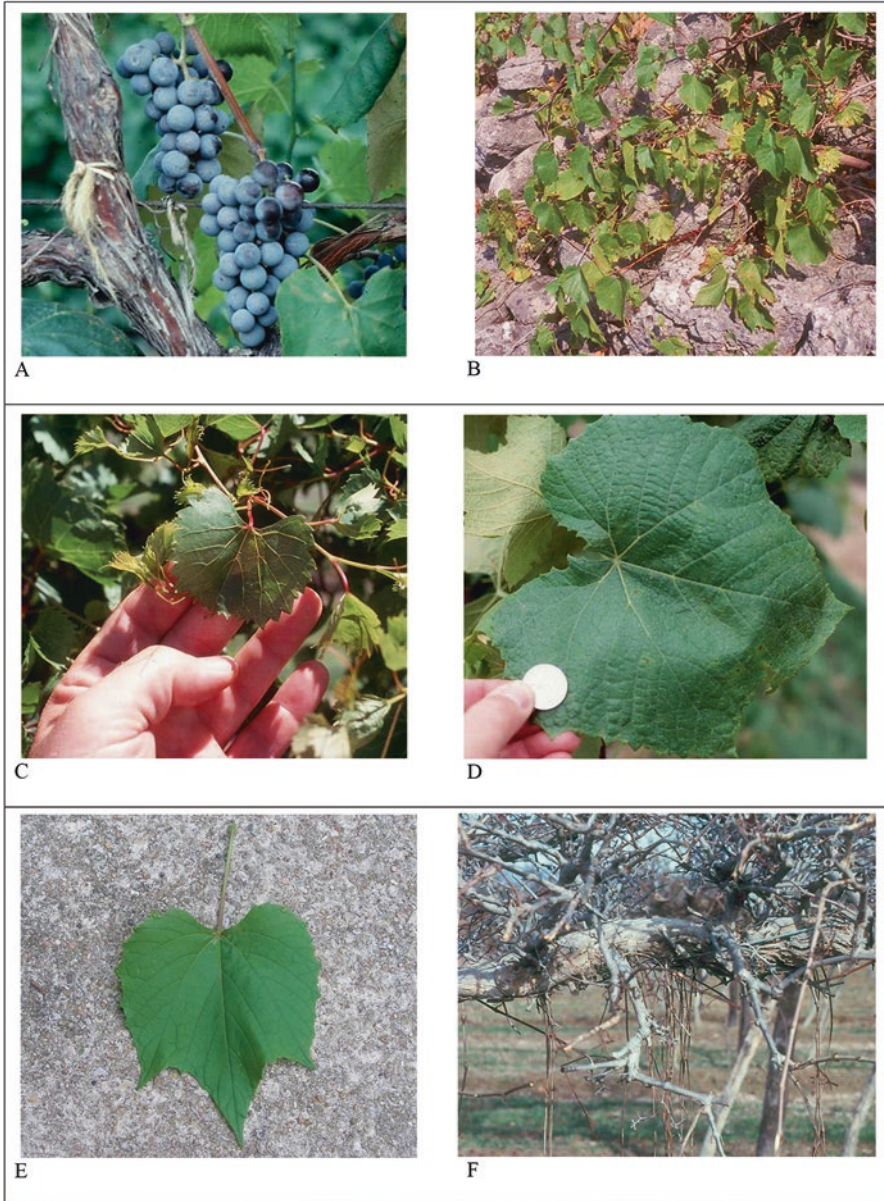

Fig. 1.1 Examples of North American Vitaceae species. (a) *V. labruscana* Concord; (b) *V. riparia*; (c) *V. rupestris*; (d) *V. aestivalis* Norton; (e) *V. candicans*; (f) *Muscadinia rotundifolia* (Photos: A.G. Reynolds)

Europe and Central Asia has a single species, *V. vinifera*, which is frequently subdivided into *V. vinifera* ssp. *sativa* (hereinafter *V. vinifera*; cultivated grape) and *V. vinifera* ssp. *sylvestriotypica* (hereinafter *V. sylvestris*; wild grape) (Olmo 1996). Present cultivars likely arose initially by collection and planting seeds. These seed-propagated populations would have been highly heterozygous, and specific cultivars could not have been selected until vegetative propagation (by cuttings or layering) was introduced. One very practical basis for selection was hermaphroditism, since *V. sylvestris* was by nature dioecious. Grape seeds recovered from early archeological sites tend to be round with short beaks (*V. sylvestris*), whereas late Neolithic and Early Bronze Age sites have revealed seeds that are longer with elongated beaks (*V. vinifera*). It is highly likely that the emergence of *V. vinifera* corresponded with vegetative propagation, cultivar selection, and establishment of vineyards of uniform hermaphroditic cultivars. Singleton (1996) has suggested that vegetative propagation may have begun as early as ca. 8000 BCE, which predates the Neolithic.

There are now >10,000 grapevine cultivars recognized, and this number has expanded substantially over the past 150 years as a result of grapevine breeding programs. Several attempts have been made to classify *V. vinifera* on the basis of ampelographic traits. Perhaps most widely accepted is that of Negrul (1946), who divided all *V. vinifera* into three classes, or *proles* (descendance) based on a combination of ampelographic, ecological, and geographical criteria. *Proles occidentalis* includes most small-clustered wine cultivars of western Europe, e.g., Pinot noir, Chardonnay, Riesling, etc.; they share common traits such as high sugar, high acidity, small clusters, and in most cases slightly hairy shoot tips. *Proles pontica* includes those cultivars that originated on the banks of the Black Sea near the purported center of origin, most of which have hairy growing tips and include Furmint, Rkatsiteli, Black Corinth, etc. This group has been subdivided into *sub-proles balcanica*, which includes most small-clustered wine grapes such as Furmint, and *sub-proles georgica*, which encompasses large-clustered wine grapes, e.g., Rkatsiteli. *Proles orientalis* has glabrous shoot tips, large clusters, and frequently muscat flavor and seedlessness. Typical cultivars are Thompson Seedless, Muscat blanc, Muscat of Alexandria, etc. This group has been subdivided into *sub-proles caspica*, which includes large-clustered wine grapes (e.g., Alicante), and *sub-proles antasiatica*, which includes large-clustered table grapes (e.g., Thompson Seedless).

The Evolution of Viticulture in Neolithic Times (10200–2000 BCE)

V. vinifera has often been said to have evolved in the Transcaucasia region, between the Black and Caspian Seas (Olmo 1996). However, there is considerable paleontological evidence to dispute this. At the end of the Tertiary Period (ca. 66 million to 2.6 million years ago) or Early Quaternary Period (ca. 2.6 million years ago), *V. sylvestris* was already present in western Europe and Asia Minor (Galet 2000;

Olmo 1996). During the Pleistocene Epoch (2.6 million to 11,700 years ago), *V. sylvestris* survived in forests throughout the Mediterranean and south of the Caspian Sea. During the Neolithic Period, *V. sylvestris* occupied a similar distribution although its range was somewhat diminished due to climate change resulting from glaciation. This wild grapevine (*V. vinifera* ssp. *sylvestris typica*) picked by humans were from dioecious vines spread by birds and other animals and are referred to as Lambrusco (i.e., lambrusque; wild) vines (Zohary 1996). Although these feral vines were substantially reduced in population by phylloxera beginning in the mid-nineteenth century, they are still widely distributed throughout Mediterranean Europe and North Africa (Zohary 1996). Seeds, canes, and other materials found in Neolithic encampments in Switzerland and Italy suggest that grapes were already becoming an important food source. There are likewise several paleobotanical finds in Greece, one of which dates to the Paleolithic Period (11000 BCE), and a lengthy list of grape-related archeological sites that date to the Early (6400–5300 BCE), Middle (5300–4300 BCE), and Late (4300–2800 BCE) Neolithic Period. Seeds from *V. sylvestris* are typically round and squat, whereas *V. vinifera* seeds are more elongated. Although the Paleolithic and Early/Middle Neolithic finds are exclusively *V. sylvestris*, some seeds from the Late Neolithic sites are definitely *V. vinifera*, strongly suggesting that viticulture had begun during this period and that vegetative propagation was being used to establish vineyards.

Godin Tepe

The Godin Tepe site in Iran may be the first archeological site that provides evidence of winemaking and wine consumption in Neolithic times (Badler 1996; McGovern and Michel 1996). This site in the Zagros Mountains dates from the late fourth millennium BCE—3500–3100 BCE for the early phase and 3100–2900 BCE for the late and final phase. The clay jars recovered from the site are inverted teardrop shapes with narrow openings at the tops to facilitate pouring (Fig. 1.2a). Small holes drilled on the sides of the jars above the base are speculated to be for draining of finished wines (i.e., decanting, racking) or for release of CO₂ during fermentation. Residue from jars has included tartaric acid and a red deposit that is presumably anthocyanin pigments. Additional information from the site suggested that inhabitants traded extensively with southern Mesopotamia and southwestern Iran. Of perhaps greater significance is the fact that Mesopotamia was a beer-drinking culture, with no evidence of native *Vitis*. Consequently, initial access to grapes must have come from further north, likely Transcaucasia. Whether the vineyards planted in Godin Tepe were seed-propagated or vegetatively propagated is unknown.

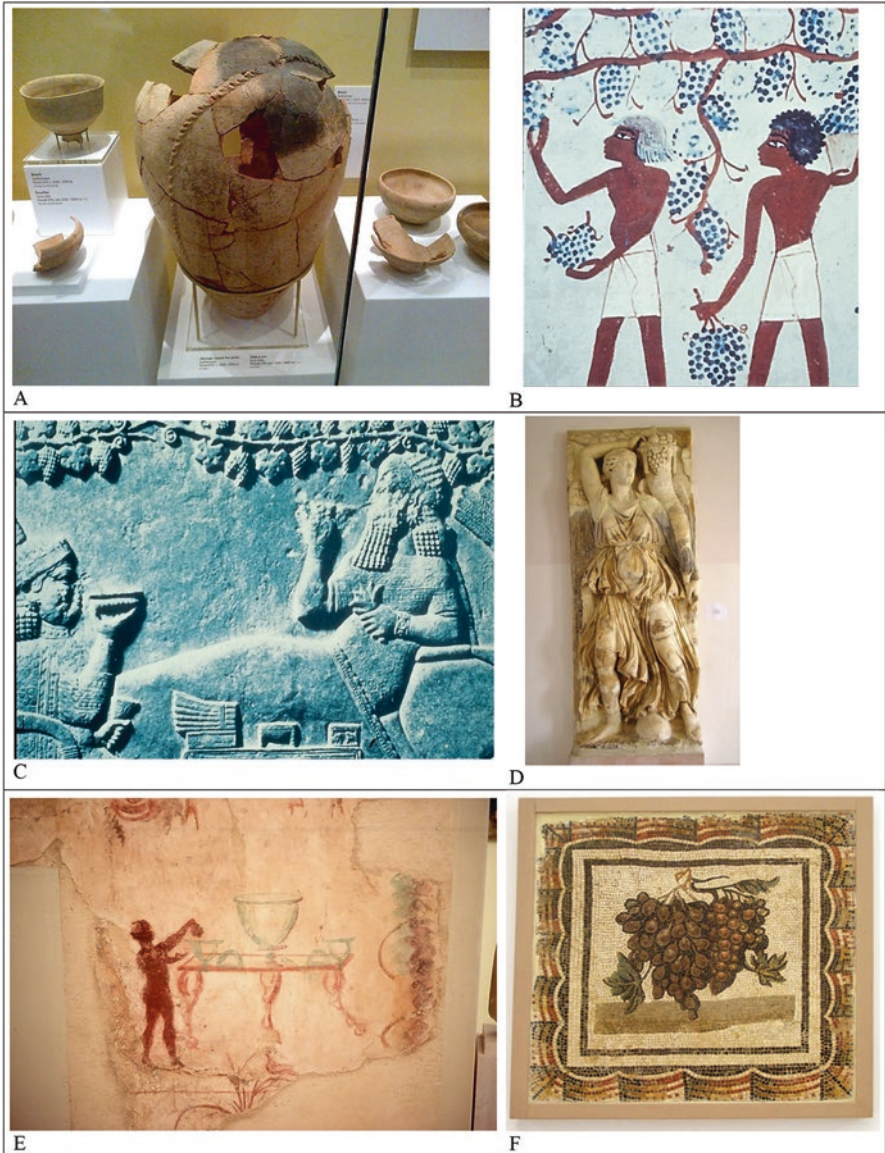

Fig. 1.2 Images of the ancient history of wine. (a) Godin Tepe vessel (ca. 4000 BCE), Royal Ontario Museum; (b) ancient Egyptian harvest scene; (c) King Ashurbanipal of Assyria (668–630 BCE) consuming wine; (d) wine-related statue, Carthage Museum, Tunis; (e) wine service fresco, Delos, Greece; (f) Roman mosaic, Bordo Museum, Tunis (Photographs: a, d, e, f: A.G. Reynolds; b, c: Wilhelm Nassau)

Mesopotamia

Evidence of grape consumption dates to pre-Bronze Age Mesopotamia. The Neolithic site Abu Hureyra revealed grape seeds that presumably came from *V. sylvestris* growing along the upper Euphrates (Algaze 1996). The Uruk Period in ancient Mesopotamia beginning in the fourth millennium BCE included numerous urban areas in valleys throughout the Zagros Mountains and in the alluvial zone between the Tigris and Euphrates rivers (Algaze 1996). These outposts extended as far north as the Taurus Mountains in eastern Anatolia and included well-known cities such as Aleppo and Nineveh, in addition to outposts of archeological significance such as Arslan Tepe in the Taurus Mountains. It is clear that these urban areas were widely engaged in trade—wood, flint, copper, precious stones, textiles, pottery, and also agricultural products that included beer and wine. Several examples of Uruk spouted bottles have been discovered in Arslan Tepe and were likely used for containment of wine and olive oil. It is speculated that these products were shipped on the Tigris and Euphrates downstream and westward into Anatolia.

Anatolia

No historical discussion of wine would be complete without a short treatise on Anatolia. Eastern Anatolia, which includes modern Armenia, Georgia, and Azerbaijan, is widely believed to be the center of origin of *V. vinifera*, and Herodotus indicated Armenia to be the source of winemaking, although evidence for this is limited (Gorny 1996). Noah is mentioned in the Bible as planting vineyards on the slopes of Mount Ararat. Neolithic evidence of wild grape consumption includes seeds uncovered in a ninth millennium BCE site in Çayönü and Can Hasan III (7200–6500 BCE) in eastern Turkey and suggests the potential for rudimentary viticultural experimentation (Gorny 1996). Invention of pottery ca. sixth millennium BCE permitted production and storage of wines. The earliest viticulture in the region has been credited to the spread of Transcaucasian culture in eastern Anatolia in the fourth millennium BCE; however, wild grapes were identified from this period throughout coastal Turkey as well as interior river valleys, which casts doubt on a Transcaucasian origin of viticulture. Chalcolithic (4500–3500 BCE) seed evidence has also been uncovered at Korucutepe, a possible cultivar from Tepecik, and Late Chalcolithic (3500–3200 BCE) seed and charcoal remains at Kurban Höyük (Gorny 1996). The majority of archeological evidence of viticulture dates from the Early Bronze Age and thereafter.

Bronze Age Viticulture (3300–1200 BCE)

Mesopotamia

The first evidence of systematic writing appeared in Mesopotamia ca. 3000 BCE with the introduction of cuneiform (Powell 1996). This is noteworthy because it is also during the Early Bronze Age (third millennium BCE) that evidence of actual viticulture emerged (Algaze 1996). Cuneiform symbols ca. 3000 BCE exist in early Sumerian texts for grape, as well as date palm, apple, and fig. However, evidence of viticulture from Babylonia in the lower Tigris-Euphrates is not extensive. Part of the reason for this is climatic—prior to the advent of irrigation, culture of temperate fruit crops was likely unsuccessful due to high summer temperatures and lack of rainfall. Moreover, the southern Tigris-Euphrates region contains poorly drained sites with highly saline soils, which do not facilitate viticulture. Those grapevines grown in the region were trained to trees—an advent of modern trellising—and also grown in raised beds. Most viticulture consequently was primarily limited to areas north of the present Syrian-Iraq border, in river valleys, and higher elevation sites. However, in the third millennium BCE, seeds and charcoal were identified in Malyan in Iran, which is outside the range of wild grape, suggesting that actual viticulture was being practiced. Sumerian texts describe production of a multitude of grape-based products, including wine, juice, concentrated grape syrups, and raisins. It also appears likely that grape syrups were used as a sugar source to facilitate beer fermentations, since the Babylonian civilization was largely a beer-drinking culture.

The Middle Bronze Age in Mesopotamia included the reign of Hammurabi (ca. 1792–1750 BCE). His destruction of the city of Mari in Assyria on the Euphrates has left evidence of viticulture in northern Mesopotamia (Powell 1996). As with southern Mesopotamia, the extent of wine production in the region does not appear to be large, and much of the wines mentioned in texts originated further north and west. There is also text evidence of wine trade between Antioch on the Mediterranean and Aleppo through the town of Alalakh in northern Assyria. However, just as agricultural limitations restricted viticulture in the lower Tigris-Euphrates and consequently defined wine as a luxury good, Middle to Late Bronze Age wines were likewise regarded as items for the elite.

Anatolia

Botanical evidence exists for Early Bronze Age viticulture in Anatolia at the beginning of the third millennium BCE. Seed evidence has been uncovered at several sites in Anatolia including Korucutepe (Early Bronze Age), Tepecik, Arslan Tepe (Early Bronze Age), Kurban Höyük (Early Bronze Age), Tell es-Sweyhet, Tell Hadidi (Late Bronze Age), and Tell Selenkahiyah (Early Bronze Age) (Gorny 1996).

Introduction of writing in the Middle Bronze Age documented development of viticulture in the region. The period referred to as the Old Assyrian Colony Age (ca. 2000–1750 BCE) provides evidence of grape harvesting and wine production, although it is apparent that the Assyrian colonists likely derived their horticultural skills from their Anatolian natives. Bronze Age Anatolia is dominated by the Hittite culture (1600–1200 BCE). This is noteworthy for several reasons—written texts in the second millennium BCE described the role of viticulture, wine production and consumption became more commonplace by the first millennium BCE, and new vessel shapes were closely linked to wine storage and transport. Wine, more than any other food, became central to the Hittite way of life and came to symbolize life itself. The development of vocabulary associated with viticulture included terms associated with a young plant, a mature vine, cane, cluster, and roots. A detailed set of laws described penalties for theft of a grapevine, burning a vineyard, release of sheep into a vineyard, etc. In their summation, they provide ample evidence that viticulture was extant throughout the Anatolian Peninsula, with the likelihood that individual cultivars had been selected, and vegetative propagation was standard practice. Other grape-derived products included raisins, raisin wine, and *basduk* (boiled-down juice dried into a leather-like substance).

Egypt

Grape seeds have been reported from predynastic fourth millennium sites south of Cairo east of the Nile River (James 1996). Dynastic Egypt began in the Early Bronze Age ca. 3100 BCE. Viticulture was likely introduced to Egypt from western Asia in predynastic times (James 1996; Zohary 1996). Old Kingdom (Second Dynasty; ca. 2890–2686 BCE) hieroglyphs depict a wine press, several variations of trellises, and vines growing from pots (Fig. 1.2b). Later evidence from the Third Dynasty (ca. 2686–2613 BCE) includes seeds in tombs, raisins, hieroglyphic representations of wine presses, and numerous storage jars. The tomb of Metjen of the Fourth Dynasty is significant insofar it describes the establishment of a vineyard in addition to detailed hieroglyphic descriptions of the winemaking process, including harvest, treading, pressing, and the filling of wine jars. However, no details appear to be available as to whether vineyard establishment occurred by use of cuttings or planting of seedlings. Scenes of winemaking are likewise found in tombs from the Fifth Dynasty (ca. 2494–2345 BCE) onward.

Archeological evidence of wine production in Middle Kingdom tombs is abundant but not necessarily more informative than Old Kingdom hieroglyphs with respect to viticulture. Late 11th Dynasty (ca. 2050–2000 BCE) tombs depict various stages of winemaking, including one where men sieve pressed juice through a cloth into a jar. In the New Kingdom 18th Dynasty (ca. 1570–1544 BCE), wine jars were marked with information such as vintage, winemaker, and vineyard (Lesko 1996).

Aegean

As in ancient Anatolia, predynastic Egypt, and much of Mesopotamia, viticulture was prevalent in Greece prior to 3000 BCE (Leonard 1996). The change from wild to domesticated grapes took place during the Early Bronze Age. Several storage jars from Crete and the Cyclades dated from this period contain images of grape leaves, providing evidence that they likely contained wine. Numerous Early, Middle, and Late Bronze Age paleobotanical sites exist throughout mainland Greece, Crete, and other Aegean islands. Most of these contain a significant percentage of *V. vinifera* seeds admixed with those from *V. sylvestris*, which could suggest that vineyards had been established simultaneously with grape harvest from wild vines. Renfrew (1996) suggests that by the Late Neolithic Period and most certainly by the Early Bronze Age, viticulture was extant to the point that propagation by cuttings and possibly grafting was typical, as was pruning, hybridization between *V. sylvestris* and *V. vinifera*, and cultivar selection for specific purposes such as for wine, table grapes, and raisins. Overall, seed evidence indicates that viticulture and wine production existed in Greece at least 1500 years before the establishment of the Mycenaean period ca. 1600 BCE, and it is likely that grapes, olives, wheat, and barley were grown in Crete and Mainland Greece ca. 2170 BCE.

Iron Age Viticulture (1200–500 BC) and Relevance to Spread of Viruses

Eastern Mediterranean and North Africa

It is highly likely that *V. sylvestris* was native to higher elevation areas in North Africa in addition to Mediterranean Europe and Transcaucasia. Moreover, although there was a vigorous wine trade during the Bronze Age among Greece, Egypt, Anatolia, and the Levant (Fig. 1.2c), there is no reason to believe that viticulture did not occur in North Africa prior to the arrival of Phoenician traders. However, there is apparently no hard evidence supporting this; so therefore, one must accept that Phoenicians established Carthage ca. eighth century BCE (Greene 1996). Earliest evidence of *V. vinifera* in Carthage dates to the fourth century BCE (Fig. 1.2D). During this period, Carthage contained vast areas of olive groves and vineyards. Writings of Mago the Carthaginian agronomist include suggestions on vine planting, pruning, site selection (planting on north-facing slopes), and production of raisin wine. It was also likely that the Phoenicians brought cuttings from the Levant for vineyard establishment in Carthage and elsewhere in North Africa.

Greece and Rome

Phoenicians traded vigorously with Greece, Carthage, and also with the developing Roman Empire (Fig. 1.2e, f). Vines were first transported to southern France and the Iberian Peninsula shortly after the Punic Wars in the second century BCE. As the empire expanded, grapevines were transported to interior river valleys of Europe, and soon viticulture was prevalent in the Loire, Rhine, and Danube river valleys. Viticulture was introduced to France (Gaul) by the Greeks ca. 600 BCE and by the Romans ca. 125–118 BCE into the Languedoc and Rhone Valley and in the second century into Bordeaux and Burgundy (Mullins et al. 1992). Grape growing was introduced later into the river valleys of Germania (Germany), and the first reference to wine production in the region was in 370. Viticulture reached Britannia (Britain) in the first century. Writings of Roman authors such as Columella and others (e.g., Cato the Elder, Pliny, Quintillian) describe viticulture in great detail, but it is interesting that in Columella's famous treatise, there are no mentions of diseases and pests except those pertaining to cattle and sheep and only a single mention of insects (Columella 1745). Extensive description is dedicated to propagation methods, particularly grafting, in which it is described as "...how a cluster of grapes may have berries of different kinds." Propagation by cuttings and through layering is also described.

Propagation and Its Relevance to Spread of Viruses

There are substantial descriptions in Roman writings with respect to propagation of grapes by cuttings, layering, and grafting (Mudge et al. 2009). It is also highly likely that as hermaphroditic *V. vinifera* cultivars were selected sometime during the Bronze Age, vegetative propagation became commonplace for the establishment of vineyards. Consequently, if we are to assume that viruses were part of the ecosystem in ancient times, and moreover that insects capable of vectoring these viruses were likewise common, then it is plausible to suggest that viruses were being spread by vegetative propagation and subsequent vineyard establishment as early as the fourth millennium BCE or before. However, although we have fossil records of *Vitaceae* as far back as the Jurassic Period, and paleobotanical records of grape canes and seeds dated to the Neolithic, there is no record of insects other than those in amber (not soft-bodied insects capable of vectoring viruses, e.g., mealybugs or leafhoppers), and certainly there is no possible historical evidence of viruses.

Nonetheless, viruses were likely with us in Neolithic times. There is speculation that nepoviruses such as grapevine fanleaf were present in the first vineyards in present-day Syria, Iraq, and Turkey and likely were spread with the propagation and transplantation of vines (Hewitt 1968). Therefore, as viticulture spread from the Fertile Crescent to Egypt, the Aegean, and throughout the Mediterranean, rooted vines likely had both the nepoviruses in their vascular system and the vector

(i.e., nematodes) present on the root systems. Fresco paintings in Pompeii (ca. 79) suggest presence of fanleaf virus (Fuchs; personal communication 2016); however, one cannot be sure whether the leaf shape was entirely accurate or whether it can be attributed to artistic license. Assuming viruses—both nepoviruses and closteroviruses/ampeloviruses—were present in vineyards during the time of the Roman Empire, they would have been transported throughout the Empire to Britain, France, Germany, and down the Danube to central and eastern Europe. However, there is no indication until the widespread use of phyloxera-resistant rootstocks that viruses were in any way debilitating to grapevines (Hewitt 1968; Vuitennez 1962).

Grapevine Fanleaf

Reports of viruslike symptoms in grapevines are found in mid-19th literature, although this predates the actual discovery of viruses by nearly a century. Numerous reviews are extant that describe the history of grapevine viruses in substantial detail (Bovey 1958; Hewitt 1968; Martelli 2014; Martelli and Boudon-Padieu 2006). The latter reference mentions that >5400 papers related to nearly 70 grapevine viruses and viruslike agents had been published as of 2004, and many more have been appeared in literature since then. For brevity, we have confined our discussion in this chapter to the two major viral diseases, Grapevine fanleaf (GFL) and Grapevine leafroll (GLR). Grapevine fanleaf was described in France (Cazalis-Allut 1865), Austria (Rathay 1882), Italy (Ruggeri 1895; cited in Martelli 2014), and Germany (Cholin 1896), and herbarium specimens suggest GFL was present in Sicily in the late nineteenth century (Martelli and Piro 1975). Baccarini (1902) first suggested that GFL may be due to a virus. Two important conclusions were reached shortly thereafter, when graft transmission of grapevine fanleaf virus (GFLV) was confirmed (Schiff-Giorgini 1906), and transmission through the soil was established (Pantanelli 1910). Several later studies speculated that GFL was viral in origin (Petri 1929; Arnaud and Arnaud 1931) but without necessary technology, this remained unproven. Introduction of electron microscopy permitted the ability to see GFLV and other plant viruses, and the first description of GFLV as well as its transmission from grapevine to herbaceous hosts was reported by Cadman et al. (1960). Prior to this Hewitt (1951, 1954) had concluded that GFLV and several other viruses were widespread in California vineyards. It was also widely believed that GFLV was transmitted by phyloxera (Arnaud 1937; Branas et al. 1937) until Hewitt et al. (1958) concluded that the nematode *Xiphinema index* was the vector. Control has been attempted by use of nematicides (Raski and Goheen 1988; Raski and Schmitt 1972; Raski et al. 1971, 1981, 1983), heat treatment (Bovey 1958; Gifford and Hewitt 1961; Goheen et al. 1965), and subsequent micropropagation (Barlass et al. 1982; Galzy 1964). The ultimate goal of virus elimination was the establishment of clean stock programs such as those in California (Olmo 1951). Detailed information on GFLV is available in Chaps. 3 and 4 of this book).

Grapevine Leafroll

Besides GFL, GLR is perhaps the second most common viral disease globally (Martelli 2014). An excellent detailed historical summary of GLR can be found in Hoefert and Gifford (1967). The first description of leafroll symptoms, called *rougeau*, was by Fabre (1853), who noted that red wine cultivars failed to develop color. A similar disease, *brunissure*, was described by Pastre (1891), which produced a brownish discoloration in autumn. Symptoms similar to what we now know as GLR were later described in California (red leaf; Butler 1905), Italy (Sannino 1906), France (*flavescence*; Ravaz and Roos 1905; Ravaz and Verge 1924), and Germany (Scheu 1935, 1936) early in the twentieth century. It was also likely, based on herbarium specimens, that GLR occurred in Sicily as early as the late nineteenth century (Martelli and Piro 1975). Scheu (1935) concluded that the GLR symptoms were viral in origin, and, graft transmissible, which suggests that grapevine leafroll-associated virus (GLRaV), may have been spread many millennia ago as a result of vegetative propagation. A disease in California known as “White Emperor Disease” (so known because the normally red Emperor fruit did not develop pigmentation) was described (Harmon and Snyder 1946) and was likewise considered as viral in origin and graft transmissible. Grapevine leafroll symptoms were described by Hewitt (1951, 1954), and subsequently Goheen et al. (1958) concluded that “White Emperor” and GLR were identical diseases.

Descriptions of GLR were subsequently published by authors in Australia (Fraser 1958), France (Vuittenez 1958), Czechoslovakia (Blattny et al. 1960), New Zealand (Chamberlain 1967), Italy (Belli and Cesati 1967), Switzerland (Bovey 1968), Hungary (Lehoczyk et al. 1969), Yugoslavia (Dimitrijevic 1970), and Israel (Tanne and Nitzany 1973). Goheen and Cook (1959) reviewed the pre-1960 literature, as well as synthesized relevant work that attempted to explain the causal organism of the malady variously known as *brunissure*, *rougeau*, red leaf, and *flavescence*. Their own experiments indicated that all of these aforementioned diseases were very likely grapevine GLRaV. It was later confirmed that GLRaV was present in the original rootstocks imported into California in 1890 (Luhn and Goheen 1970), once again suggesting its graft transmissibility. In addition to graft transmissibility, GLRaV can be transferred by several species of mealybugs such as *Planococcus ficus* (Rosciglione and Gugerli 1989), *P. longispinus* (Teliz et al. 1989), and *P. citri* (Cabaleiro and Segura 1997); *Pseudococcus affinis* (Golino et al. 1995), *Ps. longispinus*, *Ps. viburni*, *Ps. maritimus*, and *Ps. affinis* (Golino et al. 2000); and *Heliococcus bohemicus* and *Phenacoccus aceris* (Sforza et al. 2000). Transmission also occurs by scale insects such as *Pulvinaria vitis* (Belli et al. 1994; Sforza et al. 2000). Control of GLRaV has been based upon much the same strategies as for GFLV, particularly heat therapy (Diaz-Barrita et al. 2007; Goheen et al. 1965; Savino et al. 1991) and micropropagation (Barlass et al. 1982; Diaz-Barrita et al. 2007; Savino et al. 1991) followed by the establishment of clean stock programs. Strategies are also extant that involve a combination of pesticides to control mealybug vectors, as well as use of herbicides to control weeds in the vineyard perimeters that may harbor insect vectors (Pietersen et al. 2013).

Impact of Viruses on Yield, Berry Composition, and Wine Quality

Resistance and Susceptibility

Both GFLV and GLRaV produce significant debilitating effects in grapevines, particularly *V. vinifera*. However, there is evidence that some species and cultivars are at least partially resistant to GFLV (Martelli 2014). As Hewitt (1968) mentioned, GFLV is a very old virus that appears to coexist with *V. vinifera* when it is planted on its own roots. Accessions of *V. vinifera* obtained from the Middle East were reported to be GFLV resistant (Vuittenez 1962). Walker and Meredith (1990) and Walker et al. (1985) identified two *V. vinifera* accessions from Afghanistan and Iran resistant to GFLV and indicted the resistance to be based upon two unlinked recessive genes.

American species are generally susceptible to *X. index* and consequently are not GFLV resistant (Martelli 2014). However, Harris (1983, 1988), among others, indicated a wide range of American species with *X. index* or *X. americanum* resistance (see Oliver and Fuchs 2011 for a detailed list). *Muscadinia rotundifolia* has partial resistance and resists *Xiphinema index* transmission (Bouquet 1981, 1983), but becomes infected by graft transmission. Rootstock selections derived from *V. vinifera* × *M. rotundifolia* showed good GFLV resistance (Walker et al. 1985, 1989, 1994), as did hybrids of *V. rupestris* × *M. rotundifolia* (Walker and Jin 2000). The *rotundifolia*-based resistance is due specifically to a resistance to *X. index* feeding rather than host plant resistance to the virus and is controlled by a single dominant gene. More recent nematode-resistant rootstock introductions from the Davis, CA, program include *M. rotundifolia* parentage but also *V. champini*, *V. riparia*, *V. rufo-tomentosa*, and *V. rupestris* (Ferris et al. 2012).

V. labrusca is highly susceptible to GFLV but asymptomatic (Martelli 2014) and is quite susceptible to other eastern North American nepoviruses such as peach mosaic viruses (Ramsdell and Gillet 1985; Ramsdell and Myers 1978). Several French-American hybrids are highly sensitive to tomato ring spot virus, including Baco noir (Gilmer and Uyemoto 1972; Uyemoto and Gilmer 1972; Uyemoto et al. 1977), de Chaunac (Dias 1977; Uyemoto et al. 1977), Cascade (Uyemoto 1975; Uyemoto et al. 1977), and most rootstocks, e.g., C.3309, SO 4, 5BB (Gonsalves 1982; Uyemoto et al. 1977).

Unlike GFLV, there are no apparent sources of genetic resistance to GLRaV in *V. vinifera* (Martelli 2014), suggesting perhaps that it may not be an old virus. In fact, among 223 European, American, and Asian *Vitis* accessions tested, none were resistant to either GLRaV-1 or GLRaV-3 (Lahogue and Boulard 1996). Others, however, have suggested that despite this lack of host plant resistance that GLRaV is indeed an ancient virus that evolved with *V. vinifera* in the center of origin, mainly due to its common occurrence in own-rooted vines throughout the Middle East (Maree et al. 2013).

Effects on Physiology, Yield, and Berry Composition

Viruses most certainly cause debilitating effects in grapevines, and the impacts of GFLV and GLRaV have been widely researched. Grapevine fanleaf virus reduced photosynthetic rate, leaf chlorophyll concentration, trunk diameter, shoot length, berry diameter, and yield of Thompson Seedless vines in Chile compared to their virus-free counterparts (Auger et al. 1992). Yamakawa et al. (1987) reported that an unidentified virus infection of Merlot vines was associated with reduced cluster weight, berry volume and weight, and juice Brix compared to virus-free vines.

Early GLR literature described associations with reduced crops (Ravaz 1904), lack of pigmentation (Fabre 1853), delayed fruit maturity (Scheu 1936), potassium deficiencies (Ravaz et al. 1933), calcium deficiencies (Ravaz and Roos 1905), and impaired water relations (Butler 1905), although it was not clear whether these nutritional and vine water status issues were hypothesized solely as causes or effects. Cook and Goheen (1961) indeed reported lower potassium levels in leaves from GLRaV-infected vines, while Goheen and Cook (1959) reported that yields, cane lengths, and soluble solids (Brix) of five wine grape cultivars were reduced by GLR infection. Alley et al. (1963) similarly showed debilitating effects of GLR on Ruby Cabernet vines and also showed that wine color, alcohol, and tannin tended to be inversely related to severity of GLR symptoms. However, wine quality was not reduced, perhaps as a result of yield reductions in GLR-infected vines. There have been occasional reports of compromised physiology such as reduced photosynthesis (Bertamini et al. 2004; Endeshaw et al. 2014; Gutha et al. 2012) as well as other physiological metrics, e.g., stomatal conductance, transpiration, quantum efficiency of PS II, maximum carboxylation efficiency, rate of photosynthetic electron transport, and triose phosphate use (Endeshaw et al. 2014). Others have enumerated the negative effects of GLRaV including reduced yields (Alabi et al. 2016; Credi and Babini 1997; Endeshaw et al. 2014; Komar et al. 2007, 2010; Lider et al. 1975; Mannini et al. 2012; Over de Linden and Chamberlain 1970), cluster numbers (Alabi et al. 2016; Mannini et al. 2012), cluster weights (Komar et al. 2007, 2010; Mannini et al. 2012), berry weight (Hale and Woodham 1979), vine size (Credi and Babini 1997; Endeshaw et al. 2014; Guidoni et al. 1997; Komar et al. 2007, 2010; Lider et al. 1975; Mannini et al. 2012), Brix (Alabi et al. 2016; Cabaleiro et al. 1999; Endeshaw et al. 2014; Kliewer and Lider 1976; Komar et al. 2007, 2010; Lider et al. 1975; Martinson et al. 2008; Over de Linden and Chamberlain 1970; Wolpert and Vilas 1992), pH (Cabaleiro et al. 1999; Credi and Babini 1997), anthocyanins (Alabi et al. 2016; Guidoni et al. 1997; Over de Linden and Chamberlain 1970), and phenolics (Alabi et al. 2016; Guidoni et al. 1997), as well as increased titratable acidity (TA) (Cabaleiro et al. 1999; Kliewer and Lider 1976; Komar et al. 2007; Lider et al. 1975). Endeshaw et al. (2014) reported GLRaV-induced reductions in shoots per vine, shoot growth, shoot leaf area and internode length, and cane lignification. Kliewer and Lider (1976) also measured reductions in Burger fruit proline and arginine and increases in potassium, malate, and tartrate. Hale and Woodham (1979) likewise measured higher potassium, malate, and tartrate in

GLRaV-infected Sultana in Australia. Heat treatment of GLRaV-infected Nebbiolo vines led to increases in several anthocyanins as well as quercetin (Guidoni et al. 1997). Wines produced from GLRaV-infected Merlot vines in Washington State had less ethanol, anthocyanins, and phenols than those produced from virus-free vines and had less color, astringency, and red fruit aroma (Alabi et al. 2016).

GLRaV also impacts performance of hybrid vines. Kovacs et al. (2001) in Missouri found that virus infection did not reduce vine size but reduced berry weight slightly, decreased Brix and pH, and increased TA in St. Vincent and Vidal blanc. They attributed this low magnitude of effect to host tolerance. Milkus and Goodman (1999) reported the widespread occurrence of GLRaV-3 in French-American hybrids Seyval blanc (20–75% incidence) and Vignoles (0–100% incidence) in the region. Among six commercial vineyards sampled, four had GLRaV-3-infected plants. Disease incidence was also high for Norton (*V. aestivalis*) and Catawba (*V. labruscana*). The Finger Lakes region in NY also had a high percentage of sites infected with either GLRaV-1, -2, or -3 (Fuchs et al. 2009). Other indications of GLRaV infection is the exhaustive survey in Canada (Mackenzie et al. 1996) that sampled 1091 vineyards in Ontario, Quebec, and Nova Scotia and concluded that 560 had GLRaV-3-positive grapevines, of which 14.8% contained infected French-American hybrids. The common occurrence of GLRaV-3 in *V. labruscana* grapevines was also documented by Wilcox et al. (1998), who identified infected Concord, Catawba, Elvira, and Niagara grapevines in New York. None of the reports noted visual disease symptoms.

These effects of GLRaV on yield components, berry composition, and vine size have economic implications. Atallah et al. (2012) estimated a \$25,000–\$40,000 per hectare economic loss based on a 30% infection rate. They estimated that the impact of GLRaV could be substantially reduced (to \$3000–\$23,000 per ha) through roguing if levels of disease prevalence are moderate (1–25%). However, the best response to GLRaV levels >25% is removal of the entire vineyard. Binzen Fuller et al. (2015) suggested that a virus screening program could save the North Coast region of California >\$50 million. Research into vine responses to viticultural practices has been limited and mixed. Cluster thinning of GLRaV-infected Burger vines increased yield (Lider et al. 1975), Brix (Kliwer and Lider 1976; Lider et al. 1975), and proline (Kliwer and Lider 1976) and reduced TA (Lider et al. 1975). Basal leaf removal has been reported to increase Brix in fruit from GLRaV-affected vines (Pereira-Crespo et al. 2012). Rootstock choice appears not to have any impact on the magnitude of effect of GLRaV on yield components, vine size, and berry composition (Komar et al. 2010).

A recent study in Ontario examined several treatments including cluster thinning, basal leaf removal, exogenous abscisic acid (ABA), brown algal extract, and soluble silicon, alone and in various combinations on GLRaV-infected Cabernet franc (Hébert-Haché 2015). None of the treatments had any beneficial impact on yield components (Table 1.2), but leaf removal increased total anthocyanins and total phenols, while both the algal extract and a combination of cluster thinning + ABA + algal extract likewise increased phenols (Table 1.3).

Table 1.2 Yield and berry weights of Cabernet franc with confirmed GLRaV-1 and/or -3 infection, Beamsville, Ontario

Treatment ^a	Clusters/vine	Yield/vine (kg)	Cluster weight (g)	Berries/cluster	Berry weight (g)
Control	12 a ^b	1.48 ab	122.7 ab	101 ab	1.22
LR	12 a	1.37 ab	106.7 b	93 b	1.19
CT	6 bc	0.69 bc	110.7 b	93 b	1.18
SM	12 a	1.36 abc	108.3 b	86 b	1.24
2SM	13 a	1.68 a	126.1 ab	100 ab	1.21
ABA	16 a	1.47 a	146.0 a	126 a	1.19
SIL	15 a	2.02 a	125.4 ab	98 ab	1.27
SM+CT	5 c	0.71 bc	128.9 ab	107 ab	1.28
SM+CT+ABA	5 c	0.61 c	100.3 b	83 b	1.20

Hébert-Haché (2015)

^aTreatments: control, leaf removal (LR), cluster thinning (CT), Stella Maris (SM; extract from marine brown algae *Ascophyllum nodosum*), double concentration Stella Maris (2SM), abscisic acid (ABA), Silamol (SIL; soluble Si), SM+CT and SM+CT+ABA

^bMeans followed by different letters are significantly different at $p \leq 0.05$ with Tukey's multiple comparison test. Means that are boldfaced are significantly lower than the control, $p \leq 0.05$

Table 1.3 Berry composition of Cabernet Franc with confirmed GLRaV-1 and/or -3 infection, Beamsville, Ontario

Treatment	Brix	Titrateable acidity (g/L)	pH	Hue	Color intensity	Total anthocyanins (mg/L) ^{b,c}	Total phenols (mg/L) ^d
Control ^a	21.2	7.89	3.42	0.58 ab	12.3	665 b	2979 c
LR	22.7	7.55	3.44	0.56 b	15.9	889 a	4086 a
CT	21.6	7.97	3.46	0.56 b	15.4	729 ab	3473 abc
SM	21.7	7.94	3.42	0.59 ab	13.5	701 b	3288 bc
2SM	22.3	7.77	3.45	0.60 ab	13.3	740 ab	3776 ab
ABA	21.9	7.54	3.44	0.60 ab	13.4	736 ab	3644 abc
SIL	22.0	7.60	3.49	0.64 a	12.2	742 ab	3231 bc
SM + CT	22.4	7.78	3.47	0.59 ab	14.0	790 ab	3687 abc
SM + CT + ABA	21.9	8.37	3.46	0.58 ab	14.6	694 b	3829 ab

Hébert-Haché (2015)

^aTreatments: control, leaf removal (LR), cluster thinning (CT), Stella Maris (SM; extract from marine brown algae *Ascophyllum nodosum*), double concentration Stella Maris (2SM), abscisic acid (ABA), Silamol (SIL; soluble Si), SM + CT and SM+CT+ABA

^bMeans followed by different letters are significantly different at $p \leq 0.05$ with Tukey's multiple comparison test. Means that are boldfaced are significantly higher than the control, $p \leq 0.05$

^cTotal anthocyanins measured in malvidin-3-glucoside equivalents

^dTotal phenols measured in gallic acid equivalents

Interest has increased in the detection of GLRaVs and possibly Grapevine red blotch-associated virus by the use of unmanned aerial vehicles (UAVs) as well as by proximal sensing (Reynolds et al. 2015). Data were collected by GreenSeeker proximal sensing in a GLRaV-affected Cabernet franc vineyard between July and September 2014, and GIS maps were created from the data. The Cabernet franc vineyard showed clear expansion of the zones with GLRaV (Fig. 1.3). Affected areas (designated by the red-colored map zones) were largely confined to the north-west corner of the property but spread significantly from mid-July until the final sampling in mid-September. These red zones corresponded to GLRaV symptoms. Work is now underway to use both proximal sensing and UAVs to produce spectral fingerprints of vineyards, along with quantitative PCR to confirm presence and titer of the virus.

Occasionally, there are reports of desirable effects of viruses on grapevines when compared to virus-free material. A report from Australia indicated that a mild strain of GLRaV increased berry weight and volume of Emperor table grapes (Anonymous 1985), while lower TA was measured in juices from virus-infected Merlot grapevines grown in Japan (Yamakawa et al. 1987). Auger et al. (1992) showed that GFLV-infected vines produced berries with higher Brix. Wolpert et al. (1996) demonstrated that infection of Cabernet Sauvignon with yellow speckle viroids led to lowered TA and higher pH. Reynolds et al. (1997) demonstrated that *rupestris* stem pitting-infected vines at two locations generally had lower TA and higher pH than their virus-free counterparts. In the Piedmont region in Italy, GLRaV-infected Dolcetto vines produced wines that were slightly different from their virus-free counterparts and displayed lower red berry aroma and softness, but higher plum aroma, astringency, body, and violet color (Mannini et al. 2012).

Conclusions

Members of the Vitaceae family can be traced to the Jurassic Period (165 million years ago) prior to the continental drift. Modern Vitaceae in the Northern Hemisphere include *Vitis*, *Ampelopsis*, and *Parthenocissus*, whereas Southern Hemisphere genera include *Ampelocissus*, *Cissus*, and *Cayratia*. Early members of Vitaceae (*Cissites*, *Vitiphyllum*) likely evolved during the Cretaceous Period, with confirmed Vitaceae (*Ampelopsis*, *Cissus*) associated with the beginning of the Tertiary Period to Early Eocene (50 million years ago). The first true *Vitis* fossils date from the Eocene in England (*V. subglosa*) and France (*V. sezannensis*) and from the Miocene in Germany (*V. teutonica*). Fossils in Provence dated to the Early Quaternary Period include *V. ausoniae*, which resemble *V. vinifera*. Prehistoric grapevines are known in Europe from the Paleolithic/Mesolithic periods onward.

The center of origin of *V. vinifera* is widely considered to be the Transcaucasian region but archeological evidence casts doubt on this. Substantial paleobotanical evidence exists of both *V. vinifera* ssp. *sylvestris typica* (*V. sylvestris*; wild European grape) and *V. vinifera* ssp. *sativa* (cultivated grape; *V. vinifera*) throughout the

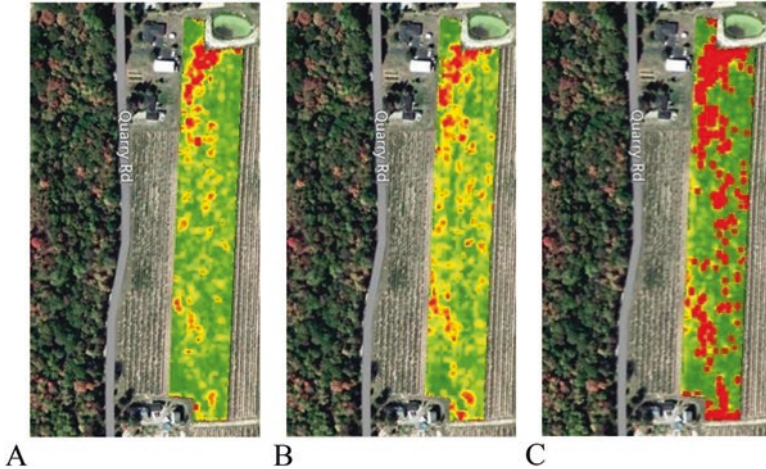

Fig. 1.3 Grapevine leafroll-associated virus (GLRaV), Cave Spring Cabernet franc, Quarry Rd. Vineyard, Beamsville, ON, 2014. *Red zones* are those showing presence of leaf symptoms

Neolithic Period in Europe and the Middle East. This includes mostly seeds but also charred canes and wood. Seed evidence indicates that *V. vinifera* was being grown as far back as the Late Neolithic Period (6000 years ago). This evidence strongly suggests that vegetative propagation was being used to establish vineyards, and the spread of viruses may have begun at this time. Production of wines has been traced back to the Zagros Mountains in modern Iran (fourth millennium BCE) and throughout the Tigris-Euphrates valleys shortly thereafter. Viticulture spread to the Aegean, Egypt, and Anatolia in the third and fourth millennia BCE. Phoenician traders brought viticulture and vegetatively propagated vines to Carthage and Iberia and also to pre-Imperial Rome. The Romans most certainly propagated vines vegetatively by cuttings, layering, and grafting and were the first to name grape cultivars. As the Romans conquered territory throughout Europe, these cultivars were used to establish vineyards. Viruses likely followed.

We now have >70 viruses that affect grapes, and research has focused on molecular methods for virus detection, understanding the nature of resistance, elucidating the viral genome, and characterization of the viral agent. There appears to be limited resistance in host plants to viruses, particularly GFLV and GLRaV, but several rootstocks have been developed that show resistance to *Xiphinema* spp., the vectors for GFLV. Control of the mealybug vectors for GLRaV as well as use of herbicides to control indigenous plants harboring mealybugs in the perimeters of vineyards has been modestly successful in reducing the spread of this virus. In general, use of heat therapy, micropropagation, followed by establishment of clean stock programs are crucial elements in the process by which viruses can be eliminated in vineyards.

References

- Alabi, O.J., L.F. Casassa, L.R. Gutha, R.C. Larsen, T. Henick-Kling, J.F. Harbertson, and R.A. Naidu. 2016. Impacts of grapevine leafroll disease on fruit yield and grape and wine chemistry in a wine grape (*Vitis vinifera* L.) cultivar. *PLoS ONE* 11: e0149666. doi:10.1371/journal.pone.0149666.
- Algabe, G. 1996. Fourth millennium B.C. trade in Greater Mesopotamia. In *The origins and ancient history of wine*, ed. P.E. McGovern, S.J. Fleming, and S.H. Katz, 89–96. Amsterdam: Gordon and Breach.
- Alley, C.J., A.C. Goheen, H.P. Olmo, and A.T. Koyama. 1963. The effect of virus infections on vines, fruit, and wines of Ruby Cabernet. *American Journal of Enology and Viticulture* 14: 164–170.
- Anonymous. 1985. A virus with grape benefits. *Australian Grapegrower and Winemaker* (258):22.
- Arnaud, G. 1937. Les maladies à virus des plantes. VI. Maladies à virus de la vigne et court-noué. *Progrès Agricole et Viticole* 58 (113): 138–141.
- Arnaud, G., and M. Arnaud. 1931. *Traité de Pathologie Végétale. Court-noué et Roncet*, Tome 1, vol. 1, 903 pp. Paris: Paul Lechevalier et Fils.
- Atallah, S.S., M.I. Gómez, M.F. Fuchs, and T.E. Martinson. 2012. Economic impact of grapevine leafroll disease on *Vitis vinifera* cv. Cabernet franc in Finger Lakes vineyards of New York. *American Journal of Enology and Viticulture* 63: 73–79.
- Auger, J.S., E.E. Aballay, M.C. Pinto, and C.V. Pastenes. 1992. Efecto del virus de la hoja de abanico (VHA) en el desarrollo y productividad de plantas de vid cv. Thompson Seedless. *Fitopatología* 27: 85–89.
- Baccarini, P. 1902. Roncet. *Viticultura Moderna* 8: 241–248.
- Badler, V.R. 1996. The archaeological evidence for winemaking, distribution, and consumption at proto-historic Godin Tepe, Iran. In *The origins and ancient history of wine*, ed. P.E. McGovern, S.J. Fleming, and S.H. Katz, 45–56. Amsterdam: Gordon and Breach.
- Barlass, M., K.G.M. Skene, R.C. Woodham, and L.R. Krake. 1982. Regeneration of virus-free grapevines using in vitro apical culture. *Annals of Applied Biology* 101: 291–295.
- Belli, G., and R. Cesati. 1967. Frequent occurrence of grapevine leafroll in Lombardia (northern Italy). *Rivista di Patologia Vegetale (S.IV)* 3: 105–112.
- Belli, G., A. Fortusini, L. Casati, P. Belli, A. Bianco, and S. Prati. 1994. Transmission of a grapevine leafroll associated closterovirus by the scale insect *Pulvinaria vitis* L. *Rivista di Patologia Vegetale (S.V)* 4: 105–108.
- Bertamini, M., K. Muthuchelian, and N. Nedunchezian. 2004. Effect of grapevine leafroll on the photosynthesis of field grown grapevine plants (*Vitis vinifera* L. cv. Lagrein). *Phytopathologia* 152: 145–152.
- Binzen, Fuller, K.J.M. Alston, and D.A. Golino. 2015. The economic benefits from virus screening: A case study of grapevine leafroll in the North Coast of California. *American Journal of Enology and Viticulture* 65: 112–119.
- Blattny, C., T. Dohnal, and Z. Prochazkova. 1960. Über das virose Blätrollen der Weinrebe. *Preslia* 32: 418–419.
- Bouquet, A. 1981. Resistance to grape fanleaf virus in muscadine grape inoculated with *Xiphinema* index. *Plant Disease* 65: 791–793.
- . 1983. Mise en évidence chez l'espece *Muscadinia rotundifolia* (Small) Michx. d'une résistance a la transmission du virus du court-noué (grape fanleaf virus) par son nematode vecteur *Xiphinema* index Thorne et Allen. *Agronomie* 3: 94–95.
- Bovey, R. 1958. État actuel des connaissances sur les maladies à virus de la vigne. *Vitis* 1: 237–256.
- . 1968. Die Blattrollkrankheit der Rebe in der Schweiz. *Weinberg und Keller* 15: 471–478.
- Branas, J., G. Bernon, and L. Levadoux. 1937. Sur les circonstances qui favorisent le développement du court-noué. *Progrès Agricole et Viticole* 58: 161–165.
- Butler, O. 1905. *Observations on some vine diseases in Sonoma County, California*. California University Agricultural Experiment Station, Bulletin No. 168, 29 pp.

- Cabaleiro, C., and A. Segura. 1997. Some characteristics of the transmission of *Grapevine leafroll-associated virus 3* by *Planococcus citri* Risso. *European Journal of Plant Pathology* 103: 373–378.
- Cabaleiro, C., A. Segura, and J.J. García-Berrios. 1999. Effects of grapevine leafroll-associated virus 3 on the physiology and must of *Vitis vinifera* L. cv. Albariño following contamination in the field. *American Journal of Enology and Viticulture* 50: 40–44.
- Cadman, C.H., H.F. Dias, and B.D. Harrison. 1960. Sap-transmissible viruses associated with diseases of grape vines in Europe and North America. *Nature (London)* 187: 577–579.
- Cattell, H., and L. Stauffer Miller. 1980. *The wines of the East. III. Native American grapes*. Lancaster: L & H Photojournalism.
- Cazalis-Allut, L.C. 1865. De la dégénération des vignes. *Ouvres Agricoles*: 57–61.
- Chamberlain, E.E. 1967. Leafroll virus in the grapevines. *Wine Review* 4: 29–32.
- Cholin, J.J. 1896. Beobachtungen über die “Reisigkrankheit” der Reben an Ahr. *Mitteilung über Weinbau und Kellerwirtschaft* 8: 63–64.
- Columella, Lucius Junius Moderatus. 1745 (trans: Anon.). *L. Junius Moderatus Columella of Husbandry, in Twelve Books: And his Book, Concerning Trees*. Translated into English, with illustrations from Pliny, Cato, Varro, Palladius and other ancient and modern authors. A. Millar, London.
- Cook, J.A., and A.C. Goheen. 1961. The effect of a virus disease, leafroll, on the mineral composition of grape tissue and a comparison of leafroll and potassium deficiency symptoms. *American Institute for Biological Science* 8: 338–354.
- Credi, R., and A.R. Babini. 1997. Effects of virus and virus-like infections on growth, yield, and fruit quality of Albana and Trebbiano Romagnolo grapevines. *American Journal of Enology and Viticulture* 48: 7–12.
- Dias, H.F. 1977. Incidence and geographic distribution of Tomato ringspot virus in De Chaunac vineyards in the Niagara Peninsula. *Plant Disease Report* 61: 24–28.
- Diaz-Barrita, A.J., M. Norton, R.A. Martinez-Peniche, M. Uchanski, R. Mulwa, and R. Skirvin. 2007. The use of thermotherapy and in vitro meristem culture to produce virus-free ‘Chancellor’ grapevines. *International Journal of Fruit Science* 7: 15–25.
- Dimitrijevic, B. 1970. The occurrence of leafroll of grapevine in Yugoslavia. *Zaštita Bilja* 21: 373–378.
- Endeshaw, S.T., P. Sabbatini, G. Romanazzi, A.C. Schilder, and D. Neri. 2014. Effects of grapevine leafroll associated virus 3 infection on growth, leaf gas exchange, yield and basic fruit chemistry of *Vitis vinifera* L. cv. Cabernet Franc. *Scientia Horticulturae* 170: 228–236.
- Fabre, E. 1853. Les maladies regnantes de la vigne. *Bulletin Societe Centrale Agricole Herault* 40: 11–75.
- Ferris, H., L. Zheng, and M.A. Walker. 2012. Resistance of grape rootstocks to plant-parasitic nematodes. *Journal of Nematology* 44: 377–386.
- Fraser, L. 1958. *Report on observations on virus diseases of grapevines in the USA and on the occurrence of leafroll and other virus diseases of grapevine in New South Wales*. New South Wales Dept. of Agriculture Report, 27 pp.
- Fuchs, M., T.E. Martinson, G.M. Loeb, and H.C. Hoch. 2009. Survey for the three major leafroll disease-associated viruses in the Finger Lakes vineyard in New York. *Plant Disease* 93: 395–401.
- Galet, P. 2000. *General Viticulture*. (J. Towey, translator). Collection Avenir Oenologie. Oenoplurimedia, Chaintré, France.
- Galzy, R. 1964. Technique de thermothérapie des viroses de la vigne. *Annales des Epiphyties* 15: 245–256.
- Gifford, E.M. Jr., and W.B. Hewitt. 1961. The use of heat therapy and in vitro shoot tip culture to eliminate fanleaf virus from the grapevine. *American Journal of Enology and Viticulture* 12: 129–130.
- Gilmer, R.M., and J.K. Uyemoto. 1972. Tomato ringspot virus in “Baco noir” grapevines in New York. *Plant Disease Report* 56: 133–135.

- Goheen, A.C., and J.A. Cook. 1959. Leafroll (Red Leaf or Rougeau) and its effects on vine growth, fruit quality, and yields. *American Journal of Enology and Viticulture* 10: 173–181.
- Goheen, A.C., F.N. Harmon, and J.H. Weinberger. 1958. Leafroll (white Emperor disease) of grapes in California. *Phytopathology* 48: 51–54.
- Goheen, A.C., C.F. Luhn, and W.B. Hewitt. 1965. Inactivation of grapevine viruses in vivo. In *Proceedings of the international conference on virus and vector on perennial hosts*, with Special Reference to Vitis, Davis, CA, pp. 255–265.
- Golino, D.A., S. Sim, and A. Rowhani. 1995. Transmission studies of grapevine leafroll-associated virus and grapevine corky bark-associated virus by the obscure mealybug. *American Journal of Enology and Viticulture* 46: 408.
- . 2000. *Experimental transmission of grapevine leafroll associated viruses by mealybugs*. Extended Abstracts, 13th Meeting of ICVG, Adelaide, Australia, pp.19–20.
- Gonsalves, D. 1982. Reaction of grape varieties to Tomato Ringspot virus. *Development in Industrial Microbiology* 23: 91–97.
- Gorny, R.L. 1996. Viniculture and ancient Anatolia. In *The origins and ancient history of wine*, ed. P.E. McGovern, S.J. Fleming, and S.H. Katz, 133–174. Amsterdam: Gordon and Breach.
- Greene, J.A. 1996. The beginnings of grape cultivation and wine production in Phoenician/Punic North Africa. In *The origins and ancient history of wine*, ed. P.E. McGovern, S.J. Fleming, and S.H. Katz, 311–322. Amsterdam: Gordon and Breach.
- Guidoni, S., F. Mannini, A. Ferrandino, N. Argamante, and R. di Stefano. 1997. The effect of grapevine leafroll and rugose wood sanitation on agronomic performance and berry and leaf phenolic content of a Nebbiolo clone (*Vitis vinifera* L.). *American Journal of Enology and Viticulture* 48: 438–442.
- Gutha, L.R., O.J. Alabi, and R.A. Naidu. 2012. Effects of grapevine leafroll disease on photosynthesis in a red-fruited wine grape cultivar. In *Proceedings of the 17th Congress of ICVG*, Davis, CA, pp. 168–169.
- Hale, C.R., and R.C. Woodham. 1979. Effect of grapevine leafroll disease on the acid and potassium composition of Sultana grapes. *American Journal of Enology and Viticulture* 30: 91–92.
- Harmon, F.N., and E. Snyder. 1946. Investigations of the occurrence, transmission, spread, and effect of “white” fruit color in the Emperor grape. *Proceedings of the American Society for Horticultural Science* 47: 190–194.
- Harris, A.R. 1983. Resistance of some *Vitis* rootstocks to *Xiphinema index*. *Journal of Nematology* 15: 405–409.
- . 1988. *Xiphinema index*-resistant *Vitis* rootstocks screened for comparative field performance in a Chasselas vineyard replant site. *Vitis* 27: 243–251.
- Hébert-Haché, A. 2015. *Mitigating the impact of Grapevine leafroll-associated virus on V. vinifera cv. Cabernet Franc using cultural practices in addition to conventional spray programs*. Undergraduate thesis, Brock University, St. Catharines, ON, 50 pp.
- Hedrick, U.P., N.O. Booth, O.M. Taylor, R. Wellington, and M.J. Dorsey. 1908. *The grapes of New York. State of New York, Dept. of Agriculture Fifteenth Annual Report—vol. 3—part II*. Albany: J.B. Lyon Co..
- Hemstad, P. 2015. Grapevine breeding in the Midwest. In *Grapevine breeding programs for the wine industry*, ed. A.G. Reynolds, 411–425. Cambridge: Woodhead.
- Hewitt, W.B. 1951. Virus and virus-like grape diseases. *Wines & Vines* 32: 14–15.
- . 1954. Some virus and virus-like diseases of grapevines. *Bulletin of the Department of Agriculture, State of California XLIII*: 47–64.
- . 1968. Viruses and virus diseases of the grapevine. *Review of Applied Mycology* 47: 433–455.
- Hewitt, W.B., D.J. Raski, and A.C. Goheen. 1958. Nematode vector of soil-borne fanleaf virus of grapevines. *Phytopathology* 48: 586–595.
- Hoefert, L.L., and E.M. Gifford. 1967. Grapevine leafroll virus-history and anatomic effects. *Hilgardia* 38: 403–426.
- International Organisation of Vine and Wine (O.I.V.). www.oiv.int. Visited 16 May 2016.

- James, T.G.H. 1996. The earliest history of wine and its importance in ancient Egypt. In *The origins and ancient history of wine*, ed. P.E. McGovern, S.J. Fleming, and S.H. Katz, 197–213. Amsterdam: Gordon and Breach.
- Kliwer, W.M., and L.A. Lider. 1976. Influence of leafroll virus on composition of Burger fruits. *American Journal of Enology and Viticulture* 27: 118–124.
- Komar, V., E. Vigne, G. Demangeat, and M.F. Fuchs. 2007. Beneficial effect of selective virus elimination on the performance of *Vitis vinifera* cv. Chardonnay. *American Journal of Enology and Viticulture* 58: 202–210.
- Komar, V., E. Vigne, G. Demangeat, O. Lemaire, and M.F. Fuchs. 2010. Comparative performance of virus-infected *Vitis vinifera* cv. Savagnin rose grafted onto three rootstocks. *American Journal of Enology and Viticulture* 61: 68–73.
- Kovacs, L.G., H. Hanami, M. Fortenberry, and M.L. Kaps. 2001. Latent infection by leafroll agent GLRaV-3 is linked to lower fruit quality in French-American hybrid grapevines Vidal blanc and St. Vincent. *American Journal of Enology and Viticulture* 52: 254–259.
- Lahogue, F., and G. Boulard. 1996. Recherche de genes de résistance naturelle a deux viroses de la vigne: le court-noué et l'enroulement. *Vitis* 35: 43–48.
- Lehoczky, J., G.P. Martelli, and G. Sarospataki. 1969. Leafroll of grapevine in Hungary. *Acta Phytopathologica Academiae Scientiarum Hungaricae* 4: 117–124.
- Leonard, A. Jr. 1996. “Canaanite jars” and the Late Bronze Age Aegeo-Levantine wine trade. In *The origins and ancient history of wine*, ed. P.E. McGovern, S.J. Fleming, and S.H. Katz, 233–254. Amsterdam: Gordon and Breach.
- Lesko, L.H. 1996. Egyptian wine production during the New Kingdom. In *The origins and ancient history of wine*, ed. P.E. McGovern, S.J. Fleming, and S.H. Katz, 215–230. Amsterdam: Gordon and Breach.
- Lider, L.A., A.C. Goheen, and N.L. Ferrari. 1975. A comparison between healthy, certified and leafroll-affected, non-certified grapevine planting stocks. *American Journal of Enology and Viticulture* 26: 144–147.
- Liu, J., and C. Liu. 2015. Grapevine breeding in China. In *Grapevine breeding programs for the wine industry*, ed. A.G. Reynolds, 273–310. Cambridge: Woodhead.
- Luhn, C.F., and A.C. Goheen. 1970. Viruses in early California grapevines. *Plant Disease Report* 54: 1055–1056.
- Mackenzie, D.J., R.C. Johnson, and C. Warner. 1996. Incidence of four important viral pathogens in Canadian vineyards. *Plant Disease* 80: 955–958.
- Mannini, F., A. Mollo, and R. Credi. 2012. Research note. Field performance and wine quality modification in a clone of *Vitis vinifera* cv. Dolcetto after GLRaV-3 elimination. *American Journal of Enology and Viticulture* 63: 144–147.
- Maree, H.J., R.P.P. Almeida, R. Bester, K.M. Chooi, D. Cohen, V.V. Dolja, M.F. Fuchs, D.A. Golino, A.E.C. Jooste, G.P. Martelli, R.A. Naidu, A. Rowhani, P. Saldarelli, and J.T. Burger. 2013. *Frontiers in Microbiology* 4: 1–28.
- Martelli, G.P. 2014. Directory of virus and virus-like diseases of the grapevine and their agents. *Journal of Plant Pathology* 96 (1S): 1–136.
- Martelli, G.P., and E. Boudon-Padiou (eds.). 2006. *Directory of infectious diseases of grapevines and viruses and virus-like diseases of the grapevine: Bibliographic report 1998–2004*, Options Méditerranéennes: Série B. Etudes et Recherches; no. 55, 280 pp. Bari: CIHEAM.
- Martelli, G.P., and G. Piro. 1975. Virus diseases of the grapevine in a Sicilian herbarium of the past century. *Vitis* 13: 329–335.
- Martinson, T.E., M. Fuchs, G. Loeb, and H.C. Hoch. 2008. Grapevine leafroll: An increasing problem in the Finger Lakes, the US and the World. *Finger Lakes Vineyard Notes* 6: 6–11.
- McGovern, P.E., and R.H. Michel. 1996. The analytical and archaeological challenge of detecting ancient wine: Two case studies from the Ancient Near East. In *The origins and ancient history of wine*, ed. P.E. McGovern, S.J. Fleming, and S.H. Katz, 57–65. Amsterdam: Gordon and Breach.
- Milkus, B.N., and R.N. Goodman. 1999. A survey of Missouri vineyards for presence of five grape viruses. *American Journal of Enology and Viticulture* 50: 133–134.

- Mudge, K., J. Janick, S. Scofield, and E.E. Goldschmidt. 2009. A history of grafting. *Horticultural Reviews* 35: 437–493.
- Mullins, M.G., A. Bouquet, and L.E. Williams. 1992. *Biology of the grapevine*. Cambridge: University Press.
- Munson, T.V. 1900. *Foundations of American grape culture*, 252 pp. Dennison: T.V. Munson and Son.
- Negrul, A.M. 1946. [Origin of the cultivated grapevine and its classification]. In Russian. *Ampelographia SSSR (Moscow)* 1: 159–216.
- Oliver, J.E., and M.F. Fuchs. 2011. Tolerance and resistance to viruses and their vectors in *Vitis* sp.: A virologist's perspective of the literature. *American Journal of Enology and Viticulture* 62: 438–451.
- Olmo, H.P. 1951. A proposed program for the introduction, improvement, and certification of healthy grape varieties. *Wines & Vines* 32: 7–9.
- . 1976. Grapes. *Vitis*, Muscadinia (Vitaceae). In *Evolution of crop plants*, ed. N.W. Simmons, 294–298. London: Longman.
- . 1996. The origin and domestication of the Vinifera grape. In *The origins and ancient history of wine*, ed. P.E. McGovern, S.J. Fleming, and S.H. Katz, 31–43. Amsterdam: Gordon and Breach.
- Over de Linden, A.J., and E.E. Chamberlain. 1970. Effect of grapevine leafroll virus on vine growth and fruit yield and quality. *New Zealand Journal of Agricultural Research* 13: 689–698.
- Pantaneli, E. 1910. Influenza del terreno su lo sviluppo del Roncet od arricciamento della vite. *Rendiconti Regia Accademia dei Lincei (S.V.)* 19: 395–401.
- Pastre, J. 1891. La brunissure de la vigne. *Progrès Agricole et Viticole* 12: 219–233.
- Pereira-Crespo, S., A. Segura, J. Garcia-Berrios, and C. Cabaleiro. 2012. Partial defoliation improves must quality of cv. Albarino infected by grapevine leafroll associated virus 3. *Phytopathologia Mediterranea* 51: 383–389.
- Petri, L. 1929. Sulle cause dell'arricciamento della vite. *Boll. della Regia Stazione di Patologia Vegetale, Roma, N.S.* 9: 101–130.
- Pietersen, G., N. Spreeth, T. Oosthuizen, A. van Rensburg, M. van Rensburg, D. Lottering, N. Rossouw, and D. Tooth. 2013. Technical brief. Control of grapevine leafroll disease spread at a commercial wine estate in South Africa: A case study. *American Journal of Enology and Viticulture* 64: 296–305.
- Powell, M.A. 1996. Wine and the vine in ancient Mesopotamia: The cuneiform evidence. In *The origins and ancient history of wine*, ed. P.E. McGovern, S.J. Fleming, and S.H. Katz, 97–122. Amsterdam: Gordon and Breach.
- Ramsdell, D.C., and J.M. Gillet. 1985. Relative susceptibility of American-French hybrids and European grape cultivars to infection by Peach rosette mosaic virus. *Phytopathologia Mediterranea* 24: 41–43.
- Ramsdell, D.C., and R.L. Myers. 1978. Epidemiology of Peach rosette mosaic virus in a Concord grape vineyard. *Phytopathology* 68: 447–450.
- Raski, D.J., and A.C. Goheen. 1988. Comparison of 1,3-dichloropropene and methyl bromide for control of *Xiphinema index* and grapevine fanleaf degeneration complex. *American Journal of Enology and Viticulture* 39: 334–336.
- Raski, D.J., and R.V. Schmitt. 1972. Progress in control of nematodes by soil fumigation in nematode-fanleaf infected vineyards. *Plant Disease Report* 56: 1031–1035.
- Raski, D.J., A.C. Goheen, L.A. Lider, and C.P. Meredith. 1983. Strategies against grapevine fanleaf virus and its nematode vector. *Plant Disease* 67: 335–339.
- Raski, D.J., W.B. Hewitt, and R.V. Schmitt. 1971. Controlling fanleaf virus-dagger nematode disease complex in vineyards by soil fumigation. *California Agriculture* 25 (4): 11–14.
- Raski, D.J., N.O. Jones, S.L. Hafez, J.J. Kissler, and D.A. Luvisi. 1981. Systemic nematicides tested as alternative to DBPC. *California Agriculture* 35 (5/6): 10–12.
- Rathay, E. 1882. Die Gabler oder Zwiewipflereben. *Österreiches Botanische Zeitschrift* 32: 316–320.

- Ravaz, L. 1904. Recherches sur la brunissure de la vigne. *Progrès Agricole et Viticole* 41: 568–569.
- Ravaz, L., E. Dupont, and R. Callaudeau. 1933. Recherches sur le rougeau de la vigne. *Annales Agronomiques n.s.* 3: 225–231.
- Ravaz, L., and L. Roos. 1905. Le rougeau de la vigne. *Progrès Agricole et Viticole* 22: 39–40.
- Ravaz, L., and G. Verge. 1924. Le rougeau de la vigne. *Progrès Agricole et Viticole* 45: 11–17, 35–38, 86–89, 110–113, 135–141.
- Renfrew, J.M. 1996. Paleoethnobotanical finds of *Vitis* from Greece. In *The origins and ancient history of wine*, ed. P.E. McGovern, S.J. Fleming, and S.H. Katz, 255–267. Amsterdam: Gordon and Breach.
- Reynolds, A.G., and B.I. Reisch. 2015. Grapevine breeding in the Eastern United States. In *Grapevine breeding programs for the wine industry*, ed. A.G. Reynolds, 345–358. Cambridge: Woodhead.
- Reynolds, A.G., W.S. Lanterman, and D.A. Wardle. 1997. Yield and berry composition of five *Vitis* cultivars as affected by *Rupestris* stem pitting virus. *American Journal of Enology and Viticulture* 48: 449–458.
- Reynolds, A.G., R.B. Brown, E. Kotsaki, and Hyun-Suk Lee. 2015. Utilization of proximal sensing technology (Greenseeker) to map variability in Ontario vineyards. In *Proceedings of the 19th GiESCO Congress*, Gruissan, France, 31 May–5 June 2015, pp. 593–597.
- Rosciglione, B., and P. Gugerli. 1989. Transmission of grapevine leafroll disease and an associated closterovirus to healthy grapevine by the mealybug *Planococcus ficus* Signoret. In *Proceedings of the 9th Meeting of ICVG*, Kiryat Anavim, Israel, pp. 67–69.
- Sannino, F.A. 1906. Il rossore delle viti. *Rivista di Patologia Vegetale* 1: 162–163.
- Savino V., D. Boscia, A.M. d’Onghia, and G.P. Martelli. 1991. Effect of heat therapy and meristem tip culture on the elimination of grapevine leafroll-associated closterovirus type III. In *Proceedings of the 10th Meeting of ICVG*, Volos, Greece, pp. 433–436.
- Scheu, G. 1935. Die Rollkrankheit des Rebstockes. *Der Deutsche Weinbau* 14: 222–223, 345–346, 356–358.
- . 1936. *Mein Winzerbuch*. Berlin: Reichnährstand Verlag.
- Schiff-Giorgini, R. 1906. Il roncel delle viti Americane in Sicilia. *Bolletín Ufficiale del Ministero dell’Agricoltura* N.S. 6: 971–979.
- Sforza, R. V. Komar, and C. Greif. 2000. *New scale insect vectors of grapevine closteroviruses*. Extended Abstracts, 13th Meeting of ICVG, Adelaide, Australia, p. 14.
- Singleton, V.L. 1996. An enologist’s commentary on ancient wine. In *The origins and ancient history of wine*, ed. P.E. McGovern, S.J. Fleming, and S.H. Katz, 67–77. Amsterdam: Gordon and Breach.
- Stafne, E.T., S.M. Sleezer, and J.R. Clark. 2015. Grapevine breeding in the Southern United States. In *Grapevine breeding programs for the wine industry*, ed. A.G. Reynolds, 379–410. Cambridge: Woodhead.
- Tanne, E., and F. Nitzany. 1973. Virus diseases of grapevines in Israel. *Vitis* 12: 222–225.
- Teliz, D., D. Gonsalves, J.S. Hu, and D.K. Hummer. 1989. Detection of a grapevine leafroll-associated closterovirus in recently infected tissues in New York and spread of the disease in Mexico. *Phytoparasitica* 17: 68–69.
- Uyemoto, J.K. 1975. A severe outbreak of virus-induced grapevine decline in Cascade grapevines in New York. *Plant Disease Report* 59: 98–101.
- Uyemoto, J.K., and R.M. Gilmer. 1972. Spread of tomato ringspot virus in “Baco Noir” grapevines in New York. *Plant Disease Reporter* 56: 1062–1064.
- Uyemoto, J.K., J.R. Cummins, and G.S. Abawi. 1977. Virus and virus-like diseases affecting grapevines in New York vineyards. *American Journal of Enology and Viticulture* 28: 131–136.
- Vuittenez, A. 1958. Transmission par greffage d’une virose type enroulement foliare commune dans le vignobles de l’Est et du Centre-Est de la France. *Comptes Rendus de l’Académie d’Agriculture de France* 44: 313–316.
- . 1962. Rapport de mission en Turquie pour l’étude des viroses de la vigne. 1–15 juin (polycopie), 22 pp.

- Walker, M.A., and Y. Jin. 2000. Breeding *Vitis rupestris* × *Muscadinia rotundifolia* rootstocks to control *Xiphinema index* and fanleaf degeneration. *Acta Horticulturae* 528: 517–522.
- Walker, M.A., and C.P. Meredith. 1990. The genetic of resistance to Grapevine fanleaf virus in *Vitis vinifera*. In *Proceedings of the 5th international symposium on grape breeding*, St. Martin/Pfalz, Germany, pp. 228–238.
- Walker, M.A., C.P. Meredith, and A.C. Goheen. 1985. Sources of resistance to grapevine fanleaf virus (GFV) in *Vitis* species. *Vitis* 24: 218–228.
- Walker, M.A., J.A. Wolpert, E.P. Vilas, A.C. Goheen, and L.A. Lider. 1989. Resistant rootstocks may control fanleaf degeneration of grapevines. *California Agriculture* 43 (2): 13–14.
- Walker, M.A., J.A. Wolpert, and E. Weber. 1994. Viticultural characteristics of VR hybrid rootstocks in a vineyard site infected with Grapevine fanleaf virus. *Vitis* 33: 19–23.
- Wilcox, W.F., Z.Y. Jiang, and D. Gonsalves. 1998. Leafroll virus is common in cultivated American grapevines in western New York. *Plant Disease* 82: 1062–1063.
- Wolpert, J.A., and E.P. Vilas. 1992. Effect of mild leafroll disease on growth, yield and fruit maturity indices of Riesling and Zinfandel. *American Journal of Enology and Viticulture* 43: 367–369.
- Wolpert, J.A., J.A. Szychowski, and J.S. Semancik. 1996. Effect of viroids on growth, yield, and maturity indices of Cabernet Sauvignon grapevines. *American Journal of Enology and Viticulture* 47: 21–24.
- Yamakawa, Y., M. Moriya, and H. Anamizu. 1987. (Appearance of the low-Brix juice on the virus-free ‘Merlot’ vines). In Japanese, summary in English. *Journal of the Institute of Enology and Viticulture, Yamanashi University* 22: 11–18.
- Zohary, D. 1996. The domestication of the grapevine *Vitis vinifera* L. in the Near East. In *The origins and ancient history of wine*, ed. P.E. McGovern, S.J. Fleming, and S.H. Katz, 23–30. Amsterdam: Gordon and Breach.

Chapter 2

An Overview on Grapevine Viruses, Viroids, and the Diseases They Cause

G.P. Martelli

Abstract Nearly 70 different viruses have been identified in grapevines (*Vitis* and *Muscadinia* sp.), about half of which (31 viruses) are associated with the four major disease complexes known as (1) infectious degeneration (12 Eurasian/European/Mediterranean nepoviruses) and decline (four American nepoviruses), (2) leafroll (five viruses), (3) rugose wood (six viruses), and (4) fleck (four viruses). By contrast, seven grapevine-infecting viroids are known, of which only two induce visible symptoms. Most of the viruses have single-stranded RNA genomes either of positive or negative sense which are encapsidated in isometric or filamentous particles. A few of these viruses have a double-stranded RNA genome, and, very recently, viruses with a DNA genome have emerged. Vectors include dorylamoid nematodes, pseudococcid mealybugs, soft scale insects, eriophyid mites, and a treehopper. A brief historical account of the major disease complexes is given and of the presumptive origins of their recognized or putative agents.

Keywords Fanleaf • Leafroll • Rugose wood • Nepoviruses • Closteroviruses • Vitiviruses • Badnaviruses • Viroids • Longidorid nematodes • Mealybugs • Soft scale insects • Epidemiology

Introduction

Some 30 or so virus and virus-like diseases of grapevines are recognized (Martelli 2014), which are characterized by a wide array of symptoms, i.e., malformations of leaves and twigs, foliar discolorations (reddening, yellowing, chlorotic or bright yellow mottling, ringspots, and line patterns), grooving and/or pitting of the woody cylinder, delayed bud break, stunting, and decline. The productive lifespan of the vineyards can be shortened and the quantity and quality of the crop badly affected.

G.P. Martelli (✉)

Department of Soil, Plant and Food Sciences, University of Bari Aldo Moro, Bari, Italy
e-mail: giovanni.martelli@uniba.it

Prevailing agents of the three major disease complexes (infectious degeneration/decline, leafroll, and rugose wood) are either viruses with isometric particles, the most relevant of which are transmitted by nematodes (nepoviruses), or viruses with filamentous particles, transmitted by pseudococcid mealybugs and soft scale insects (closteroviruses and vitiviruses). No vectors are known for the viruses of a fourth complex (fleck). Infected propagation materials (nursery productions) are the major responsible for the long-distance dissemination of the viral diseases and related agents, several of which have now a worldwide distribution and have entered areas where the grapevine industry is expanding. This is, in summary, the extant situation. However, how was it in the past, and when and where did the sanitary problems began?

The first descriptions of an alarming degenerative condition (infectious degeneration) of grapevines date back to the second half of the nineteenth century. These early records were from European countries: France (Cazalis-Allut 1865), Austria (Rathay 1882), Germany (Cholin 1896), and Italy (Baccarini 1902). In a few decades, evidence was gathered that this disease had a patchy distribution in the field and was graft transmissible and no infection occurred when the soil was heated at 120 °C (Schiff-Giorgini 1906; Pantanelli 1910, 1917; Petri 1918). Based on these evidences and his own observations, Petri (1929) endorsed Baccarini's (1902) early suggestion of the putative viral origin of the disease in question.

Notwithstanding the relevance of infectious degeneration, and after the early 1900s upsurge of interest for it, there was no much action in Europe and elsewhere up to the mid-1950s. Then, the studies carried out in California (Hewitt 1954) revealed that grapevines are affected by a number of different virus and viruslike diseases and provided a detailed description of their symptomatology. This was soon followed by the demonstration that fanleaf (i.e., the same disease as the European infectious degeneration) is indeed a soilborne disorder transmitted by the longidorid nematode *Xiphinema index* (Hewitt et al. 1958) and, shortly afterward, that the putative agent of fanleaf is a mechanically transmissible *Nepovirus* (Cadman et al. 1960). These papers revived the attention for the long-neglected viral problems of the viticultural industry, first in Europe and then in the rest of the world.

In May 1962, a group of American and European plant pathologists decided to establish a study group denoted "International Council for the Study of Virus and Virus-like Diseases of the Grapevine" [ICVG (Bovey and Gugerli 2003)], an organization which has given a tremendous impulse to virological studies. In fact, since the early 1960s, nearly 70 different viruses have been identified in grapevines (*Vitis* and *Muscadinia*), many of which (31 viruses) are associated with the four major disease complexes that, as stated above, are known as (1) infectious degeneration (12 European/Mediterranean nepoviruses) and decline (four American nepoviruses), (2) leafroll (five viruses), (3) rugose wood (six viruses) and (4) fleck (four viruses) (Table 2.1).

Table 2.1 Grapevine-infecting viruses

Family	Genus	Species
Viruses with isometric particles +ssRNA genome		
<i>Secoviridae</i>	<i>Fabavirus</i>	<i>Broadbean wilt virus 1</i> (BBWV-1) <i>Grapevine fabavirus</i> (GFabV)
	<i>Nepovirus</i>	<i>Artichoke Italian latent virus</i> (AILV); <i>Arabidopsis mosaic virus</i> (ArMV); <i>Blueberry leaf mottle virus</i> (BBLMV); <i>Cherry leafroll virus</i> (CLRV); <i>Grapevine Bulgarian latent virus</i> (GBLV); <i>Grapevine Anatolian ringspot virus</i> (GARSV); <i>Grapevine deformation virus</i> (GDefV); <i>Grapevine chrome mosaic virus</i> (GCMV); <i>Grapevine fanleaf virus</i> (GFLV); <i>Grapevine Tunisian ringspot virus</i> (GTRV); <i>Peach rosette mosaic virus</i> (PRMV); <i>Raspberry ringspot virus</i> (RpRSV); <i>Tobacco ringspot virus</i> (TRSV); <i>Tomato ringspot virus</i> (ToRSV); <i>Tomato black ring virus</i> (TBRV)
	Unassigned in the family	<i>Strawberry latent ringspot virus</i> (SLRSV)
<i>Bromoviridae</i>	<i>Alfavirus</i>	<i>Alfalfa mosaic virus</i> (AMV)
	<i>Cucumovirus</i>	<i>Cucumber mosaic virus</i> (CMV)
	<i>Ilarvirus</i>	<i>Grapevine line pattern virus</i> (GLPV); <i>Grapevine angular mosaic virus</i> (GAMoV)
<i>Tombusviridae</i>	<i>Carmovirus</i>	<i>Carnation mottle virus</i> (CarMV)
	<i>Necrovirus</i>	<i>Tobacco necrosis virus D</i> (TNV-D)
	<i>Tombusvirus</i>	<i>Grapevine Algerian latent virus</i> (GALV), <i>Petunia asteroid mosaic virus</i> (PAMV)
<i>Tymoviridae</i>	<i>Marafivirus</i>	<i>Grapevine asteroid mosaic-associated virus</i> (GAMaV); <i>Grapevine rupestris vein feathering virus</i> (GRVFV); <i>Grapevine Syrah virus 1</i> (GSyV-1); <i>Blackberry virus S</i> (BVS); Unnamed putative marafi-like virus
	<i>Maculavirus</i>	<i>Grapevine fleck virus</i> (GFkV) <i>Grapevine redglobe virus</i> (GRGV)
<i>Luteoviridae</i>	<i>Enamovirus</i>	<i>Summer grape enamovirus</i> (SGEV)
Viruses unassigned to families	<i>Idaeovirus</i>	<i>Raspberry bushy dwarf virus</i> (RBDV)
	<i>Sobemovirus</i>	<i>Sowbane mosaic virus</i> (SoMV)
Viruses with isometric particles dsRNA genome		
<i>Reoviridae</i>	<i>Oryzavirus</i> (?)	Summer grape latent virus (SGLV) = <i>Grapevine Cabernet Sauvignon reovirus</i> (GCSV)
<i>Endornaviridae</i>	<i>Endornavirus</i>	<i>Grapevine endophyte endornavirus</i> (GEEV); three unnamed grapevine-associated endornaviruses

(continued)

Table 2.1 (continued)

Family	Genus	Species
<i>Partitiviridae</i>	<i>Deltapartitivirus</i>	<i>Grapevine cryptic virus 1</i> (GCV-1) = <i>Grapevine partitivirus 1</i> (GPV-1)
		An unnamed grapevine-associated partitivirus
<i>Amalgaviridae</i>	<i>Amalgavirus</i>	An unnamed amalgavirus
Viruses with enveloped particles -ssRNA genome		
<i>Bunyaviridae</i>	<i>Tospovirus</i>	<i>Tomato spotted wilt virus</i> (TSWV)
Viruses with filamentous particles +ssRNA genome		
<i>Closteroviridae</i>	<i>Closterovirus</i>	<i>Grapevine leafroll-associated virus 2</i> (GLRaV-2)
	<i>Ampelovirus</i>	<i>Grapevine leafroll-associated virus 1</i> (GLRaV-1); <i>Grapevine leafroll-associated virus 3</i> (GLRaV-3); <i>Grapevine leafroll-associated virus 4</i> (GLRaV-4)
	<i>Velarivirus</i>	<i>Grapevine leafroll-associated virus 7</i> (GLRaV-7)
<i>Alphaflexiviridae</i>	<i>Potexvirus</i>	<i>Potato virus X</i> (PVX)
<i>Betaflexiviridae</i>	<i>Foveavirus</i>	<i>Grapevine stem pitting-associated virus</i> (GSPaV)
	<i>Trichovirus</i>	<i>Grapevine berry inner necrosis virus</i> (GINV); <i>Grapevine pinot gris virus</i> (GPNV)
	<i>Vitivirus</i>	<i>Grapevine virus A</i> (GVA); <i>Grapevine virus B</i> (GVB); <i>Grapevine virus D</i> (GVD); <i>Grapevine virus E</i> (GVE); <i>Grapevine virus F</i> (GVF)
<i>Potyviridae</i>	<i>Potyvirus</i>	<i>Bean common mosaic virus</i> (BCMV) peanut strain; an unidentified <i>Potyvirus</i> -like virus isolated in Japan from a Russian cultivar
Viruses with rod-shaped particles +ssRNA genome		
<i>Virgaviridae</i>	<i>Tobamovirus</i>	<i>Tobacco mosaic virus</i> (TMV); <i>Tomato mosaic virus</i> (ToMV)
Viruses with a DNA genome		
<i>Geminiviridae</i>	Undetermined	<i>Grapevine red blotch-associated virus</i> (GRBaV)
<i>Caulimoviridae</i>	<i>Badnavirus</i>	<i>Grapevine vein clearing virus</i> (GVCV)
		<i>Grapevine roditis leaf discoloration-associated virus</i> (GRLDaV)
Ill-defined, taxonomically unassigned viruses		<i>Unnamed filamentous virus</i> ; <i>Grapevine Ajnashika virus</i> (GAgV); <i>Grapevine stunt virus</i> (GSV); <i>Grapevine labile rod-shaped virus</i> (GLRSV)

Infectious Degeneration/Decline

Recognized as putative agents of infectious degeneration/decline are viruses with isometric particles classified in the genus *Nepovirus* (except for *Strawberry latent ringspot virus*, which is an unassigned member of the family *Secoviridae*), many of which (eight of those infecting vines) have a recognized nematode vector. These viruses have a bipartite, single-stranded, positive-sense RNA genome. The complete sequence of 12 of them has been determined (Martelli 2014): *Arabis mosaic virus* (ArMV), *Cherry leafroll virus* (CLRV), grapevine Anatolian ringspot virus (GARSV), *Grapevine Bulgarian latent virus* (GBLV), *Grapevine chrome mosaic virus* (GCMV), *Grapevine deformation virus* (GDefV), *Grapevine fanleaf virus* (GFLV), *Raspberry ringspot virus* (RpRSV), *Strawberry latent ringspot virus* (SLRSV), *Tomato black ring virus* (TBRV), *Tobacco ringspot virus* (TRSV), and *Tomato ringspot virus* (ToRSV). A comparative analysis of these sequences disclosed that recombination at the level of RNA-2 is an efficient evolutionary mechanism of these viruses, which results in the emergence of interspecific hybrids (Olivier et al. 2010) and novel viral species. The latter is the case of (1) *Grapevine chrome mosaic virus*, a recombinant between *Tomato black ring virus* and *Grapevine Anatolian ringspot virus* (Digiario et al. 2015), and (2) *Grapevine deformation virus*, a recombinant between *Grapevine fanleaf virus* and *Arabis mosaic virus* (Elbeaino et al. 2012).

Viruses involved in degenerative diseases (fanleaf and the like) are referred to as Old World nepoviruses because, except for GFLV, which has a man-fostered worldwide distribution, they occur in this geographical area and have vectors sharing the same territorial distribution (Martelli and Taylor 1990). Thus, degenerative diseases and relative agents prevail in Continental and Mediterranean Europe where they are likely to have originated, whereas with other diseases denoted “grapevine decline”, the eliciting viruses and vectors are found primarily in North America.

Based on the above, it can be hypothesized that degenerative diseases occurred in Europe before the arrival of phylloxera, thus are native to the Old World. This likelihood is supported by additional evidence:

1. Old records in the European literature describing the symptoms of the disease.
2. Discovery in a Sicilian herbarium of the second half of the nineteenth century of dried grapevine leaves with symptoms identical to those currently visible in vines infected by chromogenic and distorting strains of GFLV (Martelli and Piro 1975).
3. Old paintings, [e.g., Pompeii frescos (79 AD) and a painting by Caravaggio (1600)] depicting distorted grapevine leaves resembling those from fanleaf-diseased plants.
4. GFLV, the major causal agent of degeneration, is serologically related to ArMV, a European *Nepovirus* with which it can recombine to give rise either to new “pathotypes” [e.g., chromogenic virus strains (Elbeaino et al. 2014)] or to novel grapevine-infecting viral species [e.g., *Grapevine deformation virus* (Elbeaino et al. 2012)].

5. Tolerance to GFLV infection is widespread in European grapes, likely due to their long-lasting association with and adaptation to the virus. In fact, a high level of the “host plant resistance” type was found in *V. vinifera* accessions from the Near East (Walker and Meredith 1990), one of the areas of domestication of the grapevine (Arroyo-Garcia et al. 2006).
6. *Xiphinema index*, the vector of fanleaf, is a nematode thought to be native of Asia minor (ancient Persia) (Hewitt 1968; Mojtahedi et al. 1980). Its eastern origin was confirmed through the analysis of mitochondrial genes and microsatellite loci (Villate 2008).
7. GFLV occurs in phylloxera-free countries (e.g., Cyprus, Armenia, parts of southern Turkey, some Aegean Greek islands) (Martelli 2014), where American rootstocks have not been introduced.

Evidence of the American roots of decline syndromes rests on (1) their almost exclusive occurrence in *Vitis vinifera* and *V. labrusca* grown in the Northern United States and Canada; (2) the origin of the eliciting viruses [ToRSV, TRSV, and *Peach rosette mosaic virus* (PRMV)], whose presence in other geographical areas is due to accidental introductions; and (3) the distribution of their vectors, which are largely restricted to North America (Martelli and Taylor 1990; Martelli and Uyemoto 2011).

Leafroll

Graft transmission of leafroll from grape to grape was first obtained in Germany by Scheu (1936). A decade later, Harmon and Snyder (1946) described in California a graft-transmissible disease of cv. Emperor called “White Emperor” which, after an additional decade, and again in California, was shown to be the same as leafroll (Goheen et al. 1958). Thus, in the early 1960, the infectious nature of leafroll was established, but its etiological agent was still unknown. The importance of the discovery of filamentous viruslike particles in the sieve tubes of German vines affected by yellows (Mendgen 1971) was overlooked, notwithstanding the fact that the similarity with citrus plants infected by the *Closterovirus Citrus tristeza virus* (CTV) was striking. The breakthrough came a few years later when *Closterovirus*-like particles were recovered in Japan from vines with leafroll symptoms and their presence was linked with the disease (Namba et al. 1979).

The first partial characterization of two serologically different leafroll-associated closteroviruses came from Switzerland in 1984. These viruses were referred to as “type I” and “type II” (Gugerli et al. 1984). This was the beginning of the nomenclature based on the use of numbers. In the years that followed, the putatively new *Closterovirus* species found in leafroll-diseased vines increased in a disorderly way, so as to call for a revision of their status and nomenclature. The number of bona fide virus species was reduced to six, and their name was determined to be *Grapevine leafroll-associated virus* (GLRaV) followed by an Arabic numeral, e.g., GLRaV-1, GLRaV-2, GLRaV-3, and so on (Boscia et al. 1995).

For many years, leafroll was thought not to be spreading in the field, and the reports from different countries (e.g., Dimitrijevic 1973) that this was not the case were not paid much attention. A leap forward was made when *Grapevine virus A* (GVA), which at that time was classified as a “short *Closterovirus*,” was transmitted by the mealybug *Pseudococcus longispinus* (Rosciglione et al. 1983). In this paper it was stated that:

These observations are consistent with the notion that mealybugs could be vectors of grapevine leafroll as indicated some 20 years ago by the late Dr. H.F. Dias, then by Dr. L. Chiarappa who, in trials with an unidentified species of *Pseudococcus* carried out in California in 1961, obtained the reproduction of the leafroll syndrome on virus-free Mission vines exposed to mealybugs that had previously fed on grapevine with natural leafroll infection. (Rosciglione et al. 1983)

These findings were not published, but the information and the positive results of GVA transmission by a mealybug species (Rosciglione et al. 1983) prompted a study, which showed that *Grapevine leafroll-associated virus 3* (GLRaV-3) is vectored by *Planococcus ficus* (Rosciglione and Gugerli 1989). It was later established that the transmission is nonspecific (multiple vectors) and semi-persistent (Krüger et al. 2006; Almeida et al. 2013).

Recognized vectors of leafroll agents are as follows: *Heliococcus bohemicus*, *Phenacoccus aceris*, *Ps. affinis*, *Ps. calceolariae*, *Ps. viburni*, *Ps. maritimus*, *Ps. comstocki*, *Ph. aceris*, *Pulvinaria vitis*, *Neopulvinaria innumerabilis* and *Parthenolecanium corni* (GLRaV-1); *Planococcus ficus*, *Pl. citri*, *Pseudococcus longispinus*, *Ps. calceolariae*, *Ps. maritimus*, *Ps. affinis*, *Ps. viburni*, *Ps. comstocki*, *Phenacoccus aceris*, *Parthenolecanium corni*, *Neopulvinaria innumerabilis*, *Pulvinaria vitis*, *Coccus hesperidum*, *C. longulus*, *Saissetia* sp., *Parasaissetia* sp., and *Ceroplastes* sp. (GLRaV-3); *Ps. longispinus*, *Pl. ficus*, and *Ph. aceris* (GLRaV-4 and several of its strains).

Closteroviruses have very flexuous filamentous particles with distinct cross-banding, are members of the family *Closteroviridae*, and are classified in four genera: *Closterovirus* (vectored by aphids), *Ampelovirus* (vectored by mealybugs and soft scale insects), *Crinivirus* (vectored by whiteflies), and *Velarivirus* (vector unknown). Grapevine-infecting closteroviruses belong in the genera *Closterovirus*, *Ampelovirus*, and *Velarivirus* and possess genomes differing in size (from 13,700 to 18,500 nucleotides) and structure (from 6 to 12 genes) (Martelli et al. 2012). These differences are thought to derive from the modular evolution of a primigenial replicating viral sequence that underwent a series of successive modifications, i.e., loss of sequences due to deletion, acquisition of sequences from foreign sources, gene duplication followed by diversification, and genome bipartition (Dolja et al. 2006).

Although leafroll is now one of the most widespread virus disorders of the grapevine in the world, its origin seems to hail from the Old World where the disease is likely to have occurred long before the arrival of phylloxera. Supporting evidence is: (1) old records in the Italian and French literature describing an abnormal condition of grapevines called “rossore” and “rougeau” (reddening), respectively; (2) presence in a Sicilian herbarium of the second half of the nineteenth century of dried grapevine leaves reported as being affected by “rossore.” These specimens

show unmistakable signs of a leafroll condition, i.e., downward rolled, very heavy, thick, fractured, and blackish blades (Martelli and Piro 1975); (3) occurrence of some of the leafroll-associated viruses (especially GLRaV-1 and GLRaV-3) in countries like Cyprus, Armenia, Yemen, China (Sinkiang), parts of southern Turkey, and some Aegean Greek islands which are still phylloxera-free; thus, the vines grow on their own roots (Martelli et al. 1994; Pio Ribeiro et al. 2004); and (4) leafroll-infected vines were present among the original grape stocks imported in 1890 from Europe by the University of California (Luhn and Goheen 1970).

There is, however, a puzzling case which is not in line with the above reconstruction. It so happens that GLRaV-2 infections have recently been recorded in American native species: (1) *Vitis californica* and its natural hybrids with *Vitis vinifera* in California (Klaassen et al. 2011); and (2) *Muscadinia rotundifolia* and summer grape (*Vitis aestivalis*) in Southeastern United States, i.e., Mississippi and the Great Smoky Mountains National Park (GSMNP) (Aboughanem-Sabanadzovic and Sabanadzovic 2015). The virus isolate from GSMNP is the same as the Californian graft incompatibility inducer GLRaV-2RG (Alkowni et al. 2011) which is not known to occur in Europe, whereas the isolate from Mississippi is an ordinary leafroll-inducing strain (Meng et al. 2005). It ensues that the presence of GLRaV-2 in *V. aestivalis* growing in a natural ecosystem (GSMNP), in muscadines in an area with a small *V. vinifera* industry (Mississippi), and in the riparian vegetation of the Napa Valley (California) seems difficult to reconcile with an European origin of this virus, unless in the USA there is a vector (e.g., an aphid, as with other members of the genus *Closterovirus* in which GLRV-2 belongs?) able to acquire the virus from infected European grapevines (*V. vinifera*) and transfer it to native *Vitis* species. Should this not be the case, the notion that GLRaV-2 may be a virus native to North America gains strength.

Rugose Wood

Rugose wood, a graft-transmissible disease first reported from Italy (Graniti and Martelli 1965) and soon afterward from Hungary (Martelli et al. 1967), is a complex disorder within which, based on the differential reactions of the indicators *V. rupestris*, LN33, and Kober 5BB (Savino et al. 1987), four different syndromes have been identified: Rupestris stem pitting (RSP), Kober stem grooving (KSG), Corky bark (CB), and LN-33 stem grooving (LNSG).

The etiology of rugose wood remained uncertain for many years, until the recovery by mechanical inoculation from a symptomatic vine of a virus with particles resembling those of closteroviruses (Conti et al. 1980) provided support to its supposed viral nature. The name of this virus, which was originally denoted Grapevine stem pitting-associated virus, was later changed into *Grapevine virus A* (GVA) (Milne et al. 1984). Other similar viruses were soon identified in infected vines, four of which, i.e., *Grapevine virus B* (GVB), *Grapevine virus D* (GVD), *Grapevine virus E* (GVE), and *Grapevine virus F* (GVF), have found a taxonomic allocation in

the genus *Vitivirus* along with GVA, the type species of the genus (Martelli et al. 1997). An additional virus, called *Grapevine rupestris stem pitting-associated virus* (GRSPaV) (Meng et al. 1998), was classified in the novel genus *Foveavirus* (Martelli and Jelkmann 1998).

The extant relationship between the rugose wood syndromes and their putative agents can be summarized as follows: (1) GRSPaV (Meng et al. 1999), (2) GVA/Kober stem grooving (Garau et al. 1994), (3) GVB and GVD/Corky bark (Bonavia et al. 1996), and (4) no specific virus is associated with LNSG. As yet, there is no evidence of a cause-effect relationship for two additional vitiviruses recently found in vines showing either stem pitting (GVE) or a graft incompatibility condition (GVF) (Martelli 2014).

A breakthrough in rugose wood epidemiology came when GVA was experimentally transmitted by *Pseudococcus longispinus* (Rosciiglione et al. 1983). This represented the first evidence that pseudococcid mealybugs, till then known as DNA virus vectors, were able to transmit also RNA viruses. It was later ascertained that, the same as with closteroviruses, *Vitivirus* transmission is nonspecific and semi-persistent (La Notte et al. 1997).

Recognized vectors are the same as those reported for ampeloviruses, with which vitiviruses are often transmitted together: *Planococcus citri*, *Pl. ficus*, *Pseudococcus longispinus*, *Ps. affinis*, *Heliococcus bohemicus*, *Phenacoccus aceris*, and *Neopulvinaria innumerabilis* (GVA); *Ps. longispinus*, *Ps. affinis*, *Pl. ficus*, and *Ph. aceris* (GVB); *Pseudococcus comstocki* (GVE). The vector of GVD is still unknown, so is the vector of GRSPaV (Martelli 2014).

Vitiviruses and foveaviruses possess very flexuous filamentous particles with a morphology resembling that of closteroviruses, with which they may share a comparable evolutionary scenario (Martelli et al. 2007), the same as representatives of the genus *Trichovirus*. These latter viruses, however, are not involved in any of the rugose wood syndromes, but two different species, *Grapevine berry inner necrosis virus* (GINV) and *Grapevine pinot gris virus* (GPGV), which have eriophyid mite vectors, are pathogenic to grapevines (Giampetruzzi et al. 2012; Yoshikawa et al. 1997).

Rugose wood also appears to be an “Old World” disease based on the following evidence: (1) wood symptoms described in the French literature of the early twentieth century and (2) occurrence of the disease and some of the rugose wood-associated viruses in phylloxera-free countries like Cyprus, Armenia, Yemen, parts of southern Turkey, and some Aegean Greek islands where American rootstocks have not yet been introduced (Martelli et al. 1994).

Admittedly, this historical evidence is less substantiated than that gathered for infectious degeneration and leafroll, and it may apply only in part to GRSPaV, a definitive species of the genus *Foveavirus* and the most widespread of the rugose wood-associated viruses. In fact, GRSPaV is (1) nonmechanically transmissible, (2) may not be seed transmitted notwithstanding its presence in pollen grains and has no known vector, (3) may have evolved from an ancient recombination event between a *Carlavirus* and a *Potexvirus* (Meng and Gonsalves 2003), and (4) may have gained entrance in different *Vitis* species in the past, and, while adapting to

them, its genome has diverged, producing several groups of variants. Two of the four major groups of variants may be specific to *V. riparia* and *V. rupestris* (American species), whereas two other groups may be linked with *V. sylvestris* and, perhaps, *V. vinifera* (Old World species) (Meng and Gonsalves 2007; Meng and Rowhani, Chap. 12, this book).

Fleck

Fleck, a disease with a worldwide distribution, is latent in European grape cultivars and in most American rootstocks. Symptoms are expressed in *V. rupestris* and consist of clearing of the veins of third and fourth order resulting in localized translucent spots. Leaves with intense flecking are wrinkled, twisted, and may curl upward (Hewitt et al. 1962, 1972). The causal agent is *Grapevine fleck virus* (GFkV), the type species of the genus *Maculavirus* (Martelli et al. 2002). It has isometric particles with rounded contour and a prominent surface structure containing a single-stranded, positive-sense RNA genome (Boscia et al. 1991). These properties are shared by three additional viruses, i.e., *Grapevine asteroid mosaic-associated virus* (GAMaV), *Grapevine rupestris vein feathering virus* (GRVfV), and *Grapevine redglobe virus* (GRGV), which, together with GFkV, constitute the “fleck complex” (Martelli 2014).

Whereas historical data and other hints have allowed to hypothesize the geographical area of origin of the viruses involved in other disease complexes (infectious degeneration/decline, leafroll, and rugose wood), such exercise does not seem applicable to the agents of the fleck complex. However, one can speculate that the substantial latency of these viruses in European grape cultivars may be indicative of their longer-lasting association with *V. vinifera* than with *V. rupestris*, an American species.

The Emergence of a DNA Virus and Pararetroviruses

Notwithstanding the intensive studies conducted in the major viticultural areas of the world, no virus other than those with a RNA genome had been detected up to a few years ago, although it had been known for some time that the genome of a clone of cv. Pinot noir incorporated fragments of DNA sequences of six different pararetroviruses, mostly of the genus *Caulimovirus* (Bertsch et al. 2009). The breakthrough came when next-generation sequencing revealed that vines affected by vein clearing and decline in the Midwest region of the USA hosted a *Badnavirus* (family *Caulimoviridae*) denoted *Grapevine vein clearing virus* (GVCV) (Zhang et al. 2011). This was soon followed by the discovery of (1) a putative member of the family *Geminiviridae* (*Grapevine red blotch-associated virus*, GRBaV) in vines showing a patchy discoloration of the leaves (red blotch), first in the USA

(12 different States throughout the country) and Canada (Krenz et al. 2012; Al Rawhanh et al. 2013; Poojari et al. 2013; Sudarshana et al. 2015; Xiao et al. 2015) and then in Switzerland (Reynard and Gugerli 2015), and (2) another badnavirus (*Grapevine roditis leaf discoloration-associated virus*, GRLDaV) in Greek vines affected by a foliar discoloration (Maliogka et al. 2015) and in a symptomless wine grape from southern Italy (Chiumenti et al. 2015). Not much is known on the epidemiology of these viruses, except for the claim that GRBaV is transmitted by the Virginia creeper leafhopper (*Erythroneura ziczac*) (Poojari et al. 2013) and more recently by the three-cornered alfalfa treehopper (*Spissistilus festinus*) (Bahder et al. 2016). The latter vector is likely of epidemiological importance. In fact, there is circumstantial evidence that GRBaV is spreading, as shown by its detection in free-living *Vitis* species, e.g., *V. californica* x *V. vinifera* hybrids (Perry et al. 2016). There is also evidence of the detrimental impact of GRLDaV and GRBaV on infected vines (Rumbos and Avgelis 1989; Qiu et al. 2007; Reynard and Gugerli 2015; Sudarshana et al. 2015).

GVCV, GRBaV, and GRLDaV are three of the 85 novel plant viruses discovered up to mid-2015 using a metagenomic approach (Roossinck et al. 2015).

Viroids

Viroids are subviral pathogens endowed with autonomous replication in their hosts. They are made up of a non-encapsidated circular RNA of 246–375 nts, a size much smaller than that of the smallest viral genome. Like viruses, viroids are classified in families, genera, and species. Two families are known, *Pospiviroidae* and *Avsunviroidae*, whose discriminating traits are the presence of a central conserved region in the secondary structure and nuclear replication (*Pospiviroidae*) or a branched secondary structure lacking the central conserved region, presence of ribozymes, and plastidial replication (*Avsunviroidae*). Until recently, five grapevine-infecting viroids were known, all belonging to the family *Pospiviroidae*: *Grapevine yellow speckle viroid 1* (GYSVd-1), *Grapevine yellow speckle viroid 2* (GYSVd-2), *Australian grapevine viroid* (AGVd), *Hop stunt viroid* (HSVd), and *Citrus exocortis viroid* (CEVd) (Little and Rezaian 2003). Latest additions to the grapevine viroid list are *Grapevine latent viroid* (GLVd) (Zhang et al. 2014) and a viroid-like RNA sharing structural features with members of the family *Avsunviroidae*, whose biological role in grapevines is yet to be ascertained (Wu et al. 2012). Only GYSVd-1 and GYSVd-2 are pathogenic to grapevines inducing a disease called yellow speckle (Taylor and Woodham 1972). Another disease known as “vein banding” (Goheen and Hewitt 1962) was proven to result from a mixed infection by these viroids and GFLV (Krake and Woodham 1983; Hajizaeh et al. 2015).

Detailed accounts on the major grapevine viruses, their relationship to the different diseases, their economic impact on the grape and wine industry, as well as their epidemiology, diagnosis, and control strategies are provided in this book in the individual chapters that follow. It is important to note that the situation with viruses,

viroids, and the diseases they cause in grapevine is often complex, due in part to the large number of viruses and their wide range of genetic variants present in mixed infections, as well as to the combination of scion cultivars and rootstock genotypes in a finished vine used in commercial production.

References

- Aboughanem-Sabanadzovic, N., and S. Sabanadzovic. 2015. First report of *Grapevine leafroll-associated virus 2* infecting muscadine (*Vitis rotundifolia*) and summer grape (*Vitis aestivalis*) in the United States. *Plant Disease* 99: 163.
- Al Rawhani, M., A. Dave, M. Anderson, A. Rowhani, J.K. Uyemoto, and M. Sudarshana. 2013. Association of a DNA virus with grapevine affected by Red blotch disease in California. *Phytopathology* 103: 1069–1076.
- Alkowni, R., Y.P. Zhang, A. Rowhani, J.K. Uyemoto, and A. Minafra. 2011. Biological, molecular and serological studies of a novel strain of grapevine leafroll-associated virus 2. *Virus Genes* 43: 102–110.
- Almeida, R.P.P., K. Daane, V. Bell, K. Blaisdell, M. Cooper, E. Herrbach, and G. Pietersen. 2013. Ecology and management of grapevine leafroll disease. *Frontiers in Microbiology* 4: 94. doi:10.3389/fmicb.2013.00094.
- Arroyo-Garcia, R., L. Garcia, L. Bolling, R. Ocete, M.A. Lopez, C. Arnold, A. Ergul, G. Soylemezo Lu, H.I. Uzun, F. Cabello, J. Ibañez, M.K. Aradhya, A. Atanassov, I. Atanassov, S. Balint, J.L. Cenis, L. Costantini, S. Gorislavets, M.S. Grando, B.Y. Klein, P.E. Mcgovern, D. Merdinoglu, J. Pejic, F. Pelsy, M. Primikiri, V. Risovannaya, K.A. Roubelakis-Angelakis, H. Snoussi, P. Sotiri, S. Tamhankar, P. This, L. Troshin, J.M. Malpica, F. Lefor, and J.M. Martinez-Zapater. 2006. Multiple origins of cultivated grapevine (*Vitis vinifera* L. ssp. *sativa*) based on chloroplast DNA polymorphisms. *Molecular Ecology* 15: 3707–3714.
- Baccarini, P. 1902. Roncet. *Viticoltura Moderna* 8: 241–248.
- Bahder, B., F. Zalom, M. Jayanthi, and M. Sudarshana. 2016. Phylogeny of geminivirus coat protein sequences and digital PCR aid in identifying *Spissistilus festinus* (Say) as a vector of Grapevine red blotch-associated virus. *Phytopathology* 106 <http://dx.doi.org/10.1094/PHYTO-03-16-0125-FI>.
- Bertsch, C., M. Beuve, V.V. Dolja, M. Wirth, F. Pelsy, E. Herrbach, and O. Lemaire. 2009. Retention of the virus-derived sequences in the nuclear genome of grapevine as a potential pathway to virus resistance. *Biology Direct* 4: 21.
- Bonavia, M., M. Digiario, D. Boscia, A. Boari, G. Bottalico, V. Savino, and G.P. Martelli. 1996. Studies on “corky rugose wood” of grapevine and the diagnosis of grapevine virus B. *Vitis* 35: 53–48.
- Boscia, D., G.P. Martelli, V. Savino, and M.A. Castellano. 1991. Identification of the agent of grapevine fleck disease. *Vitis* 30: 97–105.
- Boscia, D., C. Greif, P. Gugerli, G.P. Martelli, B. Walter, and D. Gonsalves. 1995. Nomenclature of grapevine leafroll-associated putative closteroviruses. *Vitis* 34: 171–175.
- Bovey, R., and P. Gugerli. 2003. A short history of ICGV. In *Extended abstracts 14th meeting of ICGV*, Locorotondo, Italy, 1–2.
- Cadman, C.H., H.F. Dias, and B.D. Harrison. 1960. Sap-transmissible viruses associated with diseases of grape vines in Europe and North America. *Nature (London)* 187: 577–579.
- Cazalis-Allut, L.C. 1865. De la dégénération des vignes. *Ouvres Agricoles*: 57–61.
- Chiumenti, M., M. Morelli, A. Giampetruzzi, F. Palmisano, V.N. Savino, P. La Notte, G.P. Martelli, and P. Saldarelli. 2015. First report of Roditis leaf discoloration-associated virus in Italy. *Journal of Plant Pathology* 97: 551.

- Cholin, J.J. 1896. Beobachtungen über die “Reisigkrankheit” der Reben an Ahr. *Mitteilung über Weinbau und Kellerwirtschaft* 8: 63–64.
- Conti, M., R.G. Milne, E. Luisoni, and G. Boccardo. 1980. A closterovirus from a stem pitting-diseased grapevine. *Phytopathology* 70: 394–399.
- Digiario, M., E. Yahyaoui, G.P. Martelli, and T. Elbeaino. 2015. The sequencing of the complete genome of a *Tomato black ring virus* (TBRV) and of RNA2 of three *Grapevine chrome mosaic virus* (GCMV) isolates from grapevine reveals the possible recombinant origin of GCMV. *Virus Genes* 50: 165–171.
- Dimitrijevic, B. 1973. Some observations on the natural spread of grepevine leafroll disease in Yugoslavia. *Rivista di Patologia Vegetale* 9 (S.IV. Supplement): 114–119.
- Dolja, V.V., J.F. Kreuze, and J.P.T. Valkonen. 2006. Comparative and functional genomics of closteroviruses. *Virus Research* 117: 38–51.
- Elbeaino, T., M. Digiario, S. Ghebremeskel, and G.P. Martelli. 2012. Grapevine deformation virus: Completion of the sequence and evidence on its origin from recombination events between *Grapevine fanleaf virus* and *Arabis mosaic virus*. *Virus Research* 166: 136–140.
- Elbeaino, T., H. Kiyi, R. Boutarfa, A. Minafra, G.P. Martelli, and M. Digiario. 2014. Phylogenetic analysis of the homing protein domain of Grapevine fanleaf virus (GFLV) isolates associated with “yellow mosaic” and “infectious malformation” syndromes in grapevines. *Archives of Virology* 159: 2757–2764.
- Garau, R., V.A. Prota, R. Piredda, D. Boscia, and U. Prota. 1994. On the possible relationship between Kober stem grooving and Grapevine virus A. *Vitis* 33: 161–163.
- Giampetruzzi, A., V. Roumi, R. Roberto, U. Malossini, N. Yoshikawa, P. La Notte, F. Terlizzi, R. Credi, and P. Saldarelli. 2012. A new grapevine virus discovered by deep sequencing of virus- and viroid-derived small RNAs in cv Pinot gris. *Virus Research* 163: 262–268.
- Goheen, A.C., and W.B. Hewitt. 1962. Vein banding, a new virus disease of grapevines. *American Journal of Enology and Viticulture* 13: 73–77.
- Goheen, A.C., F.N. Harmon, and J.H. Weinberger. 1958. Leafroll (white Emperor disease) of grapes in California. *Phytopathology* 48: 51–54.
- Graniti, A., and G.P. Martelli. 1965. Further investigations on legno riccio (rugose wood), a graft-transmissible stem-pitting of grapevine. In *Proceedings international conference on virus and vector on perennial hosts with special reference to vitis*, Davis, USA, 168–179.
- Gugerli, P., J.J. Brugger, and R. Bovey. 1984. L’enroulement de la vigne: mise en évidence de particules virales et développement d’une méthode immuno-enzymatique pour le diagnostic rapide. *Revue Suisse de Viticulture, d’Arboriculture et d’Horticulture* 16: 299–304.
- Hajizae, M., E.M. Torchetti, N.S. Bashir, B. Navarro, H. Doulati-baneh, G.P. Martelli, and F. Di Serio. 2015. Grapevine vein banding in North-West Iran. In *Proceedings 18th congress of ICVG*, Ankara, Turkey, 86–87.
- Harmon, F.N., and E. Snyder. 1946. Investigations of the occurrence, transmission, spread, and effect of “white” fruit color in the Emperor grape. *Proceedings of the American Society of Horticultural Science* 47: 190–194.
- Hewitt, W.B. 1954. Some virus and virus-like diseases of grapevines. *Bulletin of the California Department of Agriculture* 43: 47–64.
- . 1968. Viruses and virus diseases of grapevine. *Review of Applied Mycology* 47: 433–455.
- Hewitt, W.B., D.J. Raski, and A.C. Goheen. 1958. Nematode vector of soil-borne fanleaf virus of grapevines. *Phytopathology* 48: 586–595.
- Hewitt, W.B., A.C. Goheen, D.J. Raski, and G.V. Gooding Jr. 1962. Studies on virus diseases of the grapevine in California. *Vitis* 3: 57–83.
- Hewitt, W.B., A.C. Goheen, L. Cory, and C. Luhn. 1972. Grapevine fleck disease, latent in many varieties, is transmitted by graft inoculation. *Annales de Phytopathologie*, No. hors série, 43–47.
- Klaassen, V.A., S.T. Sim, G.S. Dangel, F. Osman, M. Al Rwhanih, A. Rowhani, and D.A. Golino. 2011. *Vitis californica* and *Vitis californica* x *Vitis vinifera* hybrids are hosts for *Grapevine leafroll-associated virus 2* and *-3* and *Grapevine virus A* and *B*. *Plant Disease* 65: 657–665.

- Krake, L.R., and R.C. Woodham. 1983. Grapevine yellow speckle agent implicated in the aetiology of vein banding disease. *Vitis* 22: 40–50.
- Krenz, B., J.R. Thompson, M. Fuchs, and K.L. Perry. 2012. Complete genome sequence of a new circular DNA virus from grapevine. *Journal of Virology* 86: 7715.
- Krügler, K., D. Saccaggi, N. Douglas. 2006. Grapevine leafroll-associated virus 3-vector interactions: Transmission by the mealybugs *Planococcus ficus* and *Pseudococcus longispinus* (Hemiptera:Pseudococcidae). In *Extended abstracts 15th meeting of ICVG, Stellenbosch, South Africa*, 130–131.
- La Notte, P., N. Buzkan, E. Choueiri, A. Minafra, and G.P. Martelli. 1997. Acquisition and transmission of *Grapevine virus A* by the mealybug *Pseudococcus longispinus*. *Journal of Plant Pathology* 79: 79–85.
- Little, A., and M.A. Rezaian. 2003. Grapevine viroids. In *Viroids*, ed. A. Hadidi, R. Flores, J.W. Randles, and J.S. Semancik, 195–206. Collingwood: CSIRO Publishing.
- Luhn, C.F., and A.C. Goheen. 1970. Viruses in early California grapevines. *Plant Disease Report* 54: 1055–1056.
- Maliogka, V.I., A. Olmos, P.G. Pappi, L. Lotos, K. Efthimiou, G. Grammatikaki, T. Candresse, N.I. Katis, and A.D. Avgelis. 2015. A novel grapevine badnavirus is associated with Roditis leaf discoloration disease. *Virus Research* 203: 47–55.
- Martelli, G.P. 2014. Directory of virus and virus-like diseases of the grapevine and their agents. *Journal of Plant Pathology* 96 (1S): 1–136.
- Martelli, G.P., and W. Jelkmann. 1998. *Foveavirus*, a new plant virus genus. *Archives of Virology* 142: 1245–1249.
- Martelli, G.P., and G. Piro. 1975. Virus diseases of the grapevine in a Sicilian herbarium of the past century. *Vitis* 13: 329–335.
- Martelli, G.P., and C.E. Taylor. 1990. Distribution of viruses and their nematode vectors. *Advances in Disease Vector Research* 6: 151–189.
- Martelli, G.P., and J.K. Uyemoto. 2011. Nematode-borne viruses of stone fruits. In *Virus and virus-like diseases of pome and stone fruits*, ed. A. Hadidi, M. Barba, T. Candresse, and W. Jelkmann, 161–170. St. Paul: APS Press.
- Martelli, G.P., J. Lehoczky, A. Quacquarelli, and G. Sarospataki. 1967. A disorder resembling “legno riccio” (rugose wood) of grapevine in Hungary. *Phytopathologia Mediterranea* 6: 110–112.
- Martelli, G.P., D. Boscia, E. Choueiri, M. Digiario, M.A. Castellano, and V. Savino. 1994. Occurrence of filamentous viruses and rugose wood of grapevine in Yemen. *Phytopathologia Mediterranea* 33: 146–151.
- Martelli, G.P., A. Minafra, and P. Saldarelli. 1997. *Vitivirus*, a new genus of plant viruses. *Archives of Virology* 142: 1929–1932.
- Martelli, G.P., S. Sabanadzovic, N. Abou Ghanem-Sabanadzovic, and P. Saldarelli. 2002. *Maculavirus*, a new genus of plant viruses. *Archives of Virology* 147: 1847–1853.
- Martelli, G.P., M.J. Adams, J.F. Kreuze, and V.V. Dolja. 2007. Family *Flexiviridae*: A case study in virion and genome plasticity. *Annual Review of Phytopathology* 45: 73–100.
- Martelli, G.P., A.A. Agranovsky, M. Bar-Joseph, D. Boscia, T. Candresse, R.H.A. Coutts, V.V. Dolja, B.W. Falk, D. Gonsalves, W. Jelkmann, A.V. Karasev, A. Minafra, S. Namba, H.J. Vetten, G.C. Wisler, and N. Yoshikawa. 2012. The family *Closteroviridae* revised. *Archives of Virology* 147: 2039–2043.
- Mendgen, K. 1971. Untersuchungen über eine Vergilbungskrankheit der Reben an Rhein, Mosel und Saar. *Weinberg und Keller* 18: 345–431.
- Meng, B., and D. Gonsalves. 2003. Rupestris stem pitting-associated virus of grapevines: Genome structure, genetic diversity, detection, and phylogenetic relationship to other plant viruses. *Current Topics in Virology* 3: 125–135.
- . 2007. *Grapevine rupestris stem pitting-associated virus: A decade of research and future perspectives*, Plant Viruses. Vol. 1, 52–62. Japan: Global Science.

- Meng, B., S.Z. Pang, P.L. Forsline, J.R. McFerson, and D. Gonsalves. 1998. Nucleotide sequence and genome structure of Grapevine rupestris stem pitting-associated virus 1 reveal similarities to Apple stem pitting virus. *Journal of General Virology* 79: 2059–2069.
- Meng, B., R. Johnson, S. Peressini, P.L. Forsline, and D. Gonsalves. 1999. Rupestris stem pitting-associated virus 1 is consistently detected in vines that are infected with rupestris stem pitting. *European Journal of Plant Pathology* 105: 191–199.
- Meng, B., C. Li, D.E. Goszczynski, and D. Gonsalves. 2005. Genome sequences and structures of two biologically distinct strains of grapevine leafroll-associated virus 2 and sequence analysis. *Virus Genes* 31: 31–41.
- Milne, R.G., M. Conti, D.E. Leseemann, G. Stellmach, E. Tanne, and J. Cohen. 1984. Closterovirus-like particles of two types associated with diseased grapevines. *Phytopathologische Zeitschrift* 11: 360–368.
- Mojtahedi, H., D. Sturhan, A. Akhiani, and S. Barooti. 1980. *Xiphinema* species in Iranian vineyards. *Nematologia Mediterranea* 8: 165–170.
- Namba, S., S. Yamashita, Y. Doi, K. Yora, Y. Terai, and R. Yano. 1979. Grapevine leafroll virus, a possible member of closteroviruses. *Annals of the Phytopathological Society of Japan* 45: 497–502.
- Olivier, J.E., E. Vigne, and M. Fuchs. 2010. Genetic structure and molecular variability of Grapevine fanleaf virus populations. *Virus Research* 152: 30–40.
- Pantanelli, E. 1910. Influenza del terreno sullo sviluppo del ronchet od arricciamento della vite. *Rendiconti Regia Accademia dei Lincei* 19: 395–401.
- . 1917. Esperienze d'innesto con le viti arricciate. *Le Stazioni Sperimentali Agrarie Italiane* 50: 167–224.
- Perry, K.L., H. McLane, M.Z. Hyder, G.S. Dangl, J.R. Thompson, and M.F. Fuchs. 2016. Grapevine red blotch-associated virus is present in free-living *Vitis* spp. proximal to cultivated grapevines. *Phytopathology* 106: 663–670.
- Petri, L. 1918. Nuove vedute sulle cause dell'arricciamento delle vite. *Atti della Reale Accademia dei Lincei. Rendiconti* 27: 271–275.
- . 1929. Sulle cause dell'arricciamento della vite. *Bollettino della Regia Stazione di Patologia Vegetale, Roma* 9: 101–130.
- Pio Ribeiro, G., P. Saldarelli, N. Hong, B.Ch. Xiang, X.L. Zhang, G.P. Wang, and G.P. Martelli. 2004. First record of three grapevine viruses in the Chinese province of Sinkiang. *Journal of Plant Pathology* 86: 263–264.
- Poojari, S., O.J. Alabi, Y. Fofanov, and R.A. Naidu. 2013. A leafhopper-transmissible DNA virus with novel evolutionary lineage in the family *Geminiviridae* implicated in grapevine readleaf disease by next generation sequencing. *PloS One* 8: e64194.
- Qiu, W.P., J.D. Avery, and S. Lunden. 2007. Characterization of a severe virus-like disease in Chardonnay grapevines in Missouri. *Plant Health Progress*. doi:10.1094/PHP-2007-1119-01-BRc.
- Rathay, E. 1882. Die Gabler oder Zwiewipflereben. *Österreiches Botanische Zeitschrift* 32: 316–320.
- Reynard, J.S., and P. Gugerli. 2015. Effects of Grapevine red blotch-associated virus on vine physiology and fruit composition of field grown grapevine cv. Gamay. In *Proceedings 18th congress of ICVG*, Ankara, Turkey, 234–235.
- Roossinck, M.J., D.P. Martin, and P. Roumagnac. 2015. Plant virus metagenomics: Advances in virus discovery. *Phytopathology* 105: 716–727.
- Rosciglione, B., and P. Gugerli. 1989. Transmission of grapevine leafroll disease and an associated closterovirus to healthy grapevine by the mealybug *Planococcus ficus* Signoret. In *Proceedings 9th meeting of ICVG*, Kiryat Anavim, Israel, 67–69.
- Rosciglione, B., M.A. Castellano, G.P. Martelli, V. Savino, and G. Cannizzaro. 1983. Mealybug transmission of grapevine virus A. *Vitis* 22: 331–347.

- Rumbos, I.C., and A.D. Avgelis. 1989. Roditis leaf discoloration – A new virus disease of grapevine: Symptomatology and transmission to indicator plants. *Journal of Phytopathology* 125: 274–278.
- Savino, V., D. Boscia, and G.P. Martelli. 1987. Rugose wood complex of grapevine: Can grafting to *Vitis* indicators discriminate between diseases? In *Proceedings 9th meeting of ICVG*, Kiryat Anavim, Israel, 91–94.
- Scheu, G. 1936. *Mein Winzerbuch*. Berlin: Reichnährstand Verlag.
- Schiff-Giorgini, R. 1906. Il roncel delle viti americane in Sicilia. *Bollettino Ufficiale del Ministero dell'Agricoltura* 6: 971–979.
- Sudarshana, M.R., K.L. Perry, and M.F. Fuchs. 2015. Grapevine red blotch-associated virus, an emerging threat to the grapevine industry. *Phytopathology* 105: 10126–11032.
- Taylor, R.H., and R.C. Woodham. 1972. Grapevine yellow speckle – A newly recognized graft-transmissible disease of *Vitis*. *Australian Journal of Agricultural Research* 23: 447–452.
- Villate, L. 2008. Origin, variability and control of *Xiphinema index* populations. Ph.D. Thesis. Bio3P Joint Unit INRA, Rennes, France.
- Walker, M.A., and C.P. Meredith. 1990. The genetic of resistance to Grapevine fanleaf virus in *Vitis vinifera*. In *Proceedings 5th international symposium on grape breeding*, St. Martin/Pfalz, Germany, 228–238.
- Wu, Q., Y. Wang, M. Caob, V. Pantaleo, J. Burgyan, W.-X. Li, and S.-W. Ding. 2012. Homology-independent discovery of replicating pathogenic circular RNAs by deep sequencing and a new computational algorithm. *Proceedings of the National Academy of Sciences of the United States of America* 109: 3938–3943.
- Xiao, H., W.S. Kim, and B. Meng. 2015. Comparison and improvement of methodologies for isolation of quality RNA from diverse woody plant species and utilization in detection of viral pathogens. *Virology Journal* 12: 171.
- Yoshikawa, N., H. Iida, S. Goto, H. Magome, T. Takahashi, and Y. Terai. 1997. Grapevine berry inner necrosis, a new trichovirus: Comparative studies with several known trichoviruses. *Archives of Virology* 142: 1351–1363A.
- Zhang, Y., K. Singh, R. Kaur, and W. Qiu. 2011. Association of a novel DNA virus with the grapevine vein-clearing and vine decline syndrome. *Phytopathology* 101: 1081–1090.
- Zhang, Z., S. Qi, N. Tang, X. Zhang, S. Chen, P. Zhu, M. Lin, J. Cheng, Y. Xu, M. Lu, H. Wang, S.-W. Ding, S. Li, and Q. Wu. 2014. Discovery of replicating circular RNAs by RNA-Seq and computational algorithms. *PLoS Pathogens* 10: e1004553. doi:[10.1371/journal.ppat.1004553](https://doi.org/10.1371/journal.ppat.1004553).

Chapter 3

Grapevine fanleaf virus and Other Old World Nepoviruses

M. Digiario, T. Elbeaino, and G.P. Martelli

Abstract Eleven of the 15 *Vitis*-infecting nepoviruses are thought to have an Old World origin, either Eurasian, i.e., *Grapevine fanleaf virus* (GFLV); European, i.e., *Arabis mosaic virus* (ArMV), *tomato black ring virus* (TBRV), *Grapevine chrome mosaic virus* (GCMV), *Grapevine Bulgarian latent virus* (GBLV), *raspberry ringspot virus* (RpRSV), *artichoke Italian latent virus* (AILV), and *cherry leaf roll virus* (CLRV); north African (Tunisia), i.e., *Grapevine Tunisian ringspot virus* (GTRSV); and Asiatic (Turkey and Iran), i.e., *Grapevine deformation virus* (GDeV) and *Grapevine Anatolian ringspot virus* (GARSV). Only four of these viruses (GFLV, ArMV, RpRSV, and TBRV) have ectoparasitic longidorid nematodes belonging to the genera *Xiphinema*, *Longidorus*, and *Paralongidorus* as recognized vectors. Whereas mechanical transfer to herbaceous indicators is readily achieved with all these viruses, their transmission through pollen and seeds is rare and does not seem to occur in grapevines. Some of these viruses (GFLV, GBLV, GCMV, GTRSV, GDeV, and GARSV) are apparently restricted to *Vitis*, while AILV, CLRV, RpRSV, and TBRV have a host range that includes woody and herbaceous crops, as well as weed species. All these viruses cause systemic, symptomatic infections in grapevines. Depending on the strains involved, infection with these viruses induces either chlorotic mottling and deformation of leaves and canes (by the distorting strains) or bright yellow discolorations of the leaves (by the chromogenic strains). Like all known nepoviruses, the grapevine-infecting ones from the Old World have a bipartite genome and require both genomic RNAs for infection. Planting selected stocks that have undergone sanitation and certification procedures in soils free of the nematode vectors should guarantee the sanitary conditions of new plantings for the lifespan of the vineyards. This is not the case for plantings in nematode-infested soils because removal of the roots from the previous stand and prolonged fallow period do not prevent the resurgence of the infection.

M. Digiario (✉) • T. Elbeaino
Mediterranean Agronomic Institute, Valenzano, BA, Italy
e-mail: digiario@iamb.it

G.P. Martelli
Department of Soil, Plant and Food Sciences, University of Bari Aldo Moro, Bari, Italy

Keywords Fanleaf • Yellow mosaic • Nematode vectors • *Xiphinema* • *Longidorus* • *Paralongidorus* • *Secoviridae* • *Nepovirus* • Bipartite RNA genome

Introduction

Of the 70 or so viruses infecting the grapevine (G.P. Martelli, Chap. 2, this book), those belonging to the genus *Nepovirus*, family *Secoviridae* (Sanfaçon et al. 2012) are among the most numerous and economically important. To date, at least 15 nepoviral species and one unassigned secovirid [(*strawberry latent ringspot virus* (SLRSV))] have been found in *Vitis* spp. in different areas of the world. *Grapevine fanleaf virus* (GFLV) is by far the most important of these viruses because of its widespread occurrence and economic impact. By contrast, all the other nepoviruses are confined to more restricted areas and, on a geographical basis, can be grouped into European species, i.e., *Arabid mosaic virus* (ArMV), *tomato black ring virus* (TBRV), *Grapevine chrome mosaic virus* (GCMV), *Grapevine Bulgarian latent virus* (GBLV), *raspberry ringspot virus* (RpRSV), *artichoke Italian latent virus* (AILV), and *cherry leaf roll virus* (CLR), and American species, i.e., *tomato ringspot virus* (ToRSV), *tobacco ringspot virus* (TRSV), *blueberry leaf mottle virus* (BLMoV), and *peach rosette mosaic virus* (PRMV). Additional nepoviruses have been recorded from North Africa (Tunisia), i.e., *Grapevine Tunisian ringspot virus* (GTRSV) (Ouertani et al. 1992), and Asia (Turkey and Iran), i.e., *Grapevine deformation virus* (GDeV) and *Grapevine Anatolian ringspot virus* (GARSV) (Digiario et al. 2003; Hajizadeh et al. 2012).

In general, grapevine-infecting nepoviruses have a broad natural host range that includes annual and perennial woody and herbaceous species, with few exceptions, as for GFLV, whose host range is narrow (Martelli 2014).

Nepoviruses have non-enveloped polyhedral particles 28–30 nm in diameter, with a capsid made of a single protein (CP) of 52–60 kDa in size, which sediment as three components (T, M, and B). Component T is made up of empty protein shells, whereas components M and B contain the viral RNAs. The genome is composed of two single-stranded, positive-sense RNAs (RNA-1 and RNA-2) with Mr $2.4\text{--}2.8 \times 10^6$ Da and $1.3\text{--}2.4 \times 10^6$ Da, respectively (Mayo and Robinson 1996). Both RNA molecules have a poly(A) tail at the 3' end, and a VPg of Mr $3\text{--}6 \times 10^3$ Da is covalently linked to the 5' end (Pinck et al. 1991). Based on the size of RNA-2 and its arrangement in virus particles, the nepoviruses are subdivided in three subgroups: (1) subgroup A, typified by *tobacco ringspot virus* (TRSV), has an RNA-2 of Mr $1.3\text{--}1.5 \times 10^6$ present in both M and B components; (2) subgroup B, typified by *tomato black ring virus* (TBRV), has an RNA-2 of Mr $1.4\text{--}1.6 \times 10^6$, encapsidated only in the M component; and (3) subgroup C, typified by *tomato ringspot virus* (ToRSV), has a RNA-2 of Mr $1.9\text{--}2.2 \times 10^6$, present only in the M component which sediments nearly at the same rate of the B component (Le Gall et al. 2005;

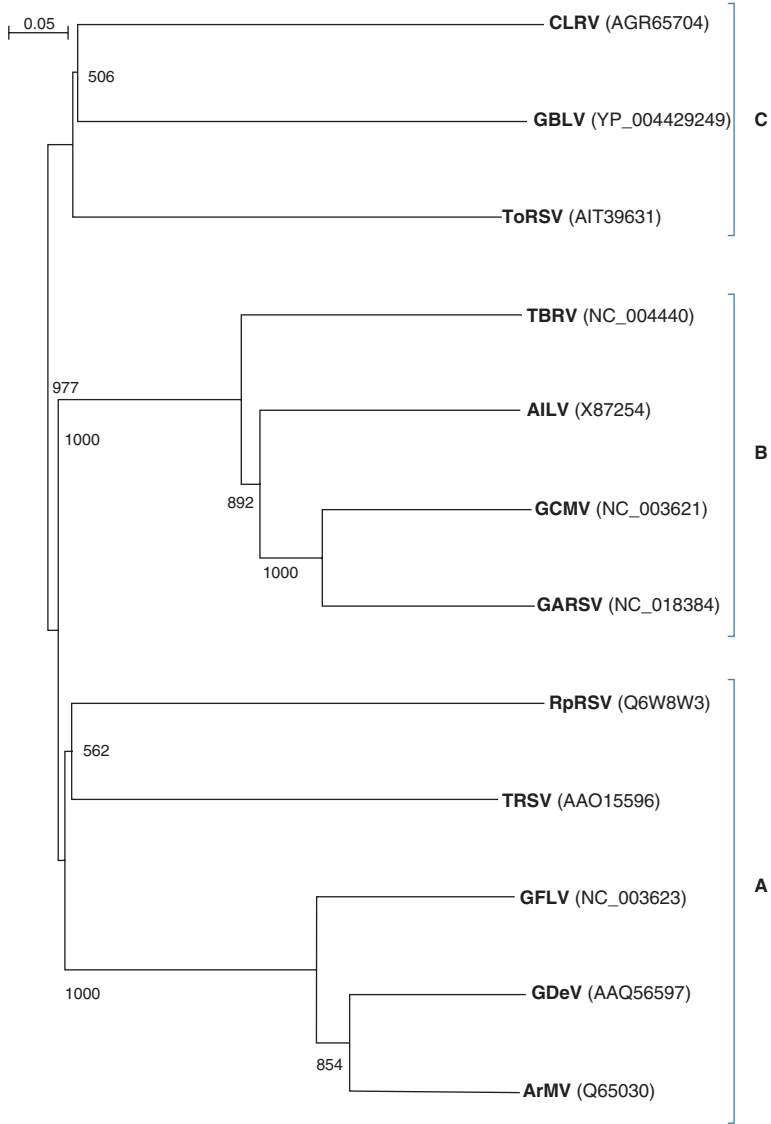

Fig. 3.1 Phylogenetic tree generated using the amino acid sequence of the coat protein of grapevine-infecting nepoviruses belonging to subgroups A, B, and C. GenBank accession numbers of the sequences used are shown within brackets. Bootstrap values are shown at branch nodes

Sanfaçon et al. 2012). The same grouping of nepoviruses is obtained in phylogenetic trees derived from CP sequences (Fig. 3.1).

Both RNA-1 and RNA-2 have a single ORF coding for a polypeptide (P1 and P2, respectively). P1 is cleaved by the viral proteinase into five individual proteins, i.e., proteinase cofactor (co-Pro), helicase (Hel), genome-linked protein (VPg),

proteinase (Pro), and RNA-dependent RNA polymerase (Pol) (Pinck et al. 1991; Ritzenthaler et al. 1991; Margis et al. 1994), while RNA-2 is cleaved into three individual mature products, i.e., homing protein (HP), which is required for RNA-2 replication, movement protein (MP), and coat protein (CP) (Serghini et al. 1990; Margis et al. 1993; Gaire et al. 1999). A sixth viral protein of unknown function occurs in the N-terminal region of RNA-1, as highlighted in ToRSV and ArMV (Zhang and Sanfaçon 2006; Sanfaçon et al. 2012; Hull 2014), and a fourth protein of unknown function is identified at the N-terminal region of ToRSV RNA-2 (Carrier et al. 2001). Noncoding regions (NCRs) of different length and unknown function are present at the 5' and 3' ends of both RNAs. In several nepovirus species, the 3' termini (and in some cases also the 5' termini) of the two RNAs display considerable sequence homology (Dodd and Robinson 1987; Rott et al. 1991; Scott et al. 1992; Ritzenthaler et al. 1991; Bacher et al. 1994), or complete identity, as in the case of the entire 3'NCR of RNAs 1 and 2 of TBRV (Greif et al. 1988), GCMV (Le Gall et al. 1989), CLRV (Scott et al. 1992), and GBLV (Elbeaino et al. 2011). Extensive reviews of the biological, epidemiological, physicochemical, and molecular characteristics of nepoviruses (Martelli and Taylor 1990; Harrison and Murrant 1996; Taylor and Brown 1997; Sanfaçon 2008) and their satellite RNAs (Mayo et al. 2000) are available.

Strawberry latent ringspot virus (SLRSV), a nematode-borne virus originally classified as a tentative species in the genus *Nepovirus*, then in the newly established genus *Sadwavirus* (Le Gall et al. 2005), is currently placed in the family *Secoviridae* as an unassigned species (Sanfaçon et al. 2012).

GFLV and several other European nepoviruses cause degenerative diseases whose symptoms resemble those of fanleaf. Indeed, some of these viruses can have distorting and chromogenic strains, often occurring in mixed infections. Their economic impact varies with the tolerance of the cultivar to the individual viruses/strains. Susceptible cultivars can be severely affected, showing progressive decline of the vines, low yields and low fruit quality, shortened productive life, and decreased resistance to adverse climatic factors.

Alterations resembling typical fanleaf symptoms were already described on grapevine in the second half of the nineteenth century in different European countries. Graft transmission of the disease provided evidence for its infectious nature, while the patchy distribution in the field and the observation that no infection occurred when the soil was heated at 120 °C suggested that it was likely a soilborne disorder; thus the viral origin of the disease was hypothesized (Martelli, Chap. 2, this book). In the mid-1950s, studies carried out in California (Hewitt 1954) revealed that grapevines could host a number of different virus and virus-like diseases and that fanleaf was indeed a soilborne disease transmitted by the longidorid nematode *Xiphinema index* (Hewitt et al. 1958), whose putative agent was a mechanically transmissible nepovirus (Cadman et al. 1960).

Transmission through nematodes is a common feature of numerous grapevine-infecting nepoviruses and of SLRV. Transmission is of “semipersistent” and “non-circulative” type and is characterized by a high specific virus/vector relationship (Taylor and Brown 1997).

Diagnosis of nepoviruses is relatively easy as they are readily transmitted to herbaceous hosts and obtained in purified form for the production of antisera. Serological (ELISA and ISEM) and molecular assays (hybridization, RT-PCR) are routinely used for their detection in grapevine tissues (primarily cortical scrapings from dormant canes) (Rowhani et al. 2005). Indexing on *Vitis* indicators can also be used. These viruses are readily eliminated by heat therapy or in vitro meristem tip culture (Golino et al., Chap. 27, this book).

Infectious Degeneration or Fanleaf (*Grapevine fanleaf virus*, GFLV)

Fanleaf is the oldest known and one of the most important and widespread virus diseases of the grapevine. Records on its presence in Europe date back some 150 years, before the introduction of American *Vitis* species used as rootstocks. The consensus is that fanleaf degeneration may have existed in the Mediterranean basin and the Near East since the earliest time of grape cultivation and that the region between the Black sea and Iran is its probable cradle of origin (G.P. Martelli, Chap. 2, this book). Today it occurs wherever the grapevine is grown.

Fanleaf disease is characterized by the presence of two distinct syndromes, i.e., infectious malformations and yellow mosaic, which are caused, respectively, by distorting and chromogenic strains of GFLV.

Infectious malformations (Fig. 3.2a–c): Leaves can be more or less severely malformed, asymmetrical, puckered, and with open petiolar sinuses, deep lobes, and acute denticulations and may show chlorotic mottling. Shoots are also malformed, showing abnormal branching, double nodes, short internodes, fasciations, and zigzag growth. Bunches are smaller and fewer than normal, and berries ripen irregularly, are small-sized and set poorly. Foliar symptoms appear early in the spring and persist throughout the vegetative season, although some masking may occur in summer.

Yellow mosaic (Fig. 3.2d, e): Chrome yellow discolorations appear early in the spring and may affect all vegetative parts (leaves, shoots, tendrils) and inflorescences. Chromatic alterations of the leaves vary from a few scattered yellow spots, sometimes in the form of rings or lines, to extensive mottling of the interveinal areas, to total yellowing. The foliage and shoots show little, if any, malformation, but bunches are small and few. With increased ambient temperatures during summer, the yellowing fades away and the canopy develops a normal green color.

Vein banding is a third syndrome associated with GFLV presence. Symptoms consist of chrome yellow flecks along the main veins of mature leaves that then invade the interveinal areas (Fig. 3.2f). Contrary to the first two syndromes, this kind of discoloration appears in mid to late summer in a limited number of leaves with little or no malformation. Fruit set is poor, bunches are straggly, and the

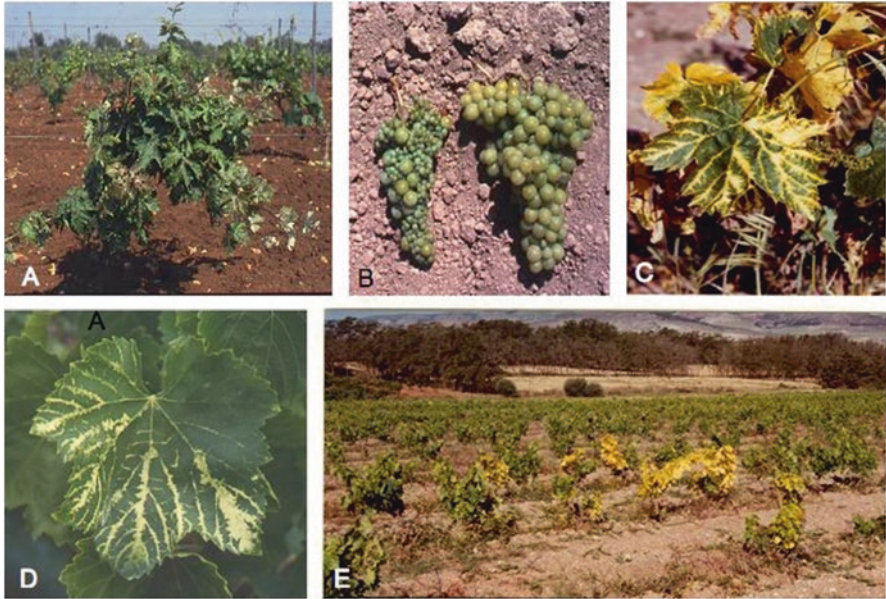

Fig. 3.2 (a) Symptomatic vine infected by a distorting strain of *Grapevine fanleaf virus* (GFLV). (b) Table grape bunches from a GFLV-infected (*left*) and a healthy (*right*) vine. (c) Leaves from a vine infected by a chromogenic strain of GFLV. (d) Vein banding, a syndrome induced by a double infection by GFLV and grapevine yellow speckle viroids. (e) Group of yellow mosaic-affected vines in a soil contaminated by *Xiphinema index*

yield may be much reduced. This disorder was first described in California and attributed to a specific GFLV strain (Hewitt et al. 1962). More recently, however, the vein banding condition has been shown to be caused by a coinfection of GFLV with grapevine yellow speckle viroids (Krake and Woodham 1983; Szychowski et al. 1995).

Agent

Grapevine fanleaf virus (GFLV) was the first grapevine virus to be recovered by mechanical inoculation (Cadman et al. 1960) and to be thoroughly characterized physicochemically and molecularly. GFLV is a nepovirus with polyhedral particles of about 30 nm in diameter (Fig. 3.3a), serologically very homogenous, and occurring as a family of minor molecular variants. It has a bipartite genome composed of two positive-sense, single-stranded RNA molecules of Mr 2.4×10^6 Da and a size of 7326–7342 nt (RNA-1) and 1.4×10^6 Da and a size of 3730–3817 nt (RNA-2). Both RNAs are required for infectivity and are encapsidated in different particles.

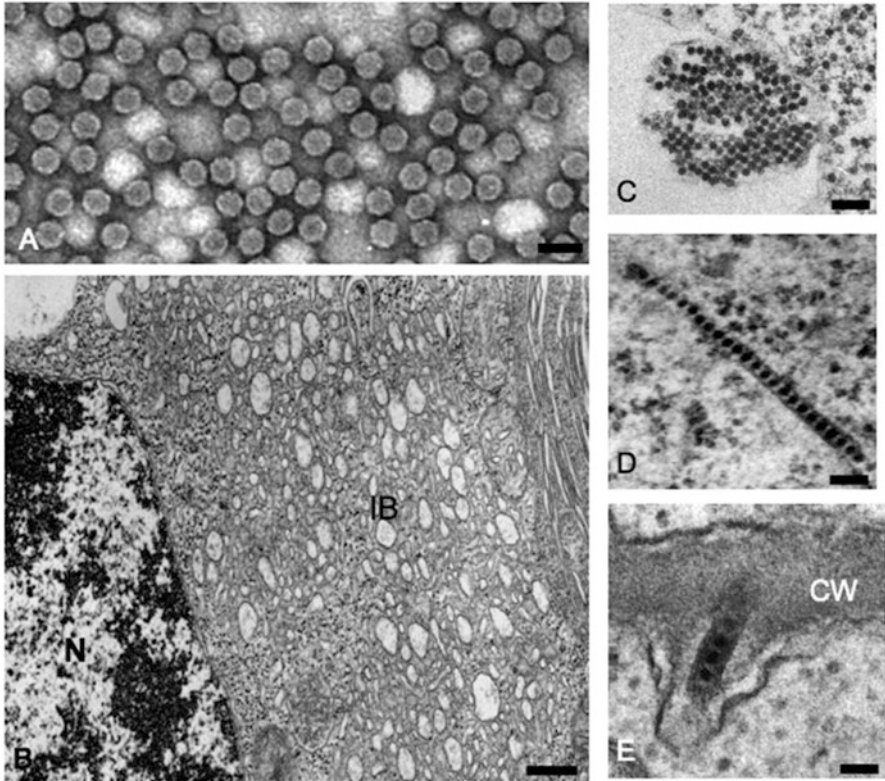

Fig. 3.3. (a) GFLV particles from a purified unfractionated virus preparation (Bar = 50 nm). (b) Vacuolate-vesiculate inclusion body (IB) next to a nucleus (N) in a GFLV-infected cell (Bar = 250 nm). (c) A small crystalline aggregate of virus particles in a cell vacuole (Bar = 100 nm). (d) Tubular structure containing a row of virions in the ground cytoplasm of an infected cell (Bar = 100 nm). (e) A virus-containing tubule embedded in a cell wall (CW) extrusion, a common feature of nepovirus-infected cells (Bar = 100 nm)

RNA species are translated into polypeptides of Mr 253 kDa (RNA-1) and 122 kDa (RNA-2), respectively. These polypeptides are cleaved by an RNA-1-encoded protease. The primary structure of the RNA-1-encoded polyprotein (P1) comprises a putative RNA-dependent RNA polymerase (92 kDa) at the N-terminus, followed by a cysteine protease (25 kDa), the genome-linked protein (3 kDa), a 88 kDa protein containing the signature of a nucleotide-binding domain and a protease cofactor, and a C-terminal protein 46 kDa in size (Margis et al. 1991, 1994; Pinck et al. 1991, Pinck 1998; Ritzenthaler et al. 1991). RNA-2 codes for the homing protein (28 kDa) implicated in RNA-2 replication, the movement protein (38 kDa), and the coat protein (56 kDa) (Serghini et al. 1990; Margis et al. 1993; Ritzenthaler et al. 1995).

Reports on the extensive genetic variability of GFLV genome sequences (Vigne et al. 2004a; Pompe-Novak et al. 2007; Liebenberg et al. 2009; Oliver et al. 2010; Zarghani et al. 2013; Elbeaino et al. 2014) are consistent with the notion of

quasispecies (Naraghi-Arani et al. 2001). The tendency to variation, however, is not the same in different genomic areas. Comparisons of RNA-2 sequences revealed that the region encoding the HP is genetically less conserved than the MP and the CP and has a variable size (765 ÷ 774 nt) and a high nucleotide diversity (33% vs. 22% and 16% of MP and CP, respectively), as shown by the analysis of 42 isolates of different origins (Elbeaino et al. 2014). An intermediate level of nucleotide variability, and consequently of pressure in the selection constrains, is observed in gene 1E^{Pol} of RNA-1 (Oliver et al. 2010; Eichmeier et al. 2011).

RNA recombination, one of the mechanisms that drive genetic variation and evolution of plant viruses (Worobey and Holmes 1999), is very common in GFLV, as substantiated by the many cases of intraspecies (Naraghi-Arani et al. 2001; Vigne et al. 2004a; Pompe-Novak et al. 2007) and interspecies (Jawhar et al. 2009; Mekuria et al. 2009; Oliver et al. 2010; Vigne et al. 2008; Elbeaino et al. 2014) recombination events reported in the literature. In GFLV, recombination involves preferentially the 5'-proximal region and, more rarely, the 3'-terminal region of RNA-2, which comprises the CP cistron (Vigne et al. 2008; Zarghani et al. 2014). An exception is the case of GDeV, which apparently originated from interspecific recombination between GFLV and ArMV in the CP gene (Elbeaino et al. 2012). Recombination with ArMV in the HP gene has been detected in numerous virus isolates recovered from vines with yellow mosaic symptoms (Jawhar et al. 2009; Elbeaino et al. 2014).

A satellite RNA of the type B, 1104–1140 nt in size, excluding the poly(A) tail and encoding a 37 kDa protein, is associated with some GFLV isolates (e.g., F13 from France, SACH44 from South Africa, R2 and R6 from California) (Pinck et al. 1988; Fuchs et al. 1989; Lamprecht et al. 2013; Gottula et al. 2013). These satRNAs do not seem to interfere with virus virulence (Saldarelli et al. 1993) and may have originated from recombination between an ancestral subgroup A (GFLV, ArMV, and GDeV) nepovirus RNA and an unknown RNA sequence (Gottula et al. 2013).

Cytopathology

GFLV infections, like other grapevine-infecting nepoviruses, give rise to cytopathological modifications of three types: (1) vesiculate-vacuolate cytoplasmic inclusions which are often apposed to the nucleus (Fig. 3.3b), (2) tubules containing rows of virus particles (Fig. 3.3c), and (3) cell wall outgrowths (Fig. 3.3d). Crystalline aggregates of virus particles (Fig. 3.3e) can also be present in the cytoplasm or vacuole. As reviewed by Martelli and Russo (1984), the vesiculate-vacuolate inclusions are primarily made up of ribosomes, endoplasmic reticulum strands, and membranous vesicles containing a network of fine fibrils resembling nucleic acid strands. Scattered virions are usually located at their periphery. Vesicles are derived from cell membrane proliferation, reorganization, and redistribution and are thought to be sites of viral polyprotein processing and RNA replication, which was demonstrated to take place on endoplasmic reticulum-derived membranes (Ritzenthaler et al. 2002). Thus, these inclusions can be regarded as virus factories. Virus particles

are often present within tubular structures which contain the viral movement protein (Ritzenthaler et al. 1995) that accumulate in bundles in the cytoplasm or the nucleus. These virus-containing tubules are usually single-walled, except in the case of SLRSV where they are double-walled as the external wall is contiguous with endoplasmic reticulum strands. These tubule-virus complexes are thought to mediate the cell-to-cell transfer of virions. They float freely in the cytoplasm or can be embedded in part or totally in finger-like protrusions of the cell wall that arise at the level of plasmodesmata, whose development may be stimulated as a secondary cell reaction by the presence of the virus-containing tubules.

Endocellular cordons or “trabeculae” are abnormal straight cylindrical spool-like or ribbon-like structures of pectocellulosic nature that cross the cell lumen in different tissues and are especially outstanding in tracheids, where they occur in a radial orientation. Their presence is connected with GFLV infections (Petri 1913).

Varietal Susceptibility

In general, *V. vinifera* cultivars are susceptible, with variable levels of sensitivity. However, tolerance to infection is widespread in European grapes, and a high resistance level of the “host plant resistance” type was found in two accessions from Afghanistan and Iran (Walker et al. 1985; Walker and Meredith 1990; Lahogue and Boulard 1996). This resistance is controlled by two unlinked recessive genes. American rootstocks are susceptible and are generally very sensitive, although some like *Vitis labrusca* can be infected, but show few symptoms. *Muscadinia rotundifolia* (Boubals and Pistre 1978; Bouquet 1981; Meredith et al. 1982; Walker et al. 1985) and *Vitis munsoniana* (Staudt and Weischer 1992) are highly resistant to *X. index* feeding. *M. rotundifolia* can be infected by GFLV when graft-inoculated, but resists infection when the virus is transmitted by the nematode (Bouquet 1981). Resistance to *X. index* in *V. rupestris* x *M. rotundifolia* hybrids is thought to be controlled by a single dominant gene (Walker and Jin 2000). Certified virus-tested scions of cv. Cabernet Sauvignon grafted on *V. vinifera* x *M. rotundifolia* hybrid rootstocks (e.g., O36-16 and O43-43) became infected but showed no reduced crop yields throughout the 12-year duration for the field trial (Walker et al. 1994). The resistance to *X. index* derived from *Vitis arizonica* is largely controlled by the quantitative trait locus XiR1 (*X. index* Resistance 1). The genetic map of this locus has been reconstructed, and markers have been developed that can expedite breeding of resistant rootstocks (Hwang et al. 2010). However, none of the rootstocks that are highly resistant to *X. index* prevent replication of GFLV, nor do they prevent virus translocation to scions (Laimer et al. 2009).

Other Natural Hosts

Natural GFLV infections have been detected in some weeds in Hungary (*Aristolochia clematitis* and *Lagenaria siceraria*) and Iran (Bermuda grass, knotweed, raspberry, Johnson grass, *Melilotus* spp., and *Plantago lanceolata*) (Horváth et al. 1994; Izadpanah et al. 2003a, b; Zakiaghl et al. 2015). Infected weeds do not seem to have a significant role in the ecology and dissemination of this virus.

Diagnosis and Detection

Indexing by grafting on *Vitis* indicators takes time and field or greenhouse space, but it is still regarded as necessary for confirming freedom from virus infection in certification programs. Although almost all grapevine cultivars are more or less susceptible to GFLV, *V. rupestris* St George is normally used as an indicator plant of fanleaf in biological indexing (Hewitt et al. 1962; Martelli 1993). The effects of graft transmission can be visible within 3–4 weeks, when the tested plants are maintained in the greenhouse, and within 1 year in the open field. Symptoms of infected *V. rupestris* St. George in greenhouse consist of chlorotic spots, rings, and lines, sometimes accompanied by malformations and localized necrosis in the tissues. In the field, various patterns of yellow discoloration, sometimes accompanied by leaf deformity, appear in the presence of chromogenic strains, while reduced growth, deformation, and acute denticulation of the leaves are exhibited when the infection is elicited by distorting virus strains.

The herbaceous host range of GFLV is fairly wide, comprising some 50 species from seven families of dicotyledonous plants (Dias 1963; Martelli and Hewitt 1963; Taylor and Hewitt 1964). The most important differential diagnostic hosts are *Chenopodium quinoa* and *C. amaranticolor*, both reacting with occasional chlorotic/necrotic local lesions 7–10 days post-inoculation, followed by systemic vein clearing, mottling, and deformation of the leaves; *Gomphrena globosa*, which exhibits chlorotic local lesion turning reddish with age and light green to yellow spots and twisting of systemically invaded upper leaves; and *Nicotiana occidentalis* which induces local chlorotic/necrotic lesions within 6–8 days post-inoculation and vein clearing and deformation on systemically invaded leaves.

GFLV was one of the first grapevine viruses whose detection benefited from the advent of ELISA (Walter et al. 1979; Bovey et al. 1980; Rowhani 1992), which helped answer questions such as the role of nematodes (Bouquet 1983; Catalano et al. 1991; Esmanjaud et al. 1992), pollen (Katsirdakis et al. 1989), and seeds (Lazar et al. 1990) in its transmission. Whereas monoclonal antibodies can discriminate virus strains (Huss et al. 1987), antibody cocktails have been used in ELISA to detect the presence of GFLV and other nepoviruses (mainly ArMV) in mixed infections (Etienne et al. 1991; Digiario et al. 2012b). The best antigen sources for

serological diagnosis are leaf tissues collected in spring or cortical shavings from mature dormant canes (Boscia et al. 1997).

Molecular assays using radioactive or digoxigenin-labeled probes (Fuchs et al. 1991; Gemmrich et al. 1993; Saldarelli et al. 1993), RT-PCR (Rowhani et al. 1993), immunocapture RT-PCR (Nolasco and De Sequeira 1993; Brandt and Himmler 1995), IC-RT-PCR with recombinant antibody (Koolivand et al. 2014), and real-time PCR (Rowhani et al. 2003; Bláhová and Pidra 2009; Cepin et al. 2010) are currently the most commonly used. In RT-PCR, primers were designed based on the MP gene (RNA-2) for the simultaneous detection of GFLV and ArMV (Wetzel et al. 2002) and on the CP gene for the simultaneous detection of GFLV, ArMV, GDeV, and TRSV (Digiario et al. 2007). GFLV has been detected in single nematodes by RT-PCR (Fresno et al. 1996; Demangeat et al. 2004) and immunosorbent electron microscopy (Roberts and Brown 1980).

Transmission

In a vineyard, GFLV is transmitted specifically in a noncirculative and semipersistent manner from grapevine to grapevine by the ectoparasitic longidorid nematode *Xiphinema index* feeding on the roots (Hewitt et al. 1958; Taylor and Brown 1997; Brown and Weischer 1998; MacFarlane et al. 2002). GFLV can be acquired from infected plants and inoculated to recipient plants within 1–10 min (Wyss 2000). GFLV does not replicate within the nematode (Das and Raski 1969), but its particles are retained for up to 8 months (Taylor and Raski 1964). In the absence of host plants, *X. index* can survive and retain GFLV for at least 4 years in vineyard soil stored at 7 or 20 °C (Demangeat et al. 2005). This study, however, did not ascertain whether the GFLV particles retained for such a long time by the nematodes were viable, nor if the potentially viruliferous nematodes were able to transmit the virus to bait plants (Demangeat et al. 2005).

There is no transovarial virus transmission (O’Bannon and Inserra 1990; Taylor and Raski 1964), and juveniles lose their ability to transmit the virus after molting because of the shedding of the cuticle lining of the odontophore and the pharynx, where GFLV particles are retained at specific sites (Taylor and Brown 1997; Decraemer and Geraert 2006). Therefore, after molting, the nematode must feed again on roots of GFLV-infected grapevines to acquire the virus and become viruliferous.

Specific transmission by *X. index* is determined by the viral coat protein (Belin et al. 2001; Andret-Link et al. 2004). In a study conducted by Schellenberger et al. (2010), a stretch of 11 conserved amino acids located in an exposed region of the CP was indicated as a putative site determining viral transmission. Further studies identified three determinants critical for virus transmissibility by *X. index* and proposed a viral pocket-like structure exposed on the surface of the virus particle as the “*Xiphinema* binding site” (XBP) (Belval et al. 2015).

The virus occurs in the pollen of infected grapevine and herbaceous hosts and the endosperm of grapevine seeds (Cory and Hewitt 1968) and is transmitted through seeds of *C. amaranticolor*, *C. quinoa*, and soybean (Dias 1963; Brückbauer 1961; Cory and Hewitt 1968). There are conflicting reports on seed transmission in grapevines (Boubals 1969; Hevin et al. 1973; Lazar et al. 1990). No plants pollinated with GFLV-carrying pollen became infected (Doazan 1978). Dissemination over medium and long distances is through infected scions and rootstocks used for propagation.

Infectious Degeneration (Old World Nepoviruses)

Geographic Distribution

Besides GFLV, several other nepoviruses can infect grapevine in Europe, the Mediterranean and Middle East. Even though they are known as “European nepoviruses”, some of these species have also been found outside the Euro-Mediterranean area. For example, ArMV, TBRV, CLRV, and SLRSV have been reported also from the Americas, New Zealand, Asia, and Africa, mainly infecting species other than grapevine. As far as infection of grapevine is concerned, the areas where most of the European nepovirus species have been found are the middle-eastern Europe (the Balkans, Germany, Hungary, Bulgaria, and Czech Republic), where most of the nematode vectors are also present, and the Near-East (mainly Turkey and Iran). In western Europe ArMV prevails in certain areas of France, whereas occasional infections by this virus and SLRV have been recorded in Italy, Spain, Germany, Greece, and Portugal (Table 3.1).

Host Range

Generally speaking, grapevine nepoviruses have a very broad natural host range that includes annual and perennial, woody, and herbaceous species. For example, ArMV naturally infects 93 dicotyledonous species of 28 families, SLRSV infects 126 species of 27 families, while TBRV infects 76 species of 29 families (Schmelzer 1963; Murrant 1981; EFSA 2013). A few viruses, however, e.g., GCMV, GBLV, GTRSV, GDeV, and GARSV, represent an exception as they infect in nature no hosts other than the grapevine (Table 3.1) and a low number of herbaceous hosts upon mechanical transmission.

Table 3.1. *Nepovirus* and *Sadwavirus* members of the “Old world” group and some of their properties

Virus	RNA-1 (nt)		5' NCR		RNA-2 (nt)	5' NCR		CP (kDa)	Natural hosts other than grapevine	Nematode vector(s)	Geographical distribution
	PI	3' NCR (nt)	P1	3' NCR (nt)		P2	3' NCR (nt)				
<i>Grapevine fanleaf virus</i> GFLV	7326–7342	244	3730–3817	200–272	56	A few weeds (<i>Aristolochia clematitis</i> , <i>Lagenaria siceraria</i> , <i>Bermuda grass</i> , <i>knorweed</i> , <i>raspberry</i> , <i>Johnson grass</i> , <i>Melilotus</i> sp., <i>Plantago lanceolata</i>)					
		6854		3324–3356							
		243–245		193–212							
<i>Arabis mosaic virus</i> ArMV	7330–7385	227–230	3707–3852	260–295	54	Wide variety of ornamental plants and fruits, cherry, euonymus, forsythia, lilac, olive, peach, plum, raspberry, rose, strawberry, cucumber, lettuce, rhubarb, sugar beet, etc.					
		6855–6861		3324–3356		<i>X. diversicaudatum</i> , <i>X. coxi</i>					
		241–252		187–197		Spain, France, Italy, Germany, Hungary, Czech Republic, Turkey, Iran, Israel, the USA, Japan					
<i>Grapevine deformation virus</i> GDeV	7386	287	3753	236	53	None known					
		6855		3560		Turkey, Iran					
		244		193		Unknown					
<i>Raspberry ringspot virus</i> RpRSV	7935	136	3912–3928	196–206	54	Raspberry, strawberry, redcurrant, cherry, rose, <i>Narcissus</i> spp.					
		7104		3321–3324		<i>Paralongidorus maximus</i> , <i>Longidorus elongatus</i>					
		695		390–398		Palatinate (Germany), Switzerland, France					

(continued)

Table 3.1. (continued)

Virus	RNA-1 (nt)	5' NCR			RNA-2 (nt)	5' NCR		CP (kDa)	Natural hosts other than grapevine	Nematode vector(s)	Geographical distribution
		P1	3' NCR (nt)	P2		3' NCR (nt)					
<i>Tomato black ring virus</i> TBRV	7358–7366	239–240	6801–6807	275–299	4032–4035	57	284–326	Tomato, bean, sugar beet, lettuce, raspberry, strawberry, celery, potato, peach, almond, <i>Robinia pseudoacacia</i> , leek, onion, cabbage, lucerne, <i>Sambucus nigra</i> , <i>Fraxinus</i>	Germany, France, Czech Republic, Hungary, Yugoslavia, Greece, Israel, Turkey, Ontario (Canada)		
		6801–6807									
		318–319									
<i>Grapevine chrome mosaic virus</i> GCMV	7212	215	6759	212–217	3975–3978	52	None known	Hungary, Czech Republic, Yugoslavia, Croatia, Austria			
		6759									
		238									
<i>Grapevine Anatolian ringspot virus</i> GARSV	7288	271	6732	275	4053	56	None known	Turkey, Iran			
		6732									
		285									
<i>Artichoke Italian latent virus</i> AILV	2.4 × 10 ⁶ Da	n.d.	n.d.	n.d.	1.5 × 10 ⁶ Da	54	Artichoke, sowthistle, pelargonium, chicory, gladiolus and several weeds	<i>L. apulus</i> and <i>L. attenuatus</i> (in vegetable crops)	Bulgaria		

<i>Cherry leaf roll virus</i> CLRV	7918	12 6342 1568	6360	12 4926 1573	54	Birch, hornbeam, dogwood, spindle, beech, ash, walnut, privet, olive, cherry, hop tree, buckthorn, blackberry, raspberry, elderberry, lilac, elm, blueberry, rhubarb, garlic, delphinium, etc.	Unknown	Germany, Poland, Chile
	7452	87 6288 1077	5821	189 4500 1132	54	None known	Unknown	Bulgaria, Yugoslavia, Hungary, Portugal
	ca. 6800	–	ca. 5800	–	59	None known	Unknown	Tunisia
<i>Strawberry latent ringspot virus</i> SLRSV	7496	252 6684 560	3842	312 2970 560	27–43	Strawberry, raspberry, <i>Robinia pseudoacacia</i> , <i>Etiominous europeaus</i> , <i>Aesculus carnea</i> , rose, asparagus, blackberry, blackcurrant, cherry, elderberry, plum, rhubarb, olive, narcissus, etc.	<i>X. diversicaudatum</i>	Palatinate (Germany), Italy, Turkey, Portugal

Symptoms and Impact

Nepoviruses other than GFLV that infect grapevines elicit diseases whose symptoms are similar to, or indistinguishable from, those of fanleaf. Some of them (e.g., ArMV, GCMV, RpRSV, CLRV, and TBRV) have both distorting and chromogenic strains. ArMV occurs often in mixed infections with GFLV in certain areas of France and Italy and with other nepoviruses in the “Reisigkrankheit” complex of western Germany. Susceptible grapevine cultivars infected by GCMV lack vigor, bear little or no crop, and tend to decline and die within a few years after infection (Lehoczky et al. 1984). Severe decline, and eventually death of the vines, can be induced in cv. Kerner by ArMV (Stellmach and Berres 1986). Heavy yield losses (up to 80%) are associated with infection by SLRSV, TBRV, and the severe strain of RpRSV, of which two strains with different virulence occur in the Palatinate (Ebel et al. 2003). RpRSV is associated with severe fanleaf-like symptoms, while in the grapevine hybrid rootstock 106/8, SLRSV induces chlorotic mottling, asymmetry, malformation of the leaves, and stunting (Credi et al. 1981). TBRV-infected vines show a reduction in growth and yield, chlorotic spots, rings, and line patterns on the leaves of newly infected plants, mottling of older leaves, and increased graft failure. “Joannes Seyve virus”, a strain of TBRV, is known to cause severe damage to the grapevine hybrid cv. Joannes Seyve in Ontario (Stobbs and Van Schagen 1985). Apparently, symptomless is the infection by GBLV in several grapevine cultivars, although some strains can reduce growth and induce fanleaf-like symptoms (Martelli et al. 1977) or yellow mosaic (Ferreira and de Sequeira 1972; Gallitelli et al. 1983).

Information on the symptoms elicited by nepoviruses that are sporadically detected and are confined to restricted areas is scanty. This is the case, for example, of GTRSV, isolated from grapevines with mottling and leaf deformation in Tunisia (Ouertani et al. 1992); AILV, from grapevine with fanleaf-like symptoms in Bulgaria (Jankulova et al. 1976; Savino et al. 1976); and GDeV and GARSV, found in Turkish vines with fanleaf-like symptoms (Digiario et al. 2003).

Genomic Structure

Among European grapevine-infecting nepoviruses, representative species of all three subgroups of the genus *Nepovirus* are present.

Subgroup A (ArMV, GDeV, and RpRSV, in addition to GFLV)

Arabis mosaic virus (ArMV), first detected in grapevine in Croatia (Panjac and Saric 1963), is serologically related to GFLV. The CP has a single type of subunits of Mr 54 kDa. The genome is composed of two positive-sense ssRNAs, separately encapsidated, with Mr 2.4×10^6 Da (RNA-1) and 1.4×10^6 Da (RNA-2). RNA-1

molecules have a rather uniform size of 7330–7336 nt and contain a single ORF encoding polypeptides of ca. 250 kDa. More variable is the size of RNA-2 molecules, ranging from 3707 to 3852 nt and containing a single ORF encoding polypeptides with Mr from 119 to 124 kDa. The virus supports the replication of two types of satellite RNAs, a linear RNA of 1104 nt, and a circular RNA of about 350 nt in size (Imura et al. 2008; Loudes et al. 1995; Wetzel et al. 2001; Vigne et al. 2008; Lopez-Fabuel et al. 2013). Natural recombinants between ArMV and GFLV are frequently found in nature.

Grapevine deformation virus (GDeV) was recovered from Turkish grapevines of cv. Kara Dimrit. It is distantly related serologically to ArMV but not to GFLV, the two viruses from whose recombination it originates (Elbeaino et al. 2012). CP subunits have a Mr of 53 kDa (Cigsar et al. 2003). The genome is bipartite. RNA-1 is 7386 nt in length and contains a single ORF encoding a polyprotein of 252 kDa (Abou Ghanem-Sabanadzovic et al. 2005). RNA-2 is 3753 nt in size and its single ORF expresses a polypeptide of 122 kDa (Elbeaino et al. 2012).

Raspberry ringspot virus (RpRSV). A strain from grapevines in Germany (Vuittenez et al. 1970) is serologically very distantly related to the Scottish and English serotypes and differs from the type strain as it often sediments as if it were a single centrifugal component. The CP has a single type of subunits of Mr 54 kDa (Jones et al. 1994). The viral genome is composed of two separately encapsidated, positive-sense ssRNAs, Mr 2.6×10^6 Da (RNA-1) and 1.6×10^6 Da (RNA-2). RNA-1 is 7935 nt long and contains a single ORF encoding a polypeptide of 263 kDa, while RNA-2 is 3912–3928 nt in size and contains a single ORF encoding a polypeptide of 124 kDa (Ebel et al. 2003; Wetzel et al. 2006; Blok et al. 1992).

Subgroup B (GCMV, TBRV, GARSV, and AILV)

Grapevine chrome mosaic virus (GCMV) was originally called Hungarian chrome mosaic virus because of its first detection near Lake Balaton (Hungary) in vines with a yellow mosaic syndrome (Martelli et al. 1965). The virus is distantly related serologically to TBRV (Martelli et al. 1968). The CP has a single type of subunits of 52 kDa. The genome is bipartite. RNA-1 has Mr of 2.8×10^6 Da and a size of 7212 nt, with a single ORF encoding a polypeptide of Mr 250 kDa (Le Gall et al. 1989), while RNA-2 has Mr of 1.6×10^6 Da and a size of 4437–4445 nt and contains a single ORF encoding a polypeptide of 147 kDa (Braut et al. 1989; Digiario et al. 2015). The hypothesis has been put forward that GCMV may have been generated by a recombination between TBRV and GARSV, to which it is phylogenetically related (Digiario et al. 2015).

Tomato black ring virus (TBRV) was first found in grapevines from Germany (Stellmach and Bercks 1963). It is serologically related to GCMV (Martelli et al. 1968). The CP consists of a single type of subunits of 57 kDa. The genome is a bipartite and is composed of two positive-sense single-stranded RNAs occurring as two separately encapsidated functional molecules of Mr 2.7×10^6 (RNA-1) and 1.65×10^6 Da (RNA-2). The RNA-1 of the grapevine isolate TBRV-Mirs is 7366 nt in

size and contains a single open reading frame encoding a polypeptide of Mr 255 kDa. RNA-2 is 4640 nt in size and codes for a polyprotein of 149 kDa (Digiario et al. 2015). TBRV supports the replication of a satellite RNA of 1372 ÷ 1376 nt encoding a polypeptide with Mr 48 kDa (Meyer et al. 1984). Some virus isolates possess smaller RNA-1 molecules (defective RNAs) that may interfere with the replication of the parental genome (Hasiów-Jaroszewska et al. 2012). Hypotheses are that TBRV-ED (carrot isolate from the English serotype) RNA-2 arose from an RNA recombination event that resulted in the exchange of the putative movement protein gene between TBRV-S (now *beet ringspot virus*, BRSV) and GCMV (Le Gall et al. 1995), while GCMV stems from a recombination between TBRV-Mirs and GARSV (Digiario et al. 2015).

Grapevine Anatolian ringspot virus (GARSV) was isolated from Turkish grapevines of cv. Kizlar Tahtasi (Gokalp et al. 2003). GARSV is not serologically related to any of the known grapevine nepoviruses. CP subunits have a Mr of 55.5 kDa. RNA-1 is 7288 nt long, encoding a polypeptide of 250 kDa (Abou Ghanem et al. 2005). RNA-2 is 4607 nt long, encoding a polypeptide of 150 kDa (Digiario et al. 2012b). The virus is phylogenetically related to TBRV and GCMV. The suggestion has been put forward that a recombination of GARSV and TBRV may have given rise to GCMV (Digiario et al. 2015).

Artichoke Italian latent virus (AILV) was isolated in Bulgaria from vines with fanleaf-like symptoms (Jankulova et al. 1976). It is not serologically related to any of the known nepoviruses. Its CP is made up of a single type of subunits with Mr 54 kDa. The two genomic RNAs have an estimated Mr of 2.4×10^6 Da (RNA-1) and 1.5×10^6 Da (RNA-2) (Savino et al. 1976; Jankulova et al. 1976). For this virus, only a partial sequence of 1828 nt in length of RNA-2 comprising the CP gene is available in GenBank.

Subgroup C (GBLV, CLRV, and GTRSV)

Grapevine Bulgarian latent virus (GBLV) was found for the first time in 1971 in symptomless cv. Rkatsiteli vines in Bulgaria, where it is widespread and infects latently several other grapevine cultivars (Martelli et al. 1977). The virus occurs as closely related but serologically distinguishable strains. The CP has a single type of subunits with Mr 54 kDa. The genome is composed of two positive-sense ssRNAs, separately encapsidated, with Mr 2.2×10^6 Da (RNA-1) and $1.95\text{--}2.1 \times 10^6$ Da (RNA-2). RNA-1 is 7452 nt in length and contains a single ORF of 6288 nt expressing a polypeptide of 234 kDa. RNA-2 is 5821 nt long and contains a single ORF of 4500 nt expressing a polypeptide of 167 kDa (Elbeaino et al. 2011). The virus supports the replication of a satellite RNA of less than 1800 nt in size (Gallitelli et al. 1983). A strain of this virus was previously found in Portugal and described as virus CM112 (Ferreira and De Sequeira 1972; Gallitelli et al. 1983). A virus serologically related to but different from GBLV, found in Concord grapes in New York State vineyards, was later recognized as a strain of *blueberry leaf mottle virus* (BLMoV) (Ramsdell and Stace-Smith 1981).

Cherry leaf roll virus (CLRV) occurs in nature as multiple strains but is not serologically related to any of the known nepoviruses. In Chile it was recovered from vines with fanleaf-like symptoms (Herrera and Madariaga 2001) and in Germany from vines with yellow mosaic-like symptoms (Ipach et al. 2003). The CP consists of a single type of subunits of 54 kDa. The genome is bipartite, comprising two separately encapsidated RNA molecules. RNA-1 is 7905 nt long and encapsidates a polyprotein 236 kDa in size. RNA-2 is 6511 nt long and encapsidates a polyprotein 180 kDa in size (Eastwell et al. 2012).

Grapevine Tunisian ringspot virus (GTRSV) was first detected from a Tunisian grapevine with mild fanleaf-like symptoms and is serologically unrelated to any of 19 nepoviruses tested, including all those known to infect grapevine. Its CP consists of a single type of subunits of 59 kDa. The virus sediments as three components: T (empty shells), M (particles containing a molecule of RNA-2 of ca. 5800 nt), and B (particles containing a molecule of RNA-1 of the apparent size of ca. 6800 nt) (Ouertani et al. 1992). No further characterization of this virus has been done, genome sequencing included.

Unassigned Species in Family *Secoviridae*

Strawberry latent ringspot virus (SLRSV) was first detected in a vine of cv. Sylvaner in Germany (Vuittenez et al. 1970; Bercks et al. 1977), then in northern Italy (Credi et al. 1981). The CP is made up of two types of subunits of 43 and 27 kDa, respectively. The genome is bipartite, comprising two positive-sense, single-stranded RNAs occurring as two separately encapsidated functional molecules. RNA-1 is 7496 nt in size and encapsidates a single polyprotein of 250 kDa. RNA-2 is 3824 nt in size and encodes a single ORF expressing a polypeptide with Mr of 109 kDa. The virus supports the replication of a satellite RNA 1117 nt in size encoding a putative protein of 31 kDa (Tzanetakis et al. 2006).

Detection and Diagnosis

As with GFLV, sorting out and identifying other grapevine-infecting nepoviruses can be done by biological indexing and/or laboratory tests. The cv. Siegfriedrebe (FS4 201-39), which is regarded as the best performing indicator for ArMV, RRV, and TBRV, shows cane deformations and foliar discoloration a few weeks post inoculation. “Pinot noir” and “Jubiläum 75” can be used for GCMV detection, whose infection induces severe stunting and apical necrosis of the shoots. “Pinot noir” is also a good indicator for TBRV. No symptoms are produced by GCMV in *V. rupestris* St. George, which differentiates GCMV from chromogenic strains of GFLV (Garau et al. 1997). Identification of nepoviruses based on differential host range responses is not easy and may pose problems even to experienced workers. Species of Chenopodiaceae, Solanaceae, Amaranthaceae, Cucurbitaceae, and Leguminosae

are indicators of several European nepoviruses, but often react with nondiscriminating symptoms. *Chenopodium quinoa* and *C. amaranticolor* are susceptible to almost all nepoviral species and show symptoms ranging from chlorotic/necrotic local lesions (GBLV, GCMV, and GDeV) to systemic vein clearing, mottling, deformation of the leaves, and apical necrosis. *Gomphrena globosa* can react with chlorotic or reddish local lesions accompanied by twisting of the top leaves (GFLV), systemic, yellowish zonate spots (GCMV), or deformation but not twisting on the upper leaves (GBLV). *Cucumis sativus* reacts with chlorotic local lesions and systemic interveinal chlorosis when inoculated with SLRSV. RpRSV induces local chlorotic or necrotic spots in *Nicotiana rustica*, followed by chlorotic/necrotic ringspots and line patterns. Necrotic ringspot and line pattern are also shown by *N. tabacum* cv. Havana infected by AILV. Local chlorotic lesions, systemic vein clearing, and deformation are induced by GARSV on the leaves of *N. occidentalis*, whereas GBLV elicits necrotic local lesions, systemic leaf mottling, and stunting in *N. clevelandii* (Martelli 1993).

ELISA is easily and efficiently applicable to all European nepoviruses (Clark and Adams 1977; Tanne 1980; Lehoczy et al. 1984; Stellmach and Berres 1985; Kölber et al. 1985). As with GFLV, the use of buds or phloem scrapings from dormant canes may allow to bypass the problem posed by the seasonal fluctuation of virus titer, which limits the use of ELISA to certain growth periods (Rüdel et al. 1983; Kölber et al. 1985). Cocktails of antibodies were used to diagnose the mixed presence of two nepoviruses (ArMV and GFLV) or nepovirus serotypes, i.e., TBRV serotypes G + S and RpRSV serotypes E + G (Digiario et al. 2012; Etienne et al. 1991).

Specific monoclonal antibodies (MAbs) were produced against ArMV (Frison and Stace-Smith 1992). In the same study, two cross-reacting MAbs were also obtained which were able to detect ArMV and GFLV, and ArMV and RpRSV, and five heterospecific MAbs, all unable to react with ArMV but able to react with RpRSV (two), CLRV (two), and TBRV (one).

Diagnosis by molecular hybridization using radioactive or digoxigenin-labeled probes (Jelkmann et al. 1988; Hadidi and Hammond 1989; Bretout et al. 1989; Fuchs et al. 1991), RT-PCR (Ipach et al. 1992), immunocapture PCR (Brandt and Himmler 1995), multiplex RT-PCR (Faggioli and La Starza 2006), and real-time PCR (Osman et al. 2008) is the most commonly used.

Sets of degenerate primers were designed for detection of representatives of each of the three subgroups (A, B, and C) of the genus *Nepovirus*, based on the nucleotide sequence homology of the CP gene (for subgroups A and B) and the untranslated region of RNA-1 (for subgroup C). These primers were able to detect simultaneously in RT-PCR all grapevine-infecting nepoviral species belonging to the same subgroup and to discriminate species of different subgroups. In the same study, a cocktail of species-specific primers were designed and used in multiplex PCR for detecting the same viruses of subgroup A (GFLV, ArMV, GDeV, and TRSV) and B (GCMV, TBRV, and GARSV) (Digiario et al. 2007). Degenerate primers were also designed for amplification of part of the RNA-dependent RNA polymerase gene (RNA-1) of nepoviruses of subgroups A and B, whose sensitivity and

specificity of detection was increased when a 12-bp noncomplementary sequence was added to the 5' termini of the forward primers (Wei and Clover 2008).

Immunosorbent electron microscopy (ISEM) was used to detect ArMV, GBLV, GCMV, and GFLV in extracts of naturally infected grapevines (Russo et al. 1982) and ArMV, GCMV, GFLV, RpRSV, SLRSV, and TBRV in extracts of viruliferous nematodes (Roberts and Brown 1980).

Transmission

Nepoviruses are among the few soilborne viruses that are vectored in nature by nematodes (Rüdel 1992; Taylor and Brown 1997). To date, 18 different nematode species of the family *Longidoridae* (genera *Xiphinema*, *Longidorus*, and *Paralongidorus*) have been ascertained to be effective vectors of nepoviruses (Demangeat 2009). A characteristic feature of transmission by nematodes is the high specificity between the species of nematode vector and its associated virus that can be “exclusive” (i.e., one nematode species transmits one virus, and one virus has only a single vector species), or “complementary” (i.e., one nematode species transmits two or more viruses/virus strains, or two or more viruses/virus strains share the same vector species) (Brown and Weischer 1998). For 12 of the 34 known nepoviruses, it has been demonstrated that the natural plant-to-plant transmission by nematodes is semi-persistent and non-circulative (Taylor and Brown 1997; Brown and Weischer 1998; Macfarlane et al. 2002; Andret-Link and Fuchs 2005). Several of these viruses are able to infect grapevine, i.e., GFLV (transmitted by *X. index*), ArMV (by *X. diversicaudatum*), RpRSV (by *L. macrosoma*, *L. elongatus*, and *P. maximus*, according to the virus strain), TBRV (by *L. elongatus*), SLRSV (by *X. diversicaudatum*), TRSV (by *X. americanum* sensu stricto, *X. californicum*, *X. rivesi*, *X. tarjanense*), ToRSV (by *X. americanum* sensu lato, *X. bricolense*, *X. californicum*, *X. rivesi*, *X. tarjanense*), and PRMV (by *L. diadecturus*, *X. americanum* sensu lato) and possibly AILV, which in Italy and Greece is transmitted by *L. apulus* and *L. fasciatus* in hosts other than grapevine (Table 3.1). A number of other longidorid species have been regarded as “questionable” vectors, i.e., species suspected but not definitely proven to transmit viruses (e.g., *X. vuittenezi* and *X. italiae* for GFLV, *X. coxi* for ArMV and SLRSV, etc.) (Rüdel 1992; Brown et al. 1996).

The vector of GCMV is still unknown, although there is an apparent natural spread in the vineyard. Also unknown are the possible vectors of GBLV, GDeV, GARSV, and GTRSV. The scattered distribution of infected vines in the vineyard suggests that these latter viruses spread primarily by infected propagation material. For at least two viruses (CLRv and BLMV), there is experimental evidence that they are not transmitted by nematodes (Jones et al. 1981; Childress and Ramsdell 1986).

In *Xiphinema* spp. the adsorption of nepoviral particles occurs at specific sites on the cuticle of the entire odontophore, the esophagus, and the esophageal bulb (Taylor and Robertson 1970). In *Longidorus* and probably in *Paralongidorus*, viral particles

are associated with the inner surface of the oesophageal guiding sheath and the interior surface of the odontostyle (Taylor and Robertson 1969; Taylor and Brown 1997). This difference in localization may explain the shorter retention time of viral particles in *Longidorus* species (only a few weeks) compared to the much longer retention time in *Xiphinema*, where virus particles are retained for the entirety of the life of the nematode.

Many nepoviruses (at least 19 species), including most of those transmitted by nematodes, are shown to be transmitted through seed and pollen (Murant 1983; Lister and Murant 1967). The seeds may be infected by virus introduced either through the ovule or through pollen, and the frequency of infection tends to be greater when both are infected (Lister and Murant 1967). The epidemiological importance of seed transmission of nepoviruses in grapevines would be irrelevant considering that they are vegetatively propagated. By contrast, seed transmission is of major importance in weeds and shrubs that constitute virus reservoirs and food for the vectors, especially for viruses, such as RpRSV and TBRV, that are retained for only a few weeks by their vectors (Murant and Taylor 1965). Infected seedlings often show few or no symptoms and grow as well as their virus-free counterparts. ArMV, CLRV, RpRSV, TBRV, TRSV, and ToRSV are transmitted to a large proportion (often more than 50%) of the seed of many host plants, including many crop and weed species (Lister and Murant 1967). In particular, seed transmission has been recorded in 19 plant species of 13 botanical families for TBRV, 13 species (11 families) for ArMV, and 6 species (5 families) for RpRSV (Lister and Murant 1967).

Transmission by pollen, another way for nepovirus dispersal, has ecological relevance for species such as CLRV and BLMoV that do not have nematode vectors. CLRV is pollen-transmitted in elm (Callahan 1957), birch (Cooper 1976), and walnut (Mirchetich et al. 1980), whereas pollen transmission of BLMoV was observed in blueberry, where the contaminated pollen is carried and spread by honeybees (Childress and Ramsdell 1987).

Control

Since direct control measures are not effective against plant viruses, preventive measures aimed at inoculum exclusion and avoidance of its spreading are necessary. Considering that the worldwide dissemination of grapevine nepoviruses, GFLV in particular, is primarily via exchange of infected propagation material, the implementation of quarantine measures and the production and use of virus-tested scions and rootstocks can significantly contribute to reduce the problem. National clean stock and certification programs are currently implemented in several countries to the significant benefit of the viticultural industry (Maliogka et al. 2015).

Virus elimination from selected grapevine clones can be achieved by a number of procedures (D. Golino et al., Chap. 27, this book). Nevertheless, despite the

implementation of effective measures for impairing the dissemination of GFLV and the like over long distances, these viruses remain a problem in established vineyards. In these, the control strategy aims at breaking the nematode/virus/alternative hosts complex through cultural practices and soil disinfestations (Raski et al. 1983; Taylor and Brown 1997).

For an effective control strategy, the factors influencing the epidemiology of grapevine nepoviruses should be considered, which include (1) the characteristics of the viral species and its vector, (2) the presence of potential alternative hosts, and (3) environmental factors.

For viruses such as GFLV that have very few alternative hosts of minor importance, the vector, *X. index*, plays a major role, by retaining infectivity for a long time even in the absence of the host and reinfesting the vines, even if the new vineyard is planted more than 4 years after the uprooting of the old one, as this nematode is able to survive and retain infectivity by feeding on residual grapevine roots in the soil. Thus, removal of grapevine roots and crop rotation or fallow before replanting have given conflicting results. A treatment with systemic herbicides before uprooting GFLV-infected vines can help the destruction of surviving roots (Descottes and Moncomble 1995).

The finding that GFLV is still present in the vectors for up to 4 years in the apparent absence of host roots contradicts earlier suggestions that a 3-year rotation could suffice for a drastic reduction of *X. index* populations (Raski 1955). Therefore, prolonged fallow or planting nonhost species (e.g., figs) for at least 10 years can be retained as an efficient strategy to eradicate *X. index*, but it is impractical and economically unfeasible for premium vineyards (Golino et al. 1992).

Different is the case of viruses, such as TBRV or RpRSV, which are transmitted by nematodes of the genus *Longidorus* that, contrary to *Xiphinema*, retain infectivity for only a few weeks. Similarly, ArMV and SLRSV are transmitted by another longidorid nematode (*X. diversicaudatum*), although they have a wider host range. For these viruses, alternative hosts, particularly weeds, play a crucial role as they serve as reservoirs of inoculum and food for vectors and contribute to the short-range dissemination and perpetuation of viruses due to their transmission by seeds (Rüdel 1977; Ramsdell and Myers 1978). In such cases, weed control may complement other sanitary measures by reducing inoculum potential.

Nematicides have limited efficacy especially in heavy and deep soils, also considering the fact that *Xiphinemas* migrate deeply enough into the soil (in excess of 3 m). Thus, superficial fumigations are ineffective (Lear et al. 1981; Brown et al. 1996). In any case, the use of nematicides is now widely prohibited because of the adverse environmental effects (Abawi and Widmer 2000; Burrows et al. 1998).

At the laboratory scale, a promising control using biological antagonists to *X. index* has been obtained with various *Trichoderma* species (Darago et al. 2013). Also, some rhizobacteria isolated from grapevines protected the roots from damage caused by *X. index* (Aballay et al. 2011, 2012), suggesting that they have the potential for use in biological control programs.

Resistance is a more effective approach to reduce the negative impact of viruses, even under high disease pressure. However, suitable sources with resistance to viruses have not been found in grapevine germplasm, except against *X. index* (Oliver and Fuchs 2011). Consequently, traditional crossing may not help in developing virus-resistant grapevine cultivars, although some interesting tolerance/resistance responses of *V. vinifera* cultivars to GFLV and of rootstocks to *X. index* feeding have been identified and discussed in other parts of this chapter.

A cross-protection approach was also evaluated for the control of GFLV. It gave promising results with the experimental host *Chenopodium quinoa* (Huss et al. 1989). Mild strains of GFLV and of the closely related ArMV were identified among numerous field isolates, and their effect on crop performance was evaluated in the open field by inoculating various rootstocks/*V. vinifera* combinations (Legin et al. 1993). Although a temporary protection was observed and the yield reduction they induced (9% with ArMV-Ta and 17% with GFLV-Ghu) was minor, currently this approach does not appear to be promising because, as stated by Komar et al. (2008), “the negative impact on yield is a limiting factor for its deployment.”

Genetic engineering is an attractive alternative for grapevine improvement because it potentially overcomes the shortcomings of conventional approaches by allowing the insertion of specific virus resistance traits directly into desirable cultivars (M. Fuchs and O. Lemaire, Chap. 29, this book).

Since the pioneering work of Mullins et al. (1990), several studies have been carried out to develop virus-resistant transgenic grapevines (see reviews by Fuchs 2003, 2006; Laimer et al. 2009; Oliver and Fuchs 2011; Maliogka et al. 2015). The main approaches were based on the overexpression of virus-derived constructs (pathogen-derived resistance) and transferring them into the genome of rootstocks and/or *V. vinifera*. Engineered sequences of GFLV coat protein, movement protein, or RNA-dependent RNA polymerase genes (Fuchs 2003; Laimer et al. 2009) were used as well as conserved sequences of GFLV, ArMV, and RpRSV in inverted repeat constructs, aimed at inducing multiple virus resistance (Reustle et al. 2005, 2006). With a different approach, in which recombinant antibodies were expressed (Fisher and Shillberg 2003; Nölke et al. 2004), transgenic *N. benthamiana* expressing a single-chain antibody fragment against GFLV CP conferred resistance to GFLV and partial resistance to ArMV (Nölke et al. 2009).

The resistance of transgenic rootstocks expressing the CP gene of GFLV-F13 strain (Mauro et al. 1995) was assessed in France in a 3-year (1997–1999) open-field trial (Vigne et al. 2004b), which was repeated over a 5-year period (2005–2009) (Hemmer et al. 2009). Notwithstanding their brief duration, due to widespread opposition of the European public opinion to genetic engineering, the preliminary results of both trials showed a lower incidence of GFLV infection, no development of detectable GFLV recombinants or specific molecular variants, and no translocation of the transgene-expressed products from transformed rootstocks to grapevine scions.

Conclusions and Future Research Directions

Notwithstanding the fact that nepoviruses were among the first grapevine-infecting viruses to be discovered, the information on some of those occurring in the Old World is still scanty. For instance, it is not clear what is the economical relevance of GTRSV, GDeV, GARSV, AILV, GBLV, and CLRV, how widespread these viruses are, and what are their vectors and alternative hosts. Furthermore, genome sequence of some of these viruses is either partial (AILV) or entirely lacking (GTRSV), whereas the genome sequence of other viral species was determined for isolates recovered from hosts other than the grapevine (CLRV), or from a single isolate (GARSV and GDeV). A deeper insight into these aspects may be useful for a better understanding of the evolution of virus species of the genus *Nepovirus* in relation to the grapevine.

The presence of many Old World nepoviruses and their nematode vectors in more or less restricted areas, with the exception of the ubiquitous GFLV and, to a lesser extent, of ArMV, makes it essential that appropriate preventive measures be adopted in viticultural countries to regulate the movement of planting material (quarantine and certification programs) for averting their further spread. However, the practical impact of preventive measures may be of little or no effect if new plantings are established in areas with a long history of grape growing in the presence of nematode vectors. Due to the severity of viral epidemics, the difficulty of implementing efficient control strategies, and the increasing demand for sustainable and environmentally safe viticulture practices, there is a need for the development of virus-resistant cultivars. Further efforts should therefore be made in the search for sources of resistance through both “conventional” (breeding) and “unconventional” (transgenesis and syngensis) ways. The understanding of the molecular mechanisms operating in plants in response to viral attacks will also facilitate the identification of possible targets to be addressed for an effective and lasting control of viral infections.

References

- Aballay, E., A. Martensson, and P. Persson. 2011. Screening of rhizosphere bacteria from grapevine for their suppressive effect on *Xiphinema index* Thorne & Allen on *in vitro* grape plants. *Plant and Soil* 347: 313–325.
- Aballay, E., S. Prodan, A. Martensson, and P. Persson. 2012. Assessment of rhizobacteria from grapevine for their suppressive effect on the parasitic nematode *Xiphinema index*. *Crop Protection* 42: 36–41.
- Abawi, G.S., and T.L. Widmer. 2000. Impact of soil health management practices on soilborne pathogens, nematodes, and root diseases of vegetable crops. *Applied Soil Ecology* 15: 37–47.
- Abou Ghanem-Sabanadzovic, N., S. Sabanadzovic, M. Digiaro, and G.P. Martelli. 2005. Complete nucleotide sequence of the RNA-2 of grapevine deformation and Grapevine Anatolian ringspot viruses. *Virus Genes* 30: 335–340.

- Andret-Link, P., and M. Fuchs. 2005. Transmission specificity of plant viruses by vectors. *Journal of Plant Pathology* 87: 153–165.
- Andret-Link, P., C. Schmitt-Keichinger, G. Demangeat, V. Komar, and M. Fuchs. 2004. The specific transmission of Grapevine fanleaf virus by its nematode vector *Xiphinema index* is solely determined by the viral coat protein. *Virology* 320: 12–22.
- Bacher, J.W., D. Warkentin, D. Ramsdell, and J.F. Hancock. 1994. Selection versus recombination: What is maintaining identity in the 3' termini of blueberry leaf mottle nepovirus RNA-1 and RNA-2? *Journal of General Virology* 75: 2133–2138.
- Belin, C., C. Schmitt, G. Demangeat, V. Komar, L. Pinck, and M. Fuchs. 2001. Involvement of RNA2-encoded proteins in the specific transmission of grapevine fanleaf virus by its nematode vector *Xiphinema index*. *Virology* 291: 161–171.
- Belval, L., A. Marmonier, P. Schellenberger, P. Andret-Link, C. Keichinger S. Gersch, V. Komar, E. Vigne, S. Trapani, P. Bron, B. Lorber, C. Sauter, M. Fuchs, O. Lemaire, C. Ritzenthaler, and G. Demangeat. 2015. New insights in nepovirus capsid determinants involved in the transmission by *Xiphinema* spp. In *Proceedings 18th meeting of ICVG, Ankara, Turkey*, 30–31.
- Bercks, R., H. Brückbauer, G. Querfurth, and M. Rüdell. 1977. Untersuchungen über die Viruskrankheit der rebe unter besonderer Berücksichtigung "atypischer Formen" der Reisigkrankheit. *Weinberg und Keller* 24: 133–180.
- Bláhová, L., and M. Pidra. 2009. Real-time PCR of grapevine fanleaf virus. In *Extended abstracts 16th meeting of ICVG, Dijon, France*, 83–84.
- Blok, V.C., J. Wardell, C.A. Jolly, A. Manoukian, D.J. Robinson, M.L. Edwards, and M.A. Mayo. 1992. The nucleotide sequence of RNA-2 of raspberry ringspot nepovirus. *Journal of General Virology* 73: 2189–2194.
- Boscia, D., M. Digiario, J. Fresno, C. Greif, S. Grenan, H.H. Kassemeyer, V.A. Prota, and O.A. De Sequeira. 1997. *ELISA for the detection and identification of grapevine viruses. Sanitary selection of the grapevine*, Les Colloques no. 86, 130–155. Paris: Editions INRA.
- Boubals, D. 1969. Observations sur la non-transmission par graine de deux viroses chez la vigne (*Vitis vinifera*). *Annales de l'amélioration des plantes* 19: 213–219.
- Boubals, D., and R. Pistre. 1978. Résistance de certaines Vitacées et des porte-greffes usuels en viticulture au nématode *Xiphinema index* et à l'inoculation par le virus du court-noué (GFV). In *Génétique et Amélioration de la Vigne*, 200–207. Paris: Editions INRA.
- Bouquet, A. 1981. Resistance to grape fanleaf virus in Muscadine grape inoculated with *Xiphinema index*. *Plant Disease* 65: 791–793.
- . 1983. Détection immunoenzymatique du virus du court-noué de la vigne dans son vecteur *Xiphinema index* Thorne et Allen. *Comptes Rendues Hebdomadaires des Séances de l'Académie des Sciences, Ser. III* 296: 271–274.
- Bovey, R., J.J. Brugger, and P. Gugerli. 1980. Detection of fanleaf virus in grapevine tissue extracts by enzyme-linked immunosorbent assay (ELISA) and immune electron microscopy (IEM). In *Proceedings 7th meeting of ICVG, Niagara Falls, NY, USA*, 259–275.
- Brandt, S., and G. Himmler. 1995. Detection of nepoviruses in ligneous grapevine material by using IC/PCR. *Vitis* 34: 127–128.
- Brault, V., L. Hilbrand, T. Candresse, O. Le Gall, and J. Dunez. 1989. Nucleotide sequence and genetic organization of Hungarian grapevine chrome mosaic nepovirus RNA-2. *Nucleic Acids Research* 17: 7809–7819.
- Bretout, C., T. Candresse, O. Le Gall, V. Brault, M. Ravelonandro, and J. Dunez. 1989. Virus and RNA-specific molecular hybridization probes for two nepoviruses. *Acta Horticulturae* 235: 231.
- Brown, D.J.F., and B. Weischer. 1998. Specificity, exclusivity and complementarity in the transmission of plant viruses by plant parasitic nematodes: An annotated terminology. *Fundamental and Applied Nematology* 21: 1–11.
- Brown, D.J.F., D.L. Trudgill, and W.M. Robertson. 1996. Nepoviruses: Transmission by nematodes. In *The plant viruses: Polyhedral virions and bipartite RNA genomes*, ed. B.D. Harrison and A.F. Murrant, 187–209. New York: Plenum Press.

- Brückbauer, H. 1961. Untersuchungen über die Viruskrankheiten der Rebe. III. Samenübertragbarkeit der Reisigkrankheit des Silvaners bei einer Testpflanze sowie Untersuchungen über das evtl. Vorkommen des Virus an Weinbergsunkräutern. *Wein-Wissenschaft* 16: 187–189.
- Burrows, P.R., A.D.P. Barker, C.A. Newell, and W.D.O. Hamilton. 1998. Plant derived enzyme inhibitors and lectins for resistance against plant-parasitic nematodes in transgenic crops. *Pesticide Science* 52: 176–183.
- Cadman, C.H., H.F. Dias, and B.D. Harrison. 1960. Sap-transmissible viruses associated with diseases of grape vines in Europe and North America. *Nature (London)* 187: 577–579.
- Callahan, K.L. 1957. Pollen transmission of elm mosaic virus. *Phytopathology* 47: 5.
- Carrier, K., Y. Xiang, and H. Sanfaçon. 2001. Genomic organization of RNA2 of *Tomato ringspot virus*: Processing at a third cleavage site in the N-terminal region of the polyprotein *in vitro*. *Journal of General Virology* 82: 1785–1790.
- Catalano, L., V. Savino, and F. Lamberti. 1991. ELISA for the detection of grapevine fanleaf nepovirus in *Xiphinema index*. In *Proceedings 10th meeting of ICVG, Volos, Greece*, 243–246.
- Cepin, U., I. Gutierrez-Aguirre, L. Balazic, M. Pompe-Novak, K. Gruden, and M. Ravnikar. 2010. A one-step reverse transcription real-time PCR assay for the detection and quantitation of Grapevine fanleaf virus. *Journal of Virological Methods* 170: 47–56.
- Childress, A.M., and D.C. Ramsdell. 1986. Lack of evidence for a nematode vector of blueberry leaf mottle virus (BBLMV). *Acta Horticulturae* 186: 87–91.
- . 1987. Bee-mediated transmission of blueberry leaf mottle virus via infected pollen in highbush blueberry. *Phytopathology* 77: 167–172.
- Cigsar, I., M. Digiario, K. Gokalp, N. Abou Ghanem-Sabanadzovic, A. De Stradis, D. Boscia, and G.P. Martelli. 2003. Grapevine deformation virus, a novel nepovirus from Turkey. *Journal of Plant Pathology* 85: 35–41.
- Clark, M.F., and A.N. Adams. 1977. Characteristics of the microplate method of enzyme-linked immunosorbent assay for the detection of plant viruses. *The Journal of General Virology* 34: 475–483.
- Cooper, J.I. 1976. The possible epidemiological significance of pollen and seed transmission in the cherry leaf roll virus, *Betula spp. complex*. *Mitteilungen biologische Bundes Anstalt Land und Forstwirtschaft* 170: 17–21.
- Cory, L., and W.B. Hewitt. 1968. Some grapevine viruses in pollen and seeds. *Phytopathology* 58: 1316–1318.
- Credi, R., A.R. Babini, L. Betti, A. Bertaccini, and C. Gelli. 1981. A distinctive isolate of strawberry latent ringspot virus from grapevines in Italy. *Phytopathologia Mediterranea* 20: 56–63.
- Darago, A., M. Szabo, K. Hrac, A. Takacs, and P.I. Nagy. 2013. *In vitro* investigations on the biological control of *Xiphinema index* with *Trichoderma* species. *Helminthologia* 50: 132–137.
- Das, S., and D.J. Raski. 1969. Effect of grapevine fanleaf virus on the reproduction and the survival of its nematode vector, *Xiphinema index* Thorne and Allen. *Journal of Nematology* 1: 107–110.
- Decraemer, W., and E. Geraert. 2006. Ectoparasitic nematodes. In *Plant nematology*, ed. J.N. Perry and M. Moens, 153–184. Wallingford: CAB International.
- Demangeat, G. 2009. Nematode-transmitted nepoviruses with special emphasis on the pair grapevine fanleaf virus/*Xiphinema index*. In *Extended abstracts 16th meeting of ICVG, Dijon, France, Progrès Agricole et Viticole, 2009, Hors Série*, 64–68.
- Demangeat, G., V. Komar, P. Cornuet, D. Esmenjaud, and M. Fuchs. 2004. A sensitive and reliable detection of *Grapevine fanleaf virus* in a single *Xiphinema index* nematode vector. *Journal of Virological Methods* 122: 79–86.
- Demangeat, G., R. Voisin, J.C. Minot, N. Bosselut, M. Fuchs, and D. Esmenjaud. 2005. Survival of *Xiphinema index* in vineyard soil and retention of Grapevine fanleaf virus over extended time in the absence of host plants. *Phytopathology* 95: 1151–1156.
- Descottes, A., and D. Moncomble. 1995. Lutte contre le court noué. *Le Vigneron Champenois* 9: 20–24.

- Dias, A. 1963. Host range and properties of Grapevine fanleaf and Grapevine yellow mosaic viruses. *Annals of Applied Biology* 51: 85–95.
- Digiario, M., N. Abou Ghanem-Sabanadzovic, I. Cigsar, K. Gokalp, A. De Stradis, D. Boscia, and G.P. Martelli. 2003. Two hitherto undescribed nepoviruses from Turkish grapevines. In *Extended abstracts 14th meeting of ICVG, Locorotondo, Italy*, 14–15.
- Digiario, M., T. Elbeaino, and G.P. Martelli. 2007. Development of degenerate and species-specific primers for the differential and simultaneous RT-PCR detection of grapevine-infecting nepoviruses of subgroups A, B and C. *Journal of Virological Methods* 141: 34–40.
- Digiario, M., L. Dida, V. Elicio, D. Frasherri, and T. Elbeaino. 2012a. Multiplex ELISA for the simultaneous detection of grapevine viruses. In *Extended abstracts 17th meeting of ICVG, Davis, CA, USA*, 144–145.
- Digiario, M., S. Nahdi, and T. Elbeaino. 2012b. Complete sequence of RNA1 of grapevine Anatolian ringspot virus. *Archives of Virology* 157: 2013–2016.
- Digiario, M., E. Yahyaoui, G.P. Martelli, and T. Elbeaino. 2015. The sequencing of the complete genome of a Tomato black ring virus (TBRV) and of the RNA2 of three Grapevine chrome mosaic virus (GCMV) isolates from grapevine reveals the possible recombinant origin of GCMV. *Virus Genes* 50: 165–171.
- Doazan, J.P. 1978. On the seed-transmission of some grapevine virus disease. In *Proceedings 6th meeting of ICVG, Cordova, Spain*, 83.
- Dodd, S.M., and D.J. Robinsos. 1987. Conservation of the 3'-terminal sequences of the genome RNA species of tomato black ring virus. *Journal of General Virology* 68: 973–978.
- Eastwell, K.C., T.A. Mekuria, and K.L. Druffel. 2012. Complete nucleotide sequences and genome organization of a cherry isolate of cherry leaf roll virus. *Archives of Virology* 157: 761–764.
- Ebel, R., A. Schnabel, G.M. Reustle, G. Krczal, and T. Wetzler. 2003. Molecular characterization of two German raspberry ringspot virus isolates infecting grapevines and construction of full length infectious clones. In *Extended abstracts 14th meeting of ICVG, Locorotondo, Italy*, 16.
- EFSA (EFSA Panel on Plant Health). 2013. Scientific opinion on the risk to plant health posed by Arabis mosaic virus, Raspberry ringspot virus, Strawberry latent ringspot virus and Tomato black ring virus to the EU territory with the identification and evaluation of risk reduction options. *EFSA Journal* 11: 3377. *Annales de Phytopathologie, No hors série*, 113–120.
- Eichmeier, A., M. Baránek, and M. Pidra. 2011. Genetic variability of Grapevine fanleaf virus isolates within genes 1B^{HEL} and 1E^{POL}. *Journal of Plant Pathology* 93: 511–515.
- Elbeaino, T., M. Digiario, F. Fallanaj, S. Kuzmanovic, and G.P. Martelli. 2011. Complete nucleotide sequence and genome organization of Grapevine Bulgarian latent virus. *Archives of Virology* 156: 875–879.
- Elbeaino, T., M. Digiario, S. Ghebremeskel, and G.P. Martelli. 2012. Grapevine deformation virus: Completion of the sequence and evidence on its origin from recombination events between grapevine fanleaf virus and arabis mosaic virus. *Virus Research* 166: 136–140.
- Elbeaino, T., H. Kiyi, R. Boutarfa, A. Minafra, G.P. Martelli, and M. Digiario. 2014. Phylogenetic analysis of the homing protein domain of Grapevine fanleaf virus (GFLV) isolates associated with “yellow mosaic” and “infectious malformation” syndromes in grapevines. *Archives of Virology* 159: 2757–2764.
- Esmanjand, D., B. Walter, G. Valentin, Z.T. Guo, and D. Cluzeau. 1992. Vertical distribution and infectious potential of *Xiphinema index* (Thorne et Allen, 1950) (Nematoda: Longidoridae) in fields affected by grapevine fanleaf virus in vineyards in the Champagne region of France. *Agronomie* 12: 395–399.
- Etienne, L., J.M. Clauzel, and M. Fuchs. 1991. Simultaneous detection of several nepoviruses infecting grapevine in a single DAS-ELISA test using mixed antisera. *Journal of Phytopathology* 131: 89–100.
- Faggioli, F., and S. La Starza. 2006. One-step multiplex RT-PCR for simultaneous detection of eight grapevine viruses and its application in a sanitary selection program. In *Extended abstracts 15th meeting of ICVG, Stellenbosch, South Africa*, 120–121.

- Ferreira, A.A., and O.A. De Sequeira. 1972. Preliminary studies on an undescribed grapevine virus. In *Proceedings 4th meeting of ICVG, Colmar, France. Annales de Phytopathologie, No. hors série*, 113–120.
- Fischer, R., and S. Schillberg. 2003. Engineering durable resistance in grapevines: A novel strategy for integrated disease management to overcome environmental impact of pesticides. In *Extended abstracts 14th meeting of ICVG, Locorotondo-Bari, Italy*, 224.
- Fresno, J., C. Blas, M. De Arias, and J. Romero. 1996. *Detección del nepovirus del entrenudo corto infeccioso de la vid en su nematodo vector por ELISA y PCR*, 83. Cordoba: VIII Congreso Nacional de la Sociedad Española de Fitopatología.
- Frison, E.A., and R. Stace-Smith. 1992. Cross-reacting and heterospecific monoclonal antibodies produced against Arabis mosaic nepovirus. *Journal of General Virology* 73: 2525–2530.
- Fuchs, M. 2003. Transgenic resistance: State of the art and perspectives. In *Extended abstracts 14th meeting of ICVG, Locorotondo-Bari, Italy*, 221–223.
- . 2006. Transgenic resistance: Advances and prospects. In *Extended abstracts 15th meeting of ICVG, Stellenbosch, South Africa*, 54–56.
- Fuchs, M., M. Pinck, M.A. Serghini, M. Ravelonandro, B. Walter, and L. Pinck. 1989. The nucleotide sequence of satellite RNA in Grapevine fanleaf virus strain F13. *Journal of General Virology* 70: 955–962.
- Fuchs, M., M. Pinck, L. Etienne, L. Pinck, and B. Walter. 1991. Characterization and detection of grapevine fanleaf virus by using cDNA probes. *Phytopathology* 81: 559–565.
- Gaire, F., C. Schmitt, C. Stussi-Garaud, L. Pinck, and C. Ritzenthaler. 1999. Protein 2A of grapevine fanleaf nepovirus is implicated in RNA2 replication and colocalizes to the replication site. *Virology* 264: 25–36.
- Gallitelli, D., V. Savino, and O.A. De Sequeira. 1983. Properties of a distinctive strain of Grapevine Bulgarian latent virus. *Phytopathologia Mediterranea* 22: 27–32.
- Garau, R., V. Padilla, I. Rumbos, B. Walter, and V. Savino. 1997. Indexing for the identification of virus and virus-like diseases of the grapevine. In *Sanitary selection of the grapevine. Protocols for detection of viruses and virus-like diseases*, Les Colloques, 86, ed. B. Walter, 97–117. Paris: Editions INRA.
- Gemrich, A.R., G. Link, and M. Seidel. 1993. Detection of grapevine fanleaf virus in infected grapevine by non-radioactive nucleic acid hybridization. *Vitis* 32: 237–242.
- Gokalp, K., M. Digiario, I. Cigsar, N. Abou Ghanem-Sabanadzovic, A. De Stradis, D. Boscia, and G.P. Martelli. 2003. Properties of a previously undescribed nepovirus from south-east Anatolia. *Journal of Plant Pathology* 85: 35–41.
- Golino, D.A., J.K. Uyemoto, and A.C. Goheen. 1992. Grape virus diseases. In *Grape pest management*, ed. D.L. Flaherty, L.P. Christensen, W.T. Lanini, J.J. Marois, P.A. Phillips, and L.J. Wilson, 101–109. Oakland: University of California, Division of Agriculture and Natural Resources Publication, 3343.
- Gottula, J., D. Lapato, K. Cantilina, S. Saito, B. Bartlett, and M. Fuchs. 2013. Genetic variability, evolution, and biological effects of Grapevine fanleaf virus satellite RNAs. *Phytopathology* 103: 1180–1187.
- Greif, C., O. Hemmer, and C. Fritsch. 1988. Nucleotide sequence of tomato black ring virus RNA-1. *Journal of General Virology* 69: 1517–1529.
- Hadidi, A., and R.W. Hammond. 1989. Construction of molecular clones for identification and detection of Tomato ringspot and Arabis mosaic viruses. *Acta Horticulturae* 235: 223–230.
- Hajizadeh, M., N. Sokhandan-Bashir, and T. Elbeaino. 2012. First report of Grapevine deformation virus and Grapevine Anatolian ringspot virus in Iran. *Journal of Plant Pathology* 94: S4.96.
- Harrison, B.D., and A.F. Murrant. 1996. *The plant viruses. Vol. 5. Polyhedral virions and bipartite RNA*. London: Plenum Press.
- Hasiów-Jaroszewska, B., N. Borodynko, M. Figlerowicz, and H. Pospieszny. 2012. Two types of defective RNAs arising from the tomato black ring virus genome. *Archives of Virology* 157: 569–572.

- Hemmer, C., E. Vigne, V. Goldschmidt, V. Komar, A. Marmonier, L. Valat, G. Demangeat, S. Vigneron, J.E. Masson, and O. Lemaire. 2009. Transgenic rootstocks expressing GFLV coat protein gene in a three years field trial; resistance assessment, impact on GFLV diversity and exchanges between rootstock and scion. In *Extended abstracts 16th meeting of ICVG, Dijon, France, Le Progrès Agricole et Viticole, 2009, Hors Série*, 228–229.
- Herrera, M.G., and V.M. Madariaga. 2001. Presence and incidence of grapevine viruses in central Chile. *Agricultura Tecnica* 61: 393–400.
- Hevin, M., M.M. Ottenwaelter, J.P. Doazan, and M. Rives. 1973. Investigating the transmission of “marbrure” and fanleaf through the seed in the grapevine. *Rivista di Patologia Vegetale* 9: 253–258.
- Hewitt, W.B. 1954. Some virus and virus-like diseases of grapevines. *Bulletin of the California Department of Agriculture* 43: 47–64.
- Hewitt, W.B., D.J. Raski, and A.C. Goheen. 1958. Nematode vector of soil-borne fanleaf virus of grapevines. *Phytopathology* 48: 586–595.
- Hewitt, W.B., A.C. Goheen, D.J. Raski, and G.V. Gooding Jr. 1962. Studies on virus diseases of the grapevine in California. *Vitis* 3: 57–83.
- Horvath, J., I. Tobias, and K. Hunyadi. 1994. New natural herbaceous hosts of grapevine fanleaf nepovirus. *HortScience* 26: 31–32.
- Hull, R. 2014. *Architecture and assembly of virus particles*. Plant virology. 5th ed, 69–143. New York: Academic.
- Huss, B., S. Muller, G. Sommermeyer, B. Walter, and M.H.V. Van Regenmortel. 1987. Grapevine fanleaf virus monoclonal antibodies: Their use to distinguish different isolates. *Journal of Phytopathology* 119: 358–370.
- Huss, B., B. Walter, and M. Fuchs. 1989. Cross-protection between Arabis mosaic virus and grapevine fanleaf virus isolates in *Chenopodium quinoa*. *Annals of Applied Biology* 114: 45–60.
- Hwang, C.F., K.N. Xu, R. Hu, R. Zhou, S. Riaz, and M.A. Walker. 2010. Cloning and characterization of XiR1, a locus responsible for dagger nematode resistance in grape. *Theoretical and Applied Genetics* 121: 789–799.
- Imura, Y., H. Oka, K. Kimata, M. Nasu, K. Nakahama, and T. Maeda. 2008. Comparisons of complete RNA-2 sequences, pathological and serological features among three Japanese isolates of Arabis mosaic virus. *Virus Genes* 37: 333–341.
- Ipach, U., B. Altmayer, and K.W. Heicchorn. 1992. Detection of Arabis mosaic virus using the polymerase chain reaction (PCR). *Vitis* 31: 213–219.
- Ipach, U., L. Kling, and D. Lesemann. 2003. First record of Cherry leaf roll virus in Germany. In *Extended abstracts 14th meeting of ICVG, Locorotondo-Bari, Italy*, 17–18.
- Izadpanah, K., M. Zaki-Aghl, and A. Rowhani. 2003a. Non-vitis hosts of grapevine fanleaf virus and their possible epidemiological significance. In *Extended abstracts 14th meeting of ICVG Locorotondo-Bari, Italy*, 210.
- Izadpanah, K., M. Zaki-Aghl, Y.P. Zhang, S.D. Daubert, and A. Rowhani. 2003b. Bermuda grass as a potential reservoir host for Grapevine fanleaf virus. *Plant Disease* 87: 1179–1182.
- Jankulova, M., V. Savino, D. Gallitelli, A. Quacquarelli, and G.P. Martelli. 1976. Isolation of Artichoke Italian latent virus from the grapevine in Bulgaria. In *Proceedings 6th meeting of ICVG, Cordoba, Spain, Monografias INIA*, 18, 143–148.
- Jawhar, J., A. Minafra, P. La Notte, C. Pirolo, P. Saldarelli, D. Boscia, V. Savino, and G.P. Martelli. 2009. Recombination events in RNA-2 of Grapevine fanleaf virus and Arabis mosaic virus in grapevines affected by yellow mosaic. In *Extended abstracts 16th meeting ICVG, Dijon France, Le Progrès Agricole et Viticole, 2009, Hors Série*, 73–74.
- Jelkmann, W., E. Maiss, M.E. Breyl, and R. Casper. 1988. Production and use of cDNA clones from arabis mosaic virus. *Annals of Applied Biology* 113: 483–491.
- Jones, A.T., F.D. McElroy, and D.J.F. Brown. 1981. Tests for transmission of cherry leaf roll virus using *Longidorus*, *Paralongidorus* and *Xiphinema* nematodes. *Annals of Applied Biology* 99: 143–150.

- Jones, A.T., D.J.F. Brown, W.J. McGavin, M. Rüdell, and B. Altmayer. 1994. Properties of an unusual isolate of Raspberry ringspot virus from grapevine in Germany and evidence of its possible transmission by *Paralodidorus maximus*. *Annals of Applied Biology* 124: 283–300.
- Katsiridakis, K.X., U.J. Potter-Damoulakis, N.I. Katis, and K.A. Roubelakis-Angelakis. 1989. Comparison of pollen grains from grapevine-fanleaf-infected and non-infected grapevines. *Phytoparasitica* 17: 65–66.
- Kölber, M., L. Beczner, S. Pacsa, and J. Lehoczky. 1985. Detection of grapevine chrome mosaic virus in field-grown vines by ELISA. In *Proceedings 8th meeting of ICVG, Bari, Italy*, 135–140.
- Komar, V., E. Vigne, G. Demangeat, O. Lemaire, and M. Fuchs. 2008. Cross-protection as control strategy against Grapevine fanleaf virus in naturally infected vineyards. *Plant Disease* 92: 1689–1694.
- Koolivand, D., N. Sokhandan-Bashira, S.A.A. Behjatniab, and R.A.J. Joozanic. 2014. Detection of Grapevine fanleaf virus by immunocapture reverse transcription-polymerase chain reaction (IC-RT-PCR) with recombinant antibody. *Archives of Phytopathology and Plant Protection* 47: 2070–2077.
- Krake, L.R., and R.C. Woodham. 1983. Grapevine yellow speckle agent implicated in the aetiology of vein banding disease. *Vitis* 22: 40–50.
- Lahogue, F., and G. Boulard. 1996. Recherche de genes de résistance naturelle à deux viroses de la vigne: le court-noué et l'enroulement. *Vitis* 35: 43–48.
- Laimer, M., O. Lemaire, E. Herrbach, V. Goldschmidt, A. Minafra, P. Bianco, and T. Wetzel. 2009. Resistance to viruses, phytoplasmas and their vectors in Europe: A review. *Journal of Plant Pathology* 91: 7–23.
- Lamprecht, R.L., M. Spaltman, D. Stephan, T. Wetzel, and J.T. Burger. 2013. Complete nucleotide sequence of a South African isolate of grapevine fanleaf virus and its associated satellite RNA. *Viruses* 5: 1815–1823.
- Lazar, J., M. Kölber, and J. Lehoczky. 1990. Detection of some nepoviruses (GFV, GFV-YM, GCMV, ArMV) in the seeds and seedlings of grapevines by ELISA. *Kertgazdasag* 22: 58–72.
- Le Gall, O., T. Candresse, V. Brault, and J. Dunez. 1989. Nucleotide sequence of Hungarian grapevine chrome mosaic nepovirus RNA-1. *Nucleic Acids Research* 17: 7795–7807.
- Le Gall, O., M. Lanneau, T. Candresse, and J. Dunez. 1995. The nucleotide sequence of the RNA-2 of an isolate of the English serotype of tomato black ring virus: RNA recombination in the history of nepoviruses. *Journal of General Virology* 76: 1279–1283.
- Le Gall, O., T. Iwanami, A. Karasev, T. Jones, K. Letho, H. Sanfacon, J. Wellink, T. Wetzel, and N. Yoshikawa. 2005. Genus Sadwavirus. In *Virus taxonomy*, Eight Report of the International Committee on Taxonomy of Viruses, ed. C.M. Fauquet, M.A. Mayo, J. Maniloff, U. Desselberger, and L.A. Ball, 799. San Diego: Academic.
- Lear, B., A.C. Goheen, and D.J. Raski. 1981. Effectiveness of soil fumigation for control of fanleaf nematode complex in grapevine. *American Journal of Enology and Viticulture* 32: 208–211.
- Legin, R., P. Bass, L. Etienne, and M. Fuchs. 1993. Selection of mild virus strains of fanleaf degeneration by comparative field performance of infected grapevine. *Vitis* 32: 103–110.
- Lehoczky, J., M. Kölber, L. Beczner, and S. Pacsa. 1984. Distribution of the grapevine chrome mosaic disease in Hungary and detection of its virus (GCMV) in the leaves of outdoor vines by ELISA technique. *Kertgazdasag* 16: 41–52.
- Liebenberg, A., M.J. Freeborough, C.J. Visser, D.U. Bellstedt, and J.T. Burger. 2009. Genetic variability within the coat protein gene of *Grapevine fanleaf virus* isolates from South Africa and the evaluation of RT-PCR, DAS-ELISA and ImmunoStrips as virus diagnostic assays. *Virus Research* 142: 28–35.
- Lister, R.M., and A.F. Murant. 1967. Seed-transmission of nematode-borne viruses. *Annals of Applied Biology* 59: 49–62.
- López-Fabuel, I., A. Olmos, A. Bassler, L. Dupuis-Maguiraga, L.B. Torres, E. Bertolini, and T. Wetzel. 2013. The complete genome sequence and molecular analysis of a Spanish isolate of Arabis mosaic virus infecting grapevine. *Spanish Journal of Agricultural Research* 11: 199–203.

- Loudes, A.M., C. Ritzenthaler, M. Pinck, M.A. Serghini, and L. Pinck. 1995. The 119 kDa and 124 kDa polyproteins of *Arabis* mosaic nepovirus (isolate S) are encoded by two distinct RNA2 species. *Journal of General Virology* 76: 899–906.
- MacFarlane, S.A., D.J.F. Brown, and R. Neilson. 2002. Nematodes. Plant virus-vector interactions. *Advances in Botanical Research* 36: 169–197.
- Maliogka, V.I., G.P. Martelli, M. Fuchs, and N.I. Katis. 2015. Control of viruses infecting grapevine. *Advances in Virus Research* 91: 175–227.
- Margis, R., M. Viry, M. Pinck, and L. Pinck. 1991. Cloning and in vitro characterization of the grapevine fanleaf virus proteinase cistron. *Virology* 185: 779–787.
- Margis, R., C. Ritzenthaler, J. Reinbolt, M. Pinck, and L. Pinck. 1993. Genome organization of grapevine fanleaf nepovirus RNA-2 deduced from the 122k polyprotein in vitro cleavage products. *Journal of General Virology* 74: 1919–1926.
- Margis, R., M. Viry, M. Pinck, N. Bardonnet, and L. Pinck. 1994. Differential proteolytic activities of precursors and mature forms of the 24K proteinase of grapevine fanleaf nepovirus. *Virology* 200: 79–86.
- Martelli, G.P. 1993. *Graft-transmissible diseases of grapevines*, Handbook for Detection and Diagnosis. Rome: FAO Publication Division.
- . 2014. Directory of virus and virus-like. Diseases of the grapevine and their agents. *Journal of Plant Pathology* 96 (1S): 1–136.
- Martelli, G.P., and W.B. Hewitt. 1963. Comparative studies on some Italian and California virus diseases of grapevine. *Phytopathologia Mediterranea* 2: 285–294.
- Martelli, G.P., and M. Russo. 1984. Use of thin sectioning for the visualization and identification of plant viruses. *Methods in Virology* 8: 143–224.
- Martelli, G.P., and C.E. Taylor. 1990. Distribution of viruses and their nematode vectors. *Advances in Disease Vector Research* 6: 151–189.
- Martelli, G.P., J. Lehoczky, and A. Quacquarelli. 1965. Host range and properties of a virus associated with Hungarian grapevines showing macroscopic symptoms of fanleaf and yellow mosaic. In *Proceedings international conference on virus and vector on perennial hosts, with special reference to Vitis, Davis, USA*, 389–401.
- Martelli, G.P., A. Quacquarelli, and J. Lehoczky. 1968. Serologische Verwandtschaft eines mit dem ungarischen “chrome mosaic” vergesellschafteten Virus mit einem Stamm des “Tomato black ring virus”. *Weinberg und Keller* 15: 505.
- Martelli, G.P., D. Gallitelli, P. Abracheva, V. Savino, and A. Quacquarelli. 1977. Some properties of Grapevine Bulgarian latent virus. *Annals of Applied Biology* 85: 51–58.
- Mauro, M.C., S. Toutain, B. Walter, L. Pick, L. Otten, P. Coutos-Thevenot, A. Deloire, and P. Barbier. 1995. High efficiency regeneration of grapevine plants transformed with GFLV coat protein gene. *Plant Science* 112: 97–106.
- Mayo, M.A., and D.J. Robinson. 1996. Nepoviruses: Molecular biology and replication. In *The plant viruses: Polyhedral virions and bipartite RNA genomes*, ed. B.D. Harrison and A.F. Murrant, vol. 5, 139–185. New York: Plenum Press.
- Mayo, M.A., C. Fritsch, M.J. Leibowitz, P. Palukaitis, K.B. Scholtof, G. Simons, and M. Taliany. 2000. Satellite nucleic acids. In *Virus taxonomy*, Seventh Report of the International Committee on Taxonomy of Viruses, ed. M.H.V. Van Regenmortel, C.M. Fauquet, D.H.L. Bishop, E.B. Carstens, M.K. Estes, S.M. Lemon, J. Maniloff, M.A. Mayo, D.J. McGeoch, C.R. Pringle, and R.B. Wickner, 1028–1032. San Diego: Academic.
- Mekuria, T.A., L.R. Gutha, R.R. Martin, and R.A. Naidu. 2009. Genome diversity and intra and interspecies recombination events in Grapevine fanleaf virus. *Phytopathology* 99: 1394–1402.
- Meredith, C.P., L.A. Lider, D.J. Raski, and N.L. Ferrari. 1982. Inheritance of tolerance to *Xiphinema index* in *Vitis* species. *American Journal of Enology and Viticulture* 33: 154–158.
- Meyer, M., O. Hemmer, and C. Fritsch. 1984. Complete nucleotide sequence of a satellite RNA of Tomato black ring virus. *Journal of General Virology* 65: 1575–1583.
- Mircetich, S.M., R.R. Sanborn, and D.E. Ramos. 1980. Natural spread, graft-transmission and possible etiology of walnut blackline disease. *Phytopathology* 70: 962–969.

- Mullins, M.G., F.C.A. Tang, and D. Facciotti. 1990. Agrobacterium-mediated genetic transformation of grapevines: Transgenic plants of *Vitis ruspestris* Scheele and buds of *Vitis vinifera* L. *Biotechnology* 8: 1041–1045.
- Murant, A.F. 1981. Nepoviruses. In *Handbook of plant virus infection comparative diagnosis*, ed. E. Kurstak, 197–238. Amsterdam: Elsevier/North Holland Biomedical Press.
- . 1983. Seed and pollen transmission of nematode-borne viruses. *Seed Science Technology* 11: 973–987.
- Murant, A.F., and C.E. Taylor. 1965. Treatment of soil with chemicals to prevent transmission of tomato black ring and raspberry ringspot viruses by *Longidorus elongatus* (De Man). *Annals of Applied Biology* 55: 227–237.
- Naraghi-Arani, P., S. Daubert, and A. Rowhani. 2001. Quasispecies nature of the genome of Grapevine fanleaf virus. *Journal of General Virology* 82: 1791–1795.
- Nolasco, G., and O.A. De Sequeira. 1993. Immunocapture polymerase chain reaction (IC/PCR) in the diagnosis of grapevine fanleaf virus (GFLV) in grapevine field samples. In *Extended abstracts 11th meeting of ICVG, Montreux, Switzerland*, 31–32.
- Nölke, G., R. Fischer, and S. Schillberg. 2004. Antibody-based pathogen resistance in plants. *Journal of Plant Pathology* 86: 6–17.
- Nölke, G., P. Cobanov, K. Uhde-Holzem, G. Reustle, R. Fischer, and S. Schillberg. 2009. Grapevine fanleaf virus (GFLV)-specific antibodies confer GFLV and Arabis mosaic virus (ArMV) resistance in *Nicotiana benthamiana*. *Molecular Plant Pathology* 10: 41–49.
- O'Bannon, J.H., and J.N. Inserra. 1990. Nematode vectors-transmission of plant viruses. *Nematology Circular* 178: 4.
- Oliver, J.E., and M. Fuchs. 2011. Tolerance and resistance to viruses and their vectors in *Vitis* sp.: A virologist's perspective of the literature. *American Journal of Enology and Viticulture* 62: 438–451.
- Oliver, J.E., E. Vigne, and M. Fuchs. 2010. Genetic structure and molecular variability of Grapevine fanleaf virus populations. *Virus Research* 152: 30–40.
- Osman, F., C. Leutenegger, D.A. Golino, and A. Rowhani. 2008. Comparison of low-density arrays, RT-PCR and real-time TaqMan RT-PCR in detection of grapevine viruses. *Journal of Virological Methods* 149: 292–299.
- Ouertani, R., V. Savino, A. Minafra, D. Boscia, M.A. Castellano, G.P. Martelli, and N. Greco. 1992. Properties of a previously undescribed grapevine nepovirus from Tunisia. *Archives of Virology* 126: 107–117.
- Panjan, M., and A. Saric. 1963. Seroloska ispitivanja Arabis mosaic virusa u vinovejlozi i tresnji geldifuzionom metodom. *Agronomski glasnik* 3: 204–206.
- Petri, L. 1913. Sul significato patologico dei cordoni endocellulari nei tessuti della vite. *Rendiconti della Reale Accademia dei Lincei, Ser.V* 22: 154–161.
- Pinck, L. 1998. Grapevine nepovirus proteinase. In *Handbook of proteolytic enzymes*, ed. A.J. Barrett and J.F. Woessner, 719–720. London: Academic.
- Pinck, L., M. Fuchs, M. Pinck, M. Ravelonandro, and B.A. Walter. 1988. Satellite RNA in grapevine fanleaf virus strain F13. *Journal of General Virology* 69: 233–239.
- Pinck, M., J. Reibolt, A.M. Loudes, M. Loret, and L. Pinck. 1991. Primary structure and location of genome-linked protein (VPg) of Grapevine fanleaf nepovirus. *FEBS Letters* 284: 117–119.
- Pompe-Novak, M., I. Gutiérrez-Aguirre, J. Vojvoda, M. Blas, I. Tomazic, E. Vigne, M. Fuchs, M. Ravnikar, and N. Petrovic. 2007. Genetic variability within RNA2 of grapevine fanleaf virus. *European Journal of Plant Pathology* 117: 307–312.
- Ramsdell, D.C., and R.L. Myers. 1978. Epidemiology of peach rosette mosaic virus in a Concord grape vineyard. *Phytopathology* 68: 447–450.
- Ramsdell, D.C., and R. Stace-Smith. 1981. Physical and chemical properties of the particles and ribonucleic acid of Blueberry leaf mottle virus. *Phytopathology* 71: 468–472.
- Raski, D.J. 1955. Additional observations on the nematodes attacking grapevines and their control. *American Journal of Enology and Viticulture* 6: 29–31.

- Raski, D.J., A.C. Goheen, L.A. Lider, and C.P. Meredith. 1983. Strategies against Grapevine fanleaf virus and its nematode vector. *Plant Disease* 67: 335–339.
- Reustle, G.M., R. Ebel, P. Winterhagen, T. Manthey, C. Dubois, A. Bassler, M. Sinn, P. Cobanov, T. Wetzel, G. Krczal, R. Jardak-Jamoussi, and A. Ghorbel. 2005. Induction of silencing in transgenic grapevines (*Vitis* sp.). *Acta Horticulturae* 689: 521–528.
- Reustle, G.M., P. Winterhagen, R. Jardak-Jamoussi, P.I. Cobanov, C. Dubois, T. Manthey, T. Wetzel, A. Ghorbel, G. Brendel, U. Ipach, and G. Krczal. 2006. Resistance against nepoviruses: Molecular and biological characterisation of transgenic tobacco and grapevine plants. In *Extended abstracts 15th meeting of ICVG, Stellenbosch, South Africa*, 59–60.
- Ritzenthaler, C., M. Viry, M. Pinck, R. Margis, M. Fuchs, and L. Pinck. 1991. Complete nucleotide sequence and organization of grapevine fanleaf nepovirus RNA1. *Journal of General Virology* 72: 2357–2365.
- Ritzenthaler, C., A.C. Schmit, P. Michler, C. Stussi-Garaud, and L. Pinck. 1995. Grapevine fanleaf nepovirus P38 putative movement protein is located on tubules in vivo. *Molecular Plant Microbe Interaction* 8: 379–387.
- Ritzenthaler, C., C. Laporte, F. Gaire, P. Dunoyer, C. Schmitt, S. Duval, A. Piequet, A.M. Loudes, O. Rohfritsch, C. Stussi-Garaud, and P. Pfeiffer. 2002. Grapevine fanleaf virus replication occurs on endoplasmic reticulum-derived membranes. *Journal of Virology* 17: 8808–8819.
- Roberts, I.M., and D.J.F. Brown. 1980. Detection of six nepoviruses in their nematode vectors by immunosorbent electron microscopy. *Annals of Applied Biology* 96: 187–192.
- Rott, M.E., J.H. Tremaine, and D.M. Rochon. 1991. Comparison of the 5' and 3' termini of tomato ringspot virus RNA-1 and RNA-2: Evidence for RNA recombination. *Virology* 185: 468–472.
- Rowhani, A. 1992. Use of F(ab')₂ antibody fragment in ELISA for detection of grapevine viruses. *American Journal of Enology and Viticulture* 43: 38–40.
- Rowhani, A., C. Chay, D.A. Golino, and B.W. Falk. 1993. Development of a polymerase chain reaction technique for the detection of grapevine fanleaf virus in grapevine tissue. *Phytopathology* 83: 749–753.
- Rowhani, A., F. Osman, and D.A. Golino. 2003. Development of a detection and quantification TaqMan assay method for grapevine viruses using real time one-step RT-PCR. In *Extended abstracts 14th meeting of ICVG, Locorotondo-Bari, Italy*, 194.
- Rowhani, A., J.K. Uyemoto, D.A. Golino, and G.P. Martelli. 2005. Pathogen testing and certification of *Vitis* and *Prunus* species. *Annual Review of Phytopathology* 43: 261–278.
- Rüdel, M. 1977. Übertragung des Tomatenschwarzringflecken-Virus (tomato black ring virus) durch den Nematoden *Longidorus attenuatus* (Nematoda) auf Reben und andere Pflanzenarten. *Wein-Wissenschaft* 32: 11–24.
- . 1992. Nepoviruses of grapevine and their nematode vectors in the EEC. In *Grapevine viruses and certification in EEC countries: State of the art*, Quaderno No. 3, ed. G.P. Martelli, 23–39. Bari: Istituto Agronomico Mediterraneo.
- Rüdel, M., M. Alebrand, and B. Altmayer. 1983. Untersuchungen über den Einsatz des ELISA-tests zum Nachweis verschiedener Rebviren. *Wein-Wissenschaft* 38: 177–185.
- Russo, M., G.P. Martelli, and V. Savino. 1982. Immunosorbent electron microscopy for detecting sap-transmissible viruses of grapevine. In *Proceedings 7th meeting of ICVG, Niagara Falls, Canada*, 251–257.
- Saldarelli, P., A. Minafra, and B. Walter. 1993. A survey of Grapevine fanleaf nepovirus isolates for the presence of satRNA. *Vitis* 32: 99–102.
- Sanfaçon, H. 2008. Nepovirus. In *Encyclopedia of virology*, ed. B.W.J. Mahy and M.H. Van Regenmortel, 405–413. Oxford: Elsevier.
- Sanfaçon, H., T. Iwanami, A.V. Karasev, R. van der Vlugt, J. Wellink, T. Wetzel, and N. Yoshikawa. 2012. Family *Secoviridae*. In *Virus taxonomy*, Ninth Report of the International Committee on the Taxonomy of Viruses, ed. A.M.Q. King, M.J. Adams, E.B. Carstens, and E.J. Lefkowitz, 881–899. Amsterdam: Elsevier/Academic.
- Savino, V., D. Gallitelli, M. Jankulova, and G.L. Rana. 1976. A comparison of four isolates of Artichoke Italian latent virus (AILV). *Phytopathologia Mediterranea* 16: 41–50.

- Schellenberger, P., P. Andret-Link, C. Schmitt-Keichinger, M. Bergdoll, A. Marmonier, E. Vigne, O. Lemaire, M. Fuchs, G. Demangeat, and C. Ritzenthaler. 2010. A stretch of 11 amino acids in the B-C loop of the coat protein of grapevine fanleaf virus is essential for transmission by the nematode *Xiphinema index*. *Journal of Virology* 84: 7924–7933.
- Schmelzer, K. 1963. Untersuchungen an viren der zier- und wildgehölze: 3. Mitteilung: virosen an Robinia, Caryopteris, Ptelea und anderen Gattungen. *Phytopathologische Zeitschrift* 46: 235–268.
- Scott, N.W., J.I. Cooper, Y.Y. Liu, and C.U.T. Helen. 1992. A 1.5 kb sequence homology in the 3-terminal regions of RNA-1 and RNA-2 of a birch isolate of cherry leaf roll nepovirus is also present, in part, in a rhubarb isolate. *Journal of General Virology* 73: 481–485.
- Serghini, M.A., M. Fuchs, M. Pinck, J. Reinbolt, B. Walter, and L. Pinck. 1990. RNA2 of grapevine fanleaf virus: Sequence analysis and coat protein cistron location. *Journal of General Virology* 71: 1433–1441.
- Staudt, G., and B. Weischer. 1992. Resistance to transmission of grapevine fanleaf virus by *Xiphinema index* in *Vitis rotundifolia* and *Vitis munsoniana*. *Wein-Wissenschaft* 47: 56–61.
- Stellmach, G., and R. Bercks. 1963. Untersuchungen an Rebenvirosen: Nachweis des Tomaten schwarzringflecken-Virus (tomato blackring virus) in kranken Stocken der Sorte Aramon x Riparia 143 A M.G. (Amerikenerrebe). *Phytopathologische Zeitschrift* 48: 200–202.
- Stellmach, G., and R.E. Berres. 1985. Investigations on mixed infections of nepoviruses in *Vitis* spp. and *Chenopodium quinoa* Willd. by means of ELISA. *Phytopathologia Mediterranea* 24: 125–128.
- . 1986. Begrenzte Infektionsanfälligkeit der *Vitis vinifera*-Sorte 'Kerner' gegenüber dem Arabismosaik-Virus? *Zeitschrift für Pflanzenkrankheiten und Pflanzenschutz* 93: 356–360.
- Stobbs, L.W., and J.G. Van Schagen. 1985. Relationship between grapevine Joannes-Seyve virus and tomato black ring virus. *Canadian Journal of Plant Pathology* 7: 37–40.
- Szychowski, J.A., M.V. McKenry, M.A. Walker, J.A. Wolpert, R. Credi, and J.S. Semancik. 1995. The vein-banding disease syndrome: A synergistic reaction between grapevine viroids and fanleaf virus. *Vitis* 34: 229–232.
- Tanne, E. 1980. The use of ELISA for the detection of some NEPO viruses in grapevines. In *Proceedings 7th meeting of ICVG, Niagara Falls, Ontario, Canada*, 293–296.
- Taylor, C.E., and D.J.F. Brown. 1997. *Nematode vectors of plant viruses*. Wallingford: CAB International.
- Taylor, R.H., and W.B. Hewitt. 1964. Properties and serological relationships of Australian and Californian soil-borne viruses of the grapevine and Arabis mosaic virus. *Australian Journal of Agricultural Research* 15: 571–585.
- Taylor, C.E., and D.J. Raski. 1964. On the transmission of grapevine fanleaf by *Xiphinema index*. *Nematologica* 10: 489–495.
- Taylor, C.E., and W.M. Robertson. 1969. The location of raspberry ringspot and tomato black ring viruses in the nematode vector, *Longidorus elongatus*. *Annals of Applied Biology* 64: 233–237
- . 1970. Sites of virus retention in the alimentary tract of the nematode vectors, *Xiphinema diversicaudatum* (Micol.) and *X. index* (Thorne and Allen). *Annals of Applied Biology* 66(3): 375–380
- Tzanetakakis, I.E., J.D. Postman, R.C. Gergerich, and R.R. Martin. 2006. A virus between families: Nucleotide sequence and evolution of Strawberry latent ringspot virus. *Virus Research* 121: 199–204.
- Vigne, E., M. Bergdoll, S. Guyader, and M. Fuchs. 2004a. Population structure and genetic variability within isolates of grapevine fanleaf virus from a naturally infected vineyard in France: Evidence for mixed infection and recombination. *Journal of General Virology* 85: 2435–2445.
- Vigne, E., V. Komar, and M. Fuchs. 2004b. Field safety assessment of recombination in transgenic grapevines expressing the coat protein gene of Grapevine fanleaf virus. *Transgenic Research* 13: 165–179.

- Vigne, E., A. Marmonier, and M. Fuchs. 2008. Multiple interspecies recombination events within RNA2 of Grapevine fanleaf virus and Arabis mosaic virus. *Archives of Virology* 153: 1771–1776.
- Vuittenez, A., J. Kuszala, M. Rüdél, and H. Brückbauer. 1970. Détection et étude sélogique du virus latent des taches annulaires du fraisier (strawberry latent ringspot), du virus des anneaux noirs de la tomate (tomato black ring) et du virus des taches annulaires du framboisier (Raspberry ringspot) chez des vignes du Palatinat. *Annales de Phytopathologie* 2: 279–327.
- Walker, M.A., and Y. Jin. 2000. Breeding *Vitis rupestris* × *Muscadinia rotundifolia* rootstocks to control *Xiphinema index* and fanleaf degeneration. *Acta Horticulturae* 528: 517–522.
- Walker, M.A., and C.P. Meredith. 1990. The genetic of resistance to Grapevine fanleaf virus in *Vitis vinifera*. In *Proceedings 5th international symposium on grape breeding, St. Martin/Pfalz, Germany*, 228–238.
- Walker, M.A., C.P. Meredith, and A.C. Goheen. 1985. Sources of resistance to grapevine fanleaf virus (GFV) in *Vitis* species. *Vitis* 24: 218–228.
- Walker, M.A., J.A. Wolpert, and E. Weber. 1994. Viticultural characteristics of VR hybrid rootstocks in a vineyard site infected with grapevine fanleaf virus. *Vitis* 33: 19–23.
- Walter, B., J. Kuszala, and A. Vuittenez. 1979. Diagnostic sérologique par les tests PALLAS et ELISA. Application aux virus de la rhizomanie de la betterave et du court-noué de la vigne. *Annales de Phytopathologie* 11: 568–569.
- Wei, T., and G. Clover. 2008. Use of primers with 5' non-complementary sequences in RT-PCR for the detection of nepovirus subgroups A and B. *Journal of Virological Methods* 153: 16–21.
- Wetzel, T., L. Meunier, U. Jaeger, G.M. Reustle, and G. Krczal. 2001. Complete nucleotide sequence of the RNA 2 of German isolates of grapevine fanleaf and arabis mosaic nepoviruses. *Virus Research* 75: 129–145.
- Wetzel, T., R. Jardak, L. Meunier, A. Ghorbel, G.M. Reustle, and G. Krczal. 2002. Simultaneous RT-PCR detection and differentiation of arabis mosaic 332 and grapevine fanleaf nepoviruses in grapevines with a single pair of primers. *Journal of Virological Methods* 101: 63–69.
- Wetzel, T., R. Ebel, B. Moury, O. Le Gall, S. Endisch, G.M. Reustle, and G. Krczal. 2006. Sequence analysis of grapevine isolates of Raspberry ringspot nepovirus. *Archives of Virology* 151: 599–606.
- Worobey, M., and E.C. Holmes. 1999. Evolutionary aspects of recombination in RNA viruses. *Journal of General Virology* 80: 2535–2543.
- Wyss, U. 2000. *Xiphinema index*, maintenance, and feeding in monoxenic cultures. In *Maintenance of human, animal and plant pathogen vectors*, ed. K. Maramorosch and F. Mahmood, 251–281. Enfield: Science Publishers.
- Zakiaghli, M., K. Izadpanah, Z. Gholampour, M. Kargar, and M. Mehrvar. 2015. Molecular characterization of Grapevine fan leaf virus from non *Vitis* hosts. In *Proceedings 18th meeting of ICVG, Ankara, Turkey*, 149–150.
- Zarghani, S.N., M. Shams-Bakhsh, N.S. Bashir, and T. Wetzel. 2013. Molecular characterization of whole genomic RNA2 from Iranian isolates of Grapevine fanleaf virus. *Journal of Phytopathology* 161: 419–425.
- Zarghani, S.N., L. Dupuis-Maguiraga, A. Bassler, and T. Wetzel. 2014. Mapping of the exchangeable and dispensable domains of the RNA2-encoded 2AHP protein of Arabis mosaic nepovirus. *Virology*, 458–459.
- Zhang, G., and H. Sanfaçon. 2006. Characterization of membrane association domains within the tomato ringspot nepovirus X2 protein, an endoplasmic reticulum-targeted polytopic membrane protein. *Journal of Virology* 80: 10847–10857.

Chapter 4

Molecular, Cellular, and Structural Biology of *Grapevine fanleaf virus*

C. Schmitt-Keichinger, C. Hemmer, F. Berthold, and C. Ritzenthaler

Abstract *Grapevine fanleaf virus* (GFLV) is one of the 15 viruses causing fanleaf degeneration, one of the most detrimental viral diseases of grapevines worldwide. GFLV belongs to the genus *Nepovirus* in the family *Secoviridae*. It was the first phytovirus for which transmission by an ectoparasitic dagger nematode vector was demonstrated and the first *Nepovirus* for which infectious clones were obtained, paving the way to studies on virus-vector-host interactions. Information on subcellular localization of GFLV-encoded proteins and the use of modified synthetic virus constructs resulted in a better understanding of virus movement and transmission. In recent years, advances on the identification of viral determinants involved in the specific transmission of GFLV by *Xiphinema index* were made, and the atomic structure of the virus was obtained at a 2.7 Å resolution, revealing potential sites of interaction with the nematode vector at the surface of the particle. Host factors involved in the early steps of the virus cell-to-cell movement and viral determinants of symptom development in herbaceous hosts were identified. Here we review the current knowledge of GFLV with a special emphasis on some of its unique features compared to other nepoviruses. We also discuss the recent progress in regard to new antiviral strategies and suggest future research priorities.

Keywords Infectious degeneration • *Nepovirus* • *Secoviridae* • Movement • Transmission • Defense • Host factors • Symptom determinant • Resistance • Antiviral strategy

C. Schmitt-Keichinger (✉) • F. Berthold • C. Ritzenthaler
Institut de Biologie Moléculaire des Plantes CNRS-UPR 2357, associé à l'Université de Strasbourg, 12 rue du Général Zimmer, 67084 Strasbourg, France
e-mail: keichinger@unistra.fr

C. Hemmer
Institut de Biologie Moléculaire des Plantes CNRS-UPR 2357, associé à l'Université de Strasbourg, 12 rue du Général Zimmer, 67084 Strasbourg, France

Institut National de la Recherche Agronomique, UMR 1131 INRA/Université de Strasbourg, 28 rue de Herrlisheim, 68021 Colmar, France

Introduction

Grapevine fanleaf virus (GFLV) is one of the 15 nepoviruses causing grapevine degeneration disease (Martelli 2014b). While the disease caused by European viruses is termed “fanleaf disease,” its American counterpart is known as “grapevine decline.” Based on a worldwide distribution, economic impact, absence of efficient management measures, and nematode transmission, this virus is one of the most damaging viruses to the grape and wine industry (Andret-Link et al. 2004a). Depending on environmental conditions, virus strains and scion/rootstock combinations, crop losses vary from 10 to 80% or can even reach a total loss of production. Foliar symptoms appear in early spring as discolorations (mosaic, chlorosis, vein banding) and deformations (distortions, closer veins, toothed margins) and petiole opening that give the appearance of a fan, hence the name of the virus (Andret-Link et al. 2004a; Martelli 2014b). These symptoms are visible throughout the vegetative period although they can fade away or even disappear during periods of high temperatures. Malformed canes can present a zigzag shape, shortened internodes, double nodes, branching abnormalities, and even fasciations (Andret-Link et al. 2004a; Martelli 1993, 2014b; Raski et al. 1983). The flowers and fruits of infected grapevines show developmental defaults leading to clusters with smaller and unevenly matured berries associated with altered sugar content and acidity concentrations. In addition to typical symptoms, various metabolic plant processes are modified, leading to a progressive decline, a reduced vigor, and ultimately a shortened longevity of the infected vine (Andret-Link et al. 2004a; Walter 1988).

In addition to the well-documented infection of most cultivated grapevines (*Vitis* spp.), GFLV is also reported to naturally infect herbaceous weeds in vineyards such as members of the *Poaceae*, which could serve as reservoirs (Cseh et al. 2012; Horvath et al. 1994; Izadpanah et al. 2003). Crude sap of infected grapevine tissue can be used to infect herbaceous plant species in the families *Amaranthaceae*, *Cucurbitaceae*, *Solanaceae*, and *Fabaceae* (Andret-Link et al. 2004a; Belin et al. 2001). More recently, inoculation of the model plant *Arabidopsis thaliana* in the family *Brassicaceae* with purified GFLV preparations was reported (Amari et al. 2010).

GFLV is encapsidated in isometric particles of about 30 nm in diameter. Particles result from the assembly of a single capsid protein of 56 kDa containing three jelly-roll domains, conferring the virus a pseudo $T = 3$ symmetry. The virus is specifically transmitted by the dagger nematode *Xiphinema index* and belongs to the genus *Nepovirus*, which stands for nematode-transmitted polyhedral virus in the subfamily *Comovirinae*, family *Secoviridae*, one of the five families within the order *Picornavirales* (Sanfaçon et al. 2009; van der Vlugt et al. 2015). This order also comprises the animal enterovirus poliovirus (PV), one of the most studied RNA viruses (Le Gall et al. 2008). Nepoviruses were divided in three subgroups [A to which GFLV and *Arabis mosaic virus* (ArMV) belong, B, and C] based on the length of RNA2, sequence similarities, and serological relationships (Francki et al. 1985; Murrant 1981; Sanfaçon 2008).

GFLV has a bipartite genome consisting of two single-stranded positive-sense RNAs. Each RNA is translated into a single polyprotein, which undergoes a proteolytic processing in an RNA1 translation product-dependent manner to produce eight final maturation products (Andret-Link et al. 2004a; Morris-Krsinich et al. 1983). Infectious cDNA clones are available for GFLV (Viry et al. 1993; Vigne et al. 2013). These infectious cDNA clones have helped elucidate the function of most viral products (reviewed in Andret-Link et al. 2004a). However, many aspects of the virus life cycle remain poorly understood.

This review summarizes the current knowledge of the molecular and cellular processes governing the main steps of the viral life cycle with a special emphasis on recent progress regarding replication, cell-to-cell movement, and nematode transmission. Other aspects of GFLV such as the genetic structure of vineyard populations or management strategies are addressed in Chaps. 3 and 25, 27, 28, and 29 of this book.

Some Historical Perspectives

An extensive historical review of infectious degeneration was recently published (Martelli 2014a). Therefore, only a short account of major discoveries will be provided here with a major emphasis on the molecular aspects of the GFLV life cycle. Grapevine degeneration disease was mentioned first in a French report from the late nineteenth century (Cazalis-Allut 1865). In 1975, typical fanleaf disease symptoms were observed on grapevine leaves that were collected between 1880 and 1886 and kept in a herbarium (Martelli and Piro 1975). Soon after the discovery of viruses then termed *contagium vivum fluidum* (Beijerinck 1898), a virus agent was suspected to cause fanleaf degeneration (Baccarini 1902; Savastano 1908). However, it is only in 1960 that the virus was identified by electron microscopy observation of partially purified virus preparations obtained from infected *Chenopodium amaranticolor* (Cadman et al. 1960). These partial purifications were also used to characterize some biochemical and serological properties of the virus. The failure to transfer GFLV from infected *C. amaranticolor* to the natural grapevine host by mechanical inoculation delayed the fulfillment of Koch's postulates. It is only after the vector was identified that the causal relationship between GFLV and the disease was established (Hewitt et al. 1962). The soil-borne transmission of the virus was long suspected from the patchy distribution of diseased vines in vineyards. The demonstration of *X. index* transmitting GFLV was the first proof of a phytovirus vectored by a nematode (Cadman et al. 1960; Hewitt et al. 1958). This groundbreaking research established that GFLV is the causal agent of fanleaf disease. The fact that *X. index* is the vector of GFLV rather than the hemipteran phylloxera was a major driver for the creation of the International Council for the Study of Virus and Virus-Like Diseases of the Grapevine (ICVG) in 1962. ICVG is still active and promotes scientific exchanges and cooperation on graft-transmissible grapevine diseases worldwide (Martelli 2014a). The findings by Hewitt et al. (1958) largely contributed to

subsequent studies on the relationship between GFLV and *X. index*. For example, the acquisition and inoculation access periods were determined in the late 1960s (Das and Raski 1968). Later, in the 1970s, GFLV was visualized as monolayers of particles in the nematode's feeding apparatus extending from the odontophore to the esophagus (Raski et al. 1973; Taylor and Robertson 1970). Then, immunosorbent electron microscopy (ISEM, Roberts and Brown 1980) and enzyme-linked immunosorbent assays (ELISA, Walter and Etienne 1987; Walter et al. 1979, 1984) were developed for the detection of nepoviruses, including GFLV, in single nematodes and plant roots or leaves. In the 1990s, the emergence of molecular tools allowed the determination of the sequence of the GFLV reference strain F13 (Fuchs et al. 1989; Ritzenthaler et al. 1991; Serghini et al. 1990), the engineering of infectious cDNA clones (Viry et al. 1993), and the development of recombinant molecules between GFLV and the serologically related ArMV (ArMV, Belin et al. 1999). This pioneering work led more recently to the identification of the coat protein (CP) as the determinant of the specific GFLV transmission by *X. index* (Andret-Link et al. 2004b; Belin et al. 2001). These efforts alongside the determination of the structure of GFLV and ArMV finally resulted in the hypothesis that a positively charged cavity at the external surface of GFLV could constitute a nematode-receptor-binding pocket (Lai-Kee-Him et al. 2013; Schellenberger et al. 2010, 2011).

Genome Organization

As GFLV was the first grapevine virus successfully passaged to herbaceous plants, it was the first to be extensively characterized and completely sequenced. Like other nepoviruses, GFLV particles sediment as three distinct components called top (T), middle (M), and bottom (B) in sucrose density gradients (Quacquarelli et al. 1976). T components correspond to empty shells whereas M and B particles contain the bipartite single-stranded RNA genome of positive polarity. The molecular mass of the two linear genomic molecules was estimated at 2.4 and 1.4×10^6 Da for RNA1 and RNA2, respectively (Morris-Krsinich et al. 1983; Quacquarelli et al. 1976). These RNAs are polyadenylated at their 3' end and covalently linked to a small viral protein (VPg) at their 5' extremity. In 1988, a GFLV strain was isolated from a Muscat vine in Frontignan, France. This strain called F13 showed exacerbated symptoms after transfer to *C. quinoa* (Vuittenez et al. 1964). GFLV-F13 contains an additional RNA (RNA3), which was shown to be a satellite RNA (satRNA) encoding a single protein (Pinck et al. 1988). This satRNA of 1114 nucleotides (nts) was the first GFLV RNA for which a complete cDNA copy was cloned and sequenced (Fuchs et al. 1989). Replication assays of *in vitro* synthesized wild-type or mutated transcripts of RNA3 in the presence of the helper virus genome in *C. quinoa* protoplasts confirmed the expression of a nonstructural protein of 37 kDa (called P3). They also revealed the absolute requirement of the 14 nt long 5' untranslated region (UTR), the 74 nt long 3'-UTR, and the P3 protein for RNA3 replication (Hans et al. 1992, 1993). The presence of a similar satRNA was subsequently described in 15%

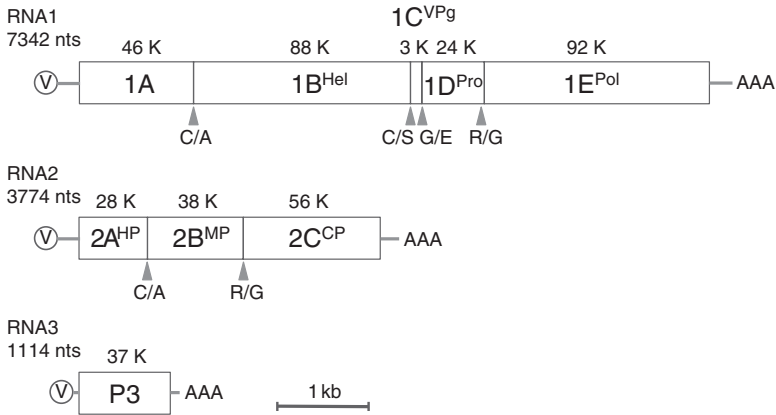

Fig. 4.1 Genetic organization of *Grapevine fanleaf virus* (GFLV). *Open boxes* represent coding sequences and *lines* represent the 5'- and 3'-UTRs. The size of RNAs and molecular masses of proteins are given for GFLV strain F13. Dipeptidic cleavage sites are indicated in the single letter code *below the arrowheads*. The VPg is depicted as a *circle containing a V sign*

of GFLV isolates passaged on *C. quinoa* plants as well as in *Vitis vinifera* cv. Glera from Italy (Saldarelli et al. 1993). More recently, additional infectious cDNA clones of satRNAs were obtained, and their specific relationship to helper viruses was shown (Gottula et al. 2013; Lamprecht et al. 2013). However, the function of GFLV satRNAs remains unknown since they did not show any effect on virus accumulation nor symptom development in herbaceous hosts, and they were proposed to have originated by chance recombination between a nepovirus genomic RNA and an unknown RNA (Gottula et al. 2013). More recently, GFLV- and ArMV-satRNAs were detected in 72% of the naturally infected grapevines analyzed in Slovenia (Čepin et al. 2015). Phylogenetic studies confirmed a specific association between satRNAs and their helper viruses but confirmed the idea that closely related satRNAs do not necessarily depend on a same helper for their replication (Čepin et al. 2015).

Soon after the cloning of RNA3, the genomic RNA1 and RNA2 of GFLV strain F13 (Fig. 4.1) were cloned and sequenced (Ritzenthaler et al. 1991; Serghini et al. 1990). *In vitro* translation studies (Margis and Pinck 1992; Margis et al. 1993, 1991) and the development of infectious cDNA clones (Viry et al. 1993) led to the description of the genetic organization of the GFLV genome and the identification of protein functions. RNA1 encodes polyprotein P1 (253 kDa) which is processed into five final products: protein 1A (46 kDa) of unknown function, protein 1B^{Hel} (88 kDa) which contains a predicted SF3 helicase domain, protein 1C^{VPg} (24 amino acids) which is genome linked, protein 1D^{Pro} (24 kDa) with a 3C proteinase activity, and protein 1E^{Pol} (92 kDa) which harbors the RNA-dependent RNA-polymerase (RdRp) signature. Polyprotein P2 (122 kDa) is translated from RNA2 and matured *in trans* into three final products: 2A^{HP}, 2B^{MP}, and 2C^{CP}. Protein 2A^{HP} (28 kDa) is necessary for RNA2 replication and is proposed to act within the P2 precursor to guide the P2-RNA2 complex to the RNA1-encoded replication sites (Gaire et al. 1999); it was

therefore referred to as a homing protein (HP, Ritzenthaler et al. 2002). Protein 2B^{MP} is the tubule-forming movement protein (MP), and 2C^{CP} is the structural coat protein (Ritzenthaler et al. 1995; Serghini et al. 1990).

RNA1 is able to self-replicate in protoplasts, whereas both genomic RNAs are essential to the onset of local and systemic infections in plants (Viry et al. 1993). The proteolytic maturation of both polyproteins is provided by the 1D^{Pro} domain of polyprotein P1, although the precursor 1C^{VPg}-1D^{Pro} seems to be more efficient on some cleavage sites, notably on the C/A dipeptide between the 1A and 1B^{Hel} domains, whereas the mature 1D^{Pro} could be superior in releasing proteins from polyprotein P2 (Margis et al. 1994). In addition to this 1A-1B^{Hel} cleavage, *Tomato ringspot virus* (ToRSV), a subgroup C *Nepovirus*, further processes its Hel-containing domain into two proteins called X2 and NTB (nucleoside triphosphate binding), the 1A protein being named X1. The ToRSV proteins X2 and NTB are involved in membrane changes necessary for the replication-complex assembly (Sanfaçon 2013; Wang and Sanfaçon 2000). This additional proteolytic cleavage is also reported for ArMV (Wetzel et al. 2008); no information is available on a X2/NTB cleavage for GFLV. Another additional proteolytic cleavage of P1 was described at the C-terminus of the ToRSV RdRp (Chisholm et al. 2007), but a similar polyprotein processing was not shown for GFLV 1E^{Pol} either upon infection or transient overexpression assays (Chisholm et al. 2007; Vigne et al. 2013).

RNA2 is needed for plant infection by GFLV because it encodes both the 2C^{CP} structural protein, 60 subunits of which form the capsid and the 2B^{MP} movement protein, which assembles into tubules. These two proteins are necessary for the virus cell-to-cell and long distance movement. The third protein encoded by RNA2, protein 2A^{HP}, or its coding sequence, is essential but not sufficient for the replication of RNA2. Indeed, although 2B^{MP} and 2C^{CP} coding sequences can be deleted from a RNA2 construct and thus are dispensable for replication in protoplasts, the 2A^{HP} coding sequence is not sufficient for replication; additional coding sequences, not necessarily of viral origin, are needed. This was demonstrated by the absence of replication of a deletion RNA2 mutant lacking 2B^{MP} and 2C^{CP} sequences and the restoration of replication upon replacement of these sequences by the nonviral green fluorescent protein (GFP) coding sequence (Gaire et al. 1999). This observation could indicate a change in the conformation or stability of the 2A^{HP} domain, depending on whether it is by itself or part of a larger protein that is critical for replication. In agreement with the homing protein hypothesis, the location of protein 2A^{HP}, when expressed as a 2A^{HP}:GFP fusion, changes from small aggregates distributed throughout the cytoplasm to a big perinuclear structure also containing the RNA1-encoded 1D^{Pro} and 1C^{VPg}. The 2A^{HP}:GFP fusion is also active in replication, as demonstrated by the presence of double-stranded (ds) RNA and its capacity to incorporate modified UTP (Gaire et al. 1999).

In addition to the coding sequence, the genomic RNAs of GFLV possess 5'- and 3'-UTRs shorter than 300 nts. Like for other nepoviruses, these regions share sequence identity between the two RNAs although to a lesser extent than the 98–99 % identity described for ToRSV (Sanfaçon et al. 2009; Walker et al. 2015). More particularly, three putative conserved stem-loop motifs were described among

GFLV, ArMV, and *Grapevine deformation virus* (GDefV, a probable recombinant between GFLV and ArMV, Elbeaino et al. 2012; Mekuria et al. 2009). This conservation suggests a common role of these conserved stem-loop sequences, most probably in replication or translation of the viral RNAs, although experimental evidence sustaining this hypothesis is lacking. More data is available on the function of these UTRs for the subgroup C *Nepovirus Blackcurrant reversion virus* (BRV), for which an internal ribosome entry site (IRES) was reported in the 5'-UTRs and a new class of cap-independent translation enhancers (CITEs) identified in the 3'-UTRs (Karetnikov et al. 2006; Karetnikov and Lehto 2007). On both genomic RNAs, the CITE in the 3'-UTR must base pair with the 5'-UTR, thus forming a kissing loop, to increase the cap-independent translation of reporter genes (Karetnikov and Lehto 2008). Whether these features and their function are conserved among nepoviruses of subgroup A like GFLV or ArMV remains to be addressed.

UTRs of RNA viruses are important *cis* elements for RNA recognition by the viral RdRp in the replication complex in order to synthesize both the intermediate minus strand RNA and the genomic viral progeny (Newburn and White 2015). Apart from the aforementioned role of the GFLV-F13 satRNA-UTRs, limited information is available on the role of GFLV UTRs in this process. However, sequence analysis of RNA2 of GFLV strain GHu has revealed a dual origin, as it results from an interspecies recombination between ArMV and GFLV, with an ArMV-derived 5'-UTR and a 3'-UTR of GFLV origin. More recombinants have been described with 5'- and 3'-UTRs of different sources (Vigne et al. 2008), suggesting that, if involved in replication, these UTRs do not provide a strict species specificity.

Infectious cDNA clones of GFLV were first obtained from the F13 reference strain (Viry et al. 1993). They consist of a cDNA copy of the genomic RNA1 and RNA2 under the control of a T7 *in vitro* transcription promoter. Because long deletions in viral genomes are often lethal, infectious clones have mainly been used to generate recombinant viruses by exchanging homologous sequences between GFLV and ArMV. This strategy has proven effective in identifying critical residues involved in systemic movement *in planta* and transmission of GFLV by *X. index* (Andret-Link et al. 2004b; Belin et al. 2001, 1999; Marmonier et al. 2010; Schellenberger et al. 2010). More recently, recombinant cDNA clones were derived from the GFLV-F13 infectious clones for expression of the fluorescent TagRFP (Merzlyak et al. 2007) or EGFP (Zhang et al. 1996) downstream of the 2A^{HP} coding sequence. Synthetic recombinant GFLV-TagRFP (F1F2-2ATR) and GFLV-EGFP (F1F2-2AEG) viruses are infectious in *C. quinoa* and *Nicotiana benthamiana* plants and thus constitute good tools to monitor virus multiplication in inoculated leaves, where doughnut-shaped infection sites are visible, and in apical uninoculated leaves, where systemic spread is visible through symptom expression (Fig. 4.2). Infectious clones are also available for GFLV-GHu (Vigne et al. 2013) and ArMV (Wetzel et al. 2013). More recently, the nepovirus infectious clone collection was expanded to tobacco ringspot virus (TRSV, Zhao et al. 2015) and tomato black ring virus (TBRV, Zarzyńska-Nowak et al. 2017).

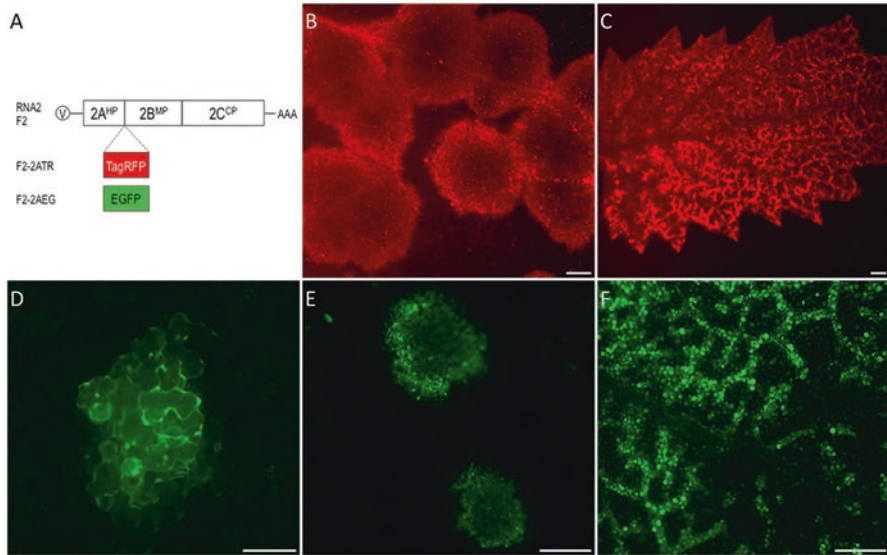

Fig. 4.2 Functionality of recombinant clones of *Grapevine fanleaf virus* (GFLV) strain F13 encoding a fluorescent protein in *Chenopodium quinoa*. **(a)** Schematic representation of the recombinant RNAs 2 F2-2ATR and F2-2AEG encoding the TagRFP or EGFP protein, respectively. When co-inoculated with synthetic RNA1 (F1) infection foci in the inoculated leaf **(b, d and e)** and systemic spread in apical non-inoculated leaves **(c and f)** are visualized. Recombinant GFLV expressing TagRFP are shown in panels **b** and **c** whereas GFLV expressing EGFP are shown in panels **d, e, and f**. Pictures were taken with a Zeiss Axio Zoom V16 microscope at 3 **(d)**, 6 **(e)**, or 10 **(b, c, and f)** days post-inoculation. *Scale bars* represent 1 mm except in **d** where it represents 0.1 mm

Symptom Determination

Viral symptom development on a diseased plant is conditioned by the genetic background of both the plant and the virus, in addition to numerous environmental factors. In perennial crops like grapevine, studying symptom development is complicated by the high frequency of multiple infections in addition to the quasi-species nature of viruses. As already mentioned, GFLV-infected grapevines present malformations and discolorations. These symptoms are thought to be associated to two syndromes called infectious malformations (MF) and yellow mosaic (YM) that are considered provoked by distorting and chromogenic strains, respectively (Elbeaino et al. 2014; Martelli and Boudon-Padieu 2006). The 2A^{HP} coding sequence is a strong symptom determinant candidate because it is the most variable sequence in GFLV and ArMV and corresponds to a hot spot of intra- and interspecies recombination, indicating it is under low selective pressure (Mekuria et al. 2009). The 2A^{HP} coding sequence is also the most variable in nucleotide diversity and size among viruses in the family *Secoviridae* (Sanfaçon et al. 2009; Wetzel et al. 2002). Furthermore, the cloned 2A^{HP} coding sequence of ArMV-NW was shown to

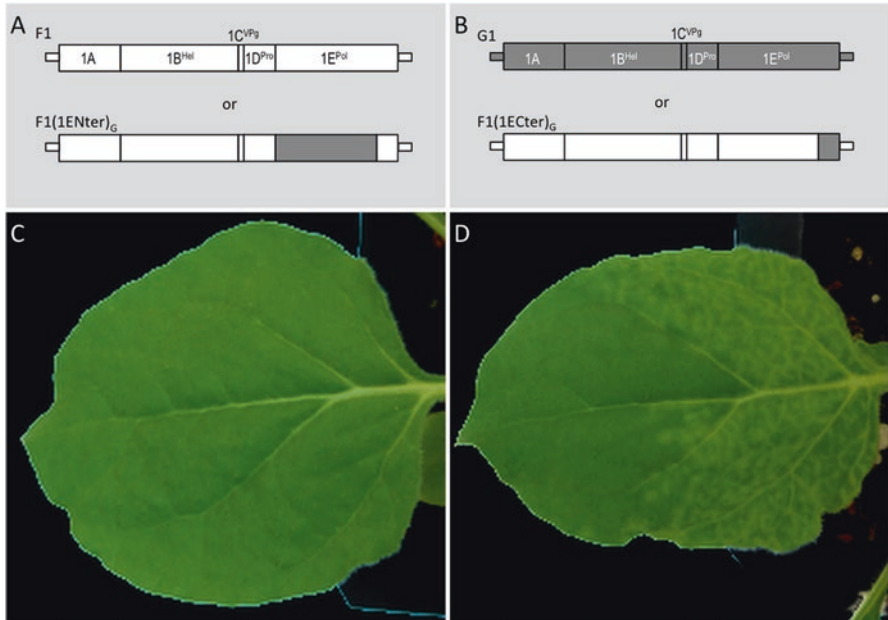

Fig. 4.3 *Grapevine fanleaf virus* (GFLV) strain F13 causes a systemic but symptomless infection on *Nicotiana benthamiana* (c). This phenotype is reproduced when synthetic RNA1 is of F13 origin (F1) or contains GHU sequences like the recombinant F1(1ENter)G encoding an N-proximal portion of protein GHU-1E^{Pol} (a). GFLV strain GHU on the other hand produces mosaic symptoms on systemic leaves (d), which are reproduced by synthetic RNA1 if the C-terminal part of the 1E^{Pol} domain is of GHU origin (b). These results are similar whether RNA2 is of F13 or GHU origin. *White boxes* represent F13 sequences whereas GHU sequences are depicted in *gray* (After Vigne et al. 2013)

withstand extensive deletions in its N-proximal, central, and C-terminal parts without losing virus infectivity on *C. quinoa* plants (Nourinejhad Zarghani et al. 2014). These properties are compatible with an involvement of the 2A^{HP} protein or coding sequence in host range and host-specific symptoms.

Sequence analysis of the 2A^{HP} coding sequence from 28 GFLV isolates of various countries suggests that this variable genomic region could be responsible for the diverse symptoms (Elbeaino et al. 2014; Mekuria et al. 2009; Naraghi-Arani et al. 2001). More specifically, recombinant ArMV sequences in the 2A^{HP} coding region of GFLV-RNA2 are hypothesized to account for YM symptoms because such recombinants were consistently isolated from vines with YM but not from vines exhibiting MF symptoms (Elbeaino et al. 2014). Whether the 2A^{HP} coding sequence actually determines the chromogenic character of a GFLV strain needs to be confirmed in a genetic gain-of-function approach (Elbeaino et al. 2014).

A study of the viral genetic determinants of symptom expression on herbaceous hosts revealed the involvement of GFLV-GHU RNA1 in vein clearing or chlorotic spots on *N. benthamiana* and *N. clevelandii* (Fig. 4.3, Vigne et al. 2013). More

precisely, a two-step reverse genetics approach showed that the 3' proximal region of the 1E^{Pol} coding sequence elicits symptoms on these two *Nicotianae* species (Vigne et al. 2013). Although the mechanism underlying symptom development is not elucidated, no link between virus accumulation and symptoms was found. Similarly, it is not known whether the 408 nucleotides or the 136 amino acids of this 1E^{Pol} region are triggering symptom development. These findings highlight differences between GFLV and the subgroup B *Nepovirus* grapevine chrome mosaic virus (GCMV). The involvement of the 5'-UTR of GFLV was ruled out as a symptom determinant (Fernandez et al. 1999; Vigne et al. 2013), but the necrogenic effect of its counterpart in GCMV was established (Fernandez et al. 1999; Vigne et al. 2013).

Replication

Like other viruses, particularly the *Comovirus Cowpea mosaic virus* (CPMV) and the *Nepovirus* ToRSV (Carette et al. 2000; Han and Sanfaçon 2003), GFLV replicates on endoplasmic reticulum (ER)-derived vesicles (Ritzenthaler et al. 2002). The assembly of these GFLV replication compartments requires *de novo* phospholipid synthesis, as demonstrated by the inhibition of replication observed when GFLV-infected protoplasts are treated with cerulenin. Immunolabeling experiments also showed that ER-derived compartments contain dsRNA replication intermediates and the genome-linked 1C^{VPg} protein in addition to being the site of UTP incorporation (Ritzenthaler et al. 2002). Immuno-trapped vesicles from these compartments were observed in electron microscopy, showing that some aggregated membranes present a “rosette-like” structure very similar to the one described in PV-infected cells (Bienz et al. 1992; Ritzenthaler et al. 2002). Although no 3D reconstruction of the GFLV replication compartment is available to date, similarities with PV suggest that GFLV replication factories could adopt a double membrane vesicle (DMV) architecture rather than a spherule architecture (Paul and Bartenschlager 2013).

In many viruses, one or two proteins are associated with membrane changes observed during virus infection (Laliberté and Sanfaçon 2010). For GFLV, domains of the self-replicating RNA1 probably encode membrane remodeling functions. Among the GFLV RNA1-derived proteins, only protein 1B^{Hel} contains predicted transmembrane domains or a putative amphipathic helix and colocalizes to the ER. However, direct evidence of a scaffolding function to anchor the replication complex is still missing. More information is available for ToRSV for which the NTB and NTB-VPg proteins are associated with the ER. When purified from infected plant membranous fractions, the NTB core region seems exposed toward the cytoplasm, while the VPg likely localizes on the luminal side of the purified membranes, suggesting that NTB-containing proteins are integral membrane proteins anchoring the replication complex within the ER-derivatives (Han and

Sanfaçon 2003). The shorter X2 protein of ToRSV also associates to ER membranes and could thus, together with NTB containing proteins, oligomerize to form a pore and cause membrane curvature (Wang et al. 2004; Zhang and Sanfaçon 2006). The GFLV 1E^{Pol} protein does not associate to membranes by itself when expressed ectopically in *N. benthamiana* leaves and thus probably depends on protein 1B^{Hel} for its anchoring to the replication complex (C. Schmitt-Keichinger and F. Berthold, unpublished results). Further protein-protein interaction studies between proteins 1E^{Pol} and 1B^{Hel} are needed to support this hypothesis.

Protein 2A^{HP} of GFLV was shown to localize to the replication complexes and, as mentioned above, is required for the replication of its cognate RNA. When expressed as a fusion to GFP, the location of protein 2A^{HP} changes during the course of infection from small aggregates distributed throughout the cytoplasm to a perinuclear and condensed structure, well in agreement with the hypothesized function of a homing protein for the recruitment of P2 and/or RNA2 to the replication complexes (Gaire et al. 1999). However, the exact role of protein 2A^{HP} in replication is not clear. Its elucidation will require better insights into its intrinsic properties and its interactions with other viral and host proteins during the replication process.

Not much is known about the involvement of other viral proteins in the GFLV replication. By analogy with other picornavirids, one can speculate that protein 1C^{VPg} probably acts as a primer for RNA amplification after its uridylation by the viral RdRp (Steil and Barton 2009), but so far, there is no evidence for such a function for any nepovirus nor is there any indication of what P1 derivative(s) could act as a VPg donor.

Cell-to-Cell and Systemic Movement

Once a plant virus has replicated in the primarily infected cell, it needs to cross the rigid cell wall to reach the neighboring uninfected cell. To do so, viruses make use of plasmodesmata (PD) that constitute natural intercellular communication routes. Viruses employ different mechanisms to move from cell to cell, all of which involve one or more MP(s). GFLV, like CPMV, modifies the PD structure, replacing the ER-derived desmotubule by a viral tubule for the transport of virions. This strategy known as tubule-guided movement requires both the assembly of the MP into PD-located tubules and the proper assembly of capsids.

The 2B^{MP} coding sequence of GFLV is the only viral product needed to form tubules within PD (Laporte et al. 2003). The use of cultured tobacco BY-2 cells that grow as short chains and thus maintain intercell contact helped address the intracellular trafficking of protein 2B^{MP} from the perinuclear viral compartment where it is produced to PD. A pharmaceutical approach demonstrated the requirement of a functional secretory pathway for the tubule assembly in cell walls. Also, the cytoskeleton is necessary for the proper targeting of the tubules at the periphery of the cell, although it seems dispensable for the tubule assembly step itself (Laporte et al. 2003). Later a small family of PD-located proteins (PDLPs) was identified (Thomas

et al. 2008). Their role in anchoring MPs in PDs to initiate tubule assembly was established, not only for GFLV but also for the unrelated DNA virus *Cauliflower mosaic virus* (CaMV), indicating a common receptor-like role of PDLPs in the tubule-guided movement of viruses (Amari et al. 2010). PDLPs are transported to PDs within the secretory pathway in a myosin-dependent manner, as shown by their mislocalization and thus inhibition of GFLV movement in the presence of dominant negative mutants of class XI myosins (Amari et al. 2011). Altogether this work on GFLV tubule formation provided mechanistic insights into cell-to-cell movement of tubule-guided viruses. The current model proposes that 2B^{MP} subunits traffic either by diffusion or along microtubules from the replication compartment to the cell periphery where they anchor on PDLPs to form tubules, likely in an oriented way, by sequential incorporation at the base of the growing tubule until it protrudes in the cytoplasm of the neighboring cell (Ritzenthaler and Hofmann 2007). How the virions and the 2B^{MP} or tubules come together and how particles travel across tubules remains undetermined. It is however likely that virions are incorporated during tubule assembly and progress like people on an escalator until tubules depolymerize in the next cell rather than virions traversing tubules like cars in a tunnel (Ritzenthaler 2011; van Lent and Schmitt-Keichinger 2006).

This tubule-guided movement of GFLV undeniably requires an interaction between the 2B^{MP} protein and either the 2C^{CP} protein or the capsid. Although such an interaction has never been demonstrated, genetic evidence of a specific interaction came from chimeric constructs between GFLV and ArMV, which showed that virus movement only occurred when the 9 C-terminal residues of 2B^{MP} originated from the same virus species as the 2C^{CP} (Belin et al. 1999). These results suggest that like the MP of CPMV, the GFLV 2B^{MP} probably points its C-terminus toward the inner side of the tubules where it interacts with virions (van Lent et al. 1991). Candidate areas of the 2C^{CP} protein for specific interactions with the nematode vector were defined as exposed at the surface of the particle, conserved among GFLV strains but different from ArMV strains. These criteria also apply for specific interactions between the capsids and the tubules. Region R4 (amino acids 258–264) in loop βE-αB of the 2C^{CP} domain B was proposed to be involved in cell-to-cell movement through 2C^{CP}-2B^{MP} interactions since its replacement by its ArMV counterpart abolished plant infection without inhibiting the protective function of the capsid (Schellenberger et al. 2010).

The availability of infectious GFLV clones encoding a fluorescent tag enables the visualization of cell-to-cell and long-distance movement (Fig. 4.2). These tools are very valuable to identify movement determinants on both the 2B^{MP} C-terminus and the capsid surface. They should also help addressing the successive steps for long distance transport, i.e., crossing different types of PDs and cells, entering the phloem vasculature, following the source-to-sink transfer of carbohydrates and unloading from the phloem into uninfected systemic leaves or roots (Hipper et al. 2013). Growing evidence collected from different viruses suggests that different steps of the virus transport require different viral proteins or protein domains and thus likely constitute particular stages that require different interactions with the host (for a review see Hipper et al. 2013). In the case of GFLV in particular, and

nepoviruses in general, little is known about distinct requirements for cell-to-cell versus long-distance movement.

Transmission

GFLV is the first plant virus for which transmission from plant to plant by an ectoparasitic nematode was demonstrated (Hewitt et al. 1958). This transmission is highly specific as GFLV is only transmitted by *X. index* and, vice-versa, *X. index* only transmits GFLV, suggesting an interaction between a yet-to-be-identified nematode-receptor and the viral particle. Similarly, ArMV is only transmitted by *X. diversicaudatum*. This specificity in vector-mediated transmission, the availability of infectious clones, and the development of conditions for reliable and efficient transmission assays prompted a reverse genetics approach to identify RNA2 and more precisely the 2C^{CP} coding sequence as the determinant of the specific transmission of both GFLV and ArMV (Andret-Link et al. 2004b; Belin et al. 2001; Marmonier et al. 2010).

A 3D homology model of GFLV based on the crystal structure of TRSV (Chandrasekar and Johnson 1998) was obtained. From this model, regions predicted at the surface of the capsid, conserved among GFLV isolates and divergent in ArMV, were selected for the design of chimeric RNA2 constructs. Transmission assays of recombinant viruses revealed a stretch of 11 residues (188-FFDLTAVTALR-198 constituting region R2) in the β B- β C loop of the 2C^{CP} subunit, near the threefold axis of the icosahedral symmetry, as a determinant of transmission (Fig. 4.4, Schellenberger et al. 2010). Also, a single 2C^{CP} residue (Gly297) is important for efficient GFLV transmission. The atomic structure of GFLV, resolved at 2.7 Å, suggests that region R2 and Gly297 delineate a positively charged cavity at the surface of the virion (Schellenberger et al. 2011). This pocket rather than individual residues could contribute to the specific retention of the virus within the nematode; it was therefore called ligand-binding pocket (LBP, Schellenberger et al. 2011). A comparative analysis of the structure of GFLV and ArMV, the latter being obtained by cryo-electron microscopy resolution at 6.5 Å, highlighted notable differences between the two capsids. The positively charged cavity in the GFLV capsid corresponds to a negatively charged cavity in ArMV. This observation strengthens the idea that this pocket could explain the differential transmission between the two viruses (Lai-Kee-Him et al. 2013), an hypothesis that is consistent with the surface-charge density of virus particles evoked almost 40 years earlier (Harrison et al. 1974). In accordance with this charge hypothesis, the replacement of Gly297 by the neutral amino acid Ala (mutant G297A) has no effect on the transmission rate of GFLV, while the negatively charged Asp (mutant G297D) dramatically reduces transmission efficiency (Schellenberger et al. 2011). More amino acid substitutions scanning the overall putative LBP and modifying its charge are needed to draw more definite conclusion.

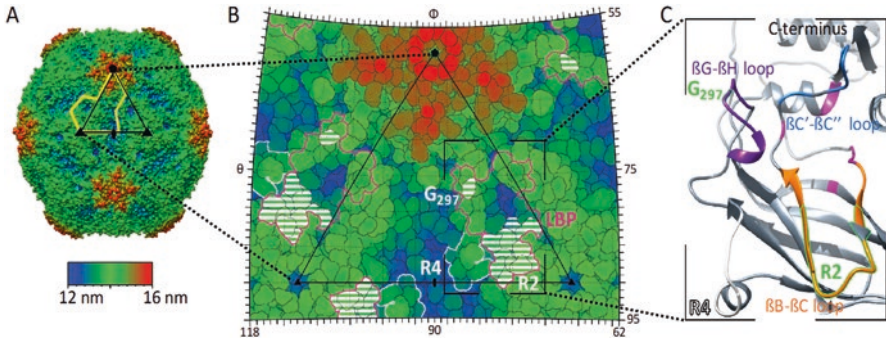

Fig. 4.4 Architecture of the *Grapevine fanleaf virus* (GFLV) capsid and surface features involved in transmission. (a) Representation of the GFLV crystal structure resolved at 3.0 Å. The capsid surface is colored according to the radial distance from the center of the particle, ranging from blue (12 nm) to red (16 nm). One icosahedral asymmetric unit (AU) and one $2C^{CP}$ subunit are shown as a black triangle and yellow delineation, respectively. The solid black pentagon, triangle, and oval symbolize fivefold, threefold, and twofold icosahedral symmetry axes, respectively. (b) Roadmap surface projection of 1 AU in which the polar angles θ and Φ represent latitude and longitude, respectively. The ligand-binding pocket (LBP) and R4 positions are delineated in magenta and white, respectively. Residues involved in GFLV transmission (G297 and R2) are indicated with horizontal white stripes. (c) Detailed view of one LBP in ribbon representation showing the $\beta\text{G}-\beta\text{H}$ (orange), $\beta\text{C}'-\beta\text{C}''$ (dodger blue), and $\beta\text{G}-\beta\text{H}$ (purple) loops surrounding the residues exposed at the bottom of the cavity (magenta) forming the LBP. The R4 (white) and C-terminus of the $2C^{CP}$ are indicated, and G297 and R2 are highlighted (neon green)

Capsid Structure and Encapsidation

The single GFLV structural protein $2C^{CP}$ contains three jelly-roll β -barrel domains characteristic of icosahedral capsids. These domains are denominated C, B, and A from the N- to the C-terminus of the protein sequence and connected by two linking peptides. The determination of the crystal structure of two GFLV isolates (TD and F13) at a 2.7 Å and 3 Å resolution, respectively, and their comparison to the pseudo atomic structures of ArMV at 6.5 Å and of BRV at 17 Å, both obtained by cryo-electron microscopy, unveiled structural features of the nepovirus capsid. The N-terminus (domain C) of all four CPs points toward the inside of the capsid and the C-terminus (domain A) are exposed at the surface of virions (Chandrasekar and Johnson 1998; Lai-Kee-Him et al. 2013; Schellenberger et al. 2011; Seitsonen et al. 2008). The four CPs exhibit two prominences, one pronounced at the fivefold axis of symmetry and another more moderate one at the threefold axis, and a minor depression at the twofold axis.

GFLV differs from TRSV mainly by its longer and more protruding $\beta\text{G}-\beta\text{H}$ loop located at the surface of the virion within the B domain of the $2C^{CP}$ subunit and by the absence of an N-terminal tail protruding inside the particle (Schellenberger et al. 2011). GFLV and ArMV are very similar in their architecture although the outer

exposed loops of the B and C domains appear slightly shifted between the two viruses. GFLV and ArMV also significantly vary in their surface potential around two cavities: the already mentioned LBP in the B domain and a cavity in the A domain (negatively charged in GFLV and positively charged in ArMV). In addition to these main differences on the whole capsid surface, local variations are also observed. Among these variations, one of the residues (Gln versus Lys in position 324) located near the threefold axis of symmetry is suggested to be accessible for transmission or movement of the virus (Lai-Kee-Him et al. 2013).

Not much is known about possible RNA-CP interactions for the encapsidation process of GFLV. However, the presence of empty particles in purified virus preparations from infected plants (Quacquarelli et al. 1976) and of virus like particles (VLPs) in cells expressing the CP of GFLV and other nepoviruses (Belval et al. 2016; Bertioli et al. 1991; Gottschammel et al. 2009; Singh et al. 1995) strongly suggest that RNA is dispensable for the formation or the stability of the capsid of GFLV and other nepoviruses. Nevertheless, it is not known whether empty capsids represent an intermediate step in RNA packaging or whether CPs auto-assemble to produce empty particles or particles containing viral RNAs, depending on the presence or concentration of genomic RNA at the site of assembly.

Unlike for movement or nematode transmission, the capsid does not display any specificity for ArMV- versus GFLV-RNAs encapsidation, as deduced from proper virion formation of recombinant GFLV-RNA2 encoding an ArMV 2C^{CP} sequence (Marmonier et al. 2010). The observation of RNA-containing particles of the same ArMV recombinant at 6.5 Å showed strong RNA-2C^{CP} interactions through five residues near the three- and fivefold axes, three of which are conserved between GFLV and ArMV. It has to be noted that the strongest interaction is near the fivefold axis involving two amino acids at the C-terminus of 2C^{CP} domain A (Lai-Kee-Him et al. 2013). For BRV, a projection of the RNA toward the fivefold axis has been described, reinforcing the hypothesis that pentameric capsomers could serve as a gate for RNA release (Lai-Kee-Him et al. 2013; Seitsonen et al. 2008).

The need for a *cis* packaging signal on the viral RNA also remains an open question for GFLV and nepoviruses in general. This type of RNA sequence or structure, although common for icosahedral viruses, is absent in many viruses in the family *Picornaviridae*, particularly in PV whose morphogenesis has been extensively studied. The specific encapsidation of the viral PV RNA has been proposed through the interaction of a structural protein with a nonstructural protein of the replication complex, resulting in the assembly of the particles around the progeny RNA (Jiang et al. 2014). Such a protein-protein interaction has recently been proposed to explain the involvement of the exposed C-terminus of the small CPMV-CP subunit in promoting RNA encapsidation despite its exposure at the virion surface (Hesketh et al. 2015).

Further studies are needed to tackle the existence of a packaging signal of the segmented genome of GFLV and to address the necessity of an active replication and/or a nonstructural protein for viral RNA encapsidation.

Antiviral Strategies

From the very beginning of the 1960s, efforts to control GFLV and fanleaf degeneration in vineyards focused on soil fumigation with nematicides, the use of rootstock genotypes with some degrees of resistance to nematode vectors, and sanitation and certification (for recent reviews, see Maliogka et al. 2015; Martelli 2014a). Although some of these approaches lead to delays in disease development, and thus help maintain vineyard profitability to some extent, they are not satisfactory, especially because their temporary effects are inappropriate for a perennial crop such as grapevine.

Since the advent of grapevine transformation techniques in the 1990s, resistant rootstocks or scions have been developed for GFLV resistance based on the concept of parasite-derived resistance (Sanford and Johnston 1985) by using different virus-derived translatable or non-translatable sequences (for an extensive review see Maliogka et al. 2015). Although the efficacy of these approaches is generally confirmed in herbaceous hosts, long-term results in vineyards are lacking. More recently, with a better understanding of the RNA interference mechanisms underlying pathogen-derived resistance (Pumplin and Voinnet 2013), virus-derived constructs inserted in the plants' genome have been optimized for double-stranded RNA production. This was accomplished by using inverted repeat constructs to produce hairpins or by mimicking micro-RNA (miRNA) precursors (artificial miRNAs, amiRNAs) to activate RNA interference (Jardak-Jamoussi et al. 2009; Jelly et al. 2012).

Another approach relied on the expression of a single-chain variable fragment (scFv) derived from a monoclonal antibody raised against GFLV *in planta*. Transgenic herbaceous hosts exhibited variable levels of resistance (up to 100%) and resistance is correlated with the level of scFv accumulation (Nölke et al. 2009). A variation of this plantibody strategy consists of using nanobodies, i.e., variable fragments derived from heavy chain only antibodies of *Camelidae* (work in progress in our laboratory, Muyltermans 2013). The application of the nanobody approach against GFLV is underway in our laboratory (patent application WO 2015/110601 A1). The transfer of all these innovative approaches to *Vitis* species is challenging, and two major difficulties need to be overcome. The first difficulty is of technical nature because virus resistance evaluation requires a vineyard setting with viruliferous nematode vectors since grapevines cannot be mechanically inoculated. The second difficulty is of societal nature, if the technology is intended to be released for disease management, because wine and grape industries and the public are reluctant to adopt genetically modified grapevines. The suspicion against transgenic grapevines seems to be primarily driven by emotions because environmental and human safety issues related to virus-resistant transgenic plants have been extensively addressed and no real risks have been documented (Oliver et al. 2011; Vigne et al. 2004).

Conclusions and Future Prospects

Since the demonstration of GFLV as the causal agent of fanleaf degeneration, much progress has been made to advance our understanding of virus biology and ecology. This particularly applies to recent progress on the transmission of the virus, a domain which has benefited from (1) functional synthetic ArMV/GFLV recombinant viruses, (2) the resolution of virion structure, and (3) the availability of reliable transmission tests with *X. index* and *X. diversicaudatum* nematodes. A cavity exposed at the surface of the particle is proposed as the viral determinant of virus retention within the vector. This hypothesis needs to be confirmed with extensive mutations of the putative LBP with a special focus on modifications of amino acid charges. On the nematode side, efforts are underway to visualize virus particles at their retention sites with the hope that optical techniques coupled with biochemical treatments will help define the nature of the nematode receptor. This approach was successful at characterizing the receptor of CaMV within the stylet of its aphid vector as a non-glycosylated protein embedded in chitin (Uzest et al. 2007). There is no doubt that the recently cloned nanobodies raised against GFLV and fused to fluorescent tags will constitute valuable tools in the quest of this receptor.

Our understanding of the tubule-guided movement of viruses has remarkably improved, particularly with the discovery of host proteins involved in anchoring the 2B^{MP} protein for the initiation of tubule assembly in PDs. This work pioneered the identification of host factors interacting with GFLV to complete a critical step of the virus life cycle. More factors involved in every steps of the infection cycle, including replication, cell-to-cell and long-distance movement, as well as nematode transmission, need to be identified. The identification and characterization of host factors will not only advance our knowledge of plant infection but also help select candidate genes for targeted mutations using technologies based on nucleases of the CRISPR/Cas (clustered regulatory interspaced short palindromic repeats), TALEN (transcription activator-like effector nuclease), or ZFN (zinc-finger nucleases) families. These nucleases introduce double-stranded breaks in the DNA of specific genes that are then repaired by the error prone nonhomologous end-joining pathway. This kind of mutagenesis is known as genome editing, and the resulting mutant plants are very similar to naturally occurring variants, with no exogenous sequences remaining in their genome (from reviews see Sauer et al. 2016; Schaeffer and Nakata 2015; Xiong et al. 2015). Grapevines obtained from the application of genome editing technologies could be included in a disease management program in a very near future (Jones 2015).

The ToRSV CP inhibits the silencing of a reporter gene through the enhancement of mRNA translation. The CP interacts with the silencing effector argonaute RISC catalytic component 1 (AGO1) and destabilizes it via its Trp/Gly (WG) motif situated in the C-terminal A domain. This position is compatible with a good accessibility in CP subunits but becomes buried in CP-CP interactions in the assembled particle (Karran and Sanfacon 2014). GFLV and ArMV CPs only bear a W residue, and although the flanking G residue was suggested to be dispensable for AGO

binding, there is no evidence, to date, that the GFLV CP interacts with AGO proteins. Moreover, no viral silencing suppressor (VSR) activity could be attributed to this structural protein in spite of many attempts (our laboratory and M. Fuchs, personal communication). The mutation of this W residue in an infectious GFLV clone for a comparative multiplication rate with the wild-type control should clarify the role of the CP and give some hints as to whether GFLV behaves akin to nepoviruses of subgroup C or whether it diverges. In any event, a VSR remains elusive for GFLV.

GFLV exhibits differences with other nepoviruses like ToRSV in terms of polyprotein cleavage. Although overexpressed *in planta*, no cleavage of the GFLV 1E^{Pol} C-terminus was observed. This is in contrast to the VPg-Pro-Pol polyprotein of ToRSV in which a 16 kDa C-terminal peptide is removed to produce a truncated VPg-Pro-Pol form (Chisholm et al. 2007). This VPg-Pro-Pol peptide associates with ER membranes during infection most probably via its interaction with a membranous viral protein. This example highlights the need to better understand the stability and function of maturation intermediates of polyproteins P1 and P2 that can accumulate upon nepovirus infection. Such translation and maturation experiments probably need to be carried out both *in vitro* and *in vivo* along with subcellular localization experiments.

A short coding sequence was recently identified as symptom determinant in *Nicotiana* spp. in a compatible reaction (Vigne et al. 2013). However, this does not prefigure the viral sequence responsible for pathogenesis in other herbaceous hosts or in the natural grapevine host. Therefore, more work is needed to understand virus-plant relationships for symptom development. Such studies are easier to conduct on herbaceous hosts and will likely require next generation sequencing-aided surveys in grapevines to provide an extensive dataset for a comparative analysis of the virome in differently affected grapevines and subsequently open the way to reverse genetics experiments. A procedure facilitating the inoculation of grapevine would be of great interest for this kind of work and also for the study of GFLV in its natural host. This improvement would also allow the use of GFLV as a vector to genetically modify gene expression in *Vitis* species. Using GFLV in this respect would overcome the phloem limited restriction of the GLRaV-2 derived vector for studies on grapevine (Kurth et al. 2012).

Acknowledgments We thank Marc Fuchs for critical reading of the manuscript, Jean-Yves Sgro for the GFLV roadmap, and Emmanuelle Vigne for the pictures of *N. benthamiana* leaves. CH was supported by grants from the Région Alsace and INRA and FB by the Ministère de l'éducation nationale, de l'enseignement supérieur et de la recherche.

References

- Amari, K., E. Boutant, C. Hofmann, C. Schmitt-Keichinger, L. Fernandez-Calvino, P. Didier, A. Lerich, J. Mutterer, C.L. Thomas, M. Heinlein, Y. Mély, A.J. Maule, and C. Ritzenthaler. 2010. A family of plasmodesmal proteins with receptor-like properties for plant viral movement proteins. *PLoS Pathogens* 6: e1001119.

- Amari, K., A. Lerich, C. Schmitt-Keichinger, V.V. Dolja, and C. Ritzenthaler. 2011. Tubule-guided cell-to-cell movement of a plant virus requires class XI myosin motors. *PLoS Pathogens* 7: e1002327.
- Andret-Link, P., C. Laporte, L. Valat, C. Ritzenthaler, G. Demangeat, E. Vigne, V. Laval, P. Pfeiffer, and M. Fuchs. 2004a. *Grapevine fanleaf virus*: Still a major threat to the grapevine industry. *Journal of Plant Pathology* 86: 183–195.
- Andret-Link, P., C. Schmitt-Keichinger, G. Demangeat, V. Komar, and M. Fuchs. 2004b. The specific transmission of *Grapevine fanleaf virus* by its nematode vector *Xiphinema index* is solely determined by the viral coat protein. *Virology* 320: 12–22.
- Baccarini, P. 1902. Roncet. *Viticultura Moderna* 8: 241–248.
- Beijerinck, M.W. 1898. *Concerning a contagium vivum fluidum as cause of the spot disease of tobacco leaves*. St. Paul: American Phytopathological Society.
- Belin, C., C. Schmitt, F. Gaire, B. Walter, G. Demangeat, and L. Pinck. 1999. The nine C-terminal residues of the grapevine fanleaf nepovirus movement protein are critical for systemic virus spread. *Journal of General Virology* 80: 1347–1356.
- Belin, C., C. Schmitt, G. Demangeat, V. Komar, L. Pinck, and M. Fuchs. 2001. Involvement of RNA2-encoded proteins in the specific transmission of *Grapevine fanleaf virus* by its nematode vector *Xiphinema index*. *Virology* 291: 161–171.
- Belval, L., C. Hemmer, C. Sauter, C. Reinbold, J.-D. Fauny, F. Berthold, L. Ackerer, C. Schmitt-Keichinger, O. Lemaire, G. Demangeat, and C. Ritzenthaler. 2016. Display of whole proteins on inner and outer surfaces of grapevine fanleaf virus-like particles. *Plant Biotechnology Journal* 14: 2288–2299.
- Bertioli, D., R. Harris, M. Edwards, J. Cooper, and W. Hawes. 1991. Transgenic plants and insect cells expressing the coat protein of arabis mosaic virus produce empty virus-like particles. *Journal of General Virology* 72: 1801–1809.
- Bienz, K., D. Egger, T. Pfister, and M. Troxler. 1992. Structural and functional characterization of the poliovirus replication complex. *Journal of Virology* 66: 2740–2747.
- Cadman, C.H., H.F. Dias, and B.D. Harrison. 1960. Sap-transmissible viruses associated with diseases of grape vines in Europe and North America. *Nature* 187: 577–579.
- Carette, J., M. Stuiver, J. Van Lent, J. Wellink, and A. Van Kammen. 2000. Cowpea mosaic virus infection induces a massive proliferation of endoplasmic reticulum but not Golgi membranes and is dependent on de novo membrane synthesis. *Journal of Virology* 74: 6556–6563.
- Cazalis-Allut, L.C. 1865. *De la dégénération des vignes*, 57–61. Montpellier: Oeuvres agricoles.
- Čepin, U., I. Gutiérrez-Aguirre, M. Ravnkar, and M. Pompe-Novak. 2015. Frequency of occurrence and genetic variability of Grapevine fanleaf virus satellite RNA. *Plant Pathology* 65: 510–520.
- Chandrasekar, V., and J. Johnson. 1998. The structure of tobacco ringspot virus: A link in the evolution of icosahedral capsids in the picornavirus superfamily. *Structure* 6: 157–171.
- Chisholm, J., G. Zhang, A. Wang, and H. Sanfaçon. 2007. Peripheral association of a polyprotein precursor form of the RNA-dependent RNA polymerase of *Tomato ringspot virus* with the membrane-bound viral replication complex. *Virology* 368: 133–144.
- Cseh, E., A. Takács, L. Kocsis, and R. Gáborjányi. 2012. General properties of grapevine viruses occurring in Hungary. *Journal of Central European Agriculture* 13: 44–57.
- Das, S., and D.J. Raski. 1968. Vector-efficiency of *Xiphinema index* in the transmission of grapevine fanleaf virus. *Nematologica* 14: 55–62.
- Elbeaino, T., M. Digiario, S. Ghebremeskel, and G.P. Martelli. 2012. Grapevine deformation virus: Completion of the sequence and evidence on its origin from recombination events between Grapevine fanleaf virus and Arabis mosaic virus. *Virus Research* 166: 136–140.
- Elbeaino, T., H. Kiyi, R. Boutarfa, A. Minafra, G. Martelli, and M. Digiario. 2014. Phylogenetic and recombination analysis of the homing protein domain of grapevine fanleaf virus (GFLV) isolates associated with ‘yellow mosaic’ and ‘infectious malformation’ syndromes in grapevine. *Archives of Virology* 159: 2757–2764.

- Fernandez, I., T. Candresse, O. Le Gall, and J. Dunez. 1999. The 5' noncoding region of grapevine chrome mosaic nepovirus RNA-2 triggers a necrotic response on three *Nicotiana* spp. *Molecular Plant-Microbe Interactions* 12: 337–344.
- Francki, R.I.B., R.G. Milne, and T. Hatya. 1985. *Nepovirus group, atlas of plant viruses*, 23–38. Raton: CRC Press.
- Fuchs, M., M. Pinck, M.A. Serghini, M. Ravelonandro, B. Walter, and L. Pinck. 1989. The nucleotide sequence of satellite RNA in grapevine fanleaf virus, strain F13. *Journal of General Virology* 70: 955–962.
- Gaire, F., C. Schmitt, C. Stussi-Garaud, L. Pinck, and C. Ritzenthaler. 1999. Protein 2A of Grapevine fanleaf nepovirus is implicated in RNA2 replication and colocalizes to the replication site. *Virology* 264: 25–36.
- Gottschammel, J., Maghuly, F., Laimer, M., Castellano, M.A., 2009. *Detection of Virus-like particles (VLPs) by ISEM in transgenic grapevines expressing different GFLV CP-constructs*. Progrès Agricole et Viticole, 2009, Hors Série – Extended abstracts 16th Meeting of ICVG, Dijon, France, 31 Aug–4 Sept 2009.
- Gottula, J., D. Lapato, K. Cantilina, S. Saito, B. Bartlett, and M. Fuchs. 2013. Genetic variability, evolution, and biological effects of grapevine fanleaf virus satellite RNAs. *Phytopathology* 103: 1180–1187.
- Han, S., and H. Sanfaçon. 2003. Tomato ringspot virus proteins containing the nucleoside triphosphate binding domain are transmembrane proteins that associate with the endoplasmic reticulum and cofractionate with replication complexes. *Journal of Virology* 77: 523–534.
- Hans, F., M. Fuchs, and L. Pinck. 1992. Replication of grapevine fanleaf virus satellite RNA transcripts in *Chenopodium quinoa* protoplasts. *Journal of General Virology* 73: 2517–2523.
- Hans, F., M. Pinck, and L. Pinck. 1993. Location of the replication determinants of the satellite RNA associated with grapevine fanleaf nepovirus (strain F13). *Biochimie* 75: 597–603.
- Harrison, B.D., W.M. Robertson, and C.E. Taylor. 1974. Specificity of retention and transmission of viruses by nematodes. *Journal of Nematology* 6: 155–164.
- Hesketh, E.L., Y. Meshcheriakova, K.C. Dent, P. Saxena, R.F. Thompson, J.J. Cockburn, G.P. Lomonosoff, and N.A. Ranson. 2015. Mechanisms of assembly and genome packaging in an RNA virus revealed by high-resolution cryo-EM. *Nature Communications* 6: 10113.
- Hewitt, W.B., D.J. Raski, and A.C. Goheen. 1958. Nematode vector of soil-borne fanleaf virus of grapevines. *Phytopathology* 48: 586–595.
- Hewitt, W.B., A.C. Goheen, D.J. Raski, and G.V.J. Gooding. 1962. Studies on virus diseases of the grapevine in California. *Vitis* 3: 57–83.
- Hipper, C., V. Brault, V. Ziegler-Graff, and F. Revers. 2013. Viral and cellular factors involved in phloem transport of plant viruses. *Frontiers in Plant Science* 4: 154.
- Horvath, J., I. Tobias, and K. Hunyadi. 1994. New natural herbaceous hosts of grapevine fanleaf nepovirus. *Horticultural Science* 26: 31–32.
- Izadpanah, K., M. Zaki-Aghl, Y.P. Zhang, S.D. Daubert, and A. Rowhani. 2003. Bermuda grass as a potential reservoir host for Grapevine fanleaf virus. *Plant Disease* 87: 1179–1182.
- Jardak-Jamoussi, R., P. Winterhagen, B. Bouamama, C. Dubois, A. Mliki, T. Wetzler, A. Ghorbel, and G.M. Reustle. 2009. Development and evaluation of a GFLV inverted repeat construct for genetic transformation of grapevine. *Plant Cell, Tissue and Organ Culture* 97: 187–196.
- Jelly, N., P. Schellenbaum, B. Walter, and P. Maillot. 2012. Transient expression of artificial microRNAs targeting *Grapevine fanleaf virus* and evidence for RNA silencing in grapevine somatic embryos. *Transgenic Research* 21: 1319–1327.
- Jiang, P., Y. Liu, H.-C. Ma, A.V. Paul, and E. Wimmer. 2014. Picornavirus morphogenesis. *Microbiology and Molecular Biology Reviews* 78: 418–437.
- Jones, H.D. 2015. Regulatory uncertainty over genome editing. *Nature Plants* 1: 14011.
- Karetnikov, A., and K. Lehto. 2007. The RNA2 5' leader of Blackcurrant reversion virus mediates efficient *in vivo* translation through an internal ribosomal entry site mechanism. *Journal of General Virology* 88: 286–297.

- . 2008. Translation mechanisms involving long-distance base pairing interactions between the 5' and 3' non-translated regions and internal ribosomal entry are conserved for both genomic RNAs of Blackcurrant reversion nepovirus. *Virology* 371: 292–308.
- Karetnikov, A., M. Keränen, and K. Lehto. 2006. Role of the RNA2 3' non-translated region of Blackcurrant reversion nepovirus in translational regulation. *Virology* 354: 178–191.
- Karran, R., and H. Sanfaçon. 2014. Tomato ringspot virus coat protein binds to ARGONAUTE 1 and suppresses the translation repression of a reporter gene. *Molecular Plant-Microbe Interactions* 27: 933–943.
- Kurth, E.G., V.V. Peremyslov, A.I. Prokhnevsky, K.D. Kasschau, M. Miller, J.C. Carrington, and V.V. Dolja. 2012. Virus-derived gene expression and RNA interference vector for grapevine. *Journal of Virology* 86: 6002–6009.
- Lai-Kee-Him, J., P. Schellenberger, C. Dumas, E. Richard, S. Trapani, V. Komar, G. Demangeat, C. Ritzenthaler, and P. Bron. 2013. The backbone model of the *Arabidopsis mosaic virus* reveals new insights into functional domains of Nepovirus capsid. *Journal of Structural Biology* 182: 1–9.
- Liberté, J.-F., and H. Sanfaçon. 2010. Cellular remodeling during plant virus infection. *Annual Review of Phytopathology* 48: 69–91.
- Lamprecht, R.L., M. Spaltman, D. Stephan, T. Wetzel, and J.T. Burger. 2013. Complete nucleotide sequence of a South African isolate of Grapevine fanleaf virus and its associated satellite RNA. *Viruses* 5: 1815–1823.
- Laporte, C., G. Vetter, A.-M. Loudes, D.G. Robinson, S. Hillmer, C. Stussi-Garaud, and C. Ritzenthaler. 2003. Involvement of the secretory pathway and the cytoskeleton in intracellular targeting and tubule assembly of grapevine fanleaf virus movement protein in tobacco BY-2 Cells. *The Plant Cell* 15: 2058–2075.
- Le Gall, O., P. Christian, C.M. Fauquet, A.Q. King, N. Knowles, N. Nakashima, G. Stanway, and A.E. Gorbalenya. 2008. Picornavirales, a proposed order of positive-sense single-stranded RNA viruses with a pseudo- $T = 3$ virion architecture. *Archives of Virology* 153: 715–727.
- Maliogka, V.I., G.P. Martelli, M. Fuchs, and N.I. Katis. 2015. Chapter six – control of viruses infecting grapevine. *Advances in Virus Research* 91: 175–227.
- Margis, R., and L. Pinck. 1992. Effects of site-directed mutagenesis on the presumed catalytic triad and substrate-binding pocket of Grapevine fanleaf nepovirus 24-kDa proteinase. *Virology* 190: 884–888.
- Margis, R., M. Viry, M. Pinck, and L. Pinck. 1991. Cloning and in vitro characterization of the grapevine fanleaf virus proteinase cistron. *Virology* 185: 779–787.
- Margis, R., C. Ritzenthaler, J. Reinbolt, M. Pinck, and L. Pinck. 1993. Genome organization of grapevine fanleaf nepovirus RNA2 deduced from the 122K polyprotein P2 in vitro cleavage products. *Journal of General Virology* 74: 1919–1926.
- Margis, R., M. Viry, M. Pinck, N. Bardonnat, and L. Pinck. 1994. Differential proteolytic activities of precursor and mature forms of the 24K proteinase of Grapevine fanleaf nepovirus. *Virology* 200: 79–86.
- Marmonier, A., P. Schellenberger, D. Esmenjaud, C. Schmitt-Keichinger, C. Ritzenthaler, P. Andret-Link, O. Lemaire, M. Fuchs, and G. Demangeat. 2010. The coat protein determines the specificity of virus transmission by *Xiphinema diversicaudatum*. *Journal of Plant Pathology* 92: 275–279.
- Martelli, G.P. 1993. *Graft-transmissible diseases of grapevines. Handbook for detection and diagnosis*. Rome: Food and Agricultural Organization of the United Nations Publication Division.
- . 2014a. Directory of virus and virus-like diseases of the grapevine and their agents. *Journal of Plant Pathology* 96: 1–136.
- . 2014b. Virus diseases of grapevine.
- Martelli, G.P., E. Boudon-Padieu. 2006. Directory of infectious diseases of grapevines and viroses and virus-like diseases of the grapevine: Bibliographic report 1998–2004., In ed. G.P. Martelli and E. Boudon-Padieu. Bari: CIHEAM, 2006. (Options Méditerranéennes : Série B. Etudes et Recherches; n. 55).

- Martelli, G.P., and G. Piro. 1975. Virus diseases of the grapevine in a Sicilian herbarium of the past century. *Vitis* 13: 329–335.
- Mekuria, T.A., L.R. Gutha, R.R. Martin, and R.A. Naidu. 2009. Genome diversity and intra- and interspecies recombination events in Grapevine fanleaf virus. *Phytopathology* 99: 1394–1402.
- Merzlyak, E.M., J. Goedhart, D. Shcherbo, M.E. Bulina, A.S. Shcheglov, A.F. Fradkov, A. Gaintzeva, K.A. Lukyanov, S. Lukyanov, T.W.J. Gadella, and D.M. Chudakov. 2007. Bright monomeric red fluorescent protein with an extended fluorescence lifetime. *Nature Methods* 4: 555–557.
- Morris-Krsinich, B.A.M., R.L.S. Forster, and D.W. Mossop. 1983. The synthesis and processing of the nepovirus grapevine fanleaf virus proteins in rabbit reticulocyte lysate. *Virology* 130: 523–526.
- Murant, A.F. 1981. Nepoviruses. In *Handbook of plant virus infections and comparative diagnosis*, ed. E. Kurstak, 197–238. Amsterdam: Elsevier/North-Holland.
- Muyldermans, S. 2013. Nanobodies: Natural single-domain antibodies. *Annual Review of Biochemistry* 82: 775–797.
- Naraghi-Arani, P., S. Daubert, and A. Rowhani. 2001. Quasispecies nature of the genome of Grapevine fanleaf virus. *Journal of General Virology* 82: 1791–1795.
- Newburn, L.R., and K.A. White. 2015. Cis-acting RNA elements in positive-strand RNA plant virus genomes. *Virology* 479–480: 434–443.
- Nölke, G., P. Cobanov, K. Uhde-Holzem, G. Reustle, R. Fischer, and S. Schillberg. 2009. *Grapevine fanleaf virus* (GFLV)-specific antibodies confer GFLV and *Arabis mosaic virus* (ArMV) resistance in *Nicotiana benthamiana*. *Molecular Plant Pathology* 10: 41–49.
- Nourinejad Zarghani, S., L. Dupuis-Maguiraga, A. Bassler, and T. Wetzel. 2014. Mapping of the exchangeable and dispensable domains of the RNA 2-encoded 2A^{HP} protein of *Arabis mosaic nepovirus*. *Virology* 458–459: 106–113.
- Oliver, J.E., P.F. Tennant, and M. Fuchs. 2011. Virus-resistant transgenic horticultural crops: Safety issues and risk assessment. In *Transgenic horticultural crops: Challenges and opportunities*, ed. B. Mou and R. Scorza, 263–287. Boca Raton: CRC Press.
- Paul, D., and R. Bartenschlager. 2013. Architecture and biogenesis of plus-strand RNA virus replication factories. *World Journal of Virology* 2: 32–48.
- Pinck, L., M. Fuchs, M. Pinck, M. Ravelonandro, and B. Walter. 1988. A satellite RNA in *Grapevine fanleaf virus* strain F13. *Journal of General Virology* 69: 233–239.
- Pumplin, N., and O. Voïnet. 2013. RNA silencing suppression by plant pathogens: Defence, counter-defence and counter-counter-defence. *Nature Reviews Microbiology* 11: 745–760.
- Quacquarelli, A., D. Gallitelli, V. Savino, and G.P. Martelli. 1976. Properties of *Grapevine fanleaf virus*. *Journal of General Virology* 32: 349–360.
- Raski, D.J., A.R. Maggenti, and N.O. Jones. 1973. Location of grapevine fanleaf and yellow mosaic virus particles in *Xiphinema index*. *Journal of Nematology* 5: 208–211.
- Raski, D.J., A.C. Goheen, L.A. Lider, and C.P. Meredith. 1983. Strategies against grapevine fanleaf virus and its nematode vector. *Plant Disease* 67: 335–339.
- Ritzenthaler, C. 2011. Parallels and distinctions in the direct cell-to-cell spread of the plant and animal viruses. *Current Opinion in Virology* 1: 403–409.
- Ritzenthaler, C., and C. Hofmann. 2007. Tubule-guided movement of plant viruses. In *Viral transport in plants*, ed. E. Weigmann and M. Heinlein. Berlin/Heidelberg/New York: Springer.
- Ritzenthaler, C., M. Viry, M. Pinck, R. Margis, M. Fuchs, and L. Pinck. 1991. Complete nucleotide sequence and genetic organization of grapevine fanleaf nepovirus RNA1. *Journal of General Virology* 72: 2357–2365.
- Ritzenthaler, C., A.-C. Schmit, P. Michler, C. Stussi-Garaud, and L. Pinck. 1995. Grapevine fanleaf nepovirus P38 putative movement protein is located on tubules *in vivo*. *Molecular Plant-Microbe Interactions* 8: 379–387.
- Ritzenthaler, C., C. Laporte, F. Gaire, P. Dunoyer, C. Schmitt, S. Duval, A. Piequet, A.M. Loudes, O. Rohfritsch, C. Stussi-Garaud, and P. Pfeiffer. 2002. Grapevine fanleaf virus replication occurs on endoplasmic reticulum-derived membranes. *Journal of Virology* 76: 8808–8819.

- Roberts, I.M., and D.J.F. Brown. 1980. Detection of six nepoviruses in their nematode vectors by immunosorbent electron microscopy. *The Annals of Applied Biology* 96: 187–192.
- Saldarelli, P., A. Minafra, and B. Walter. 1993. A survey of grapevine fanleaf nepovirus isolates for the presence of satellite RNA. *Vitis* 32: 99–102.
- Sanfaçon, H. 2008. Nepovirus. In *Encyclopedia of virology*, ed. M.H.V. van Regenmortel, 3rd ed., 405–413. Oxford: Elsevier.
- , 2013. Investigating the role of viral integral membrane proteins in promoting the assembly of nepovirus and comovirus replication factories. *Frontiers in Plant Science* 3, Article 313, 317 pages.
- Sanfaçon, H., J. Wellink, O. Le Gall, A. Karasev, R. van der Vlugt, and T. Wetzel. 2009. Secoviridae: A proposed family of plant viruses within the order *Picornavirales* that combines the families *Sequiviridae* and *Comoviridae*, the unassigned genera *Cheravirus* and *Sadwavirus*, and the proposed genus *Torradovirus*. *Archives of Virology* 154: 899–907.
- Sanford, J.C., and S.A. Johnston. 1985. The concept of parasite-derived resistance. Deriving resistance genes from the parasite's own genome. *Journal of Theoretical Biology* 113: 395–405.
- Sauer, N.J., J. Mozoruk, R.B. Miller, Z.J. Warburg, K.A. Walker, P.R. Beetham, C.R. Schöpke, and G.F.W. Gocal. 2016. Oligonucleotide-directed mutagenesis for precision gene editing. *Plant Biotechnology Journal* 14: 496–502.
- Savastano, L. 1908. Note di patologia arborea. In *Bollettino dell'arboricoltura italiana*, ed. F. Giannini, 16. Napoli: Già pubbl.
- Schaeffer, S.M., and P.A. Nakata. 2015. CRISPR/Cas9-mediated genome editing and gene replacement in plants: Transitioning from lab to field. *Plant Science* 240: 130–142.
- Schellenberger, P., P. Andret-Link, C. Schmitt-Keichinger, M. Bergdoll, A. Marmonier, E. Vigne, O. Lemaire, M. Fuchs, G. Demangeat, and C. Ritzenthaler. 2010. A stretch of 11 amino acids in the β B- β C loop of the coat protein of Grapevine fanleaf virus is essential for transmission by the nematode *Xiphinema index*. *Journal of Virology* 84: 7924–7933.
- Schellenberger, P., C. Sauter, B. Lorber, P. Bron, S. Trapani, M. Bergdoll, A. Marmonier, C. Schmitt-Keichinger, O. Lemaire, G. Demangeat, and C. Ritzenthaler. 2011. Structural insights into viral determinants of nematode mediated *Grapevine fanleaf virus* transmission. *PLoS Pathogens* 7: e1002034.
- Seitsonen, J.J.T., P. Susi, A. Lemmetty, and S.J. Butcher. 2008. Structure of the mite-transmitted Blackcurrant reversion nepovirus using electron cryo-microscopy. *Virology* 378: 162–168.
- Serghini, M.A., M. Fuchs, M. Pinck, J. Reinbolt, B. Walter, and L. Pinck. 1990. RNA2 of Grapevine fanleaf virus: Sequence analysis and coat protein cistron location. *Journal of General Virology* 71: 1433–1441.
- Singh, S., R. Rothnagel, B.V.V. Prasad, and B. Buckley. 1995. Expression of tobacco ringspot virus capsid protein and satellite RNA in insect cells and three-dimensional structure of tobacco ringspot virus-like particles. *Virology* 213: 472–481.
- Steil, B.P., and D.J. Barton. 2009. Cis-active RNA elements (CREs) and picornavirus RNA replication. *Virus Research* 139: 240–252.
- Taylor, C., and W. Robertson. 1970. Sites of virus retention in the alimentary tract of the nematode vectors, *Xiphinema diversicaudatum* (Micol.) and *X. index* (Thorne and Allen). *Annals of Applied Biology* 66: 375–380.
- Thomas, C.L., E.M. Bayer, C. Ritzenthaler, L. Fernandez-Calvino, and A.J. Maule. 2008. Specific targeting of a plasmodesmal protein affecting cell-to-cell communication. *PLoS Biology* 6: e7.
- Uzest, M., D. Gargani, M. Drucker, E. Hébrard, E. Garzo, T. Candresse, A. Fereres, and S. Blanc. 2007. A protein key to plant virus transmission at the tip of the insect vector stylet. *Proceedings of the National Academy of Sciences of the United States of America* 104: 17959–17964.
- van der Vlugt, R.A.A., M. Verbeek, A.M. Dullemans, W.M. Wintermantel, W.J. Cuellar, A. Fox, and J.R. Thompson. 2015. Torradoviruses. *Annual Review of Phytopathology* 53: 485–512.
- van Lent, J.M.W., and C. Schmitt-Keichinger. 2006. Viral movement proteins induce tubule formation in plant and insect cells. In *Cell-cell channels*, ed. F. Baluska, D. Volkmann, and P.W. Barlow, 160–175. Georgetown: Springer Landes Bioscience.

- van Lent, J., M. Storms, F. van der Meer, J. Wellink, and R. Goldbach. 1991. Tubular structures involved in movement of cowpea mosaic virus are also formed in infected cowpea protoplasts. *Journal of General Virology* 72: 2615–2623.
- Vigne, E., V. Komar, and M. Fuchs. 2004. Field safety assessment of recombination in transgenic grapevines expressing the coat protein gene of Grapevine fanleaf virus. *Transgenic Research*: 132165–132179.
- Vigne, E., A. Marmonier, and M. Fuchs. 2008. Multiple interspecies recombination events within RNA2 of *Grapevine fanleaf virus* and *Arabis mosaic virus*. *Archives of Virology* 153: 1771–1776.
- Vigne, E., J. Gottula, C. Schmitt-Keichinger, V. Komar, L. Ackerer, L. Belval, L. Rakotomalala, O. Lemaire, C. Ritzenthaler, and M. Fuchs. 2013. A strain-specific segment of the RNA-dependent RNA polymerase of *Grapevine fanleaf virus* determines symptoms in *Nicotiana* species. *Journal of General Virology* 94: 2803–2813.
- Viry, M., M.A. Serghini, F. Hans, C. Ritzenthaler, M. Pinck, and L. Pinck. 1993. Biologically active transcripts from cloned cDNA of genomic grapevine fanleaf nepovirus RNAs. *Journal of General Virology* 74: 169–174.
- Vuittenez, A., M.-C. Munck, and J. Kuszala. 1964. Souches de virus à haute agressivité isolées de vignes atteintes de dégénérescence infectieuse. *Études de Virologie Appliquée* 5: 68–78.
- Walker, M., J. Chisholm, T. Wei, B. Ghoshal, H. Saeed, M. Rott, and H. Sanfaçon. 2015. Complete genome sequence of three tomato ringspot virus isolates: evidence for reassortment and recombination. *Archives of Virology* 160: 543–547.
- Walter, B. 1988. Quelques exemples de la réaction physiologique de la vigne en présence de virus. *Bulletin de l'Organisation Internationale de la Vigne et du vin* 687–688: 383–390.
- Walter, B., and L. Etienne. 1987. Detection of the grapevine fanleaf viruses away from the period of vegetation. *Journal of Phytopathology* 120: 355–364.
- Walter, B., J. Kuszala, and A. Vuittenez. 1979. Diagnostic sérologique par les tests PALLAS et ELISA. Application aux virus de la rhizomanie de la betterave et du court-noué de la vigne. *Annales de Phytopathologie* 11: 568–569.
- Walter, B., A. Vuittenez, J. Kuszala, G. Stocky, J. Burckard, and M.H.V. van Regenmortel. 1984. Détection sérologique des virus du court-noué de la vigne par le test ELISA. *Agronomie* 4: 527–534.
- Wang, A., and H. Sanfaçon. 2000. Proteolytic processing at a novel cleavage site in the N-terminal region of the tomato ringspot nepovirus RNA-1-encoded polyprotein in vitro. *Journal of General Virology* 81: 2771–2781.
- Wang, A., S. Han, and H. Sanfaçon. 2004. Topogenesis in membranes of the NTB-VPg protein of Tomato ringspot nepovirus: Definition of the C-terminal transmembrane domain. *Journal of General Virology* 85: 535–545.
- Wetzel, T., M. Fuchs, M. Bobko, and G. Krczal. 2002. Size and sequence variability of the arabis mosaic virus protein 2A. *Archives of Virology* 147: 1643–1653.
- Wetzel, T., J. Chisholm, A. Bassler, and H. Sanfaçon. 2008. Characterization of proteinase cleavage sites in the N-terminal region of the RNA1-encoded polyprotein from *Arabis mosaic virus* (subgroup A nepovirus). *Virology* 375: 159–169.
- Wetzel, T., J. Chisholm, L. Dupuis-Maguiraga, A. Bassler, and H. Sanfaçon. 2013. In vitro and in vivo evidence for differences in the protease activity of two arabis mosaic nepovirus isolates and their impact on the infectivity of chimeric cDNA clones. *Virology* 446: 102–111.
- Xiong, J.-S., J. Ding, and Y. Li. 2015. Genome-editing technologies and their potential application in horticultural crop breeding. *Horticulture Research* 2: 15019–15028.
- Zarzyńska-Nowak, A., I. Ferriol, B.W. Falk, N. Borodynko-Filas, and B. Hasiów-Jaroszewska. 2017. Construction of *Agrobacterium tumefaciens*-mediated tomato black ring virus infectious cDNA clones. *Virus Research* 230: 59–62.

- Zhang, G., and H. Sanfaçon. 2006. Characterization of membrane association domains within the tomato ringspot nepovirus X2 protein, an endoplasmic reticulum-targeted polytopic membrane protein. *Journal of Virology* 80: 10847–10857.
- Zhang, G., V. Gurtu, and S.R. Kain. 1996. An enhanced green fluorescent protein allows sensitive detection of gene transfer in mammalian cells. *Biochemical and Biophysical Research Communications* 227: 707–711.
- Zhao, F., U.S. Hwang, S. Lim, R.H. Yoo, D. Igori, S.-H. Lee, H.-S. Lim, and J.S. Moon. 2015. Complete genome sequence and construction of infectious full-length cDNA clones of tobacco ringspot nepovirus, a viral pathogen causing bud blight in soybean. *Virus Genes* 51: 163–166.

Chapter 5

American Nepoviruses

A. Rowhani, S.D. Daubert, J.K. Uyemoto, M. Al Rwahnih, and M. Fuchs

Abstract Among the 15 nepoviruses infecting grapevines, four are of American origin based on their dependence on host plants or nematode vectors that are indigenous to America. Three of these nepoviruses, e.g., *Tobacco ringspot virus* (TRSV), *Tomato ringspot virus* (ToRSV), and *Peach rosette mosaic virus* (PRMV), are transmitted by nematodes of the *Xiphinema americanum* group, as well as by seed and manual inoculation. The fourth nepovirus, *Blueberry leaf mottle virus* (BLMoV), is transmitted through pollen and mechanically. Transmission by a nematode has not been observed. BLMoV and PRMV have a host range restricted to woody plants and are significant pathogens of *Vitis labrusca* in the Great Lakes region. TRSV and ToRSV have broad host ranges that include annuals and perennials, woody and herbaceous crops, as well as weed species. They induce systemic, symptomless infections or ringspots in herbaceous hosts. Asymptomatic infections have masked the presence of TRSV and ToRSV to facilitate their spread across agricultural sectors. Both virus species occur sporadically from coast to coast in the USA infecting a variety of host plants and occasionally found outside of North America. The four American nepoviruses may have spread initially from the Great Lakes region via own-rooted vines. Phylogenetic analysis based on coat protein gene sequence information separates American from Old World nepoviruses. Like their Old World counterparts, New World nepoviruses have a bipartite genome and require two genomic RNAs for infection *in planta*. American nepovirus infection in grapevine is controlled by the use of tolerant rootstocks, clean stock programs, as well as by regional, national, and international guidelines that regulate the dissemination of propagation material.

A. Rowhani (✉) • S.D. Daubert • M. Al Rwahnih
Department of Plant Pathology, University of California, Davis, CA 95616, USA
e-mail: akrowhani@ucdavis.edu

J.K. Uyemoto
USDA-ARS, Department of Plant Pathology, University of California,
Davis, CA 95616, USA

M. Fuchs
Section of Plant Pathology and Plant-Microbe Biology, School of Integrative Plant Science,
New York State Agricultural Experiment Station, Cornell University, Geneva, NY, USA

Keywords *Blueberry leaf mottle virus* • *Peach rosette mosaic virus* • *Tobacco ringspot virus* • *Tomato ringspot virus* • *Xiphinema americanum*

Introduction

The genus *Nepovirus* in the subfamily *Comovirinae* within the family *Secoviridae* (Sanfaçon et al., 2009) includes 36 virus species recognized by the International Committee on Taxonomy of Viruses (ICTV). Most of these viruses are soilborne and transmitted by *Xiphinema* (“dagger” nematode) and *Longidorus* (“needle” nematode) species (named for their long stylets that penetrate plant roots through the vasculature). At least 15 nepoviruses, including *Arabidopsis mosaic virus* (ArMV), *Artichoke Italian latent virus*, *Blueberry leaf mottle virus* (BLMoV), *Cherry leaf roll virus* (CLRV), *Grapevine Bulgarian latent virus* (GBLV), *Grapevine chrome mosaic virus*, *Grapevine fanleaf virus* (GFLV), *Grapevine Tunisian ringspot virus*, *Grapevine deformation virus*, *Grapevine Anatolian ringspot virus*, *Peach rosette mosaic virus* (PRMV), *Raspberry ringspot virus*, *Tobacco ringspot virus* (TRSV), *Tomato black ring virus*, and *Tomato ringspot virus* (ToRSV), as well as the unassigned *Secoviridae* *Strawberry latent ringspot virus*, are associated with diseases of grapevine (Martelli 2014; Martelli and Taylor 1990).

Most of these viruses are of European derivation and are specifically transmitted by nematode vectors indigenous to Europe, such as *Xiphinema index*, *X. diversicaudatum*, *Longidorus elongatus*, *L. marcosoma*, *L. martini*, *L. apulus*, *L. fasciatus*, and *L. attenuatus*. The origin of some nepoviruses transmitted by these vectors, such as GFLV and ArMV, can be traced (along with their vectors) to plant material introduced from Europe to the Americas. Like GFLV and ArMV, CLRV has been observed infecting *Vitis vinifera* in the New World (Herrer and Madariaga 2001). Unlike other nepoviruses of apparent European origin, CLRV’s history cannot be inferred from its specific transmission by a European nematode vector because no nematode vector has been identified for this virus (Jones et al. 1981). Because of its widespread distribution in European plants (EFSA 2014), an Old World origin is assumed for CLRV. Grapevine nepoviruses of European origin are the subject of Chap. 3 in this volume.

This chapter is concerned with grapevine-infecting nepoviruses that appear to be of North American derivation. Nematodes that specifically transmit American nepoviruses such as *X. americanum* and members of that group (e.g., *X. bricolensis*, *X. californicum*, and *X. rivesi*) are indigenous to North America (Brown et al. 1994; Taylor and Brown 1977). Even though those viruses may be found infecting plants of Old World origin, they are classified as American nepoviruses primarily through their association with nematode vectors and host plants native to America. These viruses include BLMoV, PRMV, ToRSV, and TRSV. The evolutionary separation between Old World (GFLV and ArMV) and New World (ToRSV, TRSV, and BLMoV) nepoviruses is apparent in the divergence of their respective branches in phylogenetic comparison of their coat protein gene sequences (Fig. 5.1).

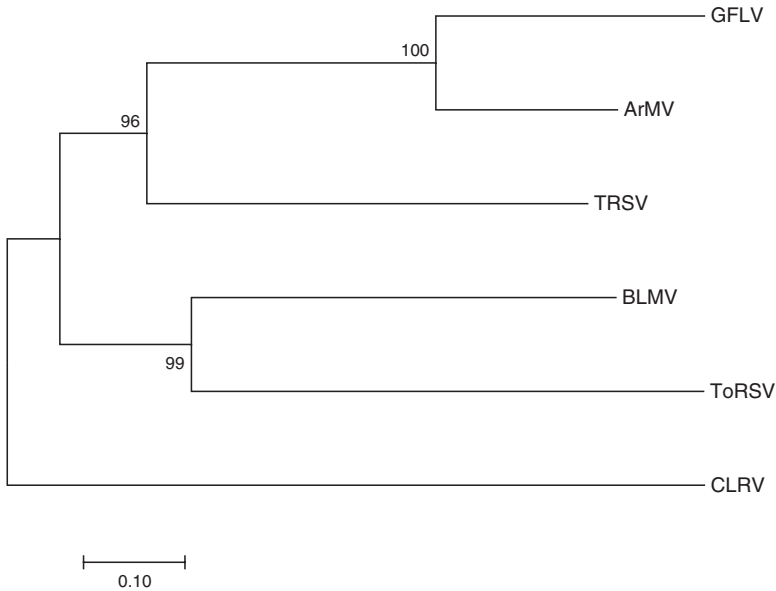

Fig. 5.1 Phylogenetic analysis of the coat protein gene nucleotide sequence of Old World (GFLV and ArMV) vs. New World (BLMoV, ToRSV, and TRSV) nepoviruses. Bootstrap values are shown as percentages; percentages less than 70% are not shown. Phylogenetic analyses were conducted using the minimum evolution method as well as maximum likelihood method from the molecular evolutionary genetic analysis software MEGA version 6. The support for the tree nodes was estimated using 1000 bootstrap replicates with default parameters. Accession numbers of the viruses used in the analysis were TRSV: [NC_005096.1](#); ArMV: [NC_006056.1](#); ToRSV: [NC_003839.2](#); GFLV: [NC_003623.1](#); BLMoV: U20621; and CLRV: [NC_003623.1](#). Sequence information is not available for the coat protein gene of PRMV

Common Characteristics

Nepoviruses have small polyhedral particles ca. 28 nm in diameter, a bipartite positive-strand RNA genome, and a conserved arrangement of protein domains within the polyproteins encoded by their large (RNA-1) and small (RNA-2) RNAs. The two genomic RNAs are indispensable for systemic infection *in planta* but RNA-1 can replicate independently of RNA-2. Of the four North American grapevine nepoviruses, TRSV was the first to be well described; it is the type species of the genus *Nepovirus*.

The two nepovirus linear positive-sense single-stranded RNAs have a 3' terminal poly(A) tail (Mayo et al. 1979a) and a small viral protein (VPg) covalently linked at the RNA 5' end (Mayo et al. 1979b). The genomic RNAs extracted from virions are infectious by mechanical inoculation, but only if the VPg has not been proteolytically removed, as shown for TRSV and ToRSV but not for other nepoviruses (Mayo et al. 1982; Sanfaçon 2008). Small, noncoding, parasitic satellite (sat) RNA species are also encapsidated within particles of TRSV and a few other nepoviruses (DeYoung et al. 1995; Keifer et al. 1982). SatRNAs depend on their helper virus for

replication and encapsidation. Type B satRNAs are 1100–1500 nt in length. They are linked to a VPg at their 5' end and polyadenylated at their 3' end and encode a nonstructural protein, which is essential for their replication although its function is unknown. Type D satRNAs are less than 500 nt long. They are not linked to a VPg nor polyadenylated and do not encode a protein. Type D satRNAs are encapsidated as monomeric or multimeric linear molecules and can modulate symptom expression either by attenuating and exacerbating their severity (Roossinck et al. 1992).

The two nepovirus genomic RNA segments are of unequal length and encapsidated together or separately. The bipartite nature of the genome allows for the expansion of its coding capacity, relative to that of a monopartite virus of similar dimensions. This encapsidation strategy is characteristic of all the members of the subfamily *Comovirinae* in the family *Secoviridae* (Sanfaçon et al., 2009, 2011). Each nepovirus encapsidates its genomic RNAs into separate viral particles, both enclosed in the same capsid material but each with a distinct buoyant density. For TRSV, particles of the greatest buoyant density (called B components, for their bottom band position in sucrose or cesium chloride gradients) contain the longer genomic component (RNA-1); less dense particles (M components) carry the smaller genomic component (RNA-2). These viruses also produce an “empty” capsid (T components) that does not contain any genomic material. For TRSV, the atomic structure of the particle shows a pseudo T=3 structure with three functional domains, each with a β -barrel (Chandrasekar and Johnson 1998). This structure shows similarities with that of other viruses in the family *Secoviridae*, as well as with picornaviroids, suggesting a common ancestor for these plant and animal viruses (Chandrasekar and Johnson 1998; Thompson et al. 2014).

Nepoviruses are divided into three subgroups (subgroups A, B, and C) based on the length and packaging of RNA-2 and on sequence similarities (Sanfaçon 2008; Sanfaçon et al. 2011). Subgroup A includes TRSV, while subgroup C includes BLMoV, ToRSV, and PRMV. Members of the two subgroups segregate onto distinct branches on a phylogenetic tree of their coat protein genes (Fig. 5.1), although they share a similar capsid structure and the same modular arrangement of replication and structural proteins. The RNA-2 of subgroup A members, which includes TRSV, ranges in size from 3700 to 4000 nt in length. The median length of the four GenBank sequence accessions of TRSV RNA-2 is 3929 nt in size. The M component of TRSV virions carries one copy of RNA-2, while two copies are contained in the TRSV B component. This B component has the same buoyant density as TRSV virions carrying a single copy of TRSV RNA-1. Subgroup B members carry a larger RNA-2 4400–4700 nt in length, which is singly present only in the M component. The RNA-2 of subgroup C members is the largest in the genus (6400–7300 nt in size) and is present only in the M component.

The complete nucleotide sequences of the TRSV (Zhao et al. 2015) and ToRSV (Rott et al. 1991, 1995; Walker et al. 2015) genomes have been determined. A complete sequence of PRMV RNA-1 was obtained (Lammers et al. 1999) and partial information is available for RNA-2 (Ho and Tzanetakis 2014). Only partial BLMoV genomic RNA sequence data are available in GenBank (accession numbers U20621 and U20622).

The nepovirus genomic RNAs code for single long open reading frames that are translated into single large polyproteins (Fig. 5.2). The 5' untranslatable region is 70–300 nt long, while the 3' untranslatable region varies in length from 200 to 400 nt for subgroup A nepoviruses; for subgroup C nepoviruses, the 3' untranslatable region is 1300–1600 nt in length. The ToRSV genomic RNA 3' noncoding regions extend to 1500 nucleotides (Sanfaçon et al. 2006). For subgroup C nepoviruses, the 3' untranslatable regions are identical between RNA-1 and RNA-2. Similarly, the 5' noncoding regions of ToRSV RNA-1 and RNA-2 share a region of 100% sequence identity which extends into the coding region.

Individual functional proteins are released by proteolytic cleavage from the polyproteins, as has been characterized extensively for ToRSV (Sanfaçon et al. 2006; Wang et al. 1999; Wang and Sanfaçon 2000a). The protein domains in the inferred polyprotein translation products are mapped across the nepovirus genome (Fig. 5.2). The RNA-1-encoded polyprotein includes a helicase (also named NTB protein because it contains a conserved nucleoside triphosphate-binding sequence motif), the VPg, a cysteine protease [which functions in the release of itself and the other mature proteins from the polyproteins (Wang et al. 1999)], and the RNA-dependent RNA polymerase. Also encoded toward the 5' end region of this polyprotein (see Fig. 5.2) is a protein with sequence homology to a cofactor for the protease (Carrier

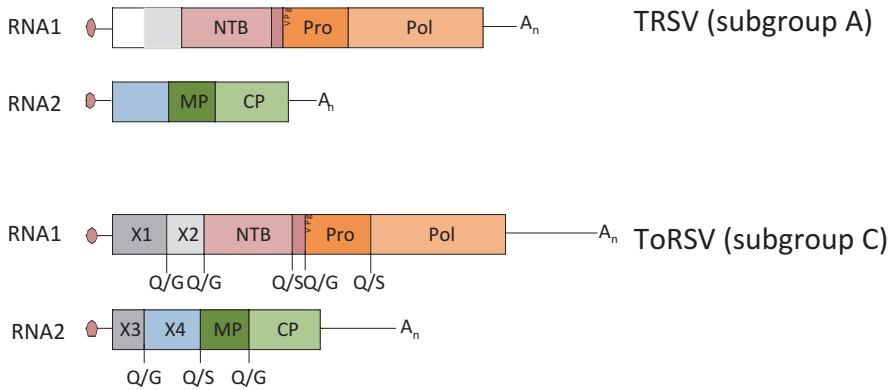

Fig. 5.2 Comparative schematic genomic organization between *Tobacco ringspot virus* (TRSV) (a subgroup A nepovirus) and *Tomato ringspot virus* (ToRSV) (a subgroup C nepovirus). The polyprotein reading frame positions within the large (*upper*) and small (*lower*) viral RNA genomic components are shown in color. The 5' and 3' untranslatable regions are indicated by a single line, and the VPg is depicted by a crimson circle. Locations of the proteolytic cleavages separating the mature protein products, including the amino acids flanking the cleavage sites, are shown below. The RNA-1 encodes an RNA-dependent RNA polymerase (Pol), a protease (Pro), a VPg, a nucleotide-binding protein (NTB), and a protease cofactor, as well as, in the case of ToRSV, an X1 protein of unknown function. The RNA-2 encodes the coat protein (CP), the movement protein (MP), and a polymerase cofactor, as well as, in the case of ToRSV, an X3 protein of unknown function. Reading frames with similarities to cofactors for the protease and for the RNA-dependent RNA polymerase reside on or near the 5' ends of the coding frames. The 3' untranslatable regions of the genomic RNAs extend for 1500 bases beyond the end of the polyprotein reading frame in subgroup C nepoviruses

et al. 2001); this sequence motif is called X2 in ToRSV. The ToRSV X2 protein is an endoplasmic reticulum-targeted membrane protein that may play a role in viral replication. Subgroup C nepoviruses also encode a protein X1 on RNA-1 (terminology of Sanfaçon et al. 2006) for which the function is unknown. Protein X1 is not present in the genome of other nepoviral subgroups (Carrier et al. 2001). The replication of nepoviruses has been shown to co-localize with endoplasmic reticulum-derived membranes in infected cells (Sanfaçon 2008). For ToRSV, the NTB protein has been proposed to play a role in anchoring the viral replication complex to the membranes. The NTB protein is targeted to endoplasmic reticulum membranes and contains two membrane-binding domains: a C-terminal transmembrane domain and a putative N-terminal amphipathic helix (Sanfaçon 2012).

The products derived from the RNA-2-encoded polyprotein inferred from the sequencing data (Sanfaçon et al. 2009; Zhao et al. 2015) include a protein involved in cell-to-cell movement of virions in plants and the capsid protein, which is involved in cell-to-cell movement, as well as in subterranean plant-to-plant spread, in its capacity as a nematode-binding protein by analogy with GFLV (Andret-Link et al. 2004; Schellenberger et al. 2011). Infected plant cells are characterized by the presence of tubular structures containing viruslike particles in or near the cell wall. The tubules result from the assembly of movement protein subunits. The 5' proximal coding region of RNA-2 shows homology to a protein that appears to act as a polymerase cofactor, functional in the replication of viral genomic RNA-2 but not RNA-1 (Carrier et al. 2001; Jafarpour and Sanfaçon 2009).

The amino-terminal stretches in the polyproteins encoded by both RNAs of subgroup C nepoviruses share regions of identity with each other. They also show a more distant similarity with the amino-terminal stretch of the open reading frame of nepovirus subgroup A RNA-2 (which encodes a homolog of the polymerase cofactor). Subgroup C nepoviruses also encode a protein on RNA-2, which is not found in other nepovirus subgroups. This X4 protein (terminology of Sanfaçon et al. 2006) appears hypervariable, being of different length in different ToRSV isolates, and only distantly related with similar domains in other subgroup C nepoviruses (Jafarpour and Sanfaçon 2009). The function of the X4 protein is unknown.

Transmission

Nepoviruses are unusual in the breadth of their means of host-to-host spread. They are one of only two plant viral genera that are transmitted underground to and from roots by nematodes (the other being tobraviruses). Some nepoviruses infect host embryonic tissue and spread vertically from one generation of hosts to the next during the natural propagation process of their host plants. They are seed-borne and confirmed in a few cases pollen-borne (Lister and Murrant 1967; Mink 1993). During pollen transmission, they can be vectored nonspecifically by honeybees and other pollen-foraging insects. In addition, nepoviruses can be experimentally transmitted to new hosts through mechanical inoculation (hence, vectored by humans).

TRSV, ToRSV, and PRMV are transmitted by nematodes in the *X. americanum* group (Breece and Hart 1959; Brown 1989; Brown et al. 1994). TRSV is acquired within 24 h of nematode feeding and transmitted by both adult and larval stage nematodes (Hibben and Walker 1971; Stace-Smith 1985). TRSV and ToRSV are seed transmitted (EPPO 2005; Mountain et al. 1983; Yang and Hamilton 1974). Seed transmission of TRSV led to the dissemination of the bud-blight strain of the virus, which was the cause of the US soybean bud-blight epidemic in the 1940s (Kahn and Latterell 1955).

PRMV (Ramsdell and Meyers 1977) and BLMoV (Uyemoto et al. 1977a) are seed transmitted in Concord grape (*V. labrusca*). Pollen transmission was not observed in PRMV (Ramsdell and Meyers 1977). BLMoV has not been demonstrated to be nematode-transmissible (Childress and Ramsdell 1986a) but the virus has been detected in pollen (Childress and Ramsdell 1986b) and appears to be honeybee-transferable from diseased to healthy blueberry bushes (Childress and Ramsdell 1987).

Host Range

TRSV and ToRSV have extremely broad host ranges comprising both annual and perennial plants. In one study, TRSV was found to infect more than 90% of the plant species tested (143 species from 40 plant families) (Price 1940). In the same study, ToRSV was found to infect 54 species from 35 plant families (50% of the species tested). In another study, ToRSV was found to infect 21 species from 12 families (Powell et al. 1984), again 50% of the tested species. The host range of ToRSV includes both woody and herbaceous plants in dicotyledonous and monocotyledonous species. ToRSV hosts include cultivated perennials such as grapevines, peaches, cherries, apple, plum, almond, and ornamentals (Stace-Smith 1984), as well as indigenous annuals (Brunt et al. 1996).

The TRSV host range includes plants in dicotyledonous and monocotyledonous families (Stace-Smith 1985; EPPO Bulletin 2001). In a novel finding, TRSV has recently been reported to infect honeybees as well as their *Varroa* mite parasites (Li et al. 2014a). The virus multiplies in the bees to produce detectable negative-strand replicative-form viral genomic RNA (Li et al. 2014b).

Experimental propagative hosts for both TRSV and ToRSV include *Chenopodium amaranticolor*, *C. quinoa*, *Cucumis sativus*, *Lycopersicon esculentum*, *Phaseolus vulgaris*, and *Vigna unguiculata*. Host plants used as experimental assay indicator plants for both of these viruses comprise *C. amaranticolor*, *C. quinoa*, *Nicotiana tabacum*, and *V. unguiculata*.

In contrast to the wide host range of TRSV and ToRSV, that of BLMoV and PRMV is more limited. BLMoV and PRMV infect primarily American blueberry (*Vaccinium* spp.) and grapevine, the latter including a range of cultivars of North American *V. labrusca* such as Concord in Michigan (A. Schielder, personal communication). PRMV also infects orchard trees (Ramsdell and Meyers 1974; Stace-Smith 1984).

Symptomatology and Economic Impact

The identification of specific grapevine virus diseases by their symptomatology is regularly confounded by the effects of coinfecting viruses or even abiotic factors. Multiple viruses regularly co-occur in infected grapevines (e.g., see Al Rwahnih et al. 2015; Chap. 27, this volume). Causality between specific viruses and the disease symptoms they cause can be rigorously established only if the symptomatic plants have been proven to be infected solely by the causative virus or if Koch's postulates have been satisfied.

Symptoms attributed to TRSV infection in a range of *Vitis* spp. include unthrifty shoots, shortened internodes, distorted leaves and stunted vines, and decreased berry yield (EPPO 2001). In colder climates, infection may render buds frost-sensitive (Gilmer and Uyemoto 1972). Growth from surviving buds is delayed, leaves are small and mottled, and the vines are stunted and set few or no fruits (Gilmer et al. 1970) (Fig. 5.3). TRSV is currently considered a significant risk to grapevines in Europe (EPPO 2001), while its economic impact is considered less significant in US vineyards.

Though ToRSV infection is of greater concern in fruit tree crops (Bitterlin et al. 1986; EPPO 2005), symptoms attributed to ToRSV in grapevine are generally similar to those of TRSV (EPPO 2005; Gonsalves 1988) (Fig. 5.4). TRSV and ToRSV have been associated with a severe decline of Cascade grapevines in New York and Pennsylvania (Powell et al. 1990; Uyemoto 1975). More recently, these two viruses



Fig. 5.3 Effect of *Tobacco ringspot virus* on the fruit set of Bertille Seyve 2862, “Le Commandant.” Note shot and uneven-sized berries of different maturity stages

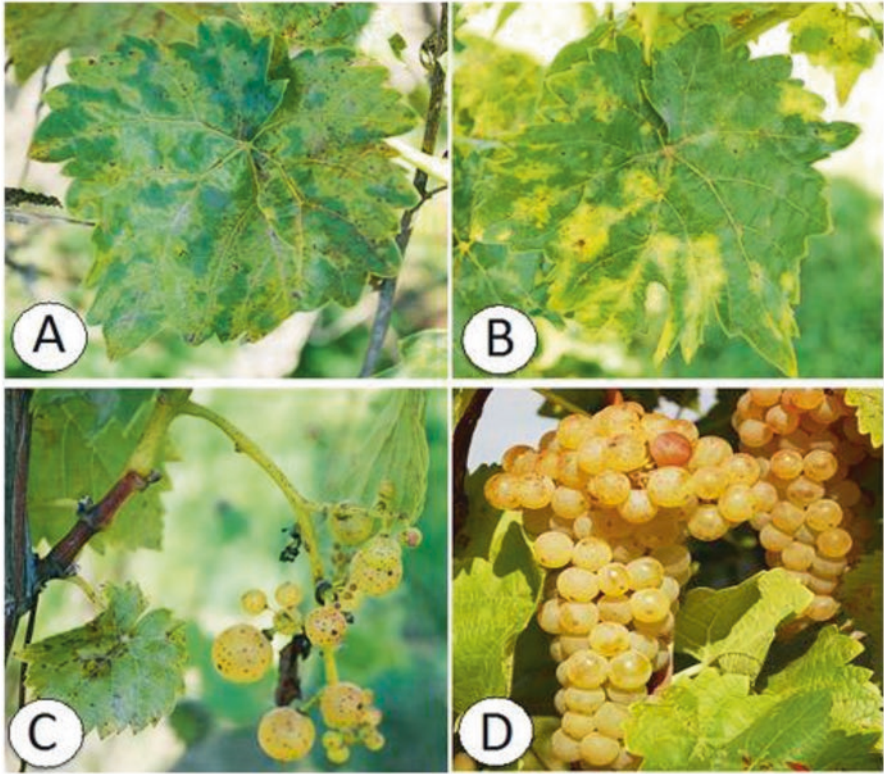

Fig. 5.4 Effect of *Tomato ringspot virus* on self-rooted Vidal (*Vitis vinifera* cv. Ugni blanc x inter-specific hybrid Rayon d’Or). Foliar symptoms of (A) mosaic and (B) chlorosis with necrotic veinal and interveinal areas. Poor berry set and size of an (C) infected compared to a (D) healthy fruit

have been detected on own-rooted Vidal, Concord, and Chardonnay in New York and Michigan (A. Schielder, personal communication). Both viruses are also reported to infect vines of European origin and cause vine decline (Gilmer and Uyemoto 1972; Gilmer et al. 1970). The decline can lead to vine death. “Grapevine yellow vein,” a ToRSV strain isolated in California, is associated with a general leaf chlorosis, chrome yellow flecking over areas of the leaves and yellow flecks along leaf veins, poor fruit set, and enlarged canes due to the absence of large grape clusters (Gooding and Hewitt 1962).

BLMoV is serologically related to GBLV (Ramsdell and Stace-Smith 1981; Uyemoto et al. 1977b); it induces delayed bud break, irregularly shaped fruit in straggly clusters, shot berries, and flattened sinuses (Uyemoto et al. 1977b) of leaves of Concord vines (*V. labrusca*).

PRMV causes disease in multiple grape cultivars in Michigan but *V. labrusca* cultivars (the most planted ones there, primarily cvs. Concord and Niagara) are heavily impacted with up to 50% crop loss (Ramsdell et al. 1995). The virus causes growth malformation, abnormalities in leaf morphology, cane growth developing

crooked internodes, narrow angle branching, berry shelling, and vine death (Ramsdell and Myers 1974). Visual assessment of nepovirus-induced symptoms in grapevine is often not reliable for diagnosis purposes. Therefore, bioassays or serological and molecular assays are needed for accurate identification.

Detection and Diagnosis

There are no published grapevine indicator bioassay host varieties for the detection of American nepoviruses; these viruses are detected by inoculation of grapevine sap to herbaceous indicator hosts. Host plants used as experimental indicators include *C. amaranticolor*, *C. quinoa*, *Nicotiana tabacum*, and *V. unguiculata*.

Symptoms diagnostic for TRSV and ToRSV are similar, in *P. vulgaris*, necrotic spots on inoculated and uninoculated leaves (systemic infections) with spots and rings and necrosis of the emerging growing tip. On *N. tabacum* and *N. clevelandii*, necrotic local lesions frequently develop into ringspots and curved line patterns following the vasculature; rings or lines may appear systemically on leaves expanding postinoculation. Chlorotic or necrotic local lesions, systemic mottling, and dwarfing with apical distortion are observed on *C. sativus* (Eppo 2001; Stace-Smith 1985; Uyemoto 1970). On *C. amaranticolor*, symptoms include chlorotic and necrotic local lesions that usually do not become systemic. Local lesions are produced on *C. quinoa* leaves inoculated with either TRSV or ToRSV, but infections by ToRSV become systemic to cause twisting and dieback of apical leaves. Another differentiating host is snapdragon (*Antirrhinum* spp.), in which TRSV induces necrotic ringspot and apical dieback, while ToRSV induces concentric line patterns or necrotic-bordered ringspots and/or a systemic chlorotic mottle (Uyemoto 1970). In many herbaceous hosts, ringspot symptoms can appear on inoculated leaves but are less evident or absent from the leaves that expand postinoculation. Asymptomatic infection can be demonstrated in those upper leaves by inoculation to another test plant or by ELISA or RT-PCR.

BLMoV produces chlorotic lesions on inoculated leaves of *C. quinoa*, systemic mottling, and epinasty of terminal leaves followed by death of the apex. In *N. clevelandii*, the virus produces necrotic ringspots on inoculated leaves and localized systemic necrotic spotting (Ramsdell and Stace-Smith 1983).

PRMV produces irregular yellow blotches on inoculated leaves of *C. quinoa*; new leaves exhibit a yellow-green mottling and terminal epinasty and finally terminal death. Symptoms on *C. amaranticolor* consist of faint chlorotic lesions on inoculated leaves, terminal epinasty and necrosis, and mottling of new leaves (Ramsdell and Gillett 1998; Ramsdell and Myers 1974).

American nepoviruses are specifically identified and distinguished in field samples by ELISA and RT-PCR (Eppo 2001; Griesbach 1995; Hoy and Mircetich 1984; Lee et al. 2016; Li et al. 2011; Powell 1984; Ramsdell et al. 1979; Sandoval et al. 1995; Stewart et al. 2007; Werner et al. 1997). High-throughput sequencing (HTS) is a robust diagnosis methodology to identify nepoviruses in grapevine. HTS

analysis has identified ToRSV and GFLV (Al Rwahnih et al. 2015), and PRMV (Ho and Tzanetakis 2014) in grapevine samples in the USA.

Geographic Distribution and Epidemiology

TRSV was first reported in eastern North America (Fromme et al. 1927) with its ringspot and banding patterns on Virginian tobacco leaves described as “hieroglyphics.” PRMV was first reported in peach, in Michigan in 1917 (see Klos 1976). In the eastern Great Lakes region, the four American nepoviruses of significance in grapevine, i.e., BLMoV, PRMV, TRSV, and ToRSV, occur together, apparently endemic within wild plant hosts (in which they are asymptomatic), propagating along with their nematode vectors.

PRMV and BLMoV occur in Michigan, with some spread through Ontario (Canada) into New York, where they infect blueberry (Childress and Ramsdell 1986a; Ramsdell and Gillett 1981) along with ToRSV and TRSV (Fuchs et al. 2010; Uyemoto et al. 1977a). PRMV (Dias and Cation 1976) and BLMoV (Childress and Ramsdell 1986b) occur in Concord grapevine in Michigan, with PRMV infections of *V. labrusca* in Ontario (Dias and Allen 1980).

Beyond its midwestern US range, ToRSV is indigenous along the North American Pacific coast (Frazier et al. 1961; Stace-Smith 1984). The occurrence of TRSV spreads southwest through the Great Plains region. This virus is endemic in grapevine from southern Ontario to the Rio Grande Valley (Stace-Smith 1985).

TRSV has occasionally been reported in row crops and ornamentals in Eurasia, Africa, and Oceania; ToRSV has likewise been reported in Eurasia, Oceania, and South America (Stace-Smith 1984, 1985). Both broad host range viruses occur in crop plants from coast to coast in North America. Their vector nematodes are found with them beyond their endemic ranges, possibly imported by the careless planting of infected rooted plants. Symptomless TRSV infections in ornamental plants may have facilitated the export of the virus (and its vector) from America to crop hosts around the world (Reynolds and Teakle 1976; Stace-Smith 1985). TRSV is considered a significant risk to grapevines in Europe (EPPO 2001).

Genetic Diversity

Examination of American nepovirus isolates recovered from different hosts or geographic locations has revealed a degree of diversity usually ranging from 2 to 20% at the nucleotide level. Isolates may also differ in their serological properties. Several isolates have emerged through recombination, implying the occurrence of mixed infections. A number of distinctive strains of TRSV (Hibben and Walker 1971; Tu 1986) and ToRSV (Bitterlin and Gonsalves 1988; Wang and Sanfaçon 2000b) are associated with different hosts. The severity of the diseases they induce,

host susceptibility, symptomatic traits, and serological or gene sequence differences unique to these strains reflect their genetic diversity.

The “grapevine yellow vein” isolate of ToRSV (Gooding and Hewitt 1962) has been found to be at significant symptomatic variance with the isolates from non-grape sources (Walker et al. 2015; Wang and Sanfaçon 2000a). ToRSV strains show differences of 20% in nucleotide sequence and separate into divergent branches on phylogenetic trees (Walker et al. 2015). Extensive variation among viral strains has been reported in the length of the sequence of the replicase cofactor coding region of ToRSV (Jafarpour and Sanfaçon 2009).

Control

Control of American nepovirus infection in grapevine is managed through clean stock programs, similar to those used to manage other viral grapevine pathogens (Maliogka et al. 2015; Chap. 27, this volume). Host resistance (either scion or rootstock) to PRMV (Ramsdell et al. 1995), TRSV (Gilmer et al. 1970) and ToRSV (Uyemoto et al. 1977b) has been evaluated in trials in Michigan and New York. In one analysis of grapevine material for its possible resistance against PRMV, seven scion cultivars and four rootstocks were analyzed. One cultivar (Seyval) remained uninfected, while the other ten genotypes eventually developed infections to various extents with percentages ranging from 4.5 to 54.5% (Ramsdell et al. 1995).

In upstate New York, infections were detected in own-rooted *V. vinifera* cultivars White Riesling, Chardonnay, Pinot blanc, Mission (TRSV), and Dutchess (ToRSV) (Uyemoto et al. 1977a). This analysis demonstrated virus susceptibility in *V. vinifera*-derived material. Among interspecific hybrid cultivars, own-rooted vines of Baco Noir, Cascade, Chelois, and De Chaunac developed disease symptoms. However, another interspecific hybrid Aurora remained free of disease (Uyemoto et al. 1977a).

Interspecific hybrids are of varied speciation; therefore, in addition to *V. vinifera* genes, they may contain susceptibility determinants from *V. linecumii*, *V. labrusca*, *V. aestivalis*, *V. rupestris*, and *V. riparia* (Remaily and Slate 1970). When the parentage of various interspecific hybrids was compared, close examination showed susceptible cultivars contained *V. riparia* genes. The apparently resistant interspecific hybrid Aurora did not, suggesting a possible correlation between breeding history and susceptibility.

In a greenhouse trial, open-pollinated seedlings of *V. riparia* and *V. rupestris* were sap-inoculated with TRSV or ToRSV. The infection rates in *V. riparia* were 33% (TRSV) and 13% (ToRSV). All *V. rupestris* seedlings remained healthy (Uyemoto 1975). When rooted cuttings of Concord, Aurore, Cascade, White Riesling, and rootstocks 3309 Couderc and SO4 were mechanically inoculated with purified virus preparations, TRSV produced systemic infection in White Riesling or local infections consisting of necrotic lesions (inoculated leaves) in Concord, Aurore, and 3309 Couderc. The necrotic lesions proved to be infectious when mechanically inoculated

onto *C. quinoa* test plants (Uyemoto 1975). Thus, virus susceptibility appeared to be contributed by genes of *V. vinifera* and *V. riparia* origin.

Overall, attempts to control nepovirus infection focused directly on the nematode vector have proven problematic. The dagger nematodes migrate deeply enough into the soil that superficial fumigation does not remove them (Brown et al. 1996); only very deep, prohibitively expensive, high-dosage applications of fumigants are successful (Lear et al. 1981). Presently, however, the phasing-out of soil fumigants, due to their environmentally damaging side effects, is removing the soil fumigation option for nematode control. Fallow periods or crop rotations do not remove *X. americanum* from the soil (Evans et al. 2007). As dagger nematodes can vector nepoviruses to weed hosts, weed control in vineyards must be practiced (Mountain et al. 1983; Izadpanah et al. 2003; Powell et al. 1984) to preclude vineyard reinfection.

Conclusions and Future Research Directions

American nepoviruses (BLMoV, PRMV, TRSV, and ToRSV) can be of economic importance in certain vineyards, particularly those established with own-rooted vines, but tolerant rootstocks, certification programs, as well as regional, national and international regulations have limited their distribution primarily from areas where they are endemic. Efforts to restrict these viruses need to be sustained as the global exchange of propagation material continues to expand worldwide at an unprecedented level (Gergerich et al. 2015). Among American nepoviruses, ToRSV is of most concern due to its wide host range that includes woody, herbaceous ornamental, and weed species, efficient transmission by several ectoparasitic dagger nematode species, and occurrence beyond its natural endemic areas.

American nepoviruses are transmitted by *X. americanum*, a group of dagger nematodes indigenous to North America. These nepoviruses often have a higher impact on self-rooted grapevine cultivars, particularly self-rooted *V. vinifera* and interspecific hybrids. Grafting susceptible cultivars onto nematode-tolerant rootstocks usually satisfactorily restores vine performance and vineyard profitability. Because resistance to PRMV, TRSV, and ToRSV has been identified in certain cultivars, it would be interesting to identify the genetic determinants of this resistance in order to build resistant rootstocks or to add resistance to own-rooted cultivars.

In comparison with subgroup A nepoviruses, limited information is available on the relationship between American nepoviruses and their nematode vectors. This is an area where research would be desirable not only to advance our understanding of virus-vector relationships but also to develop innovative management strategies.

TRSV is considered a significant risk to grapevines in Europe (EPPO 2001), but it appears to be under control in the USA, as do BLMoV and PRMV. However, with the advent and wide adoption of HTS, the presence of American nepoviruses will likely be discovered in material that is presently recognized as being clean,

particularly in tolerant cultivars or rootstock genotypes, as shown recently for PRMV (Ho and Tzaneakis 2014). This may require an audit of perceivably clean stocks and/or existing collection of clean material (Gergerich et al. 2015). Nonetheless, HTS will significantly contribute to a safer and timelier exchange of clean propagation material across regulatory boundaries in the near future.

References

- Al Rwahnih, M., S. Daubert, D. Golino, C. Islas, and A. Rowhani. 2015. Comparison of next-generation sequencing versus biological indexing for the optimal detection of viral pathogens in grapevine. *Phytopathology* 105: 758–763.
- Andret-Link, P., C. Schmitt-Keichinger, G. Demangeat, V. Komar, and M. Fuchs. 2004. The specific transmission of *Grapevine fanleaf virus* by its nematode vector *Xiphinema index* is solely determined by the viral coat protein. *Virology* 320: 12–22.
- Bitterlin, M.W., and D. Gonsalves. 1988. Serological grouping of Tomato ringspot virus isolates: Implications for diagnosis and cross-protection. *Phytopathology* 78: 278–285.
- Bitterlin, M.W., D. Gonsalves, and J.G. Barrat. 1986. Distribution of Tomato ringspot virus in peach trees: Implications for viral detection. *Plant Disease* 72: 59–63.
- Breece, J.R., and W.H. Hart. 1959. A possible association of nematodes with the spread of Peach yellow bud mosaic virus. *Plant Disease Report* 43: 989–990.
- Brown, D.J.F. 1989. Viruses transmitted by nematodes. *Bulletin OEPP/EPPO Bulletin* 19: 453–461.
- Brown, D.J.F., J.M. Halbrecht, A.T. James, T.C. Vrain, and R.T. Robbins. 1994. Transmission of three North American nepoviruses by populations of four distinct species of the *Xiphinemaamericanum* group. *Phytopathology* 84: 646–649.
- Brown, D.J.F., D.L. Trudgill, and W.M. Robertson. 1996. Nepoviruses: Transmission by nematodes. In *The plant viruses 5: Polyhedral virions and bipartite RNA genomes*, ed. B.D. Harrison and A.F. Murant, 187–209. New York: Plenum Press.
- Brunt, A.A., K. Crabtree, M.J. Dallwitz, A.J. Gibbs, L. Watson, and E.J. Zurcher. 1996. Plant Viruses Online: Descriptions and Lists from the VIDE Database.
- Carrier, K., Y. Xiang, and H. Sanfaçon. 2001. Genomic organization of *Tomato ringspot virus*: processing at a third cleavage site in the N-terminal region of the polyprotein in vitro. *The Journal of General Virology* 82: 1785–1790.
- Chandrasekar, V., and J.E. Johnson. 1998. The structure of tobacco ringspot virus: A link in the evaluation of icosahedral capsids in the picornavirus superfamily. *Current Biology* 6: 157–171.
- Childress, A.M., and D.C. Ramsdell. 1986a. Lack of evidence for a nematode vector of blueberry leaf mottle virus. *Acta Horticulturae* 186: 87–94.
- . 1986b. Detection of blueberry leaf mottle virus in highbush blueberry pollen and seed. *Phytopathology* 76: 1333–1337.
- . 1987. Bee-mediated transmission of *Blueberry leaf mottle virus* via infected pollen in highbush blueberry. *Phytopathology* 77: 167–172.
- DeYoung, M., A.M. Siwkowski, Y. Lian, and A. Hampel. 1995. Catalytic properties of hairpin ribozymes derived from Chicory yellow mottle virus and Arabis mosaic virus satellite RNAs. *Biochemistry* 34: 15785–15791.
- Dias, H.F., and W.R. Allan. 1980. Occurrence of peach rosette mosaic virus on grapevine in southern Ontario. *Canadian Journal of Botany* 58: 1747.
- Dias, H.F., and D. Cation. 1976. The characterization of a virus responsible for peach rosette mosaic and grape decline in Michigan. *Canadian Journal of Botany* 54: 1228–1239.
- EPPO. 2001. Diagnostic protocols for regulated pests. Tobacco ringspot nepovirus. *EPPO Bulletin* 31: 45–51.

- . 2005. Diagnostic protocols for regulated pests. Tomato ringspot nepovirus. *EPPO Bulletin* 35: 313–318.
- European Food Safety Authority. 2014. Scientific opinion on the pest categorization of Cherry leafroll virus. *EFSA Journal* 20: 3848–3871.
- Evans, T.A., L.C. Miller, B.L. Vasilas, R.W. Taylor, and R.P. Mulrooney. 2007. Management of *Xiphinema americanum* and soybean severe stunt in soybean using crop rotation. *Plant Disease* 91: 216–219.
- Frazier, N.W., C.E. Yarwood, and A.H. Gold. 1961. Yellow bud virus endemic along the California coast. *Plant Disease Report* 45: 649–651.
- Fromme, F.D., S.A. Wingard, and C.N. Priode. 1927. Ringspot of tobacco; an infectious disease of unknown cause. *Phytopathology* 17: 321–328.
- Fuchs, M., G.S. Abawi, P. Marsella-Herrick, R. Cox, K.D. Cox, J.E. Carroll, and R.R. Martin. 2010. Occurrence of *Tomato ringspot virus* and *Tobacco ringspot virus* in highbush blueberry in New York State. *Journal of Plant Pathology* 92: 451–459.
- Gergerich, R., R. Welliver, S. Gettys, N. Osterbauer, S. Kamenidou, R.R. Martin, D.A. Golino, K. Eastwell, M. Fuchs, G. Vidalakis, and I.E. Tzanetakis. 2015. Safeguarding fruit crops in the age of agriculture globalization. *Plant Disease* 99: 176–187.
- Gilmer, R.M., and J.K. Uyemoto. 1972. Tomato ringspot virus in Baco noir grapevine in New York. *Plant Disease Report* 56: 133–135.
- Gilmer, R.M., J.K. Uyemoto, and L.J. Kelts. 1970. A new grapevine disease induced by *Tobacco ringspot virus*. *Phytopathology* 60: 619–627.
- Gonsalves, D. 1988. *Compendium of grape diseases*, 49–51. St. Paul: APS Press.
- Gooding, G.V., and W.B. Hewitt. 1962. Grape yellow vein, symptomatology, identification, and the association of a mechanically transmissible virus with the disease. *American Journal of Enology and Viticulture* 13: 196–203.
- Griesbach, J.A. 1995. Detection of Tomato ringspot virus by polymerase chain reaction. *Plant Disease* 79: 1054–1056.
- Herrera, M.G., and V.M. Madariaga. 2001. Presence and incidence of grapevine viruses in Central Chile. *Agricultura Técnica* 61: 393–340.
- Hibben, C.R., and J.T. Walker. 1971. Nematode transmission of the ash strain of *Tobacco ringspot virus*. *Plant Disease Report* 55: 475–478.
- Ho, T., and I.E. Tzanetakis. 2014. Development of a virus detection and discovery pipeline using next generation sequencing. *Virology* 471: 54–60.
- Hoy, J.W., and S.M. Mircetich. 1984. Prune brownline disease: Susceptibility of prune rootstocks and Tomato ringspot virus detection. *Phytopathology* 74: 272–276.
- Izadpanah, K., M. Zaki-Aghl, Y.P. Zhang, S.D. Daubert, and A. Rowhani. 2003. Bermuda grass as a potential reservoir host for Grapevine fanleaf virus. *Plant Disease* 87: 1179–1182.
- Jafarpour, B., and H. Sanfaçon. 2009. Insertion of large amino acid repeats and point mutations contribute to a high degree of sequence diversity in the X4 protein of tomato ringspot virus (genus *Nepovirus*). *Archives of Virology* 154: 1713–1717.
- Jones, A.T., F.D. McElroy, and D.J.F. Brown. 1981. Tests for transmission of cherry leaf roll virus using *Longidorus*, *Paralongidorus* and *Xiphinema* nematodes. *The Annals of Applied Biology* 99: 143–150.
- Kahn, R.P., and F.M. Latterell. 1955. Symptoms of bud-blight of soybeans caused by the tobacco- and tomato-ringspot viruses. *Phytopathology* 45: 500–502.
- Kiefer, M.C., S. Daubert, I.R. Schneider, and G. Bruening. 1982. Multimeric forms of satellite of *Tobacco ringspot virus* RNA. *Virology* 121: 262–273.
- Klos, E.J. 1976. Rosette mosaic. In: U. S. Department of Agriculture Agricultural Handbook #437. U. S. Government Printing Office, Washington D. C., USA.
- Lammers, A.H., R.F. Allison, and D.C. Ramsdell. 1999. Cloning and sequencing of peach rosette mosaic virus RNA 1. *Virus Research* 65: 57–73.
- Lear, B., A.C. Goheen, and D.J. Raski. 1981. Effectiveness of soil fumigation for control of fanleaf-nematode complex in grapevine. *American Journal of Enology and Viticulture* 32: 208–211.

- Lee, S., C.S. Kim, Y.G. Shin, J.H. Kim, Y.S. Kim, and W.H. Jheong. 2016. Development of nested PCR-based specific markers for detection of *Peach rosette mosaic virus* in plant quarantine. *Indian Journal of Microbiology* 6: 108–111.
- Li, R., R. Mock, M. Fuchs, J. Halbrecht, B. Howell, and Z. Liu. 2011. Characterization of the partial RNA1 and RNA2 3' untranslated region of *Tomato ringspot virus* isolates from North America. *Canadian Journal of Plant Pathology* 33: 94–99.
- Li, J.L., R.S. Corrman, J.D. Evans, J.S. Pettis, Y. Zhao, C. Murphy, W.J. Peng, J. Wu, M. Hamilton, H.F. Boncristiani, L. Zhou, J. Hammond, and Y.P. Chen. 2014a. Systemic spread and propagation of a plant-pathogenic virus in European honeybees, *Apis mellifera*. *mBio* 5: e00898–e00813.
- . 2014b. Reply to “Conclusive evidence of replication of a plant virus in honeybees is lacking.”. *mBio* 5: e01250–e01214.
- Lister, R.M., and A.F. Murant. 1967. Seed-transmission of nematode-borne viruses. *The Annals of Applied Biology* 59: 49–62.
- Maliogka, V.I., G.P. Martelli, M. Fuchs, and N.I. Katis. 2015. Control of viruses infecting grapevine. *Advances in Virus Research* 91: 175–227.
- Martelli, G.P. 2014. Directory of virus and virus-like diseases of the grapevine and their agents. *Journal of Plant Pathology* 96: 1–136.
- Martelli, G., and C.E. Taylor. 1990. Distribution of viruses and their nematode vectors. In *Ad. Dis. Vector Res.*, ed. K. Harris, vol. 6, 151–189. New York: Springer.
- Mayo, M.A., H. Baker, and B.D. Harrison. 1979a. Polyadenylate in the RNA of five nepoviruses. *The Journal of General Virology* 43: 603–610.
- . 1979b. Evidence for a protein covalently linked to *Tobacco ringspot virus* RNA. *The Journal of General Virology* 43: 735–740.
- Mayo, M.A., H. Barker, and B.D. Harrison. 1982. Properties of the genome linked proteins of nepoviruses. *The Journal of General Virology* 59: 149–162.
- Mink, G.I. 1993. Pollen- and seed-transmitted viruses and viroids. *Annual Review of Phytopathology* 31: 375–402.
- Mountain, W.L., C.A. Powell, L.B. Forer, and R.F. Stouffer. 1983. Transmission of tomato ringspot virus from dandelion via seed and dagger nematodes. *Plant Disease* 67: 867–868.
- Powell, C.A. 1984. Comparison of enzyme-linked immunosorbent assay procedures for detection of Tomato ringspot virus in woody and herbaceous hosts. *Plant Disease* 68: 908–909.
- Powell, C.A., L.B. Forer, R.F. Stouffer, J.N. Cummins, D. Gonsalves, D.A. Rosenberg, J. Hoffman, and R.M. Lister. 1984. Orchard weeds as hosts of ToRSV and TRSV. *Plant Disease* 68: 242–244.
- Powell, C.A., J.L. Longenecker, and L.B. Forer. 1990. Incidence of Tomato ringspot virus and Tobacco ringspot virus in grapevine in Pennsylvania. *Plant Disease* 74: 702–704.
- Price, W.C. 1940. Comparative host ranges of six plant viruses. *American Journal of Botany* 27: 530–541.
- Ramsdell, D.C., and J.M. Gillett. 1981. Peach rosette mosaic virus in highbush blueberry. *Plant Disease* 65: 757–758.
- . 1998. Peach rosette mosaic virus. CMI/AAB Description of Plant Viruses No. 364. Association of Applied Biologists, Wellesbourne, UK.
- Ramsdell, D.C., and R.L. Meyers. 1974. Peach rosette mosaic virus, symptomatology and nematodes associated with grapevine ‘degeneration’ in Michigan. *Phytopathology* 64: 1174–1178.
- . 1977. Epidemiology of Peach rosette mosaic virus in a Concord grape vineyard. *Phytopathology* 68: 447–450.
- Ramsdell, D.C., and R. Stace-Smith. 1981. Physical and chemical properties of the particles and ribonucleic acid of Blueberry leaf mottle virus. *Phytopathology* 71: 468–472.
- . 1983. *Blueberry leaf mottle virus*. CMI/AAB Description of Plant Viruses No. 267. Association of Applied Biologists, Wellesbourne, UK.
- Ramsdell, D.C., R.W. Andrews, J.M. Gillett, and C.E. Morris. 1979. A comparison between enzyme-linked immunosorbent assay (ELISA) and *Chenopodium quinoa* for detection of Peach rosette mosaic virus in Concord grapevine. *Plant Disease Report* 63: 74–78.

- Ramsdell, D.C., J.M. Gillett, and G.W. Bird. 1995. Susceptibility of American grapevine scion cultivars and French hybrid rootstock and scion cultivars to infection by Peach rosette mosaic nepovirus. *Plant Disease* 79: 154–157.
- Remaily, G. and G.L. Slate. 1970. The Finger Lake Wine Growers Association. Naples, New York, 6pp.
- Reynolds, B., and D.S. Tealke. 1976. Viruses infecting commercial gladiolus cultivars in Queensland. *Australian Plant Pathology Newsletter* 5: 22–23.
- Roossinck, M., D. Sleat, and P. Palukaitis. 1992. Satellite RNAs of plant viruses: Structures and biological effects. *Microbiological Reviews* 56: 265–279.
- Rott, M.E., J.H. Tremaine, and D.M. Rochon. 1991. Nucleotide sequence of Tomato ringspot virus RNA-2. *The Journal of General Virology* 72: 1505–1514.
- Rott, M.E., A. Gilchrist, L. Lee, and D. Rochon. 1995. Nucleotide sequence of tomato ringspot virus RNA1. *The Journal of General Virology* 76: 465–473.
- Sandoval, C.R., D.C. Ramsdell, and J.F. Hancock. 1995. Infection of wild and cultivated *Vaccinium* spp. with blueberry leaf mottle nepovirus. *The Annals of Applied Biology* 126: 457–464.
- Sanfaçon, H. 2008. Nepoviruses. In *Encyclopedia of virology*, ed. B.W.J. Mahy and M.H.V. Van Regenmortel, 3rd ed., 405–413. San Diego: Academic.
- . 2012. Investigating the role of viral integral membrane proteins in promoting the assembly of nepovirus and comovirus replication factories. *Frontiers in Plant Science* 3: 313.
- Sanfaçon, H., G. Zhang, J. Chisholm, B. Jafarpour, and J. Jovel. 2006. Molecular biology of Tomato ringspot nepovirus. In *Floriculture, ornamental and plant biotechnology*, ed. J.A. Teixeira da Silva. Isleworth: Global Science Books.
- Sanfaçon, H., J. Wellink, O. Le Gall, A. Karasev, R. van der Wlugt, and T. Wetzel. 2009. Secoviridae: A proposed family of plant viruses within the order *Picornavirales* that combines the families *Sequiviridae* and *Comoviridae*, the unassigned genera *Cheravirus* and *Sadwavirus*, and the proposed genus *Torradovirus*. *Archives of Virology* 154: 899–907.
- Sanfaçon, H., T. Iwanami, A. Karasev, R.A.A. van der Wlugt, J. Wellink, T. Wetzel, and N. Yoshikawa. 2011. Secoviridae. In *Virus taxonomy; ninth report of the International Committee on Taxonomy of Viruses*, ed. A.M.Q. King, M.J. Adams, E.B. Carstens, and E.J. Lefkowitz, 881–900. Amsterdam: Elsevier.
- Schellenberger, P., C. Sauter, B. Lorber, P. Bron, S. Trapani, M. Bergdoll, A. Marmonier, E. Vigne, O. Lemaire, M. Fuchs, G. Demangeat, and C. Ritzenthaler. 2011. Structural insights into viral determinants of nematode-mediated *Grapevine fanleaf virus* transmission. *PLoS Pathogens* 7: e1002034.
- Stace-Smith, R. 1984. *Tomato ringspot virus*. CMI/AAB Description of Plant Viruses No. 290. Association of Applied Biologists. Wellesbourne, UK.
- . 1985. *Tobacco ringspot virus*. CMI/AAB Description of Plant Viruses No. 309. Association of Applied Biologists. Wellesbourne, UK.
- Stewart, E.L., X. Qu, B.E. Overton, F.E. Gildow, N.G. Wenner, and D.S. Grove. 2007. Development of a real-time RT-PCR SYBR green assay for *Tomato ringspot virus* in grape. *Plant Disease* 91: 1083–1088.
- Taylor, C.E., and D.J. Brown. 1977. *Nematode vectors of plant viruses*. Wallingford: CAB International.
- Thompson, J.R., N. Kamath, and K.L. Perry. 2014. An evolutionary analysis of the *Secoviridae* family of viruses. *PLoS ONE* 9: e106305.
- Tu, J.C. 1986. Strains of tobacco ringspot virus isolated from soybean in southwestern Ontario. *Canadian Journal of Plant Science* 66: 491–498.
- Uyemoto, J.K. 1970. Symptomatically distinct strains of Tomato ringspot virus isolated from grape and elderberry. *Phytopathology* 60: 1838–1841.
- . 1975. Severe outbreak of virus-induced grapevine decline in Cascade grapevine in New York. *Plant Disease Report* 59: 98–101.
- Uyemoto, J.K., J.F. Cummins, and G.S. Abawi. 1977a. Virus and virus-like diseases affecting grapevines in New York vineyards. *American Journal of Enology and Viticulture* 28: 131–136.

- Uyemoto, J.K., E.F. Taschenberg, and D.K. Hummer. 1977b. Isolation and identification of a strain of grapevine Bulgarian latent virus in Concord grapevine in New York State. *Plant Disease Report* 61: 949–953.
- Walker, M., J. Chisholm, T. Wei, B. Ghoshal, H. Saeed, M. Rott, and H. Sanfaçon. 2015. Complete genome sequence of three Tomato ringspot virus isolates: Evidence for reassortment and recombination. *Archives of Virology* 160: 543–547.
- Wang, A., and H. Sanfaçon. 2000a. Proteolytic processing at a novel cleavage site in the N-terminal region of the *Tomato ringspot nepovirus* RNA-1 encoded polyprotein in vitro. *The Journal of General Virology* 81: 2771–2781.
- . 2000b. Diversity in the coding regions for the coat protein, VPg, protease, and putative RNA-dependent RNA polymerase among tomato ringspot nepovirus isolates. *Canadian Journal of Plant Pathology* 22: 145–149.
- Wang, A., K. Carrier, J. Chisholm, A. Wiczorek, C. Huguenot, and H. Sanfaçon. 1999. Proteolytic processing of *Tomato ringspot nepovirus* 3C-like protease precursors: Definition of the domains for the VPg, protease and putative RNA-dependent RNA polymerase. *The Journal of General Virology* 80: 799–809.
- Werner, R., H.P. Mühlbach, and C. Büttner. 1997. Detection of Cherry leafroll nepovirus (CLRV) in birch, beech and petunia by immuno-capture RT-PCR using a conserved primer pair. *European Journal of Forest Pathology* 27: 309–318.
- Yang, A.F., and R.I. Hamilton. 1974. The mechanism of seed transmission of *Tobacco ringspot virus* in soybean. *Virology* 62: 26–37.
- Zhao, F., U.S. Hwang, S. Lim, R.H. Yoo, D. Igori, S.H. Lee, H. Lim, and J.S. Moon. 2015. Complete genome sequence and construction of infectious full-length cDNA clones of *Tobacco ringspot nepovirus*, a viral pathogen causing bud blight in soybean. *Virus Genes* 51: 163–166.

Chapter 6

Grapevine leafroll-associated virus 1

R.A. Naidu

Abstract *Grapevine leafroll-associated virus 1* (GLRaV-1, family *Closteroviridae*, genus *Ampelovirus*) is one of the five recognized viral species associated with the grapevine leafroll disease complex. A causative role in grapevine leafroll disease has been attributed to GLRaV-1 due to its consistent presence in symptomatic *Vitis vinifera* cultivars. The virus has been reported worldwide and occurs singly or in coinfection with other grapevine viruses. The approximately 18.7 kilobase genome encodes a hallmark gene array made up of nine putative open reading frames (ORFs). The 5' proximal ORF, made up of ORF1a and ORF1b, encodes proteins required for virus genome replication. The remaining eight ORFs are expressed through a nested set of subgenomic RNAs that are collinear and 3' coterminal with respect to the virus genome. Unlike other GLRaVs, GLRaV-1 uniquely has two divergent copies of the coat protein. The virus is known to occur as genetically diverse populations in vineyards and can be detected using serological and molecular diagnostic assays. Several species of mealybugs (*Pseudococcidae*) and soft-scale insects (*Coccidae*) have been documented as vectors of the virus. The epidemiological characteristics of GLRaV-1 appear to be similar to other ampeloviruses and integrated control strategies, involving a combination of virus-tested planting stock, cultural practices, and vector control, can be deployed to minimize the spread of the virus in vineyards. More research is needed on the molecular biology, vector transmission specificity, and host-virus interactions for understanding the role of GLRaV-1 in the biology of leafroll disease and elucidating the virus replication strategies as compared to other closteroviruses infecting grapevines.

Keywords Grapevine • *Vitis vinifera* • Grapevine leafroll disease • Grapevine leafroll-associated viruses • *Closteroviridae* • *Ampelovirus* • Mealybugs • Scale insects

R.A. Naidu (✉)

Department of Plant Pathology, Irrigated Agriculture Research and Extension Center,
Washington State University, Prosser, WA 99350, USA
e-mail: naidu.rayapati@wsu.edu

Introduction

Among the several diseases affecting grapevines (*Vitis* spp.), grapevine leafroll disease (GLD) is recognized as the most complex and economically important viral disease across grapevine-growing regions worldwide (Martelli 2014; Naidu et al. 2014). GLD is known to cause a wide range of negative impacts that include deleterious effects on overall vine performance and significant reductions in fruit yield and berry and wine quality (Alabi et al. 2016 and references therein). The finding of closterovirus-like virions in 1979 and the subsequent discovery in 1984 of serologically distinct closteroviruses in symptomatic grapevines (Namba et al. 1979; Gugerli et al. 1984) laid a foundation to investigate the causal agents of GLD. A series of scientific reports in the ensuing years have identified additional closteroviruses, collectively designated as grapevine leafroll-associated viruses or GLRaVs (Boscia et al. 1995; Gugerli 2009). Currently, a putative association of several distinct closteroviruses with GLD has been recognized. Although GLRaVs share many common properties, they show distinct differences in genome organization and other epidemiological properties. At present, five GLRaVs, designated numerically as GLRaV-1, -2, -3, -4, and -7, are recognized as distinct species and GLRaV-5, -6, -9, -Pr, and -De as strains of GLRaV-4 (Martelli et al. 2012). GLRaVs belong to the family *Closteroviridae*, with GLRaV-1, -3, and -4 and its strains assigned to the genus *Ampelovirus*, GLRaV-2 to the genus *Closterovirus*, and GLRaV-7 to the genus *Velarivirus* (Martelli et al. 2012; Al Rwahnih et al. 2012; Naidu et al. 2014, 2015). Within the genus *Ampelovirus*, GLRaV-1 and GLRaV-3 have larger genome size and are separated under subgroup I from GLRaV-4 and its strains that are included in subgroup II (Maliogka et al. 2008; Martelli et al. 2012).

Geographical Distribution

GLRaV-1 has been reported from grapevines across many grapevine-growing regions indicating its worldwide distribution (Habibi et al. 2007; Martelli 2014; Naidu et al. 2014). Available information suggests that GLRaV-1 is the second most widely spread and economically important virus next to GLRaV-3. The virus can frequently be found in grapevines singly or in coinfection with other grapevine viruses. Despite its worldwide distribution, the potential economic impact of GLRaV-1 on grapevines remains to be realized.

Symptoms and Host Range

Although the role of GLRaV-1 in the etiology of GLD is yet to be determined, the consistent presence of the virus in symptomatic *V. vinifera* vines suggests its causative role in the disease. Vines tested positive for the presence of GLRaV-1 alone or in coinfection with other GLRaVs show symptoms of GLD (Rayapati et al. 2008; Maree et al. 2013; Martelli 2014; Naidu et al. 2014). In red-berried cultivars, GLD symptoms consist of reddening of the interveinal areas of leaves with the primary and secondary veins remaining green (Fig. 6.1). In contrast, leaves of white-berried cultivars infected with GLRaV-1, either alone or together with other GLRaVs, show mild chlorotic symptoms that are often subtle and may not be recognizable in vineyards. It should be noted that symptom manifestation and severity of GLD due to infections with GLRaV-1, alone or in coinfections with other GLRaVs, can vary among the different vinifera cultivars. Besides cultivars of European grapes, GLRaV-1 can be found in other grapevine species and cultivars. For example, it was reported in Roger's Red, an interspecific hybrid between *Vitis californica*, a wild grape native to northern California, and the *V. vinifera* cv. Alicante Bouschet, and in Claret Vine (*V. vinifera* var. *Purpurea Nana*) that are widely grown in home gardens and other settings for their ornamental and esthetic value (Karthikeyan et al. 2011). GLRaV-1 was also reported in table grapes (Habibi et al. 1997; Bertolini et al. 2010) and other *Vitis* species such as *V. labrusca* (Fan et al. 2015). Like other GLRaVs, GLRaV-1 can cause symptomless infections in American rootstocks (Martelli 2014). Based on the above discussion, it can be concluded that further studies are needed to better understand the role of GLRaV-1 in the symptomatology of GLD across grapevine species and cultivars.

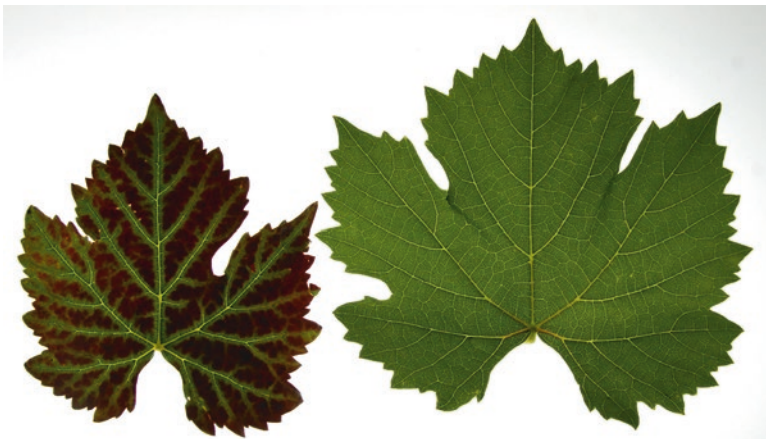

Fig. 6.1 Symptoms of grapevine leafroll disease in a wine grape cultivar (*V. vinifera* cv. Pinot noir) tested positive for *Grapevine leafroll-associated virus 1* (GLRaV-1). A symptomatic leaf (*left*) from a GLRaV-1-positive vine showing “green” veins and reddish purple discolorations in the interveinal areas compared to a green leaf (*right*) from a vine tested negative for the virus

Currently, grapevine appears to be the only natural host for GLRaV-1. Recently, sequences highly similar to GLRaV-1 were reported in pomegranate (*Punica granatum* L) from Turkey, indicating potential alternative hosts for the virus outside the genus *Vitis* (Çağlayan et al. 2016). However, additional confirmatory studies are needed to ascertain if non-*Vitis* spp. could serve as alternative hosts for GLRaV-1.

Genome Organization and Molecular Biology

The virions of GLRaV-1, obtained from either purified preparations or trapping with virus-specific antibodies, appear as long flexuous filamentous particles of approximately 2000 nm in length (Seddas et al. 2000). Like other closteroviruses, GLRaV-1 may show unique “rattlesnake-like” architecture (Agranovsky et al. 1995) with virions composed of several viral-encoded proteins as reported for *Citrus tristeza virus* (CTV) and *Beet yellows virus* (BYV) (Peremyslov et al. 2004; Satyanarayana et al. 2004). In cytopathological studies, the virions were shown to be localized in phloem-associated cells of the grapevine vascular system (Esteves et al. 2013).

The genome organization of GLRaV-1 was described earlier (Fazeli and Rezaian 2000; Habili et al. 2007; Naidu et al. 2014, 2015). GLRaV-1 genome has a monopartite, single-stranded, positive-sense RNA with presumably a 5' cap and no poly-A tail at the 3' terminus. Only partial nucleotide sequence of the virus genome from Australia (Fazeli and Rezaian 2000; accession number AF195822) and Canada (accession number NC_016509 or JQ023131) is available. The sequence of the Australian isolate was determined to be 12,394 nucleotides (nt) in size by traditional cloning and Sanger sequencing, whereas that of the Canadian isolate was reported to be 18,659 nt generated by high-throughput sequencing. It should be noted that the exact 5' and 3' terminal sequences of the two isolates were not determined so as to ascertain the actual genome size of the virus. Nevertheless, the genomic organization of GLRaV-1 isolates from both countries appears to be similar with hallmark gene array made up of nine putative open reading frames (ORFs) as shown in Fig. 6.2.

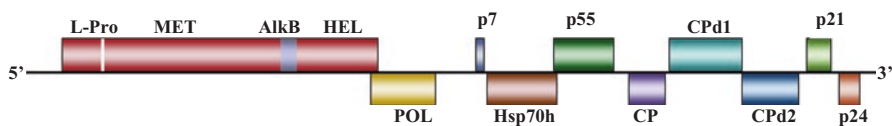

Fig. 6.2 Schematic diagram (not to scale) showing the genome organization of *Grapevine leafroll-associated virus 1* (Accession number JQ023131). The ORFs are shown as *boxes* across the genome and labeled with either associated protein designations or with approximate molecular weight and a common “p” designator (Dolja et al. 2006). *L-Pro* papain-like leader proteinase, *MET* methyl transferase domain, *AlkB* an alkylation B domain, *HEL* RNA helicase domain, *RdRp* RNA-dependent RNA polymerase, *p7* a 7-kDa protein, *HSP70h* heat shock protein-70 homologue, *p55* 55-kDa protein, *CP* coat protein, *CPd1* and *CPd2* divergent copies of the CP, *p21* 21-kDa protein, *p24* 24-kDa protein

Like other monopartite members in the genus *Closterovirus* and *Ampelovirus*, the most 5' proximal ORF, which constitutes a large portion of the virus genome, represents the replication-associated gene module consisting of two overlapping ORFs (ORF1a and b) that encode proteins required for virus replication. ORF1a encodes a large polyprotein containing a papain-like proteinase (L-PRO), methyltransferase (MET), AlkB, and helicase (HEL) domains, while ORF1b encodes the RNA-dependent RNA polymerase (RdRp). The RdRp is presumably expressed via a +1 ribosomal frameshift mechanism as proposed for other closteroviruses (Dolja et al. 2006).

The remaining eight ORFs are located downstream of ORF1a/b toward the 3' terminus of the virus genome. They are designated consecutively from 5' to 3' end of the genome as small transmembrane protein (p7), heat-shock protein 70 homolog (HSP70h), a polypeptide of 55 kDa (p55), the coat protein (CP), two divergent copies of the CP (CPd1 and CPd2), and two polypeptides of 21 kDa (p21) and 24 kDa (p24) with unknown function. The first five ORFs comprise the "quintuple gene block" (QGB), similarly to other monopartite closteroviruses (Dolja et al. 2006). CPd2, p21, and p24, located downstream of the QGB, are unique to the virus. GLRaV-1 stands apart from other closteroviruses, including the currently known GLRaVs, due to the presence of two divergent copies of the CP (CPd1 and CPd2). In analogy with their homologs in the genome of other members of the family *Closteroviridae* (Dolja et al. 2006), the 3' proximal eight ORFs are likely not required for genome replication, but presumably play multifunctional roles in virus-host interactions and other functions associated with virion assembly, virus movement, vector transmission, and suppression of the host RNA silencing. As mentioned above, GLRaV-1 is likely to have a bipolar architecture, with CP encapsidating most of the filamentous virions and a small portion of the genome toward the 5' terminus covered by a segmented head (previously referred to as a tail) structure composed of several viral-encoded proteins, as shown for CTV and BYV (Peremyslov et al. 2004; Satyanarayana et al. 2004). However, it remains to be determined whether one or both of CPd1 and CPd2 is a component of the segmented head portion of GLRaV-1 virions. Although the functional role of CPd1 and CPd2 remains unknown, it has been speculated that the presence of two divergent copies of the CP in this virus is a consequence of ancient duplication events occurred during the evolution and diversification of closteroviruses (Dolja et al. 2006).

Limited progress has been made in understanding the molecular biology of GLRaV-1 (Fazeli and Rezaian 2000; Habili et al. 2007). Like other members of the family *Closteroviridae* (Dolja et al. 1994; Karasev 2000), components of the replicase complex encoded by ORF1a/b are translated directly from the genomic RNA, whereas the other eight ORFs are expressed through a nested set of subgenomic (sg) RNAs that are collinear and 3' coterminal with respect to the virus genome. GLRaV-1 is expected to encode eight sgrNAs corresponding to each of the eight 3' proximal ORFs. Each sgrNA encoded by GLRaV-1, except the one specific to the 3'-most p24 gene, is technically polycistronic but functionally monocistronic, with only the 5'-most ORF expressed from each sgrNA. Fazeli and Rezaian (2000) observed three major 3'-coterminal sgrNA species, putatively designated as sgrNAs specific for CP, p21, and p24, when dsRNA isolated from GLRaV-1-infected grapevines was

analyzed in Northern blots using probes specific to the 3'-end of the virus genome. These observations indicate that sgRNAs encoded by GLRaV-1 are likely expressed at different levels and/or exhibit variable turnover rates in infected grapevine tissues. However, the spatiotemporal regulation of gene expression through sgRNAs needs further investigations.

Genetic Diversity

The molecular variability and evolutionary relationships were studied among an extensive collection of GLRaV-1 isolates from Australia, Czech Republic, China, Portugal, and the USA (Little et al. 2001; Komínek et al. 2005; Alabi et al. 2011; Fan et al. 2015). An analysis of partial sequences of the genes encoding HSP70h, CP, CPd2, and p24 revealed that GLRaV-1 can occur as genetically diverse populations in vineyards, with CPd2 as the most divergent compared to other genes. Further analysis of functional constraints indicated that these gene sequences are under varying selective pressures, with the CP being subjected to a relatively stronger purifying selection than others, likely due to its key role in virion formation and other biological functions including vector transmission. A comprehensive phylogenetic analysis conducted recently by Fan et al. (2015) showed segregation of GLRaV-1 isolates into well-defined genetic variants, independent of their geographic origin. These genetic variants could perpetuate in grapevines without being subjected to selection pressures, are amplified during clonal propagation, and spread during exchange of infected plant materials, leading to the diffusion of genetically diverse populations of the virus within a vineyard (Le Maguet et al. 2013).

Detection

It is virtually impossible to identify GLRaV-1 infection in vineyards based on visual observation of GLD symptoms. Several serological and/or molecular-based diagnostic methods are available for reliable detection of the virus and its discrimination from other viruses that are associated with GLD. Serological methods based on ELISA are used on a routine basis for the detection of the virus, while testing large numbers of field samples. However, the sensitivity and specificity of virus detection in grapevine samples by serological assays are influenced by several factors, such as quality and specificity of antibodies, low virus titer in the phloem tissue, uneven distribution of the virus within the host, and seasonal fluctuations in virus titer. Recently, the detection sensitivity and specificity of GLRaV-1 was improved using monoclonal antibodies produced against purified virus or a highly conserved peptide sequence in the CP of genetically distinct variants of GLRaV-1 (Seddas et al. 2000; Esteves et al. 2013). These antibodies were found to be superior compared to existing commercially available polyclonal antisera for virus detection in routine

field surveys using ELISA or the more versatile tissue print immunoblotting. Molecular-based diagnostic methods, such as RT-PCR, qRT-PCR, and IC-RT-PCR, have been employed for indexing of GLRaV-1 in grapevine samples from vineyards and for mandatory testing of grapevine propagation materials in quarantine and certification schemes (Little and Rezaian 2006; Osman et al. 2007, 2008; Sefc et al. 2000; Pacifico et al. 2011; Margaria et al. 2009). Besides, SYBR® Green-based qRT-PCR methods are amenable for multiplex analyses and to estimate viral copy numbers in a plant or vector sample for investigating the epidemiological aspects of the virus (Poojari et al. 2016). Antibody microarray systems and DNA macro- and microarrays have also been developed for use in the detection of GLRaV-1 (Abdullahi and Rott 2009; Thomson et al. 2014). The high-throughput sequencing technology is increasingly being used for unbiased detection of viruses in grapevines (Coetzee et al. 2010). Readers are referred to Methods for Diagnostics (Part II of this book) for additional information on diagnosis of grapevine viruses.

Transmission

Like other grapevine viruses, GLRaV-1 can be disseminated over long distance via contaminated planting stock. Although this mode is the major route of virus spread across regions and continents, several species of mealybugs (Pseudococcidae) and soft scale insects (Coccidae), phloem-feeding insects with piercing-sucking mouthparts, contribute to natural spread of the virus within and between vineyards. Currently, Bohemian mealybug (*Heliococcus bohemicus*), apple mealybug (*Phenacoccus aceris*), obscure mealybug (*Pseudococcus viburni* [formerly *Ps. affinis*]), citrophilous mealybug (*Pseudococcus calceolariae*), grape mealybug (*Pseudococcus maritimus*), Comstock mealybug (*Pseudococcus comstocki*), and three soft scale insects (*Pulvinaria vitis*, *Parthenolecanium corni*, *Neopulvinaria innumerabilis*) are recognized as competent vectors of GLRaV-1 (Le Maguet et al. 2012; Sforza et al. 2013; Naidu et al. 2014; Bertin et al. 2016 and references therein). Although the detailed transmission characteristics of GLRaV-1 have not been elucidated, the virus can be transmitted by these disparate insect vectors in a semi-persistent manner analogous to the mode of transmission reported for GLRaV-3 (Tsai et al. 2010; Bertin et al. 2016). In addition, mealybug and soft scale insect vectors may show species-specific differences in virus transmission efficiencies. For example, a recent study by Bertin et al. (2016) showed that *Planococcus citri* transmitted GLRaV-1 more efficiently than *Planococcus ficus*, suggesting that transmission efficiency of vector species could play a role in virus spread in the vineyards. It is also likely that factors such as virus load over the growing season, virus-vector-host interactions, and competitive or antagonistic interactions between viruses in coinfecting grapevines may influence, in part, the acquisition and transmission of the virus by individual vector species. Based on the current knowledge, mealybug nymphs are likely to be more efficient vectors of GLRaV-1 than adult females. Many of the mealybug and soft scale insect vector species often coexist in vineyards

in several regions and are considered as generalist vectors in that they can transmit other ampeloviruses, such as GLRaV-3 and GLRaV-4 and its strains, besides GLRaV-1. In addition, some species of mealybugs and soft scale insects are reported as vectors of vitiviruses, such as *Grapevine virus A* (GVA) and *Grapevine virus B* (GVB) (Minafra et al., [Chap. 11](#) of this book). Although a single nymph or an adult of these disparate vector species could potentially acquire more than one virus from coinfecting grapevines (Fuchs et al. [2009](#); Bertin et al. [2010](#)), simultaneous transmission of two or more viruses from coinfecting vines by individual vectors remains to be determined. Available data on vector-mediated transmission of ampeloviruses and vitiviruses indicates the lack of virus-vector specificity in that the same virus species can be transmitted by multiple vector species and, conversely, a single vector species can transmit different virus species (Tsai et al. [2010](#); Le Maguet et al. [2012](#); Bertin et al. [2016](#)). Therefore, further elucidation of the transmission biology of ampeloviruses and vitiviruses by different species of mealybugs and soft scale insects is necessary for a better interpretation of virus-vector interactions in the context of epidemiology and management of these two distinct groups of grapevine-infecting viruses.

Epidemiology

Little information is available on the spread of GLRaV-1 in vineyards, despite its reported worldwide distribution. Similar to other ampeloviruses, natural spread of GLRaV-1 is likely to occur via mealybug and/or scale insects as discussed above. A decade-long monitoring of two vineyards in a semi-continental region of Burgundy in France was the first comprehensive study conducted thus far in understanding the natural spread of GLRaV-1 in vineyards (Le Maguet et al. [2013](#)). The results of this study revealed distinct epidemiological patterns of the virus spread, depending on the proximity to neighboring vineyards infected with leafroll and dispersal characteristics of the mealybug vector, *P. aceris*. The spatial analysis of the virus spread in the Bonzon plot showed “edge effect,” where a disease gradient was observed with high percentage of symptomatic vines located in rows proximal to an established vineyard that had a high incidence of the disease. This observation suggested that the virus had been introduced on one side of the vineyard by migrating first instar stages of mealybugs, mostly originating from the adjacent, heavily infected vineyard. Temporal analysis of virus spread showed random distribution of symptomatic vines during initial years, indicative of primary spread initiated by alighting viruliferous mealybug vectors and clustering of infected vines during subsequent years due to vine-to-vine movement of viruliferous vectors, either between or across rows within the vineyard. In contrast, the spatial and temporal spread of GLRaV-1 in the Marsannay-la-Côte site, with neighboring vineyards having low incidence of the disease, provided a different scenario, where low rate of virus spread and random distribution pattern of symptomatic vines were observed (Le Maguet et al. [2013](#)). These epidemiological scenarios are in alignment with the patterns of

vector-mediated spread of GLRaV-3 in several countries (reviewed in Almeida et al. 2013). Besides proximity to infected vineyards, a variety of biotic and environmental factors can play a significant role in the rate of virus spread and the distance over which virus spread occurs. These include composition of vector species in a given location, vector fecundity and intrinsic rate of increase, plant age, virus titer in different tissues during the season, feeding sites at which virus acquisition or inoculation occurs, and mixed infection of GLRaV-1 either with different variants or with other viruses. Besides, regional environmental factors, landscape features, human-driven activities, and viticultural practices can modulate the dynamics of dissemination patterns by influencing the survival and dispersal of mealybug and soft scale insect vectors (Daane et al. 2012). It is evident that the patterns of spread of GLRaV-1 and GLRaV-3 are largely similar (Almeida et al. 2013; Naidu et al. 2014), and combining multiyear data on virus dissemination patterns with simulations of disease management strategies (Le Maguet et al. 2013; Sokolsky et al. 2013) provides opportunities for integrating epidemiological knowledge to implement control strategies against the spread of different ampeloviruses in vineyards.

Control

Since GLRaV-1 is transmitted via clonal propagation and by grafting or budding, the primary and, indeed, the most effective approach to controlling virus spread is to use virus-free plant materials. In the case of vineyards planted with own-rooted vines, virus-tested cuttings should be used for new plantings. Conversely, it is critical to use virus-tested scion and rootstock materials for grafted vines to ensure that both partners are virus-free. While selecting planting stock, sanitary status of source vines should be determined by virus indexing using serological or molecular methods, instead of selections made based on visual observations. In general, planting a new vineyard block with grapevines that have been certified to be virus-free would be the first line of defense in controlling the virus spread. Cultural practices, such as roguing of symptomatic vines, are practiced to remove sources of infections in a vineyard. Monitoring vineyard blocks for virus symptoms during initial years after planting and early intervention by replacing symptomatic vines with those derived from virus-tested mother vines can be effective in eliminating virus inoculum in young vineyard blocks. In case of established vineyards with high levels of infection, replanting of the entire vineyard block with virus-tested planting stock is a more economical and practical strategy to control GLRaV-1. Vineyard hygiene and sanitation measures provide synergistic benefit in preventing the likelihood of vector dispersal through workers' clothes and equipment as reported for GLRaV-3 (Pietersen et al. 2013). Since virus spread in vineyards is slow due to the sedentary behavior of insect vectors, the application of insecticides against mealybugs and soft scale insects would help reducing virus spread in vineyards. It is generally accepted that insecticide treatments against mealybugs and scale insects can slow down the spread of GLRaV-1, but are not efficient enough to totally prevent virus

spread in vineyards. Considering all this information, control of GLRaV-1 spread can best be achieved by a combination of sanitary selection of planting material, eradication of infected vines, and cultural practices in combination with vector control. In general, strategies that have been used for GLRaV-3 can successfully be deployed for minimizing the spread of GLRaV-1 in vineyards (Herrbach et al., Chap. 24 of this book).

Conclusions and Directions for Future Research

Despite its worldwide distribution and being the “first” among the reported GLRaVs, our understanding of different aspects of GLRaV-1 is still in its infancy. There are many outstanding questions regarding the biology of the virus and its role in the complex etiology of leafroll disease. Unlike other GLRaVs, the complete genome sequence of GLRaV-1 is not yet available. Hence, determining the complete genome sequence is an essential first step for the development of an amenable reverse genetic system to address fundamental questions with regard to the role of GLRaV-1 in the etiology of leafroll disease and elucidating viral gene functions and host-virus interactions in comparison with other GLRaVs. A range of negative consequences may occur in individual grapevines due to frequent coinfections, either between different variants of GLRaV-1 or GLRaV-1 with other viruses (Moutinho-Pereira et al. 2012). Therefore, impacts of GLRaV-1 alone on vine health and fruit yield and quality characteristics need to be further examined to determine its economic significance relative to other GLRaVs. Having established genetic variability and differential selection patterns, research should be extended to examine the epidemiological significance of genetic heterogeneity present in the viral population landscape for applications in improving the sanitary status of grapevine planting stock and preventing virus spread in vineyards. Additional studies are required on the transmission biology of GLRaV-1 to gain insights on the biological significance of GLRaV-1 associations with other viruses in grapevines and the role of competition and facilitation in vector-mediated transmission of these disparate viruses. Investigating the spatiotemporal spread of GLRaV-1 in vineyards in relation to the species composition of mealybug and soft scale insect vectors across agroclimatic regions would help in comprehending commonalities and distinctions in the overall epidemiology of GLRaVs and deploying the derived knowledge for designing location-specific control strategies against ampeloviruses.

Acknowledgments RAN acknowledges the support provided by the Washington State University’s Agricultural Research Center, the Wine Research Advisory Committee, the Washington Wine Commission, and Washington State Grape & Wine Research Program. PPNS Number 0721, Department of Plant Pathology, College of Agricultural, Human, and Natural Resource Sciences Agricultural Research Center Project No. WNPO 0616, Washington State University, Pullman 99164.

References

- Abdullahi, I., and M. Rott. 2009. Microarray immunoassay for the detection of grapevine and tree fruit viruses. *Journal of Virological Methods* 160: 90–100.
- Agranovsky, A.A., D.E. Lesemann, E. Maiss, R. Hul, and J.G. Atabekov. 1995. “Rattlesnake” structure of a filamentous plant RNA virus built of two capsid proteins. *Proceedings of the National Academy of Sciences of the United States of America* 92: 2470–2473.
- Al Rwahnih, M., V.V. Dolja, S. Daubert, E.V. Koonin, and A. Rowhani. 2012. Genomic and biological analysis of *Grapevine leafroll-associated virus 7* reveals a possible new genus within the family *Closteroviridae*. *Virus Research* 163: 302–309.
- Alabi, O.J., M. Al Rwahnih, G. Karthikeyan, S. Poojari, M. Fuchs, A. Rowhani, and R.A. Naidu. 2011. *Grapevine leafroll-associated virus 1* occurs as genetically diverse populations. *Phytopathology* 101: 1446–1456.
- Alabi, O.J., L.F. Casassa, L.R. Gutha, R.C. Larsen, T. Henick-Kling, J.F. Harbertson, and R.A. Naidu. 2016. Impacts of grapevine leafroll disease on fruit yield and grape and wine chemistry in a wine grape (*Vitis vinifera* L.) cultivar. *PLoS ONE* 11: e0149666.
- Almeida, R.P.P., K.M. Daane, V.A. Bell, G.K. Blaisdell, M.L. Cooper, E. Herrbach, and G. Pietersen. 2013. Ecology and management of grapevine leafroll disease. *Frontiers in Microbiology* 4: 94.
- Bertin, S., V. Cavalieri, C. Graziano, and D. Bosco. 2010. Survey of mealybug (Hemiptera: Pseudococcidae) vectors of *Ampelovirus* and *Vitivirus* in vineyards of northwestern Italy. *Phytoparasitica* 38: 401–409.
- Bertin, S., D. Pacifico, V. Cavalieri, C. Marzachi, and D. Bosco. 2016. Transmission of *Grapevine virus A* and *Grapevine leafroll-associated viruses 1* and *3* by *Planococcus ficus* and *Planococcus citri* fed on mixed-infected plants. *Annals of Applied Biology* 169: 53–63.
- Bertolini, E., J. García, A. Yuste, and A. Olmos. 2010. High prevalence of viruses in table grape from Spain detected by real-time RT-PCR. *European Journal of Plant Pathology* 128: 283–287.
- Boscia, D., C. Greif, P. Gugerli, G.P. Martelli, B. Walter, and D. Gonsalves. 1995. Nomenclature of grapevine leafroll-associated putative closteroviruses. *Vitis* 34: 171–175.
- Çağlayan, K., E. Elçi, and M. Gazel. 2016. Detection and partial characterization of grapevine leafroll-associated virus 1 in pomegranate trees in Turkey. *European Journal of Plant Pathology* 145: 199–202.
- Coetzee, B., M.J. Freeborough, H.J. Maree, J.M. Celton, D.J. Rees, and J.T. Burger. 2010. Deep sequencing analysis of viruses infecting grapevines: Virome of a vineyard. *Virology* 400: 157–163.
- Daane, K.M., R.P.P. Almeida, V.A. Bell, M. Botton, M. Fallahzadeh, M. Mani, J.L. Miano, R. Sforza, V.M. Walton, and T. Zaviezo. 2012. Biology and management of mealybugs in vineyards. In *Arthropod management in vineyards*, ed. N.J. Bostanian, R. Isaacs, and C. Vincent, 271–308. Dordrecht: Springer.
- Dolja, V.V., A.V. Karasev, and E.V. Koonin. 1994. Molecular biology and evolution of closteroviruses: Sophisticated build-up of large RNA genomes. *Annual Review of Phytopathology* 32: 261–285.
- Dolja, V.V., J.F. Kreuze, and J.P.T. Valkonen. 2006. Comparative and functional genomics of closteroviruses. *Virus Research* 117: 38–51.
- Esteves, F., M. Teixeira Santos, J.E. Eiras-Dias, and F. Fonseca. 2013. Molecular data mining to improve antibody-based detection of *Grapevine leafroll-associated virus 1* (GLRaV-1). *Journal of Virological Methods* 194: 258–270.
- Fan, X., N. Hong, Y. Dong, Y. Ma, Z.P. Zhang, F. Ren, G. Hu, J. Zhou, and G. Wang. 2015. Genetic diversity and recombination analysis of grapevine leafroll-associated virus 1 from China. *Archives of Virology* 160: 1669–1678.
- Fazeli, C.F., and M. Ali Rezaian. 2000. Nucleotide sequence and organization of ten open reading frames in the genome of *grapevine leafroll-associated virus 1* and identification of three subgenomic RNAs. *Journal of General Virology* 81: 605–615.

- Fuchs, M., P. Marsella-Herrick, G.M. Loeb, T.E. Martinson, and H.C. Hoch. 2009. Diversity of ampeloviruses in mealybug and soft scale vectors and in grapevine hosts from leafroll-affected vineyards. *Phytopathology* 99: 1177–1184.
- Gugerli, P. 2009. 25 years of serological identification of Grapevine leafroll-associated viruses: Antiserum and monoclonal antibodies to GLRaV-1 to GLRaV-9, 24–28. In *Proceedings of 16th International Council for the Study of Viruses and Virus-Like Diseases of the Grapevine (ICVG)*, Dijon, France, 31 Aug–4 Sept 2009.
- Gugerli, P., J.J. Brugger, and R. Bovey. 1984. L'enroulement de la vigne: mise en évidence de particules virales et développement d'une méthode immunoenzymatique pour le diagnostic rapide. *Revue Suisse de Viticulture Arboriculture Horticulture* 16: 299–304.
- Habili, N., C.F. Fazeli, and M.A. Rezaian. 1997. Identification of a cDNA clone specific to grapevine leafroll-associated virus 1 and occurrence of the virus in Australia. *Plant Pathology* 46: 516–522.
- Habili, N., P. Komínek, and A. Little. 2007. *Grapevine leafroll-associated virus 1* as a common grapevine pathogen. *Plant Viruses* 1: 63–68.
- Karasev, A.V. 2000. Genetic diversity and evolution of closteroviruses. *Annual Review of Phytopathology* 38: 293–324.
- Karthikeyan, G., O.J. Alabi, and R.A. Naidu. 2011. Occurrence of *Grapevine leafroll-associated virus 1* in two ornamental grapevine cultivars in Washington State. *Plant Disease* 95: 613.
- Komínek, P., M. Glasa, and M. Bryxióvá. 2005. Analysis of the molecular variability of *Grapevine leafroll-associated Virus 1* reveals the presence of two distinct virus groups and their mixed occurrence in grapevines. *Virus Genes* 31: 247–255.
- Le Maguet, J., M. Beuve, E. Herrbach, and O. Lemaire. 2012. Transmission of six ampeloviruses and two vitiviruses to grapevine by *Phenacoccus aceris*. *Phytopathology* 102: 717–723.
- Le Maguet, J., J.-J. Fuchs, J. Chadoeuf, M. Beuve, E. Herrbach, and O. Lemaire. 2013. The role of the mealybug *Phenacoccus aceris* in the spread of *Grapevine leafroll-associated virus -1* (GLRaV-1) in two French vineyards. *European Journal of Plant Pathology* 135: 415–427.
- Little, A., and M.A. Rezaian. 2006. Improved detection of grapevine leafroll-associated virus 1 by magnetic capture hybridisation RT-PCR on a conserved region of viral RNA. *Archives of Virology* 151: 753–761.
- Little, A., C.F. Fazeli, and M.A. Rezaian. 2001. Hypervariable genes in Grapevine leafroll associated virus 1. *Virus Research* 80: 109–116.
- Maliogka, V.I., C.I. Dovas, and N.I. Katis. 2008. Evolutionary relationships of virus species belonging to a distinct lineage within the *Ampelovirus* genus. *Virus Research* 135: 125–135.
- Maree, H.J., R.P. Almeida, R. Bester, K. Chooi, D. Cohen, V.V. Dolja, M.F. Fuchs, D.A. Golino, A.E. Jooste, G.P. Martelli, R.A. Naidu, A. Rowhani, P. Saldarelli, and J. Burger. 2013. Grapevine leafroll-associated virus 3. *Frontiers in Microbiology* 4: 82.
- Margarita, P., M. Turina, and S. Palmano. 2009. Detection of Flavescence dorée and Bois noir phytoplasmas, *Grapevine leafroll-associated virus-1* and -3 and *Grapevine virus A* from the same crude extract by reverse transcription-Real Time Taqman assays. *Plant Pathology* 58: 838–845.
- Martelli, G.P. 2014. Directory of virus and virus-like diseases of the grapevine and their agents. *Journal of Plant Pathology* 96 (Suppl. 1): 1–136.
- Martelli, G.P., N. Abou Ghanem-Sabanadzovic, A.A. Agranowsky, M. Al Rawhani, V.V. Dolja, C.I. Dovas, M. Fuchs, P. Gugerli, J.S. Hu, W. Jelkmann, N. Katis, V.I. Maliogka, M.J. Melzer, W. Menzel, A. Minafra, M.E. Rott, A. Rowhani, S. Sabanadzovic, and P. Saldarelli. 2012. Taxonomic revision of the family *Closteroviridae* with special reference to the grapevine leafroll-associated member of the genus *Ampelovirus* and the putative species unassigned to the family. *Journal of Plant Pathology* 94: 7–19.
- Moutinho-Pereira, J., C.M. Correia, B. Gonçalves, E.A. Bacelar, J.F. Coutinho, H.F. Ferreira, J.L. Lousada, and M.I. Cortez. 2012. Impacts of leafroll-associated viruses (GLRaV-1 and -3) on the physiology of the Portuguese grapevine cultivar 'Touriga Nacional' growing under field conditions. *Annals of Applied Biology* 160: 237–249.

- Naidu, R.A., A. Rowhani, M. Fuchs, D. Golino, and G.P. Martelli. 2014. Grapevine leafroll: A complex viral disease affecting a high-value fruit crop. *Plant Disease* 98: 1172–1185.
- Naidu, R.A., H.J. Maree, and J. Burger. 2015. Grapevine leafroll disease and associated viruses – A unique pathosystem. *Annual Review of Phytopathology* 53: 613–634.
- Namba, S., S. Yamashita, Y. Doi, K. Yora, Y. Terai, and R. Yano. 1979. Grapevine leafroll virus, a possible member of closteroviruses. *Annual Phytopathology Society of Japan* 45: 497–502.
- Osman, F., C. Leutenegger, D. Golino, and A. Rowhani. 2007. Real-time RT-PCR TaqMan®-assays for the detection of *Grapevine leafroll-associated viruses* 1–5 and 9. *Journal of Virological Methods* 141: 22–29.
- . 2008. Comparison of low-density arrays, RT-PCR and real-time TaqMan RT-PCR in detection of grapevine viruses. *Journal of Virological Methods* 149: 292–299.
- Pacifico, D., P. Caciagli, S. Palmano, F. Mannini, and C. Marzachi. 2011. Quantitation of Grapevine leafroll associated virus-1 and -3, Grapevine virus A, Grapevine fanleaf virus and Grapevine fleck virus in field-collected *Vitis vinifera* L. ‘Nebbiolo’ by real-time reverse transcription-PCR. *Journal of Virological Methods* 172: 1–7.
- Peremyslov, V.V., I.A. Andreev, A.I. Prokhnevsky, G.H. Duncan, M.E. Taliansky, and V.V. Dolja. 2004. Complex molecular architecture of beet yellows virus particles. *Proceedings of the National Academy of Sciences of the United States of America* 101: 5030–5035.
- Pietersen, G., N. Spreeth, T. Oosthuizen, A. Van Rensburg, M. Van Rensburg, D. Lottering, N. Rossouw, and D. Tooth. 2013. Control of grapevine leafroll disease spread at a commercial wine estate in South Africa: A case study. *American Journal of Enology and Viticulture* 64: 296–305.
- Poojari, S., O.J. Alabi, P.A. Okubar, and R.A. Naidu. 2016. SYBR® Green-based real-time quantitative reverse-transcription PCR for detection and discrimination of grapevine viruses. *Journal of Virological Methods* 235: 112–118.
- Rayapati, A.N., S. O’Neil, and D. Walsh. 2008. *Grapevine leafroll disease*. Pullman: Washington State University, Extension Bulletins, Washington State University. <http://cru.cahe.wsu.edu/CEPublications/eb2027e/eb2027e.pdf>. Accessed on 4 Apr 2016.
- Satyanarayana, T., S. Gowda, M.A. Ayllon, and W.O. Dawson. 2004. Closterovirus bipolar virion: evidence for initiation of assembly by minor coat protein and its restriction to the genomic RNA 5′ region. *Proceedings of the National Academy of Sciences of the United States of America* 101: 799–804.
- Seddas, A., M.M. Haidar, C. Greif, C. Jacquet, G. Cloquemin, and B. Walter. 2000. Establishment of a relationship between grapevine leafroll closteroviruses 1 and 3 by use of monoclonal antibodies. *Plant Pathology* 49: 80–85.
- Sefc, K.M., W. Leonhardt, and H. Steinkellner. 2000. Partial sequence identification of grapevine-leafroll-associated virus-1 and development of a highly sensitive IC-RT-PCR detection method. *Journal of Virological Methods* 86: 101–106.
- Sforza, R., E. Boudon-Padieu, and C. Greif. 2013. New mealybug species vectoring Grapevine leafroll associated viruses-1 and -3 (GLRaV-1 and -3). *European Journal of Plant Pathology* 109: 975–981.
- Sokolsky, T., Y. Cohen, T. Zahavi, G. Sapir, and R. Sharon. 2013. Potential efficiency of grapevine leafroll disease management strategies using simulation and real spatio-temporal disease infection data. *Australian Journal of Grape and Wine Research* 19: 431–438.
- Thompson, J.R., M. Fuchs, H. McLane, F. Celebi-Toprak, K.F. Fisher, J.L. Potter, and K.L. Perry. 2014. Profiling viral infections in grapevine using a randomly primed reverse transcription-polymerase chain reaction/microarray multiplex platform. *Phytopathology* 104: 211–219.
- Tsai, C.W., A. Rowhani, D.A. Golino, K.M. Daane, and R.P.P. Almeida. 2010. Mealybug transmission of grapevine leafroll viruses: an analysis of virus-vector specificity. *Phytopathology* 100: 830–834.

Chapter 7

Grapevine leafroll-associated virus 2

E. Angelini, N. Aboughanem-Sabanadzovic, V.V. Dolja, and B. Meng

Abstract *Grapevine leafroll-associated virus 2* (GLRaV-2) was recognized in 1984, but its nomenclature was settled only in 1995. It is one of the five viruses involved in grapevine leafroll disease. It is also associated with graft incompatibility disorders. Because of peculiar genome structure and evolutionary history, GLRaV-2 belongs to the genus *Closterovirus* in the family *Closteroviridae*. The GLRaV-2 genome is a single-stranded, positive-sense RNA of ca. 16,500 nucleotides that is presumably capped at the 5' terminus but lacks a poly(A) tail at the 3' end. The nine ORFs encoded by GLRaV-2 comprise three functional modules, including the replication module, the quintuple gene block module, and the module for RNA silencing suppressors. The translation product of ORF1a lacks an AlkB domain, unlike all members of the genus *Ampelovirus* that infect the grapevine. The genetic diversity of GLRaV-2 is very high, with six lineages that are characterized by up to 25% nucleotide divergence and different biological behavior on plant hosts. All *Vitis vinifera*, rootstocks, and interspecific hybrids are susceptible to GLRaV-2. The identification of GLRaV-2 in wild *Vitis* spp. native to the American continent supports the hypothesis that the virus originated from North America. The virus is restricted to the phloem tissue, and infected cells are characterized by a massive presence of membranous vesicles that are typical of infection by members of the genus *Closterovirus*. No arthropod vector is known for GLRaV-2, but the virus is graft transmissible and mechanically transmissible to some herbaceous hosts, unlike

E. Angelini (✉)

CREA Center for Research in Viticulture, Viale XXVIII Aprile 26, Conegliano, TV, Italy
e-mail: elisa.angelini@crea.gov.it

N. Aboughanem-Sabanadzovic

Institute for Genomics, Biocomputing and Biotechnology, Mississippi State University,
Mississippi State, MS 39762, USA
e-mail: ninaag@igbb.msstate.edu

V.V. Dolja

Department of Botany and Plant Pathology, Oregon State University,
Cordley Hall, Corvallis, OR 2082, USA
e-mail: doljav@science.oregonstate.edu

B. Meng

Department of Molecular and Cellular Biology, University of Guelph, Guelph, ON, Canada
e-mail: bmeng@uoguelph.ca

other GLRaVs. Management of GLRaV-2 is through the use of virus-tested, clean propagation materials. The recent development of infectious GLRaV-2 clones sets the foundation for studies on gene function, virus replication, pathological properties, as well as virus-host interactions.

Keywords *Closteroviridae* • *Closterovirus* • Grapevine leafroll disease • Genetic diversity • Infectious viral cDNA clones • Graft incompatibility

Introduction and Historical Aspects

Grapevine leafroll-associated virus 2 (GLRaV-2) has long been known as one of the viruses involved in leafroll disease, one of the most widespread and economically important diseases of grapevine. The discovery and nomenclature of this virus has been challenging due to the fact that grapevines are commonly infected by multiple viruses. The first indication for the existence of this virus came in 1984 from a Swiss grapevine accession Chasselas 8/22, in which two distinct types of closterovirus-like particles were observed using electron microscopy. Both virion types were filamentous in shape, 12 nm in diameter, but differed in length: type I particles were 2200 nm, while type II particles were 1800 nm (Gugerli et al. 1984). In a follow-up study, Gugerli and Ramel (1993) used a monoclonal antibody and discovered that the shorter particles belonged to two types of viruses, which they designated as GLRaV-IIa and GLRaV-IIb. During the same time period, French researchers identified a similar virus, which was named GLRaV-2 (Zimmermann et al. 1990). In 1991, the identification of a closterovirus-like virus in cv. Semillon that originated from the University of California-Davis was reported (Namba et al. 1991). Because this accession was considered the standard for corky bark (GCB) disease, these researchers designated the virus grapevine corky bark-associated virus (GCBaV).

This state of confusion was put to rest in 1995 by comparative serological assays (Boscia et al. 1995). It became evident that the three viruses reported by different research groups, type IIb from Switzerland, GCBaV from the USA, and GLRaV-2 from France, were the same virus. Boscia et al. (1995) proposed to retain GLRaV-2 as the name for this virus. This suggestion was accepted by ICTV and has been used as the official name ever since.

The genomes of two GLRaV-2 isolates were partially sequenced in 1998 (Zhu et al. 1998; Abou-Ghanem et al. 1998). The complete genome of isolate 93/955 was reported in 2005 (Meng et al. 2005). Studies on the genetic diversity conducted by various laboratories have demonstrated the existence of several distinct phylogenetic groups (see section “Genetic diversity and population structure”). More recently, certain strains of GLRaV-2 were found to be associated with either asymptomatic infections (Jarugula et al. 2010; Angelini unpublished data) or with graft incompatibility and decline (Uyemoto et al. 2001; Bonfiglioli et al. 2003; Greif et al. 1995; Bertazzon et al. 2010b; Alkowni et al. 2011). The virus is therefore

associated with at least two distinct diseases, i.e., leafroll and graft incompatibility, although Koch's postulates remain to be satisfied for both diseases. The availability of infectious cDNA clones should help in providing definitive answer to the issues revolving the etiology of both diseases.

Finally, it is worth noting that GLRaV-2 was the first grapevine virus engineered as a vector for the expression of heterologous proteins and for the elucidation of functions of grapevine genes through RNA silencing technology (Kurth et al. 2012).

Taxonomy and Nomenclature

Grapevine leafroll-associated virus 2 is a member of the *Alphavirus*-like superfamily of positive-sense, single-stranded RNA viruses. It belongs to the genus *Closterovirus*, whose type member is *Beet yellows virus* (BYV), in the family *Closteroviridae*. According to the current taxonomy, GLRaV-2 is the only grapevine leafroll-associated virus that belongs to the genus *Closterovirus*, with the majority of the leafroll-associated viruses classified in the genus *Ampelovirus* of the same family (Martelli et al. 2012a, b). This taxonomic separation of GLRaV-2 from all other viruses associated with grapevine leafroll disease is based on differences in genome structure (the number of genes and their spatial arrangement in the genome) and the biological vectors (Karasev 2000; Martelli et al. 2012b). Within this species, several strains that differ in molecular and biological properties have been reported (see sections “Genetic diversity and population structure” and “Pathological properties, associated diseases, and their impact”).

Genome Structure, Expression, and Replication

The genome of GLRaV-2 is a single-stranded, positive-sense RNA of ca.16,500 nucleotides (nt). Similar to other members of the genus *Closterovirus*, the genomic RNA is presumably capped at the 5' terminus but lacks a poly(A) tail at the 3' terminus. The genome contains nine open reading frames (ORF) designated as ORF1a, ORF1b, and ORFs 2–8, flanked by a 5'-terminal and a 3'-terminal untranslated regions (UTRs) (Fig. 7.1). The 5'-UTR is 105 or 106 nt in length and highly conserved among the different virus isolates, with sequence identities of 82–97%. The 3'-UTR, on the other hand, exhibits considerable variation both in length and in nucleotide sequence among the different isolates (Abou-Ghanem et al. 1998; Alkowni et al. 2011; Bertazzon et al. 2010a; Liu et al. 2009; Meng et al. 2005; Poojari et al. 2013; Zhu et al. 1998). The upstream part of the 3'-UTR (counting from the first nucleotide upstream of the polyadenylate sequence stretch) varies substantially in size, being longer in isolates SG (199 nt), BD (189 nt), and RG (187 nt) than in isolates 93/955 (177 nt) and OR2 (180 nt) (Fig. 7.2). The 3'-UTR of isolates RG and BD appears to be the most divergent with only 74.3% identity to

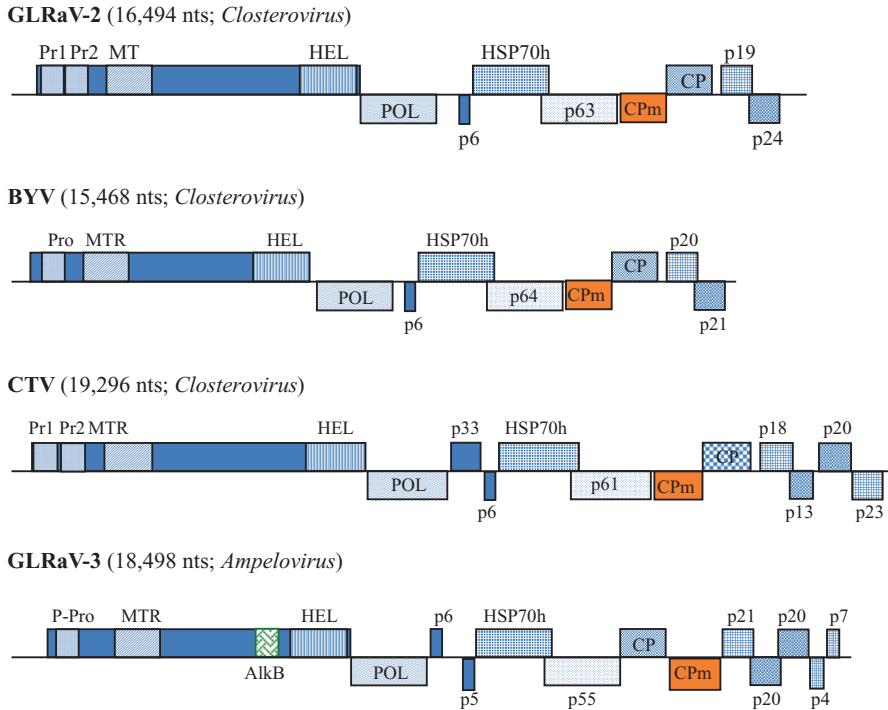

Fig. 7.1 Schematic representation of the genome structure of *Grapevine leafroll-associated virus 2* and other members of the family *Closteroviridae*. *Beet yellows virus* (BYV) and *Citrus tristeza virus* (CTV) are members of the genus *Closterovirus*, while *Grapevine leafroll-associated virus 3* (GLRaV-3) is the prototype member of the genus *Ampelovirus*. Legend: Pr1, Pr2, Pro, P-Pro papain-like protease, MTR methyltransferase, HEL helicase, POL polymerase, HSP70h heat shock protein 70 homolog, CP coat protein, CPm minor coat protein

that of isolate 93/955. The biological relevance of these differences in regard to viral replication and pathogenicity is not known. It is also worth noting that all sequenced GLRaV-2 isolates contain the conserved sequence stretch “TTATTTTTT,” which is followed by several adenosine residues (Fig. 7.2).

The genome structure of GLRaV-2 is highly similar to that of BYV (Dolja 2003; Dolja et al. 2006; Martelli et al. 2012b). Overall, the ORFs of GLRaV-2 can be divided into three modules as proposed for BYV based on shared functions: those responsible for genome replication (ORF1a and ORF1b), the quintuple gene block required for intercellular movement (ORFs 2–6), and the 3′-terminal ORF responsible for counter defense against RNA interference (RNAi) (Chiba et al. 2006; Reed et al. 2003). These functional assignments are largely based on sequence similarities and experimental data obtained for BYV and still await validation for GLRaV-2. It is interesting to note that the size of the GLRaV genome lies between that of two members of the genus *Closterovirus*, i.e., it is nearly 1000 nt longer than that of BYV and 3000 nt shorter than that of *Citrus tristeza virus* (CTV) (Dawson 2010;



Fig. 7.2 Multiple alignment of the 3' noncoding region (NCR) of the genomes of GLRaV-2 isolates for which the entire genomes have been sequenced. Names of isolates for which the 3' NCR sequences were included in this alignment are provided

Moreno et al. 2008). GLRaV-2 differs from BYV and appears more similar to CTV in that the translation product of ORF1a contains two copies of a cysteine protease (L1 and L2) at the 5' end (Fig. 7.1). As demonstrated by Liu et al. (2009) using a biologically active GFP-tagged cDNA clone of GLRaV-2 and the experimental host *Nicotiana benthamiana*, L1 plays important roles both in RNA accumulation and systemic infection, whereas L2 provides an accessory function in the latter process. Furthermore, the autocatalytic cleavage by L2 but not L1 is critical for genome replication. Interestingly, both L1 and L2 are required for establishing infection in the initially inoculated grapevine cells, suggesting that L1 and L2 fulfill additional functions during replication and infection in the grapevine, the natural host of

GLRaV-2, as compared with their functions in the herbaceous experimental host *N. benthamiana* (Liu et al. 2009).

When compared to other viruses associated with grapevine leafroll disease, the genome of GLRaV-2 is similar in length to GLRaV-7, a member of the recently established genus *Velarivirus*, shorter than GLRaV-1 and GLRaV-3 (genus *Ampelovirus*), but longer than GLRaV-4 (also a member of the genus *Ampelovirus*) (Martelli et al. 2012b). It is also worth noting that the translation product of GLRaV-2 ORF1a lacks an AlkB domain (van den Born et al. 2008), which is present in all members of the genus *Ampelovirus* that infect grapevine. Moreover, the position of the major capsid protein (CP) and the minor capsid protein (CPm) differs in these viruses. For instance, in GLRaV-2, the CPm gene is located upstream of the CP gene, whereas in GLRaV-1, GLRaV-3, and GLRaV-7, the CPm gene is downstream of the CP gene (Fig. 7.1). These differences in genome structure, phylogenetic relatedness, as well as mode of virus transmission suggest that GLRaV-2 may have followed a distinct evolutionary route.

Because GLRaV-2 is a member of the *Alphavirus*-like superfamily (Dolja and Koonin 2011) that uses 3'-coterminal subgenomic RNAs (sgRNAs) as a principal means of gene expression, the expression of all genes downstream of ORF1a/ORF1b likely occurs via sgRNAs. By analogy with BYV (Agranovsky et al. 1994; Hagiwara et al. 1999; He et al. 1997; Peremyslov and Dolja 2002) and CTV (Hilf et al. 1995), GLRaV-2 would produce seven sgRNAs, each of these sgRNAs serving as a mRNA for the translation of the 5'-proximal ORF. Analyses of the ORF1a/ORF1b overlapping region suggested that ORF1b is expressed via a +1 ribosomal frameshift, similarly to BYV (Abou-Ghanem et al. 1998; Zhu et al. 1998).

Based on information obtained for BYV, it can be assumed that the proteins required for GLRaV-2 genome replication are encoded by ORF1a/ORF1b that possess methyl transferase, RNA helicase, and RdRp domains (Peremyslov et al. 1998), as well as a leader protease encoded by the N-terminal region of the ORF1a product (Peng and Dolja 2000) and p24, a product of the 3'-proximal ORF8 (Reed et al. 2003). The function of the latter GLRaV-2 protein as a strong suppressor of RNA interference has been experimentally confirmed (Chiba et al. 2006).

Although the function of GLRaV-2 proteins in virion assembly and cell-to-cell movement has not been determined directly, it is a reasonable assumption that the same conserved quintuple gene block is involved in these processes as in BYV. In particular, it is likely that the small hydrophobic protein p6 serves as a dedicated movement protein, whereas HSP70 homolog (HSP70h), p63, and minor capsid protein (CPm) are likely involved in the formation of both the tailed virions and their intercellular transport (Alzhanova et al. 2000, 2001, 2007; Napuli et al. 2003; Peremyslov et al. 1999, 2004a, b). It should be emphasized, however, that unlike BYV, which is capable of moving among the epidermal, mesophyll, and phloem cells, GLRaV-2 accumulates primarily in the phloem cells in stems, petioles, leaves, and roots of infected grapevine. The only other known cells which GLRaV-2 is capable of entering are mesocarp cells within the berries (Kurth et al. 2012). Although it is tempting to speculate that, similarly to BYV p20, the GLRaV-2 p19 is involved in virion formation and long-distance transport (Peremyslov et al. 2004a;

Prokhnevsky et al. 2002), the amino acid sequence divergence between these proteins is too high to validate such assumption.

Genetic Diversity and Population Structure

Genetic diversity of GLRaV-2 has been investigated in many important grape-growing areas in the world, including Europe, the Americas, Africa, Asia, and Australia. As mentioned above, the genome of two viral strains, GLRaV-2 PN and GLRaV-2 Se, was originally sequenced in 1998, from USA accessions of Pinot noir and Semillon (Zhu et al. 1998; Abou-Ghanem et al. 1998). Since then, many other GLRaV-2 isolates have been identified and characterized from infected grapevines worldwide. At present, the genomes of seven other isolates have been completely or nearly completely sequenced: “OR1,” “OR2,” “RG,” and “SG” from the USA (Liu et al. 2009; Kurth et al. 2012; Alkowni et al. 2011; Poojari et al. 2013), “93/955” from South Africa (Meng et al. 2005), “BD” from Italy (Bertazzon et al. 2010a), and “3138-07” from Canada (GenBank accession JX559644). Partial genome sequences reported in GenBank or other databases number in hundreds, mostly for the CP and HSP70h ORFs. Among them, it is worth to mention “H4,” an isolate originated from an accession of *Vitis rupestris* cv. St. George from California (Abou Ghanem-Sabanadzovic et al. 2000), and “PV20” from cv. Savagnin in France (Beuve et al. 2007), because they showed a high degree of divergence from the other strains.

In general, extensive data on GLRaV-2 variability showed that the genetic polymorphism of the virus is very high. Indeed, the nucleotide sequence identity can be lower than 75% among the most divergent variants. This high degree of diversity implies potential separation of the most divergent clusters into new virus species, according to the accepted demarcation criteria by ICTV (Martelli et al. 2012a). However, current consensus based on biological and genetic traits is to consider such isolates as GLRaV-2 variants. At least six distinct virus lineages have been identified so far, each represented by a prototype isolate. These lineages encompass the entire genetic polymorphism of the virus known up to now. The phylogenetic tree obtained using the CP gene sequences provides an example of the phylogenetic distances between different molecular variants (Fig. 7.3). The GLRaV-2 type strain is PN that is nearly identical to Se isolate, with 7.9% and 3.5% sequence differences at the nt and amino acid (aa) level, respectively, compared to the closest 93/955 variant isolated in South Africa (Goszczynski et al. 1996b). The third phylogenetic cluster includes the H4 variant, whose CP sequence is different from the PN isolate by 11.1% and 6.1% at the nt and aa sequence levels, respectively. The other three GLRaV-2 lineages are more distantly related to PN and the other strains. Indeed, the RG isolate, commonly found in the table grape cv. Red Globe and other cultivars (Rowhani et al. 2000; Alkowni et al. 2011), shows 23.7% (nt) and 9.1% (aa) genetic distance in comparison to PN. The BD variant, identified in a few grapevines in an Italian ampelographic collection, is even more diverse, with 25.3% and 13.4% differences at nt and aa levels, respectively (Bertazzon et al. 2010a). Finally, the PV20

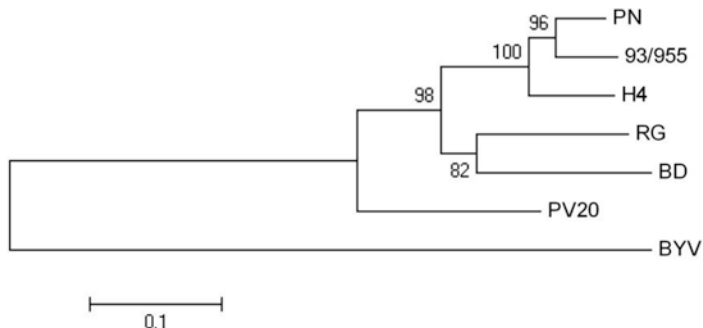

Fig. 7.3 Phylogenetic relationships between the six distinct lineages of the GLRaV-2 coat protein gene using Neighbour Joining tree in the MEGA program. A single representative isolate of each phylogenetic lineage was used to build the tree. *Beet yellows virus* (BYV) was used as an outgroup. Bootstrap values are reported at the nodes. The bar represents 0.1 substitutions per site. GenBank Accessions: PN, AF039204; 93/955, AY881628; H4, AY697863; RG, NC_004724; BD, DQ286725; PV20, EF012721; BYV, NC_001598

isolate exhibits 26.6% and 19.2% differences at nt and aa sequence level, respectively, from the type strain.

The levels of nt and aa sequence identity in the other regions are different, depending on the selection pressure acting on each ORF; however, phylogenetic relationships are generally conserved regardless of which genomic region is used in the phylogenetic analysis. In particular, comparative analyses of nt sequences have shown that the 5'-UTR is the most conserved genome region (Meng et al. 2005; Bertazzon et al. 2010a). At the aa sequence level, the RdRp (encoded by ORF1b) and the Cpm (encoded by ORF5) are the most conserved, while ORF1a is the most variable among GLRaV-2 strains (Meng et al. 2005; Bertazzon et al. 2010a). In general, variable protein sequence regions are broadly distributed within the ORFs; however, there are well-conserved aa sequence motifs in most of the ORFs. These regions include the methyltransferase (MT) and the helicase (HEL) domains in the polyprotein encoded by ORF1a, RdRp domain in the ORF1b, ATPase domain of the Hsp70h, and the capsid protein-like domain within p63, Cpm and CP (Meng et al. 2005; Dolja et al. 2006; Bertazzon et al. 2010b). More recent analyses revealed that the GLRaV-2 genome is under negative selection, as the ratio between the number of non-synonymous and synonymous mutations (dN/dS) is always much lower than one (Bertazzon et al. 2010b; Jarugula et al. 2010).

Studies of the genetic variability and occurrence of different GLRaV-2 variants in many countries were carried out in the last 10 years. A wide range of genetic variants was identified. Most of these variants were similar to the PN type strain, whereas the most unusual variants were found in autochthonous cultivars grown in restricted geographic areas (Angelini et al. 2004; Bertazzon et al. 2010b). Most of the GLRaV-2 isolates from Portuguese vineyards belong to the PN lineage, though some isolates clustered with H4 and 93/955 strains (Fonseca et al. 2016). A few surveys performed in the USA revealed that sequences aligned only with PN, H4,

and RG lineages, with the majority of the samples clustering within the PN clade (Fuchs et al. 2009; Jarugula et al. 2010; Klaassen et al. 2011; Jones et al. 2015). The molecular characterization of local Argentinian isolates proved that most of them group within PN and 93/955 lineages (Lanza Volpe et al. 2015). Phylogenetic analyses of 36 GLRaV-2 isolates from China showed that 26 belong to the PN, nine to RG, and one to H4 lineages (Fan et al. 2015). Finally, all of seven Algerian isolates that were studied belonged to the PN cluster (Lehad et al. 2015). In summary, GLRaV-2 populations are dominated by variants of the PN lineage, which are present all over the world; variants of the RG lineage are also widely spread but less common than the PN lineage. Variants of the 93/955 and H4 lineages occur almost everywhere but only sporadically. Finally, lineages BD and PV20 seem to be rare and have been found only in Italy and France so far. However, it has to be taken into account that the most commonly used primer pairs for detecting GLRaV-2 by RT-PCR are not able to detect variants in the last two lineages; thus their actual occurrence could have been underestimated. As for most of the grapevine viruses, no relationship between genetic variability and geographic origin of the host has been found.

As far as the possible origin of GLRaV-2 is concerned, the presence of the virus in wild vines in Mississippi (Abou Ghanem-Sabanadzovic and Sabanadzovic 2015) and California (Klaassen et al. 2011) seems to be consistent with the hypothesis that it originated from North America, unlike other viruses associated with leafroll, which are thought to originate primarily in the Old World (Martelli 2015).

Detection and Diagnosis

Diagnosis of GLRaV-2 can be performed by observation of symptoms, biological indexing, and serological and molecular PCR-based assays.

Symptom Observation and Biological Indexing

The detection of the virus and the associated leafroll disease by symptom observation is unreliable because different genetic variants of GLRaV-2 display diverse pathological properties and leafroll symptoms can be mild or absent (Fig. 7.4). Therefore, biological indexing can reveal only a fraction of the GLRaV-2 infections. Most common grapevine indicators for leafroll disease are red-berried cultivars such as Cabernet franc, C. Sauvignon, Carmenere, Gamay, Merlot, Pinot noir, and Mission (Gambino et al. 2010; Martelli 2014). GLRaV-2 infection on leafroll indicators shows weak symptoms, characterized by less intense red coloration of leaves compared to other leafroll viruses such as GLRaV-1 and GLRaV-3, that usually exhibit strong down-rolling and reddening of almost all the leaves from the early stage of veraison. GLRaV-2 leafroll symptoms only appear in the late vegetative

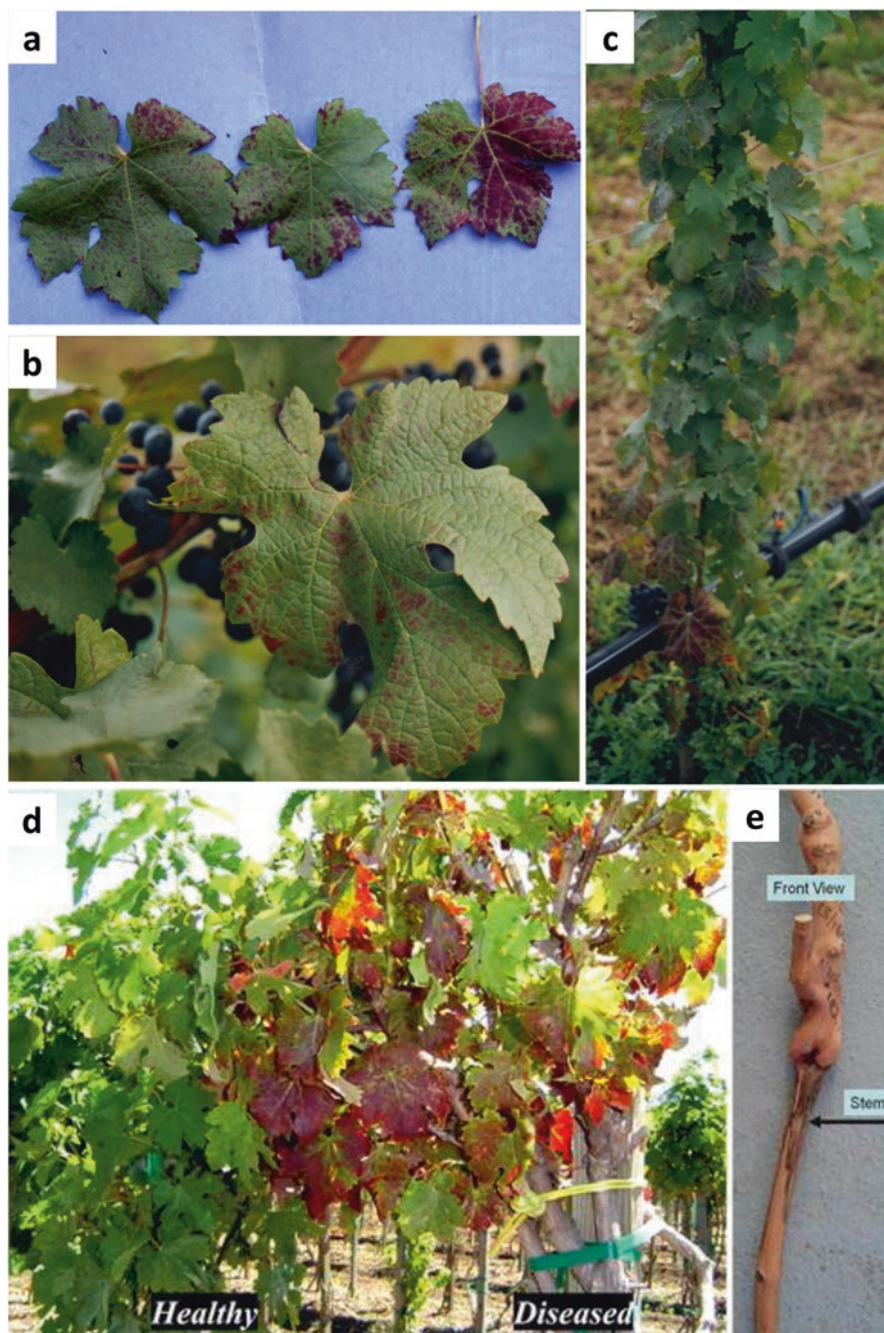

Fig. 7.4 Diseases associated with GLRaV-2. (a) Different severity degrees of leafroll symptoms in cv Cabernet franc in October in Italy (Courtesy of Dr. Michele Borgo); (b) mild leafroll symptoms in cv Cabernet Sauvignon at the end of September in Italy; (c) leafroll symptoms in 1-year-old cv Cabernet Sauvignon at the end of September; (d) graft incompatibility symptoms on Cabernet Sauvignon onto 1616C after inoculation with GLRaV-2 strain RG (*right*) compared to a uninoculated vine (*left*); and (e) rootstock stem lesion on 1616C 2 years post-inoculation with GLRaV-2 strain RG (Photos **d**, **e** from Alkowni et al. 2011)

season, mainly on the edges of the basal leaves that remain flat or slightly rolled (Bertazzon et al. 2010b). In order to reveal graft incompatibility symptoms, characteristic of some virus strains, the use of several rootstocks, such as Kober 5BB and 1103P, should be taken into account (Bertazzon et al. 2010b; Alkowni et al. 2011). Symptoms associated with graft incompatibility include cracking and strong swelling of the graft union, chromatic changes of leaves and weak shoot growth, early reddening, and decline.

Serological Diagnosis

The first antiserum against GLRaV-2 was produced in Switzerland (Roscioglione and Gugerli 1986). Monoclonal antibodies (Gugerli and Ramel 1993; Zhou et al. 2000; Besse et al. 2009) and other antisera (Zimmerman et al. 1990; Goszczynski et al. 1996a, b; Monis and Bestwick 1997; Zhu et al. 1997; Xu et al. 2006; Ling et al. 2007; Radaelli et al. 2008; Alkowni et al. 2011) were subsequently developed, some of them using a recombinant GLRaV-2 coat protein as the immunogen. A detailed review of the different antibodies produced against grapevine leafroll viruses, including GLRaV-2, was published by Gugerli (2009). Several reliable GLRaV-2 antisera are now available in the form of ELISA commercial kits, based on direct or indirect detection methods. Their specificity and sensitivity can vary (Bertazzon and Angelini 2004; Cabaleiro et al. 2009; Jarugula et al. 2010; Alkowni et al. 2011; Faggioli et al. 2012).

As is the case of a few other grapevine viruses, the diagnosis of GLRaV-2 in infected leaves using ELISA can sometimes lead to false negative results, due to the low titer of the virus in the infected vines. It is also worth noting that more reliable ELISA detection is obtained much later in the vegetative season for GLRaV-2 in comparison to other GLRaVs (Gugerli 2000). Serological detection of the virus in roots of infected rootstocks was shown to be unreliable (Beccavin et al. 2009). Indeed, the most suitable materials to be tested are dormant canes. However, it should be taken into account that dormant canes of infected vines analyzed later than 2–3 months after the collection can show false negative results in ELISA (Gambino et al. 2010).

PCR-Based Diagnosis

In general, RT-PCR assays are more sensitive than ELISA for the detection of GLRaV-2 (Bertazzon and Angelini 2004; Beccavin et al. 2009; Constable et al. 2012). The first primer pairs targeting GLRaV-2 were designed based on the sequence of the most common genetic variants sequenced in 1998 (Zhu et al. 1998; Abou-Ghanem et al. 1998; Abou Ghanem-Sabanadzovic et al. 2000). It became clear soon afterward that most primers were not suitable to detect all the strains of

GLRaV-2, due to the high genetic variability of the virus (Angelini et al. 2004; Beuve et al. 2007; Bertazzon et al. 2010b). Thus, several other pairs of primers were developed. Some primers are group specific and useful for the detection of the diverse genetic variants within a lineage, and others are “universal” for the detection of the highest possible number of genetic variants. Details on the primers used for reliable detection of GLRaV-2 and their features are provided in Table 7.1. Multiplex RT-PCR assays were developed and used for the simultaneous detection of a number of viruses, including GLRaV-2 (Faggioli and La Starza 2006; Gambino and Gribaudo 2006; Sharma et al. 2011). In general in multiplex assays, as the main purpose is to detect as many viruses as possible, the sensitivity of the PCR can be lower in comparison with a singleplex assay or even ELISA (Faggioli et al. 2012).

More recently, diagnostic tools based on real-time PCR using SybrGreen or TaqMan chemistry allowed quantitative and more sensitive detection of grapevine viruses, including GLRaV-2 (Beuve et al. 2007; Osman et al. 2007, 2008; Klaassen et al. 2011).

GLRaV-2 can also be detected simultaneously with other important grapevine viruses using oligonucleotide arrays, such as low-density arrays (LDA) (Osman et al. 2008), microarrays (Engel et al. 2010; Abdullahi et al. 2011), and macroarrays (Thompson et al. 2012, 2014). In general, LDA and microarray detection proved to be as efficient as conventional or real-time RT-PCR.

The most recent methods of grapevine virus detection are based on massive sequencing of the grapevine transcriptome including viral RNAs (RNAseq) or more targeted sequencing of small interfering RNAs; both of these approaches allow a confident identification of all viruses and viroids present in a vine (Al Rwahnih et al. 2009; Coetzee et al. 2010; Seguin et al. 2014).

In summary, several diagnostic tools are available for GLRaV-2. Some of the methods are more sensitive, some are targeting one or a few viral variants, while a few are “universal” primers, in the sense that they are able to detect all GLRaV-2 variants known so far, such as primers P19qtF4/P24qtR used in real-time RT-PCR (Table 7.1; Beuve et al. 2007). However, due to the wide genetic variability of the virus, it is recommended to use more than one approach in order to achieve an accurate and reliable diagnosis of multiple variants, as was demonstrated by the comparison of different diagnostic tools (Monis 2012; Klaassen et al. 2012).

Host Range and Transmission

All *V. vinifera* cultivars, rootstocks, and interspecific hybrids are susceptible to GLRaV-2 infection (Martelli 2014). In addition to cultivated grapevines, recent studies demonstrated that GLRaV-2 is present in wild *Vitis* spp. native to the American continent.

Study carried out in California revealed GLRaV-2 infection in *V. californica* and *V. californica* × *V. vinifera* hybrids from riparian areas not adjacent to commercial vineyards (Klaassen et al. 2011). More recently, the virus was also reported in

Table 7.1 List of primer pairs developed for GLRaV-2 diagnosis and their features

Primer pair (and probe) name	References	Target gene	Target GLRaV-2 groups					
			PN	93/955	H4	PV 20	RG	BD
Conventional RT-PCR								
LRaV-2(1)/(2)	Abou-Ghanem et al. (1998)	P60	Yes	No	Yes		No	No
GLR2 CP1/2	Abou Ghanem-Sabanadzovic et al. (2000)	CP	Yes	Yes	Yes	No	No	No
LR2-L2F/U2R	Abou-Ghanem (in Bertazzon and Angelini 2004)	HSP70h	Yes	No	Yes		No	No
V2dCPf2/CPr1	Bertazzon and Angelini (2004)	dCP-CP	Yes	Yes	Yes	Yes	Yes	No
V2dCPf2/p19r1	Bertazzon and Angelini (2004)	dCP-p19	Yes				No	No
V2dCPf2/RGp19r2	Bertazzon and Angelini (2004)	dCP-p19	No				Yes	No
BDCP1/r2	Bertazzon and Angelini (2004)	CP	No				No	Yes
CPV F/CPC R	Osman et al. (2007)	CP	Yes					
L2A/B	Gambino and Gribaudo (2006)	CP	Yes					
GLV2-RdRp-L1/R2	Xu et al. (2006)	RdRp	Yes					
GLV2-CP-L1/R2	Xu et al. (2006)	CP	Yes					
CP2-1/2	Fonseca et al. (2016)	CP	Yes	Yes	Yes			
LR2F/R	Lanza Volpe et al. (2009)		Yes				No	
LR2F/RSLR	Lanza Volpe et al. (2009)		No				Yes	
RGHSP227/777	Alkowni et al. (2011)	hHSP70	No				Yes	No
LR-2F/R	Abou Ghanem-Sabanadzovic and Sabanadzovic (2015)	hHSP70		Yes			Yes	
L2HSPL/R and L2HSPnL/R	Fan et al. (2015)	hHSP70	Yes		Yes		Yes	
LR2-F/p24R	Lanza Volpe et al. (2015)	CP-p19-p24	Yes	Yes	Yes		Yes	

(continued)

Table 7.1 (continued)

Primer pair (and probe) name	References	Target gene	Target GLRaV-2 groups					
			PN	93/955	H4	PV 20	RG	BD
Real-time RT-PCR								
P19qtF4/P24qtR	Beuve et al. (2007)	p19-p24	Yes	Yes	Yes	Yes	Yes	Yes
GLRaV-2 198f/290r (GLRaV-2 233p)	Osman et al. (2007)	hHSP70	Yes				No	
Redglobe-227f/319r (Redglobe 250p)	Osman et al. (2008)	hHSP70	No				Yes	
LR2-124f/284r (LR2-214p)	Klaassen et al. (2011)	hHSP70	Yes					

Capability of identifying different phylogenetic groups in RT-PCR is shown. When not indicated, data are not available

summer grape (*V. aestivalis*) in the Great Smoky Mountains National Park, and in muscadine grape (*Muscadinia rotundifolia*) in Mississippi (Abou Ghanem-Sabanadzovic and Sabanadzovic 2015). Curiously, none of the GLRaV-2-infected samples of native grapes examined in both studies showed visible symptoms of viral infections. Partial genome sequencing revealed that the GLRaV-2 isolates from these native grapes belong to different variant groups. Three isolates reported from native grapes in California belong to the PN lineage, those from muscadine have a 93/955-like genotype, while the isolate in summer grapes belongs to the RG lineage (Klaassen et al. 2011; Abou Ghanem-Sabanadzovic and Sabanadzovic 2015).

Unlike other characterized GLRaVs, GLRaV-2 is mechanically transmissible to some herbaceous hosts, primarily *N. benthamiana* (Monette and Godkin 1993; Castellano et al. 1995; Goszczynski et al. 1996a; Abou-Ghanem et al. 1998; Abou Ghanem-Sabanadzovic et al. 2000). Studies carried out in South Africa revealed different biological behavior of two GLRaV-2 isolates, denominated 93/955 and 94/970, upon inoculation to *N. benthamiana*, with the former being more virulent. In addition to *N. benthamiana*, the H4 isolate was able to systemically invade *N. occidentalis* and to provoke localized infections in *N. clevelandii* (Abou Ghanem-Sabanadzovic et al. 2000; Lanza Volpe et al. 2015).

GLRaV-2 has no recognized insect vector. As the virus belongs to the genus *Closterovirus*, which contains several aphid-transmissible members, the involvement of an aphid or aphid-like insect in mediating plant-to-plant transmission is plausible. However, no anecdotal or experimental evidence indicates the occurrence of spread, suggesting that GLRaV-2 might have lost its ability to be transmitted by an arthropod vector as a result of coadaptation with the grapevine host.

All isolates of GLRaV-2 are graft transmissible. Propagation of plant material collected from infected plants, especially asymptomatic ones, is certainly the major way of virus dissemination.

Cytopathology, Tissue Tropism, and Virus-Host Interactions

Cytopathological effects due to GLRaV-2 infections were studied for two different isolates, GLRaV-2 H4 and GLRaV-2 Se (at the time known as grapevine corky bark-associated virus, GCBaV) in the natural (*V. vinifera* and *V. rupestris*) and experimental hosts (*N. benthamiana*) (Castellano et al. 1995, 2000). The tissue tropism and cytopathic effects of GLRaV-2 do not vary significantly between hosts and virus isolates. Hence, in order to avoid redundancy, cytopathic effects will be broadly discussed here.

In all studies, no virus particles or cytopathic effects were observed in mesophyll cells of infected plants that had a structure and organization comparable to healthy controls. Virus effects were observed only in vascular bundles, involving phloem parenchyma and companion cells as well as in sieve tubes and xylem elements (Castellano et al. 1995), confirming that GLRaV-2 is restricted to conducting tissue (Castellano et al. 2000). Many phloem cells in infected *N. benthamiana* became necrotic and contained modifications of cell walls in the form of localized thickening due to abundant deposition of callose-like substances; however, no obvious alterations of the structure and appearance of the main organelles were observed.

Infected cells were characterized by the massive presence of membranous vesicles and inclusion bodies formed by loose aggregates of virions in the form of thin filaments. Massive bundles of virus particles were easily identifiable in the cytoplasm of sieve elements and companion cells but not in the xylem tissue (Castellano et al. 2000). Besides the cytoplasm, virion aggregates were occasionally observed in the nuclei of *N. benthamiana* infected by GLRaV-2 Se, as demonstrated by specific immunogold labeling (Castellano et al. 1995). The biological relevance of the nuclear localization of virions is unknown.

Extensive membranous vesicles up to 110 nm in diameter are present in the infected cells, which usually contained fine fibrils and often grouped in characteristic clusters surrounded by a membrane. Curiously, the bounding membrane could be single or double layered as reported for GLRaV-2 H4 and GLRaV-2 Se isolates, respectively (Castellano et al. 1995, 2000). The difference in complexity of the membrane composition remains yet to be understood.

The origin of vesicles is not clear; however, their formation by invagination of the endoplasmic reticulum (ER) is more plausible than the one involving modifications of mitochondria (as is the case for similar bodies observed in grapevines infected by GLRaV-1 or GLRaV-3) (Castellano et al. 2000). The ER origin of vesiculated bodies in GLRaV-2 infected hosts (*Vitis* spp. and *N. benthamiana*) is in agreement with similar structures present in sugar beets infected with BYV (Cronshaw et al. 1966), suggesting possible taxon-specific differences between ampelo- and closteroviruses concerning the origin and mechanisms of formation of these structures in infected cells of their respective hosts.

Pathological Properties, Associated Diseases, and Their Impact

As described earlier, GLRaV-2 was originally discovered in grapevines affected with leafroll disease in Switzerland (Gugerli et al. 1984) and Italy (Rosciglione and Gugerli 1986). Its association with leafroll disease, although at times inconsistent, is reported in numerous studies. In addition, the involvement of GLRaV-2 in other grapevine disorders, especially in various graft incompatibility conditions, has been suspected for more than two decades (Greif et al. 1995). Nowadays, it is known that GLRaV-2 contributes to different diseases with varied symptomatologies (Fig. 7.4); however, the virus is not involved in corky bark disease despite suspicions raised in early 1990s.

Graft incompatibility on Kober 5BB has been observed and studied in Europe since the early 1970s (Durquety et al. 1973, 1977; Savino et al. 1991). Possible virus involvement in the etiology of the disease was suspected based upon successful graft transmission (Fallot et al. 1979) and the elimination of the putative agent by heat therapy (Legin and Walter 1986). Results of a collaborative study carried out in France and Italy strongly suggested the association of GLRaV-2 with the Kober 5BB graft incompatibility in samples tested independently in both countries (Greif et al. 1995).

An extensive study carried out in California showed the correlation between mixed infection of GLRaV-2 and *Grapevine virus B* (GVB) and “young vine failure/decline” syndrome (Golino et al. 2000). Soon afterward, an apparently new virus, provisionally named *Grapevine rootstock stem lesion-associated virus* (GRSLaV) that later proved to be a highly divergent strain of GLRaV-2 (strain “Redglobe” or abbreviated RG), was found associated with a severe decline of cv. Redglobe grafted on several rootstocks by inducing stem lesions/necrosis on rootstock 3309C and Kober 5BB (Rowhani et al. 2000; Uyemoto et al. 2001; Uyemoto and Rowhani 2003).

At the dawn of the twenty-first century, similar disorders were reported from South America and New Zealand but with somewhat discordant conclusions about their cause. In a study of “young grafted vine decline” conducted in Argentina, GLRaV-2 was consistently found in infected samples of several clonal selections of Cabernet Sauvignon grafted on a range of rootstocks (Gomez Talquenca et al. 2003). The GLRaV-2 isolates in this study were from the RG lineage. On the other hand, the association of GLRaV-2 with a decline of cv. Thompson Seedless grafted on the rootstocks Freedom and Harmony in Chile was inconsistent; therefore, the possible cause remained elusive (Prodan et al. 2003). Studies on a graft incompatibility syndrome observed in cv. Merlot in New Zealand resulted in the report of a new molecular variant of GLRaV-2, trivially named “Alphie” (Bonfiglioli et al. 2003).

It is important to emphasize that GLRaV-2 is not implicated in the etiology of two other decline phenomena reported in the literature: Syrah decline in France (Renault Spilmont et al. 2003; Beuve et al. 2013) and graft incompatibility of cv. Pinot noir grafted on rootstock 110R in California (Al Rwahnih et al. 2012).

A relationship between genetic variability and pathological properties was established in Italy via grafting on four different rootstocks. A GLRaV-2 isolate from the RG lineage was the most virulent variant tested as it induced a decrease in graft take in more than 50% of the grafts performed (Bertazzon et al. 2010a). GLRaV-2 isolates belonging to H4 and PN lineages induced high mortality rates of grafted plants 2 years post-inoculation, depending on the viral variant, but only in some rootstocks. For example, the lineage H4 induced a severe reaction only on Kober 5BB, resulting in an 85% mortality of the grafted plants. Furthermore, no vines survived when a GLRaV-2 source belonging to the PN lineage was grafted onto 1103P, while the yield on the other rootstocks was not statistically different from the uninfected plants. An isolate from the BD lineage was a mild variant of the virus, having no effect on the graft take but reducing the vigor of the plants. The same study showed that graft incompatibility is also rootstock dependent, with no incompatibility observed on SO4 compared to Kober 5BB, 5C, and 1103P (Bertazzon et al. 2010a).

Additionally, the same study showed that GLRaV-2 is a weak elicitor of leafroll symptoms upon grafting, with only a small portion (18%) of *V. vinifera* cv. Cabernet franc plants inoculated by various GLRaV-2 variants showing disease symptoms. Isolates of the PN lineage induced leafroll symptoms, whereas none of the 18 Cabernet franc grafted with material containing an isolate of the RG lineage showed disease symptoms during the 3-year post-inoculation observation period. Association of leafroll symptoms and other GLRaV-2 variants was rather erratic (Bertazzon et al. 2010a). This is in contrast to indexing results with GLRaV-1, GLRaV-3, and GLRaV-4 strain 6 sources used in the same study that induced typical leafroll symptoms in 100% of inoculated Cabernet franc plants. Additionally, disease symptoms induced by certain variants of GLRaV-2 were weaker and characterized by less intense red coloration of leaves that remained flat or at most slightly rolled downward, compared to those induced by GLRaV-1 and GLRaV-3 (Bertazzon et al. 2010b).

The fact that a GLRaV-2 isolate that is genetically closer to 93/955 than to BD or RG was detected in asymptomatic self-rooted red-berried Sangiovese in the Pacific Northwest region of the USA (Poojari et al. 2013), along with the observation of symptomless infection in a few grapevine species native to the USA (Abou Ghanem-Sabanadzovic and Sabanadzovic 2015; Klaassen et al. 2011), furthers our knowledge of the considerable genetic variability in the population of this virus and different pathological impact on the grapevine host.

Strategies for Control and Management

Like all other viruses infecting grapevine, GLRaV-2 is transmitted through propagation materials and grafting; however it has no known vector for transmission. The use of virus-tested stocks from which clean propagation material is collected is used to manage GLRaV-2. Similar to other phloem-limited viruses, GLRaV-2 is readily eliminated through shoot tip tissue culture and heat therapy (see Chap. 27, this

book). Importantly, the virus-free status of clean materials requires the use of highly sensitive and reliable diagnostic methods. It is worth to note that at present the virus is not included in several certification programs of many countries, including in Europe. It may be prudent to consider the inclusion of GLRaV-2 in the list of pathogens to be assayed for certification.

Conclusions and Future Research Directions

Since the discovery of GLRaV-2 in the mid-1980s, much progress has been made on various aspects of this virus. Like many other viruses that infect grapevine, GLRaV-2 is composed of multiple sequence variants. Phylogenetic relationships of isolates from different grapevine samples, including *V. vinifera*, rootstocks, interspecific hybrids, and wild species, suggest six lineages (Fig. 7.3). Similar results were obtained regardless of whether the CP gene or the HSPs70h gene sequences were used in the analysis. It is becoming clear that GLRaV-2 is involved in and may be the causative agent of at least two distinct diseases (leafroll and graft incompatibility). Graft incompatibility depends on the virus isolate and the rootstock genotype. For instance, variants of the RG lineage are closely associated with graft incompatibility and decline of cv. Red Globe in different countries. On the other hand, variants of the PN lineage generally cause typical leafroll symptoms. It is important to note that manifestation of different types of symptoms may depend on the combination of scion and rootstock in a given grafted vine. It is also possible that GLRaV-2 is only one of the viruses that are capable of inducing graft incompatibility and decline. Evidently, the pathological effects of different strains of GLRaV-2 on different scion cultivars (clones), rootstocks, and their combinations ought to be investigated beyond the seminal research by Bertazzon et al. (2010b).

Our understanding of the mechanisms that govern the different phases of the GLRaV-2 infection process is very limited compared to BYV and CTV. Although the GLRaV-2 genome has a genetic structure very similar to BYV, major differences may exist between these two viruses because the natural host of GLRaV-2, the grapevine, is a woody perennial, which differs fundamentally from sugar beet, the natural host of BYV. Nevertheless, this supposition will need to be validated. The availability of an infectious clone of GLRaV-2 and its GFP-tagged derivative has made such investigations possible (Kurth et al. 2012; Liu et al. 2009). It seems that from a fundamental research point of view, the most interesting questions include the mechanisms of GLRaV-2 cell-to-cell and long-distance movement in the phloem.

It should also be mentioned that the GLRaV-2-based gene expression and virus-induced gene-silencing vector provides a powerful tool for grapevine functional genomics and pathogen control (Dolja and Meng, Chap. 31; Kurth et al. 2012). A full-scale application of this vector still awaits more effort.

Interactions of GLRaV-2 with the grapevine host need to be further studied. Electron microscopic observations suggest that infection with GLRaV-2 induces

virus replication complexes (i.e., vesicular bodies) with membrane originating from the ER. In contrast, both GLRaV-1 and GLRaV-3 induce the formation of viral replication complexes through the invagination of the outer membrane of mitochondria. It would be interesting to elucidate molecular mechanisms for the differential membrane targeting in these viruses. Moreover, interaction between GLRaV-2 and other viruses associated with the grapevine leafroll disease complex, as well as with other phloem-limited viruses, such as members of the genus *Vitivirus* (family *Betaflexiviridae*) needs to be explored. It is possible that different viruses coinfecting a grapevine may exert either synergistic or antagonistic effects.

Lastly, the origin and evolution biology of GLRaV-2 remain to be investigated. The recent detection of GLRaV-2 in wild and muscadine grapes shed light on the possible origin of the virus in North America. It is our hope that GLRaV-2, like several other grapevine viruses, may serve as excellent model system for evolution biology. The future for GLRaV-2 in particular, and grapevine viruses in general, is shining bright and awaits further exploration!

Acknowledgments We would like to thank all researchers who have made contributions to the different aspects of research on GLRaV-2. Without their continued efforts and excellent contributions, this chapter would not have been possible. The research conducted in the Meng laboratory is funded by the Discovery grant program and the Engage grant program of Natural Science and Engineering Research Council of Canada and the OMAFRA-UoG Strategic Partnerships program.

References

- Abdullahi, I., Y. Gryshan, and M. Rott. 2011. Amplification-free detection of grapevine viruses using an oligonucleotide microarray. *Journal of Virological Methods* 178: 1–15.
- Abou Ghanem-Sabanadzovic, N., and S. Sabanadzovic. 2015. First report of *Grapevine leafroll-associated virus 2* infecting muscadine (*Vitis rotundifolia*) and summer grape (*Vitis aestivalis*) in the United States. *Plant Disease* 99: 1.
- Abou-Ghanem, N., S. Sabanadzovic, A. Minafra, P. Saldarelli, and G.P. Martell. 1998. Some properties of *grapevine leafroll-associated virus 2* and molecular organization of the 3' region of the viral genome. *Journal of Plant Pathology* 80: 37–46.
- Abou Ghanem-Sabanadzovic, N., S. Sabanadzovic, M.A. Castellano, D. Boscia, and G.P. Martelli. 2000. Properties of a new isolate of *grapevine leafroll-associated virus 2*. *Vitis* 39: 119–121.
- Agranovsky, A.A., R. Koenig, E. Maiss, V.P. Boyko, R. Casper, and J.G. Atabekov. 1994. Expression of the *beet yellows closterovirus* capsid protein and p24, a capsid protein homologue, in vitro and in vivo. *Journal of General Virology* 75: 1431–1439.
- Al Rwahnih, M., S. Daubert, D. Golino, and A. Rowhani. 2009. Deep sequencing analysis of RNAs from a grapevine showing Syrah decline symptoms reveals a multiple virus infection that includes a novel virus. *Virology* 387: 395–401.
- Al Rwahnih, M., A. Rowhani, R.J. Smith, J.K. Uyemoto, and M.R. Sudarshana. 2012. Grapevine necrotic union, a newly recognized disease of unknown aetiology in grapevine grafted on 110 Richter rootstock in California. *Journal of Plant Pathology* 94: 149–156.
- Alkowni, R., Y.P. Zhang, A. Rowhani, J.K. Uyemoto, and A. Minafra. 2011. Biological, molecular, and serological studies of a novel strain of *grapevine leafroll-associated virus 2*. *Virus Genes* 43: 102–110.

- Alzhanova, D.V., Y. Hagiwara, V.V. Peremyslov, and V.V. Dolja. 2000. Genetic analysis of the cell-to-cell movement of *beet yellows closterovirus*. *Virology* 268: 192–200.
- Alzhanova, D.V., A. Napuli, R. Creamer, and V.V. Dolja. 2001. Cell-to-cell movement and assembly of a plant closterovirus: Roles for the capsid proteins and Hsp70 homolog. *EMBO Journal* 20: 6997–7007.
- Alzhanova, D.V., A.I. Prokhnevsky, V.V. Peremyslov, and V.V. Dolja. 2007. Virion tails of *Beet yellows virus*: Coordinated assembly by three structural proteins. *Virology* 359: 220–226.
- Angelini, E., N. Bertazzon, and M. Borgo. 2004. Diversity among *grapevine leafroll-associated virus 2* isolates detected by Heteroduplex Mobility Assay. *Journal of Phytopathology* 152: 416–422.
- Beccavin, I., M. Beuve, O. Lemaire, and S. Grenan. 2009. Detection of leafroll GLRaV-1, 2 and 3 on grapevine rootstocks varieties. In *Extended abstracts of the 16th ICVG meeting*, Dijon, 306–307.
- Bertazzon, N., and E. Angelini. 2004. Advances in the detection of *Grapevine leafroll-associated virus 2* variants. *Journal of Plant Pathology* 86: 283–290.
- Bertazzon, N., M. Borgo, and E. Angelini. 2010a. The complete genome sequence of the BD variant of *grapevine leafroll-associated virus 2*. *Archives of Virology* 155: 1717–1719.
- Bertazzon, N., M. Borgo, S. Vanin, and E. Angelini. 2010b. Genetic variability and pathological properties of *Grapevine leafroll-associated virus 2* isolates. *European Journal of Plant Pathology* 127: 185–197.
- Besse, S., C. Balmelli, V. Hofstetter, and P. Gugerli. 2009. Serological and molecular characterisation of *Grapevine leafroll associated virus 2* variants occurring in Switzerland. In *Extended abstracts of the 16th ICVG meeting*, Dijon, 299–301.
- Beuve, M., L. Sempé, and O. Lemaire. 2007. A sensitive one-step real-time RT-PCR method for detecting *Grapevine leafroll-associated virus 2* variants in grapevine. *Journal of Virological Methods* 141: 117–124.
- Beuve, M., B. Moury, A.-S. Spilmont, L. Sempe-Ignatovic, C. Hemmer, and O. Lemaire. 2013. Viral sanitary status of declining grapevine Syrah clones and genetic diversity of *Grapevine Rupestris stem pitting-associated virus*. *European Journal of Plant Pathology* 135: 439–452.
- Bonfiglioli, R., F. Edwards, N. Hoskins, and A. Pantaleo. 2003. Graft incompatibility syndrome in New Zealand Merlot vines involves another possible variant of GLRaV-2. *Australian and New Zealand Grapegrower and Winemaker* 476: 50–54.
- Boscia, D., C. Greif, P. Gugerli, G.P. Martelli, B. Walter, and D. Gonsalves. 1995. Nomenclature of grapevine leafroll-associated putative closteroviruses. *Vitis* 34: 171–175.
- Cabaleiro, C., A.M. Pesqueira, J.R. Pan, and I. Cortez. 2009. Serological detection of *grapevine leafroll associated viruses 1, 2 and 3*. In *Extended abstracts of the 16th ICVG meeting*, Dijon, 302–303.
- Castellano, M.A., N. Abou-Ghanem, G.P. Martelli, D. Boscia, and V. Savino. 1995. Cytopathology of two filamentous grapevine viruses and their intracellular identification by gold immunolabelling. *Journal of Plant Disease Protection* 102: 23–33.
- Castellano, M.A., N. Abou-Ghanem, E. Choueiri, and G.P. Martelli. 2000. Ultrastructure of *Grapevine leafroll-associated virus 2* and 7 infections. *Journal of Plant Pathology* 82: 9–15.
- Chiba, M., J.C. Reed, A.I. Prokhnevsky, E.J. Chapman, M. Mawassi, E.V. Koonin, J.C. Carrington, and V.V. Dolja. 2006. Diverse suppressors of RNA silencing enhance agroinfection by a viral replicon. *Virology* 346: 7–14.
- Coetzee, B., M.J. Freeborough, H.J. Maree, J.M. Celton, D.J. Rees, and J.T. Burger. 2010. Deep sequencing analysis of viruses infecting grapevines: Virome of a vineyard. *Virology* 400: 157–163.
- Constable, F.E., J. Connellan, P. Nicholas, and B.C. Rodon. 2012. Comparison of enzyme-linked immunosorbent assays and reverse transcription polymerase chain reaction for the reliable detection of Australian grapevine viruses in two climates during three growing seasons. *Australian Journal of Grape and Wine Research* 18: 239–244.

- Cronshaw, J., L. Hoefert, and K. Esau. 1966. Ultrastructural features of Beta leaves infected by beet yellows virus. *The Journal of Cell Biology* 31: 429–443.
- Dawson, W.O. 2010. Molecular genetics of *Citrus tristeza virus*. In *Citrus tristeza virus complex and tristeza diseases*, ed. A.V. Karasev and M.E. Hilf, 73–94. St. Paul: The American Phytopathological Society Press.
- Dolja, V.V. 2003. *Beet yellows virus*: The importance of being different. *Molecular Plant Pathology* 4: 91–98.
- Dolja, V.V., and E.V. Koonin. 2011. Common origins and host-dependent diversity of plant animal viromes. *Current Opinion in Virology* 1: 322–331.
- Dolja, V.V., J.F. Kreuzer, and J.P. Valkonen. 2006. Comparative and functional genomics of closteroviruses. *Virus Research* 117: 38–51.
- Durquety, P.M., J. Fallot, C. Ruchaud, J.P. Benassac, and R. Dauty. 1973. Le clone et ses reactions au greffage. I. Existence dans un cépage population de clones présentant divers degrés de compatibilité avec certains porte-greffes. *Le Progrès Agricole et Viticole* 90: 122–129 and 171–178.
- Durquety, P.M., C. Ruchaud, J.P. Gazeau, and J. Fallot. 1977. Le clone et ses réactions au greffage. II. Nouvelles recherches sur l'incompatibilité clonale d'Abouriou greffé sur 5BB. Autres cas chez la vigne. *Le Progrès Agricole et Viticole* 94: 420–427.
- Engel, E.A., P.F. Escobar, L.A. Rojas, P.A. Rivera, N. Fiore, and P.D. Valenzuela. 2010. A diagnostic oligonucleotide microarray for simultaneous detection of grapevine viruses. *Journal of Virological Methods* 163: 445–451.
- Faggioli, F., and S. La Starza. 2006. One-step multiplex RT-PCR for simultaneous detection of eight grapevine viruses and its application in a sanitary selection program. In *Extended abstracts of the 15th ICVG meeting*, Stellenbosch, South Africa, 120–121.
- Faggioli, F., F. Anaclerio, E. Angelini, M.G. Antonelli, N. Bertazzon, G. Bianchi, P. Bianchedi, P.A. Bianco, S. Botti, P. Bragagna, M. Cardoni, P. Casati, R. Credi, E. De Luca, G. Durante, C. Gianinazzi, G. Gambino, V. Gualandri, D. Luison, A. Luvisi, U. Malossini, F. Mannini, P. Saldarelli, F. Terlizzi, E. Triolo, N. Trisciuzzi, and M. Barba. 2012. Validation of diagnostic protocols for the detection of grapevine viruses covered by phytosanitary rules. In *Extended abstracts of the 17th meeting of ICVG*, Davis, California, 260–261.
- Fallot, J., C. Ruchaud, P.M. Durquety, and J.P. Gazeau. 1979. Le clone et ses réactions au greffage. III. La transmission de l'incompatibilité au greffage entre 5BB et *Vitis vinifera*. *Le Progrès Agricole et Viticole* 96: 211–216.
- Fan, X., Y. Dong, Z. Zhang, F. Ren, G. Hu, and J. Zhou. 2015. Detection and sequence analysis of *Grapevine leafroll-associated virus 2* isolates from China. *Journal of Phytopathology* 163: 978–986.
- Fonseca, F., F. Esteves, M. Teixeira Santos, J. Brazao, and J.E. Eiras-Dias. 2016. Genetic variants of Grapevine leafroll-associated virus 2 infecting Portuguese grapevine cultivars. *Phytopathologia Mediterranea* 55: 73–88.
- Fuchs, M., T.E. Martinson, G.M. Loeb, and H.C. Hoch. 2009. Survey for three major leafroll disease-associated viruses in Finger lakes vineyards in New York. *Plant Disease* 93: 395–401.
- Gambino, G., and I. Gribaudo. 2006. Simultaneous detection of nine grapevine viruses by multiplex RT-PCR with coamplification of a plant RNA internal control. *Phytopathology* 96: 1223–1229.
- Gambino, G., E. Angelini, and I. Gribaudo. 2010. Field assessment and diagnostic methods for detection of grapevine viruses. In *Methodologies and results in grapevine research*, ed. S. Del Rot, 211–228. New York: Springer.
- Golino, D.A., S. Sim, and A. Rowhani. 2000. Identification of the latent viruses associated with young vine decline in California. In *Extended abstracts of the 13th meeting of ICVG*, Adelaide, Australia, 85–86.
- Gomez Talquenca, G.S., O. Gracia, S. Garcia Lampasona, and O. Grau. 2003. A young grafted vine decline syndrome in Argentina vineyards. In *Extended abstracts of the 14th meeting of ICVG*, Locorotondo, Italy, 85–86.

- Goszczynski, D.E., G.G.F. Kasdorf, G. Pietersen, and H. Van Tonder. 1996a. Grapevine leafroll-associated virus 2 (GLRaV-2) – Mechanical transmission, purification, production and properties of antisera, detection by ELISA. *South African Journal of Enology and Viticulture* 17: 15–26.
- . 1996b. Detection of two strains of *Grapevine leafroll associated virus 2*. *Vitis* 35: 133–135.
- Greif, C., R. Garau, D. Boscia, V.A. Prota, M. Fiori, P. Bass, B. Walter, and U. Prota. 1995. The relationship of Grapevine leafroll-associated closterovirus 2 with a graft-incompatibility condition of grapevines. *Phytopathologia Mediterranea* 34: 167–173.
- Gugerli, P. 2000. Diagnosis of grapevine diseases: An overview and a practical implementation. In *Extended abstracts of the 13th meeting of ICVG*, Adelaide, Australia, 136–137.
- . 2009. 25 years of serological identification of grapevine leafroll-associated viruses: Antiserum and monoclonal antibodies to GLRaV-1 to GLRaV- 9. In *Extended abstracts of the 16th ICVG meeting*, Dijon, 24–28.
- Gugerli, P., and M.E. Ramel. 1993. *Grapevine leafroll associated virus II* analyzed by monoclonal antibodies. In *Extended abstracts of the 11th meeting of ICVG*, Montreux, Switzerland, 23–24.
- Gugerli, P., J.J. Brugger, and R. Bovey. 1984. L'enroulement de la vigne: mise en évidence de particules virales et développement d'une méthode immuno-enzymatique pour le diagnostic rapide. *Revue Suisse de Viticulture, d'Arboriculture et d'Horticulture* 16: 299–304.
- Hagiwara, Y., V.V. Peremyslov, and V.V. Dolja. 1999. Regulation of closterovirus gene expression examined by insertion of a self-processing reporter and by northern hybridization. *Journal of Virology* 73: 7988–7993.
- He, X.H., A.L.N. Rao, and R. Creamer. 1997. Characterization of *beet yellows closterovirus*-specific RNAs in infected plants and protoplasts. *Phytopathology* 87: 347–352.
- Hilf, M.E., A.V. Karasev, H.R. Pappu, D.J. Gumpf, C.L. Niblett, and S.M. Garnsey. 1995. Characterization of *Citrus tristeza virus* sub-genomic RNAs in infected tissue. *Virology* 208: 576–582.
- Jarugula, S., O.J. Alabi, R.R. Martin, and R.A. Naidu. 2010. Genetic variability of natural populations of *Grapevine leafroll-associated virus 2* in Pacific Northwest vineyards. *Phytopathology* 100: 698–707.
- Jones, T.J., N.A. Rayapati, and M. Nita. 2015. Occurrence of *Grapevine leafroll associated virus-2*, *-3* and *Grapevine fleck virus* in Virginia, U.S.A., and factors affecting virus infected vines. *European Journal of Plant Pathology* 142: 209–222.
- Karasev, A.V. 2000. Genetic diversity and evolution of closteroviruses. *Annual Review of Phytopathology* 38: 293–324.
- Klaassen, V.A., S.T. Sim, G.S. Dangl, F. Osman, M. Al Rwahnih, A. Rowhani, and D.A. Golino. 2011. *Vitis californica* and *Vitis californica* x *Vitis vinifera* hybrids are host for *Grapevine leafroll-associated virus 2* and *-3* and *Grapevine virus A* and *B*. *Plant Disease* 65: 57–665.
- Klaassen, V., D. Golino, and A. Rowhani. 2012. Diagnostic performance of Foundation Plant Service Assays. In *Extended abstracts of the 17th meeting of ICVG*, Davis, California, 124–125.
- Kurth, E.G., V.V. Peremyslov, A.I. Prokhnevsky, K.D. Kasschau, M. Miller, J.C. Carrington, and V.V. Dolja. 2012. Virus-derived gene expression and RNA interference vector for grapevine. *Journal of Virology* 86: 6002–6009.
- Lanza Volpe, M., O. Gracia, and S. Gómez Talquenca. 2009. RFLP analysis of RT-PCR products to evaluate the genetic variability of CP ORF in GLRaV-2 isolates. In *Extended abstracts of the 16th ICVG meeting*, Dijon, 314–315.
- Lanza Volpe, M., S. Moyano, D. Lijavetzky, and S. Gomez Talquenca. 2015. Partial molecular and biological characterization of *Grapevine leafroll-associated virus 2* isolates from Argentina. *Journal of Plant Pathology* 97: 349–355.
- Legin, R., and B. Walter. 1986. Etude de phénomènes d'incompatibilité au greffage chez la vigne. *Le Progrès Agricole et Viticole* 103: 279–283.
- Lehad, A., I. Selmi, M. Louanchi, M. Aitouada, and N. Mahfoudhi. 2015. Survey and genetic diversity of *Grapevine leafroll associated virus-2* in Algeria. *International Journal of Phytoremediation* 4: 35–42.

- Ling, K.S., H.Y. Zhu, N. Petrovic, and D. Gonsalves. 2007. Serological detection of *Grapevine leafroll virus 2* using an antiserum developed against the recombinant coat protein. *Journal of Phytopathology* 155: 65–69.
- Liu, Y.P., V.V. Peremyslov, V. Medina, and V.V. Dolja. 2009. Tandem leader proteases of *Grapevine leafroll-associated virus 2*: Host-specific functions in the infection cycle. *Virology* 383: 291–299.
- Martelli, G.P. 2014. Directory of virus and virus-like diseases of the grapevine and their agents. *Journal of Plant Pathology* 96 (suppl. 1): 1–136.
- . 2015. Grapevine virology: A historical account with an eye to the studies of the last 60 years or so. In *Extended abstracts of the 18th meeting of ICVG*, Ankara, Turkey, 16–22.
- Martelli, G.P., N. Abou Ghanem-Sabanadzovic, A.A. Agranovsky, M. Al Rwahnih, V.V. Dolja, C.I. Dovas, M. Fuchs, P. Gugerli, J.S. Hu, W. Jelkmann, N.I. Katis, V.I. Maliogka, M.J. Melzer, W. Menzel, A. Minafra, M.E. Rott, A. Rowhani, S. Sabanadzovic, and P. Saldarelli. 2012a. Taxonomic revision of the family *Closteroviridae* with special reference to the grapevine leafroll-associated members of the genus *Ampelovirus* and the putative species unassigned to the family. *Journal of Plant Pathology* 94: 7–19.
- Martelli, G.P., A.A. Agranovsky, M. Bar-Joseph, D. Boscia, T. Candresse, R.H.A. Coutts, V.V. Dolja, J.S. Hu, W. Jelkmann, A.V. Karasev, R.R. Martin, A. Minafra, S. Namba, and H.J. Vetten. 2012b. Family *Closteroviridae*. In *Virus taxonomy: 9th report of the international committee on taxonomy of viruses*, ed. A. King, M.J. Adams, E.B. Carstens, and E. Lefkowitz, 987–1001. San Diego: Elsevier-Academic Press.
- Meng, B., C. Li, D.E. Goszczynski, and D. Gonsalves. 2005. Genome sequences and structures of two biologically distinct strains of *Grapevine leafroll-associated virus 2* and sequence analysis. *Virus Genes* 31: 31–41.
- Monette, P.L., and S.E. Godkin. 1993. Mechanical transmission of closterovirus-like particles from a corky bark affected grapevine to a herbaceous species. *Plant Pathology (Trends in Agriculture Science)* 1: 7–12.
- Monis, J. 2012. Comparative study of Taqman® and RT-PCR combined with ELISA for the detection of grapevine viruses. In *Extended abstracts of the 17th meeting of ICVG*, Davis, California, 126.
- Monis, J., and R.K. Bestwick. 1997. Serological detection of grapevine associated closteroviruses in infected grapevine cultivars. *Plant Disease* 81: 802–808.
- Moreno, P., S. Ambros, M.R. Albiach-Marti, J. Guerri, and L. Pena. 2008. Citrus tristeza virus: A pathogen that changed the course of the citrus industry. *Molecular Plant Pathology* 9: 251–268.
- Namba, S., D. Boscia, O. Azzam, M. Maixner, J.S. Hu, J.S. Golino, and D. Gonsalves. 1991. Purification and properties of closteroviruslike particles associated with grapevine corky bark disease. *Phytopathology* 81: 964–970.
- Napuli, A.J., D.V. Alzhanova, C.E. Doneanu, D.F. Barofsky, E.V. Koonin, and V.V. Dolja. 2003. The 64-kDa capsid protein homolog of *beet yellows virus* is required for assembly of virion tails. *Journal of Virology* 77: 2377–2384.
- Osman, F., C. Leutenegger, D. Golino, and A. Rowhani. 2007. Real-time RT-PCR (TaqMan (R)) assays for the detection of *Grapevine Leafroll associated viruses 1-5* and 9. *Journal of Virological Methods* 141: 22–29.
- . 2008. Comparison of low-density arrays, RT-PCR and real-time TaqMan(R) RT-PCR in detection of grapevine viruses. *Journal of Virological Methods* 149: 292–299.
- Peng, C.W., and V.V. Dolja. 2000. Leader proteinase of the *beet yellows closterovirus*: Mutation analysis of the function in genome amplification. *Journal of Virology* 74: 9766–9770.
- Peremyslov, V.V., and V.V. Dolja. 2002. Identification of the subgenomic mRNAs that encode 6-kDa movement protein and HSP70 homologue of *Beet yellows virus*. *Virology* 295: 299–306.
- Peremyslov, V.V., Y. Hagiwara, and V.V. Dolja. 1998. Genes required for replication of the 15.5-kilobase RNA genome of a plant closterovirus. *Journal of Virology* 72: 5870–5876.
- . 1999. HSP70 homolog functions in cell-to-cell movement of a plant virus. *Proceedings of the National Academy of Sciences of the United States of America* 96: 14771–14776.

- Peremyslov, V.V., I.A. Andreev, A.I. Prokhnevsky, G.H. Duncan, M.E. Taliansky, and V.V. Dolja. 2004a. Complex molecular architecture of *beet yellows virus* particles. *Proceedings of the National Academy of Sciences of the United States of America* 101: 5030–5035.
- Peremyslov, V.V., Y.W. Pan, and V.V. Dolja. 2004b. Movement protein of a closterovirus is a type III integral transmembrane protein localized to the endoplasmic reticulum. *Journal of Virology* 78: 3704–3709.
- Poojari, S., O.J. Alabi, and R.A. Naidu. 2013. Molecular characterization and impacts of a strain of *Grapevine leafroll-associated virus 2* causing asymptomatic infection in a wine grape cultivar. *Virology Journal* 10: 324. doi:10.1186/1743-422X-10-324.
- Prodan, S., J. Montalegre, and N. Fiore. 2003. Aetiology of decline in Thompson seedless grafted table grape plants. In *Extended abstracts of the 14th meeting of ICVG*, Locorotondo, Italy, 142–143.
- Prokhnevsky, A.I., V.V. Peremyslov, A.J. Napuli, and V.V. Dolja. 2002. Interaction between long-distance transport factor and Hsp70-related movement protein of *beet yellows virus*. *Journal of Virology* 76: 11003–11011.
- Radaelli, P., T.V.M. Fajardo, O. Nickel, M. Eiras, and G. Pio-Ribeiro. 2008. Production of polyclonal antisera using recombinant coat proteins of *Grapevine leafroll-associated virus 2* and *Grapevine virus B*. *Pesquisa Agropecuária Brasileira* 43: 1405–1411.
- Reed, J.C., K.D. Kasschau, A.I. Prokhnevsky, K. Gopinath, G.P. Pogue, J.C. Carrington, and V.V. Dolja. 2003. Suppressor of RNA silencing encoded by *beet yellows virus*. *Virology* 306: 203–209.
- Renault Spilmont, A.S., S. Grenan, and J.M. Boursiquot. 2003. Syrah decline in French vineyards. In *Extended abstracts of the 14th meeting of ICVG*, Locorotondo, Italy, 144.
- Rosciglione, B., and P. Gugerli. 1986. Maladies de l'enroulement et du bois strié de la vigne: analyse microscopique et sérologique. *Revue Suisse de Viticulture, d'Arboriculture et d'Horticulture* 18: 207–211.
- Rowhani, A., Y.P. Zhang, D.A. Golino, and J.K. Uyemoto. 2000. Isolation and partial characterization of two new viruses from grapevine. In *Extended abstracts of the 13th meeting of ICVG*, Adelaide, 82.
- Savino, V., B. Di Terlizzi, S. Riviaccio, and F. Di Silvio. 1991. Presence in clonal rootstocks of a graft-transmissible factor that induces stunting and bushy growth in European grapevines. In *Extended abstracts of the 10th meeting of ICVG*, Volos, Greece, 202–210.
- Seguin, J., R. Rajeswaran, N. Malpica-López, R.R. Martin, K. Kasschau, V.V. Dolja, P. Otten, L. Farinelli, and M.M. Pooggin. 2014. *De novo* reconstruction of consensus master genomes of plant RNA and DNA viruses from siRNAs. *PLoS One* 9: e88515.
- Sharma, A.M., J. Wang, S. Duffy, S. Zhang, M.K. Wong, A. Rashed, M.L. Cooper, K.M. Daane, and R.P.P. Almeida. 2011. Occurrence of grapevine leafroll-associated virus complex in Napa Valley. *PLoS ONE* 6: e26227.
- Thompson, J.R., M. Fuchs, K.F. Fischer, and K.L. Perry. 2012. Macroarray detection of grapevine leafroll-associated viruses. *Journal of Virological Methods* 183: 161–169.
- Thompson, J.R., M. Fuchs, H. McLane, F. Celebi-Toprak, K.F. Fischer, J.L. Potter, and K.L. Perry. 2014. Profiling viral infections in grapevine using a randomly primed reverse transcription-polymerase chain reaction/macroarray multiplex platform. *Phytopathology* 104: 211–219.
- Uyemoto, J.K., and A. Rowhani. 2003. Discovery of different grapevine sources with graft-transmissible agents causing union incompatibility on sensitive rootstocks. In *Extended abstracts of the 14th meeting of ICVG*, Locorotondo, Italy, 139–140.
- Uyemoto, J.K., A. Rowhani, D. Luvisi, and R. Krag. 2001. New closterovirus in 'Redglobe' grape causes decline of grafted plants. *California Agriculture* 55: 28–31.
- van den Born, E., M.V. Omelchenko, A. Bekkelund, V. Leihne, E.V. Koonin, V.V. Dolja, and P.O. Farnes. 2008. Viral AlkB proteins repair RNA damage by oxidative demethylation. *Nucleic Acids Research* 36: 5451–5461.

- Xu, Z.Y., N. Hong, B. Xing, and G.P. Wang. 2006. Partial molecular characterization of a Chinese isolate of *Grapevine leafroll-associated virus 2* and production of antisera to recombinant viral proteins. *Journal of Plant Pathology* 88: 89–94.
- Zhou, Z., N. Abou-Ghanem, D. Boscia, O. Potere, D.E. Goszczynski, and M.A. Castellano. 2000. Monoclonal antibodies for detection and characterization of *grapevine leafroll associated virus 2*. In *Extended abstracts of the 13th meeting of ICVG*, Adelaide, Australia, 130.
- Zhu, H.Y., N. Petrovic, K.S. Ling, and D. Gonsalves. 1997. Production and application of an antibody to the *grapevine leafroll associated closterovirus 2* coat protein expressed in *Escherichia coli*. In *Extended abstracts of the 12th meeting of ICVG*, Lisbon, Portugal, 97.
- Zhu, H.Y., K.S. Ling, D.E. Goszczynski, J.R. McFerson, and D. Gonsalves. 1998. Nucleotide sequence and genome organization of *grapevine leafroll-associated virus 2* are similar to *Beet yellows virus*, the closterovirus type member. *Journal of General Virology* 79: 1289–1298.
- Zimmermann, D., P. Bass, R. Legin, and B. Walter. 1990. Characterization and serological detection of four closterovirus-like particles associated with leafroll disease on grapevine. *Journal of Phytopathology* 130: 205–218.

Chapter 8

Grapevine leafroll-associated virus 3

J.T. Burger, H.J. Maree, P. Gouveia, and R.A. Naidu

Abstract Grapevine leafroll disease (GLD) is arguably the most important virus disease of grapevine, economically on par with the foremost fungal and bacterial maladies of grapevine. This chapter reviews recent progress in research on *Grapevine leafroll-associated virus 3* (GLRaV-3), the generally accepted “main etiological agent” of GLD. The molecular characterization of the ~18,500 nt ssRNA GLRaV-3 genome and annotation of its 12 open reading frames have largely been completed, albeit functional confirmation for most ORFs is still eluding researchers. The development of infectious GLRaV-3 clones should progress this aspect significantly. The advent of next-generation sequencing (NGS) technologies allowed considerable progress in identifying the multitude of GLRaV-3 genetic variants and, through the use of metagenomic approaches, firmly established GLRaV-3 as the primary viral agent associated with GLD. The various levels of host-pathogen interactions, including the potential role of small RNAs in this complex plant-virus interaction, are receiving increasing attention with a number of studies now attempting to link biological characteristics of the virus and physiological impacts on its grapevine host. As with most virus diseases, aspects of control are focused on accurate and reliable detection and prevention of disease. Developments in GLRaV-3 detection,

J.T. Burger (✉)

Department of Genetics, Stellenbosch University, Stellenbosch, South Africa
e-mail: jtb@sun.ac.za

H.J. Maree

Department of Genetics, Stellenbosch University, Stellenbosch, South Africa

Agricultural Research Council, Infruitec-Nietvoorbij: Institute for Deciduous Fruit, Vines and Wine, Stellenbosch, South Africa

P. Gouveia

MeditBio, Faculdade de Ciências e Tecnologia, Universidade do Algarve, Campus de Gambelas, 8005-139 Faro, Portugal

Genomics of Plant Stress Unit, Instituto de Tecnologia Química e Biológica António Xavier, Universidade Nova de Lisboa and Instituto de Biologia Experimental e Tecnológica, Av. Da República, 2780-157 Oeiras, Portugal

R.A. Naidu

Department of Plant Pathology, Irrigated Agriculture Research and Extension Center, Washington State University, Prosser, WA 99350, USA

especially quantitative detection of the different variant groups, as well as NGS-based metagenomic approaches, are discussed. Disease eradication and management are illustrated with descriptions of a few case studies.

Keywords GLRaV-3 • Grapevine leafroll disease • GLD • *Ampelovirus* • Virus-host interaction

Introduction

While attempts to prioritize plant viruses by “importance” (Scholthof et al. 2011) will always be contentious (Rybicki 2015) and while opinions about the most important virus of woody fruit crops may be divided among *Plum pox virus*, *Citrus tristeza virus*, and *Grapevine leafroll-associated virus 3* (GLRaV-3), few researchers will argue against the latter being the most important virus pathogen of grapevine (Maree et al. 2013). Although the etiology of grapevine leafroll disease (GLD) has not been fully resolved, GLRaV-3 (genus *Ampelovirus*, family *Closteroviridae*) is universally considered as the “main etiological agent” contributing to this debilitating disease of wine, juice, table grape, and rootstock cultivars.

This chapter presents little information on classical aspects but concentrates on the more recent research developments of this globally important grapevine pathogen. The taxonomy of GLRaV-3 variants in the context of closteroviruses, its host range, transmission, symptomology, economic impact, and control strategies is presented. The various levels of host-pathogen interactions, including the potential role of small RNAs in this complex plant-virus interaction, are discussed. Special attention is given to recent advances in the molecular characterization of GLRaV-3; these include the complex virus genome organization; proposed functions of the 12 ORFs, which are still mostly based on the comparative sequence annotation; the expression strategies of the encoded proteins; and the different genome replication strategies employed by this virus. “New” genetic variants of GLRaV-3 are being found regularly, especially through the use of high-throughput sequencing; thus, an update on the genetic variability and phylogenetic relationships among GLRaV-3 isolates is provided. The chapter includes a discussion of diagnostic assays for the detection of the virus, with special emphasis on the latest PCR-based applications, as well as the use of next-generation sequencing (NGS) and the associated bioinformatic tools to understand the complex metagenomic nature of virus infections in grapevine cultivars.

Historical Perspectives

Grapevine (*Vitis* spp.) is arguably the most widely grown fruit crop globally. The history of cultivation of this deciduous woody perennial dates back approximately 8000 years ago in the Near East (This et al. 2006). To date, about 70 different viruses

from nearly 30 virus genera have been reported to infect grapevine (Martelli 2014 and Chap. 2, this volume). Grapevine leafroll disease is one of the major diseases of grapevine, comparable with many fungal and bacterial diseases (Rayapati et al. 2008), and possibly the most important virus disease from an economical perspective and with many intrigues from a scientific point of view (Naidu et al. 2014, 2015). The disease probably originated in the “Old World” and attained its current global geographical distribution through commercial trading of infected propagation material. The first reports of GLD in Europe, in the mid-nineteenth century (Martelli 2000), were followed by similar observations from a number of other countries (Goheen et al. 1958; Hewitt et al. 1962; Hoefert and Gifford 1967). In 1935, the infectious nature of the disease was demonstrated when GLD was shown to be graft-transmissible (Scheu 1935). The viral nature of the etiological agent was discovered when the presence of flexuous, filamentous virions was first demonstrated in GLD-affected vines by electron microscopy (Namba et al. 1979). This observation was subsequently confirmed by ultrastructure studies of GLD-affected leaf tissues (Faoro 1997; Castellano et al. 2000). Gugerli et al. (1984) identified two serologically unrelated *Closterovirus*-like viruses with different particle lengths in purified preparations from symptomatic grapevine leaves – these were denoted grapevine leafroll-associated viruses 1 and 2 (GLRaV-1 and GLRaV-2), respectively. A revision of the nomenclature of viruses associated with GLD (Boscia et al. 1995) led to the recognition of GLRaV-3, the third serologically unrelated *Closterovirus*-like species, as a distinct member of this group. A biological vector was discovered when the pseudococcid mealybug, *Planococcus ficus*, was demonstrated to transmit GLRaV-3 (Rosciglione and Gugerli 1989; Tanne et al. 1989). Subsequent studies in all grapevine-growing regions of the world, using modern molecular technologies and especially nucleotide sequencing, have resulted in the steadily increased number of GLD-associated closteroviruses to more than ten (Martelli et al. 2002). Another major revision of these viruses in 2012 led to their consolidation to five distinct species, with several GLRaVs now recognized as strains of GLRaV-4 (Martelli et al. 2012). GLRaV-3, however, remains the untested primary agent associated with GLD and the type member of the genus *Ampelovirus*.

Taxonomy and Nomenclature

Grapevine leafroll-associated viruses (GLRaVs) identified thus far belong to the family *Closteroviridae* (Martelli 2012). This family belongs to the *Alphavirus*-like superfamily of the positive strand RNA viruses and possesses the largest genomes among all known plant viruses (Dolja et al. 2006). The family *Closteroviridae* contains four genera, defined on the basis of phylogenetic analysis, genome organization, and the type of insect vectors, designated as *Ampelovirus*, *Closterovirus*, *Crinivirus*, and *Velarivirus* (Martelli et al. 2012; Adams et al. 2014). The virions of GLRaVs are long filamentous, flexuous particles ranging between 1400 and

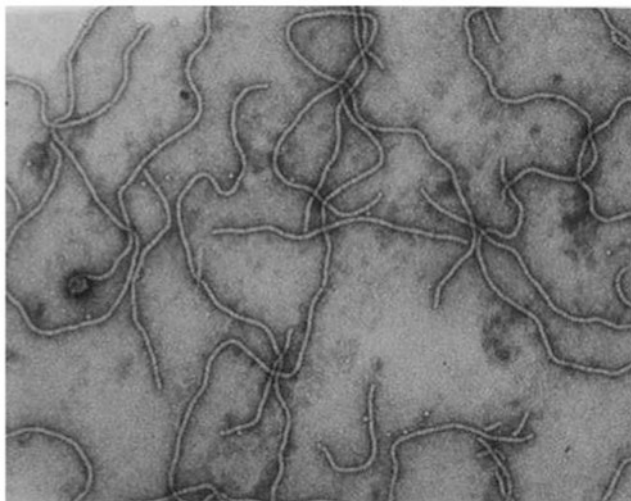

Fig. 8.1 Transmission electron micrograph of purified GLRaV-3 particles, negatively stained with uranyl acetate (Picture credit: G.G.F. Kasdorf)

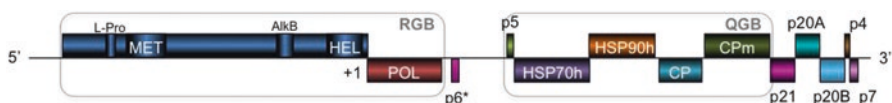

Fig. 8.2 Schematic representation (to scale) of the genome structure of *Grapevine leafroll-associated virus 3* (GLRaV-3, EU259806). Conserved structures such as the “replication gene block” (RGB) and “quintuple gene block” (QGB) are shown by dotted line boxes. The conserved domains AlkB, papain-like leader protease (*L-Pro*), methyltransferase (*MET*), and helicase (*HEL*) within the RGB are labeled

2200 nm and between 10 and 12 nm in diameter (Fig. 8.1). The monopartite, linear, positive-stranded RNA genomes of these viruses are variable in size, ranging between 13.4 and 18.6 kb (Naidu et al. 2015). Currently, five serologically distinct GLRaV species have been characterized from leafroll-infected grapevines, namely, GLRaV-1, GLRaV-2, GLRaV-3, GLRaV-4, and GLRaV-7, with GLRaV-5, GLRaV-6, GLRaV-9, GLRaV-De, GLRaV-Pr, and GLRaV-Car designated as strains of GLRaV-4 (Abou Ghanem-Sabanadzovic et al. 2012; Thompson et al. 2012a; Martelli et al. 2012).

The genus *Ampelovirus* is divided into two subgroups with GLRaV-1 and GLRaV-3 belonging to subgroup I, which comprises four species with a large (ca. 15–18 kb) and complex 9–12 open reading frame (ORF) genome, and GLRaV-4 and its related strains to subgroup II, which comprises four species with a smaller (13–14 kb) and relatively simpler (6 ORFs) genome (Fig. 8.2). GLRaV-2 belongs to the genus *Closterovirus* and GLRaV-7 to the genus *Velarivirus* (Al Rwahnih et al. 2012; Martelli et al. 2012). The virus previously designated as GLRaV-8 was found to be a *Vitis* genomic sequence and as such does not exist (Bertsch et al. 2009).

On a worldwide basis, GLRaV-3 remains the most prevalent, as well as the most economically destructive among the currently known GLRaVs (Maree et al. 2013). GLRaV-3 is the type member of the genus *Ampelovirus* and has the second largest genome of any plant virus characterized at present (18,433–18,671 nts) after *Citrus tristeza virus* (19,296 nt) (Fei et al. 2013; Maree et al. 2008). Different molecular variant groups of GLRaV-3 have been identified, but their individual contribution to leafroll disease is unknown. Studying the different GLRaV-3 variants at the molecular level can assist with elucidating leafroll disease etiology. At present, there are eight recognized GLRaV-3 phylogenetic groups (Maree et al. 2015).

Genome Structure, Genome Expression, and Replication

The first complete genome sequence of GLRaV-3 was determined for a South African isolate (GP18) and found to be 18,498 nucleotides in length (Maree et al. 2008). Genome sequence analyses of additional GLRaV-3 isolates revealed that their genome sizes vary between 18,433 and 18,671 nt. All the GLRaV-3 genomes possess long 5'UTRs that range from 510 to 802 nts. Conversely, the 3'UTR is similar in size of 259–277 nt among all isolates. Thus, GLRaV-3 appears to have an unusually long 5'UTR for members of the family *Closteroviridae* with a very high uracil content (48.5 %) (Maree et al. 2008).

Currently, the complete genome sequences of 11 distinct GLRaV-3 isolates representing five major groups of genetic variants are available (Maree et al. 2015). Despite variable sizes, the genome organization of GLRaV-3 is largely similar as shown in Fig. 8.2. Isolates from groups I–III have 12 open reading frames (ORFs) designated as 1a, 1b, and 2–12 according to the convention set out by Agranovsky et al. (1994). In contrast, the genomes of variants in groups VI and VII seem to lack ORF2 (Bester et al. 2012a; Seah et al. 2012; Maree et al. 2015). The observed large, GC-rich intergenic region is found in all variants of GLRaV-3 between ORFs 2 and 3 that is atypical of members of the family *Closteroviridae*. Isolates from groups IV and V have yet to be fully sequenced.

Limited functional studies have been conducted on the proteins encoded by GLRaV-3 ORFs 1–7. Their functions have been putatively assigned by comparison to the homologous ORFs in the genomes of other closteroviruses. GLRaV-3, like other monopartite closteroviruses, has a set of replication-associated genes toward the 5' terminus of the genome, with genes that encode structural and accessory proteins located toward the 3' terminus (Dolja et al. 2006). GLRaV-3 ORFs 1a and 1b encode the replication-associated proteins that form the replication gene block (RGB). The RGB includes the capping enzyme methyltransferase, superfamily 1 RNA helicase, and RNA-dependent RNA polymerase domains (Ling et al. 2004; Koonin and Dolja 1993; Dolja et al. 2006). In addition, ORF1a of GLRaV-3 contains a papain-like leader protease (L-Pro) (Ling et al. 2004) that is implicated in RNA accumulation, virus invasiveness, and systemic spread, as was demonstrated for BYV (Peng and Dolja 2000; Peng et al. 2003) and GLRaV-2 (Liu et al. 2009).

Curiously, GLRaV-3 ORF1a also harbors an AlkB domain (Maree et al. 2008), which is present in many RNA viruses infecting woody plants and is capable of RNA demethylation and proposed to repair methylated viral RNA (Van den Born et al. 2008).

No homologs have been detected for the small protein potentially encoded by ORF2. The expression of this ORF is however uncertain since it is absent in isolates from variant groups VI and VII and therefore unlikely to have an essential or conserved function (Bester et al. 2012a; Seah et al. 2012; Maree et al. 2015). The following five ORFs (ORFs 3–7) collectively form the quintuple gene block (QGB) that is conserved in members of the family *Closteroviridae* (Dolja et al. 2006).

The ORF3-encoded small transmembrane protein's analogous protein from BYV has been demonstrated to be a cell-to-cell movement protein targeting the endoplasmic reticulum (Peremyslov et al. 2004a).

ORF4 encodes a cellular HSP70 molecular chaperone homolog (HSP70h) that was shown for several other closteroviruses to facilitate cell-to-cell movement (Peremyslov et al. 1999) and a component of the virion head (previously referred to as the tail) assembly typical of closteroviruses (Tian et al. 1999; Satyanarayana et al. 2000; Alzhanova et al. 2001; Peremyslov et al. 2004b). The ~60 kDa protein encoded by ORF5 probably functions similarly to the HSP70h, and these two proteins likely cooperate in virion head assembly and cell-to-cell movement (Alzhanova et al. 2007).

The coat protein (CP) is encoded by ORF6 and forms the long virion body, and is also a requirement for cell-to-cell movement (Alzhanova et al. 2000). The minor capsid protein (CPm) is the last protein in the QGB and is the main component of the virion head (Agranovsky et al. 1995; Satyanarayana et al. 2004). It is interesting to note that the order of the CP- and the CPm-encoding ORFs in GLRaV-3 is reversed compared to viruses in the genus *Closterovirus* but is similar to the bipartite criniviruses (Karasev 2000). Although these proteins have not been completely characterized for GLRaV-3, it is clear that the functions of the HSP70h, ~60 kDa protein, and CPm in the virion head assembly and cell-to-cell movement of closteroviruses are genetically inseparable, and that the head assembly can be hypothesized as a *Closterovirus*-specific movement device (Dolja 2003; Peremyslov et al. 2004b).

The remaining ORFs 8–12 of GLRaV-3 are genetically unique to the genus *Ampelovirus* (Ling et al. 1998), but their function can possibly be deduced by observing similarly located ORFs of other members of the family *Closteroviridae*. ORFs 8-, 9-, and 10-encoded proteins can potentially be involved in the suppression of the host RNA interference defense response (Reed et al. 2003; Lu et al. 2004; Chiba et al. 2006) and long-distance viral transport (Prokhnevsky et al. 2002). Studies by Gouveia and Nolasco (2012) and Gouveia et al. (2012) have shown suppressor activity for the ORF10 product p19.7 (p20B) in *Nicotiana benthamiana*. ORFs 11 and 12 encode small proteins that are unique to GLRaV-3 and very diverse among the variant groups, which make them unlikely to have conserved functions.

The functional characterization of the GLRaV-3 ORFs and domains is a major challenge for future research and relies on the development of a biologically active, full-length cDNA clone.

The RGB proteins of GLRaV-3 are translated directly from the capped genomic RNA, while the RdRp (ORF1b) is translated via +1 frameshift (Agranovsky et al. 1994; Ling et al. 2004). A papain-like leader protease then processes the ORF1a and ORF1a+b polyproteins. This processing was shown to be critical for the RNA replication in BYV and GLRaV-2 (Peng and Dolja 2000; Liu et al. 2009).

Similar to other characterized members of the family *Closteroviridae*, the ORFs localized downstream of ORF1b are most likely expressed via formation of 3'-coterminal sgRNAs (Jarugula et al. 2010; Maree et al. 2010). These sgRNAs can serve as monocistronic messenger RNAs for the translation of the corresponding 5'-proximal ORF. The production of multiple sgRNAs in GLRaV-3 infected material has been reported in early studies (Hu et al. 1990; Rezaian et al. 1991; Saldarelli et al. 1994; Ling et al. 1997), but its significance in virus replication was not identified. In two later studies, sgRNAs of two different isolates were characterized in more detail (Jarugula et al. 2010; Maree et al. 2010). Northern blot analysis demonstrated the 3'-coterminal structure of three sgRNAs believed to be associated with the expression of ORFs 4, 5, and 6 (Maree et al. 2010). The study by Jarugula et al. (2010), using Northern blot analysis, found that sgRNAs associated with the expression of ORF6 (CP), ORF8 (p21), ORF9 (p20A), and ORF10 (p20B) are the most abundant viral RNAs present in a GLRaV-3-infected grapevine (*V. vinifera* cv. Merlot). They also found that sgRNA corresponding to ORF10 (p20B) accumulated to the highest level, followed by sgRNAs encoding products of the ORF8 (p21), ORF9 (p20A), and ORF6 (CP). Their results would suggest that temporal and quantitative regulation of GLRaV-3 sgRNA transcription occurs during the virus infection cycle, leading to differential expression and/or accumulation of sgRNAs in a distinct regulation pattern. The 5'-transcriptional start sites (TSS) for several GLRaV-3 sgRNAs were determined for isolates GP18 (group II) and WA-MR (group I) that belong to two different genetic variant groups (Maree et al. 2010; Jarugula et al. 2010). Two different RACE techniques were used in these studies, RLM-RACE and 5'RACE. However, identical TSSs were identified for all the sgRNAs with the exception of the ORF9 sgRNA for which the TSS differed by one nucleotide. Although attempts were made by both studies to identify conserved sequences or elements in the 5'UTRs of the different sgRNAs, none were detected (Jarugula et al. 2010; Maree et al. 2010). The length of the sgRNA 5'UTR does not seem to influence their accumulation levels, suggesting that transcriptional regulation of the genus *Ampelovirus* is likely distinct from that of the genus *Closterovirus* (Jarugula et al. 2010).

Genetic Diversity and Population Structure

The genetic variability of GLRaV-3 has been the focus of several studies in recent years and all confirmed the existence of several genetic variants. Earlier studies to determine genetic variation in surveyed GLRaV-3-infected material targeted smaller genome segments and used single-stranded conformation polymorphisms (SSCPs)

combined with sequence analysis (Jooste and Goszczynski 2005; Turturo et al. 2005). Later studies used a metagenomic NGS approach followed by Sanger sequencing to generate full genomes of genetic variants (Bester et al. 2012b; Maree et al. 2015).

Turturo et al. (2005) targeted three genomic regions (RdRp, HSP70h, and CP genes) to investigate the genetic variability of 45 GLRaV-3 isolates from 14 different countries. Their combined results indicated that mixed variant infections occurred in 10–15 % of the cases. Using SSCP analysis, Jooste and Goszczynski (2005) classified two divergent GLRaV-3 variant groups (groups I and II) from South African isolates.

Sequence comparisons between isolates using different genome regions confirmed the genetic variation shown by earlier studies and indicated a greater diversity than originally estimated. Five genetic variant groups could be identified through phylogenetic analysis of the HSP70h gene (Fuchs et al. 2009). The five groups were confirmed by subsequent studies using similar phylogenetic analyses on various genome regions, predominantly the CP but also HSP70h, CPm, p55, p20B, and RdRp (Gouveia and Nolasco 2012). Isolates that are more diverse and distantly related to variant groups I–V have more recently been identified, which warranted the formation of groups VI and VII (Chooi et al. 2009, 2013a; Gouveia et al. 2011; Sharma et al. 2011; Wang et al. 2011; Bester et al. 2012a; Chooi et al. 2013a; Seah et al. 2012). Due to limited sequence information available for the more distantly related isolates, these groups remained tentative. In the study by Maree et al. (2015), an attempt was made to reorganize the genetic variant groups using all the sequence information available on Genbank. Eight monophyletic variant groups could be identified, three of which did not have a whole genome isolate associated with the group. The phylogenetic distance between groups was also used to classify supergroups. Supergroup A includes variant groups I–V while supergroups B–D include variant groups VI, VII, and VIII respectively (Fig. 8.3).

Full-length genome comparisons of isolates from different variant groups show variable sequence homology across the genome – this highlights the risk of phylogenetic analysis using partial genome sequences. The biological relevance of the current genetic variant group classifications remains to be elucidated.

The distribution of specific GLRaV-3 variant groups in vineyards has been studied by several groups. The factors that can influence the spatial distribution include specific virus-vector interactions, prevailing wind direction, combinations of GLRaV-3 variants, use of virus-infected planting material, and viticultural practices. In a recent South African survey, groups I, II, III, VI, and VII variants were found in vineyards surveyed over two seasons, with groups II and VI occurring predominantly, and often in combination (Jooste et al. 2015). In a Chinese survey, group I genetic variants were found to be predominant (Farooq et al. 2012), while in Portugal groups I and II were the most common (Gouveia et al. 2009). In a study of vineyards in New Zealand, variant groups I and VII were mostly detected in germplasm and commercial vineyards, while variant group VI was only found in significant numbers in the germplasm block (Chooi et al. 2013b). In a study of Napa Valley vineyards (Sharma et al. 2011), 27% of the GLRaV-3 isolates characterized

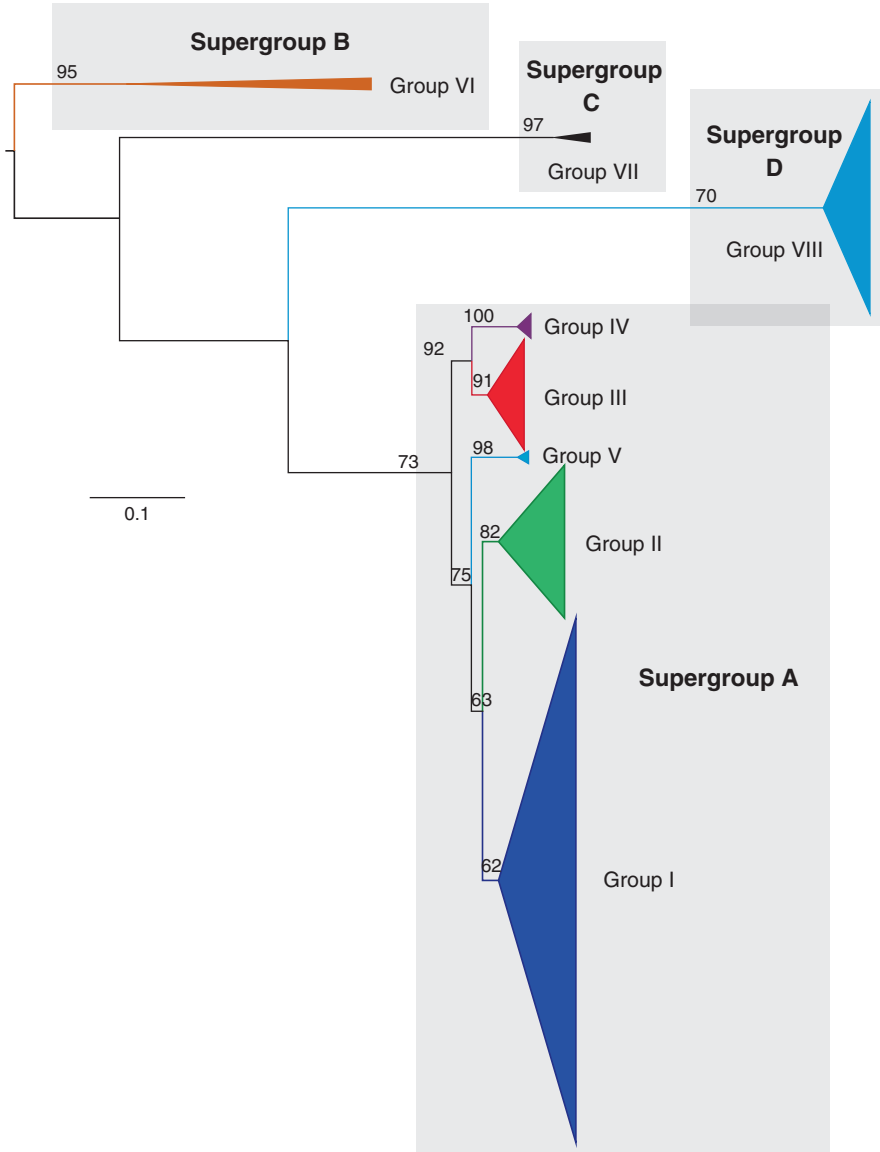

Fig. 8.3 Cartoon of a rooted phylogenetic tree of GLRaV-3 isolates with outgroups removed for ease of presentation. The *scale* indicates branch lengths in substitutions per site and the values at nodes ML bootstrap support (Groups and supergroups proposed by Maree et al. 2015 are indicated)

were of variant group I while 13% and 31% were of variant groups II and III, respectively. This study reported that mixed variant infections occurred in 21% of samples and that single variant infections with groups I and III were the most prevalent (Sharma et al. 2011).

Currently, it would seem that the prevalence of specific GLRaV-3 genetic variants differs from region to region with no discernible pattern. The risk in variability studies is always the potential bias that the detection assay used might introduce. The future of population studies will therefore focus on using unbiased approaches such as NGS to determine population diversity.

Detection and Diagnosis

At present, there are no curative measures available to control leafroll disease, once the disease is established in the vineyard. Since no natural resistance to GLRaVs has been identified in *V. vinifera*, the management of viral diseases relies on preventive cultural practices and the use of certified virus-free propagation material (Laimer et al. 2009). GLRaV-3 is included in the grapevine certification schemes of most wine-producing countries, underlining its economical importance and hence the availability of accurate and reliable detection methods. Currently these schemes are largely based on biological indexing, serological procedures (ELISA) and, more recently, on molecular biology-based protocols (Martelli and Boudon-Padieu 2006). Biological indexing takes 1–3 years before a result is obtained, and it does not provide any additional information on the viruses infecting the plant being tested. ELISA protocols are easy to conduct with large sample numbers and can be sensitive and reliable. However, low-virus titer and/or low antigen reactivity do not always allow successful, accurate, and reproducible detection by ELISA. Molecular methods based on reverse transcription followed by polymerase chain reaction (RT-PCR) have been shown to be a more reliable and sensitive detection method (Rowhani et al. 2000).

Until now, several molecular biology-based methods have been used for the detection of GLRaV-3, namely:

Conventional RT-PCR (MacKenzie et al. 1997; Santos et al. 2003)

Immunocapture RT-PCR (Nolasco et al. 1997)

Conventional RT-PCR in conjunction with single-strand conformation polymorphism (SSCP) analysis and sequencing (Gouveia et al. 2011; Jooste et al. 2010; Turturo et al. 2005)

Multiplex RT-PCR (mRT-PCR) (Bester et al. 2012a; Fuchs et al. 2009; Sharma et al. 2011; Chooi et al. 2013b)

Asymmetric PCR-ELISA (APET) (Gouveia et al. 2011)

SYBR Green and TaqMan real-time RT-PCR (López-Fabuel et al. 2013; Osman and Rowhani 2006; Pacifico et al. 2011; Bester et al. 2014)

Real-time RT-PCR in conjunction with high-resolution melting curve analysis (Bester et al. 2012a)

Loop-mediated amplification of nucleic acid with reverse transcriptase (RT-LAMP) (Nolasco 2010; Walsh and Pietersen 2013)

Low-density and oligonucleotide microarrays (Engel et al. 2010; Osman et al. 2008)

Macroarray using randomly primed and sequence non-specific amplified DNA (Thompson et al. 2012b)

Although these molecular test protocols provide increased sensitivity and reliability, the presence of unknown viruses and/or new variants of known viruses, which may contribute to the disease etiology, will go undetected and thus lead to the generation of false-negative results. With the increasing number of GLRaV-3 sequence variants identified (Gouveia et al. 2011; Sharma et al. 2011; Chooi et al. 2013a; Goszczynski 2013; Maree et al. 2015), the determination of the biological properties of the complete population of viruses in a host, and the potential impacts to grapevines, is of paramount importance. In this sense, there is a need for a protocol that can detect and discriminate the range of viruses and virus variants without prior knowledge and potentially identify both known and new viruses in a diseased sample.

NGS, while initially developed as a high-throughput sequencing technology, has rapidly been adapted for numerous applications in biological science, including virus detection. NGS executed in a metagenomic approach allows for the simultaneous detection of viral populations without requiring prior knowledge of the viral sequences present in a sample and, by including an initial unspecific cDNA synthesis step, can also be used as a metagenomic approach for the detection and identification of RNA viruses. To limit contamination by host RNAs, enrichment strategies for viral RNAs for sequencing library construction are employed. One of these, the use of viral dsRNA instead of total RNA has recently been applied to plant viruses in a model plant (Adams et al. 2009) and in grapevine (Al Rwahnih et al. 2009; Coetzee et al. 2010; Maree et al. 2015). In these studies, NGS was not used for GLRaV-3 diagnostics, but rather to detect and identify known and novel viruses, as well as new virus variants associated with leafroll disease.

The use of NGS to screen for virus-related siRNAs has been applied as an alternative for the detection of viruses that replicate at low levels or that have an uneven spatial distribution in the plant (Kreuze et al. 2009; Alabi et al. 2012a). In this case, NGS is performed with sequencing libraries produced from small RNAs (sRNAs) extracted from plant samples. Using this approach, characterization of siRNAs associated with GLRaV-3 infection was used to identify the virus (Alabi et al. 2012a). This study demonstrated the usefulness of NGS technologies as a diagnostic tool to detect and identify plant viruses when no prior knowledge of the viruses is available and provided greater insight into the etiology of grapevine leafroll disease.

The cost and turnaround time of NGS analysis are declining and will continue to do so with the advent of self-contained, in-house bench-top deep sequencing capabilities. Indeed, single-molecule DNA sequencing in a miniaturized disposable device for single use has been developed by Oxford Nanopore Technologies. This technology allows for simple and cheap high-throughput sequencing and real-time analysis of data (Jain et al. 2015). If the use of NGS were accepted for

grapevine certification and registration in place of the current hardwood indexing industry standard, growers would be able to start the production of propagation material and virus elimination programs with most new accessions years earlier than in the current situation.

Host Range and Transmission

GLRaV-3 is graft transmissible and mainly spreads through the propagation of infected material, in other words, planting new vineyards with material derived from propagated non- or poorly certified rootstocks (Martelli and Boudon-Padieu 2006). GLRaV-3 was described to be transmitted semi-persistently by mealybug species (Homoptera: Pseudococcidae) and/or soft scale insects (Homoptera: Coccidae) (Fuchs et al. 2009; Le Maguet et al. 2012; Mahfoudhi et al. 2009; Martelli and Boudon-Padieu 2006; Tsai et al. 2010), but transmission by mealybugs does not appear to be vector specific (Tsai et al. 2010). Interestingly, a study on the transmission dynamics of variants I and VI in the Napa Valley found that vector transmission of the group VI variant alone was more frequent, followed by transmission with mixed infections of the two, while transmission with the group I variant alone was the least common (Blaisdell et al. 2012). It should be highlighted that this is the first evidence that GLRaV-3 variants are biologically distinct in terms of vector transmissibility. We expect that future work will be able to identify biological differences among the various variants within these species, if they exist. Epidemiological studies on leafroll disease from grapevine-growing regions worldwide reported the spread of GLRaV-3 by mealybugs due to a combination of random dispersal, natural crawling, wind, active assistance from ants and passive assistance from humans (laborers or machinery) (Cabaleiro 2009; Charles et al. 2006; Jooste et al. 2011; Tsai et al. 2010).

Cytopathology, Tissue Tropism, and Virus-Host Interactions

Relatively few studies were conducted on molecular biology of compatible host-virus interactions in grapevines (Espinoza et al. 2007a, b; Vega et al. 2011; Alabi et al. 2012b) compared to similar studies involving herbaceous host-plant species. Consequently, our understanding of the genomics of grapevine-GLRaV-3 interactions is far from complete. Therefore, only a brief summary of our current understanding of grapevine-GLRaV-3 interactions is provided here, and readers are referred to the original publications mentioned above for detailed information. Espinoza et al. (2007a, b) have analyzed global transcript profiles of virus-infected symptomatic leaves collected at a single time point during post-veraison from two red-berried cultivars grown under field conditions. The data from these studies revealed changes in the expression of several genes involved in a variety of key biological functions of grapevines. Specifically, downregulation of genes involved

in photosynthetic processes and biosynthesis of photosynthetic pigments were observed in symptomatic leaves, besides modulated expression of genes involved in transport, gene transcription, and secondary metabolism. Conversely, defense- and stress-related genes were upregulated in infected leaves, suggesting induction of host defense responses concomitant with symptom development. Since these responses were found to be similar in two red-berried cultivars, it is likely that GLRaV-3 infection invokes host responses that are common across red-berried cultivars. In a recent study, Alabi et al. (2012b) showed altered expression levels of small RNAs (sRNAs) in symptomatic leaves of red-berried grapevines, indicating activation of RNA silencing pathway as a host defense in response to GLRaV-3 infection. Besides the production of virus-derived siRNAs (vsiRNAs), this study revealed changes in expression levels of several *V. vinifera* microRNAs (Vvi-miRNAs) that are implicated in different plant developmental processes. For example, a subset of Vvi-miRNAs belonging to the miRNA 156, 166, 167, and 168 families showed differential expression profiles, suggesting that perturbations in sRNA biosynthetic and functional pathways due to viral infections could result in altered expression levels of Vvi-miRNAs and their mRNA targets. These altered expression levels, which are typically anticorrelated between miRNAs and their targets, can lead to a variety of developmental and metabolic derangements, including the phenotypic expression of disease symptoms. In addition to changes in leaves, GLRaV-3 infection is known to affect biological functions of berries in virus-infected grapevines. Genomic and proteomic analyses of grapes from GLRaV-3-infected red-berried grapevines revealed pronounced changes in berry transcriptome and metabolome, especially during the linear phase of ripening after the onset of veraison (Vega et al. 2011; Giribaldi et al. 2011). These negative impacts include, but are not limited to, downregulation of several genes involved in berry sugar transport, metabolism, anthocyanin biosynthesis, as well as the functional integrity of berry skin cells, thereby indicating that a wide spectrum of functions are affected leading to marked changes in the whole berry metabolism due to virus infection. It is clear from this analysis that much research needs to be carried out for a comprehensive analysis of the transcription profiles in response to infection by GLRaV-3. A comparative study between red- and white-berried cultivars might contribute to the elucidation of mechanisms underlying cultivar-specific responses to GLRaV-3 infection.

Pathological Properties, Associated Diseases, and Their Impact

Symptoms

Among the several GLRaV species documented in grapevines, GLRaV-3 has been recognized as playing the most significant contributing role to the etiology and symptomatology of GLD. In general, different species of *Vitis* are known to be susceptible to GLRaV-3 infections. However, most European cultivars of *V. vinifera*

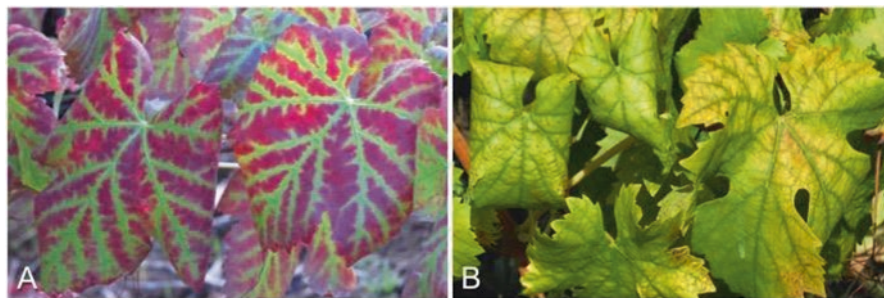

Fig. 8.4 Characteristic symptoms of grapevine leafroll disease in wine grape cultivars. (a) Interveinal reddening and downward rolling of leaf margins in red wine cultivars, and (b) interveinal chlorosis and downward rolling of leaf margins in white cultivars

and some Asian *Vitis* species have been reported to exhibit conspicuous symptoms of GLD subsequent to infection with GLRaV-3. In contrast, several other *Vitis* species show latent infections with no discernible phenotypic expression of GLD symptoms (Naidu et al. 2014). Symptomatology of GLD in GLRaV-3-infected *V. vinifera* cultivars has been described earlier (Rayapati et al. 2008), and only salient features of the disease are described here. In general, mature leaves at the bottom portions of canes begin to show GLD symptoms around or soon after veraison, which become more apparent with the advancement of the season. Variations in the onset of symptoms may, however, be influenced by geographic location and/or cultivar. The characteristic foliar symptoms in red-berried cultivars consist of red and reddish-purple coloration of interveinal areas and a narrow strip of leaf tissue on either side of the primary veins remaining green (Fig. 8.4a). In contrast, white-berried cultivars do not exhibit such dramatic symptoms but show mild yellowing or chlorotic mottling (Fig. 8.4b). The symptoms may extend progressively upward along the shoots or be confined to leaves in the basal and middle parts of shoots. Toward the end of the season, symptomatic leaves show downward rolling of leaf margins, expressing the characteristic symptom that gives the disease its common name. The phenotypic expression of reddish-purple discoloration of the leaves in red-fruited cultivars was shown to be due to the accumulation of anthocyanins, reflecting the upregulation of anthocyanin biosynthetic pathway genes in virus-infected leaves (Gutha et al. 2010). The lack of striking symptoms in white-berried cultivars analogous to those produced in red-berried cultivars could be due to the lack of colored pigments as a consequence of mutations in the promoter region of genes, *VvMYBA1* and *VvMYBA2*, regulating the expression of UDP-glucose: flavonoid 3-*O*-glucosyltransferase (UFGT) in the anthocyanin pathway (Walker et al. 2007). It should be noted, however, that symptoms of GLD are highly variable between cultivars, as well as within a cultivar, and can be influenced by scion-rootstock combinations and location-specific environmental factors. In the case of red-berried cultivars, nutritional disorders induced by potassium deficiency, mechanical damage to

the trunk or individual shoots during vineyard operations or wind abrasion between canes, girdling of petioles and shoots can produce foliar discolorations that mimic symptoms of GLD. Additionally, the symptomatology of grapevine red blotch disease (refer to Chap. 14 on red blotch elsewhere in this text) is highly similar to that of GLD, making it difficult to pursue symptom-based field diagnosis of these two distinct diseases in vineyards. Therefore, virus-specific diagnostic methods, described above, should be used for reliable detection of GLRaV-3 and to discriminate symptoms due to viral infections from that of other abiotic factors and nutritional disorders.

As discussed recently (Naidu et al. 2015), one of the unique features of GLD symptomatology is the appearance of typical symptoms during post-veraison despite the fact that GLRaV-3 is present systemically throughout the season. Thus, unlike other viral infections where symptoms are produced subsequent to infection, GLD symptoms expressed around a specific phenological stage of the grapevine. Expression of symptoms in GLRaV-3-infected grapevines appears to be uncoupled with the presence of virus, but likely influenced by host-virus interactions occurring in a development stage-specific manner, or possibly with the high-virus titer reached only post-veraison.

Impacts

Similar to other viral diseases, GLRaV-3 can affect grapevines at different trophic levels. Readers are directed to publications listed in this section that have documented a wide range of impacts of GLRaV-3 in both grafted and own-rooted wine grape cultivars. A summary of these studies is provided here to highlight our current understanding of GLRaV-3-induced disorders that include vine health problems, reduced yield, delayed fruit maturity, and poor quality of grapes. In this context, it should be mentioned that most of these studies were focused on virus-infected red-berried cultivars, and, understandably, only limited information is available on impacts of GLRaV-3 in white-berried cultivars. It should also be pointed out that these studies were performed under field conditions using grapevines infected with GLRaV-3 as single and/or coinfections with other viruses and viroids. Thus, overall impacts on grapevines cannot be attributed exclusively to GLRaV-3, although this virus could be the primary contributor to the observed phenotypic and physiological derangements. Instead, many of these coinfecting subcellular pathogens could be conferring antagonistic or synergistic influences on the complex network of GLRaV-3-grapevine interactions at the cellular and organismal level. Recent studies have indicated significant economic impacts to vineyard profitability due to GLRaV-3 infections. An estimated economic loss of \$25,000–40,000 per hectare in cv. Cabernet Franc vineyards was reported in the Finger Lakes region, New York, depending on the incidence of GLD, extent of yield reduction, and impact on fruit quality (Atallah et al. 2012). Similarly, an economic study in major California grapevine-growing regions has estimated losses of \$29,902–226,405 per hectare in

cv. Cabernet Sauvignon vineyards (Ricketts et al. 2015). Likewise, a recent economic impact study from Washington State vineyards indicated that a commercial cv. Merlot vineyard can lose up to \$20,000 per acre over a 20-year period, depending on the extent of loss in fruit yield and magnitude of reduction in berry sugars (Naidu and Walsh 2015).

Vine Performance

One of the common effects of GLRaV-3 is reduced vigor and altered physiological parameters of infected grapevines. Reduced vine vigor, measured in terms of cane pruning weight and fruit yield, is one of the commonly observed effects of GLRaV-3 infection (Alabi et al. 2016). Several studies have shown that GLRaV-3 affects different events associated with photosynthesis in red-berried cultivars under field conditions (Basso et al. 2010; Bertamini and Nedunchezian 2002; Sampol et al. 2003; Gutha et al. 2012; Moutinho-Pereira et al. 2012). A reduction in photosynthetic pigments, net photosynthesis, and chlorophyll a (Chla) fluorescence was observed in symptomatic leaves during the pre-veraison stage, but not in asymptomatic leaves during pre-veraison compared with data from corresponding healthy leaves. This dysfunctional photosynthesis physiology was attributed, at least in part, to altered structural and functional integrity of photosystem (PS) II, especially the donor site of PSII that makes up the oxygen-evolving complex of the photosynthesis apparatus (Bertamini and Nedunchezian 2002; Bertamini et al. 2004). Besides, the upregulation of anthocyanin biosynthetic pathway genes and associated accumulation of specific classes of anthocyanin pigments with concomitant reduction in photosynthetic pigments (Gutha et al. 2010) could also be contributing to reduced net photosynthesis in symptomatic leaves during post-veraison. Although the appearance of anthocyanins in the leaves was correlated with various stresses, including pathogen infections (Hatier and Gould 2008), these colored pigments can contribute to repressed photosynthesis in symptomatic leaves by masking chlorophyll. It is also likely that higher levels of carbohydrates in autotrophic leaves, retained as a consequence of diminished phloem transport of photoassimilates to berries, could trigger upregulation of anthocyanin biosynthetic pathway genes, since sugars are known to act as signaling molecules for upregulation of genes coding for anthocyanin (Solfanelli et al. 2006; reviewed in Lecourieux et al. 2014).

Fruit Yield and Quality

Several studies were conducted on impacts of GLRaV-3 in distinct geographies using grafted vines of different scion-rootstock combinations and own-rooted wine grape cultivars (Golino et al. 2009a, b; Komar et al. 2010; Lee and Martin 2009; Lee et al. 2009; Alabi et al. 2016). The consensus from these studies is that the virus can

significantly affect fruit yield, with an average annual yield loss between 10 and 40%. However, it should be noted that higher yield loss could be expected depending on the severity of virus infection across a vineyard. Differences in cultivar responses to GLRaV-3 infection, age of the vineyard, single and/or coinfection with other viruses, and seasonal climatic factors can synergistically influence the extent of yield losses incurred annually.

GLRaV-3 infection can also affect berry quality characteristics that could ultimately impact fruit and wine quality. Most of the studies on this topic were conducted with red-berried cultivars, and the data has shown that virus infection affects berry-ripening processes. Specifically, reduced levels of berry sugars and anthocyanins, the two hallmark parameters of fruit quality, have been observed in several red-berried cultivars due to GLRaV-3 infection. In a recent study, Alabi et al. (2016) have shown that sugar levels were significantly affected during berry ripening processes starting from veraison rather than in developing green berries during pre-veraison. This observation points toward altered source-sink relationships during the transition between pre- and post-veraison and supports the hypothesis that the phloem-limited GLRaV-3 could be the primary contributor for deranged vascular translocation of photoassimilates from autotrophic source leaves to ripening berries (Naidu et al. 2015). Reduced berry sugar levels, in turn, could lead to a cascading effect resulting in lower amounts of total anthocyanins in grapes, since sugars are known to modulate anthocyanin biosynthesis pathway genes (Solfanelli et al. 2006; reviewed in Lecourieux et al. 2014). Indeed, genomic and proteomic analysis of grapes from virus-infected grapevines has revealed dramatic changes in the expression levels of several genes and proteins involved in a wide spectrum of functions, ultimately reflecting on overall berry metabolome (Giribaldi et al. 2011; Vega et al. 2011). Based on these studies, it is clear that derailed source-sink relationships and perturbations in overall berry metabolism can lead to a suite of changes ultimately reflecting on the overall quality of grapes produced by grapevines infected with GLRaV-3.

Strategies for Control and Management

Strategies for the management of GLD is largely preventive, aimed at minimizing the spread of GLRaV-3. Most of the studies on control and management of GLD were focused on GLRaV-3, due to its ubiquitous distribution worldwide (Charles et al. 2006; Maree et al. 2013) and the propensity of several species of mealybugs (Pseudococcidae) and scale insects (Coccidae) to efficiently transmit the virus relative to other GLRaV species and their strains (Tsai et al. 2010; Le Maguet et al. 2012; Bahder et al. 2013; Naidu et al. 2014). Relative to mealybug vectors, however, limited knowledge is available on the role of coccid vectors in the epidemiology of GLRaV-3. Consequently, knowledge derived from GLRaV-3 transmission by different species of mealybug vectors have been exploited in designing strategies for the management of GLD. Studies conducted in several countries have shown

unequivocally that primary spread of the virus occurs via contaminated planting stocks whereas mealybug vectors play a significant role in the secondary spread within and between vineyards (Almeida et al. 2013). Commonalities in the spatio-temporal dynamics of GLRaV-3 across grapevine-growing regions and the knowledge derived from epidemiological studies from widely variable agroclimatic conditions in different countries (Habibi and Nutter 1997; Cabaleiro et al. 2008; Golino et al. 2008; Charles et al. 2006; Gribaudo et al. 2009; Le Maguet et al. 2012; Pietersen et al. 2013) have provided baseline data to design location-specific management strategies. In general, a two-pronged strategy, consisting of planting virus-tested planting stock as a first line of defense and a combination of cultural and vector control measures as a post-planting tactic in established vineyards, has been advocated for minimizing the spread of GLRaV-3 in vineyards (Almeida et al. 2013; Naidu et al. 2014).

Chemical control strategies have largely been targeted against the first-instar nymphs or “crawlers” due to their relatively high mobility and transmission efficiency compared to focusing on the largely sessile behavior of subsequent developmental stages of female mealybugs and the ephemeral, nonfeeding adult males (Daane et al. 2012). In general, both systemic and contact insecticides of different chemistries have been widely advocated for controlling the vector populations of mealybugs, especially curtailing the crawler activities (Pietersen et al. 2013). However, control measures exclusively based on insecticide applications have been discouraged due to its limited efficiency, environmental concerns, and collateral damage to beneficial insects, predators and parasites, natural enemies, and pollinators. The inability of contact insecticides to reach adult mealybugs that inhabit shielded areas of grapevines such as bark crevices and leaf axils have exposed the limitations of pesticide-based control measures. In recent years, horticultural oils as well as broad-spectrum foliar insecticides have been tried with mixed results in controlling mealybugs. Many of the systemic insecticides, including the neonicotinoids, have been tested for suppressing populations of mealybugs. Alternatively, combinations of a systemic insecticide for reducing overall populations of mealybugs and a quick-acting contact insecticide to knock down crawlers may provide a synergistic effect in vector control. Due to their propensity to survive on roots, controlling vectors such as the vine (*Planococcus ficus*) and obscure (*Pseudococcus viburni*) mealybugs involve the use of systemic insecticides prior to vineyard removal, use of herbicides to kill residual roots from a preceding vineyard, and allowing a fallow period before re-planting with clean cuttings, which all have been advocated to reduce the potential of virus spread. Although application of insecticides can provide reasonably effective vector control, measures in slowing the spread of GLRaV-3, relying exclusively on chemical control measures, have not been advocated to provide the desired benefits in complete prevention of virus spread for sustainable management of GLD in vineyards (Almeida et al. 2013).

Besides chemical control regimes, cultural practices such as roguing or removing infected vines and replantation with vines derived from certified virus-tested planting stock have commonly been advocated to eliminate sources of inoculum as part of reducing the spread of GLD within vineyards (Almeida et al. 2013).

Indeed, continuous rouging of infected vines during the first few years of post-planting was found to be effective in eradicating the virus from vineyards (Pietersen et al. 2013). Alternative methods, such as biological control, pheromone-based mating disruption, and insect growth regulators, have also been advocated with limited success for the control of mealybugs. Altogether, an integrated control program using combination of vector control together with uprooting of infected vines has proven to be an effective management strategy to control the spread of GLD (Pietersen et al. 2013).

Although these strategies have been successfully implemented across the grapevine-growing regions worldwide, location-specific differences in species composition of mealybug and scale insect vectors have played a significant role in successful implementation of effective control strategies. Additionally, a variety of factors that include, but are not limited to, the number of vector generations in a season, vector feeding behavior, grapevine cultivar, age of grapevines at which virus acquisition or inoculation occurs, presence of GLRaV-3 as single or coinfection in a grapevine can contribute to the field spread of GLRaV-3 (Naidu et al. 2014). Vineyard spread of GLRaV-3 can also be influenced by regional environmental factors, landscape features, and viticultural practices that affect the survival and dispersal of mealybug and scale insect vectors (Daane et al. 2012).

Other Aspects That Are Unique to GLRaV-3

Undoubtedly, GLRaV-3 is the most complex among the grapevine-infecting closteroviruses. The ubiquitous distribution relative to other GLRaVs is likely due in part to its propensity to be efficiently transmitted by mealybugs and scale insects. It is also possible that GLRaV-3 is more robust in countering the host defense with viral-encoded silencing suppressors. Indeed, the GLRaV-3 p20B (or p19.7) was identified as a viral silencing suppressor (Gouveia et al. 2012). Expressing the p20B from five distinct GLRaV-3 variants in *Nicotiana benthamiana* resulted in differences in the suppression activity, with the group III variant initiating typical viral symptoms that developed into necrosis (Gouveia and Nolasco 2012). The presence of genetic variant groups and differences in their counterdefense activity and vector transmissibility all contribute to the prevalence of GLRaV-3 in vineyards.

Conclusions and Future Research Directions

The economic importance of GLD ensured comprehensive international research into numerous aspects of this ubiquitous grapevine pathogen over the last few decades. Despite these efforts, the complex biology of GLD is still not completely resolved and in all likelihood will remain a major research focus in the next few years.

Pivotal to this cause will be the construction of infectious cDNA clones of the GLRaVs involved in GLD. Especially the construction of a GLRaV-3 clone, and the ability for its efficient delivery into grapevine, will be an essential tool, not only to unravel virus-host-vector interactions but also for the development of virus-based VIGS as an efficient non-transgenic system for functional genomics in grapevines. Similarly, cDNA clones to different GLRaV-3 variants, for which significant genetic variation has been shown, will be valuable in answering questions about the abundance of particular variants in certain grapevine cultivars and whether any correlations could be drawn to disease severity in terms of symptomology and other physiological impacts on the host. However, fully resolving these networks of molecular interactions between virus, vector, and host to potentially identify common and unique features of nucleic acid-protein and protein-protein interactions for rational design of novel disease intervention will probably require an omics-based “interactome” approach.

The lack of an herbaceous host for GLRaV-3 has complicated many research efforts – an intriguing question that remains unanswered is whether grapevine is the only host of GLRaV-3, and if so, what are the highly specific determinants of this interaction? Likewise, a better understanding of GLRaV-3 transmission specificity by distinct species of mealybugs and scale insects may lead to strategies to interfere with the spread of GLD.

Considering its well-documented widespread distribution and apparent dominance over other GLRaVs associated with GLD reported in many grapevine-growing regions, the question arises whether GLRaV-3 possesses an inherent super-infection fitness advantage and whether the answer to this phenomenon lies in its complex genome. Linked to this, it is clear that much research needs to be focused on a comprehensive analysis of the transcription and/or sRNA profiles in response to infection by GLRaV-3. A comparative study between red- and white-berried cultivars might contribute to the elucidation of mechanisms underlying cultivar-specific responses to GLRaV-3 infection.

The lack of natural GLD resistance in *V. vinifera* varieties and the impracticality of establishing resistance by conventional breeding have been serious stumbling blocks in the control of the disease. In this context, GLRaV-3 infectious clones can offer the promising alternative of RNAi-mediated resistance. Additionally, with more grapevine genome sequences becoming available, novel genome-editing technologies like CRISPR-Cas9 (Belhaj et al. 2013) offers exciting alternatives to classical breeding or transgenic approaches for targeted genome modification of grapevine cultivars for virus resistance.

The regularity with which “new” genetic variants of GLRaV-3 are found, and significant genetic diversity among these variants, justifies constant vigilance to ensure that detection assays remain up to date. Recent advances in high-throughput sequencing technologies and especially the design of automated bioinformatic pipelines dedicated to virus detection in complex data sets (Visser et al. 2016) are encouraging developments in this field. The design and construction of microfluidics-based point-of-care detection devices, which has important applications in field diagnostics and extension services, are lagging behind similar developments in the medical field (Shafiee et al. 2015).

Acknowledgments JTB and HJM acknowledge the support of the Wine Industry Network for Expertise and Technology (Winetech), Technology and Human Resources for Industry Programme (THRIP) of the Department of Trade and Industry, and the National Research Foundation (NRF) for their financial assistance toward this research. Opinions expressed and conclusions arrived at are those of the authors and are not necessarily to be attributed to the NRF.

RAN acknowledges the support provided by the Washington State University's Agricultural Research Center, the Wine Research Advisory Committee of the Washington State Wine Commission, and the Washington State Grape & Wine Research Program.

PG would like to thank Gustavo Nolasco for the encouragement and support and acknowledges the support provided by Fundação para a Ciência e Tecnologia (FCT), for research projects PTDC/AGR-GPL/099512/2008 and SFRH/BD/41826/2007.

References

- Abou Ghanem-Sabanadzovic, N.A., S. Sabanadzovic, P. Gugerli, and A. Rowhani. 2012. Genome organization, serology and phylogeny of Grapevine leafroll-associated viruses 4 and 6: Taxonomic implications. *Virus Research* 163: 120–128.
- Adams, I.P., R.H. Glover, W.A. Monger, R. Mumford, E. Jackeviciene, M. Navalinskiene, M. Samutiene, and N. Boonham. 2009. Next-generation sequencing and metagenomic analysis: A universal diagnostic tool in plant virology. *Molecular Plant Pathology* 10: 537–545.
- Adams, M.J., E.J. Lefkowitz, A.M.Q. King, and E.B. Carstens. 2014. Ratification vote on taxonomic proposals to the International Committee on Taxonomy of Viruses. *Archives of Virology* 159: 2831–2841.
- Agranovsky, A.A., E.V. Koonin, V.P. Boyko, E. Maiss, R. Frötschl, N.A. Lunina, and J.G. Atabekov. 1994. Beet yellows closterovirus: Complete genome structure and identification of a leader papain-like thiol protease. *Virology* 198: 311–324.
- Agranovsky, A.A., D.E. Lesemann, E. Maiss, R. Hull, and J.G. Atabekov. 1995. “Rattlesnake” structure of a filamentous plant RNA virus built of two capsid proteins. *Proceedings of the National Academy of Sciences of the United States of America* 92: 2470–2473.
- Al Rwahnih, M., S. Daubert, D. Golino, and A. Rowhani. 2009. Deep sequencing analysis of RNAs from a grapevine showing Syrah decline symptoms reveals a multiple virus infection that includes a novel virus. *Virology* 387: 395–401.
- Al Rwahnih, M., V.V. Dolja, S. Daubert, E.V. Koonin, and A. Rowhani. 2012. Genomic and biological analysis of Grapevine leafroll-associated virus 7 reveals a possible new genus within the family *Closteroviridae*. *Virus Research* 163: 302–309.
- Alabi, O.J., Y. Zheng, G. Jagadeeswaran, R. Sunkar, and R.A. Naidu. 2012a. High-throughput sequence analysis of small RNAs in grapevine (*Vitis vinifera* L.) affected by grapevine leafroll disease. *Molecular Plant Pathology* 13: 1060–1076.
- Alabi, O.J., L.R. Gutha, L.F. Casassa, J. Harbertson, M. Miralles, C.W. Beaver, and R.A. Naidu. 2012b. Impacts of grapevine leafroll disease on own-rooted wine grape cultivar in cool climate viticulture. In *Proceedings of the 17th Congress of the International Council for the Study of Virus and Virus-like Diseases of the Grapevine (ICVG)*, Davis, California, USA, October 7–14, 2012, 170–171.
- Alabi, O.J., L.F. Casassa, L.R. Gutha, R.C. Larsen, T. Henick-Kling, J.F. Harbertson, and R.A. Naidu. 2016. Impacts of grapevine leafroll disease on fruit yield and grape and wine chemistry in a wine grape (*Vitis vinifera* L.) cultivar. *PLoS ONE* 11: e0149666.
- Almeida, R.P.P., K.M. Daane, V.A. Bell, G.K. Blaisdell, M.L. Cooper, E. Herrbach, and G. Pietersen. 2013. Ecology and management of grapevine leafroll disease. *Frontiers in Microbiology* 4: 94.
- Alzhanova, D.V., Y. Hagiwara, V.V. Peremyslov, and V.V. Dolja. 2000. Genetic analysis of the cell-to-cell movement of beet yellows closterovirus. *Virology* 268: 192–200.

- Alzhanova, D.V., A. Napuli, R. Creamer, and V.V. Dolja. 2001. Cell-to-cell movement and assembly of a plant closterovirus: Roles for the capsid proteins and Hsp70 homolog. *EMBO Journal* 20: 6997–7007.
- Alzhanova, D.V., A.I. Prokhnevsky, V.V. Peremyslov, and V.V. Dolja. 2007. Virion tails of beet yellows virus: Coordinated assembly by three structural proteins. *Virology* 359: 220–226.
- Atallah, S.S., M.I. Gómez, M.F. Fuchs, and T.E. Martinson. 2012. Economic impact of grapevine leafroll disease on *Vitis vinifera* cv. Cabernet franc in Finger Lakes vineyards of New York. *American Journal of Enology and Viticulture* 63: 73–79.
- Bahder, B.W., S. Poojari, O.J. Alabi, R.A. Naidu, and D.B. Walsh. 2013. *Pseudococcus maritimus* (Hemiptera: Pseudococcidae) and *Parthenolecanium corni* (Hemiptera: Coccidae) are capable of transmitting *Grapevine leafroll-associated virus 3* between *Vitis labruscana* and *Vitis vinifera*. *Environmental Entomology* 42: 1292–1298.
- Basso, M.F., T.V.M. Fajardo, H.P. Santos, C.C. Guerra, R.A. Ayub, and O. Nickel. 2010. Leaf physiology and enologic grape quality of virus-infected plants. *Tropical Plant Pathology* 35: 351–359.
- Belhaj, K., A. Chaparro-Garcia, S. Kamoun, and V. Nekrasov. 2013. Plant genome editing made easy: Targeted mutagenesis in model and crop plants using the CRISPR/Cas system. *Plant Methods* 9: 39.
- Bertamini, M., and N. Nedunchezian. 2002. Leaf age effects on chlorophyll, Rubisco, photosynthetic electron transport activities and thylakoid membrane protein in field grown grapevine leaves. *Journal of Plant Physiology* 159: 799–803.
- Bertamini, M., K. Muthuchelian, and N. Nedunchezian. 2004. Effect of grapevine leafroll on the photosynthesis of field grown grapevine plants (*Vitis vinifera* L. cv. Lagrein). *Journal of Phytopathology* 152: 145–152.
- Bertsch, C., M. Beuve, V.V. Dolja, M. Wirth, F. Pelsy, E. Herrbach, and O. Lemaire. 2009. Retention of the virus-derived sequences in the nuclear genome of grapevine as a potential pathway to virus resistance. *Biology Direct* 4: 21.
- Bester, R., A.E.C. Jooste, H.J. Maree, and J.T. Burger. 2012a. Real-time RT-PCR high-resolution melting curve analysis and multiplex RT-PCR to detect and differentiate grapevine leafroll-associated virus 3 variant groups I, II, III and VI. *Virology Journal* 9: 219.
- Bester, R., H.J. Maree, and J.T. Burger. 2012b. Complete nucleotide sequence of a new strain of grapevine leafroll-associated virus 3 in South Africa. *Archives of Virology* 157: 1815–1819.
- Bester, R., P.T. Pepler, J.T. Burger, and H.J. Maree. 2014. Relative quantitation goes viral: An RT-qPCR assay for a grapevine virus. *Journal of Virological Methods* 210: 67–75.
- Blaisdell, G.K., S. Zhang, K. Daane, and P.P. Almeida. 2012. Patterns of virus transmission from hosts with mixed infections. In *Proceedings of the 17th Congress of the International Council for the Study of Virus and Virus-like Diseases of the Grapevine (ICVG)*, Davis, California, USA, October 7–14, 2012, 178–179.
- Boscia, D., C. Greif, P. Gugerli, G.P. Martelli, B. Walter, and D. Gonsalves. 1995. Nomenclature of grapevine leafroll-associated putative closteroviruses. *Vitis* 34: 171–175.
- Cabaleiro, C. 2009. Current advances in the epidemiology of grapevine leafroll disease. In *Proceedings of 16th International Council for the Study of Viruses and Virus-Like Diseases of the Grapevine (ICVG)*, Dijon, France, 31 Aug–4 Sept 2009, 264–268.
- Cabaleiro, C., C. Couceiro, S. Pereira, M. Cid, M. Barrasa, and A. Segura. 2008. Spatial analysis of *Grapevine leafroll associated virus 3* epidemics. *European Journal of Plant Pathology* 121: 121–130.
- Castellano, M.A., N. Abou-Ghanem, E. Choueiri, and G.P. Martelli. 2000. Ultrastructure of grapevine leafroll-associated virus 2 and 7 infections. *Journal of Plant Pathology* 82: 9–15.
- Charles, J.G., D. Cohen, J.T.S. Walker, S.A. Forgie, V.A. Bell, and K.C. Breen. 2006. A review of the ecology of Grapevine leafroll associated virus type 3 (GLRaV-3). *New Zealand Plant Protection* 59: 330–337.
- Chiba, M., J.C. Reed, A.I. Prokhnevsky, E.J. Chapman, M. Mawassi, E.V. Koonin, J.C. Carrington, and V.V. Dolja. 2006. Diverse suppressors of RNA silencing enhance agroinfection by a viral replicon. *Virology* 346: 7–14.

- Chooi, K.M., M.N. Pearson, D. Cohen, and J.C.H. Pong. 2009. Sequence variation in Grapevine leafroll-associated virus-3 (GLRaV-3) New Zealand isolates. In *Proceedings of 16th International Council for the Study of Viruses and Virus-Like Diseases of the Grapevine (ICVG)*. Dijon, France, 31 Aug–4 Sept 2009, 290–291.
- Chooi, K.M., D. Cohen, and M.N. Pearson. 2013a. Molecular characterisation of two divergent variants of Grapevine leafroll-associated virus 3 in New Zealand. *Archives of Virology* 158: 1597–1602.
- . 2013b. Generic and sequence-variant specific molecular assays for the detection of the highly variable Grapevine leafroll-associated virus 3. *Journal of Virological Methods* 189: 20–29.
- Coetzee, B., M.J. Freeborough, H.J. Maree, J.M. Celton, D.J. Rees, and J.T. Burger. 2010. Deep sequencing analysis of viruses infecting grapevines: Virome of a vineyard. *Virology* 400: 157–163.
- Daane, K.M., R.P.P. Almeida, V.A. Bell, M. Botton, M. Fallahzadeh, M. Mani, J.L. Miano, R. Sforza, V.M. Walton, and T. Zaviezo. 2012. Biology and management of mealybugs in vineyards. In *Arthropod management in vineyards*, ed. N.J. Bostanian, R. Isaacs, and C. Vincent, 271–308. Dordrecht: Springer.
- Dolja, V.V. 2003. Beet yellows virus: The importance of being different. *Molecular Plant Pathology* 4: 91–98.
- Dolja, V.V., J.F. Kreuze, and J.P.T. Valkonen. 2006. Comparative and functional genomics of closteroviruses. *Virus Research* 117: 38–51.
- Engel, E.A., P.F. Escobar, L.A. Rojas, P.A. Rivera, N. Fiore, and P.D. Valenzuela. 2010. A diagnostic oligonucleotide microarray for simultaneous detection of grapevine viruses. *Journal of Virological Methods* 163: 445–451.
- Espinoza, C., C. Medina, S. Somerville, and P. Arce-Johnson. 2007a. Senescence-associated genes induced during compatible viral interactions with grapevine and Arabidopsis. *Journal of Experimental Botany* 58: 3197–3212.
- Espinoza, C., A. Vega, C. Medina, K. Schlauch, G. Cramer, and P. Arce-Johnson. 2007b. Gene expression associated with compatible viral diseases in grapevine cultivars. *Functional and Integrative Genomics* 7: 95–110.
- Faoro, F. 1997. Cytopathology of closteroviruses and trichoviruses infecting grapevines. In *Filamentous viruses of woody plants*, ed. P.L. Monette, 29–47. Trivandrum: Research Signpost.
- Farooq, A.B.U., Y. Ma, Z. Wand, N. Zhou, and X. Wenxing. 2012. Genetic diversity analyses reveal novel recombination events in Grapevine leafroll-associated virus -3 in China. *Virus Research* 171: 15–21.
- Fei, F., M.D. Lyu, J. Li, Z.F. Fan, and Y.Q. Cheng. 2013. Complete nucleotide sequence of a Chinese isolate of Grapevine leafroll-associated virus 3 reveals a 5' UTR of 802 nucleotides. *Virus Genes* 46: 182–185.
- Fuchs, M., T.E. Martinson, G.M. Loeb, and H.C. Hoch. 2009. Survey for the three major leafroll disease-associated viruses in Finger Lakes vineyards in New York. *Plant Disease* 93: 395–401.
- Giribaldi, M., M. Purrotti, D. Pacifico, D. Santini, F. Mannini, et al. 2011. A multidisciplinary study on the effects of phloem-limited viruses on the agronomical performance and berry quality of *Vitis vinifera* cv. Nebbiolo. *Journal of Proteomics* 75: 306–315.
- Goheen, A.C., F.N. Harmon, and J.H. Weinberger. 1958. Leafroll (White Emperor disease) of grapes in California. *Phytopathology* 48: 51–54.
- Golino, D.A., E.A. Weber, S.T. Sim, and A. Rowhani. 2008. Leafroll disease is spreading rapidly in a Napa Valley vineyard. *California Agriculture* 62: 156–160.
- Golino, D.A., J. Wolpert, S.T. Sim, J. Benz, M. Anderson, and A. Rowhani. 2009a. Virus effects on vine growth and fruit components of three California 'Heritage' clones of Cabernet Sauvignon. In *Proceedings of 16th International Council for the Study of Viruses and Virus-Like Diseases of the Grapevine (ICVG)*. Dijon, France, 31 Aug–4 Sept 2009, 243–244.
- . 2009b. Virus effects on vine growth and fruit components of Cabernet Sauvignon on six rootstocks. In *Proceedings of 16th International Council for the Study of Viruses and Virus-Like Diseases of the Grapevine (ICVG)*. Dijon, France, 31 Aug–4 Sept 2009, 245–246.

- Goszczynski, D.E. 2013. Brief report of a new highly divergent variant of grapevine leafroll-associated virus 3 (GLRaV-3). *Journal of Phytopathology* 161: 874–879.
- Gouveia, P., and G. Nolasco. 2012. The p19.7 RNA silencing suppressor from Grapevine leafroll-associated virus 3 shows different levels of activity across phylogenetic groups. *Virus Genes* 45: 333–339.
- Gouveia, P., F. Esteves, M. Teixeira Santos, F. Fonseca, J.E. Eiras-Dias, and G. Nolasco. 2009. Assessment of GLRaV-3 variants occurring in Portuguese grapevine varieties according to the coat protein gene. In *Proceedings of 16th International Council for the Study of Viruses and Virus-Like Diseases of the Grapevine (ICVG)*. Dijon, France, 31 Aug–4 Sept 2009, 316–317.
- Gouveia, P., M.T. Santos, J.E. Eiras-Dias, and G. Nolasco. 2011. Five phylogenetic groups identified in the coat protein gene of grapevine leafroll-associated virus 3 obtained from Portuguese grapevine varieties. *Archives of Virology* 156: 413–420.
- Gouveia, P., S. Dandlen, Á. Costa, N. Marques, and G. Nolasco. 2012. Identification of an RNA silencing suppressor encoded by Grapevine leafroll-associated virus 3. *European Journal of Plant Pathology* 133: 237–245.
- Gribaudo, I., G. Gambino, S. Bertin, D. Bosco, A. Cotroneo, and F. Mannini. 2009. Monitoring the spread of viruses after vineyard replanting with heat-treated clones of *Vitis vinifera* “Nebbiolo”. *Journal of Plant Pathology* 91: 741–744.
- Gugerli, P., J.J. Brugger, and R. Bovey. 1984. L'enroulement de la vigne: mise en évidence de particules virales et développement d'une méthode immunoenzymatique pour le diagnostic rapide. *Revue Suisse de Viticulture, d'Arboriculture et d'Horticulture* 16: 299–304.
- Gutha, L.R., L.F. Casassa, J.F. Harbertson, and R.A. Naidu. 2010. Modulation of flavonoid biosynthetic pathway genes and anthocyanins due to virus infection in grapevine (*Vitis vinifera* L.) leaves. *BMC Plant Biology* 10: 187.
- Gutha, L.R., O.J. Alabi, and R.A. Naidu. 2012. Effects of grapevine leafroll disease on photosynthesis in a redfruited wine grape cultivar. In *Proceedings of the 17th Congress of the International Council for the Study of Virus and Virus-like Diseases of the Grapevine (ICVG)*, Davis, California, USA, October 7–14, 2012, 168–169.
- Habili, N., and F.W. Nutter. 1997. Temporal and Spatial Analysis of grapevine leafroll-associated virus 3 in Pinot Noir Grapevines in Australia. *Plant Disease* 81: 625–628.
- Hatier, J.H., and K.S. Gould. 2008. Foliar anthocyanins as modulators of stress signals. *Journal of Theoretical Biology* 253: 625–627.
- Hewitt, W.B., A.C. Goheen, D.J. Raski, and G.V. Gooding. 1962. Studies on virus diseases of grapevine in California. *Vitis* 3: 57–83.
- Hoefert, L.L., and E.M. Gifford. 1967. Grapevine leafroll virus – History and anatomical effects. *Hilgardia* 38: 403–426.
- Hu, J.S., D. Gonsalves, and D. Teliz. 1990. Characterization of closterovirus-like particles associated with grapevine leafroll disease. *Journal of Phytopathology* 128: 1–14.
- Jain, M., I.T. Fiddes, K.H. Miga, H.E. Olsen, B. Paten, and M. Akeson. 2015. Improved data analysis for the MinION nanopore sequencer. *Nature Methods* 12: 351–356.
- Jarugula, S., S. Gowda, W.O. Dawson, and R.A. Naidu. 2010. 3'-coterminal subgenomic RNAs and putative cis-acting elements of Grapevine leafroll-associated virus 3 reveals 'unique' features of gene expression. *Virology Journal* 7: 180.
- Jooste, A.E.C., and D.E. Goszczynski. 2005. Single-strand conformation polymorphism (SSCP), cloning and sequencing reveal two major groups of divergent molecular variants of grapevine leafroll-associated virus 3 (GLRaV-3). *Vitis* 44: 39–43.
- Jooste, A.E.C., H.J. Maree, D.U. Bellstedt, D.E. Goszczynski, G. Pietersen, and J.T. Burger. 2010. Three Grapevine leafroll-associated virus 3 (GLRaV-3) variants identified from South African vineyards show high variability in their 5' UTR. *Archives of Virology* 155: 1997–1193.
- Jooste, A.E.C., G. Pietersen, and J.T. Burger. 2011. Distribution of grapevine leafroll associated virus-3 variants in South African vineyards. *European Journal of Plant Pathology* 131: 371–381.

- Jooste, A.E.C., N. Molenaar, H.J. Maree, R. Bester, W.C. De Koker, and J.T. Burger. 2015. Identification and distribution of multiple virus infections in grapevine leafroll diseased vineyards. *European Journal of Plant Pathology* 142: 363–375.
- Karasev, A.V. 2000. Genetic diversity and evolution of closteroviruses. *Annual Review of Phytopathology* 38: 293–324.
- Komar, V., E. Vigne, G. Demangeat, O. Lemaire, and M. Fuchs. 2010. Comparative performance analysis of virus-infected *Vitis vinifera* cv. Savagnin rose grafted onto three rootstocks. *American Journal of Enology and Viticulture* 61: 68–73.
- Koonin, E.V., and V.V. Dolja. 1993. Evolution and taxonomy of positive-strand RNA viruses: Implications of comparative analysis of amino acid sequences. *Critical Reviews in Biochemistry and Molecular Biology* 28: 375–430.
- Kreuze, J.F., A. Perez, M. Untiveros, D. Quispe, S. Fuentes, I. Barker, and R. Simon. 2009. Complete viral genome sequence and discovery of novel viruses by deep sequencing of small RNAs: A generic method for diagnosis, discovery and sequencing of viruses. *Virology* 388: 1–7.
- Laimer, M., O. Lemaire, E. Herrbach, V. Goldschmidt, A. Minafra, P. Bianco, and T. Wetzel. 2009. Resistance to viruses, phytoplasmas and their vectors in the grapevine in Europe: A review. *Journal of Plant Pathology* 91: 7–23.
- Le Maguet, J., M. Beuve, E. Herrbach, and O. Lemaire. 2012. Transmission of six ampeloviruses and two vitiviruses to grapevine by *Phenacoccus aceris*. *Phytopathology* 102: 717–723.
- Lecourieux, F., C. Kappel, D. Lecourieux, A. Serrano, E. Torres, et al. 2014. An update on sugar transport and signalling in grapevine. *Journal of Experimental Botany* 65: 821–832.
- Lee, J., and R.R. Martin. 2009. Influence of grapevine leafroll associated viruses (GLRaV-2 and -3) on the fruit composition of Oregon *Vitis vinifera* L. cv. Pinot noir: Phenolics. *Food Chemistry* 112: 889–896.
- Lee, J., K.E. Keller, C. Rennaker, and R.R. Martin. 2009. Influence of grapevine leafroll associated viruses (GLRaV-2 and -3) on the fruit composition of Oregon *Vitis vinifera* L. cv. Pinot noir: Free amino acids, sugars, and organic acids. *Food Chemistry* 117: 99–105.
- Ling, K.S., H.Y. Zhu, H. Alvizo, J.S. Hu, R.F. Drong, J.L. Slightom, and D. Gonsalves. 1997. The coat protein gene of Grapevine leafroll-associated closterovirus 3: Cloning, nucleotide sequencing and expression in transgenic plants. *Archives of Virology* 142: 1101–1116.
- Ling, K.S., H.Y. Zhu, R.F. Drong, J.L. Slightom, J.R. McFerson, and D. Gonsalves. 1998. Nucleotide sequence of the 3'-terminal two-thirds of the grapevine leafroll-associated virus 3 genome reveals a typical monopartite closterovirus. *Journal of General Virology* 79: 1299–1307.
- Ling, K.S., H.Y. Zhu, and D. Gonsalves. 2004. Complete nucleotide sequence and genome organization of Grapevine leafroll-associated virus 3, type member of the genus *Ampelovirus*. *Journal of General Virology* 85: 2099–2102.
- Liu, Y.-P., V.V. Peremyslov, V. Medina, and V.V. Dolja. 2009. Tandem leader proteases of Grapevine leafroll-associated virus-2: Host-specific functions in the infection cycle. *Virology* 383: 291–299.
- López-Fabuel, I., T. Wetzel, E. Bertolini, A. Bassler, E. Vidal, L.B. Torres, A. Yuste, and A. Olmos. 2013. Real-time multiplex RT-PCR for the simultaneous detection of the five main grapevine viruses. *Journal of Virological Methods* 188: 21–24.
- Lu, R., A.S. Folimonov, M. Shintaku, W.X. Li, B.W. Falk, W.O. Dawson, and S.W. Ding. 2004. Three distinct suppressors of RNA silencing encoded by a 20-kb viral RNA genome. *Proceedings of the National Academy of Sciences of the United States of America* 101: 15742–15747.
- MacKenzie, D.J., M.A. Mclean, S. Mukerji, and M. Grenn. 1997. Improved RNA extraction from woody plants for the detection of viral pathogens by reverse transcription-polymerase chain reaction. *Plant Disease* 81: 222–226.

- Mahfoudhi, N., M. Digiario, and M.H. Dhoubi. 2009. Transmission of grapevine leafroll viruses by *Planococcus ficus* (Hemiptera: Pseudococcidae) and *Ceroplastes rusci* (Hemiptera: Coccidae). *Plant Disease* 93: 999–1002.
- Maree, H.J., M.-J. Freeborough, and J.T. Burger. 2008. Complete nucleotide sequence of a South African isolate of grapevine leafroll-associated virus 3 reveals a 5'UTR of 737 nucleotides. *Archives of Virology* 153: 755–757.
- Maree, H.J., H.F.J. Gardner, M.-J. Freeborough, and J.T. Burger. 2010. Mapping of the 5' terminal nucleotides of Grapevine leafroll-associated virus 3 sgRNAs. *Virus Research* 151: 252–255.
- Maree, H.J., R.P. Almeida, R. Bester, K. Chooi, D. Cohen, V.V. Dolja, M.F. Fuchs, D.A. Golino, A.E. Jooste, G.P. Martelli, R.A. Naidu, A. Rowhani, P. Saldarelli, and J. Burger. 2013. Grapevine leafroll-associated virus 3. *Frontiers in Microbiology* 4: 82.
- Maree, H.J., M.D. Pirie, R. Bester, K. Oosthuizen, and J.T. Burger. 2015. Phylogenomic analysis reveals deep divergence and recombination in an economically important grapevine virus. *PLoS ONE* 10: e0126819.
- Martelli, G.P. 2000. Major graft-transmissible diseases of grapevines: Nature, diagnosis, and sanitation. In *Proceedings 50th Anniversary Annual Meeting American Society for Enology and Viticulture (ASEV)*, 231–236. Seattle. 2000.
- . 2012. Grape virology highlights: 2010–2012. In *Proceedings of the 17th Congress of the International Council for the Study of Virus and Virus-like Diseases of the Grapevine (ICVG)*, Davis, California, USA, October 7–14, 2012, 13–31.
- . 2014. Directory of virus and virus-like disease of the grapevine and their agents. *Journal of Plant Pathology* 96: S1–S136.
- Martelli, G.P., and E. Boudon-Padieu. 2006. *Directory of infectious diseases of grapevines and viruses and virus-like diseases of the grapevine*, Bibliographic Report 1998–2004, 194. Bari: CIHEAM.
- Martelli, G.P., A.A. Agranovsky, M. Bar-Joseph, D. Boscica, T. Candresse, R.H. Coutts, V.V. Dolja, B.W. Falk, D. Gonsalves, W. Jelkmann, A.V. Karasev, A. Minafra, S. Namba, H.J. Vetten, G.C. Wisler, and N. Yoshikawa. 2002. ICTV Study Group on closteroviruses. The family *Closteroviridae* revised. *Archives of Virology* 147: 2039–2044.
- Martelli, G.P., N. Abou Ghanem-Sabanadzovic, A.A. Agranowsky, M. Al Rawhani, V.V. Dolja, C.I. Dovas, M. Fuchs, P. Gugerli, J.S. Hu, W. Jelkmann, N. Katis, V.I. Maliogka, M.J. Melzer, W. Menzel, A. Minafra, M.E. Rott, A. Rowhani, S. Sabanadzovic, and P. Saldarelli. 2012. Taxonomic revision of the family *Closteroviridae* with special reference to the grapevine leafroll-associated member of the genus *Ampelovirus* and the putative species unassigned to the family. *Journal of Plant Pathology* 94: 7–19.
- Moutinho-Pereira, J., C.M. Correia, B. Goncalves, E.A. Bacelar, J.F. Coutinho, et al. 2012. Impacts of leafroll-associated viruses (GLRaV-1 and -3) on the physiology of the Portuguese grapevine cultivar “Touriga Nacional” growing under field conditions. *Annals of Applied Biology* 160: 237–249.
- Naidu, R.A., and D. Walsh. 2015. Is ‘grape virus tax’ hitting your pocketbook? *Good Fruit Grower* 66 (10): 10–11.
- Naidu, R.A., A. Rowhani, M. Fuchs, D. Golino, and G.P. Martelli. 2014. Grapevine leafroll: A complex viral disease affecting a high-value fruit crop. *Plant Disease* 98: 1172–1185.
- Naidu, R.A., H.J. Maree, and J. Burger. 2015. Grapevine leafroll disease and associated viruses – A unique pathosystem. *Annual Review of Phytopathology* 53: 613–634.
- Namba, S., S. Yamashita, Y. Doi, K. Yora, Y. Terai, and R. Yano. 1979. Grapevine leafroll virus, a possible member of closteroviruses. *Annals of the Phytopathological Society of Japan* 45: 497–502.
- Nolasco, G. 2010. New developments in pathogen detection and identification. *Acta Horticulturae* 940: 615–630.
- Nolasco, G., Z. Sequeira, M.T. Santos, J.C. Sequeira, and O.A. Sequeira. 1997. IC/RT-PCR coupled to exonuclease fluorescent assay. Early-spring detection of GLRaV-3 in leaf petioles. In *Proceedings of the 12th Congress of the International Council for the Study of Virus and Virus-like Diseases of the Grapevine (ICVG)*, Lisbon, Portugal. 28 Sept–2 Oct, 1997, 91–92.

- Osman, F., and A. Rowhani. 2006. Application of a spotting sample preparation technique for the detection of pathogens in woody plants by RT-PCR and real-time PCR (TaqMan®). *Journal of Virological Methods* 133: 130–136.
- Osman, F., C. Leutenegger, D. Golino, and A. Rowhani. 2008. Comparison of low-density arrays, RT-PCR and real-time TaqMan® RT-PCR in detection of grapevine viruses. *Journal of Virological Methods* 149: 292–299.
- Pacifico, D., P. Caciagli, S. Palmano, F. Mannini, and C. Marzachi. 2011. Quantitation of Grapevine leafroll associated virus-1 and -3, Grapevine virus A, Grapevine fanleaf virus and Grapevine fleck virus in field-collected *Vitis vinifera* L. ‘Nebbiolo’ by real-time reverse transcription-PCR. *Journal of Virological Methods* 172: 1–7.
- Peng, C.-W., and V.V. Dolja. 2000. Leader proteinase of the beet yellows closterovirus: Mutation analysis of the function in genome amplification. *Journal of Virology* 74: 9766–9770.
- Peng, C.-W., A.J. Napuli, and V.V. Dolja. 2003. Leader proteinase of the beet yellows virus functions in long-distance transport. *Journal of Virology* 77: 2843–2849.
- Peremyslov, V.V., Y. Hagiwara, and V.V. Dolja. 1999. HSP70 homolog functions in cell-to-cell movement of a plant virus. *Proceedings of the National Academy of Sciences of the United States of America* 96: 14771–14776.
- Peremyslov, V.V., Y.-W. Pan, and V.V. Dolja. 2004a. Movement protein of a closterovirus is a type III integral transmembrane protein localized to the endoplasmic reticulum. *Journal of Virology* 78: 3704–3709.
- Peremyslov, V.V., I.A. Andreev, A.I. Prokhnevsky, G.H. Duncan, M.E. Taliansky, and V.V. Dolja. 2004b. Complex molecular architecture of beet yellows virus particles. *Proceedings of the National Academy of Sciences of the United States of America* 101: 5030–5035.
- Pietersen, G., N. Spreeth, T. Oosthuizen, A. Van Rensburg, M. Van Rensburg, D. Lottering, N. Rossouw, and D. Tooth. 2013. A case study of control of grapevine leafroll disease spread at a commercial wine estate in South Africa. *American Journal of Enology and Viticulture* 64: 296–305.
- Prokhnevsky, A.I., V.V. Peremyslov, A.J. Napuli, and V.V. Dolja. 2002. Interaction between long-distance transport factor and Hsp70-related movement protein of beet yellows virus. *Journal of Virology* 76: 11003–11011.
- Rayapati, A.N., S. O’Neil, and D. Walsh. 2008. Grapevine leafroll disease. *WSU Extension Bulletin*. <http://cru.cahe.wsu.edu/CEPublications/eb2027e/eb2027e.pdf>. Accessed on 14 Mar 2016.
- Reed, J.C., K.D. Kasschau, A.I. Prokhnevsky, K. Gopinath, G.P. Pogue, J.C. Carrington, and V.V. Dolja. 2003. Suppressor of RNA silencing encoded by beet yellows virus. *Virology* 306: 203–209.
- Rezaian, M.A., L.R. Krake, Q. Cunying, and C.A. Hazzalin. 1991. Detection of virus-associated dsRNA from leafroll infected grapevines. *Journal of Virological Methods* 31: 325–334.
- Ricketts, K.D., M.J. Gomez, S.S. Atallah, M.F. Fuchs, T.E. Martinson, M.C. Battany, L.J. Bettiga, M.L. Cooper, P.S. Verdegaal, and R.J. Smith. 2015. Reducing the economic impact of grapevine leafroll disease in California: Identifying optimal disease management strategies. *American Journal of Enology and Viticulture* 66: 138–147.
- Rosciglione, B., and P. Gugerli. 1989. Transmission of grapevine leafroll disease and an associated closterovirus to healthy grapevines by the mealybug *Planococcus ficus* Signoret. In *Proceedings of the 9th Congress of the International Council for the Study of Virus and Virus-like Diseases of the Grapevine (ICVG)*, Kiryat Anavim, Israel, 1989, 13–14.
- Rowhani, A., L. Biardi, R. Johnson, P. Saldarelli, Y.P. Zhang, J. Chin, and M. Green. 2000. Simplified sample preparation method and one-tube RT-PCR for grapevine viruses. In *Proceedings of 13th International Council for the Study of Viruses and Virus-Like Diseases of the Grapevine (ICVG)*, Adelaide, Australia, 2000, 82–83.
- Rybicki, E.P. 2015. A top ten list for economically important plant viruses. *Archives of Virology* 160: 17–20.
- Saldarelli, P., A. Minafra, G.P. Martelli, and B. Walter. 1994. Detection of grapevine leafroll-associated closterovirus III by molecular hybridization. *Plant Pathology* 43: 91–96.

- Sampol, B., J. Bota, D. Riera, H. Medrano, and J. Flexas. 2003. Analysis of the virus-induced inhibition of photosynthesis in malmsey grapevines. *New Phytologist* 160: 403–412.
- Santos, C., M.T. Santos, A.N. Pereira, I. Cortéz, O.A. Sequeira, and G. Nolasco. 2003. Survey of filamentous viruses in Portuguese vineyards. In *International Council for the Study of Viruses and Virus-Like Diseases of the Grapevine (ICVG)*, Locorotondo, 13–17 Sept 2003, 167–168.
- Satyanarayana, T., S. Gowda, M. Mawassi, M.R. Albiach-Marti, M.A. Ayllon, C. Robertson, S.M. Garnsey, and W.O. Dawson. 2000. Closterovirus encoded HSP70 homolog and p61 in addition to both coat proteins function in efficient virion assembly. *Virology* 278: 253–265.
- Satyanarayana, T., S. Gowda, M.A. Ayllon, and W.O. Dawson. 2004. Closterovirus bipolar virion: Evidence for initiation of assembly by minor coat protein and its restriction to the genomic RNA 5' region. *Proceedings of the National Academy of Sciences of the United States of America* 101: 799–804.
- Scheu, G. 1935. Die Rollkrankheit des Rebstockes. *Der Deutsche Weinbau* 14: 222–223, 345–346 and 356–358.
- Scholthof, K.B.G., S. Adkins, H. Czosnek, P. Palukaitis, E. Jacquot, T. Hohn, B. Hohn, K. Saunders, T. Candresse, P. Ahlquist, et al. 2011. Top 10 plant viruses in molecular plant pathology. *Molecular Plant Pathology* 12: 938–954.
- Seah, Y.M., A.M. Sharma, S. Zhang, R.P.P. Almeida, and S. Duffy. 2012. A divergent variant of Grapevine leafroll associated virus 3 is present in California. *Virology Journal* 9: 235.
- Shafiee, H., S. Wang, F. Inci, M. Toy, T.J. Henrich, D.R. Kuritzkes, and U. Demirci. 2015. Emerging technologies for point-of-care management of HIV infection. *Annual Review of Medicine* 66: 387–405.
- Sharma, A.M., J. Wang, S. Duffy, S. Zhang, M.K. Wong, A. Rashed, M.L. Cooper, K.M. Daane, and R.P.P. Almeida. 2011. Occurrence of grapevine leafroll-associated virus complex in Napa Valley. *PLoS ONE* 6: 10.
- Solfaneli, C., A. Poggi, E. Loreti, A. Alpi, and P. Perata. 2006. Sucrose-specific induction of the anthocyanin biosynthetic pathway in *Arabidopsis*. *Plant Physiology* 140: 637–646.
- Tanne, E., Y. Ben-Dov, and B. Raccach. 1989. Transmission of closterovirus-like particles associated with grapevine leafroll by mealybugs (Pseudococcidae) in Israel. In *Proceedings of the 9th Congress of the International Council for the Study of Virus and Virus-like Diseases of the Grapevine (ICVG)*, Kiryat Anavim, Israel, 1989, 15–16.
- This, P., T. Lacombe, and M.R. Thomas. 2006. Historical origins and genetic diversity of wine grapes. *Trends in Genetics* 22: 511–519.
- Thompson, J.R., M. Fuchs, and K.L. Perry. 2012a. Genomic analysis of Grapevine leafroll associated virus-5 and related viruses. *Virus Research* 163: 19–27.
- Thompson, J.R., M. Fuchs, K.F. Fischer, and K.L. Perry. 2012b. Macroarray detection of grapevine leafroll-associated viruses. *Journal of Virological Methods* 183: 161–169.
- Tian, T., L. Rubio, H.-H. Yeh, B. Crawford, and B.W. Falk. 1999. Lettuce infectious yellows virus: In vitro acquisition analysis using partially purified virions and the whitefly. *Journal of General Virology* 80: 1111–1117.
- Tsai, C.-W., A. Rowhani, D.A. Golino, K.M. Daane, and R.P.P. Almeida. 2010. Mealybug transmission of grapevine leafroll viruses: An analysis of virus-vector specificity. *Phytopathology* 100: 830–834.
- Turturo, C., P. Salderelli, D. Yafeng, M. Digiario, A. Minafra, V. Savino, and G.P. Martelli. 2005. Genetic variability and population structure of grapevine leafroll-associated virus 3 isolates. *Journal of General Virology* 86: 217–224.
- Van den Born, E., M.V. Omelchenko, A. Bekkelund, V. Leihne, E.V. Koonin, V.V. Dolja, and P.O. Falnes. 2008. Viral AlkB proteins repair RNA damage by oxidative demethylation. *Nucleic Acids Research* 36: 5451–5461.
- Vega, A., R.A. Gutierrez, A. Pena-Neira, G.R. Cramer, and P. Arce-Johnson. 2011. Compatible GLRaV-3 viral infection affect berry ripening decreasing sugar accumulation and anthocyanin biosynthesis in *Vitis vinifera*. *Plant Molecular Biology* 77: 261–274.

- Visser, M., J.T. Burger, and H.J. Maree. 2016. Targeted virus detection in next-generation sequencing data using an automated e-probe based approach. *Virology* 495: 122–128.
- Walker, A.R., E. Lee, J. Bogsm, D.A.J. McDavid, M.R. Thomas, and S.P. Robinson. 2007. White grapes arose through the mutation of two similar and adjacent regulatory genes. *Plant Journal* 49: 772–785.
- Walsh, H.A., and G. Pietersen. 2013. Rapid detection of Grapevine leafroll-associated virus type 3 using a reverse transcription loop-mediated amplification. *Journal of Virological Methods* 194: 308–316.
- Wang, J., A.M. Sharma, S. Duffy, and R.P.P. Almeida. 2011. Genetic diversity in the 3' terminal 4.6-kb region of Grapevine leafroll associated virus 3. *Phytopathology* 101: 445–450.

Chapter 9

Grapevine leafroll-associated virus 4

N. Aboughanem-Sabanadzovic, V. Maliogka, and S. Sabanadzovic

Abstract *Grapevine leafroll-associated virus 4* is a recognized species in the genus *Ampelovirus*, family *Closteroviridae*, which comprises several genetically diverse variants denominated GLRaV-4 strains 4, 5, 6, 9, De, Car, Pr, and Ob. They are collectively referred to as “grapevine leafroll-associated virus 4-like viruses” (or GLRaV-4LVs). These viruses have been found associated with leafroll disease of grapevine, their sole host known to date. They are characterized by flexuous virions up to 1800 nm in length and a genome made up of a non-polyadenylated, single-stranded, positive-sense RNA molecule of 13.6–13.8 kb in size, depending on the particular strain/molecular variant. In spite of considerable differences in nucleotide content between molecular variants, the genome of all GLRaV-4LVs consists of seven open reading frames (ORFs), flanked by relatively short 5′ and 3′ untranslated regions (UTRs), respectively, that encodes six proteins (in the 5–3′ direction): the replication-associated polyprotein (expressed via +1 ribosomal frameshift of two partially overlapping ORFs), a small hydrophobic protein (p5), the HSP70 homologue (HSP70h), the 60K protein (p60), the viral coat protein (CP), and a protein of unknown function with a molecular mass of 23K (p23). GLRaV-4LVs are phloem-limited, nonmechanically transmissible, and distributed worldwide. Several mealybug and soft scale insect species mediate their short distance spread, while long-distance dissemination occurs primarily through infected propagating material.

Keywords Leafroll • Virus • Grapevine • GLRaV-4 • *Ampelovirus* • *Closteroviridae* • *Vitis vinifera* • Phloem • Mealybug

N. Aboughanem-Sabanadzovic
Institute for Genomics, Biocomputing and Biotechnology, Mississippi State University,
Mississippi State, MS 39762, USA

V. Maliogka
Laboratory of Plant Pathology, School of Agriculture, Faculty of Agriculture, Forestry and
Natural Environment, Aristotle University of Thessaloniki, Thessaloniki, Greece

S. Sabanadzovic (✉)
Department of Biochemistry, Molecular Biology, Entomology and Plant Pathology,
Mississippi State University, Starkville, MS 39762, USA
e-mail: ss501@msstate.edu

Introduction and Historical Aspects

Grapevine leafroll disease (GLRD) is a ubiquitous and economically important disease of cultivated grapevines. Although the name “leafroll” was coined in late 1950s (Goheen et al. 1958), this disorder was already reported under different names from other parts of the world. Indeed, the diseases “rossore” and “rougeau” (translated “reddening”), characterized by premature leaf color change in affected red-berried grapevine plants, have been described in Europe at the dawn of the twentieth century (Arcangeli 1907; Ravaz and Roos 1905; Ravaz and Verge 1924; Sannino 1906). Furthermore, an examination of old herbaria showed the presence of specimens with leafroll-like symptoms in Sicilian vineyards dating back to the mid-nineteenth century, indicating a long history of GLRD presence in European vineyards (Martelli and Piro 1975). The disease was experimentally transmitted by grafting in Germany and the USA (Scheu 1935; Harmon and Snyder 1946), suggesting its viral nature.

Despite experimental proof of graft transmissibility, no specific virus(es) could be identified for decades as being involved in GLRD etiology. The breakthrough discoveries of flexuous particles aggregates and specific, virus-induced, cytopathological alterations consistently present in phloem cells of leafroll-affected vines in the late 1970s/early 1980s advanced understanding about possible etiological agent(s) (Namba et al. 1979; Faoro et al. 1981; Castellano et al. 1983; Gugerli et al. 1984; Rosciglione and Gugerli 1986). Results of these and additional studies suggested the complex etiology of GLRD as several serologically distinct viruses with flexuous virions, denominated grapevine leafroll-associated viruses (GLRaVs), were found in diseased vines.

Grapevine leafroll-associated virus 4 was originally discovered in 1990 (Hu et al. 1990a) in a GLRD-affected grapevine of cv. Thompson from California (lab code CA-4, synonym LR106). The virus did not react with the panel of antibodies specific to the three grapevine leafroll-associated viruses (GLRaV-I, II, or III) known at that time. In the same study, homologous antibodies raised against the virus present in grape CA-4 allowed the detection of an additional isolate of the same virus in cv. Blackrose (lab code CA-3). Based upon results of multiple serological tests and electron microscope observations, the authors concluded that isolates CA-3 and CA-4 belong to a novel, “serotype” of grapevine leafroll viruses, originally named as “serotype IV,” nowadays known as grapevine leafroll-associated virus 4 (Hu et al. 1990a).

A couple of other viruses, denominated GLRaV-5 and GLRaV-6, were described from GLRD-affected wines soon afterward (Gugerli and Ramel 1993; Gugerli et al. 1997; Zimmerman et al. 1990) as they did not react to antibodies specific to four previously recognized leafroll-associated viruses. GLRaV-6 was found in mixed infection with GLRaV-2 in a Swiss vine (cv. Chasselas 8/22). Based upon differences in serology and particle size, the two viruses were originally denominated GLRaV-IIa and GLRaV-IIb (Gugerli and Ramel 1993). During the major revision of the taxonomy and nomenclature of several GLRaVs carried out in 1995,

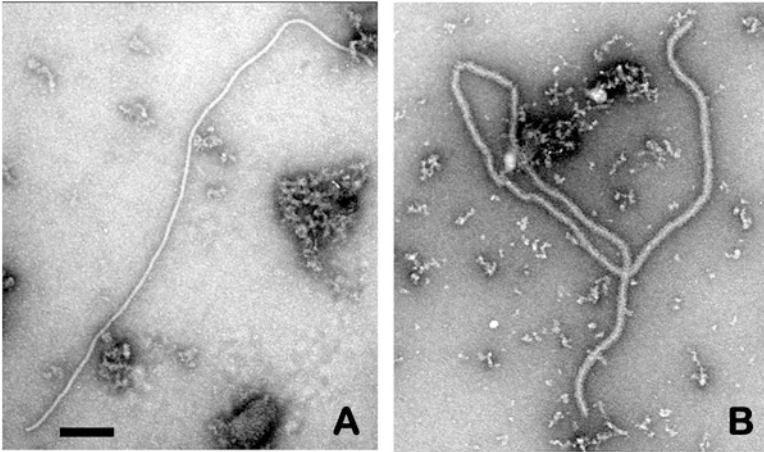

Fig. 9.1 (a) Electron micrographs of partially purified virions of GLRaV-4 strain 5 from cv. Emperor (accessions 9032–9034) at the collection in Nyon (Switzerland), negatively stained with 2% aqueous uranyl acetate. (b) The same preparation decorated by homologous monoclonal antibodies. Bar represents 200 nm (Images courtesy of Dr. Paul Gugerli, Agriscope, Nyon, Switzerland)

GLRaV-IIa was officially renamed GLRaV-6, while GLRaV-IIb became GLRaV-2 (Boscia et al. 1995).

Besides the clear-cut serological distinction between the two viruses coinfecting Chasselas 8/22, GLRaV-6 virions were clearly shorter and measured up to 1800 nm (Fig. 9.1a) compared with GLRaV-2 and, based on “decoration” assays, exhibited a different architecture. While GLRaV-2 contained the so-called tail structure at one end of the particles (not shown), a portion clearly not recognized by homologous MAb, GLRaV-6 virions were uniformly decorated (Fig. 9.1b), (Gugerli and Ramel 1993).

Therefore, the distinction between GLRaVs in 1990s was mainly based upon serological differences, i.e., selective reactivity in Western blots and ELISA to a panel of monoclonal antibodies available at that time. The advent of molecular tools/techniques, which occurred in late 1990s and at the dawn of the twenty-first century, facilitated the study on leafroll-associated viruses and resulted in discovery and genomic characterization of several additional viruses.

All of these viruses contained genomes with virtually identical organization (Fig. 9.2a), but diverse nucleotide sequence content, which ultimately led to a proliferation of preliminary reports on “putative” new species of leafroll-associated viruses (e.g., GLRaV-9, GLRaV-Pr, GLRaV-De, GLRaV-Car) (Abou Ghanem-Sabanadzovic et al. 2010; Alkowni et al. 2004; Cornuet et al. 2003; Elbeaino et al. 2009; Maliogka et al. 2008a, b, 2009; Saldarelli et al. 2006).

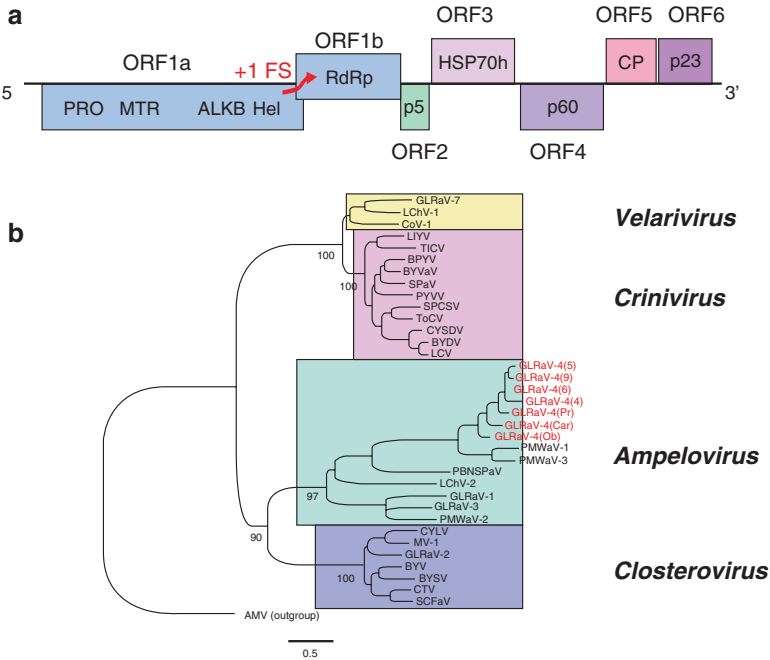

Fig. 9.2 (a) Schematic representation of the genome organization of grapevine leafroll-associated virus 4 (isolate LR106). *Boxes* represent ORFs and corresponding putative products, *lines* represent untranslated genomic regions (UTRs) at the genome extremities. Abbreviations: *MTR* methyltransferase, *PRO* endopeptidase/protease, *AlkB*alkylation B domain, *Hel* helicase, *RdRp* RNA-dependent RNA polymerase, *CP* coat protein, *HSP_h* heat shock protein homolog, *FS* frameshift. Drawings is not to scale. (b) Maximum likelihood-based phylogenetic tree showing the relationships of GLRaV-4LVs (*indicated in red*) with approved members of the family *Closteroviridae*. The tree is based on the amino acid sequences of the viral RNA-dependent RNA polymerase and was generated with MEGA 6.06. (Tamura et al. 2013) under the best-fit substitution model (LG+G+I+F). Bootstrap percentage values out of 1000 replicates are shown on the nodes. The four genera of the family *Closteroviridae* are color-coded and indicated. Names, abbreviations, and GenBank accession numbers of viruses used for generating the tree are bean yellow disorder virus (BYDV, EU19904, EU19905), beet pseudo-yellows virus (BPYV, AY330918, AY330919), beet yellows virus (BYV, X73476), beet yellow stunt virus (BYSV, U51931), blackberry yellow vein-associated virus (BYVaV, AY776334, AY776335), carrot yellow leaf virus (CYLV, FJ869862), citrus tristeza virus (CTV, U16304), cordyline virus 1 (CoV-1; HM588723), cucurbit yellow stunting disorder virus (CYSDV, AJ537493, AJ223619), grapevine leafroll-associated virus 1 (GLRaV-1, AF195822), grapevine leafroll-associated virus 2 (GLRaV-2, AY881628), grapevine leafroll-associated virus 3 (GLRaV-3, AF037268), grapevine leafroll-associated virus 4 strain 4 (GLRaV-4(4), FJ467503), grapevine leafroll-associated virus 4 strain 5 (GLRaV-4(5), AF233934), grapevine leafroll-associated virus 4 strain 6 (GLRaV-4(6), FJ467504), grapevine leafroll-associated virus 4 strain 9 (GLRaV-4(9), AY297819), grapevine leafroll-associated virus 4 strain De (GLRaV-4(De), AM494935), grapevine leafroll-associated virus 4 strain Ob (GLRaV-4(Ob), KP313764), grapevine leafroll-associated virus 4 strain Pr (GLRaV-4(Pr), AM182328), grapevine leafroll-associated virus 7 (GLRaV-7; NC_016436), lettuce chlorosis virus (LCV; NC_012909, NC_012910), lettuce infectious yellows virus (LIYV, U15440, U15441), little cherry virus 1 (LChV-1, Y10237), little cherry virus 2 (LChV-2, AF531505), mint virus 1

Taxonomy and Nomenclature

The official nomenclature and taxonomic status of these viruses was uncertain for a relatively long time. Each new virus discovered after GLRaV-6 was named differently, either by progressive numbering (i.e., grapevine leafroll-associated virus 9 (GLRaV-9)) or by specific letter code (i.e., GLRaV-Car, GLRaV-Pr, GLRaV-De, etc.). These new viruses appeared serologically distinct from previously reported ones, as they did not react with a panel of monoclonal antibodies (MAbs) specific to GLRaV-4, GLRaV-5, and GLRaV-6. However, due to the lack of substantial genome sequence data for the three “original” viruses of this group (GLRaV-4, GLRaV-5, and GLRaV-6), it was impossible to compare newly characterized viruses with those already reported in the literature. Accordingly, it was not possible to make any official decisions concerning the taxonomic classification of these viruses following the rules of the International Committee on Taxonomy of Viruses (ICTV).

The recent completion of the complete or near full-length genome sequence for GLRaV-4, GLRaV-5, and GLRaV-6 (Abou Ghanem-Sabanadzovic et al. 2012; Thompson et al. 2012b) allowed a thorough revision of the taxonomic status and modification of the nomenclature of these viruses through a collaborative effort of an international group of experts (Martelli et al. 2012a).

Phylogenetic analyses of any of the three virus-coded proteins used for inferring taxonomic relationships among members in the family *Closteroviridae* (RNA-dependent RNA polymerase (RdRp), heat shock protein 70 homologue (HSP70h), and coat protein (CP)) clearly showed that GLRaV-4LVs are monophyletic and belong to an evolutionary lineage distinct from that of GLRaV-1 and GLRaV-3 within the genus *Ampelovirus* (Abou Ghanem-Sabanadzovic et al. 2012; Alkowni et al. 2004; Maliogka et al. 2009; Martelli et al. 2012a; Reynard et al. 2015; Thompson et al. 2012b). Indeed, GLRaV-4LVs form a tight cluster characterized by low evolutionary distances among members, especially among GLRaV-4, GLRaV-5, GLRaV-6, and GLRaV-9, while GLRaV-Car, GLRaV-Pr, and GLRaV-Ob appear more distinct members of this cluster (Fig. 9.2b).

Detailed pairwise comparisons of available complete genome sequences showed that all these viruses have virtually identical genome size and organization. In addition, the extent of sequence differences among these viruses is comparable to those observed among the most divergent isolates in other GLRaVs (i.e., GLRaV-1, GLRaV-2, and GLRaV-3) and do not exceed 25% at the aa level, currently used as

←
Fig. 9.2 (continued) (MV-1, AY792620), pineapple mealybug wilt-associated virus 1 (PMWaV-1, AF414119), pineapple mealybug wilt-associated virus 2 (PMWaV-2, AF283103), pineapple mealybug wilt-associated virus 3 (PMWaV-3, DQ399259), plum bark necrosis and stem pitting-associated virus (PBNPaV, EF546442), strawberry chlorotic fleck-associated virus (SCFaV, DQ860839), strawberry pallidosis-associated virus (SPaV, AY488137, AY488138), sweet potato chlorotic stunt virus (SPCSV, AJ428554, AJ428555), potato yellow vein virus (PYVV, AJ557128, AJ557129), and tomato chlorosis virus (ToCV, EU284744, EU284745). The RdRp domain of alfalfa mosaic virus (AMV, L00163) was used as an outgroup

the species demarcation threshold by the Closteroviridae Study Group of the ICTV (Martelli et al. 2012a, b). Hence, similarities in molecular traits, along with their similar biological and epidemiological features and virion size and morphology, suggested that these viruses represent distinct molecular strains of a sole species rather than prototypes of several distinct taxa.

Accordingly, the current taxonomy (<http://www.ictvonline.org/virusTaxonomy.asp>) recognizes only one species, denominated *Grapevine leafroll-associated virus 4* (classified in the genus *Ampelovirus*, family *Closteroviridae*), that embraces several distinct genetic strains/molecular variants formerly considered members of “putative” new species (GLRaV-5, GLRaV-6, GLRaV-Pr, GLRaV-Car, GLRaV-De, etc.).

In this chapter, terminology and acronyms proposed during the recent taxonomic revision (Martelli et al. 2012a) are adopted. Therefore, specific viruses will be individually referred to as GLRaV-4 strain 4, GLRaV-4 strain 5, GLRaV-4 strain 6, GLRaV-4 strain 9, GLRaV-4 strain Pr, GLRaV-4 strain Car, GLRaV-4 strain Ob, or will collectively be referred to as “grapevine leafroll-associated virus 4-like viruses” (GLRaV-4LVs).

Genome Structure, Genome Expression, and Replication

Complete or near-complete genome sequence data have been published for several GLRaV-4LVs (Abou Ghanem-Sabanadzovic et al. 2010, 2012; Alkowni et al. 2004; Maliogka et al. 2009; Reynard et al. 2015; Thompson et al. 2012b; Velasco et al. 2015). In addition, several yet unpublished sequences are available in GenBank.

Albeit differences in the overall size and nucleotide content between variants, the genome organization of all GLRaV-4LVs is highly conserved (Fig. 9.2a). As previously reported (Abou Ghanem-Sabanadzovic et al. 2012; Maliogka et al. 2009; Reynard et al. 2015; Thompson et al. 2012a), the genome size and organization of these viruses closely resemble that of the common ancestor of viruses belonging to the family *Closteroviridae* proposed by Dolja et al. (2006). Therefore, these viruses, along with pineapple mealybug wilt-associated 1 (PMWaV-1), pineapple mealybug wilt-associated virus 3 (PMWaV-3), and plum bark stem necrosis stem pitting-associated virus (PBSNPaV), likely represent the most ancient lineage within extant closteroviruses.

The genome of GLRaV-4 isolate “CA-4” (*syn.* LR106) is composed of a positive-sense, single-stranded RNA molecule of 13,830 nucleotides (nt) in size and characterized by an overall A+U content of 56% (Abou Ghanem-Sabanadzovic et al. 2012). The coding part of the genome consists of seven open reading frames (denominated ORFs 1A, 1B, 2–6) that are flanked by untranslated regions (UTRs) of 217 and 129 nt in length at the 5′ and 3′ ends, respectively (Fig. 9.2a).

The first ORF (ORF 1a) codes for a 2345 aa-long polyprotein with estimated molecular mass of 260.1 kDa (p260). The polyprotein contains signature motifs of

several domains conserved in all closterovirids: (1) papain-like protease (P-PRO) with conserved catalytic cysteine (Cys) and histidine (His) residues (Peng et al. 2001), (2) viral methyltransferase (MTR) (pfam 01660), and (3) viral helicase (HEL) (pfam 01443) belonging to superfamily 1. In addition, an AlkB domain (van den Born et al. 2008), reported only from a subset of members of the family (i.e., PMWaV-1, PMWaV-3, PBNSPaV, little cherry virus 2, and GLRaV-3) and in some flexiviruses, is present in the protein p260 (see Chap. 32 of this book).

ORFs 1a and 1b overlap by eight nucleotides. The overlapping region between these two ORFs is characterized by the presence of highly conserved sequences surrounding the stop codon of ORF1a (5-...auguuUAGca/gu...-3' – stop codon underlined). These sequences are similar to those presumably involved in a +1 ribosomal frameshift phenomenon in beet yellows virus (BYV) (Agranovsky et al. 1994) and other closterovirids. The putative product of ORF1b, of estimated molecular mass of 58 kDa, contains all eight conserved motifs of viral RNA-dependent RNA polymerases (Koonin and Dolja 1993).

Coding portions of the GLRaV-4 genome continue with a small ORF (ORF2) that codes for 46 aa-long hydrophobic protein (p5) putatively involved in cell-to-cell movement. ORF3 encodes the 58 kDa HSP70 homologue protein, a hallmark of closteroviruses. ORF4 partially overlaps with the previous cistron and extends for 539 codons. It encodes a 60 kDa protein with the C-terminal CP-like domain (Napuli et al. 2003) belonging to the “viral_HSP90 superfamily” (Pfam 03225) with roles in virus movement in plants and virion tail assembly (Dolja et al. 2006; Peremyslov et al. 1999). An 819 nt-long ORF5 codes for the viral coat protein with a molecular mass of ca. 29.6 kDa. The size of this ORF, as well as its product, can vary slightly in different strains from 261 aa in GLRaV-4 strain Otcha bala to 273 aa in GLRaV-4 strain Pr. The coding part of the GLRaV-4 genome terminates with an ORF of 624 nt in length encoding for a putative p23 protein with unknown function. The genome of GLRaV-4 ends with the 129 nt-long 3' untranslated region. In silico studies suggest that the 3'UTR of all GLRaV-4Vs folds to form five possible stem-loop structures, which are preserved not only in these viruses but also in the evolutionarily related PMWaV-1 and PMWaV-3 (Thompson et al. 2012a).

By analogy with other closterovirids for which reverse genetics have been developed and the function of single genomic products have been experimentally demonstrated, it is inferred that GLRaV-4 ORFs 1a and b are expressed from genomic RNA (gRNA) employing +1 ribosome frameshift strategy (Fig. 9.2a). Therefore, direct translation of gRNA results in two large polyproteins: one coded by ORF1a and containing the PRO-MTR-AlkB-HEL domains and a more complex one, as a fused product of frameshift-driven translation of ORF1b. This polyprotein, composed of PRO-MTR-AlkB-HEL-RdRp domains, is presumably produced in lower amount due to the low frequency of frameshift phenomenon (Dolja et al. 2006).

ORFs 2–6 are expressed from a set of 3' coterminal subgenomic RNAs (sgRNAs). The number of sgRNAs produced in infected cells usually corresponds to the number of ORFs downstream of ORF1B. These sgRNAs are functionally monocistronic and ensure only the expression of the 5'-proximal cistron. The presence of dsRNA molecules, representing replicative forms of viral sgRNAs, in GLRaV-4 infected

tissue has been experimentally demonstrated (Abou Ghanem-Sabanadzovic et al. 2010, 2012; Alkowni et al. 2004; Maliogka et al. 2009).

A distinguishing feature of the GLRaV-4LVs genome when compared to other GLRaVs is the apparent absence of a minor coat protein. A similar situation is observed for PMWaV-1 and PMWaV-3, the closest relatives of GLRaV-4LVs (Melzer et al. 2008).

In the case of GLRaV-4LVs, protein p23 encoded by ORF6 does not appear to be a paralog of the CP because of a lack of aa identities between these two proteins and absence of an identifiable “Closter_Coat” (pfam01785) domain (Abou Ghanem-Sabanadzovic et al. 2012; Maliogka et al. 2009; Reynard et al. 2015; Thompson et al. 2012a). This is in clear contrast with other closterovirids that display significant conservation between CP and Cpm in their C-termini. The role of Cpm in tail formation has been demonstrated in the case of BYV and CTV virions (Alzhanova et al. 2007; Satyanarayana et al. 2004).

Immuno-electron microscope studies performed primarily by Dr. Paul Gugerli in Switzerland strongly suggested no tail structure and “rattlesnake” morphology in GLRaV-4LVs virions (Fig. 9.1a, b). These structures were originally described for several closter- and criniviruses and assumed to be a “standard” for virion architecture of members in the family *Closteroviridae* (Agranovsky et al. 1995; Febres et al. 1996; Tian et al. 1999). As mentioned, virions of GLRaV-4 strain 6 from the original source “Chasselas 8/22” were uniformly “decorated” by a homologous monoclonal antibody, while GLRaV-2 particles, co-purified from the same plant, showed the distinct presence of a non-decorated tail structure at one of viral ends (Abou Ghanem-Sabanadzovic et al. 2012; Gugerli et al. 1997). Assuming that GLRaV-6 has a bipolar virion as other closteroviruses, such results could be interpreted by the presence of a common antigenic site between CP and p23, or by the extreme fragility of virions in the case of GLRaV-4LVs compared to GLRaV-2, and their loss during some of the purification steps.

The role of p23 in GLRaV-4LVs and similar viruses (PMWaV-1, PMWaV-3, and PBNPaV) is yet to be experimentally studied and understood. The expression of the ORF-encoded protein P23 and production of homologous antibodies, along with additional molecular, serological, and electron microscopy approaches, should be a priority in future studies concerning these viruses to shed light on the function of p23.

Genetic Diversity and Population Structure

The comparison of ten representative sequences of GLRaV-4LVs (complete or near-complete genome) showed a great divergence, averaging approximately 75–80% or less identity at the nt level among different strains. The most diverged genomes are those of GLRaV-4 strains Car and Ob (Abou Ghanem-Sabanadzovic et al. 2010; Reynard et al. 2015) both of which differ from other strains by 40% or more. Curiously, they also mutually share only 60% of common nucleotides. On the other

hand, genomes of two isolates of GLRaV-4 strain 5, Y217 (FR822696, Thompson et al. 2012b), and 3183-03 (JX559639) are virtually identical, differing only by 0.68% at the nt level. Similarly, the two published sequences of GLRaV-4 strain 9 differ only by 5% at the nt level (Alkowni et al. 2004; Velasco et al. 2015). Another isolate of a highly divergent GLRaV-4 strain Ob was reported from Japan (Ito et al. 2013). Whether such genetic hypervariability among different GLRaV-4 strains is reflected in different pathogenicity or peculiar ecological traits is yet to be understood.

Additionally, more than 250 partial nucleotide sequences, mostly referring to HSP70h and CP genes, are currently available in GenBank for various isolates of different strains of GLRaV-4 (accessed September 2016). More than a half of deposited sequence data refers to GLRaV-4 strain 5.

Multiple alignments and pairwise comparisons among HSP70h proteins showed differences in aa content ranging from 10% between GLRaV-4 strains 5 and 9 to 33–34% between GLRaV-4 strains Car and Ob with other strains. Curiously, divergence among GLRaV-4 strains Ob and Car in HSP70h reaches 32%. CP sequence differences among strains ranges from 14–15% (GLRaV-4 strains 5, 6, and 9) to 23–24% (GLRaV-4 strains Car, Ob, and Pr). In general, Car and Ob were the most divergent and represent borderline members of this species.

Genetic variability has also been observed for isolates of the same strain of GLRaV-4LVs. The study encompassing 15 field isolates of GLRaV-4 strain 5 carried out in Portugal (Esteves et al. 2012) reported genetic differences among viral sequences present in single plants, as ascertained by the diversity of SSCP profiles. In addition, these authors compared 80 complete sequences of the CP gene available in public databases and generated in their work and observed clustering into eight lineages (Esteves et al. 2012).

On the other hand, a detailed study on genetic variability and evolutionary dynamics of members in the family *Closteroviridae* revealed three genetic groups in a population of GLRaV-4 strain 4 isolates despite the fact that the dataset was composed only by five sequences. A similar dynamics was observed for isolates of GLRaV-4 strain Pr (seven isolates belonging to five genetic groups). The same study investigated possible recombination events in the CP gene of closterovirids and suggested one recombination event among five GLRaV-4 strain 4 isolates. GLRaV-4 strain Pr had four recombinant isolates out of 15 studied. Curiously, all four isolates presented the same recombination event (Rubio et al. 2013). No recombinant isolates were identified for GLRaV-4 strain 5 among 79 isolates studied.

Positive selection analyses for HSP70h and CP genes of these viruses indicated that purifying selection was a major driving force of GLRaV-4LVs evolution (Maliogka et al. 2008). The authors hypothesized that this virus lineage had reached an adaptive peak reflected in a lower overall pathogenicity (in terms of consistency of association with GLRD symptoms) compared to GLRaV-1 and GLRaV-3 (Maliogka et al. 2008b). A study of GLRaV-4 strain 5 isolates in Portugal indicated the CP and HSP90h genes are under purifying selection (Esteves et al. 2012).

Finally, multiple alignments and pairwise comparisons between CPs of different strains revealed unusually sharp differences in the level of conservations between aa

in their amino (N) and carboxyl (C) termini. While the C-terminal portion of these proteins appeared virtually identical in all studied GLRaV-4LVs, the aa sequences of the extreme N-terminal region (initial 40–50 aa) were highly variable (not shown). Curiously, the analyses of hydrophobic profiles of CP revealed a strong immunogenic index for the N-terminal domains for all the GLRaV-4LVs suggesting that this part of the viral CP is exposed on the virion surface (Maliogka et al. 2008). Therefore, hypervariability present in the N-termini of viral CPs may account for sharp serological differences among different strains reported in a number of studies (Maliogka et al. 2008a).

Detection and Diagnosis

Different laboratory-based methods, ranging from biological to molecular assays, have been developed over the last years for the detection of GLRaV-4 and similar viruses in grapevines. They vary in sensibility and specificity as some of detection methods can be applied for universal detection of all GLRaV-4LVs, whereas others can be used for strain-specific discrimination (i.e., GLRaV-4 strains 4, 5, 6, 9, Car, Pr, and Ob).

Biological Methods Infections by GLRaV-4 and its strains can be detected by reactions induced on red-berried cultivars of *Vitis vinifera* used as indicators for leafroll disease. The choice of specific indicators may vary among different laboratories but the most commonly used are Cabernet franc, C. Sauvignon, Merlot, Pinot noir, Mission, Gamay rouge de la Loire, etc.

In general, the reaction induced by GLRaV-4LVs on indicator plants is milder compared to GLRaV-1 and GLRaV-3 and consists of premature reddening of interveinal foliar tissue, as well as mild downward rolling (Fig. 9.3). Indexing can be performed either in the field or in the greenhouse. An indexing procedure developed in France, called “green grafting,” for greenhouse work can considerably accelerate diagnosis by GLRaV-4 strain 6 compared to field indexing (Gugerli 2000).

Serological Methods Several polyclonal and monoclonal antibodies have been raised against GLRaV-4 and its strains starting from its original characterization (for a detailed review, see Gugerli 2009). Briefly, polyclonal antisera (PAb)s or monoclonal antibodies (MAb)s are available for GLRaV-4 strains 4, 5, 6, 9, and Ob (Besse et al. 2009; Hu et al. 1990a; Gugerli et al. 2009; Gugerli and Ramel 1993; Gugerli et al. 1997; Maliogka et al. 2009; Reynard et al. 2015; Saldarelli et al. 2006; Zimmerman et al. 1990a). The majority of these antibodies were raised using partially purified virions as an antigen, while the antiserum to GLRaV-4 strain Pr was produced using the in vitro cloned and expressed CP gene (Maliogka et al. 2009). Generally speaking, PAb)s to GLRaV-4LVs often cross-react with viruses that infect the plant used as a source for antigen purification and cannot discriminate among strains of the virus. On the other hand, MAb)s are often variant-specific and do not recognize nonhomologous strains of GLRaV-4.

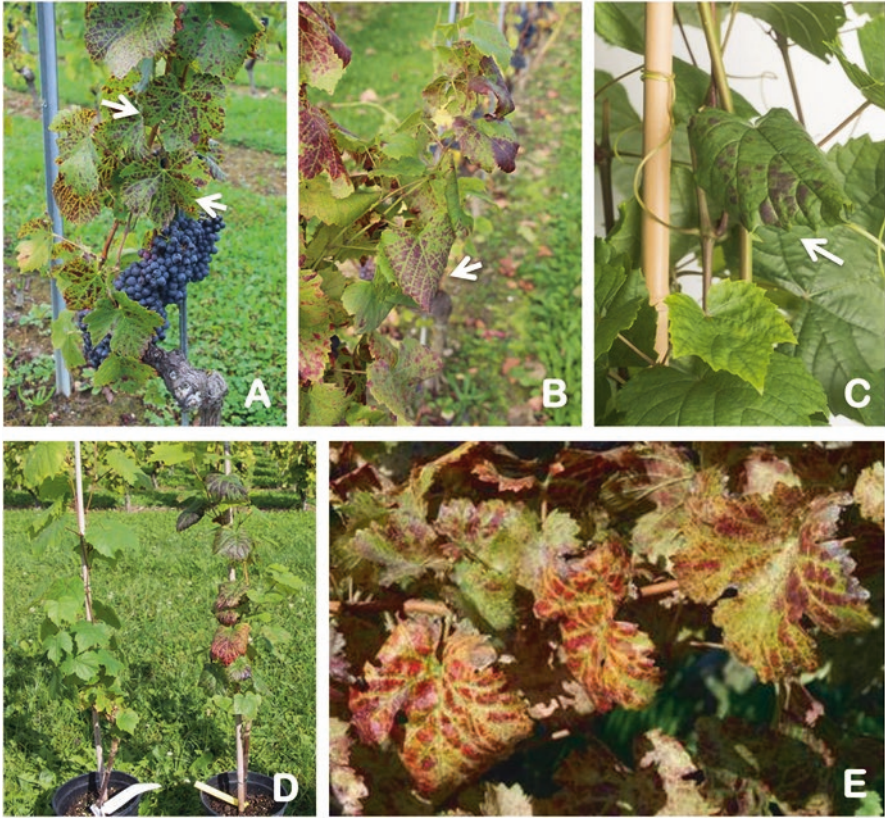

Fig. 9.3 Symptoms induced on cv. Gamay rouge de la Loire graft-inoculated with GLRaV-4 isolate LR106 (a) and GLRaV-4 strain 5 from cv. Emperor from the collection at Nyon, Switzerland (b). Initial symptoms of reddening and downward rolling induced by GLRaV-4 strain Otcha bala (GLRaV-4 Ob; Reynard et al. 2015) on cv. Gamay (c). Panel (d) contains advanced symptoms caused by GLRaV-4 Ob in graft-inoculated cv. Gamay (right) compared to healthy control (left). Interverveinal reddening and mild downward leaf rolling observed on the foliage of cv. Cabernet Franc graft-inoculated with GLRaV-4 strain Car is presented in panel E (Abou Ghanem-Sabanadzovic et al. 2010) (Images a–d are courtesy of Dr. Jean-Sébastien Reynard (Agriscopie, Nyon, Switzerland), while image E was kindly provided by Dr. Adib Rowhani (University of California, Davis, USA))

Some of these antibodies were developed only for noncommercial use, but several of them have found proper place on the international market of lab diagnostics and are commercialized by specialized companies.

As in the case of other viruses, ELISA is still a preferred choice for routine diagnosis of GLRaV-4LVs as the overall quality of commercial kits has considerably improved over the past years. A good example is an ELISA kit composed by a mixture of MAbs that can recognize GLRaV-4 strains 4, 5, 6, and 9 (Besse et al. 2009).

Besides traditional ELISA kits based on chromogenic reaction, a chemiluminescence-based format of ELISA test (LUMINO-ELISA) was developed in Switzerland (Gugerli 2000). This assay showed advantages over “classic” (chromogenic) ELISA such as increased sensitivity and at least a tenfold higher detectability. However, LUMINO-ELISA is not suited for PABs and requires an expensive luminescence reader for numeric recording of results (Gugerli 2000).

Western blots, along with electron microscopy and ELISA, have represented “core” assays used for discrimination between GLRaVs in early studies on these viruses (Boscia et al. 1995; Gugerli and Ramel 1993; Hu et al. 1990a, b; Zimmerman et al. 1990a, b). This technique is still a valid complementary tool for studying these viruses and has been employed in several recent studies (Abou Ghanem-Sabanadzovic et al. 2012; Reynard et al. 2015).

dsRNA Extraction and Analysis Although not a virus-specific diagnostic method, extraction of replicative forms of genomic and subgenomic molecules from GLRaV-4-infected grapevine tissues has proven as a good method for general detection of this type of viruses (Abou Ghanem-Sabanadzovic et al. 2010, 2012; Hu et al. 1991; Fazeli et al. 1998; Maliogka et al. 2008a, b). Additionally, dsRNA extracts are an excellent substrate for further molecular characterization (i.e., RT-PCR, probe synthesis or cloning, and genome sequencing) and have been extensively used in many laboratories throughout the world.

Patterns consisting of multiple, high-molecular-weight dsRNA molecules, which are typical of closterovirid infections, are relatively easy to recognize even by less experienced scientists. However, it must be kept in mind that seasonal variability in concentration may affect the quality and quantity of the dsRNA extracts. Additionally, because of frequent mixed infections, the dsRNA patterns extracted from GLRD-affected tissues are often nonhomogenous, consisting of GLRaVs-specific molecules and similar molecules produced by other viruses infecting the sample. Therefore, dsRNAs patterns alone cannot be utilized for final virus identification, unless they are hybridized with virus-specific probes.

However, there are some general observations to consider while applying this approach. First, GLRaV-4-associated dsRNAs are less abundant in infected grapevine tissues compared to those affected by GLRaV-1, GLRaV-2, and GLRaV-3 (Hu et al. 1991; S. Sabanadzovic and N. Aboughanem-Sabanadzovic, unpublished data). This may be due to an overall lower concentration of these viruses compared to other GLRaVs, as reported in a study from Spain (Velasco et al. 2013). Second, the patterns induced by various GLRaV-4 strains are not distinguishable (S. Sabanadzovic and N. Aboughanem-Sabanadzovic, unpublished data).

Molecular Methods Initial molecular methods applied for the detection and identification of GLRaV-4LV were based on the use of highly degenerate primers designed on conserved sequences of the HSP70h gene universally present in members of the family *Closteroviridae* (Tian et al. 1996). The procedure was adapted to grapevine-infecting closterovirids and coupled with an immunocapture step (Routh et al. 1998; Saldarelli et al. 1998). These assays allowed initial sequencing of a 550–600 nt-long portion of the HSP70h gene of GLRaV-4 and GLRaV-4 strain 5

that were used for the design of virus-specific primers (Routh et al. 1998). Contemporarily, a set of GLRaV-4-specific RT-PCR methods targeting the CP gene was developed in Australia (Fazeli et al. 1998).

A myriad of virus-specific primers, mostly designed on HSP70h and CP ORFs, were designed and used for the detection and study of different GLRaV-4LVs in various parts of the world (Buzkan et al. 2010; Engel et al. 2008, 2010a, b Escobar et al. 2008; Esteves et al. 2012; Good and Monis 2001; Liu et al. 2013; Padilla et al. 2010, 2013).

A spot nested RT-PCR assay using degenerate deoxyinosine-containing primers was developed in 2003 targeting the HSP70h gene and allowing a rapid and simultaneous detection of leafroll-associated viruses, including several isolates of GLRaV-4 strains 5 and 6 (Dovas and Katis 2003). Nested PCR amplification considerably increases specificity and sensitivity of detection compared to one-round RT-PCR. The same primer set has been successfully used for generic detection of all viruses belonging to the GLRaV-4 group known at the time (strains 4, 5, 6, 9, De, and Pr) (Maliogka et al. 2008b). In that study, new virus-specific primers were designed and applied in multiplex format for the simultaneous and discriminative detection of any of these viruses (Maliogka et al. 2008). Finally, the degenerate primers LRampF and LRampR, based on the conserved 3' terminal portion of ORF6 and part of the 3' UTR, were developed and applied for the detection of all GLRaV-4LVs (Abou Ghanem-Sabanadzovic et al. 2012).

Real-time RT-PCR assays involving TaqMan chemistry were developed for the specific detection of GLRaV-1–5 and GLRaV-9 and evaluated against a wide range of isolates of different geographic origin (Osman et al. 2007). These assays were compared with the conventional one-step RT-PCR using purified total RNA as well as crude plant extract. TaqMan assay resulted more sensitive for testing different isolates of these viruses either using RNA or crude tissue extract (Osman et al. 2007).

In an attempt to further improve the diagnostics, a sensitive, high-capacity low-density array (LDA) system was developed and investigated for the simultaneous detection of several viruses in infected grapevines, including GLRaV-4LVs (Osman et al. 2008). The comparison of three different methodologies (LDA, qRT-PCR, and RT-PCR) on 29 different grapevine samples with multiple infections suggested that LDA is a very sensitive method that is comparable to real-time TaqMan® RT-PCR. Further advantage of the LDA methodology is that it eliminates any post-PCR manipulations and need for gel electrophoresis and reduces cross-contamination problem (Osman et al. 2008).

A 70-mer oligonucleotide microarray containing 570 unique probes was developed for the simultaneous detection of ten grapevine viruses (Engel et al. 2010b) and validated by virus-specific RT-PCR tests. This study allowed the first detection of GLRaV-4 strains 4 and 9 in Chile proving its potential for diagnostics of these viruses.

Furthermore, a macroarray assay for the detection of all major GLRaVs, including GLRaV-4 strains 4, 5, 6, 9, and Pr, has recently been developed at Cornell University and successfully applied on 33 grapevine samples in comparison with

ELISA and RT-PCR (Thompson et al. 2012a). Results from macroarrays matched those from the other two tests in 25 out of 33 tested samples. Concerning GLRaV-4LVs detection in particular, microarrays underperformed in three samples, which was understandable because the microarrays were designed prior to the availability of complete sequences of several GLRaV-4 LVs (i.e., data were missing for GLRaV-4 strains 4, 5, 6, and Ob) (Thompson et al. 2012a). A modified and improved macroarray version named “Grapearray4” (containing 1578 virus-specific and 19 internal probes of 60–70 nt in size) was developed and applied for the simultaneous detection of 38 viruses in 99 vines. This macroarray contained specific probes to GLRaV-4 strains 4, 5, 6, 9, De, Pr, and Car and performed well, as ascertained by ELISA and/or RT-PCR confirmatory tests (Thompson et al. 2014).

RNA probes have not been widely used in studies of GLRaV-4LVs compared with some other viruses. Nevertheless, virus-specific probes were synthesized and applied in two early studies (Fazeli et al. 1998; Routh et al. 1998). Fazeli and coauthors reported synthesis of random-primed, ^{32}P -labeled probe and its successful application in Northern blots (Fazeli et al. 1998) to study GLRaV-4 replication. On the other hand, a nonradioactively (digoxigenin) labeled probe transcribed from a cloned GLRaV4 PCR product was synthesized by Routh et al. 1998.

Finally, high throughput sequencing (HTS) has been increasingly used as an unbiased and robust approach for plant virus diagnosis. HTS has not become a routine choice for the average diagnostic laboratory due to the still relatively high costs and processing times. Another limiting factor is a need for certain computer skills and strong cyber infrastructure if the analyses of HTS data are performed “in house” and not commercially. With the ongoing increase in commercial, custom-based services offered by numerous companies worldwide, there is no doubt that HTS will become a major part of virus diagnostics, especially in programs concerning the production of clean propagation stocks.

Host Range and Transmission

GLRaV-4 strains are reported from different grape-growing regions of the world. After the original report from California, these viruses have been recorded from Europe (Boscia et al. 2000; Esteves et al. 2012; Gugerli et al. 1997; Komorowska et al. 2012; Padilla et al. 2010; Štrukelj et al. 2016; Walter and Zimmermann 1991), Australia (Peake et al. 2004), South America (Engel et al. 2008, 2010a; Escobar et al. 2008; Fajarado et al. 2012; Gómez Talquenca et al. 2009), Africa (Mafhoudhi et al. 2009), and Asia (Buzkan et al. 2010; Ito et al. 2013; Pei et al. 2010; Turkmen et al. 2012).

Vitis spp. are the only known natural host of GLRaV-4LVs. None of GLRaV-4LVs is mechanically transmissible. These viruses are transmitted by grafting and disseminated by the movement of virus-infected planting material. In addition, several mealybugs and a soft scale insect are known to transmit GLRaV-4 within and between adjacent vineyards.

A conference paper presented at the 11th ICVG Meeting in 2003 represents the original report on successful transmission of GLRaV-4 strains 5 and 9 by a long-tailed mealybug (*Pseudococcus longispinus*) after an inoculation access period of 2 weeks and employing groups of 10–20 mealybugs (Sim et al. 2003).

In a study conducted in Tunisia, GLRaV-4 strain 5 was transmitted by a mealybug *Planococcus ficus* and a soft scale insect *Ceroplastes rusci* with the efficiencies of 8.3% and 1.7%, respectively (Mafhoudhi et al. 2009). In the same experiments, GLRaV-3 was transmitted at higher rates by both vectors (23.3% and 3.3%). The same study demonstrated that juvenile instars of *P. ficus* were more efficient virus vectors than adult females of the same insect. Subsequently, *P. ficus* was reported to be a vector of a Cypriot isolate of GLRaV-4 strain Pr (Elbeaino et al. 2009). RT-PCR with strain-specific set of primers detected the virus in all six plants used as recipients 2 months post-inoculation.

Transmission experiments carried out in California on GLRaV-1, GLRaV-2, GLRaV-3 and several strains of GLRaV-4 using *P. ficus* and *Pseudococcus longispinus* showed no evidence of mealybug-GLRaV specificity (Tsai et al. 2010) as one vector (*P. ficus*) was capable of transmitting five different viruses or strains, while GLRaV-3 and GLRaV-4 strain 9 were transmitted by both insects used in experiments. This study showed the high variability in transmissibility rates among GLRaV-4 strains: in experiments conducted with five or 20 individuals, none of the four isolates of GLRaV-4 strain 5 (LR100, LR102, LV92-04, LV93-09) were transmitted by either insect vector after a 24 h inoculation access period. In the same experiments, GLRaV-4 strain 9, from the original source LR118, was successfully transmitted by 20 individuals of both mealybugs with transmission efficiency of 20% (*P. ficus*) and 17.6% (*Ps. longispinus*). The original GLRaV-4 isolate (LR106) was transmitted on one out of 10 plants inoculated with 20 *P. ficus* mealybugs. Nevertheless, after failed transmission attempts involving five and 20 mealybugs, an isolate of GLRaV-4 strain 5 from source LR102 was detected in four out of ten plants inoculated by 50 *P. ficus* individuals, showing the importance of the amount of inoculum for successful transmission (Tsai et al. 2010).

Study conducted in France showed that another mealybug, *Phenacoccus aceris*, is able to transmit four different strains of GLRaV-4 (4, 5, 6, and 9) in experiments performed with 50 first instar nymphs of *Ph. aceris* and acquisition and inoculation access periods of 48 h. The efficiency of transmission in these experiments varied from 15% (GLRaV-4 strain 6) to 53% (GLRaV-4 strain 9). This study represents the first report on GLRaV-4 strain 6 transmissions by a mealybug vector (Le Maguet et al. 2012).

A recent study showed that *Ferrisia gilli* (Hemiptera: Pseudococcidae), originally described as a pest of pistachios and almonds in San Joaquin Valley, which has recently become an emerging problem on grapes in certain regions of California, can transmit the original isolate of GLRaV-4 (LR106) under experimental conditions, although with a much lower efficiency than for GLRaV-3 (Wistrom et al. 2016). The same study reported high transmission efficiency of strains 4 and 9 by 50 individuals of *P. ficus* (five out of six plants) and an acquisition access period of 2 days. Curiously, transmission of either GLRaV-3 or GLRaV-4 was reduced when

the acquisition access period was extended to 8 days (Wistrom et al. 2016). In a separate study, the same group of scientists found no evidence of GLRaV-4 transmission by phylloxera (*Daktulosphaira vitifoliae*) (Wistrom et al. 2017).

Therefore, dissemination of GLRaV-4 viruses at a site is mediated by several species of mealybugs and/or soft scale insects. Nevertheless, movement and exchange of infected propagative material (budwood, rootstocks, nursery productions) and grafting operations have contributed to the worldwide distribution of GLRaV-4VLs.

Cytopathology, Tissue Tropism, and Virus-Host Interactions

Despite the fact that cytopathological observations of infected cells indicated the viral nature of leafroll disease of grapevine, knowledge on specific subcellular effects due to infections by GLRaV-4LVs is limited. In a recent comprehensive review on grapevine leafroll viruses, it was reported that infections by one GLRaV-4 isolate were characterized by the presence of membranous vesicles “derived from peripheral vesiculation of mitochondria followed by disruption of the organelles” (Martelli 2014). Nevertheless, as other GLRaVs, GLRaV-4LVs are restricted to phloem tissue in grapevines, more detailed studies are needed to fully understand the effects of GLRaV-4 infections at the cellular level.

A recent qRT-PCR-based study involving three traditional Spanish cultivars infected by various combinations of GLRaV-3 and GLRaV-4 strains 4 and 5 has shown that the concentration of virus-associated RNA molecules of these viruses in plant tissue is not equal (Velasco et al. 2013). Indeed, GLRaV-3 concentrations were significantly higher than those of the two GLRaV-4 strains in infected plants either in spring or autumn. No significant difference in concentration of RNA copies of GLRaV-4 strains was found in single-infected plants compared to those coinfecting by GLRaV-3. The study suggests that GLRaV-3 is “able to establish more efficient multiplication in the host than GLRaV-4 type ampeloviruses” (Velasco et al. 2013). The same study indicated that lower efficiency of multiplication within the host of GLRaV-4 strains can be associated directly with their relatively lower efficiency in vector transmission and overall incidence in the field compared to GLRaV-1 and -3. These data are in agreement with observed differences in dsRNA concentration between GLRaV-4LVs and GLRaV-1 and GLRaV-3 (S. Sabanadzovic and N. Aboughanem-Sabanadzovic, unpublished).

The analyses of virus-derived small interfering RNAs (vsiRNAs) present in grapevine cv. Mantua infected by GLRaV-4 strain 9 showed the prevalence of the 21 nt class (75.6%) over the 22 nt class (18.5%), indicating the major involvement of dicer-like protein 4 (DCL4) in silencing mechanism (Velasco et al. 2015). These data are in accordance with reports of preferential DCL4-mediated silencing of other viruses in the same host (Alabi et al. 2012; Pantaleo et al. 2010).

Pathological Properties, Associated Diseases, and Their Impact

Infections by GLRaV-4 strains in American rootstocks are latent. Generally speaking, GLRaV-4 and related viruses are weaker elicitors of leafroll symptoms compared to GLRaV-1 and GLRaV-3, so occasionally no obvious symptoms are apparent in infected *Vitis vinifera* too (Martelli 2014).

However, several strains of GLRaV-4 are known to induce mild to moderate leafroll symptoms in infected field samples of red-berried cultivars of *Vitis vinifera* or in indicator plants. Mild leafroll symptoms were associated with infections of GLRaV-4LVs as in the of GLRaV-4 Car in cv. Carnelian (Abou Ghanem-Sabanadzovic et al. 2010), GLRaV-9 in cv. Helena (Alkowni et al. 2004) and GLRaV-4 strain Ob in cv. Otcha bala (Reynard et al. 2015).

Additionally, an intriguing association of GLRaV-4 strain 6 with cv. Cardinal has been reported from Italy (Boscia et al. 2000). Unfortunately, all symptomatic vines infected by GLRaV-4 strain 6 were coinfecting with at least another leafroll-associated virus (i.e., GLRaV-1, GLRaV-2, GLRaV-3, and/or GLRaV-7), not allowing to draw clear conclusions on the possible role of GLRaV-4 strain 6 in the etiology of leafroll in this cultivar.

Strategies for Control and Management

Taking in consideration that the host range of GLRaV-4LVs is restricted to grapevines and that few mealybug and soft scale insects can transmit these viruses, control measures must be focused on prevention, elimination of sources of infection (cultural practices), and control of vectors (Almeida et al. 2013; Naidu et al. 2014, 2015).

There are no natural sources of resistance to GLRaV-4LVs in cultivated *Vitis* spp. identified to date. A fundamental practice in management of grapevine leafroll disease and its associated viruses (including GLRaV-4LVs) is the establishment of vineyards with clean planting material. Symptom observation and elimination of infected plants (roguing) is also a good managing practice, especially if regularly practiced since the establishment of the vineyard. Nevertheless, symptom-based identification of plants affected by GLRaV-4LVs can often be challenging, considering that leafroll symptoms in white-berried cultivars are not easy to identify. In addition, some strains of GLRaV-4LVs do not elicit visible symptoms in certain red-berried cultivars. Vineyard inspection should be performed between veraison and harvest, the period of optimal symptom expression for GLRD.

The best scenario for GLRD monitoring is regular laboratory testing by sensitive diagnostics as these tests can detect the presence of virus infections much earlier than symptoms expression, therefore anticipating further steps and reducing possibilities for spread.

Besides prevention and monitoring for disease and elimination of infection sources, management of GLRaV-4LVs must also focus on control of vector population (mealybug and scale insects). Several chemicals (insecticides) with contact or systemic modes of action are currently available for their control and can be applied as a part of a holistic and integrated control approach for GLRaV-4 management.

Propagation material that is testing negative for GLRaV-4LVs is relatively easy to obtain as this group of viruses is readily eliminated by different techniques, including micro-shoot tips of less than 0.5 mm in size (Sim et al. 2012)

Conclusions and Future Research Directions

Despite the relatively rich literature on GLRD and the associated viruses documenting progress in the overall knowledge on this pathosystem, there are still numerous aspects that need to be addressed in order to better understand GLRaV-4LVs. First and foremost, the interaction between this group of viruses and their grapevine host is still largely unknown and, therefore, should be investigated at various levels. For example, the effects of single GLRaV-4LVs infections are unclear from the biochemical and organoleptic standpoints. GLRaV-4LVs are considered less pathogenic than GLRaV-1 and GLRaV-3. However, these observations are mostly, if not exclusively, based upon the severity of foliar symptoms induced on indicators. It is important to estimate the actual economic effects of infection by GLRaV-4LVs on the viticultural performance of infected vines.

Another aspect that needs better understanding is the effect of GLRaV-4LVs infection at the cellular level. Unexpectedly, enormous difficulties were met in the identification of any credible source describing the cytopathological effects of infection by any strain of GLRaV-4.

Curiously, unlike for GLRaV-1, GLRaV-2, and GLRaV-3, none of the GLRaV-4 strains has been detected in wild grapevines so far. Therefore, more attention should be given to understand if this is just a matter of sampling bias and lack of extensive studies, or the result of genetic resistance in the case of noncultivated grapevines.

In-depth studies on the role of p23 in the infection cycle of GLRaV-4LVs should be of future primary scientific interests. Clarifying the role of p23 would help not only in understanding the mechanisms involved in virus replication and virion assembly/architecture of GLRaV-4LVs but also shed light on the origin and evolutionary history of viruses belonging to the family *Closteroviridae*. The fact that the ORF expressing this type of product is present and conserved in members of other species suggests that p23 may have a key role in the infection cycle of “primitive” ampeloviruses (i.e., counter-defense action). With recently available complete genome sequences of several of GLRaV-4 strains, we anticipate rapid advancement of reverse genetics approaches in order to gain new knowledge on the replication of these viruses and their interactions with hosts and vectors at a molecular level.

Acknowledgments The authors thank Dr. Paul Gugerli, Dr. Jean-Sébastien Reynard, and Dr. Adib Rowhani for generously providing electron micrographs of purified GLRaV-4 particles and symptoms on different grape cultivars infected with several GLRaV-4LVs. We also acknowledge the time and effort of Dr. G.P. Martelli, Dr. P. Gugerli, and Dr. F. Faoro in identifying valuable bibliographic resources concerning GLRaV-4LVs. Partial financial support for SS and NAG research by Strategic Research Initiative funds from Mississippi Agriculture and Forestry Experiment Station is acknowledged. Finally, we are indebted to numerous scientists for their valuable published and unpublished data used in this endeavor, as well as to editorial team for their suggestions aimed to overall quality improvement of this chapter.

References

- Abou Ghanem-Sabanadzovic, N., S. Sabanadzovic, J.K. Uyemoto, D. Golino, and A. Rowhani. 2010. A putative new ampelovirus associated with grapevine leafroll disease. *Archives of Virology* 155: 1871–1876.
- Abou Ghanem-Sabanadzovic, N., S. Sabanadzovic, P. Gugerli, and A. Rowhani. 2012. Genome organization, serology and phylogeny of grapevine leafroll-associated viruses 4 and 6: Taxonomic implications. *Virus Research* 163: 120–128.
- Agranovsky, A.A., E.V. Koonin, V.P. Boyko, E. Maiss, R. Frötschl, N.A. Lunina, and J.G. Atabekov. 1994. Beet yellows closterovirus: Complete genome structure and identification of a leader papain-like thiol protease. *Virology* 198: 311–324.
- Agranovsky, A., D.E. Lesemann, E. Maiss, R. Hull, and J.G. Atabekov. 1995. “Rattlesnake” structure of a filamentous plant RNA virus built of two capsid proteins. *Proceedings of the National Academy of Sciences of the United States of America* 92: 2470–2473.
- Alabi, O.J., Y. Zheng, G. Jagadeeswaran, R. Sunkar, and R.A. Naidu. 2012. High throughput sequence analysis of small RNAs in grapevine (*Vitis vinifera*) affected by grapevine leafroll disease. *Molecular Plant Pathology* 13: 1060–1076.
- Alkowni, R., A. Rowhani, S. Daubert, and D.A. Golino. 2004. Partial characterization of a new ampelovirus associated with grapevine leafroll disease. *Journal of Plant Pathology* 86: 123–133.
- Almeida, R.P.P., K. Daane, V. Bell, K. Blaisdell, M. Cooper, E. Herrbach, and G. Pietersen. 2013. Ecology and management of grapevine leafroll disease. *Frontiers in Microbiology* 4: 94. doi:10.3389/fmicb.2013.00094.
- Alzhanova, D.V., A.I. Prokhnevsky, V.V. Peremyslov, and V.V. Dolja. 2007. Virion tails of *Beet yellows virus*: Coordinated assembly by three structural proteins. *Virology* 359: 200–226.
- Arcangeli, G. 1907. Su di un caso di rossore della vite a Careggiano. *Agricoltura Italiana* 13: 18–22.
- Besse, S., W. Bitterlin, and P. Gugerli. 2009. Development of an ELISA for the simultaneous detection of Grapevine leafroll-associated virus 4, 5, 6, 7 and 9. In *Extended abstracts 16th meeting of ICVG, Dijon, France*, 296–299.
- Boscia, D., C. Greif, P. Gugerli, G.P. Martelli, B. Walter, and D. Gonsalves. 1995. Nomenclature of grapevine leafroll-associated putative closteroviruses. *Vitis* 34: 171–175.
- Boscia, D., M. Digiario, V. Savino, and G.P. Martelli. 2000. Grapevine leafroll-associated virus 6 and *Vitis vinifera* cv. Cardinal: An intriguing association. In *Extended abstracts 13th meeting of ICVG, Adelaide, Australia*, 2000, 21–22.
- Buzkan, N., S. Karadag, A. Kaya, S. Baloglu, A. Minafra, and J. Ben-Dov. 2010. First report of the occurrence of grapevine leafroll-associated virus 5 in Turkish vineyards. *Journal of Phytopathology* 158: 448–449.
- Castellano, M.A., G.P. Martelli, and V. Savino. 1983. Virus-like particles and ultrastructural modifications in the phloem of leafroll-affected grapevines. *Vitis* 22: 23–39.

- Cornuet P., Andret P., Vigne E., Fuchs M., 2003. Identification and characterization of a putative new ampelovirus specifically associated to grapevine leafroll. Extended Abstracts 14th Meeting of ICVG, Locorotondo, Italy: 34
- Dolja, V.V., J.F. Kreuze, and J.P.T. Valkonen. 2006. Comparative and functional genomics of closteroviruses. *Virus Research* 117: 38–51.
- Dovas, C.I., and N.I. Katis. 2003. A spot multiplex nested RT-PCR for the simultaneous and generic detection of viruses involved in the etiology of grapevine leafroll and rugose wood of grapevine. *Journal of Virological Methods* 109: 217–226.
- Elbeaino, T., F. Nusic, M. Digiario, S. Sabanadzovic, and G.P. Martelli. 2009. Partial characterization of a grapevine leafroll-associated virus isolated from an infected Cypriot vine. *Journal of Plant Pathology* 91: 479–484.
- Engel, E.A., P.F. Escobar, C. Montt, S. Gomez-Talquenca, and P.D.T. Valenzuela. 2008. First report of grapevine leafroll-associated virus 7 and 9 in Chilean grapevines. *Plant Disease* 92: 1252–1253.
- Engel, E.A., P.F. Escobar, P.A. Rivera, and P.D.T. Valenzuela. 2010a. First report of grapevine leafroll-associated virus 5 in Chilean grapevines. *Plant Disease* 94: 1067.
- Engel, Esteban A., Paula F. Escobar, Luis A. Rojas, Paulina A. Rivera, Nicola Fiore, and Pablo D.T. Valenzuela. 2010b. A diagnostic oligonucleotide microarray for simultaneous detection of grapevine viruses. *Journal of Virological Methods* 163 (2): 445–451.
- Escobar, P., N. Fiore, P.D.T. Valenzuela, and E.A. Engel. 2008. First detection of grapevine leafroll-associated virus 4 in Chilean grapevines. *Plant Disease* 92: 1474.
- Esteves, F., Santos M. Teixeira, J.E. Eira-Dias, and F. Fonseca. 2012. Occurrence of grapevine leafroll-associated virus 5 in Portugal and population structure in field-grown grapevines. *Archives of Virology* 157: 1747–1765.
- Fajardo, T.V.M., M. Eiras, O. Nickel, C.R. Dubiela, and E.R. de Souto. 2012. Detection and partial molecular characterization of grapevine fleck virus, grapevine virus D, grapevine leafroll-associated viruses -5 and -6 infecting grapevines in Brazil. *Ciência Rural* 42: 2127–2130.
- Faoro, F., R. Tornaghi, and G. Belli. 1981. Association of a possible closterovirus with grapevine leafroll in northern Italy. *Rivista di Patologia Vegetale (S.V)* 17: 183–189.
- Fazeli, C.F., N. Habili, and M.A. Rezaian. 1998. Efficient cloning of cDNA from grapevine leafroll-associated virus 4 and demonstration of probe specificity by the viral antibody. *Journal of Virological Methods* 70: 201–211.
- Febres, V.J., L. Ashoulin, M. Mawassi, A. Frank, M. Bar-Joseph, K.L. Manjunath, R.F. Lee, and C.L. Niblett. 1996. The p27 protein is present at one end of citrus risteza virus particles. *Phytopathology* 86: 1331–1335.
- Goheen, A.C., F.N. Harmon, and J.H. Weinberger. 1958. Leafroll (white Emperor disease) of grapes in California. *Phytopathology* 48: 51–54.
- Gómez Talquenca, G.G., S. Muñoz, O. Grau, and O. Gracia. 2009. First description of grapevine leafroll-associated virus 5 in Argentina and partial genome sequence. *Virus Genes* 38: 184–186.
- Good, X., and J. Monis. 2001. Partial genome organization, identification of the coat protein gene and detection of grapevine leafroll-associated virus-5. *Phytopathology* 91: 274–281.
- Gugerli, P. 2000. Detection of grapevine leafroll-associated viruses by chemiluminometric enzyme-linked immunosorbent assay (LUMINO-ELISA). In *Extended abstracts 13th meeting of ICVG, Adelaide, Australia*, 134–136.
- . 2009. 25 years of serological identification of grapevine leafroll-associated viruses: Antiserum and monoclonal antibodies to GLRaV-1 to GLRaV-9. In *Extended abstracts 16th meeting of ICVG, Dijon, France*, 24–28.
- Gugerli, P., and M.E. Ramel. 1993. Grapevine leafroll-associated virus II analyzed by monoclonal antibodies. In *Extended abstracts 11th meeting of ICVG, Montreux, Switzerland*, 23–24.
- Gugerli, P., J.J. Brugger, and R. Bovey. 1984. L'enroulement de la vigne: mise en évidence de particules virales et développement d'une méthode immuno-enzymatique pour le diagnostic rapide. *Revue Suisse de Viticulture, Arboriculture, Horticulture* 16: 299–304.

- Gugerli, P., J.J. Brugger, and M.E. Ramel. 1997. Identification immuno- chimique du 6e virus associé à la maladie de l'enroulement de la vigne et amélioration des techniques de diagnostic pour la sélection sanitaire en viticulture. *Revue Suisse de Viticulture, Arboriculture, Horticulture* 29: 137–141.
- Gugerli, P., S. Rigotti, M-E Ramel, N. Habili, A. Rowhani, W. Bitterlin, and S. Besse. 2009. Production of monoclonal antibodies to Grapevine leafroll- associated virus 9 (GLRaV-9). In *Extended abstracts 16th meeting of ICVG, Dijon, France*, 44–46.
- Harmon, F.N., and E. Snyder. 1946. Investigations of the occurrence, transmission, spread, and effect of “white” fruit color in the Emperor grape. *Proceedings of the American Society of Horticultural Science* 47: 190–194.
- Hu, J.S., D. Gonsalves, and D. Teliz. 1990a. Characterization of closterovirus-like particles associated with grapevine leafroll disease. *Journal of Phytopathology* 128: 1–14.
- Hu, J.S., D. Gonsalves, D. Boscia, and S. Namba. 1990b. Use of monoclonal antibodies to characterize grapevine leafroll associated closteroviruses. *Phytopathology* 80: 920–925.
- Hu, J.S., D. Gonsalves, D. Boscia, M. Maixner, and D. Golino. 1991. Comparison of rapid detection assays for leafroll disease associated closteroviruses. *Vitis* 30: 87–95.
- Ito, T., R. Nakaune, M. Nakano, and K. Suzaki. 2013. Novel variants of grapevine leafroll-associated virus 4 and 7 detected from a grapevine showing leafroll symptoms. *Archives of Virology* 158: 273–275.
- Komorowska, B., T. Golis, and H. Beniak. 2012. Survey of grapevine viruses in Poland. In *Proceedings 17th Congress of ICVG, Davis, USA*, 206–207.
- Koonin, E.V., and V.V. Dolja. 1993. Evolution and taxonomy of positive-strand RNA viruses: Implications of comparative analysis of amino acid sequences. *Critical Reviews in Biochemistry and Molecular Biology* 28: 375–430.
- Le Maguet, J., M. Beuve, E. Herrbach, and O. Lemaire. 2012. Transmission of six ampeloviruses and two vitiviruses to grapevine by *Phenacoccus aceris*. *Phytopathology* 102: 717–723.
- Liu, M.H., M.J. Li, H.H. Qi, R. Guo, X.M. Liu, and Y.Q. Cheng. 2013. Occurrence of grapevine leafroll-associated viruses in China. *Plant Disease* 97: 1339–1345.
- Mafhoudhi, N., M. Digiario, and M.H. Dhouibi. 2009. Transmission of grapevine leafroll viruses by *Planococcus ficus* (Hemiptera: Pseudococcidae) and *Ceroplastes rusci* (Hemiptera: Coccidae). *Plant Disease* 93: 999–1002.
- Maliogka, V.I., C.I. Dovas, and N.I. Katis. 2008a. Evolutionary relationships of virus species belonging to a distinct lineage within the Ampelovirus genus. *Virus Research* 135: 125–135.
- . 2008b. Generic and species-specific detection of viruses belonging to an evolutionary distinct lineage within the Ampelovirus genus. *Journal of Virological Methods* 154: 41–47.
- Maliogka, V.I., C.I. Dovas, L. Lotos, K. Efthimiou, and N.I. Katis. 2009. Complete genome analysis and immunodetection of a member of a novel virus species belonging to the genus *Ampelovirus*. *Archives of Virology* 154: 209–218.
- Martelli, G.P. 2014. Grapevine leafroll. In *Directory of virus and virus-like diseases of the grapevine and their agents*. *Journal of Plant Pathology* 96 (Suppl. 1): 51–70.
- Martelli, G.P., and G. Piro. 1975. Virus diseases of the grapevine in a Sicilian herbarium of the past century. *Vitis* 13: 329–335.
- Martelli, G.P., N. Abou Ghanem-Sabanadzovic, A.A. Agranovsky, M. Al Rwahnih, V.V. Dolja, C.I. Dovas, M. Fuchs, P. Gugerli, J.S. Hu, W. Jelkmann, N.I. Katis, V.I. Maliogka, M.J. Melzer, W. Menzel, A. Minafra, M.E. Rott, A. Rowhani, S. Sabanadzovic, and P. Saldarelli. 2012a. Taxonomic revision of the family *Closteroviridae* with special reference to the grapevine leafroll-associated members of the genus *Ampelovirus* and the putative species unassigned to the family. *Journal of Plant Pathology* 94: 7–19.
- Martelli, G.P., A.A. Agranovsky, M. Bar-Joseph, D. Boscia, T. Candresse, R.H.A. Coutts, V.V. Dolja, J.S. Hu, W. Jelkmann, A.V. Karasev, R.R. Martin, A. Minafra, S. Namba, and H.J. Vetten. 2012b. Family *Closteroviridae*. In *Virus taxonomy. Ninth report of the International Committee on Taxonomy of Viruses*, ed. A.M.Q. King, M.J. Adams, E.B. Carstens, and E. Lefkowitz, 987–1001. Amsterdam: Elsevier-Academic Press.

- Melzer, M.J., D.M. Sether, A.V. Karasev, W. Borth, and J.S. Hu. 2008. Complete nucleotide sequence and genome organization of pineapple mealybug wilt-associated virus-1. *Archives of Virology* 153: 707–714.
- Naidu, R., A. Rowhani, M. Fuchs, D. Golino, and G.P. Martelli. 2014. Grapevine leafroll: A complex viral disease affecting a high-value fruit crop. *Plant Disease* 98: 1172–1185.
- Naidu, R.A., H.J. Maree, and J.T. Burger. 2015. Grapevine leafroll disease and associated viruses: A unique pathosystem. *Annual Review of Phytopathology* 53: 613–634.
- Namba, S., S. Yamashita, Y. Doi, K. Yora, Y. Terai, and R. Yano. 1979. Grapevine leafroll virus, a possible member of closteroviruses. *Annals of the Phytopathological Society of Japan* 45: 497–502.
- Napuli, A.J., D.V. Alzhanova, C.E. Doneanu, D.F. Barofsky, E.V. Koonin, and V.V. Dolja. 2003. The 64-kDa capsid protein homolog of beet yellows virus is required for assembly of virion tails. *Journal of Virology* 77: 2377–2384.
- Osman, F., C. Leutenegger, D. Golino, and A. Rowhani. 2007. Real time RT-PCR (TaqMan) assays for the detection of grapevine leafroll-associated viruses 1-5 and 9. *Journal of Virological Methods* 141: 22–29.
- . 2008. Comparison of low density arrays, RT-PCR and real-time Taq-Man RT-PCR in detection of grapevine viruses. *Journal of Virological Methods* 149: 292–299.
- Padilla, C.V., E. Cretazzo, I. Hita, N. Lopez, V. Padilla, and L. Velasco. 2010. First report of grapevine leafroll-associated virus 5 in Spain. *Plant Disease* 94: 1507.
- Padilla, C.V., E. Cretazzo, M.J. Alcal, I. Hita, N. Lopez, V. Padilla, and L. Velasco. 2013. First report of grapevine leafroll-associated virus 9 in Spain. *Journal of Plant Pathology* 95: 662.
- Peake, B.K., A.E. Macie, K. Sivathamparam, N. Habili, and S.J. McKirdy. 2004. First report of grapevine leafroll-associated virus 9 (GLRaV-9) in Western Australia. *Australasian Plant Pathology* 33: 445–446.
- Pei, G.Q., Y.F. Dong, Z.P. Zhang, and X.Z. Fan. 2010. First report of grapevine leafroll-associated virus 4 and 5 in China. *Plant Disease* 94: 130.
- Peng, C.W., V.V. Peremyslov, A.R. Mushegian, W.O. Dawson, and V.V. Dolja. 2001. Functional specialization and evolution of leader proteinases in the family *Closteroviridae*. *Journal of Virology* 5: 12153–12160.
- Peremyslov, V.V., Y. Hagiwara, and V.V. Dolja. 1999. HSP70 functions in cell-to-cell movement of a plant virus. *Proceedings of the National Academy of Sciences of the United States of America* 96: 14771–14776.
- Ravaz, L., and L. Roos. 1905. Le rougeau de la vigne. *Progrès Agricole et Viticole* 22: 39–40.
- Ravaz, L., and G. Verge. 1924. Le rugeau de la vigne. *Progrès Agricole et Viticole* 45: 11–17, 35–38, 86–89, 110–113, 135–141.
- Reynard, J.S., P.H. Schneeberger, J.E. Frey, and S. Schaefer. 2015. Biological, serological, and molecular characterization of a highly divergent strain of grapevine leafroll-associated virus 4 causing grapevine leafroll disease. *Phytopathology* 105: 1262–1269.
- Rosciglione, B., and P. Gugerli. 1986. Maladies de l'enroulement et du bois strié de la vigne: analyse microscopique et sérologique. *Revue Suisse de Viticulture, Arboriculture, Horticulture* 18: 207–211.
- Routh, G., Y.P. Zhang, P. Saldarelli, and A. Rowhani. 1998. Use of degenerate primers for partial sequencing and RT-PCR-based assays of grapevine leafroll-associated viruses. *Phytopathology* 88: 1238–1243.
- Rubio, L., J. Guerri, and P. Moreno. 2013. Genetic variability and evolutionary dynamics of viruses of the family *Closteroviridae*. *Frontiers Microbiology* 4: 151. doi:10.3389/fmicb.2013.00151.
- Saldarelli, P., A. Rowhani, G. Routh, A. Minafra, and M. Digiaro. 1998. Use of degenerate primers in a RT-PCR assay for the identification and analysis of some filamentous viruses, with special reference to closteroviruses and vitiviruses of the grapevine. *European Journal of Plant Pathology* 104: 945–950.

- Saldarelli, P., P. Cornuet, E. Vigne, F. Talas, I. Bronnenkant, A.M. Dridi, P. Andret-Link, D. Boscia, P. Gugerli, M. Fuchs, and G.P. Martelli. 2006. Partial characterization of two divergent variants of grapevine leafroll-associated virus 4. *Journal of Plant Pathology* 88: 203–214.
- Sannino, F.A. 1906. Il rossore delle viti. *Rivista di Patologia Vegetale* 1: 162–163.
- Satyannarayana, T., S. Gowda, M.A. Ayllón, and W.O. Dawson. 2004. Closterovirus bipolar virion: evidence for initiation of assembly by minor coat protein and its restriction to the genomic RNA 5' region. *Proceedings of the National Academy of Sciences of the United States of America* 101: 799–804.
- Scheu, G. 1935. Die rollkrankheit des rebstockes. *Der Deutsche Weinbau* 14: 222–223.
- Sim, S.T., A. Rowhani, R. Alkowni, and D. Golino. 2003. Experimental transmission of grapevine leafroll-associated viruses types 5 and 9 by longtailed mealybugs. In *Extended abstracts 14th meeting of ICVG, Locorotondo, Italy*, 211–212.
- Sim, S., M. Al Rwahnih, A. Rowhani, and D.A. Golino. 2012. Virus elimination from grape selections using tissue culture at Foundation Plant Services, University of California, Davis. In *Proceedings 17th Congress of ICVG, Davis, USA*, 262–263.
- Štrukelj, M., I.M. Pleško, and G. Urek. 2016. Molecular characterization of grapevine leafroll-associated virus 4 from Slovenian vineyards. *Acta Virologica* 60: 174–180.
- Tamura, K., G. Stecher, D. Peterson, A. Filipski, and S. Kumar. 2013. MEGA6: Molecular Evolutionary Genetics Analysis version 6.0. *Molecular Biology and Evolution* 30: 2725–2729.
- Thompson, J.R., M. Fuchs, K.F. Fischer, and K.L. Perry. 2012a. Macroarray detection of grapevine leafroll-associated viruses. *Journal of Virological Methods* 183: 161–169.
- Thompson, J.R., M. Fuchs, and K. Perry. 2012b. Genomic analysis of grapevine leafroll-associated virus 5 and related viruses. *Virus Research* 163: 19–27.
- Thompson, J.R., M. Fuchs, H. McLane, F. Celebi-Toprak, K.F. Fisher, J.L. Potter, and K.L. Perry. 2014. Profiling viral infections in grapevine using a randomly primed reverse transcription-polymerase chain reaction/macroarray multiplex platform. *Phytopathology* 104: 211–219.
- Tian, T., V.A. Klaassen, J. Soong, G. Wisler, J.E. Duffus, and B.W. Falk. 1996. Generation of cDNAs specific to lettuce infectious yellows closterovirus and other whitefly-transmitted viruses by RT-PCR and degenerate oligonucleotide primers corresponding to the closterovirus gene encoding the heat shock protein 70 homolog. *Phytopathology* 86: 1167–1173.
- Tian, T., L. Rubio, H.-H. Yeh, B. Crawford, and B.W. Falk. 1999. Lettuce infectious yellows virus: *In vitro* acquisition analysis using partially purified virions and the whitefly *Bemisia tabaci*. *Journal of General Virology* 80: 1111–1117.
- Tsai, C.W., A. Rowhani, D.A. Golino, K.M. Daane, and R.P.P. Almeida. 2010. Mealybug transmission of grapevine leafroll viruses: An analysis of virus-vector specificity. *Phytopathology* 100: 830–834.
- Turkmen, Y., D. Canik-Orel, and F. Ertung. 2012. Monitoring distribution of grapevine leafroll-associated viruses in Turkey. In *Proceedings 17th Congress of ICVG, Davis, USA*, 180–181.
- van den Born, E., M.V. Omelchenko, A. Bekkelund, V. Leihne, E.V. Koonin, V.V. Dolja, and P.Ø. Falnes. 2008. Viral AlkB proteins repair RNA damage by oxidative demethylation. *Nucleic Acids Research* 36: 5451–5461.
- Velasco, L., J. Bota, R. Montero, and E. Cretazzo. 2013. Differences of three ampeloviruses' multiplication may explain their incidences in vineyards. *Plant Disease* 98: 395–400.
- Velasco, L., E. Cretazzo, C.V. Padilla, and D. Janssen. 2015. Grapevine leafroll-associated virus 4 strain 9: Complete genome and quantitative analysis of virus-derived small interfering RNA populations. *Journal of Plant Pathology* 97: 189–192.
- Walter, B., and D. Zimmermann. 1991. Further characterization of closterovirus-like particles associated with the grapevine leafroll disease. In *Proceedings 10th meeting of ICVG, Volos, Greece*, 62–66.
- Wistrom, C.M., G.K. Blaisdell, L.R. Wunderlich, R.P.P. Almeida, and K. Daane. 2016. *Ferrisia gilli* (Hemiptera: Pseudococcidae) transmits grapevine leafroll-associated viruses. *Journal of Economic Entomology* 109: 1519–1523.

- Wistrom, C.M., G.K. Blaisdell, L.R. Wunderlich, M. Botton, R.P.P. Almeida, and K. Daane. 2017. No evidence of transmission of grapevine leafroll-associated viruses by phylloxera (*Daktulosphaira vitifoliae*). *European Journal of Plant Pathology*. (in press) 147: 937.
- Zimmerman, D., P. Bass, R. Legin, and B. Walter. 1990a. Characterization and serological detection of four closterovirus-like particles associated with leafroll disease on grapevine. *Journal of Phytopathology* 130: 205–218.
- Zimmermann, D., G. Sommermeyer, B. Walter, and M.H.V. Van Regenmortel. 1990b. Production and characterization of monoclonal antibodies specific to closterovirus-like particles associated with grapevine leafroll disease. *Journal of Phytopathology* 130: 277–288.

Chapter 10

Grapevine leafroll-associated virus 7

M. Al Rwahnih, P. Saldarelli, and A. Rowhani

Abstract *Grapevine leafroll-associated virus 7* (GLRaV-7) is an asymptomatic virus in the newly established genus, *Velarivirus*, in the *Closteroviridae* family. GLRaV-7 has been detected in grape-growing regions across the globe and may be quite widespread. The virus is only known to infect grapevine, is transmitted through infected propagation material, and, at this time, has no known insect vector. Detection of the virus is most reliable and accurate using RT-qPCR.

Keywords Grapevine leafroll disease • *Closteroviridae* • *Velarivirus* • GLRaV-7 • *Vitis vinifera*

Introduction and Historical Aspects

Grapevine leafroll-associated virus 7 was originally identified in Albania in a symptomless white-berried grapevine cultivar, accession AA42 (Choueiri et al. 1996). Cabernet Sauvignon indicators graft inoculated with buds from accession AA42 showed mild leafroll symptoms, hence the leafroll virus designation for the newly discovered virus. Several researchers have reported that GLRaV-7 infection causes no or uncertain leafroll symptoms (Al Rwahnih et al. 2012a; Avegelis and Boscia 2001; Morales and Monis 2007). In no case has GLRaV-7 been associated with symptomatic infection in which the presence of other coinfecting viruses has been ruled out (Al Rwahnih et al. 2012a). Reynard et al. (2015) have determined that the AA42 accession, in which GLRaV-7 was originally reported, was coinfecting with GLRaV-4. Thus, the leafroll symptoms associated with the AA42 accession may have arisen from a coinfection of GLRaV-7 with GLRaV-4.

M. Al Rwahnih (✉) • A. Rowhani
Department of Plant Pathology, University of California,
Davis, CA 95616, USA
e-mail: malrwahnih@ucdavis.edu

P. Saldarelli
CNR Istituto per la Protezione Sostenibile delle Piante UOS Bari and Dipartimento di Scienze del Suolo della Pianta e degli Alimenti, Università degli Studi di Bari, via Amendola 165/A, Bari, Italy

Al Rwahnih et al. (2012a) suggested the possibility of the existence of a broad, yet unsuspected, occurrence of asymptomatic GLRaV-7 in commercial wine, raisin, and table grape varieties. GLRaV-7 is geographically widespread, identified in Albania, Greece, Hungary, Egypt and Italy (Choueiri et al. 1996), Palestine (Alkowni et al. 1998), California (Morales and Monis 2007), Turkey (Akbas et al. 2007), Chile (Engel et al. 2008), and China (Lyu et al. 2013). Symptoms that are attributable to GLRaV-7 remain unresolved at this time. However, since GLRaV-7 cannot be conclusively associated with leafroll symptoms, it has been proposed that the virus could be renamed (Al Rwahnih et al. 2012a; Reynard et al. 2015).

Taxonomy and Nomenclature

GLRaV-7 is in the family *Closteroviridae* that was formerly separated into three genera *Ampelovirus*, *Closterovirus*, and *Crinivirus*. Placement of viruses among these genera was based in part on their transmission by vectors from separate families of insects. GLRaV-7 has no known insect vector and had remained unassigned in the *Closteroviridae* until recently (see below). Subsequent research has shown that the genome organization for GLRaV-7 is most similar to that of *Little cherry virus-1* (LChV-1; Jelkmann et al. 1997) and *Cordylone virus-1* (CoV-1; Melzer et al. 2011), both of which are also unassigned.

Al Rwahnih et al. (2012a) found that the inferred sequences of seven proteins encoded by LChV-1 and CoV-1 consistently showed higher levels of identity with their homologs in GLRaV-7 than they did with other closteroviruses. These levels of identity reached 54% for the RNA-dependent RNA polymerase, ~41% for the heat shock protein 70 homolog (HSP70h), and ~30% for the coat protein. In contrast, identity levels of these three proteins were only 10–28% when compared to GLRaV-3, which is the ampelovirus most closely related to GLRaV-7. This latter comparison indicated substantial divergence between GLRaV-3 and GLRaV-7 (Al Rwahnih et al. 2012a).

Phylogenetic analysis based on inferred amino acid sequences of the HSP70h proteins in the family *Closteroviridae* revealed a strongly supported cluster (LChV-1, CoV-1, and GLRaV-7), shown by two research groups (Al Rwahnih et al. 2012a; Jelkmann et al. 2012). Additionally, the stop codon for GLRaV-7 ORF1a is UGA, which is also found in LChV-1 and CoV-1 (Jelkmann et al. 1997, 2012; Melzer et al. 2011). Al Rwahnih et al. (2012a) proposed a new genus, *Velarivirus*, for this newly recognized phylogenetic cluster of viruses. A critical review of the taxonomic structure of the family *Closteroviridae* by a number of researchers supported the designation of *Velarivirus* as a separate genus (Martelli et al. 2012). The name has been accepted by the International Committee on Taxonomy of Viruses, and *Velarivirus* is now the fourth genus within the *Closteroviridae* family.

Recently, the complete genome sequence of a novel virus, provisionally named *Areca palm velarivirus-1* (APV-1), was reported by Yu et al. (2015). The genome organization of APV-1 is highly similar to that of the other members of genus

Velarivirus. Phylogenetic comparison of the amino acid sequence of the APV-1 ORF1a with those of other members of the family *Closteroviridae* revealed that APV-1 is most closely related to LChV-1 and GLRaV-7, suggesting that the new virus should be classified in the *Velarivirus* genus (Yu et al. 2015).

Genome Structure

Two GLRaV-7 isolates have been fully sequenced to date: the Albanian accession AA42 (16,404 nt; Mikona et al. 2009; Jelkmann et al. 2012) and a Swiss selection of cv Pinot Noir PN-23 (16,496 nt; Al Rwahnih et al. 2012a). A Japanese isolate has been partially sequenced (7726 nt; Ito et al. 2013). The genomic structures of the two fully sequenced isolates show a difference in the number of open reading frames (Fig. 10.1). As described by Martelli et al. (2012), translation of the genome sequence in the 5'→3' direction reveals the following putative proteins:

1. A polyprotein of 265 kDa in size comprising the viral protease, methyltransferase, and helicase domains (ORF1a) and the 60 kDa RNA-dependent RNA polymerase (ORF 1b).
2. An 8 kDa putative protein (ORF2) that overlaps ORF1b. This putative protein contains transmembrane helices and resembles the small membrane proteins encoded by other closteroviruses, such as *Beet yellows virus* (BYV), where it is expressed from a subgenomic messenger RNA (Al Rwahnih et al. 2012a).
3. A 4 kDa hydrophobic protein with a putative transmembrane domain (ORF3) which is only present in isolate AA42.
4. The 62 kDa HSP70h protein (ORF4).

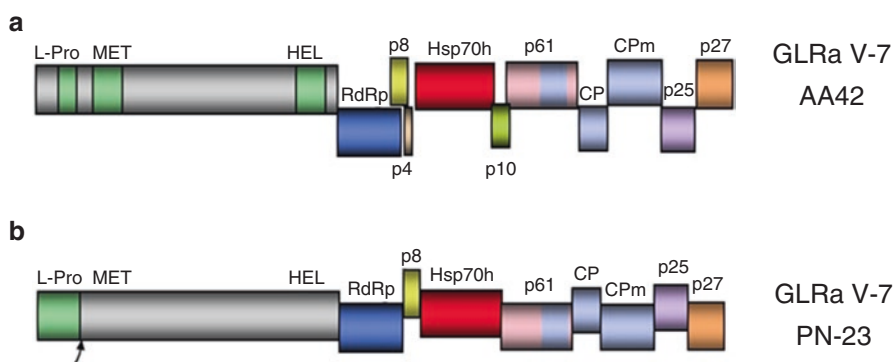

Fig. 10.1 Genome organizations of two GLRaV-7 isolates. (a) AA42; (b) PN-23. The different boxes represent open reading frames. Shared colors represent conserved sequences between the two isolates. *L-Pro* leader protease, *MET* methyltransferase domain, *HEL* RNA helicase domain, *RdRp* RNA-dependent RNA polymerase, *HSP70h* heat shock protein 70 homolog, *CP* coat protein, *CPm* minor coat protein

5. A 10 kDa protein (present in isolate AA42, but not in PN-23) showing homology with the small proteins (p4–p10) coded for by RNA-2 of some criniviruses at the same relative genomic position (ORF5).
6. A 61 kDa protein homologous with the p60 protein encoded by all other members of the family *Closteroviridae* (ORF6).
7. The coat protein 34 kDa in size (ORF6).
8. The minor coat protein 69 kDa in size (ORF7). ORF9 and ORF10 putatively code for a 25 kDa and a 27 kDa protein, respectively, neither of which shares similarities with any other viral proteins in the current database.

The presence of poorly conserved genes encoding ~20–30 kDa proteins in the 3'-region of the genome (Fig. 10.1) is a common feature of the closteroviruses (Dolja et al. 2006). The AUG initiation codons of ORFs 2, 3, and 5 are not in an optimal context for expression (Lutcke et al. 1987), suggesting the possibility of regulation of their expression at the translational level. The 5' and 3' untranslated regions are 47 and 284 nt in size, respectively, and have no apparent similarity with those of other closteroviruses. By analogy with other members of the family *Closteroviridae*, the genome expression strategy is thought to encompass direct translation and proteolytic processing of the polyprotein encoded by ORF1a, a +1 ribosomal frameshift for the expression of the RNA-dependent RNA polymerase domain encoded by ORF1b, and the expression of downstream ORFs from 3' coterminal subgenomic RNAs (Martelli et al. 2011).

Genetic Diversity and Population Structure

Lyu et al. (2014) characterized the diversity of more than 50 Chinese GLRaV-7 isolates, based on sequences amplified by PCR from the p61 and HSP70h genes. Two amplicons, of 385 and 504 bp, were derived from the HSP70h gene, while a 518 bp amplicon was derived from the 61 kDa protein. Nucleotide sequence identities among sequences of HSP70h gene were in the range of 80–100% for the 385 bp amplicon and 89.6–100% for the 502 bp amplicon. The corresponding inferred amino acid sequence identities were 89–100 and 93.6–100%, respectively. The 518 bp sequence of the p61 gene showed a similarly high degree of conservation between viral isolates. The overall mean values of genetic diversity within GLRaV-7 isolates was very low, within the range of 0.009–0.066.

Detection and Diagnosis

Since infection by GLRaV-7 is regarded as symptomless, biological assays in indicator plants are not used for its diagnosis. GLRaV-7 can be detected by enzyme-linked immunosorbent assay (ELISA), reverse transcription PCR (RT-PCR), and

quantitative real-time RT-PCR (RT-qPCR). The first detection of GLRaV-7 in Albanian accession AA42 was by ELISA (Choueiri et al. 1996). However, serological detection for GLRaV-7 may have high background, low specificity, and low reactivity, which limits its use for routine testing (Avgelis and Boscia 2001; Rigotti et al. 2006; Morales and Monis 2007; Al Rwahnih et al. 2008). The occurrence of GLRaV-7 has been reported to be sparse in some geographic areas (Avgelis and Boscia 2001; Akbas et al. 2007), which might be a reflection of low ELISA sensitivity.

Nucleic acid-based detection methods have been shown to be more sensitive than serological detection techniques for GLRaV-7 (Al Rwahnih et al. 2008). An early RT-PCR detection of an Albanian strain of GLRaV-7 used a primer pair that amplified a 189 nt segment of the viral RNA-dependent RNA polymerase gene (Turturo et al. 2000). These same primers were used to screen for GLRaV-7 in California grapevines (Morales and Monis 2007). Mikona and Jelkmann (2010) reported the detection of GLRaV-7 in woody and herbaceous plant species using SYBR Green RT-qPCR.

Al Rwahnih et al. (2012b) showed that conventional PCR tests using published primers based on the sequence of an Albanian isolate of GLRaV-7 were inadequate for testing a wider range of GLRaV-7 isolates. To improve virus detection, they designed a RT-qPCR test with primers designed based on HSP70h sequences from nine viral isolates from diverse geographical regions. This RT-qPCR assay was more comprehensive than an early RT-qPCR assay that used primers targeting coat protein gene sequences, and both RT-qPCR assays were more sensitive and capable of detecting a wider range of GLRaV-7 isolates than the conventional RT-PCR analysis.

Lyu et al. (2014) designed primers based on 56 sequences of the GLRaV-7 p61 gene. This set of primers proved to be more sensitive than the previously published primer sets, identifying a total of 44 isolates, including 12 isolates identified by other primers sets and 32 new isolates. Although the new primer set failed to detect four isolates identified by the previously published RT-qPCR protocol, it had a wider range of detection.

Host Range and Transmission

GLRaV-7 has not been detected in nature in any other plant species than grapevine. Attempts to mechanically transmit GLRaV-7 to herbaceous host plants have been unsuccessful (Choueiri et al. 1996; Mikona and Jelkman 2010). However, researchers successfully transmitted GLRaV-7 to *Nicotiana occidentalis* and *Tetragonia expansa* using dodder (*Cuscuta reflexa* and *C. europaea*, respectively). The viral titer in these two herbaceous hosts was two or three orders of magnitude higher than in grapevine (Mikona and Jelkman 2010).

Like other leafroll viruses, which are also dodder- (Woodham and Krake 1983) and graft-transmissible, GLRaV-7 is disseminated through the vegetative

propagation of infected plant material (Wilcox et al. 2015). Sister groups to the genus *Velarivirus* are arthropod transmitted. For example, members of the genus *Crinivirus* are transmitted by whiteflies, while members of the genus *Ampelovirus* are transmitted by mealybugs and soft scale insects. But no insect or other biological vectors have thus far been identified to transmit viruses of the genus *Velarivirus* (Al Rwahnih et al. 2012a).

Cytopathology, Tissue Tropism, and Virus-Host Interactions

Ultrastructural observations of GLRaV-7-infected *Vitis vinifera* indicated that the virus appears to multiply in the phloem, affecting the development of the differentiating sieve elements, parenchyma, and companion cells. There was no evidence that major cell organelles are affected, and virus particles are abundant only in the cytoplasm (Castellano et al. 2000).

Pathological Properties and Associated Diseases

GLRaV-7 infections in grapevine are often associated with infections by GLRaV-3 and, to a lesser extent, by GLRaV-1. Vines can be strongly symptomatic when infected with both GLRaV-7 and GLRaV-3. In a survey of 285 grapevines with leafroll symptoms, it was observed that 28% of these were coinfecting with GLRaV-7 and GLRaV-3 (Augelis and Boscia 2001). Interestingly, GLRaV-7 causes severe symptoms when artificially transmitted to *Nicotiana occidentalis* (Mikona and Jelkman 2010).

Strategies for Control and Management

Tissue culture therapy can eliminate GLRaVs from grapevine selections with a high success rate (Sim et al. 2012). This practice is often used to eliminate viruses from infected grape varieties prior to their certification. The best management practice for controlling grapevine leafroll virus diseases is to use certified propagation material that has tested negative for all GLRaVs.

References

- Akbas, B., B. Kunter, and D. Ilhan. 2007. Occurrence and distribution of Grapevine leafroll-associated viruses 1, 2, 3 and 7 in Turkey. *Journal of Phytopathology* 155: 122–124.

- Alkowni, R., M. Digiario, and V. Savino. 1998. Viruses and virus diseases of grapevine in Palestine. *OEPP/EPPO Bulletin* 28: 189–195.
- Al Rwahnih, M., F. Osman, and A. Rowhani. 2008. Molecular characterization of Californian isolates of *Grapevine leafroll-associated viruses 7* (GLRaV-7) and development of detection methods. In *Proceedings of the 2nd annual national viticulture research conference, Davis, CA, USA*, 1–2.
- Al Rwahnih, M., V.V. Dolja, S. Daubert, E.V. Koonin, and A. Rowhani. 2012a. Genomic and biological analysis of *Grapevine leafroll-associated virus 7* reveals a possible new genus within the family *Closteroviridae*. *Virus Research* 163: 302–309.
- Al Rwahnih, M., F. Osman, M. Sudarshana, J. Uyemoto, A. Minafra, P. Saldarelli, G. Martelli, and A. Rowhani. 2012b. Detection of *Grapevine leafroll-associated virus 7* using real time qRT-PCR and conventional RT-PCR. *Journal of Virological Methods* 179: 383–389.
- Angelis, A., and D. Boscia. 2001. *Grapevine leafroll-associated closterovirus 7* in Greece. *Phytopathologia Mediterranea* 40: 289–292.
- Castellano, M.A., N. Abou-Ghanem, E. Choueiri, and G.P. Martelli. 2000. Ultrastructure of *Grapevine leafroll-associated virus 2* and *7* infections. *Journal of Plant Pathology* 82: 9–15.
- Choueiri, E., D. Boscia, M. Digiario, M.A. Castellano, and G.P. Martelli. 1996. Some properties of a hitherto undescribed filamentous virus of the grapevine. *Vitis* 35: 91–93.
- Dolja, V.V., J.F. Kreuze, and J.P. Valkonen. 2006. Comparative and functional genomics of closteroviruses. *Virus Research* 117: 38–51.
- Engel, E.A., P. Escobar, C. Montt, S. Gomez-Talquenca, and P.D.T. Valenzuela. 2008. First report on the occurrence of *Grapevine leafroll-associated virus 7* and *9* in Chilean grapevines. *Plant Disease* 92: 1252.
- Ito, T., R. Nakaune, M. Nakano, and K. Suzuki. 2013. Novel variants of a grapevine leafroll-associated virus 4 and 7 detected from a grapevine showing leafroll symptoms. *Archives of Virology* 158: 273–275.
- Jelkmann, W., F. Beate, and A.A. Agranovsky. 1997. Complete genome structure and phylogenetic analysis of *Little cherry virus*, a mealy-bug transmissible *Closterovirus*. *The Journal of General Virology* 78: 2067–2071.
- Jelkmann, W., C. Mikona, C. Turturo, B. Navarro, M.E. Rott, W. Menzel, P. Saldarelli, A. Minafra, and G.P. Martelli. 2012. Molecular characterization and taxonomy of *Grapevine leafroll-associated virus 7*. *Archives of Virology* 157: 359–362.
- Lutcke, H.A., K.C. Chow, F.S. Mickell, K.A. Moss, H.F. Kern, and G.A. Scheele. 1987. Selection of AUG initiation codons differs in plants and animals. *EMBO Journal* 6: 43–48.
- Lyu, M.D., M.J. Li, J. Li, X. Li, M. Li, and Y.-Q. Cheng. 2013. First report of *Grapevine leafroll-associated virus 7* in two native grape varieties in China. *Plant Disease* 97: 150.
- Lyu, M.D., X.M. Li, R. Guo, M.J. Li, X.M. Liu, Q. Wang, and Y.Q. Cheng. 2014. Prevalence and distribution of *Grapevine leafroll-associated virus 7* in China detected by an improved reverse transcription polymerase chain reaction assay. *Plant Pathology* 63: 1168–1176.
- Martelli G.P. 2011. Grapevine leafroll and vitivirus diseases – our state of knowledge. Grapevine Leafroll and Vitivirus Diseases Seminar – A continued and increasing problem for vineyards. In *62nd American Society for Enology and Viticulture National Conference, Monterey, USA*, 1–5.
- Martelli, G.P., N.A. Ghanem-Sabanadzovic, A.A. Agranovsky, M. Al Rwahnih, V.V. Dolja, C.I. Dovas, M. Fuchs, P. Gugerli, J.S. Hu, W. Jelkmann, N.I. Katis, V.I. Maliogka, M.J. Melzer, W. Menzel, A. Minafra, M.E. Rott, A. Rowhani, S. Sabanadzovic, and P. Saldarelli. 2012. Taxonomic revision of the family *Closteroviridae* with special reference to the grapevine leafroll-associated members of the genus *Ampelovirus* and the putative species unassigned to the family. *Journal of Plant Pathology* 94: 7–19.
- Melzer, M.J., D.M. Sether, W.B. Borth, E.F. Mersino, and J.S. Hu. 2011. An assemblage of *Closteroviruses* infects Hawaiian ti (*Cordyline fruticosa* L.). *Virus Genes* 42: 254–260.

- Mikona, C., and W. Jelkmann. 2010. Replication of *Grapevine leafroll-associated virus-7* (GLRaV-7) by *Cuscuta* species and its transmission to herbaceous plants. *Plant Disease* 94: 471–476.
- Mikona, C., C. Turturo, B. Navarro, W. Menzel, A. Minafra, M.E. Rott, G.P. Martelli, and G.P. Jelkmann. 2009. Taxonomy, complete nucleotide sequence and genome organization of *Grapevine leafroll-associated virus-7*. In *Proceedings of the 16th Meeting of ICVG, Dijon, France, 275–277*.
- Morales, R.Z., and J. Monis. 2007. First detection of *Grapevine leafroll associated virus-7* in California vineyards. *Plant Disease* 91: 465.
- Reynard, J.-S., P.H.H. Schneeberger, J.E. Frey, and S. Schaerer. 2015. Biological, serological, and molecular characterization of a highly divergent strain of *Grapevine leafroll-associated virus 4* causing grapevine leafroll disease. *Phytopathology* 105: 1262–1269.
- Rigotti, S., W. Bitterlin, and P. Gugerli. 2006. Production of monoclonal antibodies to *Grapevine leafroll-associated virus 7* (GLRaV-7). In *Proceedings from the 15th meeting of ICVG, Stellenbosch, South Africa, 200–202*.
- Sim, S.T., M. Al Rwahnih, A. Rowhani, and D.A. Golino. 2012. Virus elimination from grape selections using tissue culture at Foundation Plant Services, University of California, Davis. In *Proceedings of the 17th Congress of ICVG, Davis, California, USA, 262–263*.
- Turturo, C., M.E. Rott, A. Minafra, P. Saldarelli, W. Jelkmann, and G.P. Martelli. 2000. Partial molecular characterization and RT-PCR detection of *Grapevine leafroll-associated virus 7*. In *Proceedings of the 13th meeting of ICVG, Adelaide, Australia, 17–18*.
- Wilcox, W.F., W.D. Gubler, and J.K. Uyemoto (Eds). 2015. *Grapevine leafroll disease. In Compendium of grape diseases, disorders, and pests*. American Phytopathological Society. St. Paul, Minnesota, 118–120.
- Woodham, R.C., and I.R. Krake. 1983. Investigations on transmission of grapevine leafroll, yellow speckle and fleck diseases by dodder. *Phytopathology* 106: 193–198.
- Yu, H., S. Qi, Z. Chang, Q. Rong, I.A. Akinyemi, and Q. Wu. 2015. Complete genome sequence of a novel *velarivirus* infecting areca palm in China. *Archives of Virology* 160: 2367–2370.

Chapter 11

Grapevine Vitiviruses

A. Minafra, M. Mawassi, D. Goszczynski, and P. Saldarelli

Abstract The discovery, isolation, and characterization of grapevine vitiviruses have spanned the history of grapevine virology. After the description of the rugose wood disease complex in the early 1960's, increasing evidence accumulated to link some members of this group of viruses with that disease. Improved serological and molecular detection techniques, findings regarding the transmission of vitiviruses by mealybugs, and the analysis of the genetic variability of these viruses have provided insights into their relevance to the grapevine industry and the importance of their inclusion in certification programs for the production of clean propagation stocks. The difficulty in satisfying Koch's postulates (i.e., the demonstration of the actual role of these viruses in eliciting wood and bark alteration symptoms) is due to the inability to infect grapevine via inoculation with virus particles. The synthesis and use of infectious full-length genomic clones and reverse genetic analyses will allow infectivity and functional genomic experiments in a variety of grapevine germplasm, in which it will be possible to discern differential reactivity leading to symptom expression.

Keywords Vitivirus • Rugose wood complex • Mealybug transmission • Indexing • Infectious full-genome clones

A. Minafra (✉)

Institute for Sustainable Plant Protection, National Research Council, Bari, Italy
e-mail: angelantonio.minafra@ipsp.cnr.it

M. Mawassi

Department of Plant Pathology and Weed Research, Agricultural Research Organization, The Volcani Center, Bet-Dagan 50250, Israel

D. Goszczynski

Agricultural Research Council, Plant Protection Research, Pretoria, South Africa

P. Saldarelli

CNR Istituto per la Protezione Sostenibile delle Piante UOS Bari and Dipartimento di Scienze del Suolo della Pianta e degli Alimenti, Università degli Studi di Bari, via Amendola 165/A, Bari, Italy

Introduction and Historical Aspects

Grapevine breeding for seedling selection and vegetative propagation in the Mediterranean Basin and the Near East has a history dating back millennia (This et al. 2006; Terral et al. 2010). Viruses affecting grapevine have a long history of coevolution and adaptation with their host plants reaching back far before cultivation (Gibbs et al. 2010). Over these many years, grape growers have selected for plants that look healthy as opposed to those showing symptoms of disease. At the same time, diseases have originated from vector-borne viruses transmitted through vegetative propagation (i.e., grafting and self-rooting) and the transport and trade of plant material with latent infections.

Wood alteration diseases in grapevine, collectively referred to as rugose wood (RW) complex (Martelli 1993), include different syndromes affecting the woody cylinder, cambium tissues, and bark. Symptoms such as swelling of tissues at the graft union and a more or less intense proliferation and cracking of the bark are apparent mainly upon grafting. It is not unusual to observe such symptoms in commercial vineyards.

RW is latent in self-rooted *Vitis* species and hybrids since most of the symptoms of this disease are visible only when infected scions or rootstocks are grafted onto presumptively healthy material. The appearance of phylloxera in Europe in the middle of the nineteenth century and the consequent adoption of the practice of grafting onto American grapevine rootstocks to avoid damage to *V. vinifera* were likely the primary causes for the appearance of vitivirus-derived diseases in susceptible germplasm. However, there is also some evidence to indicate that RW is an Old World disease: (1) Wood symptoms are described in the French literature of the early 1900s, and (2) the disease and some of the RW-associated viruses have appeared in phylloxera-free countries such as Cyprus, Armenia, and Yemen, as well as parts of Anatolia and the Aegean Greek islands. At the time of the appearance of the disease in those regions, American rootstocks had not been introduced, and old grapevine cultivars were self-rooted for propagation (Martelli et al. 1994a). Pioneer research noticed wood alterations in California (Hewitt 1954; Hewitt and Neja 1971), where a “rough bark” disease was described, as well as in Italy, where pitting and grooving on the wood in scions and rootstocks of grafted plants were referred to as *legno riccio* (Graniti and Ciccarone 1961; Graniti and Martelli 1965). Another alteration of the cambium that evolved in undifferentiated cell proliferation in LN33 seedlings (Couderc 1613 × Thompson Seedless) was described as “corky bark” by Beukman and Goheen (1965) in California. In the early 1950s in Napa Valley (California, USA), an epidemic of a putative vector-borne disease was related to undifferentiated cells extending from the phloem, with macroscopic symptoms including green rubbery canes and vine death within a few years (Hewitt 1968).

In recent decades, anecdotal disease scenarios have been brought into the age of the identification and characterization of viruses associated with described symptoms (Martelli 2014). This has been achieved through the selection of indicators (*V. rupestris*, LN33, and Kober 5BB) that can be used to differentiate between different

virus-like syndromes (Goheen and Luhn 1978; Savino et al. 1989; Martelli 1993). Electron microscopy has revealed phloem-limited, elongated virus particles in thin sections of grapevine tissues affected by RW or leafroll (LR) (Milne et al. 1984; Martelli 1993; Faoro 1997). Conti et al. (1980) mechanically inoculated *Nicotiana benthamiana* seedlings with a filamentous virus from the sap of a “stem-pitting” grapevine. That virus was eventually named *Grapevine virus A* (GVA). After this first evidence that filamentous viruses that share similar structural and biological features are associated with the RW complex, two other viruses, *Grapevine virus B* (GVB; Boscia et al. 1993) and *Grapevine virus D* (GVD, Bonavia et al. 1996; Abou-Ghanem et al. 1997), were mechanically transmitted to *Nicotiana* and characterized. Polyclonal antisera were produced, immunizing purified virus preparations obtained from herbaceous hosts infected with viruses associated with RW-affected grapes. These antisera, used in ELISA for large-scale surveys, greatly helped to increase our understanding of the associations among virus species and symptoms observed in the field (reviewed by Boscia et al. 1997a, b). Finally, the finding that the closterovirus-like particles isolated by Conti et al. (1980) could be transmitted from infected to healthy grapes by mealybugs (Rosciiglione et al. 1983) advanced the research on the epidemiology of some of the RW-associated viruses.

New tools have become available for the study of how RW-associated viruses and their host plant interact to produce infection. The full-length genomes of GVA and GVB were cloned, and their *in vitro* synthesized transcripts or cDNA clones under eukaryotic promoters were shown to be infectious in herbaceous and grapevine hosts (Galiakparov et al. 1999; Saldarelli et al. 2000a; Moskowicz et al. 2008; Goszczynski 2015). Thus, it became possible to fulfill Koch’s postulates and determine the role of these viruses in causing the syndromes associated with the RW complex – by themselves or in combination with other viruses. Reverse genetics has also provided some clues regarding determinants of pathogenicity.

Taxonomy and Nomenclature

Elongated, flexuous particles visualized by electron microscopy in the early 1980s were defined as “closterovirus like” (Boscia et al. 1997a). Later, at least two types of filamentous particles were differentiated based on their modal length (1200–1400 nm vs. 800 nm). Those different types of particles, which share a similar open structure and cross-banding of their CP subunits into virion tubules, sometimes coexist in the same infected plants (Milne et al. 1984). Some of the shortest viruses could be easily distinguished through immune-electron microscopy, using antisera to particles purified from infected herbaceous hosts. Using this method, these particles could be easily distinguished from the longest ones, when present in mixed infections. The long particles were found to be more likely associated with LR symptoms, whereas higher infection rates of GVA and GVB were detected in RW-affected grapevines.

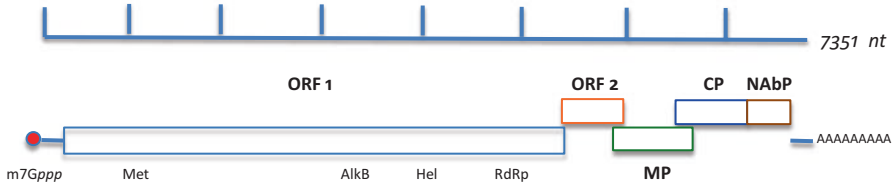

Fig. 11.1 Schematic representation of the *Grapevine virus A* RNA genome. Open reading frames (ORFs 1–5) are labeled or named by their function. A red dot represents the methyl-7-guanosine cap at the 5' end. The poly-A tail is indicated at 3' end. *Met* methyltransferase, *AlkB* alkB domain, *Hel* helicase, *RdRp* RNA-dependent RNA polymerase, *MP* movement protein, *CP* coat protein, *NabP* nucleic acid-binding protein

Their structural and biological divergence from the “long closteroviruses” served as the basis for the initial assignment of GVA and GVB to the genus *Trichovirus* (Martelli et al. 1994b). Information on sequences derived from the 3' terminal portions of the GVA and GVB genomes (Minafra et al. 1994) confirmed that both of these viruses have a different genomic organization than that of LR-associated viruses and required a separate classification. Advances in sequence analyses and the distinct phylogeny of these viruses prompted the grouping of the grapevine-infecting “trichoviruses” (GVA, GVB, and GVD) together with *heracleum latent virus* (HLV; Bem and Murrant 1979a) in the genus *Vitivirus* (Martelli et al. 1997).

A distinguishing feature of the genus is a genome organization that consists of a single-stranded positive RNA with five ORFs (Figs. 11.1 and 11.2). These viruses are naturally transmitted by pseudococcid mealybugs, soft-scale insects, and aphids (Bem and Murrant 1979b; Tzanetakakis et al. 2007; du Preez et al. 2011).

The taxonomic classification of many genera of filamentous viruses from the alphavirus-like supergroup, which essentially share the same size, genome organization, and a 150–250 kDa replication protein, was critically reconsidered. That analysis prompted Adams et al. (2004) to propose the establishment of the new family *Flexiviridae*. For the species belonging to the genus *Vitivirus*, the demarcation threshold was defined as a situation in which the amino acid sequences of any gene product differ by more than 10%.

Moreover, features in genome type and design were then integrated with phylogenetic relationships among the replicational and structural proteins in the genera. Based on a hypothesized common ancestor of the flexiviruses and members of the family *Tymoviridae*, the *Flexiviridae* were split into three new families within the order *Tymovirales*: the *Alpha-*, *Beta-*, and *Gammaflexiviridae* (Martelli et al. 2007). In addition to the abovementioned viruses (GVA, GVB, GVD, and HLV), several other vitiviruses have been recently classified as definitive or putative members of the newly established family *Betaflexiviridae* (Adams et al. 2011). Some of these viruses have recently been identified in grapevine through the use of nucleic acid-based techniques and assigned to the genus *Vitivirus* (e.g., *Grapevine virus E*; Nakaune et al. 2008b; Coetzee et al. 2010b) or considered putative members (e.g., *Grapevine virus F*; Al Rwahnih et al. 2012; Molenaar et al. 2015). A few other

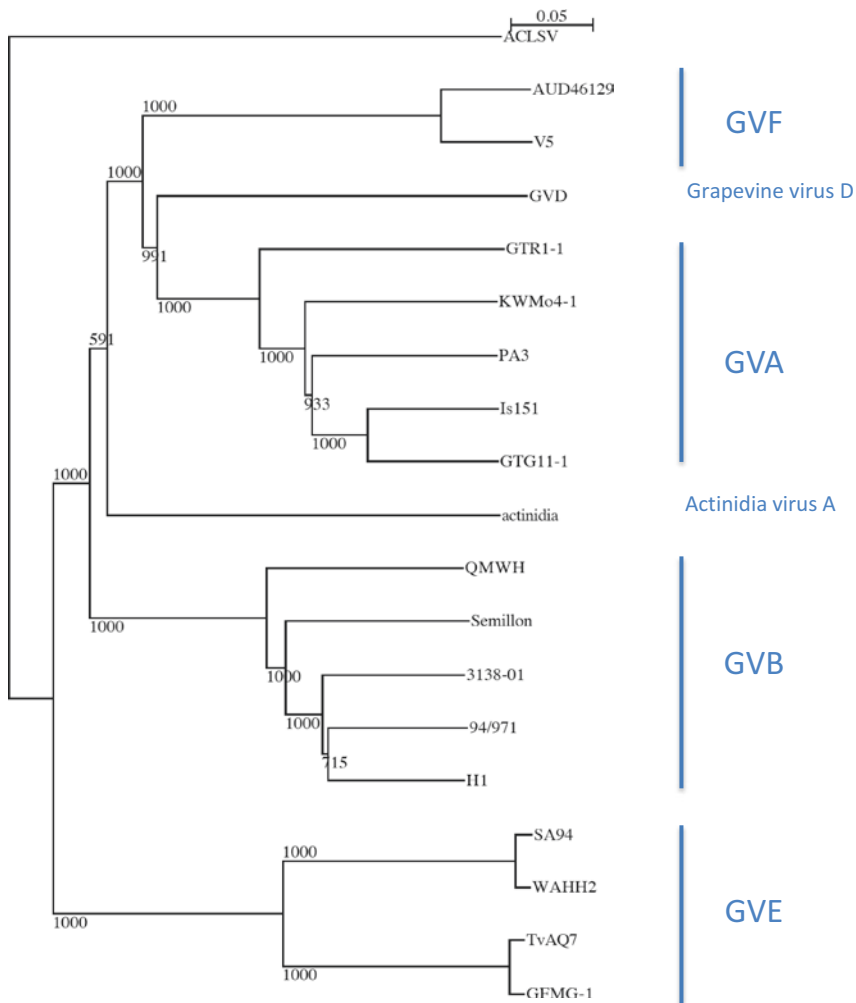

Fig. 11.2 Phylogenetic tree of several vitiviruses based on their full-length genomes. The tree was obtained using the neighbor-joining method and Clustal X nucleotide alignment. Bootstrap values (out of 1000 replicates) are indicated at the nodes. The distance reference bar (0.05 substitution/site) is shown at the top of the figure. The sequence of *Apple chlorotic leaf spot virus* (acc.nr. AJ243438) was used as an outgroup. GenBank accession numbers of the isolates are as follows: GVF (V5: KP114220; AUD46129: NC_018458), GVA (GTR1-1: DQ787959; KWMo4-1: DQ855083; PA3: AF007415; Is151: NC_003604; GTG11-1: DQ855084), *Actinidia virus A* (JN427014), GVB (QMWH: KF700375; Semillon: NC_003602; 3138-01: JX513897; 94/971: EF583906; H1: GU733707), and GVE (SA94: GU903012; WAHH2: JX402759; TvAQ7: NC_011106; GFMG-1: KF588015). The GVD sequence was received as a personal communication from M. Al Rwahnih

viruses that infect hosts other than grapevine were identified from *Mentha* (*Mint virus 2*; Tzanetakis et al. 2007) and kiwi trees (*Actinidia viruses A* and *B*; Blouin et al. 2012).

Genome Structure, Genome Expression and Replication

The genome of vitiviruses is a single strand of positive-sense RNA of about 7.4–7.6 kb that is encapsidated by flexuous virus particles. The virus particle is about 700 nm in length and has a diameter of 12 nm (Martelli et al. 2007). The 5' terminus of the genome is capped, and the 3' end has a polyadenylate tail. Early sequencing of the GVA and GVB genomes through cDNA clones obtained from total RNA of infected *Nicotiana* provided evidence that the two viruses have similar genome structures (Minafra et al. 1994). The complete genome sequences of both viruses (Saldarelli et al. 1996; Minafra et al. 1997) revealed the presence of five distinct open reading frames (ORFs), short fragments of which often overlap (Fig. 11.1).

In GVA, the type species of the genus *Vitivirus*, the 5' and 3' untranslated regions (UTR) are 86 and 68 nt in size, respectively. The GVA and GVB RNA genomes possess a polyadenylation signal (AAUAAA) located in the 3' UTR, upstream of the poly-A tail.

The largest gene, ORF1, spans 5124 nt coding for 1707 amino acids, with a protein size of 195.5 kDa. In vitiviruses, the translation products of ORF1 include an array of putative functional domains congruent with the general architecture of the flexivirid replicase gene (Martelli et al. 2007). The identified domains are a methyltransferase, a helicase, and an RNA-dependent RNA polymerase. The conserved GDD signature of RNA-dependent RNA polymerases (Koonin 1991) is located in the C-terminal region (aa: 1395–1623). The absence of any known protease, such as papain-like or ovarian tumor protease, from the vitivirus replicase is peculiarly shared with a few other genera of the *Betaflexiviridae*. Since no experimental evidence is available regarding the processing of the translation product of ORF1, we would expect the unfragmented polyprotein to operate through the timely activation of its functional domains (Martelli et al. 2007).

A second feature of the ORF1-encoded protein is the presence of an AlkB domain upstream of the helicase. This domain activates alkylated DNA repair in many cellular systems across kingdoms (Bratlie and Drabløs 2005). It was hypothesized that enzymatic repair (i.e., demethylation of virus RNA in phloem sap) could support viral survival. The increased fitness gained through this function by viruses that colonize polyphenol-rich woody hosts was fixed following the acquisition by recombination from bacteria or plants (Van den Born et al. 2008). Unlike the other vitiviruses (Coetzee et al. 2010b; Alabi et al. 2013), in GVE, the 86 amino acid-long AlkB domain is embedded inside the helicase. Moreover, a DExD amino acid domain putatively associated with an RNA helicase-like function has been identified only in a fully sequenced GVE isolate (Alabi et al. 2013).

The small ORF2 is unique to vitiviruses. It potentially encodes a polypeptide of 19.8 kDa (177 aa) with no homology with other proteins in databases. Functional analysis of infectious clones bearing mutated or silent forms of this protein has demonstrated that it plays no role in replication in *Nicotiana* (Galiakparov et al. 2003a). It has been hypothesized that this protein may instead play a role in virus transmission by insect vectors or have a function specific to infection in grapevine (Galiakparov et al. 2003a). Polyclonal antibodies raised against the recombinant GVB ORF2 product failed to localize the protein in thin sections of the infected plant but did yield faint bands in Western blots of total protein extracts (Saldarelli and Minafra 2000). The absence of selective pressure in ORF2 was reported in two Japanese GVE isolates (Nakaune et al. 2008b), while a distinctive low level of nucleotide homology in the ORF2s of an Italian isolate and a South African isolate suggests that these sequences might have originated from different sources (Adams et al. 2004).

ORF3 and ORF4 encode a movement protein (MP; 278 aa) of the 30 kDa TMV-like superfamily and the coat protein (CP; 198 aa), respectively. Polyclonal antiserum raised against a recombinant GVA MP exhibited stable expression in infected grapevine tissues (Rubinson et al. 1997). Similarly, antisera to recombinant MPs of GVA and GVB were used to probe fractionated cell extracts or thin sections from *Nicotiana*, to demonstrate the transient expression of these proteins in the cytoplasm and their association with membranes tightly linked with cell walls and plasmodesmata (Saldarelli et al. 2000b). These findings were confirmed by Haviv et al. (2012b), who used fluorescent protein labeling to demonstrate the close association of in vivo synthesized GVA and GVB MPs with plasmodesmata and the accumulation of these proteins in spots and then tubule-like structures on the outer periphery of infected tobacco or grapevine cells.

The CPs of GVA and GVB contain the conserved residues RQ/FDF, identifying the salt-bridge structure known to occur in the CPs of filamentous viruses (Dolja et al. 1991).

ORF5 codes for a small 10 kDa RNA-binding protein (p10, 90 aa). This protein contains a basic, arginine-rich motif, and a typical zinc-finger domain (Galiakparov et al. 2003c). Deletion of the basic region of p10 abolished the nucleic acid-binding activity, whereas amino acid substitution in the Zn-finger domain did not. Although mutations in ORF5 did not affect the overall replication of viral RNA in *Nicotiana* protoplasts, these mutant viruses caused a symptomless infection and a marked reduction of MP accumulation in infected *N. benthamiana* plants (Galiakparov et al. 2003c). The absence of symptoms could be attributed to the low viral titer or the abolishment of pathogenic determinants putatively borne by ORF 5. In fact, in agroinfection experiments and an in vitro small RNA binding assay, GVA p10 was shown to weakly suppress RNA silencing (Chiba et al. 2006; Zhou et al. 2006). The role of the N-terminal portion of the GVA p10 in eliciting symptoms in *N. benthamiana* was demonstrated through the identification of the eighth amino acid of this protein as the key determinant for symptom expression (Haviv et al. 2012a). A similar silencing-suppression function was demonstrated in vivo for the p10 of a GVD isolate from California (Rosa 2007).

The functions of individual GVA ORFs were studied through substitution and deletion mutagenesis (Galiakparov et al. 2003c), followed by Northern and Western blot analyses in *N. benthamiana* plants or protoplasts. ORF1 is needed for RNA replication, whereas mutations in ORF3 and ORF4 affect cell-to-cell movement. It is noteworthy that in the absence of CP, virus movement is restricted, indicating that the MP is not the only determinant for the spread of the virus within the host.

The replication strategy of vitiviruses has been extensively studied in GVA-infected *N. benthamiana* plants through functional analysis of mutated infectious clones (Galiakparov et al. 2003a, b). Two nested sets of subgenomic (sg) RNAs, either 5'- or 3'-terminal, were characterized through the observation of dsRNA extracts purified from GVA-infected *N. benthamiana* using polyacrylamide gel electrophoresis and were found to have a double-stranded form (Galiakparov et al. 2003b). The full-length cloned GVA genome was used to identify *cis*-acting sequences that promote the synthesis of these subgenomic dsRNAs. At least three short regions located upstream of the 5' terminus of ORFs 2, 3, and 4 behave as controller elements in the induction of subgenomic RNAs and are able to induce the synthesis of a nested set of dsRNA molecules upstream and downstream of this short region. The first ORF acts as a messenger for the translation of the replication-associated protein, while the three 3' coterminal aligned subgenomic RNAs encode the other viral proteins. No sgRNA corresponding to ORF5 was detected, and it was hypothesized that its expression occurs through the smaller 3' terminal subgenomic RNA (1.0 kb in size), which bears the CP gene. Interestingly, the presence of dsRNAs of 5' coterminal subgenomic RNA is common among the genera *Trichovirus*, *Carlavirus*, and *Vitivirus*. Sporadic, short intergenic regions spanning from as little as four to five to tens of nucleotides could be observed in the genomes of some vitivirus isolates, as in GVD between ORF1 and ORF2 and between ORF4 and ORF5 (M. Al Rwahnih, personal communication) and in GVB between ORF4 and ORF5 (Minafra et al. 1994; Hu et al. 2014).

Genetic Diversity and Population Structure

As the number of virus isolates transmitted from RW-affected vines to *Nicotiana* spp. increased (Castrovilli and Gallitelli 1985; Monette and James 1990; Boscia et al. 1994; Bonavia et al. 1996), it became evident that different species were selected on herbaceous plants, each showing subtle differences in symptom expression. Mild to severe dwarfing, epinasty and curling of mottled leaves, and occasional necrosis on more or less extended leaves vary among isolates of GVA and GVB. An effort to boost the retrieval of vitivirus isolates and characterization was initiated by Monette et al. (1990), who reported improved efficiency of mechanical transmission when in vitro-grown shoots of RW-affected grapevines were used. Several viral isolates have been characterized and transmitted to *Nicotiana* seedlings by mealybugs (Roscioglione et al. 1983; Garau et al. 1995; Goszczynski and Jooste 2003a).

In the 1990s, serological methods were used to survey commercial vineyards and germplasm collections for GVA and GVB. In Tunisia, GVA was detected in 50% of sampled vines, most of which were also infected with closterovirids (Agran et al. 1990). A survey in Yemen revealed the widespread presence of GVA in old, self-rooted cultivars that showed RW symptoms (Martelli et al. 1994a). A huge degree of variability in the incidence of GVA infection (ranging from 4 to 97%) was described in Southern Italy (Digiario et al. 1994).

RT-PCR was used to study the incidence and variability of GVA and GVB in commercial vineyards in Tunisia (M'hirsi et al. 2001); Brazil (Nickel et al. 2002), where the incidence of GVB in *V. labrusca* and *V. vinifera* was reported to be as high as 60%; as well as in Jordan (Anfoka et al. 2004), Spain (Velasco et al. 2005), Japan (Nakaune et al. 2008a), and Croatia (Voncina et al. 2011). Recently, surveys for GVA and GVB have been carried out in Portugal (Duarte et al. 2015), a survey of GVD was done in Tunisia (Selmi et al. 2015), and surveys for GVA (Ribeiro et al. 2004; Wang et al. 2011) and GVB (Hu et al. 2014) were carried out in China. An additional survey of GVA in *V. vinifera* × *V. labrusca* hybrids in China revealed an incidence of 16.9%, as well as mixed infections with GLRaV-3, GLRaV-2, and GVB (Wang et al. 2012). General screening for grapevine viruses has also detected GVA and GVB in Egypt (Fattouh et al. 2014) and in Chile (Fiore et al. 2008, 2011), where symptoms of RW were rare, likely due to the fact that most of the old Chilean vineyards were established with self-rooted plants. In contrast, in Tuscany, GVA was detected in 30% of tested samples of cv. Sangiovese (Rizzo et al. 2015). Most of these authors suggested that latency or mild RW symptoms may have favored the spread of vitiviruses in vineyards established with vines that were selected and propagated without reliable virus screening.

Goszczynski and Jooste (2003c) differentiated GVA isolates with a single-strand conformation polymorphism (SSCP) analysis and further sequencing. Three distinct groups of variants, denoted by clustering in phylogenetic dendrograms and supported by a significant intergroup nt divergence and intragroup homogeneity, were identified among samples of grapevine from South Africa. These isolates share average levels of homology with the Italian type strain Is151 of 96–100%, 93%, and 89%. In some isolates, recombination was identified at the 3' terminal portion of the genomic RNA, due to the coexistence of multiple genetic variants in a single plant. Mechanical or vector-mediated transmission to *Nicotiana* segregated molecular variants with different biological properties (Goszczynski and Jooste 2003b).

A survey of a large germplasm collection revealed some mixed infection of GVA and GVB (Sciancalepore et al. 2006). The mean diversity and substitution ratio in synonymous/non-synonymous positions in the CP gene were identical for both viruses and relatively low, indicating significant constraints to the modification of the amino acid composition. A homogeneous GVB cluster from Mediterranean table grape cultivars differed in phylogeny from a second cluster originating from Asian vine sources. Another survey in Southern Italy (Murolo et al. 2008) analyzed the sequences of RFLP-screened GVA CP amplicons. While a putative cluster IV [86% of diversity vs. groups I and II according to Goszczynski and Jooste (2003b)]

was identified, no correlations were detected among GVA variants, source cultivar, and geographical origin.

A survey conducted in California revealed that *V. californica* and its hybrids with *V. vinifera* are potential reservoirs of GVA and GLRaV-3, although no evidence of virus transfer from free-living vines to commercial vineyards was provided (Klaassen et al. 2011). The presence of GVA and GVB in wild grapevines along river banks, where human-driven activity can hardly be claimed, suggests that these viruses naturally spread in wild grapevines. Recent infection of these grapevines was also suggested by phylogenetic studies. Recombination events among GVA strains that could have contributed to the evolution of the virus, coupled with a strong purifying selection in the CP gene, were reported in vineyards on the West Coast of the USA (Alabi et al. 2014). Even if divergent sequence variants were obtained in individual grapevines, virus populations from California and the state of Washington were not substantially different from each other. Interestingly, these populations were found to differ from European isolates. A high level of variability among GVA isolates was identified within a limited geographical area (Slovakia and the Czech Republic; Predajna and Glasa 2016).

Extensive variation in two clusters of GVB (among 20 isolates) was described in an Australian study, in which the virus was found in 5.2% of the tested samples (Shi et al. 2004). In the four sequenced genomic regions, RNA recombination between GVB and other related viruses, such as GVA and GVD, was detected in some of these isolates. In South Africa, variants of GVB clustered in six molecular groups even in the conserved replicase domain, with 73.7–85.9% shared nt identity between groups (Goszczynski 2010).

Al Rwahnih et al. (2014) found that GVF was present in 7% of tested samples from two grapevine collections from California and characterized the phylogeny of those isolates based on the replicase gene. The variability of GVE has recently been studied in several *Vitis* species (*V. labrusca*, *V. vinifera*, *V. riparia*, and a hybrid) in California and New York State (Vargas-Asencio et al. 2016). The New York survey identified a high level of shared identity among the GVE isolates (98% at the nt level) and widespread coinfection with other grapevine viruses.

Vitiviruses, like most if not all grapevine viruses, exist as a heterogeneous population, possibly as a result of the mixing of different strains as a result of grafting practices and global trade, insect transmission, or genomic recombination (Shi et al. 2004).

Detection and Diagnosis

Even if it is sometimes possible to observe RW symptoms directly in field-grown grapevines, their appearance largely varies according to the grafting combination and environmental conditions. Bioassays (i.e., bud-grafting on *Vitis* indicators) are commonly used for the identification and sorting of RW diseases (Savino et al. 1989), but these tests are time-consuming, costly, and are also not fully reliable

because mild symptoms may go undetected and individual viruses cannot be unequivocally detected. Like most phloem-restricted viruses, all RW-related agents are irregularly distributed in infected plant tissues, and their titer increases during the vegetative period to become highest in autumn, since mature petioles and phloem scrapings are the easiest tissues in which to detect the virus (Boscia et al. 1997a). Moreover, vitiviruses are described as poor immunogens, yielding antisera that are not always suitable for use in ELISA (Boscia et al. 1997a). A reproducible, slight cross-reactivity between polyclonal antisera against heterologous viruses (GVA and GVB, Goszczynski et al. 1996; GVA and GVD, Choueiri et al. 1997) was observed well before amino acid sequence alignments highlighted highly conserved amino acid stretches in the CPs of these viruses.

Monoclonal antibodies (Mabs) were produced against GVA (Boscia et al. 1992), GVB (Bonavia et al. 1996), and GVD (Boscia et al. 2001). The immunization of recombinant MPs of GVA and GVB produced polyclonal antisera that were successfully employed to analyze virus accumulation patterns and cytoplasmic localization and reliably detect these viruses in grapevine tissues using Western blotting (Rubinson et al. 1997; Saldarelli et al. 2000b) and immuno-electron microscopy (Boscia et al. 1997b). A highly structured epitope, which reacted with four different Mabs on spotted membranes or through phage display, was mapped to a conserved peptide region of the GVA CP (Dell'Orco et al. 2002).

Since the first use of a molecular hybridization assay (Gallitelli et al. 1985) with radio isotope-labeled cDNAs to detect GVA, various radioactive GVA probes (Minafra et al. 1992b) as well as digoxigenin-labeled GVA, GVB (Saldarelli et al. 1994), and GVD riboprobes (Abou Ghanem et al. 1997) have been applied in dot-spot hybridizations of grapevine extracts. A riboprobe for routine detection of GVA was also tested on tissue prints (Kominek et al. 2008).

Quick and sensitive detection of RW-associated viruses was possible through RT-PCR using specific primers initially designed based on a single GVA isolate sequence (Minafra et al. 1992a). When larger sets of partial and full-length sequences of vitiviruses became available, more robust primers were designed (De Meyer et al. 2000; MacKenzie et al. 1997; Goszczynski and Jooste 2003b). Nassuth et al. (2000) successfully used a multiplex, one-tube RT-PCR procedure for the simultaneous detection of GRSPaV, GVA, and GVB sequences, as well as an endogenous plant sequence control. A major milestone was achieved when the alignment of the conserved replicase motifs of the few sequences of filamentous viruses available at that time allowed the design of degenerate primers that could amplify a ca. 330-bp fragment common to all of the then-known genera of the *Flexiviridae* (Saldarelli et al. 1998). Using essentially the same motifs, Dovas and Katis (2003a, b) inserted a deoxy-inosine nucleotide at highly degenerate positions and introduced a set of nested primers around the conserved motifs, to improve the sensitivity and specificity of detection of phloem-limited viruses of grapevine.

The detection of vitivirus sequences was also pursued through the use of multiplex PCR procedures, in which carefully optimized primer sets designed for specific targets were mixed in the same reaction. This multiplexing technique was applied in standard PCR (Gambino and Gribaudo 2006), as well as quantitative real-time PCR

(Osman et al. 2013). This strategy for simultaneous detection of vitivirus, together with most of the known grapevine viruses, was also explored in the oligoarray hybridization of preamplified cDNAs (Engel et al. 2010; Thompson et al. 2014).

High-throughput sequencing (HTS) techniques have been used to characterize small RNAs or dsRNAs purified from infected grapevine plants and to identify the presence of new vitivirus species, for example, GVE (Coetzee et al. 2010b) and GVF (Al Rhwanh et al. 2012; Molenaar et al. 2015). This generic, unbiased method for analyzing the full “virome” has been envisioned as an alternative diagnostic tool (Coetzee et al. 2010a; Al Rhwanh et al. 2015; Czotter et al. 2015).

Host Range and Transmission

Species of the genus *Vitis* (*V. vinifera* and wild species and rootstocks) seem to be the only natural hosts in which vitiviruses have been found, and these viruses may be transmitted by grafting. However, GVA, GVB, and GVD can infect several herbaceous plants (essentially *Nicotiana* sp.) when grapevine extracts are mechanically transmitted to those herbaceous plants, though this kind of transmission is challenging due to the low virus titer and the inhibitors present in grapevine sap. As mentioned above, an improved rate of transmission was obtained from in vitro-grown grapevine shoots (Monette et al. 1990).

Corky bark (CB) symptoms were observed in the field on previously healthy plants growing near diseased plants in Mexico (Teliz et al. 1980). In 1983, a mealybug infestation in a screenhouse in Southern Italy caused GVA and GLRaV3 to spread from an infected cv. Perricone plant to nearby healthy grapevines. Following this event, Rosciglione et al. (1983) described the transmission of GVA by *Pseudococcus longispinus*. Two years later, *P. citri* and *Planococcus ficus* were described as vectors of GVA (Rosciglione and Castellano 1985). Those reports were confirmed in Israel (Tanne et al. 1989), where *Pl. ficus* was found to act as a vector for the transfer of CB disease from affected grapevines to healthy LN33 indicator, and in South Africa (Engelbrecht and Kasdorf 1990a, b). A 7-year study of the progress of CB symptoms in a commercial vineyard in Israel (Tanne et al. 1996) indicated that the gradual increase in the number of infected vines in that vineyard was related to the active distribution of the virus by a vector.

The observation of different mealybug (*Pseudococcidae*) and soft-scale (*Coccidae*) species infesting vineyards and the grape-to-grape spread of RW symptoms prompted controlled transmission experiments. GVA is now known to be transmitted by *H. bohemicus*, *Planococcus citri*, *Pl. ficus*, *Pseudococcus comstocki*, *P. longispinus*, *P. affinis*, *Parthenolecanium corni*, *Neopulvinaria innumerabilis*, and *Phenacoccus aceris* (Engelbrecht and Kasdorf 1990b; Garau et al. 1995; Fortusini et al. 1997; Goszczynski and Jooste 2003a, b, c; Nakano et al. 2003; Zorloni et al. 2006; Hommay et al. 2008; Le Maguet et al. 2012). GVB is transmitted via *Planococcus citri*, *Pl. ficus*, *Pseudococcus longispinus*, *P. affinis*, and *Phenacoccus aceris* (Boscia et al. 1993; Tanne et al. 1993; Garau et al. 1995; Le

Maguet et al. 2012). GVD has no known vector, while *P. comstocki* is the only vector to be described for GVE to date (Nakaune et al. 2008b). Generally, first instars or crawlers are the most efficient vectors, while the less mobile adult females are less important for virus spread.

Several studies have described the simultaneous transmission of a vitivirus and an ampelovirus (GLRaV-1, GLRaV-3, or GLRaV-9) acquired from a coinfecting grape by mealybugs or soft scales (Hommay et al. 2008; Le Maguet et al. 2012). These findings reinforce previous hypotheses proposed by Engelbrecht and Kasdorf (1990b) and Fortusini et al. (1997), which indicated the possibility of some sort of assisted transmission in which ampelo- or vitiviruses act as helper viruses that supply a useful or essential factor that promotes the transmission of the other virus. There are, however, a few exceptions to this. Garau et al. (1995) showed that *Ps. affinis* can distinguish between GVA and GVB in the transmission of virus from grape to *Nicotiana* spp. La Notte et al. (1997) documented the ability of *Pl. ficus* to transmit GVA from infected to healthy *N. clevelandii* plants, in the absence of any ampelovirus. These latter authors characterized GVA as having a semi-persistent mode of transmission. The transmission of vitiviruses is nonspecific; several mealybug and soft-scale species can acquire and transmit these viruses from grape to grape and from grape to *Nicotiana*. This mode of transmission of vitiviruses and ampeloviruses implies that virions are retained on ectodermic structures, such as the stylet fascicle and/or foregut of the insect (Alliaume et al. 2015). It remains unknown whether a helper factor is produced by ampeloviruses and functions in grapevine to assist the transmission of vitiviruses.

Cytopathology and Virus-Host Interactions

Vitivirus-induced cellular modifications have been extensively studied, primarily in herbaceous hosts. A review summarizing more than two decades of electron microscopic observations was published by Faoro (1997). Essential tools for those analyses were thin-section preparations of infected tissues and the immunogold labeling (IGL) of virus particles in cell compartments using specific antibodies (Faoro et al. 1991). The production of antisera to different viruses coinfecting the same plant and the availability of in vitro-grown infected plants were fundamental for that work. Faoro (1997) stated that the use of in vitro-grown plantlets is the only effective way to study alterations in grapevine caused by vitiviruses, since the chance of observing infected cells is even lower than the chance of observing closterovirids in tissues collected from the field.

Different vitiviruses seem to induce similar cytopathology in *Nicotiana* species. In those plants, they are not restricted to the phloem, but also multiply in the xylem and mesophyll. In the mesophyll, they form banded aggregates (Roscligione et al. 1983; Monette and Godkin 1992; Castellano et al. 1995). The structure and outward appearance of major organelles of infected cells were apparently normal. Virus particles appeared as filaments, which were scattered or aggregated in small bundles.

In contrast, in vascular bundles (sieve tubes, companion, or vein border cells), viral aggregates were larger. The main cytopathological features common to the three vitiviruses GVA, GVB, and GVD are (1) virus particle aggregates of varying size, which form bundles, whorls, banded bodies, and stacked layers that may sometimes fill the entire cell lumen; (2) variously extended cell wall thickening originating from the deposit of callose-like substances; (3) proliferation and accumulation of cytoplasmic membranes; and (4) vesicular invaginations of the tonoplast that protrude into the vacuole and contain fibrillar material that resembles RNA. This last feature is distinctive of vitivirus infections in grapevine (Boscia et al. 1997b). As mixed viti- and ampelovirus infections appear frequently in grapevine, the viruses are localized to the phloem, where they can be distinguished by IGL, but coinfection of the same cells rarely occurs (Faoro et al. 1991; Castellano et al. 1995).

The molecular relationship between the mechanism of virus replication and grapevine epigenetic factors and gene expression will be further unraveled by evaluating experimental information together with the annotation of the grapevine genome (Jaillon et al. 2007; Velasco et al. 2007). As a preliminary example, Katoh et al. (2009) described a novel virus-induced grapevine protein (VIGG) that is upregulated only upon GVA infection.

The ectopic artificial expression of viral proteins has allowed us to understand their localization and interaction with cell function. Haviv et al. (2012b) expressed fluorescently labeled GVA and GVB MPs in infected protoplasts and described the appearance of tubule-like and punctate structures, indicating that these proteins localized similarly in the cell periphery. The roles of the ORF5 product in interfering with the silencing mechanism as a binder of nucleic acids (small RNAs in silencing suppression; Galiakparov et al. 2003c; Zhou et al. 2006) and as a symptom determinant (Galiakparov et al. 2003a; Haviv et al. 2012a) hint at the potential involvement of this key protein in the molecular control of virus infection.

Pathological Properties, Associated Diseases, and Their Impact

Notwithstanding the number of papers that have discussed the impact of RW disease and associated viruses on rootstock growth parameters and the enological performance of wine grape cultivars [some of which were reviewed in Mannini (2003) and Maliogka et al. (2015)], the question of how much these viruses hamper production (i.e., yield and quality) has not yet been completely answered. In addition, disease expression varies with pedoclimatic conditions, germplasm, virus strains, and potential synergistic effects of coinfecting viruses. The increased recording of mild or latent strains of RW-associated viruses and the use of sensitive diagnostic tools, capable of identifying viral sequences, revealed a contamination level much higher than expected.



Fig. 11.3 Grapevine disease symptoms putatively associated with vitivirus infections. (a) Corky bark and swelling on LN33. (b) Stem pitting and grooving on rootstock wood, under the grafting point, after the phloem was peeled off. (c) Shiraz disease symptoms on a cv. Merlot vine (natural infection in the vineyard) at the end of the vegetative season. Nearby vines unaffected by the disease showed normal hardening of their canes and normal loss of foliage (A and C courtesy of D. Goszczynski, B courtesy of D. Boscia)

As mentioned above, in grafted vines, wood symptoms may occur on the scion, rootstock, or both (Fig. 11.3). A swelling above the graft union and a marked difference in the diameter of scion and rootstock, with the scion abnormally enlarged, are common manifestations of RW. Wood alterations may vary greatly, from small pits to deep grooves accompanied by protrusions of the cambial face of the bark, which sometimes appears excessively corky and spongy, a condition denoted “corky rugose wood” (Bonavia et al. 1996). Yield, rooting ability, and graft take are reduced, and infected vines may decline and die within a few years after

planting (Martelli 1993). To further complicate our understanding of this disease, there are cases of self-rooted vines in the field showing RW-like symptoms (Martelli et al. 1994a; Ribeiro et al. 2004).

While some authors (Goheen and Luhn 1978) have suggested that RW could be the same as corky bark, which was found in California long before the discovery of RW, the suspicion that RW might involve different syndromes caused by different viruses arose when records of many years of indexing of woody indicators were critically reexamined. Thus, the proposal was put forward (Savino et al. 1989) that RW is made up of four distinct disease *facies* that can be sorted out based on differential responses obtained on a set of indicators, including *Vitis rupestris* St. George, LN 33, and Kober 5BB (*V. berlandieri* × *V. riparia*). These diseases are:

- Corky bark (CB), characterized by internodal swelling and the cracking of young shoot, that develop a few months after chip budding onto LN 33, accompanied by stunting and wood grooving. Leaf symptoms consist of yellowish spots and some reddening (Martelli 1993; Garau et al. 1997).
- Kober stem grooving (KSG), characterized by grooving of the wood of grafted Kober 5BB plants.
- LN 33 stem grooving (LNSG), characterized by grooving of the trunk of inoculated LN 33 plants, but without the phloem proliferation and internodal swelling induced by CB.

The rootstock Kober 125AA was reported to enhance the expression of both CB and KSG (Credi 1997).

Rupestris stem pitting (RSP), a similar alteration observed in grafted *V. rupestris*, is detailed in a separate section.

A primary role of climatic influence was postulated since there are indications that in a warm climate, the disease may lead to vine death (Walter and Martelli 1996), whereas in cool climates, symptoms are often almost negligible.

As soon as virus-specific detection tools became available, the crossing of indexing data and the presence of defined viruses pointed toward a close and reproducible association. Several authors reported an association of GVA with KSG (Garau et al. 1994; Chevalier et al. 1995; Credi 1997), while GVB was reported to be strongly associated with CB (Boscia et al. 1993; Bonavia et al. 1996) and GVD was thought to be somehow associated with rugose corky bark (Abou Ghanem et al. 1997; Boscia et al. 2001). The finding of GVE molecular variants in a stem pitting-affected vine and in an apparently healthy grapevine in Japan added some confusion to the understanding of the etiological role of this vitivirus (Nakaune et al. 2008b).

An experiment in California (Rosa et al. 2011) in which GVB, GVD, and GRSPaV were combined on different rootstocks revealed a remarkable reduction in trunk diameter in plants inoculated with the multiple virus combinations. Paradoxically, the *V. rupestris* source used in the indexing assay tested positive (RT-PCR) to a molecular variant of GRSPaV but produces wood-marking symptoms only when grafted with eliciting combinations.

The involvement of GVB in the etiology of CB was examined in surveys done in Australia and South Africa (Shi et al. 2004; Goszczynski 2010), which underlined

the variability of the virus strains and the presence of GVB in grafted LN33 that did not exhibit any symptoms of CB. Similarly, Komínek et al. (2009) grafted a source of RW-associated viruses (GVA, GVB, and GRSPaV) onto LN33 and did not find any CB symptoms 4 years later.

Shiraz disease (SD), a devastating disease in South Africa (Goussard and Bakker 2006), affects cv. Shiraz and other premium wine cultivars. The annual shoots do not mature and remain green with a rubbery consistency due to excessive phloem development; leaves with leafroll-like symptoms are shed much later in the season, and the affected plants die within a few years. The disease is dormant in non-susceptible grapevine cultivars, from which it can be transmitted to SD-susceptible grapevine cultivars by grafting or *Pl. ficus* (Goszczynski and Jooste 2003a). Data on the etiology of SD in South Africa (Goszczynski and Jooste 2003b); Goszczynski et al. 2008) and its relationship with Australian Shiraz disease (ASD; Goszczynski and Habili 2012) indicate that GVA variants of group II are strongly associated with both SD and ASD.

Strategies for Control and Management

Since the early 1960s, the heavy toll that viral diseases take on production has pushed regulatory authorities toward the establishment of a controlled or certified supply chain, starting with clean planting stocks and ending in nurseries and farms. In the EU, while the first Council Directive on the matter (68/93/EC; 1968) referred to the avoidance of “symptoms” checked by indexing (RW among the others) of “certified” vines for planting, the latest document (Directive 2005/43/EC; 2005) does not even mention RW-associated viruses. Some other national regulatory frameworks, such as Italy’s, explicitly require the absence of GVA and GVB and only tolerate the presence of GRSPaV in certified plants. In the EPPO protocol for grapevine certification (EPPO 2008), the statement that “testing on the woody indicators is essential for material to be classified as nuclear stock” provides strong support for RW checking, as well as the suggestion of ELISA and molecular testing for GVA and GVB. In the USA and other countries with regulated grapevine industries (see Maliogka et al. 2015), testing for vitiviruses or RW agents is required. If it is true that advanced molecular techniques, mainly NGS, are superior to indexing for the retrieval of virus sequences from almost symptomless, but infected grafted plants (Al Rwahnih et al. 2015), it also seems to be true that not all of the viruses and their molecular variants or strains will always induce biological effects.

Since no resistance to RW agents has been described in grapevine germplasm (Laimer et al. 2009; Oliver and Fuchs 2011), the importance of sanitation has been emphasized (Mannini 2003). In the long history of sanitation trials on grapevine accessions, the vitiviruses were considered quite difficult to remove. The possibility of GVA or GVB elimination has been pursued using a series of in vitro culture techniques, such as fragmented shoot apex (Barlass 1987), meristem tip culture (Bottalico et al. 2000; Mannini et al. 2015), a combination of thermotherapy and

meristem culture (Guidoni et al. 1997), cryopreservation (Wang et al. 2003), cryotherapy and electrotherapy (Bayati et al. 2011), in vitro somatic embryogenesis (Gambino et al. 2006; Bouamama et al. 2015), and micrografting of shoot apices (Spilmont et al. 2012), with varied rates of success. In vitro applications of antiviral drugs have also been used in efforts aimed at eliminating GVA (Panattoni et al. 2007; Panattoni and Triolo 2010; Guta and Buciumeanu 2011).

A genetic engineering strategy for the induction of durable resistance to vitiviruses has also been pursued. The CP genes of both GVA and GVB were inserted, through *Agrobacterium tumefaciens*-mediated transformation, first in model tobacco plants (Minafra et al. 1998; Radian-Sade et al. 2000), which were not completely resistant to infection, but showed some effects on virus replication containment, most likely due to an undetected co-suppression reaction. Transformed grapevine plants (*V. vinifera*, *V. rupestris*, 41B) demonstrating stable insertion and expression did not exhibit any resistance response when challenged (Gölles et al. 2000; Radian-Sade et al. 2000; Martinelli et al. 2002).

Vitivirus Genomic Constructs as Model Vectors for Grapevine

The full-length genomes of GVA and GVB cloned under a phage RNA polymerase promoter and, therefore, transcribed as infectious RNAs were obtained as soon as full virus genomes were sequenced (Galiakparov et al. 1999; Saldarelli et al. 2000a). The development of these constructs opened a substantial field of activity. First, the GVA construct was used for the functional analysis of viral genes (Galiakparov et al. 2003b, c), in which various mutations and deletions affecting virus replication and translocation yielded traceable effects. Later, GVA constructs from a known variant were used to obtain a single infection of grapevine, in which the virus may elicit symptoms and pathogenic determinants can be identified.

Haviv et al. (2006) engineered a full-length GVA construct, duplicating the sub-genomic promoter of ORF3, and successfully replaced the dispensable ORF2 with the GUS reporter gene or the *Citrus tristeza virus* CP gene. The problem of the instability of these constructs was alleviated by using the ORF3 promoter sequence and the downstream genes from a heterologous GVA strain. A further step was the cloning of a GVA vector under a *Cauliflower mosaic virus* 35S promoter to allow agroinfection of *Nicotiana* and grapevine (Muruganantham et al. 2009). Using this vector, the silencing of the host-specific phytoene desaturase (PDS) sequences in *N. benthamiana* and in *V. vinifera* was achieved through agroinfection, to transfer (through *Agrobacterium*) the GVA construct to rootlets of young, in vitro-grown grapevine plants. Recently, Goszczynski (2015) cloned and validated the full-length genomic cDNAs of GVA and GVB isolates by agroinfection of *N. benthamiana*.

The exploitation of silencing (i.e., the constant in vivo delivery of pathogen sequences to be targeted by endogenous silencing machinery) for the induction of durable resistance against a viral pathogen was attempted against GVA in *N. benthamiana* using a GVA minireplicon [essentially the ORF1 tagged with eGFP;

Brumin et al. (2009)]. Transgene transcription from this minireplicon was able to silence the infecting virus, which contained a sequence homologous to the transgene. The systemic spread of the antiviral PTGS signal protected a non-transgenic scion grafted onto transgenic rootstock. The targeting of GVA sequences by an artificially constructed *V. vinifera* microRNA (Roumi et al. 2012), transiently expressed in *N. benthamiana* (by agroinfiltration), conferred a promising level of resistance to virus infection.

Conclusions and Directions for Future Research

Notwithstanding the progress in vitivirus research, the discovery of new vitivirus species affecting grapevines can be anticipated. The most critical activities will be the definitive clarification of the etiological role of vitiviruses in RW and the further investigation of opportunities to induce resistance. Some GVB variants are present in asymptomatic grapevines. This suggests that different strains with conserved sequence determinants may affect different germplasm with varying degrees of pathogenicity. The investigation of these determinants is crucial for the development of a better understanding of plant-virus interactions and symptom expression.

References

- Abou Ghanem, N., P. Saldarelli, A. Minafra, N. Buzkan, M.A. Castellano, and G.P. Martelli. 1997. Properties of *Grapevine virus D*, a novel putative trichovirus. *Journal of Plant Pathology* 79: 15–25.
- Adams, M.J., J.F. Antoniw, M. Bar-Joseph, A.A. Brunt, T. Candresse, G.D. Foster, G.P. Martelli, R.G. Milne, and C.M. Fauquet. 2004. The new plant virus family *Flexiviridae* and assessment of molecular criteria for species demarcation. *Archives of Virology* 149: 1045–1060.
- Adams, M.J., T. Candresse, J. Hammond, J.F. Kreuze, G.P. Martelli, S. Namba, M.N. Pearson, K.H. Ryu, P. Saldarelli, and N. Yoshikawa. 2011. Family *Betaflexiviridae*. In *Virus taxonomy. 9th Report of the ICTV*, ed. A.M.Q. King, M.J. Adams, E.B. Carstens, and E.J. Lefkowitz, 920–941. Amsterdam: Elsevier Academic Press.
- Agran, M.K., B. Di Terlizzi, D. Boscia, A. Minafra, V. Savino, G.P. Martelli, and F. Askri. 1990. Occurrence of *Grapevine virus A* (GVA) and other closteroviruses in Tunisian grapevines affected by leafroll. *Vitis* 29: 43–48.
- Al Rwahnih, M., M.R. Sudarshana, J.K. Uyemoto, and A. Rowhani. 2012. Complete genome of a novel vitivirus isolated from grapevine. *Journal of Virology* 86: 9545.
- Al Rwahnih, M., S. Daubert, C. Islas, D. Golino, and A. Rowhani. 2014. Characterization of a fifth vitivirus in grapevine. *Journal of Plant Pathology* 96: 219–222.
- Al Rwahnih, M., S. Daubert, D. Golino, C. Islas, and A. Rowhani. 2015. Comparison of next-generation sequencing versus biological indexing for the optimal detection of viral pathogens in grapevine. *Phytopathology* 105: 758–763.
- Alabi, O.J., S. Poojari, K. Sarver, R.R. Martin, and R.A. Naidu. 2013. Complete genome sequence analysis of an American isolate of *Grapevine virus E*. *Virus Genes* 46: 563–566.
- Alabi, O.J., M. Al Rwahnih, T.A. Mekuria, and R.A. Naidu. 2014. Genetic diversity of *Grapevine virus A* in Washington and California vineyards. *Phytopathology* 104: 548–560.

- Alliaume, A., C. Reinbold, M. Uzest, M. Beuve, G. Hommay, O. Lemaire, E. Herrbach, 2015. Transmission studies of the *Grapevine leafroll-associated virus 1* and the *Grapevine virus A* by the mealybug *Phenacoccus aceris*. Proceedings of the 18th Congress of ICVG, Ankara, Turkey, pp. 110–111.
- Anfoka, G.H., W. Shahrou, and M.K. Nakhla. 2004. Detection and molecular characterization of *Grapevine virus A* in Jordan. *Phytopathologia Mediterranea* 43: 387–394.
- Barlass, M. 1987. Elimination of stem pitting and corky bark diseases from grapevine by fragmented shoot apex culture. *Annals of Applied Biology* 110: 653–656.
- Bayati, S., M. Shams-Bakhsh, and A. Moieni. 2011. Elimination of *Grapevine virus A* (GVA) by cryotherapy and electrotherapy. *Journal of Agricultural Science and Technology* 13: 443–450.
- Bem, F., and A.F. Murant. 1979a. Host range, purification and serological properties of *Heracleum latent virus*. *Annals of Applied Biology* 92: 243–256.
- . 1979b. Transmission and differentiation of six viruses infecting hogweed (*Heracleum sphondylium*) in Scotland. *Annals of Applied Biology* 92: 237–242.
- Beukman, E.F., A.C. Goheen, 1965. Corky bark, a tumor-inducing virus of grapevines. Proceedings of the International Conference on Virus and Vector on Perennial Hosts with Special Reference to *Vitis*, Davis, California, USA, pp. 164–166.
- Blouin, A.G., R.R. Chavan, M.N. Pearson, R.M. MacDiarmid, and D. Cohen. 2012. Detection and characterisation of two novel vitiviruses infecting *Actinidia*. *Archives of Virology* 157: 713–722.
- Bonavia, M., M. Digiario, D. Boscia, A. Boari, G. Bottalico, V. Savino, and G.P. Martelli. 1996. Studies on “corky rugose wood” of grapevine and the diagnosis of *Grapevine virus B*. *Vitis* 35: 53–48.
- Boscia, D., E. Asloulj, V. Elicio, V. Savino, M.A. Castellano, and G.P. Martelli. 1992. Production, characterization and use of monoclonal antibodies to *Grapevine virus A*. *Archives of Virology* 127: 185–194.
- Boscia, D., V. Savino, A. Minafra, S. Namba, V. Elicio, M.A. Castellano, D. Gonsalves, and G.P. Martelli. 1993. Properties of a filamentous virus isolated from grapevines affected by corky bark. *Archives of Virology* 130: 109–120.
- Boscia, D., N. Abou Ghanem, P. Saldarelli, A. Minafra, M.A. Castellano, R. Garau, V. Savino, and G.P. Martelli. 1994. A comparative study of *Grapevine virus B* isolates. *Rivista di Patologia Vegetale (Ser. V)* 4: 11–24.
- Boscia, D., M. Digiario, J. Fresno, C. Greif, S. Grenan, H.H. Kassemeyer, V.A. Prota, and O.A. De Sequeira. 1997a. ELISA for the detection and identification of grapevine viruses. In *Sanitary selection of the grapevine. Protocols for detection of viruses and virus-like diseases*, ed. B. Walter, 129–155. Paris: INRA (Les Colloques n. 86).
- Boscia, D., A. Minafra, and G.P. Martelli. 1997b. Filamentous viruses of the grapevine: Putative trichoviruses and capilloviruses. In *Filamentous viruses of woody plants*, ed. P.L. Monette, 19–28. Trivandrum: Research Signpost.
- Boscia, D., M. Digiario, M. Safi, R. Garau, Z. Zhou, A. Minafra, N. Abou Ghanem, G. Bottalico, and O. Potere. 2001. Production of monoclonal antibodies to *Grapevine virus D* and contribution to the study of its aetiological role in grapevine diseases. *Vitis* 40: 569–574.
- Bottalico, G., V. Savino, A. Campanale, 2000. Improvements in grapevine sanitation protocols. Extended Abstracts of the 13th ICVG Meeting, Adelaide, Australia, 167.
- Bouamama, B., I. Selmi, H.B. Mohamed, A.B. Salem, M. Borgi, L. Abbate, F. Carimi, S. Chebil, N. Mahfoudhi, 2015. Sanitation of a Tunisian grapevine cv. ‘Hencha’ via direct somatic embryogenesis. Proceedings of the 18th Congress of the ICVG, Ankara, Turkey, pp. 244–245.
- Bratlie, M.S., and F. Drabløs. 2005. Bioinformatic mapping of AlkB homology domains in viruses. *BMC Genomics* 6: 1–15.
- Brumin, M., S. Stukalov, S. Haviv, M. Muruganatham, Y. Moskovitz, O. Batuman, A. Fenigstein, and M. Mavassi. 2009. Post-transcriptional gene silencing and virus resistance in *Nicotiana* expressing a *Grapevine virus A* minireplicon. *Transgenic Research* 18: 331–345.

- Castellano, M.A., N. Abou-Ghanem, G.P. Martelli, D. Boscia, and V. Savino. 1995. Cytopathology of two filamentous grapevine viruses and their intracellular identification by gold immunolabelling. *Journal of Plant Diseases and Protection* 102: 23–33.
- Castrovilli, S., and D. Gallitelli. 1985. A comparison of two isolates of *Grapevine virus A*. *Phytopathologia Mediterranea* 24: 219–220.
- Chevalier, S., C. Greif, J.M. Clauzel, B. Walter, and C. Fritsch. 1995. Use of an immunocapture-polymerase chain reaction procedure for the detection of *Grapevine virus A* in Kober stem grooving-infected grapevines. *Journal of Phytopathology* 143: 368–373.
- Chiba, M., J.C. Reed, A.I. Prokhnevsky, E.J. Chapman, M. Mawassi, E.V. Koonin, J.C. Carrington, and V.V. Dolja. 2006. Diverse suppressors of RNA silencing enhance agroinfection by a viral replicon. *Virology* 346: 7–14.
- Choueiri, E., N. Abou Ghanem, and D. Boscia. 1997. *Grapevine virus A* and *Grapevine virus D* are serologically related. *Vitis* 36: 39–41.
- Coetze, B., H.J. Maree, D. Stephan, M.J. Freeborough, and J.T. Burger. 2010. The first complete nucleotide sequence of a *Grapevine virus E* variant. *Archives of Virology* 155: 1357–1360.
- Coetze, B., M.-J. Freeborough, H.J. Maree, J.-M. Celton, D. Jasper, G. Rees, and J.T. Burger. 2010. Deep sequencing analysis of viruses infecting grapevines: Virome of a vineyard. *Virology* 400: 157–163.
- Conti, M., R.G. Milne, E. Luisoni, and G. Boccoardo. 1980. A closterovirus from a stem pitting diseased grapevine. *Phytopathology* 70: 394–399.
- Credi, R. 1997. Characterization of grapevine rugose wood disease sources from Italy. *Plant Disease* 81: 1288–1292.
- Czotter, N., E. Szabó, J. Molnár, L. Kocsis, J. Lázár, E. Szegedi, T. Deák, G. Bisztray, G.E. Tusnády, J. Burgyán, È. Várallyay. 2015. Viromes of Hungarian grapevine plantations by next generation sequencing of small RNAs. Proceedings of the 18th Congress of the ICVG, Ankara, Turkey, pp. 95–96.
- De Meyer, J., M. Gaudin, L. Bourquin, G. Jakab, P. Malnoe, P. Gugerli, 2000. New primers for the molecular identification and detection of *Grapevine virus A* (GVA). Extended Abstracts of the 13th Meeting of the ICVG, Adelaide, Australia, pp. 138–140.
- Dell’Orco, M., P. Saldarelli, M. Minafra, D. Boscia, and D. Gallitelli. 2002. Epitope mapping of *Grapevine virus A* capsid protein. *Archives of Virology* 147: 627–634.
- Digiario, M., M. Popovic Bedzrob, A.M. D’Onghia, D. Boscia, and V. Savino. 1994. On the correlation between *Grapevine virus A* and rugose wood. *Phytopathologia Mediterranea* 33: 187–193.
- Dolja, V.V., V.P. Boyko, A.A. Agranovsky, and E.V. Koonin. 1991. Phylogeny of capsid proteins of rod-shaped and filamentous RNA plant viruses: Two families with distinct patterns of sequence and probably structure conservation. *Virology* 184: 79–86.
- Dovas, C.I., and N.I. Katis. 2003a. A spot multiplex nested RT-PCR for the simultaneous and generic detection of viruses involved in the aetiology of grapevine leafroll and rugose wood of grapevine. *Journal of Virological Methods* 109: 217–226.
- . 2003b. A spot nested RT-PCR method for the simultaneous detection of members of the *Vitivirus* and *Foveavirus* genera in grapevine. *Journal of Virological Methods* 107: 99–106.
- Du Preez, J., D. Stephan, M. Mawassi, and J.T. Burger. 2011. The grapevine-infecting vitiviruses with particular reference to *Grapevine virus A*. *Archives of Virology* 156: 1495–1503.
- Duarte, V., I. Silva, M. Teixeira Santos, J. Brazão, E. Eiras-Dias, F. Fonseca, 2015. Molecular detection of GVA and GVB variants in Portuguese grapevine varieties. Proceedings of the 18th Congress of the ICVG, Ankara, Turkey, pp. 192–193.
- Engel, E.A., P.F. Escobar, L.A. Rojas, P.A. Rivera, N. Fiore, and P.D.T. Valenzuela. 2010. A diagnostic oligonucleotide microarray for simultaneous detection of grapevine viruses. *Journal of Virological Methods* 163: 445–451.
- Engelbrecht, D.J., and G.G.F. Kasdorf. 1990a. Transmission of grapevine leafroll disease and associated closteroviruses by the vine mealybug *Planococcus ficus*. *Phytophylactica* 22: 341–346.

- . 1990b. Field spread of corky bark, fleck, leafroll and Shiraz decline diseases and associated viruses in South African grapevines. *Phytophylactica* 22: 347–354.
- European Commission, 2005. Commission Directive 2005/43/EC of 23 June 2005 amending the Annexes to Council Directive 68/193/EEC on the marketing of material for the vegetative propagation of the vine. <http://eur-lex.europa.eu/eli/dir/2005/43/oj>.
- European Council, 1968. Council Directive of 9 April 1968 on the marketing of material for the vegetative propagation of the vine (68/193/EEC). <http://eur-lex.europa.eu/eli/dir/1968/193/oj>.
- European Plant Protection Organization (EPPO). 2008. Pathogen-tested material of grapevine varieties and rootstocks (certification scheme). *EPPO Bulletin/Bulletin OEPP* 38: 422–429.
- Faoro, F. 1997. Cytopathology of closteroviruses and trichoviruses infecting grapevines. In *Filamentous viruses of woody plants*, ed. P.L. Monette, 29–47. Trivandrum: Research Signpost.
- Faoro, F., R. Tornaghi, and G. Belli. 1991. Localisation of closteroviruses on grapevine thin sections and their identification by immunogold labeling. *Journal of Phytopathology* 133: 297–306.
- Fattouh, F., C. Ratti, A.M.D. El-Ahwany, E. Abdel Aleem, A.R. Babini, and C. Rubies Autonell. 2014. Detection and molecular characterization of Egyptian isolates of grapevine viruses. *Acta Virologica* 58: 137–145.
- Fiore, N., S. Prodan, J. Montealegre, E. Aballay, A.M. Pino, and A. Zamorano. 2008. Survey of grapevine viruses in Chile. *Journal of Plant Pathology* 90: 125–130.
- Fiore, N., A. Zamorano, L. Rivera, F. González, E. Aballay, J. Montealegre, and A.M. Pino. 2011. Grapevine viruses in the Atacama region of Chile. *Journal of Phytopathology* 159: 743–750.
- Fortusini, A., G. Scattini, S. Prati, S. Cinquanta, G. Belli 1997. *Transmission of Grapevine leafroll virus 1 (GLRaV-1) and Grapevine virus A (GVA) by scale insects*. Extended Abstracts of the 12th Meeting of the ICVG, Lisbon, Portugal, pp. 121–122.
- Galiakparov, N., E. Tanne, I. Sela, and R. Gafny. 1999. Infectious RNA transcripts from a *Grapevine virus A* cDNA clone. *Virus Genes* 19: 235–242.
- . 2003a. Functional analysis of the *Grapevine virus A* genome. *Virology* 306: 42–50.
- Galiakparov, N., D.E. Goszczynski, X. Che, O. Batuman, M. Bar-Joseph, and M. Mawassi. 2003b. Two classes of subgenomic RNA of GVA produced by internal controller elements. *Virology* 312: 434–448.
- Galiakparov, N., E. Tanne, M. Mawassi, R. Gafny, and I. Sela. 2003c. ORF5 of *Grapevine virus A* encodes a nucleic acid-binding protein and affects pathogenesis. *Virus Genes* 27: 257–262.
- Gallitelli, D., V. Savino, and G.P. Martelli. 1985. The use of a spot hybridization method for the detection of *Grapevine virus A* in the sap of grapevine. *Phytopathologia Mediterranea* 24: 221–224.
- Gambino, G., and I. Gribaudo. 2006. Simultaneous detection of nine grapevine viruses by multiplex reverse transcription-polymerase chain reaction with coamplification of a plant RNA as internal control. *Phytopathology* 96: 1223–1229.
- Gambino, G., J. Bondaz, and I. Gribaudo. 2006. Detection and elimination of viruses in callus, somatic embryos and regenerated plantlets of grapevine. *European Journal of Plant Pathology* 114: 397–404.
- Garau, R., V.A. Prota, R. Piredda, D. Boscia, and U. Prota. 1994. On the possible relationship between Kober stem grooving and *Grapevine virus A*. *Vitis* 33: 161–163.
- Garau, R., V.A. Prota, D. Boscia, M. Fiori, and U. Prota. 1995. *Pseudococcus affinis* new vector of grapevine trichoviruses A and B. *Vitis* 34: 67–68.
- Garau, R., V. Padilla, I. Rumbos, B. Walter, and V. Savino. 1997. Indexing for the identification of virus and virus-like diseases of the grapevine. In *Sanitary selection of the grapevine. Protocols for detection of viruses and virus-like diseases*, ed. B. Walter, 97–117. Paris: INRA (Les Colloques n. 86).
- Gibbs, A.J., D. Fargette, F. Garcia-Arenal, and M.J. Gibbs. 2010. Time – the emerging dimension of plant virus studies. *Journal of General Virology* 91: 13–22.
- Goheen, A.C., and C.F. Luhn. 1978. Association of stem pitting with corky bark in grapes and detection by indexing in standard indicators. *Phytopathology News* 12: 172.

- Gölles, R., R. Moser, H. Puhlinger, H. Katinger, M.L. da Camara Machado, A. Minafra, V. Savino, P. Saldarelli, G.P. Martelli, and A. da Camara Machado. 2000. Transgenic grapevines expressing coat protein gene sequences of *Grapevine fanleaf virus*, *Arabis mosaic virus*, *Grapevine virus A* and *Grapevine virus B*. *Acta Horticulturae* 528: 305–311.
- Goszczynski, D.E. 2010. Divergent molecular variants of *Grapevine virus B* (GVB) from corky bark (CB)-affected and CB-negative LN33 hybrid grapevines. *Virus Genes* 41: 273–281.
- . 2015. Brief report of the construction of infectious DNA clones of South African genetic variants of *Grapevine virus A* and *Grapevine virus B*. *Springer Plus* 4: 739.
- Goszczynski, D.E., and N. Habili. 2012. Grapevine virus A variants of group II associated with Shiraz disease in South Africa are present in plants affected by Australian Shiraz disease, and have also been detected in the USA. *Plant Pathology* 61: 205–214.
- Goszczynski, D.E., Jooste, A.E.C., 2003a. Shiraz disease (SD) is transmitted by the mealybug *Planococcus ficus* and associated with *Grapevine virus A*. Extended Abstracts of the 14th Meeting of the ICVG, Locorotondo, Italy, p. 219.
- Goszczynski, D.E., and A.E.C. Jooste. 2003b. Identification of divergent variants of *Grapevine virus A*. *European Journal of Plant Pathology* 109: 397–403.
- . 2003c. Identification of grapevines infected with divergent variants of *Grapevine virus A* using variant-specific RT-PCR. *Journal of Virological Methods* 112: 157–164.
- Goszczynski, D.E., G.G.F. Kasdorf, and G. Pietersen. 1996. Western blots reveal that grapevine viruses A and B are serologically related. *Journal of Phytopathology* 144: 581–583.
- Goszczynski, D.E., J. du Preez, and J.T. Burger. 2008. Molecular divergence of *Grapevine virus A* (GVA) variants associated with Shiraz disease in South Africa. *Virus Research* 138: 105–110.
- Goussard, P., H. Bakker, 2006. Characterization of grapevines visually infected with Shiraz disease associated viruses. Wyneboer – a technical guide for wine producers. <http://www.wyneboer.co.za/recentarticles/200612shiraz.php3>.
- Graniti, A., and A. Ciccarone. 1961. Osservazioni su alterazioni virosiche e virus-simili della vite in Puglia. *Notiziario sulle Malattie delle Piante* 55: 99–102. (in Italian).
- Graniti, A., G.P. Martelli, 1965. Further investigations on *legno riccio* (rugose wood), a graft-transmissible stem-pitting of grapevine. Proceedings of the International Conference on Virus and Vector on Perennial Hosts with Special Reference to *Vitis*, Davis, California, USA, pp. 168–179.
- Guidoni, S., F. Mannini, A. Ferrandino, N. Argamante, and R. Di Stefano. 1997. The effect of grapevine leafroll and rugose wood sanitation on agronomic performance and berry and leaf phenolic content of a Nebbiolo clone. *American Journal of Enology and Viticulture* 48: 438–442.
- Guta, I.C., and E.C. Buciumeanu. 2011. Grapevine chemotherapy for elimination of multiple virus infections. *Romanian Biotechnology Letters* 16: 6535–6539.
- Haviv, S., N. Galiakparov, D.E. Goszczynski, O. Batuman, H. Czosnek, and M. Mawassi. 2006. Engineering the genome of *Grapevine virus A* into a vector for expression of proteins in herbaceous plants. *Journal of Virological Methods* 132: 227–231.
- Haviv, S., Y. Iddan, D.E. Goszczynski, and M. Mawassi. 2012a. The ORF5 of *Grapevine virus A* is involved in symptoms expression in *Nicotiana benthamiana* plants. *Annals of Applied Biology* 160: 181–190.
- Haviv, S., Y. Moskovitz, and M. Mawassi. 2012b. The ORF-3 encoded proteins of vitiviruses GVA and GVB induce tubule-like and punctate structures during virus infections and localize to plasmodesmata. *Virus Research* 163: 291–301.
- Hewitt, W.B. 1954. Some virus and virus-like diseases of grapevine. *Bulletin of the California Department of Agriculture* 43: 47–64.
- . 1968. Viruses and virus diseases of the grapevine. *Review of Applied Mycology* 47: 433–455.
- Hewitt, W.B., and R. Neja. 1971. Grapevine bark and wood pitting disease found in California. *Plant Disease Reporter* 55: 860–861.

- Hommay, G., V. Komar, O. Lemaire, and E. Herrbach. 2008. Grapevine virus A transmission by larvae of *Parthenolecanium corni*. *European Journal of Plant Pathology* 121: 185–188.
- Hu, G.J., Y.F. Dong, Z.P. Zhang, X.D. Fan, R. Fang, and H.J. Zhu. 2014. Detection and sequence analysis of *Grapevine virus B* isolates from China. *Acta Virologica* 58: 180–184.
- Jaillon, O., J.-M. Aury, B. Noel, A. Policriti, C. Clepet, et al. 2007. The grapevine genome sequence suggests ancestral hexaploidization in major angiosperm phyla. *Nature* 449: 463–467.
- Katoh, H., S. Suzuki, and T. Takaynagi. 2009. Cloning and characterization of VIGG, a novel virus-induced grapevine protein correlated with fruit quality. *Plant Physiology and Biochemistry* 47: 291–299.
- Klaassen, V.A., S.T. Sim, G.S. Dangl, F. Osman, M. Al Rwahnih, A. Rowhani, and D.A. Golino. 2011. *Vitis californica* and *Vitis californica* x *Vitis vinifera* hybrids are hosts for *Grapevine leafroll-associated virus-2* and *-3* and *Grapevine virus A* and *B*. *Plant Disease* 95: 657–665.
- Kominek, P., M. Kominkova-Bryxiyova, O.M. Jandurova, and V. Holleinova. 2008. An RNA probe for the detection of *Grapevine virus A*. *Journal of Phytopathology* 156: 762–764.
- Komínek, P., M. Glasa, and M. Komínková. 2009. Analysis of multiple virus-infected grapevine plant reveals persistence but uneven virus distribution. *Acta Virologica* 53: 281–285.
- Koonin, E.V. 1991. The phylogeny of RNA-dependent RNA polymerases of positive-strand RNA viruses. *Journal of General Virology* 72: 2197–2206.
- La Notte, P., N. Buzkan, E. Choueiri, A. Minafra, and G.P. Martelli. 1997. Acquisition and transmission of *Grapevine virus A* by the mealybug *Pseudococcus longispinus*. *Journal of Plant Pathology* 79: 79–85.
- Laimer, M., O. Lemaire, E. Herrbach, V. Goldschmidt, A. Minafra, P. Bianco, and T. Wetzel. 2009. Resistance to viruses, phytoplasmas and their vectors in the grapevine in Europe: A review. *Journal of Plant Pathology* 91: 7–23.
- Le Maguet, J., M. Beuve, E. Herrbach, and O. Lemaire. 2012. Transmission of six ampeloviruses and two vitiviruses to grapevine by *Phenacoccus aceris*. *Phytopathology* 102: 712–723.
- M'hirsi, S., S. Fattouch, H. Acheche, M. Marrakchi, and N. Marzouki. 2001. Detection of grapevine A vitivirus in Tunisian grapevines. *Bulletin OEPP/EPPO* 31: 509–513.
- Mackenzie, D.J., M.A. McLean, S. Murkerji, and M. Green. 1997. Improved RNA extraction from woody plants for the detection viral pathogens by RT-PCR. *Plant Disease* 81: 222–226.
- Maliogka, V.I., G.P. Martelli, M. Fuchs, and N.I. Katis. 2015. Control of viruses infecting grapevine. *Advances in Virus Research* 91: 175–227.
- Mannini, F., 2003. Virus elimination in grapevine and crop performance. Extended Abstracts of the 14th Meeting of the ICVG, Locorotondo, Italy, pp. 234–239.
- Mannini, F., D. Cuzzo, G. Gambino, P. Boccacci, I. Gribaudo, R. Tragni, 2015. Effect of latent GVB infection on agronomic and enological performances of wine cultivar Albarossa (*Vitis vinifera* L.). Proceedings of the 18th Congress of the ICVG, Ankara, Turkey, pp. 100–101.
- Martelli, G.P. 1993. Rugose wood complex. In *Graft-transmissible diseases of grapevines. Handbook for detection and diagnosis*, ed. G.P. Martelli, 45–53. Rome: FAO Publication Division.
- . 2014. Rugose wood complex. *Journal of Plant Pathology* 96: 73–88.
- Martelli, G.P., D. Boscia, E. Choueiri, M. Digiaro, M.A. Castellano, and V. Savino. 1994a. Occurrence of filamentous viruses and rugose wood of grapevine in Yemen. *Phytopathologia Mediterranea* 33: 146–151.
- Martelli, G.P., T. Candresse, and S. Namba. 1994b. *Trichovirus*, a new genus of plant viruses. *Archives of Virology* 134: 451–455.
- Martelli, G.P., A. Minafra, and P. Saldarelli. 1997. *Vitivirus*, a new genus of plant viruses. *Archives of Virology* 142: 1929–1932.
- Martelli, G.P., M.J. Adams, J.F. Keuze, and V.V. Dolja. 2007. Family *Flexiviridae*: A case study in virion and genome plasticity. *Annual Review of Phytopathology* 45: 73–100.
- Martinelli, L., E. Candioli, D. Costa, and A. Minafra. 2002. Stable insertion and expression of the movement protein gene of *Grapevine virus A* (GVA) in grape (*Vitis rupestris* S.). *Vitis* 41: 189–193.

- Milne, R.G., M. Conti, D.E. Lesemann, G. Stellmach, E. Tanne, and J. Cohen. 1984. Closterovirus-like particles of two types associated with diseased grapevines. *Phytopathologische Zeitschrift* 11: 360–368.
- Minafra, A., A. Hadidi, and G.P. Martelli. 1992a. Detection of grapevine closterovirus A in infected grapevine tissue by reverse transcription-polymerase chain reaction. *Vitis* 31: 221–227.
- Minafra, A., M. Russo, and G.P. Martelli. 1992b. Further studies on the use of molecular probes to grapevine closterovirus A. *Vitis* 31: 87–93.
- Minafra, A., P. Saldarelli, F. Grieco, and G.P. Martelli. 1994. Nucleotide sequence of the 3' terminal part of the RNA of two filamentous grapevine viruses. *Archives of Virology* 137: 249–261.
- Minafra, A., P. Saldarelli, and G.P. Martelli. 1997. *Grapevine virus A*: Nucleotide sequence, genome organization and relationships in the *Trichovirus* genus. *Archives of Virology* 142: 417–423.
- Minafra, A., R. Gölles, A. da Camara Machado, P. Saldarelli, N. Buzkan, V. Savino, H. Katinger, M. Laimer Da Camara Machado, and G.P. Martelli. 1998. Expression of the coat protein genes of Grapevine virus A and B in *Nicotiana* species and evaluation of the resistance conferred on transgenic plants. *Journal of Plant Pathology* 80: 197–202.
- Molenaar, N., J.T. Burger, and H.J. Maree. 2015. Detection of a divergent variant of *Grapevine virus F* by next-generation sequencing. *Archives of Virology* 160: 2125–2127.
- Monette, P.L., and S.E. Godkin. 1992. Ultrastructure of *Grapevine virus A*-infected *Nicotiana benthamiana* leaves. *Canadian Journal of Plant Pathology* 14: 1–9.
- Monette, P.L., and D. James. 1990. Detection of two strains of *Grapevine virus A*. *Plant Disease* 74: 898–900.
- Monette, P.L., S.E. Godkin, and D. James. 1990. Mechanical sap transmission of a closterovirus from in vitro shoot tip cultures of a leafroll-affected grapevine to *Nicotiana benthamiana*. *Vitis* 29: 49–55.
- Moskovitz, Y., D.E. Goszczynski, L. Bir, A. Fenigstein, H. Czosnek, and M. Mawassi. 2008. Sequencing and assembly of a full-length infectious clone of *Grapevine virus B* and its infectivity on herbaceous plants. *Archives of Virology* 153: 323–328.
- Murolo, S., G. Romanazzi, A. Rowhani, A. Minafra, P. La Notte, M.B. Branzanti, and V. Savino. 2008. Genomic variability and population structure of *Grapevine virus A* coat protein gene from naturally infected Italian vines. *European Journal of Plant Pathology* 120: 137–145.
- Muruganatham, M., Y. Moskovitz, S. Haviv, T. Horeh, A. Fenigstein, J. du Preez, D. Stephan, J.T. Burger, and M. Mawassi. 2009. *Grapevine virus A*-mediated gene silencing in *Nicotiana benthamiana* and *Vitis vinifera*. *Journal of Virological Methods* 155: 167–174.
- Nakano, M., R. Nakaune, S. Komazaki, 2003. Mealybug transmission of grapevine viruses in Japan. Extended Abstracts of the 14th Meeting of the ICVG, Locorotondo, Italy, p. 218.
- Nakaune, R., K. Inoue, H. Nasu, K. Kakogawa, H. Nitta, J. Imada, and M. Nakano. 2008a. Detection of viruses associated with rugose wood in Japanese grapevines and analysis of genomic variability of Rupestris stem pitting-associated virus. *Journal of General Plant Pathology* 74: 156–163.
- Nakaune, R., S. Toda, M. Mochizuki, and M. Nakano. 2008b. Identification and characterization of a new vitivirus from grapevine. *Archives of Virology* 153: 1827–1832.
- Nassuth, A., E. Pollari, K. Helmezczy, S. Stewart, and S.A. Kofalvi. 2000. Improved RNA extraction and one-tube RT-PCR assay for simultaneous detection of control plant RNA plus several viruses in plant extracts. *Journal of Virological Methods* 90: 37–49.
- Nickel, O., T.V.M. Fajardo, F.J.L. Aragão, C.M. Chagas, and G.B. Kuhn. 2002. Detection and coat protein gene characterization of an isolate of *Grapevine virus B* from corky bark-affected grapevines in southern Brazil. *Fitopatologia Brasileira* 27: 279–284.
- Oliver, J.E., and M. Fuchs. 2011. Tolerance and resistance to viruses and their vectors in *Vitis* sp.: A virologist's perspective of the literature. *American Journal of Enology and Viticulture* 62: 438–451.

- Osman, F., E. Hodzic, A. Omanska-Klusek, T. Olineka, and A. Rowhani. 2013. Development and validation of a multiplex quantitative PCR assay for the rapid detection of Grapevine virus A, B and D. *Journal of Virological Methods* 194: 138–145.
- Panattoni, A., and E. Triolo. 2010. Susceptibility of grapevine viruses to thermotherapy on in vitro collection of Kober 5BB. *Scientia Horticulturae* 125: 63–67.
- Panattoni, A., F. D'anna, C. Cristani, and E. Triolo. 2007. Grapevine vitivirus A eradication in *Vitis vinifera* explants by antiviral drugs and thermotherapy. *Journal of Virological Methods* 146: 129–135.
- Predajna, L., and M. Glasa. 2016. Partial sequence analysis of geographically close *Grapevine virus A* isolates reveals their high regional variability and an intra-isolate heterogeneity. *Journal of Phytopathology* 164: 427–431.
- Radian-Sade, S., A. Perl, O. Edelbaum, L. Kuznetsova, R. Gafny, I. Sela, and E. Tanne. 2000. Transgenic *Nicotiana benthamiana* and grapevine plants transformed with *Grapevine virus A* (GVA) sequences. *Phytoparasitica* 28: 79–86.
- Ribeiro, G.P., P. Saldarelli, N. Hong, B.C. Xiang, X.L. Zhang, G.P. Wang, and G.P. Martelli. 2004. First record of three grapevine viruses in the Chinese province of Sinkiang. *Journal of Plant Pathology* 86: 264.
- Rizzo, D., A. Materazzi, L. Stefani, P. Farina, S. Vanarelli, A. Panattoni, and A. Luvisi. 2015. Distribution of regulated viruses in cv. Sangiovese vineyards in Tuscany. *Journal of Plant Pathology* 97: 131–135.
- Rosa, C., 2007. Etiology of “rugose wood complex” and functional analysis of *Grapevine virus D*. PhD Thesis. University of California, Davis, 220 pages; AAT 3261187.
- Rosa, C., J.F. Jimenez, P. Margaria, and A. Rowhani. 2011. Symptomatology and effects of viruses associated with Rugose Wood complex on growth of four different rootstocks. *American Journal of Enology and Viticulture* 62: 207–213.
- Rosciglione, B., and M.A. Castellano. 1985. Further evidence that mealybugs can transmit *Grapevine virus A* (GVA) to herbaceous hosts. *Phytopathologia Mediterranea* 24: 186–188.
- Rosciglione, B., M.A. Castellano, G.P. Martelli, V. Savino, and G. Cannizzaro. 1983. Mealybug transmission of *Grapevine virus A*. *Vitis* 22: 331–347.
- Roumi, V., A. Afsharifar, P. Saldarelli, A. Niazi, G.P. Martelli, and K. Izadpanah. 2012. Transient expression of artificial microRNAs confers resistance to *Grapevine virus A* in *Nicotiana benthamiana*. *Journal of Plant Pathology* 94: 643–649.
- Rubinson, E., N. Galiakparov, S. Radian, I. Sela, E. Tanne, and R. Gafny. 1997. Serological detection of *Grapevine virus A* using antiserum to a non structural protein, the putative movement protein. *Phytopathology* 87: 1041–1045.
- Saldarelli, P., and A. Minafra. 2000. Immunodetection of the 20 kDa protein encoded by ORF2 of *Grapevine virus B*. *Journal of Plant Pathology* 82: 157–158.
- Saldarelli, P., H. Guglielmi Montano, and G.P. Martelli. 1994. Nonradioactive molecular probes for the detection of three filamentous viruses of the grapevine. *Vitis* 33: 157–160.
- Saldarelli, P., A. Minafra, and G.P. Martelli. 1996. The nucleotide sequence and genomic organization of *Grapevine virus B*. *Journal of General Virology* 77: 2645–2652.
- Saldarelli, P., A. Rowhani, G. Routh, A. Minafra, and M. Digiario. 1998. Use of degenerate primers in RT-PCR assays for identification and analysis of some filamentous viruses, with special reference to clostero and vitiviruses of the grapevine. *European Journal of Plant Pathology* 104: 945–950.
- Saldarelli, P., M. Dell’Orco, and A. Minafra. 2000a. Infectious cDNA clones of two grapevine viruses. *Archives of Virology* 145: 397–405.
- Saldarelli, P., A. Minafra, M.A. Castellano, and G.P. Martelli. 2000b. Immunodetection and sub-cellular localization of the proteins encoded by ORF 3 of Grapevine viruses A and B. *Archives of Virology* 145: 1535–1542.
- Savino, V., D. Boscia, G.P. Martelli, 1989. Rugose wood complex of grapevine: Can grafting to *Vitis* indicators discriminate between diseases? Proceedings of the 9th Meeting of the ICVG, Kiryat Anavim, Israel, pp. 91–94.

- Sciancalepore, A., G. Pio Ribeiro, C. Turturo, M. Dell'Orco, A. Minafra, P. Saldarelli, G.P. Martelli, 2006. Molecular variability of GVA and GVB coat protein genes in naturally infected grapevine accessions. Extended Abstracts of the 15th ICVG Conference, Stellenbosch, South Africa, pp. 81–82.
- Selmi, I., N. Mahfoudhi, D. Pacifico, F. Carimi, M.H. Dhouibi, M. Digiaro, T. Elbeaino, 2015. Molecular variability of *Grapevine virus D* isolates from naturally infected vineyards in Tunisia. Proceedings of the 18th Congress of the ICVG, Ankara, Turkey, pp. 214–215.
- Shi, B.J., N. Habili, R. Gafny, and R.H. Symons. 2004. Extensive variation of sequence within isolates of *Grapevine virus B*. *Virus Genes* 29: 279–285.
- Spilmont, A.S., Ruiz, A., Grenan, S., 2012. Efficiency of micrografting of shoot apices as a sanitation method against seven grapevine viruses (ArMV, Gflv, Glrav-1, -2, -3, Gfkv, Gva). Proceedings of the 17th Congress of the ICVG, Davis, California, USA, pp. 270–271.
- Tanne, E., Y. Ben-Dov, and B. Raccach. 1989. Transmission of the corky-bark disease by the mealybug *Planococcus ficus*. *Phytoparasitica* 17: 55.
- , 1993. Mealybug transmission of corky bark disease and an associated virus to healthy grapevine. 11th Meeting of the ICVG, Montreux, Switzerland, 59–60.
- Tanne, E., R. Marcus, E. Dubitzky, and B. Raccach. 1996. Analysis of progress and spatial pattern of corky bark in grapes. *Plant Disease* 80: 34–38.
- Teliz, D., P. Valle, A.C. Goheen, Luevano, S., 1980. Grape corky bark and stem pitting in Mexico. I. Occurrence, natural spread, distribution, effect on yield and evaluation of symptoms in 128 grape cultivars. Proceedings of the 7th Meeting of the ICVG, Niagara Falls, New York, USA, 51–64.
- Terral, J.-F., et al. 2010. Evolution and history of grapevine (*Vitis vinifera*) under domestication: New morphometric perspectives to understand seed domestication syndrome and reveal origins of ancient European cultivars. *Annals of Botany* 105: 443–455.
- This, P., T. Lacombe, and M.R. Thomas. 2006. Historical origins and genetic diversity of wine grapes. *Trends in Genetics* 22: 511–519.
- Thompson, J.R., M. Fuchs, H. McLane, F. Celebi-Toprak, K.F. Fisher, J.L. Potter, and K.L. Perry. 2014. Profiling viral infections in grapevine using a randomly primed reverse transcription polymerase chain reaction/microarray multiplex platform. *Phytopathology* 104: 211–219.
- Tzanetakakis, I.E., J.D. Postman, and R.R. Martin. 2007. Identification, detection and transmission of a new vitivirus from *Mentha*. *Archives of Virology* 152: 2027–2033.
- Van den Born, E., M.V. Omelchenko, A. Bekkelund, V. Leihne, E.V. Koonin, V.V. Dolja, and Ø. Falnes Pal. 2008. Viral AlkB proteins repair RNA damage by oxidative demethylation. *Nucleic Acids Research* 36: 5451–5461.
- Vargas-Asencio, J., M. Al Rwahnih, A. Rowhani, F. Celebi-Toprak, J.R. Thompson, M. Fuchs, and K.L. Perry. 2016. Limited genetic variability among American isolates of *Grapevine virus E* from *Vitis* spp. *Plant Disease* 100: 159–163.
- Velasco, R., B. García, I. Hita, and V. Padilla. 2005. Detection of *Grapevine virus B* associated to rugose wood (corky bark) symptoms in grapevine cv. Napoleon in Murcia (Spain). *Plant Pathology* 54: 264.
- Velasco, R., A. Zharkikh, M. Troggo, D.A. Cartwright, A. Cestaro, et al. 2007. A high quality draft consensus sequence of the genome of a heterozygous grapevine variety. *PLoS ONE* 2: 1326.
- Voncina, D., S. Simon, E. Dermic, B. Cvjetkovic, I. Pejic, E. Maletic, and J.K. Kotic. 2011. Differential properties of *Grapevine virus B* isolates from Croatian autochthonous grapevine cultivars. *Journal of Plant Pathology* 93: 283–289.
- Walter, B., G.P. Martelli, 1996. Sélection clonal de la vigne: Sélection sanitaire et sélection pomologique. Influences des viroses et qualité. 1ème partie: Effets des viroses sur la culture de la vigne et ses produits. Bulletin de l'O.I.V. 69, 945–971. (in French).
- Wang, Q., M. Mawassi, P. Li, R. Gafny, I. Sela, and E. Tanne. 2003. Elimination of *Grapevine virus A* (GVA) by cryopreservation of in vitro-grown shoot tips of *Vitis vinifera* L. *Plant Science* 165: 321–327.

- Wang, Z., N. Hong, Y. Liu, W. Xu, and G. Wang. 2011. Genetic variability and population structure of *Grapevine virus A* in China based on the analysis of its coat protein gene. *Canadian Journal of Plant Pathology* 33: 227–233.
- Wang, J., D. Xi, J. Liu, K. Chen, H. Li, X. Liu, S. Yuan, S. Ercişli, and H. Lin. 2012. Genetic variability in *Grapevine virus A* from *Vitis vinifera* L. x *Vitis labrusca* L. in Sichuan, China. *Turkish Journal of Biology* 36: 542–551.
- Zhou, Z.S., M. Dell’Orco, P. Saldarelli, M. Turturo, A. Minafra, and G.P. Martelli. 2006. Identification of an RNA silencing suppressor in the genome of *Grapevine virus A*. *Journal of General Virology* 87: 2387–2395.
- Zorloni, A., S. Prati, P. Bianco, and G. Belli. 2006. Transmission of *Grapevine virus A* and *Grapevine leafroll-associated virus 3* by *Helicococcus bohemicus*. *Journal of Plant Pathology* 88: 325–328.

Chapter 12

Grapevine rupestris stem pitting-associated virus

B. Meng and A. Rowhani

Abstract *Grapevine rupestris stem pitting-associated virus* (GRSPaV) is a member of the genus *Foveavirus* (family *Betaflexiviridae*, order *Tymovirales*). GRSPaV was discovered in 1998 from grapevines affected with *Rupestris* stem pitting, a widespread graft-transmissible disease among commercial grapevines worldwide. Later research has demonstrated that different genetic variants of GRSPaV are closely associated with, and likely the causal agent of, *Rupestris* stem pitting and vein necrosis. However, definitive proof for its etiological role in either disease is lacking. In the past two decades, much progress has been made in several fronts concerning this virus. Compelling evidence demonstrates that GRSPaV comprises a wide range of genetic variants differing extensively in genome sequence. To date, the complete or near-complete genomes of 15 isolates have been sequenced. Phylogenetic analyses revealed the existence of eight clusters of viral variants. Interestingly, the population structure of GRSPaV differs sharply depending on whether the infected plant is a rootstock or a scion cultivar. GRSPaV exists as a uniform population in rootstocks, with GRSPaV-1 being detected in *Vitis riparia* and its hybrids, while GRSPaV-SG1 detected in *Vitis rupestris* and its hybrids. In contrast, commercial grape cultivars are generally infected with mixtures of distinct variants. Quick, reliable, and sensitive methods have been developed to detect GRSPaV. The subcellular localization of proteins encoded by GRSPaV has been elucidated using fluorescent protein tagging and microscopy. The establishment of infectious GRSPaV clones has enabled diverse investigations on gene function and viral replication and, ultimately, the development of GRSPaV as a vector for various applications. It is hoped that GRSPaV would ultimately serve as an excellent model system for the study of members of the family *Betaflexiviridae* and perhaps many other viruses that infect woody fruit crops.

B. Meng (✉)

Department of Molecular and Cellular Biology, University of Guelph, Guelph, ON, Canada
e-mail: bmeng@uoguelph.ca

A. Rowhani

Department of Plant Pathology, University of California, Davis, CA 95616, USA

Keywords *Grapevine rupestris stem pitting-associated virus* • *Foveavirus* • *Betaflexiviridae* • *Tymovirales* • Rupestris stem pitting • Vein necrosis • Syrah decline • Grapevine • Genetic diversity • Viral diagnostics • Infectious viral clones • Evolution biology

Introduction and Historical Aspects

Grapevine rupestris stem pitting-associated virus (GRSPaV) has a short history compared to most of the other grapevine viruses. The discovery of GRSPaV has its origin in the initial efforts to identify the causal agent of the disease Rupestris stem pitting (RSP). RSP was first recognized by Austin C. Goheen in 1976 in California and was defined as a graft-transmissible disease that induces a strip of pits below the inoculation site on the woody cylinder of the indicator *Vitis rupestris* St. George after graft inoculation (Goheen 1988, 1989). Two research groups isolated high molecular weight dsRNA molecules of approximately 8 kbp in size from grapevines infected with RSP (Azzam 1991; Walter and Cameron 1991). Subsequently, the genomes of two nearly identical isolates were sequenced using cDNA libraries constructed from dsRNAs as templates (Meng et al. 1998; Zhang et al. 1998). Since then, considerable progress has been made on several fronts of research. Serological and nucleic acid-based methods were developed for use for the detection of GRSPaV. These methods are advantageous over the traditional biological assays using indicator plants because they are faster, could have broad spectrum, are less costly, and are suitable for high-throughput testing. Generation of a polyclonal anti-serum against recombinant capsid protein overexpressed in *Escherichia coli* enabled the revelation of GRSPaV virions in infected grapevine tissue (Petrovic et al. 2003). Another pioneering research was the study leading to the discovery that GRSPaV comprises a family of genetic variants (Meng et al. 1999b, 2006; Rowhani et al. 2000; Nolasco et al. 2006; Alabi et al. 2010; Terlizzi et al. 2010, 2011).

To date, the genomes of 15 isolates have been sequenced to completion or near completion. Details on these isolates, such as the source of materials, methods of sequencing, GenBank accession numbers, as well as references, are given in Table 12.1. Although definitive evidence is still lacking, it is likely that different strains of GRSPaV are involved in, and could be the causal agents of, different diseases based on a close correlation between each group of genetic variants and a particular disorder (Meng et al. 1998, 1999a, 2005; Zhang et al. 1998; Bouyahia et al. 2005; Lima et al. 2006a; Habili et al. 2006). In the past decade, several experimental systems have been developed for fundamental studies on various aspects of the virus replication and infection cycle, such as genome replication, transcription, trafficking, and virus-host interactions. For example, the subcellular localization of the translation product of each of the five open reading frames (ORFs) encoded by GRSPaV has been elucidated using autofluorescent protein tagging and fluorescence microscopy (Rebello et al. 2008; Meng and Li 2010; Prosser et al. 2015).

Table 12.1 Information on GRSPaV isolates for which the genome is completely or near completely sequenced

Isolate	GenBank accession	Source	Method of sequencing	References	Remark
GRSPaV-1	NC001948	Mixture	cDNA library and RT-PCR	Meng et al. (1998)	NCBI Reference sequence
GRSPaV-CA	AF026278	<i>V. vinifera</i> cv. Cabernet Sauvignon	cDNA library and RT-PCR	Zhang et al. (1998)	
GRSPaV-GG	JQ922417	<i>V. riparia</i> cv. Grande Glabre	RT-PCR	Meng et al. (2013)	Infectious viral clone
GRSPaV-SG1	AY881626	<i>V. rupestris</i> cv. St. George	RT-PCR	Meng et al. (2005)	Asymptomatic infection in St. George
GRSPaV-BS	AY881627	Hybrid Bertille Seyve 5563	RT-PCR	Meng et al. (2005)	
GRSPaV-SY	AY368590	<i>V. vinifera</i> cv. Syrah	cDNA library and RT-PCR	Lima et al. (2006)	Detected in Syrah with decline
GRSPaV-PN	AY368172	<i>V. vinifera</i> cv. Pinot noir	cDNA and RT-PCR	Lima et al. (2009)	Detected in Pinot noir with decline
GRSPaV-PG	HE591388	<i>V. vinifera</i> cv. Pinot Gris	NGS (small RNAs)	Giampetruzzi et al. (2012)	
GRSPaV-MG	FR691076	<i>V. vinifera</i> cv. Moscato Giallo	RT-PCR	Morelli et al. (2011)	
GRSPaV-WA	KC427107	<i>V. vinifera</i> cv. Merlot/ Cabernet Franc	NGS (Illumina)	Poorari et al. (2013)	
GRSPaV-3138-07	JX559646	<i>V. vinifera</i> cv. unknown	NGS (Illumina)	Rott and Belton (2012) (unpublished)	
GRSPaV-JF	KR054734	<i>V. labruscana</i> cv. Kyoho	RT-PCR	Hu et al. (2015)	
GRSPaV-LSL	KR054735	<i>V. vinifera</i> cv. Riesling	RT-PCR	Hu et al. (2015)	
GRSPaV-VF	KT948710	<i>V. flexuosa</i>	NGS (Illumina)	Fajardo and Nickel (2015) (unpublished)	Near-complete genome
GRSPaV-JH	NA	<i>V. vinifera</i> cv. Syrah	RT-PCR	Hooker (2017)	

More recently, the first infectious cDNA clone of GRSPaV and GFP-tagged variants became available (Meng et al. 2013). Work is in progress to develop infectious viral clones for other, likely more pathogenic variants of the virus, such as variants “SY” and “PN,” which were implicated in decline disorders that have been observed in several important commercial wine grape cultivars. Much work is ahead of us and awaits further exploration.

Taxonomy and Nomenclature

GRSPaV is classified as a definitive member of the genus *Foveavirus* with *Apple stem pitting virus* (ASPV) as the prototype member (Martelli and Jelkmann 1998). However, the taxonomic treatment of the genus *Foveavirus* has been an ever-evolving story. Initially, a new family, *Flexiviridae*, was established to contain the genus *Foveavirus* and seven other viral genera (*Potexvirus*, *Mandarivirus*, *Allexivirus*, *Carlavirus*, *Capillovirus*, *Vitivirus*, and *Trichovirus*) and a putative genus, *Citrivirus* (Adams et al. 2015). In the most recent report of the ICTV, membership of the now extinct family *Flexiviridae* was split into two families: *Alphaflexiviridae* (containing *Potexvirus*, *Allexivirus*, *Mandarivirus*, and three new genera) and *Betaflexiviridae* (comprising *Foveavirus*, *Carlavirus*, *Vitivirus*, *Capillovirus*, *Trichovirus*, and *Citrivirus*) (King et al. 2012). This split was based on the finding that members of these two families exhibit different levels of evolutionary relatedness in the core domains of the replicase (poly)protein as well as distinctive features in genome structure. For example, most members of the family *Betaflexiviridae* (with the exception of the genus *Capillovirus* whose members lack an AlkB domain) contain additional domains, such as AlkB, and the two copies of cysteine protease domain (OTU and P-Pro), in their replicase polyprotein. These domains are absent in the replicase proteins encoded by most members of the family *Alphaflexiviridae* (Fig. 12.1). Interestingly, *Lolium latent virus* (LoLV), the only member of the genus *Lolavirus* that infects tufted grass, a herbaceous perennial species, contains an AlkB domain in its replicase protein (King et al. 2012).

Another interesting point to make is that even within the same family *Betaflexiviridae*, the genome structure of different genera of viruses exhibits substantial differences. For instance, members of genera *Foveavirus* and *Carlavirus* all contain a triple gene block encoding three movement proteins. In contrast, the genomes of all members of the remaining genera contain a single movement protein gene. For a detailed discussion of these viruses, readers are referred to an excellent review (Martelli et al. 2007). This and other differences would warrant further separation of the family *Betaflexiviridae* into either two subfamilies or two new families of viruses, with the genera *Foveavirus* and *Carlavirus* being one group and the remaining genera constituting the second group. This proposal would certainly need consideration and validation by the ICTV. In fact, it was recently proposed that the family *Betaflexiviridae* be further divided into two subfamilies: *Quinvirinae* and *Trivirinae* (Adams and Kreuze 2015). The subfamily *Quinvirinae* would contain

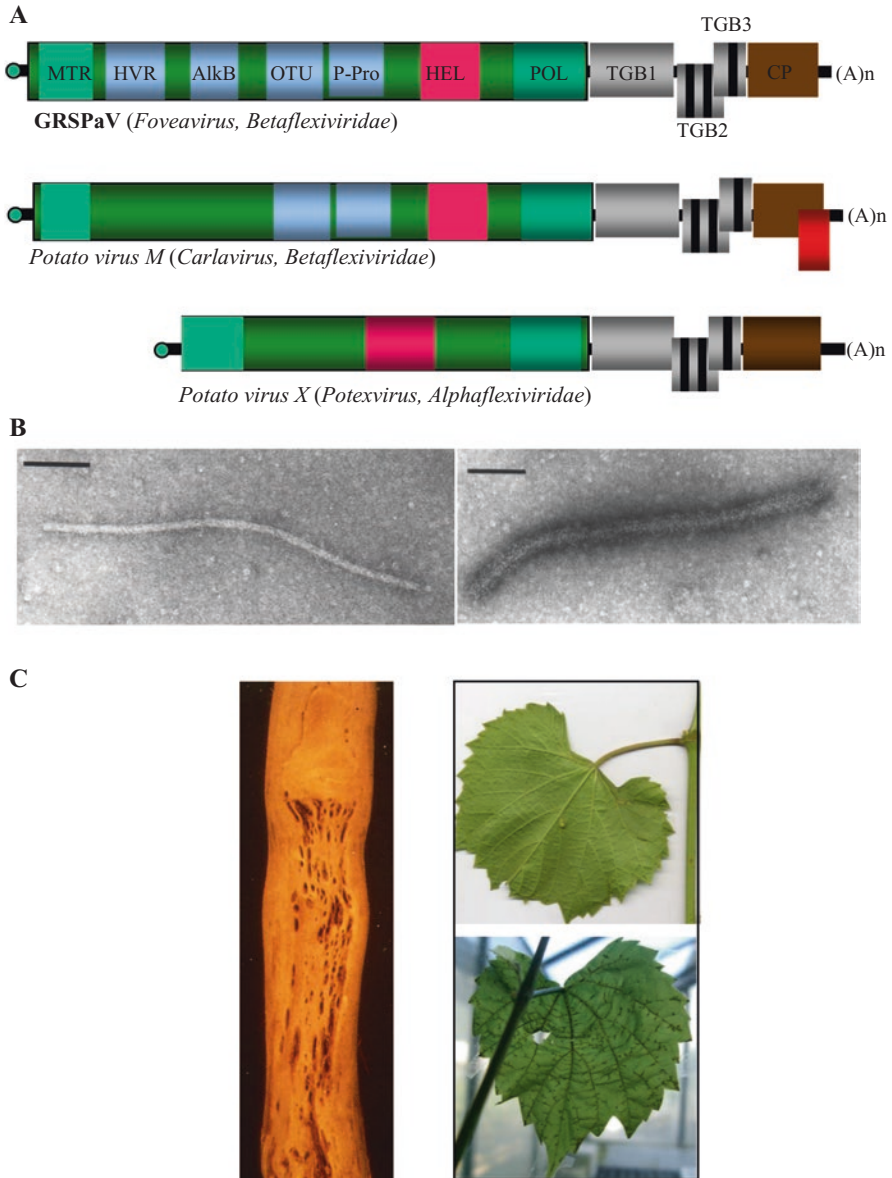

Fig. 12.1 Genome structure and virion morphology of *Grapevine rupestris stem pitting-associated virus* (GRSPaV) and its associated diseases. **(A)** Genome structure of GRSPaV as compared to *Potato virus M* (genus *Carlavirus*, family *Betaflexiviridae*) and *Potato virus X* (genus *Potexvirus*, family *Alphaflexiviridae*). *MTR* methyltransferase, *HVR* highly variable region, *AlkB* alkylation B domain, *OTU* ovarian tumorlike cysteine protease, *P-Pro* papain-like cysteine protease, *HEL* RNA helicase, *POL* RNA-dependent RNA polymerase, *TGB* triple gene block, *CP* capsid protein. **(B)** Electron micrograph showing negative-stained (*left*) and antibody-decorated (*right*) filamentous virions of GRSPaV. **(C)** Diseases that are associated with GRSPaV. *Left*: rupestris stem pitting on graft-inoculated indicator *Vitis rupestris* St. George (Photo from Martelli 1993). *Right*: vein necrosis on Richter 110R (Photo kindly provided by D. Boscia)

viruses from the genera *Carlavirus*, *Foveavirus*, and the newly established genus *Robigovirus*. The subfamily *Trivirinae* encompasses viruses from the genera *Trichovirus*, *Vitivirus*, *Capillovirus*, *Citrivirus*, plus four new genera: *Prunevirus*, *Tepovirus*, *Chordovirus*, and *Divavirus*. The distinction between these two subfamilies is the number of ORFs in their genomes: those of members of the *Trivirinae* all have the three conserved ORFs (for replicase, movement protein, capsid protein), while those of the *Quinvirinae* have the conserved ORFs (for replicase, the triple gene block movement proteins, the capsid protein) (Adams and Kreuze 2015).

Genome Structure, Expression, and Replication

Genome Structure

The genome of GRSPaV is a single-stranded, positive-sense RNA of 8725 nucleotides (nt). Its 5' noncoding region (NCR) is 60 nt in size and is presumably capped. The 3' NCR is 175 nt with a polyadenylate tail. Five ORFs are present in the genome of all sequenced isolates (Meng et al. 1998, 2005; Zhang et al. 1998; Lima et al. 2006a, b, 2009; Morelli et al. 2011; Giampetruzzi et al. 2012; Poorari et al. 2013; Hu et al. 2015) (Fig. 12.1). ORF1 (nt position 61–6546) comprises nearly three quarters of the viral genome and putatively encodes a large polyprotein of 244 kDa that is required for genome replication and mRNA transcription. As a member of the *Alphavirus* superfamily, the translation product of ORF1 contains all signature domains that are conserved in the replicase protein of this superfamily, including a methyltransferase (MTR), a helicase (Hel) (Rozanov et al. 1992; Caruthers and McKay, 2002; Kadare and Haenii, 1997; Soultanas and Wigley 2001), and a RNA-dependent RNA polymerase (Pol) domain (Koonin and Dolja, 1993; Strauss and Strauss, 1994). Interestingly, the replicase polyprotein of GRSPaV also contains three additional and rather unique domains: a papain-like cysteine protease, an ovarian tumor cysteine protease (OTU), and an alkylation B domain (AlkB). Both the OTU and the AlkB domains were identified via bioinformatic approach (Bratlie and Drablos 2005; Makarova et al. 2000) (Fig. 12.1). It is worth noting that these two domains are present only in a small number of RNA viruses, most of which infect woody perennials such as fruit trees (Martelli et al. 2007). It is predicted that these domains may play a special role in the infection process of these viruses in their native woody hosts, which are otherwise not required in their relatives that infect herbaceous plant species.

Downstream of ORF1 is a set of three ORFs designated as the triple gene block (TGB). TGB is a conserved genetic module among several genera of viruses belonging to either the family *Alphaflexiviridae* (genera *Potexvirus* and *Mandarivirus*) or *Betaflexiviridae* (genera *Foveavirus* and *Carlavirus*). Based on the information derived from *Potato virus X* (PVX), the three movement proteins encoded by the TGB work in concert to achieve cell-to-cell movement (for a review, see Verchot-Lubicz 2005; Morozov and Solovyev 2003). TGBp1 was shown to be the equivalent

of the typical movement protein encoded by most RNA viruses and is responsible for increasing the size of the exclusion limit of plasmodesmata to allow active transport of nascent viral entities (either in the form of virions or ribonucleoprotein complexes). Both TGBp2 and TGBp3 contain transmembrane domains and associate with intracellular membranes of infected cells. Downstream of the TGB is ORF5, which encodes the capsid protein (CP) (Minafra et al. 2000; Meng et al. 2003; Petrovic et al. 2003). An additional ORF, ORF6, was detected at genomic positions 8227–8586, which overlaps the CP gene, and potentially encodes a small polypeptide of 119 aa residues with a molecular mass of 14 kDa (Zhang et al. 1998). It remains to be verified if ORF6 actually is translated into a protein, and if so, what would be its function in relation to the replication and infection cycle of the virus.

Function and Localization of Proteins Encoded by GRSPaV

As a first step toward the understanding of mechanisms of the viral replication cycle, the subcellular localization of five proteins encoded by the GRSPaV genome has been recently investigated. Using autofluorescent protein tagging, coupled with fluorescence microscopy, Rebelo et al. (2008) demonstrated that GRSPaV TGBp1 has both a cytoplasmic and nuclear distribution and forms punctate structures in the cytoplasm of tobacco BY-2 cells and protoplasts upon ectopic expression of the GFP-tagged TGBp1 from plasmid-based constructs. It was also shown that (i) the position of the fusion partner has an important impact on the subcellular localization, with TGBp1-GFP resembling the native TGBp1, and (ii) both TGBp2 and TGBp3 are integral membrane proteins that associate with the endoplasmic reticulum (ER), as both proteins contain transmembrane domains (Rebelo et al. 2008). The subcellular localization pattern of GRSPaV TGB proteins is similar to their counterparts in PVX, a member of the genus *Potexvirus* (family *Alphaflexiviridae*) that has been extensively studied (Davies et al. 1993; Lucas 1998; Howard et al. 2004). Based on this information, it is predicted that GRSPaV TGB proteins would likely carry out a function similar to those encoded by PVX.

It is peculiar that GRSPaV CP contains a nuclear localization signal (KRKR) in its N-terminal region; when expressed in tobacco protoplasts, the GFP-tagged CP localizes exclusively to the nucleus (Meng and Li 2010). The biological relevance of this nuclear localization, if any, in the context of viral infection, remains to be determined.

More recently, the subcellular localization of the replicase polyprotein and its associated membranes have been studied (Prosser et al. 2015). The replicase polyprotein, when fused to GFP, forms distinctive globular structures in tobacco protoplasts as well as in leaf cells of *N. benthamiana* after agro-infiltration. These globular bodies resemble viral replication complexes (VRC) commonly observed in plant cells infected with positive-strand RNA viruses (Buck 1996; Nagy and Pogany 2008; Waigmann et al. 2007). Similar globular structures were also formed when a GFP fusion containing the N-terminal fragment of the replicase polyprotein, desig-

nated REP207-GFP, was expressed in *N. benthamiana* cells. Interestingly, these VRC-like structures did not co-localize with chloroplasts, Golgi bodies, or peroxisomes but were positioned in juxtaposition to the ER network (Prosser et al. 2015). Through membrane flotation and biochemical analysis, it was demonstrated that REP207-GFP was indeed associated with cellular membrane. This membrane association seems to be achieved in a monotopic fashion through an amphipathic helix (Prosser et al. 2015). It represents a novel mechanism for membrane association that has also been found in *Semliki Forest virus* (Salonen et al. 2004; Spuul et al. 2006) and *Brome mosaic virus* (BMV) (Liu et al. 2009).

Proteolytic Processing of the Replicase Polyprotein

Initially, a single protease domain of the papain-like cysteine protease family was identified in the translation product of ORF1 (Meng et al. 1998; Zhang et al. 1998). It was predicted that the ORF1-encoded polypeptide would undergo proteolytic processing to produce two or more functional end products that together constitute the replicase enzyme for genome replication and transcription (Meng and Gonsalves 2007, 2008). Subsequently, a second cysteine protease domain, designated the OTU domain, based on its sequence homology with the ovarian tumor gene product of fruit fly, was identified in GRSPaV and several other members of the *Betaflexiviridae* through bioinformatics (Makarova et al. 2000). It remains unknown, however, if only one or both of these domains are functional in the cleavage of GRSPaV replicase polyprotein. Based on the close similarity and potential evolutionary relatedness between the translation products of ORF1 of GRSPaV and *Turnip yellow mosaic virus* (TYMV), it was predicted that the GRSPaV replicase polyprotein would undergo processing similar to that of TYMV (Kadare et al., 1995; Jakubiec et al., 2007), the type member of the family *Tymoviridae*, order *Tymovirales* which also comprises the family *Betaflexiviridae* (King et al. 2012). The most current information suggests that the replicase polyprotein of TYMV is cleaved twice, one between the Hel and the RdRP domains and the other between the P-Pro and Hel domains. As a result, the TYMV replicase polyprotein is processed into three fragments: an N-terminal fragment of 98 kDa, a C-terminal fragment of 66 kDa, and a central fragment of 42 kDa (Jakubiec et al. 2007). The only other virus of the order *Tymovirales* for which preliminary information on replicase polyprotein processing is available is *Blueberry scorch virus* (BBScV, genus *Carlavirus*, family *Betaflexiviridae*). It was predicted that the replicase polyprotein of BBScV is cleaved at least once between the Hel and the RdRP domain (Lawrence et al. 1995). It remains to be determined whether GRSPaV replicase polyprotein would also undergo autocleavage, and if so, will it use a similar or a different processing.

To elucidate the cleavage profile of the GRSPaV replicase polyprotein, we have used several experimental approaches, which include expression in *E. coli*, in insect culture using the Bacmid system, *in vitro* transcription/translation, as well as plant-based expression (Udaskin 2016). Preliminary results derived from different experi-

mental systems seem to suggest that the GRSPaV replicase polyprotein may undergo cleavage at three sites, one immediately after the MTR domain, the second between P-Pro and Hel, and the third between Hel and RdRP (Udaskin 2016). Due to the large size of the polyprotein, low levels of protein expression, as well as unintended cleavage of the polyprotein by cellular proteases, it has been technically challenging to obtain a clear picture on the proteolytic processing of the polyprotein. Evidently, further experimentation is required to verify these initial findings. It also remains an open question as to which of the protease domains is responsible for the cleavage and where on the polyprotein the cleavage occurs.

Infectious cDNA Clones and Possibilities for a Wide Range of Fundamental Studies

Considering the potential role of GRSPaV in several diseases, efforts were made to generate infectious cDNA clones. To this end, a full-length cDNA corresponding to the genome of isolate GG was first engineered using pHST40 (Scholthof 1999), a pUC18-based plasmid vector containing the 35S promoter from *Cauliflower mosaic virus* and the Nos terminator (Meng et al. 2013). It was hoped that, upon delivery of the full-length viral clone into *N. benthamiana* via rub-inoculation, infection would commence in the inoculated leaves and such an infection would be systemic. However, absolutely no signs of infectivity were detected in the inoculated plants even after 2 months post inoculation.

It was believed that GRSPaV may have lost the ability to cause systemic infection in *N. benthamiana* simply because, as a grapevine virus, it may have coevolved with, and coadapted to, the woody perennial host for a long period of time (Meng et al. 2006; Meng and Gonsalves 2007). The rub-inoculation procedure might have allowed viral replication in individual cells that had received the viral clone; however, the rub-inoculation which was first attempted was not successful possibly due to insufficient number of individual cells of *N. benthamiana* to be transfected. Thus, the full-length cDNA clone and a GFP-tagged variant were subcloned into the binary vector pCambia (Wang et al. 2004). This second generation full-length clones allowed more effective establishment of infection in *N. benthamiana* leaves via inoculation through agro-infiltration. Both the wild-type and the GFP-tagged viral clones were infectious in both *N. benthamiana* and grapevines (Meng et al. 2013). It was noted that the rate of viral replication of the GFP-tagged clone, as judged by the level of GFP protein produced, was much lower when compared to a GFP-tagged infectious clone of PVX (Meng et al. 2013). Further, the GFP-tagged viral clone seemed very slow in initiating systemic infection in the grapevine, requiring 6 months before viral RNA could be detected in the upper, non-inoculated leaves of the infiltrated grapevine (Meng et al. 2013). This low level of GFP expression and the impaired systemic infection in the grapevine were not caused by reduced expression of the CP due to the use of a heterologous subgenomic promoter from a different strain of GRSPaV (Meng, unpublished data). It remains to be determined if the wild-type cDNA clone is more efficient in establishing systemic infection in grapevine.

Genetic Diversity and Population Structure

It is well established that GRSPaV is composed of a wide range of sequence variants (Meng et al. 1999b, 2006; Nolasco et al. 2006; Terlizzi et al. 2010, 2011; Alabi et al. 2010). The initial recognition of this phenomenon dates back to the time when the first genomes were being sequenced. Meng et al. (1999b) constructed a cDNA library using pooled dsRNA preparations isolated from several French-American hybrids (Seyval, Ravat 34, Colobel 257, and 3 others). They soon realized the occurrence of a high degree of heterogeneity among individual clones that were selected from the same library for sequencing. In fact, the presence of diverse sequence variants in the initial cDNA library severely impeded the completion of the sequence of the first genome, GRSPaV-1 (Meng et al. 1998). Similarly, Zhang et al. (1998) reported the existence of sequence variants derived from RT-PCR products. To verify these initial findings, RT-PCR products were amplified from three individual sources, cloned, individual clones were sequenced, and the resulting sequences were compared (Meng et al. 1999b). As a result, four clusters of viral sequences were obtained. It was also demonstrated that each of the three sources analyzed in this study contained two distinct groups of sequence variants. Together, these data suggested that GRSPaV comprises a family of sequence variants (Meng et al. 1998, 1999b; Rowhani et al. 2000; Zhang et al. 1998).

In efforts to obtain a more comprehensive picture on the genetic diversity of GRSPaV, several research groups representing different geographical regions performed further analysis on the genetic diversity and the population structure of GRSPaV in infected grapevines (Nolasco et al. 2006; Meng et al. 2006; Nakaune et al. 2008; Alabi et al. 2010; Terlizzi et al. 2010; Goszczynski 2010). Broad-spectrum primers targeting either the highly conserved HEL sequence or the CP gene and sequencing were used to characterize GRSPaV populations. Regardless of the primers used, four phylogenetic groups were consistently identified by different researchers (Meng et al. 2006; Terlizzi et al. 2010; Nolasco et al. 2006; Alabi et al. 2010). However, two different systems for the naming of the phylogenetic groups were used in the literature. In one system, the four groups of sequence variants were designated by Arabic numerals, 1, 2a, 2b, and 3 (Rowhani et al. 2000; Nolasco et al. 2006; Nakaune et al. 2008). In the other system, these sequence variant groups were designated by the names of the reference isolates whose entire genomes were sequenced (with the exception of group VS as only partial sequence was available at the time of the proposal). These phylogenetic groups were thus designated as GRSPaV-1, GRSPaV-SG1, GRSPaV-BS, and GRSPaV-VS (Meng et al. 2006). The intention for proposing the latter system was to unify the nomenclature of genetic variants that have been or will be obtained by researchers throughout the world and to avoid confusions that would otherwise arise and perpetuate in the literature. This latter system seems to be adopted by a majority of researchers (Meng et al. 2006; Alabi et al. 2010; Terlizzi et al. 2010, 2011; Goszczynski 2010).

More recently, a pair of degenerate primers, RSP35/RSP36, was designed based on the consensus sequence of the RdRp domain from multiple GRSPaV strains,

other viruses of the genus *Foveavirus*, as well as several members of the genus *Carlavirus*. Genetic diversity analysis of clones derived from RT-PCR using this pair of primers revealed the presence of additional new groups of sequence variants (Terlizzi et al. 2011). Compiling all sequence data obtained from RT-PCR products as well as complete genome sequences obtained through conventional methods and next-generation sequencing, a total of eight distinct phylogenetic groups of GRSPaV variants are known to exist, and further subgroups are present within some of these phylogroups (Fig. 12.3). It is likely that additional distinct groups of viral variants will be detected in the future through the use of broad-spectrum primers targeting other regions of the viral genome or in new sources.

To date, the genomes of 15 isolates have been completely or near completely sequenced (Table 12.1). The majority of these isolates were derived from commercial wine varieties of *V. vinifera* (Cabernet Sauvignon, Syrah, Pinot noir, Pinot Gris, Moscato Giallo, Riesling, Merlot, and Cabernet Franc), while one from interspecies hybrid (GRSPaV-BS), one from a table grape variety of *V. labruscana* (GLRaV-JF), and one each from grapevine rootstock derived from *V. riparia* (GRSPaV-GG) or St. George (*V. rupestris*). More recently, the near-complete genome of an isolate from *V. flexuosa* (VF1), also known as the “creeping grape” originated from Asia, was sequenced in Brazil (Fajardo and Nickel, personal communication). It is worth noting that the genome sequences of the more recent isolates were determined through high-throughput sequencing technology using either small RNAs or total RNAs as templates (Giampetruzzi et al. 2012; Pooraji et al. 2013). In 2016, another isolate, designated GRSPaV-JH, was cloned and sequenced through conventional RT-PCR from a Syrah clone exhibiting decline symptoms (Hooker 2017).

Despite the differences exhibited in genome sequences, all these isolates share identical genome structure. When the different genome regions of these isolates are compared, it becomes evident that these isolates belong to a large number of phylogroups. For example, when the nt sequence corresponding to the RdRP region flanked by primers RSP35/RSP36 were used in phylogenetic analysis, eight clusters can be clearly identified (Fig. 12.2). Interestingly, results of the phylogenetic analysis using nt sequences for the CP gene revealed a slightly different clustering pattern (Fig. 12.3). While distinct clusters are clearly identifiable for the phylogroups represented by six of the reference isolates, isolates GRSPaV-JF and GRSPaV-VF1 seem to fall within the cluster represented by GRSPaV-BS (Fig. 12.3). In addition, a new cluster is detected (see Fig. 12.3, marked by red box), suggesting the potential existence of yet another group of GRSPaV variants. Because complete genome sequences for this new cluster are unavailable at the present time, we tentatively designate this group as GRSPaV-XX. The existence of this new phylogroup needs to be verified through the sequencing of the entire genomes of isolates within this new group.

In accordance with the nomenclature of GRSPaV variants proposed by Meng et al. (2006), we propose here a revised system for the naming of GRSPaV variant groups. We designate each of these phylogroups using the name of the isolate for which the complete genome sequence is available. These phylogroups include GRSPaV-PN (isolate PN), GRSPaV-SY (isolate SY, to replace the original

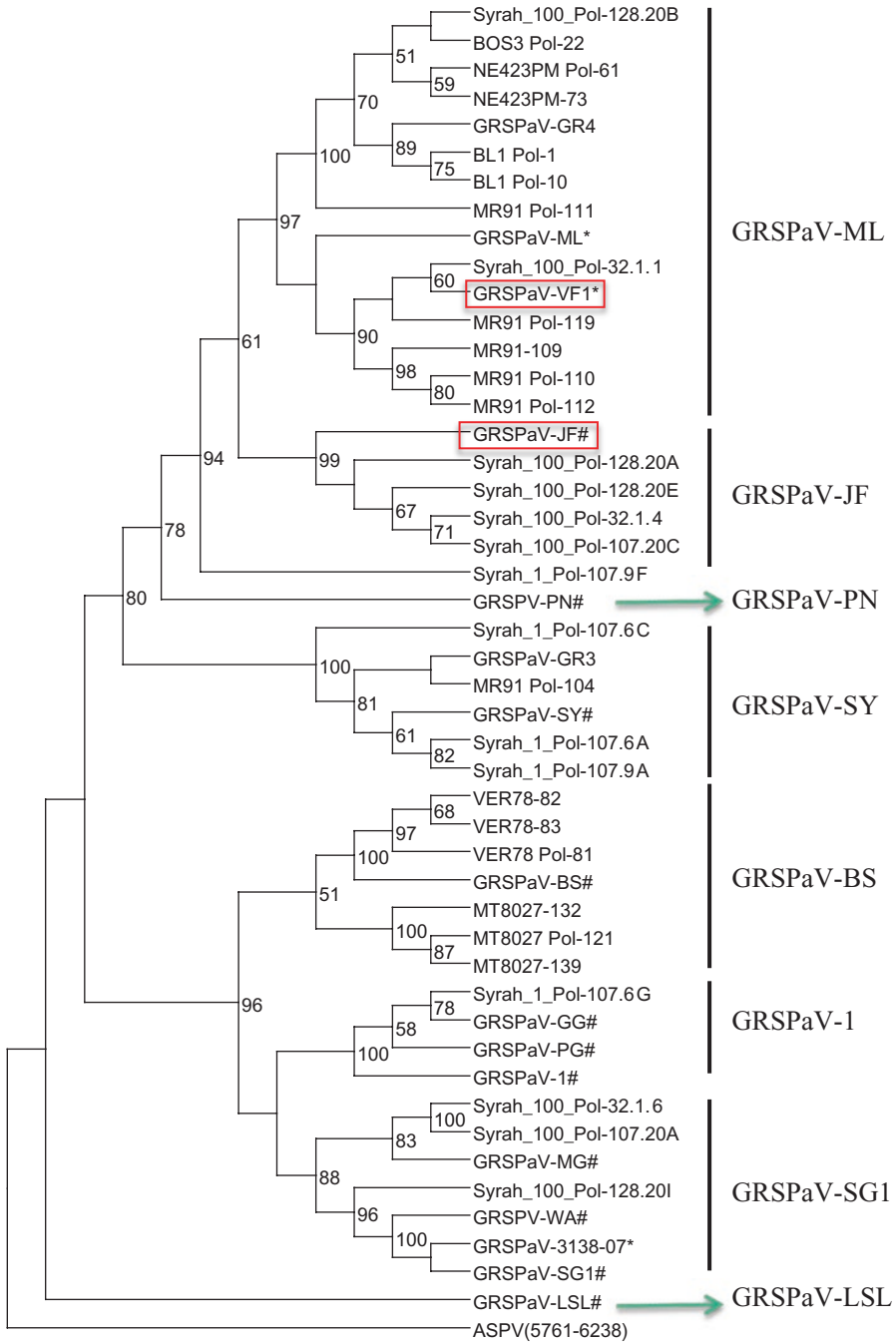

Fig. 12.2 Phylogenetic tree of GRSPaV sequence variants based on partial sequence of the RdRP region of the replicase polypeptide. Sequences were obtained from RT-PCR using broad-spectrum primers RSP35 and RSP36. Also included in the analysis are the corresponding sequences retrieved from complete genome sequences (marked with *hash signs*) or near-complete genome sequences

designation – VS due to the lack of complete genome sequence), GRSPaV-1 (isolates -1, CA, PG, and GG), GRSPaV-SG1 (isolates SG1, MG, WA, and 3138-07), GRSPaV-BS (isolate BS), GRSPaV-ML, GRSPaV-JF (isolate JF), and GRSPaV-LSL (isolate LSL). Overall, isolates LSL and PN are the most divergent, regardless which genomic region is used in the analysis. The two clusters represented by GRSPaV-1 and GRSPaV-SG1 appear to be more closely related (Fig. 12.2).

When these complete genome sequences were compared, the following conclusions were made. First, the 5' NCR appears to be the most conserved, with sequence identities ranging from 90 % to 100 % (Fig. 12.4 and data not shown). Furthermore, the 5' terminal 19 nucleotides are invariable among all sequenced isolates (Fig. 12.4). In contrast, the 3' NCR appears to be more divergent, differing by up to 21 % (Fig. 12.5 and data not shown). However, in spite of these differences in the 3' NCR, there is a stretch of 40 nucleotides that is invariable among all sequenced isolates (Fig. 12.5). Further downstream and toward the 3' terminus is another stretch of 14 nucleotides that is conserved among all isolates. Because these invariable sequences are positioned at either the 5' or the 3' terminal noncoding regions of the viral genome, these regions may play an essential role in viral genome replication. In practical terms, these regions can be used to design primers for the detection of a broad spectrum of GRSPaV variants as well as for genetic diversity analysis.

It is puzzling that the region between the MTR and the AlkB domains diverge vastly among GRSPaV isolates that have been sequenced. This region, which was designated as HVR (highly variable region), is located between genome positions 1411–2310, corresponding to aa positions 451–750 on the replicase polyprotein (Meng and Gonsalves 2007; Lima et al. 2006). When the corresponding amino acid sequences were compared, this region differs by up to 53 % among isolates from different phylogroups (Fig. 12.6 and data not shown). Similarly, when nucleotide sequences are compared, these isolates have sequence identities of as low as 55.3 % among the phylogroups. This is in line with earlier findings (Lima et al. 2006, 2009; Habili et al. 2006). It is reasonable to predict that this HVR may not be essential for the function of the replicase polyprotein and, as such, has been under less or no selection pressure during the evolution of the virus in the context of coadaptation with different grapevine hosts.

The genome of isolate GRSPaV-JF (KR054734) recently sequenced in China (Hu et al. 2015) appears to be a hybrid between GRSPaV-PN and GRSPaV-BS. Its 5' genomic region (i.e., ORF1) is more closely related to isolate PN, while the remainder of its genome has a closer relatedness to isolate BS (Hu et al. 2015). It is unclear if this incongruence reflects the existence of a naturally occurring chimeric virus or an artifact resulting from assembly of the genome using sequences derived

←
Fig. 12.2 (continued) (marked with an *asterisk*) of the reference isolates. Nucleotide sequence of *Apple stem pitting virus* (ASPV, accession number D21829) was retrieved from GenBank and used as an outgroup. Phylogenetic analyses were performed using both the Neighbor Joining (shown here) and the Maximum Likelihood methods. Each of the clusters is designated by the name of the reference isolate within that cluster whose genome has been sequenced. Bootstrap values of 50 % or greater (of 500 replication) are provided

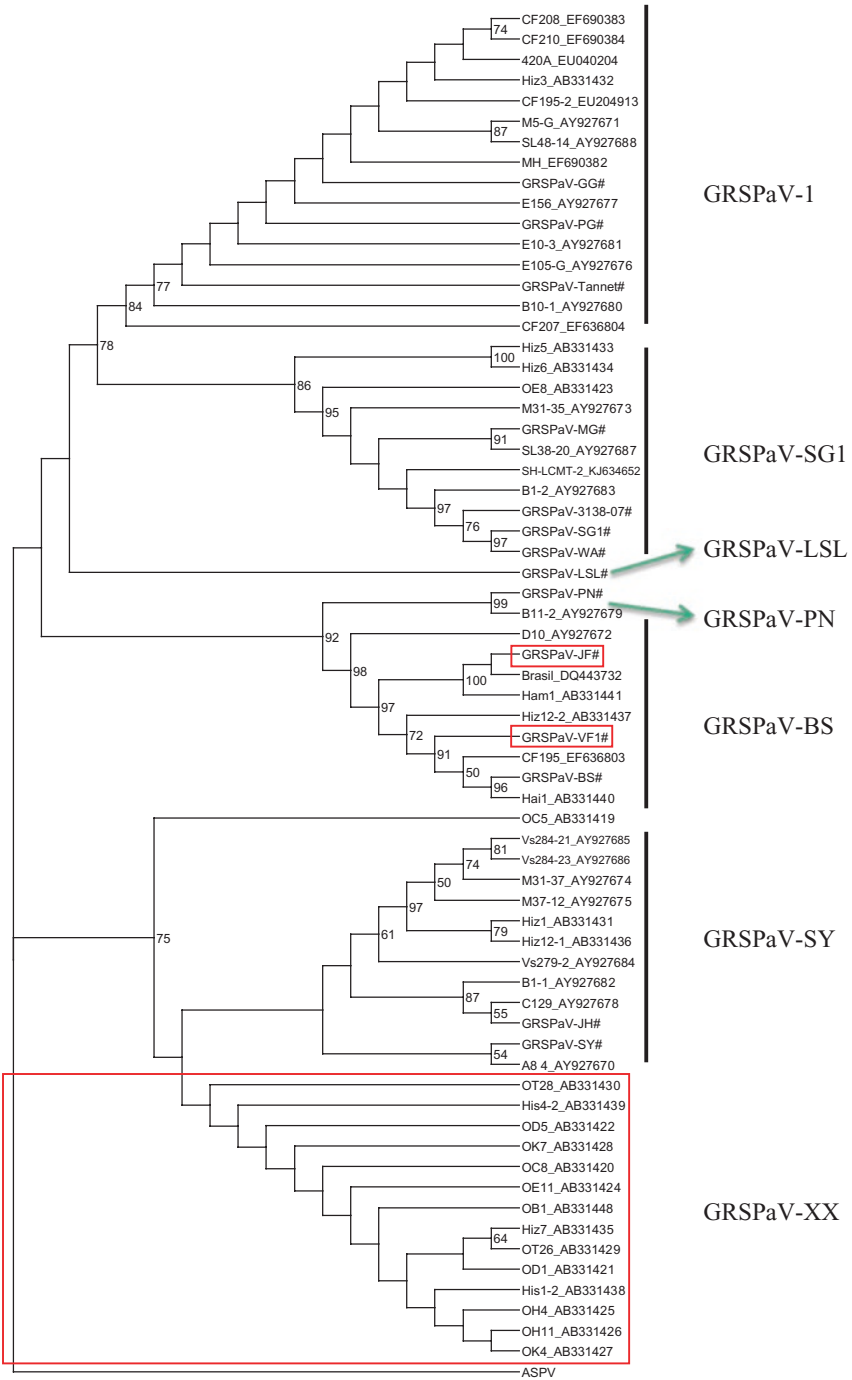

Fig. 12.3 Phylogenetic tree of GRSPaV sequence variants based on nucleotide sequence of the CP gene. Sequences were retrieved from GenBank. Corresponding sequences from reference isolates were obtained from each of the genome sequences and included in the analysis. Sequence

A

Consensus #1	GATAAACATAACAACAGAA.T..CATTGCA.TAATATTC..TGAAT.TAATTGCAACG..
GRSPaV-GG 5'NCR.seq	GATAAACATAACAACAGAA T CATTGCA TAATATTC TGAAT TAATTGCAACG 60
GRSPaV-1 5'NCR.seq	GATAAACATAACAACAGAA T CATTGCA TAATATTC TGAAT TAATTGCAACG 60
GRSPaV Zhang 5'NCR.seq	GATAAACATAACAACAGAA T CATTGCA TAATATTC TGAAT TAATTGCAACG 60
GRSPaV-PG 5'NCR.seq	GATAAACATAACAACAGAA T CATTGCA TAATATTC TGAAT TAATTGCAACG 60
GRSPaV-SG1 5' NCR.seq	GATAAACATAACAACAGAA T CATTGCA TAATATTC TGAAT TAATTGCAACG 60
GRSPaV-MG 5'NCR.seq	GATAAACATAACAACAGAA T CATTGCA TAATATTC TGAAT TAATTGCAACG 60
GRSPaV-BS 5'NCR.seq	GATAAACATAACAACAGAA T CATTGCA TAATATTC TGAAT TAATTGCAACG 60
GRSPaV-PN 5'NCR.seq	GATAAACATAACAACAGAA T CATTGCA TAATATTC TGAAT TAATTGCAACG 60
GRSPaV-SY 5'NCR.seq	GATAAACATAACAACAGAA T CATTGCA TAATATTC TGAAT TAATTGCAACG 60
GRSPaV-VF1 5'NCR.seq	GATAAACATAACAACAGAA T CATTGCA TAATATTC TGAAT TAATTGCAACG 60
GRSPaV-JF 5'NCR.seq	GATAAACATAACAACAGAA T CATTGCA TAATATTC TGAAT TAATTGCAACG 60
GRSPaV-LSL 5'NCR.seq	GATAAACATAACAACAGAA T CATTGCA TAATATTC TGAAT TAATTGCAACG 60
GRSPaV-WA 5'NCR.seq	GATAAACATAACAACAGAA T CATTGCA TAATATTC TGAAT TAATTGCAACG 60
GRSPaV-3138-07 5'NCR.seq	GATAAACATAACAACAGAA T CATTGCA TAATATTC TGAAT TAATTGCAACG 60

B

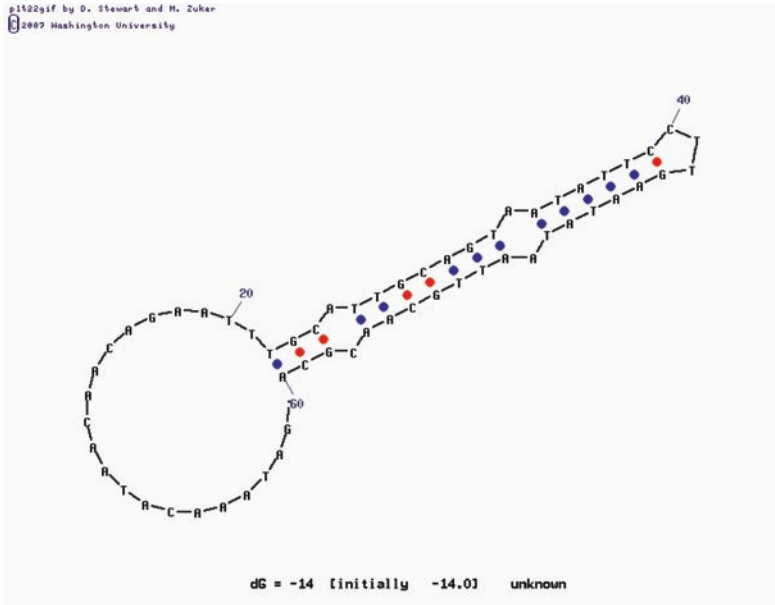

Fig. 12.4 Sequence and structure of the 5' noncoding regions (NCR) of GRSPaV. (A) Sequence alignment among all GRSPaV isolates for which the complete or near-complete genome sequences are available. As shown, the 5' NCR is highly conserved among all isolates except for a few places where mismatches exist (highlighted in magenta). (B) Secondary structure of the 5' NCR of isolate GG predicted by M-Fold. The 5' NCR is predicted to form a stem-loop structure with a large loop formed by the 5' 22 nucleotides and three small loops distributed along the stem. This stem-loop structure may play an important role during genome replication

Fig. 12.3 (continued) from the corresponding region in ASPV (accession number D21829) was used as an outgroup. Phylogenetic analyses were performed using both the Neighbor Joining (shown here) and the Maximum Likelihood methods. Bootstrap values of 50 % or greater (of 500 replication) are provided. Selection of sequences used in this analysis was based mainly on Terlizzi et al. (2010)

		
GRSPV-GG 3'NCR.seq	GGGGGATGAAGTCAGCGACAATTCCGCAGTCCAATAATTCCTGATTTCAAGGCTAGGTT	60
GRSPaV-1 3'NCR.seq	..AT..C.....C.....G....	60
GRSPaV-BS 3'NCR.seq	..TT...GT.GA...A.TGC.C.TT..TC.A...CA..C.....G....	60
GRSPaV-SG1 3'NCR.seq	A.A...A...ATGAT.G..T...T.....C.....G....	60
GRSPaV-MG 3'NCR.seq	..A...G...CTGAT.G.....ACT.....A.C.....G....	60
GRSPaV-PG 3'NCR.seqC.....G....	60
GRSPaV-WA 3'NCR.seq	A.A..C.A...ATGAT.G..T...T.....C.....G....	60
GRSPaV-SY 3'NCR.seq	..T.C..A...GGG...GTGGCC.TCAGCGTT.....C.....G....	60
GRSPaV-CA 3'NCR.seqC.....G....	60
GRSPaV-PN 3'NCR.seq	..CA...GT.G...AA...GC..AC..CCTG.....CA..C.....G....	60
GRSPaV-3138-07 3'NCR.seq	A.A...A...ATGAT.G..T...T.....C.....G....	60
GRSPaV-JF 3'NCR.seq	..TT...AGT.GA...AG.GC.C.ATT.TC.A...CA..C.....G....	60
GRSPaV-LSL 3'NCR.seq	..T...A.TGCT.GTGC...AT.GCGT.....ACT..CA.....G....	60
GRSPaV-VF1 3'NCR.seq	..CT...AGT.GA..TA..GC.C.TT..T..A.....CA..C.....G....	60
GRSPV-GG 3'NCR.seq	AAGCCTGTTCGCTGGAATACCGTACTAATAGTATTCCTTTCCATGCTAAATCCTATTTA	120
GRSPaV-1 3'NCR.seq	120
GRSPaV-BS 3'NCR.seqTG.....C.	120
GRSPaV-SG1 3'NCR.seq	120
GRSPaV-MG 3'NCR.seqA.....	120
GRSPaV-PG 3'NCR.seq	120
GRSPaV-WA 3'NCR.seq	120
GRSPaV-SY 3'NCR.seqT.....	120
GRSPaV-CA 3'NCR.seq	120
GRSPaV-PN 3'NCR.seq	..G.....T.....	120
GRSPaV-3138-07 3'NCR.seq	120
GRSPaV-JF 3'NCR.seqT.....	120
GRSPaV-LSL 3'NCR.seqC.TC.....	120
GRSPaV-VF1 3'NCR.seqT.....	120
GRSPV-GG 3'NCR.seq	ATATATAAGGTGTGGAAAGTAAAGAAGATTTGGTGTGTTTTATAGTTTTTCATTC	176
GRSPaV-1 3'NCR.seq	176
GRSPaV-BS 3'NCR.seqA.CA...G..T..T..AT...-.....C..	175
GRSPaV-SG1 3'NCR.seqT.....C.....C..	176
GRSPaV-MG 3'NCR.seqC.....C.....	176
GRSPaV-PG 3'NCR.seq	176
GRSPaV-WA 3'NCR.seqT.....C.....C..	176
GRSPaV-SY 3'NCR.seq	..C.....CA.....T..A...T.....GCG.	176
GRSPaV-CA 3'NCR.seq	176
GRSPaV-PN 3'NCR.seqA.CA.....G..T..T..-.....C...C..	175
GRSPaV-3138-07 3'NCR.seqC.....C.....CC.	176
GRSPaV-JF 3'NCR.seqCA.....A...T..AG...T.....C..	176
GRSPaV-LSL 3'NCR.seq	..A.....CACA.G.G..T..T..-...T.....C..	175
GRSPaV-VF1 3'NCR.seqCA.....C...T..A...-.....	166

Fig. 12.5 Comparison of the 3' noncoding regions of GRSPaV isolates. The 3' NCR sequences were retrieved from the genome sequence of each isolate immediately downstream of the stop codon of ORF5. The *red arrow* points to the first nucleotide of an alternative 3'NCR when ORF6 is taken into consideration. It can be seen that most of the differences are distributed in the 5' third region upstream of the *arrow*

from two different variants coinfecting the same grapevine. This question can be readily answered through cloning and sequencing the junctions of cDNA fragments that were used in the assembly of this genome.

GRSPaV-GG HVR.pro	EENVEEVMDSNFWFLGDLQFNQRAPFFLGS SYWLNSKFSVEHKFSSSTINSQIMQVILSLIPFSDDPTRFPSSTE	75
GRSPaV-1 HVR.pro	. . . D	75
GRSPaV-CA HVR.pro G	75
GRSPaV-3138-07.pro V P L GA . F . I . AV L . C	75
GRSPaV-BS HVR.pro I GA . C L . G P . I	75
GRSPaV-MG HVR.pro V P GA . F AV L . G I	75
GRSPaV-PG HVR.pro K G A	75
GRSPaV-SG1 HVR.pro I . V S P L GA . F . I . AV L . C M	75
GRSPaV-WA HVR.pro V P L GA . F . I . AV L . C	75
GRSPaV-PN HVR.pro I SNVH YS . T . H . S . P TGIV . H . L . A LPN . A T . E	75
GRSPaV-SY HVR.pro D SNA . D C . S . P . H . G I G . V . H . VLHAA F . L . S . S N	75
GRSPaV-JF HVR.pro	A . DI . . A . G N . H YS . V . H . IK . P AGV . R . LY . A V . L S . KLT . R	75
GRSPaV-VF1 HVR.pro DI S NVY YS . V . H P S . AGA . H . LH . A . A . V . LPN . S . KLAPR	75
GRSPaV-LSL HVR.pro NAH RQN SF . RDF PGIV . N LHAV LPN . K . K . GR	75
GRSPaV-GG HVR.pro	VNLALSEVKAAALATGQSKLFRFLVDDCVMREVRSSYKVGLEFKHIKALTHCFNSCGLQWFLLRQRSNLFKLNRA	150
GRSPaV-1 HVR.pro E A	150
GRSPaV-CA HVR.pro E	150
GRSPaV-3138-07.pro K R S G QK S Y KR D . V	150
GRSPaV-BS HVR.pro RT . K R . S IQ . Q AYF	150
GRSPaV-MG HVR.pro K K S G AHIF P YW C KR . G DG	150
GRSPaV-PG HVR.pro E F	150
GRSPaV-SG1 HVR.pro LK R S G QK S Y KR D . V	150
GRSPaV-WA HVR.pro LK R S G QK S Y KR D . V	150
GRSPaV-PN HVR.pro	I . FS . LSIRM . . ES . R G NSALIS . MQKK . TK . AQ . L WF . HF SK . A GECK	150
GRSPaV-SY HVR.pro	I . FV . GI . M . . GVA I . IFIN . LKL . RSR . A . LR KF . HF K . I GSE	150
GRSPaV-JF HVR.pro	. DS . . S . RK . . GV G NNTLTN . . QRG . . LR . AQ . L . S . . WL . HF . . C CR . I SD . K	150
GRSPaV-VF1 HVR.pro	. DSV . S . RM . . GI R . G N . TLIN . LQRR . LR . AQ . L . S . . WY . HF . . C NR . N GD . K	150
GRSPaV-LSL HVR.pro	. D . S . . R I V TLL . S . Q . A . RFR . SS EF . HI CR . A . . R . C . D . K	150
GRSPaV-GG HVR.pro	SSFADLCEVIKYRVFVTSQAILPEALLSLTKVFRVDSKGVSIPLVSRDELNELAHPANSVLEEQSVDCNA	225
GRSPaV-1 HVR.pro QL N E A	225
GRSPaV-CA HVR.pro A . Q . I . V K A . N G A . D	225
GRSPaV-3138-07.pro N . S . K . . A . KS . VL . T I LN . AFNSE . A . H . SIR . VGS . G . TS . KS S . E	225
GRSPaV-BS HVR.pro LV . N . A . RM . . L T . G . R R . IWE . . MENTF . THE . T . KNDPTG . V GPTP S A . DV	225
GRSPaV-MG HVR.pro N . S A . KS . V T I LNDAF . TSE . I . N SVG . VCS . G . TS . KS . P . N . E	225
GRSPaV-PG HVR.pro D Q	225
GRSPaV-SG1 HVR.pro N . S A . KS . VL . T I LN . AFNSE . A . H . SIR . VGS . G . TS . KS S . E	225
GRSPaV-WA HVR.pro N . S A . MS . VL I LN . DFNSE . A . H . SIR . VGS . G . TP . KS S . E	225
GRSPaV-PN HVR.pro N . A . L . NL . IT A . R . SG . I Y . GS . NPQQ . N . QTIFDG . SC VQSFHAGI . G CNSQE	225
GRSPaV-SY HVR.pro	T . VE . S . G . A . L . KS . IL . VSS . N SG . AR . Y . DH . S . QLC . GSHFM . D PNP . LAD . ITS . ASL . E QG	225
GRSPaV-JF HVR.pro P . G . A . I . SL . . A A . V . SG YSFG . N . QQKL . SSNILEGN . C . SVQSP . AHFG . TLVSHDQE	225
GRSPaV-VF1 HVR.pro N . TQI . . L . SA . . TA . GV G Y . CC . NTQQR . LNSLNALEGKSS . SVQ . SDACFG . TLVSN . DQE	225
GRSPaV-LSL HVR.pro S . Q . A . I . NL . VA . VT N . SSG . IQ . YIDH . R . NKN . N . HFAATG . ARDSIEAV . LDSGV . PLC . DKV	225
GRSPaV-GG HVR.pro	GRVQASVSSSQQLADHLSLSSVKSSIETANKAFNLEELRIMIRVLPEDFNWVVKNGIFKDRLRGRGASFFSKPGI	300
GRSPaV-1 HVR.pro D G A	300
GRSPaV-CA HVR.pro D S	300
GRSPaV-3138-07.pro	S . . LVNS . . T . PP . HNL . PV . N P . K . . E . V . D . G . . K . AVK I D K	300
GRSPaV-BS HVR.pro	SETPEGI . A . LP L . D . LPV . TE . F G V R E K	300
GRSPaV-MG HVR.pro	S . . PV . S . . T . LP . YNL . V . NA . PP . KITE . V . D K . TVNL K	300
GRSPaV-PG HVR.pro TD S	300
GRSPaV-SG1 HVR.pro	S . . LVNS . . T . PP . HNL . PV . N P . K . . E . V . D . G . . K . AVK I K	300
GRSPaV-WA HVR.pro	S . . LVNS . . T . PP . HNL . PV . N K E . V . D . G . . K . AVK I K	300
GRSPaV-PN HVR.pro E . AT . IPHAT . . PS . SLST . NLIPS . GLVRQ . V . GD . K . A . GA . SQP . D . I S K . K . S	300
GRSPaV-SY HVR.pro	FQTVEQAACAHPIN . ALCIDLAPP . . KKIE . S . C . G . . T . PVG KP . D S . N . K R	300
GRSPaV-JF HVR.pro K . VT . TPHTS . . L . ASIST . NLPPH . GQERQ . V . G A . GT . SQP . E . I N . K . K . S	300
GRSPaV-VF1 HVR.pro	RD . ET . T . HVP . . PNVNIDI . GSPPH . GQERQ . V . G KMA . GA . HP . D . I V . N K . S	300
GRSPaV-LSL HVR.pro	IKATTVALHASPKNLVNDA . QEAPALVA . K . S . T . . G . N . SVNS . . QS . D S N . R K	300

Fig. 12.6 Alignment of amino acid sequences corresponding to the highly variable region (HVR) of GRSPaV isolates. The amino acid sequence of the HVR from GRSPaV isolate GG is given on the top. Positions in other isolates with amino acids identical to GG are denoted by dots, while positions with different amino acids are provided with the actual amino acids

Detection and Diagnosis

Several methods have been developed for the detection of GRSPaV in infected grapevines. These include biological assays on indicator hosts; serological methods such as Western blotting, ELISA, and ISEM; and nucleic acid-based assays such as RT-PCR, RT-qPCR, and RT-LAMP. More recently, high-throughput sequencing platforms have also been developed and used for the detection of GRSPaV among other viruses. Two review articles have dealt with this topic (Meng and Gonsalves 2003, 2008). To avoid unnecessary repetition, here we only briefly touch on the serological methods and focus the discussion on the nucleic acid-based assays. These latter assays have seen increasing popularity for the diagnosis of not only GRSPaV but grapevine viruses in general due to their superior sensitivity as compared to other detection methods.

Serological Methods

Four polyclonal antisera were developed for use in serological detection of GRSPaV (Minafra et al. 2000; Meng et al. 2003; Basso et al. 2010). These antibodies were all produced in rabbits using recombinant coat proteins as the immunogen. For example, Minafra et al. (2000) expressed a polyhistidine-tagged CP in *E. coli* and produced polyclonal antibodies against this recombinant CP. These antibodies were effective in detecting the viral CP from leaf or cortical scrapings through Western blotting and dot immuno-binding. However, these antibodies were ineffective in DAS-ELISA or indirect ELISA. This is perhaps due to the fact that the expressed CP was insoluble and had to be extracted from the pellet fraction through treatment with lauryl sarcosine and triethanolamine. Such a treatment may have altered the native structure of the CP and hence its epitopes (Minafra et al. 2000).

In the same period, a protein fusion between maltose-binding protein and the viral CP was expressed in *E. coli*, and the purified fusion protein was used to immunize a rabbit, producing polyclonal antiserum designated As7-276. This antiserum was effective not only in Western blot (Meng et al. 2000, 2003) and ISEM (Petrovic et al. 2003; Terlizzi et al. 2010) but also in indirect ELISA (Meng et al. 2000, 2003) and dot immune-binding assay (Shang et al. 2009). This recombinant CP tagged with the maltose-binding protein was highly soluble and readily purified without the use of chemical treatment. This may have been the reason for the better performance of As7-276 in both Western blot and ELISA. However, a high background was encountered when As7-276 was used in ELISA, which made it difficult to distinguish between samples that were weakly positive from samples that were free of the virus (Meng et al. 2003).

It seems rather common to encounter high background in ELISA when polyclonal antibodies produced against recombinant proteins expressed in bacterial cells are used (Meng et al. 2003; Minafra et al. 2000). In an attempt to resolve this, a

different polyclonal antiserum was produced using a polyhistidine-tagged CP expressed in insect cell culture using the Bac-to-Bac baculovirus expression system (Invitrogen Life Technologies). The resulting antiserum, designated As2003, was highly reactive in Western blot and ISEM. Preliminary results indicated that As2003 was more reliable than As7-276 in detecting GRSPaV using indirect ELISA (Meng unpublished data). More recently, a fourth antiserum was produced in rabbits against a polyhistidine-tagged CP of GRSPaV expressed in *E. coli* (Basso et al. 2010).

Western blot analyses using leaf tissue collected from GRSPaV-infected French-American hybrids at different times of the season revealed that the titer of GRSPaV varies greatly with time under field conditions. It appears that the CP levels remain constantly high during the spring/summer months when grapevines are actively growing in the field and decline rapidly later on. For example, under New York climate, GRSPaV CP was readily detectable in grapevine leaves from June to mid-August or early September, depending on the plants tested; it was no longer detectable later on (Meng et al. 2003). A different pattern was reported by Minafra et al. (2000) in Italy where GRSPaV antigen remained constant from June to October. This discrepancy may have been due to differences in climatic conditions, the genotypes and cultivars chosen for the assay, or the types of tissue that were used in the tests conducted by these two research groups. On the other hand, cortical scrapings from mature canes seem to be a reliable source of GRSPaV antigen (Minafra et al. 2000; Meng et al. 2000, 2003).

Nucleic Acid-Based Methods

Reverse transcription-polymerase chain reaction (RT-PCR) and quantitative RT-PCR (RT-qPCR) are much more sensitive than serological methods, and as such, they have been widely used for the detection of GRSPaV among many other viruses (for further information, see Chap. 22 of this book). However, due to the existence of multiple sequence variants of GRSPaV, the detection efficiency varies considerably depending on the primers that were used (Zhang et al. 1998; Meng et al. 1999a; Nolasco et al. 2000; Terlizzi et al. 2010). As genome sequences of different isolates of GRSPaV became available, broad-spectrum primers have been designed based on the consensus sequences of multiple sequence variants of the virus. The commonly used primers and their target regions are listed in Table 12.2. These “universal” primers prove to be highly effective in the detection of most, if not all, of the isolates of GRSPaV. For instance, three pairs of primers (RSP21 and RSP22, RSP48 and RSP49, and RSP52 and RSP53) targeting the genomic region encoding the CP were designed and widely used for the detection of GRSPaV (Zhang et al. 1998; Rowhani et al. 2000; Meng et al. 2003; Habili et al. 2006; Lunden et al. 2010).

Similarly, another pair of primers, RSP13 and RSP14, targeting the highly conserved helicase domain of the replicase polyprotein was designed based on the consensus sequence of multiple viral variants (Meng et al. 1999a). This primer pair has been used by several research groups and shown to be capable of detecting viral

Table 12.2 Primers used for detection and genetic diversity analysis of GRSPaV

Primers	Sequence	Genomic position	Target region	Size of amplicon	References
RSP13	GATGAGGTCCAGTTGTTTCC	4373–4392	Helicase	339	Meng et al. 1999
RSP14	ATCCAAAGGACCTTTTGACC	4711–4692			
RSP35	AGRYTTAGRGTRGCTAARGC	5705–5724	RdRP	476	Terlizzi et al. (2011)
RSP36	CACATRTCATCVCCYGCAAA	6180–6161			
RSP21	GAGGATTATAGAGAATGCAC	7917–7936	CP	440	Meng et al. (2003)
RSP22	GCACTCTCATCTGTGACTCC	8357–8338			
RSP48F	AGCTGGGATTATAAGGGAGGT	8177–8197	CP	330	Zhang et al. (1998)
RSP49R	CCAGCCGTTCCACCACTAAT	8506–8487			
RSP52F	TGAAGGCTTTAGGGGTTAG	7708–7726	CP	905	Rowhani et al. (2000)
RSP53R	CTTAACCCAGCCTTGAAATC	8612–8593			
PN1F	GATGGATACAAGTTACGGGC	3033–3052	OTU	504	Lima et al. (2009)
PN2R	TTCCCCAACTTCCAATTAC	3537–3517			
SY-9F	AGGATTCCAACTGTAGAGCAA	2083–2103	HVR-AlkB	628	Lima et al. (2006)
SY8R	TTGGTCGTCATCTTCCAGTT	2709–2690			

variants that belong to multiple phylogenetic groups (Meng et al. 2006; Nolasco et al. 2000; Bouyahia et al. 2005, 2006; Terlizzi et al. 2010, 2011; Alabi et al. 2010; Buzkan et al. 2015).

More recently, degenerate primers (RSP35 and RSP36) targeting the genomic region corresponding to the highly conserved RdRP domain of the replicase polyprotein were designed based on the consensus sequences of not only different strains of GRSPaV, other viruses of the genus *Foveavirus*, and some members of the genus *Carlavirus*. The forward primer, RSP35, targets motif II, while the reverse primer, RSP36, targets motif VI of the RdRp domain. Together, they amplify a genome region of 476 nucleotides. This primer pair is shown to be highly effective in detecting GRSPaV variants from all phylogenetic groups that have been identified to date (Terlizzi et al. 2011; Fattouh et al. 2014; Xiao et al. 2015).

Both leaves and cortical scrapings serve as excellent source materials for the detection of GRSPaV using RT-PCR and RT-qPCR. In contrast to the seasonal variation of GRSPaV antigen observed through Western blotting, viral RNAs can be

detected from bud break to harvest. It is important to point out that inconsistent results were obtained in RT-PCR when nucleic acids were isolated from older tissue, especially those collected toward the end of the growing season. This is due to the presence of large amounts of secondary metabolites that abound in older leaves. To improve detection efficiency and reliability, a systematic analysis was performed to compare the effectiveness of five most commonly used commercial systems for the isolation of total RNAs from grapevine leaves. It was concluded that the Plant Spectrum system (Sigma) gave the best performance when young leaves were used as source material (Xiao et al. 2015). Unfortunately, this system is ineffective when mature leaves, especially those showing senescence or symptoms of infection, were used. A significant improvement was achieved by adding PVP-40 up to 6 % to the extraction buffer which improved the quality of the extracted nucleic acid possibly by reducing the level of RT-PCR inhibitors (Nassuth et al. 2000; Xiao et al. 2015). Total RNA preparations obtained using this improved method served as excellent templates not only in RT-PCR and RT-qPCR (Xiao et al. 2015) but also in next-generation sequencing (Xiao et al. 2016).

In a different experiment, Osman et al. (2012) compared five different nucleic acid extraction methods for preparing total RNA for the detection of viruses of grapevine including GRSPaV using either leaf petioles or cambial scrapings from mature canes. The methods used included BioSprint 96 workstation (Qiagen), MagMax™ Express 96 workstation (Life Technology), RNeasy Plant Minikit (Qiagen) using in-house prepared guanidine buffer, QIAextractor (Qiagen), and AB PRISM 6100 Nucleic Acid PrepStation (Life Technology). The data showed that the total nucleic acid extracted from RNeasy Plant Minikit worked as well as magnetic bead-based technologies (MagMax Express and BioSprint 96 workstation) for the detection of GRSPaV.

It was reported that grape berries contain a high level of GRSPaV RNA (Gambino 2012). It is interesting that GRSPaV was even detected in several years old bottled wine by RT-PCR (Habibi et al. 2012). This means that viral RNA or virions of GRSPaV and perhaps other viruses can survive the process of wine making. Several reports suggest the presence of GRSPaV in the seeds and pollen collected from infected plants (Stewart and Nassuth 2001; Rowhani et al. 2000; Lima et al. 2006b). Further investigation proved the presence of the virus in the pollen and seeds collected from infected plants. A very low percentage of seedlings (0.4 %) from infected seeds tested positive for the virus (Rowhani et al. 2000; Lima et al. 2006b).

Host Range and Transmission

GRSPaV is known to have a worldwide distribution. It has been reported in many countries including Europe, South and North America, China, Australia, Africa, Japan, Turkey, Syria, and many other countries (Fattouh et al. 2014; Coetzee et al. 2010; Goszczynski 2010; Fan et al. 2013; Mslmanich et al. 2006).

Detection of GRSPaV appears to be restricted to different species within the genus *Vitis* and their hybrids (Meng and Gonsalves 2008). Nevertheless, GRSPaV is widely distributed among commercial grapevine cultivars and clonal selections, as well as rootstocks and interspecific hybrids. For instance, it is detected in wine grapes, table grapes, and a number of rootstocks. Based on its detection in rootstock selections such as St. George (*V. rupestris*) and Grande Glabre (*V. riparia*), it is reasonable to predict that GRSPaV may also be present in certain wild grape species such as *V. rupestris*, *V. riparia*, and perhaps other species. GRSPaV sequences of four groups were detected in Japanese table grapes, *Vitis labruscana* cv. Kyoha and Pione. The use of rootstocks imported from other countries might have introduced and dispersed the virus to Japan (Nakaune et al. 2006).

In a recent investigation, Habili (2015) conducted RT-PCR assays using primers RSP48/RSP49 to detect GRSPaV in 66 samples collected from table grape cultivars from four provinces in Iran. None of these samples tested positive for the virus. Recent work has shown that GRSPaV is not detected in the juice grape cultivar Concord or the table grape Sovereign Coronation growing in a commercial vineyard in Canada (Hooker 2017).

Cytopathology, Tissue Tropism, and Virus-Host Interactions

In an earlier study, Tzeng et al. (1993) used electron microscopy to investigate the cytopathology of grapevine cv. Sylvaner indexed positive for RSP. These researchers detected aggregates of virions in phloem parenchyma cells of young shoots. Virus particles were not detected in leaf tissue. They also observed numerous tubular structures between the cell wall and the plasma membrane in cells derived from RSP-infected shoots. This was the only study on the distribution of viral particles that are possibly associated with RSP. Unfortunately, it could not be ascertained if GRSPaV was the only virus present in these Sylvaner vines. Based on the limited information on the cytopathic effects resulting from infection by *Apple stem pitting virus* (ASPV), the type member of the genus *Foveavirus* (Kundu et al. 2006) to which GRSPaV also belongs, it is logical to predict that GRSPaV, like ASPV, is not limited to the phloem tissue but rather is distributed among diverse tissue and cell types. The fact that this virus is the most difficult to eliminate through conventional means suggests that GRSPaV may even invade the meristematic tissue (Gribaudo et al. 2004, 2006; Gambino et al. 2006). Leaves of *N. benthamiana* that were inoculated with GFP-tagged infectious clone of GRSPaV revealed the presence of large globular bodies (Meng et al. 2013 and unpublished data). The fine structure and specific localization of these structures in the infected cells require further investigation.

Pathological Properties, Associated Diseases, and Their Impact

The real impact of GRSPaV infection on the vegetative growth, yield, fruit, and wine quality remains unknown. It is commonly believed in the grapevine virology community that GRSPaV is generally a benign virus, causing asymptomatic or mild infections (Reynolds et al. 1997) or may be even beneficial to the grapevine host (Gambino 2012). Though this may prove to be true for certain strains, the real economic impact of GRSPaV infections has yet to be assessed. This situation is due to the rather complex infection of most commercial grapevine cultivars and clones with multiple viruses and viral strains (Prosser et al. 2007; Komar et al. 2007; Al Rwahnih et al. 2009; Coetzee et al. 2010). It is common that different strains of a given virus may have very different pathological properties, resulting in different types of diseases or different levels of disease severity. Also, the outcome of an infection largely depends on not only strains of the virus but also the combination of scion and rootstock used, as well as the presence of other viruses and viroids with potential synergistic effects. A recent study was conducted to assess the effects of GRSPaV infection with several viruses (GLRaV-1, GLRaV-2, GLRaV-3, and GVB) on Chardonnay through comparison of virus-infected and virus-free vines that have gone through heat treatment (Komar et al. 2007).

However, definitive proof in support of the causal relationship between GRSPaV and the associated diseases is lacking. Based on the correlation between the detection of GRSPaV and the disease status judged by indicator indexing, GRSPaV appears to be associated with two distinct diseases: RSP (Meng et al. 1998, 1999a, b; Meng and Gonsalves 2007, 2008; Zhang et al. 1998) and vein necrosis (Bouyahia et al. 2005). Interestingly, GRSPaV was detected in Syrah and Pinot noir with decline syndrome (Lima et al. 2006, 2009 Habili et al. 2006). However, these associations have yet to be confirmed as other researchers obtained evidence to suggest otherwise (Borgo et al. 2006; Goszczynski 2010). It is possible that different strains of GRSPaV may be responsible for different diseases. In support of this hypothesis, Bouyahia et al. (2005, 2006) demonstrated that GRSPaV-1 and GRSPaV-SG1 are closely associated with vein necrosis, while GRSPaV-BS has a close correlation with RSP. This association was confirmed by a recent study (Bartola 2014). Ultimately, this issue revolving the etiological role of GRSPaV and its strains in these aforementioned diseases can only be resolved through inoculation of different indicator plants with pure isolates or infectious clones corresponding to each of these strains. An infectious clone for GRSPaV-GG has been constructed (Meng et al. 2013), and full-length clones for another strain will soon become available by the same research group.

Strategies for Control and Management

As is the case for the majority of viruses infecting woody perennial plants, the use of virus-free clean stocks is the only way to control GRSPaV. Unfortunately, GRSPaV has been one of the most recalcitrant viruses to eliminate through conventional means such as heat therapy and shoot tip culture (Gribaudo et al. 2004, 2006; Gambino et al. 2006; Skiada et al. 2013). A method suggested to be effective for the eradication of GRSPaV from commercial scion and rootstock selections is through somatic embryogenesis using anther as the source material (Gambino et al. 2006).

Conclusions and Future Directions

Considerable progress has been made on several fronts of research on GRSPaV since its discovery in 1998. Some of the major findings include sequencing of the genomes of 15 isolates, the discovery that GRSPaV is composed of a large family of sequence variants, the establishment of serological and nucleic acid-based methods for diagnosis, the first infectious cDNA clones, as well as experimental systems for the elucidation of subcellular localization and targeting of proteins encoded by the virus.

As is the case with most major grapevine viruses, many research questions remain to be answered concerning GRSPaV. Below we point out what we feel as the most important research directions for the near future. First, the gap between GRSPaV and the diseases to which the virus might be associated or responsible for needs to be bridged. It is likely that different groups of GRSPaV variants may be involved in different diseases, namely, RSP, vein necrosis, and perhaps Syrah decline. The high levels of correlation between GRSPaV-1 and GRSPaV-SG1 and vein necrosis suggest the etiological role of both groups of GRSPaV variants in the disease. However, the ultimate proof for the etiological role of each of the variant groups in these diseases will come only from inoculation of infectious cDNA clones corresponding to each group into grapevines that are free of all other viruses. This requires the establishment of infectious clones for each variant group as well as an effective infection system. Progresses have been made in this area, and a closure to this question may be reached in the next several years.

The functions of the novel domains identified in the replicase polyprotein of GRSPaV constitute another highly interesting area of research. The AlkB domain was identified only recently through bioinformatics in a small subset of positive-strand, single-stranded plant RNA viruses, most of which belong to the family *Betaflexiviridae* and to a lesser extent the family *Closteroviridae* (for further information, see Dolja et al., Chap. 32 of this book). Most of these viruses are pathogens of woody perennials. Although similar domains are widely distributed among cellular organisms, which are involved in the removal of methylation via oxidation, their function in these viruses remains unknown. It is possible that the AlkB domain offers a unique advantage to these woody plant viruses, such as safe guarding viral

genomes against methylation in these perennial hosts. However, this needs to be tested experimentally.

Similarly, the function of the two cysteine protease domains within the replicase polyprotein needs to be elucidated. The presence of these protease domains provides clues that the replicase polyprotein would undergo proteolytic processing to produce functional enzymes that together constitute the functional replicase machinery. However, which of the tandem protease domains is responsible for polyprotein processing is unknown. The sites and sequence of such cleavage also await determination. It is possible that one of these protease domains is responsible for polyprotein processing, while the other may have a distinct function that is required for efficient replication and infection of the virus in the grapevine host. Such a function could be to counter host defense as recently suggested for TYMV (Chenon et al. 2012).

The issue pertaining to the existence of ORF6 and the function of its translation product in GRSPaV also needs resolution. *In silico* analysis of GRSPaV genomes revealed that ORF6, as initially suggested by Zhang et al. (1998), is detected in only some but not all of the sequenced isolates. A closer examination has revealed that smaller ORFs starting from several downstream AUGs can be discerned in many of these isolates. It remains to be determined if one of these ORFs indeed encodes a polypeptide and what its function would be.

Lastly, the ubiquitous distribution of GRSPaV in *Vitis* species, both commercial wine, juice and table grapes, as well as rootstocks and wild grapes, and the existence of such a diverse range of genetic variants invite efforts to develop GRSPaV into vectors for functional genomics and resistance against highly pathogenic viruses and viral strains. Also, GRSPaV offers excellent opportunities for studies of the evolution biology of viruses infecting woody perennial plants. The readers are referred to two other chapters of this book, Chaps. 31 and 32 for further information.

Acknowledgments BM would like to thank Dr. Dennis Gonsalves for providing the precious opportunity to pursue Ph.D. studies at Cornell University and for the guidance and mentorship he has provided over the years. The generous help from numerous collaborators and colleagues on various projects is much appreciated. Sincere gratitude also goes to Mr. Clayton Moore for the help with phylogenetic analyses and the construction of phylogenetic trees, as well as to past and current members of the Meng lab, for their valuable contributions to the research on GRSPaV. Research in the Meng laboratory has been funded by Natural Science and Engineering Council of Canada through the Discovery, Special Opportunity, and Engage programs and by the OMAFRA-UoK Partnerships program.

References

- Adams, M., J. Kreuze. 2015. Revision of family *Betaflexiviridae*, order *Tymovirales*. Approved proposal to the ICTV available at the ICTV website <https://talk.ictvonline.org/taxonomy/>.
- Adams, M.J., G.P. Accotto, A.A. Agranovsky, M. Bar-Joseph, D. Boscia, A.A. Brunt, T. Candresse, R.H.A. Coutts, V.V. Dolja, B.W. Falk, G.D. Foster, D. Gonsalves, W. Jelkmann, A. Karasev, G.P. Martelli, M. Mawassi, R.G. Milne, A. Minafra, S. Namba, A. Rowhani, H.J. Vetten, V.K. Vishnichenko, G.C. Wisler, N. Yoshikawa, and S.K. Zavriev. 2005. Flexiviridae. In *Eighth*

- Report of the International Committee on Taxonomy of Viruses*, ed. C.M. Fauquet, M.A. Mayo, J. Maniloff, U. Desselberger, and L.A. Ball, 1089–1124. San Diego: Elsevier Academic Press.
- Al Rwahnih, M., S. Daubert, D. Golino, and A. Rowhani. 2009. Deep sequencing analysis of RNAs from a grapevine showing Syrah decline symptoms reveals a multiple virus infection that includes a novel virus. *Virology* 387: 395–340.
- Alabi, O.J., R.R. Martin, and R.A. Naidu. 2010. Sequence diversity, population genetics and potential recombination events in *Grapevine rupestris stem pitting-associated virus* in Pacific North-West vineyards. *Journal of General Virology* 91: 265–276.
- Azzam, Osmat I. 1991. Detection of dsRNA in grapevines showing symptoms of rupestris stem pitting disease and the variabilities encountered. *Plant Disease* 75(9): 960.
- Bartola, M.D. 2014. *Grapevine Rupestris Stem Pitting-associated Virus (GRSPaV) and Vein Necrosis: Effect of genetic variability in symptoms expression*. PhD Thesis. Università di Pisa, Scuola superiore Sant'Anna.
- Basso, Marcos Fernando, Thor Vinícius Martins Fajardo, Marcelo Eiras, Ricardo Antônio Ayub, and Osmar Nickel. 2010. Produção de antissoro policlonal utilizando a proteína capsidial recombinante do Rupestris stem pitting-associated virus. *Ciência Rural* 40(11): 2385–2388.
- Borgo, M, F. Anaclerio, N. Bertazzon, E. Angelini. 2006. The relationship between Grapevine rupestris stem pitting-associated virus and Rupestris stem pitting and vein necrosis diseases. In *Extended Abstracts of the 15th Meeting of the ICVG. Stellenbosch, South Africa*. Apr 3–7, 2006, 75–76.
- Bouyahia, H., D. Boscia, V. Savino, P. La Notte, C. Pirolo, M.A. Castellano, A. Minafra, and G.P. Martelli. 2005. Grapevine rupestris stem pitting-associated virus is linked with grapevine vein necrosis. *Vitis* 44: 133–137.
- . 2006. The aetiological role of Grapevine rupestris stem pitting-associated virus in grapevine vein necrosis and Rupestris stem pitting diseases: State of the art and open questions. In *Extended Abstracts of the 15th Meeting of the ICVG. Stellenbosch, South Africa*. Apr 3–7, 77–78.
- Bratlie, M.S., and F. Drablos. 2005. Bioinformatic mapping of AlkB homology domains in viruses. *BMC Genomics* 6: 1.
- Buck, K.W. 1996. Comparison of the replication of positive-stranded RNA viruses of plants and animals. *Advances in Virus Research* 47: 159–251.
- Buzkan, N., P. La Notte, S. Karadag, A. Aktan, P. Saldarelli, and A. Minafra. 2015. Detection of Grapevine rupestris stem pitting-associated virus in autochthonous grapevine cultivars in Turkey. *Journal of Plant Pathology* 97: 387–389.
- Caruthers, J.M., and D.B. McKay. 2002. Helicase structure and mechanism. *Current Opinion in Structural Biology* 12: 123–133.
- Chenon, M., L. Camborde, S. Cheminant, and I. Jupin. 2012. A viral deubiquitylating enzyme targets viral RNA-dependent RNA polymerase and affects viral infectivity. *The EMBO Journal* 31: 741–753.
- Coetzee, B., M.J. Freeborough, H.J. Maree, J.M. Celton, D.J.G. Rees, and J.T. Burger. 2010. Deep sequencing analysis of viruses infecting grapevines: Virome of a vineyard. *Virology* 400: 157–163.
- Davies, Christopher, Graham Hills, and David C. Baulcombe. 1993. Sub-cellular localization of the 25-kDa protein encoded in the triple gene block of potato virus X. *Virology* 197(1): 166–175.
- Fan, X.D., Y.F. Dong, Z.P. Zhang, F. Ren, G.J. Hu, and H.J. Zhu. 2013. RT-LAMP assay for detection of *Grapevine rupestris stem pitting-associated virus*. *Acta Phytopathologica Sinica* 43: 286–293.
- Fattouh, F., C. Ratti, A.M.D. El Ahwany, E. Abdel Aleem, A.R. Babin, and C.R. Autonell. 2014. Detection and molecular characterization of Egyptian isolates of grapevine viruses. *Acta Virologica* 58: 137–145.
- Gambino, G. 2012. Co-evolution between Grapevine rupestris stem pitting-associated virus and *Vitis vinifera* L. leads to decreased defence responses and increased transcription of genes related to photosynthesis. *Journal of Experimental Botany* 63: 5919–5933.

- Gambino, G., J. Bondaz, and I. Gribaudo. 2006. Detection and elimination of viruses in callus, somatic embryos and regenerated plantlets of grapevine. *European Journal of Plant Pathology* 114: 397–404.
- Giampetruzzi, Annalisa, Wahid Roumi, Roberta Roberto, Umberto Malossini, Nobuyuki Yoshikawa, Pierfederico La Notte, Federica Terlizzi, Rino Credi, and Pasquale Saldarelli. 2012. A new grapevine virus discovered by deep sequencing of virus- and viroid-derived small RNAs in Cv Pinot gris. *Virus Research* 163(1): 262–268.
- Goheen, A.C. 1989. Virus diseases and grapevine selection. *American Journal of Enology and Viticulture* 40: 67–72.
- Goszczynski, D. 2010. Rugose wood-associated viruses do not appear to be involved in Shiraz (Syrah) decline in South Africa. *Archives of Virology* 155: 1463–1469.
- Gribaudo, I., G. Gambino, and R. Vallania. 2004. Somatic embryogenesis from grapevine anthers: The optimal developmental stage for collecting explants. *American Journal of Enology and Viticulture* 55: 427–430.
- Gribaudo, L., G. Gambino, D. Cuozzo, and F. Mannini. 2006. Attempts to eliminate Grapevine rupestris stem pitting-associated virus from grapevine clones. *Journal of Plant Pathology* 88: 293–298.
- Habili, N. 2015. *Failure to detect Grapevine rupestris stem pitting-associated virus in Iran may give a clue to the origin of this virus. Proceedings of the 18th Congress of ICVG*. Ankara, Sept 7–11, 2015.
- Habili, N., N. Farrokhi, M.F. Lima, P. Nicholas, and J.W. Randles. 2006. Distribution of Rupestris stem pitting-associated virus variant in two Australian vineyards showing different symptoms. *Annals of Applied Biology* 148: 91–96.
- Habili, N, A. Yazarlou, J. Randles. 2012. First report of the detection of grapevine virus and viroid RNA in bottled wines. *Proceedings of the 17th Congress of ICVG*. Davis, CA, USA, Oct 7–114, 2012.
- Hooker, J.. 2017. *Analysis of the genetic diversity of Grapevine rupestris stem pitting-associated virus in Ontarian vineyards and construction of a full-length infectious clone*. M.Sc. Thesis. University of Guelph.
- Howard, A.R., M.L. Heppler, J.J. Ju, K. Krishnamurthy, M.E. Payton, and J. Verchot-Lubicz. 2004. Potato virus X TGBp1 induces plasmodesmata gating and moves between cells in several host species whereas CP moves only in *N. benthamiana* leaves. *Virology* 328: 185–197.
- Hu, G.J., Y.F. Dong, H.J. Zhu, Z.P. Zhang, X.D. Fan, F. Ren, and J. Zhou. 2015. Molecular characterization of two grapevine rupestris stem pitting-associated virus isolates from China. *Archives of Virology* 160: 2641–2645.
- Jakubiec, A., G. Drugeon, L. Camborde, and I. Jupin. 2007. Proteolytic processing of turnip yellow mosaic virus replication proteins and functional impact on infectivity. *Journal of Virology* 81: 11402–11412.
- Kadare, G., and A.-L. Hainni. 1997. Virus-encoded RNA helicases. *Journal of Virology* 71: 2583–2590.
- Kadare, G., M. Rozanov, and A.-L. Haenni. 1995. Expression of the turnip yellow mosaic virus proteinase in *Escherichia coli* and determination of the cleavage site within the 206 kDa protein. *Journal of General Virology* 76: 2853–2857.
- King, A.M.Q., M.J. Adams, E.B. Carstens, and E.J. Lefkowitz. 2012. *Virus taxonomy: 9th report of the international committee on the taxonomy of viruses*. San Diego: Academic Press/Elsevier.
- Komar, V., E. Vigne, G. Demangeat, and M. Fuchs. 2007. Beneficial effect of selective virus elimination on the performance of *Vitis vinifera* cv. Chardonnay. *American Journal of Enology and Viticulture* 58: 202–210.
- Koonin, E.V., and V.V. Dolja. 1993. Evolution and taxonomy of positive-strand RNA viruses: Implications of comparative analysis of amino acid sequences. *Critical Reviews in Biochemistry and Molecular Biology* 28: 375–430.
- Kundu, J.K., M. Duchacova, and M. Jokes. 2006. Cytopathology of Apple stem pitting virus in *Nicotiana occidentalis* L. *Biologia, Bratislava* 61: 469–471.

- Lawrence, D., M. Rozanov, and B. Hillman. 1995. Autocatalytic processing of the 223 kDa protein of Blueberry scorch Carlavirus by a papain-like proteinase. *Virology* 207: 127–135.
- Lima, M.F., R. Alkowni, J.K. Uyemoto, D. Golino, F. Osman, and A. Rowhani. 2006a. Molecular analysis of a California strain of Rupestris stem pitting associated virus isolated from declining Syrah grapevines. *Archives of Virology* 151: 1889–1894.
- Lima, M.F., C. Rosa, D.A. Golino, A. Rowhani. 2006b. Detection of Rupestris stem pitting associated virus in seedlings of virus-infected material grapevine plants. In *Extended Abstracts of the 15th Meeting of the ICVG, Stellenbosch, South Africa*, Apr 3–7, 2006, 244–245.
- Lima, M., R. Alkowni, J.K. Uyemoto, and A. Rowhani. 2009. Genome study and detection of a new variant of Grapevine rupestris stem pitting associated virus in declining California Pinot Noir grapevines. *Journal of Plant Pathology* 91: 155–162.
- Liu, L., W.M. Westler, J.A. den Boon, X. Wang, A. Diaz, H.A. Steinberg, and P. Ahlquist. 2009. An amphipathic alpha-helix controls multiple roles of brome mosaic virus protein 1a in RNA replication complex assembly and function. *PLoS Pathogens* 5: e1000351.
- Lucas, W.J. 1998. Molecular dissection of the mechanism by which potexvirus triple gene block proteins mediate cell-to-cell transport of infectious RNA. *Molecular Plant-Microbe Interactions* 11: 801–814.
- Lough, T.J., K. Shash, B. Xoconostle-Cázares, K.R. Hofstra, D.L. Beck, E. Balmori, R.L.S. Forster, and W.J. Lucas. 1998. Molecular dissection of the mechanism by which potexvirus triple gene block proteins mediate cell-to-cell transport of infectious RNA. *Molecular Plant-Microbe Interactions* 11(8): 801–814.
- Lunden, Shaista, Baozhong Meng, John Avery, and Wenping Qiu. 2010. Association of Grapevine fanleaf virus, Tomato ringspot virus and Grapevine rupestris stem pitting-associated virus with a grapevine vein-clearing complex on var Chardonnay. *European Journal of Plant Pathology* 126(2): 135–144.
- Makarova, K.S., L. Aravind, and E.V. Koonin. 2000. A novel superfamily of predicted cysteine proteases from eukaryotes, viruses and Chlamydia pneumoniae. *Trends in Biochemical Sciences* 25: 50–52.
- Martelli, G.P. 1993. Rugose wood complex. In *Graft-transmissible diseases of grapevines, handbook for detection and diagnosis*, ed. G.P. Martelli, 45–54. Rome: Food and Agriculture Organization of the United Nations.
- Martelli, G.P., and W. Jelkmann. 1998. Foveavirus, a new plant virus genus. *Archives of Virology* 143: 1245–1249.
- Martelli, G.P., M.J. Adams, J.F. Kreuze, and V.V. Dolja. 2007. Family *Flexiviridae*: A case study in virion and genome plasticity. *Annual Review of Phytopathology* 45: 73–100.
- Meng, B., and D. Gonsalves. 2003. Rupestris stem pitting-associated virus of grapevines: Genome structure, genetic diversity, detection, and phylogenetic relationship to other plant viruses. *Research Trends. Current Topics in Virology* 3: 125–135.
- . 2007. *Grapevine rupestris stem pitting-associated virus*: A decade of research and future perspectives. *Plant Viruses* 1: 52–62.
- . 2008. Grapevine rupestris stem pitting-associated virus. In *Characterization, diagnosis and management of plant viruses*, ed. G. Rao, K.S. Ling, and A. Myrta, 201–222. Houston: Studium Press, LLC.
- Meng, B., and C. Li. 2010. The capsid protein of *Grapevine rupestris stem pitting-associated virus* contains a typical nuclear localization signal and targets to the nucleus. *Virus Research* 153: 212–217.
- Meng, B., S.-Z. Pang, P.L. Forsline, J.R. McFerson, and D. Gonsalves. 1998. Nucleotide sequence and genome structure of grapevine rupestris stem pitting associated virus-1 reveal similarities to apple stem pitting virus. *Journal of General Virology* 79: 2059–2069.
- Meng, B., R. Johnson, S. Peressini, P.L. Forsline, and D. Gonsalves. 1999a. Rupestris stem pitting associated virus-1 is consistently detected in rupestris stem pitting-infected grapevines. *European Journal of Plant Pathology* 105: 191–199.
- Meng, B., H.-Y. Zhu, and D. Gonsalves. 1999b. Rupestris stem pitting associated virus-1 consists of a family of sequence variants. *Archives of Virology* 144: 2071–2085.

- Meng, B., R. Credi, N. Petrovic, D. Gonsalves. 2000. Serological detection of RSPaV in grapes as compared to RT-PCR and indicator indexing. In *Extended Abstracts of the 13th Meeting of the ICVG, Adelaide, South Australia*. Mar 12–18, 2000, 131–132.
- Meng, B., R. Credi, N. Petrovic, I. Tomazic, and D. Gonsalves. 2003. Antiserum to recombinant virus coat protein detects Rupestris stem pitting associated virus in grapevines. *Plant Disease* 87: 515–522.
- Meng, B., C. Li, W. Wang, D. Goszczynski, and D. Gonsalves. 2005. The complete genome sequences of two new variants of Grapevine rupestris stem pitting associated virus and comparative analyses. *Journal of General Virology* 86: 1555–1560.
- Meng, B., A.R. Rebelo, and H. Fisher. 2006. Genetic diversity analysis of Grapevine rupestris stem pitting-associated virus: Revelation of distinct population structures in scion versus rootstock varieties. *Journal of General Virology* 87: 1725–1733.
- Meng, B., S. Venkataraman, C. Li, W. Wang, C. Dayan-Glick, and M. Mawassi. 2013. Construction and biological activities of the first infectious cDNA clones of the genus *Foveavirus*. *Virology* 435: 453–462.
- Minafra, A., P. Casati, V. Elicio, A. Rowhani, P. Saldarelli, V. Savino, and G.P. Martelli. 2000. Serological detection of grapevine rupestris stem pitting-associated virus (GRSPaV) by a polyclonal antiserum to recombinant virus coat protein. *Vitis* 39: 115–118.
- Morelli, M., A. Minafra, D. Boscia, and G.P. Martelli. 2011. Complete nucleotide sequence of a new variant of grapevine rupestris stem pitting-associated virus from southern Italy. *Archives of Virology* 156: 543–546.
- Morozov, S.Y., and A.G. Solovyev. 2003. Triple gene block: Modular design of a multifunctional machine for plant virus movement. *Journal of General Virology* 84: 1351–1366.
- Mslmanieh, T. M. Digiario, T. Elbeaino, D. Boscia, G.P. Martelli. 2006. A preliminary survey of grapevine viruses in Syria. In *Extended Abstracts of the 15th Meeting of the ICVG, Stellenbosch, South Africa*. Apr 3–7, 2006, 189–190.
- Nagy, P.D., and J. Pogany. 2008. Multiple roles of viral replication proteins in plant RNA virus replication. *Methods in Molecular Biology* 451: 55–68.
- Nakaune, R., K. Inoue, H. Nasu, K. Kakogawa, H. Nitta, M. Nakano. 2006. Etiology of rugose wood disease in Japanese grapevines. In *Extended Abstracts of the 15th Meeting of the ICVG, Stellenbosch, South Africa*. Apr. 3–7, 2006, 237–238.
- Nakaune, Ryoji, Koji Inoue, Hideo Nasu, Katsura Kakogawa, Hiromichi Nitta, Jun Imada, and Masaaki Nakano. 2008. Detection of viruses associated with rugose wood in Japanese grapevines and analysis of genomic variability of Rupestris stem pitting-associated virus. *Journal of General Plant Pathology* 74(2): 156–163.
- Nassuth, A., E. Pollari, K. Helmezczy, S. Stewart, and S.A. Kofalvi. 2000. Improved RNA extraction and one-tube RT-PCR assay for simultaneous detection of control plant RNA plus several viruses in plant extracts. *Journal of Virological Methods* 90: 37–49.
- Nolasco, G., A. Mansinho, M. Teixeira Santos, C. Soares, Z. Sequeira, C. Sequeira, P.K. Correia, and O.A. Sequeira. 2000. Large scale evaluation of primers for diagnosis of rupestris stem pitting associated virus-1. *European Journal of Plant Pathology* 106: 311–318.
- Nolasco, G., C. Santos, N. Petrovic, M. Teixeira Santos, I. Cortez, F. Fonseca, J. Boben, A.M. Nazare Pereira, and O. Sequeira. 2006. Rupestris stem pitting associated virus (RSPaV) isolates are composed by mixtures of genomic variants which share a highly conserved coat protein. *Archives of Virology* 151: 83–96.
- Osman, F., T. Olinka, E. Hodzic, D. Golino, and A. Rowhani. 2012. Comparative procedures for sample processing and quantitative PCR detection of grapevine viruses. *Journal of Virological Methods* 179: 303–310.
- Petrovic, N., B. Meng, M. Ravnkar, I. Mavric, and D. Gonsalves. 2003. First detection of Rupestris stem pitting associated virus particles in grapevine using the antibody to the recombinant coat protein. *Plant Disease* 87: 510–514.
- Poorari, S., O.J. Alabi, Y. Fofanov, and R.A. Naidu. 2013. A leafhopper-transmissible DNA virus with novel evolutionary lineage in the family Geminiviridae implicated in grapevine redleaf disease by next-generation sequencing. *PLoS ONE* 8(6), e64194.

- Prosser, S.W., D.E. Goszczynski, and B. Meng. 2007. Molecular analysis of viral double-stranded RNAs reveals complex infection of grapevines with multiple viruses. *Virus Research* 124: 151–159.
- Prosser, S., H. Xiao, C. Li, R.S. Nelson, and B. Meng. 2015. Subcellular localization and membrane association of the replicase protein of *Grapevine rupestris stem pitting-associated virus*, family *Betaflexiviridae*. *Journal of General Virology* 96: 921–932.
- Rebello, Ana Rita, Stella Niewiadomski, Sean W. Prosser, Peter Krell, and Baozhong Meng. 2008. Subcellular localization of the triple gene block proteins encoded by a foveavirus infecting grapevines. *Virus Research* 138(1–2): 57–69.
- Reynolds, A.G., W.W. Lanterman, and D.A. Wardle. 1997. Yield and berry composition of five *Vitis* cultivars as affected by *rupestris* stem pitting virus. *American Journal of Enology and Viticulture* 48: 449–458.
- Rowhani, A., Y.P. Zhang, H. Chin, A. Minafra, D.A. Golino, J.K. Uyemoto. 2000. Grapevine *rupestris* stem pitting associated virus: Population diversity, titer in the host and possible transmission vector. In *Extended Abstracts of the 13th Meeting of the ICVG, University of Adelaide, Alelaide, South Australia*, Mar 12–18, 37.
- Rozanov, M.N., E.V. Koonin, and A.E. Gorbalenya. 1992. Conservation of the putative methyltransferase domain: A hallmark of the ‘Sindbis-like.’ supergroup of positive-strand RNA viruses. *Journal of General Virology* 73: 2129–2134.
- Salonen, A., T. Ahola, and L. Kaariainen. 2004. Viral RNA replication in association with cellular membranes. *Current Topics in Microbiology and Immunology* 285: 139–173.
- Scholthof, H.B. 1999. Rapid delivery of foreign genes into plants by direct rub-inoculation with intact plasmid DNA of a Tomato bushy stunt virus gene vector. *Journal of Virology* 73: 7823–7829.
- Shang, Y.F., S.J. Wang, J.H. Zhao, J.K. Zhang, Z.H. Lu, X.B. Lu, H.W. Sun, and C.L. Yang. 2009. Detection of Grapevine *rupestris* stem pitting-associated virus occurred in Shandong province. *Journal of Fruit Science* 26: 158–162.
- Skiada, F.G., V.I. Maliogka, N.I. Katis, and E.P. Eleftheriou. 2013. Elimination of Grapevine *rupestris* stem pitting-associated virus (GRSPaV) from two *Vitis vinifera* cultivars by in vitro chemotherapy. *European Journal of Plant Pathology* 135: 07–414.
- Soultanas, P., and D.B. Wigley. 2001. Unwinding the “Gordian knot.” of helicase action. *Trends in Biochemical Sciences* 26: 47–54.
- Spull, P., A. Salonen, A. Merits, E. Jokitalo, L. Kaariainen, and T. Ahola. 2006. Role of the amphipathic peptide of Semliki forest virus replicase protein nsP1 in membrane association and virus replication. *Journal of Virology* 81(2): 872–883.
- Stewart, S., and A. Nassuth. 2001. RT-PCR based detection of *Rupestris* stem pitting associated virus within field-grown grapevines throughout the year. *Plant Disease* 85: 617–620.
- Strauss, J.H., and E.G. Strauss. 1994. The Alphaviruses: Gene expression, replication, and evolution. *Microbiological Reviews* 58: 491–562.
- Terlizzi, F., C. Ratti, G. Filippini, A. Pisi, and R. Credi. 2010. Detection and molecular characterization of Italian isolates. *Plant Pathology* 59(1): 48–58.
- Terlizzi, F., C. Li, C. Ratti, W. Qu, R. Credi, and B. Meng. 2011. Detection of multiple sequence variants of *Grapevine rupestris stem pitting-associated virus* using primers targeting the polymerase domain and partial genome sequencing of a novel variant. *Annals of Applied Biology* 159: 478–490.
- Tzeng, H.C., D.D. Tzeng, and A.C. Goheen. 1993. Anatomical and tissue culture studies of *Rupestris* stem pitting-affected grapevines. *Botanical Bulletin Academia Sinica* 34: 73–82.
- Udaskin, M.L. 2016. Investigation into the proteolytic processing and localization of the replicase polyprotein of Grapevine *rupestris* stem pitting-associated virus. M.Sc. Thesis. The University of Guelph, Guelph, Ontario, Canada.
- Verchot-Lubicz, J. 2005. A new cell-to-cell transport model for Potexviruses. *Molecular Plant-Microbe Interactions* 18: 283–290.

- Walter, M., and H.R. Cameron. 1991. Double-stranded RNA isolated from grapevines affected by rupestris stem pitting disease. *American Journal of Enology and Viticulture* 42: 175–179.
- Wang, Y.S., C.M. Motes, D.R. Mohamalawari, and E.B. Blancaflor. 2004. Green fluorescent protein fusions to Arabidopsis fimbrin 1 for spatio-temporal imaging of F-actin dynamics in roots. *Cell Motility and the Cytoskeleton* 59: 9–93.
- Waigmann, E, M. Curin, and M. Heinlein. 2007. Tobacco mosaic virus – A model for macromolecular cell-to-cell spread. *Plant Cell Monograph* 7: 29–62. Berlin/Heidelberg: Springer.
- Xiao, H., W.S. Kim, and B. Meng. 2015. Comparison and improvement of methodologies for isolation of quality RNA from diverse woody plant species and utilization in detection of viral pathogens. *Virology Journal* 12: 171.
- Xiao, H., M. Shabaniyan, W. McFadden-Smith, and B. Meng. 2016. First report of Grapevine Pinot gris virus in commercial grapevines in Canada. *Plant Disease* 100: 1030.
- Zhang, Y.P., J.K. Uyemoto, D.A. Golino, and A. Rowhani. 1998. Nucleotide sequence and RT-PCR detection of a virus associated with grapevine rupestris stem-pitting disease. *Phytopathology* 88: 1231–1237.

Chapter 13

Viruses Involved in Graft Incompatibility and Decline

A. Rowhani, J.K. Uyemoto, D.A. Golino, S.D. Daubert, and M. Al Rwahnih

Abstract “Graft incompatibility” develops in young grapevines when latent viruses in scion sources are transmitted to hypersensitive rootstocks by grafting. Reverse incompatibility, when the rootstock is the source of a latent virus, has not been observed in grapevine. After transplanting, affected vines exhibit weak vegetative growth and eventual vine death. *Grapevine leafroll-associated virus 2* (GLRaV-2) was initially shown to be associated with graft incompatibility, particularly its genetic variants from the RG and PN groups. These cause a hypersensitive response on rootstocks Kober 5BB, 1103 Paulsen, 5C Teleki, 3309 Couderc, and 1616 Couderc. The genetic determinants of incompatibility in these rootstocks, which are derived from *Vitis berlandieri* and *V. riparia*, have not been identified. In addition, coinfections of GLRaV-2 in combination with *Grapevine virus B* (GVB) or of *Grapevine leafroll-associated virus 1* (GLRaV-1) in combination with *Grapevine virus A* (GVA) are also associated with vine decline on certain rootstocks derived from *V. riparia*. For diseases “110R necrotic union” and “3309C stem necrosis distortion,” causative agents have not been identified. Syrah decline disease may be associated with *grapevine rupestris stem pitting-associated virus* (GRSPaV). This disease differs markedly from graft-incompatible diseases in that stem marks appear on Syrah scions, not on rootstocks.

Keywords Grapevine rootstock stem lesion • Young vine decline • Grapevine Syrah decline • Grapevine necrotic union • Stem necrosis distortion

A. Rowhani (✉) • S.D. Daubert • M. Al Rwahnih
Department of Plant Pathology, University of California, Davis, CA 95616, USA
e-mail: akrowhani@ucdavis.edu

J.K. Uyemoto
USDA-ARS, Department of Plant Pathology, University of California,
Davis, CA 95616, USA

D.A. Golino
Foundation Plant Services, University of California, Davis, CA 95616, USA

Introduction

The vast majority of *Vitis vinifera* cultivars grown commercially throughout the world were initially cultivated on their own roots. (Grapevines are still cultivated on their own roots in Australia, Yemen, parts of Turkey, Cyprus, some Aegean Greek islands, and eastern Washington State in the USA.) However, during the past two centuries, the globalization of the grape industry brought European grapevine cultivars to the New World and later on, North American grape species to the Old World. This transoceanic exchange brought phylloxera (*Daktulosphaira vitifoliae*) from North America to Europe in the 1860s, where the insects proceeded to devastate vineyards. The technical solution to this problem was to harness the phylloxera resistance of American grape species to create resistant, hybrid rootstocks. *V. vinifera* species are readily grafted to the diverse American grape species. This strategy saved the European grape industries and has since been implemented wherever phylloxera has become established. Rootstocks and rootstock hybrids have also (1) provided resistance against ring, citrus, dagger, and root knot nematodes, (2) allowed growth in soils low in magnesium, potassium, or zinc, and (3) conferred tolerance to root fungi and resistance to some viruses (Galet 1979; Pongracz 1983).

Grapevines have often been propagated without regard to latent viruses in scion sources. This practice has resulted in vines where graft incompatibility had developed. The term graft incompatibility is used herein where stunting, collapse, and death of grafted vines occurs in association with graft-transmissible agents. (There are no described instances of incompatibility arising from grafts between genetically diverse *Vitis* cultivars or species. All *Vitis* species and cultivars are graft intercompatible.)

Hypersensitivity is a plant defensive mechanism that prevents systemic spread of virus infections. On the cellular level, the hypersensitive response to a field infection usually results in cell death, i.e., at the site of viral entry via vector transmission (Holmes 1929). The resulting leaf, stem, or root necrosis is measured in the width of a few cells and may not be readily visible. With grafted grapevines, however, the hypersensitive rootstock has been placed in direct, continuous contact with a virus source (i.e., scion tissue carrying a systemic infection) via the solid connection between both vascular systems. The hypersensitive-responding tissues are more extensively exposed to the causal agent resulting in development of extensive necrosis and graft-incompatibility symptoms. A visible necrotic region is produced at and/or below the graft union. The area of necrosis blackens the rootstock stem beneath the bark, killing the vascular elements, and the scion portion above withers and dies. There are no known instances in grapevine in which hypersensitivity arises from the graft between an infected rootstock with an uninfected, hypersensitive scion.

Early work (Garau et al. 1993) documented graft incompatibility of different cultivars propagated on the rootstock Kober 5BB (*V. berlandieri* x *V. riparia*) in Sardinia, Italy. Further studies in Italy and in France (Greif et al. 1995) identified the association of *Grapevine leafroll-associated virus 2* (GLRaV-2) with young vine

decline. In addition, graft incompatibility was characterized using green grafts onto Kober 5BB. Plants grew normally for 3 months, after which they declined. This work would correlate young vine decline with the incompatibility of latent virus infections of the scion. With certain rootstock varieties, a hypersensitive response is produced against those infections.

Graft-Incompatibility Diseases of Known Etiology

A: Rootstock Stem Lesion Caused by GLRaV-2RG

Redglobe, a popular seeded table grape cultivar developed at the University of California, Davis in the 1970s, is grown worldwide. In 1992, when table grape production in California was shifting from own-rooted to grafted vines, a field trial was established to evaluate the performance of Redglobe vines on a panel of nine rootstocks (Don Luvisi, personal communication; see Uyemoto et al. 2001). It was found that Redglobe propagated on rootstock Kober 5BB, 5C Teleki (both *V. berlandieri* x *V. riparia*), 1103 Paulsen (*V. berlandieri* x *V. rupestris*), and 3309 Couderc (*V. riparia* x *V. rupestris*) declined and died 2 years post-propagation. Declining vines were typified by leaf reddening during the first season after grafting. This is a symptom similar to scion starvation on an impaired rootstock. In the second season, the affected scions declined, some failing to break bud, or producing compacted, stunted shoots bearing reddish small sized leaves. Necrosis appeared in the rootstock below the graft (Fig. 13.1). The most severe cases led to vine death while

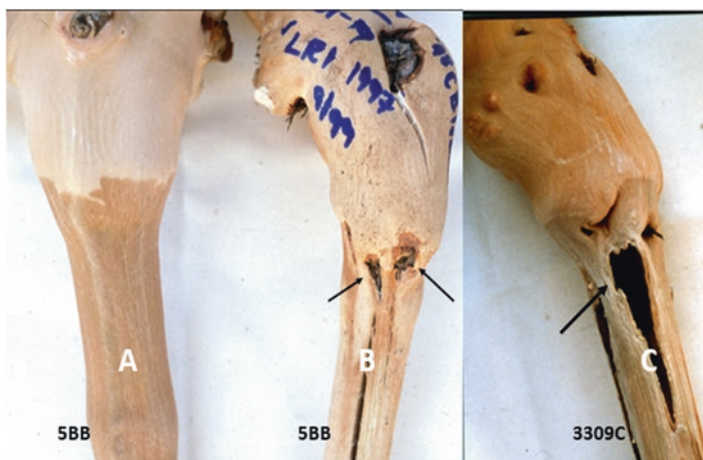

Fig. 13.1 Wood marking symptoms of GLRaV-2RG strain on Cabernet Sauvignon on rootstocks Kober 5BB (5BB) (B) and 3309 Couderc (3309C) (C) compared to a healthy Cabernet Sauvignon on Kober 5BB (A). Necrotic lesions (B) and extensive wood necrosis (C) are shown by arrows

own-rooted Redglobe controls, and those grafts onto 1103 Paulsen or 101–14 Mgt (*V. riparia* x *V. rupestris*) rootstocks showed no such symptoms. The inoculum from the Redglobe plants induced similar symptoms on Cabernet Sauvignon grafts across the same sets of rootstocks (Uyemoto et al. 2000, 2001). Bioassay analysis of the Redglobe source plants on *V. vinifera* cv Cabernet Franc did not reveal the presence of leafroll viruses or other viral pathogens (authors, unpublished data).

Analysis of these declining vines eventually revealed the presence of a novel agent tentatively named Grapevine rootstock stem lesion-associated virus (Rowhani et al. 2000; Uyemoto and Rowhani 2003). Later, sequence determination identified this as a strain of GLRaV-2. It showed 71–79% nucleotide sequence identity with known GLRaV-2 strains (Alkowni et al. 2011). The novel strain was eventually named Redglobe (RG) strain, GLRaV-2RG (Alkowni et al. 2011; Meng et al. 2005). As opposed to other strains of GLRaV-2, the RG strain was non-sap transmissible to herbaceous hosts (Alkowni et al. 2011). GLRaV-2RG did not induce leafroll symptoms on standard leafroll indicators such as Cabernet Franc or Cabernet Sauvignon (authors, unpublished data). Nonetheless, strain RG cross-reacted serologically with other GLRaV-2 strains (Alkowni et al. 2011).

Plants showing Redglobe vine decline, along with asymptomatic controls on non-inducing rootstocks, were screened by RT-PCR for a panel of viruses including GVB, GLRaV-2, strains of GRSPaV, and GLRaV-2RG. The appearance of the vine decline correlated with the presence of GLRaV-2RG (Rowhani et al. 2000).

Strain RG is widespread in wine and table grapes beyond cultivar Redglobe. In a survey of 380 accessions of table and wine grape cultivars by ELISA and RT-PCR, GLRaV-2RG was identified in *V. vinifera* cvs Italia, Crimson, Autumn Royal, and Leopoldo III (Angelini et al. 2003). GLRaV-2RG was also identified in cvs Pinot noir, Chardonnay, and Kashishi in the Pacific Northwest (Jarugula et al. 2010). Declining young vines in New Zealand vineyards hosted a strain of GLRaV-2 closely related to strain RG (Bonfiglioli et al. 2003). Diseased vines occurred with Merlot clone 481 propagated onto 3306 Couderc (*V. riparia* x *V. rupestris*). The initially observed disease symptom was red canopies in first- and second-leaf vineyards.

Strains of GLRaV-2 vary widely in nucleotide sequence and pathogenicity. An analysis of the genetic variability of 78 isolates based on the sequences of the heat shock protein 70 homolog gene and the coat protein gene revealed five (Bertazzon et al. 2010) or six (Jarugula et al. 2010) GLRaV-2 clades. A link between vine decline of test plants infected with different GLRaV-2 sources and grafts onto Kober 5BB, 5C Teleki, 1103 Paulsen, 1616 Couderc (*V. solonis* x *V. riparia*), and 3309 Couderc revealed that the hypersensitivity determinants were derived from *V. riparia* and *V. berlandieri* material. Vine mortality was highest on Kober 5BB and lowest on 5C Teleki and 1103 Paulsen. Graft incompatibility was associated with GLRaV-2 genetic variants of clades RG and PN (Uyemoto et al. 2001).

Argentina's transition from an industry growing own-rooted vines to vineyards propagated with grafted vines resulted in increased viral-associated decline problems (Gomez-Talquenca et al. 2003). The major problem involved several clonal selections of Cabernet Sauvignon grafted on 3309 Couderc, 1103 Paulsen, 101–14 Mtg (*V. riparia* x *V. rupestris*), or Kober 5BB. Significant numbers of vines showed leafroll symptoms in their third year after planting; in the following spring, most of these vines did not sprout or their growth was slow and delayed; other vines died that summer. All the symptomatic plants grafted on 3309 Couderc, 1103 Paulsen, and 101–14 Mtg tested positive for GLRaV-2; one sample from a declining vine on Kober 5BB tested positive for GLRaV-2RG. Detailed information on GLRaV-2 is the subject of Chap. 7 in this volume.

B: Young Vine Failures with Which Combinations of GLRaV-2 Plus GVB Were Associated

Viruses that are latent in certain host backgrounds have been identified in declining vines (Golino et al. 2000a, b). For example, inoculations from field collections of viral isolates from asymptomatic vines have had profound effects on the growth of Freedom (1613 Couderc open pollination (OP) seedlings x *V. champinii* OP seedling) rootstock. A total of 36 different grape accessions collected from commercial vineyards exhibited young vine decline on Freedom; all but one contained both GLRaV-2 and GVB (Golino et al. 2003). Accessions containing only one of these two viruses were not associated with young vine decline (Golino et al. 2000a). Young vine decline arising from inoculation with a combination of GLRaV-2 and GVB was termed “virus-induced rootstock decline (VIRD).” The severity of the disease correlated with Freedom and Harmony (1613 Couderc OP seedlings x *V. champinii* OP seedlings) rootstocks. Couderc 1613 is resistant to VIRD, while AXR-1 (*V. vinifera* x *V. rupestris*) and St. George (*V. rupestris*) are tolerant (Golino 1993, 2003). The combination of viruses was latent on own-rooted *V. vinifera* cultivars.

The rootstock genotype appeared to modulate virus disease expression (Golino et al. 2000b). When Cabernet Sauvignon infected with GLRaV-2 and GVB was grafted onto AXR-1 or to *V. rupestris* St. George, the plants maintained their vigor under the virus challenge. But the same scion sources grafted onto Freedom, Kober 5BB, or 3309 Couderc failed. Scions grafted on 1103 Paulsen and 5C Teleki were intermediate in response to virus challenge. A combination of GLRaV-2 plus GVB may have been involved in graft incompatibility seen in some SO4 rooted test plants (Monis and Bestwick 1997).

C: Young Vine Failures with Which Combinations of GLRaV-1 Plus GVA Were Associated

In other trials, a source designated UC-LR1 that carried GLRaV-1 plus GVA was tested across a rootstock panel. Grafts of UC-LR1 showed symptoms of graft incompatibility in test plants grafted on 3309 Couderc, 101–14 Mtg, and Freedom (Uyemoto and Rowhani 2003).

A similar situation with young vine decline was observed when *V. vinifera* cv. Cabernet Franc plants on nine different rootstocks were inoculated with GLRaV-1 and *Grapevine virus A* (GVA) from the source cultivar *V. vinifera* cv Maduar, by chip-bud grafts. The plants on rootstocks 420A Mgt (*V. berlandieri* x *V. riparia*), Freedom, 3309 Couderc, and 101–14 Mtg were stunted, showed red leaf symptoms, and declined 1–2 years post-inoculation (Golino et al. 2015). Inspection of the woody cylinder of the rootstock showed dead tissues (Fig. 13.2). Control plants on rootstocks that did not produce vine decline showed only the typical symptoms associated with leafroll disease (Golino et al. 2015).

Scattered reports of possible interactions among leafroll viruses and vitiviruses in grafted vines have arisen elsewhere. Co-occurrence of two viruses has been suggested to increase pathological effects, particularly on certain rootstocks (Credi and Babini 1997; Fortusimi et al. 1997; Hommay et al. 2008; Komar et al. 2007, 2010; Le Maguet et al. 2012; Mannini et al. 2003; Santini et al. 2011). However, specific mechanisms for the proposed interactions have yet to be determined.

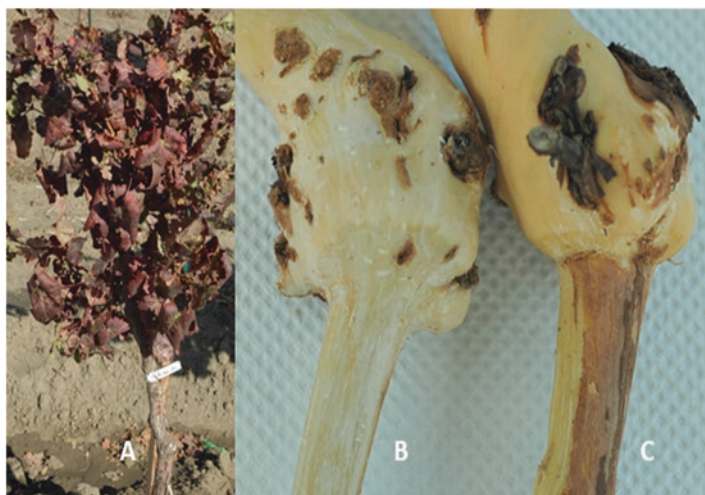

Fig. 13.2 Effects of GLRaV-1 and GVA on 3309 Couderc. (A) Solid red canopy symptoms of a 3-year-old Cabernet Franc vine on 3309 Couderc rootstock inoculated from a Maduar plant source and woody cylinder from (B) a healthy and (C) an infected rootstock showing dead wood tissue on half of the cylinder

Young Vine Failures for Which Etiological Agents Remain Uncharacterized

A: 110R Necrotic Union

In a survey in California, approximately 2% of the mature grapevines in several vineyards of Pinot noir clones 02A, 667, 777, or UCD 04 grafted on rootstock 110 Richter (*V. berlandieri* x *V. rupestris*) were found to show solid red canopies that developed on robust-canopied (the acute disease stage) or weak-canopied (chronic stage) grapevines (Al Rwahnih et al. 2012). Scion trunk girths of these red-leaved grapevines were larger in comparison to those of subtending rootstocks, revealing scion overgrowth immediately above the scion-rootstock junction. The trunk-union sections of diseased but not of healthy grapevines showed necrotic tissues at the scion-rootstock junction (Fig. 13.3) from which the name “grapevine necrotic union (GNU)” was derived (Al Rwahnih et al. 2012). Bench grafting tests with dormant Pinot noir and Chardonnay canes grafted to rootstock 110 Richter reproduced the necrotic union disease symptoms (in less than 5% of the grafted test plants).

Evidence of secondary spread of the necrotic-union causal agent was found. Over a 6-year vineyard survey, the incidence of GNU disease increased from 2.1% up to 21.9% suggesting the vector transmission in the field (Al Rwahnih et al. 2012). Annual surveys revealed that grapevines scored previously as symptomless had developed acute disease symptoms (robust red canopies and normal-sized grape

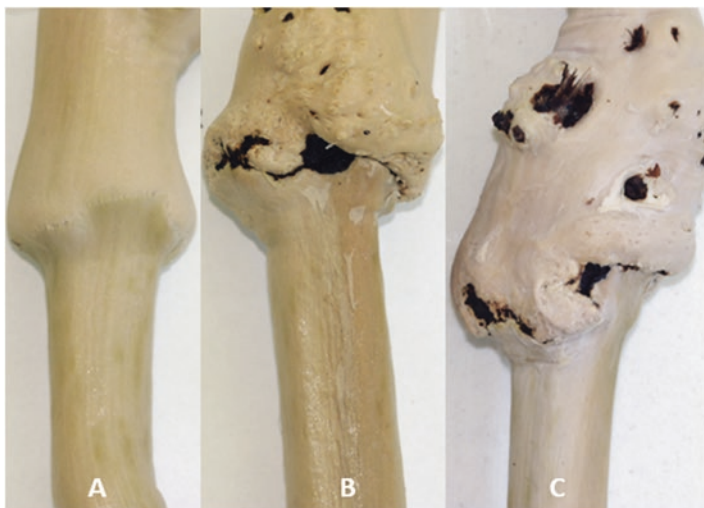

Fig. 13.3 Symptoms of grapevine necrotic union on Pinot noir clone 2A grafted on 110 Richter. (A) Woody cylinder showing graft union of healthy trunk with green vine canopy, (B) necrotic graft union which completely encircled the union with red vine canopy and (C) partial (approximately 50%) necrotic graft union with green vine canopy

clusters) over the course of one growing season. In the subsequent season, these “acute” symptomatic grapevines produced stunted, weak shoot growth and straggly fruit clusters (chronic disease stage; Al Rwahnih et al. 2012).

B: 3309C Stem Necrosis-Distortion

Along with grapevine necrotic union, many other vine decline problems in commercial vineyards are of unknown cause. Some of them have been attributed to virus infections, due to their symptoms that are similar to those seen in instances of graft incompatibility. An example is the decline of Pinot noir clone 23 (PN23) grafted onto rootstock 3309 Couderc (Lima et al. 2009).

Pinot noir has shown young vine decline in various vineyards in California. The affected plants exhibit severe stunting, red canopy, poor shoot and berry development, and rootstocks with severe necrosis and distortion of the woody cylinder (Fig. 13.4). However, efforts to graft-transmit the causal agent have failed. Double-stranded RNA (dsRNA) extracts from symptomatic PN23 plants revealed bands in gel electrophoresis 8.7 kbp in size (Lima et al. 2009). The dsRNA was used as template for sequencing, and a cDNA library was constructed. The sequences showed similarity with the GRSPaV sequence. A full genome of 8,724 nt (excluding the poly A tail) had 76–78% sequence identity with GRSPaV sequences in the GenBank. This virus was designated as GRSPaV strain PN (GRSPaV-PN). More



Fig. 13.4 Symptoms of 3309 Couderc stem necrosis-distortion on five trunk specimens. Pinot noir 23 scion (healthy looking stems) on 3309 Couderc rootstock (with stem necrosis-distortion). Healthy trunk not included

work is needed to determine if GRSPaV-PN has a role in the decline of Pinot noir grapevine. It is noteworthy that in several disease sites where affected vines have been replaced with clean planting stocks, vineyards become cured. This suggests the causal agent was removed and had no general latency in the area.

C: Syrah Decline

Syrah decline was first reported on grafted vines in Southern France in the 1990s. The symptoms included swelling at the graft union with deep bark cracks and stem grooves (Renault-Spilmont et al. 2003). Removal of the bark revealed the depth of these parallel grooves. The affected vines showed premature discoloration of the leaves during spring, turning red in the fall. Vines exhibiting swollen trunks and stem grooves have survived for many years. However, vines developing trunk symptoms and red canopies succumb within 3 years (reddening of leaves is a response to girdling and is proportional to the severity of trunk symptoms). Syrah decline is distributed in vineyards worldwide, reported in France (Renault-Spilmont et al. 2003), the USA (Battany et al. 2004), Australia (Habibi et al. 2006), Spain (Gramaje et al. 2009), Italy (Bianco et al. 2009), and Canada (Xiao et al. 2015).

Symptoms of Syrah decline have been seen to vary depending on geographic region. In California, symptoms include swollen, deformed graft unions, deep bark cracks, and ultimately vine death. Bark removal from autoclaved trunk sections exposed necrotic tissues and deep cracks on the woody cylinders beginning upward up to 2–4 cm from graft union (Fig. 13.5). Stem pits occasionally developed

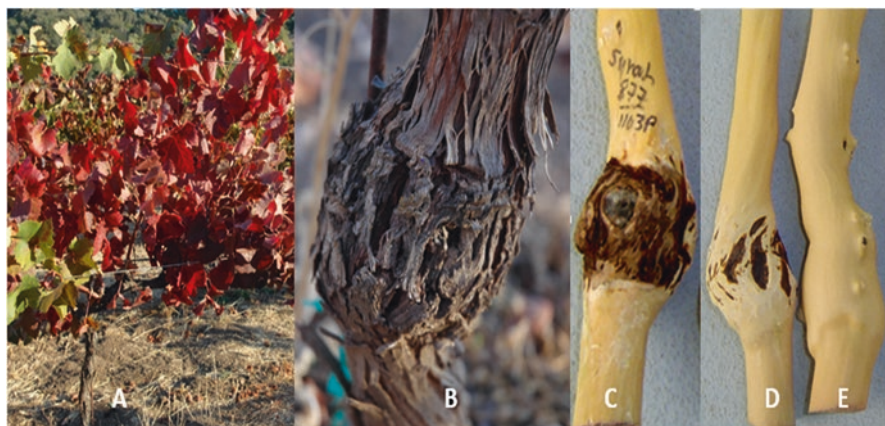

Fig. 13.5 Syrah decline symptoms from Syrah clone 877 propagated on 1103 Paulsen. (A) Solid red canopy, (B) swelling and deep crack around the graft union, (C) extensive wood necrosis and grooving above the graft union, (D) deep grooving and necrosis above the graft union, and (E) healthy control

immediately above necrotic tissues (Battany 2007; authors of this chapter, unpublished). The infected plants also developed red leaves mid- to late summer.

Different Syrah clones have shown different sensitivities to Syrah decline disorder. An experiment with 16 different Syrah ENTAV-INRA® clones (Beuve et al. 2013) produced disease showing three categories of sensitivity. From the 16 clones, four were categorized as poorly sensitive (swelling and cracking at the graft union with green canopy), five as moderately sensitive (swelling and cracking at the graft union with red canopy), and seven as highly sensitive (rapidly dying). The rootstocks 110 Richter and 99 Richter were most sensitive to the decline, and growers of Syrah were advised to avoid using them (Grenan et al. 2007; Renault-Spilmont et al. 2007, 2010).

In efforts to identify the causal agent of Syrah decline disorder in 16 certified and six noncertified ENTAV-INRA® clones, 17 viruses were surveyed by RT-PCR and six by ELISA (Beuve et al. 2013). GRSPaV was found to be present in all the clones; Grapevine Syrah virus-1 (GSyV-1) in 50% of them. These data were insufficient to suggest the involvement of any variant of GRSPaV in Syrah decline syndrome. In another study, GRSPaV was isolated from a Syrah clone exhibiting Syrah decline (Lima et al. 2006). Sequence analysis of the genome of this Syrah strain (GRSPaV-Sy) showed an overall nucleotide sequence identity of 77% compared with GRSPaV sequences available in databases. Phylogenetic analysis of coat protein and replicase gene sequences showed that GRSPaV-Sy clustered independently from other GRSPaV isolates. In a survey of several California vineyards, 383 randomly selected grapevines, which included 66 symptomatic and four asymptomatic Syrah clones, were assayed by RT-PCR. Positive tests for GRSPaV-Sy were produced from 29 symptomatic plants and one asymptomatic plant (Lima et al. 2006).

In another analysis, five different Syrah clones, one each from the poorly sensitive and the moderately sensitive group from France, along with clones 877, 525, and 99 from California were subjected to high-throughput sequencing (M. Al Rwahnih and A. Rowhani, unpublished data). A mixture of GRSPaV strains RNA was found, with the majority of the reads in each Syrah clone identified with GRSPaV-Sy. Other viruses detected in clones 99 and 877 were *Grapevine rupestris vein feathering virus* (GRVfV) and *Grapevine Redglobe virus* (GRGV).

In further analysis, 31 Syrah grapevine plants belonging to eight different clones (four were scored poorly sensitive and four highly sensitive) were analyzed for the presence of different GRSPaV genetic variants analyzed across the span of a 380 nucleotide-long sequence within the CP gene (Beuve et al. 2013). GRSPaV infections could be grouped into four sequence variants with 66% of the infections belonging to variant group 1 (group Sy), 11% to group 2a (group SG1), 21% to group 2b (group 1), and 2% to group 3 (group BS). Moreover, 8 of 15 plants from a highly susceptible clone were infected with only one GRSPaV variant, including seven that were infected only with GRSPaV strain Sy. This investigation did not conclusively identify any of the GRSPaV variants specifically with Syrah decline symptoms.

Diseases resembling Syrah decline have also been reported from Australia (Habibi et al. 2006). A vineyard in South Australia planted with Shiraz (syn. Syrah)

vines propagated on 1103 Paulsen developed swollen graft unions, rootstock pitting, leaf reddening, and vine decline. RT-PCR analysis using coat protein gene-specific primers (general GRSPaV detection primers) detected GRSPaV in all tested plants (symptomatic and asymptomatic plants). Primers designed against a GRSPaV-Sy replicase gene sequence detected GRSPaV-Sy only in symptomatic vines.

An association of viroids with Syrah decline was investigated (Renault-Spilmont et al. 2009), but results were inconclusive. Fungal pathogens were considered as potential factors associated with Syrah decline, but no conclusive evidence for their involvement was found (Gramaje et al. 2009). In addition, the role of herbicides in developing Syrah decline was also investigated (Uyemoto and Steenwerth 2007; Steenwerth et al. 2007), but the etiology of Syrah decline remains elusive.

Conclusion

An own-rooted grapevine that responds to a field virus infection with a hypersensitive response will appear healthy. Vector borne inoculation to that host will result in an undetected microlesion, in which the infected cell and the cells immediately around it die. No further symptoms result. However, when that grapevine is grafted to a rootstock and exposed through the entire width of a graft union to a high titer but asymptomatic virus infection coming through the vasculature, then the hypersensitive response is made apparent as necrosis across and below the union.

Virus-induced vine decline results from such graft-union disease. The differential response of scion vs. rootstock materials leads to vascular failure in the stem. Graft incompatibility vine decline may serve as a bioassay. It often presents the first evidence that scion material is infected with a virus that it tolerates with no symptomatic consequences but to which the rootstock is strongly resistant.

This information on vine decline can lead us to appreciate the potential of seeming inconsequential infections. The contribution of cultivar genotypes can lead to major differences in disease presentation from any given viral pathovar. We gain an appreciation of these factors from our analysis of vine decline incompatibility.

References

- Al Rwahnih, M., A. Rowhani, R.J. Smith, J.K. Uyemoto, and M.R. Sudarshana. 2012. Grapevine necrotic union, a newly recognized disease of unknown etiology in grapevines grafted on 110 Richter rootstock in California. *Journal of Plant Pathology* 94: 149–156.
- Alkowni, R., Y.P. Zhang, A. Rowhani, J. Uyemoto, and A. Minafra. 2011. Biological, molecular, and serological studies of a novel strain of *Grapevine leafroll-associated virus 2*. *Virus Genes* 43: 102–110.
- Angelini, E., N. Bertazzon, and M. Borgo. 2003. Occurrence of the Redglobe strain of Grapevine leafroll-associated virus 2 in table and wine grape in Italy. *Vitis* 42: 203–204.

- Battany, M. 2007. A brief summary of Syrah disorder/decline on the California Central Coast. In *Proceedings of the Syrah vine health symposium, University of California, Agriculture and Natural Resource*. Nov. 6, 3–4.
- Battany, M., A. Rowhani, and D. Golino. 2004. Syrah in California, decline or disorder. *Practical Wine and Vineyard* 26: 20–35.
- Bertazzon, N., M. Borgo, S. Vanin, and E. Angelini. 2010. Genetic variability and pathological properties of Grapevine leafroll-associated virus 2 isolates. *European Journal of Plant Pathology* 127: 185–197.
- Beuve, M., B. Moury, A.S. Renault-Spilmont, L. Sempe-Ignatovic, C. Hemmer, and O. Lemaire. 2013. Viral sanitary status of declining grapevine Syrah clones and genetic diversity of *Grapevine rupestris stem pitting-associated virus*. *European Journal of Plant Pathology* 135: 439–452.
- Bianco, P.A., A. Zorloni, C. De Biasi, and G. Belli. 2009. Preliminary investigation on a Syrah decline in Central Italy. In *Proceedings of the 16th International Congress on Virus and Virus-Like Diseases of Grapevine, Dijon, France*, 348–349.
- Bonfiglioli, R., F. Edwards, and A. Pantaleo. 2003. *Proceedings of the 14th International Congress on Virus and Virus-Like Diseases of Grapevine, Locorotondo, Italy*, 141.
- Credi, R., and R. Babini. 1997. Effects of virus and virus-like infections on growth, yield, and fruit quality of Albana and Trebbiano Romagnolo grapevines. *American Journal of Enology and Viticulture* 48: 7–12.
- Fortusimi, A., G. Scattini, S. Prati, S. Cinquanta, and G. Belli. 1997. Transmission of Grapevine leafroll associated virus -1 and Grapevine virus A by scale insects. In *Proc. 12th meeting of the Congress of the International Council for the Study of Virus and Virus-like Diseases of the Grapevine, Lisbon*, 121–122.
- Galet, P. 1979. *A practical ampelography: Grapevine identification*. Ithaca: Comstock Publishing Associates, a division of Cornell University Press.
- Garau, R., V.A. Porta, D. Boscia, R. Piredda, and U. Porta. 1993. Studies on grapevine virus B isolates from corky bark-affected vines in Sardinia. *Rivista di Patologia Vegetale* 3: 83–89.
- Golino, D.A. 1993. Potential interactions between rootstocks and grapevine latent viruses. *American Journal of Enology and Viticulture* 44: 148–152.
- . 2003. Emerging grapevine diseases. In *Proceedings of the 14th International Congress on Virus and Virus-Like Diseases of Grapevine, Locorotondo, Italy*, 136–138.
- Golino, D., S. Sim, and A. Rowhani. 2000a. Identification of the latent viruses associated with young vine decline in California. In *Proceedings of the 13th International Congress on Virus and Virus-Like Diseases of Grapevine, Adelaide, Australia*, 85–86.
- . 2000b. The role of GLRaV-2 and GVB in virus-induced rootstock decline in California grapevines. *Phytopathology* 90: S28. (Supplement).
- Golino, D.A., S.T. Sim, and A. Rowhani. 2003. The role of rootstock genotype in the effect of single and mixed infections of grapevine viruses. In *Proceedings of the 14th International Congress on Virus and Virus-Like Diseases of Grapevine, Locorotondo, Italy*, 246–247.
- Golino, D.A., A. Rowhani, V. Klaassen, S.T. Sim, and M. Al Rwahnih. 2015. Grapevine leafroll associated virus 1 effects on different grapevine rootstocks. In *Proceedings of the 18th International Congress on Virus and Virus-Like Diseases of Grapevine, Ankara, Turkey*.
- Gomez Talquenca, G.S., O. Gracia, S. Garcia Lampasona, and O. Grau. 2003. *Proceedings of the 14th International Congress on Virus and Virus-Like Diseases of Grapevine, Locorotondo, Italy*, 146.
- Gramaje, D., R.M. Munoz, M.L. Lerma, J. Garcia-Jimenez, and J. Armengol. 2009. Fungal grapevine trunk pathogens associated with Syrah decline in Spain. *Phytopathologia Mediterranea* 48: 396–402.
- Greif, C., R. Garau, D. Boscia, V.A. Protá, M. Fiori, P. Bass, B. Walter, and U. Protá. 1995. The relationship of grapevine leafroll-associated closterovirus 2 with a graft incompatibility condition of grapevines. *Phytopathologia Mediterranea* 34: 167–173.

- Grenan, S., A.S. Renault-Spilmont, and J.M. Boursiquot. 2007. Syrah decline in France: Historical background and first approaches. In *Proceedings of the Syrah Vine Health Symposium, University of California, Agriculture and Natural Resource*. Nov. 6, 53–54.
- Habili, N., N. Farrokhi, F.M. Lima, P. Nicholas, and J.W. Randles. 2006. Distribution of Rupestris stem pitting-associated virus variants in two Australian vineyards showing different symptoms. *Annals of Applied Biology* 148: 91–96.
- Holmes, F.O. 1929. Local lesions in tobacco mosaic. *Botanical Gazette* 87: 39–55.
- Hommay, G., V. Komar, O. Lemaire, and E. Herrbach. 2008. Grapevine virus A transmission by larvae of *Parthenolecanium corni*. *European Journal of Plant Pathology* 121: 185–188.
- Jarugula, S., O.J. Alabi, R.R. Martin, and N.A. Rayapati. 2010. Genetic variability of natural populations of Grapevine leafroll-associated virus 2 in Pacific Northwest vineyards. *Phytopathology* 100: 698–707.
- Komar, V., E. Vigne, G. Demangeat, and M. Fuchs. 2007. Beneficial effect of selective virus elimination on the performance of *Vitis vinifera* cv. Chardonnay. *American Journal of Enology and Viticulture* 58: 202–210.
- Komar, V., E. Vigne, G. Demangeat, O. Lemaire, and M. Fuchs. 2010. Comparative performance of virus-infected *Vitis vinifera* cv. Savagnin rose grafted onto three rootstocks. *American Journal of Enology and Viticulture* 61: 68–73.
- Le Maguet, J., M. Beuve, E. Herrbach, and O. Lemaire. 2012. Transmission of six ampeloviruses and two vitiviruses to grapevine by *Phenacoccus aceris*. *Phytopathology* 102: 717–723.
- Lima, M.F., R. Alkowni, J.K. Uyemoto, D. Golino, F. Osman, and A. Rowhani. 2006. Molecular analysis of a California strain of Rupestris stem pitting associated virus isolated from declining Syrah grapevines. *Archives of Virology* 151: 1889–1894.
- Lima, M.F., R. Alkowni, J.K. Uyemoto, and A. Rowhani. 2009. Genomic study and detection of a new variant of *Grapevine rupestris stem pitting associated virus* in declining California Pinot noir grapevines. *Journal of Plant Pathology* 91: 153–160.
- Mannini, F., L. Rolle, and S. Guidoni. 2003. Vineyard management to optimized grape quality in virus-free clones of *Vitis vinifera* L. *Acta Horticulturae* 603: 121–126.
- Meng, B., C. Li, D.E. Goszczynski, and D. Gonsalves. 2005. Genome sequences and structures of two biologically distinct strains of *Grapevine leafroll-associated virus 2* and sequence analysis. *Virus Genes* 31: 31–41.
- Monis, J., and R.K. Bestwick. 1997. Serological detection of grapevine-associated closteroviruses in infected grapevine cultivars. *Plant Disease* 81: 802–808.
- Pongracz, D.P. 1983. *Rootstocks for grapevines*. Capetown: David Philip Publishing.
- Renault-Spilmont, A.S., S. Grenan, and J.M. Boursiquot. 2003. Syrah decline in French vineyards. In *Proceedings of the 14th International Congress on Virus and Virus-Like Diseases of Grapevine, Locorotondo, Italy*, 144.
- . 2007. Syrah decline in French vineyards: Rootstocks and Syrah clone impact, pathological and genetic studies. In *Proceedings of the Syrah Vine Health Symposium, University of California, Agriculture and Natural Resource*. Nov. 6, 5–7.
- Renault-Spilmont, A.S., L. Bernard, P. Serra, and N. Duran-Vila. 2009. Syrah decline: No evidence for viroid etiology. In *Proceedings of the 16th International Congress on Virus and Virus-Like Diseases of Grapevine, Dijon, France*, 352–353.
- Renault-Spilmont, A.S., Y. Moreno, and L. Audeguin. 2010. Syrah decline: Similar symptoms on own-rooted plants. *Progress in Agriculture and Viticulture* 127: 63–67.
- Rowhani, A., Y.P. Zhang, D.A. Golino, and J.K. Uyemoto. 2000. Isolation and partial characterization of two new viruses from grapevine. In *Proceedings of the 13th International Congress on Virus and Virus-Like Diseases of Grapevine, Adelaide, Australia*, 82.
- Santini, D., A. Mollo, D. Pacifico, E. Borgogno, and F. Mannini. 2011. Ecophysiological and agronomic response of two ‘Nebbiolo’ clones to different leafroll virus infection. *South African Journal of Enology and Viticulture* 32: 183–189.

- Steenwerth, K., R.J. Smith, J. Roncoroni, M. Battany, and J.K. Uyemoto. 2007. *Proceedings of the Syrah Vine Health Symposium, University of California, Agriculture and Natural Resource*. Nov. 6, 19–20.
- Uyemoto, J.K., and A. Rowhani. 2003. Discovery of different grapevine sources with graft-transmissible agents causing union-incompatibility on sensitive rootstocks. In *Proceedings of the 14th International Congress on Virus and Virus-Like Diseases of Grapevines, Locorotondo, Italy*, 139–141.
- Uyemoto, J.K., and K. Steenwerth. 2007. Red leaf grapevines: Diagnosis of putative causes based on type of stem marking (includes comments Syrah red leaf-necrotic stem). In *Proceedings of the Syrah vine health symposium, University of California, Agriculture and Natural Resource*. Nov. 6, 17–18.
- Uyemoto, J.K., A. Rowhani, and D. Luvisi. 2000. An association of rootstock stem lesions in *Vitis* species and different graft-transmissible agents. In *Proceedings of the 13th International Congress on Virus and Virus-Like Diseases of Grapevine, Adelaide, Australia*, 83–84.
- Uyemoto, J.K., A. Rowhani, D. Luvisi, and C.R. Krag. 2001. New closterovirus in “Redglobe” grape causes decline of grafted plants. *California Agriculture* 55: 28–31.
- Xiao, H., J. Hooker, C. Li, and B. Meng. 2015. Syrah decline in Ontario vineyards. In *Proceedings of the 18th International Congress on Virus and Virus-Like Diseases of Grapevine, Ankara, Turkey*, 80–82.

Chapter 14

Grapevine Red Blotch: Molecular Biology of the Virus and Management of the Disease

E. Cieniewicz, K. Perry, and M. Fuchs

Abstract Red blotch is a recently recognized disease of grapevine for which the graft-transmissible grapevine red blotch-associated virus (GRBaV), a proposed member of a new genus within the family *Geminiviridae*, is the causal agent. The virus affects fruit quality, delays ripening, and probably reduces yield and vigor. Estimated economic losses range from \$2,213 to \$68,548 per hectare over a 25-year productive life span of a vineyard. The genome of GRBaV is circular and consists of a single molecule of single-stranded DNA with seven predicted open reading frames. Foliar symptoms consist of red blotches that expand and coalesce in late summer and fall and irregular chlorotic areas that become necrotic later in the season in red-berried and white-berried *Vitis vinifera* cultivars, respectively. Visual diagnosis is often unreliable due to several confounding abiotic and biotic factors, including similarities with leafroll disease symptoms; therefore, PCR-based assays are recommended for an accurate diagnosis. Although red blotch disease was only recognized in 2008, GRBaV was detected in archival grapevine leaves sampled in 1940 in California and kept in a herbarium collection, suggesting the virus was present in vineyards more than 70 years prior to its identification. Surveys of vineyards revealed the occurrence of GRBaV in some of the major grape-growing regions in the USA and Canada. Outside of North America, the virus was found so far in Switzerland in material introduced from the USA and in South Korea. An early account of the Virginia creeper leafhopper as a vector of GRBaV was not confirmed; instead, the three-cornered alfalfa treehopper was shown to be a likely vector of epidemiological significance. Disease management strategies almost exclusively rely on roguing and replacing vineyards using planting material derived from clean, virus-tested stocks. Advancing our understanding of disease epidemiology and viral gene expression are important future research topics for red blotch disease and GRBaV.

E. Cieniewicz • M. Fuchs (✉)

Section of Plant Pathology and Plant-Microbe Biology, School of Integrative Plant Science, New York State Agricultural Experiment Station, Cornell University, Geneva, NY, USA
e-mail: marc.fuchs@cornell.edu

K. Perry

Section of Plant Pathology and Plant-Microbe Biology, School of Integrative Plant Science, Cornell University, 334 Plant Science, Ithaca, NY 14853, USA

Keywords Red blotch • *Geminiviridae* • Grapevine red blotch-associated virus • Etiology • Epidemiology • Management

Introduction

Red blotch is a relatively recently recognized viral disease of grapevine. It was first described in a Cabernet Sauvignon vineyard at a Research Station of the University of California-Davis in Oakville, California (Calvi 2011). Symptoms of diseased vines were similar to leafroll disease symptoms but none of the diagnostic tools available for leafroll viruses would detect a virus. Concomitantly, several laboratories were handling material exhibiting leafroll-like symptoms for which the etiology was elusive, as all of them would test negative for the five known leafroll-associated viruses. Most of these vines were found later to be infected by the causal agent of red blotch disease after the virus was discovered and specific diagnostic tools were developed.

Research efforts at Cornell University (Krenz et al. 2012) and UC-Davis (Al Rwahnih et al. 2013) led to the identification and characterization of grapevine red blotch associated virus (GRBaV) in vines affected by red blotch disease. Subsequently, other groups described the same virus although it was initially named Cabernet franc-associated virus (Krenz et al. 2012), Grapevine redleaf-associated virus (Poojari et al. 2013), and Grapevine geminivirus (Seguin et al. 2014). Based on the characteristic symptoms initially observed on diseased vines, the name grapevine red blotch-associated virus was retained and adopted by the grape virology community (Sudarshana et al. 2015).

The objectives of this chapter are to provide an overview of our current knowledge of the biology and ecology of red blotch disease and to offer perspectives for future research.

Disease Symptoms and Economic Impact

Red blotch disease symptoms consist of foliar and fruit symptoms. Foliar symptoms first appear on older leaves at the base of the canopy in late spring to early summer. Symptoms are initially seen on older leaves (Fig. 14.1a) and progressively observed toward the top of the canopy in late summer and fall. In red-berried cultivars, red blotches are observed early in the growing season; these typically coalesce with most of the leaf blade becoming red later in the season (Fig. 14.1b). Shades of red vary from crimson to purple. Heavily symptomatic leaves often drop off prematurely late in the season. In white-berried cultivars, foliar symptoms consist of chlorotic areas that can become necrotic later in the season (Fig. 14.1c). On fruits, delays in ripening; altered fruit juice chemistry indices, particularly of total soluble solids



Fig. 14.1 Foliar symptoms of red blotch (a) at the bottom of the canopy of a diseased (*left*) compared to a healthy (*right*) Cabernet franc, close-up of foliar symptoms on (b) Cabernet franc and (c) Chardonnay, and d) fruit symptoms on a diseased (*left*) compared to a healthy (*right*) Pinot noir

(-1° to -4° Brix); and lower anthocyanin contents in berry skin (Fig. 14.1d) are characteristics of red blotch disease.

The severity of symptoms and their onset vary with cultivar, vineyard location, and growing season. In addition, a visual diagnosis can be challenging due to similarities of foliar and fruit symptoms between red blotch and leafroll diseases. Similarities exist also between red blotch symptoms in red-berried cultivars and those caused by other biotic factors such as Pierce's disease, crown gall, and mite damage and abiotic factors such as poor root health, shoot girdling due to insect damage, and trunk injury. Red blotch symptoms are also similar to symptoms elicited by nutrient deficiencies such as magnesium or potassium deficiency. These numerous confounding factors and the variation in symptom expression make a visual diagnosis of red blotch disease difficult; only PCR-based assays are reliable for an accurate diagnosis.

The economic cost of red blotch is estimated to range from \$2,213 to \$68,548 per hectare over a 25-year productive life span of Cabernet Sauvignon and Merlot vineyards, depending on the level of initial infection and price penalty for suboptimal fruit quality (Ricketts et al. 2016). These estimates are more or less within the range previously determined for leafroll disease in Cabernet Sauvignon in California and New York (\$25,000–\$226,405) (Atallah et al. 2012; Ricketts et al. 2015). The lower cost estimates for red blotch compared to leafroll are likely due to the limited information currently available on the effect of red blotch on fruit yield and on the rate of

spread in vineyards. Therefore, an intrinsic lower impact of red blotch compared to leafroll should not be assumed. Studies on the impact of GRBaV on vigor and yield are underway, as are epidemiological studies. This research will be important to improve estimates of loss due to red blotch.

The Virus Genome Structure and Genetic Variability

GRBaV is a monopartite gemini-like virus with a genome of one single-stranded circular DNA element (Fig. 14.2). The sequence of the genome has been used to predict encoded proteins and the overall organization of the genome (Al Rwahnih et al. 2013; Krenz et al. 2012, 2014; Poojari et al. 2013). There are six previously reported open reading frames (ORFs), all of which are, in part, overlapping. The circular genome is depicted with a conserved origin of replication at the top, with genome-sense ORFs clockwise to the right (V2, V1, and V3) and the complementary sense ORFs counterclockwise to the left (C1, C2, and C3). A recent analysis of transcription is consistent with the expression of a seventh ORF designated V0 (Perry et al. unpublished). The protein function is only clear for two of the viral products, as deduced from sequence conservation within the family *Geminiviridae*; these are the coat protein encoded by V1 and a replicase expressed from a spliced transcript spanning the C1 (RepA) and C2 ORFs. This gene expression strategy is seen in other members of the family *Geminiviridae*, with the splicing site confirmed in mapped GRBaV transcripts (Krenz et al. 2014). The ORFs V0, V2, and V3 show no sequence similarity to other viral genes but have been hypothesized to play a role in movement. Transient expression studies showed that protein V2 localizes in the

Fig. 14.2 Genome organization of grapevine red blotch-associated virus (GRBaV). The circular single-stranded genome of 3206 nucleotides is diagrammed with *thick arrows* indicating the open reading frames. Additional features are as described in the text

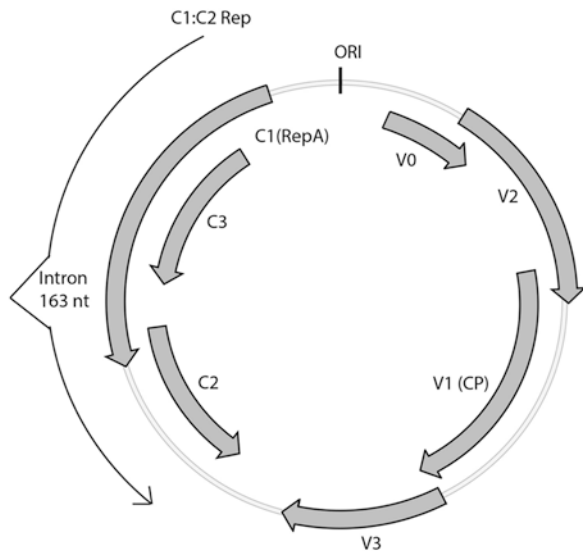

nucleoplasm, Cajal bodies, and cytoplasm when fused to GFP and protein V3 localizes in various unidentified subnuclear bodies when similarly fused to GFP (Guo et al. 2015). It is important to note that outside of the C1:C2 splice site, all other details of gene expression are entirely deduced from sequence analyses, and no encoded proteins have been detected. That said, analysis of sequence and codons in the 23 available GRBaV genomes clearly shows that five of the six ORFs were under strong purifying selection (Perry et al. 2016), from which it can be inferred these proteins are functional and expressed. When first published, the identification and functionality of ORF C3 were uncertain, but surprisingly, this gene is under strong positive selection and is now assumed to play an essential role.

Genetic variability among isolates of GRBaV is sufficient to recognize two distinct clades with nucleotide variation of up to 9% (Krenz et al. 2014). Isolates within clade I show a maximum of 5% sequence heterogeneity, while those within clade II are relatively homogeneous with a 2% or less in nucleotide variation. These levels of variation are consistent with all isolates forming a single species. Phylogenetic analyses further reveal that GRBaV is the type member of a proposed new genus within the family *Geminiviridae* (Varsani et al. 2014). This new genus is tentatively named *Grablovirus*.

Fulfilling Koch's Postulates

To satisfy Koch's postulates, infectious GRBaV clones were engineered from partial dimer constructs of the genome of isolates NY175 and NY358 that belong to phylogenetic clades I and II, respectively (Krenz et al. 2014). These clones were used in agroinoculation experiments using healthy, tissue culture-grown vines of *V. vinifera* cultivars and rootstock genotypes (Fuchs et al. 2015). Constructs of green fluorescent protein (GFP) and the two genomic RNAs of grapevine fanleaf virus (GFLV) were used as negative controls in agroinfiltration experiments.

A number of agroinfiltrated vines of Cabernet Sauvignon, Cabernet franc, Syrah, Pinot noir, Pinot gris, and Chardonnay showed red blotch-like symptoms at 1–3 months posttreatment. Foliar symptoms consisted of interveinal reddening in red-berried cultivars and chlorotic spots in the white-berried cultivar Chardonnay. Unlike wine grape cultivars, agroinoculated rootstock SO4 (*V. berlandieri* × *V. riparia*) became symptomatic (chlorosis and cupping) only after one dormancy period, whereas agroinoculated rootstock 3309C (*V. riparia* × *V. rupestris*) remained asymptomatic (Fuchs et al. 2015). Some of the agroinfiltrated grapevines tested positive for GRBaV by multiplex PCR (Krenz et al. 2014) and all the PCR-positive plants were symptomatic, while the negative plants were asymptomatic. None of the plants treated with GFP and GFLV constructs or untreated plants exhibited red blotch-like symptoms, nor did they test positive for GRBaV in PCR (Fuchs et al. 2015).

After one or two dormancy periods, the full-length genomic sequence of some of the GRBaV progeny was determined in a few selected agroinfected plants by rolling

circle amplification, cloning, and sequencing. The nucleotide sequence of the virus progeny was 99.6–99.9% identical to that of the partial dimer constructs of GRBaV isolates NY175 and NY358 used as inoculum in agroinfection assays, indicating that the recovered GRBaV variants are nearly identical to the engineered inoculum (Fuchs et al. 2015). These findings were consistent with our hypotheses that GRBaV is the causal agent of red blotch disease, satisfying Koch's postulates and demonstrating that GRBaV is the causative agent of red blotch disease (Fuchs et al. 2015).

Recently the three-cornered alfalfa treehopper, *Spissistilus festinus* (Say), was described as a vector of GRBaV (Bahder et al. 2016b). Some healthy Cabernet Sauvignon vines exposed to viruliferous treehoppers became infected and exhibited typical red blotch symptoms. This provided additional evidence that GRBaV is the causative agent of red blotch disease.

Detection and Diagnostics

The diagnostic resources for the detection of GRBaV all rely on amplification of viral DNA sequences by polymerase chain reaction (PCR). Assays were designed as a simplex reaction (Al Rwahnih et al. 2013) or in a multiplex format with two primer pairs and an internal control (Krenz et al. 2014). Quantitative PCR (qPCR) assays are employed in foundation plant programs and by commercial testing services, but thus far there is only one literature report for a qPCR assay (Bahder et al. 2016b). An isothermal amplification technology (recombinase polymerase amplification; Piepenburg et al. 2006) is under commercial development for single-use test kits and has the advantage of detecting virus in crude plant homogenates. In general, false-negative results can be problematic and have been observed for field and greenhouse vines previously shown as infected. Sampling of older symptomatic leaves appears to be more reliable for virus detection, although the viral DNA can be recovered from new growth at the tips of shoots.

The visualization of virions within, or purified from, infected plants has remained elusive, and no electron microscopic images have been obtained. Antibodies were produced against synthetic peptides and bacterially expressed coat protein. These antibodies recognize their cognate antigens, but show no differential reaction when tested against infected and uninfected plant extracts in both western blot assays and in an enzyme-linked immunosorbent assay (K.L. Perry, unpublished). The virus is assumed to be phloem limited and difficult to consistently detect, and it is not clear if antibody-based detection methods will ever be applicable.

Host Range and Geographic Distribution

The cultivated grape *Vitis vinifera* and other *Vitis* spp. are the only reported hosts of GRBaV. Free-living vines were shown to harbor GRBaV (Bahder et al. 2016a; Perry et al. 2016), and some of them were determined to be *V. californica* × *V. vinifera* hybrids (Perry et al. 2016). The virus is widespread throughout some of the major grape growing regions of the USA (Krenz et al. 2014), British Columbia, and Ontario in Canada (Poojari et al. 2016). By contrast, there are very few reports of the virus outside of this region. Five grapevine accessions in a Swiss experimental vineyard harbored GRBaV, and all of these were imported from California (Reynard 2015, 2016). A recent report indicated GRBaV was present in cultivated vines in Korea, but the origin of the vines is not known (Lim et al. 2016). GRBaV was also detected in several table grape accessions established at the USDA-ARS clonal germplasm repository in Winters, California (Al Rwahnih et al. 2015a), and in a few interspecific hybrids at the USDA-ARS cold hardy germplasm repository in Geneva, New York (Perry unpublished). Interestingly, GRBaV was also detected in archival leaf samples of *V. vinifera* cv. Abouriou that were collected in Sonoma County of California in 1940 and kept in a herbarium at UC-Davis (Al Rwahnih et al. 2015b). This finding suggested that the virus was present in vineyards prior to the recognition of the disease in 2008 and prior to the characterization of the virus genome in 2011.

Epidemiology and Transmission

GRBaV is graft-transmissible (Al Rwahnih et al. 2013; Poojari et al. 2013) and was detected in most of the grape-growing regions of the USA, which indicates a high likelihood of dissemination via infected propagation material. On a local scale, clustering of GRBaV-infected vines within healthy vineyards proximal to infected vineyards (Fig. 14.3) and the spatiotemporal increase of infected, symptomatic vines in some vineyards located on the west coast of the USA (Bahder et al. 2016b) implicate an insect vector in the spread of GRBaV. In northeastern USA, there is no evidence that GRBaV is spreading to or within vineyards. Similarly, there is no indication of GRBaV spread in Switzerland (Reynard 2016). Interestingly, GRBaV was detected in some free-living vines in the vicinity of diseased commercial vineyards in California (Bahder et al. 2016a; Perry et al. 2016), further supporting the implication of an insect vector in the spread of GRBaV from cultivated to free-living grapes or vice versa. The role of infected free-living vines as alternate host in disease epidemiology requires further investigation.

Early on, the Virginia creeper leafhopper was reported as a vector of GRBaV in the greenhouse (Poojari et al. 2013), but this result was not confirmed (Bahder et al. 2016b). Instead, the three-cornered alfalfa treehopper, *Spissistilus festinus* (Say) (Fig. 14.4), was shown to transmit GRBaV under greenhouse conditions. Vines of



Fig. 14.3 Aggregation of approximately 20 red blotch diseased vines followed by healthy vines in two adjacent rows of a Cabernet franc vineyard. Please note the changing color of the canopy between diseased and healthy vines

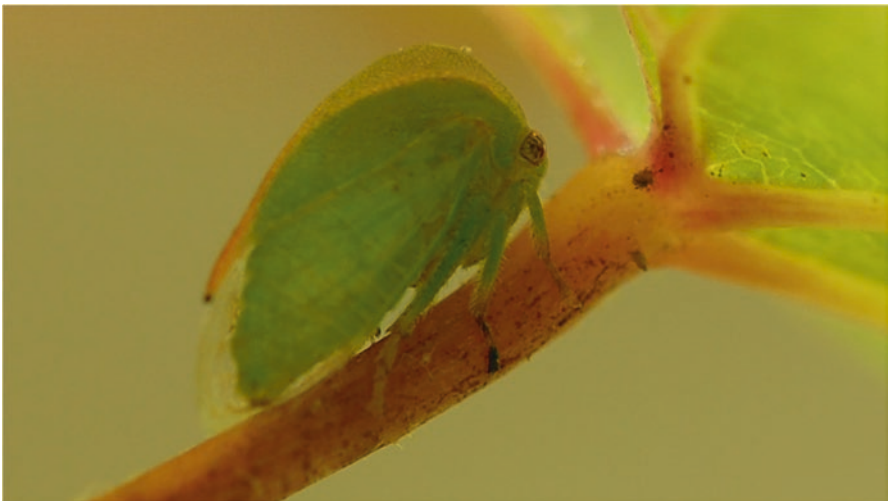

Fig. 14.4 Adult *Spissistilus festinus*, a confirmed vector of GRBaV, resting on a petiole of a *V. vinifera* cv. Cabernet Sauvignon leaf

Fig. 14.5 Girdle damage to a single leaf of a Cabernet Sauvignon shoot, suggestive of *S. festinus* feeding



Vitis vinifera cv. Cabernet Sauvignon exposed to *S. festinus* that fed on GRBaV-infected source material tested positive by digital PCR at 5 months postinoculation. Additionally, some of the exposed vines that tested GRBaV-positive developed foliar symptoms of red blotch disease around 5 months postinoculation (Bahder et al. 2016b).

While *S. festinus* is documented as a vector in the greenhouse, the extent to which it transmits GRBaV in the vineyard is to be determined. This treehopper can cause problems in soybean, peanut, alfalfa, and other legumes in the southern USA, where it undergoes several generations per year and causes girdling damage to its hosts (Mitchell and Newsom 1984). Although a generalist feeder, *S. festinus* is not known to reproduce on grape and is rarely considered a pest of grape. Notwithstanding, in red-berried grape cultivars, girdle damage to shoots or petioles is suggestive of *S. festinus* feeding (Fig. 14.5), although other insects such as leafhoppers can cause similar damage.

Management

There are currently no methods for curing a vine of GRBaV in diseased vineyards, highlighting the importance of preventive measures to manage red blotch. Since GRBaV can be introduced to vineyards via infected propagation material, planting

certified vines derived from virus-tested, clean stocks is critical in establishing healthy vineyards and preventing the introduction of the disease. Frequent scouting is also important for evaluating the presence and spread of GRBaV. Since symptoms can easily be confused with leafroll disease, mite damage, nutrient deficiency, and even mechanical damage, it is essential that symptom evaluation be confirmed with DNA-based detection assays.

Economic analyses suggest that roguing symptomatic vines and replanting with clean vines derived from virus-tested stocks minimize losses if red blotch incidence is low to moderate (below 30%), while a full vineyard replacement should be pursued if disease incidence is higher, generally above 30% (Ricketts et al. 2016). These findings should help vineyard managers in adopting appropriate management strategies. Control of the insect vector, *Spissistilus festinus*, using insecticides is currently not recommended. This approach may complement cultural management strategies once the phenology of this insect and its efficiency as a vector in vineyards are better understood.

Is Red Blotch an Emerging Virus? Origin of the Virus and Future Prospects

Grapevine red blotch is an emerging disease, having only been recognized as a distinct malady since 2008. While the virus is known to have been present in California grapevines for over 70 years, it presumably was not present at sufficient levels to gain notice as a disease-causing agent distinct from leafroll-associated viruses. The most likely explanation is that GRBaV spread within nursery stocks over the past few decades. By the time the virus was discovered in 2011 and its association with disease recognized, it had already been effectively spread throughout grape-growing regions of North America. The insect vector may play a role in the persistence of GRBaV in a viticultural setting by moving the virus among cultivated vines and to or from wild vines; thus far, the role of the vector in disease epidemiology is likely dwarfed by the movement of the virus in nursery stocks.

The geographical origin of GRBaV remains a mystery. One hypothesis is that GRBaV is globally distributed in most grape-growing areas of the world, but is not associated with a sufficient level of disease to be recognized and reported. Due to the potential negative impact of a finding on a country's economy, there is a disincentive to look for and report the virus. It may be that the virus is normally very rare, but that in North America the presence of a vector in combination with nursery operations was responsible for its spread to the point of recognition and detection. An alternative hypothesis is that the virus emerged in North America and has not yet spread to other grape production areas. Consistent with this notion is the fact that it has largely only been described from North American vineyards. There are no reports of the virus from commercial grape production areas of Europe. A survey of 2,700 vines in Switzerland did not reveal the presence of GRBaV (Reynard 2016).

GRBaV sequences were also found only to be present in high-throughput sequence datasets originating from North America. The global Sequence Read Archive of the National Center for Biotechnology Information contains 2105 *Vitis* sequence databases submitted from around the world, with the majority being from Europe. GRBaV was found in 31 of these 2105 databases and all were from North America (Vargas and Perry unpublished). The latter “survey” is biased and has limitations, but the correlation is intriguing. A third hypothesis would be that GRBaV is primarily a virus of some yet to be discovered host and only relatively recently moved into *Vitis* sp. This might have been facilitated by adaptation to a new insect vector such as the three-cornered alfalfa treehopper.

Grower awareness of red blotch disease and their desire to source GRBaV-free vines resulted recently in more widespread testing of nursery planting stocks and the establishment of new increase vineyard blocks. It appears this will be a disease that can be managed effectively through clean plant programs. As new reservoirs for the virus are identified, a better understanding of the epidemiology of red blotch will be essential to avoid further spread of virus and disease.

Acknowledgments The authors acknowledge the valued conversations and contributions of lab members and numerous cooperators over the years of study. Thanks to the American Vineyard Foundation, the New York Grape and Wine Foundation, USDA-NIFA-Agriculture Food and Research Initiative-Critical Agriculture Research and Extension, USDA-APHIS-National Clean Plant Network, USDA-NIFA-Capacity Grant, Kaplan and Saltonstall Endowment Funds, and Nolan fellowship funds for their support.

References

- Al Rwahnih, M., D. Ashita, M. Anderson, A. Rowhani, J.K. Uyemoto, and M.R. Sudarshana. 2013. Association of a DNA virus with grapevines affected by red blotch disease in California. *Phytopathology* 103: 1069–1076.
- Al Rwahnih, M., A. Rowhani, D. Golino, C. Islas, J. Preece, and M.R. Sudarshana. 2015a. Detection and genetic diversity of Grapevine red blotch-associated virus isolates in table grape accessions in the National Clonal Germplasm Repository in California. *Canadian Journal of Plant Pathology* 37: 130–135.
- Al Rwahnih, M., A. Rowhani, and D. Golino. 2015b. First report of grapevine red blotch-associated virus in archival grapevine material from Sonoma County, California. *Plant Disease* 99: 895.
- Atallah, S., M. Gomez, M. Fuchs, and T. Martinson. 2012. Economic impact of grapevine leafroll disease on *Vitis vinifera* cv. Cabernet franc in Finger Lakes vineyards of New York. *American Journal of Enology and Viticulture* 63: 73–79.
- Bahder, B.W., F.G. Zalom, and M.R. Sudarshana. 2016a. An evaluation of the flora adjacent to wine grape vineyards for the presence of alternative host plants of Grapevine red blotch-associated virus. *Plant Disease* 100: 1571–1574.
- Bahder, B., F. Zalom, M. Jayanth, and M. Sudarshana. 2016b. Phylogeny of geminivirus coat protein sequences and digital PCR aid in identifying *Spissistilus festinus* (Say) as a vector of Grapevine red blotch-associated virus. *Phytopathology* 106: 1223–1230.
- Calvi, B.L. 2011. *Effects of red-leaf disease on Cabernet Sauvignon at the Oakville experimental vineyard and mitigation by harvest delay and crop adjustment*. M.S. thesis, University of California, Davis, CA.

- Fuchs, M., B. Krenz, L.M. Yepes, J. Thompson, H. McLane, and K.L. Perry. 2015. Is Grapevine red blotch-associated virus the causal agent of red blotch disease? In: *Proceedings of the 18th Congress of the International Council for the Study of Virus and Virus-like Diseases of the Grapevine*, 72–73.
- Guo, T.W., D. Vimalasvaran, J.R. Thompson, K.L. Perry, and B. Krenz. 2015. Subcellular localization of grapevine red blotch-associated virus ORFs V2 and V3. *Virus Genes* 51: 156–158.
- Krenz, B., J. Thompson, M. Fuchs, and K.L. Perry. 2012. Complete genome sequence of a new circular DNA virus from grapevine. *Journal of Virology* 86: 7715.
- Krenz, B., J.R. Thompson, H. McLane, M. Fuchs, and K.L. Perry. 2014. Grapevine red blotch-associated virus is widespread in the United States. *Phytopathology* 102: 1232–1240.
- Lim, S., D. Igori, F. Zhao, and J.S. Moon. 2016. First report of Grapevine red blotch-associated virus on grapevine in Korea. *Plant Disease* 100: 1957.
- Mitchell, P., and L. Newsom. 1984. Seasonal history of the three cornered alfalfa hopper (Homoptera: Membracidae) in Louisiana. *Journal of Economic Entomology* 77: 906–914.
- Perry, K.L., H. McLane, M.Z. Hyder, G.S. Dangl, J.R. Thompson, and M.F. Fuchs. 2016. Grapevine red blotch-associated virus is present in free-living *Vitis* sp. proximal to cultivated grapevines. *Phytopathology* 106: 663–670.
- Piepenburg, O., C.H. Williams, D.L. Stemple, and N.A. Armes. 2006. DNA detection using recombination proteins. *PLoS Biology* 4: 1115–1121.
- Poojari, S., O.J. Alabi, V.Y. Fofanov, and R.A. Naidu. 2013. A leafhopper-transmissible DNA virus with novel evolutionary lineage in the family geminiviridae implicated in grapevine redleaf disease by next-generation sequencing. *PLoS One* 8: e64194.
- Poojari, S., T. Lowery, A-M Schmidt, M. Rott, W. Mcfadden-Smith, L. Stobbs, and J.R. Urbez-Torres. 2016. Red blotch and the virus in Canada. In: *Webinar on red blotch disease*, 26 February, <http://www.ipmcenters.org/index.cfm/center-products/ipm-eacademy/upcoming-events/red-blotch-speakers/>
- Reynard, J.S. 2015. Survey of emerging viruses in Switzerland. In: *Proceedings of the 18th Congress of the International Council for the Study of Virus and Virus-like Diseases of the Grapevine*, 223–224.
- . 2016. Red blotch and the virus in Europe. IPM eAcademy webinar. 26 February 2016. <https://www.youtube.com/watch?v=LEGXd3iLBx4&list=PLK93eCG1nCcKFZWFwuMqKPyAvU-Qk--B3&index=7>
- Ricketts, K.D., M.I. Gomez, S.S. Atallah, M.F. Fuchs, T. Martinson, R.J. Smith, P.S. Verdegaal, M.L. Cooper, L.J. Bettiga, and M.C. Battany. 2015. Reducing the economic impact of grapevine leafroll disease in California: Identifying optimal management practices. *American Journal of Enology and Viticulture* 66: 138–147.
- Ricketts, K.D., M.I. Gomez, M.F. Fuchs, T.E. Martinson, R.J. Smith, M.L. Cooper, M. Moyer, and A. Wise. 2016. Mitigating the economic impact of grapevine red blotch: Optimizing disease management strategies in U.S. Vineyards. *American Journal of Enology and Viticulture* 68: 127–135.
- Seguin, J., R. Rajeswaran, N. Malpica-Lopez, R.R. Martin, K. Kasschau, V.V. Dolja, P. Otten, L. Farinelli, and M.M. Poogin. 2014. *De novo* reconstruction of consensus master genomes of plant RNA and DNA viruses from siRNAs. *PLoS One* 9: e88513.
- Sudarshana, M.R., K.L. Perry, and M.F. Fuchs. 2015. Grapevine red blotch-associated virus, an emerging threat to the grapevine industry. *Phytopathology* 105: 1026–1032.
- Varsani, A., J. Navas-Castillo, E. Moriones, C. Hernández-Zepeda, A. Idris, J.K. Brown, F. Murilo Zerbini, and D.P. Martin. 2014. Establishment of three new genera in the family *Geminiviridae*: *Becurtovirus*, *Eragrovirus* and *Turncurtovirus*. *Archives of Virology* 159: 2193–2203.

Chapter 15

Grapevine vein clearing virus: Diagnostics, Genome, Genetic Diversity, and Management

W. Qiu and J. Schoelz

Abstract *Grapevine vein clearing virus* (GVCV) is a recently discovered DNA virus that is closely associated with a severe disease that poses a great threat to the sustainable growth and productivity of grapevines in the Midwest region of the USA. The most damaged vineyards have been removed because of GVCV infection. Diagnostic symptoms are translucent vein clearing along the second and tertiary veins on young leaves and mosaic patterns on mature leaves of the affected grapevine. GVCV genome comprises a circular, double-stranded DNA, which is characteristic of the viruses in the genus *Badnavirus*, family *Caulimoviridae*. Three large open reading frames (ORFs) are predicted on the plus-strand of the genome. The promoter region and transcription start and termination sites have been mapped. GVCV is replicated through transcription of a terminally redundant transcript as other members of the *Caulimoviridae* family. Increasing incidences of GVCV on grapevines over the last few years suggest the transmission of the virus by a vector, whose identity is still under investigation. Two new isolates of GVCV were also found in wild grapevines native in Missouri (USA). The reservoirs of genetically complex GVCV populations in wild grapevines create challenges to the management of GVCV-associated disease. The rising prevalence of GVCV and the severity of the emerging disease with which this virus is associated with warrant that it should be tested routinely in the grapevine certification program.

Keywords Grapevine • Vein clearing • Badnavirus • Detection • Epidemics

W. Qiu (✉)
William H. Darr College of Agriculture, Missouri State University,
9740 Red Spring Road, Mountain Grove, MO 65711, USA
e-mail: wenpingqiu@missouristate.edu

J. Schoelz
Division of Plant Sciences, University of Missouri, Columbia, MO 65211, USA

Introduction and Historical Aspects

In 2004, a severe disease was reported in the grape cultivar Chardonnay in a vineyard in Augusta, Missouri, USA (Qiu et al. 2007). The shoots of the diseased vines had a zigzag shape and short internodes. Leaves on the symptomatic shoots were small, deformed, and showed a mosaic pattern of chlorotic and green tissues. The growth of the affected vines slowed, the vigor declined, and fruit load decreased. The affected berries were not suitable for making premium wines. The entire cv. Chardonnay vineyard of approximately two acres was removed because of this disease in 2007. A related observation reported that similar symptoms had been noticed on the grape cv. Vidal Blanc in the early 1990s in a vineyard in Altus, Arkansas (K. Striegler, personal communication). A visual survey in 2012 of commercial vineyards in Altus confirmed the report and found that almost all of the cv. Vidal Blanc vines in the vineyard exhibited severe mosaic and vein-clearing symptoms and had significantly low crop yield and fruit quality.

Based on symptomology, the disease was originally speculated to be caused by nepoviruses. However, serological and PCR assays did not find a close association of the disease with the known nepoviruses that were selected for diagnosis (Lunden et al. 2009). A high-throughput sequencing of small RNA molecules was then employed to analyze the profiles of virus-derived small RNAs (Singh et al. 2012; Zhang et al. 2011). The majority of small RNAs that were isolated from the diseased grapevines shared a high percentage of identical nucleotides with the genome sequences of badnaviruses in the family Caulimoviridae. Primers were then designed to amplify large DNA fragments with overlapping sequences. Three large DNA fragments were obtained, cloned, and sequenced. Subsequently, the entire genome of a DNA virus, designated *Grapevine vein clearing virus* (GVCV), was assembled and assigned to the genus *Badnavirus* in the Caulimoviridae family (Zhang et al. 2011). GVCV is the first DNA virus reported in grapevines. After this report, more GVCV isolates of genetic variability have been discovered in cultivated grapevines and also in native wild *Vitis rupestris* grapevines. Currently, the first isolate whose genome has been completely sequenced is referred to as GVCV-CHA and considered to be a reference isolate. The two isolates identified in wild *V. rupestris* grapevines are referred to as GVCV-VRU1 and GVCV-VRU2.

Detection and Diagnostics

Symptomology

Various types of symptoms are associated with GVCV infection. Symptoms change as shoots and leaves mature during the progression of the growing season. Even on a single GVCV-infected vine, some shoots exhibit typical viral symptoms, while others remain symptomless. A spectrum of symptoms may appear on the same shoot, with apparent symptomatic leaves and recovered, asymptomatic leaves at the

apex. The most distinct symptom for diagnostics, however, is the translucent clearing of secondary or tertiary veins on young leaves (Fig. 15.1a–e). Mosaic and mottle patterns of green and yellow tissues may appear on mature leaves as the season progresses (Fig. 15.1f).

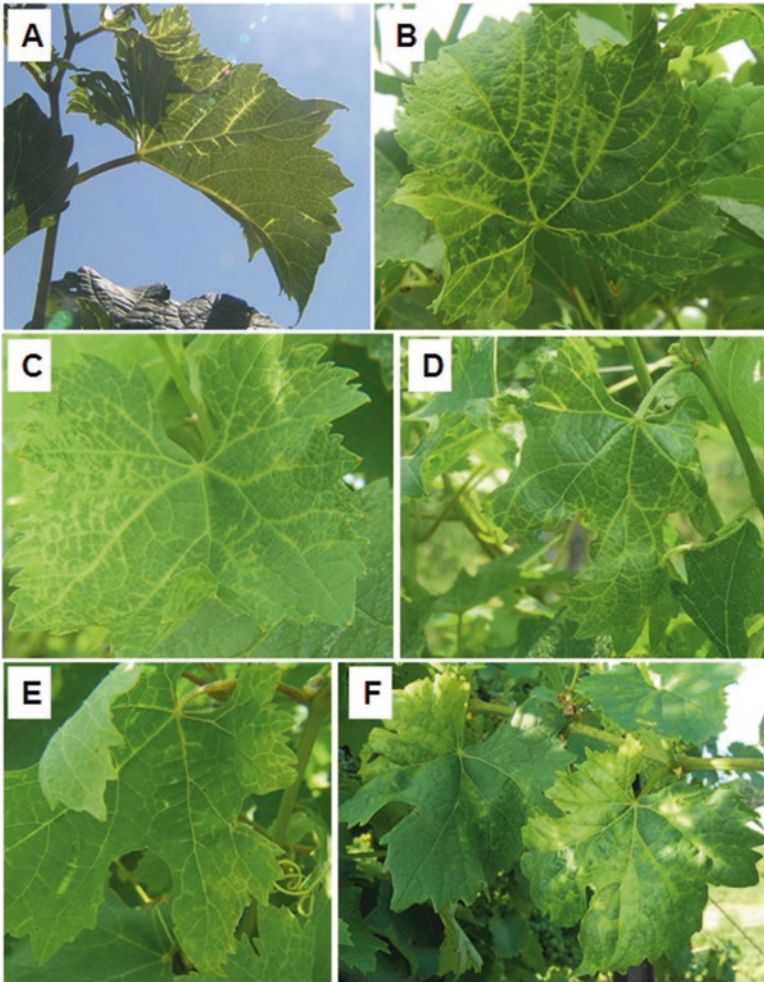

Fig. 15.1 Various symptoms of diseased grapevine leaves on three most susceptible grape cultivars that were infected by *Grapevine vein clearing virus*. (a) Translucent vein-clearing against sunlight on Chardonnay. (b) Vein clearing with *yellow highlighter* effect on Chardonnay. (c) Vein clearing with *yellow highlighter* effect on Vidal Blanc. (d) Vein-clearing with deformation of leaf shape on Cabernet Sauvignon. (e) Vein-clearing on Cabernet Franc. (f) Chlorotic and mosaic symptoms on old leaves of Chardonnay. (g) Zigzagged and short internodes on a young shoot of Chardonnay. (h) Short internodes with small and split leaves on a young shoot of Chardonnay; (i) Brownish and irregularly shaped berry on the affected Chardonnay vine. (j) Small berries and leaves with mosaic and vein-clearing symptoms on the affected Vidal Blanc vine. (k) Vine decline and reduction of fruit load on the affected Vidal Blanc vine



Fig. 15.1 (continued)

GVCV-associated symptoms vary slightly from cultivar to cultivar. On cvs. Chardonnay and Chardonef, affected leaves are deformed and crinkled (Fig. 15.1a, b). Diseased shoots exhibit a typical zigzag pattern with short internodes in Chardonef (Fig. 15.1g–h). GVCV-infected Vidal Blanc vines exhibit mild translucent vein-clearing symptoms on young leaves (Fig. 15.1c), while mosaic and mottle symptoms appear on mature leaves. GVCV-infected Cabernet Sauvignon and Cabernet Franc leaves show vein clearing on the entire leaf, forming spider web-like symptoms (Fig. 15.1d–e). The first two or three leaves on the young shoots often are small and distorted with split edges. Berries on the infected vines are deformed and discolored. Brownish berries are not fully developed, do not ripen properly, and form a stony texture (Fig. 15.1i, j). Severely infected vines are stunted and do not have normally developed cordons and shoots (Fig. 15.1k). The entire vine eventu-

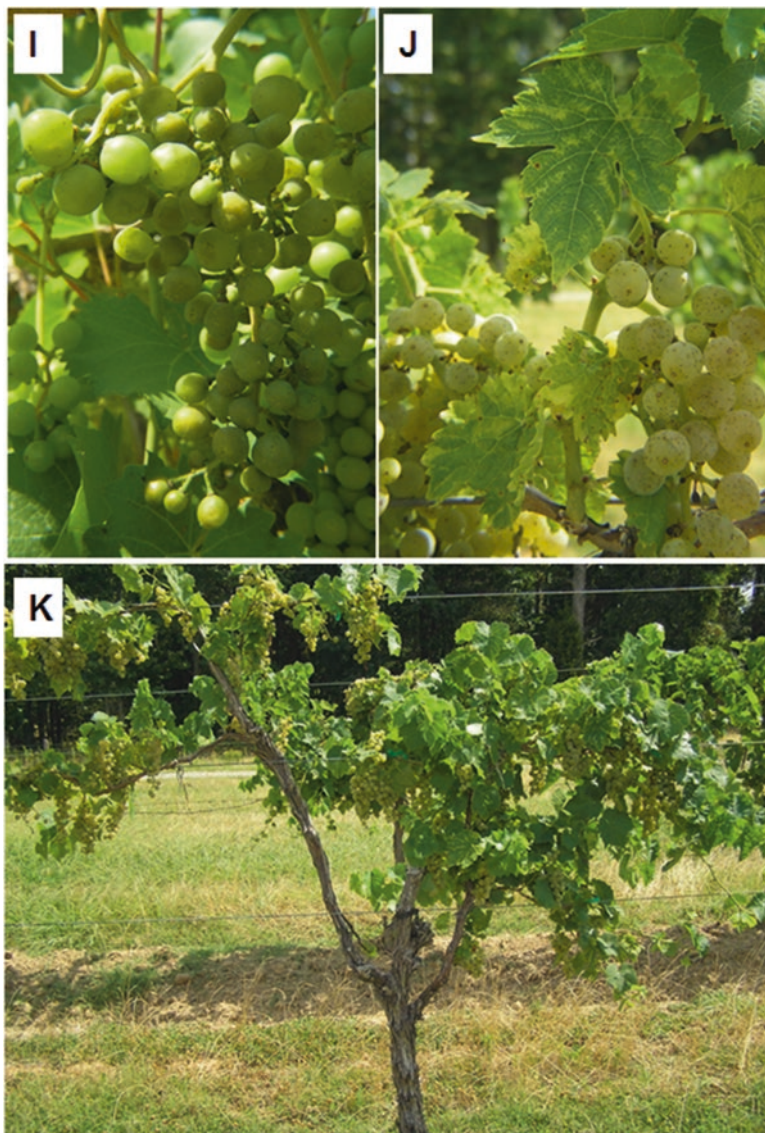

Fig. 15.1 (continued)

ally declines (Fig. 15.1k) and bears less fruit with each growing season. These symptoms become more pronounced as the vines age. In a few extreme cases, the affected vines die.

On indicator grapevine Cabernet Franc vines that were graft-inoculated with tissue from GVCV-infected grapevine under greenhouse conditions, vein clearing is obvious; small leaves are formed but still maintain five distinct lobes. GVCV-grafted

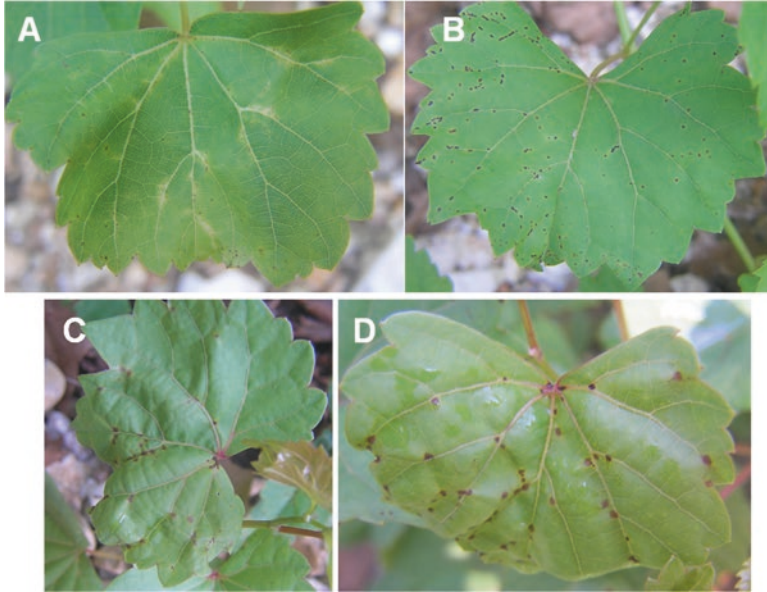

Fig. 15.2 Development of symptoms on GVCV-VRU1-infected *Vitis rupestris* “VRU89” and GVCV-VRU2-infected *V. rupestris* “VRU1405” grapevine at their native habitats. (a) Translucent vein clearing on *V. rupestris* “VRU89.” (b) Necrotic spots on mature leaf of *V. rupestris* “VRU89.” (c) Necrotic spots along veins on mature leaf of *V. rupestris* “VRU1405” vine. (d) Large necrotic spots around terminal veins on mature leaf of *V. rupestris* “VRU1405” vine

indicator grapevine Baco Blanc shows very mild vein clearing on the entire leaf, while the GVCV-grafted LN33 used as indicator for other viral diseases does not show noticeable symptoms.

GVCV-associated symptoms on wild *V. rupestris* vines are readily distinguished from those on grape cultivars in commercial vineyards. Vein clearing on young leaves still is the diagnostic symptom (Fig. 15.2a). But vein clearing progresses to vein necrosis on mature leaves (Fig. 15.2b) or necrotic spots along the originally cleared veins on GVCV-VRU1- or GVCV-VRU2-infected wild *V. rupestris* (Fig. 15.2). Symptoms differ slightly between GVCV-VRU1- and GVCV-VRU2-infected wild *V. rupestris* vines in that large necrotic spots around the terminal veins are often associated with GVCV-VRU2 (compare Fig. 15.2b with 15.2c).

Polymerase Chain Reaction Assay

Polymerase chain reaction (PCR) is the only method for detecting GVCV at this time. Total DNA is extracted from 100 mg of fully expanded young leaf tissue by using a DNeasy Plant Mini Kit (QIAGEN). In a standard protocol, 10 ng of DNA is routinely used in the PCR assays. DNA quality is assured by amplifying a 105

bp DNA fragment of the gene for the 16S rRNA by using the 16S forward primer (5'-TGCTTAACACATGCAAGTCGGA-3') and 16S reverse primer (5'-AGCCGTTTCCAGCTGTTGTTC-3'). Four sets of primers were designed based on the GVCV reference genome sequence [GenBank accession number: JF301669]. The sequences of the four pairs of primers, annealing temperatures, and sizes of amplified DNA fragments are listed in Table 15.1. In addition, two sets of primers were designed to differentiate GVCV-CHA and GVCV-VRU1 isolates (Table 15.1).

PCRs are performed with Platinum® Taq DNA Polymerase according to the protocol provided by Life Technologies™ (Grand Island, NY) or with a GoTaq kit by Promega (Madison, WI). PCR reagents are composed of 1× Taq buffer, 2 mM MgCl₂, 0.2 mM dNTP, 0.2 μM primers, 10 ng of template DNA, and 1 unit Platinum Taq. The PCR thermocycler program is as follows: initial denaturation for 1 min at 94 °C, 35 cycles of denaturation at 94 °C for 30 sec, annealing for 40 sec at a temperature specific for each set of primer (Table 15.1), and extension at 72 °C for 1 min for fragments of less than 1 kb or 1 min/per kb for fragments of more than 1 kb, final extension at 72 °C for 10 min. The DNA fragments are separated on a 1% agarose gel in 0.5× Tris-borate-EDTA buffer (45 mM Tris-borate, 1 mM EDTA) through electrophoresis and visualized and recorded under UV illumination after the gel had been stained with GelRed™ (Biotium Inc., Hayward, CA). Since GVCV exists as a genetically diverse population, it is recommended that at least two sets of primers should be used in PCR to verify the results. For each PCR assay, a reaction without the DNA template should be used as a negative control and a reaction with DNA extracted from GVCV-infected sample should be included as a positive control.

Genome Structure, Genome Expression, and Replication

Genome Size and Structure

The genome of GVCV-CHA consists of circular, double-stranded DNA of 7753 bp in size (Fig. 15.3a). Three large open reading frames (ORFs) are located on one of the two DNA strands, a genome organization similar to other badnaviruses (Fig. 15.3a) (Zhang et al. 2011). ORFs I and II encode proteins of unknown function that have predicted sizes of 24.2 and 14.3 kDa. ORF III encodes a polyprotein that has a predicted size of 219.5 kDa. Amino acid comparisons with other badnaviruses have made it possible to map domains for a movement protein, coat protein, protease, core reverse transcriptase, and RNase H. The approximate boundaries for each of these domains in the polyprotein are illustrated in Fig. 15.3. However, since none of these proteins have been detected from GVCV-infected leaves, the exact cleavage sites of the polyprotein remain to be characterized.

Table 15.1 Sequence, position, fragment size, and annealing temperature of the primers for diagnostic detection of *Grapevine vein clearing virus* (GVCV)

Primers	Sequences (5'–3')	Position on genome	Fragment size	Annealing Tm	Annotation
GVCV1101F	CTGAAAGGTAGATGTCCACG	1101–1935	835 bp	54.7	GVCV detection
GVCV1935R	TCGGGTAGACACTTGATTTCT				
GVCV2460F	AGACACAGGAGAAAGGGTA ACT	2460–3122	663 bp	52.3	GVCV detection
GVCV3122R	GCTAAAACCTTCGAGCTAAC				
GVCV4142F	GTA AACCTC ATGACTCTCATG	4142–4387	246 bp	58.7	GVCV detection
GVCV4387R	CTTCTCCTTCAGAAAATTGAGCAGAT				
GVCVCHAI352F	ACTTTGGAA AAGGAAAGGGCTC	1352–1827	476 bp	64.0	GVCV-CHA -specific detection
GVCV1827R	CTGCCGGTCTATGACATGGG				
GVCVVRU1367F	AAGGGAAAGTCAAAAAGCAACAGC	1367–1834	477 bp	64.0	GVCV-VRU1 -specific detection
GVCV1834R	CTATGACGTGGCCCTTACT				
GVCV988F	ACCTAAGCCGATTGAAGCAG	988–1562	575 bp	52.3	GVCV detection ^a /ORFII cloning
GVCV1562R	GCTAAAACCTTCGAGCTAAC				

^aGVCV generic test for all known isolates

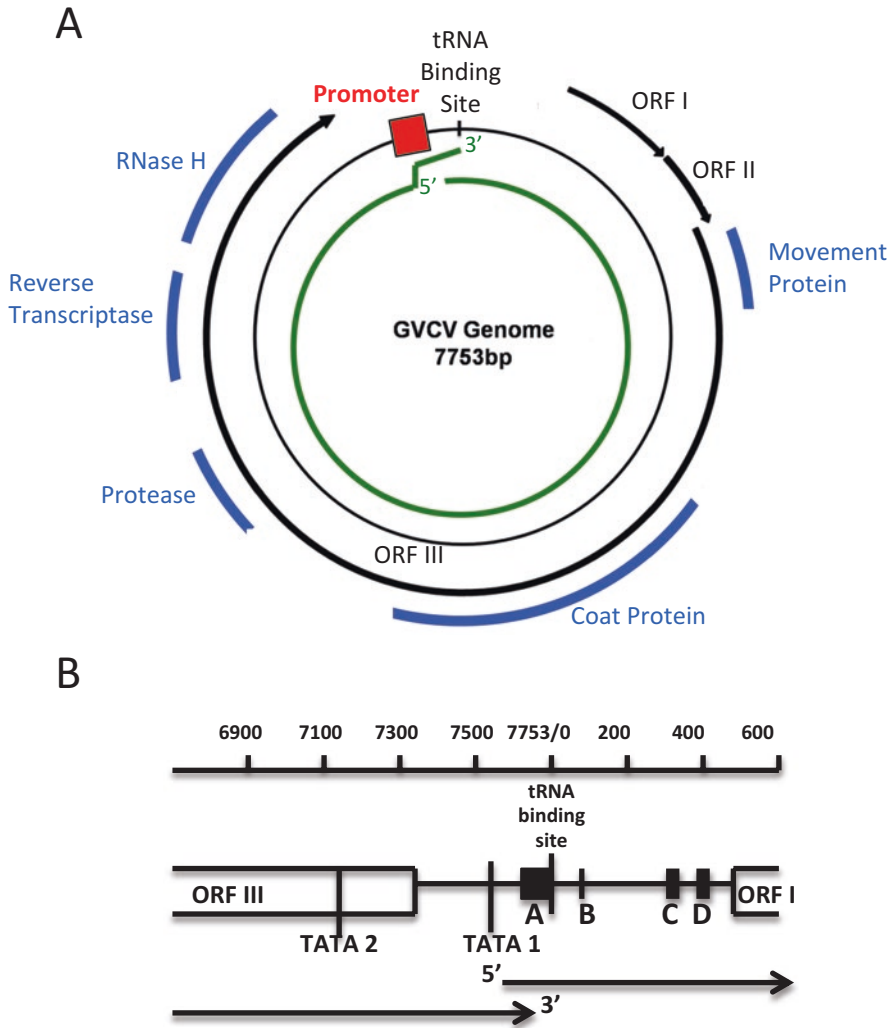

Fig. 15.3 Schematic presentation of the GVCV genome. (a) The tRNA binding site for first-strand DNA synthesis is located at the *top* of the circular genome and also marks the beginning and end of the 7753 bp circular DNA genome. The positions of the three ORFs are illustrated by *black arrows*. ORFIII is a polyprotein; the approximate locations of the movement protein, coat protein, protease, reverse transcriptase, and RNase H domains within the ORF III polyprotein are illustrated by the *blue boxes*. The 5' and 3' ends of the terminally redundant genomic RNA is shown by the *green arrow*, whereas the promoter sequences for the genomic RNA are delimited by the *red box*. (b) Detailed structure of the intergenic region of GVCV. The boundaries of the intergenic region are determined by the 3' end of ORFIII and the 5' end of ORF I. The large intergenic region contains the TATA box (TATA1), and the transcriptional start and stop sites of the genomic RNA, indicated by the *arrows*. In addition, the diagram illustrates the four small ORFs (sORFs A–D) present in the leader sequence of the genomic RNA upstream from ORF I

Characterization of the GVCV Promoter and Major Transcript

The promoter of GVCV was identified through an analysis of the nucleotide sequence of GVCV-CHA and confirmed through an agroinfiltration assay in *Nicotiana benthamiana* (Zhang et al. 2015). An inspection of the GVCV nucleotide sequence corresponding to the large intergenic region (IGR) revealed two potential TATA boxes, beginning at nucleotides 7131 and 7539, respectively. To identify the actual boundaries of the promoter, DNA segments from the large IGR of GVCV that contained both the TATA boxes were fused to a green fluorescent protein (GFP) reporter gene in a plasmid and the constructs were then inserted into the T-DNA of a binary plasmid for transient expression in *N. benthamiana*. This analysis showed that a 340 bp GVCV segment containing the TATA box at nt 7131 was capable of directing a high level of expression of GFP. A direct comparison of the promoters of the GVCV and the *Cauliflower mosaic virus* 35S promoter showed that the GVCV promoter was significantly stronger than the 35S promoter. The 35S promoter has been widely used in plant biotechnology for activating the expression of foreign genes in plants. Similarly, the GVCV promoter may be valuable for regulating the expression of transgenes in grapevines.

The identification of the GVCV promoter has led to further characterization of the major transcript of GVCV. A 5' RACE (Rapid Amplification of cDNA Ends) analysis of RNA transcripts isolated from GVCV-infected leaves showed that the transcript initiation site was at nucleotide 7571, whereas a 3' RACE analysis mapped the termination of the transcript at nucleotide 7676 (Fig. 15.3b) (Zhang et al. 2015). The positioning of the transcript initiation and termination sites suggests that a terminally redundant RNA is synthesized from the GVCV genomic DNA, with a reiteration of 105 nucleotides. The terminal redundant ends of the pre-genomic RNA are a key element in the replication strategy of caulimoviruses and badnaviruses, as this RNA serves as a template for reverse transcription of the viral RNA genome into double-stranded DNA. The first-strand cDNA synthesis is primed by a tRNA. In the case of GVCV, nucleotides 1–12 of the GVCV genomic (DNA) sequence correspond to the 3' end of the methionine tRNA (Fig. 15.3b). Consequently, the tRNA binds to nucleotides 183–195 present in the GVCV genomic RNA to prime the first-strand cDNA synthesis. First-strand DNA synthesis then proceeds from the primer binding site 182 nucleotides downstream of the 5' end of the transcript before the reverse transcriptase switches templates to the 3' end of the genomic transcript. The terminally redundant ends of the GVCV transcript ensure that the reverse transcriptase will be able to switch templates.

Another unusual feature of the genomic RNA revealed by the identification of the 5' end of the GVCV transcript is the length and structure of its leader sequence, defined as the nucleotide sequence from the 5' end of the transcript to the beginning of ORF I. The GVCV leader sequence is 686 nt in length and contains four short ORFs (sORFs A–D, Fig. 15.3b) ranging in size from 5 to 30 codons that are upstream from ORF I. The length and complexity of the GVCV leader sequence is comparable to that of other caulimoviruses and badnaviruses (Pooggin et al. 1999, 2006). By

contrast, the leader sequences of most eukaryotic mRNAs are less than 100 nucleotides in length and do not contain any short open reading frames.

The leader sequence of the genomic RNA in the family Caulimoviridae is able to fold into an elaborate stem-loop structure, which allows ribosomes that enter at the 5' end of the RNA to bypass most of the leader and the sORFs to gain access to ORF I. This mechanism of translation has been described as ribosomal shunting (Fütterer et al. 1993, 1988). A comparison of the leader sequences present in the pre-genomic RNAs of 14 caulimoviruses revealed that, in each case, the stem-loop structure led to the juxtaposition of the first sORF and the first long ORF (Pooggin et al. 1999). An analysis of the leader sequence of GVCV with the RNA folding computer program mFold revealed that its leader sequence also could fold into a stem-loop structure similar to other caulimoviruses (Y. Zhang and J. Schoelez, unpublished), indicating that GVCV also utilizes the ribosomal shunt strategy for translation of GVCV ORF I.

Genetic Diversity and Population Structure

Nucleotide sequence variability was first observed among GVCV isolates in the form of the restriction fragment length polymorphisms after PCR-amplified DNA fragments were subject to digestion with three restriction enzymes (Guo et al. 2014). Genetic diversity of GVCV isolates was also observed in the sequence variations within two relatively conserved regions encoding a zinc-finger (ZF) domain of 540 bp and a reverse transcriptase (RT) domain of 570 bp. A total of 13 GVCV isolates were collected from cvs. Cabernet Sauvignon, Chardonnay, Chardonel, Cabernet Franc, and Riesling that were grown in the States of Missouri, Illinois, and Indiana, USA. The analysis of the phylogenetic relationship of the 13 GVCV populations revealed that the sequence variants of GVCV could not be phylogenetically grouped into clades according to geographical locations or grape cultivar (Guo et al. 2014). Frequent exchanges of vegetatively propagated grapevine materials and spread by potential insect vectors across the states are two main means of broadening the genetic spectrum of GVCV populations.

New Isolates in Wild Grapevines

More than 30 *V. rupestris* samples were collected from native habitats in Missouri and Oklahoma and subjected to PCR assay to determine if GVCV exists in wild grapevines. GVCV was confirmed to be present in two samples that were collected from their native sites at Swan Creek, Branson, Missouri (W. Qiu, unpublished information). Currently, three genetically diverse isolates, GVCV-CHA, GVCV-VRU1, and GVCV-VRU2, have been identified in grapevines. The GVCV-CHA

genome sequence is used as a reference in the comparative genomic study of GVCV isolates. The genomes of GVCV-CHA, GVCV-VRU1, and GVCV-VRU2 are 7753 bp, 7755 bp, and 7725 bp in length, respectively. Nucleotide sequence identity of the three GVCV isolates in the IGR ranges from 90.2 to 91.1%. The length of the IGR differs among the three GVCV isolates, as GVCV-CHA has a 917 nt IGR, GVCV-VRU1 has a 913 nt IGR, and GVCV-VRU2 has an 883 nt IGR. The plus-strand of each of the three GVCV genomes encodes three ORFs. The nucleotide sequences of ORF II are the most variable among the three isolates, ranging from 83.4 to 88.5% identity.

Diverse Isolates in Commercial Vineyards

GVCV has been detected in all the diseased vines showing typical vein-clearing symptoms. To investigate the genetic diversity of GVCV populations, four sets of primers were designed from the GVCV reference genome and used to detect GVCV isolates. Results from PCR assays demonstrated that four DNA fragments in the size of 246 bp, 461 bp, 663 bp, and 835 bp were all detected in 7 out of the 20 samples (Table 15.2), one to three GVCV-specific amplicons were detected in remaining symptomatic samples, and no GVCV-specific DNA fragments were detected in symptomless vines (Table 15.2). These results indicated the presence of diverse GVCV isolates as defined by the four regions covering the primer sequences.

After it was discovered that ORF II is the most variable region, the nucleotide sequences of ORF II have been obtained from more GVCV isolates that were collected in commercial vineyards. The sequence analysis found that identities of ORF II range from 83.5 to 99.2% among GVCV isolates. The analysis also indicated that GVCV isolates similar to GVCV-VRU1 and GVCV-VRU2 are present in commercial vineyards in Arkansas and Missouri, USA.

The presence of genetically diverse GVCV isolates suggests an ongoing dynamic evolution of GVCV populations in grapevines grown in vineyards and native habitats. This creates a challenge for the management of GVCV-associated diseases. It also presents challenges to the detection of GVCV using PCR since one set of specific primers may not be able to detect all isolates in a population.

Host Range and Transmission

GVCV is slowly but surely spreading in the grape-growing areas in the Midwest region of the USA. Results from surveys over the last 3 years indicated that the GVCV-associated disease is increasing in commercial vineyards and spreading to newly planted susceptible grape cultivars. At the present time, GVCV has been detected in cvs. Chardonnay, Chardonel, Vidal Blanc, Vignoles, Riesling, Cabernet Sauvignon, Cabernet Franc, Malvin Muscat, and Viognier. Various isolates of

Table 15.2 Presence of diverse GVCV isolates that were defined by the four sets of primers on six grape cultivars in four commercial vineyards in Missouri, USA

Samples ID	Cultivar	GVCV-specific amplicon			
		246 bp	461 bp	663 bp	835 bp
BBV 1	Cabernet Franc	+ ^a	+	+/-	+
BBV 2	Cabernet Franc	+	+	+	+
BBV 3	Cabernet Franc	+	+	+	+
BBV 4	Cabernet Franc	+	+	+	+
BBV 5	Chardonnay	+	+	+	+
BBV 6	Chardonnay		+		
SJV 1	Chardone	+	+		
SJV 2	Chardone	+			
SJV 3	Chardone				
SJV 4	Chardone				
SJV 5	Chardone	+	+		+
CVV 1	Vignoles				
CVV 2	Valvin Muscat	+	+	+	
CVV 3	Valvin Muscat		+/-		+/-
CVV 4	Valvin Muscat		+/-	+/-	+/-
CVV 5	Valvin Muscat	+	+	+	+
CVV 6	Viognier	+	+		+/-
CMV 1	Chardone	+/-			+/-
CMV 2	Chardone	+	+	+	+
CMV 3	Chardone	+	+	+	+

^aPlus sign (+) indicates presence of DNA fragment; minus sign (-) indicates absence of DNA fragment; +/-, ambiguous result

GVCV have been detected in commercial vineyards that are separated by hundreds of miles. Symptomatic vines are sporadically distributed in Chardone commercial vineyards in Missouri and have been found to be clustered along adjacent vines and rows in Vidal Blanc vineyards in Missouri and Arkansas, USA. The highest incidences of GVCV-affected vines were observed on Vidal Blanc vines in a vineyard that was established more than 30 years ago in Arkansas. GVCV was detected in Malvin Muscat and Viognier vines that were recently introduced to Missouri vineyards. In a Foundation Vineyard that was planted with seven hybrid grapes in the Missouri State Fruit Experiment Station (MSFES), Mountain Grove, Missouri in 2007, GVCV was detected in Chardone and Vidal Blanc vines in 2014, but mother vines that were grown in the greenhouse from which these Chardone and Vidal Blanc vines were originally propagated tested negative for GVCV. The incidences of GVCV on Vidal Blanc and Chardone vines in the MSFES Foundation Vineyard were 33% and 23%, respectively. GVCV was not detected in cvs. Vignoles, Cayuga White, and Traminette (W. Qiu, unpublished information). These observations and survey results strongly suggest that an insect vector is responsible for spread of GVCV in vineyards.

GVCV is easily transmitted by grafting under greenhouse conditions (Guo et al. 2014). Symptoms start to appear on GVCV-grafted Chardonnay, Vidal Blanc, and Cabernet Sauvignon 1 month after wedge grafting. The majority of badnaviruses have been shown to be transmitted by mealybugs, whereas aphids have been implicated in the transmission of a few badnaviruses (Fauquet et al. 2005). To date, one aphid species was tested in a transmission study, but it did not transmit GVCV under experimental conditions. Candidate mealybugs for transmitting GVCV are currently under investigation.

Strategies for Control and Management

GVCV-Resistant and GVCV-Tolerant Grape Cultivars

GVCV-associated diseases occur with a high incidence in Cabernet Sauvignon, Chardonnay, Chardonnay, and Vidal Blanc vineyards. To date, one Cabernet Sauvignon, one Chardonnay, one Vidal Blanc, and two Chardonnay vineyards had been removed as a result of GVCV infection. Grape cultivars Norton, Chambourcin, Chardonnay, Vignoles, Vidal Blanc, Traminette, and Cayuga White are suitable and profitable to be grown in the Midwest region of the USA because of their tolerance and resistance to fungal diseases. To investigate if these cultivars are resistant to GVCV, we assessed their resistance by grafting GVCV-infected scions onto each of these grape cultivars. An evaluation of the results indicated that Chambourcin is resistant to GVCV (Guo et al. 2014). Recent results confirmed that GVCV was not detected in the scion or rootstock of Norton vines after they were graft-inoculated with the GVCV-infected tissues. The mechanisms for Chambourcin and Norton's resistance to GVCV remain unclear. We speculate that GVCV may not be able to proliferate in these two cultivars or to move across the graft union. The graft-transmitted GVCV resulted in the appearance of severe symptoms on cvs. Cabernet Sauvignon, Chardonnay, Chardonnay, and Vidal Blanc 1 month after grafting. Vignoles, Traminette, and Cayuga White are tolerant in that GVCV-infected vines showed mild or no symptoms. In addition, based on the survey of GVCV by PCR assay in the Foundation Vineyard at MSFES, Vignoles, Traminette, and Cayuga White vines were not found to be infected with GVCV even though the virus was detected in 7-year-old Chardonnay and Vidal Blanc vines in the same vineyard.

Growing Certified Grapevine Stocks That Tested Free of Major Viruses

The most effective strategy of preventing viral diseases in vineyards is to start a new vineyard by planting grapevines that tested free of major viruses. It significantly reduces the chance of virus infection during the establishment phase. Potential

insect vectors infest vineyards each year, and they can still transmit GVCV and other viruses. Once GVCV-associated symptoms are observed and GVCV is confirmed by PCR assays in the vines, these vines should be removed to reduce further spread of GVCV.

Distribution of GVCV in wild grapevines in their native habitats is a challenge to the management of this emerging disease on grapevine. The incidence and spread of GVCV among wild *Vitis* species other than *V. rupestris* remains unknown. One approach may be to remove wild vines surrounding the selected site before establishing a new vineyard. This will reduce the chance of the infection of newly grown vines with wild isolates of GVCV.

Conclusion and Future Focuses

The genetic complexity of GVCV populations poses a great challenge to the management of GVCV-associated disease. GVCV has been discovered in two wild *V. rupestris* plants. A more comprehensive survey is needed to investigate the distribution of GVCV in *V. rupestris* and other *Vitis* species in native habitats. Due to the increasing incidence of GVCV and its damaging impact on grape production as well as its presence in wild grapevines, it is recommended that GVCV be included in the standards of testing grapevine viruses for the certification program.

Future research should focus on (1) identifying the vector or vectors that transmit GVCV; (2) conducting a comprehensive survey of GVCV in native wild grapevines to investigate possible reservoirs of GVCV; (3) testing the infectivity, symptomology, and biology of infectious GVCV clones; and (4) studying biological and pathogenic differences among GVCV isolates.

Acknowledgments We thank USDA-National Clean Plant Network Program and Missouri Grape and Wine Board for providing financial support to the research projects. We thank graduate students for making contributions to the discovery and study of *Grapevine vein clearing virus*. Our appreciation is also extended to Sylvia Petersen for reviewing the chapter.

References

- Fauquet, C.M., M.A. Mayo, J. Maniloff, U. Desselberger, and L.A. Ball. 2005. *Virus taxonomy: Eighth report of the international committee on taxonomy of viruses*. London: Academic.
- Fütterer, J., K. Gordon, J.M. Bonneville, H. Sanfaçon, B. Pisan, J. Penswick, and T. Hohn. 1988. The leading sequence of caulimovirus large RNA can be folded into a large stem-loop structure. *Nucleic Acids Research* 16: 8377–8390.
- Fütterer, J., Z. Kiss-László, and T. Hohn. 1993. Nonlinear ribosome migration on cauliflower mosaic virus 35S RNA. *Cell* 73: 789–802.
- Guo, Q., S. Honesty, M.L. Xu, Y. Zhang, J.E. Schoelz, and W.P. Qiu. 2014. Genetic diversity, tissue and host specificity of *Grapevine vein clearing virus*. *Phytopathology* 104: 539–547.

- Lunden, S., B. Meng, J.D. Avery, and W.P. Qiu. 2009. Characterization of a grapevine vein-clearing complex on Chardonnay. *European Journal of Plant Pathology* 126: 135–144.
- Pooggin, M.M., J. Fütterer, K.G. Skryabin, and T. Hohn. 1999. A short open reading frame terminating in front of a stable hairpin is the conserved feature in pregenomic RNA leaders of plant pararetroviruses. *Journal of General Virology* 80: 2217–2228.
- Pooggin, M.M., L.A. Ryabova, X. He, J. Fütterer, and T. Hohn. 2006. Mechanism of ribosome shunting in Rice tungro bacilliform pararetrovirus. *RNA* 12: 841–850.
- Qiu, W.P., J.D. Avery, and S. Lunden. 2007. Characterization of a severe virus-like disease in Chardonnay grapevines in Missouri. *Plant Health Progress*. doi:[10.1094/PHP-2007-1119-01-BR](https://doi.org/10.1094/PHP-2007-1119-01-BR).
- Singh, K., A. Talla, and W. Qiu. 2012. Small RNA profiling of virus-infected grapevines: Evidences for virus infection-associated and variety-specific miRNAs. *Functional & Integrative Genomics* 12: 659–669.
- Zhang, Y., C.A. Angel, S. Valdes, W. Qiu, and J.E. Schoelz. 2015. Characterization of the promoter of Grapevine vein clearing virus. *Journal of General Virology* 96: 165–169.
- Zhang, Y., K. Singh, R. Kaur, and W. Qiu. 2011. Association of a novel DNA virus with the grapevine vein-clearing and vine decline syndrome. *Phytopathology* 9: 1081–1090.

Chapter 16

Grapevine fleck and similar viruses

S. Sabanadzovic, N. Aboughanem-Sabanadzovic, and G.P. Martelli

Abstract Grapevine fleck virus (GFkV), grapevine red globe virus (GRGV), grapevine rupestris vein feathering virus (GRVfV), grapevine asteroid mosaic-associated virus (GAMaV), and grapevine Syrah virus 1 (GSyV-1) are a group of evolutionarily related viruses with similar morphological, physicochemical, and molecular properties. GFkV is the agent of fleck disease, and GAMaV and GRVfV are associated with asteroid mosaic and vein feathering diseases, respectively, while GRGV is not involved in any specific symptomatology. GSyV-1 is included in this chapter as it shares many traits with the four aforementioned viruses, but has not yet been associated with any particular syndrome. All these viruses are phloem limited, nonmechanically transmissible, and primarily spread through infected propagating material. GFkV is ubiquitous, while the other viruses have been reported only from certain geographical areas. Despite few unconfirmed reports of natural field transmission of GFkV, no vector has been identified for it, nor any of the other viruses. Viral genomes consist of a single molecule of a capped and polyadenylated, cytosine-rich, messenger-like RNA 6.5–7.5 kb in size. According to the current taxonomy, these viruses belong to recognized or putative species in the genera *Maculavirus* (GFkV and GRGV) and *Marafivirus* (GSyV-1, GRVfV, and GAMaV) in the family *Tymoviridae*, order *Tymovirales*.

Keywords Asteroid mosaic • Fleck • *Maculavirus* • *Marafivirus* • Phloem • *Tymovirales* • *Tymoviridae*

S. Sabanadzovic (✉)

Department of Biochemistry, Molecular Biology, Entomology and Plant Pathology,
Mississippi State University, Mississippi State, MS 39762 USA
e-mail: ss501@msstate.edu

N. Aboughanem-Sabanadzovic

Institute for Genomics, Biocomputing and Biotechnology, Mississippi State University,
Mississippi State, MS 39762, USA

G.P. Martelli

Department of Soil, Plant and Food Sciences, University of Bari Aldo Moro, Bari, Italy

Introduction and Historical Aspect

The grapevine fleck complex comprises several diseases, most of which can be detected by grafting onto the indicator *Vitis rupestris* St. George (Martelli 2014; Martelli et al. 2015). Asteroid mosaic (AM), the first recognized disease of this complex, is characterized by translucent/chlorotic starlike spots on the foliage of several cultivars of *Vitis vinifera* and clearing of primary and secondary veins on *V. rupestris*. It was described in California and successfully transmitted by grafting (Hewitt 1954). Fleck disease (FK) was reported, also in California, almost a decade later from symptomless *V. vinifera* vines which, upon grafting onto *V. rupestris*, induced symptoms distinct from those of AM (Hewitt et al. 1962, 1972).

No virus could be identified in vines affected by these two diseases for a couple of decades, prompting suggestions of prokaryote origin of fleck (Milkus 1974). Finally, in 1983, two contemporary but independent studies revealed the presence of an isometric nonmechanically transmissible virus in the phloem tissues of some leafroll-affected vines (Castellano et al. 1983; Verderevskaia et al. 1983). This virus, which was initially named grapevine phloem-limited isometric virus (GPLIV), was later purified, and the first virus-specific antiserum was produced (Castellano et al. 1985). Virus particles are isometric, ca. 30 nm in diameter, and have a rounded contour and prominent surface structure with clusters of CP subunits arranged as pentamers and hexamers. In 1990, the physicochemical properties of GPLIV were determined, and its association with leafroll disease was ruled out (Boulila et al. 1990). Shortly afterward, a study conducted in Switzerland reported the close association of an isometric virus with fleck symptoms shown on *V. rupestris* (Gugerli et al. 1991). At the same time, Boscia et al. (1991a,b) observed the consistent presence of GPLIV in fleck-affected *V. rupestris* in Italy, demonstrated the role of this virus in disease etiology, and renamed it grapevine fleck virus (GFkV) (Boscia et al. 1991b).

Soon afterward, an isometric virus with morphological traits resembling those of GFkV was recovered and partially purified from asteroid mosaic-affected *V. rupestris* from California that were kept in a virus collection at the University of Bari (Italy) (Boscia et al. 1994). Despite the morphological resemblance with GFkV, this virus proved to be serologically distinct and was named grapevine asteroid mosaic-associated virus (GAMaV) (Fig. 16.1). Further studies, based on the design and use of degenerate primers, allowed the amplification of two signature domains (i.e., methyltransferase and RNA-dependent RNA polymerase) of the viral replicase gene and their cloning and sequencing (Sabanadzovic et al. 2000). Molecular data confirmed that GAMaV is a distinct virus, evolutionary related to GFkV, which led to further molecular characterization by sequencing of the 3' end of its genome (Abou Ghanem-Sabanadzovic et al. 2003a).

Virions resembling those of GFkV were found in Italy in a leafroll-diseased vine of cv. Red Globe. Since this vine was not infected by GFkV, a more in-depth investigation was conducted, which disclosed that the virus under study was distinct from both GFkV and GAMaV. Thus, it was given the name of grapevine red globe

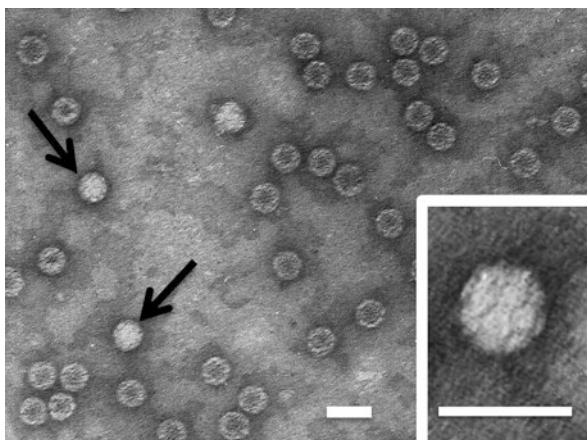

Fig. 16.1 Electron micrograph of negatively stained partially purified preparation of grapevine asteroid mosaic-associated virus (GAMaV) containing two types of virus particles: empty particles (penetrated by the stain) and apparently intact particles with prominent surface structures (*arrows*). *Inset* shows a close-up of a virus particle. Magnification bars = 50 nm

virus (GRGV) (Sabanadzovic et al. 2000). GRGV is also biologically different from GFkV and GAMaV, as it does not elicit symptoms in *V. rupestris*.

Grafting on *V. rupestris* of budwood from a vine of cv. Sultanina of Greek origin with symptoms resembling those of asteroid mosaic (Kyriakopoulou 1991, Kyriakopoulou et al. 1993) resulted in the transient expression of mild chlorotic discoloration of the primary and secondary leaf veins (vein feathering), quite different from the reaction elicited in the same indicator by true asteroid mosaic sources (Boscia et al. 1994). Symptomatic *V. rupestris* vines contained another virus distantly related with those of members of the fleck complex (Elbeaino et al. 2001). This virus was later characterized and named grapevine rupestris vein feathering virus (GRVfV) (Abou Ghanem-Sabanadzovic et al. 2003a).

Grapevine Syrah virus 1 (GSyV-1) was discovered in 2009 as a result of a next-generation sequencing (NGS) run performed in the attempt to clarify the etiology of a decline syndrome affecting vines of cv. Syrah in California (Al Rwahnih et al. 2009). Contemporarily, during an investigation on the virome of native grapes in the Southeastern USA, an apparently new virus found in symptomless muscadine vines was described under the name grapevine virus Q (GVQ) (Sabanadzovic et al. 2009). Comparison of the GSyV-1 and GVQ genome organization and sequence disclosed that the two viruses are the same.

The advent of new technologies and the increased interest in grapevine research are continuing to add knowledge on GFkV and related viruses, especially about their distribution (Table 16.1) and genetic diversity. Hence, the ubiquitous nature of GFkV (Martelli 2014) was further confirmed by recent reports of this virus from India (Kumar et al. 2013), former Yugoslavian Republic of Macedonia (Kostadinovska et al. 2014), the UK (Immanuel et al. 2015), and Canada (Poojari

Table 16.1 Current geographic distribution of grapevine fleck virus-like viruses

Virus	Country (state)
GFkV	Worldwide
GRVFV	Greece, Italy, USA (California, New York), South Africa ^{GB} , Brazil ^{GB} , Spain ^{GB}
GAMaV	USA (California, New York), Canada
GRGV	Greece, Albania, Italy, USA (New York), France, China, Brazil ^{GB}
GSyV-1	USA (California, Washington, Mississippi, North Carolina, New York), Italy, France, Slovakia, Czech Republic, Chile, South Africa, Brazil, Canada, Hungary, Australia ^a

GB – data available in GenBank

^a– reported as GFkV ‘variant 416’ by Shi et al. (2003)

Table 16.2 Percent amino acid identity among RdRp (above diagonal) and CP (below diagonal) encoded by grapevine fleck virus (GFkV) and related viruses: grapevine red globe virus (GRGV), grapevine rupestris vein feathering virus (GRVFV), grapevine asteroid mosaic-associated virus (GAMaV), and grapevine Syrah virus 1 (GSyV-1)

	GFkV	GRGV	GRVFV	GAMaV	GSyV-1
GFkV		62.2	62.2	64.4	65.5
GRGV	38.6		61.2	65.3	61.2
GRVFV	31.2	30.6		73.0	68.4
GAMaV	30.6	31.8	39.7		68.9
GSyV-1	32.0	31.6	57.7	36.2	

et al. 2016). Published reports on the presence of GSyV-1 in South America (Engel et al. 2010), Central Europe (Glasa et al. 2015; Czotter et al. 2016), and South Africa (Oosthuizen et al. 2016) and unpublished data from Brazil (GenBank Acc No KX130754) suggest a distribution pattern similar to that of GFkV. The occurrence of GRGV is documented from Greece, Italy (Pantaleo et al. 2010), France (Beuve et al. 2015), China (Fan et al. 2016), Spain (Cretazzo et al. 2017), and Brazil (GenBank Acc No KR107538), while GRVFV appears to have a more restricted distribution. GAMaV, until recently known to infect vines only in the USA (California, New York), has been reported from Canada (Xiao and Meng 2016) as well as from Uruguay (Jo et al. 2015) (Table 16.2).

Taxonomy and Nomenclature

The current classification (Dreher et al. 2012) assigns GFkV to the homonymous type species of the genus *Maculavirus*, while GSyV-1 belongs to a recognized definitive species in the genus *Marafivirus* (both in the family *Tymoviridae*, order *Tymovirales*).

Other GFkV-like viruses have not been officially classified yet, mainly due to the lack of complete genome sequences. Nevertheless, the tentative taxonomic position of these viruses could be inferred with a relatively high confidence based upon the

available information on particle morphology, physicochemical properties, partial genome sequences, pairwise comparisons, and phylogenetic analyses (Martelli et al. 2002a, b). Grouping of GAMaV and GRVfV with recognized species in the genus *Marafivirus* in phylogenetic trees constructed with taxonomically relevant genes (i.e., RdRp and CP) strongly suggests that they represent distinct species worth classification in the said genus. This taxonomic allocation has been supported by recent data on GAMaV and GRVfV complete genome sequences (Vargas-Asencio et al. 2017; N. Aboughanem-Sabanadzovic, unpublished data). Therefore, their formal recognition as members of the genus *Marafivirus* is expected to happen soon. Likewise, similarities in the organization of the 3' end of genomic RNA and the phylogenetic affiliation with GFkV in both RdRp and CP genes support the notion that GRGV belongs in the genus *Maculavirus* (family *Tymoviridae*) as a member in its own right. Nevertheless, at present, GAMaV, GRVfV, and GRGV are still awaiting their official taxonomic recognition.

Genome Structure, Genome Expression, and Replication

Complete genome sequences are currently available for GFkV (Sabanadzovic et al. 2001), GSyV-1 (Al Rwahnih et al. 2009; Sabanadzovic et al. 2009; Glasa et al. 2015), GAMaV (Vargas-Asencio et al. 2017), and GRVfV (N. Aboughanem-Sabanadzovic, unpublished information). Partial data on GRGV genome comprises nucleotide sequences of the genes involved in replication (MTR and RdRp), as well as the viral coat protein (CP) cistron.

Albeit there are differences in the organization of the different GFkV-like virus genomes, all of them share several common features, as they are (i) made up of a single molecule of positive-sense single-stranded RNA, (ii) polyadenylated at the 3' end, (iii) presumably capped at the 5' terminus, (iv) rich in cytidine (exceeding 40% of the nucleotide content), and (v) expressed via a combination of posttranslational processing of a large precursor polyprotein into several mature proteins involved in viral replication and synthesis of 3' coterminal subgenomic RNA molecules as templates for CP translation (Fig. 16.2).

Grapevine fleck virus (*GFkV*)

The GFkV genome is the largest of all (Fig. 16.3a). It consists of 7.5-kb-long, polyadenylated, and extremely cytosine-rich (50% of the total content) RNA molecule, comprising four open reading frames (ORFs) and untranslated regions (UTRs) of 291 and 35 nt at the 5' and 3' ends, respectively. ORF1 codes for a putative polyprotein with estimated molecular mass of 215 kDa that contains signature motifs of several domains involved in the replication cycle of viruses belonging in the family *Tymoviridae* (order *Tymovirales*), namely, methyltransferase (MTR), papain-like

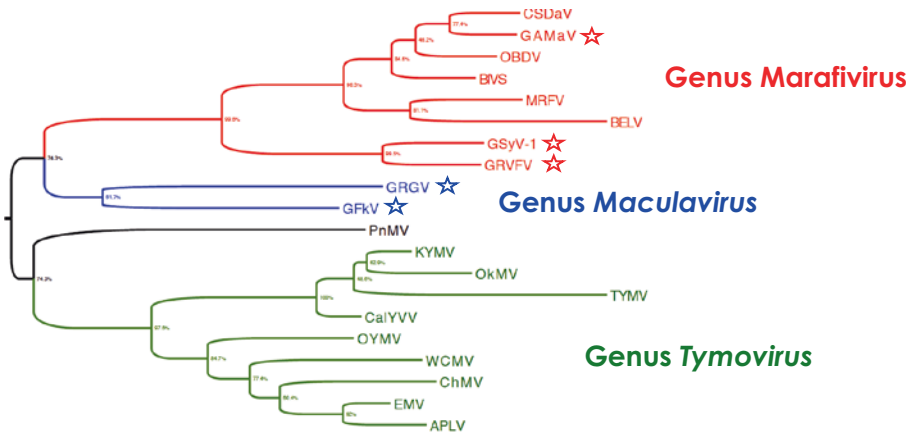

Fig. 16.2 Maximum likelihood-based phylogenetic tree showing the relationships of grapevine fleck virus and related viruses (indicated by stars) with approved and putative members in the family *Tymoviridae*. The tree is based on the amino acid sequences of viral RdRps and was generated with MEGA 6.06. (Tamura et al. 2013) under the best-fit substitution model (LG + G) for amino acid dataset. Bootstrap percentage values out of 1000 replicates are shown on the nodes. The three genera of the family *Tymoviridae* are color coded. Names, abbreviations, and GenBank accession numbers of viruses used for generating the tree are Andean potato latent virus (APLV, AF035402), Calopogonium yellow vein virus (CalYVV, AAC58458), chayote mosaic virus (ChMV, AF195000), citrus sudden death-associated virus (CSDaV, NC_006950), eggplant mosaic virus (EMV, J04374), grapevine asteroid mosaic-associated virus (GAMaV, AJ249358), grapevine fleck virus (GFkV, NC_003347), grapevine red globe virus (GRGV, AJ249360), grapevine rupestris vein feathering virus (GRVFV, AY128949), Kennedy yellow mosaic virus (KYMV, NC_001746), maize rayado fino virus (MRFV, AF265566), oat blue dwarf virus (OBDV, U87832), okra mosaic virus (OkMV, AF035202), ononis yellow mosaic virus (OYMV, J04375), poinsettia mosaic virus (PnMV, NC_002164), turnip yellow mosaic virus (TYMV, NC_004063), and wild cucumber mosaic virus (WCMV, AF035633)

protease (PRO), helicase (HEL), and RNA-dependent RNA polymerase (RdRp). Because of the similarity in domain content with similar proteins encoded by tymoviruses, it is assumed that mature proteins are produced via autocatalytic cleaving of the 215 kDa precursor polyprotein. An in-frame ORF2 is separated from ORF1 by a double stop codons and potentially codes for a 24.5 kDa protein identified as the viral CP. ORF3 and ORF4 are 3' coterminal and potentially code for proteins of 31 and 16 kDa, respectively, both rich in proline and serine. The role of these two putative proteins in the life cycle of GFkV is still unknown. Expression of ORFs coding for the putative CP, p31, and p16 is likely ensured by the synthesis of at least two subgenomic RNAs produced in infected tissue and occasionally encapsidated in virus particles (Sabanadzovic et al. 2001). However, expression of these two putative ORFs is yet to be experimentally confirmed.

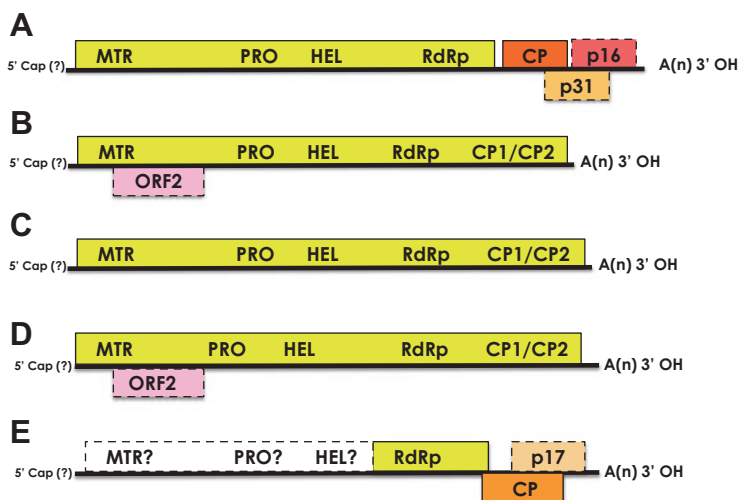

Fig. 16.3 Diagrammatic representation of complete genomes of grapevine fleck virus (a), grapevine Syrahvirus 1 (b), grapevine rupestris vein feathering virus (c), grapevine asteroid mosaic-associated virus, (d) and the partially sequenced genome of grapevine red globe virus (e). *Boxes* represent large ORFs and corresponding putative products; *lines* represent untranslated genomic regions (UTRs) at the genome extremities. Known genome sequences are depicted with *full lines*, while *dotted lines* represent parts of genomes yet to be sequenced, or ORFs yet to be confirmed functional/expressed in plants. Schemes are not to scale. Abbreviations: *MTR* = methyltransferase, *PRO* = endopeptidase/protease, *HEL* = helicase, *RdRp* = RNA-dependent RNA polymerase, *CP* = coat protein. Not to scale

Grapevine Syrahvirus1 (*GSyV-1*)

Genomes of *GSyV-1* isolates from cv. Syrah affected by a decline syndrome (Al Rwahnih et al. 2009) and from symptomless muscadines (Sabanadzovic et al. 2009) are colinear; consist of 6481 nucleotides, excluding the polyA tail at the 3' end; and contain two ORFs (Fig. 16.3b). ORF1 represents the majority (95%) of the genome and potentially codes for a polyprotein with an estimated molecular mass of 230 kDa. The three fourths of this polypeptide, located at the N-terminus, is characterized by the presence of conserved motifs of MTR, P-PRO, HEL, and RdRp, while the carboxy coterminal part encodes two CPs with an estimated size of 23 kDa and 21 kDa, respectively. An additional, small ORF, potentially coding for a polypeptide with a molecular mass of 26–27 kDa, is present near the 5' end. It is not clear whether this ORF is expressed *in planta* or not and what its role is. However, its expression product is rich in proline and serine and shares 43% identical residues with p43, a protein putatively expressed by an ORF present in the genome of maize rayado fino virus (MRFV), a typical *Marafivirus* (Hammond and Ramirez 2001).

The unique feature of the *GSyV-1* genome is the structural permutation of the characteristic RdRp motifs A-B-C that form the active site (Sabanadzovic et al.

2009). Unlike other plant viruses, the 21 amino acid long motif C of the viral RdRp is relocated upstream of the motif A to form an unusual C-A-B sequence. Such permutation does not seem to occur in other positive-sense alphavirus-like RNA viruses. Its biological implications are yet to be understood.

Full genome sequences of additional three GSyV-1 isolates from Central Europe have recently been published (Glasa et al. 2015), two of which contain an extra nucleotide compared with the isolates from California and Mississippi.

Grapevine rupestris vein feathering virus (*GRVfV*)

Published partial nucleotide sequences comprising the viral MTR, RdRp, and CPs (Abou Ghanem-Sabanadzovic et al. 2003a) substantiated by unpublished data on its complete genome (S. Sabanadzovic and N. Aboughanem-Sabanadzovic, unpublished information) indicate the close relationships of GRVfV with extant members of the genus *Marafivirus* (family *Tymoviridae*). The 6.7 kb GRVfV genome (Fig. 16.3c) is monocistronic and closely resembles that of oat blue dwarf virus (OBDV) in organization. The large ORF codes for a putative polyprotein of approx 234 kDa containing the conserved motifs of proteins involved in virus replication and, possibly, two CPs with estimated molecular masses of 23 kDa and 21 kDa. The marafibox precedes two AUG codons, the putative initiation sites for the translation of CPs.

Grapevine asteroid mosaic-associated virus (*GAMaV*)

For more than a decade, the knowledge about GAMaV genome was limited to partial sequences of isolate USA9 encompassing a fragment of the viral MTR and the 3' region comprising the RdRp domain and two CPs (Abou Ghanem-Sabanadzovic et al. 2003a). Nevertheless, genome of GAMaV isolate GV30 has been completely sequenced very recently (Vargas-Asencio et al. 2017). The complete genome of GAMaV is 6719 nt long excluding a poly(A) tail and shares 94% identical nucleotides with isolate USA9. Computer analysis identified the presence of a unique large ORF encoding a possible polyprotein of 2158 aa with recognized conserved domains of MTR, PRO, HEL, RdRp, and CPs and a genome organization similar to that of the marafiviruses (Dreher et al. 2012). The large ORF is preceded and followed by 129 and 116 nt long 5' and 3' untranslated regions, respectively (Vargas-Asencio et al. 2017). The putative subgenomic RNA promoter ("marafibox") has been identified in the GAMaV genome upstream of the possible initiation sites for translation of two putative CPs with estimated molecular mass of 24 kDa and 21 kDa, respectively (Abou Ghanem-Sabanadzovic et al. 2003a; Vargas-Asencio et al. 2017). An additional 5' proximal ORF, with a potential of coding for a putative product of 38.5 kDa but lacks a canonical AUG start codon, has been identified in GAMaV genome.

Grapevine red globe virus (*GRGV*)

The available nt sequence of GRGV comprises a stretch of approximately 2 kb at the 3' end of the genome (Fig. 16.3e). This genomic fragment is characterized by a high cytosine content (exceeding 41%); comprises three putative ORFs, which are followed by a 139-long 3' NCR; and terminates with a polyA tract (Abou Ghanem-Sabanadzovic et al. 2003a). The first ORF is partially sequenced and codes for the C-proximal part of the viral replicase, containing the RdRp domain. The second ORF partially overlaps ORF1 and encodes a 25 kDa peptide identified as CP. The 3'-proximal possible ORF3 codes for a putative 17 kDa protein characterized by an unusually high proline content (31%). Whether ORF3 is expressed *in planta* and what could be the possible role of protein p17 in the life cycle of GRGV is still unknown (Abou Ghanem-Sabanadzovic et al. 2003a).

Genetic Diversity and Population Structure

More than 80 partial nt sequences, along with the complete genome of isolate MT48 from Italy (Sabanadzovic et al. 2001), are currently available for GFkV in GenBank (database accessed in late November 2015). The majority of deposited sequences are representative of viral RdRp and CP genes. However, many of them are too short and not sufficiently informative.

The most significant study on GFkV population targeting the viral CP gene was carried out in Slovakia (Glása et al. 2011). Sequencing this gene from 36 GFkV isolates collected from local grapevines and its comparison with sequences from databases revealed nt identities ranging from 88 to 100%, with a maximum divergence of 12% between a few Slovakian isolates and the type strain MT48. Most of the mutations were silent, and a maximum divergence of 5% was found in the amino acid (aa) content. The same study showed that the analyzed virus isolates clustered in two distinct molecular groups and suggested that the CP gene is under a negative selection pressure (Glása et al. 2011). The presence of two distinct molecular groups with a significant range of intergroup variability (up to 10%) was also reported for a dozen of GFkV isolates from Idaho (Kanuya et al. 2012). The CP of several GFkV isolates from Washington State in the USA showed 94–95% nt sequence identity with the type isolate (Mekuria and Naidu 2010).

Eight complete (or nearly complete) nt sequences are available for GSyV-1, including those of two isolates from California (Acc. no. FJ436028; Al Rwahnih et al. 2009) and Mississippi (Acc. No. FJ977041; Sabanadzovic et al. 2009) and of six additional isolates: two from Slovakia, one from the Czech Republic (Acc. nos. KP221255-257; Glása et al. 2015), plus two sequences of Brazilian isolates (Acc. nos. KT037017 and KR153306) and one from Canada (Acc. no. JX513896). Direct comparison shows that significant nt differences exist among these isolates. In particular, the Brazilian isolate “MH” was the most divergent and uniformly distinct

from all the others (nt identity 82.5–83.8%). Interestingly, the three GSyV-1 isolates from Central Europe were more diverse (max nt difference 7.1%) than the three representatives from North America (only 1.2% intragroup divergence) (Glasa et al. 2015).

As to GRVFV, based upon available data from four isolates (two complete or near-complete genome sequences from Greece and California and two partial CP sequences from Brazil), this virus appears to be rather divergent, as pairwise comparisons between CP sequences indicated an inter-isolate variability of up to 14%.

Comparison of CP sequences between two of GAMaV sequences (one from the original source and one from Italy) showed a diversity of 5% at the nt level (4% in the aa content) in a very small genome segment. Additionally, GRGV has been recently reported from France upon Illumina sequencing of a Cabernet franc plant showing fanleaf-like symptoms (Beuve et al. 2015). Two contigs matched the viral replicase and shared 85% nt identity with the “type” isolate (Abou Ghanem-Sabanadzovic et al. 2003a), while partial CP sequences of the two isolates shared 92% common nucleotides.

Detection and Diagnosis

Diverse methods, spanning from traditional to modern ones, have been developed and are currently available for detection and identification of GFkV and related viruses.

Biological Methods

Infections by GFkV and some related viruses (i.e., GAMaV and GRVFV) can readily be discriminated from those of any other grapevine disease (and from each other) by the specific responses of *V. rupestris* in which fleck usually induces localized translucent spots of the young leaves due to clearing of the veins of lower (third and fourth) order (Fig. 16.4a). Severe forms of fleck cause stunting, poor rooting, and reduced graft take of nursery productions (Triolo and Materazzi 1987; Credi and Babini 1996), whereas asteroid mosaic elicits creamy-yellow bands along the major veins of the leaves, which are twisted and asymmetric (Fig. 16.4b). A transient chlorotic discoloration (feathering) of the primary and secondary veins is the reaction to GRVFV (Fig. 16.4c). GRGV does not seem to induce any particular symptomatology, and the possible effects of GSyV-1 are yet to be studied.

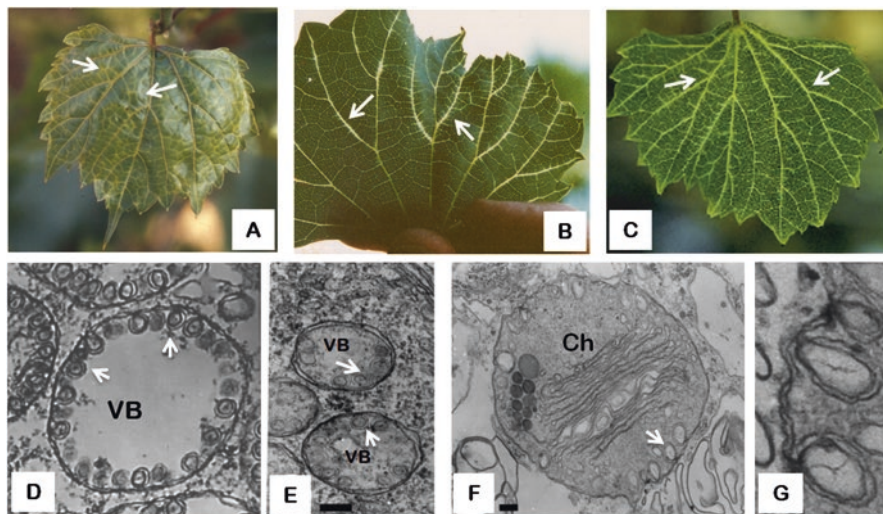

Fig. 16.4 Effects of infections by grapevine fleck virus and related viruses in grapevines. Symptoms of different diseases of the grapevine fleck complex induced in the specific indicator *Vitis rupestris* “St. George”: fleck, clearing of the tertiary and quaternary veins (a); asteroid mosaic, strong clearing of primary and secondary veins (b); and vein feathering, transient vein discoloration (c). Cytopathic structures associated with grapevine infections by GFkV and similar viruses. Vesiculated bodies (VB), originating from mitochondria, present in differentiating sieve tubes and companion cells of GFkV- (d) and GAMaV-infected (e) grapevines. VBs are characterized by the presence of peripheral double-membrane vesicles (arrows) that line the mitochondrial bounding membrane. Rounded and altered chloroplasts (Ch) with numerous double-membrane vesicles (f) containing fine fibrillar material in sieve tubes and companion cells of GRGV-infected plants. A close-up of the chloroplast vesicles is in panel (g) (Images c and d–g reproduced from Martelli et al. 2015 and Sabanadzovic et al. 2000, respectively)

Serological Methods

Polyclonal antisera and monoclonal antibodies to GFkV have been raised (Boscia et al. 1991a, 1995; Schieber et al. 1997), and commercial ELISA kits are now available for routine diagnosis of this virus. There are no serological tools for the detection of the other GFkV-related viruses.

Molecular Methods

Molecular detection of GFkV was initially based on the use of a nonradioactive cRNA probe for virus identification in dot spot, Northern blot, and tissue blot assays (Sabanadzovic et al. 1996). The same approach was used for GAMaV and GRGV (Elbeaino et al. 2001).

The first RT-PCR detection system was developed in the mid-1990s (Sabanadzovic et al. 1996). It was followed by the design of a number of virus-specific or “universal” primers allowing RT-PCR-based detection of GFkV and allied viruses, either in single- or multiple-target formats. Sets of degenerate primers targeting the MTR and RdRp genes were designed and successfully used on purified viral dsRNAs or total nucleic extracts for the nondiscriminative recognition of GFkV, GAMaV, and GRGV, the three viruses known at that time (Sabanadzovic et al. 2000). Another set of degenerate primers, targeting the viral helicase gene, was developed soon afterward and used for the simultaneous detection of these viruses, while, in the same study, DIG-RNA probes were successfully employed for the selective identification of the different viruses in dot spot hybridization tests (Elbeaino et al. 2001).

Degenerate primers targeting the viral RdRp, developed in 2000 and modified in 2009, proved most useful for the routine and nondiscriminative detection of these viruses, as well as other marafi- and maculaviruses in plants other than grapevines, such as blackberry and ranunculus (Sabanadzovic et al. 2009; S. Sabanadzovic, unpublished information). Because of the specific targeted region that encompasses the permuted motif in GSyV-1, these primers discriminate GSyV-1 from related viruses because of the different size of the amplified products due to an insertion of 63 nt (344 bp in GFkV, GRVfV, GRGV, and GAMaV vs 407 bp in GSyV-1).

Several sets of GFkV-specific primers targeting different parts of the viral genome were described and used in two-step or single-tube assays for the recognition of this virus in single (Sabanadzovic et al. 1996; Osman and Rowhani 2006; Mekuria and Naidu 2010; Glasa et al. 2011) or mix infections with other viruses (Gambino and Gribaudo 2006). A quantitative real-time PCR (qRT-PCR) assay based on TaqMan chemistry was developed for GFkV in single (Osman et al. 2008; Bertolini et al. 2010) or multiple reactions (López-Fabuel et al. 2013). In addition, Low Density Arrays have been designed for GFkV along with other 12 grapevine viruses (Osman et al. 2008). The TaqMan-based real-time RT-PCR approach was successfully developed and applied for quantitation of several viruses in field-grown samples of cv. Nebbiolo, including GFkV (Pacífico et al. 2011).

GAMaV-, GRVfV-, and GRGV-specific RT-PCR assays have also been finalized (Sabanadzovic et al. 2000; Abou Ghanem-Sabanadzovic et al. 2003b), whereas another set of GRGV-specific primers has more recently been employed for its detection in France (Beuve et al. 2015).

Although several sets of primers had been designed for the RT-PCR detection of GSyV-1 immediately following the virus discovery and characterization (Al Rwahnih et al. 2009, Sabanadzovic et al. 2009; Mekuria and Naidu 2010), the availability of sequences of multiple virus isolates has led to conceiving improved primers targeting the viral CP gene, which are based on the highly conserved nucleotide sequences shared by diverse GSyV-1 isolates (Glasa et al. 2015). These primers confirmed the presence of an inter-isolate molecular diversity and allowed the detection of 29 divergent GSyV-1 isolates in a survey carried out in Central Europe (Glasa et al. 2015), compared to only 15 identified by the primers designed on the original sequence of the Californian virus isolate (Al Rwahnih et al. 2009).

Finally, multiple virus-specific probes were designed for GFkV-like viruses in the framework of an “universal” crop-specific microarray platform, aimed at detecting any of the 38 most important or emerging grapevine viruses, which successfully identified the targeted viruses in single or multiple infections, including GFkV and allied viruses (Thompson et al. 2014).

Host Range and Transmission

GFkV and related viruses are known to infect only *Vitis* spp., except for GSyV-1, which has a natural host range comprising also wild blackberries (*Rubus* sp.), muscadine (*Vitis rotundifolia*), and summer grape (*Vitis aestivalis*) (Sabanadzovic et al. 2009).

Reports from Japan (Yamakawa 1989), South Africa (Engelbrecht and Kasdorf 1990), and Italy (Fortusini et al. 1996) of natural field spread of GFkV have not been experimentally confirmed, nor the putative vector has been identified. Mechanisms of natural spread of GRGV, GRVfV, and GAMaV, if any, are also unknown. Although GSyV-1 was detected in adults of the variegated leafhopper (*Erythroneura variabilis*) collected from infected grapevines in California (Al Rwahnih et al. 2009), no transmission trials have been reported.

Thus, the primary way of long-distance dissemination of GFkV-like viruses is through propagative material (budwood, rootstocks, nursery productions) and, at a site, by grafting. None of these viruses is mechanically transmissible to herbaceous indicators, and GFkV is not seed transmissible (Hévin et al. 1973). Dodder-mediated grape-to-grape transmission of the fleck agent to 50% of acceptor *V. rupestris* plants was obtained in Australia (Woodham and Krake 1983). In some cases, typical fleck symptoms appeared 3 weeks after dodder bridge establishment. Anyway, dodder-mediated transmission from the same grape donors to ten different herbaceous hosts failed.

Cytopathology, Tissue Tropism, and Virus-Host Interactions

The cytopathology of grapevine cells infected by GFkV, GAMaV, and GRVfV has been described (Castellano et al. 1983; Castellano and Martelli 1984; Sabanadzovic et al. 2000). Ultrastructural modifications are restricted to phloem tissues (differentiating sieve elements, companion cells, phloem parenchyma cells) in which virus particles usually occur, either in a scattered form, in disorderly aggregates, or in crystalline arrays.

GFkV-infected cells show secondary vacuolation and proliferation of membranes appearing as vesicles scattered in the cytoplasm or aggregated in paramural bodies. Whereas nuclei are apparently unaltered, chloroplasts and mitochondria are modified. Mitochondrial alterations are much more prominent and common, often affecting the totality of such organelles present in a cell. The ultrastructural changes suffered by mitochondria consist of a series of modifications that initiate with the

development of peripheral double-membraned vesicles, originated by the invagination of the organelle's bounding membrane. The increase in the number of the vesicles is accompanied by the progressive loss of the cristae and thinning of the stroma (Castellano and Martelli 1984). The outcome of these transformations is a cytopathic structure with an apparently empty electron-lucent center, peripherally lined with vesicles, to which the name of vesiculated body (VB) was given (Castellano et al. 1983) (Fig. 16.4d). VB vesicles are flask shaped, their neck opening to the surrounding cytoplasm, and contain a network of fine fibrils which, by analogy with the comparable material present in the vesiculated organelles typical of tombusvirus (Rubino et al. 2014) and tymovirus (Lesemann 1977) infections, are thought to be viral RNA.

Cells from foliar and root tissues of *V. rupestris* affected by asteroid mosaic possess an apparently normal and well-preserved organization and structure. However, some of the root cells contained round, double-membrane structures with peripheral vesicles of *ca* 80 nm in diameter, resembling the VB associated with GFkV infections (Fig. 16.4e). Unlike GFkV-infected cells, which usually contain plenty of virions, these were not seen in the examined samples of GAMaV-infected *V. rupestris* (Sabanadzovic et al. 2000).

Differentiating sieve tubes and companion cells of GRVfV-infected grapevine tissues contained chloroplasts with a rounded shape, a heavily modified internal structure and flask-shaped double-membraned vesicles lining their periphery (Fig. 16.4f, g) (Sabanadzovic et al. 2000). These vesicles had the fibrillar content suggestive of viral dsRNA. Thus, contrary to GFkV and GAMaV infections, where VB originate from altered mitochondria, GRVfV appears to target chloroplasts.

Pathological Properties, Associated Diseases, and Their Impact

Infections by GFkV and related viruses are latent or semi-latent in most *V. vinifera* cultivars and American rootstocks (Martelli 2014; Martelli et al. 2015). The exceptions are the Californian asteroid mosaic and asteroid-like disease from Greece, both of which are characterized by chlorotic star-shaped spots on the leaves of some cultivars (Hewitt 1954; Kyriakopoulou 1991). As mentioned, putative agents of these two diseases are GAMaV and GRVfV (Sabanadzovic et al. 2000, Elbeaino et al. 2001, Abou Ghanem-Sabanadzovic et al. 2003a). GRGV was isolated from a vine of cv. Red Globe and did not induce any specific symptom upon grafting on *V. rupestris* (Abou Ghanem-Sabanadzovic et al. 2003a and unpublished information). GSyV-1, originally discovered in a decline-affected vine, does not seem to have a bearing in this disorder (Al Rwahnih et al. 2009) and was also found in muscadines with no obvious symptoms (Sabanadzovic et al. 2009).

There are few additional diseases described in the literature that suggest the involvement of GFkV-like and still undescribed virus(es). One of them is "rupestris necrosis," reported from Japan (Matsumoto and Ohki 1998), which owes its name to

the reaction of *V. rupestris* grafted with buds from a symptomless vine of cv. Abujiaoqi of Chinese origin, consisting of localized necrosis of shoots, leaf petioles, and secondary veins. Symptomatic indicators contained isometric virus particles morphologically resembling those of GFkV and mitochondria-derived VB were observed in thin-sectioned cells. Finally, studies carried out in Brazil suggest the presence of at least three GFkV-like viruses (referred to as “three distinct strains”) based upon the differential reaction of *V. rupestris* and other indicators (Kuniyuki and Costa 1995).

Strategies for Control and Management

Because of the latency of symptoms, sanitary selection of *V. vinifera* cultivars and most American rootstock hybrids is ineffective. However, GFkV-free mother stocks are readily obtained as this virus is efficiently eliminated by an array of different techniques, i.e., heat therapy (Ottenwaelter et al. 1973), fragmented shoot apex culture (Barlass et al. 1982), meristem-tip culture (Boscia et al. 1991a), and micro-grafting of shoot apices (Spilmont et al. 2012). The same sanitation procedures may also operate successfully with the other viruses of the complex, but no experimental data are available.

Conclusions and Future Research Directions

Pathogenicity and epidemiology are two little explored aspects of the behavior of viruses of the fleck complex. As a whole, these viruses are retained as being little or no pathogenic. For example, the grapevine certification scheme enforced in the European Union considers only GFkV for exclusion, limitedly to the American rootstocks (Maliogka et al. 2015). Nevertheless, the heavy damage that some of the viruses inflict to major organelles, such as mitochondria (GFkV in particular) and chloroplasts, could have a bearing on plant health that may be worth investigating.

Likewise, experimental confirmation should be sought of the field observations from Japan (Yamakawa 1989), South Africa (Engelbrecht and Kasdorf 1990), and Italy (Fortusini et al. 1996), reporting natural spread of GFkV in vines showing leafroll symptoms. It seems plausible to hypothesize that GFkV, which occupies the same ecological niche (sieve tubes) of ampeloviruses and vitiviruses, may be moved by the same vectors that spread these pathogens (Martelli 2014).

Acknowledgments The authors would like to thank all scientists that contributed to the current knowledge on these viruses, providing an inspiration and a valuable source of information for the preparation of this chapter. Thanks are extended to various funding agencies that allowed studies on these viruses at the University of Bari and Mississippi State University in particular to Mississippi Agricultural and Forestry Experiment Station (MAFES) Strategic Research Initiative and NIFA Hatch Projects for financial support to SS and NA.

References

- Abou Ghanem-Sabanadzovic, N., S. Sabanadzovic, and G.P. Martelli. 2003a. Sequencing of the 3' end of three grapevine fleck virus-like viruses. *Virus Genes* 27: 11–16.
- Abou Ghanem-Sabanadzovic, N., S. Sabanadzovic, A. Rowhani, and G.P. Martelli. 2003b. Multiplex RT-PCR detection of grapevine fleck virus-like viruses in grapevine with coamplification of control plant mRNA. Extended abstracts 14th meeting of ICVG, Locorotondo, Italy: 195.
- Al Rwahnih, M., S. Daubert, D.A. Golino, and A. Rowhani. 2009. Deep sequencing analysis of RNAs from a grapevine showing Syrah decline symptoms reveals a multiple virus infection that included a novel virus. *Virology* 387: 395–401.
- Barlass, M., K.G.M. Skene, R.C. Woodham, and L.R. Krake. 1982. Regeneration of virus-free grapevines using in vitro apical culture. *Annals of Applied Biology* 101: 291–295.
- Bertolini, E., J. Garcia, A. Yuste, and A. Olmos. 2010. High prevalence of viruses in table grape from Spain detected by real-time RT-PCR. *European Journal of Plant Pathology* 128: 283–287.
- Beuve, M., T. Candresse, M. Tannières, and O. Lemaire. 2015. First report of grapevine redglobe virus in grapevine in France. *Plant Disease* 99: 422.
- Boscia, D., G.P. Martelli, V. Savino, and M.A. Castellano. 1991a. Identification of the agent of grapevine fleck disease. *Vitis* 30: 97–105.
- Boscia, D., V. Savino, G.P. Martelli, and M.A. Castellano. 1991b. Association of a phloem-limited non mechanically transmissible isometric virus with grapevine fleck disease. Proceedings 10th meeting of ICVG, Volos, Greece: 173–174.
- Boscia, D., S. Sabanadzovic, V. Savino, P.E. Kyriakopoulou, and G.P. Martelli. 1994. A non mechanically transmissible virus associated with asteroid mosaic of the grapevine. *Vitis* 33: 101–102.
- Boscia, D., V. Elicio, V. Savino, and G.P. Martelli. 1995. Production of monoclonal antibodies to grapevine fleck virus. *Plant Pathology* 44: 160–163.
- Boullila, M., D. Boscia, B. Di Terlizzi, M.A. Castellano, A. Minafra, V. Savino, and G.P. Martelli. 1990. Some properties of a phloem-limited non mechanically transmissible grapevine virus. *Journal of Phytopathology* 129: 151–158.
- Castellano, M.A., G.P. Martelli, and V. Savino. 1983. Virus-like particles and ultrastructural modifications in the phloem of leafroll-affected grapevines. *Vitis* 22: 23–39.
- Castellano, M.A., and G.P. Martelli. 1984. Ultrastructure and nature of vesiculated bodies associated with isometric virus-like particles in diseased grapevines. *Journal of Ultrastructure Research* 89: 56–64.
- Castellano, M.A., G.P. Martelli, V. Savino, and D. Boscia. 1985. Progress in the study of the phloem-limited isometric virus-like particles associated with leafroll-diseased grapevines. *Phytopathologia Mediterranea* 24: 165–169.
- Credi, R., and A.R. Babini. 1996. Effect of virus and virus-like infections on the growth of grapevine rootstocks. *Advances in Horticultural Science* 10: 95–98.
- Cretazzo E., C.V. Padilla, and L. Velasco, 2017. First report of grapevine red globe virus in grapevine in Spain. *Plant Disease* (in press) Doi:[10.1094/PDIS-06-16-0932-PDN](https://doi.org/10.1094/PDIS-06-16-0932-PDN)
- Czotter, N., E. Szabo, J. Molnar, L. Kocisz, T. Deák, G. Bisztray, G. Tusnády, J. Burgyán, and Várallyay E. 2016. First description of grapevine Syrah virus-1 from grapevine in Hungary. *Journal of Plant Pathology* 97 (in press).
- Dreher, T.W., M.C. Edwards, A.J. Gibbs, A.-L. Haenni, R.W. Hammond, I. Jupin, R. Koenig, S. Sabanadzovic, and G.P. Martelli. 2012. Family *Tymoviridae*. In *Virus Taxonomy. Ninth Report of the International Committee on Taxonomy of Viruses*, ed. A.M.Q. King, M.J. Adams, E.B. Carstens, and E.J. Lefkowitz, 944–952. Amsterdam: Elsevier-Academic Press.
- Elbeaino, T., S. Sabanadzovic, M. Digiario, N. Abou Ghanem-Sabanadzovic, A. Rowhani, P.E. Kyriakopoulou, and G.P. Martelli. 2001. Molecular detection of grapevine fleck virus-like viruses. *Vitis* 40: 65–68.

- Engel, E.A., P.A. Rivera, and P.D.T. Valenzuela. 2010. First report of grapevine Syrah virus 1 in Chilean grapevines. *Plant Disease* 94: 633.
- Engelbrecht, D.J., and G.G.F. Kasdorf. 1990. Field spread of corky bark, fleck, leafroll and Shiraz decline diseases and associated viruses in South African grapevines. *Phytophylactica* 22: 347–354.
- Fan, X.D., Y.F. Dong, Z.P. Zhang, F. Ren, G.J. Hu, Z.N. Li, and J. Zhou. 2016. First report of grapevine red globe virus (GRGV) in China. *Plant Disease* 100: 2340.
- Fortusini, A., G. Scattini, S. Cinquanta, and S. Prati. 1996. Diffusione naturale del virus 1 (GLRaV-1) e del virus 3 (GLRaV-3) dell'accartocciamento fogliare e del virus della maculatura infettiva o "fleck" (GFKV) della vite. *Informatore Fitopatologico* 46: 39–43.
- Gambino, G., and I. Gribaudo. 2006. Simultaneous detection of nine grapevine viruses by multiplex reverse transcription-polymerase chain reaction with coamplification of a plant RNA as internal control. *Phytopathology* 96: 1223–1229.
- Glasa, M., L. Predajňa, and P. Kominek. 2011. Grapevine fleck virus isolates split into two distinct molecular groups. *Journal of Phytopathology* 159: 805–807.
- Glasa, M., L. Predajna, K. Soltys, S. Sabanadzovic, and A. Olmos. 2015. Detection and molecular characterization of grapevine Syrah virus 1 isolates from Central Europe. *Virus Genes* 51: 112–121.
- Gugerli, P., B. Rosciglione, J.-J. Brugger, S. Bonnard, M.-E. Ramel, and F. Tremea. 1991. Further characterization of grapevine leafroll disease. Proceedings 10th meeting of ICVG, Volos, Greece: 59–60.
- Hammond, R.W., and P. Ramirez. 2001. Molecular characterization of the genome of maize rayado fino virus, the type member of the genus *Marafivirus*. *Virology* 282: 338–347.
- Hévin, M., M.M. Ottenwaelter, J.P. Doazan, and M. Rives. 1973. Investigating the transmission of marbrure and fanleaf through the seed in the grapevine. *Rivista di Patologia Vegetale (Ser. IV)* 9: 253–258.
- Hewitt, W.B. 1954. Some virus and virus-like diseases of grapevines. *Bulletin California Department of Agriculture* 43: 47–64.
- Hewitt, W.B., A.C. Goheen, D.J. Raski, and G.V. Gooding Jr. 1962. Studies on virus diseases of the grapevine in California. *Vitis* 3: 57–83.
- Hewitt, W.B., A.C. Goheen, L. Cory, and C. Luhn. 1972. Grapevine fleck disease, latent in many varieties, is transmitted by graft inoculation. *Annalen der Physik, NHS* 43–47.
- Immanuel, T.M., C. Delmiglio, L.I. Ward, J.O. Denton, and G.R.G. Glover. 2015. First reports of grapevine virus A, grapevine fleck virus and grapevine leafroll-associated virus 1 in the UK. *Plant Disease* 99: 898.
- Jo, Y., H. Ghoi, J.K. Cho, J.-Y. Yoon, S.-K. Choi, and W.K. Cho. 2015. *In silico* approach to reveal viral populations in grapevine cultivar Tannat using transcriptome data. *Scientific Reports* 5: 15841.
- Kanuya, E., L.A. Clayton, R.A. Naidu, and A.V. Karasev. 2012. First report of grapevine fleck virus in Idaho grapevines. *Plant Disease* 96: 1705.
- Kostadinovska, E., S. Mitrov, P.A. Bianco, P. Casati, and D. Bulgari. 2014. First report of grapevine virus A and grapevine fleck virus in the former Yugoslav Republic of Macedonia. *Plant Disease* 98: 1747.
- Kumar, S., L. Singh, L. Ferretti, M. Barba, A.A. Zaidi, and V. Hallan. 2013. Evidence of grapevine leafroll-associated virus 1–3, grapevine fleck virus and grapevine virus B occurring in Himachal Pradesh, India. *Indian J. Virology* 24: 66–69.
- Kuniyuki, H., and A.S. Costa. 1995. Occorrenca de mais um isolado do virus do mosaico da nervuras da videira que no causa sintomas no porta-enxerto Kober 5BB. *Fitopatologia Brasileira* 20: 618–622.
- Kyriakopoulou, P.E. 1991. Symptoms of grapevine asteroid mosaic in Greece. Proc. 10th meeting ICVG, Volos, Greece: 143–146.

- Kyriakopoulou, P.E., S. Tzortzakaki, and M. Tsagris. 1993. Grapevine asteroid mosaic in Greece: positive indexing results and viroids associated. Extended abstracts 11th meeting ICVG, Montreux, Switzerland: 41.
- Lesemann, D.E. 1977. Virus group-specific and virus-specific cytological alterations induced by members of the tymovirus group. *Phytopathologische Zeitschrift* 90: 315–336.
- López-Fabuel, I., T. Wetzel, E. Bertolini, A. Bassler, E. Vidal, B.L. Torres, A. Yuste, and A. Olmos. 2013. Real-time multiplex RT-PCR for the simultaneous detection of five main grapevine viruses. *Journal of Virological Methods* 188: 21–24.
- Maliogka, V.I., G.P. Martelli, M. Fuchs, and N.I. Katis. 2015. Control of viruses infecting grapevine. *Advances in Virus Research* 91: 175–227.
- Martelli, G.P. 2014. Directory of virus and virus-like diseases of the grapevine and their agents. *Journal of Plant Pathology* 96 (1 Supplement): 136.
- Martelli, G.P., A. Rowhani, and S. Sabanadzovic. 2015. The fleck complex. In *Compendium of grape diseases*, ed. W.F. Wilcox, W.D. Gubler, and J.K. Uyemoto, 2nd ed., 115–117. St. Paul: APS Press.
- Martelli, G.P., S. Sabanadzovic, N. Abou Ghanem-Sabanadzovic, and P. Saldarelli. 2002a. *Maculavirus*, a new genus of plant viruses. *Archives of Virology* 147: 1847–1853.
- Martelli, G.P., S. Sabanadzovic, N. Abou Ghanem-Sabanadzovic, M.C. Edwards, and T. Dreher. 2002b. The family *Tymoviridae*. *Archives of Virology* 147: 1837–1846.
- Matsumoto, T., and S.T. Ohki. 1998. A possible new necrotic diseases of grapevine associated with small isometric particles and novel membrane-bound large particles. *Annals of the Phytopathological Society of Japan* 64: 560–564.
- Mekuria, T.A., and R.A. Naidu. 2010. First report of grapevine virus sequences highly similar to Grapevine Syrah virus 1 from Washington vineyards. *Plant Disease* 94: 787.
- Milkus, B. 1974. Mycoplasma- or chlamydia-like bodies in grape, affected by marbour. *Acta Physiologica Academiae Scientiarum Hungaricae* 9: 385–388.
- Osman, F., and A. Rowhani. 2006. Application of a spotting sample preparation technique for the detection of pathogens in woody plants by RT-PCR and real-time PCR (TaqMan). *Journal of Virological Methods* 133: 130–136.
- Osman, F., C. Leutenegger, D. Golino, and A. Rowhani. 2008. Comparison of low-density arrays, RT-PCR and real-time TaqMan RT-PCR in detection of grapevine viruses. *Journal of Virological Methods* 149: 292–299.
- Oosthuizen, K., B. Coetzee, H. Maree, and J. Burger. 2016. First report of grapevine Syrah virus-1 in South African vineyards. *Plant Disease* 100: 1252.
- Ottenwaelter, M.M., M. Hévin, P. Leclair, J.P. Doazan, and M. Rives. 1973. Heat therapy eliminates the ability to transmit the causal agent of “marbrure” in several *V. vinifera* clones and in *V. rupestris* “du Lot” (St. George). *Rivista Di Patologia Vegetale*. (Ser. IV) 9:281–285.
- Pacifico, D., P. Caciagli, S. Palmano, F. Mannini, and C. Marzacchi. 2011. Quantitation of grapevine leafroll-associated virus 1, grapevine virus A, grapevine fanleaf virus and grapevine fleck virus in field-collected *Vitis vinifera* L. ‘Nebbiolo’ by real-time reverse transcription PCR. *Journal of Virological Methods* 172: 1–7.
- Pantaleo, V., P. Saldarelli, L. Miozzi, A. Giampetruzzi, A. Gisel, S. Moxon, T. Dalmay, G. Bisztray, and J. Burgyan. 2010. Deep sequencing analysis of viral short RNAs from an infected Pinot Noir grapevine. *Virology* 408: 49–56.
- Poojari, S., T. Lowery, M. Rott, A.-M. Schmidt, N. DeLury, J. Boulé, and J.R. Úrbez_Torres. 2016. First report and prevalence of grapevine fleck virus in grapevines (*Vitis vinifera* L.) in Canada. *Plant Disease* 100: 1028.
- Rubino, L., M. Russo, and G.P. Martelli. 2014. Tombusvirus-induced multivesicular bodies: Origin and role in virus-host interactions. In *Plant-virus interaction. Molecular Approaches and Viral Evolution*, ed. R.K. Gaur, T. Hon, and P. Sharma, 163–175. Amsterdam: Elsevier-Academic Press.
- Sabanadzovic, S., P. Saldarelli, and V. Savino. 1996. Molecular detection of grapevine fleck virus. *Vitis* 35: 137–140.

- Sabanadzovic, S., N. Abou Ghanem, M.A. Castellano, M. Digiario, and G.P. Martelli. 2000. Grapevine fleck virus-like viruses in *Vitis*. *Archives of Virology* 145: 553–565.
- Sabanadzovic, S., N. Abou Ghanem-Sabanadzovic, P. Saldarelli, and G.P. Martelli. 2001. Complete nucleotide sequence and genomic organization of grapevine fleck virus. *Journal of General Virology* 82: 2009–2015.
- Sabanadzovic, S., N. Abou Ghanem-Sabanadzovic, and A.E. Gorbalenya. 2009. Grapevine virus Q: the first plant virus with a permuted active site of RNA-dependent RNA polymerase. *Virology* 394: 1–7.
- Schieber, O., A. Seddas, C. Belin, and B. Walter. 1997. Monoclonal antibodies for detection, serological characterization and immunopurification of grapevine fleck virus. *European Journal of Plant Pathology* 103: 767–774.
- Shi, B.J., N. Habili, and R.H. Symons. 2003. Nucleotide sequence variation in a small region of grapevine fleck virus replicase provide evidence for two sequence variants of the virus. *Annals of Applied Biology* 142: 349–355.
- Spilmont, A.S., A. Ruiz, and S. Grenan. 2012. Efficiency of micrografting of shoot apices as a sensitive sanitation method against seven grapevine viruses (ArMV, GFLV, GLRaV-1, -2, -3, GFkV, GVA). Proc. 17th Cong. of ICVG, Davis, USA, 270–271.
- Tamura, K., G. Stecher, D. Peterson, A. Filipski, and S. Kumar. 2013. MEGA6: Molecular evolutionary genetics analysis version 6.0. *Molecular Biology and Evolution* 30: 2725–2729.
- Thompson, J.R., M. Fuchs, H. McLane, F. Celebi-Toprak, K.F. Fischer, J.L. Potter, and K.L. Perry. 2014. Profiling viral infections in grapevine using a randomly primed reverse transcription-polymerase chain reaction/microarray multiplex platform. *Phytopathology* 104: 211–219.
- Triolo, E., and A. Materazzi. 1987. La maculatura infettiva della vite: Influenza di isolati diversi sull'attitudine alla propagazione vegetativa di *Vitis rupestris* St. George. *Rech. Agronom. Suisse* 26: 320–324.
- Vargas-Asencio, J., K. Wojciechowska, M. Baskerville, A.L. Gomez, K.L. Perry, and J.R. Thompson. 2017. The complete nucleotide sequence and genomic characterization of grapevine asteroid mosaic associated virus. *Virus Research* 227: 82–87.
- Verderevskaia, T.D., V.G. Marinesku, and E.S. Semtschik. 1983. Etiologie und diagnose der marmorierung der weinrebe. *Archiv Für Phytopathologie Und Pflanzenschutz* 19: 221–226.
- Woodham, R.C., and L.R. Krake. 1983. Investigations on transmission of grapevine leafroll, yellow speckle and fleck diseases by dodder. *Phytopathologische Zeitschrift* 106: 193–198.
- Xiao, H., and B. Meng. 2016. First report of grapevine asteroid mosaic-associated virus and grapevine rupestris vein feathering virus in grapevines in Canada. *Plant Disease* 100: 2175.
- Yamakawa, Y. 1989. Virus reinfection of virus-free Cabernet sauvignon and Cabernet franc vines. *Journal of the Japanese Society for Horticultural Science* 58: 297–302.

Chapter 17

Grapevine Pinot gris virus

P. Saldarelli, V. Gualandri, U. Malossini, and M. Glasa

Abstract *Grapevine Pinot gris virus* (GPGV) is a new trichovirus identified in grapevine plants showing symptoms of chlorotic mottling and leaf deformations (GLMD: grapevine leaf mottling and deformation). The virus and/or the disease has been detected in different countries around the world although its association with symptoms and cultivar susceptibility are not deeply explored. GLMD is reproduced on vine indicators by grafting and GPGV is transmitted to healthy vines by the mite *Colomerus vitis*. However, the recent detection of GPGV on two herbaceous hosts makes the epidemiology of this virus more complex. Different studies suggest that GPGV genome variants exist, some of which are able to elicit GLMD on grapevine. As such GPGV represents an interesting candidate for the study of plant/virus interactions in grapevine. GPGV is a grapevine-emerging virus not listed in regulations for production of grapevine propagation materials, whose testing is recommended.

Keywords Virus • Grapevine • Chlorotic mottling • GLMD • Trichovirus

Introduction and Historical Aspects

The occurrence of a new virus-like disease in a continuously evolving and globalized agriculture is frequent, although it is sometimes difficult to identify the responsible agent(s). Broad detection tools based on High-Throughput Sequencing (HTS) techniques can help to quickly detect new and unknown pathogens (see Chap. 30 of this

P. Saldarelli (✉)

CNR Istituto per la Protezione Sostenibile delle Piante UOS Bari and Dipartimento di Scienze del Suolo della Pianta e degli Alimenti, Università degli Studi di Bari, via Amendola 165/A, Bari, Italy
e-mail: pasquale.saldarelli@ipsp.cnr.it

V. Gualandri • U. Malossini

Fondazione E. Mach, Via E. Mach 1, 38010, San Michele all'Adige, Italy

M. Glasa

Institute of Virology, Biomedical Research Center, Slovak Academy of Sciences, Dubravská cesta 9, 84505 Bratislava, Slovakia

book). The discovery of *Grapevine Pinot gris virus* (GPGV), which is associated with symptoms of leaf mottling and deformation (Fig. 17.1) in *Vitis vinifera* (GLMD: Grapevine Leaf Mottling and Deformation) (Martelli 2014), largely benefitted from these technological advances.

GLMD is a new disease that was first observed in a commercial vineyard in Trentino (Northern Italy) in 2003. Symptoms were similar to those induced by mite infestations, although the involvement of these pests in disease expression was firmly excluded. In the originally studied vineyard, affected vines of cvs Pinot gris and Pinot blanc were planted in 1985 and 1970, respectively (Mauro Varner, unpublished information). Subsequently, the disease was observed in cvs Pinot blanc, Pinot noir, and Traminer. In this latter cultivar, a severe stunting and necrosis of the shoots were observed (Fig. 17.1). In the same year, GLMD symptoms were recorded in vineyards of cvs Pinot gris, Traminer, Friulano (Tocai), and Glera (Prosecco) in Friuli Venezia Giulia (Bianchi et al. 2015). The inability to associate any known virus or virus-like agent to GLMD symptoms led to investigate the involvement of boron deficiency, among other factors, but mineral deficiency was ruled out. The distribution of symptomatic vines in the whole Friuli Venezia Giulia region was scattered and limited, if any, temporal increase was observed. This was in contrast to a striking increase of symptomatic vines in the Gorizia province, which is close to the Slovenian border (Bianchi et al. 2015). In Slovenia symptoms of short internodes, leaf mottling, and deformation of cvs Pinot gris and Sauvignonasse were under investigation since 2001, and laboratory efforts were unsuccessful in associating the disease with known viruses using available serological and molecular detection tools (Mavric-Plesko et al. 2014).

The etiology of GLMD remained unsolved for about a decade even by using degenerate primers for the generic detection of closteroviruses, flexiviruses, and nepoviruses by RT-PCR. Because of continuous concerns expressed by grape growers, colleagues at the Fondazione Mach, San Michele all'Adige (FEM) sought the collaboration of several Italian laboratories. The timing of this initiative coincided with the advent of HTS in grapevine virology. Therefore, it was proposed to analyze tissues from symptomatic vines by HTS. A private winery, Cantine Cooperative di Mezzocorona, funded the research. Two libraries of small RNAs, extracted from a GLMD and a symptomless vine of cv Pinot gris, were sequenced by Illumina technology and analyzed by a bioinformatic pipeline based on the *de novo* assembly of sequenced reads into larger contigs. A coupled HTS and Sanger sequencing allowed the reassembly of the genome of a new virus, which resembled that of the trichovirus *Grapevine berry inner necrosis virus* (GINV) (Yoshikawa et al. 1997). Due to the lack of a yet established correlation with GLMD, this new virus was named *Grapevine Pinot gris virus*, based on the vine and the cultivar in which it was initially described (Giampetruzzi et al. 2012). Molecular relationships of GPGV isolate ZA505-1A with GINV were further confirmed by the existence of striking similarities among symptoms elicited by both viruses on grapevine leaves and shoots (Fig. 17.2a). However, GINV induces a necrosis of berries, which is not observed on GPGV-infected vines. Similarities between the two viruses raised a number of questions about the GPGV origin since GINV was only found (Yoshikawa

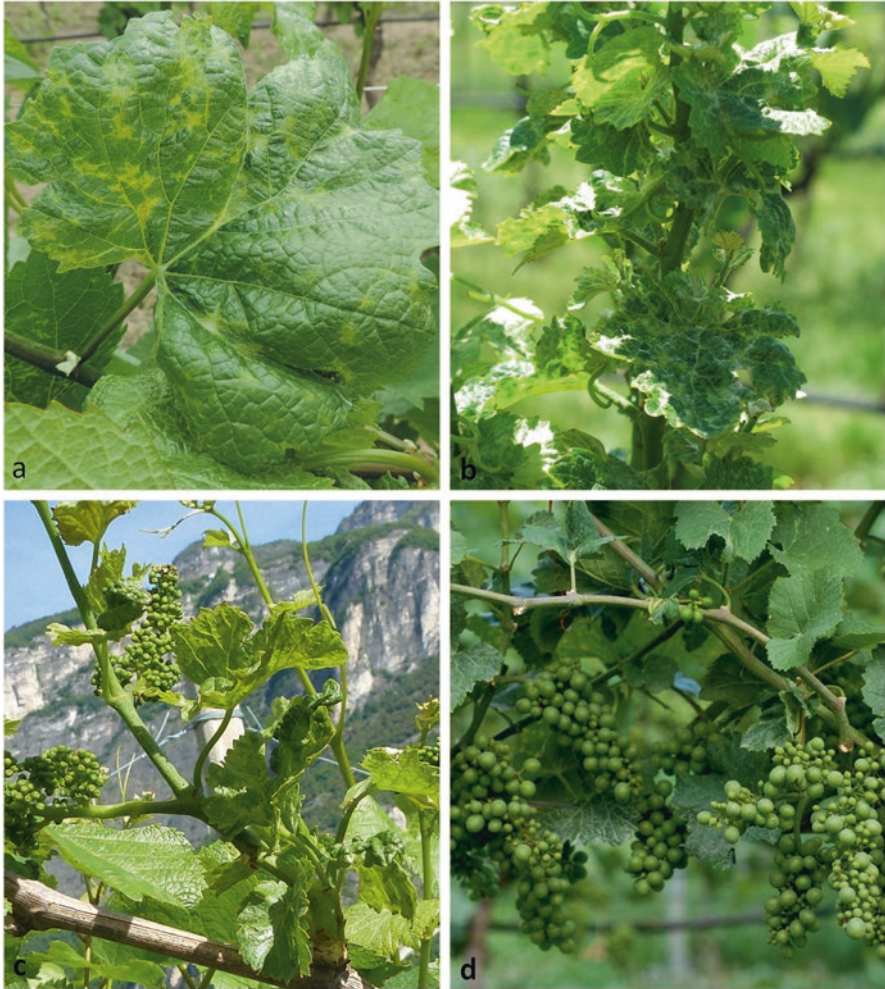

Fig. 17.1 Chlorotic mottling (a), stunting and bushy growth (b), deformations (c), and uneven fruit set (d) in leaves and shoot of cv Pinot gris (Courtesy of M. Varner)

et al. 1997) in Japan infecting diverse selections of *Vitis labrusca* (Takao, Kyoho and Pione). This first study showed that the virus was also found in symptomless vines. This finding did not conclusively associate GPGV with GLMD (Giampetruzzi et al. 2012).

The discovery of GPGV triggered a number of studies, which led to the report of the virus and/or the observed disease in several other regions in Italy and Europe (Table 17.1). Surprisingly, the first GPGV detection outside of Europe came from South Korea in the grapevine hybrid cv Tamnara (*V. vinifera* x *V. labrusca*), where, in addition to symptoms of leaf deformations and mottling, necrosis of the berries was also observed (Cho et al. 2013). Subsequently, the virus and/or the disease was

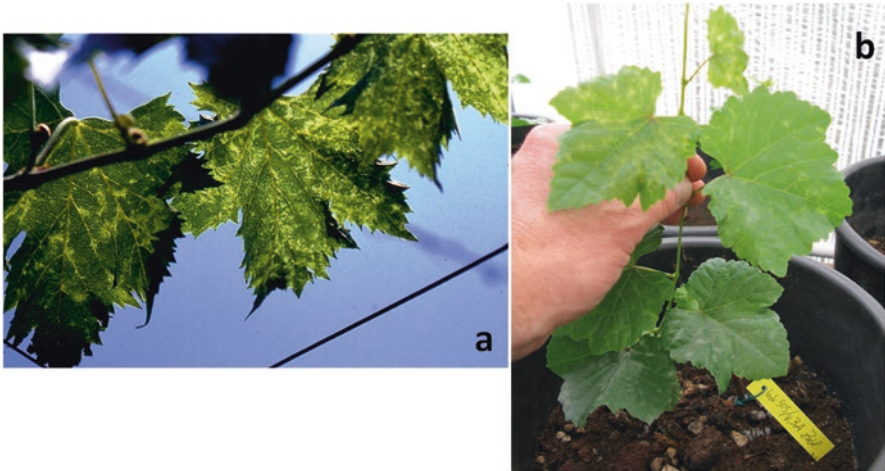

Fig. 17.2 Chlorotic mottling (a) on cv Pione in Japan (courtesy of Dr. Terai). (b) Symptoms of chlorotic mottling of a *Pinot gris* vine grafted on a GPGV-infected vine of the same cv

described in several white- and red-berry cultivars in different European, South and North American, and Asian countries, although the association between the presence of the virus and GLMD symptoms was not always established due to multiple infections of the analyzed vines (Table 17.1). The presence of GPGV was documented in archival grapevine samples from different European countries that were stored before 2005, suggesting an eastern European origin of the virus and subsequent introduction to viticultural areas of Veneto (northeast Italy) (Bertazzon et al. 2016).

Taxonomy and Nomenclature

Grapevine Pinot gris virus is an established member of the genus *Trichovirus* (family *Betaflexiviridae*, order *Tymovirales*) (Giampetruzzi et al. 2012), whose type species is *Apple chlorotic leaf spot virus* (ACLSV) (Martelli et al. 2007). Besides GINV, GPGV is the second species of the genus infecting grapevine. All members of the genus [*Apricot pseudo-chlorotic leaf spot virus* (APCLSV), *Cherry mottle leaf virus* (CMLV), *Peach mosaic virus* (PcMV), except *Phlomis mottle virus* (PhMV)] infect woody plants. To date, the complete or near-complete genome sequence of seven GPGV isolates (SK30-1, SK13, SK01, and SK30 from the Slovak Republic; Tannat, from Uruguay; ZA505-1A from Italy; and Merlot from France) has been described.

Table 17.1 GPGV distribution in different countries

Country (region)	Cultivar	References
Italy (Trentino Alto Adige)	Pinot blanc, Pinot noir, Traminer	Giampetruzzi et al. (2012)
Italy (Friuli Venezia Giulia)	Pinot gris, Traminer, Friulano (Tocai), Glera	Bianchi et al. (2015)
Italy (Emilia Romagna)	Chardonnay	http://archives.eppo.int/EPPORreporting/2014/Rsf-1401.pdf
Italy (Veneto)	Glera	Raiola et al. (2013) and Bertazzon et al. (2016)
Italy (Lombardia)	Chardonnay, Pinot noir	Casati et al. (2014)
Italy (Apulia)	Supernova, Black Magic	Morelli et al. (2014)
South Korea	Tamnara (<i>V. vinifera</i> x <i>V. labrusca</i>)	Cho et al. (2013)
Slovenia	Pinot gris, Sauvignonasse	Mavric-Plesko et al. (2014)
Slovakia	Veltliner, Dornfelder, Muller Thurgau, Welschriesling, André, Alibernet	Glasa et al. (2014)
Czech Republic (South Moravia)	Laurot (interspecific hybrid)	Glasa et al. (2014)
Czech Republic (South Moravia)	Kodjanka, Pamjati Negrula, Muller Thurgau, Chardonnay	Eichmeier et al. (2016)
France	Merlot, Carignan	Beuve et al. (2015)
Greece	Unknown	V. Maliogka, personal information
Switzerland	Chasselas	Reynard (2015)
China	Red Globe, Merlot, Muscat Hamburg, Cabernet Franc, Moldova, Beta (rootstock)	Fan et al. (2015)
United States	Touriga Nacional	Al Rwahnih et al. (2016)
United States	Cabernet Franc, Cabernet Sauvignon and Chardonnay	Angelini et al. (2016)
Canada	Cabernet Franc, Riesling	Xiao et al. (2016)
Turkey	Pinot noir, Chardonnay, Muscat of Hamburg and two local cultivars	Gazel et al. (2016)
Georgia	Local cultivars	Casati et al. (2016)
Uruguay	Tannat	Jo et al. (2015)
Canada	Pinot gris	Poojari et al. (2016)

The list reports the cultivars infected and the corresponding references

Morphology, Genome Structure, Genome Expression, and Replication

GPGV particles have not been observed yet in infected grapevine tissue (P. Saldarelli unpublished), but its classification in the genus *Trichovirus* suggests a filamentous morphology. GPGV genome is a (+)-sense single-stranded RNA molecule of 7259 nucleotides in length excluding the 3' polyA terminus. The 5' untranslated region is 104 nucleotides long in isolates SK13, SK01, and SK30, as determined by using 5'-RACE RT-PCR. The 3' untranslated region is 82 nucleotides long in isolates ZA505-1A and SK30. The 5'UTR and 3'UTR of Slovak GPGV isolates share ca. 78 and 85% identity, respectively, with that of GINV (Giampetruzzi et al. 2012; Glasa et al. 2014).

Nucleotide sequence identity of GPGV with other trichoviruses for which complete genome sequences are available reaches 69.0% (GINV, NC_015220), 49.0% (ACLSV, X99752), 48.7% (APCLSV, AY713379), 47.7% (CMLV, NC_002500), and 48.6% (PcMV, NC_011552).

The GPGV genome is organized in three open reading frames (ORF) encoding, in the 5' → 3' direction (Fig. 17.3), a putative viral replicase (ORF1, RdRp ca. 214 kDa), movement (ORF2, MP ca. 42 kDa), and coat (ORF3, CP ca. 22 kDa) proteins (Giampetruzzi et al. 2012). The replicase contains basic methyltransferase, helicase, and RdRp domains of the replication proteins of (+) ssRNA viruses. It also contains an AlkB-like domain for protecting the viral RNA from methylation. An additional putative small ORF has been identified within ORF1 at nucleotide positions 3538–3840 in an overlapping reading frame. The deduced 11.5 kDa protein has no conserved domains or homology to known proteins in the databases and is present in the genome of the three Slovak and Italian GPGV isolates, but not in GINV (Glasa et al. 2014). Side-by-side comparisons of the GPGV RdRp, MP, and CP proteins with counterparts from other species in the family *Betaflexiviridae* classify the virus in the genus *Trichovirus* with the closest homology with GINV (Giampetruzzi et al. 2012).

Studies of genome expression of ACLSV (German et al. 1992) suggest that the GPGV strategy of RNA translation and replication likely relies on polyprotein processing and production of subgenomic RNAs.

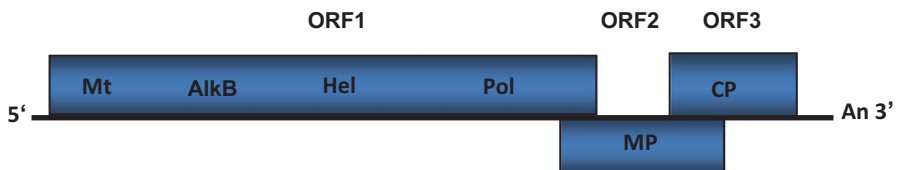

Fig. 17.3 Organization of *Grapevine Pinot gris virus* genome RNA. Open reading frames encoding the replicase (ORF1), movement protein (ORF2, MP), and coat proteins (ORF3, CP) are shown. Replicase domains corresponding to methyltransferase (Mt), AlkB, helicase (Hel), and polymerase (Pol) domains are indicated

Genetic Diversity of GPGV

The alignment of the genome sequence of Italian (ZA505-1A) and Slovak (SK30) isolates revealed a high percentage of homology (95.5–95.8% identity), but unusual patterns of local divergences were noticed. Nucleotide differences were mainly localized in the 5' part of the genomic RNA containing the 5'UTR and the very beginning of ORF1 up to nucleotide position 233 as well as in three short regions of ORF1 (Glasa et al. 2014). These differences in the 5' region were also found on a larger group of isolates (Bertazzon et al. 2016). A strong recombination signal between the 5'UTR and ORF1 sequences of the Slovak isolates SK01, SK13, and SK30 of GPGV and GINV was found using the RDP4 program with breakpoints predicted at nt positions 92 and 208. This potential recombination event would explain the high divergence in the amino acid portion 4–43 between the Slovak and Italian ZA505-1A isolates. It cannot however be discounted that this detection represents the local divergence of the sequence of isolate ZA505-1A rather than from a true recombination event (Glasa et al. 2014). According to Glasa et al. (2014), local nucleotide divergences in the three regions of ORF1 may have originated from sequencing errors or real polymorphisms in genome regions not subjected to evolution constraints.

With the two additional recent genomes identified in cvs Merlot (Beuve et al. 2015) and Tannat (Jo et al. 2015), the current GPGV phylogeny confirms the clustering of all GPGV isolates distinctly from other trichovirus species and from GINV. It also confirms the limited divergence of the ZA505-1A isolate and the grouping of the two French (Mer and Tannat) and the four Slovak isolates (Fig. 17.4).

The genetic diversity of GPGV was studied to investigate its association with GLMD symptoms. The nucleotide sequences of MP/CP and RdRpol genome regions from 45 and 20 GPGV isolates, respectively, from Trentino (Italy) were analyzed (Saldarelli et al. 2015). This study showed a clear clustering of GPGV isolates originating from symptomless as compared to those from symptomatic vines. Intriguingly, the presence of six extra amino acid residues in the MP of isolates from symptomless grapevines was observed due to a C/T polymorphism in the stop codon. This polymorphism was also found in a survey of GPGV in Switzerland (Reynard 2015). However, the lack of experimental demonstration of the involvement of this nucleotide polymorphism in symptom expression does not allow this feature to be used as a marker to distinguish symptomless from symptomatic isolates.

GPGV surveys in two viticultural regions in the north of Italy also documented the virus presence in symptomless vines. In Trentino, GPGV was found in 79% and 21% of symptomatic and symptomless vines, respectively (Saldarelli et al. 2015). In Friuli Venezia Giulia, a 95% GPGV incidence in symptomatic vines was observed, but the virus was also present in 61.5–87.1% symptomless vines (Bianchi et al. 2015).

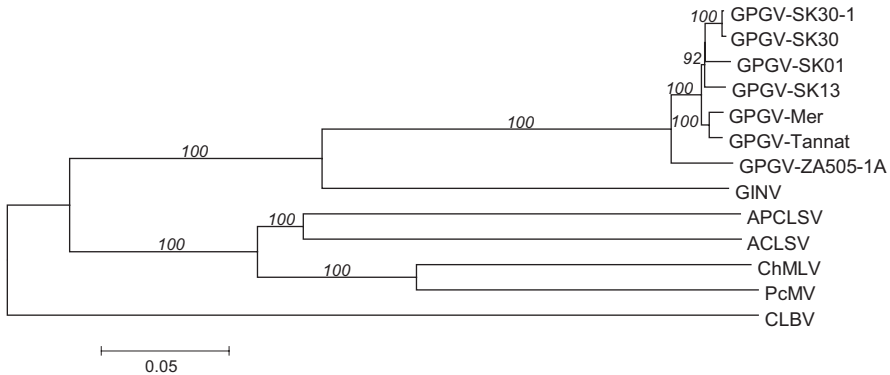

Fig. 17.4 GPGV phylogeny performed by maximum likelihood analysis using the full-length nucleotide sequence of virus species in the genus *Trichovirus*. Genome accession numbers of the different species are *Grapevine Pinot gris virus* (GPGV), isolate SK30-1 (KF686810.1), GPGV-SK30 (KF134123.1), GPGV-SK01 (KF134124.1), GPGV-Mer (KM491305.1), and GPGV-ZA505-1A (NC_15782.1); *Grapevine berry inner necrosis virus* (GINV) (NC_015220.1); *Apricot pseudo-chlorotic leaf spot virus* (APCLSV) (AY713379.1); *Apple chlorotic leaf spot virus* (ACLSV) (X99752.1); *Cherry mottle leaf virus* (ChMLV) (NC_002500.1); *Peach mosaic virus* (PcMV), (NC_011552.1); and *Citrus leaf blotch virus* (CLBV) (NC_003877.1). Bootstrap values at relevant nodes and scale of nucleotide substitutions *per site* are indicated

Detection and Diagnosis

The presence of GPGV in symptomless grapevines and the lack of information about the diverse susceptibility of grapevine cvs to the disease make visual diagnosis of GPGV unreliable.

Commercial antibodies are not yet available but a polyclonal serum raised against an *Escherichia coli*-expressed GPGV CP was obtained in rabbit (Gualandri et al. 2015). This serum was unsuitable for ELISA but recognized a putative GPGV CP in samples from infected vines when used on denatured proteins in western blot analysis (Saldarelli unpublished).

Several primer pairs designed in the MP/CP (588 bp, Saldarelli et al. 2015), MP (302 bp, Glasa et al. 2014; 770 bp, Beuve et al. 2015), and CP (412 bp, Glasa et al. 2014; 430 bp, Bertazzon et al. 2016) genomic regions have been developed for efficient detection of GPGV using end point RT-PCR. A real-time RT-qPCR assay was developed with primers and probes targeting the RdRp and CP genes (Bianchi et al. 2015). This assay also developed in a multiplex format targeting both the RdRp and CP regions, proved sensitive for detecting GPGV in infected grapevine tissues and was used for an extensive virus survey in the Friuli Venezia Giulia region in Italy.

Host Range and Epidemiology

GPGV infects grapevine but was recently detected in the two herbaceous hosts *Silene latifolia* subsp. *Alba* (Mill) and *Chenopodium album* L (Gualandri et al. 2016). The virus was detected by RT-PCR in plants of both species collected in the field, which showed symptoms of chlorotic mottling of the leaves. GPGV infection was confirmed by the amplification and cloning of the whole viral RNA genome. Repeated attempts to transmit the virus to the herbaceous hosts *Chenopodium quinoa*, *Nicotiana benthamiana*, and *N. occidentalis* and to dodder (*Cuscuta europaea*) were unsuccessful (Saldarelli, unpublished and Beber 2012). The virus is transmitted by grafting; this makes the infected plant material the main source of dissemination (Giampetruzzi et al. 2012; Saldarelli et al. 2015). A recent study reports that GPGV is present in the body of the eriophyid mite *Colomerus vitis* and is transmitted to healthy vines through mite infestation (Malagnini et al. 2016), although symptoms were not observed in the recipient vines throughout the time of the experiment. This finding is in line with the involvement of a vector that transmits the virus in vineyards, as suggested by observations of an aggregated pattern of GPGV symptomatic vines in the vineyard (Malossini et al. 2015; Bertazzon et al. 2015b). Therefore, a likely epidemiological model of GPGV infections relies on the introduction of the virus in the vineyard through planting material and a subsequent spread from vine-to-vine by a slow-moving vector such as mites. This model is in agreement with the transmission of GINV by *C. vitis*, which was demonstrated in confined conditions and in the field (Kunugi et al. 2000). However, the recent GPGV detection in wild plants in the vineyard reveals the existence of an alternative route of transmission. It is now compelling to understand how it occurs and whether these new GPGV hosts are a dead end for the virus or have a role in the epidemiology.

Cytopathology, Tissue Tropism, and Virus-Host Interactions

The virus has yet to be observed in grapevine tissues and information on cytopathology, tissue tropism and virus-host interactions is lacking.

Pathological Properties, Associated Diseases, and Their Impact

GPGV is easily transmitted to *Vitis* spp. by grafting, but the susceptibility to GLMD of grapevine cultivars is variable and unexplored to date. As an example, cv Teroldego seems to be tolerant to GLMD in Trentino (Malossini, unpublished observations). GLMD symptoms were reproduced by bud- and green grafting (Fig. 17.2b) in cvs Pinot gris and Traminer (Saldarelli et al. 2015).

The distinct genetic diversity between GPGV isolates from symptomatic and symptomless vines supports the existence of viral variants responsible for eliciting disease symptoms (Saldarelli et al. 2015). In support of this hypothesis, a statistically significant higher virus titre was found in symptomatic compared to symptomless vines (Bertazzon et al. 2015a, b; Bianchi et al. 2015). This observation was ascertained by measuring GPGV concentration in cv Glera, which decreased in both symptomatic and symptomless vines with the progress of the vegetative season.

GLMD symptoms appear in early spring and are followed by a period of poor vegetation of the infected shoots. Shoot necrosis is observed in cvs Traminer and Pinot gris but not in cv Glera (Bertazzon et al. 2015a, b; Giampetruzzi et al. 2012). Vines with GLMD have fewer canes and a lower number of clusters as well as reduced cluster weight (Malossini et al. 2012). Moreover, a reduced fruit set and an uneven ripening is observed in cv Glera (Bertazzon et al. 2015a). During the summer, the new vegetation completely recovers from symptoms, making the observation of foliar symptoms unreliable for diagnosis.

The impact of the disease on enological parameters related to wine production is mainly related to the lower weight of clusters (Malossini et al. 2012) which is more evident in cv Pinot gris than in Glera (Bertazzon et al. 2015a).

Strategies for Control and Management

Management of GPGV relies on a preventive approach that needs integrated actions based on a thorough knowledge of GPGV epidemiology, availability of GPGV-free plant propagation material, and vector control. Preliminary studies indicate that elimination of GPGV from infected vines is possible through *in vitro* culture and meristem-tip excision with or without thermotherapy (Gualandri et al. 2015). Since *C. vitis* mites likely play a role in virus transmission, the management of this pest in vineyards is recommended.

Conclusions and Future Research Directions

GPGV is an emerging virus associated with GLMD, a recently recognized disease of grapevine. Its widespread occurrence and its likely recent introduction in several premium viticultural areas in Europe call for further research efforts to evaluate its impact.

To date, studies of GLMD and the discovery of GPGV were scattered and funded by regional government and private organizations in response to growers' requests. Desirable research trends should be directed to the study of the epidemiology and etiology of the disease, its impact, and management. The mode of transmission of GPGV by *C. vitis* would be an interesting area of research, bearing in mind that PcMV is transmitted by *Eriophyes insidiosus* in a semipersistent manner (Gispert

et al. 1998). The finding that two herbaceous hosts are a reservoir for the virus suggests a more complex epidemiology, which should be explored and eventually considered in the design of management strategies.

The existence of GPGV viral variants should lead to research on virus/host interactions, particularly on virus determinants of symptoms expression. In response to stakeholder's needs, efforts should be devoted to the sanitation of infected vines and knowledge of GLMD impact in different grapevine cvs.

The production of certified grapevine propagation materials does not currently include GPGV in the list of viruses and diseases of consideration. Based on the impact of GLMD and globalized nursery activities, testing for GPGV is recommended.

Acknowledgments The research presented in this chapter was supported by:

“Progetto di ricerca per una nuova malattia della vite in Trentino” funded by FEM-IASMA, Centre for Technology Transfer, via E. Mach, 1 San Michele all'Adige (TN), Italy.

METAGERM (in the frame of “Conoscenze Integrate per la Sostenibilità e l'Innovazione del made in Italy Agroalimentare,” Ministry of Economy, Italy). The NGS activity was hosted by the Illumina platform at Rete di laboratori pubblici di ricerca SELGE (www.selge.uniba.it).

M.G. received the support from the Scientific Grant Agency of the Ministry of Education and Slovak Academy of Sciences (grant VEGA 2/0036/16).

References

- Al Rwahnih, M., D. Golino, and A. Rowhani. 2016. First report of *Grapevine Pinot gris virus* infecting grapevine in the United States. *Plant Disease* 100: 1030. <http://dx.doi.org/10.1094/PDIS-10-15-1235-PDN>.
- Angelini, E., N. Bertazzon, J. Montgomery, A. Zinkl, X. Wang, J.A. Stamp, and A. Wei. 2016. Occurrence of *Grapevine Pinot gris virus* in commercial vineyards in the U.S. *Plant Disease* 100: 1254. <http://dx.doi.org/10.1094/PDIS-01-16-0055-PDN>.
- Beber R. 2012. Studi su una nuova virosi della vite in Trentino. Dissertation, University of Bologna
- Bertazzon, N., V. Forte, L. Filippin, and E. Angelini. 2015a. Studies on *Grapevine Pinot gris virus* (GPGV) presence and its association with an emergent disease of grapevine. In *Proceedings of the 18th Congress of ICVG*, Ankara, Turkey, 7–11 September 2015, 78–79
- Bertazzon, N., M. Maixner, L. Filippin, I. Bazzo, V. Forte, and E. Angelini. 2015b. Survey on a new emergent grapevine disease and *Grapevine Pinot gris virus* (GPGV) in Veneto, Northeast Italy. In *Proceedings of the 18th Congress of ICVG*, Ankara, Turkey, 7–11 September 2015, 201–202.
- Bertazzon, N., L. Filippin, V. Forte, and E. Angelini. 2016. *Grapevine Pinot gris virus* seems to have recently been introduced to vineyards in Veneto, Italy. *Archives of Virology*. doi:[10.1007/s00705-015-2718-2](https://doi.org/10.1007/s00705-015-2718-2).
- Beuve, M., T. Candresse, M. Tannieres, and O. Lemaire. 2015. First report of *Grapevine Pinot gris virus* (GPGV) in grapevine in France. *Plant Disease* 99: 293.
- Bianchi, G.L., F. De Amicis, L. De Sabbata, N. Di Bernardo, G. Governatori, F. Nonino, G. Prete, T. Marrazzo, S. Versolatto, and C. Frausin. 2015. Occurrence of *Grapevine Pinot gris virus* in Friuli Venezia Giulia (Italy): field monitoring and virus quantification by real-time RT-PCR. *Bulletin OEPP/EPPO Bulletin* 45 (1): 22–32.
- Casati, P., G. Durante, F. Quaglino, E. Zacchi, and P.A. Bianco. 2014. Preliminary data on the presence of *Grapevine Pinot gris virus* in Lombardy. *Journal of Plant Pathology* 96 (suppl): S4.46–S4.47.

- Casati, P., D. Maghradze, F. Quaglino, A. Ravasio, O. Failla, and P.A. Bianco. 2016. First report of *Grapevine Pinot gris virus* in Georgia. *Journal of Plant Pathology*. doi:[10.4454/JPP.V9811.003](https://doi.org/10.4454/JPP.V9811.003).
- Cho, I.S., S.M. Jung, J.D. Cho, G.S. Choi, and H.S. Lim. 2013. First report of *Grapevine Pinot gris virus* infecting grapevine in Korea. *New Disease Report* 27: 10.
- Eichmeier, A., E. Penazova, R. Pavelkova, Z. Mynarzova, and P. Saldarelli. 2016. Detection of *Grapevine Pinot gris virus* in certified grapevine stocks in Moravia, Czech Republic. *Journal of Plant Pathology* 98: 155–157.
- Fan, X.D., Y.F. Dong, Z.P. Zhang, F. Ren, G.H. Hu, Z.N. Li, and J. Zhou. 2015. First report of *Grapevine Pinot gris virus* in grapevines in China. *Plant Disease* 100: 540. <http://dx.doi.org/10.1094/PDIS-08-15-0913-PDN>.
- Gazel, M., M. Çağlayan, E. Elçi, and L. Ozturk. 2016. First report of *Grapevine Pinot gris virus* in grapevine in Turkey. *Plant Disease* 100: 657. <http://dx.doi.org/10.1094/PDIS-05-15-0596-PDN>.
- German, S., T. Candresse, O. Le Gall, M. Lanneau, and J. Dunez. 1992. Analysis of the dsRNAs of apple chlorotic leaf spot virus. *Journal of General Virology* 73: 767–773.
- Giampetruzzi, A., V. Roumi, R. Roberto, U. Malossini, N. Yoshikawa, P. La Notte, F. Terlizzi, R. Credi, and P. Saldarelli. 2012. A new grapevine virus discovered by deep sequencing of virus- and viroid-derived small RNAs in cv Pinot gris. *Virus Research* 163: 262–268.
- Gispert, C., G.N. Oldfield, T.M. Perring, and R. Creamer. 1998. Biology of the transmission of *Peach Mosaic Virus* by *Eriophyes insidiosus* (Acari: Eriophyidae). *Plant Disease* 82: 1371–1374.
- Glasa, M., L. Predajna, P. Kominek, A. Nagyova, T. Candresse, and A. Olmos. 2014. Molecular characterization of divergent *Grapevine Pinot gris virus* isolates and their detection in Slovak and Czech grapevines. *Archives of Virology* 159: 2103–2107.
- Gualandri, V., P. Bianchedi, M. Morelli, A. Giampetruzzi, P. Valenzano, G. Bottalico, and A. Campanale, P. Saldarelli. 2015. Production of *Grapevine Pinot gris virus*-free germplasm: techniques and tools. In *Proceedings of the 18th Congress of ICVG*, Ankara, Turkey, 7–11 September 2015, 246–247.
- Gualandri, V., E. Asquini, P. Bianchedi, L. Covelli, M. Brillì, U. Malossini, P. Bragagna, P. Saldarelli, and A. Si-Ammour. 2016. Identification of herbaceous hosts of the *Grapevine Pinot gris virus* (GPGV). *European Journal of Plant Pathology*. doi:[10.1007/s10658-016-0989-4](https://doi.org/10.1007/s10658-016-0989-4).
- Jo, Y., H. Choi, J.K. Cho, J.Y. Yoon, S.K. Choi, and W.K. Cho. 2015. *In silico* approach to reveal viral populations in grapevine cultivar Tannat using transcriptome data. *Scientific Reports* 5: 15841. doi:[10.1038/srep15841](https://doi.org/10.1038/srep15841).
- Kunugi, Y., S. Asari, Y. Terai, and A. Shinkai. 2000. Studies on the *Grapevine berry inner necrosis virus* disease. 2. Transmission of grapevine berry inner necrosis virus by the grape erineum mite *Colomerus vitis* in Yamanashi. *Bull. Yamanashi Fruit Tree Experimental Station* 10: 57–63.
- Malagnini, V., E. de Lillo, P. Saldarelli, R. Beber, C. Duso, A. Raiola, L. Zanotelli, D. Valenzano, A. Giampetruzzi, M. Morelli, C. Ratti, R. Causin, and V. Gualandri. 2016. Transmission of *Grapevine Pinot Gris virus* by *Colomerus vitis* (Acari: Eriophyidae) to grapevine. *Archives of Virology*. doi:[10.1007/s00705-016-2935-3](https://doi.org/10.1007/s00705-016-2935-3).
- Malossini, U., R. Moscon, M. Ferrazza, P. Bianchedi, M. Varner, and R. Credi. 2012. Caratteristiche vegeto-produttive di viti Pinot grigio e Traminer aromatico affette da una nuova virosi segnalata in Trentino. IV Convegno Nazionale di Viticoltura CONAVI.TO Asti, 10-11-12 luglio 2012 pp 37. http://www.unito.it/unitoWAR/ShowBinary/FSRepo/D046/Allegati/CONAVI_2012/CONAVI_2012_Libro_dei_riassunti.pdf
- Malossini, U., P. Bianchedi, R. Beber, R. Credi, P. Saldarelli, and V. Gualandri. 2015. Spread of GPGV-associated disease in two vineyards in Trentino (Italy). In *Proceedings of the 18th Congress of ICVG*, Ankara, Turkey, 7–11 September 2015, 212–213.
- Martelli, G.P. 2014. Directory of virus and virus-like diseases of the grapevine and their agents. *Journal of Plant Pathology* 96 (1, Supplement): 110–111.
- Martelli, G.P., M.J. Adams, J.F. Kreuze, and V.V. Dolja. 2007. Family *Flexiviridae*: A case study in virion and genome plasticity. *Annual Review of Phytopathology* 45: 73–100.

- Mavric-Plesko, I., M.V. Marn, G. Seljak, and I. Zezlina. 2014. First report of *Grapevine Pinot gris virus* infecting grapevine in Slovenia. *Plant Disease* 98: 1014.
- Morelli, M., Catarino A. de Moraes, L. Susca, P. Saldarelli, V. Gualandri, and G.P. Martelli. 2014. First report of *Grapevine Pinot gris virus* from table grapes in Southern Italy. *Journal of Plant Pathology* 96: 439.
- Poojari, S., T. Lowery, M. Rott, A.-M. Schmidt, and J.R. Úrbez-Torres. 2016. First report of *Grapevine Pinot gris virus* in British Columbia, Canada. *Plant Disease* 100: 1513. <http://dx.doi.org/10.1094/PDIS-02-16-0178-PDN>.
- Raiola, A., C. Scopel, D. Ferrigo, F. Taglietti, C. Duso, and R. Causin. 2013. First report of *Grapevine Pinot gris virus* infecting cv. Glera in the Conegliano-Valdobbiadene area. Abstracts of the IXX Congress of the Italian Phytopathological Society, Padua 23–25 September 2013. *Journal of Plant Pathology* 95 (4, Supplement): S4.58.
- Reynard, J.S. 2015. Survey of emerging viruses in Switzerland. In *Proceedings of the 18th Congress of ICVG*, Ankara, Turkey, 7–11 September 2015, 223–224.
- Saldarelli, P., A. Giampetruzzi, M. Morelli, U. Malossini, C. Pirolo, P. Bianchedi, and V. Gualandri. 2015. Genetic Variability of *Grapevine Pinot gris virus* and Its Association with Grapevine Leaf Mottling and Deformation. *Phytopathology* 105(4): 555–563.
- Xiao, H., M. Shabanian, W. McFadden-Smith, and B. Meng. 2016. First report of *Grapevine Pinot gris virus* in commercial grapevines in Canada. *Plant Disease* 100: 1030. <http://dx.doi.org/10.1094/PDIS-12-15-1405-PDN>.
- Yoshikawa, N., H. Iida, S. Goto, H. Magome, T. Takahashi, and Y. Terai. 1997. *Grapevine berry inner necrosis*, a new trichovirus: comparative studies with several known trichoviruses. *Archives of Virology* 142: 1351–1363.

Chapter 18

Other Grapevine Viruses of Lesser Economic Importance

G.P. Martelli, D.A. Golino, and N.I. Katis

Abstract Symptomatic vines infected by *Alfalfa mosaic virus* (AMV), *Grapevine angular mosaic virus* (GAMV), *Grapevine line pattern virus* (GLPV), *Raspberry bushy dwarf virus* (RBDV), and *Grapevine Roditis leaf discoloration-associated virus* (GRLDaV) have been reported from different European countries, whereas infections by *Grapevine berry inner necrosis virus* (GINV) and *Summer grape latent virus* (SGLV) were found in Japan and the USA, respectively. These viruses have a limited geographical distribution and have only a relevant economic impact regionally, except for a few of them (RBDV, GRLDaV, and GINV). Medium- and long-distance dissemination occurs via infected propagative material, whereas local spread is mediated by the eriophyid mite *Colomerus vitis* (GINV) and, as hypothesized but not proven, by the nematode *Longidorus juvenilis* (RBDV).

Keywords Line pattern • Angular mosaic • *Alfamovirus* • *Ilarvirus* • *Badnavirus* • *Trichovirus* • *Idaeovirus* • Epidemiology

Several graft-transmissible diseases are known, with which specific viruses are associated or suspected to be their putative causal agents. The overall importance of these diseases is minor when compared with that of the main diseases dealt with in previous chapters, but a few are of some economic relevance locally, e.g., those induced by *Grapevine berry inner necrosis virus* (GINV) or by *Grapevine Roditis leaf discoloration-associated virus* (GRLDaV).

G.P. Martelli (✉)

Department of Soil, Plant and Food Sciences, University of Bari Aldo Moro, Bari, Italy

e-mail: giovanni.martelli@uniba.it

D.A. Golino

Foundation Plant Services, University of California, Davis, CA, USA

N.I. Katis

Laboratory of Plant Pathology, Faculty of Agriculture, Forestry and Natural Environment, Aristotle University of Thessaloniki, Thessaloniki 54 124, Greece

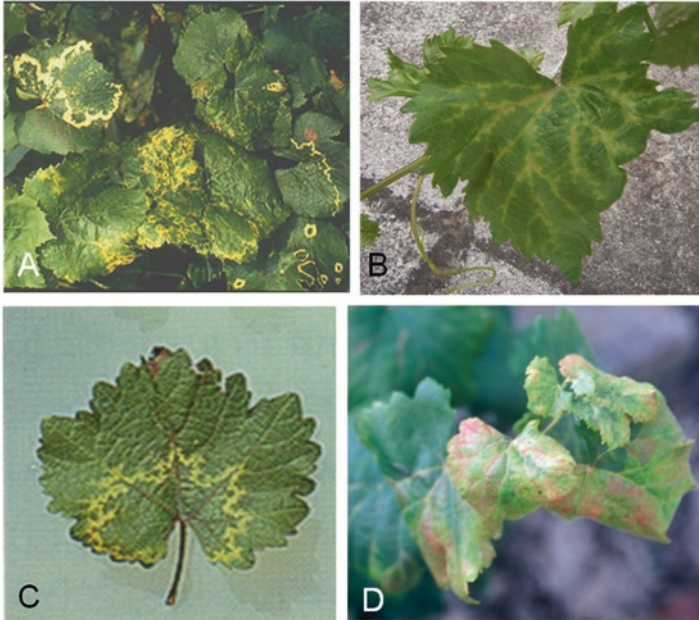

Fig. 18.1 Symptoms shown by vines infected by *Alfalfa mosaic virus* (a), *Grapevine angular mosaic virus* (b) (courtesy of Dr. S.M. Girgis, National Agricultural Research Foundation, Lykovrissi, Athens, Greece), *Grapevine line pattern virus* (c), and *Grapevine Roditis leaf discoloration-associated virus* (d)

Alfalfa mosaic virus (AMV)

AMV occurs in vines from Germany (Bercks et al. 1973), Switzerland, Hungary, former Czechoslovakia, Bulgaria, and Turkey showing various patterns of leaf discolorations (yellow mottling, rings, and line patterns) (Fig. 18.1a) that persist throughout the vegetative season. Plant vigor and yield do not seem to be appreciably affected. AMV, the type species of the genus *Alfamovirus*, has differently shaped particles, from quasi-isometric to bacilliform, 30–57 nm in size, and a tripartite RNA genome accounting for ca. 18% of the particle weight, with the following mol. wts.: RNA-1, 1.04×10^6 Da (3644 nt); RNA-2, 0.73×10^6 Da (2593 nt); and RNA-3, 0.62×10^6 Da (2037 nt). Capsid protein subunits are of one type, with Mr 24×10^3 Da (Francki 1985). AMV is efficiently transmitted by aphids in a nonpersistent manner and can cause epidemic outbreaks in many of its natural hosts. In grapevines, however, infections are scattered and occasional, suggesting that the virus spreads primarily through infected planting material. The virus is mechanically transmissible from symptomatic vines to herbaceous hosts such as *Chenopofium quinoa*, *Nicotiana tabacum*, *Ocimum basilicum*, and *Phaseolus vulgaris*, is readily identified in infected vines by ELISA and molecular assays, and can be eliminated by heat treatment (Bovey and Cazelles 1979).

Grapevine angular mosaic virus (GAMV)

GAMV has only been recorded from Greece, where it was transmitted by manual inoculation to herbaceous hosts from “Baresana x Baresana” *Vitis vinifera* hybrid vines exhibiting chlorotic angular spots of the leaf blade along the veins and in vein angles, discoloration of tissues bordering the veins, and crinkling and deformation of the leaves (Fig. 18.1b). Infected grapevines are stunted and decline gradually and some die. Due to flower abortion, bunches are straggly and have small wrinkled berries that bear nonviable seeds (Girgis et al. 2000). These symptoms are observed throughout the year in the vineyard. GAMV has not been detected in other vine cultivars in Greece or elsewhere. The field syndrome was reproduced in grapevine seedlings mechanically inoculated with GAMV, which, therefore, is retained as the agent of the disease (Girgis et al. 2003). The virus has quasi-isometric particles ca. 29 nm in diameter, a tripartite RNA genome, and a 30 kDa coat protein and is molecularly related to a number of species of the genus *Ilarvirus* (Girgis et al. 2009), but it is still an unclassified tentative member of this genus. GAMV differs from *Grapevine line pattern virus* (GLPV), the only other putative *Ilarvirus* found in grapevines, and is readily identified in infected plants by ELISA and RT-PCR, from which it can be eliminated by heat treatment combined with meristem tip culture (Grammatikaki et al. 2006).

Grapevine line pattern virus (GLPV)

GLPV was recovered by mechanical inoculation from Hungarian grapevines showing bright yellow discolorations of the leaves in the form of marginal rings, scattered spots or blotches, or maple leaflike line patterns typically confined to the petiolar area or to the upper part of the blade, roughly following its contour (Fig. 18.1c). Affected vines have reduced vigor and yield (Lehoczky et al. 1987). The virus, a putative member of the genus *Ilarvirus*, has differently shaped particles, quasi-spherical 25–30 nm in diameter to bacilliform 40–75 nm in length, and a multipartite genome (Lehoczky et al. 1989). GLPV is mechanically transmissible to herbaceous hosts and by grafting to European grapes. It is also transmitted through grapevine seeds and spreads with diseased propagative material (Lehoczky et al. 1992).

Raspberry bushy dwarf virus (RBDV)

RBDV was originally isolated by manual transmission from vines of cv. Laski Rizling from Slovenia exhibiting a yellow line pattern syndrome resembling the line pattern disease described from Hungary (Mavric et al. 2003). It was then detected in

several cultivars of white- and red-berried grapevines also in Serbia and Hungary. RBDV, the type species of the genus *Idaeovirus*, is a pollen- and seed-borne virus with quasi-spherical particles ca. 33 nm in diameter, made up of a single type of coat protein subunits (Mr ca. 30×10^3). The viral genome is a single-stranded RNA accounting for ca. 24% of the particle weight, consisting of two functional species: RNA-1 with mol. wt. of 2×10^6 Da (5.5 Kb in size) and RNA-2 with mol. wt. 0.8×10^6 Da (2.2 Kb in size) (Murant 1976). In phylogenetic trees, viral isolates from the grapevine group in a clade are different from those comprising isolates from red and black raspberries and *Rubus multibracteatus* (Mavric-Plesko et al. 2009). Grapevine isolates can be differentiated from raspberry isolates by monoclonal antibodies. A sequenced fragment of 941 bp at the 5' terminus of the RNA-1 of a grapevine Serbian isolate of this virus shared 93.6% identity at the nucleotide level with the comparable sequence of a raspberry viral isolate (Jeremovic and Paunovic 2011). RBDV is irregularly distributed in field-infected vines (Mavric and Virscek Marn 2006). It infects raspberry progeny seedlings through pollen (up to 77%), but it is not seed-transmitted in grapevine. Natural spread in the field is suspected to be mediated by nematodes since the virus was detected in a few individuals of *Longidorus juvenilis* (Mavric-Plesko et al. 2009). However, experimental evidence of transmission by this nematode species is lacking. Infected propagative material is responsible for medium- and long-distance virus dissemination.

Grapevine berry inner necrosis virus (GINV)

This disease occurs only in Japan, representing the most important virus disorder in Yamanashi Prefecture. Symptom severity varies with the cultivar and the *Vitis* species (Nishijima et al. 2000). Vines of cv. Kyoho infected by GINV have low vigor, delayed bud break, shoots with short internodes, and internal browning. Leaves show chlorotic mottling, rings, and line patterns, ripening of bunches is delayed, and berries are small and show external discolorations and internal necrosis (Terai et al. 1993). GINV, a member of the genus *Trichovirus*, is the causal agent of the disease (Yanase and Terai 1987). The virus has filamentous particles about 750 nm in length and a single-stranded RNA genome with mol. wt. of 7.5×10^6 Da (Yoshikawa et al. 1997). The GINV genome contains three open reading frames (ORF) encoding a protein with the conserved motifs of RNA polymerase (ORF1), a 39 kDa putative movement protein (ORF2), and a 22 kDa capsid protein (ORF3) (Yoshikawa et al. 1997). GINV is phylogenetically related to *Grapevine Pinot gris virus* (GPGV) of genus *Trichovirus*, with which it groups in the same clade in phylogenetic trees and has an identity at the amino acid level of 66% (ORF1), 65% (ORF2), and 71% (ORF3) (Giampetruzzi et al. 2012). The virus is readily identified by serological and molecular assays, is transmitted by grafting to grapevines and by mechanical inoculation to herbaceous hosts, and spreads naturally in vineyards, where it is transmitted by the eriophyid mite *Colomerus vitis* (Kunugi et al. 2000).

***Grapevine Roditis leaf discoloration-associated virus* (GRLDaV)**

Roditis leaf discoloration (RLD) is a graft-transmissible disease described initially in the cultivar Roditis from Greece (Rumbos and Avgelis 1989). Its symptoms are prominent in late summer and consist of yellow and/or reddish discolorations of the tissues along the veins, the interveinal areas, or variously extended sectors of the leaf blade, especially near the petiole (Fig. 18.1d). Leaves are deformed in correspondence to discolored sectors. Bunches are reduced in number and size and have low sugar content. Symptomatic vines were first reported to host *Grapevine fanleaf virus* (GFLV) and *Carnation mottle virus* (CarMV) (Avgelis and Rumbos 1991), then *Grapevine virus B* (GVB) (Avgelis et al. 2006). However, none of these viruses has been proved to be the causal agent of the disease. More recently, however, a member of the genus *Badnavirus*, denoted *Grapevine Roditis leaf discoloration-associated virus* (GRLDaV), was identified in infected vines upon next-generation sequencing and characterized (Maliogka et al. 2015). Although Koch's postulates have not yet been fulfilled, GRLDaV has been detected in all vines showing typical symptoms of the disease. GRLDaV is a member of the family *Caulimoviridae* closely related phylogenetically with *Fig badnavirus 1* (FBV-1). It has a circular genome 6988 nt in size, comprising four open reading frames (ORFs). ORF1, ORF2, and ORF4 code for proteins with unknown functions, while ORF3 encodes a polyprotein with motifs related to the replication, encapsidation, and movement of the virus. GRLDaV is mechanically transmissible to herbaceous hosts and has recently been recorded also from southern Italy (Chiumenti et al. 2015). In a recent survey in Greece, GRLDaV was detected in different areas of the country, in some self-rooted and grafted autochthonous grapevine cultivars, most of which were symptomless (V. I. Maliogka, unpublished information). The virus was not detected in any of the imported cultivars tested.

***Summer grape latent virus* (SGLV)**

SGLV was first detected in a symptomless vine of *Vitis aestivalis* (summer grape) in the Great Smoky Mountains National Park (Tennessee, USA) (Sabanadzovic 2009), then in California (USA) in a *Vitis vinifera* plant of cv. Cabernet Sauvignon showing severe leafroll symptoms, and was described under the name of Grapevine Cabernet Sauvignon reovirus (Al Rwahnih et al. 2015). The complete genome sequence of both viral isolates disclosed that they are the same and represent a putative new member of the family *Reoviridae*, subfamily *Spinareovirinae* (Sabanadzovic and Abou Ghanem-Sabanadzovic 2012). The SGLV genome consists of 10 double-stranded RNA segments ranging from 3.5 kbp (S1) to 1.1 kbp (S10), all of which are monocistronic except for one encoding the putative RNA-dependent RNA polymerase, and for segment 10, both of which are bicistronic. All genomic segments

contain conserved terminal sequences identical to those found in *Raspberry latent virus* (RpLV), an aphid-transmitted and still unclassified putative reovirus from the Pacific Northwest of the USA. There is no information on the epidemiology of SGLV, but the virus is not restricted to North America, as shown by its detection in Brazil (T. Fajardo, quoted by Al Rawhni et al. 2015).

In addition to the viruses described above, a number of other viruses have occasionally been detected in vines from different countries: *Grapevine Syrah virus 1* (GSyV-1), *Grapevine cryptic virus 1* (GCV-1), *Grapevine Algerian latent virus* (GALV), *Petunia asteroid mosaic virus* (PAMV), and several unidentified potyviruses, including *Bean common mosaic virus* (BCMV) (Martelli 2014). Most of these viruses occur in symptomatic vines in mixed infection with recognized grapevine pathogens, which makes their etiological significance largely undetermined.

References

- Al Rawhni, M., D. Golino, S. Daubert, and A. Rowhani. 2015. Characterization of a novel reovirus species in Cabernet Sauvignon in California. *Proceedings 18th Congress of ICVG, Ankara, Turkey*: 194–195.
- Avgelis, A.D., and I.C. Rumbos. 1991. *Carnation mottle virus* isolated from vines affected by “Roditis leaf discoloration”. *Proceedings 10th Meeting of ICVG, Volos, Greece*: 437–443.
- Avgelis, A., P. Saldarelli, and D. Boscia. 2006. Grapevine viruses associated with Roditis leaf discoloration. *Extended Abstracts 15th Meeting of ICVG, Stellenbosch, South Africa*: 161–162.
- Bercks, R., D. Lesemann, and G. Querfurth. 1973. Über den Nachweis des *Alfalfa mosaic virus* in einer Weinrebe. *Phytopathologische Zeitschrift* 76: 166–171.
- Bovey, R., and O. Cazelles. 1979. *Alfalfa mosaic virus* on grapevine. *Proceedings 6th Meeting of ICVG, Cordoba, Spain. Monografias INIA No 18*: 131–134.
- Chiumenti, M., M. Morelli, A. Giampetruzzi, F. Palmiano, V.N. Savino, P. La Notte, G.P. Martelli, and P. Saldarelli. 2015. First report of Grapevine Roditis leaf discoloration-associated virus in Italy. *Journal of Plant Pathology* 97: 11.
- Francki, R.I.B. 1985. The viruses and their taxonomy. In *The plant viruses. Polyhedral virions with tripartite genomes*, ed. R.I.B. Francki, 1–18. New York: Plenum Press.
- Giampetruzzi, A., V. Roumi, R. Roberto, U. Malossini, N. Yoshikawa, P. La Notte, F. Terlizzi, R. Credi, and P. Saldarelli. 2012. A new grapevine virus discovered by deep sequencing of virus- and viroid-derived small RNAs in cv Pinot gris. *Virus Research* 163: 262–268.
- Girgis, S.M., F.P. Bem, P.E. Kyriakopoulou, C.I. Dovas, A.P. Sklavounos, A. Avgelis, N. Katis, S. Tzortzakakis, and M. Tsagris. 2000. A new ilarvirus isolated from grapevine in Greece. *Plant Disease* 84: 1345.
- Girgis, S.M., F.P. Bem, P.E. Kyriakopoulou, C.I. Dovas, A. Avgelis, and N. Katis. 2003. The etiology of a new virus disease: grapevine angular mosaic. In *Extended abstracts 14th meeting of ICVG, Locorotondo, Italy*, 19.
- Girgis, S.M., F.P. Bem, C.I. Dovas, A. Sclavounos, A.D. Avgelis, M. Tsagris, N. Katis, and P.E. Kyriakopoulou. 2009. Characterization of a novel ilarvirus causing grapevine angular mosaic disease. *European Journal of Plant Pathology* 125: 203–211.
- Grammatikaki, G., S.M. Girgis, and A. Avgelis. 2006. Elimination of Grapevine angular mosaic virus (GAMV) by heat treatment and meristem shoot tip culture. In *Extended abstract 15th meeting of ICVG, Stellenbosch, South Africa*, 153–154.

- Jeremovic, D., and S. Paunovic. 2011. *Raspberry bushy dwarf virus* – A grapevine pathogen in Serbia. *Pesticidi i fitomedicina* 26: 55–60.
- Kunugi, Y., S. Asari, Y. Terai, and A. Shinkai. 2000. Studies on the grapevine berry inner necrosis virus disease. 2. Transmission of grapevine berry inner necrosis virus by the grape erineum mite *Colomerus vitis* in Yamanashi. *Bulletin of Yamanashi Fruit Tree Experimental Station* 10: 57–63.
- Lehoczky, J., D. Boscia, G.P. Martelli, J. Burgyan, M.A. Castellano, L. Beczner, and G. Farkas. 1987. Occurrence of line pattern a hitherto unknown virus disease of grapevine in Hungary. *Kertgazdasag* 19: 61–79.
- Lehoczky, J., D. Boscia, J. Burgyan, M.A. Castellano, L. Beczner, and G. Farkas. 1989. Line pattern, a novel virus disease of grapevine in Hungary. In *Proceedings 9th meeting of ICVG, Kiryat Anavim, Israel*, 23–30.
- Lehoczky, J., G.P. Martelli, and J. Lazar. 1992. Seed transmission of grapevine line pattern virus. *Phytopathologia Mediterranea* 31: 115–116.
- Maliogka, V.I., A. Olmos, P.G. Pappi, L. Lotos, K. Efthimiou, G. Grammatikaki, T. Candresse, N.I. Katis, and A.D. Avgelis. 2015. A novel grapevine badnavirus is associated with Roditis leaf discoloration disease. *Virus Research* 203: 47–55.
- Martelli, G.P. 2014. Directory of virus and virus-like diseases of the Grapevine and their agents. *Journal of Plant Pathology* 96 (Supplement 1): 105–120.
- Mavric I., and Marn M. Virscek. 2006. Preliminary results show irregular distribution of *Raspberry bushy dwarf virus* in infected grapevines. In *Extended abstracts 15th meeting of ICVG, Stellenbosch, South Africa*, 234.
- Mavric, I., Marn M. Virscek, and I. Zezlina. 2003. *Raspberry bushy dwarf virus* infection of grapevine in Slovenia. In *Extended abstracts 14th meeting of IGVG, Locorotondo, Italy*, 20.
- Mavric-Plesko, I., Marn M. Virscek, S. Sirca, and G. Urek. 2009. Biological, serological and molecular characterization of *Raspberry bushy dwarf virus* from grapevine and its detection in the nematode *Longidorus juvenilis*. *European Journal of Plant Pathology* 123: 261–268.
- Murant, A.F. 1976. *Raspberry bushy dwarf virus*. *CMI/AAB Description of Plant Viruses*, No. 165.
- Nishijima, T., Y. Terai, and Y. Kunugi. 2000. Studies on the grapevine berry inner necrosis virus disease. 1. Symptoms on vines, varietal susceptibility and natural spread. *Bulletin of Yamanashi Fruit Tree Experimental Station* 10: 47–56.
- Rumbos, I.C., and A.D. Avgelis. 1989. Roditis leaf discoloration – A new virus disease of grapevine: symptomatology and transmission to indicator plants. *Journal of Phytopathology* 125: 274–278.
- Sabanadzovic, S. 2009. Viruses of native *Vitis* germplasm in the Southeastern United States. *Extended Abstracts 16th Meeting of ICVG, Dijon, France*: 32–35.
- Sabanadzovic, S., and N. Abou Ghanem-Sabanadzovic. 2012. Molecular characterization of two dsRNA viruses in native *Vitis* species. In *Proceedings 17th Congress of ICVG, Davis CA, USA*, 110–111.
- Terai, Y., Y. Kunugi, and H. Yanase, 1993. A new virus disease, grapevine berry inner necrosis with natural spread in Japan. In *Extended abstracts 11th meeting of ICVG, Montreux, Switzerland*, 77–78.
- Yanase, H., and Y. Terai. 1987. Back-transmission of a grapevine filamentous virus to grapevine seedlings and induction of foliar and berry symptoms in grapevine. *Annals of the Phytopathological Society of Japan* 53: 423.
- Yoshikawa, N., H. Iida, S. Goto, H. Magome, T. Takahashi, and Y. Terai. 1997. Grapevine berry inner necrosis, a new trichovirus: comparative studies with several known trichoviruses. *Archives of Virology* 142: 1351–1363.

Chapter 19

Viroids Infecting the Grapevine

F. Di Serio, K. Izadpanah, M. Hajizadeh, and B. Navarro

Abstract Viroids are nonprotein-coding, small, circular RNAs infecting plants in which they may induce specific symptoms. Five different viroids have been identified in the grapevine in the period elapsed from 1985 to 1990. Since then, no new viroid has been reported from grapevines until the application of next-generation sequencing allowed the discovery of an additional viroid and a new viroid-like RNA. Possibly, new small, circular RNAs will be identified in the future by metagenomic approaches, but bioassays, which are time intensive and require phytopathological expertise, will always be needed for establishing conclusively their true identity as viroids. Although viroids generally do not elicit severe symptoms in grapevines, some of them are the agent of diseases in certain environmental conditions or in combination with certain viruses. Some of grapevine-infecting viroids may cause severe diseases in other crops. This chapter reviews the molecular, biological, and epidemiological features of viroids and viroid-like RNAs infecting grapevines and the methods for their detection and control and discusses the future perspectives of research.

Keywords Circular RNAs • Viroid-like RNAs • Next-generation sequencing • AGVd • CEVd • GYSVd.1 • GYSVd-2 • HSVd • GLVd

Introduction and Historical Aspects

Viroids are the smallest infectious agents known so far. They are naked, circular, single-stranded RNAs composed of only 250–400 nucleotides (nt). In contrast to viruses, viroid RNAs do not code for proteins and rely almost completely on cellular enzymes for their infectivity (Navarro et al. 2012; Rao and Kalantidis 2015).

F. Di Serio (✉) • B. Navarro
Institute for Sustainable Plant Protection, National Research Council, Bari, Italy
e-mail: francesco.diserio@ips.cnr.it

K. Izadpanah
Plant Virology Research Center, College of Agriculture, Shiraz University, Shiraz, Iran

M. Hajizadeh
Plant Protection Department, Faculty of Agriculture, University of Kurdistan, Sanandaj, Iran

Due to self-complementary nucleotide sequences, viroid RNAs adopt compact (rod-like or branched) conformations *in vitro*, which have major roles *in vivo* due to structural elements that, by mimicking host RNAs, allow parasitization of the cellular transcriptional and RNA trafficking machineries (Flores et al. 2012). Actually, the ability of using host enzymes and molecular routes for replication and movement within the infected cell, from cell to cell, and systemically throughout the plant is the major biological trait for establishing the viroid nature of an infectious, circular RNA. This feature is, indeed, unique to viroids and demarcates a strong biological difference from viroid-like satellite RNAs, another group of infectious, nonprotein-coding RNAs that may also exist as circular RNAs in plant cells but whose infectivity depends on a coinfecting helper virus (Rubino et al. 2003).

Viroids have been reported only from plants and, similarly to viruses, they may remain latent or elicit ultrastructural and macroscopic alterations to the infected hosts (Di Serio et al. 2013). Molecular mechanisms underlying viroid pathogenicity are largely unknown, although they have been frequently linked to the modulation of host gene expression induced, directly or indirectly, by the viroid RNAs (Flores et al. 2015; Hammann and Steger 2012).

Based on structural and biological properties, the International Committee on Taxonomy of Viruses (ICTV) classifies viroids in 33 species and eight genera, grouped in the families *Pospiviroidae* and *Avsunviroidae* (Di Serio et al. 2014). Members of the family *Pospiviroidae* [type species *Potato spindle tuber viroid* (PSTVd)] have genomic RNAs assuming a rod-like or quasi rod-like conformation, with a central conserved region (CCR) playing major roles in replication (Flores et al. 2011; Gas et al. 2007). The sequence of the CCR and other conserved structural motifs [terminal conserved region (TCR) and terminal conserved hairpin (TCH)] assume taxonomic relevance for discriminating genera within the family *Pospiviroidae* (Di Serio et al. 2014). Experimental evidence has shown that PSTVd and other representatives of this family replicate and accumulate in the nucleus (Flores et al. 2005). In contrast, the chloroplast is the subcellular localization site for the replication and accumulation of members of the family *Avsunviroidae*. Viroids of this family may assume branched conformations, lack the CCR, and contain hammerhead ribozymes involved in viroid RNA self-cleavage during replication (Flores et al. 2000). The overall conformation of the genomic RNA, its solubility in 2 M lithium chloride, the G + C content, and the type of hammerhead ribozymes constitute criteria for discriminating genera within the family in question (Di Serio et al. 2014).

Viroids replicate through a rolling circle mechanism based exclusively on RNA intermediate molecules that are generated by host DNA-dependent RNA polymerases, with the RNA polymerase II (Pol II) and the nuclear-encoded chloroplastic RNA polymerase (NEP) being likely involved in the case of members of the families *Pospiviroidae* and *Avsunviroidae*, respectively (Flores et al. 2015). Therefore, viroids have the ability to convert host DNA-dependent enzymes to enzymes using RNAs as templates. This feature was recently confirmed by the involvement of a DNA ligase in the replication of PSTVd (Nohales et al. 2012).

Table 19.1 Classification of viroids infecting grapevine and tentative classification of new viroid and viroid-like RNAs recently reported in grapevine

Species	Genus	Family
<i>Hop stunt viroid</i>	<i>Hostuviroid</i>	<i>Pospiviroidae</i>
<i>Citrus exocortis viroid</i>	<i>Pospiviroid</i>	<i>Pospiviroidae</i>
<i>Grapevine yellow speckle viroid-1</i>	<i>Apscaviroid</i>	<i>Pospiviroidae</i>
<i>Grapevine yellow speckle viroid-2</i>	<i>Apscaviroid</i>	<i>Pospiviroidae</i>
<i>Australian grapevine viroid</i>	<i>Apscaviroid</i>	<i>Pospiviroidae</i>
Grapevine latent viroid ^a	<i>Apscaviroid</i>	<i>Pospiviroidae</i>
Tentative new viroid species		
Grapevine hammerhead viroid-like RNA ^b		

^aNot yet included in the official ICTV classification

^bThe viroid nature (replication in the absence of a helper virus) has not yet been shown, leaving open the possibility that it could be a viroid-like satellite RNA

Grapevine was recognized as a natural host of viroids more than 30 years ago, when the *Hop stunt viroid* (HSVd) was detected in Japanese vines (Shikata et al. 1984; Sano et al. 1985) and two viroid-like RNAs, one of which identified as the *Citrus exocortis viroid* (CEVd), were found in several grapevine accessions from Spain and California (Flores et al. 1985). A few years later, *Grapevine yellow speckle viroid 1* (GYSVd-1), *Grapevine yellow speckle viroid 2* (GYSVd-2), and *Australian grapevine viroid* (AGVd) were discovered and characterized (Koltunow and Rezaian 1988, 1989; Rezaian 1990; Rezaian et al. 1988), thus scaling up to five the number of viroids infecting the grapevine. ICTV classifies all these viroids into the family *Pospiviroidae*, with the species *Grapevine yellow speckle viroid 1*, *Grapevine yellow speckle viroid 2*, and *Australian grapevine viroid* belonging to the genus *Apscaviroid* (type member *Apple scar skin viroid*) and the species *Hop stunt viroid* and *Citrus exocortis viroid* to the genera *Hostuviroid* and *Pospiviroid*, respectively (Table 19.1) (Owens et al. 2012). The number of viroids infecting grapevine has increased in the last few years mainly due to the advent of detection methods based on next-generation sequencing (NGS) technology. NGS allowed discovering Grapevine latent viroid [GLVd (Zhang et al. 2014)], which has the typical characteristics of members in the genus *Apscaviroid* (family *Pospiviroidae*), and a viroid-like RNA sharing structural features with members of the family *Avsunviroidae* but whose biological features are still unknown (Wu et al. 2012) (Table 19.1).

Viroids infecting grapevine have been reviewed previously (Little and Rezaian 2003), and a historical perspective of major contribution in the field has been published recently (Martelli 2014).

Hop Stunt Viroid

HSVd was first identified in dwarfed hop plants (Sasaki and Shikata 1977). Over time, it turned out to be a ubiquitous viroid infecting many other crops worldwide. Hosts besides grapevine (Sano et al. 1985) include cucumber (Van Dorst and Peters 1974; Sano et al. 1984), citrus (Diener et al. 1988; Semancik et al. 1988), plum and peach (Sano et al. 1989), apricot (Flores et al. 1990), almond and pomegranate (Astruc et al. 1996), mulberry (Elbeaino et al. 2012; Amiri Mazhar et al. 2014), jujube (Zhang et al. 2009), pistachio (Elleuch et al. 2013), fig (Yakoubi et al. 2007), and chickpea (Pirovano et al. 2015). HSVd may cause severe diseases in some hosts, like hop (Sano 2003), cucumber (Van Drost and Peters 1974; Sano et al. 1984), citrus (Semancik et al. 1988), plum, and peach (Sano et al. 1989), while it remains latent in most other plant species, including grapevine. The absence of symptoms in many natural hosts has likely favored the worldwide dispersion of this viroid. In Australia (Koltunow et al. 1988), Germany (Polivka et al. 1996), Hungary (Farkas et al. 1999), New Zealand (Ward et al. 2011), Iran (Hajizadeh et al. 2012), India (Sahana et al. 2013), and Italy (Gambino et al. 2014), all, or almost all, tested grapevines proved to be infected by this viroid, while the incidence of HSVd infection was about 64% in China (Jiang et al. 2012). A similar HSVd incidence (68%) has been reported in grapevine from Japan (Jiang et al. 2012), thus partially modifying data from a previous survey in which 88% of the tested vines, including accessions from Europe and the USA, had tested positive (Sano et al. 1985).

HSVd variants from grapevine range in size from 296 to 302 nt and assume rod-like conformation containing the typical CCR and the TCH (Fig. 19.1). Sequence variability was observed not only among the variants from different isolates but also within the same isolate, thus supporting the conclusion that HSVd infecting grapevine has the typical features of quasispecies (Sano et al. 2001). Therefore, similarly to other viroids, a single grapevine is generally infected by a polymorphic population of HSVd variants slightly differing from each other and generally distributed around a predominant sequence (the master sequence) (Codoñer et al. 2006).

According to sequence and phylogenetic analyses, HSVd variants from different host species were clustered in three groups: (1) the grapevine and hop group; (2) the plum, almond, peach, and apricot group; and (3) the citrus group (Kofalvi et al. 1997; Sano et al. 1989). Later on, characterization of new variants showed the existence of two additional minor groups of variants, presumably derived from recombination events between members of the three main groups (Kofalvi et al. 1997). More recently, additional HSVd variants not fitting in any of these five groups were reported from grapevines in China, thus suggesting the possible existence of additional phylogenetic clusters of HSVd variants (Zhang et al. 2012b). Altogether, the studies on HSVd sequence variability in grapevine, as well as in other hosts, show that this viroid admits a remarkable sequence variability which is mainly restricted to some specific genomic regions, i.e., the so-called pathogenic (P) and variable (V) domains identified in several representative members of the family *Pospiviroidae*

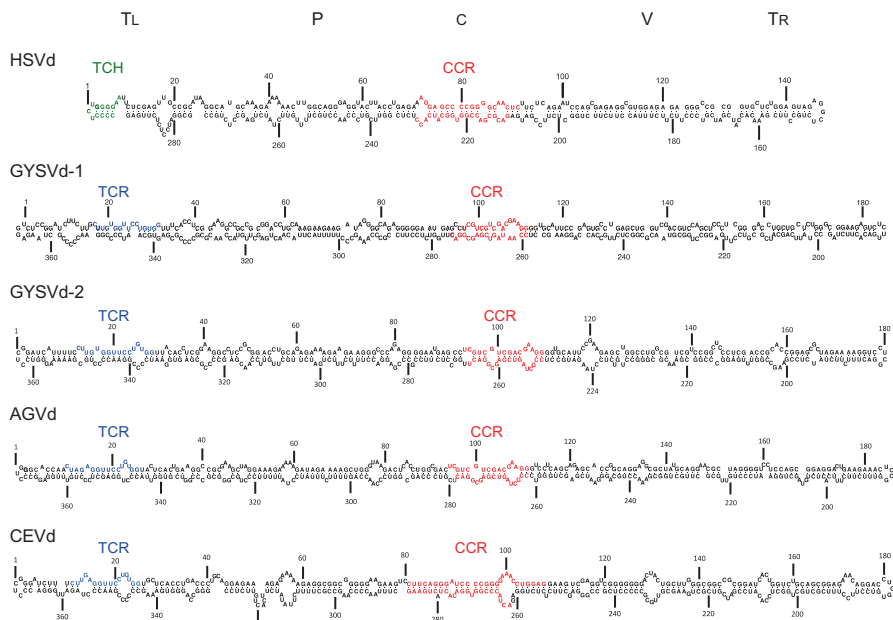

Fig. 19.1 Primary and computer-predicted secondary structure of the (+) strand of grapevine variants of HSVd (ID: X06873), GYSVd-1 (ID: GQ995473), GYSVd-2 (ID: KJ489020), AGVd (ID: KJ489016), and CEVd (ID: Y00328). The core nucleotides of the central conserved region (CCR), terminal conserved region (TCR), and terminal conserved hairpin (TCH) are denoted in red, blue, and green, respectively. The locations of the five structural domains, central (C), pathogenic (P), variable (V), and terminal left (TL) and terminal right (Tr) identified by Keese and Symons (1985), are indicated on the top. The secondary structures of minimal free energy of GYSVd-2, AGVd, and CEVd were calculated by the program RNAfold (<http://rna.tbi.univie.ac.at/cgi-bin/RNAfold.cgi>); the secondary structure of HSVd and GYSVd-1 was reproduced from Navarro et al. (2009)

(Keese and Symons 1985), thus preserving the rod-like conformation proposed for the viroid genomic RNA (Fig. 19.1).

After the identification of HSVd in grapevine, the risk that this viroid could be transmitted to hop crops and cause economic losses was considered (Koltunow et al. 1988). Based on the close phylogenetic relationships among HSVd variants from grapevine and hop, Sano et al. (2001) proposed that HSVd variants infecting hop in Japan and causing hop stunt disease might have derived from grapevines latently infected by this viroid. This hypothesis was further supported by a long-term bioassay. Kawaguchi-Ito et al. (2009) inoculated hop plants with HSVd isolates from four host species (hop, grapevine, plum, and peach) and analyzed the viroid population in the inoculated plants 15 years post-inoculation. The authors showed that variants from grapevine exhibited a convergent evolution during prolonged persistent infection in hop, giving rise to HSVd variants almost identical to those currently responsible for the epidemic in commercial hops in Japan (Kawaguchi-Ito et al. 2009). Since mutations identical to those found in the natural HSVd-hop

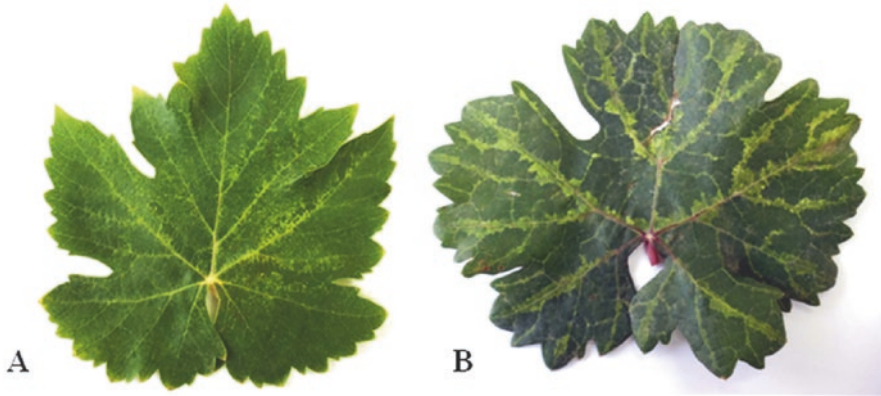

Fig. 19.2 (a) A grapevine leaf infected by the viroids GYSVd-1 and GYSVd-2 and showing yellow speckle symptoms. (b) A grapevine leaf infected by GYSVd-1, GYSVd-2, and GFLV and showing vein-banding symptoms (Reproduced from Hajizadeh et al. 2015)

variants were also observed in the progeny recovered from hop plants inoculated with an infectious *in vitro* transcript of a cloned HSVd-grapevine variant, it was shown that the adaptation of the grapevine viroid to the new host (hop) likely depends on the *de novo* emergence of mutants, instead of selection of mutants pre-existing in the original inoculum (Kawaguchi-Ito et al. 2009). This study is a worthy example of how a viroid that is latent in certain hosts may jump to different host species, in which it may evolve to become a serious pathogen, something that has likely happened frequently in the natural history of viroids (Diener 1995). Interestingly, the possible origin of HSVd, and other viroids, in citrus from infected but symptomless grapevines has also been proposed (Bar-Joseph 2003). Therefore, although no HSVd-induced symptom has ever been observed in grapevine (Little and Rezaian 2003), HSV-infected grapevines can be the source of potentially dangerous HSVd epidemics in hop and other susceptible species.

Grapevine Yellow Speckle Viroid 1 and Grapevine Yellow Speckle Viroid 2

Among viroids infecting grapevine, only GYSVd-1 and GYSVd-2 (originally named GYSVd and Grapevine viroid 1B, GV1B, respectively) have been identified as the agents of a grapevine disease (Kolunow et al. 1989). Yellow speckle (YS), a graft-transmissible disease first reported in Australia (Taylor and Woodham 1972), is characterized by tiny yellow spots or dots dispersed on the leaves or distributed along the leaf veins (Fig. 19.2a). These symptoms are ephemeral, are frequently present on a few shoots of the same vine, and are incited by high temperature (Stellmach and Goheen 1988). Leaf exposure to the sun also may favor expression

of YS symptoms (Habibi and Randles 2010). After identifying and sequencing the two circular RNAs (Koltunow and Rezaian 1988, 1989), Koltunow et al. (1989) showed that GYSVd-1 and GYSVd-2, each independently on the presence of the other, can replicate autonomously in inoculated grapevines, thus confirming that they are viroids and may cause YS disease.

After the first description, GYSVd-1 was reported from many countries, thus emerging as a widespread viroid in grapevine. In contrast, distribution of GYSVd-2 appeared more restricted and possibly limited to Australia. However, reports from Italy (Minafra et al. 1990; Gambino et al. 2014), Turkey (Gazel and Önelge 2003), Iran (Zaki-Aghl and Izadpanah 2009), China (Li et al. 2007), and the USA (Al Rwahnih et al. 2009) suggest that the occurrence of this viroid may be wider than supposed. While a relatively low incidence of GYSVd-2 was recorded in Turkey, China, and Italy (about 2%, 11%, and 5%, respectively) (Gambino et al. 2014; Gazel and Önelge 2003; Jiang et al. 2009c), two independent studies have shown that this viroid occurs with higher frequency in Iran (infection confirmed in more than 60% of the tested samples) (Zaki-Aghl and Izadpanah 2009; Hajizadeh et al. 2012). Both GYSVd-1 and GYSVd-2 possess the rod-like conformation containing the CCR and TCR domains conserved in the other members of the genus *Apscaviroid* (Fig. 19.1).

Sequence identity between GYSVd-1 and GYSVd-2 is about 73% and both viroids exist as quasispecies in their hosts. Studies on sequence variability of GYSVd-1 in symptomatic and non-symptomatic samples revealed the existence of at least three prevalent types of variants, possibly differing in their capacity of eliciting YS symptoms (Rigden and Rezaian 1993; Szychowski et al. 1998). However, a defined pathogenic determinant in the GYSVd-1 genome has not been conclusively identified (Polivka et al. 1996; Rigden and Rezaian 1993; Szychowski et al. 1998). Recently, it has been proposed that GYSVd-1 variants with the specific signature consisting of the simultaneous presence of U and A at position 309 and 311, respectively (according to positions in the variant reported by Little and Rezaian 2003), might induce YS symptoms, while variants that have the nucleotides A and U at the same positions, respectively, do not elicit these symptoms (Salman et al. 2014). However, the same authors also consider that additional factors, including other mutations in the viroid genome as well as climate conditions, may be directly or indirectly involved in the development of YS symptoms (Salman et al. 2014). In fact, in line with previous data (Szychowski et al. 1998), Salman et al. (2014) confirmed that YS symptoms appeared only when the temperature was higher than 32 °C and suggested that mutations favoring the elicitation of symptoms could also be climate-dependent. If confirmed by bioassays with infectious cDNA clones and artificial mutants, these findings may garner particular interest, especially considering the possible implications of global warming in viroid evolution and, more specifically, in the possible aggravation of YS disease in grapevine in the future.

Sequence variants sharing 88–89% nt identity with the GYSVd-1 reference sequence (accession number X06904) were proposed to be the representatives of a different species, tentatively named Grapevine yellow speckle viroid 3 (Jiang et al. 2009a). However, according to ICTV rules (Di Serio et al. 2014), acceptance of

such a proposal requires further discrimination based on differential biological traits between members of the tentative species and the other GYSVd-1 variants, which has not been shown so far.

Sequence variability of GYSVd-2, within and between isolates, has also been reported. However, although polymorphic positions were identified in GYSVd-2 variants from Chinese (Jiang et al. 2009c), Italian (Gambino et al. 2014), and Iranian (Hajizadeh et al. 2015) isolates, phylogenetic studies did not show any significant clustering of the sequence variants according to their geographical origin. On the other hand, although the capability of this viroid to induce YS has been proven (Koltunow et al. 1989), whether only some of the existing GYSVd-2 variants are actually pathogenic is still unknown.

In 1995, it was shown that vein banding (VB), a grapevine disease characterized by the appearance of chrome yellow flecks along the main leaf veins that may spread to the interveinal areas (Goheen and Hewitt 1962) (Fig. 19.2b), is caused by the concomitant infection by GYSVd-1 and/or GYSVd-2 and *Grapevine fanleaf virus* (GFLV) (Krake and Woodham 1983; Szychowski et al. 1995). Results of a recent survey are consistent with the involvement of either or both viroids and GFLV in the VB disease frequently occurring in Iran (Hajizadeh et al. 2015).

Australian Grapevine Viroid

AGVd was first discovered in Australia as a component of a viroid complex isolated from grapevine (Rezaian et al. 1988). It was distinguished from other viroids by its electrophoretic properties, nucleotide sequence, and analysis based on molecular hybridization.

Although grapevine is the unique natural host of AGVd, this viroid is transmissible to several herbaceous plants by artificial inoculation. Rezaian et al. (1988) used an electrophoretically isolated viroid preparation as inoculum for the mechanical transmission to cucumber and tomato. Zaki-Aghl and colleagues (2010, 2013) obtained AGVd infection in tomato and cucumber by stem injection of nucleic acid extracted from grapevine. They further used *Agrobacterium tumefaciens* cells transformed with plasmids containing full-length cDNA dimeric constructs of AGVd to successfully infect, in addition to cucumber and tomato, *Cucurbita pepo* (squash), *Gynura aurantiaca*, *Calendula officinalis*, and *Nicotiana glutinosa*. In contrast, *N. tabacum* (cv. Turkish) was not infected. The viroid induced stunting in cucumber; stunting, leaflet deformation, and mottling in tomato; twisting and leaf edge sharpening in *G. aurantiaca*; mottling and faint vein banding in *N. glutinosa*; and no symptoms in *C. officinalis* and *C. pepo*.

As originally described by Rezaian (1990), the genome of AGVd consists of a circular, single-stranded RNA molecule of 369 nt forming a rod-like structure with a CCR and a TCR similar to that of other apscaviroids (Fig. 19.1). The genome of the type isolate is 369 nt long. Other genome sizes reported range from 361 [a Tunisian isolate, Elleuch et al. (2002)] to 371 [an Iranian isolate, Zaki-Aghl et al. (2013)].

Despite low overall sequence diversity reported within each isolate, phylogenetic analyses showed that variants from Italy, Tunisia, and Australia are more closely related to each other than to variants from China and Iran (Gambino et al. 2014).

Zaki-Aghl (2010) generated a series of point mutations in the genome of AGVd and tested the mutants for changes in the viroid accumulation, trafficking, and symptom development in herbaceous hosts. Most mutations in the TR region reduced the viroid accumulation and trafficking. Mutations in TL (G365C, G351C) resulted in increased accumulation but reduced systemic trafficking to 67–75% compared to the wild type. Possible pathogenic determinants in the viroid genome were also investigated, with the G365C mutation reversing stunting of cucumber plants. Mutations in the CCR and V regions generally reduced the steady-state level of the viroid but had variable effect on the severity of symptoms and trafficking. A chimera, in which the right part of AGVd (163 nt of the right side of CCR) was replaced with the corresponding part of GYSVd-1, induced severe top necrosis in tomato, while the GYSVd-1 monomers did not infect tomato at all (Zaki-Aghl and Izadpanah 2015). Therefore, it appears that factors determining infectivity and host range of AGVd are located in the left side of the viroid, while the right part of the rod-like RNA molecule could be involved in determining symptom severity in some herbaceous host.

In addition to Australia, AGVd has been reported from grape-growing regions of China (Jiang et al. 2009b), India (Adkar-Purushothama et al. 2014), Iran (Zaki-Aghl and Izadpanah 2010), Italy (Gambino et al. 2014), Tunisia (Elleuch et al. 2003), and the USA (Al Rwahnih et al. 2009). Thus, it seems to have a worldwide distribution, with higher incidence in Iran and Tunisia (Hajizadeh et al. 2012; Zaki-Aghl et al. 2013). Since no symptoms have been attributed to AGVd in its natural host (Rezaian et al. 1988; Zaki-Aghl and Izadpanah 2010), this viroid may not have economic relevance.

Citrus Exocortis Viroid

This viroid was first isolated and characterized in citrus as the causal agent of exocortis disease (Semancik and Weathers 1972). After the first report in a symptomless grapevine (Flores et al. 1985), CEVd variants from this host were further molecularly and biologically characterized, showing high sequence identity with those previously reported from citrus, including a central core in the pathogenic domain previously observed in the variants inducing severe symptoms in tomato (Garcia-Arenal et al. 1987). The observed sequence variability preserves the proposed rod-like secondary structure (Fig. 19.1) and is consistent with the quasispecies nature proposed for this viroid (Gandía et al. 2005; Garcia-Arenal et al. 1987; Eiras et al. 2006). Grapevines naturally infected by CEVd have been reported in Spain (Flores et al. 1985), Australia (Rezaian et al. 1988), Turkey (Gazel and Önelge 2003), Brazil (Eiras et al. 2006), China (Shu et al. 2010), and California (Semancik and

Szychowski 1992). This viroid was not found in field surveys carried out in Italy (Gambino et al. 2014), Japan (Jiang et al. 2012), and Iran (Hajizadeh et al. 2012, 2015; Zaki-Aghl and Izadpanah 2010). Therefore, the incidence of CEVd appears restricted to a few cultivars and/or geographic areas, with no evident economic impact. Similarly to HSVd, a possible grapevine origin has been proposed for CEVd infecting citrus (Bar-Joseph 2003), thus posing the question of whether grapevines latently infected by CEVd may actually be the source of inoculum for other susceptible crops.

Viroids and/or Viroid-Like RNAs Identified in Grapevine by Next-Generation Sequencing

Using as substrate double-stranded (ds) RNAs or highly structured single-stranded RNAs (Qi et al. 2005), plant RNase III-like proteins (Dicer-like proteins, DCL) generate endogenous microRNAs of 21–22 nt (miRNAs) and endogenous or exogenous small interfering RNAs of 21–24 nt (siRNAs) (Carthew and Sontheimer 2009) that guide the degradation or translation inhibition of complementary RNAs (posttranscriptional gene silencing), or the methylation of cognate DNA (transcriptional gene silencing) (Axtell 2013). Identification of viroid-derived small RNAs (vd-sRNAs) similar to miRNAs and siRNAs, accumulating in tissues infected by members of both viroid families (*Pospiviroidae* and *Avsunviroidae*) (Itaya et al. 2001; Martinez de Alba et al. 2002; Papaefthimiou et al. 2001), showed that viroids, as also reported for viruses, are targeted by host DCLs. After the partial characterization of vd-sRNAs accumulating in viroid-infected herbaceous plants (Itaya et al. 2007; Machida et al. 2007; Martin et al. 2007), vd-sRNAs from grapevine infected with HSVd and GYSVd-1 were further studied by next-generation sequencing (NGS) based on Illumina technology (Navarro et al. 2009). This approach, which allows sequencing thousands of sRNAs at once, showed that HSVd and GYSVd-1 vd-sRNAs of both polarities accumulated in grapevine tissues, thus strongly suggesting the involvement of dsRNAs in their biogenesis (Navarro et al. 2009). Besides further dissecting the molecular mechanisms underlying plant-viroid interactions (reviewed by Flores et al. 2015), NGS also had major implications for the identification of known and previously unreported viroids. Indeed, sRNAs can be assembled *in silico* generating contigs that may unveil the presence of viroid RNAs by comparisons with sequences available in the databases. Specific protocols have been developed for using NGS as an extremely sensitive detection method of both viruses and viroids (Burger and Maree 2015; Wu et al. 2015). In the case of viroids, the circularity of the genomic RNAs has been exploited for developing algorithms able to assemble the vd-sRNAs into circular molecules, thus setting homology-independent detection methods of circular RNAs based on NGS (Wu et al. 2012; Zhang et al. 2014). In the case of grapevine, application of these protocols allowed discovering two possible new viroids in the last few years.

Grapevine Latent Viroid

Grapevine latent viroid (GLVd) was identified in a more than 100-year-old grapevine in China (Zhang et al. 2014). The circular genomic RNA of this viroid, composed of 328 nt, assumes a rod-like conformation in which a CCR, almost identical to the CCR of viroids in the genus *Apscaviroid*, is contained (Zhang et al. 2014). Other typical motifs conserved in the other members of this viroid genus were also found in GLVd, including the TCR and a poly-purine stretch in the P domain. From a phylogenetic point of view, GLVd seems more closely related to *Apple scar skin viroid* (ASSVd) than to the other apscaviroids previously found in grapevine (AGVd, GYSVd-1, and GYSVd-2). Besides NGS, this viroid has been detected by Northern-blot hybridization and RT-PCR using specific primers (Zhang et al. 2014). Autonomous replication of GLVd in grapevine and the absence of symptoms associated with the infection were confirmed by bioassays using infectious *in vitro* transcripts of a cloned GLVd variant (Zhang et al. 2014). Taking into consideration these features, it is likely that in the future ICTV will classify this viroid as a new species in the genus *Apscaviroid*.

Grapevine Hammerhead Viroid-Like RNA

In 2012, a 375 nt long viroid-like RNA containing self-cleaving hammerhead ribozymes in both polarity strands was identified, through NGS and *in silico* assembly of sRNAs isolated from a grapevine of cv. Pinot noir ENTAV115 grown in a collection field (Wu et al. 2012). The same hammerhead viroid-like RNA was found by RT-PCR in the tendrils of a grapevine of the same Pinot noir accession grown in California (Wu et al. 2012). However, this RNA was not detected, by Northern-blot hybridization or RT-PCR, in the leaves of other accessions of the cv. Pinot noir ENTAV115 from Italy (F. Di Serio, unpublished information). Since the grapevine hammerhead viroid-like RNA was not associated with any symptoms, it has apparently no economic impact. Dimeric *in vitro* transcripts of a cloned variant of this viroid-like RNA were not infectious when they were slash-inoculated to grapevine cuttings with a razor blade (Wu et al. 2012). However, at this stage, it seems premature to exclude that this RNA is not endowed of autonomous replication (and therefore that it is not a viroid). Indeed, several of its structural features, including the proposed branched conformation, stabilized by a long base-paired arm and by a kissing-loop pseudoknot, are surprisingly similar to those previously reported for *Peach latent mosaic viroid* (PLMVd) and *Chrysanthemum chlorotic mottle viroid* (for a review, see Flores et al. 2006, 2012), which are two chloroplast-replicating viroids classified in the genus *Pelamoviroid* (family *Avsunviroidae*). In addition, similarly to PLMVd (Di Serio et al. 2009), vd-sRNAs of 24 nt deriving from the hammerhead grapevine viroid-like RNAs were almost absent in the grapevine tissues (Wu et al. 2012), providing an additional link with chloroplast-replicating viroids that, in contrast to nuclear-replicating viroids (Navarro et al. 2009), are also not associated with the accumulation of 24-nt vd-sRNAs. Therefore, conclusive

definition of the biological properties of the grapevine hammerhead viroid-like RNA requires additional efforts, i.e., bioassays performed with the circular RNA forms purified by preparative polyacrylamide gel electrophoresis (PAGE; see below) from naturally infected tissues. Should the autonomous replication of this RNA be confirmed, it could be classified as representative of a new viroid species in the genus *Pelamoviroid* of the family *Avsunviroidae*.

Detection of Viroids Infecting Grapevine

In the absence of obvious symptoms in grapevine, biological indexing is not possible to detect most viroids infecting grapevine. Although GYSVd-1 and GYSVd-2 may induce YS in grapevine, and AGVd may induce symptoms in several experimental herbaceous hosts (see above), the efficiency of bioassays based on the inoculation of these hosts has not been evaluated and is considered not useful for testing a large number of samples. Most grapevine viroids, especially in the past, have been detected by PAGEs specifically developed for separating viroid circular RNA forms from the linear RNAs of the same sizes (Hanold et al. 2003), followed by staining the gel with ethidium bromide or silver nitrate (Flores et al. 1985; Koltunow and Rezaian 1989; Rezaian et al. 1988). Circular RNAs, after PAGE separation, can also be eluted from the gel for further molecular studies or biological characterization through bioassays. Northern-blot hybridization using radioisotope- or digoxigenin-labeled riboprobes specific for each viroid species strongly improves the sensitivity and the specificity of the detection because the viroids are recognized based on both the molecular size and sequence composition (Hajizadeh et al. 2012; Semancik and Szychowski 1992). Due to the high sequence similarity between GYSVd-1 and GYSVd-2, discrimination of these two viroids by Northern-blot hybridization requires prolonged separation of the RNA preparations by denaturing PAGE (Hajizadeh et al. 2012), or the use of synthetic and specifically labeled oligonucleotides for their identification, which may be useful in both Northern-blot or dot-blot assays (Kolonow et al. 1989). Molecular hybridization methods may also allow detection of multiple viroid infections by mixing several specific probes in the hybridization solution (Hajizadeh et al. 2012) or applying a specifically developed cRNA polyprobe able to simultaneously detect infections by GYSVd-1, GYSVd-2, CEVd, and HSVd (Zhang et al. 2012a). RT-PCR protocols were largely applied for detecting separately each viroid infecting grapevine (Jiang et al. 2012; Rezaian et al. 1992; Sano et al. 2001). Recently, a multiplex RT-PCR method allowing the simultaneous detection of five viroids infecting grapevine has been developed and applied to survey grapevine viroid infections in Iran (Hajizadeh et al. 2012, 2015) and Italy (Gambino et al. 2014). In these areas, HSVd was detected in 100% of the tested vines, suggesting that this viroid could serve as an internal positive control of multiplex RT-PCR assays (Hajizadeh et al. 2012). However, it must be also taken into consideration that in other geographic areas (i.e., Japan and China), the incidence of HSVd is apparently lower than 100%. In this case, another internal control,

possibly based on a host mRNAs, is preferred, although it requires additional time and costs for DNase treatments to eliminate the host DNA counterpart before the assay. Finally, as reported above, application of NGS allowed the detection of several previously known (Al Rwahnih et al. 2009, 2012; Alabi et al. 2012; Giampetruzzi et al. 2012; Navarro et al. 2009) and new viroids and viroid-like RNAs in grapevine (Wu et al. 2012; Zhang et al. 2014).

Epidemiology of Grapevine-Infecting Viroids and Control Options

With six viroids and one viroid-like RNA reported so far, grapevine is one of the most permissive natural hosts of these infectious noncoding RNAs. Grapevines are generally infected by a combination of different viroids, with mixed infection by HSVd and GYSVd-1 being prevalent. However, a recent survey revealed that in Northwest Iran almost 91% of the tested vines were simultaneously infected by four (HSVd, GYSVd-1, GYSVd-2, and AGVd) or three viroids (HSVd, GYSVd-1, and GYSVd-2) (Hajizadeh et al. 2015). Five different viroids (HSVd, GYSVd-1, GYSVd-2, AGVd, GLVd) were detected in a grapevine more than 100 years old (Zhang et al. 2014).

The widespread distribution of several viroids in the grapevine is very likely due to the absence of obvious symptoms in the infected plants and to vegetative propagation and grafting practices (Szychowski et al. 1988; Staub et al. 1993) adopted in this crop since a long time ago. No insect vector has ever been implicated in the spread of grapevine viroids, while seed transmission, initially considered unlikely, was reported for GYSVd-1, GYSVd-2, AGVd, and CEVd (Wan Chow Wah and Symons 1997, 1999). Transmission of grapevine viroids in the field through pruning tools was shown (Szychowski et al. 1988), although the contribution to viroid spread was minor when compared with the role of grafting (Staub et al. 1993). Therefore, although the use of sodium hypochlorite or formaldehyde for decontamination of pruning tools may contribute to reduce spreading of these viroids, the most effective strategy relies on the use of pathogen-free propagation material.

Successful elimination of viroids from grapevines was achieved through shoot apical meristem culture by Duran-Vila et al. (1988), although a much lower effectiveness of this technique was reported by others (Wan Chow Wah and Symons 1997). Thermotherapy, another traditional technique used to eliminate phloem-limited grapevine viruses, was ineffective with viroids (Gambino et al. 2011). In contrast, GYSVd-1 and HSVd were efficiently eradicated from four grapevine cultivars by somatic embryogenesis (Gambino et al. 2011), a sanitation technique highly effective also against grapevine viruses (Gambino et al. 2006). In this study, HSVd and GYSVd-1 were detected, by *in situ* hybridization, within proliferating calli, but never in somatic embryos during embryogenesis, thus showing that viroid-free embryos are generated from the infected calli (Gambino et al. 2011).

However, it was not possible to establish whether sanitation was due to impairment of viroid translocation within the calli or, alternatively, embryogenesis was compromised in viroid-infected cells. Incidentally, these experiments based on *in situ* hybridization also showed that both GYSVd-1 and HSVd accumulate within the nucleus of the infected grapevine cells, thus providing a firm experimental evidence of the subcellular localization of these viroids that previously was only presumed (Gambino et al. 2011).

Conclusions and Directions for Future Research

Although most viroids known to infect grapevine do not induce symptoms in this plant, some of them may seriously affect other crops. Therefore, efforts must be made to impair their spread using viroid-free propagation material. Whether latent viroid infections are accompanied by modifications of some organoleptic characteristics of major relevance for grape or wine quality is almost completely unknown. In this respect, it has been reported that fruit of viroid-free cv. Cabernet Sauvignon vines had higher titratable acidity and lower pH than the viroid-infected controls (Wolpert et al. 1996), but the effects on other metabolites, on other cultivars, and, ultimately, on the quality of the wine remain unknown.

Whether viroids modify gene expression in grapevine, thus interfering with resistance to other biotic or abiotic stresses, has not yet been investigated. These studies are particularly complex in the case of grapevine due to the lack of appropriate noninfected controls. In this respect, the availability of somatic embryogenesis as an efficient technique for eliminating at once both viruses and viroids from grapevine (Gambino et al. 2011) is particularly interesting not only for improving the sanitary status of grapevine propagation material but also for basic research. Viroid- and virus-free vines can be inoculated with a single viroid of interest (or a mixture of them) to perform transcriptomics and metabolomics studies in the absence of synergistic or antagonistic effects of concurrent infections by other undesired viruses and/or viroids and, more importantly, using the appropriate healthy controls. The publication of the grapevine genome sequences (Jaillon et al. 2007; Velasco et al. 2007) and the increasing accessibility of high-throughput technologies will offer great opportunities to further dissect the molecular mechanism underlying viroid-grapevine interplay. Due to the powerful sensitivity of NGS, identification of other novel viroids and viroid-like RNAs infecting grapevine is also expected in the future.

Acknowledgments The work in B.N. and F.D.S. laboratories are partially supported by the project MEDIPLANT (CISIA, a dedicated grant of the Ministero dell'Economia e Finanze Italiano to the CNR, Legge n. 191/2009) and by the project AQUA, Gestione sostenibile della risorsa acqua in agricoltura (funded by MIUR - Decreto MIUR 973 del 25/11/2013).

References

- Adkar-Purushothama, C.R., P.R. Kanchepalli, S.M. Yanjarappa, Z. Zhang, and T. Sano. 2014. Detection, distribution, and genetic diversity of Australian grapevine viroid in grapevines in India. *Virus Genes* 49: 304–311.
- Alabi, O.J., Y. Zheng, G. Jagadeeswaran, R. Sunkar, and R.A. Naidu. 2012. High-throughput sequence analysis of small RNAs in grapevine (*Vitis vinifera* L.) affected by grapevine leafroll disease. *Molecular Plant Pathology* 13: 1060–1076.
- Al Rwahnih, M., S. Daubert, D. Golino, and A. Rowhani. 2009. Deep sequencing analysis of RNAs from a grapevine showing Syrah decline symptoms reveals a multiple virus infection that includes a novel virus. *Virology* 387: 395–401.
- Al Rwahnih, M., V.V. Dolja, S. Daubert, E.V. Koonin, and A. Rowhani. 2012. Genomic and biological analysis of grapevine leafroll-associated virus 7 reveals a possible new genus within the family Closteroviridae. *Virus Research* 163: 302–309.
- Amiri Mazhar, M., S.A.A. Bagherian, and K. Izadpanah. 2014. Variants of hop stunt viroid associated with mulberry vein clearing in Iran. *Journal of Phytopathology* 162: 269–271.
- Astruc, N., J. Marcos, G. Macquaire, and T.V.P. Candresse. 1996. Studies on the diagnosis of hop stunt viroid in fruit trees: Identification of new hosts and application of a nucleic acid extraction procedure based on non-organic solvents. *European Journal of Plant Pathology* 102: 837–846.
- Axtell, M.J. 2013. Classification and comparison of small RNAs from plants. *Annual Review in Plant Biology* 64: 137–159.
- Bar-Joseph, M. 2003. Natural history of viroids-horticultural aspects. In *Viroids*, ed. A. Hadidi, R. Flores, J.W. Randles, and J.S. Semancik, 246–251. Collingwood: CSIRO Publishing.
- Burger, J.T., and H.J. Maree. 2015. Metagenomic next-generation sequencing of viruses infecting grapevines. *Methods in Molecular Biology* 1302: 315–330.
- Carthew, R.W., and E.J. Sontheimer. 2009. Origins and mechanisms of miRNAs and siRNAs. *Cell* 136: 642–655.
- Codoñer, F.M., J.A. Darós, R.V. Solé, and S.F. Elena. 2006. The fittest versus the flattest: Experimental confirmation of the quasispecies effect with subviral pathogens. *PLoS Pathogens* 2: e136.
- Diener, T.O. 1995. Origin and evolution of viroids and viroid-like satellite RNAs. *Virus Genes* 11: 119–131.
- Diener, T.O., D.R. Smith, R.H. Hammond, G. Albanese, R. La Rosa, and M. Davino. 1988. Citrus B viroid identified as strain of hop stunt viroid. *Plant Disease* 72: 691–693.
- Di Serio, F., A. Gisel, B. Navarro, S. Delgado, A.-E.M. de Alba, G. Donvito, and R. Flores. 2009. Deep sequencing of the small rnas derived from two symptomatic variants of a chloroplastic viroid: Implications for their genesis and for pathogenesis. *Plos One* 4 (10): e7539.
- Di Serio, F., A. De Stradis, S. Delgado, R. Flores, and B. Navarro. 2013. Cytopathic effects incited by viroid RNAs and putative underlying mechanisms. *Frontiers in Plant Science* 3: 1–13.
- Di Serio, F., R. Flores, J.T.J. Verhoeven, S.F. Li, V. Pallas, J.W. Randles, T. Sano, G. Vidalakis, and R.A. Owens. 2014. Current status of viroid taxonomy. *Archives of Virology* 159: 3467–3478.
- Duran-Vila, N., J. Juárez, and J.M. Arregui. 1988. Production of viroid-free grapevines by shoot tip culture. *American Journal of Enology and Viticulture* 39: 217–220.
- Eiras, M., M.L.P.N. Targon, T.V.M. Fajardo, R. Flores, and E.W. Kitajima. 2006. Citrus exocortis viroid and Hop Stunt viroid Doubly infecting grapevines in Brazil. *Fitopatologia Brasileira* 31: 440–446.
- Elbeaino, T., R.A. Kubaa, E. Choueiri, M. Digiario, and B. Navarro. 2012. Occurrence of Hop stunt viroid in mulberry (*Morus alba*) in Lebanon and Italy. *Journal of Phytopathology* 60: 48–51.
- Elleuch, A., H. Fakhfakh, M. Pelchat, P. Landry, M. Marrakchi, and J. Perreault. 2002. Sequencing of Australian grapevine viroid and yellow speckle viroid isolated from a Tunisian grapevine without passage in an indicator plant. *European Journal of Plant Pathology* 108: 815–820.

- Elleuch, A., M. Marrakchi, J. Perreault, and H. Fakhfakh. 2003. First report of Australian grapevine viroid from the Mediterranean region. *Journal of Plant Pathology* 85: 53–57.
- Elleuch, A., I. Hamdi, O. Ellouze, M. Ghrab, H. Fkafhakh, and N. Drira. 2013. Pistachio (*Pistacia vera* L.) is a new natural host of Hop stunt viroid. *Virus Genes* 47: 330–337.
- Farkas, E., L. Palkovics, J. Mikulás, and E. Balázs. 1999. High incidence of hop stunt viroid in Hungarian grapevines. *Acta Phytopathologica et Entomologica Hungarica* 34: 7–11.
- Flores, R., N. Duran-Vila, V. Pallas, and J.S. Semancik. 1985. Detection of viroid and viroid-like RNA species from grapevine. *Journal of General Virology* 66: 2095–2102.
- Flores, R., C. Hernández, S. García, and G. Llácer. 1990. Is apricot “viruela” (pseudopox) induced by a viroid? In *Proceedings of the 8th congress of the Mediterranean Phytopathological Union, Agadir, Morocco*. Agadir: Mediterranean Phytopathological Union.
- Flores, R., J.A. Daros, and C. Hernandez. 2000. Avsunviroidae family: Viroids containing hammerhead ribozymes. *Advances in Virus Research* 55: 271–323.
- Flores, R., C. Hernandez, A.E.M. de Alba, J.A. Daros, and F. Di Serio. 2005. Viroids and viroid-host interactions. *Annual Review in Phytopathology* 43: 117–139.
- Flores, R., S. Delgado, M.-E. Rodio, S. Ambros, C. Hernandez, and F. Di Serio. 2006. Peach latent mosaic viroid: Not so latent. *Molecular Plant Pathology* 7: 209–221.
- Flores, R., D. Grubb, A. Elleuch, M. Nohales, S. Delgado, and S. Gago. 2011. Rolling-circle replication of viroids, viroid-like satellite RNAs and hepatitis delta virus: Variations on a theme. *RNA Biology* 8: 200–206.
- Flores, R., P. Serra, S. Minoia, F. Di Serio, and B. Navarro. 2012. Viroids: From genotype to phenotype just relying on RNA sequence and structural motifs. *Frontiers in Microbiology* 3: 1–13.
- Flores, R., S. Minoia, A. Carbonell, A. Gisel, S. Delgado, A. López-Carrasco, B. Navarro, and F. Di Serio. 2015. Viroids, the simplest RNA replicons: How they manipulate their hosts for being propagated and how their hosts react for containing the infection. *Virus Research* 209: 136–145.
- Gambino, G., J. Bondaz, and I. Gribaudo. 2006. Detection and elimination of viruses in callus, somatic embryos and regenerated plantlets of grapevine. *European Journal of Plant Pathology* 114: 397–404.
- Gambino, G., B. Navarro, R. Vallania, I. Gribaudo, and F. Di Serio. 2011. Somatic embryogenesis efficiently eliminates viroid infections from grapevines. *European Journal of Plant Pathology* 130: 511–519.
- Gambino, G., B. Navarro, E. Torchetti, P. La Notte, A. Schneider, F. Mannini, and F. Di Serio. 2014. Survey on viroids infecting grapevine in Italy: Identification and characterization of Australian grapevine viroid and grapevine yellow speckle viroid 2. *European Journal of Plant Pathology* 140: 199–205.
- Gandía, M., L. Rubio, A. Palacio, and N. Duran-Vila. 2005. Genetic variation and population structure of an isolate of Citrus exocortis viroid (CEVd) and of the progenies of two infectious sequence variants. *Archives of Virology* 150: 1945–1957.
- García-Arenal, F., V. Pallas, and R. Flores. 1987. The sequence of a viroid from grapevine closely related to severe isolates of citrus exocortis viroid. *Nucleic Acids Research* 15: 4203–4210.
- Gas, M.-E., C. Hernandez, R. Flores, and J.-A. Daros. 2007. Processing of nuclear viroids in vivo: An interplay between RNA conformations. *Plos Pathogens* 3: 1813–1826.
- Gazel, M., and N. Önelge. 2003. First report of grapevine viroids in the east Mediterranean region of Turkey. *Plant Pathology* 52: 405–405.
- Giampetruzzi, A., V. Roumi, R. Roberto, U. Malossini, N. Yoshikawa, P. La Notte, F. Terlizzi, R. Credi, and P. Saldarelli. 2012. A new grapevine virus discovered by deep sequencing of virus- and viroid-derived small RNAs in Cv Pinot gris. *Virus Research* 163: 262–268.
- Goheen, A.C., and W.B. Hewitt. 1962. Vein banding: A new virus disease of grapevine. *American Journal of Enology and Viticulture* 13: 73–77.
- Habili, N., and J.W. Randles. 2010. Sudden increase in the onset of grapevine yellow speckle disease in 2010. *Australia & New Zealand Grapegrower & Winemaker* 558: 23–26.

- Hajizadeh, M., B. Navarro, N.S. Bashir, E.M. Torchetti, and F. Di Serio. 2012. Development and validation of a multiplex RT-PCR method for the simultaneous detection of five grapevine viroids. *Journal of Virological Methods* 179: 62–69.
- Hajizadeh, M., E. Torchetti, N. Sokhandan-Bashir, B. Navarro, H. Doulati-Baneh, G. Martelli, and F. Di Serio. 2015. Grapevine viroids and grapevine fanleaf virus in North-west Iran. *Journal of Plant Pathology* 97: 363–368.
- Hammann, C., and G. Steger. 2012. Viroid-specific small RNA in plant disease. *RNA Biology* 9: 809–819.
- Hanold, D., J.S. Semancik, and R.A. Owens. 2003. Polyacrylamide gel electrophoresis. In *Viroids*, ed. A. Hadidi, R. Flores, J.W. Randles, and J.S. Semancik, 95–102. Collingwood: CSIRO Publishing.
- Itaya, A., A. Folimonov, Y. Matsuda, R.S. Nelson, and B. Ding. 2001. Potato spindle tuber viroid as inducer of RNA silencing in infected tomato. *Molecular Plant-Microbe Interaction* 14: 1332–1334.
- Itaya, A., X. Zhong, R. Bundschuh, Y. Qi, Y. Wang, R. Takeda, A.R. Harris, C. Molina, R.S. Nelson, and B. Ding. 2007. A structured viroid RNA serves as a substrate for dicer-like cleavage to produce biologically active small RNAs but is resistant to RNA-induced silencing complex-mediated degradation. *Journal of Virology* 81: 2980–2994.
- Jaillon, O., J.M. Aury, B. Noel, A. Policriti, C. Clepet, A. Casagrande, et al. 2007. The grapevine genome sequence suggests ancestral hexaploidization in major angiosperm phyla. *Nature* 449: 463–467.
- Jiang, D., R. Guo, Z. Wu, H. Wang, and S. Li. 2009a. Molecular characterization of a member of a new species of grapevine viroid. *Archives of Virology* 154: 1563–1566.
- Jiang, D., S. Peng, Z. Wu, Z. Cheng, and S. Li. 2009b. Genetic diversity and phylogenetic analysis of Australian grapevine viroid (AGVd) isolated from different grapevines in China. *Virus Genes* 38: 178–183.
- Jiang, D., Z. Zhang, Z. Wu, R. Guo, H. Wang, P. Fan, and S. Li. 2009c. Molecular characterization of grapevine yellow speckle viroid-2 (GYSVd-2). *Virus Genes* 38: 515–520.
- Jiang, D., T. Sano, M. Tsuji, H. Araki, K. Sagawa, C. Purushothama, Z. Zhang, R. Guo, L. Xie, Z. Wu, H. Wang, and S. Li. 2012. Comprehensive diversity analysis of viroids infecting grapevine in China and Japan. *Virus Research* 169: 237–245.
- Kawaguchi-Ito, Y., S.F. Li, M. Tagawa, H. Araki, M. Goshono, S. Yamamoto, M. Tanaka, M. Narita, K. Tanaka, S.X. Liu, E. Shikata, and T. Sano. 2009. Cultivated grapevines represent a symptomless reservoir for the transmission of hop stunt viroid to hop crops: 15 years of evolutionary analysis. *PLoS One* 4: e8386.
- Keese, P., and R.H. Symons. 1985. Domains in viroids: Evidence of intermolecular RNA rearrangements and their contribution to viroid evolution. *Proceedings of National Academy of Science U.S.A* 82: 4582–4586.
- Kofalvi, S.A., J.F. Marcos, M.C. Cañizares, V. Pallás, and T. Candresse. 1997. Hop stunt viroid (HSVd) sequence variants from *Prunus* species: Evidence for recombination between HSVd isolates. *Journal of General Virology* 78: 3177–3186.
- Koltunow, A.M., and M.A. Rezaian. 1988. Grapevine yellow speckle viroid: Structural features of a new viroid group. *Nucleic Acids Research* 16: 849–864.
- . 1989. Grapevine viroid 1B, a new member of the apple scar skin viroid group contains the left terminal region of tomato planta macho viroid. *Virology* 170: 575–578.
- Koltunow, A.M., L.R. Krake, and M.A. Rezaian. 1988. Hop stunt viroid in Australian grapevine cultivars: Potential for hop infection. *Australasian Plant Pathology* 17: 7–10.
- Koltunow, A.M., L.R. Krake, S.D. Johnson, and M.A. Rezaian. 1989. Two related viroids cause grapevine yellow speckle disease independently. *Journal of General Virology* 70: 3411–3419.
- Krake, L.R., and R.C. Woodham. 1983. Grapevine yellow speckle agent implicated in the aetiology of vein banding disease. *Vitis* 22: 40–50.
- Li, S.F., R. Guo, S. Peng, and T. Sano. 2007. Grapevine yellow speckle viroid 1 and Grapevine yellow speckle viroid 2 isolates from China. *Journal of Plant Pathology* 89: S72.

- Little, A., and M.A. Rezaian. 2003. Grapevine viroids. In *Viroids*, ed. A. Hadidi, R. Flores, J.W. Randles, and J.S. Semancik, 195–206. Collingwood: CSIRO Publishing.
- Machida, S., N. Yamahata, H. Watanuki, R.A. Owens, and T. Sano. 2007. Successive accumulation of two size classes of viroid-specific small RNA in potato spindle tuber viroid-infected tomato plants. *Journal of General Virology* 88: 3452–3457.
- Martelli, G.P. 2014. Viroids. *Journal of Plant Pathology* 96 (1S): 131–136.
- Martín, R., C. Arenas, J.A. Daròs, A. Covarrubias, J.L. Reyes, and N.H. Chua. 2007. Characterization of small RNAs derived from Citrus exocortis viroid (CEVd) in infected tomato plants. *Virology* 367: 135–146.
- Martinez de Alba, A.E., R. Flores, and C. Hernandez. 2002. Two chloroplastic viroids induce the accumulation of small RNAs associated with posttranscriptional gene silencing. *Journal of Virology* 76: 13094–13096.
- Minafra, A., G.P. Martelli, and V. Savino. 1990. Viroids of grapevine in Italy. *Vitis* 29: 173–182.
- Navarro, B., A. Gisel, F. Di Serio, S. Delgado, R. Flores, G. Donvito, and A.-E. Martinez De Alba. 2009. Deep sequencing of the small RNAs derived from two symptomatic variants of a chloroplastic viroid: Implications for their genesis and for pathogenesis. *Plos ONE* 4 (10): e7539.
- Navarro, B., A. Gisel, M.-E. Rodio, S. Delgado, R. Flores, and F. Di Serio. 2012. Viroids: How to infect a host and cause disease without encoding proteins. *Biochimie* 94: 1474–1480.
- Nohales, M.-A., R. Flores, and J.-A. Daros. 2012. Viroid RNA redirects host DNA ligase 1 to act as an RNA ligase. *Proceedings of National Academy of Science U.S.A* 109: 13805–13810.
- Owens, R.A., R. Flores, F. Di Serio, S.-F. Li, V. Pallás, J.W. Randles, T. Sano, and G. Vidalakis. 2012. Viroids. In *Virus taxonomy: Ninth Report of the International Committee on Taxonomy of Viruses*, ed. Andrew M.Q. King, Michael J. Adams, Eric B. Carstens, and Elliot J. Lefkowitz, 1221–1234. London: Elsevier Academic Press.
- Papaefthimiou, I., A. Hamilton, M. Denti, D. Baulcombe, M. Tsagris, and M. Tabler. 2001. Replicating potato spindle tuber viroid RNA is accompanied by short RNA fragments that are characteristic of post-transcriptional gene silencing. *Nucleic Acids Research* 29: 2395–2400.
- Pirovano, W., L. Miozzi, M. Boetzer, and V. Pantaleo. 2015. Bioinformatics approaches for viral metagenomics in plants using short RNAs: Model case of study and application to a *Cicer arietinum* population. *Frontiers in Microbiology* 5: 790.
- Polivka, H., U. Staub, and H.J. Gross. 1996. Variation of viroid profiles in individual grapevine plants: Novel grapevine yellow speckle viroid 1 mutants show alterations of hairpin I. *Journal of General Virology* 77: 155–161.
- Qi, Y., A.M. Denli, and G.J. Hannon. 2005. Biochemical specialization within Arabidopsis RNA silencing pathways. *Mol Cell* 19: 421–428.
- Rao, A., and K. Kalantidis. 2015. Virus-associated small satellite RNAs and viroids display similarities in their replication strategies. *Virology* 479: 627–636.
- Rezaian, M.A. 1990. Australian grapevine viroid—Evidence for extensive recombination between viroids. *Nucleic Acids Research* 18: 1813–1818.
- Rezaian, M.A., A.M. Koltunow, and L.R. Krake. 1988. Isolation of three viroids and a circular RNA from grapevines. *Journal of General Virology* 69: 413–422.
- Rezaian, M., L. Krake, and D. Golino. 1992. Common identity of grapevine viroids from USA and Australia revealed by PCR analysis. *Intervirology* 34: 38–43.
- Rigden, J.E., and M.A. Rezaian. 1993. Analysis of sequence variation in grapevine yellow speckle viroid 1 reveals two distinct alternative structures for the pathogenic domain. *Virology* 193: 474–477.
- Rubino, L., F. Di Serio, and G.P. Martelli. 2003. Viroid-like RNAs. In *Viroids*, ed. A. Hadidi, R. Flores, J.W.E. Randles, and J.S. Semancik, 76–86. Collingwood: CSIRO Publishing.
- Sahana, A., C. Adkar-Purushothama, G. Chennappa, Z. Zhang, M. Sreenivasa, and T. Sano. 2013. First report of grapevine yellow speckle viroid-1 and hop stunt viroid infecting grapevines (*Vitis vinifera*) in India. *Plant Disease* 97: 1517–1517.
- Salman, T.M., N. Habili, and B. Shi. 2014. Effect of temperature on symptom expression and sequence polymorphism of grapevine yellow speckle viroid 1 in grapevine. *Virus Research* 189: 243–247.

- Sano, T. 2003. Hop stunt viroid. In *Viroids*, ed. A. Hadidi, R. Flores, J.W. Randles, and J.S. Semancik, 207–212. Collingwood: CSIRO Publishing.
- Sano, T., I. Uyeda, E. Shikata, T. Ohno, and Y. Okada. 1984. Nucleotide sequence of cucumber pale fruit viroid: Homology to hop stunt viroid. *Nucleic Acids Research* 12: 3427–3434.
- Sano, T., I. Uyeda, and E. Shikata. 1985. A viroid-like RNA isolated from grapevine has high sequence homology with hop stunt viroid. *Journal of General Virology* 66: 333–338.
- Sano, T., T. Hataya, Y. Terai, and E. Shikata. 1989. Hop stunt viroid strains from dapple fruit disease of plum and peach in Japan. *Journal of General Virology* 70: 1311–1319.
- Sano, T., R. Mimura, and K. Ohshima. 2001. Phylogenetic analysis of hop and grapevine isolates of hop stunt viroid supports a grapevine origin for hop stunt disease. *Virus Genes* 22: 53–59.
- Sasaki, M., and E. Shikata. 1977. On some properties of hop stunt disease agent, a viroid. *Proceedings of Japanese Academy of Science Series B* 53: 109–112.
- Semancik, J.S., and J.A. Szychowski. 1992. Relationships among the viroids derived from grapevines. *Journal of General Virology* 73: 1465–1469.
- Semancik, J.S., and L.G. Weathers. 1972. Exocortis disease: Evidence for a new species of “infectious” low molecular weight RNA in plants. *Nature New Biology* 237: 242–244.
- Semancik, J.S., C.N. Roistacher, R. Rivera-Bustamante, and N. Duran-Vila. 1988. Citrus cachexia viroid a new viroid of citrus, relationship to viroids of exocortis disease complex. *Journal of General Virology* 69: 3059–3068.
- Shikata, E., T. Sano, and I. Uyeda. 1984. An infectious low molecular weight RNA was detected in grapevines by molecular hybridization with hop stunt viroid cDNA. *Proceedings of Japanese Academy of Science* 60 (B): 202–205.
- Shu, J., G. Wang, W. Xu, and N. Hong. 2010. First report of Citrus exocortis viroid from Grapevine in China. *Plant Disease* 94: 1071–1071.
- Staub, U., H. Polivka, J.V. Herrmann, and H.J. Gross. 1993. Transmission of grapevine viroids is not likely to occur mechanically by regular pruning. *Vitis* 34: 119–123.
- Stellmach, G., and A.C. Goheen. 1988. Other virus and viruslike diseases. In *Compendium of grape diseases*, ed. R.C. Pearson and A.C. Goheen, 53–54. St. Paul: APS Press.
- Szychowski, J.A., A.C. Goheen, and J.S. Semancik. 1988. Mechanical transmission and rootstock reservoirs as factors in the widespread distribution of viroids in grapevines. *American Journal of Enology and Viticulture* 39: 213–216.
- Szychowski, J.A., M.V. McKenry, M.A. Walker, J.A. Wolpert, R. Credi, and J.S. Semancik. 1995. The vein-banding disease syndrome: A synergistic reaction between grapevine viroids and fan-leaf virus. *Vitis* 34: 229–232.
- Szychowski, J.A., R. Credi, K. Reanwarakorn, and J.S. Semancik. 1998. Population diversity in grapevine yellow speckle viroid-1 and the relationship to disease expression. *Virology* 248: 432–444.
- Taylor, R.H., and R.C. Woodham. 1972. Grapevine yellow speckle – A newly recognized graft-transmissible disease of *Vitis*. *Australian Journal of Agricultural Research* 23: 447–452.
- Van Dorst, H.J.M., and D. Peters. 1974. Some biological observations on pale fruit, viroid-incited disease of cucumber. *Netherland Journal of Plant Pathology* 80: 85.
- Velasco, R., A. Zharkikh, M. Troggio, D.A. Cartwright, A. Cestaro, D. Pruss, et al. 2007. A high quality draft consensus sequence of the genome of a heterozygous grapevine variety. *PLoS One* 2: e1326.
- Wan Chow Wah, Y.F., and R.H. Symons. 1997. A high sensitivity RT-PCR assay for the diagnosis of viroids in grapevines in the field and in tissue culture. *Journal of Virological Methods* 63: 57–69.
- Wan Chow Wah, Y.F., and R.H. Symons. 1999. Transmission of viroids via grape seeds. *Journal of Phytopathology*. 147: 285–291.
- Ward, L., G. Burnip, L. Liefing, S. Harper, and G. Clover. 2011. First report of grapevine yellow speckle viroid 1 and hop stunt viroid in grapevine (*Vitis vinifera*) in New Zealand. *Plant Disease* 95: 617–617.

- Wolpert, J.A., J.A. Szychowski, and J.S. Semancik. 1996. Effect of viroids on growth, yield, and maturity indices of Cabernet Sauvignon Grapevines. *American Journal of Enology and Viticulture* 47: 21–24.
- Wu, Q., Y. Wang, M. Cao, V. Pantaleo, J. Burgyan, W.X. Li, and S.W. Ding. 2012. Homology-independent discovery of replicating pathogenic circular RNAs by deep sequencing and a new computational algorithm. *Proceedings of National Academy of Science U.S.A* 109: 3938–3943.
- Wu, Q., S. Ding, Y. Zhang, S. Zhu, and N. VanAlfen. 2015. Identification of viruses and viroids by next-generation sequencing and homology-dependent and homology-independent algorithms. *Annual Review in Phytopathology* 53: 425–444.
- Yakoubi, S., A. Elleuch, N. Besaies, M. Marrakchi, and H. Fakhfakh. 2007. First report of Hop stunt viroid and Citrus exocortis viroid on fig with symptoms of fig mosaic disease. *Journal of Phytopathology*. 155: 125–128.
- Zaki-Aghl, M.. 2010. Identification of genomic sites involved in replication and movement of Iranian Isolate of Australian Grapevine Viroid. Ph.D. thesis, Shiraz University.
- Zaki-Aghl, M., and K. Izadpanah. 2009. Identification and partial characterization of grapevine viroids in southern Iran. In: *Extended Abstracts 16th meeting of ICVG, Dijon, France*, 354–355.
- . 2010. Identification and partial molecular characterization of grapevine viroids in Fars Province. *Iranian Journal of Plant Pathology* 46: 249–262 (Farsi) and 69–71 (English).
- . 2015. Symptom alterations in Australian grapevine viroid chimeras. In: *Proceedings 18th Congress ICVG, 208–209, Ankara, Turkey*.
- Zaki-Aghl, M., K. Izadpanah, A. Niazi, S. Behjatnia, and A. Afsharifar. 2013. Molecular and biological characterization of the Iranian isolate of the Australian grapevine viroid. *Journal of Agricultural Science and Technology* 15: 855–865.
- Zhang, B., G. Liu, C. Liu, Z. Wu, D. Jiang, and S. Li. 2009. Characterisation of Hop stunt viroid (HSVd) isolates from jujube trees (*Ziziphus jujuba*). *European Journal of Plant Pathology* 125: 665–669.
- Zhang, Z., S. Peng, D. Jiang, S. Pan, H. Wang, and S. Li. 2012a. Development of a polyprobe for the simultaneous detection of four grapevine viroids in grapevine plants. *European Journal of Plant Pathology* 132: 9–16.
- Zhang, Z., Y. Zhou, R. Guo, L. Mu, Y. Yang, S. Li, and H. Wang. 2012b. Molecular characterization of Chinese Hop stunt viroid isolates reveals a new phylogenetic group and possible cross transmission between grapevine and stone fruits. *European Journal of Plant Pathology* 134: 217–225.
- Zhang, Z., S. Qi, N. Tang, X. Zhang, S. Chen, P. Zhu, L. Ma, J. Cheng, Y. Xu, M. Lu, H. Wang, S.W. Ding, S. Li, and Q. Wu. 2014. Discovery of replicating circular RNAs by RNA-seq and computational algorithms. *PLoS Pathogens* 10: e1004553.

Part II
Methods for Diagnostics

Chapter 20

Biological Assays

A. Rowhani, P. La Notte, J.K. Uyemoto, S.D. Daubert, and V. Savino

Abstract Biological indexing is a methodology for the detection of grapevine virus diseases that relies on specific responses from panels of indicator host plants. Grafting to a set of four *Vitis* indicators and rub inoculation on a set of herbaceous hosts are routinely used in clean plant centers to transmit virus diseases to indicator hosts. Dormant bud chips from accession plants are grafted to the woody stems of indicator vines. Green grafting of first year canes to young indicator material is also used. When candidate buds are diseased, indicator vines develop typical foliar or stem symptoms 2–4 years post-grafting. Sap from accession plants that are infected with mechanically transmissible viruses can be screened by rub inoculation to a panel of herbaceous indicator plants, on which positive reactions develop in a matter of weeks. Biological indexing is seldom diagnostic for a given virus species. The presence of well-characterized species can be confirmed by ELISA, PCR, or RT-PCR. The more recently developed technique of high-throughput sequencing (HTS) can detect both well-characterized and novel viruses. Those molecular-based methodologies in general are more reliable, more sensitive, and more rapid than bioassays. However, the classic biological assay cannot yet be completely replaced by the more modern laboratory analyses. The bioassay is still used to demonstrate the presence of unidentified graft-transmissible agents, especially diseases such as 110R necrotic union or 3309C stem necrosis distortion, where the causative pathogens have not yet been specifically identified by other means.

Keywords Biological host indicators • Chip-bud inoculation • Green grafting • Mechanical inoculation • Virus assay

A. Rowhani (✉) • S.D. Daubert
Department of Plant Pathology, University of California, Davis, CA 95616, USA
e-mail: akrowhani@ucdavis.edu

P. La Notte • V. Savino
Dipartimento di Protezione delle Piante e Microbiologia Applicata,
Universita degli Studi and Istituto di Virologia Vegetale, CNR, Sezione di Bari,
Via Amendola 165/A, 70126 Bari, Italy

J.K. Uyemoto
USDA-ARS, Department of Plant Pathology, University of California,
Davis, CA 95616, USA

Introduction

Biological indexing with indicator hosts is a classic testing strategy that has been used for decades for the detection of virus diseases in many different crops. One of the first applications of biological assays in pathogen detection was in viticulture. Scheu (1935) first demonstrated the graft transmissibility of leafroll disease in Germany. Later in California, a detection assay was initiated by Olmo and Rizzi (1943) who were working at the University of California on a disease that affected Red Emperor grapevines. The disease decreased the vigor of the vines and caused such poor color in the grapes that it was named “White” Emperor disease. Olmo and Rizzi demonstrated that the disease was graft transmissible, implicating an infectious agent. (The viral nature of this agent would not be understood for decades after their demonstration.) Later, Austin Goheen transmitted White Emperor disease to Mission grapevines by grafting. Mission was first cultivated by the Spanish at the California missions. Goheen et al. (1959) found that Mission reliably produced distinct leafroll symptoms after graft inoculation. Hence, Mission vines became one of the first indicator host plants used in the diagnosis of grapevine viral disease.

Goheen (1989) went on to optimize a set of grapevine cultivars for use as indicator hosts for the identification of each of the major viral diseases of California grapevines. He worked with the Native American *Vitis rupestris* St. George rootstock. *V. rupestris* reproducibly produced uniform foliar symptoms following grafting with *Grapevine fanleaf virus* (GFLV)-infected material. (The symptoms in source plant cultivars were unreliable, varying widely from “fanleaf degeneration” to “grape yellow vein” presentations.) Goheen found that those same *V. rupestris* St. George indicator plants also produced diagnostic stem markings in response to grafts from plants carrying a disease he named “*rupestris* stem pitting.” The causative virus induced no significant effect on the growth of most *V. vinifera* European grape cultivars. Further assays demonstrated that most if not all European grapevines were infected with *rupestris* stem pitting disease. Furthermore, Goheen identified a complex *V. berlandieri* hybrid grape cultivar LN33 as a reliable indicator of “corky bark” disease. *Grapevine virus B* (GVB), the virus closely associated with the disease, was otherwise difficult to detect, being latent in many *V. vinifera* cultivars. In addition, Goheen demonstrated that *V. vinifera* cultivar Cabernet Franc was the most reliable index host for leafroll disease detection.

The advent of a set of grapevine cultivars optimized for use as indicator hosts enabled the identification of clean stocks for the production of certified planting material. As such, it facilitated the early elimination of diseased stocks from the propagation scheme. This enabled grape growers to clean plant material sources and reduce disease incidence in vineyards. Should virus diseases and viruses go undetected in foundation stocks, they would be vegetatively perpetuated by plant propagators. Moreover, planting material derived from diseased stock and released to growers for establishing vineyards would provide the endogenous arthropod vectors with a pathogen source to spread disease beyond the newly planted vineyards. Biological assays, applied at the first steps in the process of vegetative propagation

of clean material, are designed to preclude such infection amplification problems and to identify clean foundation stocks for certification programs.

Two different biological assays are used for the screening of virus diseases in grapevine stocks. Herbaceous indicator plants are used to detect the presence of mechanically transmissible viruses such as nepoviruses, some vitiviruses, and some closteroviruses. Inoculation of herbaceous plants with grapevine sap extract can induce diagnostic symptoms in greenhouse indicator plants in a matter of weeks.

Vitis indicator plants are used to detect virus diseases for which associated viruses are not sap transmissible, including most closteroviruses, *Grapevine rupestris stem pitting-associated virus* (GRSPaV), marafiviruses, and maculaviruses. These biological assays involve inoculation from accession sources to indicator vines by bud chip or green grafting. But, as opposed to herbaceous plant indexing which takes 3–4 weeks, biological assay using a panel of grapevine indicator hosts requires up to 3 years to complete. Biological indexing methods specific to some of the most recently identified novel viruses, such as *Grapevine red blotch-associated virus* (GRBaV), *Grapevine vein clearing virus* (GVCV), or some members of the genus *Vitivirus*, have not been established yet.

Sap-Transmissible Virus Analysis

Biological indexing on herbaceous hosts is used to detect sap-transmissible viruses, primarily nepoviruses, in test plants. In some cases, viruses in the genus *Vitivirus* such as *Grapevine virus A* (GVA) and GVB (Garau et al. 1993; Boscia et al. 1993) or in the genus *Closterovirus* such as *Grapevine leafroll-associated virus 2* (GLRaV-2, Goszczynski et al. 1996) can be detected with difficulty when inoculated to *Nicotiana occidentalis* or *N. benthamiana*. When that is possible, the herbaceous host test offers a more rapid assay compared to graft inoculations onto woody grape indicators. Detectable grapevine nepoviruses include *Arabidopsis mosaic virus* (ArMV), GFLV, *Raspberry ringspot virus* (RpRSV), *Tobacco ringspot virus* (TRSV), *Blueberry leaf mottle virus* (BLMoV), *Tomato ringspot virus* (ToRSV), and other viruses such as *Strawberry latent ringspot virus* (SLRSV). Commonly used herbaceous indicators include *Chenopodium quinoa*, *C. amaranticolor*, *N. tabacum*, and *Cucumis sativus*.

With sap inoculations, succulent tissues (young leaves and tips of actively growing shoots of a candidate grapevine specimen) are triturated in 10 mM phosphate buffer pH 7.0–7.5 containing 2% nicotine or 3% polyvinyl pyrrolidone 40 (PVP40) or insoluble PVP (approximately 1:10, wt. tissue-ml buffer). The liquid slurry is applied to herbaceous plants pre-dusted with an abrasive powder (Jones 1993) such as carborundum (silicon carbide), corundum (aluminum oxide), or celite (diatomaceous earth). The tissue extract is gently rub-inoculated onto cotyledons and leaves of indicators using a pestle, cotton tip swab, or one's finger (Fig. 20.1). The rubbed leaves and cotyledons are then gently rinsed with water to prevent leaf damage resulting from prolonged exposure to the additives in the buffer. The ages of the

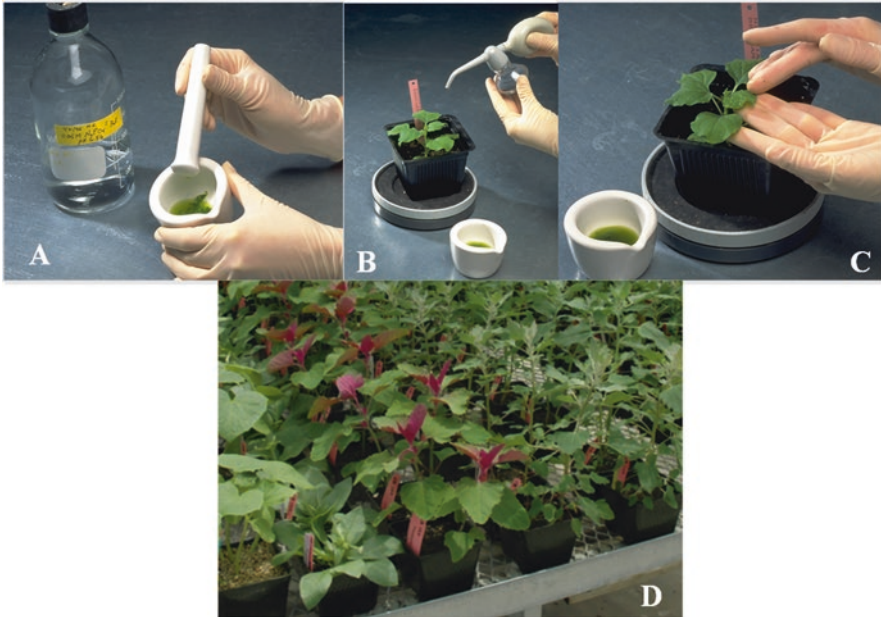

Fig. 20.1 Steps in biological index using herbaceous host indicators. (A) Homogenization of leaf tissue from a candidate grapevine, (B) application of carborundum on the indicator host, (C) application of leaf homogenate on the leaf of the indicator host, and (D) maintenance of inoculated indicators in the greenhouse for symptom development

indicators that give best results are *C. quinoa* and *C. amaranticolor*, both at 4–6 leaf stages; *N. tabacum*, at 2–4 leaf stages; and cucumber, cotyledon seedling stage. The additives nicotine and PVP are used to neutralize the inhibitory effects of polyphenolic compounds and other host cell inhibitors of virus infectivity. As such, they facilitate virus transmission (Jones, 1993; Authors, unpublished data).

When inoculation is successful, symptoms develop in 7–10 days. In general, *Nepovirus*-infected *C. quinoa* and *C. amaranticolor* develop diagnostic chlorotic and/or necrotic local lesions and systemic mottling (Uyemoto et al. 1976); some nepoviruses also induce leaf deformation and shoot tip necrosis. *Nicotiana* spp. may show variable symptoms depending on the indicator cultivar, the virus species, and the growing conditions. Those symptoms can include local chlorotic lesions, chlorotic or necrotic rings and systemic mottling, ringspot and line patterns, and/or leaf deformation. Cucumber may be asymptomatic for GFLV, while developing chlorotic local lesions and systemic mottling for TRSV and ToRSV. As infected cucumber seedlings grow, newly expanding leaves may be asymptomatic (Cadman et al. 1960; Dias 1963; Hewitt et al. 1970; Martelli 1993; Ramsdell and Gillett 1998; Ramsdell and Stace-Smith 1983; Stace-Smith 1984, 1985; Uyemoto et al. 1976).

Non-Sap Transmissible Virus Analysis

Biological indexing on grapevine indicator hosts is a classical approach in plant pathology used to detect diseases caused by virus infection (Martelli et al. 1993). Grapevine viruses in the families *Closteroviridae*, *Betaflexiviridae*, and *Tymoviridae* (Martelli et al. 2002) cause diagnostic symptoms on indicators such as St. George (*V. rupestris*), LN33 (1613 Couderc x *V. vinifera* cv. Thompson seedless), Kober 5BB (*V. berlandieri* x *V. riparia*), and *V. vinifera* cv. Cabernet Franc indicator hosts. Grapevine red blotch-associated virus (GRBaV) from the family *Geminiviridae* also causes disease symptoms in *V. vinifera* hosts such as Cabernet Franc (unpublished data).

V. rupestris cv. St. George produces diagnostic symptoms in response to infections by GFLV, *Grapevine fleckvirus* (GFkV), *Grapevine asteroid mosaic-associated virus* (GAMaV), and GRSPaV. Symptoms induced by GFLV infection consist of leaf vein clearing, chlorotic ringspots, oak leaf patterns, short internodes, and/or distortion of leaf blades (Bovey et al. 1980; Brunt et al. 1996; Krake et al. 1999; Martelli 1993; Wilcox et al. 2015). GFLV leaf symptoms develop in early spring, are ephemeral in nature, and fade with the rise in ambient temperatures (Golino et al. 1991). GFkV leaf symptoms consist of a “clearing” of third- and fourth-order veinlets and localized translucent spots. In severe cases, leaves may wrinkle, twist, and curl upward. Further, a diffused mosaic pattern may develop on mature leaves (Bovey et al. 1980; Brunt et al. 1996; Krake et al. 1999; Martelli 1993; Wilcox et al. 2015). With GAMaV, chlorotic star-shaped spots, which may cluster irregularly, develop on leaves (Martelli 1993; Wilcox et al. 2015). Finally, symptoms ascribed to GRSPaV include stem markings, i.e., distinct basipetal pitting extending downward from the grafted chip bud. Occasionally, stem pits encircle the woody cylinder (Martelli 1993; Wilcox et al. 2015). GRSPaV does not show symptoms on grapevine virus indicators LN33 and Kober 5BB.

LN33 is an indicator for corky bark disease, to which GVB is associated. Symptoms include grooves and pits on the woody cylinder, trunk bark split, and red leaves due to swelling of canes and proliferation of spongy callus tissues (hence the name corky bark) (Krake et al. 1999; Martelli 1993; Wilcox et al. 2015). Kober 5BB and St. George are asymptomatic hosts for corky bark disease and GVB.

Kober 5BB is an indicator for Kober stem grooving disease to which GVA is associated. Symptoms include wood necrosis, pits, and grooves, often accompanied by yellowish spots on the leaves (Martelli 1993; Garau et al. 1994). St. George and LN33 are asymptomatic hosts for Kober stem grooving disease and GVA.

V. vinifera cv. Cabernet Franc is diagnostic for leafroll disease and GRBaV. Other leafroll disease indicators include *V. vinifera* cvs. Pinot noir, Mission, Cabernet Sauvignon, Gamay, and Barbera. The choice of indicator depends upon professional experience of the investigator with local climatic and environmental conditions (Krake et al. 1999; Martelli 1993; Wilcox et al. 2015). On Cabernet Franc, leafroll virus symptoms are interveinal reddening of the leaf blade, beginning in early fall and intensifying thereafter, with primary veins prominently green, although these

green veins fade late in the season. Leaf margins may roll downward. Often internodes are shortened and stunting is apparent. The currently characterized viruses associated with leafroll are members of the family *Closteroviridae*. To date, five *Grapevine leafroll-associated viruses* (GLRaV) have been reported (Martelli et al. 2012). Redglobe strain of GLRaV-2 and GLRaV-7 are asymptomatic on *V. vinifera* cv. Cabernet Franc. Symptoms of GRBaV on Cabernet Franc include development of red blotches on the leaves.

Inoculation Methods

Chip-Bud Inoculation

Self-rooted indicator plants grown in pots are inoculated with dormant bud chips from accession canes of interest. The bud chips are placed onto matching cut areas on stems of the indicator plants, overlaid with a plastic strip and secured with budding rubber (Fig. 20.2). Three replicates of two or three bud chips are grafted per indicator plant. A set of healthy indicator plants and another set grafted with known disease sources are included as controls in these tests.

Chip-bud grafts are usually made in late winter or early spring. The inoculated plants are maintained in a greenhouse for a month and bud chips are evaluated for viability. Then indicator plants are acclimated for a few weeks in a lathhouse prior to being transplanted to an isolated field site. While growing in the field, indicator vines are visually inspected annually during spring and fall of the following and subsequent years. Examination for wood markings involves uprooting indicator

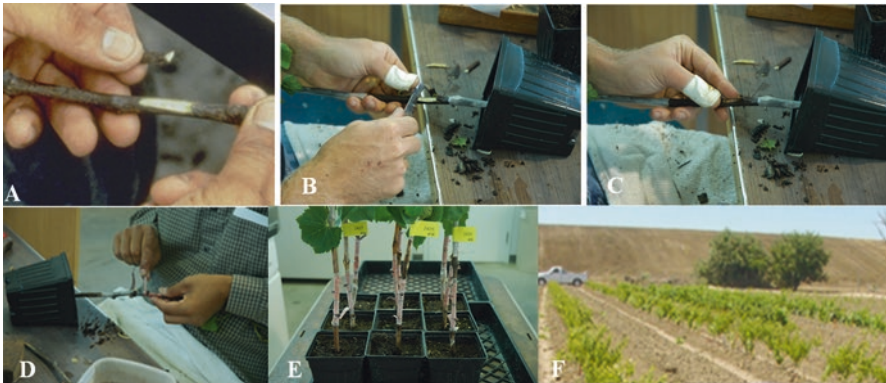

Fig. 20.2 Steps in biological index using grape indicator host. (A) Selection of bud chip from a dormant cane collected from a candidate plant, (B) preparing a matching cut on the indicator plant, (C) placement of the bud chip from the candidate plant onto the matching cut produced on the indicator host, (D and E) securing the bud chip on the indicator host by wrapping it with a rubber band, and (F) planting of the grafted indicators in the field for symptom development observation

plants and removing the bark to expose the woody cylinders. This is usually done during the second or third growing season post graft inoculation. How quickly definitive symptoms develop is dependent on the climate. In warmer areas where strong growing conditions exist, symptom development is faster.

Green Grafting

The indicator host on its own roots can be green grafted with accession sources (Taylor et al. 1967; Walter et al. 1990). With this procedure, both the accession vine, as the scion, and the indicator are used as herbaceous cuttings during the growing season. They are fitted together with a cleft graft. All grafted vines must be maintained under greenhouse conditions. This technique is used to screen for virus in certification programs (Pathirana and McKenzie 2005; Tanne et al. 1993). Infection of the indicator host through green grafting results in diagnostic symptoms expressed more rapidly (Taylor et al. 1967; Pathirana and McKenzie 2005) than would be expressed by field indexing on woody indicator vines. Although green grafting is not as sensitive as dormant grafting for diseases that cause wood markings (Lahogue et al. 1995), this drawback must be balanced against its potentially more rapid development of foliar symptoms and its independence from environmental conditions and seasonal time frame constraints in the field (Cirami et al. 1988).

A third method used for the biological assay of grapevine viruses is micropropagation and acclimatization of indicator plants for green grafting with petioles or secondary shoots from accession plants (Vindimian et al. 1998). In this method the indicator plant is micropropagated *in vitro* and then subcultured by nodal cuttings on culture media. After the plants produce sufficient roots, they are transferred to soil and acclimatize to greenhouse conditions. These plants are then green grafted with leaves (petiole attached) or secondary shoots collected from accession plants. The grafted plants are kept in the greenhouse and inspected periodically for symptom development.

A fourth grafting method used for the detection of grapevine viruses involves micrografting. Tanne et al. (1996) used tissue culture technology to mimic indexing and to enhance symptom development *in vitro*. This allows for rapid diagnosis of grapevine viral diseases by grafting *in vitro* onto cultured indicators. In this technique, the grafted plants are put under mild stress by adding sorbitol at 4% to the culture medium. A variety of distinct symptoms result within 4–8 weeks.

Detection of Diseases of Unknown Etiology

110R Necrotic Union

Biological indexing was used in 2012 to investigate a disease of Pinot noir (PN) observed in California. The affected vineyards had been established with PN clones 02A, 667, 777, and UCD 04, each cultivated on rootstock 110 Richter (110R; *V. berlandieri* × *V. rupestris*). Diseased vines exhibited solid red canopies and necrosis of the graft union. Two distinct disease stages were evident: diseased vines showing no stunting and normal-sized grape clusters were designated “acute disease stage” vines; stunted vines with short shoots and straggly grape clusters were designated “chronic stage” vines (Al Rwahnih et al. 2012a, b). Similar canopy symptoms (showing chlorotic instead of solid red leaves) along with necrosis at the graft union were found on accessions Chardonnay 04 and Pinot gris 152. Disease progress from 2004 to 2009 in one PN 02A vineyard established in 1997 revealed an increase from 2.1% (14 of 664 vines) to 21.9% (145 of 664 vines) in 2009, suggesting the occurrence of secondary spread (see also Chap. 13 in this volume).

None of the diseased vines induced typical reactions on the panel of four conventional indicators. Repeated bud-chip inoculations or extended lengths of diseased canes side-grafted onto test plants cultivated on 110R produced viable grafts, but no disease transmission was observed. However, some bench grafts using asymptomatic sources of the disease in Pinot noir and Chardonnay accessions cultivated on rootstocks other than 110R produced necrotic union symptoms.

RT-PCR failed to detect virus, phytoplasma, or *Xylella fastidiosa* association with this disease (Al Rwahnih et al. 2012a, b). Samples from PN clones 02A and UCD 04 were tested by high-throughput sequencing (Rowhani, unpublished data). Viruses found in PN 02A were GRSPaV and *Grapevine redglobe virus* and in Pinot noir UCD 04, GRSPaV and *Grapevine rupestris vein feathering virus*. The role of these viruses in inducing 110R necrotic union has yet to be demonstrated.

3309C Stem Necrosis Distortion

In several California vineyards planted with PN clone 23 (PN23) cultivated on 3309 Couderc rootstock, grapevines were observed in decline. Decline symptoms consisted of severe stunting, red canopy, and poor berry development, with severe stem necrosis and distortion on the rootstock. Biological assays failed to identify a transmissible disease with typical symptomatology on the four conventional indicators. RT-PCR failed to detect the presence of known viruses, phytoplasmas, or *Xylella fastidiosa* in diseased material. However, double-stranded RNA(dsRNA) extracts from diseased grapevines were found to contain high molecular weight bands about 8.7 kb in size (Lima et al. 2009). A cDNA library was constructed from the dsRNA, and its sequencing revealed a viral genome with similarities to GRSPaV. The

genome was found to be 8724 nt in length (excluding the poly A tail) with an identity of 76–78% with GRSPaV sequences listed in GenBank. This sequence was designated as the PN strain of GRSPaV. Its role in inducing stem necrosis distortion on 3309C has yet to be demonstrated.

Strengths and Limits of Biological Indexing

Serological and molecular analyses, such as ELISA, RT-PCR, or HTS analyses, are designed for the specific identification of virus species and strains. These analyses are constrained by their need for prior characterization of the viruses they detect. Information about the antigenicity of the virion (required for ELISA) or about the viral genomic sequence (necessary for PCR primer design, or for identification of HTS reads for contig construction) is required for the molecular analyses. In contrast, biological assays are broad spectrum; they detect diseases but do not identify the causative agents of those diseases to the species level (Al Rwahnih et al. 2015). For example, to date four virus species and their multiple strains are associated with grapevine leafroll disease. In California, the grapevine indicator Cabernet Franc responds to inoculations with any of them by producing the same generic leafroll disease symptoms irrespective of the identity of the causative GLRaV species or strains. (The bioassay would not detect GLRaV-2 RG strain or GLRaV-7, since they are asymptomatic on Cabernet Franc.)

The bioassay would be crucial in cases of previously uncharacterized leafroll agents. The biological assay could still reveal the appearance of leafroll disease symptoms, even though the inducing agent itself was unknown and could not be detected by laboratory analytics. The use of biological indexing analysis for the certification of clean stock nursery material is discussed in Chap. 27 of this volume.

A disadvantage of the bioassays, compared to serological and molecular methods, is the time and expense required. Bioassays on woody indicators can take years to yield results, they are expensive and labor intensive, and they require considerable greenhouse and field space (Al Rwahnih et al. 2015). Furthermore, test results may be influenced by seasonal environment and growth conditions (Constable et al. 2013). Also, specific biological assay is not available for some viruses of significance found in grapevine, including some members of the *Maculavirus*, *Marafivirus*, and *Vitivirus* genera. Some members of the family *Closteroviridae* are asymptomatic in biological index hosts that are currently employed in clean stock programs.

Conclusion and Directions for Future Research

Biological indexing was once the mainstay of grapevine viral disease diagnosis programs. However, ELISA followed by RT-PCR and now HTS have replaced it in many applications. The newer techniques show greater specificity and sensitivity and lower cost (Al Rwahnih et al. 2015). In the future, biological indexing may be eclipsed as a primary diagnostic by the advent of more modern laboratory and computer techniques of pathogen detection.

Biological indexing is still necessary in many grapevine virus characterization capacities. These would include the diagnosis of disease associated with a novel virus for which no serological reagent is available and no nucleotide sequence is known (Rowhani et al. 2005; Martelli and Walter 1998). In that case, modern diagnostic methods will not be available for identification by comparison with known sequence datasets. Biological analysis would be the fallback diagnostic in that scenario.

Modern diagnostic technologies, particularly HTS, do not predict pathogenicity. The possibility that a newly discovered virus can be pathogenic or have differential virulence in various cultivar backgrounds (Alkowni et al. 2011) can only be evaluated through biological analysis. The possibility that a novel virus could synergize in combination with a second virus (Rosa et al. 2011) will also require a biological assay to demonstrate the synergy.

When HTS analysis discovers a putative viral grapevine pathogen, biological assay is used to validate the discovery and to characterize the graft transmissibility of the agent. The validity of the viral sequence data is demonstrated by graft transmission of the infection from the discovery host plant into another vine. HTS provides the sequence information used to design PCR diagnostics for newly characterized viruses. The PCR diagnostics designed from HTS data are then employed to confirm virus transmission to the recipient plant.

HTS has the capacity to discover a wide range of new grapevine viruses. In the past 8 years, previously unknown viruses identified by HTS have included Grapevine Syrah virus-1 (Al Rwahnih et al. 2009), Grapevine virus F (Al Rwahnih et al. 2012a, b), Grapevine red blotch-associated virus (Al Rwahnih et al. 2013), Grapevine Cabernet Sauvignon reovirus (Al Rwahnih et al. 2015), and Grapevine geminivirus (Al Rwahnih et al. 2017). When a novel virus is identified, biological assays will be employed to demonstrate the agronomic significance of the find, particularly its pathological potential. The biological assay would be required to demonstrate that a cloned viral sequence derived from HTS sequence data is infectious, which is proof that the data from the sequencing analysis is correct.

Plant viruses exist as quasispecies mixtures of genetic variants. The biological activity of such a mixture is readily demonstrated by biological assays. Eventually, modern techniques will (a) identify novel viral pathogens by their genomic sequences and (b) *in vitro* synthesize full-length genome copies of those newly identified viruses, so that (c) the synthetic genomes can be inoculated into index grapevine plants to characterize their infectivity. In the process of sequencing a full-length viral genome and then synthesizing it *in vitro*, all of the quasispecies

diversity is lost to the production of the single cloned genome sequence. The difference in infectivity between that single-sequence genome, and the multitude of variant sequences that make up the genome of a viral field isolate, will then be readily apparent in the comparison of their respective biological assays.

References

- Alkowni, R., Y.-P. Zhang, A. Rowhani, J.K. Uyemoto, and A. Minafra. 2011. Biological, molecular, and serological studies of a novel strain of grapevine leafroll-associated virus 2. *Virus Genes* 43: 102–110.
- Al Rwahnih, M., S. Daubert, D. Golino, and A. Rowhani. 2009. Deep sequencing analysis of RNAs from a grapevine showing Syrah decline symptoms reveals a multiple virus infection that includes a novel virus. *Virology* 387: 395–401.
- Al Rwahnih, M., A. Rowhani, R.J. Smith, J.K. Uyemoto, and M.R. Sudarshana. 2012a. Grapevine necrotic union, a newly recognized disease of unknown etiology in grapevines grafted on 110 Richter rootstock in California. *Journal of Plant Pathology* 94: 149–156.
- Al Rwahnih, M., M.R. Sudarshana, J.K. Uyemoto, and A. Rowhani. 2012b. Complete genome sequence of a novel vitivirus isolated from grapevine. *Journal of Virology* 86: 9545–9545.
- Al Rwahnih, M., A. Dave, M.M. Anderson, A. Rowhani, J.K. Uyemoto, and M.R. Sudarshana. 2013. Association of a DNA virus with grapevines affected by red blotch disease in California. *Phytopathology* 103: 1069–1076.
- Al Rwahnih, M., S. Daubert, D. Golino, C. Islas, and A. Rowhani. 2015. Comparison of next generation sequencing vs. biological indexing for the optimal detection of viral pathogens in grapevine. *Phytopathology* 105: 758–763.
- Al Rwahnih, M., O. Alabi, N.M. Westrick, D. Golino, and A. Rowhani. 2017. Description of a novel monopartite geminivirus and its defective subviral genome in grapevine. *Phytopathology* 107 (2): 240–251.
- Boscia, D., V. Savino, A. Minafra, S. Namba, V. Elicio, M.A. Castellano, and G.P. Martelli. 1993. Properties of a filamentous virus isolated from grapevines affected by corky bark. *Archives of Virology* 130: 109–120.
- Bovey, R., W. Gartel, W.B. Hewitt, G.P. Martelli, and A. Vuittenez. 1980. *Virus and virus-like diseases of grapevine, color atlas of symptoms*, 181pp. Paris: La Maison Rustique.
- Brunt, A.A., K. Crabtree, M.J. Dallwitz, A.J. Gibbs, and L. Watson. 1996. *Viruses of plants, description and lists from the VIDE database*, 1484 pp. Wallingford: CAB Int.
- Cadman, C.H., H.F. Dias, and B.D. Harrison. 1960. Sap-transmissible viruses associated with diseases of grapevines in Europe and North America. *Nature* 187: 577–579.
- Cirami, R.M., R.J. van Velsen, and J. Niejalke. 1988. Grapevine virus indexing in the South Australian vine improvement scheme, 1974–1987. *Australian Journal of Experimental Agriculture* 28: 645–649.
- Constable, F.E., J. Connellan, P. Nicholas, and B.C. Rodoni. 2013. The reliability of woody indexing for detection of grapevine virus-associated diseases in three different climatic conditions in Australia. *Australian Journal of Grape and Wine Research* 19: 74–80.
- Dias, H.F. 1963. Host range and properties of grapevine fanleaf and grapevine yellow mosaic viruses. *Annals of Applied Biology* 51: 85–95.
- Garau, R., V.A. Porta, D. Boscia, R. Piredda, and U. Porta. 1993. Studies on grapevine virus B isolates from corky bark-affected vines in Sardinia. *Rivista di Patologia Vegetale* 3: 83–89.
- Garau, R., V.A. Porta, R. Piredda, and U. Porta. 1994. On the possible relationship between Kober stem grooving and grapevine virus A. *Vitis* 33: 161–163.
- Goheen, A.C. 1989. Virus diseases and grapevine selection. *American Journal of Enology and Viticulture* 40: 67–72.

- Goheen, A.C., W.B. Hewitt, and C.J. Alley. 1959. Studies of grape leafroll in California. *American Journal of Enology and Viticulture* 10: 78–84.
- Golino, D.A., A. Rowhani, and M.A. Walker. 1991. Fanleaf in the vineyard. *Practical Winery and Vineyard*. November/December 21–23.
- Goszczynski, D.E., G.F. Kasdorf, G. Pietersen, and H. Tonder. 1996. Detection of two strains of grapevine leafroll-associated virus 2. *Vitis* 3: 133–135.
- Hewitt, W.B., G. Martelli, H.F. Dias, and R.H. Taylor. 1970. *Grapevine fanleaf virus*. CMI/AAB description of plant viruses No. 28. Association of Applied Biologists. Wellesbourne, UK.
- Jones, A.T. 1993. Experimental transmission of viruses in diagnosis. In *Diagnosis of plant virus diseases*, ed. R.E.F. Matthews, 59–62. London: CRC Press.
- Krake, L.R., N.S. Scott, M.A. Rezaian, and R.H. Taylor. 1999. *Graft-transmitted diseases of grapevines*, 137pp. Canberra: CSIRO.
- Lahogue, F., G. Boulard, and C. Schneider. 1995. Comparaison de différentes techniques de greffage vis-à-vis de leur efficacité de transmission virale sur vigne. *Vitis* 34: 177–183.
- Lima, M., R. Alkowni, J.K. Uyemoto, and A. Rowhani. 2009. Genomic study and detection of a new variant of Grapevine rupestris stem pitting associated virus in declining California Pinot Noir grapevines. *Journal of Plant Pathology* 91: 153–160.
- Martelli, G.P. 1993. *Graft-transmissible diseases of grapevines, handbook for detection and diagnosis*, 263pp. Rome: Food and Agriculture Organization of the United Nations.
- Martelli, G.P., and B. Walter. 1998. Virus certification of grapevines. In *Plant virus disease control*, ed. A. Hadidi, R.K. Khetarpal, and H. Koganezawa. St. Paul: APS Press.
- Martelli, G.P., V. Savino, and B. Walter. 1993. Indexing on *Vitis* indicators. In *Graft-transmissible diseases of grapevines, handbook for detection and diagnosis*, ed. G.P. Martelli. Rome, 263pp: FAO.
- Martelli, G.P., S. Sabanadzovic, N. Abou-Ghanem Sabanadzovic, M.C. Edwards, and T. Dreher. 2002. The family *Tymoviridae*. *Archives of Virology* 147: 1837–1846.
- Martelli, G.P., N. Abou Ghenem-Sabanadzovic, A.A. Agranovsky, M. Al Rwahnih, V.V. Dolja, C.I. Dovas, M. Fuchs, P. Gugerli, J.S. Hu, W. Jelkmann, N.I. Katis, V.I. Maliogka, M.J. Melzer, W. Menzel, A. Minafra, M.F. Rott, A. Rowhani, S. Sabanadzovic, and P. Saldarelli. 2012. Taxonomic revision of the family *Closteroviridae* with special reference to the Grapevine leafroll-associated members of the genus *Ampelovirus* and the putative species unassigned to the family. *Journal of Plant Pathology* 94: 7–19.
- Olmo, H.P., and A.D. Rizzi. 1943. Selection for fruit color in the Emperor grape. *Proceedings of the American Society of Horticultural Science* 4: 395–400.
- Pathirana, R., and M. McKenzie. 2005. Early detection of grapevine leafroll virus in *Vitis vinifera* using *in vitro* micrografting. *Plant Cell, Tissue and Organ Culture* 81: 11–18.
- Ramsdell, D.C., and J.M. Gillett. 1998. CMI/AAB description of plant viruses No. 364. Association of Applied Biologists. Wellesbourne, UK.
- Ramsdell, D.C., and R. Stace-Smith. 1983. CMI/AAB description of plant viruses No. 267. Association of Applied Biologists. Wellesbourne, UK.
- Rosa, C., J.F. Jimenez, P. Margaria, and A. Rowhani. 2011. Symptomatology and effects of viruses associated with rugose wood complex on the growth of four different rootstocks. *American Journal of Enology and Viticulture* 62: 207–213.
- Rowhani, A., J.K. Uyemoto, D.A. Golino, and G.P. Martelli. 2005. Pathogen testing and certification of *Vitis* and *Prunus* species. *Annual Review of Phytopathology* 43: 261–278.
- Scheu, G. 1935. Die Rollkrankheit des Rebstockes. *D.D. Weinbau* 14: 222–358.
- Stace-Smith, R. 1984. *Tomato ringspot virus*. CMI/AAB Description of Plant Viruses No. 290. Association of Applied Biologists. Wellesbourne, UK.
- . 1985. *Tobacco ringspot virus*. CMI/AAB Description of Plant Viruses No. 309. Association of Applied Biologists. Wellesbourne, UK.
- Tanne, E., N. Shtanovitz, and P. Spiegel-Roy. 1993. Rapid diagnosis of grapevine corky bark by *in vitro* micrografting. *Horticultural Science* 28: 667–668.
- Tanne, E., P. Spiegel-Roy, and N. Shlamovitz. 1996. Rapid *in vitro* indexing of grapevine viral diseases: the effect of stress-inducing agents on the diagnosis of leafroll. *Plant Disease* 80: 972–974.

- Taylor, R.H., R.C. Woodham, and A.W. Allen. 1967. Green-grafting: a useful technique for detecting grapevine viruses. *Australian Journal of Experimental Agriculture and Animal Husbandry* 7: 91–95.
- Uyemoto, J.K., A.C. Goheen, C.F. Luhn, and L.J. Peterson. 1976. Use of *Chenopodium quinoa* in indexing for *Grapevine fanleaf virus*. *Plant Disease Reporter* 60: 536–538.
- Vindimian, M.E., A.M. Ciccotti, U. Malossini, and I. Rancador. 1998. Biological indexing in greenhouse with the use of micropropagated material of genus *Vitis*. *Acta Horticulturae* 473: 151–153.
- Walter, B., P. Bass, R. Legin, C. Martin, R. Vernoy, A. Collas, and G. Vesselle. 1990. The use of a green-grafting technique for the detection of virus-like disease of the grapevine. *Journal of Phytopathology* 128: 137–145.
- Wilcox, F.W., D.G. Gubler, and J.K. Uyemoto. 2015. *Compendium of Grape Diseases, Disorders and Pests*, pp 114–134. St. Paul: APS Press.

Chapter 21

Serological Methods for the Detection of Major Grapevine Viruses

A.G. Blouin, K.M. Chooi, D. Cohen, and R.M. MacDiarmid

Abstract Serological methods are routinely used for the detection of many economically important grapevine viruses. The most commonly used format is the enzyme-linked immunosorbent assay (ELISA) which provides a robust, sensitive and rapid method to screen large numbers of samples from the field. A number of companies provide high-quality ELISA kits against most of the main viral pathogens infecting grapevines. Although virus titre shows seasonal fluctuations and the viruses may be unevenly distributed in vines, particularly for recent infection, ELISA provides reliable diagnosis if samples are collected at the optimal time in the specified vine tissue. Relative quantification can be achieved and the dynamic range of the assay can be extended by calculation of reaction rates from a kinetic assay and interpolation of these rates onto a dose-response curve. Additionally, comparing reaction rates obtained using monoclonal or polyclonal antibodies for detection can assist the identification of novel serotypes of a virus. Results from ELISA should be supplemented by molecular tests in critical situations, and vice versa, since some viral strains may not be detected by one or other type of tests. Antibodies can also be used to trap viruses or double-stranded RNA (immunocapture), thus providing an inexpensive and simple way to concentrate and purify viral RNA for subsequent molecular analyses. Further techniques that may assist serological detection of viruses are described.

Keywords Grapevine • Virus • ELISA • Serology • Antibody • Diagnostics

A.G. Blouin and K.M. Chooi contributed equally to this work.

A.G. Blouin (✉) • R.M. MacDiarmid

The New Zealand Institute for Plant and Food Research Limited, Auckland, New Zealand

School of Biological Sciences, University of Auckland, Auckland, New Zealand

e-mail: arnaud.blouin@plantandfood.co.nz

K.M. Chooi • D. Cohen

The New Zealand Institute for Plant and Food Research Limited, Auckland, New Zealand

Introduction

The enzyme-linked immunosorbent assay (ELISA) is a test that uses antibody binding specificity to detect substances such as peptides, proteins, antibodies and hormones. Its use is now very common in plant virus detection, with antibodies specific to the coat protein of the target virus. It was first described by Engvall and Perlmann (1971). Their new assay followed the principle of radioimmunoassay (RIA), which was developed in 1960 (Yalow and Berson 1960) with major modifications. Instead of measuring the antigen antibody reaction using radioactivity, the ELISA measured the reaction using the activity of an enzyme (alkaline phosphatase). Eliminating the use of a radioactive label transformed this immunoassay into one that could be used in many diagnostic laboratories. In addition, a significant simplification was achieved by coating plastic with either the antigen or antibody instead of using cellulose particles as previously required. The introduction of the plastic medium reduced dramatically the number of washing steps required and excluded the centrifugation step. In 1974, the microtitre plate was introduced as a platform for ELISA against malaria (Voller et al. 1974). Introduction of the microtitre plate led to the small, economical and standardized form of the ELISA we know today. The rapid uptake of this new assay, combined with the universal platform, allowed further development of diagnostic laboratories' equipment, including multichannel pipettes, plate washer, plate reader and automated liquid handler, which greatly improved the throughput, simplicity and cost-effectiveness of ELISA. In 1977, Clark and Adams used most of these developments to successfully detect and quantify plant viruses, i.e. *Arabidopsis mosaic virus* (ArMV) and *Plum pox virus* (PPV), which led to the rapid uptake of companies to produce and commercialize ELISA reagents for plant virus diagnostics. Subsequently, ELISA has been the most popular assay in diagnostic laboratories for detection of human, animal and plant viral pathogens. Most viruses that cause serious diseases in plants can now be screened by ELISA.

For grapevines, commercial ELISA kits are available for the main viral pathogens, including the ampeloviruses *Grapevine leafroll-associated virus 1, 3 and 4* (GLRaV-1, GLRaV-3, GLRaV-4), the closterovirus *Grapevine leafroll-associated virus 2* (GLRaV-2), the nepoviruses ArMV and *Grapevine fanleaf virus* (GFLV), the vitiviruses *Grapevine virus A and B* (GVA and GVB) and the maculavirus *Grapevine fleckvirus* (GFkV) (Table 21.1).

We here describe serological methods for the detection of major grapevine viruses, with the description of the antibodies and the ELISA formats; the improvement of the assays; the sampling strategies for accurate detection; the main usage of serological methods, including the place of antibodies in research; and the advantages, limitations and the future role of serology in grapevine virology.

Table 21.1 Format and suppliers of the main ELISA reagents

Virus	Type of assay	Capture and detection antibodies	Company
GLRaV-1	DAS-ELISA	Monoclonal:monoclonal	Bioreba
	DAS-ELISA	Monoclonal:monoclonal	Sediag
	DAS-ELISA	Polyclonal:polyclonal	Agritest
	TAS-ELISA	Polyclonal:monoclonal:anti-mouse-AP	AC Diagnostics
GLRaV-1 +GLRaV-3	DAS-ELISA	Polyclonal:polyclonal	Agritest
	DAS-ELISA	Polyclonal:polyclonal	AC Diagnostics
	DAS-ELISA	Polyclonal/monoclonal:polyclonal/ monoclonal	Bioreba
GLRaV-2	DAS-ELISA	Polyclonal:monoclonal	Agritest
	DAS-ELISA	Monoclonal:polyclonal	Bioreba
	TAS-ELISA	Polyclonal:monoclonal:anti-mouse-AP	Sediag
	TAS-ELISA	Polyclonal:monoclonal:anti-mouse-AP	AC Diagnostics
GLRaV-3	DAS-ELISA	Polyclonal/monoclonal:polyclonal/ monoclonal	Bioreba
	DAS-ELISA	Polyclonal:polyclonal	Sediag
	DAS-ELISA	Polyclonal:polyclonal	Agritest
	DAS-ELISA	Polyclonal:polyclonal	AC Diagnostics
	DAS-ELISA	Polyclonal:polyclonal	Agri Analysis
GLRaV-4 strain 5	DAS-ELISA (biotin)	Polyclonal:monoclonal:streptavidin-AP	Sediag
	DAS-ELISA	Polyclonal:polyclonal	AC Diagnostics
GLRaV-4 strain 6		Polyclonal:monoclonal	Bioreba
GLRaV-4 generic	DAS-ELISA	Monoclonal:monoclonal	Bioreba
GLRaV-7	DAS-ELISA	Polyclonal:polyclonal	Agritest
	DAS-ELISA (biotin)	Polyclonal:polyclonal:streptavidin-AP	Sediag
	DAS-ELISA	Polyclonal:polyclonal	AC Diagnostics
GVA	DAS-ELISA	Protein A:polyclonal:monoclonal	Agritest
	DAS-ELISA (biotin)	Polyclonal:polyclonal:streptavidin-AP	Sediag
	DAS-ELISA	Polyclonal:polyclonal/monoclonal	Bioreba
	DAS-ELISA	Polyclonal:polyclonal	AC Diagnostics
GVB	PTA-ELISA	Direct binding:monoclonal:anti-mouse	Agritest
	DAS-ELISA (biotin)	Monoclonal:monoclonal	Sediag
	TAS-ELISA	Polyclonal:monoclonal:anti-mouse-AP	AC Diagnostics
ArMV	DAS-ELISA	Polyclonal:polyclonal	Agritest
	DAS-ELISA	Polyclonal:polyclonal	Sediag
	DAS-ELISA	Polyclonal:polyclonal	Bioreba
	TAS-ELISA	Polyclonal:monoclonal:anti-mouse-AP	AC Diagnostics

(continued)

Table 21.1 (continued)

Virus	Type of assay	Capture and detection antibodies	Company
ArMV + GFLV	DAS-ELISA	Polyclonal:polyclonal	Agritest
	DAS-ELISA	Polyclonal:polyclonal	Sediag
	DAS-ELISA	Polyclonal:monoclonal:monoclonal	Bioreba
GFLV	DAS-ELISA	Polyclonal:monoclonal	Agritest
	DAS-ELISA	Polyclonal:monoclonal	Sediag
	DAS-ELISA	Polyclonal:monoclonal	Bioreba
	TAS-ELISA	Polyclonal:monoclonal:anti-mouse-AP	AC Diagnostics
GFkV	DAS-ELISA	Polyclonal:monoclonal	Agritest
	TAS-ELISA	Polyclonal:monoclonal:anti-mouse-AP	Sediag
	DAS-ELISA	Polyclonal:monoclonal	Bioreba
	TAS-ELISA	Polyclonal:monoclonal:anti-mouse-AP	AC Diagnostics
GRSPaV	DAS-ELISA	Polyclonal:polyclonal	AC Diagnostics

Bioreba AG, Switzerland; Sediag, France; Agritest SRL, Italy; AC Diagnostics Inc., USA; Agri Analysis Inc., USA

The Antibodies

ELISA is now ubiquitous in diagnostic and research laboratories thanks to its simplicity and robustness conferred by the capacity of the antibody to bind an antigen with great specificity and affinity.

An ELISA test is only as good as the antibodies it uses. The most common antibodies used in virus diagnostics are polyclonal antibodies (PABs) produced in rabbits, sheep or goats. These animals are chosen because of the ease of housing and the volume of serum yielded. PABs are produced when the animal is exposed to an antigen injected as purified (or partially purified) virus. The virus preparation represents a complex antigen with multiple potential epitopes recognized by different lymphocytes, resulting in the production of many distinctive antibodies.

In contrast, monoclonal antibodies (MAbs) are produced by a single, immortalized B lymphocyte clone. The MAbs are almost always produced from B lymphocytes that are extracted from the antigen-exposed mouse and fused with myeloma cells. These hybridoma cells can divide indefinitely and produce a single form of MAbs perpetually. The clones can be frozen for storage and re-cultured when needed.

Some of the main characteristics of antibodies are their specificity, affinity and avidity. The *specificity* is defined by how well an antibody can recognize a specific epitope and not another. Because PABs are the result of a population of antibodies targeting multiple epitopes, their specificity is generally lower than that of MAbs. A lower specificity can be advantageous since a broad range of variants of the same plant virus species can be detected, but it can result in cross-reactivity when an antibody recognizes a different virus species than the one against which it was

produced. A case in point is the cross-reaction observed between the vitiviruses infecting grapevines (Goszczyński et al. 1996). MAbs can have a very broad spectrum if they bind a highly conserved and essential motif of the target; MAbs have proven to be very popular to detect grapevine viruses at the species level, as shown in Table 21.1. The *affinity* measures the binding strength between an epitope and the antigen-binding site of an antibody. Affinity can be measured for MAbs, but PABs are heterogeneous, and only an average affinity can be determined. Antibodies are multivalent and *avidity* is a measure of the overall stability of these multiple binding sites to the antigen, which can also be polymeric. Avidity determines the success of all immunochemical techniques (Harlow and Lane 1988).

The ELISA protocol remains the same whether using MAbs or PABs, with several kits using a combination of MAbs and PABs. It is important to note that different batches of PABs may show differences in sensitivity and/or specificity whereas individual MAbs do not suffer from this problem.

ELISA Formats

ELISA is generally prepared in 96-well plate format. The protocol consists of the serial addition of reagents, followed by incubation and washing.

The most common format of ELISA used is the *double antibody sandwich* (DAS)-ELISA. Using the analogy of a sandwich, two different antibodies form the bread, while the virus coat protein or the virion (antigen) is the filling. The first antibody is coated to the plate during the initial incubation step. Following incubation and washing, the antigen is added in the form of crude extract from the grapevine, and the plate is once again incubated to allow for the binding between antigen and primary antibody. The plate is washed, and then the second (conjugated) antibody is added. In plant virology, the conjugate of choice is generally alkaline phosphatase (AP). After a third incubation, the plate is washed, and a substrate for colorimetric detection is added, such as para-nitrophenylphosphate (pNPP) that is dephosphorylated by AP to the yellow product, p-nitrophenol. The speed and the intensity of the colour change directly correspond to the amount of conjugated antibody that is bound to antigen from the crude extract.

The *double antibody sandwich indirect* (DAS-I)- or *triple antibody sandwich* (TAS)-ELISA is a protocol used when the second antibody is not conjugated with an enzyme or has been conjugated with a tag such as biotin. In this case, a third reagent is required. This reagent either targets the antibody species (e.g. anti-rabbit or anti-mouse) or uses streptavidin-AP to target the biotin tag. If an anti-species antibody is used, it is essential that the first and second antibodies used initially are of distinct species, such as goat and rabbit or rabbit and mouse. In the TAS-ELISA format, the first antibody does not need to be highly specific as specificity is defined by the secondary antibody. TAS-ELISA is also considered more sensitive than DAS-ELISA (Garnsey and Cambra 1993) but may have a higher background as a

result of non-specific binding. It is sometimes recommended that the second and third antibodies are mixed, saving one loading/incubation/washing step.

The *plate-trapped antigen* (PTA)-ELISA entails coating the plate with the antigen (plant extract) first, detecting the virus with a primary antibody specific to that virus and then detecting this primary antibody with a labelled antibody (anti-species). This makes possible an ELISA with only a single virus-specific antibody; however, this protocol is often less sensitive. This format is not common for the detection of grapevine viruses but is used for the detection of GVB (reagents from Agritest; Table 21.1).

Improving Performance

When Clark and Adams (1977) developed the application of ELISA for detection of plant viruses, there were no plate readers, and many of the early commercial antibody kits were designed to allow users to assess results visually. Protocols recommended that the enzyme reaction should be stopped by the addition of sodium hydroxide after 30 min to 2 h. This is commonly referred as an endpoint assay.

The development of automatic plate readers affords the opportunity to follow the development of reactions by reading the optical density (OD) periodically over time. The basis of ELISA is to measure enzyme activity, and the standard way to express enzyme activity is to measure reaction rates under standard conditions. Reaction rates are mostly linear over time until high OD values are reached. This limit is affected by the technical constraints of the spectrophotometer/plate reader. Hence, early plate readers lost linearity at about OD of 1.5, while modern readers are linear to OD of 2.5 or higher. For higher enzyme concentrations (that reflect higher virus titres), clear results may be obtained within 10 min. However, if the plate is allowed to incubate for several hours, much lower concentrations of enzyme (that reflect low virus titres) can be detected. By this time, samples with a high titre of virus have an optical density above 2.5. If the plates are read soon after addition of substrate and then several times over the next 2–4 h, reaction rates can be calculated using the equation: reaction rate, expressed in milli-OD per min (mOD/min) = $(OD_2 - OD_1) / (T_2 - T_1) * 1000$, where T1 is the time in minutes for the first reading and T2 is the time in minutes for the last reading made for all wells that have an OD below 2.5. For wells with an OD above 2.5, an accurate reaction rate can be calculated by using an earlier reading where the OD is less than 2.5.

A key to extend the dynamic range is to obtain a background reaction rate for negative samples that is as low as that of a buffer control. To achieve this, test conditions need to be optimized to reduce non-specific binding of the conjugate, for example, by using non-ionic detergents or a protein such as skim milk as blocking agents; by increasing the number of washing steps, particularly after the additions of the AP conjugate; and by reducing the concentration of the detection antibody and/or enzyme conjugate while maintaining sufficient reaction rates with positive samples. The purpose of this optimization is to enhance the signal-to-noise ratio.

Absolute positive controls are rarely used in ELISA for the detection of plant viruses. Nevertheless relative quantification can be achieved by carrying out serial dilutions of a known positive extract to determine the dilution endpoint, which is the lowest concentration of a positive control that can be distinguished from an uninfected sample of the same plant tissue. If the results obtained by dilution of a positive sample in sap from a non-infected plant or buffer are the same, there is no non-specific binding due to the plant extract. In early studies, the dynamic range of ELISA was often shown as about 100-fold (Clark and Adams 1977). This can be extended to 1000-fold or higher by measuring reaction rates rather than an endpoint OD. Advantages of calculating reaction rates, such as the elimination of some error sources and the possibility of direct comparison between samples and between runs, were discussed by Garnsey and Cambra (1993).

The determination of a cut-off point is the critical aspect that sets the sensitivity of the diagnostic assay. It is sometimes set by an arbitrary threshold value relative to a healthy control for a positive reaction. Often only one or two wells are used for positive and negative controls, and two or three times the average OD value of the negative controls is selected as the threshold value. A much preferred procedure is described in protocols recommended by Bioreba (Bioreba 2014); sample data from all wells in a plate are sorted in ascending or descending order and viewed as a histogram in Microsoft Excel. Background values are distinguished from potential positive samples by a clear jump in OD value. For a typical assay, the limit of detection can be estimated from the mean and standard deviation of all background samples as a cut-off value using the following equation: $\text{cut-off} = (\text{mean of background values} + 3 \times \text{standard deviation}) + 10\%$. We recommend using a serial dilution of a positive on every plate in order to demonstrate the sensitivity of a test. The limit of detection is the lowest dilution of the positive control that can be detected using the calculated cut-off value. For test samples, reaction rates close to the cut-off are treated as uncertain. For critical work, samples that give values close to the cut-off point should be re-extracted and retested.

Sampling Strategies

More than 70 ELISA sets of reagents are commercially available for the detection of 18 different viruses or combination of viruses that infect grapevines. At present, ELISA assays for the detection of ampeloviruses GLRaV-1 and GLRaV-3 and nepoviruses GFLV and ArMV are the most commonly supplied assays to diagnostic laboratories and research centres reflecting both the high quality of antibodies available and the economic impact of these diseases. Depending on the target virus (or viruses) and/or the supplier of reagents, the ELISA platforms and combinations of MAbs and PAbs antibodies for capture and detection can differ. For instance, commercially available ELISA assays for the detection of GLRaV-2 include DAS-ELISA that consists of a MAb for capture and conjugated PAb for detection or a

Table 21.2 Timing and preferred sample tissue suitable for the detection of grapevine viruses by ELISA

Virus	Season	Tissue
Nepoviruses (GFLV, ArMV, TomRSV and others)	Spring	Leaves from new active growth
	Fall/winter	Phloem scrapings
Leafroll viruses (GLRaV-1, GLRaV-2, GLRaV-3, GLRaV-4 strains, GLRaV-7)	Late summer/fall	Leaves from basal to mid-canopy
	Fall/winter	Phloem scrapings
Vitiviruses (GVA, GVB and GVD)	Fall/winter	Phloem scrapings
GFkV	Spring	Leaves from new active growth
	Fall/winter	Phloem scrapings

PAb for capture and a MAbs for detection. In addition two companies offer reagents for an alternative TAS-ELISA assay (Table 21.1).

The quality and suitability of the sample is critical to run a valid test. Low virus titre and/or uneven virus distribution within the plant host and/or the restriction of the virus to the phloem can lead to false-negative results. Consequently, it is critical that the appropriate plant tissue(s) is sampled at the optimal time of the year to ensure the reliability of diagnostic detection methods (Table 21.2). Serological- and molecular-based research have tested the reliability of different plant tissues for virus detection and monitored the titre and movement of grapevine viruses at particular times throughout the season(s) (Constable et al. 2012; Fiore et al. 2009; Krebelj et al. 2015; Ling et al. 2001; Monis and Bestwick 1996; Rowhani et al. 1992; Teliz et al. 1987; Walter and Cornuet 1993; Walter and Etienne 1987). These studies have illustrated different seasonal fluctuations in virus titre and distribution within the host plant for different grapevine viruses, indicating that different sampling protocols may be required when testing for multiple viruses (Table 21.2).

The majority of studies have shown that the apparent virus titre based on the OD ELISA readings of nepoviruses such as GFLV and ArMV are highest early in the growing season during the intensive active growth of shoots (Rowhani et al. 1992; Fiore et al. 2009; Krebelj et al. 2015). Young leaf material from opening buds, shoot tips or unfolded leaves has resulted in consistently high ELISA readings (Rowhani et al. 1992; Fiore et al. 2009; Krebelj et al. 2015). As the season progresses, and once shoots have stopped growing and temperatures rise in the summer period, the apparent virus titre decreases to levels that can cause difficulties for virus detection such as for GFLV (Walter and Etienne 1987; Rowhani et al. 1992; Krebelj et al. 2015). Furthermore, the extent to which the ELISA readings reduce during summer has been shown to vary for different grapevine cultivars (Krebelj et al. 2015). Phloem scrapings from lignified canes have consistently been shown to provide effective detection for nepoviruses, with ELISA OD readings relatively consistent throughout the season, though readings are generally lower compared to that of ELISA readings from leaf samples of new growth in the spring (Walter and Etienne 1987; Rowhani et al. 1992; Fiore et al. 2009; Krebelj et al. 2015). In a study by

Rowhani et al. (1992), the detection of the grapevine-infecting strain of nepovirus *Tomato ringspot virus* was observed to be an exception to the described seasonal fluctuations, with reduced ELISA readings at the start of the season, which progressively increased during the season and remained relatively constant thereafter. There was no significant difference in ELISA readings between plant tissues.

Studies on GFkV have shown nepovirus-like seasonal fluctuations in reliable ELISA detection at the start of the vegetative period, followed by reduced ELISA readings in the summer period (Walter and Cornuet 1993; Fiore et al. 2009). However, other studies found that GFkV titre in leaf tissue remained within the threshold required for ELISA detection through to autumn in hot and cold climatic environments (Constable et al. 2012; Fiore et al. 2009).

Generally, for ELISA testing of closteroviruses, mature leaves are sampled in late summer to autumn from the basal to mid-canopy region, and in winter the lignified canes are collected for phloem scraping. Using ELISA, researchers have closely examined the distribution of GLRaV-3 along developing shoots/canes and the impact the seasons can have on virus detection (Monis and Bestwick 1996; Teliz et al. 1987; Ling et al. 2001; Constable et al. 2012). At the start of the growing season, GLRaV-3 appears to move from the roots and trunks into the shoots; it is detected in flower clusters by ELISA but not in the young leaves during new spring growth including opening buds and shoot tips. Once inflorescences fully develop in early summer, GLRaV-3 becomes detectable in leaves positioned at the basal position of the shoot and then as the season progresses from leaves in the middle and apex positions of the shoot. This corresponds to the apparent GLRaV-3 titres based on ELISA OD, that gradually increase as the season progresses with the highest virus titre found in the leaves at the base of the shoot and the lowest at the tip of the shoot (Monis and Bestwick 1996; Teliz et al. 1987). However, from the berry touch stage (the end of berry development where berries are still hard and green), until harvest, GLRaV-3 was detectable along the cane including all the young apical leaves (Teliz et al. 1987; Fiore et al. 2009), and the previously significant difference in apparent GLRaV-3 titre between the base and apex of the cane becomes less obvious (Monis and Bestwick 1996). In addition, more consistent detection of GLRaV-3 by ELISA can be achieved when testing from symptomatic leaf samples (Ling et al. 2001). Throughout the season, phloem scrapings from canes have been shown to provide consistent GLRaV-3 detection, particularly outside the vegetative period and importantly for infected but non-symptomatic vines in addition to symptomatic vines (Ling et al. 2001; Fiore et al. 2009; Constable et al. 2012). It is important to note here that **leaf samples are not suitable for ELISA of non-vinifera species** of the *Vitis* genus, since ELISA results have shown that GLRaV-3 was either non-detectable, or results were unreliable, with *Vitis rupestris* and *V. riparia* and their hybrids that are used as rootstocks (Boscia et al. 1990).

When sampling plant tissue for testing, it is also common practice to collect tissue from more than one position on the plant and test this as a composite sample. This improves the chance of virus detection, taking into account that the virus may be unevenly distributed within a plant, particularly with a recent infection.

For fresh tissue collections, care should be taken to keep samples cool in the field and then stored at 4 °C, or below, until processed in the laboratory. Cane samples can be held at 4 °C for longer periods with no loss of virus detectability, whereas, for long-term storage of plant material, for instance positive controls, the plant tissue can be frozen at -20 °C, or freeze-dried.

The Place of ELISA in the Laboratories' Toolbox

Disease management is one of the main purposes for serological methods as a diagnostic tool. It includes the high health propagation, as well as field monitoring.

Regulations vary widely across the world, influenced in part by the importance of distinct graft transmissible agents (GTAs) in different countries, the presence of vectors that spread the GTA in the field and whether the application of standards is voluntary or obligatory. Nevertheless, what all regulations have in common is that the accurate and reliable detection of grapevine viruses in nursery and field plants is a critical part of grapevine improvement and disease management programmes worldwide. In order to minimize the probability of infected material entering vineyards, nurseries need to test plants from mother blocks of rootstock and scion material. In addition, they can test a proportion of the newly grafted vines for viruses, thus ensuring that “high-health plants” or “plants free of specific viruses” are released to vineyards. Furthermore, identifying virus-infected vines in existing vineyards, which are a source of inoculum for further spread, is another important aspect of a disease control programme (Andrew et al. 2015; Bell 2015; Pietersen et al. 2013). This requires continual virus screening of vineyards, where identified virus-infected vines are removed and replaced with nursery-certified “high-health plants”.

High-Health Propagation

For the selection of nucleus stock plants for a high-health program, a full screen for viruses is required, and these phytosanitary testing regimes can vary for different geographic areas depending on the prevalence of viral disease(s) and the needs of the industry (Chaps. 27 and 28, this book). Firstly, records can be checked for evidence that the block is planted with the desired variety and clone. Vines can then be visually examined for disease symptoms and the positions of symptomatic vines noted. At an appropriate time, samples can then be taken for laboratory screening (Table 21.2). For most testing regimes, ELISA is a recommended assay for the detection of the main grapevine viruses. For example, the European and Mediterranean Plant Protection Organization (EPPO) and the North American Plant Protection Organization (NAPPO) recommend the use of ELISA assays to test for GFLV and other nepoviruses, grapevine leafroll viruses (GLRaV-1 to GLRaV-4 and

related strains), vitiviruses (GVA and GVB) and GFkV. However, ELISA testing is only recommended for the detection of nepoviruses and grapevine leafroll viruses GLRaV-1, GLRaV-2, GLRaV-3, GLRaV-4 and GLRaV-7 within foundation stock blocks in California, USA. Notably, molecular testing is recommended for the detection of vitiviruses GVA and GVB and grapevine leafroll viruses GLRaV-2RG and GLRaV-4 (strain 9). Generally, ELISA testing is recommended as a complementary tool to other testing regimes such as molecular testing, particularly as a cost-effective and time-saving test for preliminary large-scale screening and randomized testing of blocks, as described in the following section. Within the California Department of Food and Agriculture Grapevine Registration and Certification Program, in the first instance, ELISA testing is used in addition to biological indexing and PCR tests on all accessions to be added to the foundation vineyard. Thereafter, ELISA is used for the continual screening of accessions in the entire vineyard, and in addition to repeated visual monitoring, plants from the foundation vineyard are periodically re-indexed and tested by ELISA and PCR.

For nursery propagation, rootstock and scion wood blocks should be planted with certified vines and then maintained with stringent protocols to control virus vectors. To ensure that the vines have not become infected, plant tissues should be sampled and tested using the recommended regimes, mentioned above. To obtain certification of nursery stock, the Grafted Grapevine Standard in New Zealand specifies that all new blocks used for scion wood collection must be 100% tested by ELISA, using composites of no more than six vines per sample. In subsequent years, the proportion of vines in each block that need to be retested for the presence of GLRaV-3 may be reduced depending on the infection level recorded in the previous season. The aim of this protocol is to ensure that the number of vines infected with GLRaV-3 from any given combination of rootstock and cultivar is less than 0.1%. To audit this process, a proportion of the grafted vines from each rootstock/scion combination is tested by ELISA at the end of the first growing season, using composite leaf samples (New Zealand Winegrowers 2014a). These protocols have led to a vast improvement in the quality of vines available to vineyards.

Screening of Vineyard Plants

Following the planting of vines certified to be free of specific viruses, the aim of the control programme is to then monitor for possible in-field infection from secondary spread, followed by the removal of infected vines (Andrew et al. 2015; Bell 2015; Pietersen et al. 2013).

As a case study, grapevine leafroll disease (GLD) in red-berried cultivars can be detected visually by trained staff. An essential part of that training should include validation of positive, negative or uncertain for the presence of the virus in question by a diagnostic laboratory using a method such as ELISA. This feedback assists staff to improve their diagnostic accuracy and confidence. For white-berried cultivars, visual identification for GLD can be difficult at best. As an alternative in New

Zealand, randomized testing of white-berried cultivar blocks for GLRaV-3 by ELISA can be used to estimate the virus incidence and monitor its spread (Andrew et al. 2015; New Zealand Winegrowers 2014b). For example, if leaves from 200 plants are collected from a vineyard block and tested as 40 composite samples of five leaves each, the proportion of infected composite samples detected by ELISA can be used to calculate the proportion of infected vines in the block with a 90% confidence (New Zealand Winegrowers 2014b). The detection of a single positive composite computes to an infection level of 0.5% with a 90% confidence that the actual infection level is not greater than 1.35%. If greater accuracy is required to determine low levels of infection, the total number of sampled plants should be increased. Repeated testing annually, or every 2 or 3 years thereafter, will aid monitoring for spread of GLRaV-3 in the block.

Research Tools

In addition to the wide use of ELISA for diagnostics, antibody-based assays have been developed for research purposes. The main research focus has been visualization/localization of the virus in the plant, virus isolation before molecular application and classification of serotypes.

Similar to ELISA as described in this chapter, immunosorbent electron microscopy (ISEM) is a method for the detection of plant viruses that is based on capturing virions onto a surface, in this case transmission electron microscopy grids, decorating these virions with a primary antibody, which is subsequently detected using another specific antibody that is labelled with heavy metal particles such as colloidal gold, to allow for the visualization of specific virions under transmission electron microscopes. This method is as sensitive as ELISA assays; however, it is not suitable for large-scale testing and requires laboratories to have such sophisticated and costly instrumentation as electron microscopes (Martelli 1993; Milne and Lesemann 1984). Nevertheless, this method has been important in fundamental research for the visualization of virion morphology, aiding with the identification of viruses, defining disease aetiology, better understanding host-virus interactions and verifying plant virus-vector relationships. For example, ISEM was used for detecting nepoviruses in plants and its nematode vectors (Roberts and Brown 1980; Russo et al. 1980). This method was also used to better understand the plant-GLRaV-3 relationship with visualization of virions in successive generations of callus tissue (Scagliusi et al. 2002). Furthermore, ISEM was used for the first visualization of GRSPaV particles from tissue culture, greenhouse and field-grown plants (Petrovic et al. 2003).

An alternative to DAS-ELISA is the direct tissue blotting assay also referred to as direct immunoprinting (DIP) (Cabaleiro et al. 2008; Couceiro et al. 2006). An advantage of this technique is that it reveals the distribution of virus-infected phloem tissue, but this requires careful observation under a dissecting microscope to observe the purple-stained deposits.

Western blotting is another serological method to detect proteins that typically have been separated by mass on a denaturing polyacrylamide gel; alternatively a non-denaturing gel can be used to separate the mass of proteins in their native structure and/or in association with other proteins or nucleic acids. For example, western analysis has been used in grapevine virus research to identify the relatedness of strains (Alkowni et al. 2011) or to distinguish strains. This method can complement ELISA as the mass of the detected protein is identified and the method can be used to research non-structural proteins. In addition, semi-quantitative data on the accumulation of the target protein can be investigated across an infection time course, thereby providing kinetic information (Moser et al. 1992). Subcellular fractionation of the sample enables the use of western analysis to determine the intracellular compartmentation of the target protein (Saldarelli et al. 2000). The antibody used in western analysis may be raised against the target virus protein (either native or recombinant) or by tagging the target protein, for instance within an infectious virus clone (Alkowni et al. 2011; Maliogka et al. 2009; Meng et al. 2013). Such data on size and accumulation of target proteins allow western analysis to be used for determining enzymatic functions such as protease cleavage and suppressor of RNA silencing of grapevine viruses even in the presence of background reactivity from healthy plants (Vigne et al. 2013). Western analysis has also been used to confirm the expression of specific proteins within engineered viruses as to identify vector transmission determinants (Belin et al. 2001).

Antibodies can also be used in the initial steps of some molecular assays to preferentially isolate the target virus. The most time-consuming and labour-intensive component in carrying out reverse transcription (RT)-PCR is the extraction of high-quality RNA. A number of studies have shown that the method used to extract RNA is a major factor in the reliability and sensitivity of the subsequent RT-PCR (Gambino and Gribaudo 2006; MacKenzie et al. 1997). A simple alternative is to capture virions using antibodies bound to plastic surfaces (Wetzel et al. 2002) or magnetic beads (Gambley et al. 2009). Sensitivity of immunocapture (IC)-RT-PCR is high (Acheche et al. 1999; Kumar et al. 2015) and allows the subsequent sequencing of PCR products. An added advantage of this approach is that extracts screened using ELISA can be re-tested directly by IC-RT-PCR and the thorough washing made possible due to the strong binding of the virus reduces the presence of PCR inhibitors (polysaccharides and polyphenols) from otherwise recalcitrant RNA preparations.

Different serotypes within a viral species are commonly described (Halk 1986; Reynard et al. 2015). For diagnostic purposes, to ensure detection of all virus strains, MAbs are often screened against different viral isolates, and ELISA kits often contain mixtures of MAbs. Alternatively, for research purposes, the different serotypes and antibody avidity to particular epitopes can lead to the identification of a new virus or viral strain. In the case of GLRaV-3, single MAb such as MAbNY1.1, raised against the NY1 isolate (Hu et al. 1990), was believed to detect all isolates of GLRaV-3. However, research in New Zealand identified serotypes of GLRaV-3 that react weakly to MAbNY1.1 but strongly to commercial PABs, leading to the identification of two molecularly distinct serotypes, highly divergent at the molecular level (Chooi et al. 2013, Cohen et al. 2012).

Advantages and Limitations of Immunoassays

ELISA provides either highly specific or broad detection capability depending on the antibody used. For example, the AP-conjugated antibodies for the detection of GFLV distributed by Bioreba detect all known GFLV strains. With the continual addition of sequences in GenBank, genetic diversity of viruses is more fully understood, and alignments of the coat protein sequences can be used to select a conserved amino acid sequence synthesized against which antibodies can be produced, as shown by Esteves et al. (2013) for GLRaV-1. A difficulty of this approach is that not all conserved sequences are in structurally accessible parts of the protein, explaining why some peptide MAb strategies fail. In order to increase the breadth of the ELISA across different species of viruses, it is possible to mix antibodies for several viruses. For example, Pietersen et al. (2013) mixed the antibodies against GLRaV-1, GLRaV-2 and GLRaV-3 for simultaneous multiplex detection. This approach has been used by several diagnostic companies (e.g. for the detection of GLRaV-1 and/or GLRaV-3, or GFLV and/or ArMV). However, a positive ELISA result does not indicate which one of the target viruses is present in the samples. Alternatively, despite fewer applications, it is technically possible to select MAbs that are specific to a virus strain, for instance to discriminate between GLRaV-4 strains (Gomez Talquenca et al. 2015; Reynard et al. 2015).

The sensitivity of detection by ELISA depends on the affinity between the antibodies and antigen, the amount of conjugate-enzyme bound and the substrate used, but there is no amplification of the antigen itself. Therefore, molecular methods have proven to be more sensitive when compared directly with ELISA (Gambino and Gribaudo 2006; Komínek and Bryxiová, 2004; Liebenberg et al. 2009), and they provide the opportunity to gain more information about the virus, i.e. sequence data. However, the lack of template amplification in ELISA means that the assay is less prone to contamination. In addition, ELISA is not affected by polysaccharides or polyphenols present in the sap that are often responsible for interfering with PCR reactions. These features contribute to the robustness of the ELISA when compared to the molecular assays.

By contrast to molecular-based methods, ELISA is technically less demanding as the sample preparation for ELISA is much simpler than for nucleic acid-based detection. The equipment required to run the test is very simple and relatively inexpensive. In addition, most reagents are affordable, with the antibodies remaining the major cost, but their prices vary depending on the type and supplier. A typical ELISA assay is completed within 2 days, but a substantial part of this time involves incubation periods during which the laboratory operator can undertake other tasks.

A simple form of serological test is the lateral flow immunochromatographic assay that detects the presence of an antigen in an extremely short time (minutes) from the plant sap extract. Since these assays can be performed in the field, it removes the errors that can arise from mislabelling and handling. With this minimum point of care, the test is suited for rapid response in the case of a new disease and also a perfect tool during training of symptom identification. Although still rare

in the grapevine virus field, there have been reports of their use (Liebenberg et al. 2009; Huseynova et al. 2015). Availability, price and sensitivity are the main challenges for this tool to become widely adopted.

When using sensitive antibodies, tissue from multiple plants can be combined into a composite test sample, thus reducing the cost while still testing a large number of plants. This approach is most cost-effective when the incidence of virus is low and only a small number of samples need to be re-analysed to identify infected plants. This method is validated and accepted for the detection of GLRaV-3 in the New Zealand Grafted Grapevine Standards (New Zealand Winegrowers 2014a).

In contrast to the development of a new PCR protocol, the development of a new ELISA protocol can be a slow and expensive process. The virus needs to be purified or its coat protein synthesized or expressed in a suitable cell culture system via recombinant DNA technology in full or partially. Purification of a specific grapevine virus can be challenging because, as is typical for many grapevine viruses, it may be in a mixed infection, as well as in a low titre, be phloem-limited and/or may be labile. ELISA kits are not yet available for the recently described viruses *Grapevine Pinot gris virus* (GPGV) and *Grapevine red blotch-associated virus* (GRBaV). A GPGV PAb was described (Saldarelli et al. 2015) for use in western blotting, but it is not suitable for use in an ELISA format.

ELISA has decreased in popularity with the promise of more sensitive or specific molecular technologies; however, these latter platforms also have inherent limitations such as the specificity of primers and problems of cross-contamination when handling large numbers of field samples. ELISA is reliable and sensitive and therefore continues to provide robust results.

Conclusions and Future Directions

Despite the increased demand for molecular tools, at a time where the cost of sequencing is in steady decline, alternative usage of antibodies is being developed. The Luminex xMAP is, for example, a variation to ELISA that improves the speed of diagnostic by the simultaneous detection of multiple viruses. It uses fluorescent microspheres (beads) as a support for antibodies (van der Vlugt et al. 2015). The beads used for one assay are labelled with a set ratio of two fluorochromes, the bead address. By altering the ratio of the two fluorochromes, theoretically, up to 500 different beads can be distinguished. Individual bead addresses can be used for each assay, and mixtures of bead addresses are used to simultaneously run assays with multiple viral targets. The tests use a 96-well plate format, and since the beads are magnetic, washing steps can be automated and provide very high stringency. At the end of the assay, samples are analysed on a small flow cytometer (or LED-based image analyser) that recognizes the individual bead address. The total amount of fluorescence per bead address is correlated to the titre of each virus for each sample. Beads can also be covalently coupled with oligonucleotides to make a molecular assay. Although xMAP has been available for many years (Vignali 2000), its uptake

by plant virology has been slow with only a handful of publications of multiplex detection of viruses by serological assay (Bergervoet et al. 2008; Charlermroj et al. 2013; Croft et al. 2008). Since this method can be used to assay for multiple viruses that infect a crop simultaneously in a single well, it provides a step change in throughput that would be of significant benefit for routine detection in a systematic testing regime such as the quarantine testing for import/export and the quality control of propagation material for vegetatively propagated crops such as grapes.

A recent improvement to further lower the cost and increase accessibility of immunoassays for diagnostic testing to growers is the development of a high-throughput smartphone optical sensing platform (HiSOP) (Wang et al. 2016). HiSOP is based on a 64-well micropillar array and smartphone application that is designed to measure the light intensities in each well and convert these readings into absorbance based on the average intensities from five pictures normalized against the light intensity of deionized water (Wang et al. 2016). The HiSOP signifies a new opportunity for mobile disease diagnostics, reducing the point of care and increasing the speed for disease management decisions to be made on location.

In parallel to the development of new assays, some progress has recently been made to design epitope-specific antibodies. Nanobodies, a novel class of antibodies with a single domain naturally produced by camelids, were reported in 1993 (Hamers-Casterman et al. 1993). They present the advantage of being small with a high stability and high sensitivity. They can be produced in transgenic plants to a very high concentration (up to 30% of the total leaf protein in *Nicotiana benthamiana*) (Teh and Kavanagh 2010). Once expressed *in planta*, the flexibility for storage and production is a great advantage for diagnostic use, as they can be stored as seed and sown upon request. A similar approach was taken by Cogotzi et al. (2009) who expressed a single-chain fragment variable (scFv) antibody specific to GLRaV-3 in *Escherichia coli*. Nanobodies as well as the scFv can be used in a similar way to MAbs produced from hybridoma cells in an ELISA format as shown in the medical lab by Zhu et al. (2014), for the detection of influenza H5N1, but also for grapevine virus detection with the nanobody specific to GFLV (Ackerer et al. 2015) or the scFv raised against GLRaV-3 (Cogotzi et al. 2009). Another application of the nanobody is its direct expression within the host of a virus to generate a transgenic plant resistant to that virus (Ghannam et al. 2015). When applied to grapevine viruses, this method was demonstrated to protect against GFLV (Hemmer et al. 2015).

Most of the antibodies are produced to detect a single viral strain or species, but some antibodies can detect most species in a viral genus [e.g. Potyvirus (Jordan and Hammond, 1991; Richter et al. 1995)]. However, the broadest detection of viruses can be achieved with a monoclonal antibody that binds double-stranded (ds)RNA produced by most RNA viruses during genome replication. These antibodies were first developed 40 years ago (Moffitt and Lister 1975) and have been tested for ELISA (Aramburu and Moreno 1994; Aramburu et al. 1991; Garcia-Luque et al. 1986; Powell 1991; Schonborn et al. 1991). However, the high level of background made these antibodies unsuitable for ELISA, but their specificity and avidity to one type of nucleic acid (O'Brien et al. 2015) showed great fit for IC-PCR (Nolasco

et al. 1993). Recently, with the possibility of the untargeted sequencing at low cost using next-generation sequencing, the dsRNA antibodies were shown to be an efficient method to enrich for virus nucleic acid (Blouin et al. 2016).

To conclude, more than 45 years after its development by Engvall and Perlmann (1971), ELISA still has a place of choice in the diagnostic laboratory. When asked why ELISA has not been completely replaced by more modern assays, Eva Engvall (2010) replied “Few assays are as simple as the ELISA and require so little in terms of automation and equipment. There is beauty in simplicity”. Alongside with ELISA, several classic serological assays remain essential to detect or characterize viral disease; thus, the management and research of grapevine viruses will continue to benefit from new developments of antibody-based methods for years to come.

Acknowledgements We are grateful to Dr. Vaughn Bell and Dr. Erik Rikkerink for their helpful comments. We would like to thank the staff at Bioreba, Sediag, Agri Analysis and Agritest for their prompt response and useful information. In addition to support from The New Zealand Institute for Plant & Food Research Limited, AGB is the current recipient of the Rod Bonfiglioli Memorial Fund, provided by New Zealand Winegrowers Inc., and KMC is supported through funding from the New Zealand Agricultural and Marketing, Research and Development Trust.

References

- Acheche, H., S. Fattouch, S. M’Hirsi, N. Marzouki, and M. Marrakchi. 1999. Use of optimised PCR methods for the detection of GLRaV3: A closterovirus associated with grapevine leafroll in Tunisian grapevine plants. *Plant Molecular Biology Reporter* 1: 31–42.
- Ackerer, L., B. Monsion, C. Hemmer, V. Komar, E. Vigne, C. Gertz, K. Hleibieh, I. Beccavin, L. Audeguin, A.S. Spilmont, S. Muyldermans, C. Ritzenthaler, and G. Demangeat. 2015. Nanobody-based products as diagnostic tool for grapevine fanleaf degeneration viruses. *Proceedings 18th Meeting of ICVG, Ankara, Turkey*, 68–69.
- Alkowni, R., Y.P. Zhang, A. Rowhani, J.K. Uyemoto, and A. Minafra. 2011. Biological, molecular, and serological studies of a novel strain of grapevine leafroll-associated virus 2. *Virus Genes* 43 (1): 102–110.
- Andrew, R., V. Bell, N. Hoskins, G. Pietersen, and C. Thompson. 2015. *Leafroll 3 virus and how to manage it*. Auckland: New Zealand Winegrowers. 108p.
- Aramburu, J., and P. Moreno. 1994. Detection of double-stranded-RNA (dsRNA) in crude extracts of virus-infected plants by indirect ELISA. *Journal of Phytopathology* 141: 375–385.
- Aramburu, J., J. Navascastillo, P. Moreno, and M. Cambra. 1991. Detection of double-stranded RNA by ELISA and dot immunobinding assay using an antiserum to synthetic polynucleotides. *Journal of Virological Methods* 33: 1–11.
- Belin, C., C. Schmitt, G. Demangeat, V. Komar, L. Pinck, and M. Fuchs. 2001. Involvement of RNA2-encoded proteins in the specific transmission of grapevine fanleaf virus by its nematode vector *Xiphinema* index. *Virology* 291 (1): 161–171.
- Bell, V.A. 2015. *An integrated strategy for managing grapevine leafroll-associated virus 3 in red berry cultivars in New Zealand vineyards*. PhD thesis, Victoria University of Wellington, New Zealand.
- Bergervoet, J.H.W., J. Peters, J.R.C.M. van Beckhoven, G.W. van den Bovenkamp, J.W. Jacobson, and J.M. van der Wolf. 2008. Multiplex microsphere immuno-detection of potato virus Y, X and PLRV. *Journal of Virological Methods* 149: 63–68.

- Bioreba. 2014. *ELISA data analysis*. http://www.bioreba.ch/popup.php?docFile=http://www.bioreba.ch/files/Technical_Info/ELISA_Data_Analysis.pdf. Accessed 1 Aug 2016.
- Blouin, A.G., H.A. Ross, J. Hobson-Peters, C. O'Brien, B. Warren, and R. MacDiarmid. 2016. A new virus discovered by immunocapture of double-stranded RNA, a rapid method for virus enrichment in metagenomic studies. *Molecular Ecology Resources* 16: 1255–1263.
- Boscia, D., V. Savino, V. Elicio, S.D. Jebahi, and G.P. Martelli. 1990. Detection of closteroviruses in grapevine tissues. *Proceedings 10th Meeting ICVG, Volos, Greece*, 52–57.
- Cabaleiro, C., C. Couceiro, S. Pereira, M. Cid, M. Barrasa, and A. Segura. 2008. Spatial analysis of epidemics of grapevine leafroll associated virus-3. *European Journal of Plant Pathology* 121: 121–130.
- Charlarmroj, R., O. Himananto, C. Seepiban, M. Kumposiri, N. Warin, M. Oplatomska, O. Gajanandana, I.R. Grant, N. Karoonuthaisiri, and C.T. Elliott. 2013. Multiplex detection of plant pathogens using a microsphere immunoassay technology. *Plos One* 8: e62344.
- Chooi, K.M., D. Cohen, and M.N. Pearson. 2013. Molecular characterisation of two divergent variants of grapevine leafroll-associated virus 3 in New Zealand. *Archives of Virology* 158: 1597–1602.
- Clark, M.F., and A.N. Adams. 1977. Characteristics of the microplate method of enzyme-linked immunosorbent assay for the detection of plant viruses. *Journal of General Virology* 34: 475–483.
- Cohen, D., K.M. Chooi, V.A. Bell A.G. Blouin, and M.N. Pearson. 2012. Detection of new strains of GLRaV-3 in New Zealand using ELISA and RT-PCR. *Proceedings the 17th Congress of ICVG, Davis, CA, USA*, 118–119.
- Cogotzi, L., A. Giampetruzzi, G. Nölke, M. Orecchia, V. Elicio, M.A. Castellano, G.P. Martelli, R. Fischer, S. Schillberg, and P. Saldarelli. 2009. An assay for the detection of grapevine leafroll-associated virus 3 using a single-chain fragment variable antibody. *Archives of Virology* 154: 19–26.
- Constable, F.E., J. Connellan, P. Nicholas, and B.C. Rodoni. 2012. Comparison of enzyme-linked immunosorbent assays and reverse transcription-polymerase chain reaction for the reliable detection of Australian grapevine viruses in two climates during three growing seasons. *Australian Journal of Grape and Wine Research* 18: 239–244.
- Couceiro, C., M. Cid, S. Pereira, A. Segura, and C. Cabaleiro. 2006. Use of direct immunoprinting (DIP)-ELISA for the detection of grapevine leafroll viruses. *Proceedings 15th Meeting of ICVG, Stellenbosch, South Africa*, 180–181.
- Croft, H., T. Malinowski, L. Krizbai, I. Mikec, V. Kajic, C. Reed, A. Varga, and D. James. 2008. Use of Luminex xMAP-derived Bio-Plex bead-based suspension array for specific detection of PPV W and characterization of epitopes on the coat protein of the virus. *Journal of Virological Methods* 153: 203–213.
- Engvall, E. 2010. The ELISA, enzyme-linked immunosorbent assay. *Clinical Chemistry* 56: 319–320.
- Engvall, E., and P. Perlmann. 1971. Enzyme-linked immunosorbent assay (ELISA) quantitative assay of immunoglobulin G. *Immunochemistry* 8: 871–874.
- Esteves, F., M. Teixeira Santos, J.E. Eiras-Dias, and F. Fonseca. 2013. Molecular data mining to improve antibody-based detection of grapevine leafroll-associated virus 1 (GLRaV-1). *Journal of Virological Methods* 194: 258–270.
- Fiore, N., S. Prodan, and A. Pino. 2009. Monitoring grapevine viruses by ELISA and RT-PCR throughout the year. *Journal of Plant Pathology* 91: 489–493.
- Gambino, G., and I. Gribaudo. 2006. Simultaneous detection of nine grapevine viruses by multiplex reverse transcription-polymerase chain reaction with coamplification of a plant RNA as internal control. *Phytopathology* 96: 1223–1229.
- Gambley, C.F., A.D. Geering, and J.E. Thomas. 2009. Development of an immunomagnetic capture-reverse transcriptase-PCR assay for three pineapple amelloviruses. *Journal of Virological Methods* 155: 187–192.
- García-Luque, I., A. Brieva, J.R. Diazruiz, and N. Rubio. 1986. Isolation and partial characterization of a monoclonal-antibody specific for a naturally-occurring double-stranded RNA. *Virology* 152: 252–255.

- Garnsey, S., and M. Cambra. 1993. Enzyme-linked immunosorbent assay (ELISA). In *Graft-transmissible diseases of grapevines: Handbook for detection and diagnosis*, ed. G.P. Martelli, 169–185. Rome: FAO Publication Division.
- Ghannam, A., S. Kumari, S. Muyldermans, and A.Q. Abbady. 2015. Camelid nanobodies with high affinity for broad bean mottle virus: a possible promising tool to immunomodulate plant resistance against viruses. *Plant Molecular Biology* 87: 355–369.
- Gomez Talquenca, G.S., S. Moyano, and M. Lanza Volpe. 2015. Serological relationships among GLRaV-4 strains reflects the genetic variability of its coat protein gene. *Proceedings 18th Meeting of ICVG, Ankara, Turkey*, 51–52.
- Goszczynski, D., G. Kasdorf, and G. Pietersen. 1996. Western blots reveal that grapevine viruses A and B are serologically related. *Journal of Phytopathology* 144: 581–583.
- Halk, E.L. 1986. Serotyping plant viruses with monoclonal antibodies. *Methods in Enzymology* 118: 766–780.
- Hamers-Casterman, C., T. Atarhouch, S. Muyldermans, G. Robinson, C. Hammers, E.B. Songa, N. Bendahman, and R. Hammers. 1993. Naturally occurring antibodies devoid of light chains. *Nature* 363 (6428): 446–448.
- Harlow, E., and D. Lane. 1988. *A laboratory manual*, 579. New York: Cold Spring Harbor Laboratory.
- Hemmer, C., L. Ackerer, A. Marmonier, K. Hleibieh, C. Schmitt-Keichinger, E. Vigne, S. Gersch, V. Komar, I. Orlov, B. Lorber, L. Belval, F. Berthod, B. Monsion, B. Klaholz, O. Lemaire, S. Muyldermans, G. Demangeat, and C. Ritzenthaler. 2015. Nanobodies: Getting over the hump of fanleaf degeneration? *Proceedings 18th Meeting of ICVG, Ankara, Turkey*, 68–69.
- Hu, J.S., D. Gonsalves, D. Boscia, and S. Namba. 1990. Use of monoclonal-antibodies to characterize grapevine leafroll-associated closteroviruses. *Phytopathology* 80: 920–925.
- Huseynova, I., N. Sultanova, A. Mammadov, N. Kosayeva, M. Khanishova, and J. Aliyev. 2015. Detection of grapevine leafroll-associated virus type 3 (GLRaV-3) in Azerbaijan and study of some histopathological changes in leaves of infected plants. *Proceedings 18th Meeting of ICVG, Ankara, Turkey*, 48–49.
- Jordan, R., and J. Hammond. 1991. Comparison and differentiation of potyvirus isolates and identification of strain-, virus-, subgroup-specific and potyvirus group-common epitopes using monoclonal antibodies. *Journal of General Virology* 72: 25–36.
- Komínek, P., and M. Bryxiová. 2004. Comparison of three techniques for detection of grapevine leafroll-associated virus 1. *Acta Virologica* 49: 37–43.
- Krebelj, A., U. Čepin, M. Ravnikar, and M. Novak. 2015. Spatio-temporal distribution of grapevine fanleaf virus (GFLV) in grapevine. *European Journal of Plant Pathology* 142: 159–171.
- Kumar, S., R. Rai, and V. Baranwal. 2015. Development of an immunocapture–reverse transcription–polymerase chain reaction (IC-RT-PCR) using modified viral RNA release protocol for the detection of grapevine leafroll-associated virus 3 (GLRaV-3). *Phytoparasitica* 43: 311–316.
- Liebenberg, A., M.-J. Freeborough, C.J. Visser, D.U. Bellstedt, and J.T. Burger. 2009. Genetic variability within the coat protein gene of grapevine fanleaf virus isolates from South Africa and the evaluation of RT-PCR, DAS-ELISA and ImmunoStrips as virus diagnostic assays. *Virus Research* 142: 28–35.
- Ling, K.S., H.Y. Zhu, N. Petrovic, and D. Gonsalves. 2001. Comparative effectiveness of ELISA and RT-PCR for detecting grapevine leafroll-associated closterovirus-3 in field samples. *American Journal of Enology and Viticulture* 52: 21–27.
- MacKenzie, D.J., M.A. McLean, S. Mukerji, and M. Green. 1997. Improved RNA extraction from woody plants for the detection of viral pathogens by reverse transcription-polymerase chain reaction. *Plant Disease* 81: 222–226.
- Maliogka, V.I., C. Dovas, L. Lotos, K. Efthimiou, and N. Katis. 2009. Complete genome analysis and immunodetection of a member of a novel virus species belonging to the genus Ampelovirus. *Archives of Virology* 154 (2): 209–218.
- Martelli, G. 1993. Immunosorbent electron microscopy (ISEM) and antibody coating. In *Graft-transmissible diseases of grapevines: Handbook for detection and diagnosis*, ed. G.P. Martelli, 193. Rome: FAO Publication Division.

- Meng, B.Z., S. Venkataraman, C.H. Li, W.Z. Wang, C. Dayan-Glick, and M. Mawassi. 2013. Construction and biological activities of the first infectious cDNA clones of the genus Foveavirus. *Virology* 435 (2): 453–462.
- Milne, R., and D. Lesemann. 1984. Immunosorbent electron microscopy in plant virus studies. *Methods in Virology* 8: 85–101.
- Moffitt, E., and R. Lister. 1975. Application of a serological screening test for detecting double-stranded RNA mycoviruses [from *Penicillium chrysogenum*]. *Phytopathology* 65: 851–859.
- Monis, J., and R.K. Bestwick. 1996. Detection and localization of grapevine leafroll associated closteroviruses in greenhouse and tissue culture grown plants. *American Journal of Enology and Viticulture* 47: 199–205.
- Moser, O., M. Fuchs, L. Pinck, and C. Stussi-Garaud. 1992. Immunodetection of grapevine fan-leaf virus satellite RNA-encoded protein in infected *Chenopodium quinoa*. *Journal of General Virology* 73 (11): 3033–3038.
- Nolasco, G., C. Deblas, V. Torres, and F. Ponz. 1993. A method combining immunocapture and PCR amplification in a microtiter plate for the detection of plant viruses and subviral pathogens. *Journal of Virological Methods* 45: 201–218.
- New Zealand Winegrowers. 2014a. New Zealand Winegrowers Grafted Grapevine Standard <http://www.nzwine.com/assets/sm/upload/6v/b5/ib/oe/GGS%20V%202%204%20final.pdf>. Accessed 1 Aug 2016.
- . 2014b. Testing white varieties for Leafroll 3, <http://www.nzwine.com/assets/sm/upload/m2/rc/0t/tz/NZVE-112-Testing%20white%20varieties%202014.pdf>. Accessed 1 Aug 2016.
- O'Brien, C.A., J. Hobson-Peters, A.W. Yam, A.M. Colmant, B.J. McLean, N.A. Prow, D. Watterson, S. Hall-Mendelin, D. Warrilow, M.L. Ng, A.A. Khromykh, and R.A. Hall. 2015. Viral RNA intermediates as targets for detection and discovery of novel and emerging mosquito-borne viruses. *PLoS Neglected Tropical Diseases* 9: e0003629.
- Petrovic, N., B. Meng, M. Ravnkar, I. Mavric, and D. Gonsalves. 2003. First detection of Rupestris stem pitting associated virus particles by antibody to a recombinant coat protein. *Plant Disease* 87: 510–514.
- Pietersen, G., N. Spreeth, T. Oosthuizen, A. van Rensburg, M. van Rensburg, D. Lottering, N. Rossouw, and D. Tooth. 2013. Control of grapevine leafroll disease spread at a commercial wine estate in South Africa: A case study. *American Journal of Enology and Viticulture* 64: 296–305.
- Powell, C. 1991. Preparation and characterization of monoclonal antibodies to double-stranded RNA. *Phytopathology* 81 (2): 184–187.
- Reynard, J.-S., P.H. Schneeberger, J.E. Frey, and S. Schaerer. 2015. Biological, serological, and molecular characterization of a highly divergent strain of grapevine leafroll-associated virus 4 causing grapevine leafroll disease. *Phytopathology* 105: 1262–1269.
- Richter, J., F. Rabenstein, E. Proll, and H.J. Vetten. 1995. Use of cross-reactive antibodies to detect members of the *Potyviridae*. *Journal of Phytopathology* 143: 459–464.
- Roberts, I., and D. Brown. 1980. Detection of six nepoviruses in their nematode vectors by immunosorbent electron microscopy. *Annals of Applied Biology* 96: 187–192.
- Rowhani, A., M. Walker, and S. Rokni. 1992. Sampling strategies for the detection of grapevine fanleaf virus and the grapevine strain of Tomato ringspot virus. *Vitis* 31: 35–44.
- Russo, M., G.P. Martelli, and V. Savino. 1980. Immunosorbent electron microscopy for detecting sap-transmissible viruses of grapevine. *Proceedings 7th Meeting of ICVG, Niagara Falls, Canada*, 251–257.
- Saldarelli, P., A. Minafra, M.A. Castellano, and G.P. Martelli. 2000. Immunodetection and subcellular localization of the proteins encoded by ORF 3 of grapevine viruses A and B. *Archives of Virology* 145 (8): 1535–1542.
- Saldarelli, P., V. Gualandri, and G.P. Martelli. 2015. Grapevine leaf mottling and deformation and Grapevine Pinot gris virus: An update on an emerging Mediterranean disease and a new virus. *Proceedings 18th Meeting ICVG, Ankara, Turkey*, 68–69.
- Scaglusi, S., J. Vega, and H. Kuniyuki. 2002. Cytopathology of callus cells infected with grapevine leafroll-associated virus 3. *Fitopatologia Brasileira* 27: 384–388.

- Schonborn, J., J. Oberstrass, E. Breyel, J. Tittgen, J. Schumacher, and N. Lukacs. 1991. Monoclonal-antibodies to double-stranded-RNA as probes of RNA structure in crude nucleic acid extracts. *Nucleic Acids Research* 19: 2993–3000.
- Teh, Y.-H.A., and T.A. Kavanagh. 2010. High-level expression of camelid nanobodies in *Nicotiana benthamiana*. *Transgenic Research* 19: 575–586.
- Teliz, D., E. Tanne, D. Gonsalves, and F. Zee. 1987. Field serological detection of viral-antigens associated with grapevine leafroll disease. *Plant Disease* 71: 704–709.
- van der Vlugt, R.A., H. van Raaij, M. de Weerd, and J.H. Bergervoet. 2015. Multiplex detection of plant pathogens through the luminex magplex bead system. *Plant Pathology: Techniques and Protocols*, 2nd ed., 283–299.
- Vignali, D.A.A. 2000. Multiplexed particle-based flow cytometric assays. *Journal of Immunological Methods* 243: 243–255.
- Vigne, E., J. Gottula, C. Schmitt-Keichinger, V. Komar, L. Ackerer, L. Belval, L. Rakotomalala, O. Lemaire, C. Ritzenthaler, and M. Fuchs. 2013. A strain-specific segment of the RNA-dependent RNA polymerase of grapevine fanleaf virus determines symptoms in *Nicotiana* species. *Journal of General Virology* 94 (12): 2803–2813.
- Voller, A., D. Bidwell, G. Hultdt, and E. Engvall. 1974. A microplate method of enzyme-linked immunosorbent assay and its application to malaria. *Bulletin of the World Health Organization* 51: 209–211.
- Walter, B., and P. Cornuet. 1993. ELISA detection of grapevine fleck virus (GFkV). *Agronomie* 13: 651–657.
- Walter, B., and L. Etienne. 1987. Detection of the grapevine fanleaf viruses away from the period of vegetation. *Journal of Phytopathology* 120: 355–364.
- Wang, L., R. Sun, T. Vasile, Y. Chang, and L. Li. 2016. High-throughput optical sensing immunoassays on smartphone. *Analytical Chemistry* 88 (16): 8302–8308.
- Wetzel, T., R. Jardak, L. Meunier, A. Ghorbel, G.M. Reustle, and G. Krczal. 2002. Simultaneous RT/PCR detection and differentiation of arabis mosaic and grapevine fanleaf nepoviruses in grapevines with a single pair of primers. *Journal of Virological Methods* 101: 63–69.
- Yalow, R.S., and S.A. Berson. 1960. Immunoassay of endogenous plasma insulin in man. *The Journal of Clinical Investigation* 39: 1157–1175.
- Zhu, M., X. Gong, Y. Hu, W. Ou, and Y. Wan. 2014. Streptavidin-biotin-based directional double nanobody sandwich ELISA for clinical rapid and sensitive detection of influenza H5N1. *Journal of Translational Medicine* 12: 1–10.

Chapter 22

Polymerase Chain Reaction Methods for the Detection of Grapevine Viruses and Viroids

A. Rowhani, F. Osman, S.D. Daubert, M. Al Rwahnih, and P. Saldarelli

Abstract The need to diagnose and manage viral pathogens that have been accumulating in grapevines across most of recorded history has become a central focus of modern viticulture. In recent times, the polymerase chain reaction (PCR) has replaced other diagnostic methods, such as biological indexing assays and enzyme-linked immunosorbent assays (ELISA), in most applications. For virus detection, the PCR reaction now provides the highest possible level of sensitivity and specificity in virus identification. Advances in primer production have made degenerate primers routinely available for the detection of broad generic groups of distantly related viruses. The more diverse members of those groups had previously been invisible to PCR reactions primed by specific sequence primers. The PCR process has benefited from declines in the costs of primers, as well as from improved procedures for sample preparation, improvements in the fidelity of thermostable polymerases, and from the integration of computer data processing capabilities into thermocyclers. Real-time fluorescent detection of the progress of the amplification reaction has significantly boosted the precision and accuracy of quantitative PCR analysis. Reverse transcription quantitative PCR (RT-qPCR) has been combined with multiplex combinations of primers each labeled with different fluorescent dyes to allow for the simultaneous detection of specific members of broad groups of viruses in single reactions. The PCR assay in its many forms has become the primary diagnostic tool in plant virus control programs for grapevine.

Keywords PCR • RT-PCR • Quantitative real-time PCR • Multiplex PCR • Nested PCR • LAMP • Grapevine virus detection

A. Rowhani (✉) • F. Osman • S.D. Daubert • M. Al Rwahnih
Department of Plant Pathology, University of California, Davis, CA 95616, USA
e-mail: akrowhani@ucdavis.edu

P. Saldarelli
CNR Istituto per la Protezione Sostenibile delle Piante UOS Bari and Dipartimento di Scienze del Suolo della Pianta e degli Alimenti, Università degli Studi di Bari, via Amendola 165/A, Bari, Italy

Introduction

Due to its thousand-year-plus history of vegetative propagation, grapevine (*Vitis vinifera*) has come to support more pathogens than any other cultivated crops (Martelli 2014). In the more recent past, grapevine cultivars have been moved from the Old World to the New World, while grapevine rootstocks have been moved from the New World back to the Old. The intercontinental transplantation has exposed those cultivar stocks to pathogens with which they do not have a history of coexistence. The need to diagnose and manage those pathogens has become a central focus of modern viticulture.

Grapevine viruses can be detected by biological assays using indicator host and by serological methods (see Chaps. 20 and 21 in this volume). However, the polymerase chain reaction (PCR) technique developed in the 1980s (Saiki et al. 1985; Mullis et al. 1986) has shown advantages over the earlier diagnostics. PCR has been found to be very reliable and more than 100-fold more sensitive than ELISA (Sefc et al. 2000). As measured by numbers of publications, sequence-based analysis has become more prevalent than ELISA in plant pathology applications (Vincelli and Tisserat 2008). For the development and application of PCR, Kary Mullis was awarded the Nobel Prize in chemistry in 1993.

PCR became adapted to the identification of plant pathogens through their genomic sequences soon after the technique became generally accessible (Hanson and French 1993). The procedure uses repeated cycles of template denaturation, primer annealing, and polymerase extension to amplify specific sequences selected by oligonucleotide primers. The procedure uses a thermostable DNA polymerase, such as the Taq polymerase that is isolated from the thermophilic bacterium *Thermus aquaticus*. The use of such polymerases permits cycles of high-temperature template denaturation to proceed without the addition of more polymerase at each step. Due to their exponential cycles of amplification, PCR assays are extremely sensitive. The assay is well suited for the detection of viruses at low titer (Maliogka et al. 2014).

PCR was originally conceived for the detection of DNA sequences, but the majority of plant viruses, including grapevine viruses and viroids, contain RNA as their genomic material. Therefore, a reverse transcription step was added to generate DNA PCR templates from viral RNAs. Reverse transcription PCR (RT-PCR) was first used to detect grapevine viruses in 1993 (Rowhani et al. 1993; Nolasco et al. 1993). Because of its speed and sensitivity, RT-PCR and its various modifications (Candresse et al. 1998) have found wide application (see Table 22.1) in the detection of viruses and viroids of grapevine (Glasa et al. 2015; Osman et al. 2007, 2008, 2012; Al Rwahnih et al. 2012; Adkar-Purushothama et al. 2014; Fattouh et al. 2014; Hu et al. 2014; Osman and Rowhani 2008; Routh et al. 1998; Liebenberg et al. 2009; Wan Chow Wah and Symons 1997; Little and Rezaian 2006; Rowhani et al. 2005; Komínek and Bryxiová 2005; Demangeat et al. 2004; Dovas and Katis 2003a; Goszczynski and Jooste 2003; La Notte et al. 1997; Stewart and Nassuth 2001;

Table 22.1 Grapevine viruses and viroids for which the PCR and its modifications have been reported

<i>RT-PCR</i>	
GFLV	Rowhani et al. (1993)
GRSPaV	Nolasco et al. (2000), Nassuth et al. (2000)
GVA	Goszczynski and Jooste (2003)
GVB	Hu et al. (2014), Fattouh et al. (2014)
GLRaV-1	Little and Rezaian (2006)
GLRaV-7	Al Rwahnih et al. (2012)
AGVd	Adkar-Purushothama et al. (2014)
GSyV-1	Glasa et al. (2015)
<i>IC-RT-PCR</i>	
GFLV	Naraghi-Arani et al. (2001), Koolivand et al. (2014)
ArMV	Wetzel et al. (2002)
<i>Nested PCR</i>	
GVA, GVB, GVD	Nassuth et al. (2000), Dovas and Katis (2003b)
GFLV	Zhou et al. (2015)
GLRaV-4, GLRaV-5, GLRaV-6, GLRaV-9, GLRaV-De, GLRaV-Pr	Maliogka et al. (2008)
GLRaV-2	Fan et al. (2015)
<i>Multiplex PCR</i>	
GRSPaV, GFkV	Gambino and Gribaudo (2006)
GYSVd, AGVd, CEVd	Hajizadeh et al. (2012)
<i>RT-qPCR</i>	
GFLV, ToRSV	Cepin et al. (2010)
GLRaV-1, GLRaV-2, GLRaV-3, GLRaV-4, GLRaV-5, GLRaV-9	Osman et al. (2007)
GLRaV-3	Tsai et al. (2012)
<i>Multiplex RT-qPCR</i>	
GLRaV-3	Bester et al. (2014)
GVA, GVB, GVD	Osman et al. (2013)
GFLV, ArMV, GLRaV-1	López-Fabuel et al. (2013)
<i>LAMP</i>	
GLRaV-3	Walsh and Pietersen (2013)

Good and Monis 2001; Sefc et al. 2000; Nolasco et al. 2000) and for the detection of other plant pathogens (Hanson and French 1993; Martin et al. 2000).

Immune specificity can be combined with RT-PCR reactions in instances where specific antisera have previously been raised against the viruses under study. The presence of viruses, viroids, or viral RNA satellites can be assayed by immobilizing them with specific antibodies and then using the RT-PCR reaction in situ on the immobilized particles (Nolasco et al. 1993). This immunocapture RT-PCR (IC-RT-PCR) allows for a concentration and purification of the species to be detected.

RT-PCR was used in the amplification of genomic segments for the detection of variants (Goszczynski and Jooste 2003) through restriction fragment length polymorphism (Naraghi-Arani et al. 2001; Demangeat et al. 2004) or through sequencing studies. RT-PCR has been used to study the mobility of grapevine viruses, detecting them in their natural vectors such as mealybugs (Cabaleiro and Segura 1997; Fuchs et al. 2009) and nematodes (Demangeat et al. 2004; Van Ghelder et al. 2015).

Grapevine viruses can be unrecognized causes of low yields and poor plant growth as well as vine decline. Viral disease pathology is a serious vineyard problem, and in recent years the need for specific and rapid diagnostic methods for the certification of propagation materials has grown. The underestimation of the prevalence of *Grapevine rupestris stem pitting-associated virus* (GRSPaV) was revealed by RT-PCR analysis (Nolasco et al. 2000). At that time, GRSPaV appeared to be poorly diagnosed by bioassay (Stewart and Nassuth 2001), and there was no reliable ELISA test for the virus. RT-PCR analysis for GRSPaV, however, proved to be sensitive and consistent, revealing multiple asymptomatic strains of GRSPaV (Meng et al. 2006).

PCR has proven amenable to modifications that allow the reaction to handle many different experimental questions. A narrow range of genomic sequence variants can be detected by raising the annealing temperature of the reaction, excluding more distantly related sequences. Under less stringent reaction conditions, a broader range of targets may be detected, so as to identify the range of generic relatives of the target sequence. Nested RT-PCR allows for the detection of the specific members of a group of sequences related through an amplicon initially containing a broad range of related species. In the examples of Dovas and Katis (2003a) and Nassuth et al. (2000), the vitiviruses *Grapevine virus A* (GVA), *Grapevine virus B* (GVB), and *Grapevine virus D* (GVD) were all initially amplified by PCR using a primer complementary to a sequence conserved in them all. Then, using primers that were specific to each virus individually, sequences specific of each were amplified using the initial amplicon as template.

Multiplex RT-PCR simultaneously identifies a range of related viral species that may be present in field samples (Gambino 2015; Digiario et al. 2007; Hajizadeh et al. 2012). Real-time quantitative PCR (qPCR) allows for the quantitative detection of important grapevine pathogens (Osman and Rowhani 2006, 2008; Osman et al. 2007, 2008). The RT-qPCR detection of relative levels of multiple sections of the GLRaV-3 genome has described the expression of the viral subgenomic RNAs (Bester et al. 2014). These various modifications of the PCR reaction will be discussed in more detail below.

The PCR Reaction

Reverse Transcription Reverse transcriptase PCR (RT-PCR) was developed for the detection of RNA viruses and viroids (Candresse et al. 1998; Hanson and French 1993). The method uses reverse transcriptases derived from retroviral sources to copy the RNA into complementary DNA, which can then be used as template for amplification by the PCR reaction.

DNA Amplification Repeated cycles of template denaturation, primer annealing, and polymerase extension amplify the target DNA sequence that is selected by the annealing of specific oligonucleotide primer pairs. The primers are usually 16–30 nucleotides (nt) in length. The forward primer's sequence is the same as a section of the sequence of the original RNA (or DNA for a DNA virus) at the 5' end of the designed amplicon. The reverse primer's sequence is complementary to a section of the target sequence at the far 3' end of the amplicon. The amplification reaction mixture consists of the four deoxyribonucleotide triphosphates, the DNA template, and the thermostable DNA polymerase in its buffer solution.

The reaction components may be heated prior to their admixture (hot start) to minimize the amplification of low-temperature mis-priming events (Paul et al. 2010). A modification of the hot start procedure involves the initial sequestration of the Taq polymerase by a specific, thermolabile antibody (Kellogg et al. 1994).

In subsequent cycles, the mix is heated (DNA denaturation) to 94–98 C° for 30–60s (based on the size of amplicon) to denature the dsDNA. Heating the mixture separates the dsDNA into two single strands. Then the temperature is reduced to 35–65 C° (based on the primers' length and GC content) for the hybridization of the primers to their complementary DNA binding sites for another 30–60s. Finally, the temperature is raised to 72 C° for the extension of the annealed primers into the new DNA copies of the template strand. The length of extension time is proportional to the length of the expected product. The length of the product generated during this process is equal to the sum of the length of the two primers plus the length of the target sequence between them. In the next cycle, each of the two new dsDNA copies denatures at high temperature and produces four templates for further subsequent primer annealing and extension. This sequence of reaction cycles is 30–40 times, exponentially amplifying the target DNA sequence several millionfold.

Hadidi et al. (2011) have described in detail the parameters that should be considered in PCR assays. These parameters include magnesium ion concentration, primer annealing temperature, choice of primers, hot starting the PCR reaction, number of PCR cycles, presence of various additives to increase specificity, purity of the nucleic acid extract, inclusion of an RNA denaturation step before reverse transcription, and choice and concentration of enzymes. To obtain a sensitive, reliable, and specific PCR amplification, these parameters should be optimized for each virus.

There are several choices available for thermostable DNA polymerase. Some such enzymes possess both reverse transcriptase and DNA polymerase activities.

High-fidelity DNA polymerase is used in the production of long (thousands of nucleotides) DNA products.

Numerous publications are available on the development of RT-PCR for the detection of viruses and viroids in grapevines. RT-PCR methods have been employed to detect divergent variants of GVA (Goszczyński and Jooste 2003), GVB isolates from China (Hu et al. 2014) and Egypt (Fattouh et al. 2014), five different grapevine viroids from field and tissue culture samples (Wan Chow Wah and Symons 1997), *Australian grapevine viroid* (AGVd) in India (Adkar-Purushothama et al. 2014), divergent isolates of *Grapevine leafroll-associated virus 7* (GLRaV-7) through the design of a universal primer pair (Al Rwahnih et al. 2012) and *Grapevine Syrah virus 1* (GSyV-1) incidence in grapevine from Slovakia and Czech Republic (Glasa et al. 2015), among many other such examples.

Primers Oligonucleotide primers for the PCR reaction are usually in the range of 16–30 bases in length and 50–60% G + C content and work best if they have closely matched melting points. Of the many factors that affect the quality of the PCR amplification, the most important is the design of primers. Several factors should be considered in their selection and design. In general, longer lengths of available DNA target sequence provide for more options in the design of primers (Rychlik 1993). Primers should be able to form a single stable duplex with a site unique in the target DNA, while avoiding dimerization with the other primer in the reaction as well as self-complementary autodimerization. Primers that are complementary at their 3' termini will prime the synthesis of double-stranded primer dimers, which reduces the PCR product yield. Self-complementarity may cause primer dimer synthesis that unbalances the primer ratio. Longer primers, from 24 to 30 bases, work well at higher annealing temperature (60 C° or more) and serve to decrease general mis-priming problems. However, these longer oligos have greater possibilities for dimer formation and self-complementary issues.

Primers may be designed by sequence inspection or by a computer program. Dedicated design programs generate primer sequences with optimal G + C percentage, annealing temperature, and target specificity while minimizing the potential for primer dimers.

Degenerate Primers The inclusion of positions in the oligos in which more than one nucleotide or a wobble (i.e., inosine) base occurs allows for the synthesis of single primers that recognize multiple sequences. These degenerate primers can be designed to anneal to different variants of viral genomic target sequences or different species of a viral genus or even a family (Routh et al. 1998; Saldarelli et al. 1998; Dovas and Katis 2003b). Wetzel et al. (2002) used primers that included a few positions in which both of the purine and pyrimidine bases could occur. This allowed these authors to detect both *Grapevine fanleaf virus* (GFLV) and *Arabidopsis mosaic virus* (ArMV) in a single IC-RT-PCR reaction. Later, Digiario et al. (2007) detected the presence of every member of each of the three nepovirus subgroups in single analyses, using primers that included a wider range of positional substitutions. Their sequences include positions in which any one of multiple nucleotides could be

incorporated, such as in the sequence “TCGHA,” where H could be A or C or T, as dictated by the consensus of the targeted sequences.

Naraghi-Arani et al. (2001) used IC-RT-PCR and primers binding in the coat protein region of the viral genome to generate amplicons from 14 different GFLV isolates. Restriction nuclease digestion was used to demonstrate the variation among these amplicons. Later, Cepin et al. (2010) developed degenerate primers that could detect more than 98% of 86 diverse GFLV isolates in their sample, using RT-qPCR analysis.

Quantitative Real-Time PCR (qPCR)

The quantitation of viral sequences is measured by fluorimetric monitoring of the continuous production of dsDNA over the course of the qPCR reaction (Alemu 2014; Mackay et al. 2002). The method has increasingly been employed in the detection and quantitation of the spectrum of RNA plant viruses; a reverse transcriptase first stage (Stewart et al. 2007) is required. The capacity of this PCR protocol to quantitate the amount of viral template in grapevine samples was first reported by Knorr et al. (1995) for the detection of GFLV.

TaqMan-based qPCR employs fluorescent sequence probes in the reaction mix. These probes are short oligonucleotides complementary to conserved regions within target amplicon sequences. The simplest and most commonly used type of probe is the dual-labeled probe (e.g., TaqMan). This probe is labeled with a fluorescent reporter molecule, such as 6-carboxyfluorescein (6-FAM), at its 5' end and with a quencher fluorochrome such as 6-carboxytetramethyl-rhodamine (TAMRA) at its 3' end. As long as the reporter and quencher molecules are both bound together in the probe, the quencher molecule blocks the fluorescence of the reporter. When the TaqMan probe is annealed to its complement in the PCR amplicon, it will be degraded by the 5–3' exonuclease activity of the *Taq* polymerase during the subsequent primer elongation cycle (Holland et al. 1991). During degradation, the fluorescent reporter chromophore is released from the probe and freed to diffuse away from the quencher. At that stage, its fluorescence will be maximal. The amount of fluorescence is monitored during each amplification cycle and is proportional to the amount of PCR product generated. The probe sequence is approximately 25–30 nt long and is designed to have a higher T_m than the primers. As PCR product accumulates, more probe can bind to its complement sequence at the annealing stage of the cycle, prior to its destruction during the next cycle of primer elongation. Fluorescence plateaus when all of the probe has been destroyed or reagents exhausted (Schaad and Frederick 2002; Alemu 2014).

With the “molecular beacon” system, a probe carrying the two dyes on its two ends linearizes as it hybridizes to form a duplex with the amplicon products. This hybrid linearization of the probe provides enough separation between the fluorophore and the quencher to allow the fluorescence to shine, in proportion to the

increasing amount of its complement, produced in the PCR reaction (Elsayed et al. 2003; Takacs et al. 2008).

In a different approach to quantitative real-time PCR, non-sequence-specific fluorescent intercalating molecules are used to measure the increase in double-stranded PCR product over the course of the reaction. One such intercalater is SYBR Green, a cyanine dye, the fluorescence efficiency of which is amplified when bound to dsDNA (Wilhelm and Pingoud 2003).

Real-time RT-qPCR has been adopted for the detection of the most prominent viral pathogens of grapevine (Osman and Rowhani 2006, 2008; Osman et al. 2007, 2008, 2012; Blahova and Pidra 2009; Cepin et al. 2010; Pacifico et al. 2010; Al Rwahnih et al. 2012; Tsai et al. 2012; Sun et al. 2014; Bianchi et al. 2015; Xiao et al. 2015). The one-step SYBR green RT-qPCR procedure has become common (Beuve et al. 2007; Stewart et al. 2007; Malan et al. 2009; Blahova and Pidra 2009; Alliaume and Spilmont 2012; Poojari et al. 2012; Bester et al. 2012, 2014; Chooi et al. 2013; Aloisio et al. 2015; Maree et al. 2015; Frazenburg 2015; Molenaar 2015).

RT-qPCR has been used to demonstrate the seasonal decline in GFLV titer in phloem tissue, down to its minimum in late summer (Cepin et al. 2010). Tsai et al. (2012) used RT-qPCR to examine the seasonal dynamics and translocation of *Grapevine leafroll-associated virus3* (GLRaV-3) in field-grown grapevines. Analysis of parts of the vine from basal to apical and from month to month revealed viral spread from trunks to newly growing shoots and leaves over the course of the growing season.

Multiplex PCR

Multiplex PCR employs multiple primer sets in the same reaction to detect multiple viruses in the same sample. Gambino and Gribaudo (2006) designed a simultaneous RT-PCR analysis for nine grapevine viruses (including nepo-, viti-, and leafroll viruses, GRSPaV, and GFkV) using nine sets of primers designed from the conserved regions of each of the viruses, with the outcome based on specific-sized PCR products for each virus, as assessed on gel analysis.

Digiario et al. (2007) used PCR to detect multiple viruses in nepovirus subgroups directly by combining primers specific for each virus and a multiplex primer specific to each subgroup in the same reaction. Specific viruses were detected through amplicons specific to each virus, distinguished by their nucleotide length.

Dovas and Katis (2003b) detected grapevine leafroll viruses, grapevine vitiviruses, and GRSPaV in single-tube PCR reactions using multiplex primers. Their degenerate sequence primers carried inosine at nucleotide positions with consensus fourfold degeneracy.

Hajizadeh et al. (2012) developed sets of viroid-specific primers all of which primed PCR reactions under the same specific set of conditions, using template cDNAs made with random hexamer primers from total nucleic acid extracted from grapevine. With this set of ten primers, the five grapevine viroids (GYSDv-1 and

GYSVd-2, AGVd, HSVd, and CEVd) could be identified in single reactions by the size of the respective products.

qPCR has also been adapted for the detection of multiple viruses in a sample. This multiplex RT-qPCR reaction contains hybridizing probes of different sequences and labeled with dyes of different colors, which fluoresce after they hybridize to their newly synthesized complements. With this protocol, multiple viruses could be detected and identified in a single test. The selected reporter fluorophores are required to have minimal overlapping emission spectra with other fluorophore dyes in the reaction and are required to be compatible with the excitation and emission of the filters used in the real-time instrument.

Minor groove binding probes labeled with different colored reporter fluorophores and a non-fluorescent “Black Hole” quencher for multiplex qPCR quantitation of product DNAs have been adopted (Doyle et al. 2005). A multiplex RT-qPCR assay for the simultaneous detection of GVA, GVB, and GVD was developed by Osman et al. (2013). A similar analysis for the simultaneous detection of GFLV, ArMV, GLRaV-1, GLRaV-3, and *Grapevine fleck virus* (GFkV) has been reported by López-Fabuel et al. (2013).

Nested RT-PCR

Nested PCR involves consecutive PCR amplifications. The secondary reaction is primed at primer binding loci within the initial amplicon sequence. The primary PCR reaction may produce an amplicon primed at conserved genomic loci, but spanning a region of variation. In that case, the amplification and gel purification of the initial amplicon may facilitate the secondary PCR reaction that amplifies a minor sequence variant. Maliogka et al. (2008) used this approach in a characterization of the members of subgroup 1 viruses in the genus *Ampelovirus*. An initial PCR reaction used degenerate primers to detect all members of the subgroup. That reaction produced a 490 bp product formed between conserved primer binding sites in the HSP70h homologue gene. Sequences within the initial amplicon contained subgroup-member-specific variants. Subsequent reactions using PCR primers specific for these variants (GLRaV-4 strains GLRaV-5, GLRaV-6, GLRaV-9, GLRaV-De, and GLRaV-Pr) produced amplicons ranging in size from 161 to 370 bp, each of which was diagnostic for one subgroup member. This nested RT-PCR strategy was used to characterize 95 subgroup 1 ampelovirus field strains as to their specific subgroup affiliations.

Dovas and Katis (2003b) designed degenerate primers (containing inosine) to generate an initial amplification from a sequence conserved in the polymerase genes of GVA, GVB, and GVD, as well as GRSPaV. Specific vitivirus and foveavirus sequences in that generic amplicon were detected by a second round of PCR using species-specific primers. Those specific detections were facilitated by the purification and amplification of the PCR template, compared to direct PCR of infected woody tissue extracts, which would contain a low and variable virus titer. This

approach provided for the sensitive detection of viruses from two different genera involved in rugose wood disease, in a single test. The second PCR reaction produced amplicons of diagnostic sizes.

Fan et al. (2015) characterized a range of Chinese isolates of *Grapevine leafroll-associated virus 2* (GLRaV-2) using a nested PCR approach. The entire broad range of diverse isolates in the sample was identified in the first stage PCR reaction, which used degenerate primers that recognized conserved regions in the HSP70h gene. This first stage analysis enabled the discovery of a selection of GLRaV-2 strains that were undetected by primers designed against the viral coat protein gene; many of the newly detected strains were asymptomatic and so undetectable in bioassay. The second stage PCR reaction used also degenerate primers, annealing to sites within the borders of the amplicon sequence from the first stage. The sequences of these second stage amplicons were used in phylogenetic comparisons among the set of new GLRaV-2 strains identified in the nested PCR first stage. The sequencing revealed the presence of multiple different viral strains in some vines. This approach allowed for the discovery of a group of highly variable, relatively low titer, previously undescribed strains of GLRaV-2. This same research group (Zhou et al. 2015) carried out a similar analysis of Chinese GFLV isolates. They again used nested PCR with sets of degenerate primers designed from the consensus sequences of known viral strains to expand the range and diversity of known GFLV strains in China.

Loop-Mediated Isothermal Amplification (LAMP)

LAMP employs a set of four primers containing sense as well as antisense sequences of the target (Notomi et al. 2000). They prime strand displacement DNA synthesis, which proceeds at constant temperature to amplify a stem-loop DNA structure. The reaction cycles produce multiple loops by primer annealing between alternately inverted repeats of the target. As with the PCR reaction, product formation increases geometrically. LAMP recognizes six target sequences initially and four distinct sequences thereafter, specifically amplifying the target. [The LAMP reaction mechanism is described in detail at <http://loopamp.eiken.co.jp/e/index.html>; animation.] Walsh and Pietersen (2013) have added a reverse transcriptase step to adapt LAMP to the detection of GLRaV-3, in a colorimetric, isothermal 60 °C reaction that runs for 2 h. The reaction is no more difficult than an ELISA test, yet it is as sensitive as a PCR analysis (Notomi et al. 2015).

Data Collection and Analysis

PCR reactions that run to an end-point at 30–40 cycles produce a qualitative result that confirms the presence of a particular virus in the test sample. The size of the final PCR product, visualized by gel electrophoresis, is estimated by comparison with control sequence standards of known size run on the same gel. The identity of the final product is confirmed if the calculated sequence length matches the length predicted from the genomic sequence against which the primers were designed. Mis-priming artifacts generating side products of incorrect sizes are visualized on the same electrophoretic gel analysis. The amount of virus in the sample cannot be deduced from such end-point PCR reactions.

qPCR analysis runs to a midpoint in the reaction to give a quantitative result. The length of the product is not shown by the reaction. The quantity of the PCR product is calculated by comparison with a standard control of known quantity. Mis-priming artifacts that generated side products will raise the calculated concentration of the particular virus in the test sample by unknown amounts.

qPCR calculates the concentration of a particular virus by measuring the fluorescence of a dye molecule that begins the reaction either (i) attached to a sequence complementary to the sequence of the viral genome or (ii) free in solution (both described in the section on qPCR). The change in measured fluorescence is proportional to the increase in the concentration of the qPCR DNA product. This fluorescence [as determined by a quantitative cycle (C_q)] is measured by a computing qPCR fluorimeter in real time as the reaction proceeds.

The computed data takes the form of a plot of fluorescence versus the log of the number of PCR cycles. At the midpoint of the reaction, the plot will show specific fluorescence doubling with each cycle. The relative concentration of a particular virus in the sample is calculated from the displacement of the fluorescence curve for that virus from the curve produced for the control standard of known quantity.

Sample Preparation

Recovery of the viral genomic RNA template is a primary limiting factor for the use of RT-PCR in detecting plant viruses and viroids. Many sample preparation issues affect this recovery when the starting material is the extract from woody canes or from grapevine tissues that turn brown when extracted into aqueous solution.

Optimal Seasons for Sampling Nepovirus titer fluctuates during the growing season. ELISA data has shown that GFLV reaches its highest titer early in the growing season in young leaves and shoot tips. Virus then diminishes, sometimes to undetectable levels, during the heat of the summer (Rowhani et al. 1992; Cegin et al. 2009). These observations were later quantitated by real-time RT-qPCR (Cegin et al. 2010). Comparing different grapevine tissues, the same study showed that the

GFLV titer was moderately high off-season, in bark scrapings from lignified dormant canes.

For leafroll viruses, the titer peaks in mid- to late summer. This was reported by Ling et al. (2001) when leaves, petioles, flowers, fruits, and bark scrapings from symptomatic and asymptomatic vines infected with GLRaV-3 were collected and tested by ELISA and by nested immunocapture RT-PCR. In this study, the virus was detected from the bark scraping samples throughout the season as well as in the petioles of symptomatic and asymptomatic plants from the developing berry stage onward. When testing the leaf lamina collected from apical, middle, and basal positions of the canes, the virus was detected in more samples from the symptomatic vine. In the symptomatic vine, the virus was also detected in all samples of basal leaves throughout the season and from the pea-sized berry stage onward for other leaves. In contrast, the detection of GLRaV-3 in asymptomatic vines was erratic (Ling et al. 2001). Seasonal effects on virus titer were also confirmed by several other investigators (Xu et al. 2012; Tsai et al. 2012; Constable et al. 2012).

GRSPaV can be detected in different tissues including buds from dormant canes, shoot tips, seeds, and bark scrapings. However, in the summer the virus was not detected in young buds (Stewart and Nassuth 2001).

Nucleic Acid Extraction PCR methods for the detection of grapevine viruses have to deal with the problems presented by phenolic compounds, polysaccharides, and other substances present in the grapevine tissues (Flores et al. 1985; Rezaian and Krake 1987; Demeke and Adams 1992; Rowhani et al. 1993). These substances can co-purify with the RNA or DNA genomes of the viruses during nucleic acid extraction; when present, they can inhibit the PCR reaction (Newbery and Possingham 1977; John 1992). The inclusion of polyvinylpyrrolidone (PVP) in the RNA isolation buffer will help in removing these plant by-products from solution, improving the recovery of RNA from grapevine tissue homogenates (Nassuth et al. 2000).

The first step in RT-PCR analysis for viruses and viroids is direct nucleic acid extraction of infected tissue. For tissue homogenization, semiautomated and automated homogenization techniques were compared for processing samples from grapevine petioles and cambial tissues (Osman et al. 2012; Nakaune and Nakano 2006). Osman et al. (2012) found that homogenization of grapevine tissues using the tissue lyser as well as DNase digestion of the purified RNA prior to cDNA synthesis improved virus detection by RT-qPCR.

Several methods have been developed for direct nucleic acid extraction. Rezaian and Krake (1987) used five molar sodium perchlorate in the extraction buffer and obtained good results in the detection of *Tobacco ringspot virus* (TRSV) in grapevine by dot blot hybridization. The method of Dellaporta et al. (1983) was modified for the extraction of total nucleic acid from grapevine tissue for the first successful detections of GFLV by RT-PCR (Rowhani et al. 1993).

Staub et al. (1995) developed two microscale procedures for the isolation of high-quality total RNA from grapevine. They used a two-step isolation, first extracting the grapevine tissue homogenate with a mixture of phenol-chloroform-isoamyl alcohol and then using either DEAE-cellulose chromatography or 2-butoxyethanol

extraction to remove the remaining inhibitors from the sample. Later, Gambino et al. (2008) optimized a method based on a cetyltrimethylammonium bromide (CTAB) protocol to reduce the time and cost of nucleic acid extraction from grapevine tissue without reducing the quality and yield of the product. Little and Rezaian (2006) developed a magnetic capture hybridization protocol to analyze field samples for the presence of GLRaV-1. From grapevine extracts, they captured the viral RNA by hybridization to an 80-mer nucleotide complementary to the genomic 3' end. The 80-mer was biotinylated, allowing the binding of the hybridized genomic RNA to avidin-bound magnetic beads. Washing the beads removed inhibitors from the ensuing RT-PCR reaction. Several other investigators have reported improvements in the isolation protocols for recovery of nucleic acid from grapevine (Walsh and Pietersen 2013; Paylan et al. 2014; Sun et al. 2014; Kumar et al. 2015).

Later, commercial RNA extraction kits such as the Plant RNeasy kit (Qiagen, The Netherlands) became available for the recovery of clean nucleic acid templates (MacKenzie et al. 1997). These kits compared favorably with basic laboratory extraction methods (Osman et al. 2007). The RNA extraction kits did not work well for nucleic acid preparation from tissues of *Vitis riparia* or hybrid SO4 (*V. riparia* x *V. berlandieri*) plants (Nassuth et al. 2000), especially from field samples or samples of more mature leaf tissue, which may contain inhibitors of the PCR reaction. In one improvement, the concentration of PVP-40 in the lysis buffer was increased from 2.5 to 6% to raise the quality of the extracted nucleic acid, possibly by reducing the level of RT-PCR inhibitors (Nassuth et al. 2000).

Xiao et al. (2015) compared five commonly used kits in isolating total RNA from 12 species of woody perennials, including grapevines. The study concluded that Sigma (spectrum plant total RNA kit) and Norgen Biotek (plant/fungi total RNA kit) kits were most efficient in isolating quality total nucleic acid from grapevines and a wide range of other woody perennials using young leaf tissues. Furthermore, they found that the addition of 2.5% PVP-40 in the lysis buffer dramatically improved the quality and quantity of nucleic acids isolated from both young and mature grapevine leaves collected from the field throughout the growing season.

Multiple extraction procedures for total nucleic acid purification from grapevine including the use of automated nucleic acid extraction systems have been compared for the optimal detection of various viruses (Osman et al. 2008, 2012; Osman and Rowhani 2008; Gambino et al. 2008; Walsh and Pietersen 2013; Paylan et al. 2014; Sun et al. 2014; Kumar et al. 2015). Protocols for the recovery of viral genomes for RT-PCR for the extraction of grapevine viruses from vector insects (Minafra and Hadidi 1994; Acheche et al. 1999) and nematodes (Demangeat et al. 2004; Van Ghelder et al. 2015) have also been developed. Initial purification of virus particles before extraction of their genomes may remove inhibitors of the RT-PCR reaction. Virions can be removed from solution by immunocapture (Koolivand et al. 2014; Naraghi-Arani et al. 2001; Nolasco et al. 1993) or by immobilizing plant extract on a membrane (La Notte et al. 1997; Dovas and Katis 2003a, b) prior to PCR analysis.

Osman and Rowhani (2006) compared two different kinds of membranes (positively charged Hybond N+ Nylon from Pharmacia Biotech and FTA from Whatman)

by spotting both with tissue extracts from grapevines infected with different viruses and using them side by side in RT-PCR and RT-qPCR for the detection of target viruses. They found that with Hybond N+, the spotted membrane performed best when boiled at 95 C° in GES buffer (0.1 M glycine, 0.05 M NaCl, 1 mM EDTA, and 0.5% Triton X-100) for 10 min, but with FTA membrane, the spotted membrane could be used directly in the PCR reaction. Rowhani et al. (1995) compared immobilization of virions on plastic surfaces versus immunocapture to allow the removal of inhibitors prior to the RT-PCR reaction.

Quality Control in the PCR Laboratory

PCR analysis is extremely sensitive to its target sequences, which may lead to the amplification of nucleic acid contaminants, even when they are present in exquisitely small amounts. Such contaminants may exist as microscopic air-borne particles derived either from field samples or from aerosolized amplification reactions. This dust has the capacity to drift into reaction tubes and be amplified to generate false-positive results (Lo et al. 2006). The contaminant can persist on the woodwork indefinitely and can be observed by the generation of a PCR product in the no-template control tube.

Protocols for the avoidance of such cross contamination are standard procedure in dedicated PCR laboratories. These practices can include the physical separation of the pre-PCR (sample and reagent preparation) and post-PCR (amplification) work areas. Ideally, laboratory design should provide both of those areas with their own dedicated airflow sources (Mifflin 1997). Equipment, materials, and supplies should not be shared between these two workstations. Laboratory personnel should pursue a unidirectional workflow between these stations, using disposable gloves and changing lab coats when moving between sequential workstations.

References

- Acheche, H., S. Fattouch, S. M'hirsi, N. Marzouki, and M. Marrakchi. 1999. Use of optimized PCR methods for the detection of GLRaV-3: A closterovirus associated with grapevine leafroll in Tunisian grapevine plants. *Plant Molecular Biology Reporter* 17: 31–42.
- Adkar-Purushothama, C.R., P.R. Kanchepalli, S.M. Yanjarappa, Z. Zhang, and T. Sano. 2014. Detection, distribution, and genetic diversity of Australian grapevine viroid in grapevines in India. *Virus Genes* 49: 304–311.
- Al Rwahnih, M., F. Osman, M. Sudarshana, J. Uyemoto, A. Minafra, P. Saldarelli, G. Martelli, and A. Rowhani. 2012. Detection of Grapevine leafroll-associated virus 7 using real time qRT-PCR and conventional RT-PCR. *Journal of Virological Methods* 179: 383–389.
- Alemu, K. 2014. Real-time PCR and its application to plant disease diagnosis. *Advances in Life Science & Technology* 27: 39–49.

- Alliaume, A., and A.-S. Spilmont . 2012. *Development of a reliable diagnostic test for 10 viruses and evaluation of its potential use in different organs of grapevine*. In Proceedings 17th meeting of ICVG, Davis, CA, USA.
- Aloisio, M., M. Morelli, V. Elicio, P. Saldarelli, and A. Minafra. 2015. *Detection of GFLV, ArMV, GLRaV-1 and GLRaV-3 in a single tube real-time PCR based on melting curve analysis with EvaGreen®*. In Proceedings 18th meeting of ICVG, Ankara, Turkey, 219–220.
- Bester, R., A.E. Jooste, H.J. Maree, and J.T. Burger. 2012. Real-time RT-PCR high-resolution melting curve analysis and multiplex RT-PCR to detect and differentiate grapevine leafroll-associated virus 3 variant groups I, II, III and VI. *Virology Journal* 9: 219.
- Bester, R., P.T. Pepler, J.T. Burger, and H.J. Maree. 2014. Relative quantitation goes viral: An RT-qPCR assay for a grapevine virus. *Journal of Virological Methods* 210: 67–75.
- Beuve, M., L. Sempé, and O. Lemaire. 2007. A sensitive one-step real-time RT-PCR method for detecting Grapevine leafroll-associated virus 2 variants in grapevine. *Journal of Virological Methods* 141: 117–124.
- Bianchi, G.L., F. De Amicis, L. De Sabbata, N. Di Bernardo, G. Governatori, F. Nonino, G. Prete, T. Marrazzo, S. Versolato, and C. Frausin. 2015. Occurrence of Grapevine Pinot gris virus in Friuli Venezia Giulia (Italy): Field monitoring and virus quantitation by real-time RT-PCR. *Bulletin OEPP/EPPO Bulletin* 45: 22–32.
- Blahova, L., and M. Pidra. 2009. *Real time PCR for Grapevine fanleaf virus*. Extended abstracts 16th meeting of ICVG, Dijon, France, 83–84.
- Cabaleiro, C., and A. Segura. 1997. Field transmission of grapevine leafroll associated virus 3 (GLRaV-3) by the mealybug *Planococcus citri*. *Plant Disease* 81: 283–287.
- Candresse, T., R.W. Hammond, and A. Hadidi. 1998. Detection and identification of plant viruses and viroids using polymerase chain reaction (PCR). In *Plant virus disease control*, ed. A. Hadidi, R.K. Khetarpal, and H. Koganezawa, 399–416. St. Paul: APS Press.
- Cepin, U., S. Kršmanovic, M. Pompe-Novak, and M. Ravnikar. 2009. *Distribution of grapevine fanleaf virus (GFLV) in grapevines*. Extended abstracts 16th meeting of ICVG, Dijon, France, 90–91.
- Cepin, U., I. Gutiérrez-Aguirre, L. Balažic, M. Pompe-Novak, K. Gruden, and M.A. Ravnikar. 2010. One-step reverse transcription real-time PCR assay for the detection and quantitation of Grapevine fanleaf virus. *Journal of Virological Methods* 170: 47–56.
- Chooi, K.M., D. Cohen, and M.N. Pearson. 2013. Generic and sequence-variant specific molecular assays for the detection of the highly variable Grapevine leafroll-associated virus 3. *Journal of Virological Methods* 189: 20–29.
- Constable, F.E., J. Connellan, P. Nicholas, and B.C. Rodon. 2012. Comparison of enzyme-linked immunosorbent assays and reverse transcription polymerase chain reaction for the reliable detection of Australian grapevine viruses in two climates during three growing seasons. *Australian Journal of Grape Wine Research* 18: 239–244.
- Dellaporta, S.L., J. Wood, and J.B. Hicks. 1983. A plant DNA miniprep: Version 11. *Plant Molecular Biology Reporter* 1: 19–21.
- Demangeat, G., V. Komar, P. Cornuet, D. Esmenjaud, and M. Fuchs. 2004. Sensitive and reliable detection of grapevine fanleaf virus in a single *Xiphinema index* nematode vector. *Journal of Virological Methods* 122: 79–86.
- Demeke, T., and R.P. Adams. 1992. The effects of plant polysaccharides and buffer additives on PCR. *BioTechniques* 12: 332–334.
- Digiario, M., T. Elbeaino, and G.P. Martelli. 2007. Development of degenerate and species-specific primers for the differential and simultaneous RT-PCR detection of grapevine-infecting nepoviruses of subgroups A, B and C. *Journal of Virological Methods* 141: 34–40.
- Dovas, C., and N.I. Katis. 2003a. A spot multiplex nested RT-PCR for the simultaneous and generic detection of viruses involved in the aetiology of grapevine leafroll and rugose wood of grapevine. *Journal of Virological Methods* 109: 217–226.
- . 2003b. A spot nested RT-PCR method for the simultaneous detection of members of the Vitivirus and Foveavirus genera in grapevine. *Journal of Virological Methods* 107: 99–106.

- Doyle, C.K., M.B. Labruna, E.B. Breitschwerdt, Y.W. Tang, R.E. Corstvet, B.C. Hegarty, K.C. Bloch, P. Li, D.H. Walker, and J.W. McBride. 2005. Detection of medically important *Ehrlichia* by quantitative multicolor TaqMan real-time polymerase chain reaction of the *dsb* gene. *Journal of Molecular Diagnostics* 7: 504–510.
- Elsayed, S., B.L. Chow, N.L. Hamilton, D.B. Gregson, J.D. Pitout, and D.L. Church. 2003. Development and validation of a molecular beacon probe-based real-time polymerase chain reaction assay for rapid detection of methicillin resistance in *Staphylococcus aureus*. *Archives of Pathology & Laboratory Medicine* 127: 845–849.
- Fan, X., Y. Dong, Z.P. Zhang, F. Ren, G. Hu, and J. Zhou. 2015. Detection and sequence analysis of grapevine leafroll-associated virus 2 isolates from China. *Journal of Phytopathology* 163: 978–986.
- Fattouh, F., C. Ratti, A.M. El-Ahwany, E.A. Aleem, A.R. Babini, and C.R. Autonell. 2014. Detection and molecular characterization of Egyptian isolates of grapevine viruses. *Acta Virologica* 58: 137–145.
- Flores, R., N. Duran-Vila, V. Pallas, and J.S. Semancik. 1985. Detection of viroid and viroid-like RNA from grapevines. *Journal of General Virology* 66: 2095–2102.
- Frazenburg, L. 2015. *The development of a diagnostic assay for nepoviruses in grapevine*. MSc thesis, Stellenbosch University, Stellenbosch, South Africa.
- Fuchs, M., P. Marcella-Herrick, G.M. Loeb, E. Martinson, and H.C. Hoch. 2009. Diversity of ampeloviruses in mealybugs and soft scale vectors and in grapevine hosts from leafroll-affected vineyards. *Phytopathology* 99: 1177–1184.
- Gambino, G. 2015. Multiplex RT-PCR method for the simultaneous detection of nine grapevine viruses. *Methods in Molecular Biology* 1236: 39–47.
- Gambino, G., and I. Gribaudo. 2006. Simultaneous detection of nine grapevine viruses by multiplex reverse transcription-polymerase chain reaction with coamplification of a plant RNA as internal control. *Phytopathology* 96: 1223–1229.
- Gambino, G., I. Perrone, and I. Gribaudo. 2008. A rapid and effective method for RNA extraction from different tissues of grapevine and other woody plants. *Phytochemical Analysis* 19: 520–525.
- Glasa, M., L. Predajňa, K. Šoltys, S. Sabanadzovic, and A. Olmos. 2015. Detection and molecular characterisation of Grapevine Syrah virus-1 isolates from Central Europe. *Virus Genes* 51: 112–121.
- Good, X., and J. Monis. 2001. Partial genome organization, identification of the coat protein gene, and detection of Grapevine leafroll-associated virus 5. *Phytopathology* 91: 274–281.
- Goszczyński, D.E., and A.E. Jooste. 2003. Identification of grapevines infected with divergent variants of Grapevine virus A using variant-specific RT-PCR. *Journal of Virological Methods* 112: 157–164.
- Hadidi, A., A. Olmos, A. Pasquini, M. Barba, R.R. Martin, and A.M. Shamloul. 2011. Polymerase chain reaction for detection of systemic plant pathogens. In *Virus and virus-like diseases of pome and stone fruits*, ed. A. Hadidi, M. Barba, T. Candresse, and W. Jelkmann, 341–359. St. Paul: APS Press.
- Hajizadeh, M., B. Navarro, N.S. Bashir, E.M. Torchetti, and F. Di Serio. 2012. Development and validation of a multiplex RT-PCR method for the simultaneous detection of five grapevine viroids. *Journal of Virological Methods* 179: 62–69.
- Hanson, J.M., and R. French. 1993. The polymerase chain reaction and plant disease diagnosis. *Annual Review of Phytopathology* 31: 81–109.
- Holland, P.M., R.D. Abramson, R. Watson, and D.H. Ge. 1991. Detection of specific polymerase chain reaction product by utilizing the 5'-3' nuclease activity of *Thermus aquaticus* DNA polymerase. *Proceedings of the National Academy of Sciences USA* 88: 7276–7280.
- Hu, G.J., Y.F. Dong, Z.P. Zhang, X.D. Fan, R. Fang, and H.J. Zhu. 2014. Detection and sequence analysis of grapevine virus B isolates from China. *Acta Virologica* 58: 180–184.
- John, M.E. 1992. An efficient method for isolation of RNA and DNA from plants containing polyphenolics. *Nucleic Acids Research* 20: 2381.

- Kellogg, D.E., I. Rybalkin, S. Chen, N. Mukhamedova, T. Vlasik, P.D. Siebert, and A. Chenchik. 1994. TaqStart Antibody: "Hot start" PCR facilitated by a neutralizing monoclonal antibody directed against Taq DNA polymerase. *BioTechniques* 16: 1134–1137.
- Knorr, D.A., A. Rowhani, and D.A. Golino. 1995. TaqMan fluorescent PCR assay for gel-free detection of plant pathogens. *Phytopathology* 85: 1205.
- Komínek, P., and M. Bryxiová. 2005. Comparison of three techniques for detection of grapevine leafroll-associated virus 1. *Acta Virologica* 49: 37–43.
- Koolivand, D., N. Sokhandan-Bashir, S. Akbar-Benjatmia, and R. Jafzi-Joozani. 2014. Detection of Grapevine fanleaf virus by immune-capture reverse transcription polymerase chain reaction with recombinant antibody. *Archives of Phytopathology and Plant Protection* 47: 2070–2077.
- Kumar, S., R. Rai, and V.K. Baranwal. 2015. Development of an immunocapture-reverse transcription-polymerase chain reaction (IC-RT-PCR) using modified viral RNA release protocol for the detection of Grapevine leafroll associated virus 3 (GLRaV-3). *Phytoparasitica* 43: 311–316.
- La Notte, P., A. Minafra, and P. Saldarelli. 1997. A spot-PCR technique for the detection of phloem-limited grapevine viruses. *Journal of Virological Methods* 66: 103–108.
- Liebenberg, A., M.J. Freeborough, C.J. Visser, D.U. Bellstedt, and J.T. Burger. 2009. Genetic variability within the coat protein gene of Grapevine fanleaf virus isolates from South Africa and the evaluation of RT-PCR, DAS-ELISA and ImmunoStrips as virus diagnostic assays. *Virus Research* 142: 28–35.
- Ling, K.S., H.Y. Zhu, N. Pertovic, and D. Gonsalves. 2001. Comparative effectiveness of ELISA and RT-PCR for detecting Grapevine leafroll-associated closterovirus-3 in field samples. *American Journal of Enology and Viticulture* 52: 21–27.
- Little, A., and M.A. Rezaian. 2006. Improved detection of Grapevine leafroll-associated virus 1 by magnetic capture hybridisation RT-PCR on a conserved region of viral RNA. *Archives of Virology* 151: 753–761.
- Lo, Y.M. Dennis, W.K. Chiu Rossa, and K.C. Allen Chan. 2006. Setting up a Polymerase chain reaction laboratory. In *Clinical applications of PCR*, Methods in molecular biology, vol. 336, 11–18. Totowa: Humana Press.
- López-Fabuel, I., T. Wetzel, E. Bertolini, A. Bassler, E. Vidal, L.B. Torres, A. Yuste, and A. Olmos. 2013. Real-time multiplex RT-PCR for the simultaneous detection of the five main grapevine viruses. *Journal of Virological Methods* 188: 21–24.
- Mackay, I.M., K.E. Arden, and A. Nitsche. 2002. Real-time PCR in virology. *Nucleic Acids Research* 30: 1292–1304.
- MacKenzie, D.J., M.A. Mclean, S. Mukerji, and M. Green. 1997. Improved RNA extraction from woody plants for the detection of viral pathogens by reverse transcription-polymerase chain reaction. *Plant Disease* 81: 222–226.
- Malan, S., M-J. Freeborough, and J. Burger. 2009. *Real time PCR for sensitive reliable grapevine virus detection*. Extended abstracts, 16th meeting of ICVG, Dijon, France, 48–49.
- Maliogka, V.I., C.I. Dovas, and N.I. Katis. 2008. Generic and species-specific detection of viruses belonging to an evolutionary distinct lineage within the Amperlovirus genus. *Journal of Virological Methods* 154: 41–47.
- Maliogka, V.I., G.P. Martelli, M. Fuchs, and N.I. Katis. 2014. Control of viruses infecting grapevine. *Advances in Virus Research* 91: 175–227.
- Maree, H., R. Bester M.D. Pirie, P.T. Pepler, K. Oosthuizen, and J.T. Burger. 2015. *GLRaV-3: Diversity, detection and quantitation*. In Proceedings 18th Meeting of ICVG Ankara, Turkey, 53–54.
- Martelli, G.P. 2014. Directory of virus and virus-like diseases of the Grapevine and their agents. *Journal of Plant Pathology* 96 (Suppl. 1): 1–136.
- Martin, R.R., D. James, and C.A. Levesque. 2000. Impact of molecular diagnostic technologies on plant disease management. *Annual Review of Phytopathology* 38: 207–239.
- Meng, B., A.R. Rebelo, and H. Fisher. 2006. Genetic diversity analyses of grapevine Rupestris stem pitting-associated virus reveal distinct population structures in scion versus rootstock varieties. *Journal of General Virology* 87: 1725–1733.

- Mifflin, T.E. 1997. *Control of contamination associated with PCR and other amplification reactions*. San Diego: Molecular Bio-Products, Inc..
- Minafra, A., and A. Hadidi. 1994. Sensitive detection of grapevine virus A, B, or leafroll-associated III from viruliferous mealybugs and infected tissue by cDNA amplification. *Journal of Virological Methods* 47: 175–187.
- Molenaar, N. 2015. *Determination of the virus diversity associated with grapevine leafroll disease*. MSc. thesis. Faculty of AriSciences, Stellenbosch University, Stellenbosch, South Africa.
- Mullis, K., F. Faloona, S. Scharf, R. Saiki, G. Horn, and H. Erlich. 1986. Specific enzymatic amplification of DNA in vitro: The polymerase chain reaction. In *Cold Spring Harbor symposia on quantitative biology*, vol. 51, 263–273. Cold Spring Harbor: Cold Spring Harbor Laboratory Press.
- Nakaune, R., and M. Nakano. 2006. Efficient methods for sample processing and cDNA synthesis by RT-PCR for the detection of grapevine viruses and viroids. *Journal of Virological Methods* 134: 244–249.
- Naraghi-Arani, P., S. Daubert, and A. Rowhani. 2001. Quasispecies nature of the genome of Grapevine fanleaf virus. *Journal of General Virology* 82: 1791–1795.
- Nassuth, A., E. Pollari, K. Helmezczy, S. Stewart, and S.A. Kofalvi. 2000. Improved RNA extraction and one-tube RT-PCR assay for simultaneous detection of control plant RNA plus several viruses in plant extracts. *Journal of Virological Methods* 90: 37–49.
- Newbery, H.J., and J.V. Possingham. 1977. Factors affecting the extraction of intact ribonucleic acid from plant tissue containing interfering phenolic compound. *Plant Physiology* 60: 543–547.
- Nolasco, G., C. de Blas, V. Torres, and F. Ponz. 1993. A method combining immunocapture and PCR amplification in a microtiter plate for the detection of plant viruses and subviral pathogens. *Journal of Virological Methods* 45: 201–218.
- Nolasco, G., A. Mansinho, M. Teixeira Santos, C. Soares, Z. Sequeira, C. Sequeira, P.K. Correia, and O.A. Sequeira. 2000. Large scale evaluation of primers for diagnosis of Rupestris stem pitting associated virus-1. *European Journal of Plant Pathology* 106: 311–318.
- Notomi, T., H. Okayama, H. Masubuchi, T. Yonekawa, K. Watanabe, A. Nobuyuki, and T. Hase. 2000. Loop-mediated isothermal amplification of DNA. *Nucleic Acids Research* 28: e63.
- Notomi, T., Y. Mori, N. Tomita, and H. Kanda. 2015. Loop-mediated isothermal amplification (LAMP): principle, features, and future prospects. *Journal of Microbiology* 53: 1–5.
- Osman, F., and A. Rowhani. 2006. Application of a spotting sample preparation technique for the detection of pathogens in woody plants by RT-PCR and real-time PCR (TaqMan). *Journal of Virological Methods* 133: 130–136.
- . 2008. Real-time RT-PCR (TaqMan) assays for the detection of viruses associated with Rugose wood complex of grapevine. *Journal of Virological Methods* 154: 69–75.
- Osman, F., C. Leutenegger, D. Golino, and A. Rowhani. 2007. Real-time RT-PCR (TaqMan) assays for the detection of Grapevine Leafroll associated viruses 1-5 and 9. *Journal of Virological Methods* 141: 22–29.
- . 2008. Comparison of low-density arrays, RT-PCR and real-time TaqMan RT-PCR in detection of grapevine viruses. *Journal of Virological Methods* 149: 292–299.
- Osman, F., T. Olineka, E. Hodzic, D. Golino, and A. Rowhani. 2012. Comparative procedures for sample processing and quantitative PCR detection of grapevine viruses. *Journal of Virological Methods* 179: 303–310.
- Osman, F., E. Hodzic, A. Omanska-Klusek, T. Olineka, and A. Rowhani. 2013. Development and validation of a multiplex quantitative PCR assay for the rapid detection of Grapevine virus A, B and D. *Journal of Virological Methods* 194: 138–145.
- Pacifico, D., P. Caciagli, S. Palmano, F. Mannini, and C. Marzachi. 2010. Quantitation of Grapevine leafroll associated virus –1 and-3, Grapevine virus A, Grapevine fanleaf virus and Grapevine fleck virus in field-collected *Vitis vinifera* L. “Nebbiolo” by real-time reverse transcription-PCR. *Journal of Virological Methods* 172: 1–7.
- Paul, N., J. Shum, and T. Li. 2010. Hot start PCR. *Methods in Molecular Biology* 630: 301–318.

- Paylan, I.C., A. Çandari, M. Gümüş, S. Pazarlari, and S. Önder. 2014. Comparison of six total RNA isolation methods for diagnosis of GYSVD-1 (Grapevine Yellow Speckle viroid-1) on *Vitis vinifera* L. leaves. *Pakistan Journal of Botany* 46: 2089–2093.
- Poojari, S., O.J. Alabi, P. Okubara, and R. Naidu. 2012. *Detection and discrimination of Grapevine leafroll associated viruses by Real-Time PCR and Amplicon melting curve analysis*. In Proceedings 17th meeting of ICVG, Davis, CA, USA pp. 130–131
- Rezaian, M.A., and L.R. Krake. 1987. Nucleic acid extraction and virus detection in grapevine. *Journal of Virological Methods* 17: 277–285.
- Routh, G., Y.P. Zhang, P. Saldarelli, and A. Rowhani. 1998. Use of degenerate primers for partial sequencing and RT-PCR-based assays of Grapevine leafroll-associated viruses 4 and 5. *Phytopathology* 88: 1238–1243.
- Rowhani, A., M.A. Walker, and S. Rokni. 1992. Sampling strategies for the detection of Grapevine fanleaf virus and the grapevine strain of tomato ringspot virus. *Vitis* 31: 33–42.
- Rowhani, A., C. Chay, D.A. Golino, and B.W. Falk. 1993. Development of a polymerase chain-reaction technique for the detection of Grapevine fanleaf virus in grapevine tissue. *Phytopathology* 83: 749–753.
- Rowhani, A., M.A. Maningas, L.S. Lile, S.D. Daubert, and D.A. Golino. 1995. Development of a detection system for viruses of woody plants based on PCR analysis of immobilized virions. *Phytopathology* 85: 347–352.
- Rowhani, A., J.K. Uyemoto, D.A. Golino, and G.P. Martelli. 2005. Pathogen testing and certification of *Vitis* and *Prunus* species. *Annual Review of Phytopathology* 43: 261–278.
- Rychlik, W. 1993. *Selection of primers for the polymerase chain reaction*, 31–40. Current Methods and Applications: PCR Protocols.
- Saiki, R.K., S. Scharf, F. Faloona, K.B. Mullis, G.T. Horn, H.A. Erlich, and N. Arnheim. 1985. Enzymatic amplification of β -globin genomic sequences and restriction site analysis for diagnosis of sickle cell anemia. *Science* 230: 1350–1354.
- Saldarelli, P., A. Rowhani, G. Routh, A. Minafra, and M. Digiario. 1998. Use of degenerate primers in a RTPCR assay for the identification and analysis of some filamentous viruses, with special reference to clostero- and vitiviruses of the grapevine. *European Journal of Plant pathology* 104: 945–950.
- Schaad, N.W., and R.D. Frederick. 2002. Real-time PCR and its application for rapid plant disease diagnostics. *Canadian Journal of Plant Pathology* 24: 250–258.
- Sefc, K.M., W. Leonhardt, and H. Steinkellner. 2000. Partial sequence identification of grapevine leafroll-associated virus-1 and development of a highly sensitive IC-RT-PCR detection method. *Journal of Virological Methods* 86: 101–106.
- Staub, U., H. Polivka, and H.J. Gross. 1995. Two rapid microscale procedures for isolation of total RNA from leaves rich in polyphenols and polysaccharides: application for sensitive detection of grapevine viroids. *Journal of Virological Methods* 52: 209–218.
- Stewart, S., and A. Nassuth. 2001. RT-PCR based detection of *Rupestris stem pitting associated virus* within field-grown grapevines throughout the year. *Plant Disease* 85: 617–620.
- Stewart, E.L., X. Qu, B.E. Overton, F.E. Gildow, N.G. Wenner, and D.S. Grove. 2007. Development of a real-time RT-PCR SYBR green assay for *Tomato ring spot virus* in grape. *Plant Disease* 91: 1083–1088.
- Sun, N., C. Deng, X. Zhao, Q. Zhou, G. Ge, Y. Liu, W. Yan, and Q. Xia. 2014. Extraction of total nucleic acid based on silica-coated magnetic particles for RT-qPCR detection of plant RNA virus/viroid. *Journal of Virological Methods* 196: 204–211.
- Takacs, T., C. Jenny, L. Kovacs, J. Mozes, M. Benczik, and A. Sebe. 2008. Molecular beacon-based real-time PCR method for detection of 15 high-risk and 5 low-risk HPV types. *Journal of Virological Methods* 149: 153–162.
- Tsai, C.W., M.P. Daugherty, and R.P.P. Almeida. 2012. Seasonal dynamics and virus translocation of Grapevine leafroll-associated virus 3 in grapevine cultivars. *Plant Pathology* 61: 977–985.
- Van Ghelder, C., A. Reid, D. Kenyon, and D. Esmenjaud. 2015. Detection of nepovirus vector and nonvector Xiphinema species in grapevine. *Methods in Molecular Biology* 1302: 149–159.

- Vincelli, P., and N. Tisserat. 2008. Nucleic acid-based pathogen detection in applied plant pathology. *Plant Disease* 92: 660–689.
- Walsh, H.A., and G. Pietersen. 2013. Rapid detection of Grapevine leafroll-associated virus type 3 using a reverse transcription loop-mediated amplification method. *Journal of Virological Methods* 194: 308–316.
- Wan Chow Wah, Y.F., and R.H. Symons. 1997. A high sensitivity RT-PCR assay for the diagnosis of grapevine viroids in field and tissue culture samples. *Journal of Virological Methods* 63: 57–69.
- Wetzel, T., R. Jardak, L. Meunier, A. Ghorbel, G.M. Reustle, and G. Krczal. 2002. Simultaneous RT/PCR detection and differentiation of arabis mosaic and grapevine fanleaf nepoviruses in grapevines with a single pair of primers. *Journal of Virological Methods* 101: 63–69.
- Wilhelm, J., and A. Pingoud. 2003. Real-time polymerase chain reaction. *ChemBioChem* 4: 1120–1128.
- Xiao, H., W.S. Kim, and B. Meng. 2015. A highly effective and versatile technology for the isolation of RNAs from grapevines and other woody perennials for use in virus diagnostics. *Virology Journal* 12: 171.
- Xu, M., J. Li, H. Li, and W. Qiu. 2012. *Study on the time and tissue for reliable detection of grapevine leafroll-associated virus 3 in carbernet gernischt*. In Proceedings 17th meeting of ICVG, Davis, CA, USA, 134–135.
- Zhou, J., X. Fan, Y. Dong, Z.P. Zhang, F. Ren, and G. Hu. 2015. Detection and genetic variation analysis of grapevine fanleaf virus (GFLV) isolates in China using RT-PCR, and nested RT-PCR. *Archives of Virology* 160: 2661–2667.

Part III
Effects of Viral Diseases, Epidemiology
and Strategies for the Control and
Management of Viruses and Viral Diseases

Chapter 23

The Effects of Viruses and Viral Diseases on Grapes and Wine

F. Mannini and M. Digiario

Abstract Grapevine is one of the plant species most susceptible to virus infections, which cause several complex diseases. The effects of viruses on grapevine performances are generally accepted as potentially severe, although an exact estimation is difficult because of the complexity of the factors influencing vine response (mixed infections, viral strain, environment, grape cultivar and rootstock, vineyard management, etc.). However, diseases like infectious degenerations caused by nepoviruses are clearly detrimental and dramatically affect plant vigor and yield. More controversial is the effect of members of the genera *Ampelovirus*, *Closterovirus* and *Vitivirus*, the causative agents of leafroll and rugose wood. In these cases, infected vines usually bear an adequate crop, so that growers are unaware of the real damage, especially to qualitative parameters. Sanitized vines usually present a more luxuriant growth and increased yield; therefore, cultivation practices (i.e., green pruning, bunch thinning, wider spacing, etc.) should be adjusted to cope with these enhanced performances. Grapevines are also affected by “minor” virus diseases (i.e., fleck, vein mosaic, rupestris stem pitting, etc.), whose impact is still unclear. Nevertheless, their presence should not be overlooked, because synergistic negative effects of their agents with other major viruses cannot be excluded. Viticulture currently faces new emerging virus diseases, such as red blotch (grapevine red blotch-associated virus) and leaf mottling and deformation (*Grapevine Pinot gris virus*), which threaten the profitability of the grape and wine industry. Viruses are dangerous and elusive pathogens whose presence in vines must be prevented by using clean propagation material. The new -omics technologies are expected to provide more information on plant-virus interactions.

Keywords Virus • Grapevine • Economic impact • Grape physiology • Grape performances • Grape phenolics • Grape propagation • Wine quality

F. Mannini (✉)

Institute for Sustainable Plant Protection, CNR, Torino, Italy

e-mail: franco.mannini@ips.cnr.it

M. Digiario

Mediterranean Agronomic Institute, Valenzano, BA, Italy

© Springer International Publishing AG 2017

B. Meng et al. (eds.), *Grapevine Viruses: Molecular Biology, Diagnostics and Management*, DOI 10.1007/978-3-319-57706-7_23

453

Introduction

Grapevine is one of the plant species most susceptible to virus infections. At least 62 viruses are known to infect it (Martelli 2015), and other viral agents are suspected of being involved in etiologically undetermined diseases (“viruslike” diseases). However, despite the great number of viruses, the number of grapevine diseases remains low.

Most virus-induced grapevine disorders are regarded as complex diseases, since they show different symptoms and are caused by different viral species. Examples of complex diseases are “infectious degeneration” characterized by two syndromes, i.e. malformation (or fanleaf) and leaf yellowing, and “decline,” both caused by several species of the genus *Nepovirus*; “leafroll” caused by viruses of the family *Closteroviridae* and “rugose wood” (pitting to deep longitudinal grooves of the woody cylinder), caused by viruses of the genera *Vitivirus* and *Foveavirus* (Martelli 2014).

The effects of viral diseases on grapevine yield and quality are generally accepted as potentially severe, although they are difficult to assess precisely, and the results reported in the literature are sometimes contradictory. Although this is justified by the numerous variability factors involved in the virus-host relationship (i.e., virus strain, coinfection by different viruses, grape cultivar and/or clone, rootstock, vineyard management, and environmental conditions), it should also be remembered that many early assessments were based on inaccurate approaches; effects on yield or grape quality were assessed by comparing the performance of symptomatic vs. symptomless vines, or, at the best, the complexity of the disease was judged merely by indexing using woody indicators (Walter and Martelli 1996). This approach is not infallible, since visible symptoms may be enhanced or attenuated by environmental and cropping conditions or may result from a combination of viruses. In addition, investigations often involved genetically nonuniform vine populations, thereby increasing the degree of variability in the performances of vines. More recent studies have compared single clones before and after virus eradication (by heat treatment or meristem tip culture, or both, or by infecting healthy vines by artificial inoculation). At present, knowledge of the etiological agents of grapevine diseases has improved significantly, and research has finally considered the involvement of specific viral agents and/or their strains in specific diseases.

In this kind of evaluation, increased yield is not necessarily the main goal, especially for high-quality wine production. In addition, research on perennial crops requires long-term study, which may explain why the impacts of viruses on yield and enological performances have not been adequately investigated, despite the importance of the issue. It is not by chance that, after decades of grape clonal selection, breeders are still wondering whether the genetic approach should prevail over the sanitary aspects or vice versa.

The Impact of Viruses Associated with Infectious Degeneration

Infectious degeneration (fanleaf) mainly caused by *Grapevine fanleaf virus* (GFLV) is one of the most damaging diseases of European grapevines. Other species of the genus *Nepovirus* are also known to infect grapevine in European and Mediterranean countries, i.e., *Arabis mosaic virus* (ArMV), *Grapevine deformation virus* (GDeV), *Grapevine chrome mosaic virus* (GCMV), *Tomato black ring virus* (TBRV), *Grapevine Anatolian ringspot virus* (GARSV), *Artichoke Italian latent virus* (AILV), *Grapevine Tunisian ringspot virus* (GTRSV), *Raspberry ringspot virus* (RpRSV), and *Grapevine Bulgarian latent virus* (GBLV), some of which cause symptoms similar to those of fanleaf.

GFLV and some of the other grapevine-infecting European nepoviruses have distorting and chromogenic strains and may occur in mixed infections. Their economic impact on a crop varies considerably depending on the virulence of the viral strains (Dias 1977; Walter et al. 1990), susceptibility of the cultivar (Allen et al. 1982; Ramsdell and Gillet 1985), rootstock type (Gallay et al. 1955; Walker et al. 1994), plant age (Rüdel 1985), and environmental factors (Martelli and Savino 1988).

American *Vitis* species and their hybrids are not generally resistant to GFLV (Egger et al. 1985). In a sense, rootstocks transfer their GFLV susceptibility to *V. vinifera* which, due to its coevolution with the virus, shows a generalized tolerance to GFLV when self-rooted (Hewitt 1968; Martelli 1978). Almost all known *V. vinifera* cultivars are susceptible, with variable levels of sensitivity, although a few accessions from Afghanistan and Iran were found to be highly resistant (Walker et al. 1985; Walker and Meredith 1990). Among American grapevines, *V. labrusca* can be infected but shows few symptoms, while *Muscadinia rotundifolia* and *V. munsoniana* are highly resistant to *Xiphinema index* feeding (Staudt and Weischer 1992) and have therefore been used in genetic improvement programs for rootstocks (Walker et al. 1994).

Tolerant cultivars produce relatively good crops, whereas sensitive cultivars are severely affected by progressive decline, low yield and fruit quality, a shortened productive life span, reduced graft take, reduced rooting ability of propagation material, and decreased resistance to adverse climatic factors (Martelli 2014).

RNA satellites are commonly associated with nepoviruses (Saldarelli et al. 1993; Fritsch and Mayo 1993; Oncino et al. 1995), but their effects on grapevine are unclear. Fuchs et al. (1991) hypothesized a possible role of satellites in modulating symptomatic effects in vines. Satellite RNAs associated with GFLV apparently had no effect on virus accumulation or on symptom expression in infected herbaceous hosts (Gottula et al. 2013).



Fig. 23.1 Negative effect of GFLV on vine growth (*left row*) compared to healthy control (*right row*) in cv. Nebbiolo

Effects on Vine Growth, Yield, and Juice Composition

In general, GFLV-infected vines are markedly less vigorous and productive than healthy vines (Fig. 23.1). Fruit clusters are smaller and fewer, and they have unevenly sized berries which ripen irregularly (Martelli and Savino 1988; Andret-Link et al. 2004). The effects on quality parameters (contents of soluble solids, phenols, anthocyanins, aromatic substances, total and titratable acidity) are not uniform and appear to be inversely correlated with the level of yield reduction. Therefore, it is not surprising that GFLV infection may have sometimes beneficial effects on fruit composition or wine quality when associated to a strong reduction in yield (Gay et al. 1981; Lenzi et al. 1993; Mannini et al. 1994; Legorburu et al. 2009).

Drastic reductions in yield were reported repeatedly before the 1990s, although the assessments were based on comparing productive performances of groups of vines with symptomatic vs. symptomless vines, for which the exact status of virus infection was unknown or simply of groups of vines grown on soil plots treated or untreated with nematicides (Vuittenez 1958; Boubals et al. 1964; Walter and Martelli 1996). Depending on the cultivars, geographical areas, and experimental design, yield reductions attributed to “fanleaf” varied largely from 12 to 26% in Thompson Seedless, White Muscat, Barbera, and Nebbiolo (Auger et al. 1992; Gay et al. 1981) and up to 75–98% in Muscat blanc à petits grain, Chardonnay, Traminer, Chasselas, Merlot, and Pinot Noir (Boubals et al. 1964; Legin 1972; Rüdel 1985; Bovey 1970).

Severe yield reductions (up to 77%) were also reported on ArMV-infected cv. Faber in the Palatinate (West Germany) (Rüdel 1985). This virus is also believed to be responsible for the severe dieback of cv. Kerner in Germany, which in extreme cases may kill vines (Stellmach and Berres 1986; Becker et al. 1987). Significant yield losses (47%) were also associated with GCMV infections in cv. Zold Szilvani in Hungary (Lehoczky and Tasnady 1971) and RpRSV infections in Germany (over 30%) (Vuittenez et al. 1970).

Production performances of groups of homogeneous vines, both “healthy” and artificially inoculated with GFLV, were compared for a more precise estimation of its effects. In one experiment in France, three different viruses/strains (ArMV-Ta, GFLV-CB844, and GFLV-F13) were analyzed over 5 years by comparing the performances of groups of healthy and infected vines of three cultivars (Klevener de Heiligenstein, Chardonnay, and Pinot Noir) grafted onto the rootstock Kober 5BB. Although the three viruses were selected from those inducing mild symptoms intended for possible use in cross protection, they reduced pruning wood weight from 1–17% (ArMV-Ta) to 28–51% (GFLV-CB844) and yield from 15–43% (ArMV-Ta) to 48–60% (GFLV-F13), mainly due to the reduction in bunch weight. However, the three viruses had a low or nonsignificant effect on berry sugar content (Legin et al. 1993). In a similar study, involving 3 years of observation, five different GFLV strains caused crop losses of 45% in Gewürztraminer and 63% in Chardonnay, independently of the viral strain (except for strain B844, which induced a 77% reduction in Gewürztraminer) (Vigne et al. 2015).

Great differences in field performances were also observed between GFLV-infected vines and heat-treated vines of two Gewürztraminer clones in Northern Italy. The elimination of GFLV resulted in significantly longer shoots, larger leaves, and increased bud fertility (14.7%), yield (50%), bunch weight (35.6%), and berry weight (11%). This happened without any apparent reduction in the quality characteristics of the must (Malossini et al. 2006). The same thermotherapy approach applied to Nebbiolo vines infected with GFLV + GFkV gave statistically higher levels of vigor (19%) and yield (27%) in sanitized vines and heavier berries (7%) with a larger diameter (5%) (Santini et al. 2011). In three clones of the Michet subvariety of Nebbiolo, elimination of GFLV and GFkV by heat treatment gave a strong increase in vigor and a reduction in bud fertility, without any significant improvements in grape and wine quality (Mannini et al. 1999). A wider vine spacing in the vineyard, however, allowed an easier green canopy management and a better light interception, with a consequent enhancement in soluble solids and berry skin anthocyanins (Mannini et al. 2003).

During 4 years of field observations, GFLV-infected vines of the Majorcan cv. Callet gave a 20.7% lower yield than healthy vines. The same plants also had significantly reduced vigor (–15.2% pruning weight), fewer bunches (13.2%), and a slightly decreased berry weight (5.1%) (Cretazzo et al. 2009).

In general, GFLV infection also reduces the productive life span of vineyards to 15–20 years instead of 30–40 years or longer and makes vines less resistant to adverse environmental conditions (Andret-Link et al. 2004).

Effects on Vine Physiology

There are numerous reports that GFLV and GCMV reduce photosynthesis in infected vines (Pozsár et al. 1969; Abracheva and Slavcheva 1974; Auger et al. 1992; Balo et al. 1997; Walter 1988). Studies on GFLV-infected Malvasia de Banyalbufar vines (mixed infection with GLRaVs) showed that reduced photosynthetic capacity (ca. 50%) was mainly due to the reduction in carboxylation and CO₂ diffusion capacities through the mesophyll (Sampol et al. 2003). Chlorophyll and carotenoid contents were also significantly reduced in GFLV-infected vines (Abracheva and Slavcheva 1974; Sampol et al. 2003; Malossini et al. 2003), as well as the total anthocyanin content (Cretazzo et al. 2009). Chlorophyll content and the photosynthetic CO₂ fixation capacity in cv. Veltliner were adversely affected by GCMV (Pozsár et al. 1969). GFLV greatly modifies leaf morphology (Mannini et al. 2000; Santos et al. 2003, 2006), and this may have had great practical implications on clonal identification, in that a clone may be correctly identified by its leaf morphology only when free of major viruses.

Effects on Grape Phenols and Aromatic Compounds

The overall phenol contents of grapes seem uninfluenced by GFLV infection. Nevertheless, GFLV interferes with the anthocyanin synthesis pathway, inducing a profile with more unstable disubstituted anthocyanins (i.e., cyanidin and peonidin-3-glucoside) and reduced trisubstituted malvidin-3-glucoside content. This negatively influences wine color intensity and stability for cultivars like Nebbiolo, whose anthocyanin profile is genetically poorer in the more stable trisubstituted anthocyanins (Santini et al. 2011).

GFLV reduced also the extractability index (EA%), which indicates lower cell wall phenolic extractability. This might be related to the physical characteristics of the berries at harvest, skin thickness in particular, which is greater in berries from infected vines (Santini et al. 2011). Regarding aromatic compounds (in particular geraniol and rose oxide), no significant change was observed after sanitation of two different Gewürztraminer clones (Malossini et al. 2003).

Effects on Vine Propagation

Rootstock rooting ability and scion graft take are both substantially affected by GFLV. In Italy, pruning wood weight from GFLV-inoculated rootstocks decreased by up to 46%, depending on the type of rootstock (Babini et al. 1981). In Germany, the success of rooting rootstock SO4 was decreased by two-thirds by GFLV. Graft take of Riesling vines on SO4 decreased drastically from 30–45% in noninfected rootstock to 6–10% in GFLV-infected SO4 (Brückbauer 1962).

Pruning wood weight from 420A, Kober 5BB, and Teleki 5A rootstock mother vines was reported as highly reduced (79%–89%) by GFLV (mixed with GLRaV-3) (Credi and Babini 1996), and there was also a substantial reduction in the growth and rooting of vines propagated in vitro (Abracheva et al. 1994; Barba et al. 1993; González et al. 1995).

The Impact of Nepoviruses Associated with Decline

In North America, *Nepovirus* spp. cause a degenerative grapevine condition known as “Decline” in susceptible species and/or hybrids. Symptoms vary with the host species (i.e., *Vitis vinifera*, *V. labrusca*, interspecific hybrids), the infecting virus, and climatic conditions. *Tomato ringspot virus* (TRSV) and *Tobacco ringspot virus* (ToRSV) induce more severe decline in European cultivars, especially if self-rooted, in colder [e.g., New York State, Pennsylvania, Michigan (USA), and Ontario (Canada)] than in warmer climates [e.g., Maryland and California (USA)]. Infected vines decline rapidly, displaying stunted growth, mottled (oak-leaf pattern and/or ring spots), and distorted leaves and canes, poor fruit setting, and straggly and shelled clusters. Weakened vines often die from winter injury. In warmer climates, yield is affected but not the vigor (Gilmer et al. 1970; Uyemoto 1975; Uyemoto et al. 1977a).

Unlike *V. vinifera* cultivars and interspecific hybrids, which are highly sensitive to ToRSV and TRSV infections, certain American *Vitis* species are immune or hypersensitive to both viruses (Uyemoto et al. 1977a). However, yield losses from 75 to 95% were reported in cv. De Chaunac infected by different strains of ToRSV (Dias 1977). The impact of these viruses is also significant for propagation in nurseries: mild and severe strains of ToRSV reduced the number of two-bud cuttings by 70–86% and their graft take from 17 to 52%, respectively (Uyemoto et al. 1977a).

TRSV was detected with GFLV and GRSPaV (Lunden et al. 2010) in Chardonnay vines in Missouri (USA) affected by a severe disease known as “vein-clearing complex” and exhibiting symptoms of vigor decline, stunted crinkled and mottled leaves, and small clusters with few berries (Qiu et al. 2007).

Peach rosette mosaic virus (PRMV) is a nepovirus prevalent in Michigan, which causes delayed bud burst, leaf malformation and mottling, poor fruit set, severe crop loss, and death in “Concord” grapevine (*V. vinifera* × *V. labrusca*) (Dias and Cation 1976). *Vitis* spp. and French-American hybrids show wide variation in susceptibility to this virus, with the greatest reduction in yield (up to 40%) and growth (up to 60%) in Concord (Ramsdell et al. 1995). Grapes from infected vines contained only one seed at maturity and tasted insipid (Ramsdell and Myers 1974).

Blueberry leaf mottle virus (BLMoV) latently infects European grapes, whereas in Concord it delays bud burst, causing fanleaf-like symptoms on leaves and canes, together with poor fruit setting (Uyemoto et al. 1977b; Ramsdell and Stace-Smith 1981).

The Impact of Ampeloviruses and Closteroviruses Associated with Leafroll

Leafroll is the most widespread viral disease of grapevines in the world. Although identification of the phloem-limited viruses associated with typical leafroll symptoms began only in the 1980s (Gugerli et al. 1984), leafroll's detrimental effects, i.e., poor berry color and reduced yield of low quality, were already known (Goheen et al. 1958; Goheen and Cook 1959). Leafroll damage is generally less evident than fanleaf damage, since infected vines usually have a "normal" growth and bear an adequate crop during the early years of infection. The typical leaf reddening/yellowing and rolling symptoms that develop in summer are so widespread in older vineyards that they become a sort of landscape feature that the growers become used to. Leafroll disease is spread rapidly across vineyards by mealybug vectors. While transmission by vectors can be quite slow in cool climates, taking more than a decade before it produces worrisome rates of infected vines (Gribaudo et al. 2009), it spreads more quickly in warmer areas, e.g., South Africa (Pietersen 2006).

Leafroll is caused by viruses of the family *Closteroviridae* belonging to the genera *Ampelovirus* (GLRaV-1, GLRaV-3, and GLRaV-4), *Closterovirus* (GLRaV-2), and *Velarivirus* (GLRaV-7). GLRaV-1 to GLRaV-3 are very widespread, and GLRaV-3 seems to be the most harmful. Economic losses due to leafroll are generally considered severe, although different studies do not give similar results. An underlying factor influencing the different outcome of these studies is the frequent occurrence of virus "cocktails" (especially GLRaV-3 with GLRaV-1 and/or GVA) in symptomatic vines, making it difficult to assign pathological effects to a specific virus or to different strain(s) of the same virus. The main detrimental effects reported in the literature are described briefly below.

Effects on Vine Growth, Yield, and Juice Quality

As mentioned earlier, several field experiments in Europe, California, and Australia indicated that symptomatic vines show reduced vigor, yield, and bunch size compared to the symptomless presumably leafroll-free ones (Walter and Martelli 1996). The amplitude of reduced vine performance depends on symptom severity, vintages, cultivars, rootstocks, etc. In recent times, trials have been carried out in a more controlled and accurate fashion, either by comparing the performance of the same clonal material prior to and after sanitation by heat treatment and/or meristem tip culture or by infecting healthy material with a specific virus through graft inoculation.

Mild leafroll had no effect on vine growth or yield on inoculated vines of cvs. Riesling and Zinfandel in California (Wolpert and Vilas 1992). In Australia, heat-treatment elimination of leafroll gave a 22% yield increase in cv. Muscadelle without modifying the juice quality (McCarthy et al. 1989) and an increase of up to 25% in 1-year-old pruning wood weight in cv. Cabernet Franc (Clingeleffer and Krake

1992). In France, eradication of leafroll induced a 27% increase in the yield of a cv. Gewürztraminer clone but led to a slight reduction in soluble solids (Balthazard 1993). The effects of specific viruses, particularly GLRaV-1 and GLRaV-3, have also been investigated. In Northern Italy, Cabernet Franc, Cabernet Sauvignon, and Merlot clonal vines infected by GLRaV-3 showed a considerable yield loss compared to healthy vines, due to the smaller number of bunches/vine and the lower bunch weight (Borgo 1991; Borgo et al. 1993). In central Italy, healthy cvs. Albana and Trebbiano Romagnolo vines inoculated with single or multiple viruses, including GLRaV-1, GLRaV-3, and rugose wood agents, showed reduced growth and yield (by 20%), especially in the presence of mixed infections, but little or no effect was observed on fruit quality (Credi and Babini 1997). Observations relative to several local cultivars in Portugal suggest that the impact of GLRaV-3 on yield may be moderate in warm climates (Magalhães et al. 1997). This finding was confirmed in the hot climate of Sardinia (Italy), where no significant reduction in yield and quality was registered in own-rooted selections of five local cultivars (Garau et al. 1997). In northwestern Italy, the elimination of GLRaV-3 (alone or together with GVA) and GLRaV-1 (mix-infected with GVA) from clones of several cultivars induced an increase in vegetative vigor and variable effects on yield. Vines of cvs. Dolcetto, Grignolino, and White Muscat that were free of GLRaV-3 and GLRaV-1 + GVA produced 20–30% more yield than infected controls, with no effect on soluble solid accumulation. Conversely, the eradication of GLRaV-3 and GVA did not increase the yield of cv. Nebbiolo but improved sugar concentration by 0.5–1° Brix (Mannini et al. 1994, 1996, 1999, 2006, 2012). A field trial in northern France comparing three Chardonnay clones infected with multiple combinations of viruses or after sanitation showed a strong negative effect of GLRaV-2 + GLRaV-3 infection on pruning weight (–21%), yield (–22%), and sugars (–9%). These results confirmed the findings from Northern Italy indicating a greater influence of GLRaV-1 on yield and of GLRaV-3 on fruit quality (Komar et al. 2007). Comparison of GLRaV-3-positive (mix-infected with GVB and GFkV) vs. meristem-derived virus-free progenies of three Cabernet Sauvignon clones in California disclosed notable reductions in pruning wood weight (31–58%), yield (30–45%), and fruit maturity (average 4° Brix) (Golino et al. 2009a). Again in California, the influence of rootstocks was analyzed comparing vine growth and fruit components of Cabernet Sauvignon and Cabernet Franc with or without single or mixed infections of leafroll viruses, when grafted onto different rootstocks. Infected vines had significant reductions in the sugar content in all rootstock/scion combinations; the worst effects were on vines grafted on Kober 5BB, 101–14 Mgt, 3309 C, and Freedom, whereas those grafted on *Vitis rupestris* St. George and 1103 P showed a certain degree of tolerance. Other growth and fruit components were affected in variable ways, depending on the rootstock, by mixed infections with different viruses or virus strains (Golino et al. 2009b; Rowhani et al. 2015). GLRaV-1 in coinfection with GVA almost killed all plants grafted on 420 A, Freedom, 3309 C, and 101–14 Mgt 2 years after planting (Rowhani et al. 2012). Later observations on adult vines showed a GLRaV-1/rootstock negative interaction that was statistically significant for cane length and pruning weight and, in some virus isolate/rootstock combinations, also for berry

weight and total yield (Golino et al. 2015). Conversely, this type of significant interaction between virus (GLRaV-1 + GVA + GRSPaV) and rootstock genotype (*V. rupestris*, Kober 5BB, and 161–49 C) was not seen in three Savagnin rosé clones over six consecutive years, although the same virus combination significantly reduced vigor (19–23%) and yield (42–54%) of vines grafted onto all rootstocks, without affecting juice soluble sugars and titratable acidity (Komar et al. 2010).

A study on Gamay Rouge de la Loire in Switzerland found that GLRaV-1 significantly reduced yield parameters and grapevine vigor. Coinfection with *Grapevine fleck virus* (GFkV) did not increase the impact on those parameters but had a negative effect on fruit composition. Vines infected only by GLRaV-1 had an even higher fruit sugar content, probably due to the lower yield (–20%) (Spring et al. 2012). This compensative effect, already reported in the literature (Balthazard 1993; Mannini et al. 1998, 2003; Tomažic et al. 2005), should lead growers to adopt suitable vine management practices, especially summer bunch thinning, in order to avoid possible overproduction of vineyards established using clean propagating materials (Mannini et al. 2003).

GLRaV-3 is latent (asymptomatic) in French-American hybrids, but the absence of symptoms does not necessarily imply that their performance is unaffected by the virus. A study on Vidal Blanc and St. Vincent hybrids in Canada disclosed a 5% reduction in berry weight and a 5–9% increase in juice titratable acidity. However, the absence of differences in other yield features and in vegetative vigor suggested some tolerance of both cultivars to the virus (Kovacs et al. 2001).

GLRaV-2 caused a severe reduction in vigor (21%), yield (22%), and soluble solids (9%) on Chardonnay in France (Komar et al. 2007), while infected Zinfandel field selections in California produced significantly fewer clusters per vine, and pruning weight was lower than in GLRaV-2-free vines (Smith and Yeo 2012). However, GLRaV-2 is present in some good-performing certified French Cabernet Sauvignon clones. In the case of clone 337 (the most popular), the healthy line sanitized by meristem tip culture showed an increased vigor and yield that compromised its previously good enological features (Adeguin et al. 2012).

Effects on Vine Physiology

The impact of GLRaV-3 (+GVA) on some aspects of grapevine physiology, such as leaf net photosynthesis (P_n), transpiration rate (E), and stomatal conductance (g_s), was first investigated in Italy on cv. Nebbiolo (Mannini et al. 1996). P_n activity was clearly reduced (18%) in infected plants, as were other physiological parameters. The reduced leaf efficiency was associated to a strong decrease in vine vigor, soluble solids, and berry skin phenolic compounds, whereas no significant effect was registered on yield. Interestingly, the influence of viruses on depressing physiological activity started early in the season and well before symptom appearance, thus implying a direct interference of the pathogen with plant metabolism. These results

were then confirmed on the same cultivar and related to anthocyanin accumulation over the vegetative season in leaves and berries (Guidoni et al. 1997). Anthocyanins accumulated in grape skins of healthy plants more rapidly than in GLRaV-3-infected vines from veraison to harvest, whereas the trend was the opposite for the anthocyanin levels in leaf blades. The reduced physiological efficiency in field-grown, GLRaV-3-infected cv. Albariño vines lessened juice sugar content and increased titratable acidity (Cabaleiro et al. 1999), whereas it depressed vigor and yield in GLRaV-3 + GVA-infected Nebbiolo vines, without affecting grape qualitative parameters (Santini et al. 2012). The latter investigation also detected an overall milder effect of GLRaV-1 + GVA. Finally, reductions in Pn, E, g_s, and chlorophyll and carotenoid contents were registered in GLRaV-3-infected field-grown cv. Lagrein vines in Italy (Bertamini et al. 2004), Cabernet Franc in Michigan (Endeshaw et al. 2014), and Merlot in Washington State, USA (Gutha et al. 2012), and, in GLRaV-1-infected, field-grown Marzemino vines in Italy (Malossini et al. 2009a). Similar effects were observed in in vitro-grown cv. Albariño microcuttings (González et al. 1997).

Effects on Grape Phenols and Aromatic Compounds

Phenolic maturation of grape berries is a fundamental enological parameter for red wine cultivars, since wine color and body depend on the quantity and quality of anthocyanins and flavonoids. Several studies have found that leafroll viruses, particularly GLRaV-3, adversely affect accumulation of these compounds (Mannini et al. 1996, 1999, 2002; Guidoni et al. 2000; Borgo and Angelini 2002; Borgo et al. 2003; Kim et al. 2003; Jungmin and Martin 2009; Alabi et al. 2012a). It remains unclear if leafroll viruses impede the translocation of anthocyanins from leaves to berries implying a possible link with leaf carbohydrate status (sugars and starch increase severalfold in symptomatic leaves) (Gutha et al. 2012) or if they interfere with methylating enzyme activity that regulates anthocyanin biosynthesis in the berry (Guidoni et al. 1997).

Grape skin color significantly affects the attractiveness of red table grape cultivars; therefore, any modification may have a negative impact on their economic value. Severely reduced fruit color due to a combination of leafroll viruses was reported on cv. Emperor in California (Harmon and Snyder 1946; Goheen et al. 1958) and Australia (Krake 1993), as well as on Red Globe, King's Ruby, and Crimson in Italy (Digiario et al. 1997, 2006).

Grape aromatic compounds are essential for the quality of wines made from cultivars with a rich terpene content, including Muscats and Malvasias. A study comparing infected and healthy White Muscat vines in two different areas of Italy showed negative effect of GLRaV-3 on the quantity of both free and bound linalool terpenes in berries (Mannini et al. 2006).

Effects on Wine Quality

It is not easy to test the effect of viruses on wine quality. Difficulties mainly concern the representativeness of experimental small-scale winemaking compared with those from large-scale production.

Schoefling (1980) reported the first evidence of positive effects on wine quality associated with the elimination of leafroll using heat treatment. However, the influence of specific viruses on wine was only investigated many years later. For example, the elimination of mixed infections of GLRaV-1 + GVA or of GLRaV-3 + GVA from clones of Nebbiolo had beneficial effects on wine quality, as confirmed by a statistical sensory ranking test (Mannini et al. 1998). Elimination of GLRaV-3 + GVA gave the most rewarding results, since wine from healthy vines had a more complex bouquet and better color intensity. In contrast, when GLRaV-1 + GVA were eliminated, the result of the ranking test was not statistically significant; in this case, however, virus sanitation significantly increased the yield. A severe impact of GLRaV-3 on berry anthocyanins, and consequently on wine color intensity, was confirmed by different investigations on cvs. Tempranillo, Pinot Noir, and own-rooted Merlot in Spain, Switzerland, and Washington State, respectively (Legorburu et al. 2009; Besse et al. 2009; Alabi et al. 2012a). Interestingly, the Swiss researchers also reported a milder positive effect of GLRaV-1 elimination on wine quality. Elimination of GLRaV-3 from a red-berried cv. Dolcetto clone in Italy gave an overall improvement in field performances (higher vigor, yield, bunch size, and bunch number per vine) but not in wine quality (Mannini et al. 2012). The wine obtained from GLRaV-3-free vines had a richer flavor and smoother taste but a weaker body and color. In conclusion, grape growers should be aware that the use of virus-free plants does not de facto imply improved wine quality.

Effects on Vine Propagation

An early investigation into the possible impact of leafroll on grape propagation by Lider et al. (1975) found no effect of leafroll on graft take of cv. Burger onto the rootstock Dogridge. On the contrary, Golino (1993) reported strong evidence that leafroll can cause graft incompatibility in grapevine, although the specific viruses involved were not determined. The negative influence of phloem-limited agents in grape propagation was confirmed on Nebbiolo, whose bench-grafting take on Kober 5BB was reduced by up to 30% when using scions with mixed infections of GLRaV-3 and GVA (Mannini et al. 1998). The presence of GLRaV-1 or GLRaV-3 coupled with different rugose wood syndromes in mother plants of different rootstocks (420 A, Kober 5BB, and Teleki 5A) caused a significant reduction (50% on average) in the pruning wood weight of diseased vs. healthy plants (Credi and Babini 1996). Here it should be noted that the marketing of “virus-free” rootstock materials is currently mandatory in EU countries.

Fig. 23.2 Severe graft incompatibility induced by GLRaV-2 on cv. Vermentino grafted on Kober 5BB rootstock



Concerning GLRaV-2, it has been shown that this virus is related to severe graft incompatibility between *V. vinifera* cultivars and some rootstocks, particularly Kober 5BB (Greif et al. 1995; Garau et al. 1997; Uyemoto et al. 2001; Bonfiglioli et al. 2003; Borgo et al. 2006; Rowhani et al. 2012). In a trial to evaluate the susceptibility of different rootstocks to graft incompatibility due to GLRaV-2 infection, grafting failure of two wine grape (Primitivo and Vermentino) and two table grape (Cardinal and Red Globe) cultivars was very high when grafted onto Kober 5BB (83.9%), high on 225 Ru, 34 EM, 1103 P, and 140 Ru (30–60%), and low or absent onto 779 P (17.9%), 157–11 (3.0%), and 420 A (0%) (Pirolo et al. 2009) (Fig. 23.2).

The negative influence of GLRaV-1, GLRaV-3, GVA, and RSP in single or in mixed infection was also evident on the micropropagation efficiency as compared to healthy plants, which produced more shoots per explant and longer shoots and roots on in vitro media than infected plantlets (González et al. 1995; Gribaudo et al. 1999).

The Economic Impacts of Leafroll Infection

Commendable attempts to estimate leafroll's effect on profitability have been made in Europe and elsewhere. Walker et al. (2004) examined the economic impact of GLRaV-3 in New Zealand vineyards using a model of virus spread with three infection scenarios (high, moderate, and low) over six growing seasons. The estimated damage in sensitive cultivars amounted to over US \$10,000/ha by years 7, 9, and 12 depending on the scenario, and profitability was sufficiently affected by year 11 to justify replanting of the vineyard. Another study on cvs. Sauvignon Blanc and

Merlot in New Zealand was based on the “net present value” approach (calculations based on costs, revenues, and financial assumptions) and compared the economic cost in three disease management scenarios (replanting the vineyards at year 6, annual rouging of infected vines, and rouging extended to the neighboring vines). The conclusion was that early vine rouging was more expensive than total vineyard replacement in year 6 (Nimmo-Bell 2006). Another study on Cabernet Sauvignon in New York State used the “net present value” approach and estimated the economic impact of leafroll at US \$25,000–40,000/ha due to yield reduction and penalty for poor fruit quality (Shady et al. 2012).

In Europe, Besse et al. (2009) estimated the economic impact of leafroll at approximately 5% of the annual gross yield in Valais (Switzerland). Pesqueira et al. (2012) calculated that in the Spanish Rias Baixas area, an average of 40% infected vines in the vineyards of cv. Albariño were responsible for around 20% economic losses due to the reduction in the potential alcohol content of grapes.

The Impact of Viruses Associated with Rugose Wood

The rugose wood (RW) complex refers to all alterations of viral origin (pits and/or grooves) to the woody cylinder of grapevines, which affect water and nutrient movement in vessels and reduce plant vigor and yield. RW is generally considered a typical “graft disease” in which symptom severity varies according to the scion/stock combinations. Nevertheless, cases of latent infection in grafted vines are not rare. In contrast, self-rooted European grapes, and sometimes American rootstocks, can present, on rare occasions, wood alterations. Within RW, indexing on woody indicators makes it possible to distinguish at least four different syndromes: Kober stem grooving (KSG), Rupestris stem pitting (RSP), corky bark (CB), and LN33 stem grooving (LNSG) (Savino et al. 1989). Putative causal agents of some of these syndromes are species of the genera *Vitivirus* and *Foveavirus* in the family *Betaflexiviridae*. In particular, *Grapevine virus A* (GVA) is associated with KSG (Garau et al. 1994; Digiario et al. 1994; Chevalier et al. 1995), *Grapevine virus B* (GVB) with CB (Boscia et al. 1993; Bonavia et al. 1996), and *Grapevine rupestris stem pitting-associated virus* (GRSPaV) with RSP (Meng et al. 1998, 1999).

Other more recently identified vitiviruses, i.e., *Grapevine virus D* (GVD), *E* (GVE), and *F* (GVF), may play a role in the RW, although this is still unclear. Their presence was reported in vines with symptoms of corky rugose wood (GVD), stem pitting (GVE), and graft incompatibility (GVF), but no definite relationship could be established between these viruses and the syndromes (Abou-Ghanem et al. 1997; Nakaune et al. 2008; Al Rwahnih et al. 2012).

Effects on Vine Growth, Yield, and Juice Composition

Reduced vine vigor, yield, graft take, and sometimes death have been reported in association with RW (Garau et al. 1985; Savino et al. 1985). Consistent crop losses associated to RW have been reported from several areas of the world, mainly based on visual observation in the field. These losses were quantified at 14–36% in South Africa (Engelbrecht 1973, 1976), Italy (Garau et al. 1985), and Slovenia (Tomažic et al. 2005); 70% in Mexico (Téliz and Valle 1980; Téliz et al. 1980); 75% in Spain (mixed with leafroll) (Padilla 1987); and up to 100% in Greece (Rumbos and Avgelis 1993). In extreme cases, RW can even cause vine death in particularly adverse weather conditions or susceptible graft combinations (Lehoczky 1972; Savino et al. 1985; Tomažic et al. 2005). It is difficult to accurately interpret these results, since several factors can influence disease impact on vine yield and vigor. These include the specific virus/strain involved (Goszczynski and Jooste 2003a; Goszczynski 2010; Terlizzi et al. 2011), susceptibility of the scion (Téliz and Valle 1980; Téliz et al. 1980; Garau et al. 1985; Savino et al. 1985) and the rootstock (Credi et al. 1991; Kriel et al. 1980; Savino et al. 1985; Tanne et al. 1990), and climatic conditions, since damage is often less visible in cool and rainy climates. In recent years, RW impact has been more correctly studied by analyzing the effects of each putative virus pathogen on grapevines, although it is difficult to find singly infected vines in the field, since vitiviruses frequently combine with other viruses, especially ampeloviruses transmitted by the same mealybug species.

In one study, heat-treated Marzemino vines were more vigorous and had greater bud fertility (23%) than GVA-infected vines of the same clone, but sanitation had no apparent beneficial effects on yield and quality parameters (Malossini et al. 2009b).

GVA in combination with leafroll viruses induces a major impact on grape production. As already stated, several trials comparing the performances of heat-treated and infected Nebbiolo and Grignolino vines of the same clones found that elimination of GVA and GLRaV-1 increased the yield from 24 to 30%, mainly due to the larger bunches, whereas the effects on quality parameters were apparently inconsistent (Mannini et al. 1998; Mannini et al. 1999; Santini et al. 2011). A similar result was obtained with a Nebbiolo clone infected by a combination of GVA, GLRaV-1, and GRSPaV: the healthy vines produced higher yield due to higher shoot fertility, a lower titratable acidity, and resveratrol contents, but there was no effect on soluble solids or phenols (Giribaldi et al. 2011).

A different performance was observed in heat-treated vines originally infected by GVA and GLRaV-3. In several trials, sanitized Nebbiolo vines had significantly increased soluble solids and total grape skin anthocyanins, without any effect on the yield (Guidoni et al. 1997; Mannini et al. 1998, 1999; Santini et al. 2011). The presence of GVA significantly exacerbated the decline and death of leafroll-infected cv. Red Globe table grape in Southern Italy (Digiario et al. 1997).

Unlike GVA, elimination of GVB gave a significant increase in plant vigor and yield of heat-treated Chardonnay (35% and 16%, respectively) and Albarossa (14% and 34%, respectively) vines. The greater yield was mainly due to larger numbers

of cluster/vine. Fruit maturity indices were not affected in either cultivar (Komar et al. 2007; Mannini et al. 2015). Increased yield (37.5%), cluster/vine (24.6%), and vigor (+37.1% of pruning weight) were also observed in two of three grapevine selections freed of GVB, GLRaV-3, and GFkV by meristem shot tip culture. In this case, sanitation also led to a consistent increase in sugar content (4° Brix) in all three selections, probably due to coinfection with GLRaV-3 (Golino et al. 2009a).

GRSPaV is probably the most widespread virus-infecting *Vitis* spp. in all grape-growing areas of the world but is generally considered to have little impact on yield. Early evidences of low or negligible effect of RSP infection on yield components were reported by Reynolds et al. (1997) on five cultivars grown in two ecologically different areas of Canada.

Rootstock probably influences the impact of GRSPaV on grapes, as confirmed in the USA by the significant reduction in yield of vines grafted onto 110 R and 3309 C, but not on Kober 5BB, 1103 P, 101–14 Mgt, and *V. rupestris* St. George (Golino et al. 2009b). In Italy, GRSPaV-infected vines of cv. Bosco showed moderate reductions in juice sugar content and yield (the latter only in the first of 3 years of observation) compared to heat-treated vines of the same clone; yield reduction was mainly due to smaller-sized bunches and grapes (Gambino et al. 2012; Cuozzo et al. 2013).

Effects on Vine Physiology

Information on the effects of individual vitiviruses on vine physiology is relatively scarce and fragmented. Nevertheless, a study using GVA-free and GVA-infected Marzemino vines found that the potential photosynthetic activity and pigment content of the leaves were unaffected, except for chlorophyll fluorescence (Fv/Fm ratio) at veraison (Malossini et al. 2009b). More exhaustive data come from studies on the effects of vitiviruses in mixed infection with ampeloviruses on vine physiology. The reader is referred to the paragraph on leafroll in this chapter, which contains an extensive report of these results.

Concerning GRSPaV, infected scions grafted onto virus-free rootstocks showed a three to fivefold reduction in photosynthetic potential and an increased dark respiration rate compared with healthy scion/rootstock combinations (Fajardo et al. 2004). A reduced photosynthetic rate and chlorophyll content of GRSPaV-infected Bosco vines were also reported in Italy (Gambino et al. 2012). The analysis of transcriptomic changes in transcript profiles of petiole, leaf, and berry samples showed that infected vines attempted to react to the photosynthetic rate reduction caused by GRSPaV by stimulating expression of genes involved in photosynthesis and CO₂ fixation. The authors hypothesized that a form of mutual adaptation has evolved through long-term coexistence between grapevine and GRSPaV, favoring specific modulation of several transcripts involved in photosynthesis and CO₂ fixation and some defense mechanisms (mainly to water and salinity stresses), the final result of which is the absence of visible symptoms (Gambino et al. 2012; Pantaleo et al. 2015).

Effects on Grape Phenols, Aromatic Compounds, and Wine Quality

As already said, phenolic ripening of the berries and the quality and quantity of anthocyanins and flavonoids are key factors for the final quality of red wines. RW-associated viruses seem to play a more marginal role on these aspects than other viruses, especially those responsible for leafroll and fanleaf. In various analyses of the effects of each single vitivirus species (GVA and GVB), sanitized clones did not present significantly better qualitative parameter values than infected vines (Malossini et al. 2009b; Mannini et al. 2015). In any case, it is possible that the presence of RW viruses in combination with other viruses may contribute to the worsening of the physiological and pathological status of the plant, hence impacting wine quality. A previous paragraph gives an extensive account on the numerous studies on this subject involving RW viruses (especially GVA) in combination with leafroll-associated viruses (Guidoni et al. 2000; Giribaldi et al. 2011; Mannini et al. 1999, 2002; Santini et al. 2011; Tomažič et al. 2003).

Effects on Vine Propagation

As already said, RW has a notably negative impact on plant vigor and consequently on all nursery activity, both in terms of quantity (lower pruning weight cuttings and graft take) and quality (fewer first-class graftings obtainable). The impact on nursery production depends considerably on the particular scion/rootstock combination used.

In trials in Southern Italy, infected Italia buds from vines with stem grooving symptoms were grafted onto six different rootstocks; this led to death or a total lack of fruit in over 60% of vines 6 years after grafting (Savino et al. 1985).

In Northern Italy, graft inoculation of a vine source containing a multiple KSG, RSP, and GLRaV-3 infection and vein necrosis (VN) onto rootstocks 420 A, Kober 5BB, and Teleki 5A led to a 42–57% reduction in cane pruning weight. When a vine source infected by KSG, RSP, GLRaV-1, and vein mosaic (VM) was used as an inoculum, an equally marked reduction in woody material was obtained only on 420 A (66%) and Kober 5BB (48%), whereas the effect on Teleki 5A was not significant (Credi and Babini 1996).

The elimination of GLRaV-3 + GVA infection from Nebbiolo scions improved the nursery take (30%) expressed as first-class grafted rootlings (Mannini et al. 1998), and the elimination of GRSPaV significantly increased the take of cv. Bosco (18%) (Cuozzo et al. 2013).

Abracheva et al. (1994) observed that RSP reduced the growth of *V. rupestris* cultivated *in vitro*. On the contrary, RSP did not negatively affect the proliferation percentage, number of shoots per explant, and shoot length of cv. Albariño plantlets

compared with healthy plants, although there was a significant reduction in rooted shoots and root length (González et al. 1995).

Effects of Minor Viruses and Viruslike Diseases

The term “minor” is arbitrarily given to viruses or viruslike diseases, which are considered less important since they have milder effects on grapes or are symptomless in *V. vinifera* or are not very widespread. Only the main effects of *Grapevine fleckvirus* (GFkV), enation, vein mosaic (VM), and vein necrosis (VN) are briefly described in this paragraph, although in recent times new emerging disorders are threatening grapevine (Syrah decline, red blotch disease, Grapevine leaf mottling and deformation, etc.).

Grapevine fleck virus (GFkV)

This causal agent of fleck is widespread in grapevines. GFkV infection is symptomless in *V. vinifera* cultivars and is very often found in mixed infection with other more harmful viruses (i.e., GFLV, GLRaVs, GVA, etc.), making it very difficult to discriminate its specific impact. Fleck seems to have a major effect on rootstocks, reducing growth and propagation attitudes of *V. rupestris* St. George, 420 A, and Kober 5BB (Triolo and Materazzi 1987; Credi and Babini 1996; Credi 2001). On the contrary, fleck (alone or in mixed infection with VM and VN) was reported as having a negligible influence on the growth, yield, and juice composition of *V. vinifera* cvs. Albana and Trebbiano Romagnolo (Credi and Babini 1997). However, a synergistic effect is possible when GFkV is in coinfection with other viruses. For instance, a mixed infection of fleck and RW (named Ajinashika disease) led to a significant reduction in berry color and soluble solids in Japanese wine grape Koshu, whereas single infections had practically no effect (Teray 1990). A similarly negative synergistic effect was also observed on cv. Gamay Rouge de la Loire in coinfection with GLRaV-1 (Spring et al. 2012).

The elimination of GFkV improved some physiological processes of potted cv. Manto negro vines, such as stomatal conductance (g_s), leaf transpiration (E), and internal CO₂ concentration (C_i), but not the photosynthetic rate (P_n) (Bota et al. 2014). Since the virus is very widespread in *V. vinifera* and has generally mild effects, EU regulations allow the certification of *V. vinifera* clones even if they are GFkV-infected, although rootstock clones must be GFkV-free.

Enation

The causal agent of this viruslike disease is still unknown. Deep sequencing of cDNA libraries from vines affected by enation disease failed to identify sequences of any unknown virus that could be associated with this disorder (Chiumenti et al. 2012). The same authors (Chiumenti et al. 2013) reported that micro-RNAs (vvi-miRNAs) in enation-showing leaf tissues showed an increase of miR166 which controls leaf morphogenesis. The typical symptomatology is erratic and the disease is not very widespread. Early reports associated enation to severe yield reduction in both cool and hot climates (Prota et al. 1981; Walter and Martelli 1996). In Sardinia (insular Italy), it was found that the mean yield loss of diseased vines ranged from 17.4% to 48.3% (Prota and Garau 1979), whereas on cv. Trebbiano Romagnolo yield was reduced by up to 23%, according to the severity of symptoms and the year of their expression, while the growth rate was only slightly affected (Credi and Babini 1996). In cv. Sangiovese, Murolo and Romanazzi (2012) observed a yield loss of approximately 50% in the year of symptom occurrence.

Vein Mosaic (VM) and Vein Necrosis (VN)

Both are considered viruslike, since the viral agents are still unknown, although there is evidence linking vein necrosis with some GRSPaV strains (Bouyahia et al. 2004). The two diseases are symptomless on *V. vinifera* cultivars and on most American species and rootstocks but are very often associated with other virus diseases. To date, their impact on vine performances is considered negligible, although possible synergistic effect with other viruses cannot be ruled out.

Grapevine-Virus Interactions: New Prospects

In recent years, interest has increased in molecular events in virus-infected grapevine. Due to the availability of a genome sequence (Jaillon et al. 2007) and new -omics technologies, grapevine is becoming a model species for fruit trees regarding several aspects of plant biology, including the study of plant-virus interactions.

Microarray analyses were used to study the effects of GLRaV-3 on the leaves. This virus induces changes in leaf transcript profiling concerning a wide range of cellular processes involving protein turnover, transport, metabolism, transcription, and cell defense (Espinoza et al. 2007a). In addition, grapevine responds to GLRaV-3 infection by activating the senescence program in leaves (Espinoza et al. 2007b). Vega et al. (2011) found a downregulation of the anthocyanin biosynthesis pathway during grape ripening associated with an altered expression of genes involved in sugar transport and hormone response. Global gene expression analyses on

GRSPaV-infected *V. vinifera* plants showed some unexpected responses for a plant-virus interaction, such as an increase in transcripts involved in photosynthesis and CO₂ fixation, a reduction in some defense mechanisms, and an overlap with water and salinity stress responses (Gambino et al. 2012).

In addition to identification of unknown viruses (Roossinck et al. 2015), the high-throughput sequencing technologies applied to small RNAs have been used in recent years to study the perturbation of endogenous small RNA profiles induced by virus infection. There are several reports that some viruses can modify micro-RNAs (miRNAs) accumulation in grapevine (Alabi et al. 2012b; Singh et al. 2012; Chiumenti et al. 2013; Pantaleo et al. 2016).

The potential these techniques offer for understanding the effects of viruses on grapevine physiology can help our comprehension of the mechanisms used by infected vines to combat viral pathogens, thus providing useful information for control strategies.

References

- Abou-Ghanem, N., P. Saldarelli, A. Minafra, N. Buzkan, M.A. Castellano, and G.P. Martelli. 1997. Properties of Grapevine virus D, a novel putative trichovirus. *Journal of Plant Pathology* 79: 15–25.
- Abbracheva, P., and T. Slavcheva. 1974. The effects of fanleaf virus on the intensity of photosynthesis in the grapevine. (In Bulgarian, Russ., Fr. sum.). *Gradinar Lozar Nauka (Horticulture and Viticulture Sciences)* 11: 125–129.
- Abbracheva, P., L. Rozenova, and M. Todorova. 1994. L'influence de grapevine fanleaf virus et de stem pitting sur la cultivation de la vigne *in vitro* [Influence of grapevine fanleaf virus and stem pitting on *in vitro* culture of grapevine]. *Vitis* 33: 181–182.
- Adeguin, L., D. Forget, T. Lusseau, and M.C. Dufour. 2012. GLRaV-2: Sanitation and performance of emblematic French clones of Cabernet sauvignon. In *Proceedings 17th ICVG meeting*, Davis, CA, USA, 2012, 154–155.
- Al Rwahnih, M., M.R. Sudarshana, J.K. Uyemoto, and A. Rowhani. 2012. Complete genome of a novel vitivirus isolated from grapevine. *Journal of Virology* 86: 9545.
- Alabi, O.J., L.R. Gutha, L.F. Casassa, J. Harbertson, M. Miralles, C.W. Beaver, and R.A. Naidu. 2012a. Impacts of grapevine leafroll disease on own-rooted wine grape cultivar in cool climate viticulture. In *Proceedings 17th ICVG meeting*, Davis, CA, USA, 2012, 170–171.
- Alabi, O.J., Y. Zheng, G. Jagadeeswaran, R. Sunkar, and R.A. Naidu. 2012b. High-throughput sequence analysis of small RNAs in grapevine (*Vitis vinifera* L.) affected by grapevine leafroll disease. *Molecular Plant Pathology* 13: 1060–1076.
- Allen, W.R., H.F. Dias, and J.G. Van Shagen. 1982. Susceptibility of grape cultivars and rootstocks to an Ontario isolate of Tomato ringspot virus. *Canadian Journal of Plant Pathology* 4: 275–277.
- Andret-Link, P., C. Laporte, L. Valat, V. Laval, C. Ritzenthaler, G. Demangeat, E. Vigne, P. Pfeiffer, C. Stussi-Garaud, and M. Fuchs. 2004. Grapevine fanleaf virus: Still a major threat to the grapevine industry. *Journal of Plant Pathology* 86: 183–195.
- Auger, J., E. Aballay, E.M. Pinto, and C. Pastenes. 1992. Efecto del virus de la hoja en abanico (VHA) en el desarrollo y productividad de plantas de vid cv. Thompson seedless [Effect of grapevine fanleaf virus on the growth and productivity of grapevine plants cv. Thompson seedless]. *Fitopatologia* 27: 85–89.

- Babini, A.R., R. Credi, L. Giunchedi, and A. Canova. 1981. Effetto di infezioni virali su alcuni portainnesti della vite [Effect of virus infections on some grapevine rootstocks]. In *Proceedings 3rd international symposium on the clonal selection of grapevine*, Venice, Italy, 1981, 310–318.
- Balo, B., G.Y. Veradi, E. Papp, L.A. Muerdy, and K.D. Poly. 1997. Structural and functional alterations in photosynthetic apparatus of virusinfected ‘Chardonnay’ vines. In *Proceedings 5th international symposium on grapevine physiology*, Jerusalem, Israel, 1997, 56.
- Balthazard, J. 1993. Valeur culturale du Gewürztraminer clone n.º 913 guéri du virus de l’enroulement par thérapie. [Agricultural value of a leafroll-infected Gewürztraminer clone n. 913 sanitized by therapy]. *Progrès Agricole et Viticole* 110: 382–385.
- Barba, M., A. Cupidi, and L. Casorri. 1993. Influence of virus and virus-like diseases of grapevine in shoot cultures. In *Extended abstracts 11th ICGV meeting*, Montreux, 1993, 43–44.
- Becker, A., J. Jäger, and B. Altmayer. 1987. Association of Arabis mosaic virus-infected rootstocks with the dieback of the *Vitis vinifera* cv. “Kerner” in Germany. In *Proceedings 9th ICGV meeting*, Kiryat Anavim, Israel, 57–61.
- Bertamini, M., K. Muthuchelian, and N. Nedunchezian. 2004. Effect of grapevine leafroll on the photosynthesis of field grown grapevine plants (*Vitis vinifera* L. cv. Lagrein). *Journal of Phytopathology* 152: 145–152.
- Besse, S., C. Rütsche, and P. Gugerli. 2009. Tentative analysis of the economic impact of grapevine leafroll disease in the vineyard of Valais (Switzerland). In *Progrès Agricole et Viticole, Horse Série – Extended abstracts 16th ICGV meeting*, Dijon, France, 2009, 232–233.
- Bonavia, M., M. Digiario, D. Boscia, A. Boari, G. Bottalico, V. Savino, and G.P. Martelli. 1996. Studies on “corky rugose wood” of grapevine and the diagnosis of grapevine virus B. *Vitis* 35: 53–48.
- Bonfiglioli, R., F. Edwards, N. Hoskins, and V. Pantaleo. 2003. Graft incompatibility syndrome in New Zealand Merlot vines involves another possible variant of GLRaV-2. *The Australian & New Zealand Grapegrower & Winemaker* 476: 50–54.
- Borgo, M. 1991. Influenza della virosi dell’ accartocciamento fogliare della vite su alcuni parametri della produzione. [Influence of grapevine leafroll on some production parameters]. *Rivista di Viticoltura ed Enologia, Conegliano* 2: 21–30.
- Borgo, M., and E. Angelini. 2002. Influence of grapevine leafroll (GLRaV3) on Merlot cv. grape production. *Bulletin de l’OIV* 75 (859–860): 611–622.
- Borgo, M., E. Angelini, and R. Flamini. 1993. Effetti del virus GLRaV-3 dell’ accartocciamento fogliare sulle produzioni di tre vitigni. [Effects of GLRaV-3 on the production of three grapevine varieties]. *L’Enologo* 39: 99–110.
- Borgo, M., E. Angelini, and R. Flamini. 2003. Effects of grapevine leafroll associated 3 on main characteristics of three vineyards. *L’Enologo* 3: 99–110.
- Borgo, M., N. Bertazzon, F. Anaclerio, and E. Angelini. 2006. Graft incompatibility and leafroll symptoms in grapevine affected by different GLRaV-2 variants. In *Extended abstracts 15th ICGV meeting*, Stellenbosch, South Africa, 2006, 136–138.
- Boscia, D., V. Savino, A. Minafra, S. Namba, V. Elicio, M.A. Castellano, D. Gonsalves, and G.P. Martelli. 1993. Properties of a filamentous virus isolated from grapevines affected by corky bark. *Archives of Virology* 130: 109–120.
- Bota, J., E. Cretazzo, R. Montero, J. Rosselló, and J. Cifre. 2014. Grapevine fleck virus (GFkV) elimination in a selected clone of *Vitis vinifera* L. cv. Manto negro and its effects on photosynthesis. *Journal International des Sciences de la Vigne et du Vin* 48: 11–19.
- Boubals, D., C. Caillaud, and R. Pistre. 1964. La lutte contre le court-noué de la vigne. Note sur les techniques de sélection sanitaire permettant l’obtention de bois et plants de vigne exempts de dégénérescence infectieuse. [Control of grapevine fanleaf. Note on the methods of sanitary selection for obtaining grapevine plants free of fanleaf]. *Progrès Agricole et Viticole* 81e ann., 217–221–250–261.
- Bouyahia, H., D. Boscia, V. Savino, P. La Notte, C. Pirolo, M.A. Castellano, A. Minafra, and G.P. Martelli. 2004. Is grapevine vein necrosis a reaction to Grapevine rupestris stem pitting-associated virus? *Journal of Plant Pathology* 86: 295–340.

- Bovey, R. 1970. Importance économique des viroses de la vigne [Economic importance of grapevine virus diseases]. *Bulletin de l'OIV* 43: 124–138.
- Brückbauer, H. 1962. Untersuchungen über die Viruskrankheiten der Rebe. V. Übertragungsversuche mit reisigkranken Amerikaner-Reben [Investigations on virus diseases of grapevine. Virus transmission experiments with “reisig”-infected American grapevines]. *Wein-Wiss* 17: 133–140.
- Cabaleiro, C., A. Segura, and J.J. Garcia-Berrios. 1999. Effects of grapevine leafroll associated virus 3 on the physiology and must of *Vitis vinifera* L. cv. Albariño following contamination in the field. *American Journal of Enology and Viticulture* 50: 40–44.
- Chevalier, S., C. Greif, J.M. Clauzel, B. Walter, and C. Fritsch. 1995. Use of an immunocapture-polymerase chain reaction procedure for the detection of grapevine virus A in Kober stem grooving-infected grapevines. *Journal of Phytopathology* 143: 368–373.
- Chiumenti, M., A. Giampetruzzi, C. Pirolo, M. Morelli, P. Saldarelli, A. Minafra, G. Bottalico, P. La Notte, A. Campanale, V. Savino, and G.P. Martelli. 2012. Approaches of next generation sequencing to investigate grapevine diseases of unknown aetiology. In *Proceedings 17th ICVG meeting*, Davis, USA, 2012, 116–117.
- Chiumenti, M., A. Giampetruzzi, C. Pirolo, P. Saldarelli, A. Minafra, G. Bottalico, A. De Stradis, V. Roseti, A. Campanale, V. Savino, and G.P. Martelli. 2013. Investigations on a grapevine virus-like disease: Enations. *Journal of Plant Pathology* 95: S4.38.
- Clingeffer, P.R., and L.R. Krake. 1992. Response of Cabernet franc grapevine to minimal pruning and virus infection. *American Journal of Enology and Viticulture* 43: 31–37.
- Credi, R. 2001. Malattie infettive latenti e semilattenti della vite [Latent and semilattent infectious diseases of grapevine]. *Quaderno di Viticoltura ed Enologia, Università di Torino* 25: 15–25.
- Credi, R., and A.R. Babini. 1996. Effects of virus and virus-like infection on growth of grapevine rootstocks. *Advances in Horticulture Science* 10: 95–98.
- Credi, R., and A.R. Babini. 1997. Effects of virus and virus-like infection on growth, yield, and fruit quality of Albana and Trebbiano romagnolo grapes. *American Journal of Enology and Viticulture* 48: 7–12.
- Credi, R., O. Silvestroni, A. Santucci, and A. Canova. 1991. Variation in Grapevine rootstock susceptibility to the rugose wood disease “legno riccio”. *Phytopathologia Mediterranea* 30: 41–46.
- Cretazzo, E., C. Padilla, C. Carambula, I. Hita, E. Salmer, and J. Cifre. 2009. Comparison of the effects of different virus infections on performance of three Majorcan grapevine cultivars in field conditions. *Annals of Applied Biology* 156: 1–12.
- Cuozzo, D., Vitali, M., Gambino, G., and F. Mannini. 2013. Effect of grapevine rupestris stem pitting-associated virus on the agronomical and physiological performances of a clone of “Bosco” (*Vitis vinifera* L.). In *Proceedings 18th international symposium GiESCO*, Porto, Portugal, 2013, 805–809.
- Dias, H.F. 1977. Incidence and geographic distribution of tomato ringspot virus in De Chaunac vineyards in the Niagara Peninsula. *Plant Disease Reporter* 61: 24–28.
- Dias, H.F., and D. Cation. 1976. The characterization of a virus responsible for peach rosette mosaic and grape decline in Michigan. *Canadian Journal of Botany* 54: 1228–1239.
- Digiario, M., M. Popovic Bedzrob, A.M. D’Onghia, D. Boscia, and V. Savino. 1994. On the correlation between Grapevine virus A and rugose wood. *Phytopathologia Mediterranea* 33: 187–193.
- Digiario, M., D. Boscia, V. Simeone, and V. Savino. 1997. Detrimental effects of filamentous viruses to table grape varieties newly introduced in southern Italy. In *Extended abstracts 12th ICVG meeting*, Lisbon, Portugal, 1997, 169–170.
- Digiario, M., N. Fiore, L. Tarricone, S. Prodan, and T. Elbeaino. 2006. Influence of viruses on the performance and quality of cv. Crimson seedless. In *Extended abstracts 15th ICVG meeting*, Stellenbosch, South Africa, 2006, 186–188.
- Egger, E., M. Borgo, and P. Antoniazzi. 1985. Tolleranza dei portinnesti della vite ad alcune malattie virali o virus-simili [Tolerance of grapevine rootstocks to some virus and virus-like diseases]. *Rivista di Viticoltura ed Enologia Conegliano* 38: 302–307.

- Endeshaw, S.T., P. Sabbatini, G. Romanazzi, A.C. Schilder, and D. Neri. 2014. Effects of grapevine leafroll associated virus 3 infection on growth, leaf gas exchange, yield and basic fruit chemistry of *Vitis vinifera* L. cv. Cabernet franc. *Scientia Horticulturae* 170: 228–236.
- Engelbrecht, D.J. 1973. Effect of stem-grooving on yield of young “Queen of the Vineyard” table grapes (*Vitis vinifera* L.) grafted on tolerant rootstock. *Rivista di Patologia Vegetale, Ser IV* 9: 235–242.
- Engelbrecht, D.J. 1976. Nature and effect of the breakdown in tolerance of Jacques rootstock to grapevine stem-grooving in grafted *Vitis vinifera* L. CV. Queen of the Vineyard vines. In *Proceedings 6th ICVG meeting*, Cordoba, Spain, Monografias INIA 1979, 18: 171–178.
- Espinoza, C., A. Vega, C. Medina, K. Schlauch, G. Cramer, and P. Arce-Johnson. 2007a. Gene expression associated with compatible viral diseases in grapevine cultivars. *Functional & Integrative Genomics* 7: 95–110.
- Espinoza, C., C. Medina, S. Somerville, and P. Arce-Johnson. 2007b. Senescence-associated genes induced during compatible viral interactions with grapevine and Arabidopsis. *Journal of Experimental Botany* 58: 3197–3212.
- Fajardo, T.V.M., M. Eires, H.P. Santos, O. Nickel, and G.B. Kuhn. 2004. Biological and molecular detection and characterization of Rupestris stem-pitting associated virus and its effect on photosynthesis of grapevines [Detecção e caracterização biológica e molecular de Rupestris stem-pitting associated virus e seu efeito na fotossíntese de videiras]. *Fitopatologia Brasileira* 29: 209–214.
- Fritsch, C., and M. Mayo. 1993. Properties of the satRNA of nepoviruses. *Biochimie* 75: 561–567.
- Fuchs, M., M. Pinck, M.A. Serghini, L. Pinck, and B. Walter. 1991. The satellite RNA associated with grapevine fanleaf virus strain F13. In *Proceedings 10th ICVG meeting*, Volos, Greece, 1990, 131–137.
- Gallay, R., W. Wurgler, R. Bovey, M. Staehelin, and H. Leyraz. 1955. La dégénérescence infectieuse de la vigne [Infectious degeneration of grapevine]. *Revue romande d'agriculture, de viticulture et d'arboriculture* 11: 17–23.
- Gambino, G., D. Cuozi, M. Fasoli, C. Pagliarani, M. Vitali, P. Boccacci, M. Pezzotti, and F. Mannini. 2012. Co-evolution between *Grapevine rupestris stem pitting-associated virus* and *Vitis vinifera* L. leads to decreased defence responses and increased transcription of genes related to photosynthesis. *Journal of Experimental Botany* 63: 5319–5333.
- Garau, R., M. Cugusi, M. Dore, and U. Prota. 1985. Investigations on the yields of “Monica” and “Italia” vines affected by legno riccio (stem pitting). *Phytopathologia Mediterranea* 24: 64–67.
- Garau, R., V.A. Prota, R. Piredda, D. Boscia, and U. Prota. 1994. On the possible relationship between Kober stem grooving and Grapevine virus A. *Vitis* 33: 161–163.
- Garau, R., P.P. Fiori, V.A. Prota, G. Tolu, M. Fiori, and U. Prota. 1997. Effect of virus infection on own-rooted clones of different wine grape cultivars from Sardinia. In *Extended abstracts 12th ICVG meeting*, Lisbon, Portugal, 1997, 171–172.
- Gay, G., F. Mannini, L. Giunchedi, R. Credi, and V. Gerbi. 1981. Relazioni fra attitudini agronomiche ed enologiche e condizioni sanitarie rilevate nelle prime fasi della selezione clonale della vite [Correlation between agronomical and enological aptitudes and the sanitary status of grapevine detected in the early steps of clonal selection]. In *Proceedings 3rd International symposium on clonal selection in Vines*, Venice, Italy, 1981, 392–396.
- Gilmer, R.M., J.K. Uyemoto, and L.J. Kelts. 1970. A new grapevine disease induced by Tobacco ringspot virus. *Phytopathology* 60: 619–627.
- Giribaldi, M., M. Purrotti, D. Pacifico, D. Santini, F. Mannini, P. Caciagli, L. Rolle, L. Cavallarin, M.G. Giuffrida, and C. Marzachi. 2011. A multidisciplinary study on the effects of phloem-limited viruses on the agronomical performance and berry quality of *Vitis vinifera* cv. Nebbiolo. *Journal of Proteomics* 75: 306–315.
- Goheen, A.C., and J.A. Cook. 1959. Leafroll (red-leaf or rougeau) and its effects on vine growth, fruit quality and yields. *American Journal of Enology and Viticulture* 10: 173–181.
- Goheen, A.C., F.N. Harmon, and J.H. Weinberger. 1958. Leafroll (White Emperor Disease) of grapes in California. *Phytopathology* 48: 51–54.

- Golino, D.A. 1993. Potential interactions between rootstocks and grapevine latent viruses. *American Journal of Enology and Viticulture* 44: 148–152.
- Golino, D.A., J. Wolpert, S.T. Sim, J. Benz, M. Anderson, and A. Rowhani. 2009a. Virus effects on vine growth and fruit components of three California ‘Heritage’ clones of Cabernet sauvignon. In *Progrès Agricole et Viticole, Horse Série. Extended abstracts 16th ICGV meeting*, Dijon, France, 2009, 243–244.
- . 2009b. Virus effects on vine growth and fruit components of Cabernet sauvignon on six rootstocks. In *Progrès Agricole et Viticole, Horse Série. Extended abstracts 16th ICGV meeting*, Dijon, France, 2009: 245–246.
- Golino, D.A., A. Rohwani, V. Klaasen, S.T. Sim, and M. Al Rwahnih. 2015. Grapevine leafroll associated virus 1 effects on different grapevine rootstocks. In *Proceedings 18th ICGV meeting*, Ankara, Turkey, 2015, 46–47.
- González, E., T. Díaz, and M.V. Mosquera. 1995. Effects of various types of virus on *Vitis vinifera* L cv. Albariño cultivated in vitro. *Vitis* 34: 243–244.
- González, E., M.V. Mosquera, M.C. San José, and M. Diaz. 1997. Influence of virus on chlorophyll, carotenoid and polyamine contents in grapevine microcuttings. *Journal of Phytopathology* 141: 185–187.
- Goszczynski, D.E. 2010. Divergent molecular variants of *Grapevine virus B* (GVB) from corky bark (CB)-affected and CB-negative LN33 hybrid grapevines. *Virus Genes* 41: 273–281.
- Goszczynski, D.E., and A.E.C. Jooste. 2003. Identification of divergent variants of *Grapevine virus A*. *European Journal of Plant Pathology* 109: 397–403.
- Gottula, J., D. Lapato, K. Cantilina, S. Saito, B. Bartlett, and M. Fuchs. 2013. Genetic variability, evolution, and biological effects of Grapevine fanleaf virus satellite RNAs. *Phytopathology* 103: 1180–1187.
- Greif, C., R. Garau, D. Boscia, V. Prota, M. Fiori, P. Bass, B. Walter, and U. Prota. 1995. The relationship of grapevine leafroll associated virus 2 with graft incompatibility condition of grapevines. *Phytopathologia Mediterranea* 34: 167–173.
- Gribaudo, I., A. Lisa, R. Lenzi, and F. Mannini. 1999. Comportamento in vitro di un biotipo di *Vitis vinifera* cv. Albarola affetto da virusi (GLRaV-1, GLRaV-3 and GVA) e risanato. [Behavior in vitro of a biotype of *Vitis vinifera* cv. Albarola affected by viruses (GLRaV-1, GLRaV-3 and GVA) and sanitized]. *Rivista di Viticoltura ed Enologia, Conegliano* 52: 3–7.
- Gribaudo, I., D. Cuzzo, G. Gambino, S. Bertin, A. Cotroneo, and F. Mannini. 2009. Monitoring the spread of viruses after vineyard replanting with heat-treated clones of *Vitis vinifera* ‘Nebbiolo’. *Journal of Plant Pathology* 91: 633–636.
- Gugerli, P., J.J. Brugger, and R. Bovey. 1984. L’enroulement de la vigne: mise en évidence de particules virales et développement d’une méthode immune-enzymatique pour la diagnostic rapide [The winding of the vine: evidence of viral particles and development of immune-enzymatic method for rapid diagnosis]. *Revue suisse de Viticulture, Arboriculture, Horticulture* 16: 229–304.
- Guidoni, S., F. Mannini, A. Ferrandino, N. Argamante, and R. Di Stefano. 1997. The effect of grapevine leafroll and rugose wood sanitation on agronomic performance and berry and leaf phenolic content of a Nebbiolo clone (*Vitis vinifera* L.). *American Journal of Enology and Viticulture* 348: 438–442.
- . 2000. Effect of virus status on leaf and berry phenolic compound in two wine grapevine *Vitis vinifera* cultivars. In *Proceedings of 5^o International symposium on grapevine physiology*, Jerusalem, Israel, 1997. *Acta Horticulture*, 526: 445–452.
- Gutha, L.R., O.J. Alabi, and R.A. Naidu. 2012. Effects of grapevine leafroll disease on photosynthesis in a red-fruited wine grape cultivar. In *Proceedings 17th ICGV meeting*, Davis, CA, USA, 2012, 168–169.
- Harmon, F.N., and E. Snyder. 1946. Investigations of the occurrence, transmission, spread, and effect of “white” fruit color in the Emperor grape. *Proceedings of the American Society of Horticultural Science* 47: 190–194.

- Hewitt, W.B. 1968. Viruses and virus diseases of the grapevine. *Review of Applied Mycology* 47: 433–455.
- Jaillon, O., J.M. Aury, B. Noel, A. Policriti, C. Clepet, A. Casagrande, et al. 2007. The grapevine genome sequence suggests ancestral hexaploidization in major angiosperm phyla. *Nature* 449: 463–467.
- Jungmin, L., and R.R. Martin. 2009. Influence of grapevine leafroll associated viruses (GLRaV-2 and -3) on the fruit composition of Oregon *Vitis vinifera* L. cv. Pinot noir: Phenolics. *Food Chemistry* 112: 889–896.
- Kim, H.R., J.D. Chung, K.R. Kim, Y.M. Choi, M.S. Yiem, and J.W. Park. 2003. Effects of grapevine leafroll-associated virus 3 infection on vine growth and fruit quality in Kyoho grapevines. *Korean Journal of Horticultural Science* 44: 335–339.
- Komar, V., E. Vigne, G. Demangeat, and M. Fuchs. 2007. Beneficial effect of Selective Virus Elimination on the Performance of *Vitis vinifera* cv. Chardonnay. *American Journal of Enology and Viticulture* 58: 202–210.
- Komar, V., E. Vigne, G. Demangeat, O. Lemaire, and M. Fuchs. 2010. Comparative Performance of Virus-Infected *Vitis vinifera* cv. Savagnin rose Grafted onto Three Rootstocks. *American Journal of Enology and Viticulture* 61: 68–73.
- Kovacs, L.G., H. Hanami, M. Fortenberry, and M.L. Kaps. 2001. Latent infection by leafroll agent GLRaV-3 is linked to lower fruit quality in French-American hybrid grapevine Vidal blanc and S. Vincent. *American Journal of Enology and Viticulture* 52: 254–259.
- Krake, L.R. 1993. Characterization of grapevine leafroll disease by symptomatology. *Australian & New Zealand Wine Industry Journal* 2: 40–44.
- Kriel, G.J.L.R., C.J. Orffer, and E.F. Beukman. 1980. Symptomatology and anatomy of stem grooving (Legno Riccio) in the grape vine. *South African Journal of Enology and Viticulture* 1: 85–101.
- Legin, R. 1972. Expérimentation pour étudier l'effet des principales viroses sur la végétation et la production de la vigne [Experimentation to study the effect of the major virus diseases on vegetation and production of the vine]. In *Proceedings 4th ICGV meeting*, Colmar, France, 1970, *Annales de Phytopathologie*, 1972, H.S., 49–57.
- Legin, R., P. Bass, L. Etienne, and M. Fuchs. 1993. Selection of mild virus strains of fanleaf degeneration by comparative field performance of infected Grapevine. *Vitis* 32: 103–110.
- Legorburu, F.J., E. Recio, E. López, J. Baigorri, M. Larreina, A. Remesal, J.F. Cibrián, L. Caminero, J. Suberviola, and F. Aguirrezábal. 2009. Effect of grapevine fanleaf virus (GFLV) and grapevine leafroll-associated virus 3 (GLRaV-3) on red wine quality. In *Progrès Agricole et Viticole, Horse Série. Extended abstracts 16th ICGV meeting*, Dijon, France, 2009, 251.
- Lehoczky, J. 1972. Destructive effect of legno riccio (rugose wood) on European grapevine varieties. *Annales de Phytopathologie*, Numéro hors série: 59–65.
- Lehoczky, J., and G. Tasnady. 1971. The effect of fanleaf and chrome mosaic virus diseases on yield and the fruit sugar content of grapevine. *Kiserletugyi-Kozlemenyek* 64: 49–64.
- Lenzi, R., P. Roggero, F. Mannini, and M. Conti. 1993. ELISA detection of viruses in “Moscato bianco” grapevine showing differing cluster morphology. In *Extended abstracts 11th ICGV meeting*, Montreaux, Switzerland, 1993, 66–67.
- Lider, L.A., A.C. Goheen, and N.L. Ferrari. 1975. A comparison between healthy and leafroll affected grapevine planting stocks. *American Journal of Enology and Viticulture* 26: 144–147.
- Lunden, S., B. Meng, J. Avery, and W. Qiu. 2010. Association of Grapevine fanleaf virus, Tomato ringspot virus and Grapevine rupestris stem pitting-associated virus with a grapevine vein-clearing complex on var. Chardonnay. *European Journal of Plant Pathology* 126: 135–144.
- Magalhães, N., A. Oliveira, J.B. Carvalho, E. Toscano, M.J. Correia, A.M. Pereira, L.C. Carneiro, and A. Martins. 1997. Evolution of leafroll (GLRaV-3) effect on grapevine yield and potential ethanol. In *Extended abstracts 12th ICGV meeting*, Lisbon, Portugal, 1997, 175–176.

- Malossini, U., A.M. Ciccotti, P. Bragagna, M.E. Vindimian, S. Moser, G. Versini, and G. Nicolini. 2003. Changes in agronomical and oenological performances of clones of the grapevine cv. Gewürztraminer after grapevine fanleaf virus elimination by heat therapy. In *Extended abstracts 14th ICGV meeting*, Locorotondo, Italy, 2003, 252–253.
- Malossini, U., L. Zulini, S. Moser, G. Versini, S. Carlin, G. Nicolini, P.L. Bianchedi, and A.D. Serra. 2006. Agronomical and oenological performances of heat-treated vs. GFLV-infected “Gewürztraminer” clones in Trentino (North East Italy). In *Extended abstracts 15th ICGV meeting*, Stellenbosch, South Africa, 2006, 226–227.
- Malossini, U., L. Zulini, G. Nicolini, A. Vecchione, E. Decarli, P. Bianchedi, and R. Moscon. 2009a. Effects of GLRaV-1 elimination on physiological, agronomic and oenological characteristics of two cv. Marzemino clones. In *Progrès Agricole et Viticole, Horse Série. Extended abstracts 16th ICGV meeting*, Dijon, France, 2009, 256–257.
- Malossini, U., L. Zulini, A. Vecchione, E. Decarli, P.L. Bianchedi, R. Moscon, and G. Nicolini. 2009b. Effects of GVA elimination on physiological, agronomic and oenological characteristics of a *V. vinifera* Marzemino clone. In *Progrès Agricole et Viticole, Horse Série – Extended abstracts 16th ICGV meeting*, Dijon, France, 2009, 254–255.
- Mannini, F., R. Credi, V. Gerbi, J.L. Minati, N. Argamante, and A. Lisa. 1994. Ruolo delle infezioni virali sul comportamento in campo e sulle attitudini enologiche di cloni delle cultivar Ruchè e Dolcetto. [Role of viral infections on behavior in the field and on the oenological attitudes of clones of cultivars Ruchè and Dolcetto]. *Quaderno di Viticoltura ed Enologia, Università di Torino* 18: 55–71.
- Mannini, F., N. Argamante, and R. Credi. 1996. Improvements in quality grapevine ‘Nebbiolo’ clones obtained by sanitation. In *Proceedings workshop ‘Strategies to optimize wine grape quality’*. Conegliano, Italy, 1995, *Acta Horticulture* 427, ISHS 1996, 319–324.
- Mannini, F., V. Gerbi, and R. Credi. 1998. Heat-treated v. virus-infected grapevine clones: Agronomic and oenological modifications. In *Proceedings international symposium “The importance of varieties and clones in the production of quality wine”*, Kecskemét, Hungary, 1997, *Acta Horticulture* 473, ISHS 1998, 155–163.
- Mannini, F., N. Argamante, and R. Credi. 1999. Contribution of virus infection to clonal variability of some *Vitis vinifera* L. cultivars. *Bulletin de l’OIV* 72 (817–818): 144–160.
- Mannini, F., N. Argamante, and R. Credi. 2000. Leaf morphological modifications induced by different viruses in clones of *Vitis vinifera* cultivars. *ISHS Acta Horticulture* 528: 765–768.
- Mannini, F., N. Argamante, and S. Guidoni. 2002. Effetto delle virosi della vite sull’accumulo di antociani delle bacche. [Effect of viruses of the grapevine on the accumulation of anthocyanins in the berries]. *Quaderno di Viticoltura ed Enologia, Università di Torino* 26: 43–59.
- Mannini, F., L. Rolle, and S. Guidoni. 2003. Vineyard management to optimize grape quality in virus-free clones of *Vitis vinifera* L. In *Proceedings 8th international conference on grape genetics and breeding*, Kecskemét (Hungary) 2002, *Acta Horticulture*, ISHS 2003, 121–126.
- Mannini, F., N. Argamante, D. Cuzzo, and R. Credi. 2006. Modification in field behavior and grape quality with focus on terpenes after GLRaV-3 eradication in a clone of White Muscat (*Vitis vinifera* L.). In *Extended abstracts 15th ICGV meeting*, Stellenbosch, South Africa, 2006, 136–138.
- Mannini, F., A. Mollo, and R. Credi. 2012. Field performances and wine quality modification in a clone of Dolcetto (*Vitis vinifera* L.) after GLRaV-3 elimination. *American Journal of Enology and Viticulture* 63: 144–147.
- Mannini, F., D. Cuzzo, G. Gambino, P. Boccacci, I. Gribaudo, and R. Tragni. 2015. Effect of latent GVB infection on agronomic and oenological performances of wine cultivar Albarossa (*Vitis vinifera* L.). In *Proceedings 18th ICGV meeting*, Ankara, Turkey, 2015, 100–101.
- Martelli, G.P. 1978. Nematode-borne viruses of grapevine, their epidemiology and control. *Nematologia Mediterranea* 6: 1–27.
- . 2014. Directory of virus and virus-like diseases of the grapevine and their agents. *Journal of Plant Pathology* 96 (Suppl. 1): 1–136.

- Martelli, G.P. 2015. Grapevine Virology: A historical account with an eye to the studies of the last 60 years or so. In *Proceedings 18th ICVG meeting*, Ankara, Turkey, 2015: 16–22.
- Martelli, G.P., and V. Savino. 1988. Fanleaf degeneration. In *Compendium of grape diseases*, ed. R.C. Pearson and A.C. Goheen, 48–49. St. Paul: APS Press.
- Mc Carthy, M.G., R.M. Ciriame, and R.J. Van Velsen. 1989. Virus thermo-therapy effects on the performance of a Muscadelle selection. *Vitis* 28: 13–19.
- Meng, B., S.Z. Pang, P.L. Forsline, J.R. Mc Ferson, and D. Gonsalves. 1998. Nucleotide sequence and genome structure of Grapevine rupestris stem pitting-associated virus 1 reveal similarities to Apple stem pitting virus. *Journal of General Virology* 79: 2059–2069.
- Meng, B., R. Johnson, S. Peressini, P.L. Forsline, and D. Gonsalves. 1999. Rupestris stem pitting-associated virus 1 is consistently detected in vines that are infected with rupestris stem pitting. *European Journal of Plant Pathology* 105: 191–199.
- Murolo, S., and G. Romanazzi. 2012. Grapevine enation disease: First records in Marche region (Central-Eastern Italy). In *Proceedings 17th ICVG meeting*, Davis, CA, USA, 2012, 211–213.
- Nakaune, R., S. Toda, M. Mochizuki, and M. Nakano. 2008. Identification and characterization of a new vitivirus from grapevine. *Archives of Virology* 153: 1827–1832.
- Nimmo-Bell. 2006. *The economic effects and financial impact of GLRaV-3*, 18. Wellington: Nimmo-Bell and Company.
- Oncino, C., O. Hemmer, and C. Fritsch. 1995. Specificity in the association of *Tomato black ring virus* satRNA with helper virus. *Virology* 213: 87–96.
- Padilla, V. 1987. Considérations au sujet de la sélection clonale-sanitaire du cv. de raisin de table D. Mariano (Napoléon noir) dans le sud-est de l'Espagne [Considerations on clonal and sanitary selection of table grape cv. D. Mariano (Napoléon noir) in south-eastern Spain]. *Schw. landw Forschung/La Recherche agronomique en Suisse* 26: 326–327.
- Pantaleo, V., M. Vitali, P. Boccacci, L. Miozzi, D. Cuzzo, W. Chitarra, F. Mannini, C. Lovisolo, and G. Gambino. 2015. Grapevine rupestris stem pitting-associated virus improves tolerance to water stress and miRNAs are involved in these virus-plant-drought interactions. In *Proceedings 18th ICVG meeting*, Ankara, Turkey, 2015: 188–189.
- . 2016. Novel functional microRNAs from virus-free and infected *Vitis vinifera* plants under water stress. *Scientific Reports* 6: 20167. doi:10.1038/srep20167.
- Pesqueira, A.M., J.J. Garcia-Berrios, M. Barrasa, and C. Cabaleiro. 2012. Economic impact of leafroll disease in vineyards of the cultivar Albariño in Rias Baixas (Spain). In *Proceedings 17th ICVG meeting*, Davis, CA, USA, 2012, 57–58.
- Pietersen, G. 2006. Spatio-temporal distribution dynamics of grapevine leafroll disease in Western Cape vineyards. In *Extended abstracts 15th ICGV meeting*, Stellenbosch, South Africa, 2006, 126–127.
- Pirola, C., D. Boscia, P. La Notte, A. Cardone and G.P. Martelli. 2009. Further data on the sensitivity of different rootstocks on the graft incompatibility associated with GLRaV-2 infection. In *Progrès Agricole et Viticole, Horse Série – Extended abstracts 16th ICGV meeting*, Dijon, France, 2009, 320–321.
- Pozsár, B.I., L. Horváth, J. Lehoczky, and G.Y. Sárospataki. 1969. Effect of the grape chrome-mosaic and grape fanleaf yellow mosaic virus infection on the photosynthetic carbon dioxide fixation in vine leaves. *Vitis* 8: 206–210.
- Prota, U., and R. Garau. 1979. Enations of grapevine in Sardinia. In *Proceedings 6th ICVG meeting*, Cordoba, Spain, *Monografias INIA* 18: 179–189.
- Prota, U., R. Garau, and M. Cugusi. 1981. Studies on some variable characters of grapevine affected by enation disease in Sardinia. *Phytopathologia Mediterranea* 20: 7–12.
- Qiu, W.P., J.D. Avery, and S. Lunden. 2007. Characterization of a severe virus-like disease in Chardonnay grapevines in Missouri. *Plant Health Progress*. doi:10.1094/PHP-2007-1119-01-BR.
- Ramsdell D.C., and J.M. Gillet. 1985. Relative susceptibility of America-French hybrids and European grape cultivars to infection by peach rosette mosaic virus. In *Proceedings 8th ICVG meeting*, Bari, 1984, *Phytopathologia Mediterranea*, 1985, 24: 41–43.

- Ramsdell, D.C., and R.L. Myers. 1974. Peach rosette mosaic virus, symptomatology and nematodes associated with grapevine 'degeneration' in Michigan. *Phytopathology* 64: 1174–1178.
- Ramsdell, D.C., and R. Stace-Smith. 1981. Physical and chemical properties of the particles and ribonucleic acid of blueberry leaf mottle virus. *Phytopathology* 71: 468–472.
- Ramsdell, D.C., J.M. Gillett, and G.W. Bird. 1995. Susceptibility of American grapevine scion cultivars and French hybrid rootstock and scion cultivars to infection by peach rosette mosaic nepovirus. *Plant Diseases* 79: 154–157.
- Reynolds, A.G., W.S. Lanterman, and D.A. Wardle. 1997. Yield and berry composition of five *Vitis* cultivars as affected by *Rupestris* stem pitting virus. *American Journal of Enology and Viticulture* 48: 449–458.
- Roossinck, M.J., D.P. Martin, and P. Roumagnac. 2015. Plant virus metagenomics: Advances in virus discovery. *Phytopathology* 105: 716–727.
- Rowhani, A., D.A. Golino, S.T. Sim, and M. Al Rwahnih. 2012. Grapevine leafroll associated viruses effects on yield, vine performance and grape quality. In *Proceedings 17th ICVG meeting*, Davis, CA, USA, 2012, 52–53.
- Rowhani, A., D.A. Golino, V. Klaassen, S.T. Sim, M. Gouran, and M. Al Rwahnih. 2015. Grapevine Leafroll associated virus 3: Effects on rootstocks, vine performance, yield and berries. In *Proceedings 18th ICVG meeting*, Ankara, Turkey, 2015, 161–162.
- Rüdel M. 1985. Grapevine damage induced by particular virus-vector combinations. In *Proceedings 8th ICVG meeting*, Bari, Italy, 1984, *Phytopathologia Mediterranea* 1985, 24: 183–185.
- Rumbos, I.C., and A.D. Avgelis. 1993. Further investigations on 'Roditis leaf discoloration' disease. In *Extended abstracts 11th ICVG meeting*, Montreux, Switzerland, 1993, 76.
- Saldarelli, P., A. Minafra, and B. Walter. 1993. A survey of *Grapevine fanleaf nepovirus* isolates for the presence of satellite RNA. *Vitis* 32: 99–102.
- Sampol, B., J. Bota, D. Riera, H. Medrano, and J. Flexas. 2003. Analysis of the virus-induced inhibition of photosynthesis in Malmsey grapevines. *New Phytologist* 160: 403–412.
- Santini, D., L. Rolle, P. Cascio, and F. Mannini. 2011. Modifications in chemical, physical and mechanical properties of 'Nebbiolo' (*Vitis vinifera* L.) grape berries induced by mixed virus infection. *South African Journal of Enology and Viticulture* 32: 183–189.
- Santini, D., A. Mollo, D. Pacifico, E. Borgogno, and F. Mannini. 2012. Ecophysiological and agronomic response of two 'Nebbiolo' clones to different leafroll virus infection. *Progress Agricole et Viticole* 129: 307–312.
- Santos, M.T., M.L.G. Rocha, J.M.S. Martins, and L.C. Carneiro. 2003. Effect of grapevine viruses GFLV, GLRV 3 and GFkV on leaf morphology of the Portuguese white variety Arinto by multivariate discriminant analysis. In *Extended abstracts, 14th ICVG meeting*, Locorotondo, Italy, 2003: 21–22.
- Santos, M.T., M. Lurdes, M.L.G. Rocha, J.M.S. Martins, and L.C. Carneiro. 2006. Morphological changes of grapevine leaves (cv. Arinto) in relation to infections by viruses and weather conditions. In *Extended abstracts 15th ICVG meeting*, Stellenbosch, South Africa, 2006, 248–249.
- Savino, V., D. Boscia, D. Musci, and G.P. Martelli. 1985. Effect of legno riccio (stem pitting) on 'Italia' vines grafted onto rootstocks of different origin. *Phytopathologia Mediterranea* 24: 68–72.
- Savino, V., D. Boscia, and G.P. Martelli. 1989. Rugose wood complex of grapevine: Can grafting to *Vitis* indicators discriminate between diseases?. In *Proceedings 9th ICVG meeting*, Kiryat Anavim, Israel, 1987, 91–94.
- Schoeffling, H. 1980. First results of a field-trial on the performances of the heat-treated and not heat-treated white Riesling clones. In *Proceedings 7th ICVG meeting*, Niagara Falls, Canada, 1980, 311–320.
- Shady, S.A., M.I. Gómez, M.F. Fuchs, and T.E. Mortison. 2012. Economic impact of grapevine leafroll disease on *Vitis vinifera* cv. Cabernet franc in Finger Lakes vineyards of New York. *American Journal of Enology and Viticulture* 63: 73–79.

- Singh, K., A. Talla, and W. Qiu. 2012. Small RNA profiling of virus-infected grapevines: Evidences for virus infection-associated and variety-specific miRNAs. *Functional & Integrative Genomics* 12: 659–669.
- Smith, R.J., and J.R. Yeo. 2012. Virus effects on vine growth and fruit composition of selected zinfandel field selections. In *Proceedings 17th ICVG meeting*, Davis, CA, USA, 2012: 176–177.
- Spring, J.L., J.S. Reynard, O. Viret, D. Maigre, P. Gugerli, and J.J. Brugger. 2012. Influence du virus 1 associé à l'enroulement (GLRaV-1) et du virus de la marbrure (GFkV) sur le comportement agronomique et la qualité des vins chez le Gamay [Influence of the Grapevine Leafroll Associated Virus (GLRaV-1) and Grapevine Fleck Virus (GFkV) on the Grape and Wine Production of cv. Gamay]. *Revue suisse de viticulture arboriculture horticulture* 31: 141–145.
- Staudt, G., and B. Weischer. 1992. Resistance to transmission of grapevine fanleaf virus by *Xiphinema index* in *Vitis rotundifolia* and *Vitis munsoniana*. *Wein-Wiss* 47: 56–61.
- Stellmach, G., and R.E. Berres. 1986. Sind mit Nepoviren infizierte Pfropfreben immer Quellen der Virus-Kontamination von Rebschulen? [Is grapevine graftwood infected with nepoviruses always a source of contamination for grape nurseries?]. *Wein-Wiss* 41: 418–423.
- Tanne, E., E. Dubitsky, and H. Bazak. 1990. Preliminary data on the effect of corky bark disease on Thompson seedless vines grafted on various rootstocks. In *Proceedings 10th ICVG meeting*, Volos, Greece, 1990: 386–389.
- Téliz, D., and P. Valle. 1980. Grape corky bark and stem pitting in Mexico. III. Evaluation of symptoms in 130 cultivars grafted on 17 rootstocks. In *Proceedings 7th ICVG meeting*, Niagara Falls, Canada, 1980, 71–75.
- Téliz, D., P. Valle, and A.C. Goheen. 1980. Grape corky bark and stem pitting in Mexico. II. Evaluation of symptoms in 17 rootstocks. In *Proceedings 7th ICVG meeting*, Niagara Falls, Canada, 1980, 65–70.
- Teray, Y. 1990. Anjinashika disease: A combined effect of grapevine leafroll and grapevine fleck virus on sugar content in the Japanese grape cultivar Koshu. In *Proceedings 10th ICVG meeting*, Volos, Greece, 1990, 67–70.
- Terlizzi, F., C. Li, C. Ratti, V. Qiu, R. Credi, and B. Meng. 2011. Detection of multiple sequence variants of Grapevine rupestris stem pitting-associated virus using primers targeting the polymerase domain and partial genome sequencing of a novel variant. *Annals of Applied Biology* 159: 478–490.
- Tomazič, I., U. Vrhovšek, and Z. Korošec-Koruza. 2003. The influence of virus diseases on grape polyphenols of cv. 'Refošk'. *Acta Agriculturae Slovenica* 81: 287–295.
- Tomazič, I., N. Petrovič, and Z. Korošec-Koruza. 2005. Effects of rugose wood and GLRaV-1 on yield of cv. 'Refošk' grapevine. *Acta Agriculturae Slovenica* 85: 91–96.
- Triolo, E., and A. Materazzi. 1987. La 'Maculatura infettiva' della vite: Influenza di isolati diversi sull'attitudine alla propagazione vegetative di *Vitis rupestris* 'St. George'. *Recherche Agronomique Suisse* 3: 320–324.
- Uyemoto, J.K. 1975. A severe outbreak of virus-induced grapevine decline in Cascade grapevines in New York. *Plant Disease Reporter* 59: 98–101.
- Uyemoto, J.K., J.R. Cummins, and G.S. Abawi. 1977a. Virus and virus like diseases affecting grapevines in New York vineyards. *American Journal of Enology and Viticulture* 28: 131–136.
- Uyemoto, J.K., E.F. Taschenberg, and D.K. Hummer. 1977b. Isolation and identification of a strain of *Grapevine Bulgarian latent virus* in Concord grapevines in New York State. *Plant Disease Reporter* 61: 949–953.
- Uyemoto, J.K., A. Rowhani, D. Luvisi, and R. Krag. 2001. New closterovirus in 'Red Globe' grape causes decline of grafted plants. *California Agriculture* 55: 28–31.
- Vega, A., R.A. Gutiérrez, A. Peña-Neira, G.R. Cramer, and P. Arce-Johnson. 2011. Compatible GLRaV-3 viral infections affect berry ripening decreasing sugar accumulation and anthocyanin biosynthesis in *Vitis vinifera*. *Plant Molecular Biology* 77: 261–274.

- Vigne, E., V. Komar, M. Tannières, G. Demangeat, E. Duchêne, D. Steyer, G. Lemarquis, C. Ritzenthaler, and O. Lemaire. 2015. Comparative pathogenic effects of distinct Grapevine fanleaf virus strains on *Vitis vinifera* cvs. Gewürztraminer and Chardonnay. In *Proceedings 18th ICVG meeting*, Ankara, Turkey, 2015, 236–237.
- Vuittenez, A. 1958. Activité comparée des fumigants, des insecticides et de divers produits appliqués en traitement du sol sur les contaminations par la dégénérescence infectieuse de la vigne [Comparative activity of fumigants, insecticides and various products, applied as soil treatments, on the contamination by infectious degeneration of grapevine]. *Comptes Rendus de l'Académie d'Agriculture de France* 44: 901–907.
- Vuittenez, A., J. Kuszala, M. Rüdel, and H. Brückbauer. 1970. Détection et étude serologique du virus latent des taches annulaires du fraisier (strawberry latent ringspot), du virus des anneaux noirs de la tomate (tomato black ring) et du virus des taches annulaires du framboisier (raspberry ringspot) chez des vignes du Palatinat (Detection and serological study of strawberry latent ringspot, tomato black ring and raspberry ringspot in grapevines from the Palatinat). *Annales de Phytopathologie* 2: 279–327.
- Walker, M.A., and C.P. Meredith. 1990. The genetics of resistance to grapevine fanleaf virus in *Vitis vinifera*. In *Proceedings 5th International symposium on grape breeding*, St. Martin/Pfalz, Germany, 1989, 228–238.
- Walker, M.A., C.P. Meredith, and A.C. Goheen. 1985. Sources of resistance to grapevine fanleaf virus (GFV) in *Vitis* species. *Vitis* 24: 218–228.
- Walker, M.A., J.A. Wolpert, and E. Weber. 1994. Viticultural characteristics of VR hybrid rootstocks in a vineyard site infected with grapevine fanleaf virus. *Vitis* 33: 19–23.
- Walker, J.T.S., J.G. Charles, K.J. Froud, and P. Connolly. 2004. Leafroll virus in vineyards: Modelling the spread and economic impact. *Report to New Zealand Winegrowers Limited, Hort Research Report n.° 12795*, Auckland.
- Walter, B. 1988. Some examples of the physiological reaction of the vine in the presence of virus. *Bulletin de l'OIV* 61: 383–390.
- Walter, B., and G.P. Martelli. 1996. Sélection clonale de la vigne: sélection sanitaire et sélection pomologique. Influence des viroses et qualité. 1^{ère} partie: Effets des viroses sur la culture des vignes et ses produits [Clonal selection of the grapevine: sanitary selection and pomological selection. Influence of viruses and quality. Part 1: Effects of viruses on the cultivation of grapevine and its products]. *Bulletin de l'OIV* 69: 945–971.
- Walter, B., P. Bass, P. Cornuet, R. Legin, and M. Fuchs. 1990. Interaction between Arabis mosaic virus and Grapevine fanleaf virus isolates. In *Proceedings 10th ICVG meeting*, Volos, Greece 1990, 120–128.
- Wolpert, J.A., and E.P. Vilas. 1992. Effect of mild leafroll disease on growth, yield and fruit maturity indices of Riesling and Zinfandel. *American Journal of Enology and Viticulture* 43: 367–369.

Chapter 24

Vector Transmission of Grapevine Leafroll-Associated Viruses

E. Herrbach, A. Alliaume, C.A. Prator, K.M. Daane, M.L. Cooper,
and R.P.P. Almeida

Abstract The ampeloviruses causing grapevine leafroll disease are transmitted by mealybug and soft scale insect vectors. Vector transmission of virus species in this complex occurs in a semi-persistent manner, with no current evidence of a strict vector-virus species specificity. However, only a limited number of studies have addressed questions such as virus-vector transmission efficiency, and there are no published studies on virus-vector molecular interactions. Here we present a summary of what is known about the vector transmission of grapevine-associated ampeloviruses. Because the management of grapevine leafroll diseases depends on a robust understanding of how these viruses are disseminated in vineyards, we also highlight research needs and knowledge gaps.

Introduction

Reported by winegrowers since the turn of the twentieth century, the grapevine leafroll syndrome was regarded as being solely transmitted by cuttings and grafting, so much so that in 1988, Goheen wrote that “no vector for the causal agent of leafroll has been established” (Goheen 1988). However, the ability of the mealybug *Pseudococcus maritimus* to transmit leafroll in California had first been demonstrated, but not published, in 1961 by Dr. L. Chiarappa (Roscioglione et al. 1983; Martelli 2014a). Later on, the natural spread of leafroll in vineyards was reported by Dimitrijevic (1973) and correlated to the presence of scale insect populations, which were therefore suspected to act as the vectors in this disease system (Caudwell and Dalmaso 1985; Engelbrecht and Kasdorf 1985, 1990b; Teliz et al. 1989; Jordan

E. Herrbach (✉) • A. Alliaume
SVQV, INRA, Université de Strasbourg, 68000 Colmar, France
e-mail: etienne.herrbach@inra.fr

C.A. Prator • K.M. Daane • R.P.P. Almeida
Department of Environmental Science, Policy and Management, University of California at Berkeley, Berkeley, CA, USA

M.L. Cooper
University of California Cooperative Extension, Napa, CA, USA

1993). The first experimental evidence that mealybugs are vectors of *Grapevine leafroll-associated virus-3* (GLRaV-3) was published by Tanne (1988) in Israel, rapidly followed by Rosciglione and Gugerli (1989) in Switzerland and by Engelbrecht and Kasdorf (1990a) in South Africa. The latter represents the first peer-reviewed paper on the topic.

Within plant-sap-feeding hemipterans with piercing-sucking mouthparts, scale insects form the superfamily Coccoidea, which contains over 8000 species classified in ca. 30 extant families (García et al. 2016). Approximately 35 species in the Coccoidea have so far been identified as vectors of ca. 30 virus species, and they belong to only two families: the Pseudococcidae (mealybugs) and the Coccidae (soft scales) (Herrbach et al. 2016). As to grapevine leafroll viruses, only the members of the genus *Ampelovirus* (GLRaV-1, -3, and -4-like) are transmitted by scale insects, i.e., eleven mealybug and eight soft scale species, as far as known today. Note that the natural vectors (if any) of GLRaV-2 (genus *Closterovirus*) are unknown but would be expected to be aphids based on the evolutionary history of the group (Tsai et al. 2010; Klaassen et al. 2011). GLRaV-7 (genus *Velarivirus*), which has been proposed to be nonpathogenic to grapevines (see Chap. 10), is transmitted through the parasitic dodder plants *Cuscuta* spp. (Mikona and Jelkmann 2010).

Several species recognized as *Ampelovirus* vectors can also transmit the vitiviruses *Grapevine virus A* (GVA), GVB, and GVE, which are involved in the rugose wood disease complex of grapevine (see Chap. 11). The transmission of GVA by *Pseudococcus longispinus* was first demonstrated by Rosciglione et al. (1983). Vitiviruses are often detected in grapevine in coinfection with a leafroll-associated *Ampelovirus*; this frequent association of vitiviruses with ampeloviruses raises questions about their mutual interactions during vector transmission and/or grapevine infection. Nothing is known about the natural vectors, if any, of the vitiviruses GVD and GVF. It should be mentioned that attempts to transmit grapevine leafroll- or rugose wood-associated viruses by other grapevine sap-feeding insects, such as some aphid species including grape phylloxera (Charles et al. 2006; Conti et al. 1980; Kuniyuki et al. 1995; Teliz et al. 1989) and the flatid *Metcalfa pruinosa* (Materazzi et al. 1998), have all failed.

Various aspects of the role of scale insects in transmitting grapevine ampeloviruses and vitiviruses have been reviewed or summarized earlier in Charles et al. (2006), Laimer et al. (2009), Oliver and Fuchs (2011), Daane et al. (2012), Almeida et al. (2013), Maree et al. (2013), Martelli (2014a, b), Naidu et al. (2014, 2015), Hull (2016), and Herrbach et al. (2016). Here we focus exclusively on the vector transmission of grapevine leafroll-associated viruses. We also direct the reader to chapters in this book addressing grapevine leafroll-associated viruses (Chaps. 6 and 8) and vitiviruses (Chap. 11), topics relevant to this chapter but not covered here.

The Vectors

Mealybug and Soft Scale Species Identified as Vectors

After the reports of *Planococcus ficus* and *Ps. longispinus* as vectors of GVA and GLRaV-3, respectively (Roscioglione et al. 1983; Tanne 1988), research has demonstrated that many other grapevine-colonizing pseudococcid species transmit grapevine leafroll-associated viruses, including insects in the genera *Pseudococcus*, *Planococcus*, *Phenacoccus*, *Heliococcus*, and *Ferrisia* (Golino et al. 1994; Sforza et al. 2003; Tsai et al. 2010; Wistrom et al. 2016). Several species in the family Coccidae have also been identified as vectors of grape ampeloviruses and GVA, especially the grapevine-dwelling species *Parthenolecanium corni*, *Pulvinaria vitis*, and *Neopulvinaria innumerabilis* (Belli et al. 1994; Fortusini et al. 1997; Sforza et al. 2003). All vector species presently known as able to transmit at least one grape ampelo- or vitivirus are listed in Table 24.1. The fact that grape ampelo- and vitiviruses can be transmitted by members of two scale insect families is unique among vector-transmitted plant viruses and suggests a broad specificity or even a general lack of vector-virus specificity (Tsai et al. 2010). Therefore, additional vector species are expected to be identified in the future, even among insects that do not colonize grapevine and are unlikely to have any epidemiological relevance. Indeed, South African workers (Krüger and Douglas 2009; Krüger and Douglas-Smit 2013) obtained GLRaV-3 transmission events with the coccids *Coccus longulus*, *Parasaissetia nigra*, and *Saissetia* sp., when forced to feed on grapevine under laboratory conditions; however, these species did not survive on grapevine, a plant they rarely colonize in vineyards (García et al. 2016).

Vector Cycle and Ecology

Although morphologically similar, each vector species has distinct biological characteristics and generally unique geographic origins that result in differing host plant preferences and present regional distributions (Daane et al. 2012). In general, vineyard mealybugs and soft scales have two or three larval instars for the female, and three or four instars for the male, with the last instar male going through a cocoon or pupal stage before the winged adult emerges (McKenzie 1967; Ben-Dov 1995; Wakgari and Giliomee 2005). Most species of mealybugs and soft scales lay eggs in an ovisac; however, some species like *Heliococcus bohemicus* are ovoviviparous. The general body shape is elongate-oval, and the body is covered with a protective wax secretion (mealybugs) or a chitinized shield (soft scales). Following each successive molt, the instars increase in size and amount of wax secreted. The first instar – which is commonly referred to as a crawler since it is considered the dispersal stage – measures ca. 0.6 mm, with the female growing to a length of 4–5 mm, depending on the species. The winged male typically measures ca. 1.5 mm in length.

Table 24.1 Scale insect species of the families Pseudococcidae and Coccidae known as vectors of leafroll-associated ampeloviruses and of rugose wood-associated vitiviruses of grapevine

Scale insect species	GLRaV-1	GLRaV-3	GLRaV-4 strain 4	GLRaV-4 strain 5	GLRaV-4 strain 6	GLRaV-4 strain 9	GVA	GVB	GVE	References
Pseudococcidae (mealybugs)										
<i>Ferrisia gilli</i> (Gill's mealybug)		X								Wistrom et al. (2016)
<i>Heliococcus bohemicus</i> (Bohemian mealybug)	X	X		X			X			Sforza et al. (2003), Zorloni et al. (2003, 2004, 2006a) and Bertin et al. (2016b)
<i>Phenacoccus aceris</i> (apple mealybug)	X	X	X	X	X	X	X	X		Sforza et al. (2003) and Le Maguet et al. (2012)
<i>Planococcus citri</i> (citrus mealybug)	X	X					X	X		Agran et al. (1990), Pedroso et al. (1991), Cabaleiro and Segura (1997), Golino et al. (2000, 2002), Ioannou et al. (2000), Cid et al. (2007), Scotto et al. (2009) and Bertin et al. (2016a)

<i>Planococcus ficus</i> (vine mealybug)	X	X	X	X	X	X	X	X	X	Engelbrecht and Kasdorf (1985, 1990a), Rosciglione and Castellano (1985), Rosciglione and Gugerli (1989), Tanne et al. (1989a, 1989b, 1993), Boscia et al. (1993), Acheche et al. (2000), Ioannou et al. (2000), Goszczynski and Jooste (2003), de Borbon et al. (2004), Zorloni et al. (2004), Douglas and Krüger (2006), Krüger et al. (2006, 2015), Douglas and Krüger (2008), Tsai et al. (2008, 2010, 2011), Elbeaino et al. (2009), Mahfoudhi et al. (2009), Blaisdell et al. (2012, 2015), Jooste and Krüger (2015) and Bertin et al. (2016a)
<i>Pseudococcus calceolariae</i> (citrophilus mealybug)	X									Petersen and Charles (1997)
<i>Pseudococcus comstocki</i> (Comstock mealybug)	X								X	Nakano et al. (2003) and Nakaume et al. (2008)

(continued)

Table 24.1 (continued)

Scale insect species	GLRaV-1	GLRaV-3	GLRaV-4 strain 4	GLRaV-4 strain 5	GLRaV-4 strain 6	GLRaV-4 strain 9	GVA	GVB	GVE	References
<i>Pseudococcus longispinus</i> (long-tailed mealybug)	X			X		X	X	X		Rosciglione et al. (1983), Tanne (1988), Tanne et al. (1989b, 1993), Golino et al. (1994, 1995, 2000, 2002), La Notte et al. (1997), Petersen and Charles (1997), Sim et al. (2003), Krüger et al. (2006), Kuniyuki et al. (2006), Sciancalepore et al. (2006), Douglas and Krüger (2008), Tsai et al. (2010), Sandanayaka et al. (2013) and Krüger et al. (2015)
<i>Pseudococcus maritimus</i> (grape mealybug)		X								Golino et al. (2000, 2002), Martin et al. (2005), Soule et al. (2006) and Bahder et al. (2013)
<i>Pseudococcus viburni</i> (<i>Ps. affinis</i>) (obscure mealybug)		X					X	X		Garau et al. (1995), Golino et al. (1994, 1995, 2000, 2002) and Blaisdell et al. (2015)
Coccidae (soft scales)										
<i>Ceroplastes rusci</i> (fig wax scale)	X			X						Mahfoudhi et al. (2009)
<i>Coccus longulus</i> (long brown scale)	X									Krüger and Douglas (2009) and Krüger and Douglas-Smit (2013)

<i>Neopulvinaria innumerabilis</i> (cottony maple scale)	X	X							X			Fortusini et al. (1997), Zorloni et al. (2006b) and Le Maguet (2012)
<i>Parasaissetia nigra</i> (nigra scale)		X										Krüger and Douglas (2009) and Krüger and Douglas-Smit (2013)
<i>Parthenolecanium corni</i> (European fruit lecanium)	X	X			X				X			Fortusini et al. (1997), Sforza et al. (2003), Hommay et al. (2008) and Bahder et al. (2013)
<i>Parthenolecanium persicae</i> (European peach scale)		X										Habili (2015)
<i>Pulvinaria vitis</i> (cottony vine scale)		X							X			Belli et al. (1994), G. Hommay (INRA Colmar, F), unpublished
<i>Saissetia</i> sp.		X										Krüger and Douglas (2009) and Krüger and Douglas-Smit (2013)

Mealybug females emit sex pheromones to attract males, and it is generally accepted that mating is probably necessary for vineyard mealybugs (Zaviezo et al. 2010; Waterworth et al. 2011). Identification of the sex pheromones of multiple species has facilitated the synthesis of compounds used in monitoring and mating disruption programs (Daane et al. 2012; Zou and Millar 2015). It should be added that many soft scale species are parthenogenetic throughout their distribution area or only in specific regions (Danzig 1997; Kosztarab and Kozar 1988).

The number of generations developing per year is influenced chiefly by temperature; development time and critical temperature thresholds differ by species. For example, in California's interior valleys, *Ps. maritimus* completes two generations per year (Geiger and Daane 2001), whereas *Pl. ficus* may complete up to seven generations, but only three to five in coastal regions in northern California (Gutierrez et al. 2008). In Europe, all grapevine mealybug and soft scale species are monovoltine in northeastern France and in Germany (Le Maguet 2012), whereas *Pa. corni* and *H. bohemicus* are bivoltine in Mediterranean regions (Kosztarab and Kozar 1988; Duso 2013). Similarly, feeding location on the vine also varies by season, a phenomenon that is likely driven both by temperature and access to a high-quality food source. For instance, during the dormant (winter) period, mealybugs are more likely to be found under the bark of permanent woody structures such as the trunk or cordon, while around harvest (summer, late fall), they are more likely to be found on leaves or in the bunches (Geiger and Daane 2001), whereas adult soft scales prefer the woody canes in the spring, and their larval progeny then invades leaves (Marotta and Tranfaglia 1997). The vineyard mealybug and soft scale pests often have a wide host range, e.g., *Ps. viburni* and *Ps. longispinus* are well-known pests of ornamental plants, whereas *Phenacoccus aceris* is a pest on apple. Still, each species has a number of differences in their biological characteristics and complex of natural enemies; monitoring and management programs (see Chap. 26) must consider each of these targeted vector species.

Vector Feeding

Scale Insect Mouthparts and Foregut

Scale insects are plant-sap feeders and with specialized piercing-sucking mouthparts that play key roles in host choice, feeding, and virus transmission (Blanc et al. 2014; Whitfield et al. 2015). Similar to that of other hemipterans, these mouthparts are composed of a clypeolabral shield and a labium containing the stylet bundle, which is composed of two maxillary stylets and two mandibular stylets (Fig. 24.1) (Bronn 1939; Calatayud and Le Rü 2006; Ahmad et al. 2012; Cicero et al. 2015). The labium bears a variable number of sensilla, probably playing a mechano- and/or chemoreceptive role as in other hemipterans (Calatayud and Le Rü 2006; Alliaume 2016). When the mealybug does not feed, the stylet bundle is retracted as a loop in the body cavity of the insect inside a sheath called "crumena" (Heriot

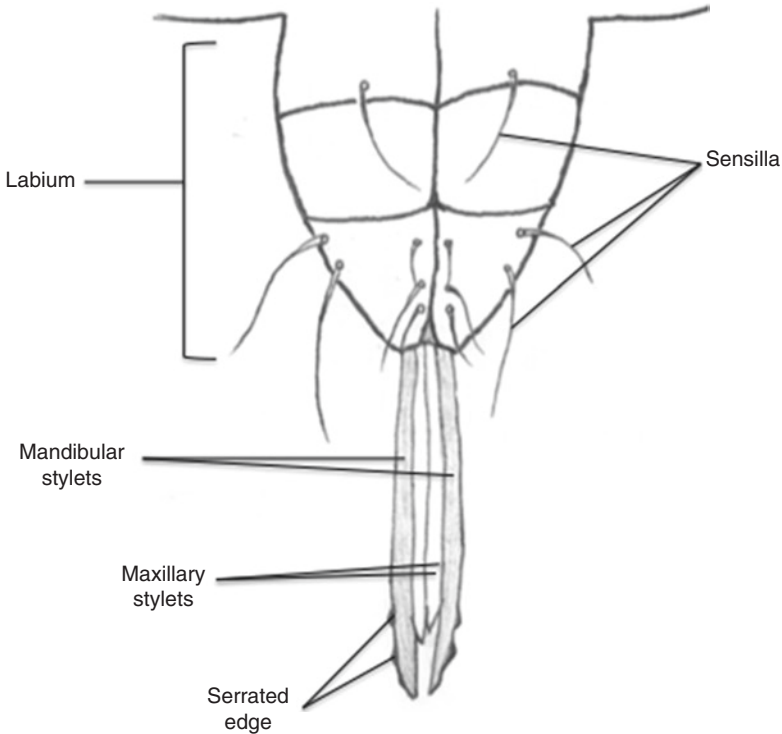

Fig. 24.1 Schematic diagram showing the general structure of the mouthparts of scale insects (Drawn by Antoine Alliaume)

1936). The crumena allows the redirection of the stylet bundle from a posterior to a ventral direction to initiate penetration of host tissues (Pollard 1969). The mandibular stylets provide support to the maxillary stylets, which are sealed against each other longitudinally by means of parallel ridges through the length of each stylet; two grooves are generated by pairing the maxillary stylets, the food canal and the smaller salivary canal. Recent observations of the tips of maxillary stylets of *Ph. aceris* (Alliaume 2016) do not provide evidence of a typical “acrostyle” as found in aphids (Uzest et al. 2010). The mandibular stylets surround the coapted maxillary stylets and display serrated ridges or “mandibular teeth” at their tip, with one longitudinal canal containing one or more dendrites, likely of mechanoreceptive function (Ahmad et al. 2012; Alliaume 2016). The food canal is connected to the foregut, comprising the precibarium, the cibarium, equipped with a muscular pump, and the esophagus (Balachowsky 1937; Pesson 1944). The alimentary tract then follows with the midgut and the hindgut. Adult males of scale insects are devoid of mouthparts and therefore are unable to feed. The feeding apparatus of soft scales is very similar to that of mealybugs (Foldi 1997).

Mealybug Feeding Behavior

Calatayud and Le Rü (2006) proposed that the first step in identifying a suitable feeding site involves physical and probably chemical cues perceived by receptors in the antennae and labium, followed by the insertion of the stylets into plant tissues. The insertion site is usually marked by a small deposit of gelling saliva, the salivary flange (Ahmad et al. 2012), which may facilitate the penetration of plant tissue by providing structural support and protection for the maxillary stylets. The use of histology (Ahmad et al. 2012) and electropetrography (EPG) (Calatayud et al. 1994; Calatayud and Le Rü 2006; Huang et al. 2012; Sandanayaka et al. 2013) has revealed that the stylets penetrate plant tissues in a perpendicular and mainly inter-cellular pathway associated with secretion of a salivary sheath, similar to that described for other phytophagous hemipterans (e.g., Leopold et al. 2003; Pollard 1973; Tjallingii 1988). Eventually the stylet tips reach the vascular tissues where ingestion and presumably watery salivation start. Epidermal short probes, which are common in aphids and involved in nonpersistent virus transmission, have not been reported in scale insects (Herrbach et al. 2016). Pseudococcids and coccids feed primarily on phloem tissue (Calatayud et al. 1994; Sandanayaka et al. 2013), but xylem-sap feeding has also been reported (Cid and Fereres 2010).

Effect of Scale Insects Feeding on Plants

Mealybugs and soft scales usually have no direct negative effect on grapevines, except when populations reach high-density levels, in which case plant vigor is reduced and honeydew excretion leads to the development of sooty mold on leaves and fruit; the presence of any mealybugs is also an issue for table grapes because of cosmetic damage and exportation regulations (Daane et al. 2012). In addition, a recent study suggests that grapevine infested by *Pl. citri* responds only weakly at the transcriptional level (Timm and Reinecke 2014). Citrus and tomato infested by a coccid displayed a decreased photosynthetic activity (Huang et al. 2013; Golan et al. 2015); however, whether a similar effect exists in coccoid-infested grapevine is not known.

Transmission of Grapevine Leafroll Viruses

Transmission Biology

There is limited information available on the mode of vector transmission of grapevine leafroll-associated viruses. So far, only one vector-pathogen combination (*Pl. ficus* – GLRaV-3) has been sufficiently studied to conclude that transmission occurs in a semi-persistent manner (Tsai et al. 2008). Earlier efforts generated compatible

yet inconclusive results in regard to a semi-persistent mode of transmission (e.g., Cabaleiro and Segura 1997; Golino et al. 2002; Le Maguet et al. 2012; Alliaume 2016). Transmission of GLRaV-3 by *Pl. ficus* increased in efficiency as a function of plant access period up to 1 day, either for inoculation or acquisition; no latent period was required for transmission, and inoculum as well as infectivity were lost 4 days post-acquisition (Tsai et al. 2008). Even though no other studies have addressed this question in as much detail to our knowledge, there is the expectation that other grapevine-infecting ampeloviruses will be transmitted in a similar manner, as transmission characteristics are generally conserved among members of a viral genus, and other viruses in the *Closteroviridae*, including in the genus *Closterovirus*, are also semi-persistently transmitted (Tsai et al. 2010).

Even though evidence for a semi-persistent and non-circulative mode of transmission by grapevine ampeloviruses by mealybugs seems now established for specific virus-vector combinations (Tsai et al. 2008; Le Maguet et al. 2012; Alliaume 2016), the report of the presence of GLRaV-3 virions, at least components thereof, in the salivary glands of *Pl. citri*, raised the idea of a hypothetical circulative transmission (Cid et al. 2007). However, these reports, whether artifactitious or not, have not been confirmed by others. The short plant access time required for virus acquisition or inoculation (1 h being the shortest period tested) and the absence of a latent period for transmission are generally not considered to be compatible with a circulative mode of transmission. Moreover, it has been suggested, on the basis of in vitro results and of the above unconfirmed findings by Cid et al. (2007), that GLRaV particles could interact with obligate symbiotic bacteria harbored in the hemolymph of mealybugs (Gatehouse et al. 2012; Iasur-Kruh et al. 2015). However, this hypothesis seems improbable since non-circulative virions are by nature not present in the hemolymph and therefore unlikely to interact in vivo with these symbionts, or products thereof.

Despite our limited knowledge of the transmission biology of these ampeloviruses, virus-vector specificity has been characterized. Petersen and Charles (1997) reported on differences in transmission efficiency among mealybug life stages, an observation that was later reproduced with different vectors as well as different viruses, including GVA (Tsai et al. 2008; Mahfoudhi et al. 2009; Le Maguet et al. 2012). The finding that early instars of mealybug and soft scales are more efficient vectors, when compared to adults, makes biological sense; adult females are largely immobile, and adult males do not have functional mouthparts. Therefore, virus transmission from plant to plant by adults would be unlikely. However, there are concerns over improper insect handling and the possibility of stylet bundles breaking during experimental manipulations. While this may occur, these observations have now been reproduced by different groups working on distinct insect species as well as virus species. We hypothesize that the observed differences in transmission among life stages are not experimental artifacts but reflect the differences in probing behavior, possibly in relation to the retention site of the virus in the foregut (which remains unknown).

Possible Interactions Between Ampelovirus and Vitivirus During Transmission

The frequent coinfection of grapevine by phloem-limited viruses belonging to two distinct viral genera (*Ampelovirus* and *Vitivirus*) raises interesting questions about their potential mutual effects in virus-plant-vector interrelations. It is known that GVA and other vitiviruses are frequently found together with GLRaV-1, -3, or both (e.g., Engelbrecht and Kasdorf 1990a; Fiore et al. 2011; Goszczynski and Jooste 2003; Ipach and Kling 2008; Zorloni et al. 2004, 2006a), although that is not always the case (Agran et al. 1990; Gribaudo et al. 2009; Milkus et al. 2000). GVA, GVB, and GVE were often transmitted along with GLRaV-1 or -3 by scale insects fed on co-infected vines (Herrbach et al. 2016). However, GVA can also be transmitted alone to grapevine (Bertin et al. 2016a, b), at least when recipient vines were analyzed for infection 4–5 months post inoculation, which may be insufficient to detect the possible presence of the *Ampelovirus*. Engelbrecht and Kasdorf (1990a) and Hommay et al. (2008) suggested that GVA could depend on the presence of a co-infecting *Ampelovirus* for transmission, while the opposite situation, i.e., GLRaV-1 depending on GVA to be transmitted, has also been reported (Fortusini et al. 1997). To date, it is not known whether these results are merely circumstantial or reflect a possible “dependent transmission” or “hetero-assistance” phenomenon, at least for specific virus-vector combinations. If confirmed, such a phenomenon would imply that a putative factor (a helper component or a structural peptide bearing a transmission determinant) of one virus, and necessary to its own transmission, would assist the transmission of the other.

Vector-Virus Molecular Interactions

The non-circulative transmission of plant viruses can be split into two strategies. While many viruses interact directly with insect vectors by means of their coat protein, others require an intermediate nonstructural protein, or helper component, to act as a molecular bridge between virus and the vector (reviewed in Whitfield et al. 2015). The strategy used by grapevine ampeloviruses has yet to be determined; however, potential leads to follow are provided by members of other genera in the *Closteroviridae* family. Firstly, a direct capsid strategy has been described for the transmission of the whitefly-borne *Lettuce infectious yellows virus* (LIYV), a member of the genus *Crinivirus* (Tian et al. 1999; Stewart et al. 2010), and the aphid-borne *Citrus tristeza virus* (CTV, *Closterovirus* genus) (Killiny et al. 2016). Secondly, using an immunofluorescent localization assay, Chen et al. (2011) showed that the minor coat protein (CPm) of LIYV, a component of the virion “tail” (a structure probably common in all closterovirids; Alzhanova et al. 2007; Dolja et al. 2006), is the major determinant of transmission by whiteflies and that LIYV virions were localized to a specific retention site in the foregut of *Bemisia tabaci*. Using

similar approaches, Killiny et al. (2016) confirmed the involvement of the CPM and other tail components of CTV in its transmission by the aphid *Toxoptera citricida*, as well as in retention in the foregut. These authors proposed that this foregut retention is mediated by direct interactions between the vector foregut and the CPM on the virion and is associated with transmission success of LIYV and CTV. This is in contrast to an unrelated non-circulative virus, *Cauliflower mosaic virus* (CaMV, *Caulimovirus*), which localizes to the tip of maxillary stylets in aphids via the helper strategy (Uzest et al. 2007). The viral determinants of transmission and retention sites for any *Ampelovirus*-vector species combination remain undescribed.

Prospects

Although information about the transmission of grapevine-infecting ampeloviruses by mealybugs and soft scales remains limited and fragmented, recent efforts to close many of these current knowledge gaps have provided many insights into the mechanisms underlying the transmission of grapevine leafroll-associated ampeloviruses, as well as the rugose wood-associated vitiviruses. In view of these insights, we propose the following hypotheses and questions, which we hope will be tested and addressed, respectively, by the community at large.

First, we hypothesize that all grapevine-infecting ampeloviruses are transmitted in a semi-persistent manner. This mode of transmission has been demonstrated in the case of GLRaV-3 and *Pl. ficus* (Tsai et al. 2008), and findings reported with other vector-virus species combinations tested are generally compatible with this mode. However, it cannot be ruled out that the transmission mode may possibly differ in some combinations, e.g., with soft scale vectors as compared to mealybugs. Moreover, we hypothesize that differences in transmission efficiency among life stages of the insect vectors are not experimental artifacts but rather reflect an adaptation driven by the fact that adult insects are unlikely virus vectors. Furthermore, we hypothesize that the observed differences in transmission efficiency among various vector-virus species combinations that were investigated are due to a combination of factors, which include viral populations available in source plants, differences in vector probing behaviors and/or in intraspecific vector ability, as well as a variable affinity of virion binding sites.

Finally, the following questions need to be addressed to fill significant knowledge gaps in this research field. The determinants of virus-vector molecular interactions are still unknown: What is/are the viral peptide(s) involved in the recognition by a virus retention site in the vector? Is this *Ampelovirus* retention site located in the vector's foregut, like for LIYV and CTV? Most studies on transmission biology by scale insects were performed in controlled cabinet or greenhouse conditions. However, Blaisdell et al. (2016) reported that transmission efficiency may be lower in the vineyard; therefore, the extrapolation of transmission efficiency data gathered in controlled conditions to vineyards should be investigated. Moreover, how to apply transmission biology data to disease epidemiology is an important prerequisite

for better understanding and forecasting of the spread and impact of grapevine leafroll and rugose wood diseases in vineyards.

Acknowledgments A. Alliaume was supported by a Ph.D. grant from Department SPE of INRA and three French committees for viticulture: *Comité Interprofessionnel du Vin de Champagne*, Epernay; *Bureau Interprofessionnel des Vins de Bourgogne*, Beaune; and *Comité Interprofessionnel des Vins d'Alsace*, Colmar. Financial support from FranceAgriMer is also acknowledged. Grapevine leafroll disease research in the groups of R.P.P. Almeida, M.L. Cooper, and K.M. Daane has been funded by the American Vineyard Foundation and the USDA-NIFA SCRI program. C.A. Prator was supported by an NSF fellowship.

References

- Acheche, H., S. Fattouch, S. M'Hirsi, N. Chabbouh, N. Marzouki, and M. Marrakchi. 2000. Studies on *Grapevine leafroll associated virus 3* transmission by mealybugs in Tunisian grapevines. In *Extended abstracts of the 13th meeting of I.C.V.G., Adelaide, Australia*, 23.
- Agran, M.K., B. Di Terlizzi, D. Boscia, A. Minafra, V. Savino, G.P. Martelli, and F. Askri. 1990. Occurrence of *Grapevine virus A* (GVA) and other closteroviruses in Tunisian grapevines affected by leafroll disease. *Vitis* 29: 43–48.
- Ahmad, A., S. Kaushik, V.V. Ramamurthy, S. Lakhanpaul, R. Ramani, K.K. Sharma, and A.S. Vidyarthi. 2012. Mouthparts and stylet penetration of the lac insect *Kerria lacca* (Kerr) (Hemiptera: Tachardiidae). *Arthropod Structure & Development* 45: 435–441.
- Alliaume A. 2016. Biologie de la vection de l'ampélovirus GLRaV-1 et du vitivirus GVA par la cochenille *Phenacoccus aceris*. PhD thesis, University of Strasbourg, 189 p.
- Almeida, R.P.P., K.M. Daane, V.A. Bell, G.K. Blaisdell, M.L. Cooper, E. Herrbach, and G. Pietersen. 2013. Ecology and management of grapevine leafroll disease. *Frontiers in Microbiology* 4: 1–13.
- Alzhanova, D.V., A.I. Prokhnovsky, V.V. Peremyslov, and V.V. Dolja. 2007. Virion tails of *Beet yellows virus*: Coordinated assembly by three structural proteins. *Virology* 359: 220–226.
- Bahder, B.W., S. Poojari, O.J. Alabi, R.A. Naidu, and D.B. Walsh. 2013. *Pseudococcus maritimus* (Hemiptera: Pseudococcidae) and *Parthenolecanium corni* (Hemiptera: Coccidae) are capable of transmitting *Grapevine leafroll-associated virus 3* between *Vitis x labruscana* and *Vitis vinifera*. *Environmental Entomology* 42: 1292–1298.
- Balachowsky, A. 1937. Les cochenilles de France, du nord de l'Afrique et du Bassin Méditerranéen. Hermann et Cie Ed.
- Belli, G., A. Fortusini, P. Casati, L. Belli, P.A. Bianco, and S. Prati. 1994. Transmission of a grapevine leafroll associated closterovirus by the scale insect *Pulvinaria vitis* L. *Rivista di Patologia Vegetale* 4: 105–108.
- Ben-Dov, Y. 1995. *A systematic catalogue of the mealybugs of the world (Insecta: Homoptera: Coccoidea: Pseudococcidae and Putoidae) with data on geographical distribution, host plants, biology and economic importance*. Hampshire: Intercept Ltd..
- Bertin, S., D. Pacifico, V. Cavalieri, C. Marzachi, and D. Bosco. 2016a. Transmission of *Grapevine virus A* and *Grapevine leafroll-associated viruses 1* and *3* by *Planococcus ficus* and *Planococcus citri* fed on mixed-infected plants. *Annals of Applied Biology* 169: 53–63.
- . 2016b. Transmission of *Grapevine virus A* and *Grapevine leafroll-associated viruses 1* and *3* by *Heliococcus bohemicus* (Hemiptera: Pseudococcidae) nymphs from plants with mixed infection. *Journal of Economic Entomology* 109 (4): 1504–1511.
- Blaisdell, G.K., S. Zhang, K.M. Daane, R.P.P. Almeida. 2012. Patterns of virus transmission from hosts with mixed infections. In *Proceedings of the 17th Congress of I.C.V.G., Davis, California*, 178–179.

- Blaisdell, G.K., S. Zhang, J.R. Bratburd, K.M. Daane, M.L. Cooper, and R.P.P. Almeida. 2015. Interactions within susceptible hosts drive establishment of genetically distinct variants of an insect-borne pathogen. *Journal of Economic Entomology* 108: 1531–1539.
- Blaisdell, G.K., M.L. Cooper, E.J. Kuhn, K.A. Taylor, K.M. Daane, and R.P.P. Almeida. 2016. Disease progression of vector-mediated *Grapevine leafroll-associated virus 3* infection of mature plants under commercial vineyard conditions. *European Journal of Plant Pathology* 146: 105–116.
- Blanc, S., M. Drucker, and M. Uzest. 2014. Localizing viruses in their insect vectors. *Annual Review of Phytopathology* 52: 403–425.
- Boscia, D., V. Savino, A. Minafra, S. Namba, V. Elicio, M.A. Castellano, D. Gonsalves, and G.P. Martelli. 1993. Properties of a filamentous virus isolated from grapevines affected by corky bark. *Archives of Virology* 130: 109–120.
- Bronn, H.G., 1939. Coccina. In: *Klassen und Ordnungen des Tierreichs, Pflugfelder, O. (Ed.), vol. 5, VIII, 121 p., Akademische Verlagsgesellschaft, Leipzig.*
- Cabaleiro, C., and A. Segura. 1997. Some characteristics of the transmission of *Grapevine leafroll-associated virus 3* by *Planococcus citri* Risso. *European Journal of Plant Pathology* 10: 373–378.
- Calatayud, P.A., and B. Le Rü. 2006. *Cassava-Mealybug Interactions*. IRD Éditions ed. Paris: Actiques.
- Calatayud, P.A., Y. Rahbé, W.F. Tjallingii, M. Tertuliano, and B. Le Rü. 1994. Electrically recorded feeding behaviour of cassava mealybug on host and non-host plants. *Entomologia Experimentalis et Applicata* 72: 219–232.
- Caudwell, A., and A. Dalmasso. 1985. Epidemiology and vectors of grapevine viruses and yellows diseases. *Phytopathologia Mediterranea* 24: 170–176.
- Charles, J.G., D. Cohen, J.T.S. Walker, S.A. Forgie, V.A. Bell, and K.C. Breen. 2006. A review of Grapevine leafroll associated virus type 3 (GLRaV-3) for the New Zealand wine industry. Report to N.Z. Winegrowers, HortResearch Client Report, n°18447.
- Chen, A.Y., G.P. Walker, D. Carter, and J.C. Ng, 2011. A virus capsid component mediates virion retention and transmission by its insect vector. In *Proceedings of National Academy of Sciences of the U.S.A.* 108, 16777–16782.
- Cicero, J.M., P.A. Stansly, and J.K. Brown. 2015. Functional anatomy of the oral region of the potato psyllid (Hemiptera: Psylloidea: Trioziidae). *Annals of the Entomological Society of America* 108: 743–761.
- Cid, M., and A. Fereres. 2010. Characterization of the probing and feeding behavior of *Planococcus citri* (Hemiptera: Pseudococcidae) on grapevine. *Annals of the Entomological Society of America* 103: 404–417.
- Cid, M., S. Pereira, C. Cabaleiro, F. Faoro, and A. Segura. 2007. Presence of *Grapevine leafroll associated virus 3* in primary salivary glands of the mealybug vector *Planococcus citri* suggests a circulative transmission mechanism. *European Journal of Plant Pathology* 118: 23–30.
- Conti, M., R.G. Milne, E. Luisoni, and G. Boccoardo. 1980. A closterovirus from a stem-pitting diseased grapevine. *Phytopathology* 70: 394–399.
- Daane, K.M., R.P.P. Almeida, V.A. Bell, J.T.S. Walker, M. Botton, M. Fallahzadeh, M. Mani, J.L. Miano, R. Sforza, V.M. Walton, and T. Zaviezo. 2012. Biology and management of mealybugs in vineyards. In *Arthropod management in vineyards: Pests, approaches, and future directions*, ed. N.J. Bostanian, C. Vincent, and R. Isaacs, 271–307. New York: Springer.
- Danzig, E.M. 1997. Intraspecific variation of taxonomic characters. In *Soft Scale Insects. Their Biology, Natural Enemies and Control*, ed. Y. Ben Dov and C.J. Hodgson, 203–212. Amsterdam: Elsevier.
- de Borbon, C.M., O. Gracia, and G.S. Gomez Talquenca. 2004. Mealybugs and *Grapevine leafroll-associated virus 3* in vineyards of Mendoza, Argentina. *American Journal of Enology and Viticulture* 55: 283–285.
- Dimitrijevic, B. 1973. Some observations on natural spread of grapevine leafroll disease in Yugoslavia. *Rivista di Patologia Vegetale* 9: 114–119.

- Dolja, V.V., J.F. Kreuze, and J.P.T. Valkonen. 2006. Comparative and functional genomics of closteroviruses. *Virus Research* 117: 38–51.
- Dolja, N., and K. Krüger. 2006. *Grapevine leafroll-associated virus 3* transmission efficiency of *Planococcus ficus* and *Pseudococcus longispinus* (Hemiptera: Pseudococcidae). In *Extended abstracts of the 15th meeting of I.C.V.G., Stellenbosch, South Africa*, 191–192.
- Douglas, N., and K. Krüger. 2008. Transmission efficiency of *Grapevine leafroll-associated virus 3* (GLRaV-3) by the mealybugs *Planococcus ficus* and *Pseudococcus longispinus* (Hemiptera: Pseudococcidae). *European Journal of Plant Pathology* 122: 207–212.
- Duso, C. 2013. Problems with scale insects in vineyards. *Atti Accademia Nazionale Italiana di Entomologia* 61: 103–104.
- Elbeaino, T., F. Nunic, M. Digiario, S. Sabanadzovic, and G.P. Martelli. 2009. Partial characterisation of a grapevine leafroll associated virus isolated from an infected Cypriot vine of cv. *Mavro*. *Journal of Plant Pathology* 91: 479–484.
- Engelbrecht, D.J., and G.G.F. Kasdorf. 1985. Association of a closterovirus with grapevines indexing positive for grapevine leafroll disease and evidence for its natural spread in grapevine. *Phytopathologia Mediterranea* 24: 101–105.
- . 1990a. Transmission of grapevine leafroll disease and associated closteroviruses by the vine mealybug, *Planococcus ficus*. *Phytophylactica* 22: 341–346.
- . 1990b. Field spread of corky bark, fleck, leafroll and Shiraz decline diseases and associated viruses in South African grapevines. *Phytophylactica* 22: 347–354.
- Fiore, N., A. Zamorano, R. Rivera, F. Gonzalez, E. Aballay, and J. Montealegre. 2011. Grapevine viruses in the Atacama region of Chile. *Journal of Phytopathology* 159: 743–750.
- Foldi, I. 1997. Internal anatomy of the adult female. In *Soft scale insects. Their biology, natural enemies and control*, ed. Y. Ben Dov and C.J. Hodgson, 73–90. Amsterdam: Elsevier.
- Fortusini, A.G., G. Scattini, S. Prati, S. Cinquanta, and G. Belli. 1997. Transmission of *Grapevine leafroll virus-1* (GLRaV-1) and *Grapevine virus A* (GVA) by scale insects. In *Extended abstracts of the 12th meeting of I.C.V.G., Lisbon*, 121–122.
- Garau, R., V.A. Prota, D. Boscia, M. Fiori, and U. Prota. 1995. *Pseudococcus affinis* Mask., new vector of grapevine trichoviruses A and B. *Vitis* 34: 67–68.
- García, M., B. Denno, D.R. Miller, G.L. Miller, Y. Ben-Dov, and N.B. Hardy. 2016. *ScaleNet: A literature-based model of scale insect biology and systematics*. <http://scalenet.info>. Accessed: 20 Jan 2016.
- Gatehouse, L.N., P. Sutherland, S.A. Forgie, R. Kaji, and J.T. Christeller. 2012. Molecular and histological characterization of primary (*Betaproteobacteria*) and secondary (*Gammaproteobacteria*) endosymbionts of three mealybug species. *Applied and Environmental Microbiology* 78: 1187–1197.
- Geiger, C.A., and K.M. Daane. 2001. Seasonal movement and distribution of the grape mealybug (Homoptera: Pseudococcidae): Developing a sampling program for San Joaquin Valley vineyards. *Journal of Economic Entomology* 94: 291–301.
- Goheen, A.C. 1988. Leafroll. In *Compendium of grape diseases*, ed. R.C. Pearson and A.C. Goheen, 52. St Paul MN: APS Press.
- Golan, K., K. Rubinowska, K. Kmiec, I. Kot, E. Górska-Drabik, B. Łagowska, and W. Michałek. 2015. Impact of scale insect infestation on the content of photosynthetic pigments and chlorophyll fluorescence in two host plant species. *Arthropod-Plant Interactions* 9: 55–65.
- Golino, D.A., S.T. Sim, R.J. Gill, and A. Rowhani. 1994. Evidence that California mealybug species can transmit grapevine leafroll-associated viruses. *American Journal of Enology and Viticulture* 45: 356.
- Golino, D.A., S.T. Sim, and A. Rowhani. 1995. Transmission studies of grapevine leafroll associated virus and grapevine corky bark associated virus by the obscure mealybug. *American Journal of Enology and Viticulture* 46: 408.
- Golino, D., S. Sim, R. Gill, and A. Rowhani. 2000. Four species of California mealybugs can transmit leafroll virus. *American Journal of Enology and Viticulture* 50: 1999–2000.

- Golino, D.A., S.T. Sim, R. Gill, and A. Rowhani. 2002. California mealybugs can spread grapevine leafroll disease. *California Agriculture* 56: 196–201.
- Goszczynski, D.E., and A.E.C. Jooste. 2003. Shiraz disease (SD) is transmitted by mealybug *Planococcus ficus* and associated with *Grapevine virus A* (GVA). In *Proceedings of the 14th Congress of I.C.V.G., Locorotondo, Italy*, 219–220.
- Griboaud, I., G. Gambino, S. Bertin, D. Bosco, A. Cotroneo, and F. Mannini. 2009. Monitoring the spread of viruses after vineyard replanting with heat-treated clones of *Vitis vinifera* ‘Nebbiolo’. *Journal of Plant Pathology* 91: 741–744.
- Gutierrez, A.P., K.M. Daane, L. Ponti, V.M. Walton, and C.K. Ellis. 2008. Prospective evaluation of the biological control of vine mealybug: Refuge effects and climate. *Journal of Applied Ecology* 45: 524–536.
- Habili, N. 2015. Grapevine leafroll – Australia: Vector. *ProMED Plants*. <http://www.promedmail.org>, published 2015-12-25.
- Heriot, A.D. 1936. The crumena of the *Coccidae* and the *Adelges*. *Proceedings of the Entomological Society of British Columbia* 33: 22–24.
- Herrbach, E., J. Le Maguet, and G. Hommay. 2016. Virus transmission by mealybugs and soft scales (Hemiptera, Coccoidea). In *Vector-mediated transmission of plant pathogens*, ed. J.K. Brown, 147–161. St Paul MN: APS Press.
- Hommay, G., V. Komar, O. Lemaire, and E. Herrbach. 2008. *Grapevine virus A* transmission by larvae of *Parthenolecanium corni*. *European Journal of Plant Pathology* 121: 185–188.
- Huang, F., W.F. Tjallingii, P. Zhang, J. Zhang, Y. Lu, and J. Lin. 2012. EPG waveform characteristics of solenopsis mealybug stylet penetration on cotton. *Entomologia Experimentalis et Applicata* 143: 47–54.
- Huang, J., P.J. Zhang, J. Zhang, Y.B. Lu, F. Huang, and M.J. Li. 2013. Chlorophyll content and chlorophyll fluorescence in tomato leaves infested with an invasive mealybug, *Planococcus solenopsis* (Hemiptera: Pseudococcidae). *Environmental Entomology* 42: 973–979.
- Hull, R. 2016. *Plant Virology*. Amsterdam: Elsevier & Academic Press.
- Iasur-Kruh, L., L. Taha-Salaime, W.E. Robinson, R. Sharon, S. Droby, S.J. Perlman, and E. Zchori-Fein. 2015. Microbial associates of the vine mealybug *Planococcus ficus* (Hemiptera: Pseudococcidae) under different rearing conditions. *Microbial Ecology* 69: 204–214.
- Ioannou, N., A. Hadjinikolis, and A. Hadjinikoli. 2000. Transmission of *Grapevine leafroll-associated virus 3* (GLRaV-3) by two mealybug species, *Planococcus ficus* and *P. citri*. *Phytopathologia Mediterranea* 30: 317–318.
- Ipach, U., and L. Kling. 2008. *Grapevine virus A* in Rheinland-Pfalz: Vorkommen und Bedeutung für den deutschen Weinbau. *Gesunde Pflanzen* 60: 63–66.
- Jooste, A.E.C., and K. Krüger. 2015. Mealybug transmission efficiency of four *Grapevine leafroll-associated virus 3* (GLRaV-3) genetic variants. In *Proceedings of the 18th Meeting of I.C.V.G., Ankara, Turkey*, 42–43.
- Jordan, D. 1993. Spread of grapevine leafroll and its associated virus in New Zealand vineyards. In *Proceedings of the 11th meeting of I.C.V.G., Montreux, Switzerland*, 113–114.
- Killiny, N., S.J. Harper, S. Alfaress, C. El Mohtar, and W.O. Dawson. 2016. Minor coat and heat-shock proteins are involved in binding of citrus tristeza virus to the foregut of its aphid vector, *Toxoptera citricida*. *Applied and Environmental Microbiology* 82 (21): 6294–6302.
- Klaassen, V.A., S.T. Sim, G.S. Dangel, F. Osman, M. Al Rwahnih, A. Rowhani, and D.A. Golino. 2011. *Vitis californica* and *Vitis californica* x *Vitis vinifera* hybrids are hosts for *Grapevine leafroll-associated virus-2* and *-3* and *Grapevine virus A* and *B*. *Plant Disease* 95: 657–665.
- Kosztarab, M., and F. Kozar. 1988. *Scale insects in Central Europe*. Budapest: Akadémiai Kiado.
- Krüger, K., and N. Douglas. 2009. Transmission *Grapevine leafroll-associated virus 3* (GLRaV-3) by three soft scale insect species (Hemiptera: Coccidae) and notes on their developmental biology on grapevine. In *Extended abstracts of the 16th meeting of I.C.V.G., Dijon, France*, 281–282.

- Krüger, K., and N. Douglas-Smit. 2013. *Grapevine leafroll-associated virus 3* (GLRaV-3) transmission by three soft scale insect species (Hemiptera: Coccidae) with notes on their biology. *African Entomology* 21: 1–8.
- Krüger, K., D. Saccaggi, and N. Douglas. 2006. *Grapevine leafroll-associated virus 3* – vector interactions: Transmission by the mealybugs *Planococcus ficus* and *Pseudococcus longispinus* (Hemiptera: Pseudococcidae). In *Extended abstracts of the 15th meeting of I.C.V.G., Stellenbosch, South Africa*, 130–131.
- Krüger, K., D.L. Saccaggi, M. van der Merwe, and G.G.F. Kasdorf. 2015. Acquisition, inoculation and retention by the mealybugs *Planococcus ficus* and *Pseudococcus longispinus* (Hemiptera: Pseudococcidae). *South African Journal of Enology and Viticulture* 36: 223–230.
- Kuniyuki, H., V.A. Yuki, C.L. Costa, and A.S. Costa. 1995. Não transmissão de três vírus da videira através do afídeo *Aphis illinoisensis*. *Fitopatologia Brasileira* 20: 513–514.
- Kuniyuki, H., R. Gioria, J.A.M. Rezende, C.G. Willink, J.P.S. Novo, and V.A. Yuki. 2006. Transmissão experimental do *Grapevine virus B* pela cochonilha *Pseudococcus longispinus* Targioni-Tozzetti (Hemiptera: Pseudococcidae). *Summa Phytopathologica* 32: 151–155.
- La Notte, P., N. Buzkan, E. Choueiri, A. Minafra, and G.P. Martelli. 1997. Acquisition and transmission of *Grapevine virus A* by the mealybug *Pseudococcus longispinus*. *Journal of Plant Pathology* 78: 79–85.
- Laimer, M., O. Lemaire, E. Herrbach, V. Goldschmidt, A. Minafra, P. Bianco, and T. Wetzel. 2009. Resistance to viruses, phytoplasmas and their vectors in grapevine in Europe: A review. *Journal of Plant Pathology* 91: 7–23.
- Le Maguet, J., 2012. *Épidémiologie de l'enroulement viral de la vigne dans les vignobles français septentrionaux et transmission par cochenilles vectrices*. PhD thesis, University of Strasbourg, 204 p.
- Le Maguet, J., M. Beuve, E. Herrbach, and O. Lemaire. 2012. Transmission of six ampeloviruses and two vitiviruses to grapevine by *Phenacoccus aceris*. *Phytopathology* 102: 717–723.
- Leopold, R.A., T.P. Freeman, J.S. Buckner, and D.R. Nelson. 2003. Mouthpart morphology and stylet penetration of host plants by the glassy-winged sharpshooter, *Homalodisca coagulata* (Homoptera: Cicadellidae). *Arthropod Structure & Development* 32: 189–199.
- Mahfoudhi, N., M. Digiario, and M.H. Dhoubi. 2009. Transmission of grapevine leafroll viruses by *Planococcus ficus* (Hemiptera: Pseudococcidae) and *Ceroplastes rusci* (Hemiptera: Coccidae). *Plant Disease* 93: 999–1002.
- Maree, H.J., R.P.P. Almeida, R. Bester, K.M. Chooi, D. Cohen, V.V. Dolja, M.F. Fuchs, D.A. Golino, A.E.C. Jooste, G.P. Martelli, R.A. Naidu, A. Rowhani, P. Saldarelli, and J.T. Burger. 2013. Grapevine leafroll-associated virus 3. *Frontiers in Microbiology* 4 (82): 1–21.
- Marotta, S., and A. Tranfaglia. 1997. Seasonal history; diapause. In *Soft scale insects. Their biology, natural enemies and control*, ed. Y. Ben Dov and C.J. Hodgson, 343–350. Amsterdam: Elsevier.
- Martelli, G.P. 2014a. Grapevine leafroll. *Journal of Plant Pathology* 96 (1S): 51–70.
- . 2014b. Rugose wood complex. *Journal of Plant Pathology* 96 (1S): 73–88.
- Martin, R.R., K.C. Eastwell, A. Wagner, S. Lamprecht, and I.E. Tzanetakis. 2005. Survey for viruses of grapevine in Oregon and Washington. *Plant Disease* 89: 763–766.
- Materazzi, A., E. Triolo, and A. Lucchi. 1998. No evidence for the transmission of three grapevine viruses by *Metcalfa pruinosus* (Say) (Homoptera, Fulgoroidea). *Journal of Plant Pathology* 30: 175.
- McKenzie, H.L. 1967. *Mealybugs of California with taxonomy, biology and control of North American species*. Berkeley: University of California Press.
- Mikona, C., and W. Jelkmann. 2010. Replication of *Grapevine leafroll-associated virus 7* (GLRaV-7) by *Cuscuta* species and its transmission to herbaceous plants. *Plant Disease* 94: 471–476.
- Milkus, B.N., R.N. Goodman, and W.J. Avery Jr. 2000. Detection of viruses in grapevines imported in Missouri from Eastern European countries. *Phytopathologia Mediterranea* 39: 310–312.

- Naidu, R., A. Rowhani, M. Fuchs, D. Golino, and G.P. Martelli. 2014. Grapevine leafroll: A complex viral disease affecting a high-value fruit crop. *Plant Disease* 98: 1172–1185.
- Naidu, R.A., H.J. Maree, and J.T. Burger. 2015. Grapevine leafroll disease and associated viruses: A unique pathosystem. *Annual Review of Phytopathology* 53: 61334.
- Nakano, M., R. Nakaune, and S. Komazaki. 2003. Mealybug transmission of grapevine viruses in Japan. In *Proceedings of the 14th Congress of I.C.V.G., Locorotondo, Italy*, 218.
- Nakaune, R., S. Toda, M. Mochizuki, and M. Nakano. 2008. Identification and characterization of a new vitivirus from grapevine. *Archives of Virology* 153: 1827–1832.
- Oliver, J.E., and M. Fuchs. 2011. Tolerance and resistance to viruses and their vectors in *Vitis* sp., a virologist's perspective of the literature. *American Journal of Enology and Viticulture* 62: 438–451.
- Pedroso, E.I., O.A. Sequeira, M.E.G. Pinto, and V. Simoes. 1991. Ensaios de transmissão de vírus de videira por cochonilhas. *Ciência e Técnica Vitivinícola* 10: 39–46.
- Pesson, P., 1944. Contribution à l'étude morphologique et fonctionnelle de la tête, de l'appareil buccal et du tube digestif des femelles de coccides. Imprimerie Nationale.
- Petersen, C.L., and J.G. Charles. 1997. Transmission of grapevine leafroll-associated closteroviruses by *Planococcus longispinus* and *P. calceolariae*. *Plant Pathology* 46: 509–515.
- Pollard, D.G., 1969. Directional control of the stylets in phytophagous Hemiptera. In *Proceedings of the Royal Entomological Society of London*, A, 44, 173–185.
- . 1973. Plant penetration by feeding aphids (Hemiptera: Aphidoidea): A review. *Bulletin of Entomological Research* 62: 631–714.
- Rosciglione, B., and M.A. Castellano. 1985. Further evidence that mealybugs can transmit *Grapevine virus A* (GVA) to herbaceous hosts. *Phytopathologia Mediterranea* 24: 186–188.
- Rosciglione, B., and P. Gugerli. 1989. Transmission of grapevine leafroll disease and an associated closterovirus to healthy grapevine by the mealybug *Planococcus ficus*. *Phytoparasitica* 17: 63.
- Rosciglione, B., M.A. Castellano, G.P. Martelli, V. Savino, and G. Cannizzaro. 1983. Mealybug transmission of *Grapevine virus A*. *Vitis* 22: 331–347.
- Sandanayaka, W.R.M., A.G. Blouin, E. Prado, and D. Cohen. 2013. Stylet penetration behaviour of *Pseudococcus longispinus* in relation to acquisition of *Grapevine leafroll virus 3*. *Arthropod-Plant Interactions* 7: 137–146.
- Sciancalepore, A., A. Campanale, P. La Notte, A. Minafra, F. Maghuli, S. Leopold, M. Laimer, V. Savino, and G.P. Martelli. 2006. Infection of CP-transgenic grapevines with vitiviruses by grafting, mealybug transmission and *Nicotiana* heterografting. In *Extended abstracts of the 15th meeting of I.C.V.G., Stellenbosch, South Africa*, 250–251.
- Scotto, C., B. Conti, A. Panattoni, and E. Triolo. 2009. Acquisition and transmission of GLRaV-1 (*Grapevine leafroll-associated ampelovirus 1*) by *Planococcus citri* (Risso) (Hemiptera Pseudococcidae). In *Extended abstracts of the 16th meeting of I.C.V.G., Dijon, France*, 322–323.
- Sforza, R., E. Boudon-Padieu, and C. Greif. 2003. New mealybug species vectoring *Grapevine leafroll associated viruses-1* and *-3* (GLRaV-1 and -3). *European Journal of Plant Pathology* 109: 975–981.
- Sim, S.T., A. Rowhani, R. Alkowni, and D.A. Golino. 2003. Experimental transmission of *Grapevine leafroll-associated virus 5* and *9* by longtailed mealybugs. In *Proceedings of the 14th Congress of I.C.V.G., Locorotondo, Italy*, 211–212.
- Soule, M.J., K.C. Eastwell, and R.A. Naidu. 2006. First report of *Grapevine leafroll-associated virus-3* in American *Vitis* spp. grapevines in Washington State. *Plant Disease* 90: 1461.
- Stewart, L.R., V. Medina, T. Tian, M. Turina, B.W. Falk, and J.C.K. Ng. 2010. A mutation in the *Lettuce infectious yellows virus* minor coat protein disrupts whitefly transmission but not *in planta* systemic movement. *Journal of Virology* 84: 12165–12173.
- Tanne, E. 1988. Evidence for the transmission by mealybugs to healthy grapevines of a clostero-like particle associated with grapevine leafroll disease. *Phytoparasitica* 16: 288.
- Tanne, E., Y. Ben-Dov, and B. Raccach. 1989a. Transmission of the corky-bark disease by the mealybug *Planococcus ficus*. *Phytoparasitica* 17: 55.

- . 1989b. Transmission of the closterolike particles associated with grapevine leafroll by mealybugs (Pseudococcidae) in Israel. In *Proceedings of the 9th meeting of I.C.V.G., Kiryat Anavim, Israel*, 71–73.
- . 1993. Mealybug transmission of corky bark disease and an associated virus to healthy grapevine. In *Proceedings of the 11th meeting of I.C.V.G., Montreux, Switzerland*, 71–73.
- Teliz, D., D. Gonsalves, J. Hu, and D.K. Hummer. 1989. Detection of grapevine leafroll-associated closterovirus in recently infected tissues in New York and spread of the disease in Mexico. In *Proceedings of the 9th meeting of I.C.V.G., Kiryat Anavim, Israel*, 109–115.
- Tian, T., L. Rubio, H.H. Yeh, B. Crawford, and B.W. Falk. 1999. *Lettuce infectious yellows virus: In vitro* acquisition analysis using partially purified virions and the whitefly *Bemisia tabaci*. *Journal of General Virology* 80: 1111–1117.
- Timm, A.E., and A. Reinecke. 2014. First insights into grapevine transcriptional responses as a result of vine mealybug *Planococcus ficus* feeding. *Arthropod-Plant Interactions* 8: 495–505.
- Tjallingii, W.F. 1988. Electrical recording of stylet penetration activities. In *Aphids. Their biology, natural enemies and control*, ed. A.K. Minks and P. Harrewijn, 95–108. Amsterdam: Elsevier.
- Tsai, C.W., J. Chau, L. Fernandez, D. Bosco, K.M. Daane, and R.P.P. Almeida. 2008. Transmission of *Grapevine leafroll-associated virus 3* by the vine mealybug (*Planococcus ficus*). *Phytopathology* 98: 1093–1098.
- Tsai, C.W., A. Rowhani, D.A. Golino, K.M. Daane, and R.P.P. Almeida. 2010. Mealybug transmission of grapevine leafroll viruses: An analysis of virus–vector specificity. *Phytopathology* 100: 830–834.
- Tsai, C.W., D. Bosco, K.M. Daane, and R.P.P. Almeida. 2011. Effect of host plant tissue on the vector transmission of *Grapevine leafroll-associated virus 3*. *Journal of Economic Entomology* 104: 1480–1485.
- Uzest, M., D. Gargani, M. Drucker, E. Hébrard, E. Garzo, T. Candresse, A. Fereres, and S. Blanc. 2007. A protein key to plant virus transmission at the tip of the insect vector stylet. In *Proceedings of National Academy of Sciences of the U.S.A.* 104, 17959–17964.
- Uzest, M., D. Gargani, A. Dombrovsky, C. Cazevieuille, D. Cot, and S. Blanc. 2010. The “acrostyle”: A newly described anatomical structure in aphid stylets. *Arthropod Structure & Development* 39: 221–229.
- Wakgari, W.M., and J.H. Giliomee. 2005. Description of adult and immature females of six mealybug species (Hemiptera: Pseudococcidae) found on Citrus in South Africa. *African Entomology* 13: 281–332.
- Waterworth, R.A., I.M. Wright, and J.G. Millar. 2011. Reproductive biology of three cosmopolitan mealybug (Hemiptera: Pseudococcidae) species, *Pseudococcus longispinus*, *Pseudococcus viburni*, and *Planococcus ficus*. *Annals of the Entomological Society of America* 104: 249–260.
- Whitfield, A.E., B.W. Falk, and D. Rotenberg. 2015. Insect vector-mediated transmission of plant viruses. *Virology* 479–480: 278–289.
- Wistrom, C.M., G.K. Blaisdell, L.R. Wunderlich, R.P.P. Almeida, and K.M. Daane. 2016. *Ferrisia gilli* Gullan (Hemiptera: Pseudococcidae) transmits grapevine leafroll associated viruses. *Journal of Economic Entomology* 109: 1519–1523.
- Zaviezo, T., E. Cadena, M.F. Flores, and J. Bergmann. 2010. Influence of different plants substrates on development and reproduction for laboratory rearing of *Pseudococcus calceolariae* (Maskell) (Hemiptera: Pseudococcidae). *Ciencia e Investigación Agraria* 37: 31–37.
- Zorloni, A., S. Cinquanta, S. Prati, and P.A. Bianco. 2003. Transmission of an Italian isolate of *Grapevine leafroll-associated virus 3* (GLRaV-3) by the mealybug *Heliococcus bohemicus*. In *Proceedings of the 14th Congress of I.C.V.G., Locorotondo, Italy*, 214–215.
- Zorloni, A., S. Prati, P.A. Bianco, and G. Belli. 2004. Further data on the experimental transmission of *Grapevine leafroll-associated virus 1* and *3* and of *Grapevine virus A* by mealybugs. *Journal of Plant Pathology* 86: 339–340.

- Zorloni, A., Prati, S., Bianco, P.A., Belli, G. 2006a. Transmission of *Grapevine virus A* and *Grapevine leafroll associated virus 3* by *Heliococcus bohemicus*. *Journal of Plant Pathology* 88: 325–328.
- Zorloni, A., S. Prati, S. Chiesa, and P.A. Bianco. 2006b. Transmission of *Grapevine leafroll associated virus 3* by the soft scale *Neopulvinaria innumerabilis*. *Journal of Plant Pathology* 88: S61.
- Zou, Y., and J.G. Millar. 2015. Chemistry of the pheromones of mealybugs and scale insects. *Natural Product Reports* 32: 1067–1113.

Chapter 25

Ectoparasitic Nematode Vectors of Grapevine Viruses

P. Andret-Link, A. Marmonier, L. Belval, K. Hleibieh,
C. Ritzenthaler, and G. Demangeat

Abstract Nematodes of the genera *Longidorus*, *Paralongidorus*, and *Xiphinema* in the family *Longidoridae* can parasitize grapevine roots. These ectoparasitic soil-borne nematodes live in proximity to the rhizosphere and use a stylet to feed on root cells. During the feeding process, some nematodes are able to acquire and transmit nepoviruses, the causal agents of grapevine degeneration disease. The association between nematode vectors and the virus(es) they transmit is specific. This specificity is linked to the nature, site, and mechanism of virus retention. Here, we present and discuss major features of the interaction between nematodes and viruses with regard to the biology, ecology, and life cycle of the nematodes. In addition, we discuss how reverse genetics in combination with virus structural data have recently provided insights into the specificity of the transmission process through the identification of a cavity-like domain on the virion surface that could be recognized by a ligand within the nematode feeding apparatus. Finally, we offer some perspectives on future research to further advance nematode-virus interactions.

Keywords Fanleaf degeneration • Grapevine • *Longidoridae* • Nepovirus • Specificity • Transmission • Vector

P. Andret-Link • A. Marmonier • G. Demangeat (✉)
SVQV, INRA, Université de Strasbourg, 68000 Colmar, Strasbourg, France
e-mail: gerard.demangeat@inra.fr

L. Belval
SVQV, INRA, Université de Strasbourg, 68000 Colmar, Strasbourg, France
Institut de Biologie Moléculaire des Plantes, CNRS/Université de Strasbourg,
12 rue du Général Zimmer, 67084 Strasbourg, France

K. Hleibieh • C. Ritzenthaler
Institut de Biologie Moléculaire des Plantes, CNRS/Université de Strasbourg,
12 rue du Général Zimmer, 67084 Strasbourg, France

Introduction

Soil-inhabiting nematodes cause economically important phytosanitary problems on a global scale by parasitizing many crops such as vegetables, ornamentals, fruit trees, and grapevines. Plant-parasitic nematodes are estimated to reduce total crop production by 8.8–14.6% with losses of €90–140 billion worldwide (Abad et al. 2008; Nicol et al. 2011; Singh et al. 2013).

Grapevine roots can be parasitized by different plant-parasitic nematodes, including root-knot (*Meloidogyne* spp.), lesion (*Pratylenchus* spp.), citrus (*Tylenchulus semipenetrans*), ring (*Mesocriconema* spp.), needle (*Longidorus* spp.), and dagger (*Xiphinema* spp.) nematodes (Nicol et al. 1999). One of the most serious viral diseases of grapevine is fanleaf degeneration. This disease is caused by viruses transmitted by soil-borne ectoparasitic nematode species from the genera *Longidorus*, *Paralongidorus*, and *Xiphinema* of the family *Longidoridae*. Among these nematodes, *Xiphinema index*, the vector of *Grapevine fanleaf virus* (GFLV), has the most significant impact on grapevine production (Andret-Link et al. 2004a). Within more than 4100 species of plant-parasitic nematode, *Xiphinema index* is ranked 8th on the top 10 list of nematodes for their scientific and economic importance (Jones et al. 2013).

Fifteen viruses of the family *Secoviridae* are responsible for fanleaf degeneration, but only half of them are transmitted by *Longidoridae* nematode species. The association of a nematode and its virus(es) is highly specific. This specificity is determined by unique viral determinant(s) and the ability of the nematode to retain the virus at specific sites (probably via a receptor) in the alimentary tract.

The development of molecular tools and a better understanding of the biology of nepoviruses have facilitated the study of their interactions with nematode vectors. This chapter offers a comprehensive review of the association between *Longidoridae* and the viruses they transmit to grapevine. It also summarizes recent information on the biology of transmission and our current knowledge of the viral determinants of transmission with a special emphasis on GFLV and its vector *X. index*.

Longidoridae Nematode Vectors of Grapevine Viruses

The first experimental evidence of a plant virus transmission by a plant-parasitic nematode was provided in the late 1950s (Hewitt et al. 1958). These investigators demonstrated that the soil-borne ectoparasitic nematode *Xiphinema index* transmits GFLV, the main agent responsible for fanleaf degeneration (Fig. 25.1, Table 25.1). Soon after, Jha and Posnette (1959) and Harrison and Cadman (1959) documented *X. diversicaudatum* as the vector of *Arabidopsis mosaic virus* (ArMV), a nepovirus closely related to GFLV (Fig. 25.1, Table 25.1). From these initial discoveries, over 40 associations between nematodes and viruses have been described in the literature, but many of them were quickly revoked because evidence for a strict

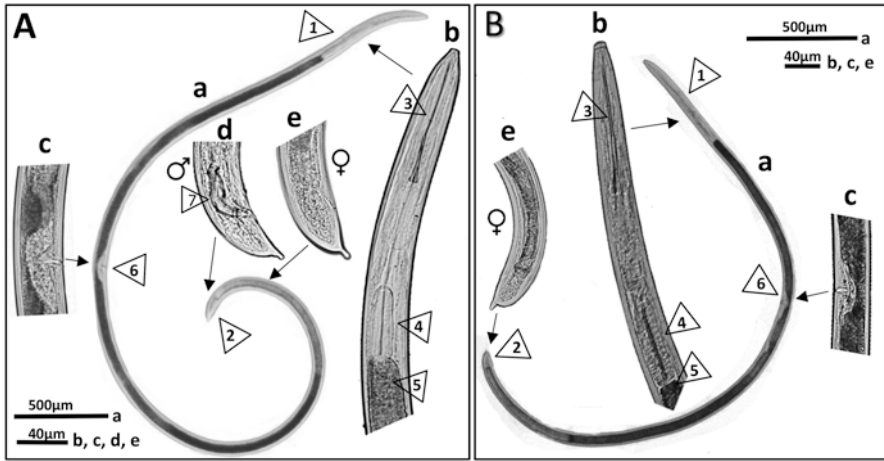

Fig. 25.1 Photographs of the dagger nematode *Xiphinema diversicaudatum* (a) and *Xiphinema index* (b). (a) A full body length with arrows 1 and 2 indicating the head and the tail, respectively; (b) head region showing a full stylet (arrow 3) and the esophageal bulb (arrow 4) followed by the intestine (arrow 5); (c) lateral view of the vulva (arrow 6); (d) lateral view of a male tail region with paired spicules (arrow 7). As males are very scarce for *X. index* (1 male for 1000 females), the male lateral view is not represented; (e) lateral view of the female tail. Scale bars are indicated for each element

interaction between a vector and a virus, as established by Trudgill et al. (1983), was missing.

Five *Longidorus*, one *Paralongidorus*, and seven *Xiphinema* species are established as vectors of grapevine soil-borne viruses (Table 25.1). Nematode vectors of grapevine viruses are essentially endemic in Europe and on the American continent. Some nematode species are of European origin, while others are of North American origin. Some of them likely spread from Europe and the North American continent to South America, South Africa, China, Asia, Australia, and New Zealand with their associated viruses (Brown and MacFarlane 2001). Some virus-nematode associations have a wide geographical distribution. For example, *X. index* and GFLV occur worldwide in temperate regions where *Vitis* spp. are cultivated (Andret-Link et al. 2004a).

It is commonly accepted that *X. index* has been introduced to vineyards from the Middle East, where it has been found in natural woodlands in association with wild grapevines and where GFLV is believed to have originated (Hewitt 1985; Mojtahedi et al. 1980). From this region both *X. index* and GFLV were distributed to grapevine-growing areas of the world across the Mediterranean basin by the Phoenicians, Greeks, and Romans. *X. diversicaudatum*, the specific vector of ArMV, is mainly present in Europe and has been reported in Asia, India, Canada, and countries of the former Soviet Union (Adekunle et al. 2006; Brown and MacFarlane 2001; Sturhan et al. 1997; Taylor and Brown 1997). Also, *L. elongatus*, the vector of *Tomato black ring virus* (TBRV), has a wide distribution in Europe but is also present in North

Table 25.1 *Longidoridae* nematode vectors and their associated viruses

Nematode vector species		Virus names	Acronym	Main geographical location
<i>Longidorus</i>	<i>apulus</i>	Artichoke Italian latent virus	AILV	Italy
	<i>attenuatus</i>	Tomato black ring virus	TBRV	Europe
	<i>diadecturus</i>	Peach rosette mosaic virus	PRMV	North America
	<i>elongatus</i>	Tomato black ring virus	TBRV	Europe
		Raspberry ringspot virus	RpRSV	
<i>macrosoma</i>	Raspberry ringspot virus	RpRSV	Europe	
<i>Paralongidorus</i>	<i>maximus</i>	Raspberry ringspot virus (grapevine strain)	RpRSV	Europe
<i>Xiphinema</i>	<i>americanum sensu lato</i>	Peach rosette mosaic virus	PRMV	Worldwide
		Tobacco ringspot virus	TRSV	
		Tomato ringspot virus	ToRSV	
	<i>americanum sensu stricto</i>	Tobacco ringspot virus	TRSV	North America
		Tomato ringspot virus	ToRSV	
	<i>bricolensis</i>	Tomato ringspot virus	ToRSV	North America
	<i>californicum</i>	Tobacco ringspot virus	TRSV	North and South America
		Tomato ringspot virus	ToRSV	
	<i>diversicaudatum</i>	Arabis mosaic virus	ArMV	Europe
		Strawberry latent ringspot virus ^a	SLRSV	
<i>index</i>	Grapevine fanleaf virus	GFLV	Worldwide	
<i>rivesi</i>	Tobacco ringspot virus	TRSV	North and South America	
	Tomato ringspot virus	ToRSV	Europe	

^aPreviously a tentative member of nepovirus, now an unassigned species of the family *Secoviridae*

America and South Africa (Hooper 1973). It was reported in Thailand, India, and Pakistan (Sturhan et al. 1997) and from a single location in South Australia (McLeod et al. 1994).

L. macrosoma transmits the type strain of *Raspberry ringspot virus* (RpRSV) and is widely distributed in Europe. It is present on grapevine roots on the west side of the Rhine valley in Germany, in Italy, and in Tajikistan (Brown et al. 1990). This nematode is fairly common in the British Isles, Belgium, England, France, the Netherlands, and Switzerland (Taylor and Brown 1997). However, the grapevine strain of RpRSV is transmitted by *Paralongidorus maximus* (Jones et al. 1994). Although *P. maximus* is restricted to Europe, a population of *P. maximus* was found in the rhizosphere of grapevines at three localities in the Western Cape Province in South Africa (Swart et al. 1996). For other vector-virus associations present in Europe, the geographical distribution is rather limited to a country or a region. For example, *L. apulus* transmits *Italian Artichoke latent virus* (AILV) and is only recorded in Italy (Brown and MacFarlane 2001; Lamberti and Roca 1987).

X. americanum sensu lato (*s.l.*) is a complex group of polyphagous plant ectoparasitic nematodes that comprises 51 species (Van der Gaag et al. 2010). This group includes *X. americanum sensu stricto* (*s.s.*), *X. bricolensis*, *X. californicum*, and *X. rivesi*, among others to be identified. These nematodes transmit *Tobacco ringspot virus* (TRSV), *Tomato ringspot virus* (ToRSV), and *Peach rosette mosaic virus* (PRMV) to grapevine (Table 25.1) (Brown et al. 1994; Pinkerton et al. 2008; Van der Gaag et al. 2010). *X. americanum s.l.* is present on all continents, except Oceania and Antarctica, and is highly polyphagous (Hockland and Prior 2009; Lamberti et al. 2000; Van der Gaag et al. 2010). PRMV is transmitted by *X. americanum* (Allen et al. 1984) and also by *L. diadecturus*, which is distributed in central USA (Robbins and Brown 1991) where it affects the production of grape, peach, and blueberry (Brown et al. 1993; Nyczepir and Halbrendt 1993; Stace-Smith and Ramsdell 1987). *X. rivesi* is one of the vectors of ToRSV and TRSV (Robbins and Brown 1991). It occurs in North and South America and is present in Europe (Lamberti et al. 2000; Sirca et al. 2007). This species may have been introduced from North America to Europe (Lamberti and Cianco 1993), but no transmission of ToRSV and TRSV has been documented so far in European vineyards. However, transmission of ToRSV and TRSV in controlled conditions was recently demonstrated with a *X. rivesi* population in Slovenia (Sirca et al. 2007), suggesting a potential to transmit these two nepoviruses in vineyards. *X. americanum s.s.* is widespread in North America and locally present in Africa whereas *X. californicum*, which transmits TRSV and ToRSV, is reported from several states in North America and several countries in South America (Robbins and Brown 1991). *X. bricolensis* is a vector of ToRSV and is relatively widespread along the Pacific coast of North America, including California and British Columbia in Canada (Brown et al. 1994; Cho and Robbins 1991; Graham et al. 1988).

X. italiae is mainly established on grapevine and present in 13 European countries particularly of the Mediterranean region. *X. italiae* was reported to transmit GFLV (Cohn et al. 1970); however, extensive surveys of vineyards never confirmed these findings (Catalano et al. 1992; Martelli and Taylor 1990). Therefore, *X. index*

is likely the sole vector of GFLV that is of epidemiological importance in vineyards. Finally, the presence of *L. juvenilis* was recorded in association with grapevines infected with *Raspberry bushy dwarf virus* (RBDV) in Slovenia. RBDV from the genus *Idaeovirus* was detected in *L. juvenilis* specimens collected in the field and other specimens isolated from infested soil after 4 and 8 months of storage (Mavric Pleško et al. 2009). More work is needed to ascertain the role of *L. juvenilis* in the transmission of RBDV to grapevine.

Longidoridae spp. feeding on roots may lead to reduced or stunted vine growth. This damage is often more pronounced on plants used for rearing the nematode in the greenhouse than on field-grown plants (Taylor and Brown 1997). Direct damage caused by *Longidoridae* does not generally have a major economic impact in vineyards because nematode populations are often low and conditions for nematode reproduction are seldom optimal (Esmenjaud and Bouquet 2009). Therefore, soil-borne ectoparasitic nematodes cause damage not so much as pests but rather as vectors of viruses.

Nematode-Transmitted Grapevine Viruses

Among the 36 nepoviruses listed by the International Committee on Taxonomy of Viruses, 15 species cause grapevine fanleaf degeneration (Martelli 2014). The name nepovirus derives from “NE” for nematode transmission and “PO” for the polyhedral shape of viral particles. *Strawberry latent ringspot virus* (SLRSV) also causes fanleaf degeneration. This virus was previously recognized as a nepovirus but is now classified as an unassigned species of the family *Secoviridae* (Table 25.1) (Thompson et al. 2014). Along the 16 viruses involved in fanleaf degeneration, nematode transmission has been demonstrated only for eight nepoviruses, including AILV, ArMV, GFLV, PRMV, RpRSV, TBRV, ToRSV, TRSV, and also for SLRSV. For the other seven nepoviruses involved in fanleaf degeneration (BLMoV, CLRV, GBLV, GCMV, GDefV, GRASV, and GTRSV), no nematode vector has been identified. For example, *Grapevine chrome mosaic virus* (GCMV) was detected by ELISA in *X. index* fed on infected hosts, and *X. vuittenezi* was found associated with spread of the disease in Hungary (Martelli and Sároszpataki 1969); however, the transmission of GCMV by these two nematode species was never confirmed. Jones et al. (1981) excluded *L. elongatus*, *L. macrosoma*, *X. diversicaudatum*, and *X. vuittenezi* as nematode vectors of *Cherry leafrollvirus* (CLRV). On the other hand, *Grapevine deformation virus* (GDefV), which originated from interspecific recombination between GFLV and ArMV, harbors a coat protein (CP) with a high level of genetic similarity with the ArMV CP, suggesting a putative role of *X. diversicaudatum* in its transmission (Elbeaino et al. 2012). However, experimental evidence to ascertain the role of this nematode species as a vector of GDefV is lacking. For *Blueberry leaf mottle virus* (BLMoV), *Grapevine Anatolian ringspot virus* (GRASV), *Grapevine Bulgarian latent virus* (GBLV), and *Grapevine Tunisian ringspot virus* (GTRSV), no nematode vector has been associated with infected grapevines.

GFLV has a narrow host range, while other nepoviruses have a wide host range extending from small fruit crops, fruit trees, or other crops such as hop, soybean, tobacco, birch, and ornamentals. In addition, many of these viruses also infect common weed species and are mechanically transmissible to herbaceous plants (Le Gall et al. 2008; Mayo et al. 1994). The host range of viruses overlaps with the plant host range of their associated nematode vector. For example, *Vitis* is the only natural host of GFLV and *X. index*. In contrast, ArMV and SLRSV have a wide host range, including fruit trees, berry plants, ornamental trees and shrubs, vegetable crops, and weeds because *X. diversicaudatum*, the nematode vector, is polyphagous (Lamberti et al. 1975; Taylor and Brown 1997). Nepoviruses without any assigned nematode vector may be transmitted by seed and/or pollen like those that have a recognized nematode vector, and all grapevine nepoviruses as well as SLRSV are graft transmissible (Martelli 2014).

Nepoviruses and SLRSV cause grapevine leaf deformation as a result of abnormally gathered primary veins and widely open petiolar sinuses. In addition, leaves may also show yellowing or mosaic with mottling. Shortened internodes and abnormal branching are often apparent, and poor graft take and a progressive decline in growth and vigor over time are also reported. Infected plants may also exhibit a decreased resistance to drought and cold, as well as reduced ability to root. Nepoviruses can greatly reduce yield by causing poor berry set and numerous unfertilized berries (Andret-Link et al. 2004a). Yield reductions ranging from 44% in Traminer (Rüdel 1985) up to 98% in Pinot noir (Bovey 1970) are reported.

Nepoviruses share common genetic features (Sanfaçon et al. 2009; Thompson et al. 2014). They possess a bipartite genome composed by two single-stranded positive-sense RNA covalently linked to a VPg (viral protein genomic) at the 5' extremity and possess a 3' poly (A) tail. Some isolates have an additional RNA called satellite RNA (Fritsch et al. 1993). RNAs are encapsidated into isometric particles of 30 nm in diameter. Particles are composed of 60 subunits of a single peptide ranging from 52 to 60 kDa in size. Each RNA encodes a single large polyprotein, which is posttranslationally cleaved by the viral protease. RNA-1 encodes proteins involved in RNA replication, proteolytic processing (Sanfaçon et al. 2009), and symptom expression on herbaceous host (Vigne et al. 2013). RNA-2 encodes proteins involved in RNA-2 replication (2A protein), cell-to-cell movement (MP protein), and capsid assembly (CP) (Sanfaçon et al. 2009). Investigations on GFLV have highlighted the multifunctional role of the CP. GFLV CP subunits self-assemble into a capsid to protect the viral genome (Belin et al. 1999), which is also the entity moving from cell to cell through tubules formed by the MP protein embedded in plasmodesmata (Ritzenthaler and Hofmann 2007). The CP also bears the determinants of GFLV and ArMV retention in their respective soil-borne vectors (Andret-Link et al. 2004b; Marmonier et al. 2010; Schellenberger et al. 2010, 2011). SLRSV share many common features with nepoviruses in genomic organization and expression, except that the CP consists of a small and a large subunit (Sanfaçon et al. 2009; Thompson et al. 2014).

***Longidoridae* Are Slender Nematodes**

Ectoparasitic nematodes live on the outer surface of a host, and their body does not penetrate plant tissues. Nematode development includes three to four juvenile stages prior to the adult stage. Nematodes of the genera *Xiphinema*, *Longidorus*, and *Paralongidorus* are morphologically closely related. Nematodes are slender at all stages of development. Adults are long to very long, and the body length ranges from 1.8 (*X. americanum*) to 12 mm (*P. maximus*) (Decraemer and Geraert 2006). Nematodes are coated with a cuticle, which is an extremely flexible exoskeleton that permits locomotion, confers protection, and allows growth by molting (Lamberti et al. 1975). The cuticle is highly hydrophilic and always covered by a thin layer of water for gas and chemicals exchange (Esmenjaud and Bouquet 2009).

Longidoridae nematodes are characterized by the presence of a long, hollow stylet, which penetrates plant roots for feeding on root cells (Figs. 25.1 and 25.2). The length of the feeding stylet ranges from 60 to 250 μm according to the species and larvae stage with an average diameter of 450 nm. All stages of ectoparasitic nematodes may feed on roots. The longer the stylet, the deeper the nematode can feed. The stylet is composed of two parts: the odontostyle and the odontophore (Decraemer and Geraert 2006; MacFarlane et al. 2002; Taylor and Brown 1997) (Fig. 25.2). The odontostyle is like a flexible, open needle, which can be extruded to puncture root cells. Adult nematodes harbor a functional odontostyle. An additional replacement odontostyle is carried by all larvae stages; the replacement odontostyle becomes functional after the functional odontostyle is eliminated during molting. The protraction and retraction of the odontostyle are performed by muscles attached to the odontophore and esophagus. The odontophore, also named stylet extension, extends the odontostyle. It is formed by a cuticularization of the most anterior part of the esophagus and functions as a supporting and ejecting mechanism for the odontostyle. The odontophore is followed by the esophagus, a narrow flexible tube, and then by a cylindrical esophageal bulb which is associated with dorsal and ventral glands (Fig. 25.2) (MacFarlane et al. 2002).

The Nematodes' Life Cycle and Ecology

The nematode life cycle varies from species to species and is strongly influenced by environmental conditions (Taylor et Brown 1997; Weischer 1975). Eggs are laid in the soil close to the feeding site and hatch in the spring and early summer, especially when new roots are produced. In general, *Longidorus* spp. have a shorter life cycle than *Xiphinema* spp. For example, *X. index* completes its life cycle on grapevine in 7–9 months when most of the *Longidorus* spp. reach the adult stage in about 4 months. This duration can be shortened when nematodes are reared in a greenhouse (1–2 months for most of the *Longidoridae*). Also, the plant host impacts the

Fig. 25.2 Schematic representation of the morphological structure of the anterior region of *Longidorus* and *Xiphinema* showing the feeding apparatus. The retention site of the viral particles is highlighted in red brackets for both genera; *odp* odontophore, *gs* guiding sheath, *Odt* odontostyle

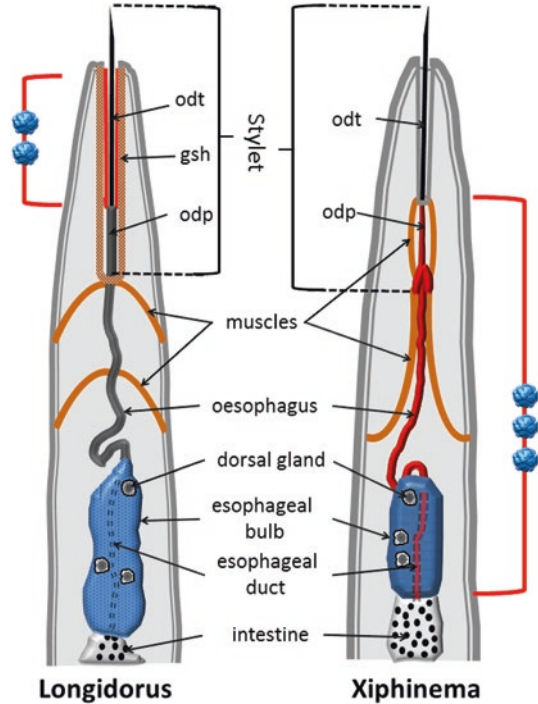

reproduction rate. For example, more *X. index* eggs are produced on fig plants than on grapevines (Coiro et al. 1987). Males are very scarce within *Xiphinema* nematodes, with the exception of *X. diversicaudatum*, which is amphimictic. Consequently, the reproduction is essentially asexual by meiotic parthenogenesis, and a single larva can generate a population, although rare sexual reproduction events have been detected within a clonal *X. index* population (Villate et al. 2010). For *Longidorus* spp., both sexual and asexual modes of reproduction occur (Taylor and Brown 1997).

Longidoridae nematodes tolerate a wide range of soil temperatures with an optimum of 20–30 °C for reproduction. Below 15 °C no development occurs, and over 30 °C, the efficiency of virus transmission is greatly reduced. Most European *Xiphinema* populations are not severely affected by low temperatures, and all development stages are recovered from the field during a full calendar year (Flegg 1968a, b; Taylor and Brown 1997). *X. index* survives between –11 and 35 °C, but constant temperatures of 45 or –22 °C for 10 days are lethal (Van Zyl et al. 2012). Adult females and larvae of *L. elongatus* overwinter although larvae are more sensitive to frost than adults. In contrast, *X. americanum* does not survive in frozen soil, and

only eggs and larvae overwinter (Lamberti et al. 1975). Soil nematodes are active in water-filled pores in the soil matrix and in moisture films around soil particles. Therefore, *Longidoridae* are sensitive to humidity and do not survive outside a 20–90% relative humidity range (Weischer 1975).

Nematode Distribution in Soil and Dissemination

Soil texture and structure are critical for the development of soil-inhabiting nematodes (Pitcher 1975). Pore space and moisture capacity are physical characteristics that determine soil suitability as a habitat for nematodes. *Longidorus*, *Paralongidorus*, and *Xiphinema* have been recovered from a wide range of soil types; therefore, their distribution is mostly limited by adequate moisture and the presence of suitable hosts. Populations of *Longidorus* and *Xiphinema* are higher in lighter soils (Taylor and Brown 1976). *L. macrosoma* like *X. diversicaudatum* and *X. italie* is more often recovered from sandy soils but can survive in clay soils (Arias et al. 1987; Dewaele and Coomans 1990). *X. index* prefers heavy soils that are less subject to drought but is also present in sandy soils if moisture is sufficient (Esmenjaud et al. 1992). These conditions are also favorable for the cultivation of grapevine, its main natural host. Similarly, *X. americanum* and *L. elongatus* occur in light and heavy clay soils (Taylor and Brown 1997).

The horizontal and vertical distribution of nematodes in vineyard soils is generally clustered and closely related to the distribution of roots. Nematode density is higher within than between vine rows (Feil et al. 1997), and the aggregated pattern of nematode distribution correlates with GFLV-infected grapevines (Villate et al. 2008). Usually absent from shallow soil layers, *X. index* is located 0.3–1.5 m deep in vineyard soils where fine rootlets are most abundant (Esmenjaud et al. 1992; Feil et al. 1997; Villate et al. 2008). Specimens can even be detected at a depth of 3.6 m (Raski et al. 1965).

The movement of nematodes is limited to a few dozen of cm per year (Pitcher 1975; Taylor et al. 1994). Nematodes move horizontally and vertically in the soil by following the progression of the roots on which nematodes feed (Esmenjaud et al. 1988; Thomas 1981). Dagger nematodes are disseminated through the use of contaminated equipment, planting of infested plants/sod, and soil transfer. Equipment such as tractors, planters, ridgers, and worker's boots should be cleaned after use in each vineyard in order to minimize the dissemination of nematodes from vineyard to vineyard (Esmenjaud and Bouquet 2009; Bileva et al. 2009). Water provides also an important means for active migration of nematodes in soil. Nematodes may be dispersed passively by streams, floodwaters, and percolating water in vineyards (Rocuzzo and Cianco 1991).

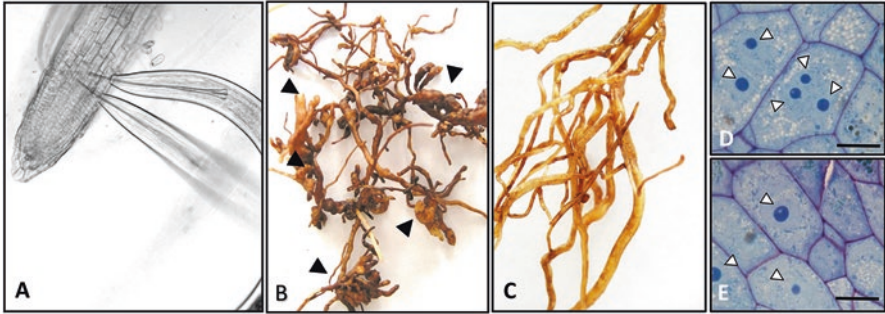

Fig. 25.3 (a) A dagger nematode, *Xiphinema* spp., feeding at plant root tip. The odontostyle is deeply inserted in the root (Photo courtesy of Dr. Jasmin Duerr, Institute for Biology II, Albert Ludwigs University Freiburg, Germany); (b) root system on young grapevine showing terminal galling and swelling (black arrows) caused by *Xiphinema* spp.; (c) root deformation are not observed in uninfected grapevine; (d) light micrograph of a longitudinal section through a swollen root tip of a young grapevine showing a bi- and trinucleate cells after *X. index* feeding; (e) multinucleate cells are not observed on the root tip unexposed to *X. index*. Nuclei are indicated by white arrows. Scale bars represent 20 μm

Nematode Feeding Process

The acquisition and transmission of viral particles are two steps that are linked to the feeding of nematodes. The feeding process has been well studied for *X. index* and *X. diversicaudatum* on several host plants including grapevine (Trudgill et al. 1991; Weischer and Wyss 1976; Wyss 2000). *Xiphinema* nematodes nearly always start feeding in the region of root cell elongation. After a suitable site for cell wall perforation is found by lip rubbing, the stylet is pushed vigorously against the cell wall, so that perforation is achieved within a few seconds until the wall of the underlying cell is hit (Fig. 25.3). *Xiphinema* usually perforates intracellularly a column of three or four cells before it starts ingesting plant cell contents. Ingestion can last several hours. Food ingestion is typically intermittent with periods of continuous bulb pulsation with duct dilation and interspersed short and long period of pauses with duct depletion. After the last stylet thrust, ingestion is preceded by a definite sequence of events lasting a few seconds, at the end of which dilated ducts of the dorsal gland cell in the basal bulb become depleted. During this process, the cell content of the target cells is forced through the valve into the intestine. A nematode can empty the content of 40 root cells per hour (Wyss 2000).

The bulb is associated with several gland cells with ducts leading to the esophageal tract (Fig. 25.2). Before feeding, and at regular intervals while feeding, nematodes pump secretions from their dorsal gland cells into the plant root cell. These secretions liquefy the cytoplasm including the organelles (but not the plasma mem-

brane or the nucleus) to facilitate the transfer of the cell content through the food canal (Wyss 2000). Secretions from several *Longidoridae* species also induce increased RNA and DNA synthesis in cells surrounding the feeding site in which root cells become enlarged, amoeboid, and, with *Xiphinema* species, multinucleate (Fig. 25.3). When the feeding process is complete, the nematode completely withdraws its stylet and searches for another feeding site within the root elongation zone. Continuous feeding at the same tip for several days transforms the swelling into a terminal gall, which remains strongly attractive to nematodes, providing food for egg production (Fig. 25.3) (Weischer and Wyss 1976; Wyss 2000).

Nematode Identification and Virus Diagnostics

Nematodes are among the most difficult species to identify because field populations often consist of specimens at different development stages and of mixed populations of several species. Moreover, nematodes share many common morphological characteristics. Therefore, the identification of virus vectors requires specialized skill sets. The difficulty of identifying *Longidoridae* is further increased by the fact that nematodes are often present in low numbers especially in vineyards (Van Ghelder et al. 2015a). Virus diagnostics in nematodes is an additional challenge although the annotated genome of the root-knot nematode and availability of virus sequences have facilitated the development of robust tools.

Nematode Identification

The identification of nematode vectors depends upon the use of morphological keys based on anatomical characteristics of each group and species. Those characteristics of *Longidorus*, *Paralongidorus*, and *Xiphinema* species are well documented for *Xiphinema* (Coomans et al. 2001; Loof and Luc 1990, 1993; Loof et al. 1996), *Longidorus* (Chen et al. 1997; Loof and Chen 1999), and *Paralongidorus* (Escuer and Arias 1997). A combination of about 20 morphometric and morphological features has been established to elaborate dichotomous or polytomous keys for the identification of different nematode species. The main diagnostic traits are body length, structure and size of the stylet, structure and position of the guide ring, shape and size of the lips, amphidials, and position and size of the pharyngeal gland nuclei. Additional features at the species level are the development and structure of the female reproductive system, tail shape in all developmental stages, and presence or absence of males. Well adapted to differentiate most of the *Longidoridae* spp., these morphological keys are of limited use to solve the current taxonomic situation of the *X. americanum* group. Fifty-one nominal species have been placed in this group (Van der Gaag et al. 2010), but the number of species is debated because many of the morphology and morphometric features overlap within this group, and, so far,

no user-friendly molecular diagnostic tools are available to specifically identify nematode vectors within the *X. americanum* group.

Multiplex PCR approaches using species-specific primers targeting the rDNA 18S and/or ITS-1 regions differentiate 20 species of *Longidorus* and *Xiphinema* (Hübschen et al. 2004a, b; Olivera et al. 2005; Wang et al. 2003). These assays are sensitive to identify a single nematode, regardless of its development stage (larvae or adult), within a nematode community in vineyard soils or within a mixed population consisting of non-vectoring and vectoring nematodes (Hübschen et al. 2004a, b; Wang et al. 2003). A major breakthrough in nematode identification was made recently with the development of a real-time PCR for the specific detection of *X. index*, *X. diversicaudatum*, *X. vuittenezi*, and *X. italiae* and the quantification of *X. index* (Van Ghelder et al. 2015a). This sensitive and reliable technique is useful to evaluate the population density in vineyard soils (Van Ghelder et al. 2015b).

Virus Diagnostic

To assess the viruliferous status and vectoring capacity of nematodes, transmission assays with susceptible host plants are used (MacFarlane et al. 2002; Taylor and Brown 1997). These bioassays are time consuming and tedious and require specialized skills in virus detection and nematode management (Brown et al. 1995; Jones et al. 1981). Several user-friendly and faster alternative procedures have been developed. Specific antibodies raised against purified viral particles are used for the detection of GFLV, TRSV, and ToRSV in their respective nematode vectors by ELISA, immunosorbent microscopy, immunofluorescence microscopy, or immunocapture-RT-PCR (Belin et al. 2001; Bouquet 1983; Catalano et al. 1991; Esmenjaud et al. 1993; Roberts and Brown 1980; Wang and Gergerich 1998). In addition, RT-PCR protocols have been developed for the detection of GFLV, ArMV, SLRSV, and TRSV in their specific vectors (Demangeat et al. 2004; Finetti-Sialer and Ciancio 2005; Kulshrestha et al. 2005; Martin et al. 2009). These protocols were also adapted for the detection of GFLV in a single nematode (Demangeat et al. 2004; Finetti-Salieri and Ciancio 2005) and for the characterization of GFLV isolates in a single *X. index* by restriction fragment length polymorphism (Demangeat et al. 2004) or real-time PCR (Finetti-Sialer and Ciancio 2005).

Site of Virus Retention in Nematodes and Virus Release

GFLV does not persist through the molt of juvenile *X. index*. This discovery was an impetus for investigating the feeding apparatus as the most likely site of virus retention. Virus particles are bound on the surface of the alimentary tract of nematode vectors, although their localization differs between *Longidorus* and *Xiphinema* spp. (Fig. 25.2). Specific sites of retention have been identified by electron microscopy

of thin sections of the feeding apparatus of nematodes exposed to virus-infected plants. In *Longidorus* and likely in *Paralongidorus*, viral particles are retained exclusively on the inner surface of the odontostyle and the space between the stylet and the guiding sheath (Fig. 25.3) (Martelli and Taylor 1990; Taylor and Robertson 1970). In *Xiphinema* spp., viral particles are absorbed as a monolayer lining the cuticle of the odontophore, the esophagus, and esophageal bulb (Martelli and Taylor 1990; Taylor and Brown 1997; Taylor and Robertson 1970). The difference of localization and the smaller retention area probably explain the difference in conservation of viral particles between the two nematode genera. In addition, *Xiphinema* spp. retain viruses for several years, while *Longidorus* spp. keep viruses only for several weeks (Demangeat et al. 2005).

Virus adsorption on the alimentary tract is a selective and specific process. The inability of phytoparasitic nematodes to transmit certain viruses probably reflects the absence or a different composition of the putative retention sites. ArMV, specifically vectored by *X. diversicaudatum*, is not transmitted by *L. elongatus*, although it is detectable in the gut of the latter species (Taylor 1980). *X. index* does not transmit ArMV because the virus is not retained (Belin et al. 2001; Schellenberger et al. 2010). The existence of a specific virus receptor was strongly suggested by analyses of ArMV transmission efficiencies of a progeny of a Scottish (an efficient ArMV vector) and an Italian (a poor ArMV vector) *X. diversicaudatum* population. The F1 progeny transmitted ArMV with an intermediate efficiency compared to the two parental populations, and the efficiency increased with the F2 generation (Brown 1986). The low efficiency of transmission by the Italian population is related to its inability to successfully adsorb virus particles at the site of retention (Brown and Trudgill 1983).

The putative receptor anchored in the inner cuticle of the virus retention site is unknown. In *X. index* and *X. diversicaudatum*, a discontinuous layer of carbohydrate-staining material was identified lining the cuticle of the odontophore and esophagus. ArMV particles are adsorbed only where this stained layer occurs (Robertson and Henry 1986). Consequently, it was suggested that surface charges on virus particles could interact with oppositely charged carbohydrate moieties associated with the cuticular lining of the nematodes' feeding apparatus. This hypothetical model of virus interaction is reinforced by our recent investigations showing that the addition of a negative charge on one surface outer-exposed amino acid of GFLV particles strongly affects the transmission efficiency by *X. index* (Schellenberger et al. 2011). A layer of carbohydrate material was not documented in *Longidorus* spp. nematodes, suggesting another retention mechanism of viral particles.

The mechanism by which viruses might be actively released from the retention site is also unknown. In agreement with the virus/nematode electrostatic interaction hypothesis, adsorbed particles may be passively released and washed into the punctured cell when nematode injects esophageal gland secretions during the feeding process. The secretions might change the pH in the esophageal tract or odontostyle region and alter the surface charge of the virus particles. The force with which gland secretions are expelled into the plant cells may dislodge the virus particle from their retention site with no specific mechanism. An alternative option would be a disso-

ciation of virus particles from the retention site mediated by enzyme activities associated with gland secretions (Brown et al. 1995, 1996; MacFarlane et al. 2002; Taylor and Brown 1997; Wyss 2000).

Nematodes Retain Viruses Over Extended Periods of Time

Nematode-transmitted viruses are retained for several weeks and even up to several years at specific sites in the vector feeding apparatus. Viruses do not replicate in the vector species and are not passed transovarially through nematode eggs (Taylor and Raski 1964). Viruses are shed when juvenile stages of the nematodes molt, at which time most of the cuticle of the feeding apparatus and the odontostyle together with the body cuticle is exuviated. Therefore, neonate larvae or adults are not viruliferous anymore and must feed again on infected roots to acquire the virus and become viruliferous.

The virus/vector association is persistent over time. This often results in a perpetual contamination of vineyards, even after extended periods of fallow. The longevity of the association is closely related to the long life cycle of nematodes and their capacity to survive in suboptimal conditions. Nematodes can persist in soil after several crop rotations because most of *Longidoridae* nematodes are very polyphagous (Taylor and Brown 1997). For example, *X. diversicaudatum* associated with ArMV was found 24 years after the first investigation in an arable site and after successive crop rotations including with weeds (Taylor et al. 1994). Also, after a fallow period of 6 years in an uprooted GFLV-infected vineyard, 6% of the replants became infected by GFLV (Vuittenez et al. 1969). Similarly, a 5-year fallow failed to remove *X. index* and GFLV in a naturally infected vineyard (Raski et al. 1965).

X. americanum and *X. diversicaudatum* transmit their associated virus, TRSV and ArMV, respectively, to bait plants after 9 months of storage under controlled conditions (McGuire 1973; McNamarra 1980). *X. rivesi* transmits ToRSV to bait plants after a 2-year storage in natural soil (Bitterlin and Gonsalves 1987). Similarly, although a population of *X. index* decreased significantly after 4 years of soil sample storage at 7 and 20 °C in the absence of host plant, live individuals (adults and larvae), including viruliferous specimens, were isolated for both storage conditions (Demangeat et al. 2005). Although *Longidorus* species can survive for long periods without feeding, *L. elongatus* loses its ability to transmit TBRV after 120 days of storage in sterile soil in the absence of host plant and RpRSV after 80 days (Taylor 1980).

Nematodes are poikilothermic organisms and have no capacity to change their microenvironment or to move away from it. To overcome unfavorable environmental conditions during growth and development, a resting stage has evolved in the life cycle of many nematodes. By reducing their metabolic activity, nematodes have an innate capacity to interrupt their development at an early developmental stage for survival (Antonioni 1989). *Paralongidorus maximus* and *Xiphinema pachtaicum* (a species often present in vineyards but not recognized as a virus vector) were strongly

curled up in dry soil without any apparent activity. Both species became active when soil moisture was restituted (Antoniou 1989).

Specificity of Association and Viral Determinants

Only a few nematode species transmit viruses, and a restricted number of viruses use nematodes as their vector. Of approximately 480 *Longidoridae* nematode species, 18 species have been proven as natural vectors of 11 of the 36 putative members of the genus *Nepovirus* and of SLRSV (MacFarlane et al. 2002). Among them, 13 nematode species are recognized vectors of only nine of 16 viruses responsible for the fanleaf degeneration (Martelli 2014) (Table 25.1). This highlights a high degree of specificity between nematodes and their associated viruses.

Specific Association

The concept of specificity was first suggested by Harrison (1964) who referred to specific nematode vectors for serologically distinct forms of viruses. Specificity was further characterized by Brown and Weischer (1998), who proposed the concepts of exclusivity and complementarity. Exclusivity applies to a nematode species that transmits one virus or one serologically distinct virus strain, and the virus or virus strain has a single vector. Exclusivity is exemplified by *X. index* and GFLV and by *L. apulus* and AILV. Also, *L. elongatus* and *L. marcosoma* transmit the serologically distinct Scottish and English RpRSV isolates, respectively. Complementarity refers to situations where one nematode species transmits two or more viruses (or serologically distinct virus strains), and two or more viruses or virus strains share the same vector species (Brown and Weischer 1998). Complementarity is the most frequent case of the specific association between a nematode and a virus. For example, *X. diversicaudatum* transmits ArMV and SLRSV, and *L. elongatus* transmits RpRSV and TBRV.

The geographical isolation of some nematode/virus associations sometimes leads to very high level of specificity. An Italian isolate of SLRV can only be transmitted by a local population of *X. diversicaudatum* (Taylor and Brown 1997). By contrast, the transmission of GFLV by seven *X. index* lines from diverse geographical origins is unrelated to their country of origin although differences in their reproductive rate on *Vitis* spp. were observed (Demangeat et al. 2010).

The specific association between nematodes and viruses has been mainly demonstrated for *Longidoridae* vectors present in Europe. For the *X. americanum* group, the unclear taxonomic status makes the identification of specific associations very difficult. Several *X. americanum* spp. transmit two or three different viruses to grapevine. Nonetheless, even if there are specific associations between some viruses and their nematode, the specificity could be restricted and applied to localized virus

isolates and nematode populations (Brown et al. 1994). Altogether, these features suggest a more complex interaction between *X. americanum* and their associated nepoviruses than that observed for the other *Longidoridae* vectors.

Viral Determinant Involved in Nematode Transmission

The transmission of GFLV and ArMV illustrates the type of extreme specificity exists between vectors and viruses. Although GFLV and ArMV share a similar genome organization and high sequence similarities, GFLV is exclusively transmitted by *X. index* whereas ArMV is transmitted specifically by *X. diversicaudatum* (Andret-Link and Fuchs 2005). This specific interaction is triggered by viral determinants and probably by receptors in the nematode. Knowing that transmissibility segregates with RNA-2 (Harrison et al. 1974; Harrison and Murrant 1977), chimeric RNA-2 constructs were engineered by replacing the 2A, MP, or CP sequences of GFLV with their ArMV counterpart sequences. All recombinant viruses with a GFLV CP are transmitted by *X. index* but not by *X. diversicaudatum*. In a complementary situation, recombinant viruses expressing an ArMV CP are transmitted by *X. diversicaudatum* but not by *X. index*. This reverse genetic approach demonstrated that the transmission specificity of GFLV and ArMV maps to their respective CP (Andret-Link et al. 2004b; Belin et al. 2001; Marmonier et al. 2010; Schellenberger et al. 2010).

Subsequent studies focus on the CP amino acids involved in GFLV transmission by *X. index*. Structural approaches combined with reverse genetic experiments enabled the identification of a putative domain at the surface of the GFLV capsid, which may constitute a binding site for the vector. The atomic structure of the GFLV at a resolution of 2.7 Å revealed that this domain is composed of a positively charged pocket surrounded by three surface outer-exposed loops, namely, GH, BC, and C'C". The involvement of two of three loops (GH and BC) in GFLV transmission by *X. index* was demonstrated by site-directed mutagenesis. Moreover, the introduction of a negative charge at position Gly 297 (mutant Gly 297 Asp) in the GH loop diminishes virus retention inside the nematode's feeding apparatus and thereby hinders virus transmission (Schellenberger et al. 2011). The additional negative charge modifies the electrostatic environment of the putative nematode-binding pocket and could affect the interaction of the virus particle with a specific receptor in the cuticle lining of the feeding apparatus of *X. index*.

Conclusions and Directions for Future Research

A striking feature of nematode-virus interactions is their specificity. Each virus is transmitted by only one or a few nematode species. This specificity relies on the viral determinant of the CP of the virus, as shown for ArMV and GFLV. Unravelling

the atomic structure of GFLV at 2.7 Å was a major advancement in our understanding of the putative mechanism involved in nematode transmission. The GFLV atomic structure led to the identification of a surface outer-exposed positively charged pocket as the putative domain that could interact with a ligand anchored in the cuticle of the feeding apparatus of the nematode. This finding opened new perspectives for the fine mapping of the viral determinant and the identification of a ligand in the nematode. Providing insights into virus-vector interactions at the atomic level will facilitate the implementation of new strategies to break the transmission process.

Another remarkable feature of nematode-virus associations is the longevity of the interaction between nematodes of the *Xiphinema* genus and their associated viruses. *Xiphinema* spp. are able to survive in adverse conditions and conserve their viruses over long periods of time. These features in association with a deep vertical distribution of nematodes in vineyards clearly indicate that nematode eradication from infested vineyard represents a huge challenge. They also explain the low efficiency of chemical approaches at reducing nematode populations. As the typically recommended 10-year fallow for eradication of *X. index* is difficult to implement in most vineyards for economic reasons, determining the infectious potential of *X. index* can aid the determination of the time interval required to eliminate viruliferous nematodes between two successive plantings.

Proper nematode identification and the ability to detect viruliferous nematodes are, and will continue to be, key components of disease management. This is an area that has advanced significantly during the last decade. Sensitive and reliable molecular tools have been developed to discriminate the main species of virus-transmitting nematodes. Such molecular tools applied to PCR-based techniques provide rapid and user-friendly diagnostics, with the particular benefit of not requiring the involvement of highly trained taxonomists and of being adapted to low nematode densities usually found in vineyards (Van Ghelder et al. 2015a). Moreover, it is now possible to discriminate and estimate numbers of *X. index* among a nematode community extracted from soil samples, avoiding the tedious morphological measurements and time-consuming counting.

Transcriptional analyses, high-throughput DNA sequencing, and the use of comparative genomics are powerful approaches to understanding the processes by which a nematode causes plant disease. Combining with the availability of free-living, animal- and plant-parasitic nematode genomes, the determination of the genome sequence of the *Longidoridae* as well as *X. index* may help to decipher the plant-ectoparasitic nematode interactions and the mechanisms they use for virus retention and/or release. Such knowledge should provide new insights to further development of target-specific strategies to limit virus dissemination.

There is a renaissance in research on nematode transmission of plant viruses. Since *X. index* was demonstrated as the vector of GFLV (Hewitt et al. 1958), considerable information on interactions between the nematode, virus, and grapevine has been gathered. Many of the advances on the biology and ecology of nematodes and virus/nematode vector interactions have been gained through studies on grape pathosystems. Indeed, nepoviruses transmitted by *Longidoridae* are the causal

agent of fanleaf degeneration, one of the most detrimental diseases for the grape and wine industry. So far, no sustainable approach is available to manage this disease. This research area will remain of prime interest in the future to enable the development of new management strategies aimed at breaking the transmission cycle or at more efficiently reducing nematode populations in infested vineyards.

Acknowledgments Research at INRA (Colmar) and IBMP-CNRS (Strasbourg) is supported by grants from the French INRA Research Division “Santé des Plantes et Environnement” (SPE) and the Centre National de la Recherche Scientifique (CNRS), respectively. Part of this work was supported by the Conseils Interprofessionnels des Vins d’Alsace, Champagne and Bourgogne, and the Bacchus Interreg IV project.

References

- Abad, P., J. Gouzy, J.M. Aury, P. Castagnone-Sereno, E. Danchin, E. Deleury, L. Perfus-Barbeoch, V. Anthouard, F. Artiguenave, V.C. Blok, M.C. Caillaud, P.M. Coutinho, C. Dasilva, F. De Luca, F. Deau, M. Esquibet, T. Flutre, J.V. Goldstone, N. Hamamouch, T. Hewezi, O. Jaillon, C. Jubin, P. Leonetti, M. Magliano, T.R. Maier, G.V. Markov, P. McVeigh, G. Pesole, J. Poulain, M. Robinson-Rechavi, E. Sallet, B. Ségurens, D. Steinbach, T. Tytgat, E. Ugarte, C. van Ghelder, P. Veronico, T.J. Baum, M. Blaxter, T. Bleve-Zacheo, E.L. Davis, J.J. Ewbank, B. Favery, E. Grenier, B. Henrissat, J.T. Jones, V. Laudet, A.G. Maule, H. Quesneville, M.N. Rosso, T. Schiex, G. Smant, J. Weissenbach, and P. Wincker. 2008. Genome sequence of the metazoan plant-parasitic nematode *Meloidogyne incognita*. *Nature Biotechnology* 26: 909–915.
- Adekunle, O.K., S. Kulshrestha, R. Prasad, V. Hallan, G. Raikhy, N. Verma, R. Ram, S. Kumar, and A.A. Zaidi. 2006. Plant parasitic and vector nematodes associated with Asiatic and Oriental hybrid lilies. *Bioresource Technology* 97: 364–371.
- Allen, W.R., J.G. Van Schagen, and B.A. Ebsary. 1984. Comparative transmission of the *Peach rosette mosaic virus* by Ontario populations of *Longidorus diadecturus* and *Xiphinema americanum* (Nematoda: Longidoridae). *Canadian Journal of Plant Pathology* 6: 29–32.
- Andret-Link, P., and M. Fuchs. 2005. Transmission specificity of plant viruses by vectors. *Journal of Phytopathology* 87: 153–165.
- Andret-Link, P., C. Laporte, L. Valat, C. Ritzenthaler, G. Demangeat, E. Vigne, V. Laval, P. Pfeiffer, C. Stussi-Garaud, and M. Fuchs. 2004a. *Grapevine fanleaf virus*: Still a major threat to the grapevine industry. *Journal of Plant Pathology* 86: 183–195.
- Andret-Link, P., C. Schmitt-Keichinger, G. Demangeat, V. Komar, and M. Fuchs. 2004b. The specific transmission of *Grapevine fanleaf virus* by its nematode vector *Xiphinema index* is solely determined by the viral coat protein. *Virology* 320: 12–22.
- Antoniou, M. 1989. Arrested development in plant parasitic nematodes. *Helminthological Abstracts Series B* 58: 1–19.
- Arias, M., A. Navas, and M.F. Andrés. 1987. Studies on morphometrics, distribution and ecology of the *Xiphinema coxi* complex in Spain. *Revue de Nematologie* 10: 377–380.
- Belin, C., C. Schmitt, F. Gaire, B. Walter, G. Demangeat, and L. Pinck. 1999. The nine C-terminal residues of the grapevine fanleaf nepovirus movement protein are critical for systemic virus spread. *Journal of General Virology* 80: 1347–1356.
- Belin, C., C. Schmitt, G. Demangeat, V. Komar, L. Pinck, and M. Fuchs. 2001. Involvement of RNA2-encoded proteins in the specific transmission of *Grapevine fanleaf virus* by its nematode vector *Xiphinema index*. *Virology* 291: 161–171.

- Bileva, T., B. Choleva, S. Hockland, and A. Ciancio. 2009. Management of virus-transmitting nematodes with nematodes with special emphasis on South-East Europe. In *Integrated management of fruit crops and forest nematodes*, ed. A. Ciancio and K.G. Mukerji, 215–242. Dordrecht: Springer.
- Bitterlin, M.W., and D. Gonsalves. 1987. Spatial distribution of *Xiphinema rivesi* and persistence of *Tomato ringspot virus* and its vector in soil. *Plant Disease* 71: 408–411.
- Bouquet, A. 1983. Détection immuno-enzymatique du virus du court-noué de la vigne dans son vecteur *Xiphinema index* Thorne et Allen. *Comptes Rendus de l'Académie des Sciences. Série III* 296: 271–273.
- Bovey, R. 1970. Importance économique des viroses de la vigne (Economic importance of grapevine virus diseases). *Bulletin de l'Office International du Vin* 43: 124–138.
- Brown, D.J.F. 1986. Transmission of virus by the progeny of crosses between *Xiphinema diversicaudatum* from Italy and Scotland. *Revue de Nematologie* 9: 71–74.
- Brown, D.J.F., and S.A. MacFarlane. 2001. Worms that transmit viruses. *Biologist* 48: 35–40.
- Brown, D.J.F., and D.L. Trudgill. 1983. Differential transmissibility of arabis mosaic and strains of strawberry latent ringspot viruses by three populations of *Xiphinema diversicaudatum* (Nematoda: Dorylaimida) from Scotland, Italy and France. *Revue de Nematologie* 6: 229–238.
- Brown, D.J.F., and B. Weischer. 1998. Specificity, exclusivity and complementarity in the transmission of plant viruses by plant parasitic nematodes: An annotated terminology. *Fundamental and Applied Nematology* 21: 1–11.
- Brown, D.J.F., C.E. Taylor, B. Choleva, and R.D. Romanenko. 1990. The occurrence of *Longidoridae* (Nematoda:Dorylaimida) in western USSR with further comments on longidorid nematodes in Europe and the Mediterranean basin. *Nematologia Mediterranea* 18: 199–207.
- Brown, D.J.F., A. Dalmaso, and D.L. Trudgill. 1993. Nematodes pests of soft fruits and vines. In *Plant parasitic nematodes in temperate agriculture*, ed. K. Evans, D.L. Trudgill, and J.M. Webster, 427–462. Wallingford: CAB International.
- Brown, D.J.F., J.M. Halbrendt, A.T. Jones, T.C. Vrain, and R.T. Robbins. 1994. Transmission of three North American Nepoviruses by population of four distinct species of the *Xiphinema americanum* group. *Phytopathology* 84: 646–649.
- Brown, D.J.F., W.M. Robertson, and D.L. Trudgill. 1995. Transmission of viruses by plant nematodes. *Annual Review of Phytopathology* 33: 223–249.
- Brown, D.J.F., D.L. Trudgill, and W.M. Robertson. 1996. Nepoviruses, transmission by nematodes. In *The plant viruses, polyhedral virions and bipartite RNA genomes*, ed. B.D. Harrison and A.F. Murant, vol. 5, 187–209. New York: Plenum Press.
- Catalano, L., V. Savino, and F. Lamberti. 1991. Elisa identifying GFLV-carrying Longidoridae. *Journal of Nematology* 23: 523.
- Catalano, L., V. Savino, and F. Lamberti. 1992. Presence of grapevine fanleaf nepovirus in populations of longidorid nematodes and their vectoring capacity. *Nematologia Mediterranea* 20: 67–70.
- Chen, Q.W., D. Hooper, P.A.A. Loof, and J. Xu. 1997. A revised polytomous key for the identification of species of the genus *Longidorus* Micoletzky, 1922 (Nematoda: Dorylaimoidea). *Fundamental and Applied Nematology* 20: 15–28.
- Cho, M.R., and R.T. Robbins. 1991. Morphological variation among 23 *Xiphinema americanum* populations. *Journal of Nematology* 23: 134–144.
- Cohn, E., E. Tanne, and F.E. Nitzani. 1970. *Xiphinema italiae*, a new vector of grapevine fanleaf virus. *Phytopathology* 60: 181–182.
- Coiro, M.I., F. Lamberti, E. Egger, and M. Borgo. 1987. Population changes of *Xiphinema index* in relation to host plant, soil type and temperature in southern Italy. *Nematologia Mediterranea* 15: 173–181.
- Coomans, A., R. Huys, J. Heyns, and M. Luc. 2001. Character analysis, phylogeny, and biogeography of the genus *Xiphinema* Cobb, 1973, (Nematoda, Longidoridae). *Annales du Musée Royal de l'Afrique Centrale (Zoologie), Tervuren, Belgique* 287: 1–239.
- Decraemer, W., and E. Geraert. 2006. Ectoparasitic nematodes. In *Plant nematology*, ed. R.N. Perry and M. Moens, 153–184. Wallingford: CABI Publishing.

- Demangeat, G., V. Komar, P. Cornuet, D. Esmenjaud, and M. Fuchs. 2004. Sensitive and reliable detection of grapevine fanleaf virus in a single *Xiphinema index* nematode vector. *Journal of Virological Methods* 122: 79–86.
- Demangeat, G., R. Voisin, J.C. Minot, N. Bosselut, M. Fuchs, and D. Esmenjaud. 2005. Survival of *Xiphinema index* in vineyard soil and retention of *Grapevine fanleaf virus* over extended time in the absence of host plants. *Phytopathology* 95: 1151–1156.
- Demangeat, G., V. Komar, C. Van-Ghelder, R. Voisin, O. Lemaire, D. Esmenjaud, and M. Fuchs. 2010. Transmission competency of single-female *Xiphinema index* lines for *Grapevine fanleaf virus*. *Phytopathology* 100: 385–389.
- Dewaële, D., and A. Coomans. 1990. Occurrence and ecology of longidorid nematodes in Belgium. *Revue de Nematologie* 13: 197–202.
- Elbeainoa, M., M. Digiara, S. Ghebremeskela, and G.P. Martelli. 2012. *Grapevine deformation virus*: Completion of the sequence and evidence on its origin from recombination events between *Grapevine fanleaf virus* and *Arabidopsis mosaic virus*. *Virus Research* 166: 136–140.
- Escuer, M., and M. Arias. 1997. *Paralongidorus iberis* and *P. monegrensis* sp.n. from Hooper & Khan, 1963 (Nematoda: Longidoridae). *Fundamental and Applied Nematology* 20: 135–148.
- Esmenjaud, D., and A. Bouquet. 2009. Selection and application of resistant germplasm application for grapevine nematodes management. In *Integrated management of fruit crops and forest nematodes*, ed. A. Ciancio and K.G. Mukerji, 195–214. Dordrecht: Springer.
- Esmenjaud, D., R. Pistre, and M. Bongiovanni. 1988. Nematicide activity of aldicarb in deep and clayey soils against *Xiphinema index* Thorne & Allen, 1950 (Nematoda: Longidoridae) vector of grapevine fanleaf virus (in French). *Mededelingen Van De Faculteit Landbouwwetenschappen Rijksuniversiteit. Gent* 53 (2b): 885–891.
- Esmenjaud, D., B. Walter, G. Valentin, Z.T. Guo, and D. Cluzeau. 1992. Vertical distribution and infectious potential of *Xiphinema index* (Thorne & Allen, 1950) (Nematoda: Longidoridae) in fields affected by grapevine fanleaf virus in vineyards in the Champagne region of France. *Agronomie* 12: 395–399.
- Esmenjaud, D., B. Walter, J.C. Minot, R. Voisin, and P. Cornuet. 1993. Biotin-Avidin ELISA detection of grapevine fanleaf virus in the vector nematode *Xiphinema index*. *Journal of Nematology* 25: 401–405.
- Feil, H., B.B. Westerdahl, R.J. Smith, and P. Verdegaal. 1997. Effects of seasonal and site factors on *Xiphinema index* in two California vineyards. *Journal of Nematology* 29: 491–500.
- Finetti-Sialer, M.M., and A. Ciancio. 2005. Isolate-specific detection of *Grapevine fanleaf virus* from *Xiphinema index* through DNA-based molecular probes. *Phytopathology* 95: 262–268.
- Flegg, J.M.M. 1968a. The occurrence and depth distribution of *Xiphinema* and *Longidorus* species in south eastern England. *Nematologica* 14: 189–196.
- . 1968b. Life cycle studies of *Xiphinema* and *Longidorus* species in south eastern England. *Nematologica* 14: 197–210.
- Fritsch, C., M. Mayo, and O. Hemmer. 1993. Properties of the satellite RNA of nepoviruses. *Biochimie* 75: 561–567.
- Graham, M.B., B.A. Ebsary, T.C. Vrain, and J.M. Webster. 1988. Distribution of *Xiphinema bri-colensis* and *X. pacificum* in vineyards of the Okanagan and Similkameen valleys, British Columbia. *Canadian Journal of Plant Pathology* 10: 259–262.
- Harrison, B.D. 1964. Specific nematode vectors for serologically distinctive forms of raspberry ringspot and tomato black ring viruses. *Virology* 22: 544–550.
- Harrison, B.D., and C.H. Cadman. 1959. Role of a dagger nematode (*Xiphinema* sp.) in out breaks of plant disease caused by *Arabidopsis mosaic virus*. *Nature (London)* 184: 1624–1626.
- Harrison, B.D., and A.F. Murrant. 1977. Nematode transmissibility of pseudorecombinant isolates of Tomato black ring virus. *Annals of Applied Biology* 86: 209–212.
- Harrison, B.D., A.F. Murrant, M.A. Mayo, and I.M. Roberts. 1974. Distribution of determinants for symptom production, host range and nematode transmissibility between the two RNA components of Raspberry ringspot virus. *Journal of General Virology* 22: 233–247.

- Hewitt, W.B. 1985. From virus-like to virus diseases of grapevines: Some unsolved problems including immunity and ideas for researching them. *Phytopathologia Mediterranea* 24: 1–7.
- Hewitt, W.B., D.J. Raski, and A.C. Goheen. 1958. Nematode vector of soil-borne fanleaf virus of grapevines. *Phytopathology* 48: 586–595.
- Hockland, S., and T. Prior. 2009. *Xiphinema americanum* sensu lato. PM 7/95 (1). *EPPO Bulletin* 39: 382–392.
- Hooper, D.J. 1973. *Longidorus elongatus*. In *CIH descriptions of plant-parasitic nematodes, set 2, n°30*, 4. St Albans: Commonwealth Institute of Helminthology.
- Hübchen, J., L. Kling, U. Ipach, V. Zinkernagel, N. Bosselut, D. Esmenjaud, D.J.F. Brown, and R. Neilson. 2004a. Validation of the specificity and sensitivity of species-specific primers that provide a reliable molecular diagnostic for *Xiphinema diversicaudatum*, *X. index* and *X. vuittenenzi*. *European Journal of Plant Pathology* 110: 779–788.
- Hübchen, J., L. Kling, U. Ipach, V. Zinkernagel, D.J.F. Brown, and R. Neilson. 2004b. Development and validation of species-specific primers that provide a molecular diagnostic for virus-vector longidorid nematodes and related species in German Viticulture. *European Journal of Plant Pathology* 110: 883–891.
- Jha, A., and A.F. Posnette. 1959. Transmission of a virus to strawberry plants by a nematode (*Xiphinema* sp.). *Nature (London)* 184: 962–963.
- Jones, A.T., F.D. McElroy, and D.J.F. Brown. 1981. Tests for transmission of cherry leaf roll virus using *Longidorus*, *Paralongidorus* and *Xiphinema* nematodes. *Annals of Applied Biology* 99: 143–150.
- Jones, A.T., D.J.F. Brown, W.J. McGavin, M. Rüdell, and B. Altmayer. 1994. Properties of an unusual isolate of raspberry ringspot virus from grapevine in Germany and evidence for its possible transmission by *Paralongidorus maximus*. *Annals of Applied Biology* 124: 283–300.
- Jones, J.T., A. Haegeman, E.G. Danchin, H.S. Gaur, J. Helder, M.G. Jones, T. Kikuchi, R. Manzanilla-López, J.E. Palomares-Rius, W.M. Wesemael, and R.N. Perry. 2013. Top 10 plant-parasitic nematodes in molecular plant pathology. *Molecular Plant Pathology* 14: 946–961.
- Kulshrestha, S., V. Hallan, G. Raikhy, O.K. Adekunle, N. Verma, Q.M.R. Haq, and A.A. Zaidi. 2005. Reverse transcription polymerase chain reaction-based detection of *Arabidopsis mosaic virus* and *Strawberry latent ringspot virus* in vector nematodes. *Current Science* 89: 1759–1762.
- Lamberti, F., and A. Ciancio. 1993. The diversity of *Xiphinema americanum* and related species and the problems associated with taxonomic identification. *Journal of Nematology* 25: 332–343.
- Lamberti, F., and F. Roca. 1987. Present status of nematodes as vectors of plant viruses. In *Vistas on nematology*, ed. J.A. Vecch and D.W. Dickson, 321–328. Hyattsville: Society of nematologists.
- Lamberti, F., R.H. Taylor, and J.W. Seinhorst. 1975. *Nematode vectors of plant viruses*, 460. New York/London: Plenum Press.
- Lamberti, F., S. Molinari, M. Moens, and D.J.F. Brown. 2000. The *Xiphinema americanum* group. I. Putative species, their geographical occurrence and distribution, and regional polytomous identification keys for the group. *Russian Journal of Nematology* 8: 65–84.
- Le Gall, O., P. Christian, C.M. Fauquet, A.M.Q. King, N.J. Knowles, N. Nakashima, G. Stanway, and A.E. Gorbalenya. 2008. Picornavirales, a proposed order of positive-sense single-stranded RNA viruses with a pseudo-T=3 virion architecture. *Archives of Virology* 153: 715–727.
- Loof, P.A.A., and Q. Chen. 1999. A revised polytomous key for the identification of species of the genus *Longidorus* Micoletzky, 1922. (Nematoda: Dorylaimoidea): Supplement 1. *Nematology* 1: 55–59.
- Loof, P.A.A., and M.A. Luc. 1990. Revised polytomous key for the identification of species of the genus *Xiphinema* Cobb, 1913 (Nematoda: Longidoridae) with exclusion of the *X. americanum*-group. *Systematic Parasitology* 16: 35–66.
- Loof, P.A.A., and M. Luc. 1993. A revised polytomous key for the identification of species of the genus *Xiphinema* Cobb, 1913 (Nematoda: Longidoridae) with exclusion of the *X. americanum*-group: Supplement 1. *Systematic Parasitology* 24: 185–189.

- Loof, P.A.A., M. Luc, and P. Baujard. 1996. A revised polytomous key for the identification of species of the genus *Xiphinema* Cobb, 1913. (Nematoda: Longidoridae) with exclusion of the *X. americanum*-group: Supplement 2. *Systematic Parasitology* 33: 23–29.
- MacFarlane, S.A., R. Neilson, and D.J.F. Brown. 2002. Nematodes. In *Advances in botanical research*, ed. R.T. Plumb, vol. 36, 169–198. New York: Academic Press.
- Marmonier, A., P. Schellenberger, D. Esmenjaud, C. Schmitt-Keichinger, C. Ritzenthaler, P. Andret-Link, O. Lemaire, M. Fuchs, and G. Demangeat. 2010. The coat protein determines the specificity of virus transmission by *Xiphinema diversicaudatum*. *Journal of Plant Pathology* 92: 275–279.
- Martelli, G.P. 2014. Directory of virus and virus diseases of the grapevine and their agents. *Journal of Plant Pathology* 96: 1–136.
- Martelli, G.P., and G. Saropataki. 1969. Nematodes of the family Longidoridae (Thorne, 1935) Meyl, 1960 found in Hungarian vineyards and virus transmission trials with *Xiphinema index* Thorne and Allen. *Phytopathologia Mediterranea* 8: 1–7.
- Martelli, G.P., and C.E. Taylor. 1990. Distribution of viruses and their nematode vectors. In *Advances in disease vector research*, ed. K. Harris, vol. 6, 151–189. New York: Springer.
- Martin, R.R., J.N. Pinkerton, and J. Kraus. 2009. The use of collagenase to improve the detection of plant viruses in vector nematodes by RT-PCR. *Journal of Virological Methods* 155: 91–95.
- Mavric Plesko, I., M. Marn Virscek, S. Sirca, and G. Urek. 2009. Biological, serological and molecular characterization of Raspberry bushy dwarf virus from grapevine and its detection in the nematode *Longidorus juvenilis*. *European Journal of Plant Pathology* 123: 261–268.
- Mayo, M.A., W.M. Robertson, F.J. Legorburu, and K.M. Brierley. 1994. Molecular approaches to an understanding of the transmission of plant viruses by nematodes. In *Advances in molecular plant nematology*, ed. F. Lamberti, C.D. Giorgi, and D. Bird, 227–293. London: Plenum Press.
- McGuire, J.M. 1973. Retention of Tobacco ringspot virus by *Xiphinema americanum*. *Phytopathology* 63: 324–326.
- McLeod, R., F. Reay, and J. Smyth. 1994. *Plant nematodes of Australia listed by plant and by genus*, 201. Rydalmere: NSW Agriculture.
- McNamara, D.G. 1980. The survival of *Xiphinema diversicaudatum* in plant-free soil. *Nematologica* 26: 170–181.
- Mojtahedi, H., D. Sturhan, A. Akhiani, and S. Barooti. 1980. *Xiphinema* species in Iranian vineyards. *Nematologia Mediterranea* 8: 165–170.
- Nicol, J.M., G.R. Stirling, B.J. Rose, P. May, and R. Van Heeswijk. 1999. Impact of nematodes on grapevine growth and productivity: current knowledge and future directions, with special reference to Australian viticulture. *Australian Journal of Grape and Wine Research* 5: 109–127.
- Nicol, J.M., S.J. Turner, D.L. Coyne, L.D. Nijs, S. Hockland, and Z.T. Maafi. 2011. Current nematode threats to world agriculture. In *Genomics and molecular genetics of plant-nematode interactions*, ed. J. Jones, G. Gheysen, and C. Fenoll, 21–43. Dordrecht: Springer.
- Nyczepir, A.P., and J.M. Halbrendt. 1993. Nematode pests of deciduous fruit and nut trees. In *Plant parasitic nematodes in temperate agriculture*, ed. K. Evans, D.L. Trudgill, and J.M. Webster, 381–425. Wallingford: CAB International.
- Olivera, C.M.G., B. Fenton, G. Malloch, D.J.F. Brown, and R. Neilson. 2005. Development of species-specific primers for the ectoparasitic nematode species *Xiphinema brevicolle*, *X. diffusum*, *X. elongatum*, *X. ifacolum* and *X. longicaudatum* (Nematoda: Longidoridae) based on ribosomal DNA sequences. *Annals of Applied Biology* 146: 281–288.
- Pinkerton, J.N., J. Kraus, R.R. Martin, and R.P. Schreiner. 2008. Epidemiology of *Xiphinema americanum* and *Tomato ringspot virus* on red raspberry, *Rubus idaeus*. *Plant Diseases* 92: 364–371.
- Pitcher, R.S. 1975. Factors influencing the movement of nematodes in soil. In *Nematode vectors of plant viruses*, ed. F. Lamberti, C.E. Taylor, and J.W. Seinhorst, 391–407. London/New York: Plenum Press.
- Raski, D.J., W.B. Hewitt, A.C. Goheen, C.E. Taylor, and R.H. Taylor. 1965. Survival of *Xiphinema index* and reservoirs of fanleaf virus in fallowed vineyard soil. *Nematologica* 11: 349–352.

- Ritzenthaler, C., and C. Hofmann. 2007. Tubule-guided movement of plant viruses. In *Plant cell monographs*, ed. E. Waigmann and M. Heinlein, 63–83. Berlin/Heidelberg: Springer.
- Robbins, R.T., and D.F.J. Brown. 1991. Comments on the taxonomy, occurrence and distribution of *Longidoridae* (Nematoda) in North America. *Nematologica* 37: 395–419.
- Roberts, I.M., and D.J.F. Brown. 1980. Detection of six nepoviruses in their nematode vectors by immunosorbent electron microscopy. *Annals of Applied Biology* 96: 187–192.
- Robertson, W.M., and C.E. Henry. 1986. An association of carbohydrates with particles of arabis mosaic virus retained within *Xiphinema diversicaudatum*. *Annals of Applied Biology* 109: 299–305.
- Rocuzzo, G., and A. Ciancio. 1991. Note on nematodes found in irrigation water in southern Italy. *Nematologia Mediterranea* 19: 105–108.
- Rüdel, M. 1985. Grapevine damage induced by particular virus-vector combinations. In Proceedings of 8th meeting ICVG, Bari. *Phytopathologia Mediterranea* 24: 183–185.
- Sanfaçon, H., J. Wellink, O. Le Gall, A. Karasev, R. Vlugt van der, and T. Wetzel. 2009. Secoviridae: A proposed family of plant viruses within the order Picornavirales that combines the families Sequiviridae and Comoviridae, the unassigned genera Cheravirus and Sadwavirus, and the proposed genus Torradovirus. *Archives of Virology* 154: 899–907.
- Schellenberger, P., P. Andret-Link, C. Schmitt-Keichinger, M. Bergdoll, A. Marmonier, E. Vigne, O. Lemaire, M. Fuchs, G. Demangeat, and C. Ritzenthaler. 2010. A stretch of 11 amino acids in the β B- β C loop of the coat protein of *Grapevine fanleaf virus* is essential for transmission by the nematode *Xiphinema index*. *Journal of Virology* 84: 7924–7933.
- Schellenberger, P., C. Sauter, B. Lorber, P. Bron, S. Trapani, M. Bergdoll, A. Marmonier, C. Schmitt-Keichinger, O. Lemaire, G. Demangeat, and C. Ritzenthaler. 2011. Structural insights into viral determinants of nematode mediated *Grapevine fanleaf virus* transmission. *PLoS Pathogens* 7: e1002034.
- Singh, S.K., M. Hodda, and G.J. Ash. 2013. Plant-parasitic nematodes of potential phytosanitary importance, their main hosts and reported yield losses. *EPPO Bulletin* 43: 334–374.
- Sirca, S., B.G. Stare, I. Marvic Plesko, M. Marn Virscek, G. Urek, and B. Javornik. 2007. *Xiphinema rivesi* from Slovenia transmit Tobacco ringspot virus and Tomato ringspot virus to cucumber bait plants. *Plant Disease* 91: 770.
- Stace-Smith, S., and D.C. Ramsdell. 1987. Nepoviruses of the Americas. In *Current topics in vector research*, ed. K.F. Harris, 131–166. New York: Springer.
- Sturhan, D., W.M. Woutsb, G.S. Grandison, and C.J. Barberd. 1997. Nematode vectors of plant viruses in New Zealand. *New Zealand Journal of Zoology* 24: 309–322.
- Swart, A., A.P. Malan, and J. Heyns. 1996. *Paralongidorus maximus* (Bütschli) Siddiqi (Dorylaimida: Longidoridae) from South Africa. *South African Plant Protection* 2: 31–34.
- Taylor, C.E. 1980. Nematodes. In *Vectors of plant pathogens*, ed. K.F. Harris and K. Maramorosch, 375–415. New York: Academic Press.
- Taylor, C.E., and D.J.F. Brown. 1976. The geographical distribution of *Xiphinema* and *Longidorus* in the British Isles and Ireland. *Annals of Applied Biology* 84: 383–402.
- . 1997. *Nematode vectors of plant viruses*, 286. Wallingford: CAB International.
- Taylor, C.E., and D.J. Raski. 1964. On the Transmission of grape fanleaf by *Xiphinema index*. *Nematologica* 10: 489–495.
- Taylor, C.E., and W.M. Robertson. 1970. Sites of virus retention in the alimentary tract of the nematode vectors, *Xiphinema diversicaudatum* (Nicol.) and *X. index* (Thorne and Allen). *Annals of Applied Biology* 66: 375–380.
- Taylor, C.E., D.J.F. Brown, R. Neilson, and A.T. Jones. 1994. The persistence and spread of *Xiphinema diversicaudatum* in cultivated and uncultivated biotopes. *Annals of Applied Biology* 124: 469–477.
- Thomas, P.R. 1981. Migration of *Longidorus elongatus*, *Xiphinema diversicaudatum* and *Ditylenchus dispaci* in soil. *Nematologia Mediterranea* 9: 75–81.
- Thompson, J.R., N. Kamath, and K.L. Perry. 2014. An evolutionary analysis of the *Secoviridae* family of viruses. *PLoS One* 9: e106305.

- Trudgill, D.L., D.J.F. Brown, and D.G. McNamara. 1983. Methods and criteria for assessing the transmission of plant viruses by longidorid nematodes. *Revue de Nematologie* 6: 133–141.
- Trudgill, D.L., W.M. Robertson, and U. Wyss. 1991. Analysis of the feeding of *Xiphinema diversicaudatum*. *Revue de Nematologie* 14: 107–112.
- Van der Gaag, D.J., G. Karssen, and A. Werkman. 2010. Pest risk analysis for *Xiphinema americanum* s.l., 77, version 1.0. Wageningen: Plant Protection Service, Ministry of Economic Affairs, Agriculture and Innovation.
- Van Ghelder, C., A. Reid, D. Kenyon, and D. Esmenjaud. 2015a. Development of a real-time PCR method for the detection of the dagger nematodes *Xiphinema index*, *X. diversicaudatum*, *X. vuittenezi* and *X. italiae*, and for the quantification of *X. index* numbers. *Plant Pathology* 64: 489–500.
- . 2015b. Detection of nepovirus vector and non vector *Xiphinema* species in grapevine. *Methods in Molecular Biology* 1302: 149–159.
- Van Zyl, S., M.A. Olivier, and S. Walker. 2012. *Xiphinema index* and its relationship to grapevines: A review. *South African Journal of Enology and Viticulture* 33: 21–32.
- Vigne, E., J. Gottula, C. Schmitt-Keichinger, V. Komar, L. Ackerer, L. Belval, L. Rakotomalala, O. Lemaire, C. Ritzenthaler, and M. Fuchs. 2013. A strain-specific segment of the RNA-dependent RNA polymerase of grapevine fanleaf virus determines symptoms in *Nicotiana* species. *Journal of General Virology* 94: 2803–2813.
- Villate, L., V. Fievet, B. Hanse, F. Delemarre, O. Plantard, D. Esmenjaud, and M. van Helden. 2008. Spatial distribution of the dagger nematode *Xiphinema index* and its associated *Grapevine fanleaf virus* in french vineyard. *Phytopathology* 98: 942–948.
- Villate, L., D. Esmenjaud, M. Van Helden, S. Stoeckel, and O. Plantard. 2010. Genetic signature of amphimixis allows for the detection and fine scale localization of sexual reproduction events in a mainly parthenogenetic nematode. *Molecular Ecology* 19: 856–873.
- Vuittenez, A., R. Legin, and J. Kuszala. 1969. Février 5–7. Les viroses de la vigne. *Les maladies des Plantes. Journées françaises d'étude et d'information*, 557–577. Paris: ACTA.
- Wang, S., and R.C. Gergerich. 1998. Immunofluorescent localization of Tobacco Ringspot nepovirus in the vector nematode *Xiphinema americanum*. *Phytopathology* 88: 885–889.
- Wang, X., N. Bosselut, C. Castagnone, R. Voisin, P. Abad, and D. Esmenjaud. 2003. PCR multiplex identification of single individuals of the Longidorid nematodes, *Xiphinema index*, *X. diversicaudatum*, *X. vuittenezi* and *X. italiae* using specific primers from ribosomal genes. *Phytopathology* 93: 160–166.
- Weischer, B. 1975. Ecology of *Xiphinema* and *Longidorus*. In *Nematode vectors of plant viruses*, ed. F. Lamberti, C.E. Taylor, and J.W. Seinhorst, 291–307. London/New York: Plenum Press.
- Weischer, B., and U. Wyss. 1976. Feeding behavior and pathogenicity of *Xiphinema index* on grapevine roots. *Nematologica* 22: 319–325.
- Wyss, U. 2000. *Xiphinema index*, maintenance, and feeding in monoxenic cultures. In *Maintenance of human, animal and plant pathogen vectors*, ed. K. Maramorosch and F. Mahmood, 251–281. Enfield: Science Publishers Inc.

Chapter 26

Management of Grapevine Leafroll Disease and Associated Vectors in Vineyards

G. Pietersen, V.A. Bell, and K. Krüger

Abstract In this chapter, we discuss methods to manage the spread of grapevine leafroll disease in the vineyard itself. We briefly describe the viruses and vectors involved and present epidemiological properties of the virus-vector relationship that are relevant to the management of the disease. We review natural spread of the disease, the rate of spread, and the spatiotemporal disease patterns commonly observed. We provide theoretical and proven vector dispersal and virus transmission mechanisms to explain these spatiotemporal patterns. We provide methods and protocols to prevent primary spread of the virus by infected planting material or from other infected vineyards (proximal, at some distance, adjoining, and preceding) and also how to prevent secondary spread of the disease by roguing. We discuss the critical aspect of vector control to achieve this. A few examples of successful leafroll management are provided. Deficiencies in our knowledge and potential future studies are mentioned throughout the chapter.

Keywords Grapevine leafroll • Control • Epidemiology • Roguing • Spread

Introduction

Plant viruses, including those of grapevines, are best controlled by preventative measures such as import regulations, quarantine, and local restriction of movement of infected planting material. In the case of grapevines, considerable movement of planting material occurred worldwide prior to the discovery of plant viruses, and

G. Pietersen (✉)

ARC-PPRI, c/o Department of Microbiology and Plant Pathology,
University of Pretoria, Pretoria 0002, South Africa
e-mail: gerhard.pietersen@up.ac.za

V.A. Bell

The New Zealand Institute for Plant & Food Research Limited,
Private Bag 1401, Havelock North, 4130 Auckland, New Zealand

K. Krüger

Department of Zoology and Entomology, University of Pretoria, Pretoria 0002, South Africa

as a consequence, a number of important viruses of grape have worldwide distributions.

Selection and breeding for resistance to either the virus or the vector has also been successful for control of plant viruses, but such programs are time consuming and difficult with woody perennial crops. Future strategies involving transgenic approaches to obtain resistant plants using newly discovered genome editing and gene driver technology (Jinek et al. 2012; Champer et al. 2016) may provide an alternative.

Curative measures such as virus elimination by various means, followed by propagation of healthy material, are commonly employed in control of viruses of vegetative propagated crops, including grapevines. These measures are typically conducted off-site by phytosanitary authorities, certification schemes, researchers, and nurseries (Chaps. 27 and 28). Such plants, however, remain susceptible to plant viruses and become reinfected when exposed to field conditions with naturally occurring vectors and reservoirs of infection.

The measures mentioned are typically conducted off-site by phytosanitary authorities, certification schemes, researchers, and nurseries. In this chapter, we discuss the measures required to control the spread of grapevine leafroll disease in the vineyard itself by practicing plant pathologists and virologists, viticulturists, and farm managers.

In the absence of viricides, akin to fungicides to control fungal diseases on a vineyard scale, control of viruses requires interventions targeted at various aspects of the disease spread. Invariably this involves control of the vector, its dispersal, and prevention of access to sources of the virus. Such strategies are generally utilized in an integrated (multi-tactic) manner, so an in-depth knowledge of the virus epidemiology, especially its spread, is required. Grapevine leafroll disease epidemiology and control of spread in the field is a neglected area of research, and a dearth of information exists.

Recently a number of excellent review articles on broader aspects of leafroll, grapevine leafroll control, mealybug, and scale insect management have been published (Maree et al. 2013; Daane et al. 2012; Almeida et al. 2013; Naidu et al. 2014; Maliogka et al. 2015; Camacho and Chong 2015; Herrbach et al. 2013).

Viruses

Currently five phloem limited virus species of the family *Closteroviridae* are associated with what is collectively called grapevine leafroll disease. These are Grapevine leafroll-associated virus-1, virus-3, and virus-4 (GLRaV-1, GLRaV-3, and GLRaV-4) of the genus *Ampelovirus*, Grapevine leafroll-associated virus-2 (GLRaV-2) of the genus *Closterovirus*, and Grapevine leafroll-associated virus-7 (GLRaV-7) of the genus *Velarivirus* (Martelli 2014). A number of strains of each of the members of the *Ampeloviruses* and GLRaV-2 have been reported. GLRaV-7 has only recently been described (Al Rwahnih et al. 2012; Jelkmann et al. 2012), and its variability is unknown.

GLRaV-3 appears to be the most prevalent and widespread virus associated with leafroll worldwide (Maree et al. 2013; Maliogka et al. 2015), with GLRaV-1 also common in temperate climates (Charles et al. 2006; Martelli and Boudon-Padieu 2006). GLRaV-3, along with GLRaV-1 and most strains of GLRaV-2, induces clear leafroll symptoms in the foliage of red cultivars (Maliogka et al. 2015). The GLRaV-4 cluster generally elicits milder leafroll symptoms, while infections with GLRaV-7 induce no or very mild symptoms (Al Rwahnih et al. 2012; Martelli et al. 2012; Maliogka et al. 2015).

Transmission

Viruses associated with leafroll disease are all transmitted by vegetative propagation as well as by grafting of infected material. These viruses are presumed to be able to cross the graft union in both directions, but this has not been established for all of them. They are not mechanically transmissible.

The ampeloviruses associated with leafroll disease (GLRaV-1, GLRaV-3, and GLRaV-4) are transmitted by members of Coccidae (soft scale insects) and Pseudococcidae (mealybugs). Included are mealybugs in the genera of *Ferrissia*, *Heliococcus*, *Phenacoccus*, *Planococcus*, and *Pseudococcus* and soft scale insects in the genera of *Ceroplastes*, *Coccus*, *Neopulvinaria*, *Parasaissetia*, *Parthenolecanium*, *Pulvinaria*, and *Saissetia* (Herrbach et al. 2013; Naidu et al. 2014; Wistrom et al. 2016). There are no known vectors for GLRaV-2 or GLRaV-7. The majority of reports on transmission biology of the ampeloviruses support a non-circulative semi-persistent means of transmission (Herrbach et al. 2013; Almeida et al. 2013; Naidu et al. 2014). Among the known vectors, there is no transstadial or transovarial passage of the virus (Tsai et al. 2008; Herrbach et al. 2013). A number of the mealybug vectors are polyphagous, for example, *Planococcus ficus* (Walton and Pringle 2004). Virus transmission by the mealybugs is not specific, and viruses are often transmitted by a number of species (Tsai et al. 2010). The biology and ecology of the mealybug species most problematic to viticulture is summarized by Daane et al. (2012) and for soft scale insects by Camacho and Chong (2015).

Virus Host Range

Until recently, leafroll viruses were thought to lack hosts other than *Vitis* spp. (Klaassen et al. 2011), but pomegranate (*Punica granatum*) was recently reported as a host of GLRaV-1 (Caglayan et al. 2016). However, very few studies to detect alternative hosts have been conducted since the availability of rapid and sensitive methods of virus detection and identification was developed. Perhaps there was a lack of impetus to conduct such studies, possibly as members of the *Closteroviridae* are known to have restricted host ranges. None of 83 non-*Vitis* hosts surveyed in

Napa Valley, California, in the proximity of nine vineyards, were infected with GLRaV-1, GLRaV-2, GLRaV-3, or GLRaV-4, with only *Vitis californica* and *Vitis californica* × *Vitis vinifera* found infected with GLRaV-2 and GLRaV-3 (Klaassen et al. 2011). Abou Ghanem-Sabanadzovic and Sabanadzovic (2014), surveying *Vitis* spp. native to Mississippi, USA, found GLRaV-2 infecting *Vitis rotundifolia* and *Vitis aestivalis*. Experimentally, GLRaV-2 has been transmitted with difficulty to *N. benthamiana* (Goszczynski et al. 1996). GLRaV-7 was also transmitted experimentally using dodder to *Tetragonia expansa* and *Nicotiana occidentalis* (Mikona and Jelkmann 2010).

Natural Spread of Leafroll Disease

Natural spread of “Rougeau” (accepted to be leafroll disease) was first reported by Fabr e, 1853, who observed that the disease appeared to be transmitted from one vine to another (Ravaz and Verge 1924, quoted in Hoefert and Gifford 1967). This observation appears to have become lost within the literature. Spread of leafroll disease was for many years assumed to occur only through infected planting material and primarily so by asymptomatic American rootstocks (Goheen et al. 1958; Bovey 1970; Boubals 1970; Goheen 1970; Hewitt 1971). The first recorded observation of natural leafroll disease spread in modern times was by Dimitrijevic (1973), who plotted the spread of leafroll infection in a vineyard in Yugoslavia over three seasons. Observations of natural spread were probably easier from the 1980s onwards, once relatively healthy planting material, derived from certification schemes, was planted. Prior to this, the presumed ubiquitous nature of leafroll in planting material would have masked any disease spread. Impetus to record natural spread only followed the demonstration by Rosciglione and Gugerli (1989), which GLRaV-3 was vectored by *Planococcus ficus*. The first demonstration of natural spread potential in vineyards comes from the studies of Engelbrecht and Kasdorf (1985) in South Africa.

Since then, natural spread of grapevine leafroll disease has been recorded from most grape-growing regions of the world including Mexico (Teliz et al. 1989), Israel (Tanne et al. 1989; Sharon et al. 2012; Sokolsky et al. 2013), Italy (Rosciglione and Gugerli 1989; Belli et al. 1993; Borgo and Michelini 2000; Bertin et al. 2009; Gribaudo et al. 2015), Cyprus (Ioannou 1993; Ioannou et al. 1997), New Zealand (Jordan et al. 1993; Bonfiglioli et al. 2002; Charles et al. 2009; Bell et al. 2015), Australia (Habli et al. 1995; Habli and Nutter 1997), Spain (Cabaleiro and Segura 1997, 2006; Cabaleiro et al. 2007; Recio and Legorburu 2006; Velasco et al. 2015), France (Sforza et al. 2003; Le Maguet et al. 2009; Hommay et al. 2009, 2012), USA (Golino et al. 2002, 2008; Martin et al. 2005; Fuchs et al. 2009; Atallah et al. 2012; Blaisdell et al. 2012; Fuchs and Loeb 2012, 2013; Naidu et al. 2012), South Africa (Pietersen et al. 2003, 2013, 2015; Pietersen 2006; Jooste et al. 2011; Pietersen and Walsh 2012), Austria (Gangl et al. 2011), and Germany (Frotscher et al. 2015; Hoffman et al. 2015).

Epidemiology

Rate of Spread

The multiple virus-vector associations of leafroll disease make its epidemiology complex. Differences in virus-vector interactions can potentially alter the epidemiology of the disease. In respect of vectors, this may include differences in life history, seasonal development, and climatic preferences, fecundity and dispersal adaptations, behavioral variability, plant host range, efficiency of virus transmission, and potentially many more. These differences may result in a unique epidemiology and disease spread, hence requiring customized disease management strategies. For example, *Pl. ficus* and *Pseudococcus calceolariae* are known to have a subterranean phase in their seasonal cycle (Walton and Pringle 2004; Bell et al. 2009). These vectors potentially can feed and acquire virus from dormant remnant roots from a previously infected vineyard and spread the virus to a new vineyard at the same site (Pietersen 2006; Bell et al. 2009). For other mealybug species lacking a subterranean phase, this putative route of virus spread will not occur. As a second example, Gangl et al. (2011), studying a large number of vineyards in Austria, observed that GLRaV-1-infected vines tended to be aggregated, while GLRaV-3-infected vines were randomly distributed through vineyards in spite of the two viruses having the same range of vectors, highlighting an inherent difference in the epidemiology of these two viruses.

In view of this, we discuss epidemiological aspects, including rate of spread, in terms of the specific pathosystem present, where known, following the lead of Le Maguet et al. (2013).

A number of reports exist that cite increases in the incidence of leafroll. In a number of these, natural spread or, more accurately, natural spread potential is monitored by the creation of experimental situations to maximize infection of healthy plants (e.g., interplanting of healthy plants and infected plants). Many of these studies were designed to record the occurrence rather than the change in incidence caused by natural spread (Engelbrecht and Kasdorf 1985). The reported natural spread potential of leafroll varies considerably. Engelbrecht and Kasdorf (1985, 1990), working with a GLRaV-3/*Pl. ficus* pathosystem in South Africa, observed that 71% of interplanted healthy vines became infected within seven seasons. Similarly, in Spain, Cabaleiro and Segura (2003, 2006), working with the GLRaV-3/*Planococcus citri* pathosystem, found that during eight years, 82% of interplanted vines were infected in the presence of low numbers of *Pl. citri*. The natural spread potential rates of both reports are thus c. 10% per annum. In contrast, in Piedmont, Italy (Gribaudo et al. 2009), only 15.2% of the healthy vines were infected with at least GLRaV-3 and 1.5% with at least GLRaV-1 more than 10 years after being interplanted among rows of either grapevine virus A (GVA)- and GLRaV-1-infected or GVA- and GLRaV-3-infected vines. These represent natural spread potential rates of less than 1.5% per annum for GLRaV-3 and less than 0.15% per annum for GLRaV-1 in the presence of *Heliococcus bohemicus* (Gribaudo et al. 2009).

In Australia, Habili et al. (2003) observed natural spread of GLRaV-4 strain 9 (formerly GLRaV-9) to 17% of Shiraz vines planted 11 years previously next to a row of cv. Cabernet Sauvignon infected with GVA and GLRaV-4 strain 9, a natural spread potential rate of 1.5% per annum. No mention of the potential vectors at this site was made.

Natural spread rates of leafroll have been determined in several studies by monitoring representative samples or sections of a vineyard (Cabaleiro et al. 2007; Charles et al. 2009). Belli et al. (1993) report natural spread of leafroll in a limited part of the vineyard from four to nine infected plants in three seasons in the absence of mealybugs but presence of scale insects of the genera *Eulecanium* and *Pulvinaria*. Cabaleiro and Segura (2006) monitored representative plots or diagonals over a period of 15 years for the temporal spread of the GLRaV-3/*Pl. citri* pathosystem, where leafroll incidence increased from 35% to 97.5% from 1991 to 2000 over the diagonal of a plot.

Only a few instances of spatiotemporal studies have been conducted in large vineyards, where all plants were evaluated over a number of seasons, and which therefore yield information on rate of spread under commercial viticultural conditions. These are summarized in Table 26.1. Where spread rates have been

Table 26.1 Increase in leafroll due to natural spread

No of vines in vineyard	Increase in incidence (%)	Period monitored (years)	Average annual increase in % infection	Pathosystem	References
626	2.2–4.9	1970–1972	1.35	“leafroll”	Dimetrijevci (1973)
?	9.1–93.1	1988–1992(5)	21	“leafroll”	Jordan et al. (1993)
?	37–60	1991–1993(3)	11.5	“leafroll”	Jordan et al. (1993)
?	14–26	1992–1993(2)	12	“leafroll”	Jordan et al. (1993)
160	21.3–25.3	1992–1995(4)	1.3	GLRaV-3/ <i>Pl. citri</i> ?	Cabaleiro and Segura (1997)
104	23.1–51.9	1986–1996(11)	2.8	GLRaV-3/?	Habili and Nutter (1997)
?	19.7–70.5	1991–1996(6)	10.2	GLRaV-3/?	Ioannou (1993), Ioannou et al. (1997)
?	5–5	1991–1996(6)	0	GLRaV-3/?	Ioannou et al. (1997)
?	44–70	1991–1996(6)	5.2	GLRaV-3/?	Ioannou (1993), Ioannou et al. (1997)
15680	23.3–66.1	2002–2006(5)	10.7	GLRaV-3/ <i>Ps. maritimus</i>	Golino et al. (2009)
1142	4.5–31	2005–2011(7)	4.4	GLRaV-3/ <i>Pl. ficus</i>	Sharon et al. (2012), Sokolsky et al. (2013)
2758	5–86	2004–2011(8)	11.6	GLRaV-1/ <i>Ph. aceris</i>	Le Maguet et al. (2009, 2013)
2435	5–9	2005–2011(7)	0.6	GLRaV-1/ <i>Ph. aceris</i>	Le Maguet et al. (2009, 2013)

transformed to reflect the growth curve, the rate of spread in New Zealand (Jordan et al. 1993) was 1.19 logits/year, *ca* three times faster than South Australia at 0.35 logits/year (Habibi and Nutter 1997). In France, Le Maguet et al. (2013) found one site with logits per year increase of 0.76, while another with 0.05. These were with GLRaV-1/*Ph. aceris*. In South Africa, infection levels of leafroll disease (GLRaV-3/*Pl. ficus* pathosystem) increased exponentially ($y = 898.16e^{0.655x}$, $R^2 = 0.9983$) in 57 commercial vineyards, monitored with an average year-on-year increase of 1.94 times (Pietersen et al. 2013).

Spatial Patterns of Disease Spread

Spatiotemporal studies of diseases caused by plant viruses yield critical information for use in management of the disease. These include identifying the sources and direction of viral inoculum, infection pressure, the type of dispersal (aerial, soil-borne, wind-borne, farming implements), distances, and rate of dispersal of vectors (slow moving sessile vectors, flying vectors). Various disease-spread patterns have been described for leafroll and have yielded important information regarding the epidemiology of the disease and, consequently, means to manage the disease.

Random Infection Patterns

Randomly occurring leafroll-infected vines within vineyards have been reported in a number of studies (Jordan et al. 1993; Cabaleiro and Segura 1997; Habibi and Nutter 1997; Bonfiglioli et al. 2002; Pietersen et al. 2003; Pietersen 2006; Recio and Legorburu 2006; Cabaleiro et al. 2007; Charles et al. 2009; Gangl et al. 2011; Sokolsky et al. 2013; Le Maguet et al. 2013). Most authors ascribed this pattern to the planting of propagation material, at least some of which was leafroll infected. This spatial pattern was traced back to infected planting material with certainty, by correlating it with only specific planting material by Jordan et al. (1993), Habibi and Nutter (1997) and Pietersen (2006), and in one report to certified planting material (Pietersen et al. 2013). By analogy with seed-transmitted viruses, the distribution of virus-infected vines is generally random when planting material is infected at a low incidence, but would tend to have an even distribution, lacking gradients, when planting material contains a high incidence of infected vines. Infected planting material may also result in the occurrence of random foci or clusters of infected vines if cane material from a specific rootstock or scion, when the cuttings from an infected vine remain associated with each other during the process of producing new propagation material. This has been observed (Pietersen et al. 2013) and was correlated with infected planting material in one whole vineyard (Fig. 26.1), as well as a portion of a second vineyard where this planting material was used (not shown). Based on planting at other sites of other rootstock/scion combinations of this original material, the infection was traced back to the rootstock component of the grafted

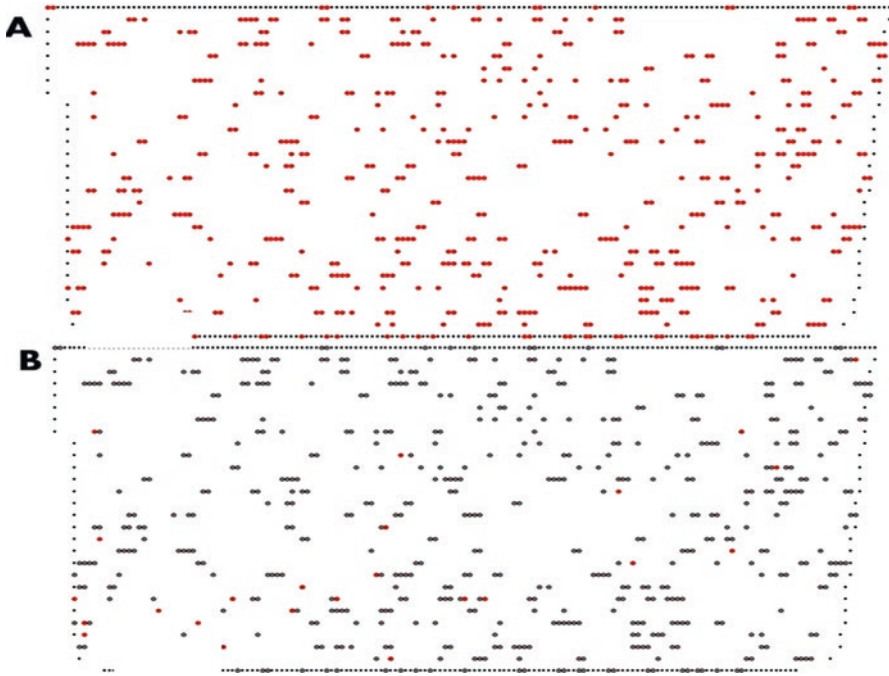

Fig. 26.1 Distribution of leafroll infected vines in a Cabernet Sauvignon vineyard ($n = 4475$ vines) planted in 2002 on Vergelegen Wine Estate, South Africa. (a) 2003 Red dots denote position of infected vines in 2003 ($n = 548$). Note the aggregation present. (b) Grey dots denote the position of rogued vines from 2003 and red dots denote leafroll observed in 2004 ($n = 25$). (Pietersen et al. 2013)

vines (Pietersen, *unpublished data*). The occurrence of infected planting material from certification schemes reflect past difficulties in managing leafroll spread in propagation field plots, as well as current difficulties in detecting the virus, (a) on the massive scale of propagation often required of the schemes, (b) in recently infected vines within propagation plots, and (c) in various rootstocks, where the virus titer and in-plant distribution is erratic (Credi and Santucci 1990; Cid et al. 2003). Advances in new large-scale in situ or extremely sensitive virus detection methods such as use of spectral reflectance measurements and remote sensing (Pietersen 2006; Naidu et al. 2009), sentinel cane bioassay (Thompson and Pietersen, *unpublished data*) (Fig. 26.2), and reverse transcriptase loop-mediated isothermal amplification of DNA (RT-LAMP) (Walsh and Pietersen 2013) show promise and are expected to address these shortcomings in the future.

Not all random infections can be ascribed to disease spread by planting material. Long distance primary spread can also appear as random infections of leafroll. This mode of dispersal is well documented for viruliferous aphids on various crops (Irwin et al. 1988). Pietersen et al. (2013) reduced incidence of leafroll (GLRaV-3/*Pl. ficus* pathosystem) to less than 0.01% using an integrated control strategy, but at the time of writing had been unable to eradicate the disease from all vineyards,



Fig. 26.2 Leafroll symptoms observed cultivar Pinot Noir canes grafted as healthy buds in October/November, 2012 on the trunk of commercially grown, GLRaV-3 infected white grapevines cultivars Chardonnay, Sauvignon Blanc and Pinot Gris, on Mission Estate, Hawkes Bay, New Zealand as part of a proof-of-concept trial to assess the usefulness of these so-called, sentinel canes for *in situ* leafroll detection on white cultivars (Thompson and Pietersen, unpublished results) (Images provided by C. Thompson)

some being infected with single, randomly occurring, newly symptomatic vines (G. Pietersen, unpublished results). These occurred longer than 10 years after planting and could no longer be ascribed to infected planting material. They were not associated spatially with previously infected, rogued vines and were observed in vineyards in which no infected vines had been observed for as many as three prior growth seasons. Furthermore, such vineyards had no infected vineyards in their proximity, and the infected vines were unrelated to vineyard edges and displayed no obvious gradients within the vineyard. Furthermore, of 21 vineyards in which this phenomenon was observed, 13 were vineyards established on soil previously unplanted to *Vitis*. It is suggested that these infections reflect relatively long distance dispersal of viruliferous *Pl. ficus* at least between 900 m and 1.2 km, the distance from the closest known leafroll inoculum sources which were, coincidentally, upwind with regard to prevailing winds. This putative long distance establishment of random infections in vineyards would not be observed in situations where other modes of leafroll spread are active.

Random patterns of leafroll spread can also be obtained where new vineyards are established on the same site as a replaced highly infected vineyard due to the mealybug infection from infected volunteer (regrown) *Vitis* plants coming up in the new

vineyard and possibly also from dormant remnant roots left behind in the case of vectors with a subterranean life cycle (discussed in greater detail below).

Aggregation of Diseased Plants

The initial random occurrence of leafroll-infected vines in a vineyard is often followed, when further spread occurs, by an aggregated pattern of infected vines (Jordan et al. 1993; Cabaleiro and Segura 1997, 2003; Habili and Nutter 1997; Ioannou et al. 1997; Golino et al. 2002; Bonfiglioli et al. 2002; Pietersen et al. 2003; Pietersen 2006; Recio and Legorburu 2006; Cabaleiro et al. 2007; Cabaleiro 2009; Le Maguet et al. 2009, 2012, 2013; Charles et al. 2009; Gangl et al. 2011; Sharon et al. 2012; Arnold et al. 2012; Naidu et al. 2012; Sokolsky et al. 2013; Gribaudo et al. 2015). Most often this aggregation of infected plants occurs primarily along a row, and to a slightly lesser degree across rows, and was first reported by Jordan et al. (1993) in New Zealand. Cabaleiro and Segura (1997), however, reported equally rapid spread along and across vine rows and suggested that this was due to the continuous, horizontal trellises used, with mealybugs therefore having no preference to move along either rows or columns, while in New Zealand and Australia where vertical shoot positioned trellises dominate, mealybugs preferentially move along rows.

An aggregated leafroll-infected vine pattern has been reported for many leafroll pathosystems and in many countries: from Australia with a GLRaV-3/unreported vector pathosystem (Habili et al. 1995); Spain with a GLRaV-3/*Planococcus citri* pathosystem (Cabaleiro and Segura 1997); Cyprus with a GLRaV-3/*Pl. ficus* and/or *Pl. citri* pathosystem (Ioannou et al. 1997); California, USA, with a GLRaV-3 or GLRaV-5/*Pl. ficus* and/or *Pseudococcus viburni* and/or *Pl. citri* and/or *Pseudococcus longispinus* and/or *Pseudococcus maritimus* pathosystem (Golino et al. 2002); South Africa with a GLRaV-3/*Pl. ficus* pathosystem (Pietersen et al. 2003); Washington, USA, with GLRaV-3/*Ps. maritimus* pathosystem (Donda and Naidu 2014); Austria with a GLRaV-1 or GLRaV-3/unreported vector pathosystem (Gangl et al. 2011); France with a GLRaV-1/*Phenacoccus aceris* pathosystem (Le Maguet et al. 2013); and Israel with a GLRaV-3/*Pl. ficus* pathosystem (Sokolsky et al. 2013).

This aggregated pattern is due to secondary spread of virus, which is the result of dispersal of viruliferous mealybug crawlers from an infected vine either by their own motility on trellising wires, on intermingled canes and leaves of adjoining plants, on farm equipment and implements, on farm workers moving along rows, or a combination of these factors. Virus transmission through root graft unions among adjoining plants may theoretically also occur (Pietersen 2004; Cabaleiro et al. 2007) as shown for various horticultural trees (Epstein 1978). While Ioannou et al. (1997) excluded the latter possibility in experiments by planting vines next to each other in pots and still demonstrating virus transmission between the vines, root grafting (Epstein 1978) may occur in commercial vineyards at unknown incidences. Cabaleiro and Segura (2003) described the occurrence of new foci of leafroll infection from an initial infection foci of a GLRaV-3/*Pl. citri* pathosystem. This pattern

of disease spread was reported for mealybug transmission of *Cacao swollen shoot virus* (CSSV) and is referred to as jump-spread (Cornwall 1958) and constitutes longer distance secondary spread possibly due to wind dispersal of viruliferous mealybugs and dispersal on farm equipment and/or farm workers.

Gradients

Cabaleiro and Segura (1997) first reported that four vineyards out of nine vineyards analyzed in Spain contained a preponderance of leafroll (GLRaV-3/*Pl. citri* pathosystem)-infected vines from the vineyard edges with a diminishing gradient of infected plants toward the middle or other sides of the vineyards. Subsequently, disease gradients like these have been reported for various other leafroll pathosystems and a number of other countries including Bonfiglioli et al. (2002) in New Zealand (GLRaV-3/unreported vector), Pietersen (2004, 2006) in South Africa with a GLRaV-3/*Pl. ficus* pathosystem, Le Maguet et al. (2009, 2012, 2013) in France with GLRaV-1/*Ph. aceris*, Charles et al. (2009) in New Zealand with GLRaV-3/ mainly *Ps. longispinus* and some *Ps. calceolariae*, Hommay et al. (2012) in France with GLRaV-1/*Parthenolecanium corni*, Naidu et al. (2012) and Donda and Naidu (2014) in the USA with GLRaV-3/*Ps. maritimus*, and Frotscher et al. (2015) in Germany with GLRaV-1/unreported vector. The slope of gradients observed, which yields information on distances dispersed, have been analyzed on some occasions (Cabaleiro and Segura 1997). In most instances reported, the numbers of infected vines in these gradients increased in the direction of infected, older proximal vineyards, but some exceptions to this occurred with Cabaleiro and Segura (1997), reporting a disease gradient in the direction of a *Eucalyptus* planting and Pietersen (2004) reporting a number of gradients in a direction of the vineyard with no obvious leafroll infection source.

Disease gradients infer the introduction of leafroll to the vineyard consistently from a source external to it. In the absence of evidence of alternative hosts to GLRaV-3 other than *Vitis* (Klaassen et al. 2011), it is safe to assume that all primary infection in a vineyard, other than by infected planting material, would be due to the occurrence of GLRaV-3 viruliferous vectors, which had acquired the virus from another GLRaV-3-infected *Vitis* source. Based on reported disease gradients, this is mainly adjoining leafroll-infected vineyards. However, with no obvious source of leafroll disease in the direction of the gradient (Cabaleiro and Segura 1997; Pietersen 2006), long distance spread of the disease by dispersing vectors on farm workers, farm implements, and by wind and birds has been suggested (Bonfiglioli et al. 2002; Sforza et al. 2003; Pietersen 2006; Spreeth et al. 2006; Cabaleiro et al. 2007; Charles et al. 2009; Frotscher et al. 2015). Wind dispersal of mealybugs serving as vectors of plant viruses is a well-established phenomenon (Cornwall 1958). Wind dispersal of grapevine-colonizing species have also been reported; Barrass et al. (1994) collected first and second instars of *Ps. longispinus* on sticky traps around pear orchards, wind dispersal of *Ps. maritimus* from grapevines was reported by Grasswitz and James (2008), and in France, Hommay et al. (2012) demonstrated the

dispersal of GLRaV-1 viruliferous *P. corni* larvae. Nymphs and egg sacs have been found on wind-blown fallen leaves (N.A. Spreeth and W.T. Oosthuizen, personal communication), a possibility previously considered (Lo et al. 2006).

Cultivation History-Related Disease Patterns

These may be disease-spread patterns that are unusual and are often related to specific cultivation practices or past activities that may have occurred at a site. Top-working of healthy planting material is one such example where the disease status of the replaced rootstock/scion would be expected to closely mirror that of the original, a practice to be discouraged (Bonfiglioli et al. 2003).

A second such example was observed during an analysis of the spatiotemporal spread of leafroll disease in 57 vineyards of the GLRaV-3/*Pl. ficus* pathosystem (Pietersen 2006) wherein one half of a vineyard, coinciding with an area left fallow previously, had considerably less leafroll diseased vines than in the other half which lacked a prior fallow period. In the latter half, infected vines with a random distribution, lacking a disease gradient in any direction, occurred. It was suggested that leafroll spread could occur from an old vineyard to a young, replacement vineyard on the same site (Pietersen 2006). Such spread could be by (i) leafroll-infected volunteer vines persisting into the new vineyards, a phenomenon commonly observed in replanting situations, (ii) the persistence of leafroll-infected remnant dormant roots that could serve as reservoirs of the virus for mealybugs in the new planting, or (iii) the persistence of viruliferous mealybugs from the previous vineyard on dormant remnant roots or in the soil for short periods of time. This observation coincided with Walton and Pringle (2004) demonstrating that *Pl. ficus* has a subterranean phase in its lifecycle. Bell et al. (2009) conducted field trials with the GLRaV-3/*Ps. calceolariae* pathosystem in New Zealand to determine the status of GLRaV-3 in remnant roots after applying herbicide and/or leaving ground fallow for variable intervals following removal of leafroll-infected vines. In over two thirds of the approximately 100 dormant remnant root samples tested, virus was detected up to 24 months after vine removal. In one vineyard, GLRaV-3 was detected by real-time PCR four years after vine removal (Bell et al. 2009). Virus detection was not influenced by treatment with one of three herbicides (metsulfuron, triclopyr, or glyphosate) or by the duration of the passive fallow period (six months to four years). Some colonies of *Ps. calceolariae* found on root samples at a depth of *ca* 10 cm at six and 12 months after vine removal tested positive for GLRaV-3 by real-time PCR (Bell et al. 2009). While the Bell et al. (2009) study confirms the longevity of dormant remnant roots and suggests mealybug feeding and ingestion of GLRaV-3 from them, further research is required to confirm virus acquisition and transmission from such roots to newly planted vines in their proximity. The random pattern of infection suggested of this route of leafroll spread makes it difficult to differentiate it from spread due to infected planting material without correlations being made with either specific single origin rootstock scion combinations or a previous fallowed area.

Field Control of Leafroll Disease

Field control of leafroll disease, and probably that of the rugose wood complex, which share mealybug and scale insect vectors, in broad terms requires removal of the viral inoculum and control of the populations of insect vectors. It is likely that each of the leafroll and rugose wood pathosystems may vary in the detail of disease management, but general principles discussed here, based primarily on current information and understanding of the epidemiology of the GLRaV-3/*Pl. ficus*, GLRaV-3/*Pl. citri*, GLRaV-3/*Ps. calceolariae* leafroll pathosystems, will probably be applicable for managing other mealybug or scale insect-vectorized leafroll or rugose wood pathosystems. As our understanding of the epidemiology of the various pathosystems develops, it is expected that refinement of management principles will also occur. The absence of evidence of natural alternative hosts for GLRaV-3 other than *Vitis* (Klaassen et al. 2011), the lack of demonstrated mechanical transmission of the leafroll viruses between *Vitis* individuals, and the lack of evidence of transstadial or transovarial passage of GLRaV-3 simplify the management of these diseases. A substantial amount of research on control of mealybugs in the field has been done (Reviewed by Daane et al. 2012), but less reports on field control of leafroll disease exist (Pietersen et al. 2003, 2009, 2013, 2015; Spreeth et al. 2006; Pietersen and Walsh 2012; Cabaleiro 2009; Bell et al. 2009; Zahavi et al. 2012; Atallah et al. 2015; Sokolsky et al. 2013; Almeida et al. 2013; Naidu et al. 2014; Maliogka et al. 2015).

Based on interpretations of the spatiotemporal disease-spread patterns of leafroll, it is evident that management of the disease requires (i) prevention of primary spread of the virus by infected planting material, (ii) prevention of primary spread from other infected vineyards (proximal, distant, adjoining, and preceding), and (iii) prevention of secondary spread of the disease. Inherent, and essential, to each of these is vector control. These interventions are each discussed below.

Primary Infection in Planting Material

Establishing new vineyards with virus-tested, certified planting material constitutes an essential component of leafroll control. In countries where shortcomings in propagation of nursery material allow for virus infection, and hence dissemination of infected planting material, use of certified planting material cannot be solely relied on to establish healthy vineyards free of leafroll. In mitigation, newly planted vines can be treated with a systemic insecticide (imidacloprid) shortly after planting, visually monitored for leafroll symptoms (in red cultivars), or tested for GLRaV-1, GLRaV-2, and GLRaV-3 (by ELISA or PCR) in the case of asymptomatic white cultivars in subsequent seasons, with all infected vines removed (rogued) (Pietersen et al. 2013). The strategy is to protect the vine from mealybug colonization, feeding, or dispersal during the latent phase of the virus infection and to prevent it from

serving as a source from which secondary infection can occur. The effectiveness of this approach is evident from the data in Fig. 26.1 where a vineyard with 548 leafroll-infected vines, introduced as infected planting material, was reduced to just 25 new symptomatic plants the next season after roguing (data extracted from vineyard Rooiland 7, Pietersen et al. 2013). Based on the average rate of disease spread in South Africa, had no control been applied the number of infected plants would have increased 1.94 times annually (almost doubling) (Pietersen et al. 2013). A proof-of-concept trial in which nursery material was treated with imidacloprid prior to transplanting this material failed to prevent artificially induced *Pl. ficus* infestations after transplanting (R. Carstens and G. Pietersen, unpublished results); however, this concept may warrant further investigation.

Primary Spread from Other Vineyards

To prevent leafroll spread to healthy new vineyards from adjoining vineyards, and distant vineyards sharing farm equipment and workers, the following interventions have been utilized (Pietersen et al. 2013): (i) chemical control of mealybugs in old adjoining vineyards and distant vineyards on the same estate with high leafroll infection levels; (ii) spatial isolation of newly established vineyards from older highly infected vineyards by a minimum of 20 m over a road and windbreak of trees; (iii) planting new vineyards systematically next to each other rather than among older, leafroll-infected vineyards; (iv) separating implement and farm worker activities spatially and temporally between infected vineyards and new healthy vineyards; and (v) washing farm implements with a weak solution of detergent following work in old-infected vineyards. Unfortunately, as the aim of the Pietersen et al. (2013) study was to assess the likelihood of leafroll management through an integrated control strategy at a commercial estate, the effect of individual interventions was not quantified and will require future research. In spite of all the above precautions, evidence of spread of leafroll between old-infected vineyards and new healthy vineyards was observed over a period of seven successive years (G. Pietersen unpublished data), which correlated with the prevailing summer winds. The established windbreaks did not completely prevent mealybug vector wind dispersal, and it is unknown whether they had any effect on leafroll spread. Depending upon specific on-farm requirements, further precautions could include (i) planting new vineyards upwind of leafroll-infected vineyards where possible, (ii) maintenance of a *Vitis*-free buffer zone between new vineyards and infected vineyards (the distance of which is unquantified but which can be assessed from disease gradients), (iii) establishing large blocks (of a close to square shape) in preference to small blocks with low edge/inside vine ratios, and (iv) where permissible, establishing new blocks with rows orientated at 90° to that of adjoining, infected vineyards (to discourage the movement of implements and farm workers directly between vineyards).

Primary Spread from a Preceding Vineyard

The use of a theoretical protocol to prevent this means of leafroll spread from a preceding vineyard was proposed by Pietersen (2004). It included treating the infected vines in old vineyards with a systemic insecticide (imidacloprid), the thorough removal of those infected vines or herbicide treatment to kill vines, a fallow period with active removal of volunteer vines, and establishing the new vineyard with certified planting material treated with a systemic insecticide. This protocol, initially including herbicide treatment, was utilized in 23 replaced leafroll-infected vineyards (Pietersen et al. 2013). Herbicide treatment did not kill the vine roots effectively, a result supported by controlled experiments in this regard (Bell et al. 2009; Pietersen et al. 2015). The inability to include untreated control sites in the commercial estate means that the effect of the protocol, or any of its components, was not quantified (Pietersen et al. 2013). A field trial designed to confirm the route of leafroll spread and to develop a science-based management strategy to prevent leafroll spread from a preceding to new vineyard was conducted with the GLRaV-3/*Pl. ficus* pathosystem (Pietersen et al. 2015). Replicated and controlled plots of various treatments were conducted: (i) three fallow periods with active remnant vine tissue removal, (ii) treatment of old-infected vines with imidacloprid prior to removal, and (iii) herbicide treatment of the old-infected vines. A new vineyard of leafroll-sensitive Cabernet franc was established where these treatments and their buffer strips had been conducted and was evaluated for the number of GLRaV-3-infected vines found spatially associated with the treatment plots. The trial yielded inconclusive results. The level of infection obtained in treatment plots, while rapidly appearing, was initially too infrequent to allow statistical comparisons and later displayed an aggregated spatial pattern. This result could reflect areas of greater transmission of the virus from dormant remnant roots, but could also be as a result of aerial secondary spread via viruliferous vectors. Leafroll spread from dormant roots remains to be proven. Of those mealybug species not known to have a subterranean phase in their lifecycle, transmission of virus from dormant remnant roots is unlikely, however, disease spread from infected volunteer hosts derived from the previous vineyard may still occur.

Pending further studies to confirm transmission from dormant remnant roots, a cautionary approach is adopted in New Zealand and South Africa, with growers advised to (i) remove vines entirely rather than use herbicide on infected vines (Bell et al. 2009; Pietersen et al. 2013); (ii) actively manage vectors and root removal to a depth of about 30 cm, the maximum depth of most subterranean populations of *Ps. calceolariae* and *Pl. ficus* observed (Walton and Pringle 2004; Bell et al. 2009; Andrew et al. 2015), and (iii), in South Africa, actively remove volunteer vines during a period of at least one season in the new vineyard.

Secondary Spread

Secondary spread, and the resultant aggregated pattern of infected vines often observed in vineyards, is the consequence of having an initial infected vine at a specific position in the vineyard. Thereafter, mealybugs and soft scale insects affect vine-to-vine virus transmission over relatively short distances or over longer distances within the vineyard, the latter known as jump-spread (Cornwall 1958). Secondary spread was identified as the most prevalent means of leafroll spread among 57 vineyards analyzed, occurring in all of them and resulting in the largest numbers of new infected vines (Pietersen 2006). Reduction of secondary leafroll spread is likely to have the most positive influence on the management of leafroll disease. In plant virus terms, the spread of GLRaV-3 is relatively slow and the spread gradient very steep; hence, roguing, tested initially on an experimental level (Pietersen et al. 2003), was anticipated to be a very successful measure for preventing this spread. This has been confirmed by modeling (Atallah et al. 2015), especially when combined with mealybug control (Pietersen et al. 2013; Sokolsky et al. 2013). Roguing, combined with stringent vector control, was utilized on a commercial wine estate on 63 red grape cultivar vineyards and 31 vineyards of white grape cultivars (Pietersen et al. 2013; Pietersen and Walsh 2012). In addition, roguing was also successfully applied across a whole wine region in New Zealand and by some producers in Napa Valley, California, USA (Almeida et al. 2013), as well as in Israel (Sokolsky et al. 2013).

For effective roguing, leafroll-infected vines must be easily detected on a vineyard-wide scale. Good correlations between leafroll symptoms in red cultivars and GLRaV-3 ELISA-positive vines have been reported (Golino et al. 2008; Naidu et al. 2012; Bell et al. 2015). Annual roguing based on autumn visual identification of leafroll-infected vines, in conjunction with vector control, not only arrested disease spread but resulted in near-elimination of leafroll in red cultivars at a commercial wine estate in South Africa (Pietersen et al. 2013) and resulted in dramatic reductions in leafroll disease incidence in an entire appellation in New Zealand (Almeida et al. 2013).

Visual detection of leafroll symptoms for the purpose of roguing infected vines is not effective for white cultivars because of the lack of obvious foliar symptoms in most cultivars or the long asymptomatic phase in those that do display leafroll symptoms. ELISA tests have been used to detect GLRaV-3 on white cultivars in order to rogue infected vines (Walsh and Pietersen 2013) and have proven effective, albeit impractical and prohibitively expensive in most commercial situations. An RT-LAMP technique was developed to detect GLRaV-3 within much larger pooled samples *in situ* (Walsh and Pietersen 2013). A proof-of-concept trial to assess the potential of using an *in situ* bioassay for leafroll detection prior to roguing has yielded promising results with symptoms on a red leafroll indicator cane (cv. Pinot noir) grafted on the stems of individuals of white cultivars correlating well with ELISA tests for GLRaV-3 on the recipient vine (C. Thompson and G. Pietersen, unpublished results) (Fig. 26.2).

Roguing symptomatic vines for a limited period of time did not fully eliminate disease foci (Pietersen et al. 2003), and often previously healthy vines immediately beside rogued vines show symptoms in subsequent seasons. The vines adjoining symptomatic vines in the vine row are at the greatest risk of becoming infected through secondary spread (Sokolsky et al. 2013; Bell 2015) and often have a latent infection period. Initially, roguing symptomatic vines, along with the two adjoining vines in the row, was done at Vergelegen (Pietersen et al. 2013); however, this was later modified by applying a soil-drench application of imidacloprid to the adjoining vines and only roguing these in subsequent seasons if they displayed symptoms. In a further permutation, when systemic insecticide was applied to the entire vineyard through the drip irrigation system, only symptomatic vines were removed. The value of these modifications were confirmed by Sokolsky et al. (2013) who tested the effect of (i) roguing alone, (ii) roguing supplemented with insecticide treatment of neighboring vines, and (iii) treatment of neighboring vines with no roguing on spread of leafroll. Roguing with and without supplemental treatment to neighboring vines significantly decelerated infection spread over a seven-year period (from 30 to 8.6%). The combined treatment of infected and neighboring vines, however, yielded a lower infection incidence with fewer roguing events compared with roguing alone. Furthermore, Bell (2015) showed that if the symptomatic and the two adjoining vines were routinely removed, a high percentage of vines would be needlessly rogued.

Vines of the same cultivar and clone were replanted (reset) in gaps created by roguing leafroll-infected vines (Pietersen et al. 2013). This process worked well, even in well-established older vineyards when the whole foci of infection were removed (Fig. 26.3). However, where single vines need to be reset among established ones, this protocol was only successful in young vineyards, as in more established vineyards considerable input of targeted water and nutrient supplements is required, which is generally only practical in newly established vine plantings. Some instances of leafroll infection of replanted vines in the spaces left by rogued vines have been recorded; for example, in the vineyard presented in Fig. 26.1, 11 of 547 vines replanted became leafroll-infected between two and eight seasons later (Pietersen et al. 2013). Roguing is not effective in situations where primary infection from proximal vineyards consistently occurs (G. Pietersen, unpublished data).

Thresholds for the feasibility of roguing reflect a balance between the cost of roguing and the cost of potential leafroll spread and damage and require economic considerations (Atallah et al. 2012; Ricketts et al. 2015). In New Zealand, a 20% threshold is utilized above which roguing is not recommended (Bell 2015), whereas a threshold of 25% is recommended in the USA (Atallah et al. 2012), and growers in California utilize thresholds depending on various factors (Almeida et al. 2013; Ricketts et al. 2015).

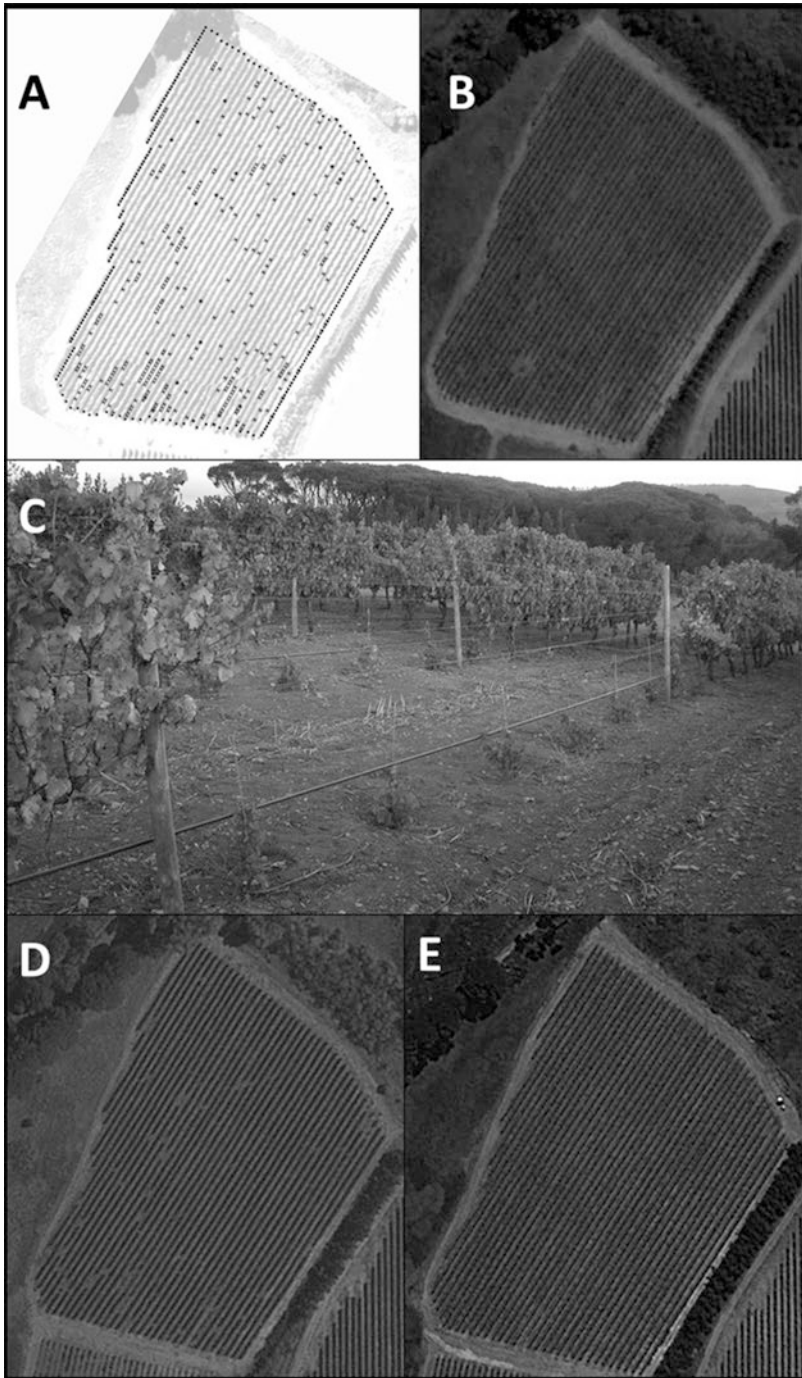

Fig. 26.3 Example of the reset of rogued vine clusters in a Cabernet Sauvignon vineyard planted in 1999 on Vergelegen Wine Estate, South Africa. **(a)** Leafroll Infected vines observed in the vineyard in 2005 (*x*'s) and 2007 (*dots*), and rogued. **(b)** Aerial view of the vineyard in 2005, gaps where vines were removed can clearly be seen. **(c)** Resetting in 2006 of new vines in the gaps created by rogued vines. **(d)** Aerial view in 2009 and **(e)** 2013 showing progressive closing of gaps until an even stand was achieved

Vector Management

Monitoring

Monitoring is a key component of vector management. Monitoring mealybugs and soft scale insects is difficult due to their cryptic lifestyle and a high degree of within-vine spatiotemporal variability (Charles 1981; Geiger and Daane 2001). Consequently, in the absence of a substantial sampling effort, visual searches of vines for either pest group are difficult to accomplish reliably. However, monitoring of *Pl. ficus* has been dramatically improved using species-specific synthetic female sex pheromone (Hinkens et al. 2001; Walton 2003). Species-specific synthetic sex pheromones are also available for *Ps. viburni* (Millar et al. 2005), *Pl. longispinus* (Zou and Millar 2009), *Ps. maritimus* (Figadere et al. 2007), and *Ps. calceolariae* (Unelius et al. 2011).

For early detection of mealybugs and for making management decisions, monitoring can be reliably undertaken using synthetic sex pheromone-baited delta traps, which can be combined with physical grapevine inspections (Daane et al. 2012). Monitoring programs have been developed for some mealybug species, including *Pl. ficus* in South Africa and the USA and *Ps. maritimus* in the USA (Millar et al. 2002; Walton et al. 2004; Bahder et al. 2013), but thresholds have not been determined. Due to their status as virus vectors, pheromone traps are often used to determine the presence/absence of mealybug species in vineyards (Almeida et al. 2013).

Chemical Control

Controlling mealybugs and soft scale insects has historically relied on a wide range of insecticide active ingredients with varying modes of action (Daane et al. 2012; Camacho and Chong 2015). Insecticides registered for use against these insect pests are broadly categorized as either contact or systemic and include the likes of organophosphates, neonicotinoids, insect growth regulators, and biosynthesis inhibitors.

Concerns related to the negative influence of organophosphates on beneficial insects has meant that in some countries the use of this technology has progressively declined and been replaced with alternative products targeting specific insect groups and/or life stages (Daane et al. 2006). In this regard, buprofezin, a contact insecticide and insect growth regulator, controls mealybug crawlers and juveniles very effectively (Lo et al. 2009; Prabhaker et al. 2012). However, early in the growing season, mealybugs found under bark and in cracks and crevices on old vine wood can compromise control efforts when insecticide label recommendations are not followed. The emergence of mealybugs from these sites over a period of weeks to several months may further confound vector management. Thus, the effectiveness of buprofezin is maximized by two applications separated by several weeks, using high water volumes giving good vine wetting and coverage targeting individuals in protected locations (Lo et al. 2009; Wise et al. 2010; Almeida et al. 2013).

Insecticide resistance management is most effective when the use of an active ingredient like buprofezin is alternated with other products like the systemic neonicotinoid, imidacloprid (Daane et al. 2006), and/or spirotetramat, a tetramic acid derivative (Brück et al. 2009). As well as offering effective control to aerial parts of the vine, systemic products translocated through the vascular system of the vine may control mealybugs feeding on roots. Applied as a soil drench, imidacloprid was effective against *Ps. calceolariae* (Lo and Walker 2011), and when applied via drip irrigation, there was significantly less cluster damage by *Pl. ficus* compared with the untreated control (Daane et al. 2006).

As part of an integrated strategy to control leafroll, *Pl. ficus* numbers were managed with two chlorpyrifos applications on dormant vines, two weeks apart using hand-gun high-volume sprays (Pietersen et al. 2013). This tactic was supplemented with imidacloprid treatment every three seasons, initially as a soil drench, but later via the drip irrigation system (Daane et al. 2006). When more than 10 *Pl. ficus* males were observed in pheromone-baited traps during any two-week period, a vineyard was treated with imidacloprid on alternate years. However, recent data from laboratory bioassays indicated that viruliferous *Pl. ficus* successfully transmitted GLRaV-3 to recipient virus-free vines treated with imidacloprid five months earlier (Allsopp 2015). The author suggests that imidacloprid will therefore be ineffective at controlling primary spread, but its use, coupled with roguing, is likely to prevent secondary spread of the disease (Allsopp 2015).

In the case of spirotetramat, good efficacy against mealybugs and soft scale insects was also demonstrated (Brück et al. 2009; Wallingford et al. 2015). Importantly, with evidence that spirotetramat posed minimal risk to several species of mealybug natural enemies, this active ingredient would appear to be compatible with integrated pest management systems (Brück et al. 2009; Mansour et al. 2011; Planes et al. 2013).

In order to maintain and then achieve a leafroll-free status in new vineyards, the high degree of control required of these efficient vectors necessitates the adoption of a stringent chemical program wherever leafroll infection occurs, be it a low, moderate, or high disease incidence. However, once these vineyards have been replaced and most vineyards in a region are effectively virus free, chemical control may be combined with, or replaced by, biological control (Pietersen et al. 2013). With the introduction of selective chemicals, which are more target-specific and have less negative effect on natural enemies, biological control is becoming an increasingly attractive option as part of integrated pest management approach in vineyards (Charles et al. 2010).

Biological Control

Mealybugs and scale insects are attacked by a range of natural enemies. These include parasitoids (Hymenoptera: Aphelinidae, Encyrtidae, Pteromalidae), insect predators such as ladybugs (ladybirds or ladybeetles) (Coleoptera, Coccinellidae), larvae of midges (Diptera, Cecidomyiidae), dustwings (Neuroptera,

Coniopterygidae), lacewings (Neuroptera, Chrysopidae), and entomopathogenic nematodes (Walton and Pringle 2004; Charles et al. 2010; Fallahzadeh et al. 2011; Daane et al. 2012; Le Vieux and Malan 2013). Surveys in vineyards revealed an unexpected variety of natural enemies (Walton and Pringle 2004; Charles et al. 2010; Fallahzadeh et al. 2011), which has been attributed to a reduction in the use of pesticides (Charles et al. 2010). Little information is available on the levels of parasitism or the effectiveness of predators. Parasitism of mealybugs in vineyards reached 19% during a survey of natural enemies in New Zealand (Charles et al. 2010). The parasitoid *Anagyrus dactylopii* (Hymenoptera: Encyrtidae) and the coccinellid beetle *Scymnus coccivora* were responsible for 70% of the parasitism/predation of *Maconellicoccus hirsutus*, the most common mealybug in vineyards in India (Daane et al. 2012). In California, the parasitoid *Anagyrus pseudococci* parasitized 80% of exposed mealybugs in the San Joaquin Valley vineyards, whereas parasitism with the same species reached only 25% in the Coachella Valley, possibly because mealybugs occurred in less exposed locations on vines, e.g., underneath bark and on roots (Malakar-Kuenen et al. 2001).

Biological control, whether in the form of augmentation of natural enemies or classical biological control (importation of enemies), has focused on mealybugs because of their importance as vectors of grapevine viruses; scale insects rarely reach pest proportions. Exotic natural enemies of pest mealybug species were either imported as part of biological control programs or arrived accidentally (Charles et al. 2010). Parasitoids and predatory beetles are commonly used for the biological control of mealybugs and scale insects in vineyards. A number of natural enemies are commercially available in many countries, e.g., parasitic wasps of the genus *Anagyrus* and *Coccidoxenoides perminutus* (Hymenoptera, Encyrtidae) and among predators the coccinellid beetle *Cryptolaemus montrouzieri* (Franco et al. 2009; Kairo et al. 2013). Effective biological control has been achieved with repeated inundative releases of *C. perminutus* in consecutive years for the management of *Pl. ficus* in table grapes in South Africa (Walton 2003; Walton et al. 2012). *C. montrouzieri*, one of the most effective predators, has been released for classical biological control and augmentation. In the USA, this predator was originally imported for classical biological control of *Pl. citri* on citrus, but this species also preys on other mealybug species, including *Pl. ficus* (Daane et al. 2012). In Georgia, inundative releases of the predator reduced nymphs of the cottony maple scale *Neopulvinaria innumerabilis* by up to 54% in a field trial (Yashnosh et al. 2001). The success of biological control, however, is variable and can be hindered by mealybugs taking refuge under bark and roots (Gutierrez et al. 2008). In addition, ants tending mealybugs for their honeydew interfere with biological control by protecting and defending mealybugs from attack by natural enemies (Daane et al. 2007; Mgocheki and Addison 2009; Mansour et al. 2012). Therefore, ant management may also need to be considered to achieve effective biological control of mealybugs in vineyards.

Mating Disruption

Mating disruption, a form of behavioral control that involves pheromone-based mass trapping of mealybug males, is not commonly utilized, although female sex pheromones have been identified for a number of mealybug species (Franco et al. 2009). The registration of products for mating disruption is rare, partially because of high development costs and regulatory requirements (Suckling 2015). In an initial trial in the USA, where the synthetic sex pheromone of *Pl. ficus* was deployed through an air-blast sprayer as a microencapsulated formulation, the results were variable (Walton et al. 2006). Population reduction appeared to be influenced by mealybug density: in areas where population densities were high, no treatment effect was detected. Since then, other dispensers have been tested, and mating disruption for *Pl. ficus* is now used successfully in California, and the manufacturer is planning to expand to other countries (Zou and Millar 2015). Mating disruption works best at low mealybug densities, and it is recommended that it be used together with insecticide applications early in the season when populations are low (Walton et al. 2006).

Conclusion

Control of leafroll disease spread in vineyards can be achieved using an integrated control strategy, as demonstrated by the successes in South Africa (Pietersen et al. 2013), New Zealand (Almeida et al. 2013), and Israel (Sokolsky et al. 2013). The approaches utilized in these countries, however, are based on a number of preventative strategies for routes of transmission and methods of vector dispersal that have not yet been fully elucidated. Individual components of such management options require considerably more research in order to optimize disease management in terms of inputs and outcomes.

References

- Abou Ghanem-Sabanadzovic, N., and S. Sabanadzovic. 2014. First report of grapevine leafroll-associated virus 2 infecting muscadine (*Vitis rotundifolia*) and summer grape (*Vitis aestivalis*) in the United States. *Plant Disease* 99: 163.
- Al Rwahnih, M., V.V. Dolja, S. Daubert, E.V. Koonin, and A. Rowhani. 2012. Genomic and biological analysis of grapevine leafroll-associated virus 7 reveals a possible new genus within the family Closteroviridae. *Virus Research* 163: 302–309.
- Allsopp, E. 2015. Transmission of grapevine leafroll-associated virus 3 by vine mealybug, *Planococcus ficus* (Signoret), to grapevines treated with imidacloprid. *South African Journal of Enology and Viticulture* 36: 252–254.
- Almeida, R.P.P., K.M. Daane, V.A. Bell, G.K. Blaisdell, M.L. Cooper, E. Herrbach, and G. Pietersen. 2013. Ecology and management of grapevine leafroll disease. *Frontiers in Microbiology* 4 (Article 94): 1–13.

- Andrew, R., V. Bell, N. Hoskins, G. Pietersen, and C. Thompson. 2015. *Leafroll 3 virus and how to manage it*, 108. Auckland: New Zealand Winegrowers.
- Arnold, K., D.A. Golino, and N. McRoberts. 2012. *Statistical parameters of spatial patterns of spread for leafroll disease*. Proceedings 17th congress of ICVG, Davis, CA, USA, 192–193
- Atallah, S.S., M.I. Gomez, M.F. Fuchs, and T.E. Martinson. 2012. Economic impact of grapevine leafroll disease on *Vitis vinifera* cv Cabernet franc in Finger Lakes vineyards of New York. *American Journal of Enology and Viticulture* 63: 73–79.
- Atallah, S.S., M.I. Gomez, J.M. Conrad, and J.P. Nyrop. 2015. A plant-level, spatial, bioeconomic model of plant disease diffusion and control: Grapevine leafroll disease. *American Journal of Agricultural Economics* 97: 199–218.
- Bahder, B.W., R.A. Naidu, K.M. Daane, J.G. Millar, and D.B. Walsh. 2013. Pheromone-based monitoring of *Pseudococcus maritimus* (Hemiptera: Pseudococcidae) populations in concord grape vineyards. *Journal of Economic Entomology* 106: 482–490.
- Barrass, I.C., P. Jerie, and S.A. Ward. 1994. Aerial dispersal of first- and second-instar longtailed mealybug, *Pseudococcus longispinus* (Targioni Tozzetti) (Pseudococcidae: Hemiptera). *Australian Journal of Experimental Agriculture* 34: 1205–1208.
- Bell, V.A. 2015. *An integrated strategy for managing Grapevine leafroll-associated virus 3 in red berry cultivars in New Zealand vineyards*. Doctoral thesis, Victoria University of Wellington, New Zealand <http://researcharchive.vuw.ac.nz/handle/10063/4147> Accessed 15 July 2016.
- Bell, V.A., R.G.E. Bonfiglioli, J.T.S. Walker, P.L. Lo, J.F. Mackay, and S.E. McGregor. 2009. Grapevine leafroll-associated virus 3 persistence in *Vitis vinifera* remnant roots. *Journal of Plant Pathology* 91: 527–533.
- Bell, V.A., K.M. Chooi, A. Blouin, D. Cohen, G. Pietersen, and R.M. MacDiarmid, 2015. *Timing of the symptoms influences the management strategies of grapevine leafroll-associated virus 3 in New Zealand*. Proceedings 18th congress of ICVG, Ankara, Turkey, 40.
- Belli, G., A. Fortusini, and S. Prati. 1993. *Natural spread of grapevine leafroll disease in a vineyard of Northern Italy*. Proceedings 11th meeting of the ICVG, Montreux, Switzerland, 6–9 September 1993, 110
- Bertin, S., F. Mannini, D. Bosco, G. Gambino, D. Cuozzo, and I. Gribaudo. 2009. *Spread of GVA, GLRaV-1 and -3 and role of the mealybug vector Helicococcus bohemicus in a vineyard of Langhe (Northwestern Italy)*. Extended abstracts 16th meeting of ICVG, Dijon, France, 279–280.
- Blaisdell, G.K., S. Zhang, K. Daane, and R.P.P. Almeida. 2012. *Patterns of virus transmission from hosts with mixed infections*. Proceedings 17th congress of ICVG, Davis, CA, USA, 178–179.
- Bonfiglioli, R., N. Hoskins, and F. Edwards. 2002. Grapevine leafroll virus type 3 spreading in New Zealand. *The Australian & New Zealand Grapegrower & Winemaker*, February 2002: 58–63.
- Bonfiglioli, R.G., N. Habili, L.F. Schliefert, and R.H. Symons. 2003. Serious problems with top-working old vines: A warning to grapegrowers about the grapevine leafroll viruses. In *The Australian & New Zealand Grapegrower & Winemaker*, June, 2003: 16–18.
- Borgo, M., and Michelini. 2000. Natural spread of grapevine leafroll in varieties and biotypes of *Vitis vinifera* (In Italian). *Rivista di Viticoltura e di Enologia* 54: 3–13.
- Boubals, D. 1970. Importance économique des viroses de la vigne. Ref. IV Conf. de V.O.I.V., Montpellier, June, 1970.
- Bovey, R. 1970. Importance économique des viroses de la vigne. *Bulletin de l'OIV*. 43: 124–138.
- Brück, E., A. Elbert, R. Fischer, S. Krueger, J. Kühnhold, A.M. Klueken, R. Nauen, J.-F. Niebes, U. Reckmann, H.-J. Schnorbach, R. Steffens, and X. van Waetermeulen. 2009. Movento®, an innovative ambimobile insecticide for sucking insect pest control in agriculture: Biological profile and field performance. *Crop Protection* 28: 838–844.
- Cabaleiro, C. 2009. *Current advances in the epidemiology of Grapevine leafroll disease*. Extended abstracts 16th meeting of ICVG, Dijon, France, 264–268
- Cabaleiro, C., and A. Segura. 1997. Field transmission of Grapevine leafroll associated virus 3 (GLRaV-3) by the mealybug *Planococcus citri*. *Plant Disease* 81: 283–287.

- . 2003. *Monitoring the field spread of GLRaV-3 for 12 years*. Proceedings 14th meeting of ICVG, Locorotondo, Italy, 216–217.
- . 2006. Temporal analysis of grapevine leafroll associated virus 3 epidemics. *European Journal of Plant Pathology* 114: 441–446.
- Cabaleiro, C., C. Couceiro, S. Pereira, M. Cid, M. Barrasa, and A. Segura. 2007. Spatial analysis of epidemics of Grapevine leafroll associated virus-3. *European Journal of Plant Pathology* 121: 121–130.
- Caglayan, K., E. Elci, and M. Gazel. 2016. Detection and partial characterization of Grapevine leafroll-associated virus 1 in pomegranate trees in Turkey. *European Journal of Plant Pathology* 145: 199–202.
- Camacho, E.R., and J.-H. Chong. 2015. General biology and current management approaches of soft scale pests (Hemiptera: Coccidae). *Journal of Integrated Pest Management* 6(1), 17, 1–22. doi:10.1093/jipm/pmv016.
- Champer, J., A. Buchman, and O.S. Akbari. 2016. Cheating evolution: Engineering gene drives to manipulate the fate of wild populations. *Nature Reviews Genetics* 17 (3): 146–159.
- Charles, J.G. 1981. Distribution and life history of the longtailed mealybug *Pseudococcus longispinus* (Homoptera: Pseudococcidae) in Auckland vineyards. *New Zealand Journal of Zoology* 8: 285–293.
- Charles, J.G., D. Cohen, J.T.S. Walker, S.A. Forgie, V.A. Bell, and K.C. Breen. 2006. A review of the ecology of Grapevine leafroll associated virus type 3 (GLRaV-3). *New Zealand Plant Protection* 59: 330–337.
- Charles, J.G., K.J. Froud, R.V.D. van den Brink, and D.J. Allan. 2009. Mealybugs and the spread of grapevine leafroll-associated virus 3 (GLRaV-3) in a New Zealand vineyard. *Australasian Plant Pathology* 38: 576–583.
- Charles, J.G., V.A. Bell, P.L. Lo, L.M. Cole, and A. Chhagan. 2010. Mealybugs (Hemiptera: Pseudococcidae) and their natural enemies in New Zealand vineyards from 1993–2009. *New Zealand Entomologist* 33: 84–91.
- Cid, M., C. Cabaleiro, and A. Segura. 2003. *Detection of grapevine leafroll-associated virus 3 in rootstocks*. Proceedings 14th meeting of ICVG, Locorotondo, Italy, 41.
- Cornwall, P.B. 1958. Movements of the vectors of virus diseases of cacao in Ghana. I. Canopy movement in and between trees. *Bulletin of Entomological Research* 49: 613.
- Credi, R., and A. Santucci. 1990. *Serological detection of grapevine leafroll-associated closteroviruslike particles: Apparent absence of viral antigens in leaves of graft-inoculated American rootstocks*. Proceedings 10th meeting of ICVG, Volos, Greece, 71–80.
- Daane, K.M., W.J. Bentley, V.M. Walton, R. Malakar-Kuenen, J.G. Millar, C.A. Ingels, E.A. Weber, and C. Gispert. 2006. New controls investigated for vine mealybug. *California Agriculture* 60: 31–38.
- Daane, K.M., K.R. Sime, J. Fallon, and M.L. Cooper. 2007. Impacts of Argentine ants on mealybugs and their natural enemies in California's coastal vineyards. *Ecological Entomology* 32: 583–596.
- Daane, K.M., R.P.P. Almeida, V.A. Bell, J.T.S. Walker, M. Botton, M. Fallahzadeh, M. Mani, J.L. Sforza, V.M. Walton, and T. Zaviezo. 2012. Biology and management of mealybugs in vineyards. In *Arthropod management in vineyards: Pests, approaches, and future directions*, ed. N.J. Bostanian, C. Vincent, and R. Isaacs, 271–307. Dordrecht: Springer.
- Dimitrijevic, B. 1973. Some observations on natural spread of grapevine leafroll disease in Yugoslavia. *Rivista di Patologia Vegetale, SIV* 9: 114–119.
- Donda, B., and R. Naidu. 2014. Spatio-temporal spread of Grapevine leafroll disease in Washington vineyards. *Phytopathology* 104: 34–35.
- Engelbrecht, D.J., and G.G.F. Kasdorf. 1985. Association of a closterovirus with grapevines indexing positive for grapevine leafroll disease and evidence for its natural spread in grapevine. *Phytopathologia Mediterranea* 24: 101–105.
- . 1990. Transmission of grapevine leafroll disease and associated closteroviruses by the vine mealybug *Planococcus ficus*. *Phytophylactica* 22: 341–346.

- Epstein, A.H. 1978. Root graft transmission of tree pathogens. *Annual Review of Phytopathology* 16: 181–192.
- Fallahzadeh, M., G. Japoshvili, N. Saghaei, and K.M. Daane. 2011. Natural enemies of *Planococcus ficus* (Hemiptera: Pseudococcidae) in Fars Province vineyards, Iran. *Biocontrol Science and Technology* 21: 427–433.
- Figadere, B.A., J.S. McElfresh, D. Borchardt, K.M. Daane, W. Bentley, and J.G. Millar. 2007. Trans- α -Necrolyl isobutyrate, the sex pheromone of the grape mealybug, *Pseudococcus maritimus*. *Tetrahedron Letters* 48: 8434–8437.
- Franco, J.C., A. Zada, and Z. Mendel. 2009. Novel approaches for the management of mealybug pests. In *Biorational control of arthropod Pests*, ed. I. Ishaaya and A. Horowitz, 233–278. Dordrecht: Springer.
- Frotscher, J., B. Lindner, S. Rolletter, M. Hauck, O. Herczynski, E. Ruehl, and A. Reineke. 2015. Recent spread of grapevine leafroll viruses in German vineyards: Spatial distribution of infected plants and identification of potential vectors. Proceedings 18th congress of ICVG, Ankara, Turkey, 183.
- Fuchs, M., and G. Loeb. 2012. Seasonal pattern and dynamics of virus acquisition by the grape mealybug in a leafroll-diseased vineyard. Proceedings 17th congress of ICVG, Davis, CA, USA, 188–189.
- . 2013. Seasonal pattern of virus uptake by the grape mealybug in a leafroll-diseased vineyard. *Phytopathology* 103: 46–46.
- Fuchs, M., T.E. Martinson, G.M. Loeb, and H.C. Hoch. 2009. Survey for the three major leafroll disease associated viruses in Finger Lakes vineyards in New York. *Plant Disease* 93: 395–401.
- Gangl, H., G. Leitner, C. Hack, A. Tiefenbrunner, M. Tiefenbrunner, and W. Tiefenbrunner. 2011. Comparison of virus infection patterns in Austrian vineyards with simulated ones and some conclusions about transmission. *Mitteilungen Klosterneuburg* 61: 11–22.
- Geiger, C.A., and K.M. Daane. 2001. Seasonal movement and distribution of the grape mealybug (Homoptera: Pseudococcidae): Developing a sampling program for San Joaquin Valley vineyards. *Journal of Economic Entomology* 94: 291–301.
- Goheen, A.C. 1970. Grape leafroll. In *Virus diseases of small fruits and grapevines*, ed. N.W. Frazier, 209–212. Berkeley: University of California, Division of Agricultural Sciences.
- Goheen, A.C., F.N. Harmon, and J.H. Weinberger. 1958. Leafroll (White Emperor disease) of grapes in California. *Phytopathology* 48: 51–54.
- Golino, D.A., S.T. Sim, R. Gill, and A. Rowhani. 2002. Californian mealybugs can spread leafroll. *California Agriculture* 56: 196–201.
- Golino, D.A., E. Weber, S. Sim, and A. Rowhani. 2008. Leafroll disease is spreading rapidly in a Napa Valley vineyard. *California Agriculture* 62: 156–160.
- Goszczynski, D., G.G.F. Kasdorf, G. Pietersen, and H. van Tonder. 1996. Grapevine leafroll-associated virus 2 (GLRaV-2) – Mechanical transmission, purification, production and properties of antisera, detection by ELISA. *South African Journal of Enology and Viticulture* 17: 15–26.
- Grasswitz, T.R., and D.G. James. 2008. Movement of grape mealybug, *Pseudococcus maritimus*, on and between host plants. *Entomologia Experimentalis et Applicata* 129: 268–275.
- Gribaudo, I., G. Gambino, S. Bertin, D. Bosco, A. Cotroneo, and F. Mannini. 2009. Monitoring the spread of viruses after vineyard replanting with heat-treated clones of *Vitis vinifera* “Nebbiolo”. *Journal of Plant Pathology* 91: 741–744.
- Gribaudo, I., D. Cuzzo, G. Gambino, P. Boccacci, and F. Mannini. 2015. Field spread of phloem-limited viruses in a Mediterranean vineyard. Proceedings 18th congress of ICVG, Ankara, Turkey, 167–167.
- Gutierrez, A.P., K.M. Daane, L. Ponti, V.M. Walton, and C.K. Ellis. 2008. Prospective evaluation of the biological control of vine mealybug: Refuge effects and climate. *Journal of Applied Ecology* 45: 524–536.
- Habili, N., and F.W. Nutter Jr. 1997. Temporal and spatial analysis of grapevine leafroll-associated virus 3 in Pinot noir grapevines in Australia. *Plant Disease* 81: 625–628.

- Habili, N., C.F. Fazeli, A. Ewart, R. Hamilton, R. Cirami, P. Saldarelli, A. Minafra, and M.A. Rezaian. 1995. Natural spread and molecular analysis of grapevine leafroll-associated virus 3 in Australia. *Phytopathology* 85: 1418–1422.
- Habili, N., J.W. Randles, and A. Rowhani. 2003. Evidence for the apparent spread of grapevine virus A and grapevine leafroll associated virus 9 in a research vineyard in Australia. In *Extended abstracts 14th ICVG conference, Locorotondo, Italy*, 213–215.
- Herrbach, E., J. Le Maguet, and G. Hommay. 2013. Virus transmission by mealybugs and soft scales (Hemiptera, Coccoidea). In *Vector-mediated transmission of plant pathogens*, ed. J.K. Brown, 147–161. St Paul: APS Press.
- Hewitt, W.B. 1971. Les maladies à virus de la vigne. *Bulletin de l'O.I.V.* 480: 97–125.
- Hinkens, D.M., J.S. McElfresh, and J.G. Millar. 2001. Identification and synthesis of the sex pheromone of the vine mealybug, *Planococcus ficus*. *Tetrahedron Letters* 42: 1619–1621.
- Hoefert, L.L., and E.M. Gifford Jr. 1967. Grapevine leafroll virus – History and anatomic effects. *Hilgardia* 38: 403–426.
- Hoffman, C., G. Michl, I. Führ, M. Maixner, and W. Jelkmann. 2015. *Investigations on distribution patterns of mealybugs and grapevine leafroll in vineyards near the river Nahe in Southern Germany*. Proceedings 18th congress of ICVG, Ankara, Turkey, 248–249.
- Hommay, G., J. LeMaguet, V. Komar, O. Lemaire, and E. Herrbach. 2009. *Transmission of Grapevine leaf roll-associated virus-1 and -3 (Ampelovirus) and grapevine virus A (Vitivirus) by natural populations of soft scales and mealybugs in the North-Eastern French vineyard*. Proceedings 16th meeting of ICVG, Dijon, France, 286–287.
- Hommay, G., L. Wiss, J. Le Maguet, M. Beuve, and E. Herrbach. 2012. *First results on wind dispersal of Parthenolecanium corni crawlers in a newly planted vine plot*. Proceedings 17th congress of ICVG, Davis, CA, USA, 202–203.
- Ioannou, N. 1993. *Occurrence and natural spread of grapevine leafroll-associated closteroviruses in Cyprus*. Proceedings 11th meeting of ICVG, Montreux, Switzerland 6–9 September, 1993, 110.
- Ioannou, N., A. Hadjinicolis, and A. Hadjinicoli. 1997. *Epidemiology of the grapevine leafroll-mealybug complex in Cyprus*. Proceedings 12th meeting of ICVG, Lisbon, Portugal, 123.
- Irwin, M.E., J.M. Thresh, and B.D. Harrison. 1988. Long-range aerial dispersal of cereal aphids as virus vectors in North America. *Philosophical Transactions of the Royal Society B* 321: 445–446.
- Jelkmann, W., C. Mikona, C. Turturo, B. Navarro, M.E. Rott, W. Menzel, P. Saldarelli, A. Minafra, and G.P. Martelli. 2012. Molecular characterization and taxonomy of grapevine leafroll-associated virus 7. *Archives of Virology* 157: 359–362.
- Jinek, M., K. Chylinski, I. Fonfara, M. Hauer, J.A. Doudna, and E. Charpentier. 2012. A programmable dual-RNA-guided DNA endonuclease in adaptive bacterial immunity. *Science* 337 (6096): 816–821.
- Jooste, A.E.C., G. Pietersen, and J.T. Burger. 2011. Distribution of Grapevine leafroll associated virus 3 variants in South African vineyards. *European Journal of Plant Pathology* 131: 371–381.
- Jordan, D., C. Petersen, L. Morgan, and A. Segaran. 1993. *Spread of grapevine leafroll and its associated virus in New Zealand vineyards*. Proceedings 11th meeting of ICVG, Montreux, Switzerland, 6–9 September 1993, 113–113.
- Kairo, M.T.K., O. Paraiso, R.D. Gautam, and D.D. Peterkin. 2013. *Cryptolaemus montrouzieri* (Mulsant) (Coccinellidae: Scymninae): A review of biology, ecology, and use in biological control with particular reference to potential impact on non-target organisms. *CAB Reviews* 8: 1–20.
- Klaassen, V.A., S.T. Sim, G.S. Dangel, F. Osman, M. Al Rwahnih, A. Rowhani, and D.A. Golino. 2011. *Vitis californica* and *Vitis californica* × *Vitis vinifera* hybrids are hosts for grapevine leafroll-associated virus 2 and -3 and grapevine virus A and B. *Plant Disease* 95: 657–665.
- Le Maguet, J., E. Herrbach, G. Hommay, M. Beuve, E. Boudon-Padieu, and O. Lemaire. 2009. *Monitoring of grapevine leafroll-associated virus 1 (GLRaV-1) dispersion by mealybug Phenacoccus aceris*. Proceedings 16th meeting of ICVG, Dijon, France, 283–284.

- Le Maguet, J., M. Beuve, E. Herrbach, and O. Lemaire. 2012. Transmission of six ampeloviruses and two vitiviruses to grapevine by *Phenacoccus aceris*. *Phytopathology* 102: 717–723.
- Le Maguet, J., J.-J. Fuchs, J. Chadæuf, M. Beuve, E. Herrbach, and O. Lemaire. 2013. The role of the mealybug *Phenacoccus aceris* in the spread of grapevine leafroll-associated virus –1 (GLRaV-1) in two French vineyards. *European Journal of Plant Pathology* 135: 415–427.
- Le Vieux, P.D., and A.P. Malan. 2013. An overview of the vine mealybug (*Planococcus ficus*) in South African vineyards and the use of entomopathogenic nematodes as potential biocontrol agent. *South African Journal of Enology and Viticulture* 34: 108–118.
- Lo, P.L., and J.T.S. Walker. 2011. Soil applications of two neonicotinoid insecticides to control mealybugs (Pseudococcidae) in vineyards. *New Zealand Plant Protection* 64: 101–106.
- Lo, P.L., V.A. Bell, J.T.S. Walker, L.C. Cole, D.J. Rogers, and J.G. Charles. 2006. *Ecology and management of mealybugs in vineyards. HortResearch Client Report No. 19636*. The Horticultural and Food Research Institute of New Zealand, Auckland, New Zealand.
- Lo, P.L., V.A. Bell, and J.T.S. Walker. 2009. Maximising the effectiveness of insecticides to control mealybugs in vineyards. *New Zealand Plant Protection* 62: 296–301.
- Malakar-Kuenen, R., K.M. Daane, K.E. Godfrey, J.C. Ball, W.J. Bentley, G.Y. Yokota, M. Lee, and D. Gonzalez. 2001. Population dynamics of vine mealybug and its natural enemies in the Coachella and San Joaquin Valleys. *University of California Plant Protection Quarterly* 11: 1–3.
- Maliogka, V.I., G.P. Martelli, M. Fuchs, and N.I. Katis. 2015. Control of viruses infecting grapevine. *Advances in Virus Research* 91: 175–227.
- Mansour, R., P. Suma, G. Mazzeo, K.G. Lebdi, and A. Russo. 2011. Evaluating side effects of newer insecticides on the vine mealybug parasitoid *Anagyrus* sp. near *pseudococci*, with implications for integrated pest management in vineyards. *Physiologie* 39: 369–376.
- Mansour, R., P. Suma, G. Mazzerao, A. La Pergola, V. Pappalardo, K. Grissa Lebdi, and A. Russo. 2012. Interactions between the ant *Tapinoma nigerrimum* (Hymenoptera: Formicidae) and the main natural enemies of the vine and citrus mealybugs (Hemiptera: Pseudococcidae). *Biocontrol Science and Technology* 22: 527–537.
- Maree, H.J., R.P.P. Almeida, R. Bester, K.M. Chooi, D. Cohen, V.V. Dolja, M.F. Fuchs, D.A. Golino, A.E.C. Jooste, G.P. Martelli, R.A. Naidu, A. Rowhani, P. Saldarelli, and J.T. Burger. 2013. Grapevine leafroll associated virus 3. *Frontiers in Microbiology* 4 (Article 82). <http://dx.doi.org/10.3389/fmicb.2013.00082>
- Martelli, G.P. 2014. Directory of virus and virus-like diseases of the grapevine and their agents. *Journal of Plant Pathology* 96 (Suppl. 1): 1–136.
- Martelli, G.P., and E. Boudon-Padieu. 2006. Directory of infectious diseases of grapevines. *CIHEAM-IAMB. Options Méditerranéennes Série B* 55: 9–194.
- Martelli, G.P., N. Abou Ghanem-Sabanadzovic, A.A. Agranovsky, M. Al Rwahnih, V.V. Dolja, C.I. Dovas, M. Fuchs, P. Gugerli, J.S. Hu, W. Jelkmann, N.I. Katis, V.I. Maliogka, M.J. Melzer, W. Menzel, A. Minafra, M.F. Rott, A. Rowhani, S. Sabanadzovic, and P. Saldarelli. 2012. Taxonomic revision of the family Closteroviridae with special reference to the grapevine leafroll-associated members of the genus *Ampleovirus* and the putative species unassigned to the family. *Journal of Plant Pathology* 94: 7–19.
- Martin, R.R., K.C. Eastwell, A. Wagner, S. Lamprecht, and I.E. Tzanetakis. 2005. Survey for viruses of grapevine in Oregon and Washington. *Plant Disease* 89: 763–766.
- Mgocheki, N., and P. Addison. 2009. Interference of ants (Hymenoptera: Formicidae) with biological control of the vine mealybug *Planococcus ficus* (Signoret) (Hemiptera: Pseudococcidae). *Biological Control* 49: 180–185.
- Mikona, C., and W. Jelkmann. 2010. Replication of Grapevine leafroll-associated virus 7 (GLRaV-7) by *Cuscuta* species and its transmission to herbaceous plants. *Plant Disease* 94: 471–476.
- Millar, J.G., K.M. Daane, J.S. Mcelfresh, J.A. Moreira, R. Malakar-Kuenen, M. Guillén, and W.J. Bentley. 2002. Development and optimization of methods for using sex pheromone for monitoring the mealybug *Planococcus ficus* (Homoptera: Pseudococcidae) in California vineyards. *Journal of Economic Entomology* 95: 706–714.

- Millar, J.G., S.L. Midland, J.S. McElfresh, and K.M. Daane. 2005. (2,3,4,4-Tetramethylcyclopentyl) methyl acetate, a sex pheromone from the obscure mealybug: First example of a new structural class of monoterpenes. *Journal of Chemical Ecology* 31: 2999–3005.
- Naidu, R.A., E.M. Perry, F.J. Pierce, and T. Mekuria. 2009. The potential of spectral reflectance technique for the detection of Grapevine leafroll-associated virus 3 in two red-berried wine grape cultivars. *Computers and Electronics in Agriculture* 66: 38–45.
- Naidu, R.A., O.J. Alabi, T. Mekuria, K. Gandhi, A.L. Schulz, and S. Jarugula. 2012. *Elucidating disease epidemiology for management of a complex virus pathosystem in cool-climate viticulture*. Proceedings 17th congress of ICVG, Davis, CA, USA, 220–221.
- Naidu, R., A. Rowhani, M. Fuchs, D. Golino, and G.P. Martelli. 2014. Grapevine leafroll: A complex viral disease affecting a high-value fruit crop. *Plant Disease* 98: 1172–1185.
- Pietersen G. 2004. *Spread of grapevine leafroll disease in South Africa – A difficult but not insurmountable problem*, Wynboer June 2004. <http://www.wynboer.co.za/recentarticles/0406leaf.php3>. Accessed 12 Dec 2008.
- Pietersen, G. 2006. *Spatio-temporal distribution dynamics of grapevine leafroll disease in Western Cape vineyards*. Proceedings 15th meeting of ICVG, Stellenbosch, South Africa, 126–127.
- Pietersen, G., and H.A. Walsh. 2012. *Development of a LAMP technique for the control of grapevine leafroll-associated virus type 3 (GLRaV-3) in infected white cultivar vines by roguing*. Proceedings 17th congress of ICVG, Davis, CA, USA, 50–51.
- Pietersen, G., U. Kellerman, W.T. Oosthuizen, and N. Spreeth. 2003. *Effect of roguing on natural spread of grapevine leafroll disease in two vineyards in South Africa*. 8th international congress of plant pathology. Christchurch, New Zealand, 301.
- Pietersen, G., N. Spreeth, T. Oosthuizen, A. van Rensburg, D. Lottering, D. Tooth, and N. Rossouw. 2009. A case study of grapevine leafroll spread on Vergelegen wine estate, South Africa, 2002–2008. In *Extended abstracts 16th congress of ICVG, Dijon, France*, 230–231.
- Pietersen, G., N. Spreeth, T. Oosthuizen, A. Van Rensburg, M. Van Rensburg, D. Lottering, N. Rossouw, and D. Tooth. 2013. Control of grapevine leafroll disease spread at a commercial wine estate in South Africa: A case study. *American Journal of Enology and Viticulture* 64: 296–305.
- Pietersen, G., M. Louw, K. Krüger, B. Faure, and H. van Rensburg. 2015. *Grapevine leafroll disease spread from old to replacement vineyards*. Proceedings 18th congress of ICVG, Ankara, Turkey, 106–107.
- Planes, L., J. Catalán, A. Tena, J.L. Porcuna, J.A. Jacas, J. Izquierdo, and A. Urbaneja. 2013. Lethal and sub-lethal effects of spirotetramat on the mealybug destroyer, *Cryptolaemus montrouzieri*. *Journal of Pest Science* 86: 321–327.
- Prabhaker, N., C. Gispert, and S.J. Castle. 2012. Baseline susceptibility of *Planococcus ficus* (Hemiptera: Pseudococcidae) from California to select insecticides. *Journal of Economic Entomology* 105: 1392–1400.
- Ravaz, L., and G. Verge. 1924. Le rougeau de la vigne. *Progrès Agricole et Viticole* 81: 11–17.
- Recio, E., and F.J. Legorburu. 2006. *GLRaV-3 shows a lesser aggregated spatial distribution than GFLV in Rioja Aalavesa vineyards*. Proceedings 15th meeting of ICVG, Stellenbosch, South Africa, 221–222.
- Ricketts, K.D., M.I. Gomez, S.S. Atallah, M.F. Fuchs, T.E. Martinson, M.C. Battany, L.J. Bettiga, M.L. Cooper, P.S. Verdegaal, and R.J. Smith. 2015. Reducing the economic impact of grapevine leafroll disease in California: Identifying optimal disease management strategies. *American Journal of Enology and Viticulture* 66: 138–147.
- Rosciglione, B., and P. Gugerli. 1989. Transmission of grapevine leafroll disease and an associated closterovirus to healthy grapevine by the mealybug *Planococcus ficus*. *Phytoparasitica* 17: 63–64.
- Sforza, R., E. Boudon-Padiou, and C. Greif. 2003. New mealybug species vectoring Grapevine leafroll-associated viruses-1 and -3 (GLRaV-1 and -3). *European Journal of Plant Pathology* 109: 975–981.
- Sharon, R., T. Zahavi, T. Sokolski, C. Sofer-Arad, G. Sapir, M. Mawassi, and Y. Cohen. 2012. *The combined effect of preliminary infested vines, spatial spread pattern and the VMB population*

- level on the grapevine leafroll disease infestation rate. Proceedings 17th congress of ICVG, Davis, CA, USA, 182–183.
- Sokolsky, T., Y. Cohen, T. Zahavi, G. Sapir, and R. Sharon. 2013. Potential efficiency of grapevine leafroll disease management strategies using simulation and real spatio-temporal disease infection data. *Australian Journal of Grape and Wine Research* 19: 431–438.
- Spreeth, N.A., W.T. Oosthuizen, A. Van-Rensburg, D. Tooth, N. Rossouw, and G. Pietersen. 2006. *Vergelegen, South Africa: a case study of an integrated control strategy to prevent the spread of grapevine leafroll disease*. Extended abstracts 15th meeting of ICVG, Stellenbosch, South Africa, 142.
- Suckling, D.M. 2015. Can we replace toxicants, achieve biosecurity, and generate market position with semiochemicals? *Frontiers in Ecology and Evolution* 3 (Article 17): 1–7. doi:[10.1002/ps.3950](https://doi.org/10.1002/ps.3950).
- Tanne E., Y. Ben-Dov, and B. Raccach. 1989. *Transmission of closterolike particles by mealybugs (Pseudococcidae) in Israel*. Proceedings 9th meeting of ICVG, Kiryat Anavim, Israel, 71–73.
- Teliz, D., D. Gonsalves, J. Hu, and D.K. Hummer. 1989. Detection of grapevine leafroll-associated closteroviruses in recently infected tissue in New York and spread of the disease in Mexico. Proceedings 9th meeting of ICVG, Kiryat Anavim, Israel, 109–115.
- Tsai, C.-W., J. Chau, L. Fernandez, D. Bosco, K.M. Daane, and R.P.P. Almeida. 2008. Transmission of grapevine leafroll-associated virus 3 by the vine mealybug (*Planococcus ficus*). *Phytopathology* 98: 1093–1098.
- Tsai, C.-W., A. Rowhani, D.A. Golino, K.M. Daane, and R.P.P. Almeida. 2010. Mealybug transmission of grapevine leafroll viruses: An analysis of virus-vector specificity. *Phytopathology* 100: 830–834.
- Unelius, C.R., A.M. El-Sayed, A. Twidle, B. Bunn, T. Zaviezo, M.F. Flores, V.A. Bell, and J. Bergmann. 2011. The absolute configuration of the sex pheromone of the citrophilus mealybug, *Pseudococcus calceolariae*. *Journal of Chemical Ecology* 37: 166–172.
- Velasco, L., E. Cretazzo, M.J. Alcalá, C.V. Padilla, M.J. Serrano, J.A. Perez-Ortiz, R.Gutierrez, and M. Talavera 2015. *Virus incidence and dispersion in the grapevine germplasm bank in Andalusia, Spain*. Proceedings 18th congress of ICVG, Ankara, Turkey, 108–109.
- Wallingford, A.K., M.F. Fuchs, T. Martinson, S. Hesler, and G.M. Loeb. 2015. Slowing the spread of grapevine leafroll-associated viruses in commercial vineyards with insecticide control of the vector, *Pseudococcus maritimus* (Hemiptera: Pseudococcidae). *Journal of Insect Science* 15: 1–6.
- Walsh, H.A., and G. Pietersen. 2013. Rapid detection of grapevine leafroll-associated virus type 3 using a reverse transcription loop-mediated amplification method. *Journal of Virological Methods* 194: 308–316.
- Walton, V.M. 2003. *Development of an integrated pest management system for vine mealybug, Planococcus ficus (Signoret), in vineyards in the Western Cape Province, South Africa*. PhD thesis, University of Stellenbosch, South Africa.
- Walton, V.M., and K.L. Pringle. 2004. A survey of mealybugs and associated natural enemies in vineyards in the Western Cape Province, South Africa. *South African Journal of Enology and Viticulture* 25: 23–25.
- Walton, V.M., K.M. Daane, and K.L. Pringle. 2004. Monitoring *Planococcus ficus* in South African vineyards with sex pheromone-baited traps. *Crop Protection* 23: 1089–1096.
- Walton, V.M., K.M. Daane, W.J. Bentley, J.G. Millar, T.E. Larsen, and R. Malakar-Kuenen. 2006. Pheromone-based mating disruption of *Planococcus ficus* (Hemiptera: Pseudococcidae) in California vineyards. *Journal of Economic Entomology* 99: 1280–1290.
- Walton, V.M., K.M. Daane, and P. Addison. 2012. Biological control of arthropods and its application in vineyards. In *Arthropod management in vineyards: Pests, approaches, and future directions*, ed. J.N. Bostanian, C. Vincent, and R. Isaacs, 91–117. Dordrecht: Springer.
- Wise, W.C., P.E. Jenkins, A.M.C. Schilder, C. Vandervoort, and R. Isaacs. 2010. Sprayer type and water volume influence pesticide deposition and control of insect pests and diseases in juice grapes. *Crop Protection* 29: 378–385.

- Wistrom, C.M., G.K. Blaisdell, L.R. Wunderlich, R.P.P. Almeida, K.M. Daane. 2016. *Ferrisia gilli* (Hemiptera: Pseudococcidae) transmits grapevine leafroll-associated viruses. *Journal of Economic Entomology*. <http://dx.doi.org/10.1093/jee/tow124>
- Yashnosh, V., M. Rtskhiladze, and E. Tabatadze. 2001. Coccids (Hemiptera, Coccinea) and their natural enemies in the vineyards of Georgia: present situation. *Bollettino di Zoologia Agraria e Bachicoltura* 33: 351–355.
- Zahavi, T., M. Mawassi, A. Naor, Y. Gal, M. Peres, I. Roshansky, R. Nelevitzky, G. Sapir, and O. Crane 2012. *Effects of irrigation on leafroll symptom development in Cabernet Sauvignon vines*. Proceedings 17th congress of ICV. G. Davis, CA, USA, 162–163.
- Zou, Y.F., and J.G. Millar. 2009. Synthesis of the pheromone of the longtailed mealybug, a sterically congested, irregular monoterpene. *Journal of Organic Chemistry* 74: 7207–7209.
- Zou, Y., and J.G. Millar. 2015. Chemistry of the pheromones of mealybug and scale insects. *Natural Product Reports* 32: 1067–1113.

Chapter 27

Improvement of Grapevine Planting Stock Through Sanitary Selection and Pathogen Elimination

D.A. Golino, M. Fuchs, S. Sim, K. Farrar, and G.P. Martelli

Abstract Sanitary selection is the most economic, prophylactic strategy to reduce the presence of viruses in propagation material and limit their prevalence in newly established vineyards through the production of clean stocks from which high-quality planting material is derived. The selection of clean stock requires efficient therapy methodologies and rigorous screening of elite accessions of scion and root-stock material for economically important viruses. Several therapeutic methodologies have been developed to sanitize infected accessions, among which microshoot tip culture is one of the most commonly employed for its effectiveness, ease of implementation, and reduced potential to regenerate off-type vines. Efforts at clean plant centers throughout the world to select and produce clean stocks are contributing directly to increasing the quality of the planting material, augmenting the profitability of vineyards, and sustaining the development of the grape and wine industry.

Keywords Clean stock • Disease • Economic value • Grapevine • Microshoot tip culture • Sanitary selection • Therapeutics • Virus

D.A. Golino (✉)

Foundation Plant Services, University of California, Davis, CA, USA
e-mail: dagolino@ucdavis.edu

M. Fuchs

Section of Plant Pathology and Plant-Microbe Biology,
School of Integrative Plant Science, New York State Agricultural Experiment Station
Cornell University, Geneva, NY, USA

S. Sim • K. Farrar

Foundation Plant Services, Department of Plant Pathology,
University of California, Davis, CA 95616, USA

G.P. Martelli

Department of Soil, Plant and Food Sciences, University of Bari Aldo Moro, Bari, Italy

Introduction

The key to improving the sanitary status of vineyards around the world lies in selecting and supplying the highest possible quality propagating material, which has been rigorously screened for economically important viruses and tested negative. The quality of elite propagating material depends upon the accuracy of diagnostic tools (discussed elsewhere in this volume) and the ability to perform therapy for sanitizing valuable grape selections when they are infected. A multitude of virus elimination techniques have been used experimentally and some are used routinely. Therapeutic methodologies are reviewed in this chapter, and the economic value of clean programs is discussed.

Sanitary Selection

Sanitary selection is an important tool in the field of grapevine improvement. The objective of sanitary selection is to propagate scion clones and rootstock genotypes free of important viruses and to protect them from infection in foundation vineyard blocks which serve as a source for propagation material. In its most primitive form, grape growers have practiced sanitary selection by the simple practice of propagating their highest quality, apparently disease-free vines. In North America, formal recognition of the importance of selecting vines to improve performance began in the mid-twentieth century. While this selection process resulted in increased vigor and production, the clean plant programs were not intended to evaluate vine performance related to wine quality (Boidron 1995). In Europe, it is traditionally preferred to carry out clonal and sanitary selection simultaneously including the evaluation of wine quality potential of individual selections; but elsewhere, grapevine selection basically means virus sanitation: testing selected materials for important viruses and maintaining the selection free of virus through the certification process (Mannini 2000).

In the late nineteenth century, clonal selection began in Germany when Gustav Froelich selected single Silvaner [sic] vines based on visual appearance and performance. Progeny vines were kept separate and evaluated for their performance, which led to high-performing, uniform mother blocks and large-scale virus elimination (Rühl et al. 2004; Schmid et al. 1995). By the 1950s, high-performing clonal propagation material of most traditional cultivars was available, and since the 1970s, only clonal material has been planted (Rühl et al. 2004). German breeders at the Geisenheim Research Center are working to maintain a range of genetic resources to prevent gene erosion by selecting a large number of clones of each cultivar to preserve genetic variability between and within cultivars (Rühl et al. 2004). In addition, researchers are looking to old vineyards, found mainly on the steep slopes in the Mosel region, with non-clonal plantings as a source of new clones (Rühl et al. 2011). Material is identified based on visual appearance and virus testing. If, after

laboratory and field evaluations, the new clone is virus-free, it is registered with the German Federal Variety Office (Rühl et al. 2011).

French methods of clonal selection are based on two factors: sanitary selection and genetic selection. In the 1960s and 1970s, the focus of selection was based on improving yields that had been reduced by *Grapevine fanleaf virus* (GFLV). Then in the 1980s and 1990s, the selection focus was directed toward genetics while still maintaining sanitary selection, as consumer preferences and the wine trade evolution favored qualitative criteria (Grenan et al. 2000). Sanitary selection begins with visually selecting material in the vineyard, which may be based on several years of observation (Boidron 1995). Plant material is then tested for important viruses: the viruses and testing techniques change over time as knowledge and advances in diagnostic tools become available. The genetic selection component of the selection process provides growers with knowledge of the production (yield) and quality performance (sugar content, acidity, aromas, etc.) of the material (Boidron 1995). The French Institute of Vine and Wine (IFV) is responsible for selecting clones, evaluating for viruses, processing material through sanitary selection, and selecting for agronomical characteristics including tasting. After clones have undergone sanitary and genetic evaluation, the selection is registered and certified by the Committee of Selection of Cultivated Plants (CTPS) of the French Ministry of Agriculture. Certified material in France is sold and distributed under the name ENTAV-INRA®, which is managed by the IFV (Audeguin 2016).

Clonal and sanitary selection methods are also well established in Italy. The first reports of grapevine clonal selection from this country date back to the 1960s when the need to improve the quality of the propagation material was recognized. The National Grapevine Certification Scheme began in 1969 and includes registration, preservation, pre-multiplication, and multiplication of certified stocks (Mannini 1995). Selected vines are registered in the National Catalog of Grapevine Varieties after approval by the National Committee for the Evaluation of Grapevine Varieties. Vines are then maintained at a foundation nursery (*Nucleo di premoltiplicazione*), which is the source of materials of the basic category (pre-multiplication). Commercial production in nurseries then starts with the establishment of mother plant vineyards from basic material (Mannini 1995).

The present European national grapevine certification schemes conform to European Union (EU) Directives, although they may differ by country with reference to regulated viruses (Maliogka et al. 2015). The six main influential viticultural countries in the EU are France, Italy, and Spain, which are followed by Germany, Portugal, and Greece. A unique aspect of the EU certification schemes is that they not only ensure clean stock but also trueness to type, for sources with a well-established clonal nature are registered and certified (Martelli 1992; Maliogka et al. 2015). Standards adopted by the European and Mediterranean Plant Protection Organization (EPPO) Certification Scheme are selection of vines for viticultural and enological quality, production of nuclear stock, maintenance of nuclear stock, production of propagation stock, and production of certified plants. This process is carried out by officially registered, specialized nurseries and laboratories (EPPO 2008). Specific requirements and standards of certification nurseries and

micropropagation facilities in Europe are currently directed by the EPPO. The standards address general conditions of the facility and specific measures necessary for growing plants of candidate nuclear stock, nuclear stock, or propagation stock (EPPO 2001). Each participating country has developed its own governing organization to administer and monitor the certification scheme.

The first grape sanitary program in North America was developed at the University of California at Davis, known for its strong programs in both viticulture and plant pathology. During the 1940s, as the state's grape and wine industry had developed and plantings expanded, new knowledge and methods of disease detection gradually made clear to scientists just how widespread virus disease problems were in the state's vineyards. The first published observations documenting virus-induced crop losses involved a table grape, cv. 'Emperor,' which had originally been introduced from Iran. Professor H. Olmo and his colleagues demonstrated that undesirable variation in the color of this grape, from deep to very pale red, was likely caused by a virus because the condition was graft transmissible (Olmo and Rizzi 1943). Olmo partnered with the plant pathologist W. B. Hewitt to raise grower awareness of the need for a sanitary selection scheme for grapevines (Olmo 1951, 1975). This leads to further research which demonstrated that there were widespread virus infections in all of the vineyards of California, regardless of whether the grapes were used for wine, fresh fruit, or raisins (Hewitt 1954). By 1956, the State of California had its first regulations in place, thereby creating the California Grapevine Registration and Certification (CGR&C) Program. Over the years, this program was modeled to create similar programs in Oregon, Washington, New York, and Virginia.

Unlike Europe, the United States has never had a national program for the production of grape clean stock. Certification programs in the United States are managed individually by the states (see 826). However, there is a US Department of Agriculture (USDA) program known as the National Clean Plant Network (NCPN), which provides funding for sanitary selection programs for a variety of specialty crops including grapevines, fruit and nut trees, berries, hops, roses, and sweet potatoes. This funding goes to selected centers which create virus-screened collections. Five grapevine centers are currently funded by NCPN: Foundation Plant Services (FPS), University of California at Davis; Clean Plant Center Northwest, Washington State University, Prosser, Washington; Cornell University, Geneva, New York; Midwest Grape Tissue Culture and Virus-testing Laboratory, Center for Grapevine Biotechnology, Missouri State University; and Center for Viticulture and Small Fruit Research, Florida Agricultural and Mechanical University, Tallahassee, Florida. Both California and Washington States have voluntary "registration and certification" at the state level which govern the production of what is called foundation stock. There are, however, no national regulations in the United States governing the production of grape nursery stock. Plant regulatory aspects of grapevine nursery production are discussed in Chap. 28 of this volume.

Commercial nurseries that produce certified grapevines and participate in the California Grapevine R&C program obtain their clean stock from FPS at the University of California, Davis. UC Davis has a foundation vineyard for major

grape cultivars and clones, as well as rootstocks. Before being planted in the foundation vineyard, all entries are tested across biological indicators, by ELISA and RT-PCR. The foundation vineyard is monitored by visual inspections in spring and fall, and a portion of it is retested by ELISA and RT-PCR on an annual basis to monitor for the possibility of reinfection (Rowhani et al. 2005).

It is clear that using high-performing healthy grapevine propagation material is invaluable for productive vineyards for which a reliable source for clean, pathogen-tested material (rootstock and scion) is essential. While sanitary and clonal selection programs vary by country, the prominent programs described here have evolved to include sanitary selection methods and the establishment of foundation blocks for the production of certified material. These blocks require regular monitoring and testing for vector-transmitted viruses as well as newly discovered viruses of economic importance.

The production of clean cultivars and selections, as well as rootstock genotypes, relies on the implementation of various virus elimination methodologies. Some have been extensively used experimentally; others are used routinely by clean plant centers worldwide.

Heat Treatment

Heat therapy was utilized by Kunkel (1936) for pathogen elimination when infected trees were subjected to dry heat or a hot water treatment for inactivation of peach yellows. In 1950, the first report of virus elimination was by B. Kassanis who used heat therapy to eliminate leafroll virus from potato (Kassanis 1950). Heat therapy to eliminate virus disease in plants was being successfully used during the 1950s on an experimental basis with stone fruits, potatoes, strawberries, and other crops (Nyland and Goheen 1969). W.B. Hewitt and A.C. Goheen, UC Davis plant pathologists, felt that heat therapy would offer promise in the elimination of grapevine virus diseases and, in 1959, began experimenting with this technique using a hot air treatment of plants in a closed growth chamber (Gifford and Hewitt 1961; Goheen et al. 1965). Unfortunately, the only climate control chambers available between 1959 and 1969 had been designed to meet the specific requirements of plants other than grapevines and, although they offered opportunities for experimentation, were not of great use in grapevine disease therapy. Only in 1969, when a chamber with capacity adequate to meet the needs of the grapevines became available, A.C. Goheen began to make headway in pioneering the use of heat therapy to eliminate grapevine virus diseases. In brief, A.C. Goheen experimented with taking cuttings to the very edge of their heat tolerance, exposing the cuttings to high temperatures for extended periods of time to retard or inactivate viruses without also killing the plants. When new, ostensibly clean buds began to appear on the cuttings, they would be removed and utilized to propagate new, clean stock. Thus, A.C. Goheen ultimately settled on an optimum treatment temperature of 38 °C for a period of approximately 60 days (Luhn, personal communication). This heat treatment eliminated 100% of GFLV in

the tested plants (Goheen 1989). Other viruses, however, were more heat stable. Goheen (1989) reported eliminating 42% of corky bark infections, 25% of leafroll infections, and 14% of rupestris stem-pitting infections. This breakthrough in heat therapy set a standard that was widely used. The success of heat therapy depends, in most cases, upon removing a portion of the treated plant post-therapy (Nyland and Goheen 1969). Alternately, Goheen and Luhn (1973) grafted individual buds from candidate vines onto healthy LN-33 (Couderc 1613 x *V. vinifera* cv Thompson Seedless) rooted cuttings followed by the 60-day heat treatment. Virus was eliminated from 77% of the shoots (Goheen and Luhn 1973).

Savino et al. (1985) found that heat therapy reduced the incidence of the following viral diseases: leafroll (from 50% to 34%), vein necrosis (from 71% to 36%), and fleck (from 46% to 12%). While heat therapy is beneficial in reducing incidence of disease, if used alone it may not be sufficient for a successful clean stock program. Combining heat therapy with meristem shoot tip culture has proved to be highly effective, especially for non-heat-labile viruses. A study by Salami et al. (2009) showed that heat treatment for 7 weeks at 40/30 °C (day/night temperatures) eliminated GFLV in 70% (cv. Bidaneh Sefid) and 90% (cv. Shahroodi) of the treated plants. In the same study, meristem tip culture was 80% efficacious in eradicating GFLV. However, when heat therapy was combined with meristem tip culture, 100% of GFLV was eradicated from plants.

Although heat therapy continues to be used for successful elimination of viruses for a number of crops, including hops, stone fruits, potatoes, strawberry, and ornamentals, switching to microshoot tip culture has proven successful for many high-volume clean grapevine stock programs.

Microshoot Tip Culture

Viruses have been eliminated successfully using microshoot tip culture at different institutions worldwide. Between 1993 and 2015, at the Department of Plant, Soil and Food Sciences of the University of Bari (DPSFS-Uniba), more than 1200 selections belonging to 240 cultivars from different Italian regions (Marche, Abruzzo, Apulia, and Calabria) and foreign countries (Portugal, Lebanon, Malta, Albania, Croatia, and Serbia) have undergone successful microshoot tip therapy to eliminate virus infections (G. Bottalico, personal communication). At the Cornell University, microshoot tip culture has been the preferred therapeutic methodology for the elimination of viruses from a dozen accessions since 2005 (Fuchs, unpublished observation).

Based on 25 years' experience in an active grapevine clean plant center, FPS at UC Davis, microshoot tip tissue culture is the method of choice to eliminate virus(es) and other pathogens from grapes (Golino, unpublished observation). At FPS, microshoot tip culture successfully eliminated viruses in 90% of the processed selections (Fig. 27.1). Since 2000, FPS has processed over 1000 grapevine selections through microshoot tip culture. Many of these selections were processed even when the

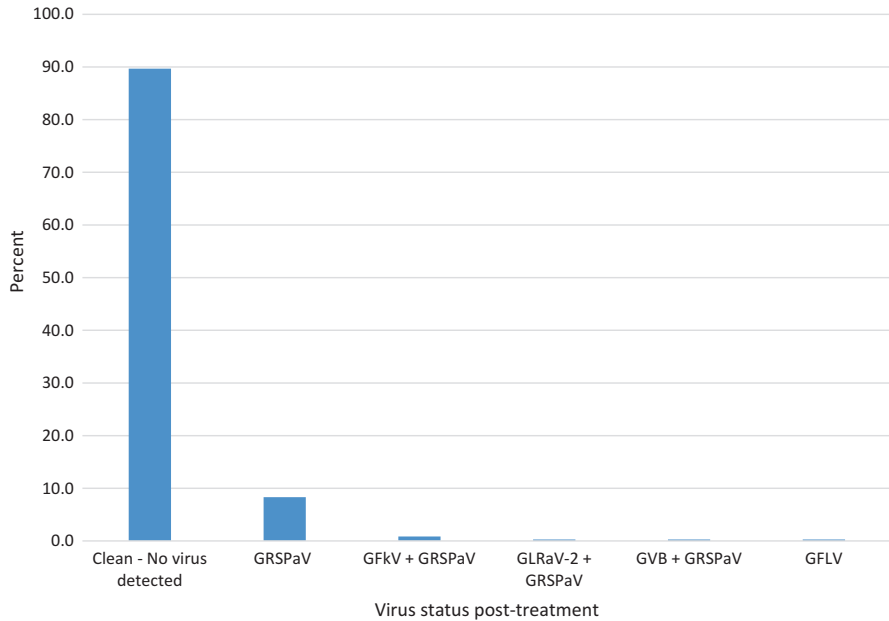

Fig. 27.1 Virus status of 349 selections after processing through microshoot tip tissue culture at FPS. Before treatment selections were often infected with multiple viruses; afterwards, GRSPaV alone was the most common virus detected, indicating the relative difficulty in eliminating this virus. Selections were tested to meet Protocol 2010 standards. Number above bar indicates the number of selections in that category. [Note to printer: actual percents are (left to right) 89.7, 8.3, 0.9, 0.3, 0.3, 0.3%]

original plant material tested negative for viruses. This was done to meet a new rigorous standard that FPS set for grapevine foundation material, referred to as Protocol 2010. Protocol 2010 standards require that vines must be generated using microshoot tip culture and be tested for an extensive list of pathogens. Vines meeting Protocol 2010 standards are planted in a foundation vineyard at Russell Ranch on the UC Davis campus. Since new pathogens may be identified at any time, microshoot tip culture may be considered a preventive measure to limit the presence of viruses and other pathogens in foundation stock. This may have been the case for two recently characterized viruses, *Grapevine red blotch-associated virus* (GRBaV) and *Grapevine Pinot gris virus* (GPGV). Despite not having a test for the viruses at the time of planting in Russell Ranch, high-throughput sequencing has demonstrated that these new viruses have been excluded from the foundation vineyard.

Overall, microshoot tip culture has been a very effective method for eliminating viruses and creating foundation planting material. Microshoot tip tissue culture has the advantage of regenerating a single plant from a single, minuscule (approximately 0.4–0.5 mm in size) explant including the meristem and one to three pairs of leaf primordia (Fig. 27.2). The survival rate of these microshoot tips is higher than that of a meristem as the presence of leaf primordia increases the survival rate.

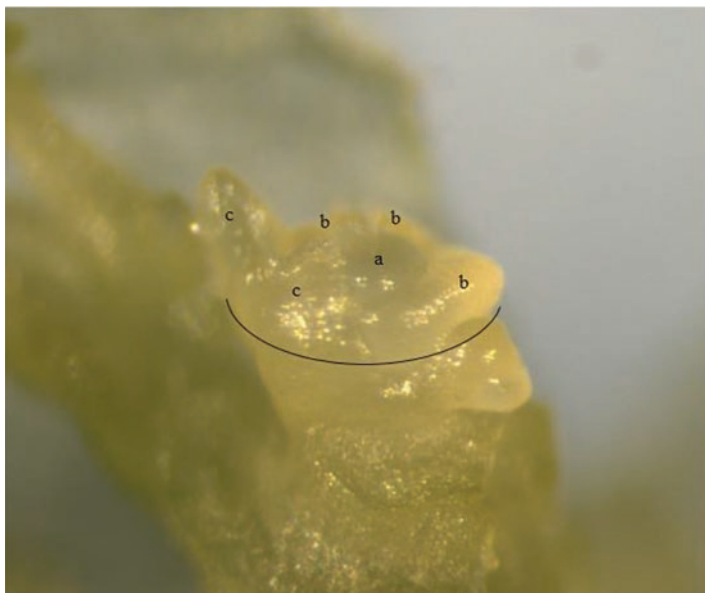

Fig. 27.2 A grape microshoot tip measures less than 0.5 mm and consists of the meristem dome (a) and two to three pairs of leaf primordia (b). Leaf primordia (c) are removed before the final excision cut is made, indicated by the *line*, and the microshoot tip is placed into growth medium

Survival is highly dependent on cultivar; approximately 75% of tips excised survive to form a plant with roots and shoots (Sim et al. 2012). The combination of low hormone levels and a minimum time in culture reduces the chance of mutation and regeneration of an off-type plant. Microshoot tip tissue culture also avoids the production of plants from callus, which can lead to regeneration of an off-type plant, a serious drawback of other types of virus therapy such as fragmented shoot tip and somatic embryogenesis (see below).

One question that is frequently asked about microshoot tip tissue culture is whether the procedure results in off-types or mutations in a cultivar. This is a subject of concern when using tissue culture for mass increase of propagation material, referred to as micropropagation, and other tissue culture techniques but has not proved to be a concern with microshoot tip culture for virus elimination. As mentioned above, microshoot tip culture produces a single plant from a single microshoot tip; micropropagation involves repeated increases to produce thousands of plants in culture for years. It is the mass increase, long periods of time in tissue culture, and specific techniques, such as somatic embryogenesis and fragment shoot tip culture, that may lead to mutations in micropropagation. These types of mutations, known as somaclonal variation, have been studied extensively and are of interest for plant breeding. Cases of detrimental and beneficial mutations in micropropagated plants have been documented in other crops. There are several excellent

review articles on somaclonal variation and factors that affect it (Leva et al. 2012; Rani and Raina 2000; Ruffoni and Savona 2013).

In several older studies described in a review by Monette (1988), micropropagated grapes exhibited juvenile morphology, described as lack of tendrils, leaf shape, and other characteristics similar to a seedling after field establishment. However, it was later concluded that pruning was responsible for artificial maintenance of juvenility (Grenan 1984). In other studies, juvenile characteristics led to a lower yield in micropropagated vines (Martinez and Mantilla 1995; Deloire et al. 1995). Pruning may have been a factor in maintaining juvenility in these cases also. It was reported that all differences progressively disappeared after 7 years (Deloire et al. 1995). Another study observed that vegetative growth differences were not significant after some years and micropropagated plants had higher yield than conventional plants (Gribaudo et al. 2000). Thomas and Prakash (2004) found that vines that were planted in the field after 8 years of micropropagation initially exhibited juvenile characteristics but they disappeared in 6–8 months.

Finally, micropropagation in grapes is studied periodically for commercial increase and breeding purposes. Genetic homogeneity of grapes that were mass propagated by various methods *in vitro* was assessed using molecular techniques including microsatellite markers, ISSR, and AFLP. In all cases, there was no difference between and among the micropropagated plants and the mother plant. Additionally, there was no difference when plants were grown in a greenhouse or field (Nookaraju and Agrawal 2012; Baránek et al. 2009; Schellenbaum et al. 2008; Gribaudo et al. 2009). In a review article, Bouquet and Torregrosa (Bouquet and Torregrosa 2003) concluded that tissue culture was best used for pathogen elimination and for embryo rescue in seedless cultivars. However, the usefulness of tissue culture for micropropagation was questionable because of the high inputs needed but could be successful if the number of subcultures was limited and phenotype was monitored diligently. Since then, micropropagation has been investigated for many different cultivars especially for use in breeding programs with no apparent problems. It is worth repeating that there have been no reports of somaclonal variation in plants subjected to microshoot tip tissue culture for virus elimination.

For microshoot tip tissue culture, rapidly growing shoots in the spring and early summer provide the best tissue for excision. Microshoot tips are excised aseptically in a laminar flow hood using a 50X stereoscope magnification. The initial and maintenance medium is full-strength Murashige and Skoog (MS) salts (Murashige and Skoog 1962) and vitamins with 1.0 ml/l 6-benzylaminopurine (BA), 3% sucrose, and 6.0 g/l agar adjusted to pH 5.8. Explants are incubated in a growth chamber at 25 °C, 50% relative humidity, and 16-h daylight under cool white fluorescent and incandescent bulbs. Explants are transferred to fresh medium every 2–3 weeks. When the explants develop a shoot, they are transferred to rooting medium [half-strength MS salts and vitamins with 1.0 mg/l indole-3-acetic acid (IAA), 1.5% sucrose, and 6.0 g/l agar adjusted to pH 5.8]. When roots are well developed, plants are transplanted to sterilized potting mix (Golino et al. 2000).

Over the course of 7 months or more, the tips grow into a small plant with shoots and roots (Fig. 27.3). From there, they must produce enough plant material for



Fig. 27.3 Microshoot tip culture of grapevines at stages from 1 day to 6 months old. The microshoot tip on the *left* is less than 0.5 mm; when the explant shoot is approximately 2 cm high, it is transferred from medium with 1 mg/L BA to rooting medium containing 1 mg/L IAA. The rooted 6-month-old explant, far *right*, is ready to transplant to soil in the greenhouse

retesting to see if the targeted virus was successfully eliminated. In most cases, the virus is eliminated, but careful retesting is necessary, and success varies depending on virus and cultivar (see below; Sim et al. 2012). As described elsewhere in this volume, molecular detection techniques for grapevine viruses have improved, making it possible to test young plants regenerated from tissue culture, greatly improving the speed and accuracy of the virus-screening process. However, it is important to test the health status after at least one dormancy as viruses can remain below the detection threshold in young plants.

There has been speculation by many authors on the mechanism of action by which microshoot and/or meristem culture eliminates virus(es) in horticultural crops (Panattoni et al. 2013). Most hypothesize that the lack of vascular tissue in the meristem and immediately adjacent cells of the shoot tip prevents or impedes the movement of virus into those cells. There is also speculation about the presence of possible inhibitors of virus replication in the tissues.

A variation on microshoot tip culture technique is used routinely by IFV in France. Apical tips that are approximately 0.2–0.4 mm in size are excised and grafted onto hypocotyls of grapevine seedlings that were germinated *in vitro*. Using this method, approximately 90% of the cultivars survive and test negative for viruses (Spilmont et al. 2012; Spilmont 2016, personal communication).

Other Therapy Strategies

Other tissue culture strategies have been used to eliminate viruses from grapevines but are not widely or currently used, due to low survival or virus elimination rates, technical difficulties, or concerns about somatic mutations. These strategies include fragmented tip culture, chemotherapy, somatic embryogenesis, electrotherapy, and cryotherapy or a combination of several of them. As with the microshoot tip and heat treatment techniques described above, survival and virus elimination success depends on the cultivar as well as the virus species. These techniques may be useful in special cases if microshoot tip therapy is not successful.

Fragmented shoot tip culture was developed in 1978 (Barlass et al. 1982) and involves regenerating a plant from shoot tips that are aseptically cut into small pieces of tissue measuring less than 0.5 mm. Virus elimination was highly successful; 100% of plants regenerated tested negative for viruses using detection technology available at the time. Careful observations and electron microscopy revealed that plants grew from adventitious buds formed from leaf primordial fragments (Barlass et al. 1982). Concerns about mutations in the adventitious buds leading to off-types are the reason this technique is not widely used.

Chemotherapy has been investigated with mixed success. In most chemotherapy strategies, 1–2-cm-long green shoot tips are established *in vitro* in a medium containing antiviral compounds for at least 30 days. Plants are then subcultured to a medium without antiviral chemicals to recover. Ribavirin, oseltamivir, tiazofurin, and mycophenolic acid are commonly used as antiviral chemicals. Survival and virus elimination rate ranges widely depending on which antiviral compound is used and its concentration, cultivar, and virus (Panattoni et al. 2006, 2013; Skiada et al. 2013; Guta et al. 2014). The main obstacle to the regular use of chemotherapy is the high phytotoxicity of the antiviral compounds.

Electrotherapy has been attempted in several studies with limited success. It involves subjecting 1–2 node green cuttings to an electric current for 15–30 min and then establishing them *in vitro*. The theory is similar to that for heat treatment – the electrical field heats the tissue, inactivates virus particles, and prevents the viral genome from replicating. Survival rate is approximately 60%, and virus elimination rate of cuttings that survive is approximately 40%. Concerns about abnormal morphology developing have been expressed (Guta et al. 2010; Bayati et al. 2011). Electrotherapy is relatively quick and simple and could be a useful technique after more long-term studies are carried out to observe plants for off-types and virus status.

Somatic embryogenesis has also been investigated as a strategy for virus elimination from grapevines with excellent results. In this technique, anthers and/or ovaries are cultured and induced to form callus tissue; calli are then induced to form embryos. Embryos are cultured to regenerate into plants. Virus elimination was 100% in 97 selections in one study, including *Grapevine rupestris stem pitting-associated virus* (GRSPaV), one of the more difficult viruses to eliminate by microshoot tip culture and thermotherapy (Gribaudo et al. 2006). However, somatic

embryogenesis is technically more difficult and time-consuming and has an increased risk of off-types due to somaclonal mutations and variations.

Cryotherapy is the process of freezing shoot tips in liquid nitrogen for a short period of time then thawing them and regenerating a plant. It is the same reasoning as meristem tip culture, except that instead of excising the meristem, freezing temperatures are used to kill cells other than meristematic cells. Due to the fact that meristem cells have very dense cytoplasm with few vacuoles and less water relative to other cells, they are able to survive the freezing, while other cells burst. Tissue requires some type of preconditioning before freezing, either encapsulating in beads and dehydration or culturing medium with increasing sucrose concentration for osmotic protection. The process is reported to yield high survival and a 100% success rate at virus elimination (Wang et al. 2003). Again, cryotherapy is technically difficult and time-consuming.

In summary, plant survival, cultivar genotype, virus species, and technical skills and resources are important considerations for determining which strategy to use to eliminate viruses from grapevines. All strategies rely on regenerating clean plants to create foundation stock plants. From these, clean cuttings are provided to nurseries for establishing increase blocks to harvest cuttings for the production of material for actual planting of productive vineyards. Since there is no cure for infected vineyards, the importance of prevention and the production of clean stock are apparent.

The Place of Grape Clonal Variation in Clean Plant Programs

There are two critical areas that need to be considered in developing a superior grape cultivar collection. The first is disease status. Until a new selection is assayed for viruses and shown to test negative, vine performance is impossible to evaluate because vigor, yield, and fruit quality are all affected by viruses. By using planting material derived from certified, virus-tested stock, grape growers can reduce uncertainty about vine performance. Secondly, as selections of the same cultivar from different sources are compared, subtle performance differences become apparent. These differences are caused by mutations in genes that control characters such as characteristics of the leaf lobes, cluster size and compactness, berry color, disease resistance, and ripening date, among other factors. Over time, mutations accumulate and lead to greater diversity in older cultivars or selections. Selections propagated from single vines that differ in these ways and have been evaluated are known as “clones” of a cultivar. Planting superior clones can improve a cultivar’s production and winemaking characteristics. In the wine grape industry in particular, clonal variability is the subject of numerous studies and discussions.

There have been ongoing debates in the viticultural community about the relative merits of heat treatment versus microshoot tip culture for the elimination of viruses from infected grapevines. A commonly held belief among wine grape growers from California and elsewhere is that heat treatment produces high-yielding clones that

are excessively vigorous for the highest quality winemaking (neither table grape growers nor raisin growers have ever expressed a concern over high yields). Little scientific evidence exists for this theory. The FPS program at UC Davis produced the majority of heat-treated grape selections grown in grape collections around the world. At the time that the “heat treatment clones” were sourced from commercial vineyards by the grape breeder H. Olmo and others for inclusion in the FPS collection, high yield, cluster size, and vigor were important characteristics which were consciously sought (Alley and Golino 2000). Therefore, it is not surprising that many of the early FPS selections were high yielding but that is regardless of whether or not the selection received heat treatment. For example, cv. Zinfandel Selection 1A in the FPS collection never received heat treatment but is reported to be vigorous and productive as is the heat-treated selection Zinfandel Selection 6 (Wolpert 1996).

When A.C. Goheen performed heat treatment, he normally maintained the original preheat treatment selection as well as sequentially numbered selections, which represented varying treatment durations. In the FPS collection, there are multiple selections with varying heat treatment time, which have been produced from the same original source vine. These selections can be expected to be genetically identical in most cases and are not likely to be the source of significant clonal diversity (Christensen et al. 1995). However, because there is some statistical possibility of change and/or different disease profile, individual sources propagated from the same original accession with varying heat treatment history (number of days) are maintained under separate selection numbers at FPS. In more recent years, the same cautious approach has resulted in each tissue culture explant from the microshoot tip therapy program receiving a unique selection number when it is made available to the nurseries.

Variation in Therapy Success Rates Due to Virus Taxa

Successful virus elimination depends on virus taxa. Experience has shown that the leafroll viruses, which are phloem limited, are easier to eliminate than other viruses, perhaps due to the fact that the microshoot tip has no vascular connection to phloem tissue. The following sanitation rates were recorded at the DPSFS-Uniba relative to the analysis of nearly 3000 accessions of different cultivars derived from microshoot tip therapy: *Grapevine leafroll-associated virus 1* (GLRaV-1; 100%), *Grapevine leafroll-associated virus 2* (GLRaV-2; 98%), *Grapevine leafroll-associated virus 3* (GLRaV-3; 98%), *Grapevine virus B* (GVB; 99%), *Grapevine virus A* (GVA; 92%), *Grapevine fleck virus* (GFkV; 94%), and GFLV (84% heat therapy alone; 92% meristem tip culture and heat therapy) (La Notte et al. 2006; Morelli et al. 2015; Botalico, personal communication). At Cornell, a dozen clean accessions of six cultivars each were obtained after elimination of GLRaV-1, GLRaV-3, and *Grapevine red blotch-associated virus* (GRBaV) by microshoot tip culture and testing after two dormancy periods. At FPS, 90% of the selections were successfully cleaned through microshoot tip culture. Many of these selections were

infected with more than one virus. After processing, approximately 8% were infected only with GRSPaV. Other viruses that were detected after processing in the remaining 2% of selections were GVB, GFLV, GFkV, and GLRaV-2. This confirms other studies in which GRSPaV was less likely to be eliminated (Maliogka et al. 2009; Gribaudo et al. 2006). GRSPaV is considered a minor virus with no documented economic impact.

Economic Value of Clean Stock

Grapevine viruses and related pathogens have no cure in a vineyard and impose high costs on nurseries and crop producers. Viral diseases are typically disseminated through infected planting stock and plant-propagation material as a consequence of a careless selection of budwood. However, virus dissemination can be minimized if virus-screened stocks are used. Documenting the value of creating virus-screened “clean” planting stock is critical to insure the public sector funding of this expensive and time-consuming work. The development of meaningful data about the economic value of clean plant programs is challenging. The prospect of documenting benefits may seem overwhelming to those knowledgeable about the diversity of the viruses infecting grapevines, the documented variability in the impact of the various virus diseases, demonstrated diversity in the effect of different strains of individual viruses, the frequency of multiple virus infections in field situations, and the role of *Vitis* genotype in the response of the vine to infection.

Nonetheless, several studies in recent time have been able to estimate the economic impact of leafroll viruses. Atallah et al. (2012) found that, using data from a Cabernet franc vineyard in the Finger Lakes region of New York, if no control measures were implemented, the cost of GLRaV-3 ranged from \$25,407/ha with 30% yield loss and no quality penalty to \$41,000/ha with 50% yield loss and 10% quality penalty. They further found that initially planting GLRaV-3-screened vines rather than unscreened vines was financially rewarding over a 25-year horizon, even under the assumption that GLRaV-3-screened vines cost 25% more than unscreened vines. Among practices they evaluated, the removal of individual infected vines (roguing) was the most efficient and could reduce the losses to between \$3000 and \$23,000 per hectare if the vineyard contained less than 25% leafroll-infected vines, and replacing with GLRaV-3-free vines would reduce losses further, down to approximately \$1800 per hectare (Atallah et al. 2012).

In a related article, Atallah et al. (2014) examined various control strategies using a plant-level spatial dynamic model of the disease. In their simulation analysis, they found that a strategy of roguing and replacing symptomatic vines and testing their four immediate neighbors was economically superior to all other strategies evaluated; compared with a no-control strategy, it yielded benefits over 50 years having a net present value of \$59,000 for a 2-ha vineyard. They found that incorporating the less-than-perfect detectability of diseased vines and allowing for a time lag before the vine becomes symptomatic added substantially to the measured disease costs over 25 years, a net present value of \$25,000 versus \$4000 per hectare.

In California, another economic study estimated the costs and benefits of a virus-screening program for GLRaV-3 in the North Coast region of California (Fuller et al. 2015). Grower costs and benefits from using GLRaV-3-free vines were computed and extrapolated to the North Coast industry as a whole. Economic benefits from the GLRaV-3 testing and cleaning program were found to be in excess of \$50 million per year for the region and to substantially outweigh its costs. The results showed potential benefits from removing and replacing diseased vines rather than leaving them in the vineyard where they can be foci for disease spread. In addition, significant costs are associated with disease entering from virus-infected vines in neighboring properties.

A recent study focusing on three major grape-growing counties (Napa, Sonoma, and Northern San Joaquin Valley) in California estimated the economic impact of leafroll on Cabernet Sauvignon (Ricketts et al. 2015). Estimated costs of leafroll with no disease control ranged from \$29,902 to \$226,405 per ha depending on region, yield reduction, quality reduction, and varying levels of initial infection. The results of the study also found that if disease prevalence is between 5 and 10%, roguing symptomatic vines, replanting with certified vines, and controlling for mealybugs can minimize losses to leafroll. However, if disease incidence is greater than 25%, full vineyard replacement should be considered.

In New Zealand, a 2004 study produced a model that showed the cumulative cost of leafroll virus spread under three different (high, moderate, and low) infection scenarios to be NZ\$30,000 per ha by years 12, 15, and 17 (Walker et al. 2004). Furthermore, by year 11, infection might sufficiently justify vineyard replacement when the cost of leafroll infection exceeds the cost of vineyard establishment. In another New Zealand study, the economic impacts of leafroll were investigated by comparing the net present value of healthy and diseased vineyard blocks under three different management strategies: vineyard replacement, roguing and replacing symptomatic vines, and roguing and replacing symptomatic vines along with immediately adjacent vines. Over an 8-year period, roguing and replacing symptomatic vines reduced disease impact by 30% compared to no treatment in both varieties studied (Anonymous 2006). An economic impact model based on a net present value method has been developed and made available to New Zealand winegrowers. The model allows growers to set inputs of some parameters specific to an individual vineyard and provides them with the estimated costs and benefits for various treatment scenarios. For example, forecast revenue lost to removal of infected vines in the year of infection and replacing them the following year is 5% compared to a 28% revenue loss by waiting 6 years to replace all vines after one fallow year (Anonymous 2015).

South Africa is another country where an integrated control strategy of leafroll disease is being successfully implemented. This strategy is essentially based on the use of certified virus-free planting material, systemic insecticide treatments, removal of infected vines by roguing, careful cleaning of agricultural implements, and clothing for reducing passive transport of vectors between vineyards (Pietersen 2006; Pietersen and Walsh 2012).

Conclusive Remark

Sanitary selection of grapevines is a viable and reliable approach to limiting the damage done to vineyards by infection with grapevine viruses. With a combination of robust virus detection technology and the success of microshoot tip culture for virus elimination, programs around the world continue to provide virus-screened grapevine cultivars and clones, as well as rootstock genotypes. This is a tremendous benefit to growers of grapevines, which are used for many purposes, including winemaking, fresh table grapes, raisins, and juice.

References

- Alley, L., and D. Golino. 2000. The origins of the grape program at Foundation Plant Materials Service. *American Journal of Enology and Viticulture* 51: 222–230.
- Anonymous. 2006. *Report for New Zealand Winegrowers: The economic effects and financial impact of GLRaV3*.
- . 2015. *New Zealand Winegrowers fact sheet: NZVE103*. What are the commercial costs associated with leafroll 3?
- Atallah, S.S., M.I. Gómez, M.F. Fuchs, and T.E. Martinson. 2012. Economic impact of grapevine leafroll disease on *Vitis vinifera* cv. Cabernet franc in Finger Lakes vineyards of New York. *American Journal of Enology and Viticulture* 63: 73–79.
- Atallah, S.S., M.I. Gómez, J.M. Conrad, and J.P. Nyrop. 2014. A plant-level, spatial, bioeconomic model of plant disease diffusion and control: Grapevine leafroll disease. *American Journal of Agricultural Economics* 97: 199–218.
- Audeguin, L. 2016. IFV: A network service for the wine industry. Presentation.
- Baránek, Miroslav, Jana Raddová, Bretislav Krizan, and Miroslav Pidra. 2009. Genetic changes in grapevine genomes after stress induced by *in vitro* cultivation, thermotherapy and virus infection, as revealed by AFLP. *Genetics and Molecular Biology* 32 (4): 834–839.
- Barlass, M., K.G.M. Skene, R.C. Woodham, and L.R. Krake. 1982. Regeneration of virus-free grapevines using *in vitro* apical culture. *The Annals of Applied Biology* 101: 291–295.
- Bayati, Sh., M. Shams-Bakhsh, and A. Moieni. 2011. Elimination of Grapevine virus A (GVA) by cryotherapy and electrotherapy. *Journal of Agricultural Science and Technology* 13: 443–450.
- Boidron, R. 1995. Clonal selection in France. Methods, organization, and use. In: *Proceeding of the international symposium on clonal selection*, 1–7. Portland: ASEV.
- Bouquet, A., and L. Torregrosa. 2003. Micropropagation of the grapevine (*Vitis* spp.). In *Micropropagation of Woody trees and fruits*, Forestry sciences, 75, ed. S.M. Jain and K. Ishii, 319–352. Dordrecht: Kluwer Academic Publishers.
- Christensen, L.P., D.A. Golino, and M.M. Moriyam. 1995. Comparison of registered selections of French Colombard and Chenin blanc with and without thermotherapy. ASEV international symposium on clonal selection, City, State, USA, 111–113.
- Deloire, A., M. Charpentier, G. Berlioz, A. Colin, and G. Gimonet. 1995. Micropropagation of grapevine: Results of 10 years of experiments in the champagne vineyard and results of the first vinifications. *American Journal of Enology and Viticulture* 46: 571–578.
- EPPO. 2001. Nursery requirements. *EPPO Bulletin* 31: 441–444.
- . 2008. Pathogen-tested material of grapevine varieties and rootstocks. *EPPO Bulletin* 38: 422–429.
- Fuller, K.B., J.M. Alston, and D.A. Golino. 2015. The economic benefits from virus screening: A case study of grapevine leafroll in the North Coast of California. *American Journal of Enology and Viticulture* 66: 112–119.

- Gifford, E.M., and W.B. Hewitt. 1961. The use of heat therapy and *in vitro* shoot tip culture to eliminate fanleaf virus from the grapevine. *American Journal of Enology and Viticulture* 12: 129–130.
- Goheen, A.C. 1989. Virus diseases and grapevine selection. *American Journal of Enology and Viticulture* 40: 67–72.
- Goheen, A.C., and C.F. Luhn. 1973. Heat inactivation of viruses in grapes. *Rivista di Patologia Vegetale*. 9: 287–289.
- Goheen, A.C., C.F. Luhn, and W.B. Hewitt. 1965. Inactivation of grapevine viruses *in vivo*. *Proceedings international conference virus vector perennial hosts*, Davis, CA, 255–265.
- Golino, D.A., S.T. Sim, A. Bereczky, and A. Rowhani. 2000. The use of shoot tip culture in foundation plant materials service programs. *Proc. Int. Plant Propagation Soc.* 50: 568–573.
- Grenan, S. 1984. Polymorphisme foliaire consécutif à la culture *in vitro* de *Vitis vinifera* L. *Vitis* 23: 159–174.
- Grenan, S., A. Bonnet, and R. Boidron. 2000. Results and thoughts on 35 years of sanitary selection in France. Proc. VII Int'l Symp on grapevine genetics and breeding. *Acta Horticulturae* 528: 713–721.
- Gribaudo, I., F. Mannini, A. Lisa, and D. Cuzzo. 2000. Phenotypical modifications of micro-propagated grapevines. *Acta Horticulturae* 530: 231–236.
- Gribaudo, I., G. Gambino, D. Cuzzo, and F. Mannini. 2006. Attempts to eliminate *Grapevine Rupestris stem pitting-associated virus* from grapevine clones. *Journal of Plant Pathology* 88: 293–298.
- Gribaudo, I., D. Torello Marinoni, G. Gambino, F. Mannini, A. Akkak, and R. Botta. 2009. Assessment of genetic fidelity in regenerants from two *Vitis vinifera* cultivars. *Acta Horticulturae* 827: 131–136.
- Guta, I.C., E.C. Buciumeanu, R.N. Gheorghe, and A. Teodorescu. 2010. *Solutions to eliminate grapevine leafroll associated virus serotype 1+3 from V. vinifera L. cv. Rânâi Magaraci*. Romanian Biotechnological Letters 15 No.1. Supplement.
- Guta, I.C., E.C. Buciumeanu, and E. Visoiu. 2014. Elimination of *Grapevine fleck virus* by *in vitro* chemotherapy. *Not Bot Horti Agrobo* 42: 115–118.
- Hewitt, W.B., 1954. *Some virus and virus-like diseases of grapevines*. The Bulletin, Department of Agriculture, State of California, XLIII, 47–64.
- Kassanis, B. 1950. Heat inactivation of leaf-roll virus in potato tubers. *Applied Biology* 37: 339–341.
- Kunkel, L.O. 1936. Heat treatments for the cure of yellows and other virus diseases of peach. *Phytopathology* 26: 809–830.
- La Notte, P., C. Pirolo, G. Bottalico, A. Campanale, and V. Savino. 2006. Sanitary status and sanitation of local germplasm in southern Italy. Extended abstracts 15th Meeting ICVG, Stellenbosch, South Africa, 3–7 April 2006, 114–115.
- Leva A.R., R. Petruccelli, and L.M.R. Rinaldi. 2012. *Somaclonal variation in tissue culture: A case study with olive, recent advances in plant in vitro culture*, Dr. Annarita Leva (Ed.), ISBN: 978-953-51-0787-3, InTech, DOI: [10.5772/50367](https://doi.org/10.5772/50367). Available from: <http://www.intechopen.com/books/recent-advances-in-plant-in-vitro-culture/somaclonal-variation-in-tissue-culture-a-case-study-with-olive>
- Maliogka, V.I., F.G. Skiada, E.P. Eleftheriou, and N.I. Katis. 2009. Elimination of a new ampelovirus (GLRaV-Pr) and *Grapevine rupestris stem pitting associated virus* (GRSPaV) from two *Vitis vinifera* cultivars combining *in vitro* thermotherapy with shoot tip culture. *Scientia Horticulturae* 123: 280–282.
- Maliogka, V.I., G.P. Martelli, M. Fuchs, and N.I. Katis. 2015. Control of viruses infecting grapevine. *Advances in Virus Research* 91: 176–227.
- Mannini, F. 1995. Grapevine clonal selection in Piedmont (Northwest Italy): Focus on Nebbiolo and Barbera. In *Proceedings of the international symposium on clonal selection*, 20–32. Portland: ASEV.
- . 2000. Clonal selection in grapevine: interactions between genetic and sanitary strategies to improve propagation material. VII International Symposium on Grapevine. *Genetics and Breeding*. 528: 703–712.

- Martelli, G.P. 1992. Infectious diseases and certification of grapevines. *Proceedings of the Mediterranean Network on Grapevine Closteroviruses*. 1997: 1985–1997.
- Martinez, M.C., and J.L.G. Mantilla. 1995. Morphological and yield comparison between *Vitis vinifera* L. cv. Albariño grown from cuttings and from in vitro propagation. *Amer. J. Enol. Viticult.* 46: 195–203.
- Monette, P.L. 1988. *Grapevine (Vitis vinifera L.), biotechnology in agriculture and forestry*, Vol.6, Crops II. Bajaj Y.P.S. ed. 6: 3–37. Berlin/Heidelberg: Springer.
- Morelli, M., S. Zicca, G. Botalico, G. Campanale, M. Calderaro, G. Donatelli, P. Saldarelli, C.S. Pirolo, V.N. Savino, and P. La Notte. 2015. Virus infections and sanitation of ancient grapevine cultivars from Apulia. Proceedings 18th congress of the ICVG, Ankara, Turkey, 242–243.
- Murashige, T., and F. Skoog. 1962. A revised medium for rapid growth and bioassays with tobacco tissue cultures. *Physiologia Plantarum* 15: 473–497.
- Nookaraju, A., and D.C. Agrawal. 2012. Genetic homogeneity of in vitro raised plants of grapevine cv. Crimson Seedless revealed by ISSR and microsatellite markers. *South African Journal of Botany* 78: 302–306.
- Nyland, G., and A.C. Goheen. 1969. Heat therapy of virus diseases of perennial plants. *Annual Review of Phytopathology* 7: 331–354.
- Olmo, H.P. 1951. A proposed program for the introduction, improvement, and certification of healthy grape varieties. *Wines & Vines* 32: 7–9.
- . 1975. *The California grape certification program*. Proceedings of the 1st International Seminar on Wine, Jerez, Spain, 379–389.
- Olmo, H.P., and A.D. Rizzi. 1943. Selection for fruit color in the Emperor grape. *Proceedings of the American Society for Horticultural Science* 42: 395–400.
- Panattoni A., F. D'Anna, and E. Triolo. 2006. *Improvement in grapevine chemotherapy*. Proceedings 15th Meeting of the ICVG, Stellenbosch, South Africa pp. 139–140.
- Panattoni, A., A. Luvisi, and E. Triolo. 2013. Review. Elimination of viruses in plants: twenty years of progress. *Spanish Journal of Agricultural Research* 11: 173–188.
- Pietersen, G. 2006. *Spatio-temporal distribution dynamics of grapevine leafroll disease in Western Cape vineyards*. Extended abstracts 15th meeting of ICVG, Stellenbosch, South Africa, 126–127.
- Pietersen G., and E. Walsh. 2012. *Development of a LAMP technique for control of Grapevine leafroll-associated virus type 3 (GLRaV-3) in infected white cultivar vines by roguing*. Proceedings of 17th Congress of ICVG, Davis, CA, USA, 50–51.
- Rani, V., and S. Raina. 2000. Genetic fidelity of organized meristem derived micropropagated plants: A critical reappraisal. *In Vitro Cellular & Developmental Biology. Plant* 36: 319–330.
- Ricketts, K.D., M.I. Gomez, S.S. Atallah, M.F. Fuchs, T.E. Martinson, M.C. Battany, L.J. Bettiga, M.L. Cooper, P.S. Verdegaal, and R.J. Smith. 2015. Reducing the economic impact of grapevine leafroll disease in California: Identifying optimal disease management strategies. *American Journal of Enology and Viticulture* 66: 138–147.
- Rowhani, A., J.K. Uyemoto, D. Golino, and G.P. Martelli. 2005. Pathogen testing and certification of *Vitis* and *Prunus* species. *Annual Review of Phytopathology* 43: 261–278.
- Ruffoni, B., and M. Savona. 2013. Physiological and biochemical analysis of growth abnormalities associated with plant tissue culture. *Horticulture, Environment and Biotechnology* 54 (3): 191–205.
- Rühl, E.H., H. Konrad, B. Lindner, and E. Bleser. 2004. Quality criteria and targets for clonal selection in grapevine. *Proceedings of St IS on Grapevine. Acta Horticulturae*. 652: 29–33.
- Rühl, E.H., F. Manty, H. Konrad, and E. Bleser. 2011. The importance of pathogen-free grapevine propagation material in regards to clonal selection and rootstock breeding in Germany. *International Journal of Horticultural Science*. 17: 11–13.
- Salami, S.A., A. Ebadi, Z. Zamani, and M.K. Habibi. 2009. Distribution of GFLV in Iranian vineyards and improvements to sanitation protocols for production of virus-free grapevines. Proc. VIth IS on *In Vitro* Cult. and Hort. Breed. *Acta Horticulturae* 829: 389–393.

- Savino, V., D. Boscia, and G.P. Martelli. 1985. Incidence of some graft-transmissible virus-like diseases of grapevine in visually selected and heat-treated stocks from Southern Italy. *Phytopathologia Mediterranea* 24: 204–207.
- Schellenbaum, P., V. Mohler, G. Wenzel, and B. Walter. 2008. Variation in DNA methylation patterns of grapevine somaclones. (*Vitis vinifera* L.). *BMC Plant Biology* 8: e78.
- Schmid, J., R. Ries, and E.H. Rühl. 1995. *Aims and achievements of clonal selection at Geisenheim*. Proceedings of the International Symposium on Clonal Selection, 70–73. Portland: ASEV.
- Sim, S., M. Al Rwahnih, A. Rowhani, and D. Golino. 2012. *Virus elimination from grape selections using tissue culture at foundation plant services*, 262–263. Davis: University of California.
- Skiada, F.G., V.I. Maliogka, N.I. Katis, and E.P. Eleftheriou. 2013. Elimination of *Grapevine rupestris stem pitting-associated virus* (GRSPaV) from two *Vitis vinifera* cultivars by *in vitro* chemotherapy. *European Journal of Plant Pathology* 135: 407–414.
- Spilmont, A.S., A. Ruiz, and S. Grenan. 2012. *Efficiency of micrografting of shoot apices as a sanitation method against seven grapevine viruses (ArMV, GFLV, GLRaV-1, -2, -3, GFkV, GVA)*. Proceedings of the 17th Congress of ICVG, Davis, California, USA, pp. 270–271.
- Thomas, P., and G.S. Prakash. 2004. Sanitizing long-term micropropagated grapes from covert and endophytic bacteria and preliminary field testing of plants after 8 years *in vitro*. *In Vitro Cellular & Developmental Biology. Plant* 40: 603–607.
- Walker, J.T.S., J.G. Charles, K.J. Froud, and P. Connolly. 2004. Leafroll virus in vineyards: modeling the spread and economic impact. *HortResearch Client Report* 12795.
- Wang, Q.C., M. Mawassi, P. Li, R. Gafny, I. Sela, and E. Tanne. 2003. Elimination of Grapevine virus A (GVA) by cryopreservation of *in vitro*-grown shoot tips of *Vitis vinifera* L. *Plant Science* 165: 321–327.
- Wolpert, J.A. 1996. Performance of Zinfandel and Primitivo clones in a warm climate. *American Journal of Enology and Viticulture* 47: 124–126.

Chapter 28

Regulatory Aspects of Grape Viruses and Virus Diseases: Certification, Quarantine, and Harmonization

D.A. Golino, M. Fuchs, M. Al Rwahnih, K. Farrar, A. Schmidt, and G.P. Martelli

Abstract While the existence of grapevine diseases and their negative impacts on vegetative growth and fruit production and quality have long been acknowledged, it is only relatively recently that clean stock programs around the world have made a significant impact on the health status of grapevines by providing the highest-quality virus-tested propagation material. Clean stock programs strive to ensure that continual advancements are made in disease detection and elimination while working with government agencies to develop and update certification and quarantine regulations. Global efforts to unify regulations among trading partners are necessary to ensure grapevine health worldwide.

Keywords Certification • Quarantine clean stock • Disease • Grapevine • Regulatory programs • Sanitary selection • Virus

D.A. Golino (✉)

Foundation Plant Services, University of California, Davis, CA, USA
e-mail: dagolino@ucdavis.edu

M. Fuchs

Section of Plant Pathology and Plant-Microbe Biology, School of Integrative Plant Science, New York State Agricultural Experiment Station Cornell University, Geneva, NY, USA

M. Al Rwahnih • K. Farrar

Foundation Plant Services, Department of Plant Pathology, University of California, Davis, CA 95616, USA

A. Schmidt

Sidney Laboratory - Plant Viruses and Virus-like Diseases, Canadian Food Inspection Agency, North Saanich, BC, Canada

G.P. Martelli

Department of Soil, Plant and Food Sciences, University of Bari Aldo Moro, Bari, Italy

Introduction

Various centers of expertise around the world use detection and therapy techniques (Rowhani et al., Chap. 20; Blouin et al., Chap. 21; Rowhani, et al., Chap. 22; and Golino et al., Chap. 27 in this book) to create grapevine selections that test negative for damaging viruses. The quality of the clean products depends upon the resources available to those centers and the goals of the individual programs. Producing truly virus-free planting stocks is a lofty goal; therefore, experts make practical judgments about how to use finite resources to make the most meaningful improvements possible in vine health. Some of the challenges faced by these expert centers involve making judgments about (1) which virus(es) has economically significant effects on vine health, (2) whether some viruses can be tolerated, (3) whether a virus can be practically excluded in a given geographic location once clean material is delivered to nurseries, (4) how to adopt the latest diagnostic advancements to streamline to production of clean stocks, and (5) how to prevent the infection of clean stocks in foundation vineyards. When it comes to vine health vis-à-vis virus testing and treatment, progress is made over time, with improvements in diagnostic and therapeutic technologies and with the education of scientists, regulators, nurseries, and growers. In some ways, it is analogous to the continuing work of specialists in human health, i.e., there is never a perfect control of the grapevine virus diseases through clean plant programs, but there are steady and measurable improvements where the programs are well funded and endorsed by the grape and wine community.

In an effort to document the benefits of the California's certification program and the impact on vine health, a survey of North Coast California vineyards was conducted. Each vineyard was classified by age and a subset of vines was tested for nine different viruses, all of which have been detected in California. The prevalence of each virus found in vineyards decreased steadily over the decades when the viral profiles were compared. The only virus, which was not significantly reduced since the program was established in the 1950s, was *Grapevine rupestris stem pitting-associated virus* (GRSPaV), which is notoriously difficult to eliminate. In fact, this virus is exempted from the California and many other certification programs because, despite numerous efforts, the effect of GRSPaV on vine performance has not been established, and it may be pollen transmissible (Rowhani et al. 2000), which means it would be challenging to control. Many of the other viruses common in older vineyards (planted from 1880 to 1980) were not found at all in the younger vineyards sampled (planted from 2011 to 2014). The two exceptions were *Grapevine leafroll-associated virus 3* (GLRaV-3) and *Grapevine red blotch-associated virus* (GRBaV), both of which are spread by vectors in this part of the state (Arnold et al. [in press](#)). The data show a steady reduction in the incidence of regulated virus diseases in newer vineyards with major challenges still posed by the viruses which are readily transmitted by vectors. To our knowledge, this is the first comprehensive study of the benefits of a certification program in terms of the prevalence of viruses in commercial vineyards

Here, we outline certification and quarantine programs in some of the major grape-producing areas of the world and discuss harmonization efforts. Our intent is to provide a realistic account of the different programs while suggesting opportunities for improvement.

Certification

Certification is defined as the confirmation of certain characteristics of an object, person, or organization. In plant pathology, it usually involves a product certification, which requires processes intended to ensure that a product meets certain quality standards, i.e., freedom from a pathogen. In the very specific case of grapevine certification, it normally involves viruses combined with cultivar and/or clonal identification, and often viticultural performance. Discussions have also been initiated in various quarters of certification programs to consider freedom from the crown gall bacterium *Agrobacterium vitis* and from the fungi which cause trunk diseases. Where crown gall is part of an existing program, detection is often based on visual observation of symptoms.

Certification programs are usually, but not always, performed at public institutions with the involvement of state, national, or regional regulatory officials. Grapevine certification programs worldwide share the common goal of providing what is called foundation stock (G1 stock in international regulatory terminology). We will discuss some of the various programs and the procedures and protocols which are used by each.

The European Union

There is over a century of experience in grapevine selection (for both clonal and sanitary purposes) in the European Union (EU). This process had its beginning with efforts initiated in Germany near the end of the nineteenth century. The commitment to improve grapevine sanitary conditions grew stronger in the 1960s as a consequence of two events: first, the development of new knowledge on the viral nature of some serious disorders, such as fanleaf degeneration, and the potential to procure virus-free shoot tips from infected plants through thermotherapy; and second, the alarming sanitary deterioration of the crop in many regions, which was in part counterbalanced by the programs of individual member states (France, Germany, and Italy). These events prompted the EU Council to issue directives for the improvement of the EU's viticulture industry. The first Directive 68/193 (issued on 9 April 1968) on the "Marketing of Vegetatively Propagated Material of Grapevines" categorized propagative materials as "basic," "certified," and "standard" and defined the sanitary characteristics of mother vineyards destined for their production.

Whereas participation in the California certification system (and other North American programs) is voluntary, in Europe it is mandatory. Even so, in the European program, the acceptance of the “standard” category allows for the propagation of materials lacking significant phytosanitary guarantees. In reality, the “standard” category was a consequence of the lack of clones suitable for certification when the program was initiated and of the lengthy and costly procedures required for their procurement and increase. However, the same directive contained the auspices for a progressive improvement of the sanitary status toward production of “certified” materials. Enforcement toward that endeavor came in Directive 2002/11 (14 February 2002), issued to modify Directive 68/193, which abolished the production of rootstocks in the “standard” category (which had already been required by some member countries) starting January 2005.

Moreover, EU certification schemes should not be regarded merely as clean stock programs applied to viticulturally uncontrolled mother sources. Registration and certification of source materials require identification as true-to-type and verified as to clonal origin, as well as documented viticultural and oenological performance. The identification of clones is regulated by EU Directive 72/169 and outlined in a Resolution of the Office International de la Vigne et du Vin (Anonymous 1991). Thus, in the EU, clonal and sanitary selection involves interdisciplinary activity requiring the joint effort of viticulturists, virologists, and wine grape technologists.

The Directive 68/193, successively modified and integrated by the Directives 71/140 and 77/629, was an innovative regulation of great social and economic importance because it included concepts for certification and sanitary status accepted as valid in all EU member countries. It defines the sanitary requirement of current EU certification as follows: “In the vineyards producing basic material, harmful virus diseases, notably fanleaf and leafroll, must be eliminated. Vineyards producing materials of other categories must be kept free from plants showing symptoms of virus diseases.” By-laws generated by these directives were promulgated in EU member countries and national certification schemes were implemented.

It is clear that the sanitary provisions of these directives are not satisfactory and fail to ensure an acceptable sanitary status of propagative material in any category. Furthermore, they are no longer adequate, failing to take into account recent scientific discoveries in grapevine virology. Much progress has been made in the etiology, epidemiology, and diagnosis of grapevine viruses and virus-like diseases; unfortunately, the improved technology is largely ignored. In an attempt to address this issue, some European countries enacted their own measures. Although national certification schemes implemented in EU member countries are inspired by, and more or less conform to, EU directives, they vary. Some differences pertain to the viticultural aspects of clonal selection. In Germany, for example, the selection process requires a longer time period compared to France and Italy. Additional differences reside in sanitary requirements where, in most instances, they are stricter than those in the EU directives, the latter requiring tests for only fanleaf and leafroll diseases.

Overall, individual sanitary schemes may vary widely, with Portugal, France, and Italy requiring all selections to test negative for rugose wood diseases, which is not required in Germany. In Spain, assays are limited to rupestris stem pitting and corky bark. And, interestingly, EU directives require that all rootstock be free of fleck, but scion sources are exempt from this requirement.

The abovementioned scenario has impeded the full harmonization of the European production scheme, a goal attempted by Directive 68/193. As a consequence of continued efforts involving several organizations and grapevine virologists for an updated directive to harmonize the system, the EU has developed a new Directive 2002/11/CE. However, the practical impact of this directive depends greatly on the contents of the technical appendix, which has yet to be made public for a full evaluation of its content.

Although other differences exist in how certified materials are maintained, propagated, and distributed, certain steps are commonplace to all schemes. Registered clones (primary sources or nuclear stocks) are maintained by the organization or individual who owns them (“obteneur” or conservation breeder) and undergo a first multiplication in specialized facilities. The propagating material is distributed to nurseries for the establishment of certified mother blocks and used for the production of certified budwood, rooted cuttings, or grafted plants for commercial plantings. An officially authorized organization is responsible for the sanitary status, the origin of materials, and quantities of certified plants produced prior to being issued certification labels.

California

In the New World, the oldest grapevine certification program is the California Department of Food and Agriculture (CDFA) Grapevine Registration and Certification (R&C) Program, established in 1956 (Alley and Golino 2000). Other state programs in the United States are modeled after it, and several use its stock as initial source materials for their own certification or clean stock programs. The California program also has historic ties to clean stock programs of Canada and Australia, where similar techniques and protocols have been adopted.

The current certification program is described in some detail to illustrate typical protocols used for grapevine clean stock programs. In two key areas, this program differs from many European programs. First, the program is entirely voluntary; nurseries are free to participate or not under this system. Second, this program does not include cultivar or clonal evaluation – a key part of many European grapevine clean stock programs (Golino and Wolpert 2003). Selections entering the program are normally chosen for potential viticultural merit and become available for performance evaluations once the phytosanitary requirements of the program are met. These efforts are managed separately from the regulatory program, which focuses on target diseases and pathogens coupled with management protocols intended to reduce the chance of reinfection of clean stock.

Foundation Plant Services (FPS) is a service department in the College of Agricultural and Environmental Sciences at the University of California, Davis. This department performs the disease testing required by the CDFA R&C program and maintains the foundation vineyards that supply nursery participants.

Each grapevine in the FPS collection is assigned a registration category according to its health and cultivar identification status. Registered foundation grapevines are those propagated from sources that meet requirements mandated by the CDFA R&C program guidelines, and professionally identified to cultivar. Provisional foundation grapevines are those that have passed the disease tests (CDFA R&C program), but cultivar identification is incomplete. Non-registered grapevines have either tested positive for targeted diseases, are of unknown disease status, or are of questionable cultivar identity. All non-registered grapevines are maintained separated from the elite foundation block, awaiting therapy or identification. Provisional and non-registered selections are distributed only to customers receiving notification of the grapevines' status and willing to assume all of the associated risks.

The CDFA R&C program includes provisions for three levels of grapevine stock: foundation, registered, and certified (Fig. 28.1). Propagation materials derived from foundation grapevines in the FPS foundation vineyard are known as "foundation stock." Participants in the CDFA R&C program use the California foundation stock to establish their own vineyards, referred to as "primary" or "secondary increase blocks." These blocks are inspected annually and are virus tested as required by CDFA inspectors. Cuttings taken from the registered increase blocks are used to produce "registered stock." Grape plants produced by own-rooting registered stocks or by grafting registered stock scions to registered stock rootstocks qualify as "certified stock." These plants are sold for commercial plantings. CDFA regulations govern all Grapevine R&C Program responsibilities, which include eligibility requirements, planting and maintenance requirements, inspection and testing procedures, and approval, suspension, and cancelation of certification, application, and fees.

All woody and herbaceous index tests prescribed in CDFA R&C regulations are used to screen grape materials before qualifying as foundation stock at FPS (Rowhani et al. 2005). In addition to the biological indexing (Rowhani, et al., Chap. 20 in this book), enzyme-linked immunosorbent assay (ELISA) and polymerase chain reaction (PCR) are performed at FPS on every accession destined for inclusion in the foundation vineyard (Blouin et al., Chap. 21 and Rowhani, et al., Chap. 22 in this book).

Furthermore, during their first two growing seasons, the new accessions in the foundation vineyard are tested twice by ELISA for Grapevine leafroll-associated viruses; three nematode-transmitted viruses, namely, *Arabidopsis mosaic virus* (ArMV), *Grapevine fanleaf virus* (GFLV), and *Tomato ringspot virus* (ToRSV); plus, *Grapevine fleckvirus* (GFkV) and *Grapevine virus A* (GVA). Thereafter, one-fifth of the foundation grapevines (third-leaf and older) are ELISA tested each year so that over a 5-year period the entire foundation vineyard is retested. This 20% retesting procedure is repeated for the life of the foundation vineyard. As an additional precaution at FPS, the foundation grapevines are periodically re-indexed biologically and retested by ELISA and PCR. Lastly, the foundation vineyards are visually

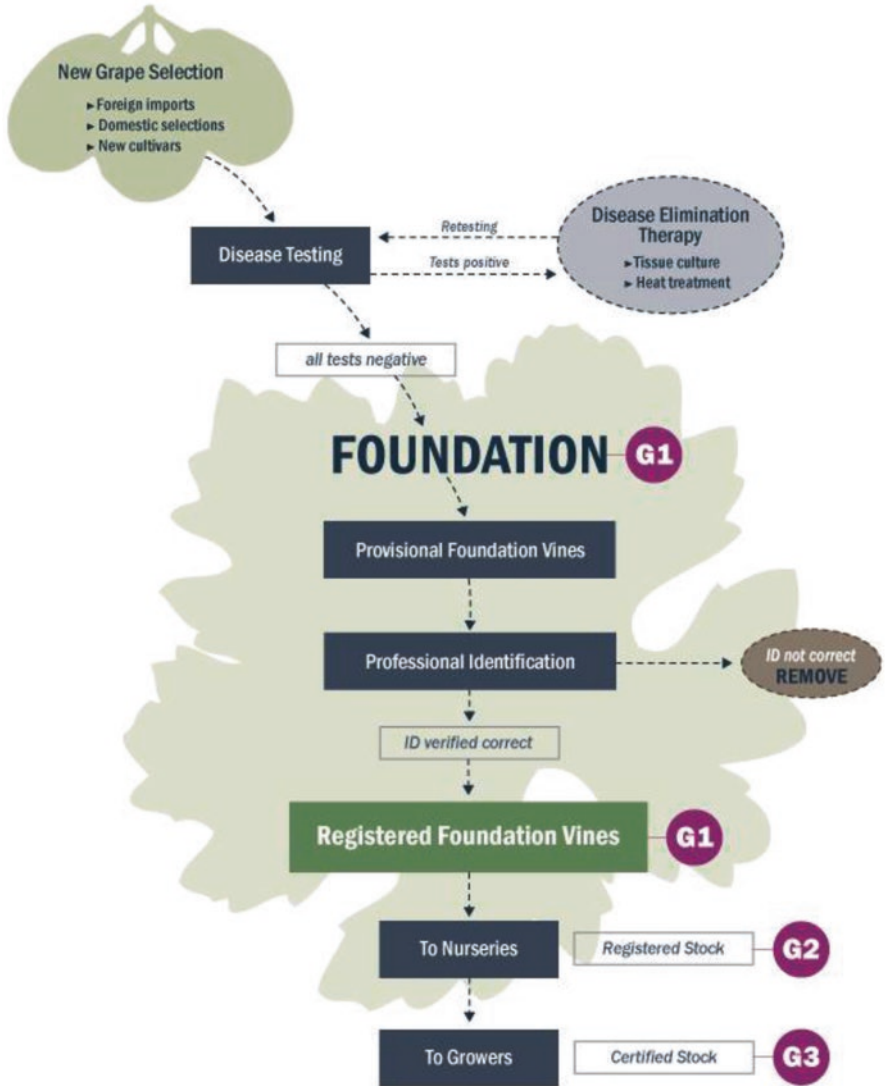

Fig. 28.1 Flowchart of grapevines from introduction through foundation, registration, and certification

inspected twice per year, spring and summer, for disease symptoms. When suspicious symptoms are found, the grapevine(s) are immediately tested with laboratory-based assays and, as warranted, by woody host indexing. Infected grapevines are removed.

New York

A grapevine certification program managed by the Department of Agriculture and Markets was established in New York State in the early 1960s. This program mirrored the program created earlier in California. The New York program was well perceived until the late 1980s when its attractiveness vanished. This coincided with an unprecedented expansion of the grape acreage in the State, which resulted, as expected, in the deterioration of the sanitary status of local vineyards. The recurrent issues of viruses in local vineyards and early accomplishments of the National Clean Plant Network (NCPN) for grapes triggered a strong grassroots movement led by local nurseries and the wine and grape industry to reinstate a certification program in New York State. The new program focuses exclusively on G2 blocks for which clean vines are primarily sourced from recognized foundation G1 blocks and strict site selection criteria are applied. Plants at each G2 block are visually inspected for viral disease symptoms in the spring and fall, and one-fourth of them is tested each year for viruses [GFLV, ToRSV, *Tobacco ringspot virus* (TRSV), GLRaV-1, GLRaV-2, GLRaV-3, GLRaV-4, and GRBaV] by ELISA and/or PCR-based assays for the entire life span of the vineyard. If a vine is found infected, it is immediately removed and so are adjacent vines, whether infected or not.

Canada

The Canadian Grapevine Export Program (CGEP) is managed by the Canadian Food Inspection Agency (CFIA) under Directive D-15-02. This directive replaces Directive D-97-06 to incorporate a systems approach for producing virus-tested grapevines for export certification to the USA. The material produced in this program can also be used within Canada. Independent components such as virus testing, field inspection, isolation distance, and vector control are considered to minimize the presence and spread of viruses. Plants produced under the CGEP must originate from first-generation (G1) stock produced by the CFIA or approved facilities, and these original mother plants are tested for viruses and virus-like pathogens of concern determined by the North American Plant Protection Organization (NAPPO) Standard No. 35. A combination of tests is performed on all G1 accessions, including biological indexing (woody and herbaceous), serological tests (ELISA), and PCR assays. Canada follows the G-level naming system where at each stage of propagation, progeny plants drop to a lower certification level. Plants qualifying for CGEP purposes belong to one of four categories (G1A, G2, G3, and G4) derived from G1 stock (Anonymous 2016b).

Argentina and Chile

Certification procedures with the characteristics of clean stock programs were established in Argentina in 2001 and in Chile in 2007. In both countries, nuclear stocks, which do not undergo clonal selection, are certified for the absence of a limited number of viruses. In Argentina, these are GFLV, Grapevine leafroll-associated viruses (GLRaV-1, GLRaV-2, and GLRaV-3), GFKV, rugose wood, vein mosaic, and vein necrosis. In Chile, they are GFLV; GLRaV-1, GLRaV-2, and GLRaV-3; GVA, and *Grapevine virus B* (GVB) (Golino et al. 2015).

South Africa

The Vine Improvement Association in South Africa was established in 1986 to promote the interests of the South African wine industry through plant improvement and certification of vine propagation material. The certification scheme for wine grapes was licensed under the South African Plant Certification Scheme for Wine Grapes under the Plant Improvement Act No. 53 of 1976 by the South African Department of Agriculture, Forestry and Fisheries. The South African certification protocol encompasses clonal selection and requires rootstock and scion material to be free from the following virus diseases: fanleaf, fleck, leafroll, corky bark, stem pitting/grooving, and “Shiraz disease” (unknown etiological agent). It also requires visual freedom from crown gall (*Agrobacterium vitis*), bacterial blight (*Xylophilus ampelinus*), *Pythium* spp., *Phytophthora* spp., and a group of nematodes and insects among which are the pseudococcid mealybugs (*Pseudococcus longispinus* and *Planococcus ficus*), known vectors of some viruses associated with leafroll and rugose wood (Anonymous 2009b; Golino et al. 2015).

New Zealand and Australia

In an effort to manage the quality of new grapevine plantings in New Zealand, the New Zealand Winegrowers Board has developed a Grafted Grapevine Standards and an associated certification program with the objective of minimizing the probability of infected material being released to the industry. Certified mother plants are true-to-type at the varietal level and free from GLRaV-3 at the time of testing. Specific physical specifications and the related management systems are within the scope of the requirements (Anonymous 2011).

The Australian Standard for Grapevine Propagation Material is a clean stock program announced with the publication “AS5588–2013 Grapevine Propagation Material.” As specified, the standard encompasses the definition of specifications and guidelines related to the health status; origin, source, and traceability; and the

authentic, valid naming of grapevine propagation material (Hayes 2013). Certification is entirely voluntary in Australia. Certified vines must test negative for GLRaV-1, GLRaV-2, GLRaV-3, and GLRaV-4 and GFkV, GVA, GVB, and GRSPaV. Technically, corky bark disease is screened at the border in quarantine; the lab testing for GVB is considered separate from that quarantine screening which may reflect some redundancy since there is wide acceptance that GVB is closely associated with corky bark disease. Schemes may undertake active testing for some or all these viruses and possibly some other pathogens, certainly at the nuclear stage. At the mother block stage, they may undertake active testing and/or visual observation (F. Constable, personal communication).

Quarantine

Quarantine is defined as official confinement of regulated articles for observation and research or for further inspection, testing, and treatment (Martin and Tzanetakis 2014). Quarantine regulations restrict the movement of grape nursery stock into most countries. These regulations attempt to prevent the importation of exotic pests and pathogens into pest-free areas and to limit the distribution of economically important pests and pathogens that might be under domestic control programs. Quarantine regulations for *Vitis* are highly variable between countries. Some of the reasons are historical, but in general, new grape-growing regions have fewer disease and insect problems than the older grape-growing regions. These new regions are more likely to attempt to protect their industry from the inadvertent introductions of exotic pest problems from older grape-growing regions. Some of the strictest regulations in the world for *Vitis* are found in Australia, Chile, New Zealand, South Africa, and the USA; in these countries importation may take years. However, the relative health and freedom from pests that vineyards enjoy in these regions are a reasonable compensation in the eyes of most viticulturists. Another factor faced by international traders in grape plant materials, beyond the variation in the regulations themselves, is the uneven enforcement of existing regulations. Two countries might, in theory, have identical regulations when, in fact, grape nursery stock would move freely into one country and the identical stock could not enter the second country (Golino 2000).

The European Union

The EU adopted a very strict regulation concerning the introduction of grapevine germplasm from areas outside it. According to Directive 2000/68, the importation of plants or plant parts (except fruits) of *Vitis* spp. is forbidden. However, under certain conditions, member countries can allow the importation of germplasm after its testing and indexing under strict quarantine conditions. For example, an Italian

legislation (DM 31.01.1996), in agreement with the European directives, requires the following procedure concerning *Blueberry leaf mottle virus* (BLMoV), the grapevine yellows phytoplasmas (including that causing Flavescence dorée), *Peach rosette mosaic virus* (PRMV), TRSV, ToRSV, *Xylella fastidiosa*, *Xylophilus ampelinus*, Ajinashika disease, Grapevine stunt, and summer mottle. First, therapeutic treatments must be completed according to the technical guidelines FAO/IBPGR (International Board for Plant Genetic Resources), to be followed by indexing and laboratory analysis in proper facilities (Frison and Ikin 1991).

The sanitary provisions of current EU directives for non-quarantine pathogens are currently outdated and do not provide an acceptable status of propagative material in any category of plants, failing to consider and incorporate recent developments in grapevine virus disease research. Moreover, they lack guidelines for the implementation of sound research-based protocols. Under current directives, there is variation in the sanitary status of grapevine propagative materials produced in the EU; quality standards are largely determined by different national certification schemes. Even among the six member countries with large viticulture interests (Italy, France, Germany, Greece, Portugal, and Spain), the harmonization of sanitary protocols is lacking.

United States

The Animal and Plant Health Inspection Service (APHIS) Plant Protection and Quarantine (PPQ) 7 Code of Federal Regulations (CFR) 319–37 governs the importation of propagative material into the USA. Currently, PPQ is revising 319–37 and other regulations governing the importation of plants for planting. A principal component of this revision is establishing a regulatory systems approach protocol, utilizing performance-based criteria. The criteria in the Grapevine Standard will be used as a basis for this regulation change. However, the legality of using performance-based criteria needs to be determined for this application. Actual implementation of the criteria outlined in the standard will be based on bilateral negotiations and result in the development of an acceptable operational work plan for the production and export of certified plants. The United States currently has grapevine, pome, and stone fruit trees certification programs, which have been approved by PPQ and implemented by interested states. These programs already meet most of the criteria outlined in the standard. However, PPQ needs to establish National Plant Protection Office (NPPO) oversight and minimum conditions for certification as outlined in the standard. The United States is currently piloting a national certification program through the NCPN for grapes with voluntary state participation through a memorandum of understanding (MOU). The certification standards under NCPN would meet the criteria outlined in this standard. At this point APHIS has the authority to legally implement the conditions of the standard (Anonymous 2009a). NCPN is a collaborative effort among three USDA agencies: APHIS for quarantine and regulatory programs, USDA-ARS for technology and germplasm issues, and the National

Institute for Food and Agriculture (NIFA) for outreach and partnership initiatives. Some NCPN Clean Plant Centers (CPCs) serve as quarantine centers (Gergerich et al. 2015). While NCPN has adopted the suggested G1–G4 terminology, the use of the tiered generation level concept has not been universally adopted.

Canada

Canada regulates the importation of grapevines from all countries according to the guidelines outlined in Canadian Food Inspection Agency (CFIA) Directive D-94-34: Import Requirements for Grapevine Propagative Material (Anonymous 2014). Canada allows the importation of grapevine propagative material that has been certified under certain US state certification programs, including those in California, Oregon, and Washington. Currently, France and Germany are the only off-continent sources with CFIA-approved nurseries certified to export specific, approved grapevine rootstocks and varieties/clones for propagation to Canada. Any previously non-approved grapevine rootstocks and varieties/clones that originate from a country other than the United States and that are produced by a non-approved nursery must be authorized by the CFIA prior to importation, even if the material originated from within a country or certification program for which other materials have previously been approved by the CFIA. All grapevine material from CFIA-approved foreign sources must be free of quarantine and regulated non-quarantine pests of Canada and must be free from soil, sand, and related plant debris. Grapevines imported from Europe must be hot water treated for phytoplasmas. For grapevines originating from the United States and destined to British Columbia (BC), approved treatments for the control of phylloxera and virus-vectoring nematodes that are not known to occur in BC must be applied. A phytosanitary certificate must accompany each consignment. The approved certifying authority of the exporting country must provide Canada with separate certificates of origin for the mother blocks of the imported material for every shipment. Furthermore, they must ensure that certification tags clearly indicating the source and its applicable certification code are attached to each lot of grapevines exported to Canada. Upon arrival at the first point of entry in Canada, all shipments are subject to inspection, including verification of documentation, by CFIA. Each year, a sampling of selected material imported from CFIA-approved sources is collected and sent to the CFIA Sidney Laboratory for testing. The detection of quarantine and regulated non-quarantine pests will lead to a reevaluation of the program and possible suspension of approved rootstock and variety/clones, nurseries, or the program.

Grapevine propagative material from any CFIA non-approved foreign source may only be imported into Canada under Section 43 of the Plant Protection Regulations. In this case, imported material must be sent directly to the CFIA Sidney Laboratory for post-entry quarantine and full-range testing before being released.

New Zealand and Australia

The Ministry for Primary Industries (MPI) is charged with leadership of the New Zealand biosecurity system. *Vitis* dormant cuttings and plants in tissue culture are approved for entry into the country following guidelines set forth in the MPI Standard 155.02.06 Importation of Nursery Stock pursuant to section 24A of the Biosecurity Act of 1993. Imports must be accompanied by a phytosanitary certificate and follow approved inspection, testing, and treatment requirements for insects, mites, fungi, bacteria, viruses, viroids, phytoplasmas, and diseases of unknown etiology (Anonymous 2016a).

In Australia, economically important pests and pathogens not currently present in Australia are “quarantinable,” and before release, all imported planting material must be determined by the Australian Quarantine and Inspection Service (AQIS) to have non-detectable levels of these pathogens/pests. At present, AQIS is not required to test for endemic pathogens in planting material entering the country. As a consequence, material being released from quarantine is not usually of a defined health status (Constable and Drew 2004).

International Phytosanitary Systems

In 1995, the World Trade Organization (WTO) was formed and member nations agreed to honor its charter. Included in these international codes is an Agreement on the Application of Sanitary and Phytosanitary Measures, known as the SPS Agreement. This agreement contains provisions allowing member nations to enforce regulations that might otherwise violate the terms of free trade when those provisions are “necessary to protect human, animal or plant life or health.” It is under these provisions that most national importation and quarantine regulations are allowed. It is incumbent on member states to ensure that these restrictions are not disguised trade barriers. The WTO administers disputes and provides resolutions in cases where member countries feel that the SPS agreement is being used unfairly or arbitrarily (Kreith and Golino 2003).

The WTO/SPS authorizes the setting of international trade standards. In cases involving plant health, the Food and Agriculture Organization (FAO) of the United Nations is the responsible organization, working under the terms of the International Plant Protection Convention (IPPC; <https://www.ippc.int/en/>), a treaty, which began in 1951. As of September 2015, the Convention had 182 signatories. The IPPC has three core areas: international standard setting, information exchange, and implementation of IPPC phytosanitary standards. At this time, the process involves establishing guidelines and definitions, as well as coordinating efforts of regional plant protection organizations to establish consistent standards. The regional plant protection organizations are being asked to make the first efforts at harmonized standards, because geographically contiguous areas often share common exotic pest and

pathogen concerns and often work in concert to establish both internal and external control programs.

According to international guidelines, the national regulation programs – either through mandatory certification programs or official control programs for target diseases for each commodity – could allow classification of endemic economically important diseases as regulated non-quarantine pests. Regional, national, state, or local regulations might also serve this purpose. By establishing strict regulations, only imported nursery stock meeting high standards of freedom from specific domestic diseases could enter the regulated area.

NAPPO, operating under IPPC guidelines, recommends that the certification program have clearly defined certification levels, including nomenclature, propagation, and pest management measures (Anonymous 2002). According to NAPPO guidelines, certification levels represent successive generations of propagation material from the original tested material and may have additional phytosanitary measures applied depending on the generation (Anonymous 2004). As such, they can represent a categorical measure of the health status of certified plants. The generation or “G-level” concept is used to identify the degree to which plant stock is related to the original virus-tested plant material (Fig. 28.1). Regulations developed by certification programs specify the conditions under which each generation level must be maintained in order to qualify for the program. In vegetatively propagated crops, G1 material refers to the original mother plants which have tested negative for all targeted pathogens and is the source for all further propagation; it is normally housed at a CPC. Authors have used a myriad of terms to describe G1 material, including foundation, nuclear, elite, pre-elite, extra super elite, pre-prebasic, and pre-selection (Martin and Tzanetakis 2014; Boidron 1995). Generation 2 (G2) material is propagated from G1 stock and is frequently maintained by nurseries in increase blocks to supply to commercial growers. G2 stock may also be known as elite, foundation, super elite, or pre-basic. Generation 3 (G3) material is propagated from G2 stock; it is commonly used in secondary increase blocks and certified nursery blocks. G3 stock is also known as registered, basic, elite, and increase block. Generation 4 (G4) plant material is propagated from G2 or G3 stock. G4 stock refers to the certified plants delivered to consumers (Anonymous 2012; Martin and Tzanetakis 2014).

Efforts at Harmonization

The NAPPO is a regional organization with members from the national plant protection organizations of Canada, the USA, and Mexico. It is one of many regional organizations whose primary responsibility is to develop regional plant protection standards, designed to protect the member states from the entry and establishment of pests, while facilitating trade. In addition, NAPPO participates with other regional plant protection groups within both the Western Hemisphere and the global level to develop international standards. The document “Guidelines for the Importation of

Grapevines into a NAPPO Member Country RSPM #15 Part 1: Viruses and Virus-like Pests, Viroids, Phytoplasmas, and Bacteria” was developed by a committee of experts and signed on October 20, 2002. This document is the initial regional guideline for the development of harmonized North American Standards for grapevine nursery stock (Anonymous 2004); it is superseded by RSPM 35: “Guidelines for the Movement of Stone and Pome Fruit Trees and Grapevines into a NAPPO Member Country” signed on October 19, 2009.

In the area of grape certification, Canada has a formal national certification program, which is voluntary. Mexico has no national grape certification program, but the majority of grape nursery stock comes from California and must meet California certification standards to be imported. The United States operates under a system of voluntary state certification programs, which combined with strict quarantine regulations have resulted in high-quality grape nursery stock with a minimum of regulatory infrastructure. There is no national standard for grapevine nursery stock, though such a national standard is being developed under the United States Department of Agriculture (USDA)’s NCPN organized in 2009 as a result of the 2008 Farm Bill (Gergerich et al. 2015). However, as regional organizations like NAPPO and international agencies like the FAO work to harmonize standards for the movement of plant materials internationally, a more formal, coordinated national and international system is being discussed in the United States to ensure that growers and industry are protected from non-quarantine damaging diseases which can be carried in planting stocks.

Challenges of Globalization and New Technology

One important result of globalization has been that there has been a dramatic increase in plant pathogens and pests presenting new challenges to the production and security of food, fiber, and forest resources (Bostock et al. 2014). One of the most effective pathways for the introduction of new biological agents has been trade in “plants for planting” because infected and infested seed and nursery plants provide a very robust avenue for the establishment of exotic pests and diseases. In the case of *V. vinifera*, movement of planting material around the world has been a very effective means of dispersal of many serious pests and disease (Golino 2000; Martelli, Chap. 2 in this book).

Challenges introduced by advances in technology must be considered as well. The application of high-throughput sequencing (HTS) analysis in grapevine virology has yielded significant achievements in the field including the discovery of the new viruses, the use as a superior routine diagnostic tool, and the most comprehensive detection technology for certifying the phytosanitary status of commercial grapevine propagation stocks. These successes are detailed in Chap. 30 (Saldarelli et al. of this book). However, there are limitations inherent with the benefits of this advanced technology. Bioinformatic analysis does not prove pathological causality, nor does it describe biological characteristics of a virus. In order to weed out

insignificant background viruses, biological effects of discovered viruses must be assessed. Studies including graft transmission, fulfillment of Koch's postulates, and spread and distribution analysis can assess the agronomic significance of novel viruses. HTS is a powerful, advanced diagnostic tool that will yield the most meaningful results when coupled with basic plant pathological methods.

Conclusive Remarks

The International Council for the Study of Virus and Virus-like Diseases of the Grapevine (ICVG) represents grapevine virologists worldwide. These scientists believe that concerns about the introduction of exotic viruses and virus diseases to nonindigenous regions should be a primary focus of international regulations governing the movement of grapevine nursery stock. At the same, this group acknowledges the need to maintain diverse heritage grapevine cultivars and clones in regional areas where the resources may not be available to sanitize all grapevine plant stocks.

The high value of grapevine plant material, the competitive nature of the grapevine nursery business, and rapid globalization of the grapevine and wine community have resulted in some fundamental changes in the availability of clean grapevine selections, cultivars, and clones. Recent years have seen a worldwide increase in patented grapevine cultivars and rootstock selections, the introduction of trademarked clones of traditional cultivars, and the development of proprietary programs in which valuable selections are marketed exclusively and cannot be obtained by all growers. Some sales contracts for grapevine nursery stock even limit the rights of growers to subsequently propagate selections. Governments are having increasing difficulties funding public programs for importation, certification, and distribution of grapevine stock, making the few remaining programs increasingly international in influence. The technology involved in both grapevine identification and plant disease detection has changed radically in the past decade and is likely to continue doing so. All of these factors have a profound effect on international grapevine quarantine, clean stock, and certification programs.

Continuing work on the development of harmonized international standards for grapevine nursery stock is likely to increase trade among the grape-growing regions of the world. This would result in more open competition for the nursery industries and lower prices for growers but would also increase the potential for importation of damaging pests and diseases and a resulting degradation of crop quality and productivity. As efforts are made to harmonize grapevine certification protocols, high standards are essential to ensure that no viticultural region is compromised by the introduction and spread of diseases. In the USA, the NCPN for grapes has the responsibility to produce the top tier (G1) plants that would serve as the starting material for state certification programs. There is also an effort to develop a grapevine certification standard that would be agreed to by all states producing certified stocks, essentially creating a national standard. These efforts include an attempt to

harmonize certification standards with trading partners (e.g., EPPO and/or NAPPO standards) where possible (Anonymous 2008). Within this context lies the challenge of determining which microbes are relevant and actionable from a regulatory point of view, in order to maintain the delicate balance of protecting local and national industries from introduced pests and diseases while reaping the benefits of expanded trade (Golino et al. 2015). International regulations are based on a philosophy of expediting a level playing field vis-à-vis trade. However, in practice, from a plant protection perspective, plants for planting are a potentially dangerous vehicle for the introduction of damaging pests and diseases, and our ability to accurately calculate risk is limited. So it is not surprising that in practice, local regulators tend to be very conservative about change and slow in modifying standards. For this reason, a continued dialogue between scientists, regulators, nurseries, and growers is crucial to provide the highest-quality virus-tested propagation material.

References

- Alley, L., and D. Golino. 2000. The origins of the grape program at Foundation Plant Materials Service. *American Journal of Enology and Viticulture* 51: 222–230.
- Anonymous. 1991. Programme type pour la réalisation de la sélection clonale de la vigne. *Bulletin OIV* 64: 752–763.
- . 2002. RSPM No. 15, guidelines for the importation of grapevines into a NAPPO member country, Part 1: Viruses and virus-like pests, viroids, phytoplasmas, and bacteria, 15 pp.
- . 2004. RSPM No. 25, guidelines for international movement of pome and stone fruit trees into a NAPPO member country, 22 pp.
- . 2008. Pathogen-tested material of grapevine varieties and rootstocks. *EPPO Bulletin* 38: 422–429.
- . 2009a. RSPM No. 35, guidelines for the movement of stone and pome fruit trees and grapevines into a NAPPO member country, 52 pp.
- . 2009b. Constitution of the vine improvement: wine grape scheme: Phytosanitary requirements. South Africa.
- . 2011. *Grafted grapevine standard*. Hastings: Nimmo-Bell and Co Ltd.
- . 2012. NCPN glossary terms. National clean plant network, Web. 06 July 2016.
- . 2014. D-94-34: Import requirements for grapevine propagative material. Canadian Food Inspection Agency.
- . 2016a. Ministry for primary industries import health standard 155.02.06. Importation of nursery stock 06 May 2016, pp. 337–352.
- . 2016b. Canadian grapevine export program. Directive D-15-02. Canadian Food Inspection Agency, 25 pp.
- Arnold, K.L., N. McRoberts, and D.A. Golino. in press. North coast virus survey reveals improving health of vineyards over decades. *California Agriculture*.
- Boidron, R. 1995. Clonal selection in France. Methods, organization, and use. In *Proceedings of the international symposium on clonal selection*. Portland, OR, USA, 1–7.
- Bostock, R., C. Thomas, R.W. Hoenisch, D. Golino, and G. Vidalakis. 2014. Diagnostics in plant health: how diagnostic networks and inter-agency partnerships protect plant systems from pests and pathogens. *California Agriculture* 68: 117–124.
- Constable, F., and C. Drew. 2004. Review of vine health parameters, implementation priorities and capabilities for vine improvement groups and accredited nurseries. In *Final Report to Grape*

- and Wine Research and Development Corporation*, 105. Fullarton: Scholefield Robinson Horticultural Services Pty Ltd.
- Frison, E.A., and R. Ikin (eds.). 1991. *FAO/IBPGR technical guidelines for the safe movement of Grapevine Germplasm*. Food and Agricultural Organization of the United Nations, Rome/International Board for Plant Genetic Resources, Rome.
- Gergerich, R.C., R. Welliver, S. Gettys, N.K. Osterbauer, S. Kamenidou, R.R. Martin, D. Golino, K. Eastwell, M. Fuchs, G. Vidalakis, E. Rudyj, and I.E. Tzanetakis. 2015. Safeguarding fruit crops in the age of agricultural globalization. *Plant Disease* 99: 176–187.
- Golino, D. 2000. Trade in Grapevine Plant Materials: Local, National and Worldwide Perspectives. *American Journal of Enology and Viticulture* 51: 216–221.
- Golino, D.A., and J.A. Wolpert. 2003. Vine selection and clones. In *Wine grape varieties in California*, 8–11. Oakland: University of California Agricultural and Natural Resources Publication.
- Golino, D.A., V. Savino, G.P. Martelli, and M. Fuchs. 2015. Certification and international regulation of planting materials. In *Compendium of Grapevine Diseases*. St Paul: APS Press.
- Hayes, P. 2013. Australian vine quality standards scheme – Vine assurance: *Australian Grapevine Propagation Material Standard*. Rep. no. AS 5588-2013. Grape and Wine Research and Development Corporation.
- Kreith, M., and D.A. Golino. 2003. Regulatory framework and institutional players. In *Exotic pests and diseases: biology and economics for biosecurity*, ed. D. Summer, 19–38. Ames: Iowa State Press.
- Martin, R.R., and I.E. Tzanetakis. 2014. Pathogen-tested plant material. In *Encyclopedia of agriculture and food systems*, ed. N.K. Van Alfen, 304–312. Cambridge, MA: Academic.
- Rowhani, A., Y.P. Zhang, H. Chin, A. Minafra, D.A. Golino, and J.K. Uyemoto. 2000. Grapevine Rupestris stem pitting associated virus: population diversity, titer in the host and possible transmission vector. In *Extended abstracts 13th meeting of ICVG* Adelaide, Australia, 37.
- Rowhani, A., J.K. Uyemoto, D.A. Golino, and G.P. Martelli. 2005. Pathogen testing and certification of *Vitis* and *Prunus* species. *Annual Review of Phytopathology* 43: 261–278.

Chapter 29

Novel Approaches for Viral Disease Management

M. Fuchs and O. Lemaire

Abstract Due to the severity of viral epidemics, the limited efficacy and cost of disease management strategies, and lack of recognized sources of resistance in *Vitis* spp., as well as the increasing societal demand for sustainable and environmentally safe viticulture practices, there is a great need to develop grapevines that are resistant to viruses. Genetic transformation and the antiviral pathways of RNA interference have been extensively explored to develop virus-resistant grapevines. These technologies have been validated against several viruses primarily in herbaceous experimental hosts. Their application to grapevines is more limited with only a restricted number of field trials conducted so far in naturally infected vineyard settings in France and in the USA. These field trials essentially focused on resistance to grapevine fanleaf virus with encouraging preliminary results. Recent advances in our understanding of RNA interference as a plant immune mechanism against viruses and of the structure and genetic variability of virus populations are providing new opportunities to facilitate the engineering of virus-derived transgene constructs for durable resistance. Other antiviral strategies based on nanobody interference, vector control, and host genome editing are explored; these will eventually pave the way for a paradigm shift in viral disease management in grapevine. Today, the development of virus-resistant grapevines for practical disease management remains at an early genesis; unfortunately, roadblocks preventing an evolution toward release are legion, especially in regions where research and industry priorities are disconnected, and the flow of communication between researchers and industry groups is sporadic. Building bridges between the research community and potential end users, while establishing a transparent and sustained dialogue, is essential for a timely deployment of highly needed virus-resistant grapevines in the future.

M. Fuchs (✉)

Section of Plant Pathology and Plant Microbe Biology, School of Integrative Plant Science, New York State Agricultural Experiment Station, Cornell University, 630 W. North Street, Geneva, NY, 14456, USA
e-mail: marc.fuchs@cornell.edu

O. Lemaire

Santé de la Vigne et Qualité des Vins, Institut National de la Recherche Agronomique, Université de Strasbourg, 68000 Colmar, France

Keywords Adoption • Grapevine fanleaf virus • New strategies • Resistance • Perception • Rootstock • Transgenics • RNA interference

Introduction

Strategies to control viruses are essentially preventive through the implementation of sanitary selection, virus elimination, and certification programs (Maliogka et al. 2014). These strategies are effective at limiting the presence of viruses in propagation material; however, their practical impact is somewhat limited if clean vines are established in vineyard areas with a long history of virus infection because the high risk of vector-mediated virus transmission will compromise their optimal performance. To reduce populations of virus vectors, nematocides and insecticides can be applied, but restrictions to limit or ban the use of agrochemicals continue to be enforced because of their acute toxicity and potential adverse effects on the environment and human health. Due to the severity of viral epidemics, the difficulties at implementing efficient management strategies, and the increasing societal demand for sustainable and environmentally safe viticulture practices, there is a great need to develop grapevines that are resistant to viruses. Interestingly, resistance against major viruses of grapevines has not yet been achieved in elite cultivars or rootstocks. This is because useful sources of resistance have not been found for the most prevalent viruses in *Vitis* spp. germplasm (Oliver and Fuchs 2011).

Genetic transformation and the activation of the antiviral pathways of RNA interference in the plant host are attractive alternatives for the development of virus-resistant grapevines. These technologies have been extensively explored and validated against a number of grapevine viruses in herbaceous hosts. Their application to grapevines has been more limited and has primarily focused on grapevine fanleaf virus (GFLV) in rootstock genotypes thus far. Field trials have been conducted in naturally GFLV-infected vineyard settings in France and in the USA with encouraging results. Recent advances in our understanding of RNA interference as a plant defense mechanism against viruses and of the structure and genetic variability of virus populations are providing new opportunities to facilitate the engineering of virus-derived transgene constructs for durable and practical resistance. Other strategies based on the expression of virus-specific antibodies in plants have been explored to confer resistance (Laimer et al. 2009). Recent developments in genome editing are paving the way for the deployment of innovative technologies to achieve virus resistance in plants. All these approaches have yet to be applied to grapevines.

So far, research on virus resistance in grapevines remains at a proof of concept phase or at a development stage. Anticipating a release of virus-resistant grapevines in the future, it is critical to nurture a transparent and sustained dialogue between researchers and potential end users for a timely deployment of the highly needed

technology and its adoption by growers. Such a dialogue is essential to avoid misunderstandings and proactively exchange on the pros and cons of the technology.

In this chapter, we briefly review the economic impact of fanleaf and leafroll, the two major viral diseases of grapevines, and provide a short summary of disease management strategies currently implemented to mitigate their impact while stressing the need for resistance. We then discuss different approaches to engineer resistance to viruses and their application to grapevines and highlight some of the early experiments designed to estimate the level of resistance of transgenic rootstocks to GFLV in naturally infected vineyards. Finally, we discuss the overall perception of the technology and provide some perspectives on the development of virus-resistant grapevines by identifying some critical paths for adoption.

Economic Impact of Major Viral Diseases

Fanleaf and leafroll diseases are the two most damaging and widespread viral diseases of grapevine (Martelli 2014). Fanleaf disease is the most severe and oldest viral disease recognized in grapevine (Andret-Link et al. 2004; Laimer et al. 2009). It has likely spread worldwide from the Near East, the birthplace of viticulture, starting thousands of years ago. Fanleaf disease affects all *Vitis* spp., including rootstocks and *Vitis vinifera* cultivars. GFLV is transmitted through the careless selection of budwood used for propagation and grafting and by the soil-inhabiting nematode vector *Xiphinema index*. Once infested with viruliferous nematodes, vineyard soils are a source of the virus and its dissemination through erosion, transfer of soil, soil adhesion to vineyard equipment, and flooding (see Chap. 25, this book). Most importantly, a vineyard soil that is infested with viruliferous nematodes will retain its infectious potential for many years even in the absence of host material (Demangeat et al. 2005). Unless herbicide devitalization followed by careful uprooting of infected vines and soil disinfection with nematicides in combination with a fallow period of at least 8 years is practiced, GFLV will continue to cause severe crop losses (Andret-Link et al. 2004). A recent comparative study of the effect of five distinct GFLV strains exhibiting at least 9% nucleotide sequence diversity within their coat protein (CP) gene showed diverse symptoms ranging from severe stunting to subtle mosaic on singly infected *V. vinifera* cvs Chardonnay and Gewurztraminer. Crop losses were higher in Chardonnay (63%) than in Gewurztraminer (45%), regardless of the GFLV strain used in this study, with the exception of GFLV-B844 on Gewurztraminer with an 80% yield loss (Vigne et al. 2015). These results were consistent with previous studies (for a review, see Walter and Martelli 1996). Economic losses due to GFLV are estimated to US \$16,600 per hectare (Andret-Link et al. 2004; Fuchs 2008). In France alone, it is estimated that ca. two thirds of the vineyards are affected by the virus with an economic impact of at least US \$1.5 billion per year (Fuchs 2008). No information is available on the economic impact of GFLV in other countries. In view of its huge economic impact, increasing acreages of infested vineyard soils, persistence of the

inoculum over extended time in vineyard soil, limited efficacy of current management options, and the lack of recognized resistance sources (Oliver and Fuchs 2011), new strategies are needed to minimize the impact of GFLV on grapevine.

Grapevine leafroll disease is probably the most widespread and economically significant viral disease of grapevines worldwide (Maliogka et al. 2014). Five serologically distinct flexuous viruses belonging to the family *Closteroviridae* are associated with leafroll disease. *Grapevine leafroll-associated virus 1* (GLRaV-1), GLRaV-3, and GLRaV-4 from the genus *Ampelovirus* are transmitted by phloemophagous insects, including ten mealybug and eight soft scale species (Martelli 2014; Herrbach et al. 2016). Efficient spread of ampeloviruses by mealybugs has been reported in many countries (Almeida et al. 2013). GLRaV-2 belongs to the genus *Closterovirus* and GLRaV-7 to the genus *Velarivirus*, but no vector is known for these two viruses (Martelli 2014). GLRaV-3 is the most prevalent virus associated with leafroll worldwide (Maliogka et al. 2014; Martelli 2014). Leafroll disease affects all *Vitis* spp., including rootstocks and *Vitis vinifera* cultivars. Like other grapevine viruses, leafroll is graft-transmissible, but unlike GFLV, for which no tissue tropism is known, leafroll viruses are restricted to phloem tissues. GLRaV infection impacts fruit yield and quality with alterations of berry color, sugar content, and juice chemistry (Naidu et al. 2014; see also Chap. 23, this book). The economic losses due to leafroll are estimated to be US \$21,000 per hectare of Merlot and Sauvignon blanc in New Zealand (Walker et al. 2004; Nimmo-Bell 2006), and to range from US \$25,000 to \$40,000 per hectare over a 25-year vineyard lifespan of Cabernet franc in New York (Atallah et al. 2012), as well as from US \$30,000 to \$226,000 per hectare of Cabernet Sauvignon in California (Ricketts et al. 2015). Based on the economic impact, worldwide distribution, efficient transmission by mealybugs and soft scales, limited efficacy of currently adopted management strategies, and lack of recognized sources of resistance (Oliver and Fuchs 2011), new options are needed to mitigate the impact of the viruses associated with leafroll disease on grapevine, in particular of GRLaV-3.

Current Management Strategies to Mitigate the Impact of Viruses and the Need for Resistance

Prophylactic and curative measures are used to control viral diseases (Maliogka et al. 2014). Prophylactic strategies include sanitary selection and certification schemes to produce clean stocks, to prevent the distribution of infected propagation material, and to facilitate the establishment of new vineyards with clean material derived from virus-tested stocks.

Different sanitation methodologies have been used for virus elimination and the production of clean stocks (Chap. 27, this book). Thermotherapy, based on the thermic inactivation of viruses (and phytoplasmas), used to be the most frequently adopted procedure for the production of clean stocks. This technique is more

efficient against parenchyma-located viruses such as nepoviruses than phloem-limited viruses such as ampeloviruses, closteroviruses, and vitiviruses. Other therapeutic methods include meristem and shoot tip culture, chemotherapy, cryotherapy, and electrotherapy (Maglioka et al. 2014). The most recalcitrant viruses to these different sanitation procedures are grapevine virus A (GVA) and grapevine Rupestris stem pitting-associated virus (GRSPaV). Indirect somatic embryogenesis is another therapeutic methodology used to cure infected grapevines accessions. This approach is efficient at eradicating the most important grapevine viruses and viroids (Gambino et al. 2011). Using next-generation sequencing on material obtained through somatic embryogenesis that was maintained in a greenhouse for 10 years, no reads corresponding to virus and viroid sequences were found (J.M. Hily and S. Djennane, personal communication). Beyond its application to sanitation, it is important to keep in mind that somatic embryogenesis is the most commonly used methodology for grapevine transformation using genetic engineering, suggesting that transgenic material derived from somatic embryos have the highest sanitary status.

Management methods target virus vectors such as mealybugs and dagger nematodes that are essentially controlled by insecticides and nematicides, respectively. However, the intensive use of agrochemicals can have adverse environmental effects. New legislation in the EU has recently banned some agrochemicals, especially those used for controlling nematodes and for disinfecting soils, leading to increased challenges in terms of viral disease management.

Management of Fanleaf Disease

Efforts to manage GFLV have primarily focused on reducing populations of the dagger nematode vector, *X. index*. Resistance to *X. index* has been identified in *Muscadinia rotundifolia* and introduced into several rootstock genotypes. For example, in Europe, breeding *M. rotundifolia* x *Vitis* hybrids resulted in a rootstock genotype, named RPG1, which displays a good level of resistance to a range of *X. index* isofemale lines from various geographic areas. Multisite bioassays performed during 15 years in French vineyards showed an 8-year delay in GFLV infection by the use of RPG1, but this partially *X. index*-resistant genotype is not suitable for use in lime soil. Also, a progressive adaptation of nematode populations to the plant resistance factors has been observed after 4 years (Esmenjaud et al. 2011). In the USA, resistance to *X. index* was successfully transferred into several rootstock genotypes that are commercially available. These resistant rootstocks do not prevent GFLV translocation into the scion, but a significant delay in infection allows for suitable production in California vineyards (Oliver and Fuchs 2011).

Plant species adapted to vineyard soils that exhibit nematicidal activity have been evaluated for their antagonistic effect on *X. index* in the greenhouse and in naturally infested vineyards. Among species of the families Asteraceae (sunflower, marigold, zinnia, and nyjer), Poaceae (sorghum and rye), Fabaceae (white lupin, white melilot, hairy vetch, and alfalfa), Brassicaceae (rapeseed and camelina), and

Boraginaceae (phacelia), white lupin, nyjer, and marigold significantly reduced *X. index* populations compared to bare soil in the greenhouse. A single vineyard assay showed that marigold and hairy vetch reduced *X. index* populations (Villate et al. 2012), but multisite vineyard experiments in France demonstrated that hairy vetch and alfalfa did not reduce the pathogenic potential of heavily infested soils (O. Lemaire et al., unpublished observation). Based on the high survival rate of *X. index* and its presence in deep soil layers, selective nematicidal cover crops and fallow are likely of limited interest at reducing populations to a level such that GFLV infection would be reduced in newly established vineyards. Strategies deployed to reduce populations of *X. index* using resistant rootstock genotypes and nematicides mitigate the impact of GFLV but do not provide sustainable control. Based on these limitations, there is a need to develop resistance to GFLV in grapevine material.

Management of Leafroll Disease

Efforts to manage leafroll viruses have focused on (1) the selection of planting material derived from clean, GLRaVs-tested (negative) stocks using the most robust detection methods, (2) implementation of sanitary measures, and (3) precision spraying of insecticides to control mealybug and soft scale vectors. Neonicotinoids and biosynthesis inhibitors reduce populations of mealybugs (Maliogka et al. 2014), but the neurotoxicity of neonicotinoids on bees is raising environmental concerns. Roguing symptomatic vines and those immediately adjacent and replanting with clean vines in combination with the use of insecticides may decrease leafroll disease if prevalence is low (between 5 and 10%), while a complete vineyard replacement is recommended if disease prevalence is above 25% (Naidu et al. 2014; Ricketts et al. 2015). Similar combinations of prophylactic and curative measures have been proposed in South Africa (Pietersen et al. 2013). A 10-year-long effort in an 80 ha vineyard reduced leafroll incidence from 100% to 0.03% as a result of a careful removal of infected vines after an herbicide treatment to destroy remnant roots, followed by fallow periods during which volunteer hosts are removed to reduce plant reservoirs of insect vectors. Planting clean vines, using contact and systemic insecticides, and implementing sanitary practices to minimize spread of viruliferous vectors were also critical to lower disease incidence (Pietersen et al. 2013). In spite of diligent efforts, leafroll viruses, particularly GLRaV-3, continues to spread (Almeida et al. 2013). This suggests a need to develop grapevine material with resistance to GLRaV-3.

Experimental Approaches to Engineer Resistance Against Viruses

In response to pathogens, especially viruses, plants have developed different protection strategies that involve the modification of gene expression, activation of metabolic pathways, and posttranslational modification of proteins, which culminate into the accumulation of primary and secondary metabolites implicated in defense responses. The mechanisms underlying virus attacks are being deciphered, leading to a better understanding of virus-host interactions and the virus infectious cycle, as well as the identification of targets for the development of virus-resistant plants. These targets are discussed below.

The advent of molecular genetics and plant transformation, and the concept of pathogen-derived resistance in particular (Sanford and Johnston 1985), opened new avenues for the development of virus-resistant crops, including grapevines (Fuchs and Gonsalves 2007; Gottula and Fuchs 2009; Laimer et al. 2009). Since the pioneering work of M.G. Mullins and colleagues who were the first to stably transform grape plants (Mullins et al. 1990), several reports described the development of transgenic grapevine rootstocks, *V. vinifera*, or interspecific hybrids expressing gene constructs derived from the GFLV genome (Bardonnnet et al. 1994; Barbier et al. 2000; Gölles et al. 2000; Gray et al. 2002; Gutoranov et al. 2001; Gambino et al. 2005; Krastanova et al. 1995; Maghuly et al. 2006; Martinelli et al. 2002; Mauro et al. 2000; Radian-Sade et al. 2000; Reustle et al. 2006; Spielmann et al. 2000; Valat et al. 2006; Vigne et al. 2004a, b; Xue et al. 1999). These genetic constructs comprised gene sequences for the CP, movement protein, or RNA-dependent RNA polymerase, as complete, truncated, sense, antisense, translatable, or untranslatable versions. GFLV-derived gene fragments were also used as hairpin constructs (Gambino et al. 2010; Jardak-Jamoussi et al. 2009; Winterhagen et al. 2009).

A strategy combining resistance to GFLV and tolerance to *X. index* by which resistance to GFLV is conferred by a GFLV CP gene construct and nematode tolerance is derived from a *M. rotundifolia* accession was outlined (Bouquet et al. 2003, 2004). Inheritance of the GFLV-derived transgene was documented in several crosses following hybridization with transgenic rootstock genotypes of *Vitis rotundifolia* du Lot and 110R as staminate parents (Bouquet et al. 2004), but resistance to either *X. index* and/or GFLV in these crosses has not yet been reported.

Transgenic grapevines expressing gene constructs derived from arabis mosaic virus (ArMV) (Gölles et al. 2000; Spielmann et al. 1993, 2000), raspberry ringspot virus (RpRSV) (Reustle et al. 2005, 2006), GVA (Buzkan et al. 2001; Gölles et al. 2000; Radian-Sade et al. 2000), grapevine virus B (GVB) (Gölles et al. 2000), GLRaV-2 (Xue et al. 1999), and GLRaV-3 (Xue et al. 1999) were also developed. The mechanisms underlying engineered resistance to viruses in transgenic plants had not yet been deciphered in the late 1980s and early 1990s. It was only later that RNA silencing was discovered and shown to contribute to the plant's defense arsenal against viruses (Poulsen et al. 2013; Pumplin and Voinnet 2013).

RNA Silencing Most approaches to develop virus-resistant grapevines have relied on the activation of the plant's innate defense mechanisms (Gottula and Fuchs 2009; Laimer et al. 2009). Plants have developed RNA silencing, also referred to as RNA interference (RNAi), as an innate immune system that targets viral nucleic acids (Poulsen et al. 2013; Pumplin and Voinnet 2013). The silencing mechanism is initiated by double-stranded RNA (dsRNA) molecules that are identical in sequence to the invading virus RNA and can arise from self-complementary RNA produced by inverted-repeat genetic elements or by bidirectional convergent transcription. Silencing is associated with the production of 21–24 nt duplexes called small interfering RNAs (siRNAs) and are generated from dsRNA precursors by ribonuclease III-type Dicer-like enzymes. The siRNAs are then incorporated and converted to single-stranded RNAs (ssRNAs) in an Argonaute-containing RNA-induced silencing complex (RISC). This complex targets RNA for cleavage in particular mRNAs that are complementary to siRNAs, i.e., genomic RNAs of an invading virus, by inducing their posttranscriptional gene silencing process through endonucleolytic cleavage. As a result, viral RNAs are chopped and nonfunctional, hence resistance to virus infection (Poulsen et al. 2013; Pumplin and Voinnet 2013). On the other hand, viruses encode proteins that act as suppressors of RNA silencing. Their role is to counteract the innate defense system of the plant by interference with some critical steps of the antiviral pathways of RNA silencing.

Knowledge of RNA silencing has led to the discovery of transgene designs capable of stimulating the antiviral pathways of RNA silencing more effectively, thereby increasing the proportion of resistant individuals among a population of transgenic lines produced following *A. tumefaciens*-mediated transformation (Prins 2003; Prins et al. 2008; Wesley et al. 2001). For example, following the realization that dsRNAs elicit gene silencing, inverted-repeat RNAs (hairpin RNAs) and intron-spliced hairpin RNA constructs, collectively referred to as RNAi constructs herein, are used to provide efficient and consistent virus resistance (Wesley et al. 2001). In particular, RNAi constructs designed based on conserved regions of viral genes coding for RNA silencing suppressors are effective at conferring resistance to viruses in plants. Interestingly, siRNAs were detected in some of the transgenic grapevines expressing inverted-repeat GFLV constructs (Reustle et al. 2006) and the GFLV CP gene (Gambino et al. 2010).

Another approach to confer resistance to viruses consists of engineering artificial microRNAs (amiRNAs), which are important regulators of gene expression in eukaryotes. By creating artificial amiRNAs through the exchange of a specific sequence within an miRNA precursor with a sequence designed to match a target gene, a miRNA-based strategy can be applied to silence target genes. For example, the pre-miR319a of *Arabidopsis thaliana* was modified to replace miR319a with two amiRNAs targeting different regions of the CP gene of GFLV, e.g., amiR(CP)-1 and amiR(CP)-2 (Jelly et al. 2012). Transient expression of these two pre-amiRNA constructs was confirmed in grapevine somatic embryos after cocultivation with *Agrobacterium tumefaciens* by an endpoint stem-loop RT-PCR, indicating active processing of pre-amiRNAs (Jelly et al. 2012). It will be interesting to test the effect

of amiR(CP)-1 and amiR(CP)-2 on GFLV multiplication in stable grapevine transformants.

P. Gugerli and M. Laimer and colleagues were the first to report on the development of transgenic *Nicotiana spp.* expressing various gene fragments from GFLV or ArMV at the 11th ICVG Meeting in Montreux, Switzerland (Spielmann et al. 1993; Steinkellner et al. 1993). Subsequently, many more reports on resistance to grapevine viruses in transgenic *Nicotiana* were reported (Bardonnnet et al. 1994; Martinelli et al. 2000; Monier et al. 2000; Radian-Sade et al. 2000; Spielmann et al. 2000; Yoshikawa et al. 2000). Reaction of transgenic material to virus infection was essentially evaluated by mechanical inoculation. High levels of resistance were reported in transgenic plants against GFLV (Bardonnnet et al. 1994; Monier et al. 2000; Jardak-Jamoussi et al. 2003; Reustle et al. 2005, 2006; Valat et al. 2006), ArMV (Spielmann et al. 2000), GVA (Martinelli et al. 2000; Radian-Sade et al. 2000), GLRaV-2 (Ling et al. 2008), GVB (Martinelli et al. 2000), grapevine chrome mosaic virus (GCMV) (Brault et al. 1993), and grapevine berry inner necrosis virus (GINV) (Yoshikawa et al. 2000) in *Nicotiana spp.*

Other Approaches The expression of antibodies in plants has been explored to engineer resistance to viruses in plants. For example, monoclonal antibodies binding specifically to the CP of GFLV (Nölke et al. 2004, 2009) and GLRaV-3 (Orecchia et al. 2008) were used to construct single-chain antibody fragments. The GFLV antibody called scFvGFLVcp-55 expressed in transgenic *N. benthamiana* plants conferred partial or complete protection against GFLV and enhanced tolerance to ArMV. Resistance to GFLV was correlated to accumulation levels of the antibody fragment (Nölke et al. 2009). The plantibody approach to confer virus resistance has not been applied to grapevines yet. It will be interesting to assess its potential at providing practical resistance to viruses in the vineyard.

Field Trials of Transgenic Grapevines and Prospects

In spite of the remarkable progress on the development of transgenic grapevines for virus resistance, no resistant genotype has yet been obtained (Laimer et al. 2009). Field trials of transgenic grapevines engineered for virus resistance are limited. The first experiments were carried out 20 years ago. Moët & Chandon, a French winery and prominent champagne house that co-owns LVMH Moët Hennessy Louis Vuitton SE, pioneered the development of grapevine rootstocks for resistance to GFLV in cooperation with the Institut National de la Recherche Agronomique (INRA) and the Centre National de la Recherche Scientifique (CNRS). The premise was that a GFLV-resistant grapevine rootstock would protect a scion from virus infection following inoculation by viruliferous *X. index* populations present in vineyards. The intention of Moët & Chandon was to explore innovative strategies to manage GFLV, a devastating virus that crippled their vineyards and those of the Champagne region in France. The approach was to overexpress the CP gene of

GFLV in rootstocks, particularly in the 41B Millardet et De Grasset rootstock (*V. berlandieri* x *V. vinifera*) that is extensively used in the Champagne region for its lime tolerance. Transgenic 41B rootstock lines were produced, propagated, and tested for resistance to GFLV in naturally infected vineyards in the Champagne region. The first field trials were established in 1996. Preliminary resistance data were encouraging (Fuchs et al. 2000). Unfortunately, at the dawn of the twenty-first century, just prior to the upbeat celebrations for the new century, a French multinational retail company that is openly campaigning against genetic modification threatened to withdraw LVMH Moët Hennessy Louis Vuitton SE's products from their stores worldwide, including their special 2000 vintages, if Moët & Chandon was going to continue any research on genetically modified grapevines. LVMH Moët Hennessy Louis Vuitton SE took this threat into account and decided to cease any research activity related to genetically modified grapevines at Moët & Chandon. This business decision halted efforts to explore innovative strategies to manage GFLV. Consequently, all plant material in experimental vineyards was destroyed on site in 1999, and plantlets grown in tissue culture facilities at Moët & Chandon was sorted out and transferred to INRA.

INRA decided to actively pursue research on resistance to GFLV in grapevine rootstocks and to establish a new field trial. Concomitantly, social and ethical concerns on the use of transgenic grapevines were increasingly expressed in France, sometimes creating a strong climate of opposition. The general confusion on the usefulness of GFLV-resistant transgenic grapevines within various groups, including the grapevine and wine industry, the scientific community, and the political arena, prompted the Director of INRA to take a novel and unique initiative in 2001 (<http://www.inra.fr/Internet/directions/SED/science-gouvernance/ITA-Vignes/index.html>) in conjunction with the Secretaries of Agriculture and of the Environment. This initiative was based on a proactive and transparent dialogue and a wide consultation with stakeholders. Representatives of the scientific community, grape growers, nurseries, environmental protection agencies, and the public at large were invited to debate on the legitimacy and relevance of research activities on transgenic grapevines engineered for resistance to GFLV. Another topic of discussion was the legitimacy and necessity of testing transgenic grapevines in the field. This unique experience lasted for almost 2 years, a period during which all research was put on hold; the production of new grapevine transformation events and efforts to establish a new field trial were stopped.

In 2002, the debate group concluded their discussion by calling for a strong support of research but did not favorably consider any commercial release of transgenic grapevines in the future. Consequently, INRA decided to establish a new field trial at the INRA center in Colmar, France, with the most promising transgenic rootstock lines that were identified in the earlier Champagne trials (Vigne et al. 2004b). INRA also decided to form a local monitoring committee. The committee consisted of representatives of local grape grower associations, environmental protection groups, consumer groups and the public at large, as well as individual grape growers. Some researchers from INRA were ad hoc members of the local monitoring committee which was established in 2003 and chaired by an INRA administrator. The initial



Fig. 29.1 Field trial of transgenic grapevine rootstocks expressing the coat protein gene of grapevine fanleaf virus (GFLV) grafted with *V. vinifera* cv. Pinot Meunier in an artificially GFLV-infected vineyard site in France. The experimental approach was designed by The Local Monitoring Committee (The Local Monitoring Committee et al. 2010). The fenced site consists of three distinct zones: an outside border zone composed of about 1100 conventional grapevines, an inner zone of bare soil with an incinerator, and a central core zone composed of transgenic and conventional grapevines planted in soil harboring viruliferous *Xiphinema index* (dug out from a naturally GFLV-infected neighboring vineyard). A permeable textile liner was buried underneath the two central zones to partially isolate the experimental area which could be considered as a confined field trial

charge of the committee was to discuss the scope and conditions of the new field trial in an advisory capacity. Interestingly, through the influence of the chair, the mission of the local monitoring committee shifted from an initial consultation role to an active role in the design of the new field trial (The Local Monitoring Committee et al. 2010). It soon became apparent that the educational component of the interaction between INRA researchers and the local monitoring committee was occluded in favor of a strong interest in addressing emotion-driven issues.

As a result, a field experiment of 1588 vines, including 70 vines grafted onto transgenic rootstocks expressing the CP gene of GFLV and 1518 control vines, was set on an isolated site in 2005 (Fig. 29.1). The experimental site was located at the INRA center of Colmar outside of the areas dedicated to commercial grape production in the region. Since *X. index* nematodes were not known to occur at the site, a deep area at the center of the field site was dug out, and soil from a local vineyard infested with viruliferous nematodes was transferred to the test site. Prior to the transfer of soil, the excavation site was lined with a permeable textile material to

control erosion and contain nematodes that would eventually acquire GFLV from transgenic rootstocks and escape (The Local Monitoring Committee et al. 2010). Test vines consisted of transgenic and nontransgenic rootstocks onto which a non-transgenic scion cultivar, i.e., *V. vinifera* cv. Pinot Meunier, was grafted. This non-transgenic scion cultivar was selected because it is not a popular cultivar in commercial vineyards in the region where the field trial was set. The rationale for the selection of cv. Pinot Meunier scion was a public relation issue so that a neophyte would understand that a segment of the local industry was not supportive of the field trial. In addition, inflorescences were hand-removed from all the nontransgenic scions, whether grown on transgenic or nontransgenic rootstocks, to prevent opportunities to study fruits and derived products, and send a strong message that wines were not going to be made from any fruits produced at the experimental site.

The field trial lasted through 2009 and showed a delayed GFLV infection in cv. Pinot Meunier grafted onto transgenic 41B and a lower infection rate compared to control vines (30 vs. 70%) (Hemmer et al. 2009). In addition, no translocation of transgene-derived products between transgenic rootstocks and conventional scion tissue material was detected (Hemmer et al. 2009). Unfortunately, the field site was vandalized in September 2009 by an isolated activist who was locally known for his publically expressed opposition to the field release and actually to any gene modification technology. Because he had destroyed only the scion material, the established rootstocks could be top worked. Following top working with new scion budwood, the experimental vines lasted less than a year because an organized group of activists uprooted and killed the experimental vines in August 2010. So, in spite of an exemplary initiative to reach out to growers, consumer associations, and the public at large, the field trial of transgenic rootstocks engineered for GFLV resistance at INRA-Colmar was put to rest.

In the USA, a field trial with transgenic rootstocks expressing the CP gene of GFLV was carried out in the late 1990s to early 2000s in California. This experiment resulted from a partnership between Cornell University, a private company, and an individual grower. The field experiment was established in a naturally GFLV-infected commercial vineyard. It lasted only for 2 years because the private company ceased its activities. Another field trial started in 2008 in a naturally GFLV-infected commercial site that was far removed from the first site and consisted of transgenic rootstocks expressing the CP gene of GFLV in sense or anti-sense orientation (Fig. 29.2). Nontransgenic rootstocks were used as control. Rootstock genotypes were *V. rupestris* St. George, 3309 Couderc (*V. riparia* x *V. rupestris*), 110 Richter (*V. berlandieri* x *V. rupestris*), 101–14 Millardet et De Grasset (*V. riparia* x *V. rupestris*), and 5C Teleki (*V. berlandieri* x *V. riparia*). None of the test vines was grafted. Two to 55 transgenic lines were tested for each genotype for a total of 3304 test vines, including 1785 transgenic and 1519 control vines. This approximately 1 ha field experiment lasted for 4 years. Resistance data showed a delay in GFLV infection in some of the transgenic rootstock lines that were evaluated (Fig. 29.3). Unfortunately, the experiments were terminated in 2012 after the private company ceased its activities.



Fig. 29.2 Field trial of transgenic grapevine rootstocks expressing the coat protein gene of grapevine fanleaf virus (GFLV) in a naturally GFLV-infected vineyard site in California. Experimental transgenic and conventional vines (identified by white growth tubes in the center of the photo) were established following the removal of existing vines. A buffer zone of existing vines surrounded the field site

In summary, the first field experiments with transgenic rootstocks engineered for resistance to GFLV lasted only four consecutive growing seasons in France and in the USA. This time period is too short for a fair evaluation of resistance to virus infection in a perennial crop like grapevine. Therefore, the stability and durability of the engineered resistance to GFLV will need to be assessed to properly grasp the full potential of the technology.

Perception and Potential Adoption

Social and ethical concerns have been expressed on the development and use of virus-resistant transgenic grapevines, sometimes creating a strong climate of opposition. The development of virus-resistant transgenic grapevines requires an open, transparent, and sustained communication, as illustrated by the French initiative (The Local Monitoring Committee et al. 2010). A dialogue is critical to build up confidence in the technology and expose the researcher's intentions through outreach. The expectation of such a dialogue is to engage stakeholders and to initiate a

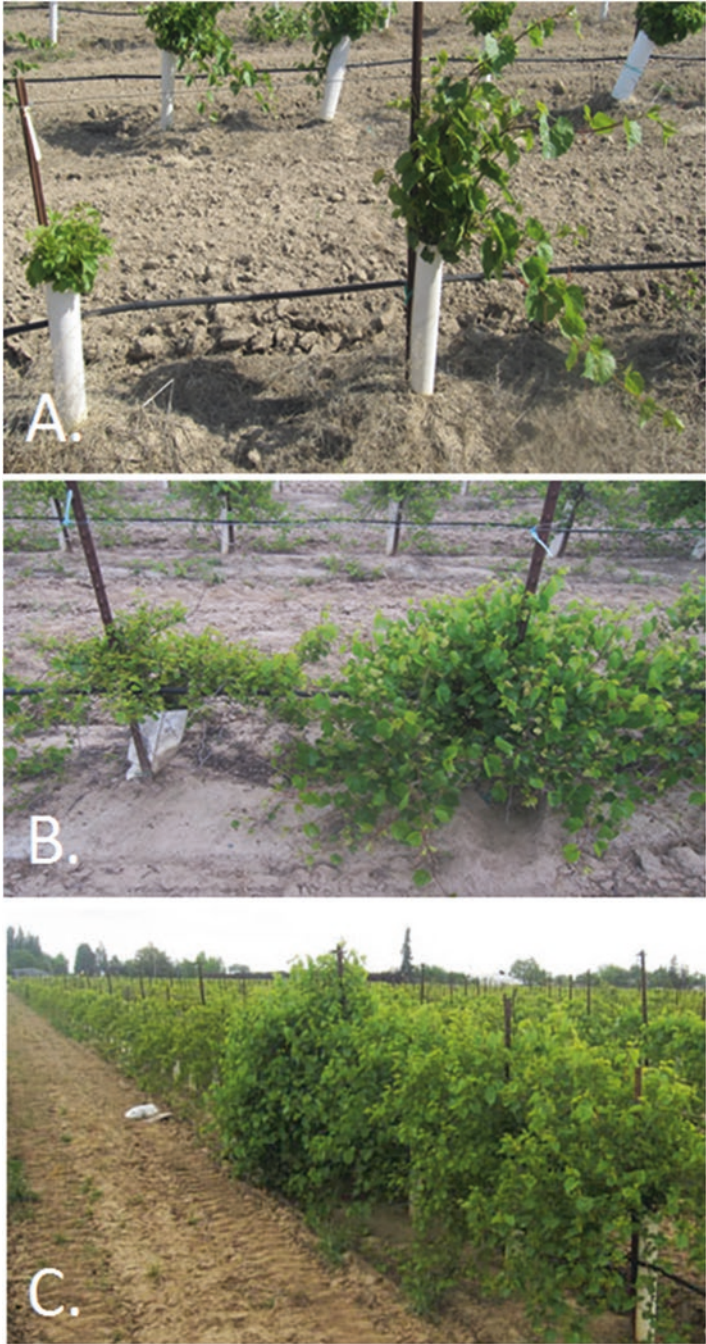

Fig. 29.3 Reaction of transgenic grapevine rootstock to GFLV infection following *X. index*-mediated virus transmission. Comparative reaction of (a) a conventional (*left*) and a transgenic (*right*) rootstock 1 year post-establishment, (b) a conventional (*left*) and a transgenic (*right*) rootstock 2 years post-establishment, and (c) a panel of five transgenic (*foreground*) followed by five conventional rootstocks 3 years post-establishment in a naturally GFLV-infected vineyard in California

dialogue so that growers, vineyard managers, owners, and the general public can build an informed opinion on the usefulness and benefits of virus-resistant transgenic grapevines based on sound biosocioeconomic considerations.

The grapevine industry at large is generally not very receptive to any kind of innovation that might conflict with the image of their products and their cultural practices (Pretorius and Høj 2005). Grape growers are also concerned with consumer's acceptance of new technologies. Therefore, the perception of virus-resistant transgenic grapevines is somewhat controversial. Concerns can be deeply rooted among the most traditionalist table grape and wine producers who view the use of biotechnology with suspicion and fear. In addition, the general public is often confused or skeptical and does not favorably perceive the technology.

Communicating scientific information on risks and benefits of virus-resistant transgenic grapevines is important to educate growers and the general public. Continuous efforts of communication and debates from the scientific community are needed to gain a full appreciation of the benefits of this ever-evolving technology. It is fundamental to assess rigorously the potential environmental impact associated with the introduction and application of the technology. Environmental risk assessment studies are important to provide scientific evidence on the impact of the technology, promote informed choice, and assist regulatory authorities in making science-based decisions on the safe release of virus-resistant transgenic crops. The first field assessment of recombination in transgenic grapevines expressing a GFLV CP gene construct indicated no adverse effect, beyond natural background events, on the diversity and dynamics of virus populations (Vigne et al. 2004a, b). More recent efforts to assess the impact of transgenic rootstocks engineered for GFLV resistance on the virus population structure and rhizosphere microbiome suggest no emergence of virus recombinants and no significant impact on bacterial communities. Surprisingly, however, vast changes to the bacterial metagenome were observed in soil from confined (greenhouse) and open-field experiments, revealing the influence of the environment on the genetic makeup, selection, and adaptation of microbial populations (Lemaire 2014).

The debate over risks and benefits of the technology can be driven by misinformation based on unsubstantiated allegations. This contributes to spreading an atmosphere of scaremongering and hostility. Sociocultural and economic factors may also explain differences in dealing with perceived risks and benefits associated with the development and use of virus-resistant transgenic grapevines. However, the attitude of most grapevine growers and the general public is changing and is becoming more positive, maybe because criticisms expressed by some activists, politicians, scientists, and the media now appear to be unsubstantiated. A long history (20 years) of the safe release of transgenic crops, including virus-resistant transgenic crops, in several countries worldwide may also contribute to a more positive attitude. As a consequence, although the technology is not fully embraced, the general opinion is that science should move forward.

Misunderstandings on the usefulness of a technology are clearly more pronounced in regions where there is a limited dialogue between grower and academic communities or where the dialogue is occurring almost exclusively between the

leadership of the industry and research communities. This is likely to create antagonistic relationships between the grower and research communities. Misunderstandings on the usefulness of a technology are also more pronounced in regions where research and extension are disconnected, as is the case in Europe. A tight connection between research and extension is providing multiple opportunities for open and continuous dialogues between researchers and growers. This facilitates a continuous exchange of ideas and perspectives on multiple topics of common interest, including controversial topics. A continuous dialogue is critical to build trust, understand the pros and cons of the technology, and be able to make informed decisions. Similarly, a close and long-term relationship rather than opportunistic initiatives for interactions, as experienced with the Local Monitoring Committee in France (The Local Monitoring Committee et al. 2010), is likely to contribute to a better mutual understanding. The closeness of interaction between the research community, and the grape and wine industry community is a reality in regions where the grape and wine industry directly supports research by providing funds and by strategically setting priorities while nurturing partnerships with state and federal legislators and regulators.

When emotionally and politically driven motivations are guiding the decision process in terms of strategically envisioning which technology the grape community might adopt and how its future might shape up, common sense approaches are often neglected in favor of emotionally motivated and conservative motions based on precautionary, risk-averse approaches and sometimes even fear mongering and obscurantism. Advocating for a transparent and sustained dialogue is paramount. Interestingly, a 2015 survey of the grape and wine industry in the USA revealed a strong support to the academic community for pursuing biotechnology/gene modification research (73% favorable support), and the majority of the participants were in favor of using genetically enhanced materials/products (57% favorable support) (<http://www.avf.org/assets/files/surveyresults/2015SurveyResultsViticulture.pdf>). Another survey performed in the Champagne region of France in 2015 revealed that 75 and 50% of conventional and organic growers, respectively, were ready to use modified rootstocks if the efficacy and sustainability of the resistance, as well as its environmental friendliness, were demonstrated (Lemaire and Uriel 2016). Moreover, 90% of the growers mentioned that public research institutions should be encouraged to pursue research on new technologies to develop resistance against fanleaf disease in grapevine. These survey outputs both in the USA and in France are encouraging for the development of virus-resistant grapevines.

Conclusions and Future Research Prospects

Transgenic grapevines have been developed for virus resistance, but limited information is available on their performance in the vineyard. The first resistance data obtained in the vineyard are promising, but the experiments lasted only for 4 years (Hemmer et al. 2009; Vigne et al. 2004b). These preliminary results need to be

confirmed by conducting new field trials in naturally infected vineyards for at least a decade. Such experiments would provide valuable insights into the practical usefulness of transgenic grapevines that are engineered for virus resistance. In addition to RNA interference, new approaches to disrupt key steps of the virus life cycle can be anticipated, but more information is needed to ascertain not only the potential of these technologies but also to pave the way for their timely delivery to growers.

Environmental safety issues have been expressed with the release of transgenic plants, including virus-resistant transgenic grapevines. Such issues are particularly relevant in the case of a perennial crop like grapevine because it is grown for decades in the field, thus increasing the probability of occurrence of unintentional biotic or non-biotic phenomena (Fuchs and Gonsalves 2007). Identifying risks and assessing their impact on the environment are a necessary prerequisite for the safe deployment of virus-resistant transgenic grapevines. It is also a wise approach to develop sustainable and environmentally friendly viticulture practices. Risk assessment studies with virus-resistant transgenic grapevines have been done but are limited. Since the genome of most grapevines does not contain virus-derived genes, recombination between viral transgene transcripts and RNAs from field viruses, which infect transgenic plants, is of potential concern in terms of the emergence of recombinant viruses. To address this issue, transgenic grapevines expressing the GFLV CP gene have been assessed for their potential impact on the diversity and dynamics of GFLV populations. Of the GFLV isolates from transgenic and conventional grapevines that were examined, none had characteristics similar to strain F13, the source of the CP transgene (Hemmer et al. 2009; Lemaire 2014; Vigne et al. 2004a, b). In addition, no statistically significant difference in molecular variability due to host genotype, i.e., transgenic or nontransgenic vines, was found for most isolates. Interestingly, a few GFLV recombinants were identified in conventional vines proximal to experimental vines (Vigne et al. 2004a, b). One of these GFLV recombinant isolates had similar biological properties to nonrecombinant isolates (Vigne et al. 2005). This research suggested that virus-resistant transgenic grapevines should not favor the development of recombinant viruses with undesirable biological properties, confirming observations made on other virus-resistant transgenic plants (Fuchs 2007).

Genetic engineering expands the possibilities of grapevine breeding programs that have exclusively relied so far on hybridization schemes and clonal selection (Pretorius and Høj 2005). RNA interference, an innate immune defense mechanism of plants against viruses, is applied to confer virus resistance in grapevine. Efforts are also under way to apply RNA interference, a regulatory mechanism of gene expression, against insect vectors. This approach holds great promise against sap-sucking arthropod pests, including virus vectors (Kumar et al. 2014; Pitino et al. 2011; Scott et al. 2013; Zha et al. 2011). In addition to RNA interference, it is reasonable to anticipate that new strategies will broaden the targets to interfere with the viral infectious cycle. For example, nanobodies, i.e., a type of antibodies that lack the light chain, may have the potential to target plant viruses. These single-domain peptides derived from heavy-chain antibodies found in camelids have been recently

shown to confer immunity to GFLV in *N. benthamiana* upon mechanical and nematode-mediated inoculation (C. Ritzenthaler, G. Demangeat, and O. Lemaire, personal communication). This result provides a promising approach to engineer resistance to GFLV in grapevine.

Targeted genome editing technologies such as the clustered regularly interspaced short palindromic repeat (CRISPR) associated with the “protein 9 system” (Cas9) have a promising potential to accelerate the development of elite grapevine selections if, for example, targets involved in incompatible host-virus interactions are identified. Although more than 15 plant species, including some of agronomic interest (rice, corn, wheat, oat, tomato, and citrus, etc.), have already benefited from such versatile technology, grapevine has not yet been engineered using this technology (Bortesi and Fischer 2015). Nonetheless, recent studies have highlighted the potential of CRISPR/Cas9 to accelerate the improvement of many perennial crops (Liu et al. 2016) and to engineer resistance to multiple viruses in *N. benthamiana* (Zaidi et al. 2016).

Will virus-resistant transgenic grapevines be made available to growers? It is difficult to realistically envision any commercial release of virus-resistant transgenic grapevines in the near future. However, knowing the detrimental impact of viruses on fruit production and vineyard profitability, the strong demand for a reduction in the reliance on toxic agrochemicals for the control of virus vectors, and the pledge for a safer and more sustainable viticulture, there is a wide open window of opportunities for the practical use of virus-resistant transgenic grapevines within a reasonable period of time, given education, dialogues, and promotion of informed choices are recognized as essential.

A number of virus-resistant transgenic crops other than grapevines have been produced and commercialized (James 2014), none of which has caused any health problems in human or animals nor created any environmental issue (Fuchs and Gonsalves 2007). Perception can be fueled by emotive arguments that are not underpinned by scientific evidence and by an apparent conflict with the established, conservative image of viticultural practices and grapevine products (Pretorius and Høj 2005). Therefore, despite the many advances made in recent years, a level of confidence to fully grasp the benefits of the technology has not been reached yet. The challenges are great, and meeting them will require sustained efforts. Ultimately, the success or failure of the technologies will depend not so much on technological aspects but more on coordinated communication efforts among scientists, growers, politicians, and the public at large. Active and open discussions should continue to take place; otherwise the technology is unlikely to benefit the present generation of grape growers and consumers.

References

- Almeida, R.P.P., K.M. Daane, V.A. Bell, G.K. Blaisdell, M.L. Cooper, E. Herrbach, and G. Pietersen. 2013. Ecology and management of grapevine leafroll disease. *Frontiers in Microbiologie*. doi:10.3389/fmicb.2013.00094.
- Andret-Link, P., C. Laporte, L. Valat, V. Laval, C. Ritzenthaler, G. Demangeat, E. Vigne, P. Pfeiffer, C. Stussi-Garaud, and M. Fuchs. 2004. Grapevine fanleaf virus: Still a major threat to the grapevine industry. *Journal of Plant Pathology* 86: 183–195.
- Atallah, S.S., M.I. Gomez, M.F. Fuchs, and T.E. Martinson. 2012. Economic impact of grapevine leafroll disease on *Vitis vinifera* cv. Cabernet franc in Finger Lakes vineyards of New York. *American Journal of Enology and Viticulture* 63: 73–79.
- Barbier, P., M. Perrin, P. Cobanov, and B. Walter. 2000. Probing pathogen-derived resistance against the fanleaf virus in grapevine. *Acta Horticulturae* 528: 385–388.
- Bardonnnet, N., F. Hans, M.A. Serghini, and L. Pinck. 1994. Protection against virus infection in tobacco plants expressing the coat protein of grapevine fanleaf nepovirus. *Plant Cell Reports* 13: 357–360.
- Bortesi, L., and R. Fischer. 2015. The CRISPR/Cas9 system for plant genome editing and beyond. *Biotechnology Advances* 33: 41–52.
- Bouquet, A., G. Marck, D. Pistagna, and L. Torregrosa. 2003. Transfer of *Grapevine fanleaf virus* coat protein gene through hybridization with *Xiphinema index* resistant genotypes to obtain rootstocks resistant to virus spread. *Acta Horticulturae* 603: 325–334.
- Bouquet, A., L. Torregrosa, and P. Chatelet. 2004. Combination of biotechnological and conventional approaches to rootstock selection presenting a sustainable resistance to grapevine fanleaf disease transmission. *OIV Bulletin* 77: 361–376.
- Brault, V., T. Candresse, O. Le Gall, R.P. Delbos, M. Lanneau, and J. Dunez. 1993. Genetically engineered resistance against grapevine chrome mosaic nepovirus. *Plant Molecular Biology* 21: 89–97.
- Buzkan, N., A. Minafra, P. Saldarelli, A. Castellano, M. Dell’Orco, G.P. Martelli, R. Gölles, and M. da Laimer Camara Machado. 2001. Heterologous encapsidation in non-transgenic and transgenic *Nicotiana* plants infected by *Grapevine viruses A* and *B*. *Journal of Plant Pathology* 83: 37–43.
- Demangeat, G., R. Voisin, J.-C. Minot, N. Bosselut, M. Fuchs, and D. Esmenjaud. 2005. Survival of in vineyard soil and retention of over extended time in the absence of host plants. *Phytopathology* 95: 1151–1156.
- Esmenjaud, D., A. Bouquet, and G. Demangeat. 2011. Nematode-resistant rootstocks as a major component of the management alternative for *Grapevine fanleaf virus* control in grape. *Acta Horticulturae* 904: 111–115.
- Fuchs, M. 2007. Potential for recombination and creation of new viruses in transgenic plants expressing viral genes: Real or perceived risk? In *Biotechnology and plant disease management*, ed. Z.K. Punja, S.H. DeBoer, and H. Sanfaçon, 416–435. Wallingford: CABI Press.
- . 2008. Les plantes transgéniques et la lutte contre les virus phytopathogènes: état de l’art et perspectives. *Virologie* 12: 27–37.
- Fuchs, M., and D. Gonsalves. 2007. Safety of virus-resistant transgenic plants two decades after their introduction: Lessons from realistic field risk assessment studies. *Annual Review of Phytopathology* 45: 173–202.
- Fuchs, M., B. Walter, and L. Pinck. 2000. Evaluation of transgenic grapevine rootstocks expressing the coat protein gene of *Grapevine fanleaf virus* under vineyard conditions. In *Extended abstracts 13th meeting of ICVG*, 50–51. Adelaide, Australia.
- Gambino, G., I. Gribaudo, S. Leopold, A. Scharl, and M. Laimer. 2005. Molecular characterization of grapevine plants transformed with GFLV resistance genes. I. *Plant Cell Reports* 24: 655–662.
- Gambino, G., I. Perrone, A. Carra, W. Chitarra, P. Boccacci, D. Torello Marinoni, M. Barberis, F. Maghuly, M. Laimer, and I. Gribaudo. 2010. Transgene silencing in grapevines transformed

- with GFLV resistance genes: analysis of variable expression of transgene siRNAs production and cytosine methylation. *Transgenic Research* 19: 17–27.
- Gambino, G., B. Navarro, R. Vallania, I. Gribaudo, and F. Di Serio. 2011. Somatic embryogenesis efficiently eliminates viroid infections from grapevines. *European Journal of Plant Pathology* 130: 511–519.
- Gölles, R., R. Moser, H. Puhlinger, H. Katinger, M.L. da Camara Machado, A. Minafra, V. Savino, P. Saldarelli, G.P. Martelli, and A. da Camara Machado. 2000. Transgenic grapevines expressing coat protein gene sequences of grapevine fanleaf virus, arabis mosaic virus, grapevine virus A and grapevine virus B. *Acta Horticulturae* 528: 305–311.
- Gottula, J., and M. Fuchs. 2009. Toward a quarter century of pathogen-derived resistance and practical approaches to engineered virus resistance in crops. *Advances in Virus Research* 75: 161–183.
- Gray, D.J., J. Subramanian, Z. Li, J. Cordts, R. Scorza, and C. Srinivasan. 2002. Transgenic grapevines. In *Transgenic plants and crops*, ed. G.G. Khachatourians, A. McHughen, R. Scorza, W.-K. Nip, and Y.H. Hui, 397–405. New York: M. Dekker.
- Gutoranov, G.P., I.J. Tsvetkov, V.M. Colova-Tsolova, and A.I. Atanassov. 2001. Genetically engineered grapevines carrying GFLV coat protein and antifreeze genes. *Agriculturae Conspectus Scientificus* 66: 69–74.
- Hemmer, C., E.Vigne, V. Goldschmidt, V. Komar, A. Marmonier, L. Valat, G. Demangeat, S. Vigneron, J.E. Masson, and O. Lemaire. 2009. Transgenic rootstocks expression GFLV coat-protein gene in a three years field trial: Resistance assessment, impact on GFLV diversity and exchanges between rootstock and scion. In *Extended abstracts 16th meeting of ICVG*, 228–229. Dijon, France.
- Herrbach, E., J. Le Maguet, and G. Hommay. 2016. Virus transmission by mealybugs and soft scales (Hemiptera, Coccoidea). In: *Vector-mediated transmission of plant pathogens*, ed. J.K Brown, 147–161. St Paul: APS Press.
- James, C. 2014. *Global Status of Commercialized Biotech/GM Crops: 2014*. ISAAA Brief No.49. ISAAA: Ithaca, NY.
- Jardak-Jamoussi, R., B. Bouamama, T. Wetzel, A. Mliki, G.M. Reustle, and A. Ghorbel. 2003. Evaluation of different gene constructs for production of resistant grapevines against Grapevine fanleaf and Arabis mosaic viruses. *Acta Horticulturae* 603: 315–323.
- Jardak-Jamoussi, R., P. Winterhagen, B. Bouamama, C. Dubois, A. Mliki, T. Wetzel, A. Ghorbel, and G.M. Reustle. 2009. Development and evaluation of a GFLV inverted repeat construct for genetic transformation of grapevine. *Plant Cell Tissue and Organ Culture* 97: 187–196.
- Jelly, N.S., P. Schellenbaum, B. Walter, and P. Maillot. 2012. Transient expression of artificial microRNAs targeting *Grapevine fanleaf virus* and evidence for RNA silencing in grapevine somatic embryos. *Transgenic Research* 21: 1319–1327.
- Krastanova, S., M. Perrin, P. Barbier, G. Demangeat, P. Cornuet, N. Bardonnnet, L. Otten, L. Pinck, and B. Walter. 1995. Transformation of grapevine rootstocks with the coat protein gene of grapevine fanleaf nepovirus. *Plant Cell Reports* 14: 550–554.
- Kumar, P., S.S. Pandit, A. Steppuhn, and I.T. Baldwin. 2014. Natural history-driven, plant mediated RNAi based study reveals CYP6B46's role in a nicotine-mediated antipredator herbivore defense. *Proceedings of the National Academy of Sciences of the United States of America* 111: 1245–1252.
- Laimer, M., O. Lemaire, E. Herrbach, V. Goldschmidt, A. Minafra, P. Bianco, and T. Wetzel. 2009. Resistance to viruses, phytoplasmas and their vectors in grapevine in Europe: a review. *Journal of Plant Pathology* 91: 7–23.
- Lemaire, O. 2014. Genetically modified crops: GM progress and tentative transgrafting. International Innovation, Ed: Research Media, September 2014, 134–135.
- Lemaire, O., and G. Uriel. 2016. Les avancées dans la lutte contre le court-noué. Le Vigneron Champenois April, 36–49.
- Ling, K.S., H.Y. Zhu, and D. Gonsalves. 2008. Resistance to *Grapevine leafroll-associated virus 2* is conferred by post-transcriptional gene silencing in transgenic *Nicotiana benthamiana*. *Transgenic Research* 17: 733–740.

- Liu, D., R. Hu, K.J. Palla, G.A. Tuskan, and X. Yang. 2016. Advances and perspectives on the use of CRISPR/Cas9 systems in plant genomics research. *Current Opinion in Plant Biology* 30: 70–77.
- Maghuly, F., S. Leopold, A. da Câmara Machado, E. Borroto Fernandez, M. Ali Khan, G. Gambino, I. Gribaudo, A. Scharl, and M. Laimer. 2006. Molecular characterization of grapevine plants transformed with GFLV resistance genes: II. *Plant Cell Reports* 6: 546–553.
- Maliogka, V., G.P. Martelli, M. Fuchs, and N. Katis. 2014. Control of viruses infecting grapevine. *Advances in Virus Research* 91: 175–227.
- Martelli, G.P. 2014. Directory of virus and virus-like diseases of the grapevine and their agents. *Journal of Plant Pathology* 96(Suppl. 1): 1–136.
- Martinelli, L., D. Costa, V. Poletti, S. Festi, N. Buzkan, A. Minafra, P. Saldarelli, G.P. Martelli, and A. Perl. 2000. Genetic transformation of tobacco and grapevine for resistance to viruses related to the rugose wood disease complex. *Acta Horticulturae* 528: 321–327.
- Martinelli, L., E. Candioli, D. Costa, and A. Minafra. 2002. Stable insertion and expression of the movement protein gene of *Grapevine virus A* (GVA) in grape (*Vitis rupestris* S.). *Vitis* 41: 189–193.
- Mauro, M.C., P. Coutos-Thevenot, M. Boulay, L. Valat, P. Barbier, B. Walter, and L. Pinck. 2000. Analysis of 41B (*Vitis vinifera* x *Vitis berlandieri*) grapevine rootstocks for grapevine fanleaf virus resistance. *Acta Horticulturae* 528: 313–319.
- Monier, C., P. Barbier, and B. Walter. 2000. Protection against grapevine fanleaf virus in transgenic tobacco containing non-translatable sequences. *Acta Horticulturae* 528: 379–383.
- Mullins, M.G., F.C.A. Tang, and D. Facciotti. 1990. *Agrobacterium*-mediated genetic transformation of grapevines: Transgenic plants of *Vitis ruspestris* Scheele and buds of *Vitis vinifera* L. *Biotechnology* 8: 1041–1045.
- Naidu, R., A. Rowhani, M. Fuchs, D.A. Golino, and G.P. Martelli. 2014. Grapevine leafroll disease: A complex viral disease affecting a high value fruit crop. *Plant Disease* 98: 1172–1185.
- Nimmo-Bell. 2006. The economic effects and financial impact of GLRaV-3. Hastings: A Nimmo-Bell 379 Publication, 1–18. Wellington: Nimmo-Bell and Company.
- Nölke, G., R. Fischer, and S. Schillberg. 2004. Antibody-based pathogen resistance in plants. *Journal of Plant Pathology* 86: 6–17.
- Nölke, G., P. Cobanov, K. Uhde-Holzem, G. Reustle, R. Fischer, and S. Schillberg. 2009. *Grapevine fanleaf virus* (GFLV)-specific antibodies confer GFLV and *Arabis mosaic virus* (ArMV) resistance in *Nicotiana benthamiana*. *Molecular Plant Pathology* 10: 41–49.
- Oliver, J.E., and M. Fuchs. 2011. Tolerance and resistance to viruses and their vectors in *Vitis* sp.: A virologist's perspective of the literature. *American Journal of Enology and Viticulture* 62: 438–451.
- Orecchia, M., G. Nölke, P. Saldarelli, M. Dell'Orco, K. Uhde-Holzem, M. Sack, G. Martelli, R. Fischer, and S. Schillberg. 2008. Generation and characterization of a recombinant antibody fragment that binds to the coat protein of grapevine leafroll-associated virus 3. *Archives of Virology* 153: 1075–1084.
- Pietersen, G., N. Spreeth, T. Oosthuizen, A. van Rensburg, M. van Rensburg, D. Lottering, N. Rossouw, and D. Tooth. 2013. Control of grapevine leafroll disease spread at a commercial wine estate in South Africa: A case study. *American Journal of Enology and Viticulture* 64: 296–305.
- Pitino, M., A.D. Coleman, M.E. Maffei, C.J. Ridout, and S.A. Hogenhout. 2011. Silencing of aphid genes by dsRNA feeding from plants. *PLoS One* 6: e25709.
- Poulsen, C., H. Vaucheret, and P. Brodersen. 2013. Lessons on RNA silencing mechanisms in plants from eukaryotic argonaute structures. *Plant Cell* 25: 22–37.
- Pretorius, I.S., and P.B. Høj. 2005. Grape and wine biotechnology: Challenges, opportunities and potential benefits. *Australian Journal of Grape and Wine Research* 11: 83–108.
- Prins, M. 2003. Broad virus resistance in transgenic plants. *Trends in Biotechnology* 21: 373–375.
- Prins, M., M. Laimer, E. Noris, J. Schubert, M. Wassenegger, and M. Tepfer. 2008. Strategies for antiviral resistance in transgenic plants. *Molecular Plant Pathology* 9: 73–83.

- Pumplin, N., and O. Voinnet. 2013. RNA silencing suppression by plant pathogens: Defence, counter-defence and counter-counter-defence. *Nature Reviews* 11: 745–760.
- Radian-Sade, S., A. Perl, O. Edelbaum, L. Kuznetsova, R. Gafny, I. Sela, and E. Tanne. 2000. Transgenic *Nicotiana benthamiana* and grapevine plants transformed with grapevine virus A (GVA) sequences. *Phytoparasitica* 28: 79–86.
- Reustle, G.M., R. Ebel, P. Winterhagen, T. Manthey, C. Dubois, A. Bassler, M. Sinn, P. Cobanov, T. Wetzel, G. Krczal, R. Jardak-Jamoussi, and A. Ghorbel. 2005. Induction of silencing in transgenic grapevines (*Vitis* sp.). *Acta Horticulturae* 689: 521–528.
- Reustle, G., P. Winterhagen, R. Jardak-Jamoussi, P. Cobanov, C. Dubois, T. Manthey, T. Wetzel, A. Ghorbel, G. Brendel, U. Ipach, and G. Krczal. 2006. Resistance against nepoviruses: Molecular and biological characterisation of transgenic tobacco and grapevine plants. In *Extended abstracts 15th meeting of ICVG*, Stellenbosch, South Africa 59–60.
- Ricketts, K.D., M.I. Gomez, S.S. Atallah, M.F. Fuchs, T. Martinson, R.J. Smith, P.S. Verdegaal, M.L. Cooper, L.J. Bettiga, and M.C. Battany. 2015. Reducing the economic impact of grapevine leafroll disease in California: Identifying optimal management practices. *American Journal of Enology and Viticulture* 66: 138–147.
- Sanford, J.C., and S.A. Johnston. 1985. The concept of parasite-derived resistance – Deriving resistance genes from the parasite’s own genome. *Journal of Theoretical Biology* 113: 395–405.
- Scott, J.G., K. Michel, L.C. Bartholomay, B.D. Siegfried, W.B. Hunter, G. Smaghe, K.Y. Zhu, and A.E. Dougals. 2013. Towards the elements of successful insect RNAi. *Journal of Insect Physiology* 59: 1212–1221.
- Spielmann, A., S. Marc-Martin, M.E. Ramel, and P. Gugerli. 1993. Expression of several modified Grapevine fanleaf nepovirus coat protein genes in transgenic tobacco plants. In *Extended abstracts 11th meeting of ICVG*, Montreux, Switzerland, 173–174.
- Spielmann, A., S. Krastanova, V. Douet-Orhant, and P. Gugerli. 2000. Analysis of transgenic grapevine (*Vitis rupestris*) and *Nicotiana benthamiana* plants expressing an *Arabidopsis* mosaic virus coat protein gene. *Plant Science* 156: 235–244.
- Steinkellner, H., H. da Camara Machado, M. da Laimer Camara Machado, R. Gölles, and H. Katinger. 1993. Studies on coat protein mediated cross protection of nepoviruses. In *Extended abstracts 11th meeting of ICVG*, Montreux, Switzerland, 175.
- The Local Monitoring Committee, O. Lemaire, A. Moneyrin, and J.E. Masson. 2010. “Interactive technology assessment” and beyond: the field trial of genetically modified grapevines at INRA-Colmar. *PLoS Biology* 8: e1000551.
- Valat, L., M. Fuchs, and M. Burrus. 2006. Transgenic grapevine rootstock clones expressing the coat protein or movement protein genes of *Grapevine fanleaf virus*: Characterization and reaction to virus infection upon protoplast infection. *Plant Science* 170: 739–747.
- Vigne, E., M. Bergdoll, S. Guyader, and M. Fuchs. 2004a. Population structure and genetic diversity within *Grapevine fanleaf virus* isolates from a naturally infected vineyard: Evidence for mixed infection and recombination. *Journal of General Virology* 85: 2435–2445.
- Vigne, E., V. Komar, and M. Fuchs. 2004b. Field safety assessment of recombination in transgenic grapevines expressing the coat protein gene of *Grapevine fanleaf virus*. *Transgenic Research* 13: 165–179.
- Vigne, E., G. Demangeat, V. Komar, and M. Fuchs. 2005. Characterization of a naturally occurring recombinant isolate of Grapevine fanleaf virus. *Archives of Virology* 150: 2241–2255.
- Vigne, E., V. Komar, M. Tannières, G. Demangeat, E. Duchêne, D. Steyer, G. Lemarquis, C. Ritzenthaler, and O. Lemaire. 2015. Comparative pathogenic effects of distinct Grapevine fanleaf virus strains on *Vitis vinifera* cvs Gewürztraminer and Chardonnay. In *Extended abstracts of the 18th ICVG meeting, Ankara, Turkey*, 236–237.
- Villate, L., E. Morin, G. Demangeat, M. van Helden, and D. Esmenjaud. 2012. Control of *Xiphinema index* populations by fallow plants under greenhouse and field conditions. *Phytopathology* 102: 627–634.
- Walker, J.T.S., J.G. Charles, K.J. Froud, and P. Connolly. 2004. Leafroll virus in vineyards: modelling the spread and economic impact. HortResearch Client Report, 12795.

- Walter, B., and G.P. Martelli. 1996. Sélection clonale de la vigne: sélection sanitaire et sélection pomologique. Influence des viroses et qualité. 1ère partie: Effets des viroses sur la culture des vignes et ses produits. *OIV Bulletin* 69: 945–971.
- Wesley, V., C.A. Helliwell, N.A. Smith, M.B. Wang, D.T. Rouse, Q. Liu, P.S. Gooding, S.P. Singh, D. Abbott, P.A. Stoutjesdijk, S.P. Robinson, A.P. Gleave, A.G. Green, and P.M. Waterhouse. 2001. Construct design for efficient, effective and high-throughput gene silencing in plants. *Plant Journal* 27: 581–591.
- Winterhagen, P., C. Dubois, M. Sinn, T. Wetzel, and G.M. Reustle. 2009. Gene silencing and virus resistance based on defective interfering constructs in transgenic *Nicotiana benthamiana* is not linked to accumulation of siRNA. *Plant Physiology and Biochemistry* 47: 739–742.
- Xue, B., K.-S. Ling, C.L. Reid, S. Krastanova, M. Sekiya, E.A. Momol, S. Sule, J. Mozsar, D. Gonsalves, and T.J. Burr. 1999. Transformation of five grape rootstocks with plant virus genes and a virE2 gene from *Agrobacterium tumefaciens*. *In Vitro Cellular and Development Biology - Plant* 35: 226–231.
- Yoshikawa, N., S. Gotoh, M. Umezawa, N. Satoh, H. Satoh, T. Takabashi, T. Ito, and K. Yoshida. 2000. Transgenic *Nicotiana occidentalis* plants expressing the 50-kDa protein of *Apple chlorotic leaf spot virus* display increased susceptibility to homologous virus, but strong resistance to *Grapevine berry inner necrosis virus*. *Phytopathology* 90: 311–316.
- Zaidi, S.S., S. Mansoor, Z. Ali, M. Tashkandi, and M.M. Mahfouz. 2016. Engineering plants for geminivirus resistance with CRISPR/Cas9 system. *Trends in Plant Science* 21: 279–281.
- Zha, W., X. Peng, R. Chen, B. Du, L. Zhu, and G. He. 2011. Knockdown of midgut genes by dsRNA-transgenic plant-mediated RNA interference in the hemipteran insect *Nilaparvata lugens*. *PLoS One* 6: e20504.

Part IV
Metagenomics, Evolution
and Biotechnological Applications
of Grapevine Viruses

Chapter 30

High-Throughput Sequencing: Advantages Beyond Virus Identification

P. Saldarelli, A. Giampetruzzi, H.J. Maree,
and M. Al Rwahnih

Abstracts The application of high-throughput sequencing (HTS) in plant virology research had an immense influence on our perspective of disease etiology. The technology opened a new avenue of exploration that is unbiased and at an unparalleled level of sensitivity. Initially, HTS was used for virus discovery with the greatest success up until now being the discovery of *Grapevine red blotch-associated virus* (GRBaV) and *Grapevine Pinot gris virus* (GPGV). Most of the early studies constructed HTS libraries from either an enriched dsRNA extract or the small RNA fraction, but other nucleic acids have also been used. The expansion of virus databases and improved bioinformatic tools would suggest that HTS will be implemented as a sensitive virus detection tool more routinely. The discovery of the complex grapevine virome challenges the concept of what can be considered as a healthy vine although offering new opportunities to the implementation of certification schemes and exchanges of plant propagation materials.

In this chapter the history of HTS in grapevine virus research is reviewed followed by the exploration of the different strategies used for the discovery of new viruses and new variants of known viruses. The concept of a “background” virome is introduced and explored within the context of its interaction with the host and the impact this might have on certification of healthy plant material. The chapter is concluded with some thoughts on the future of HTS in grapevine virus research.

Keywords Grapevine • Virus • High throughput • Sequencing • Small RNA • Double-stranded RNA • Virome • Diagnosis • Detection

P. Saldarelli (✉) • A. Giampetruzzi
CNR Istituto per la Protezione Sostenibile delle Piante UOS Bari and Dipartimento di Scienze del Suolo della Pianta e degli Alimenti, Università degli Studi di Bari,
via Amendola 165/A, Bari, Italy
e-mail: pasquale.saldarelli@ipsp.cnr.it

H.J. Maree
Genetics Department, Stellenbosch University, Stellenbosch, South Africa
Infruitec-Nietvoorbij, Agricultural Research Council, Stellenbosch, South Africa

M. Al Rwahnih
Department of Plant Pathology, University of California,
One Shields Avenue, Davis, CA 95616, USA

Introduction

Sequencing technologies went through several evolutions and became commercially viable with the development of Sanger sequencing (Sanger et al. 1977). This approach, although improved over time, has the limitation of being able to determine the sequence of only one fragment of ca. 1200 bp at a time. High-throughput sequencing (HTS) caused a paradigm shift from sequencing single reads to millions of reads in a random massive parallel sequencing strategy. Different HTS platforms are available whose outputs mainly differ in the error rate of sequencing, throughput per run, and length of the sequenced reads. For a comprehensive description of their characteristics, readers are referred to specific technical review (Kircher and Kelso 2010).

The development of HTS has a great impact on plant virology by moving rapidly from a new virus identification and discovery technique to a powerful tool for exploring viral biodiversity, ecology, and host interactions. This fast progression brought new challenges to researchers especially in the management and analysis of such an abundance of data, forcing plant virologists to change the paradigm from “one assay to detect one virus” to one assay that disclose the “virome” of a plant. The concept of a virome is more pertinent in a woody perennial such as grapevine, where grafting and vegetative propagation are the norm. This is because these viticultural practices, coupled with long-term exposure to viruses that are spreading in the environment, stacked viruses and viroids in a single plant, leading to multiple infections. The application of HTS to grapevine generates complex datasets, due to the large number of viruses and viroids that simultaneously infect a single plant as compared to other plant species. Effects of these complex viromes on the ecology of viruses in the host also populated by mycoviruses are now points of discussion among grapevine virologists.

A first practical application of HTS is in the production of grape material for propagation, which is regulated in almost all major viticultural countries of the world according to technical specifications that list detrimental viruses and diseases in that country. The application of HTS to generate a virome of a grapevine sample can disclose the presence of virus and viroid species not currently considered for regulation, which raises immediate questions about their role in disease and their impacts on regulatory strategies. Moreover, HTS has shown that nonregulated viruses and viroids are routinely found in grapevine independent of the presence of symptoms, thus questioning the concept of a “healthy” vine. HTS is undeniably an unbiased diagnostic approach, which will most likely substitute existing diagnostic techniques in the near future. The scope of this chapter is to review less than one decade of research regarding HTS application in grapevine virology, to highlight achievements and limitations concerning the application of the technology to grapevine virology, and to stimulate discussions about the interpretation of results for virus detection, production of clean propagation material, and virus ecology in grapevine.

HTS in Grapevine Virology: A Chronology of Major Achievements

Grapevine virologists and, in a broader sense, scientists studying plant–virus interactions at the molecular level seized the opportunity to use HTS in *Vitis* spp. research. The first use of the technology in grapevine was to explore the etiology of Syrah decline, a grapevine disease whose etiology is yet unknown (Al Rwahnih et al. 2009). Although a new virus, *Grapevine Syrah virus 1* (GSyV-1), was described, the inconsistency of data did not allow for an association of GSyV-1 with the disease. A main and important outcome of this investigation was the demonstration that a new virus could be identified by genome homologies to unrelated species of the family *Tymoviridae*. Several other viruses (*Grapevine rupestris stem pitting-associated virus*, GRSPaV; *Grapevine rupestris vein feathering-associated virus*, GRVfV; *Grapevine leafroll-associated virus 4* strain 9, GLRaV-9) and three viroids (*Australian grapevine viroid*, AGVd; *Grapevine yellow speckle viroid*, GYSVd; and *Hop stunt viroid*, HSVd) were also found, complicating the establishment of a direct link or possible synergistic role of GSyV-1 in the etiology of Syrah decline. This study provided the first snapshot of a grapevine virome, disclosing the virus complexity that would be confirmed by all successive studies. The full potential of HTS was exploited by Coetzee et al. (2010), who performed a metagenomic analysis of an entire vineyard. Sequencing the dsRNA fraction of a pooled sample of 44 randomly selected grapevines allowed for the detection of *Grapevine leafroll-associated virus 3* (GLRaV-3), GRSPaV, *Grapevine virus A* (GVA), and, first reported in South Africa, *Grapevine virus E* (GVE). In addition, the almost complete genome sequences of several viruses (genome coverage spanned 100% for GLRaV-3, 94% for GVA, and 90% for GRSPaV) were obtained in a single step of sequencing, speeding up work that in the past would have required months or even years of cloning and sequence analyses. The study also identified several mycoviral sequences in the phloem of infected vines, a discovery successively reported by Al Rwahnih et al. (2011) who found that these viruses were prevailing in the virome of a single vine. In a different approach, Pantaleo et al. (2010a) made a viral census of the grapevine cv Pinot Noir clone ENTAV-INRA 115, whose genome was already available. The analysis of the small RNA (sRNA) fraction of this vine was the first example of the application of the method of Kreuze et al. (2009) in grapevine. The presence of a complex virome composed of members of the genera *Foveavirus*, *Maculavirus*, *Marafivirus*, and *Nepovirus* was demonstrated in libraries from berries, flowers, tendrils, and leaves, and different viruses had diverse profiles of virus-derived small interfering RNAs (vsiRNAs) in these tissues. This work highlighted the need for a thorough interpretation of the dataset and a suitable bioinformatic pipeline to perform metadata analysis. As already reported by Al Rwahnih et al. (2009), a careful analysis of the sequence reads, the needs of a *de novo* assembly, and the detection by alternative techniques of not thoroughly studied viruses (i.e., marafiviruses and maculaviruses) were necessary to reach a correct identification. From the same sRNA dataset, Navarro et al. (2009) described multiple infection of clone

ENTAV-INRA 115 by *HSVd* and *GYSVd-1* thus confirming the broad ability of the technique in detecting pathogens from different taxa. Results of this study also provided information on the antiviral RNA silencing pathway in grapevine, allowing these researchers to make inferences about the mechanism of action either on virus or viroid genomes. These fundamental works, although highlighting technical difficulties and costs in performing HTS analysis in grapevine, firmly outlined future trends and benefits of applying the technique to economically important plant species. Two approaches started to emerge from these initial investigations that relied on the analysis of the double-stranded RNA or on small RNA populations. Apparently, both strategies were able to detect known and unknown viruses, as well as viroids representative of a grapevine virome, provided that enough metadata was obtained. However, comparative studies about their performances would be advisable.

Discovery of New Emerging Viruses and New Genome Variants of Known Viruses

HTS can be considered as “a dream for a plant virologist,” since it does not require prior information on the virus. The potential of this technology was seized as an opportunity by grapevine virologists and resulted in several studies set out to examine the virome of grapevine virus-like diseases whose etiology was unknown. Zhang et al. (2011) analyzed sRNA libraries of grapevines showing symptoms of vein clearing and vine decline to which *Grapevine fanleaf virus* (GFLV), *Tomato ringspot virus* (ToRSV), and GRSPaV were found inconsistently associated. Surprisingly, a new badnavirus, *Grapevine vein clearing virus* (GVCV) with a double-stranded DNA genome was discovered. This finding demonstrated the ability of using sRNA libraries in detecting also DNA viruses due to the RNA silencing activity of degrading overlapping viral messenger RNAs (Seguin et al. 2014) and confirmed multiple infections of vitiviruses, marafiviruses, maculaviruses, and nepoviruses in these vines. The authors concluded that, although strongly correlated to symptoms of vein clearing, GVCV could not be assigned as the only agent responsible for the disease since additional viruses were identified in these vines. With the use of HTS, this will be a recurring situation and a major obstacle in the interpretation of HTS data in grapevine.

In an attempt to clarify the etiology of Shiraz disease in South Africa, Maree et al. (2012) confirmed the major involvement of GLRaV-3 and of GVA group II variants in this disease. In addition, four viroids (*GYSVd-1*, *GYSVd-2*, *AGVd*, and *HSVd*) were identified for the first time in South Africa, likely because of an improved method of extraction of the dsRNA substrates used to synthesize the library. The same group of researchers (Espach et al. 2012) described the grapevine mycovirome through RNASeq of purified dsRNA by two HTS technologies: Illumina and SOLiD (Applied Biosystems). Both methods identified a total of 28

viruses that belong to the following mycoviral families: *Chrisoviridae*, *Endornaviridae*, *Narnaviridae*, *Partitiviridae*, and *Totiviridae*. However, attempts to confirm the presence of these virus species by PCR on diverse purified DNA or RNA substrates were successful for only two of them.

Al Rwahnih et al. (2012a) excluded the involvement of *Grapevine leafroll-associated virus 7* (GLRaV-7) in leafroll disease and proposed this virus as a member of the genus *Velarivirus*. The analysis of a dsRNA library from an asymptomatic grapevine discovered the presence of GLRaV-7, GRSPaV, GSyV-1, GRVfV, GRGV, HSVd, and GYSVd-1. Chiumenti et al. (2012) performed HTS analysis of vines showing symptoms of enation and spring chlorosis by the comparison of libraries synthesized from dsRNAs or sRNA. A degraded sanitary situation reflected by a virome composed of GLRaV-1, GLRaV-2, and GLRaV-3, GLRaV-4 strains 5 and 9, GVA, GVB, GRSPaV, GFLV, GfKv, and the two viroids (HSVd and GYSVd-1) was revealed from the analysis of data of vines with enations, but results from both libraries were not identical. Particularly, metadata from the dsRNA sequencing were enriched in closterovirus sequences, likely because of the propensity of these viruses to accumulate more replicative intermediate dsRNAs than GFLV. Conversely, the sRNA library allowed a better coverage of the GFLV genome, which likely predominates as a single-stranded RNA. The work did not unveil the etiology of the enation disease due to the large number of viruses involved but allowed to confirm the lack of involvement of GFLV in the disease. A similar complex virome was described in vines showing symptoms of spring chlorosis.

At the 17th meeting of the International Council for the Study of Viruses and Virus-like Diseases of the Grapevine (ICVG) held in Davis in 2012, HTS was put to the forefront with the announcement of the discovery of three new viruses. Al Rwahnih et al. (2012a) identified the new vitivirus *Grapevine virus F* (GVF) in a Cabernet Sauvignon vine inducing graft incompatibility on different rootstock indicators. The partial virus sequence, obtained by the analysis of a dsRNA library, was completed by conventional Sanger sequencing of cDNA fragments. In the same year, Giampetruzzi et al. (2012b) described the second grapevine trichovirus, *Grapevine Pinot gris virus* (GPGV), in vines showing symptoms of chlorotic mottling and leaf deformation. Massive sequencing of two sRNA libraries from symptomless and symptomatic Pinot gris vines disclosed a complex virome composed of GPGV, GRSPaV, GRVfV, GSyV-1, and the two viroids HSVd and GYSVd-1. The presence of the virus also in symptomless vines meant that the etiology of the disease could not be conclusively ascribed to GPGV, although grafting assays reproduced the symptoms. Using a similar approach, Al Rwahnih et al. (2013a) investigated the etiology of a vine showing red blotch symptoms and reddening of leaves that tested negative for the presence of known grapevine leafroll-associated closterovirids. The HTS libraries from three symptomatic vines, deliberately synthesized from dsRNAs isolated without any DNase and RNase digestion, disclosed the presence of a circular, single-stranded DNA showing homologies with members of the family *Geminiviridae*. Again in this case a conclusive assignment of the new virus, *Grapevine red blotch-associated virus* (GRBaV), to the disease was not possible due to the presence of GRSPaV and GLRaV-2 and the lack of symptom

expression in bioassays up to 1 year after grafting. However, a limited survey of field-sampled vines by PCR showed a very close association of GRBaV with red blotch symptoms. GRBaV was concurrently discovered in a further HTS study, which used a RNASeq approach for the synthesis of libraries (Poojari et al. 2013). In the attempt to enrich viral RNA sequences, total RNA preparations were subjected to depletion of ribosomal RNAs with or without selection of messenger RNAs, before library synthesis. A re-examination of the dsRNA library from grape AUD46129, previously analyzed for Syrah decline (Al Rwahnih et al. 2009), led to the discovery of a viral satellite in grapevine (Al Rwahnih et al. 2013b). This finding, besides reporting an agent never described in grapevine, highlights a further advantage of the technology: the opportunity of re-inquiring the HTS libraries to search for new information. Therefore, sequence data from a plant can be subjected to multiple queries in order to discover new viruses or new molecular variants.

Having consolidated its role as a new and powerful tool of investigation, HTS was applied for new scopes. The genetic diversity of GPGV was studied by Glasa et al. (2014), who reported the complete genome of three viral isolates from Slovakia and Czech Republic. The sequencing of sRNA populations from these vines allowed for the identification of nucleotide divergence among Slovak GPGV genomes from the original Italian reference isolate (Giampetruzzi et al. 2012b). The occurrence of a mixed infection with other viruses did not allow to determine an association of the symptomatology with the presence of GPGV. The genetic diversity of GPGV was studied by Saldarelli et al. (2015), who assembled consensus genome sequences of viral isolates using HTS-sequenced sRNA libraries. This strategy, which was based on the mapping of vsRNAs to a reference sequence, was used to identify the more likely GPGV master genome sequence in the viral quasispecies infecting the vines. The phylogenetic clustering of viral consensus genomes separated those originating from symptomless to those derived from symptomatic vines. A combined HTS/Sanger sequencing approach was followed by Maree et al. (2015) to assemble the genome sequence of a divergent variant of GLRaV-3. The consensus sequence obtained by the analysis of a dsRNA library had 12 ambiguous nucleotides in comparison with the Sanger sequence data. The author resolved these ambiguities with the choice of the HTS-obtained base having the higher coverage. In both papers, a superior informative value was given to the HTS data due to the higher coverage of each single nucleotide position in respect to the conventional Sanger sequencing. A French isolate of GPGV was identified in the cv Merlot (Beuve et al. 2015) showing fanleaf-like symptoms by the analysis of a HTS library of total RNAs. Again in this vine the concurrent infection with *Tomato black ring virus* (TBRV) hampered the association of GPGV with the disease symptoms. An enquiry into available HTS metadata (Glasa et al. 2014) was made by Glasa et al. (2015), resulting in a described complete GSyV-1 genome sequence originating from Central Europe. A similar study on South African vineyards also yielded a complete genome of GSyV-1 (Oosthuizen et al. 2016). The sRNA library, which previously allowed to obtain the GPGV genome sequence (Glasa et al. 2014), revealed more information since the vine had a mixed infection with *Arabidopsis mosaic virus* (ArMV), GFLV, *Grapevine deformation virus* (GDefV), GRSPaV, GFkV, GLRaV-1, and GLRaV-3. A complex

virome composed of GLRaV-3, GLRaV-4 strain 5 and 9, GLRaV-7, GVA, GYSVD-1, HSVd, and AGVd was detected in four grapevines by Velasco et al. (2014). The sample library consisted of a pool of sRNA extracted from four different vines sequenced by Ion Torrent technology. The same technology allowed Maliogka et al. (2015) to discover *Grapevine Roditis leaf discoloration-associated virus* (GRLDaV), a new badnavirus, likely associated with an old disease in *V. vinifera* cv Roditis. The virus, whose genome was assembled from a sRNA library, was not conclusively associated with the symptoms since the analyzed vine had a mixed infection with GVA, GVB, and GLRaV-3. The same virus was found in a symptomless grapevine of the *V. vinifera* cv Bombino Nero during the analysis of a sRNA library (Giampetruzzi et al. 2015). HTS proved to be able to identify a new Reovirus in the dsRNA library of a Cabernet Franc source (Al Rwahnih et al. 2015a). This vine, showing severe leafroll disease symptoms, was however mixed infected with GLRaV-2 and GLRaV-3. A re-examination of publicly available metadata obtained in previously sequenced libraries was performed by Jo et al. (2015). These authors screened 11 libraries from total RNAs (RNASeq) of berry, skin, and seed tissues of the grapevine *V. vinifera* cv Tannat that is rich in polyphenolic substances. Transcriptomes originating from the de novo assembly of single libraries or their pooled data gave diverse virome profiles. After excluding the presence of non-grapevine viruses *Alfalfa mosaic virus* (AMV), *Maize rayado fino virus* (MRFV), *Oat blue dwarf virus* (OBDV), and *Potato virus S* (PVS) represented in transcriptomes of single libraries by short contigs, the authors concluded that the virome of the cv Tannat vineyard contained eight viruses and two viroids. Retracing the previous experiences of Al Rwahnih et al. (2009) and Pantaleo et al. (2010a), GRVfV, GAMaV, and GRGV were reliably identified instead of MRFV and OBDV. In addition GRSPaV, GPGV, GLRaV-2, HSVd, *Cucumber mosaic virus* (CMV), and *Potato virus Y* (PVY) also were shown to be part of the virome of the vineyard. The presence of CMV and PVY, known to infect grapevine (Martelli G, 2014), was uncommon, although the PVY genome was completely assembled.

Different Libraries, Strategies and Outputs

The enrichment of dsRNAs, using cellulose affinity purification (spin column or chromatography), is a well-established procedure in plant virology to obtain dsRNA preparations rich in molecules of viral origins (Fig. 30.1). This was the reason that led Al Rwahnih et al. (2009) to select this approach to explore the etiology of Syrah decline by HTS technology. In this work the comparison of libraries of total nucleic acids (TNA) with those of dsRNAs was carried out, with the aim to include possible DNA viruses in the analysis. The authors found that virus-related reads increased from 2% to 53% after dsRNA enrichment, demonstrating that sequencing of this fraction dramatically increases the proportion of reads specific to viruses and viroids, because of the elimination of the host ribosomal RNAs (rRNAs) or other cellular single-stranded RNAs (tRNAs, mRNAs) from dsRNA preparations. The

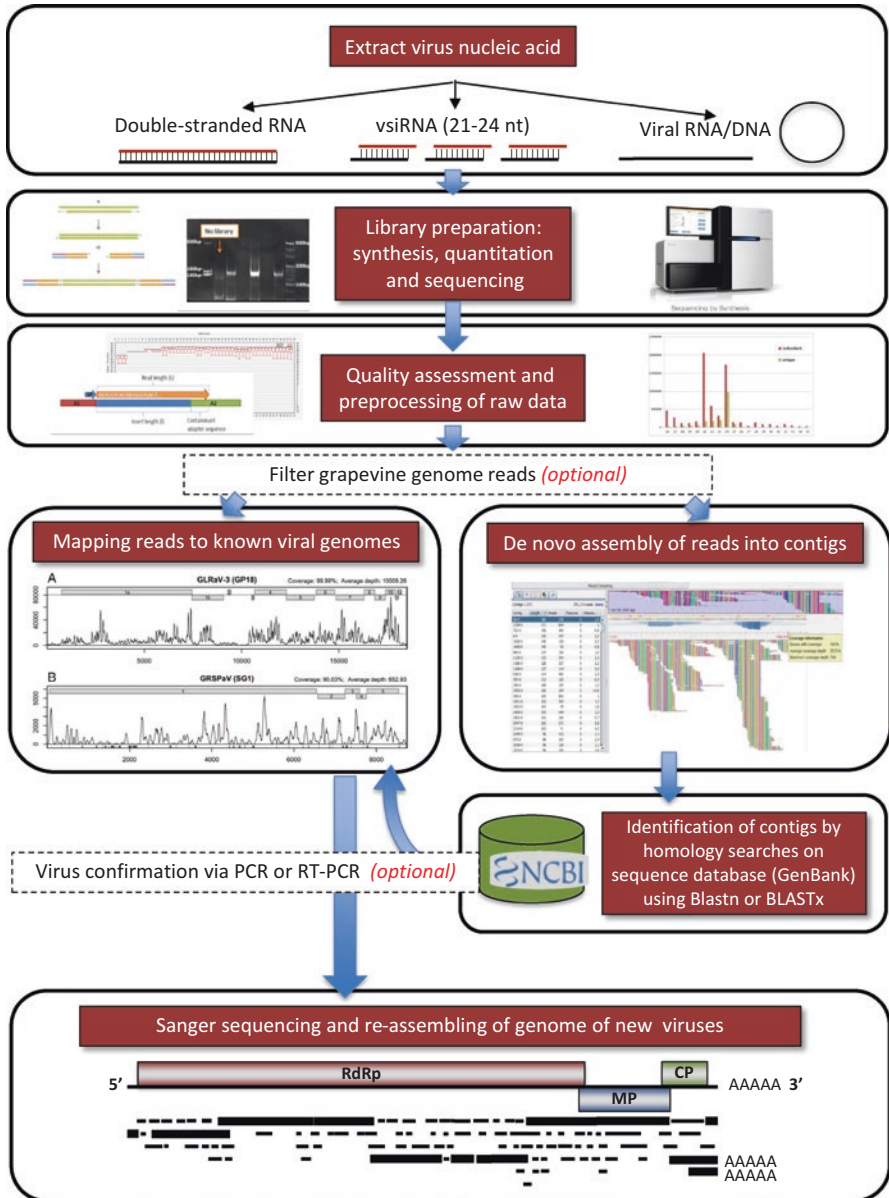

Fig. 30.1 Schematic of the laboratory procedures and the bioinformatic pipeline suggested for the assembly of the genome of a virus by HTS. Main steps related to (1) extraction of viral nucleic acids, (2) library preparation and sequencing, (3) mapping reads to a known genome or (4) de novo assembly of reads into contigs, (5) homology search of contigs by BLAST analysis, and (6) Sanger sequencing for genome confirmation of a new virus are boxed. Optional steps regarding filtering reads against the grapevine genome and virus confirmation by alternative PCR or RT-PCR methods are shown

dsRNA strategy consists of the purification of viral dsRNA and its successive reverse transcription to generate complementary DNA (cDNA). A possible constraint of this strategy is the limited amount of dsRNAs from viruses belonging to the genus *Nepovirus* (i.e., GFLV), because of their poor propensity to accumulate replicative intermediate RNAs (Chiumenti et al. 2012). However, a modified protocol, in which dsRNA preparations were not treated with RNase and DNase before library construction, allowed these authors (Al Rwahnih et al. 2013a) to discover the DNA virus GRBaV, demonstrating the wide potential of the dsRNA strategy.

The more widely used strategy for the enrichment of viral RNAs reads for sequencing consists of the purification of the sRNA fraction from total RNAs. This approach relies on the ability of plants to produce virus-derived small interfering RNAs (vsiRNA) in response to infection by both RNA and DNA viruses. The strategy is commonly known as virus discovery by deep sequencing and assembly of small RNAs (vdSAR; Wu et al. 2015). Its general outline consists of the sRNA enrichment from diseased cells/tissues for deep sequencing by HTS platforms and assembling sequence reads into large sequence contigs/fragments that are then used for virus discovery.

The original protocols to construct a library of sRNAs for sequencing were time-consuming since it required the excision from a polyacrylamide gel of RNA molecules 18–30 nucleotide in size (Lu et al. 2007). Recent HTS investigations do not rely on gel purification of sRNAs and use diverse commercial kit such as mirVana™ miRNA Isolation Kit (Life Technologies, USA) to separate the fraction of low molecular weight RNAs having a size lower than *c.* 300 nucleotides from total RNA preparations. A combined protocol consisting of tissue extraction with a guanidine thiocyanate buffer and successive Trizol (Sigma-Aldrich Inc., USA) and mirVana™ (ThermoFisher, USA) isolation of low molecular weight RNAs has been used (Giampetruzzi et al. 2015). However, in our experience (Giampetruzzi et al. personal communication), gel excision of the 18–30 nucleotide sRNAs provides more informative data since additional host-derived low molecular weight RNAs, which are present in kit-purified preparations, are excluded. Successively, the TruSeq™ Small RNA Sample Prep Kit (Illumina Inc., USA) is used for library construction. Recently, an optimized version for the synthesis of sRNA libraries was used that consisted of the early priming of cDNA synthesis by the RT primer before the 5' adapter ligation (Giampetruzzi et al. 2015). This improved protocol resulted in a high reduction of the presence of the adapter dimer, which still represents a critical step in the synthesis of sRNA libraries.

The only example of use of HTS sequencing of grapevine total RNAs (RNASeq) for virus discovery came from the reexamination of existing libraries of the cultivar Tannat (Jo et al. 2015). The range of viruses and viroids identified in this transcriptome data was similar to what was previously described in dsRNA and sRNA HTS-based approaches.

An issue related to the application of HTS in plant virology, also debated in a specific European project (COST action FA1407, <http://www.cost-divas.eu/>), is the targeted nucleic acid classes to be used for acquiring the data. With the exception of the work of Jo et al. (2015), grapevine viral metagenomic studies have mainly

targeted dsRNAs and vsRNAs, but comparative analysis of the performances of libraries synthesized with both nucleic acid classes in the detection of viruses having diverse replication strategies [i.e., nepoviruses (polyprotein processing); ampeloviruses (subgenomic RNA production)] and tissue localization (i.e., parenchyma vs. phloem) is lacking and needs to be further investigated.

In addition, assays aiming at defining the viral detection limits of the HTS techniques in grapevine need to be performed. Taking into account the existing literature, a library of sRNAs or dsRNAs sequenced by Illumina technology should contain a minimum of 1.0×10^6 unique reads after removing low-complexity and tRNA or rRNA sequences. This library size, although not analytically obtained from ad hoc designed experiments, was sufficient in comprehensively representing the virome of tested vines and detecting unknown viruses.

Established protocols are provided for the 454/Roche pyrosequencing or Illumina sequencing by synthesis technologies to clean up data before sequence assembly and virus identification. Raw sequence data are removed of adaptors and evaluated for quality according to strict parameters and threshold values, and a de-multiplexing step is performed whenever multiple bar-coded libraries are sequenced in a single lane. In addition, the availability of the grapevine genome would allow the subtraction of host sequences and improve bioinformatics analysis. It is clear that *de novo* assembly of sequenced reads is necessary before proceeding to identify viral-related sequences. This assembly process is mainly operated by Velvet (Zerbino and Birney 2008), SOAP (Li et al. 2008), Oases (Schulz et al. 2012), and VCAKE (Jeck et al. 2007) to obtain longer sequences, i.e., contigs. These contigs are successively queried for homologies in public databases by using BLASTN programs. More distant homologies can be found by BLASTX, which can be more sensitive in identifying unknown viruses by recognizing conserved domains or signature motifs in viral proteins (i.e., RNA-dependent RNA polymerase, movement or coat proteins). Although commercial packages (CLC Workbench, Geneius, Stratagene) that do not require specific bioinformatics skills but perform all the analysis with a simplified interface exist, the availability of specifically trained personnel is necessary to complement the field and laboratory work especially for the identification of new viruses.

A possible drawback of *de novo* assembly is the generation of artificial hybrid contigs which can be composed of sequences from different viruses or from a virus and the host. In the first instance, resolving contigs containing reads from taxonomically related virus could be impossible. Whereas the availability of the grapevine genome helps identifying viral contigs containing sequences from the host. However, in the case of unknown viruses, classical Sanger sequencing would confirm the viral origin of the obtained sequences.

A major importance in the assessment of the presence of a virus in a vine rests on the evaluation of the genome coverage and reads/contigs distribution along the viral genome. Due to the low titer that viruses reach in infected grapevine tissues, these conditions should be carefully evaluated particularly for unknown viruses. As an example few contigs having distant homologies with the badnavirus *Fig mosaic*

virus allowed for the identification of *Grapevine Roditis leaf discoloration-associated virus* (Giampetruzzi et al. 2015).

An alternative method for the detection of known viruses in HTS data was developed by Stobbe et al. (2013). In their approach e-probes were designed to detect virus specific reads in raw HTS data. The advantage of this approach is that it does not require the same amount of data or hardware to run as *de novo* assembly does. However, it suffers the obvious drawback that it can only detect known viruses. The probes are designed and evaluated to be unique, and collectively through the analysis, can provide a *p*-value for the probability of infection. The same authors demonstrated the strength of their method by designing e-probes that were able to differentiate genetic variants of *Plum pox virus* (Stobbe et al. 2014). It was the sensitivity and specificity of this detection method that lead Visser et al. (2016) to develop a user-friendly e-probe-based virus detection platform that uses HTS data to detect known viruses. The software they developed, called Truffle, was evaluated for its ability to detect known grapevine viruses in HTS data of a dsRNA library. They found that e-probe-based detection was more sensitive in detecting viruses for which the complete genome sequences are available.

HTS offers great potential for the study of virus evolution, quasispecies, and ecology. Consensus viral genome sequences can be assembled by read mapping toward a virus RNA/DNA sequence using a software for alignment (i.e., SOAP) or by approaches of *de novo* assembly. The high coverage and the quality threshold assigned to each single massively sequenced nucleotide allowed to reconstruct the “master sequence” of the viral quasispecies infecting a plant, without the need for Sanger sequencing. This represents a technological improvement since genome sequences obtained by Sanger sequencing can originate from a mosaic of the different cloned sequences, whether viable or not. This strategy is exemplified in the paper of Seguin et al. (2014) in which HTS is used to reassemble consensus “master genome sequences” of diverse DNA virus and their genome microvariants and to rapidly generate infectious clones of viruses. The same approach was used by Saldarelli et al. (2015) to study the phylogeny of GPGV.

A “Background” Virome in Grapevine

Almost all HTS studies revealed the existence of a grapevine background virome composed of GRSPaV, HSVd, GYSVd-1, and, to a lesser extent, viral species in the genera *Maculavirus* and *Marafivirus*. While enough genome information about GRSPaV and the two viroids are present in nucleotide databases, the complexity and genetic diversity of GSyV-1, GFkV, GRGV, and GRVfV are poorly explored due to the paucity of whole genome data. In support of this latter argument is the recent work of Jo et al. (2015) in which the search of homologies gave a misleading identification of contigs related to tymoviruses (see above), which, only after a careful bioinformatics analysis were correctly assigned to the grapevine species in the family. Although the study of the etiology of these viruses is not a matter of

discussion in the present review, we have noted that they are regularly found in HTS-sequenced grapevine libraries to the point that they could be considered stable components of the virome. This would seem to indicate that a “virus-free” grapevine is a misnomer and most likely unnecessary. According to this “microbiome” view, the role of these background viruses and viroids, even if invoked for their synergistic role, is not primarily critical in the expression of disease symptoms since these are induced by the additional infection of really damaging viruses. In this view it is the superinfection of these damaging viruses that disrupts the existing virome, leading to the expression of symptoms. Whether or not a newly discovered virus is able to induce, alone or in synergy, a disease expression is not important for a practical point of view since it has to be excluded from foundation stocks of vine material. Moreover, it should be highlighted that this background virome existed before the use of HTS and this did not hamper the association of damaging viruses (i.e., leafroll viruses and vitiviruses) with diseases. Lessons from the HTS experiences are that the equilibrium of the grapevine virome is disrupted by the presence of severely damaging viruses, which of course must be excluded from plant propagation material.

HTS in Grapevine/Virus Interactions

Following the growing interest aroused by the RNA silencing in plants, Pantaleo et al. (2010b) analyzed the sRNA libraries from cv Pinot Noir clone ENTAV-INRA 115 and described the first grapevine “microRNAome” in different plant organs. This paper, although designed to identify grape-specific microRNAs (miRNAs) and their targets, constituted the basic sRNA dataset that allowed the identification of viruses (Pantaleo et al. 2010a) and viroids (Navarro et al. 2009) infecting this commercial grapevine clone. Different from similar studies in other species, grapevine presented an abundant 21 nucleotide-long sRNA population. The authors explained this unusual size distribution with the onset of a progressive silencing of the 24 nucleotides heterochromatic loci in perennial hosts in comparison with annual plants in which this population prevails. This uncommon sRNA profile showing a prevalent 21 nucleotide size population was repeatedly found in vines healthy or infected by GFLV (Giampetruzzi et al. 2012a) and GLRaV-3 (Alabi et al. 2012). These studies confirmed that the antiviral RNA silencing in grapevines generates prevailing viral small interfering RNAs (vsiRNAs) that are 21, 22, and 24 nucleotide long (Alabi et al. 2012; Pantaleo et al. 2010a), similarly to the pathway operating in the model species *Arabidopsis thaliana*. In agreement with the hypothesis that the substrate of RNA silencing is viral dsRNA, almost similar amount of plus (+) and minus (–) strand GLRaV-3 vsiRNAs were found (Alabi et al. 2012). Conversely, RNA silencing toward GFLV and GRSPaV yielded predominant (+) sense vsiRNAs, likely supporting the hypothesis that highly structured single-stranded regions of the viral genome RNA are degraded (Szittyta et al. 2010). It is not known whether this diverse behavior originates from different replication

mechanisms of the ampelovirus GLRaV-3, which, differently from the nepovirus GFLV and the foveavirus GRSPaV, accumulates more dsRNAs. Exceptions were found for members of the family *Tymoviridae*: *Grapevine fleck virus* (GFkV), *Grapevine Red Globe virus* (GRGV), and *Grapevine asteroid mosaic-associated virus* (GAMaV) (Pantaleo et al. 2010a), which had dominant 21, 22, and 24 nucleotide (–) sense vsiRNAs. The explanation for this unusual finding could rely on the particular genome composition of members of this virus family, which is rich in cytosines. The integration of vsiRNAs data originating from GFkV and GRSPaV genomes with those from a library of cleaved uncapped host transcripts of a “degradome” dataset was investigated by Miozzi et al. (2013). This particular analysis, which is based on the sequencing of the mRNAs fraction of molecules cleaved by miRNAs and vsiRNAs, allowed to identify in silico several vsiRNAs likely targeting grapevine mRNAs. Many of the identified grapevine mRNAs encode proteins possibly responsible of symptoms due to their involvement in ribosome biogenesis and in biotic and abiotic stresses. Virus-induced expression of miRNAs was reported by Singh et al. (2012) in vines infected by GVCV. These authors described 54 new *Vitis vinifera* miRNAs, of which six were exclusively detected in GVCV-infected vines. Besides miRNAs known to be induced during viral infections (vvimiR168 and vvimiR3623), the new vvimiRNA18 was identified, which was shown to target in silico a mRNA encoding a transcription factor regulating plant development and stress responses.

HTS in Grapevine Virus Certification: Toward the Adoption of a Common Language

A thorough, sensitive reliable analysis certifying the absence of major viral pathogens is fundamental to grapevine clean stock certification programs, which are necessary for the assessment of the sanitary status of the nuclear stocks at the base of the process. In all national or state-regulated protocols for the production of clean propagation materials, candidate nuclear plants are subjected to bioassays on a set of indicators, whose reliability suffers from the lack of shared protocols and the varied success rates of bud-take and climatic conditions (Constable et al. 2013). HTS now provides the most comprehensive detection technology for certifying the phytosanitary status of commercial grapevine propagation stocks. Al Rwahnih et al. (2015b) compared HTS analysis against the currently mandated bioassay used in the registration of grapevine material. HTS analysis was found to be superior to the standard bioassay in detection of viruses of agronomic significance, including virus infections at low titers. Unlike the bioassay, HTS was not affected by environmental conditions and was effective in the detection of asymptomatic viral strains. HTS was also found to be superior to the bioassay in its accuracy and comprehensiveness, and in the cost of its analysis. The analysis can be completed in a number of weeks, as opposed to years for the bioassay. The study by Al Rwahnih concluded

that HTS provides the highest standard available for the certification of grapevine material as free of the major listed viral pathogens.

With its capacity to identify unknown viruses to the viral family level (through generic analysis of viral genomic sequences), HTS has also become the method of choice for the discovery of novel, uncharacterized grapevine viruses. However, HTS analysis cannot be used to describe biological characteristics of novel viruses, such as their pathogenicity. The agronomic significance of newly discovered (so potentially invasive) viruses must be discovered through the observation of infected plants. HTS can facilitate such *in vivo* studies by providing the sequences of novel viruses from which PCR detection assays can be designed. These assays can then be used to (1) analyze the graft transmissibility of novel agents, (2) characterize the distribution and spread of novel viruses in field survey studies, and (3) correlate the presence of the virus with the presence of disease symptoms. Such studies are needed to establish the viticultural significance of viruses discovered during HTS analysis, prior to their addition to registration and certification lists.

Conclusions and Directions for Future Researches

HTS provided significant improvements in grapevine virology both in the applied and the basic science fields. Research that is otherwise limited by the non-transmissibility to herbaceous hosts of the majority of infectious agents hosted by the grapevine, their low titers, and the difficulties in working with woody tissues benefitted from the technology. The study of vine/virus interactions is largely facilitated and allowed to make inferences and establish similarities with known pathways of plant response to viral infections. HTS has become the method of choice in the study of new diseases and the discovery of new viruses although it remains a technique that complements biological assays specifically designed to define disease etiology. HTS alone has not been able to explain the etiology of complex diseases in which viruses likely synergistically contribute to the expression of symptoms. Examples of this are the studies on Syrah decline and Shiraz disease. In these cases a carefully planned research considering the contribution of each virus in the expression of symptoms, the diverse susceptibility of grapevine cultivars to the disease, and the existence of viral variants with different pathogenicity should be considered in future studies. Moreover, the possible presence of unknown agent(s) belonging to completely new viral taxa with no similarities in the databases cannot be excluded. As nucleotide databases are enriched with new viral sequences and/or new efficient software are developed, available metadata should be re-examined to look for previously undescribed viruses. As an example the re-examination of HTS data from 2011 (Martelli et al. 2012) originating from the GLRaV-7-infected vine isolate AA42 revealed the presence of GLRaV-4. This virus could not be detected at the time of sequencing since the GLRaV-4 genome (FJ467503) was only made available in the NCBI database in February 2012.

More sequencing efforts to explore viral diversity in the genera *Maculavirus* and *Marafivirus* and specifically designed assays to evaluate their etiological role are desirable. According to the view of Roossinck et al. (2015), “background viruses” which are recurrently present in almost all sequenced grapevine viromes can be considered healthy component of the vine holobiome, whereas disease occurs when a perturbation is induced by the infection of an additional, pathogenic virus. In this framework causation of a disease must take into account microbial interactions as shown in a recent review regarding the adaptation of Koch’s postulates in relation to technology improvements (Byrd and Segre 2016).

In the near future, we can imagine that each grapevine mother plant could be equipped with its HTS-generated metadata passport and the corresponding virome obtained according to shared standards and the state of the art in grapevine virology at the time of sampling. This “vine metagenome passport” certification will promote the adoption of internationally recognized standards for the movement and exchange of grapevine propagation material, which are now lacking.

Acknowledgments This work was supported by the following projects: **Re.Ge.Vi.P.** project (“Recupero del germoplasma viticolo pugliese”), funded by Regione Puglia, Italy, in the frame of the PSR 2007-2013, Measure 214, action 4a, “Progetti integrati per la Biodiversità.” METAGERM (in the frame of “Conoscenze Integrate per la Sostenibilità e l’Innovazione del made in Italy Agroalimentare,” Ministry of Economy, Italy). The NGS activity was hosted by the Illumina platform at Rete di laboratori pubblici di ricerca SELGE (www.selge.uniba.it).

References

- Alabi, O.J., Y. Zheng, G. Jagadeeswaran, R. Sunkar, and R.A. Naidu. 2012. High-throughput sequence analysis of small RNAs in grapevine (*Vitis vinifera* L.) affected by grapevine leafroll disease. *Molecular Plant Pathology* 13: 1060–1076.
- Al Rwahnih, M., S. Daubert, D. Golino, and A. Rowhani. 2009. Deep sequencing analysis of RNAs from a grapevine showing Syrah decline symptoms reveals a multiple virus infection that includes a novel virus. *Virology* 387: 395–401.
- Al Rwahnih, M., S. Daubert, J.R. Urbez-Torres, F. Cordero, and A. Rowhani. 2011 Mar. 2011. Deep sequencing evidence from single grapevine plants reveals a virome dominated by mycoviruses. *Archives of Virology* 156: 397–403.
- Al Rwahnih, M., V.V. Dolja, S. Daubert, E.V. Koonin, and A. Rowhani. 2012a. Genomic and biological analysis of *Grapevine leafroll-associated virus 7* reveals a possible new genus within the family *Closteroviridae*. *Virus Research* 163: 302–309.
- Al Rwahnih, M., M.R. Sudarshana, J.K. Uyemoto, and A. Rowhani. 2012b. Complete Genome sequence of a novel vitivirus isolated from grapevine *Genome Announcements*. doi:10.1128/JVI.01444-12.
- Al Rwahnih, M., A. Dave, M.M. Anderson, A. Rowhani, J.K. Uyemoto, and M.R. Sudarshana. 2013a. Association of a DNA virus with grapevines affected by red blotch disease in California. *Phytopathology* 103: 1069–1076.
- Al Rwahnih, M., S. Daubert, M.R. Sudarshan, and A. Rowhani. 2013b. Gene from a novel plant virus satellite from grapevine identifies a satellite lineage. *Virus Genes* 47: 114–118.

- Al Rwahnih M., D. Golino, S. Daubert, and A. Rowhani. 2015a. Characterization of a novel reovirus species in Cabernet Grapevine in California. In *Proceedings of the 18th ICVG congress*, Ankara, September 7–11, 2015, 194–195.
- Al Rwahnih, M., S. Daubert, C. Islas, D.A. Golino, and A. Rowhani. 2015b. Comparison of Next Generation Sequencing vs. Biological Indexing for the Optimal Detection of Viral Pathogens in Grapevine. *Phytopathology* 6: 758–763.
- Beuve, M., T. Candresse, M. Tannières, and O. Lemaire. 2015. First Report of *Grapevine Pinot gris virus* (GPGV) in grapevine in France. *Plant Disease* 99: 293.
- Byrd, A.L., and J.A. Segre. 2016. Adapting Koch's postulates. *Science* 351: 224–226.
- Chiumenti, M., A. Giampetruzzi, C. Pirolo, M. Morelli, P. Saldarelli, A. Minafra, G. Bottalico, P. La Notte, A. Campanale, V. Savino, and G.P. Martelli. 2012. Approaches of Next Generation Sequencing to Investigate Grapevine Diseases of Unknown Aetiology. In *Proceedings of the 17th congress of ICVG*, Davis, California, USA, October 7–14, 116–117.
- Coetzee, B., M.J. Freeborough, H.J. Maree, J.M. Celton, D.J. Rees, and J.T. Burger. 2010. Deep sequencing analysis of viruses infecting grapevines: virome of a vineyard. *Virology* 400: 157–163.
- Constable, F.E., J. Connellan, P. Nicholas, and G.C. Rodoni. 2013. The reliability of woody-indexing for detection of grapevine virus-associated diseases in three different climatic conditions in Australia. *Australian Journal of Grape and Wine Research* 19: 74–80.
- Espach, Y., H.J. Maree, and J.T. Burger. 2012. The use of next-generation sequencing to identify novel mycoviruses in individual grapevine plants. In *Proceedings of the 17th congress of ICVG*, Davis, USA October 7–14, 114–115.
- Giampetruzzi, A., R. Roberto, P. La Notte, C. Pirolo, and P. Saldarelli. 2012a. Small RNAs profiling in Virus-infected Grapevines. In *Proceedings of the 17th congress of ICVG*, Davis, California, USA, October 7–14, 158–159.
- Giampetruzzi, A., V. Roumi, R. Roberto, U. Malossini, N. Yoshikawa, P. La Notte, F. Terlizzi, R. Credi, and P. Saldarelli. 2012b. A new grapevine virus discovered by deep sequencing of virus- and viroid-derived small RNAs in cv Pinot gris. *Virus Research* 163: 262–268.
- Giampetruzzi, A., M. Morelli, M. Chiumenti, V.N. Savino, G.P. Martelli, P. La Notte, F. Palmisano, and P. Saldarelli. 2015. Towards the definition of the absolute sanitary status of certified grapevine clones and rootstocks. grapevine clones and rootstocks. In *Proceedings of the 18th ICVG congress*, Ankara, September 7–11, 146–147.
- Glasa, M., L. Predajňa, P. Komínek, A. Nagyová, T. Candresse, and A. Olmos. 2014. Molecular characterization of divergent *Grapevine Pinot gris virus* isolates and their detection in Slovak and Czech grapevines. *Archives of Virology* 159: 2103–2107.
- Glasa, M., L. Predajňa, K. Soltys, S. Sabanadzovic, and A. Olmos. 2015. Detection and molecular characterisation of *Grapevine Syrah virus-1* isolates from Central Europe. *Virus Genes* 51: 112–121.
- Jeck, W.R., J.A. Reinhardt, D.A. Baltrus, M.T. Hickenbotham, V. Magrini, E.R. Mardis, J.L. Dangl, and C.D. Jones. 2007. Extending assembly of short DNA sequences to handle error. *Bioinformatics* 23: 2942–2944.
- Jo, Y., H. Choi, J.K. Cho, J.Y. Yoon, S.K. Choi, and W.K. Cho. 2015. *In silico* approach to reveal viral populations in grapevine cultivar Tannat using transcriptome data. *Scientific Reports* 5 (15841): 2015. doi:10.1038/srep15841.
- Kircher, M., and J. Kelso. 2010. High-throughput DNA sequencing—concepts and limitations. *Bioessays* 32: 524–536.
- Kreuze, J.F., A. Perez, M. Untiveros, D. Quispe, S. Fuentes, I. Barker, and R. Simon. 2009. Complete viral genome sequence and discovery of novel viruses by deep sequencing of small RNAs: a generic method for diagnosis, discovery and sequencing of viruses. *Virology* 388: 1–7.
- Li, R., Y. Li, K. Kristiansen, and J. Wang. 2008. SOAP: short oligonucleotide alignment program. *Bioinformatics* 24: 713–714.
- Lu, C., B.C. Meyers, and P.J. Green. 2007. Construction of small RNA cDNA libraries for deep sequencing. *Methods* 43: 110–117.

- Maliogka, V.I., A. Olmos, P.G. Pappia, L. Lotosa, K. Efthimiou, G. Grammatikaki, T. Candresse, N.I. Katis, and A.D. Avgelis. 2015. A novel grapevine badnavirus is associated with the Roditis leaf discoloration disease. *Virus Research* 203: 47–55.
- Maree H.J., Y. Espach, D.J.G. Rees, and J. Burger. 2012. A Study of Shiraz Disease Etiology Using Next-Generation Sequencing Technology In *Proceedings of the 17th congress of ICVG*, Davis, California, USA, October 7–14, 100–102
- Maree H.J., M.D. Pirie, K. Oosthuizen, R. Bester, D.J.G. Rees, and J.T. Burger. 2015. Phylogenomic analysis reveals deep divergence and recombination in an economically important grapevine virus. *PLoS One*. 2015 May 18;10(5):e0126819. doi:[10.1371/journal.pone.0126819](https://doi.org/10.1371/journal.pone.0126819)
- Martelli, G. 2014. Directory of virus and virus-like diseases of the grapevine and their agents. *Journal of Plant Pathology* 96 (1S): 7–8.
- Martelli, G.P., N.A. Ghanem-Sabanadzovic, A. Agranovsky, M. Al Rwahnih, V.V. Dolja, C.I. Dovas, M. Fuchs, P. Gugerli, J.S. Hu, W. Jelkmann, N.I. Katis, V.I. Maliogka, M.J. Melzer, W. Menzel, A. Minafra, M.E. Rott, Rowhani, S. Sabanadzovic, and P. Saldarelli. 2012. Taxonomic revision of the family *Closteroviridae* with special reference to the grapevine leafroll-associated members of the genus ampelovirus and the putative species unassigned to the family. *Journal of Plant Pathology* 94: 7–19.
- Miozzi, L., G. Gambino, J. Burgyan, and V. Pantaleo. 2013. Genome-wide identification of viral and host transcripts targeted by viral siRNAs in *Vitis vinifera*. *Molecular Plant Pathology* 14: 30–43.
- Navarro, B., V. Pantaleo, A. Gisel, S. Moxon, T. Dalmay, et al. 2009. Deep Sequencing of Viroid-Derived Small RNAs from Grapevine Provides New Insights on the Role of RNA Silencing in Plant-Viroid Interaction. *PLoS One* 4 (11): e7686. doi:[10.1371/journal.pone.0007686](https://doi.org/10.1371/journal.pone.0007686).
- Oosthuizen, K., B. Coetzee, H.J. Maree, and J.T. Burger. 2016. First Report of Grapevine Syrah virus-1 in South African Grapevines. *Plant Disease* 100 (6): 1252.
- Pantaleo, V., P. Saldarelli, L. Miozzi, A. Giampetruzzi, A. Gisel, S. Moxon, T. Dalmay, G. Bisztray, and J. Burgyan. 2010a. Deep sequencing analysis of viral short RNAs from an infected Pinot Noir grapevine. *Virology* 408: 49–56.
- Pantaleo, V., G. Szittyá, S. Moxon, L. Miozzi, V. Moulton, T. Dalmay, and J. Burgyan. 2010b. Identification of grapevine microRNAs and their targets using high-throughput sequencing and degradome analysis. *The Plant Journal* 62: 960–976.
- Poojari, S., O.J. Alabi, V.Y. Fofanov, and R.A. Naidu. 2013. A Leafhopper-Transmissible DNA Virus with Novel Evolutionary Lineage in the Family Geminiviridae Implicated in Grapevine Redleaf Disease by Next-Generation Sequencing. *PLoS One* 8: e64194.
- Roossinck, M.J., D.P. Martin, and P. Roumagnac. 2015. Plant virus metagenomics: Advances in virus discovery. *Phytopathology* 105: 716–727.
- Saldarelli, P., A. Giampetruzzi, M. Morelli, U. Malossini, C. Pirolò, P. Bianchedi, and V. Gualandri. 2015. Genetic Variability of Grapevine Pinot gris virus and Its Association with Grapevine Leaf Mottling and Deformation. *Phytopathology* 105: 555–563.
- Sanger, F., S. Nicklen, and A.R. Coulson. 1977. DNA sequencing with chain-terminating inhibitors. *Proceedings of the National Academy of Sciences of the United States of America* 74: 5463–5467.
- Schulz, M.H., D.R. Zerbino, M. Vingron, and E. Birney. 2012. Oases: robust *de novo* RNA-seq assembly across the dynamic range of expression levels. *Bioinformatics* 28: 1086–1092.
- Seguin, T.M., R. Rajeswaran, N. Malpica-Lopez, R.R. Martin, K. Kasschau, V.V. Doljia, P. Otten, L. Farinelli, and M.M. Pooggin. 2014. *De novo* reconstruction of consensus master genomes of plant RNA and DNA viruses from siRNAs. *PLoS One* 9: e88513.
- Singh, K., A. Talla, and W. Qiu. 2012. Small RNA profiling of virus-infected grapevines: evidences for virus infection associated and variety-specific miRNAs. *Functional & Integrative Genomics* 12: 659–669.
- Stobbe, A.H., J. Daniels, A.S. Espindola, R. Verma, U. Melcher, F. Ochoa-Corona, C. Garzon, J. Fletcher, and W. Schneider. 2013. E-probe Diagnostic Nucleic acid Analysis (EDNA): a theoretical approach for handling of next generation sequencing data for diagnostics. *Journal of Microbiological Methods* 94: 356–366.

- Stobbe, A.H., W.L. Schneider, P.R. Hoyt, and U. Melcher. 2014. Screening metagenomic data for viruses using the e-probe diagnostic nucleic acid assay. *Phytopathology* 104: 1125–1129. doi:[10.1094/PHYTO-11-13-0310-R](https://doi.org/10.1094/PHYTO-11-13-0310-R).
- Szittya, G., S. Moxon, V. Pantaleo, G. Toth, R.L. Rusholme Pilcher, V. Moulton, et al. 2010. Structural and Functional Analysis of Viral siRNAs. *PLoS Pathogens* 6: e1000838. doi:[10.1371/journal.ppat.1000838](https://doi.org/10.1371/journal.ppat.1000838).
- Velasco, L., J. Bota, R. Montero, and E. Cretazzo. 2014. Differences of three ampeloviruses' multiplication in plant may explain their incidences in vineyards. *Plant Disease* 98: 395–400.
- Visser, M., J.T. Burger, and H.J. Maree. 2016. Targeted virus detection in next-generation sequencing data using an automated e-probe based approach. *Virology* 495: 122–128.
- Wu, Q., S.W. Ding, Y. Zhang, and S. Zhu. 2015. Identification of Viruses and Viroids by Next-Generation Sequencing and Homology-Dependent and Homology-Independent Algorithms. *Annual Review of Phytopathology* 53: 425–444.
- Zerbino, D.R., and E. Birney. 2008. Velvet: algorithms for *de novo* short read assembly using de Bruijn graphs. *Genome Research* 18: 821–829.
- Zhang, Y., K. Singh, R. Kaur, and W. Qiu. 2011. Association of a novel DNA virus with the grapevine vein-clearing and vine decline syndrome. *Phytopathology* 101: 1081–1090.

Chapter 31

Biotechnology Applications of Grapevine Viruses

V.V. Dolja and B. Meng

Abstract Plant virus genomes are engineered as vectors for functional genomics and production of foreign proteins. The application of plant virus vectors is of potential interest to the worldwide, multibillion dollar, grape and wine industries. These applications include grapevine functional genomics, pathogen control, and production of beneficial proteins such as vaccines and enzymes. However, grapevine virus biology exerts certain limitations on the utility of the virus-derived gene expression and RNA interference vectors. As is typical for viruses infecting woody plants, several grapevine viruses exhibit prolonged infection cycles and relatively low overall accumulation levels, mainly because of their phloem-specific pattern of systemic infection. Here we consider the biotechnology potential of grapevine virus vectors with a special emphasis on members of the families *Closteroviridae* and *Betaflexiviridae*.

Keywords Plant viruses • Gene expression vectors • RNAi • Functional genomics • Grapevine • *Closteroviridae* • *Betaflexiviridae*

Introduction

The decades-long history of transient gene expression vectors derived from plant viruses went through a period of initial exuberance followed by a more sober understanding and development of their practical applications (Dawson 2014; Gleba et al. 2014). A main promise of viral vectors is their abilities to replicate and to produce high levels of virus-derived mRNAs and proteins with no need for stable plant transformation resulting in genetically modified plants. These abilities are particularly

V.V. Dolja (✉)

Department of Botany and Plant Pathology and Center for Genome Research and Biocomputing, Oregon State University, Corvallis, Oregon 97331, USA
e-mail: doljav@oregonstate.edu

B. Meng

Department of Molecular and Cellular Biology, University of Guelph,
Guelph, ON, Canada

strong in positive-strand RNA viruses that directly replicate mRNAs using their RNA-dependent RNA polymerase (RdRp) and RdRp recognition signals present in viral RNAs. In contrast, plant hosts, similar to all other cellular organisms, do not replicate their mRNAs, but rather transcribe them from their DNA genomes. The only known RNAs replicated by plants are small interfering RNAs or siRNAs that are derived from double-stranded RNA produced by the host RdRp that is nonhomologous to viral RdRps (Shabalina and Koonin 2008).

The major applications of plant virus vectors are epitomized by *Tobacco mosaic virus* (TMV), *Tobacco rattle virus* (TRV), and *Potato virus X* (PVX) (Kumagai et al. 1995; Ratcliff et al. 2001; Burton et al. 2000), which are the most widely used in protein expression and functional genomics. The TMV vector is characterized by a fast infection cycle and extremely high levels of virus-encoded protein accumulation in infected cells and plants. The major drawback of this vector is a relatively low genetic stability that results in a rapid loss of the inserted foreign genes. To mitigate this drawback, streamlined/deconstructed TMV vectors delivered by agroinoculation were designed (Gleba et al. 2014). By avoiding genetic bottlenecks of the virus systemic transport that favor deletion of foreign inserts, massive direct agro-infection of whole plants has deflected the virus infection cycle toward rapid protein production. By deleting the TMV capsid protein gene required for systemic infection, the host cell resources were redirected to mass production of the recombinant protein, thus elevating the yield to 80% of the total soluble protein in leaf tissue or 5 g per kg of the “wet” leaf biomass (Gleba et al. 2014).

The RNA interference (RNAi) machinery is one of the molecular signatures of eukaryotes that has likely emerged as an antiviral host defense response and has subsequently diversified to fulfill a multitude of additional functions (Shabalina and Koonin 2008). Unlike animals, plants do still rely on RNAi as a major way to withstand viral infections. In a counter-defense response, a variety of diverse RNAi suppressors have evolved in plant viruses (Csorba et al. 2015). As a result, modulation of virus infection process by the interplay between plant RNAi and viral suppressors results in a spectrum of virus infection cycle scenarios ranging from host immunity to extreme susceptibility, depending on specific virus-host combinations and environmental conditions. One of the rather counter-intuitive outcomes of such interplay is virus-induced gene silencing (VIGS), a process whereby insertion of a recombinant nucleic acid fragment into virus genome triggers RNAi-mediated degradation of the RNAs possessing identical sequence. The VIGS approach is now widely used in functional genomics via transient silencing of the endogenous plant genes and assessing the resulting phenotypes. Although several plant viruses infecting both dicots and monocots were developed into VIGS vectors (Lacomme 2014), one derived from TRV appears to be the most potent and most widely used in such studies (Bachan and Dinesh-Kumar 2012).

This review focuses on the biotechnological potential of grapevine viruses (such as its applications in protein expression and functional genomics) that depends primarily on knowledge of their replication and genome expression mechanisms and particular features of their host biology.

Arguably, the most significant impediment to developing virus vector technologies for grapevine is the recalcitrance of this woody plant host to both mechanical inoculation and agro-infiltration, two techniques broadly used to launch virus vectors into host plants. In vineyard settings, most of the grapevine viruses are transmitted either by invertebrate vectors, such as mites, mealybugs, or nematodes, or by grafting and top working, processes that are prohibitive for the use of engineered virus vectors. Furthermore, the systemic spread of the viruses in grapevine upon initial infection is slow, on a scale of months, another obstacle to facile development of useful virus vectors. Here, we will consider the most promising approaches to overcoming these problems and paving the way to broader implementation of the virus vector technologies suited for grapevine.

Although in theory any of the grapevine-infecting viruses can be engineered into transient gene expression or VIGS vector, in practice, only one of them, the filamentous *Grapevine leafroll-associated virus-2* (GLRaV-2) from the genus *Closterovirus* (family *Closteroviridae*), was demonstrated to fulfill these roles (Dolja and Koonin 2013; Kurth et al. 2012). Ongoing work will likely result in successful development of additional vectors derived from other members of the family *Closteroviridae*. Certain progress has also been made toward developing vectors based on representatives of the genera *Vitivirus* and *Foveavirus* of the family *Betaflexiviridae* that are also filamentous, positive-strand RNA viruses (Muruganantham et al. 2009; Meng et al. 2012). Additional attractive opportunities in this field include *Grapevine fan-leaf virus* (GFLV), an icosahedral, positive-strand RNA nepovirus capable of expressing a recombinant protein (Amari et al. 2010), and a single-strand DNA, geminivirus-like *Grapevine red blotch-associated virus* (Sudarshana et al. 2015).

Closterovirus-Derived Gene Expression and VIGS Vectors

The *Closteroviridae* is a large and economically important family of positive-strand RNA viruses that infect a variety of crop plants including grapevine, citrus, small fruits, and vegetables. The genomes of closterovirids are the largest among plant RNA viruses and come second to only those of the family *Coronaviridae* of animal viruses (Dolja et al. 2006). Based on phylogenetic analysis, genome architecture, and transmission by distinct insect vectors, this family is classified into four virus genera: the aphid-transmitted *Closterovirus*, the mealybug-transmitted *Ampelovirus*, the whitefly-transmitted *Crinivirus* (Dolja et al. 2006; Karasev 2000), and *Velarivirus* for which no insect vector is known (Al Rwahnih et al. 2012; Martelli et al. 2012). Each of these genera except for the genus *Crinivirus* contains grapevine-infecting viruses, most of which are associated with the leafroll disease complex. Among these viruses, only GLRaV-2, a closterovirus, has been so far engineered into a vector capable of systemic infection of grapevine that either produces recombinant protein or elicits VIGS response (Kurth et al. 2012). The most important aspects of *Closterovirus* research that enabled this development are considered below.

The first prerequisite of generating an RNA virus-based vector is a fully biologically active cDNA clone of the virus genome. Originally, such a clone has been developed for *Beet yellows virus* (BYV), a prototype closterovirus (Dolja 2003; Peremyslov and Dolja 2007). Due to the large size of BYV genome (15.5 kb), this development has been done in three steps. First, a full-length cDNA clone was generated and demonstrated to be replication-competent upon protoplast transfection with in vitro transcripts, allowing mapping of the replication-associated genes (Peremyslov et al. 1998). At the time, it was the largest cDNA clone available for any RNA virus. However, because this clone was defective in virus cell-to-cell movement, screening of additional BYV cDNA clones has been done, yielding variants competent in cell-to-cell movement (Peremyslov et al. 1999). Finally, due to relatively low infectivity of RNA transcripts upon mechanical inoculation, the viral cDNA has been cloned into a binary plasmid useful for agro-inoculation, a more efficient inoculation technique aided by agrobacteria that launch viral cDNA into plant cell nuclei, jump-starting its transcription followed by RNA translation and replication (Prokhnevsky et al. 2002).

All of the three incarnations of the BYV cDNA were tagged with either β -glucuronidase (GUS) or green fluorescent protein (GFP) reporters to facilitate measurements of virus replication and to visualize infected cells. Using these vectors was paramount to the identification of genes contributing to genome replication (Peng and Dolja 2000; Peremyslov et al. 1998), virus cell-to-cell movement (Alzhanova et al. 2000; Peremyslov et al. 1999, 2004b), virion assembly (Napuli et al. 2000, 2003; Peremyslov et al. 2004a), as well as the interdependence of the latter two processes (Alzhanova et al. 2001, 2007). Finally, two genes contributing to BYV systemic transport (Peng et al. 2003; Prokhnevsky et al. 2002) and a gene coding for a strong RNAi suppressor (Reed et al. 2003) were also identified, thus completing the functional characterization of the BYV genome (Dolja 2003). It was later found that co-expression of strong suppressors of RNAi with the BYV cDNA increased the number of primarily infected cells upon agro-inoculation by up to three orders of magnitude, thus boosting the efficiency of this process (Chiba et al. 2006). This phenomenon emphasized a critical role of a host RNAi defense in the virus invasiveness, that is, the ability to establish infection in the primarily inoculated cells. In addition, mapping of the transcription start sites of the BYV subgenomic RNAs and characterization of the dynamics of their accumulation provided critical information on the mechanisms of BYV genome expression (Agranovsky et al. 1994; Hagiwara et al. 1999; Peremyslov and Dolja 2002; Vitushkina et al. 2007).

Concurrently, important work on other closterovirids, *Citrus tristeza virus* (CTV) (Dawson et al. 2015) and *Lettuce infectious yellows virus* (LIYV, genus *Crinivirus*) (Tian et al. 1999), provided synergistic contributions to understanding of their molecular biology and functional genomics. In particular, a replication-competent CTV cDNA clone, even larger than that of BYV, has been generated and tagged with reporter genes (Folimonov et al. 2007; Satyanarayana et al. 1999). The more recently developed CTV-based gene expression vectors were shown to be not only capable of systemic infection in the natural citrus hosts but also exhibited remark-

able genetic stability in regard to retention of the inserted recombinant gene, as well as VIGS capability (Dawson et al. 2015; Hajeri et al. 2014).

The studies of BYV provided the bulk of knowledge on the engineering of the closterovirus genome required to generate an analogous cDNA clone of GLRaV-2. There were, however, several features that distinguish the two viruses and had to be investigated before this task could be successfully accomplished. Unlike BYV, which has one papain-like leader proteinase that is required for efficient genome amplification and systemic infection (Peng et al. 2003; Peng and Dolja 2000), GLRaV-2 has two such proteases that have likely evolved via gene duplication and functional divergence (Meng et al. 2005; Peng et al. 2001). Similar to other members of the family *Closteroviridae*, BYV is transmitted by aphids, whereas no aphid or other insect vectors are known for GLRaV-2, which, in agricultural settings, is transmitted exclusively by grafting or top working (Angelini et al., this book). This latter feature of GLRaV-2 is a positive attribute in regard to its vector potential, because it mitigates regulatory concerns for the uncontrolled spread of the modified virus via biological vectors. Perhaps, the most prominent biological differences between the two viruses is that BYV naturally infects several herbaceous hosts and is capable of exiting the phloem into surrounding tissues, whereas GLRaV-2 is only found in grapevine, where it is limited to phloem, similar to other grapevine viruses from the genera *Ampelovirus* and *Velarivirus* (Martelli et al. 2012). Importantly, grapevine is a perennial woody host that is recalcitrant to mechanical inoculation by viruses, likely due to leaf hardness defined both in physical and chemical terms. It should be emphasized, however, that unlike other closteroviruses of the leafroll disease complex, GLRaV-2 can be mechanically transmitted (albeit with difficulty) to a herbaceous plant, *Nicotiana benthamiana*, a promiscuous experimental host for a vast variety of plant viruses including BYV.

Because GLRaV-2 accumulates in *N. benthamiana* to higher levels than in grapevine, this convenient herbaceous host was used to isolate the virus, to sequence its genome and to engineer the first-generation full-length GLRaV-2 cDNA clone (Liu et al. 2009). Similar to the most advanced BYV clones, this GLRaV-2 clone possessed a strong 35S promoter derived from *Cauliflower mosaic virus* for viral cDNA transcription upon agro-inoculation (Fig. 31.1). A ribozyme sequence has been inserted downstream from the 3'-terminal nucleotide of the viral cDNA to facilitate release of the authentic viral RNA from a primary transcript, the termination of which was directed by the nopaline synthase terminator. This clone was tagged by insertion of the GFP open reading frame (ORF) downstream from the translation initiation codon of the viral capsid protein gene. Thus, a GFP-encoding recombinant subgenomic (sg) RNA has been produced under control of the native GLRaV-2 sgRNA promoter to direct GFP expression (Fig. 31.1). To restore expression of the GLRaV-2 capsid protein, a BYV sgRNA promoter that directs capsid protein expression in this closely related virus has been inserted downstream from the GFP stop codon (Liu et al. 2009). As was originally demonstrated for TMV (Donson et al. 1991), the use of heterologous sgRNA promoters from similar viruses to express recombinant genes is superior to duplication of homologous promoters

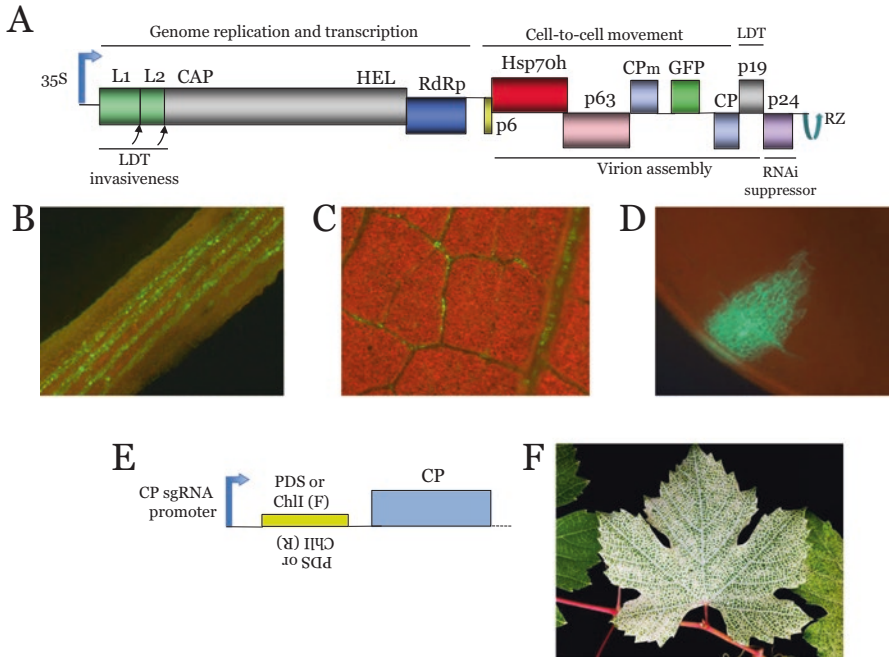

Fig. 31.1 The GLRaV-2-derived gene expression and VIGS vector dubbed vLR2 and engineered to express GFP (**a–d**) or a fragment of grapevine endogenous genes (**e, f**). (**a**) Genome map of vLR2-GFP. L1 and L2, papain-like leader proteases; CAP, capping enzyme; HEL, RNA helicase; RdRp, RNA-dependent RNA polymerase; p6, 6-kDa movement protein; Hsp70h, heat shock protein, 70-kDa, homolog; p63, 63-kDa virion protein; CPm, minor capsid protein; CP, major capsid protein; p19, 19-kDa protein; p24, 24-kDa RNAi suppressor. Gene functions inferred from BYV homologs are shown above and below diagram (**b**) Imaging of the vLR2-GFP in the inner bark of grapevine plants. (**c**) Imaging of the vLR2-GFP in the leaf veins. (**d**) Invasion of the vLR2-GFP into berry mesocarp. (**e**) Expression cassettes harboring RNAi-triggering gene fragments derived from the grapevine PDS or ChII genes. Inserts were either in forward (*F*) or reverse (*R*) orientation. (**f**) Image of the leaf bleaching symptoms caused by VIGS of ChII induced vLR2 infection. Note different bleaching levels in adjacent leaves

because the latter induce high rates of homologous recombination and rapid loss of the inserted genes.

Upon agro-inoculation to *N. benthamiana* plants, the resulting GLRaV-2 cDNA clone was able to establish a systemic infection in the phloem tissue. This virus-host combination has been used to determine contributions of the GLRaV-2 leader proteinases to polyprotein processing, RNA amplification, and long-distance transport (Liu et al. 2009). It was also found that each of the leader proteinases is required for virus invasiveness defined as an ability to establish infection in the primarily inoculated cells in grapevine. However, LR-GFP failed to establish systemic infection in the virus' natural host, grapevine, suggesting that propagation in *N. benthamiana* might have resulted in selection of a virus variant fit to reproduce in this herbaceous host, but not in grapevine.

To test this possibility, the entire viral cDNA clone has been reassembled using cDNA fragments obtained by reverse transcription of the GLRaV-2 genomic RNA present in the infected grapevine. Only the fragments with a consensus sequences were used in this process to avoid incidental mutations that could emerge during error-prone virus replication or cDNA generation. The resulting reassembled cDNA clone vLR2-GFP contained as many as 75 single nucleotide differences compared to that of the *N. benthamiana*-propagated LR-GFP. Some of these differences could be due to natural variation between the two virus isolates used in this work, whereas others could have resulted from propagation of the original isolate in *N. benthamiana*. Strikingly, the vLR2-GFP was systemically infectious in grapevine upon vacuum agro-infiltration of the whole micropropagated plantlets that were transferred to soil following this process (Kurth et al. 2012).

Investigation of the vLR2-GFP infection dynamics showed that, starting at ~1 month upon agro-inoculation, the virus was initially detected in the stem phloem cells, then in leaf petioles, gradually invading leaf veins and later entering the root phloem. When the berry clusters emerge, vLR2-GFP was detected in some berries where it was present in phloem vasculature, later exiting into mesocarp (berry flesh) cells (Kurth et al. 2012). The visual symptoms of virus infection including leaf reddening appeared late in a season; typically, these symptoms induced by vLR2-GFP infection were milder compared to those of the wild type GLRaV-2.

One of the most common limitations of the plant virus-derived gene expression vector is their relatively low genetic stability that is particularly problematic in TMV-based vectors (Dawson 2014; Gleba et al. 2007). Even in potyvirus vectors, in which there is selection pressure for the maintenance of the polyprotein-encoding open reading frame, a few weeks long propagation of the vector infection results in consistent appearance of variants with truncation or total loss of the expression cassette (Dolja et al. 1992; 1993). This overall genetic instability was attributed to spontaneous nonhomologous recombination that shortens virus vector genome and gives the resulting variants competitive advantage over the intact vector genomes. The vLR2-GFP vector exhibited much greater genetic stability in a course of infection in grapevine. Only a fraction of vector-infected plants showed deletions within the expression cassette at 1 year postinoculation, providing an ample time window for using this vector for both research and applied purposes (Kurth et al. 2012).

Further boost to the utility of vLR2 vectors was their ability to elicit strong virus-induced gene silencing (VIGS) response in the infected grapevine. Given that BYV and GLRaV-2 possess strong suppressors of RNAi (Chiba et al. 2006; Reed et al. 2003), the VIGS capability of vLR2 was rather surprising. This capability was demonstrated via insertion into vLR2 expression cassette of the cDNA sequences derived from the endogenous grapevine genes encoding the enzymes required for chlorophyll biogenesis, phytoene desaturase (PDS), and subunit I of magnesium-protoporphyrin IX chelatase (ChII) (Kurth et al. 2012). The few hundred nucleotides-long fragments of the PDS or ChII ORFs were engineered into vLR2 in either forward or reverse orientation (Fig. 31.1e); each of the four resulting vector variants caused strong VIGS response upon grapevine infection. This response was manifested as yellow or white chlorosis due to chlorophyll photobleaching that initially

appeared along the leaf veins where virus replicated, gradually spreading into other leaf tissues (Fig. 31.1f). Upon growth of the vines, VIGS symptoms appeared in cyclical manner apparently reflecting complex pattern of virus spread, VIGS response, and plant growth and differentiation. Once again, VIGS was well pronounced in plants for long periods of time, in excess of 17 months postinoculation (Dolja and Koonin 2013). Although the mechanisms underlying unusual genetic stability of the vectors derived from closteroviruses including GLRaV-2 and CTV are not known, it seems possible that, similar to coronaviruses, closterovirus replication-associated polyproteins contain RNA-processing enzymatic domains with the proofreading activities (Denison et al. 2011). By reducing the number of mismatches, and/or the replicase-template dissociation rate, these very large replication complexes could therefore reduce the frequency of deletions via copy-choice mechanism.

Obviously, with the significant progress in understanding molecular biology of the closteroviruses, any of these viruses infecting grapevine could be developed into gene expression and, potentially, VIGS vectors. However, the utility of such vectors could be limited by at least two important features related to the virus biology. One such feature is transmissibility by the insect vectors. For instance, GLRaV-1 and GLRaV-3 are transmitted by several mealybug and soft scale insect species raising a serious regulatory concern with the release of corresponding recombinant viruses into agricultural settings. Another problem is the relatively high pathogenicity of GLRaV-1 and GLRaV-3, each of which severely affects vine productivity and also results in gradual decline of infected plants (Maree et al. 2013). Thus, tagging each of these viruses with a reporter such as GFP could be useful for investigating molecular and cellular biology of virus infection, but practical utility of the corresponding vectors is questionable at best.

There is, however, a closterovirid, the biology of which appears even better suited for the purposes of virus vector development than that of GLRaV-2. This virus was traditionally designated GLRaV-7; however, at least by itself, it is not known to cause leafroll or any other detectable disease symptoms in grapevine. Furthermore, GLRaV-7 is not known to be transmitted by any vector organisms. Sequencing of the entire ~16.5 kb GLRaV-7 genome followed by phylogenetic analysis showed substantial divergence from each of the three previously established genera of the family *Closteroviridae* (Al Rwahnih et al. 2012). On the other hand, this analysis revealed a significant relatedness of GLRaV-7 with two other unclassified closterovirids also not known to elicit pronounced disease symptoms, *Little cherry virus 1* and *Cordyline virus-1* (Jelkmann et al. 1997; Melzer et al. 2011). Recently, these three viruses were classified by ICTV into a new genus termed *Velarivirus*. It seems all but certain that GLRaV-7 will be developed into a promising gene expression vector for grapevine, although its VIGS potential is yet to be determined.

Vector Potential of Vitiviruses and Foveaviruses

Betaflexiviridae is another important plant virus family that contains 11 genera of single-stranded, positive sense RNA viruses with filamentous virion morphology (King et al. 2012). Three of the genera contain viruses that naturally infect grapevine: *Vitivirus*, *Foveavirus*, and *Trichovirus*. The genomes of viruses in the family *Betaflexiviridae* range from 6.5 to 9.3 kb in size and encode between two and six ORFs, depending on the specific genus. For example, members of the genus *Vitivirus* have genomes of ~7.6 kb which encode five ORFs with a single movement protein. Like members of the family *Closteroviridae*, viruses of the genus *Vitivirus* are restricted to the phloem tissue (King et al. 2012). In contrast, members of the genus *Foveavirus* have larger genomes (8.7–9.3 kb) that encode five ORFs, three of which encode a set of three movement proteins collectively termed as the triple gene block (Martelli and Jelkmann 1998; King et al. 2012). The type member of the genus *Foveavirus*, *Apple stem pitting virus* (ASPV), is not phloem limited. However, it remains to be determined if other members of the genus are also not phloem limited. Members of the genus *Vitivirus* and GRSPaV, the only grapevine-infecting species of the genus *Foveavirus*, are involved in the rugose wood disease complex (Martelli et al. 2012; Meng and Gonsalves 2008; Chap. 12, Meng and Rowhani, this book).

Development of the members of the family *Betaflexiviridae* into vectors for protein expression and VIGS has begun only recently. *Grapevine virus A* (genus *Vitivirus*) was engineered as a vector in which the putative promoter responsible for the expression of the movement protein (MP) from a distinct strain of the virus was inserted into the viral genome (Haviv et al. 2006). This GVA-based vector successfully expressed several foreign genes, including those for GFP, GUS, and the capsid protein of CTV (Haviv et al. 2006). To further test the potential of GVA as a VIGS vector for use in the elucidation of gene functions, a 500-bp fragment derived from *PDS* of *N. benthamiana* was cloned into the GVA vector. When introduced into leaves of *N. benthamiana* through agro-infiltration, the resulting recombinant virus induced silencing of the endogenous *PDS*, as judged by the photobleaching phenotype, as well as reduced levels of the *PDS* mRNA (Muruganatham et al. 2009). As expected for a virus with tropism to the phloem tissue, the effects of gene silencing were confined to the vascular tissue.

To investigate the potential use of GVA as a VIGS vector for grapevine, a 304-bp fragment derived from the *PDS* gene of grapevine was amplified and introduced into the GVA vector. This vector, designated pGVA-vvPDS-377, induced photobleaching in leaves 2–3 weeks after inoculation through agro-drenching (Muruganatham et al. 2009) validating a potential of GVA-based vector for VIGS in grapevine. Interestingly, the photobleaching phenotype exhibited in grapevine differed considerably from that in *N. benthamiana*. The photobleaching was not confined to the vascular tissue but rather was observed uniformly at leaf margins and later on the entire leaf blade (Muruganatham et al. 2009). This is quite different from the photobleaching induced by the GLRaV-2-based vector (Kurth et al. 2012). In theory, both viruses are restricted to the phloem tissue and are expected to

exhibit similar phenotypes when used to silence the *PDS* gene in grapevines. It remains to be elucidated if the difference in the phenotype due to silencing of *PDS* between the two viral vector systems is a reflection of the inherent difference between the two viruses, the different delivery systems, or the grapevine cultivars that were used by the two research groups.

Another candidate to be developed as a vector for protein expression and VIGS is GRSPaV, which is the only grapevine-infecting member of the genus *Foveavirus* that was recently characterized (Meng et al. 1998; Zhang et al. 1998; Martelli and Jelkmann 1998). Several characteristics make GRSPaV an attractive candidate for this purpose. First, it is widely distributed in commercial grapevines and is not regulated in most grape-growing countries. Second, the genome structure and expression strategy of GRSPaV are similar to those of PVX, a virus that has been one of the most successful plant virus-based gene expression vectors. Third, GRSPaV has filamentous virions with a helical symmetry, an open structure that allows packaging of genome with a large insert. This offers significant advantage over viruses that have closed spherical structure. Lastly, infection with GRSPaV, at least with certain strains of the virus, causes no or very mild symptoms in most commercial grape cultivars. This is a very important consideration when choosing a virus as a vector because delivery of vectors derived from highly pathogenic viruses would lead to disease and symptoms that will interfere with the intended purpose of the vector (Zhang et al. 1998; Meng et al. 1998, 1999, 2005, 2006; Meng and Gonsalves 2007). For details on this virus, the reader is referred to Chap. 12 of this book.

Toward this end, a full-length cDNA clone of GRSPaV and its GFP-tagged variant were engineered into a binary vector. When launched through agro-inoculation, both constructs were infectious in *N. benthamiana* and the grapevine host (Meng et al. 2013). Importantly, the GFP-tagged variant successfully expressed GFP in both *N. benthamiana* and grapevine. Interestingly, the GFP-tagged clone was unable to move systemically in *N. benthamiana*. Perhaps GRSPaV has coevolved with and adapted to the grapevine host and as such is unable to move systemically in this herbaceous plant. This GFP-tagged variant was very slow at systemic movement in the grapevine, as demonstrated in a preliminary study (Meng et al. 2013). Evidently, further testing of this GFP-tagged variant and the wild-type clone in different grapevine cultivars is necessary before the potential of GRSPaV as a protein expression or VIGS vector can be clearly established.

Numerous other grapevine viruses with different genetic makeups, genome expression strategies, and classification in different taxonomic groups are potential candidates as vectors in grapevine. Examples include members of the genera *Nepovirus* (family *Secoviridae*), *Maculavirus*, and *Marafivirus* (both in the family *Tymoviridae*) and the recently identified geminivirus, *Grapevine red blotch-associated virus* (GRBaV). It should be noted that all these viruses have spherical virions with limited capacity of accommodating foreign sequences compared to viruses with helical symmetry such as those of the families *Closteroviridae* and *Betaflexiviridae* (Gleba et al. 2007).

Applications of Gene Expression Vectors Derived from Grapevine Viruses

The most immediate applications of recombinant virus vectors are in molecular virology. An ability to tag virus genomes with reporter genes that has been pioneered in the potexvirus and potyvirus models (Chapman et al. 1992; Dolja et al. 1992) facilitated investigation of the virus infection cycle, including virus transport and interactions with the host. There is, however, an area of plant virology that is poorly explored due to difficulties of launching infections of the woody plants using viruses engineered to express reporter proteins. It is not known how these viruses manage to sustain multiyear infections in the voluminous and hostile environment of these plants. Are there aspects of virus-host interactions that are unique to woody and perennial plants compared to annual herbaceous plants? Rather intriguing initial insights to this question were provided using comparative genomics and the best developed models of woody plant viruses, CTV and GLRaV-2. In a CTV-citrus model, visualization of infection using the GFP reporter revealed complex and host species-specific patterns of virus-host interactions mostly reflected in the ability of the virus to spread systemically and from cell-to-cell in distinct phloem tissues. These patterns, as well as virus pathogenicity, are defined, in a large degree, by the CTV-specific genes that are dispensable for successful infection in some host species, but not in others (Dawson et al. 2013). Although more limited, similar studies using GFP-tagged GLRaV-2 showed that the tandem leader proteinases L1 and L2 play grapevine host-specific roles in virus invasiveness (Liu et al. 2009); a likely function of these proteins in virus systemic spread in its natural host is yet to be explored.

Other questions that could be answered using tagged viruses are seasonal changes in tissue-specific infection patterns including dormancy, mechanisms of virus transmission by insect vectors, and functions of the genes that are specific to particular viruses infecting woody plants. Sometimes, as is the case for CTV, such genes are found in only a single virus (see above). In other instances exemplified by AlkB (a gene encoding RNA demethylase), such genes are more broadly, but not universally, distributed among diverse viruses infecting woody or perennial plants (Martelli et al. 2007; van den Born et al. 2008). Although it is assumed that AlkB could play a role in protecting viral RNA from methylation by enzymes that may constitute a host defense from long-term virus infections, the exact function of AlkB is yet to be addressed by means of reverse genetics. Although not all of the grapevine-infecting viruses possess AlkB, some of them, including GLRaV-3, GVA, and GRSPaV, do. Even though most of these questions pertain to fundamental research, answering them will facilitate both the practical application of virus-derived vectors and control of viral diseases.

The second major field where virus gene expression vectors could find immediate and broad application is functional genomics of grapevine. As has been shown, the vLR2 vector has powerful, systemic VIGS capability that efficiently shuts down expression of the endogenous grapevine genes PDS and ChII (Kurth et al. 2012).

Thus, this vector holds strong potential for mapping gene functions in grapevine including those involved in metabolic and biosynthetic pathways that determine nutritional, medicinal, and winemaking qualities of this crop plant. It should be emphasized that the major advantages of VIGS over stable plant transformation are more rapid implementation and relative ease of obtaining desired phenotypes. An additional potential benefit is that gene silencing triggered by VIGS is applicable to mature plants thus allowing the targeting of genes that could induce embryonic lethality if shut off permanently. As discussed above, the remarkable genetic stability of vLR2 VIGS variants provides years-long experimental window sufficient to determine phenotypes associated with seasonal development, e.g., flowering or berry ripening (Dolja and Koonin 2013). On the other hand, it appears that the vLR2 has only a limited utility for producing beneficial proteins, e.g., “edible vaccines,” in grapevine, due to relatively low levels of recombinant protein expression and patchy distribution patterns throughout the plant, especially in berry clusters (Kurth et al. 2012).

The third potential application of the vLR2 is for the control of pathogens and herbivores. A VIGS capability of this vector could be used to map grapevine genes responsible for pathogen resistance: downregulation of the candidate resistance gene via RNAi will result in increased disease susceptibility of infected plants. When identified, novel resistance genes can be introduced to grape cultivars that lack such genes, either via stable transformation or by expression from a virus vector.

Reciprocally, VIGS can be used to downregulate pathogen susceptibility genes, particularly those specifically expressed in the phloem. In this case, the expected phenotype is a reduced pathogen invasiveness and disease attenuation or complete immunity of the plants to infection. In this case, VIGS itself will control a target pathogen, streamlining the use of a viral vector for practical application.

Another direct and potentially powerful VIGS application is targeting of the RNAi-susceptible pathogens and herbivores themselves. A practical potential of such applications has been demonstrated for citrus plants infected by a CTV vector that was able to induce RNAi in an insect that transmits the bacterial citrus greening disease (Hajeri et al. 2014).

It should be recognized that, despite a broad spectrum and a great potential applicability of viral vectors in grapevine, the utility of these vectors is yet to be tapped into. This apparent paradox may depend on a variety of circumstances with a lack of proper and focused investment being among the most important.

References

- Agranovsky, A.A., R. Koenig, E. Maiss, V.P. Boyko, R. Casper, and J.G. Atabekov. 1994. Expression of the beet yellows closterovirus capsid protein and p24, a capsid protein homologue, in vitro and in vivo. *The Journal of General Virology* 75: 1431–1439.
- Al Rwahnih, M., V.V. Dolja, S. Daubert, E.V. Koonin, and A. Rowhani. 2012. Genomic and biological analysis of Grapevine leafroll-associated virus 7 reveals a possible new genus within the family Closteroviridae. *Virus Research* 163: 302–309.

- Alzhanova, D.V., Y. Hagiwara, V.V. Peremyslov, and V.V. Dolja. 2000. Genetic analysis of the cell-to-cell movement of beet yellows closterovirus. *Virology* 268: 192–200.
- Alzhanova, D.V., A. Napuli, R. Creamer, and V.V. Dolja. 2001. Cell-to-cell movement and assembly of a plant closterovirus: Roles for the capsid proteins and Hsp70 homolog. *The EMBO Journal* 20: 6997–7007.
- Alzhanova, D.V., A.I. Prokhnevsky, V.V. Peremyslov, and V.V. Dolja. 2007. Virion tails of Beet yellows virus: Coordinated assembly by three structural proteins. *Virology* 359: 220–226.
- Amari, K., E. Boutant, C. Hofmann, C. Schmitt-Keichinger, L. Fernandez-Calvino, P. Didier, A. Lerich, J. Mutterer, C.L. Thomas, M. Heinlein, Y. Mély, A.J. Maule, and C. Ritzenthaler. 2010. A family of plasmodesmal proteins with receptor-like properties for plant viral movement proteins. *PLoS Pathogens* 23, pii: e1001119.
- Bachan, S., and S.P. Dinesh-Kumar. 2012. Tobacco rattle virus (TRV)-based virus-induced gene silencing. *Methods in Molecular Biology* 894: 83–92.
- Burton, R.A., D.M. Gibeau, A. Bacic, K. Findlay, K. Roberts, A. Hamilton, D.C. Baulcombe, and G.B. Fincher. 2000. Virus-induced gene silencing of a plant cellulose synthase gene. *Plant Cell* 12: 691–706.
- Chapman, S., T. Kavanagh, and D. Baulcombe. 1992. Potato virus X as a vector for gene expression in plants. *The Plant Journal* 2: 549–557.
- Chiba, M., J.C. Reed, A.I. Prokhnevsky, E.J. Chapman, M. Mawassi, E.V. Koonin, J.C. Carrington, and V.V. Dolja. 2006. Diverse suppressors of RNA silencing enhance agroinfection by a viral replicon. *Virology* 346: 7–14.
- Csorba, T., L. Kontra, and J. Burgyán. 2015. Viral silencing suppressors: Tools forged to fine-tune host-pathogen coexistence. *Virology* 479–480: 85–103.
- Dawson, W.O. 2014. A personal history of virus-based vector construction. *Current Topics in Microbiology and Immunology* 375: 1–18.
- Dawson, W.O., S.M. Garnsey, S. Tatineni, S.Y. Folimonova, S.J. Harper, and S. Gowda. 2013. Citrus tristeza virus-host interactions. *Frontiers in Microbiology* 4: 88.
- Dawson, W.O., M. Bar-Joseph, S.M. Garnsey, and P. Moreno. 2015. Citrus tristeza virus: Making an ally from an enemy. *Annual Review of Phytopathology* 53: 137–155.
- Denison, M.R., R.L. Graham, E.F. Donaldson, L.D. Eckerle, and R.S. Baric. 2011. Coronaviruses: An RNA proofreading machine regulates replication fidelity and diversity. *RNA Biology* 8: 270–279.
- Dolja, V.V. 2003. Beet yellows virus: The importance of being different. *Molecular Plant Pathology* 4: 91–98.
- Dolja, V.V., and E.V. Koonin. 2013. The closterovirus-derived gene expression and RNA interference vectors as tools for research and plant biotechnology. *Frontiers in Microbiology* 4: 1–10.
- Dolja, V.V., H.J. McBride, and J.C. Carrington. 1992. Tagging of plant potyvirus replication and movement by insertion of beta-glucuronidase into the viral polyprotein. *Proceedings of the National Academy of Sciences of the United States of America* 89: 10208–10212.
- Dolja, V.V., K.L. Herndon, T.P. Pirone, and J.C. Carrington. 1993. Spontaneous mutagenesis of a plant potyvirus genome after insertion of a foreign gene. *Journal of Virology* 67: 5968–5975.
- Dolja, V.V., J.F. Kreuze, and J.P. Valkonen. 2006. Comparative and functional genomics of closteroviruses. *Virus Research* 117: 38–51.
- Donson, J., C.M. Kearney, M.E. Hilf, and W.O. Dawson. 1991. Systemic expression of a bacterial gene by a tobacco mosaic virus-based vector. *Proceedings of the National Academy of Sciences of the United States of America* 88: 7204–7208.
- Folimonov, A.S., S.Y. Folimonova, M. Bar-Joseph, and W.O. Dawson. 2007. A stable RNA virus-based vector for citrus trees. *Virology* 368: 205–216.
- Gleba, Y., V. Klimyuk, and S. Marillonnet. 2007. Viral vectors for the expression of proteins in plants. *Current Opinion in Biotechnology* 18: 134–141.
- Gleba, Y., D. Tusé, and A. Giritch. 2014. Plant viral vectors for delivery by *Agrobacterium*. *Current Topics in Microbiology and Immunology* 375: 155–192.
- Hagiwara, Y., V.V. Peremyslov, and V.V. Dolja. 1999. Regulation of closterovirus gene expression examined by insertion of a self-processing reporter and by northern hybridization. *Journal of Virology* 73: 7988–7993.

- Hajeri, S., N. Killiny, C. El-Mohtar, W.O. Dawson, and S. Gowda. 2014. Citrus tristeza virus-based RNAi in citrus plants induces gene silencing in *Diaphorina citri*, a phloem-sap sucking insect vector of citrus greening disease (Huanglongbing). *Journal of Biotechnology* 176: 42–49.
- Haviv, S., N. Galiakparov, D. Goszczynski, O. Batuman, M., H. Czosnek, and M. Mawassi. 2006. Engineering the genome of Grapevine Virus A into a vector for expression of Proteins in herbaceous plants. *Journal of Virological Methods* 132: 227–231.
- Jelkmann, W., B. Fechtner, and A.A. Agranovsky. 1997. Complete genome structure and phylogenetic analysis of little cherry virus, a mealybug-transmissible closterovirus. *The Journal of General Virology* 78: 2067–2071.
- Karasev, A.V. 2000. Genetic diversity and evolution of closteroviruses. *Annual Review of Phytopathology* 38: 293–324.
- King, A.M.Q., M.J. Adams, E.B. Carstens, and E.J. Lefkowitz. 2012. *Virus Taxonomy: 9th Report of the International Committee on the Taxonomy of Viruses*. San Diego: Academic Press/Elsevier.
- Kumagai, M.H., J. Donson, G. Della-Cioppa, D. Harvey, K. Hanley, and L.K. Grill. 1995. Cytoplasmic inhibition of carotenoid biosynthesis with virus-derived RNA. *Proceedings of the National Academy of Sciences of the United States of America* 92: 1679–1683.
- Kurth, E.G., V.V. Peremyslov, A.I. Prokhnevsky, K.D. Kasschau, M. Miller, J.C. Carrington, and V.V. Dolja. 2012. Virus-derived gene expression and RNA interference vector for grapevine. *Journal of Virology* 86: 6002–6009.
- Lacomme, C. 2014. Milestones in the development and applications of plant virus vector as gene silencing platforms. *Current Topics in Microbiology and Immunology* 375: 89–105.
- Liu, Y.-P., V.V. Peremyslov, V. Medina, and V.V. Dolja. 2009. Tandem leader proteases of Grapevine leafroll-associated virus-2: Host-specific functions in the infection cycle. *Virology* 383: 291–299.
- Maree, H.J., R.P. Almeida, R. Bester, K.M. Chooi, D. Cohen, V.V. Dolja, M.F. Fuchs, D.A. Golino, A.E. Jooste, G.P. Martelli, R.A. Naidu, A. Rowhani, P. Saldarelli, and J.T. Burger. 2013. Grapevine leafroll-associated virus 3. *Frontiers in Microbiology* 4: 1–21.
- Martelli G.P., W. Jelkmann (1998) Foveavirus, a new plant virus genus. *Archives of Virology* 143: 1245–1249
- Martelli, G.P., M.J. Adams, J.F. Kreuze, and V.V. Dolja. 2007. Family Flexiviridae: A case study in virion and genome plasticity. *Annual Review of Phytopathology* 45: 73–100.
- Martelli, G.P., N. Abou Ghanem-Sabanadzovic, A.A. Agranovsky, and 16 others. 2012. Taxonomic revision of the family Closteroviridae with special reference to the grapevine leafroll-associated members of the genus Ampelovirus and the putative species unassigned to the family. *Journal of Plant Pathology* 94: 7–19.
- Melzer, M.J., D.M. Sether, W.B. Borth, E.F. Mersino, and J.S. Hu. 2011. An assemblage of closteroviruses infecting Hawaiian ti (*Cordyline fruticosa* L.). *Virus Genes* 42: 254–260.
- Meng, B., S.-Z. Pang, P.L. Forsline, J.R. McFerson, and D. Gonsalves. 1998. Nucleotide sequence and genome structure of Grapevine Rupestris stem pitting associated virus-1 reveal similarities to apple stem pitting virus. *Journal of General Virology* 79: 2059–2069.
- Meng, B., H.-Y. Zhu, and D. Gonsalves. 1999. Rupestris stem pitting associated virus-1 consists of a family of sequence variants. *Archives of Virology* 144: 2071–2085.
- Meng, B., C. Li, D.E. Goszczynski, and D. Gonsalves. 2005. Genome sequences and structures of two biologically distinct strains of Grapevine leafroll-associated virus 2 and sequence analysis. *Virus Genes* 31: 31–41.
- Meng, B., A.R. Rebelo, and H. Fisher. 2006. Genetic diversity analysis of Grapevine Rupestris stem pitting-associated virus: Revelation of distinct population structures in scion versus root-stock varieties. *Journal of General Virology* 87: 1725–1733.
- Meng, B., and D. Gonsalves. 2007. Grapevine rupestris stem pitting-associated virus: A decade of research and future perspectives. *Plant Viruses* 1: 52–62.
- Meng, B., and D. Gonsalves. 2008. Grapevine Rupestris stem pitting-associated virus. In *Characterization, diagnosis and management of plant viruses*, ed. G. Rao, K.S. Ling, and A. Myrta, 201–222. Houston: Studium Press/LLC.

- Meng, B., S. Venkataraman, C. Li, W. Wang, C. Dayan-Glick, and M. Mawassi. 2013. Construction and biological activities of the first infectious cDNA clones of the genus Foveavirus. *Virology* 435: 453–462.
- Muruganantham, M., Y. Moskovitz, S. Haviv, T. Horesh, A. Fenigstein, J. Preez, D. Stephan, J.T. Burger, and M. Mawassi. 2009. Grapevine virusA-mediated gene silencing in *Nicotiana benthamiana* and *Vitis vinifera*. *Journal of Virological Methods* 155: 167–174.
- Napuli, A.J., B.W. Falk, and V.V. Dolja. 2000. Interaction between HSP70 homolog and filamentous virions of the Beet yellows virus. *Virology* 274: 232–239.
- Napuli, A.J., D.V. Alzhanova, C.E. Doneanu, D.F. Barofsky, E.V. Koonin, and V.V. Dolja. 2003. The 64-kDa capsid protein homolog of beet yellows virus is required for assembly of virion tails. *Journal of Virology* 77: 2377–2384.
- Peng, C.W., and V.V. Dolja. 2000. Leader proteinase of the beet yellows closterovirus: Mutation analysis of the function in genome amplification. *Journal of Virology* 74: 9766–9770.
- Peng, C.W., V.V. Peremyslov, A.R. Mushegian, W.O. Dawson, and V.V. Dolja. 2001. Functional specialization and evolution of leader proteinases in the family closteroviridae. *Journal of Virology* 75: 12153–12160.
- Peng, C.-W., A.J. Napuli, and V.V. Dolja. 2003. Leader proteinase of the beet yellows virus functions in long-distance transport. *Journal of Virology* 77: 2843–2849.
- Peremyslov, V.V., and V.V. Dolja. 2002. Identification of the subgenomic mRNAs that encode 6-kDa movement protein and Hsp70 homolog of beet yellows virus. *Virology* 295: 299–306.
- . 2007. Cloning of large positive-strand RNA viruses. *Current Protocols in Microbiology*: 16F.11.11–16F.11.26.
- Peremyslov, V.V., Y. Hagiwara, and V.V. Dolja. 1998. Genes required for replication of the 15.5-kilobase RNA genome of a plant closterovirus. *Journal of Virology* 72: 5870–5876.
- . 1999. HSP70 homolog functions in cell-to-cell movement of a plant virus. *Proceedings of the National Academy of Sciences of the United States of America* 96: 14771–14776.
- Peremyslov, V.V., I.A. Andreev, A.I. Prokhnevsky, G.H. Duncan, M.E. Talianky, and V.V. Dolja. 2004a. Complex molecular architecture of beet yellows virus particles. *Proc. Natl. Acad. Sci* 101: 5030–5035.
- Peremyslov, V.V., Y.-W. Pan, and V.V. Dolja. 2004b. Movement protein of a closterovirus is a type III integral transmembrane protein localized to the endoplasmic reticulum. *Journal of Virology* 78: 3704–3709.
- Prokhnevsky, A.I., V.V. Peremyslov, A.J. Napuli, and V.V. Dolja. 2002. Interaction between long-distance transport factor and Hsp70-related movement protein of beet yellows virus. *Journal of Virology* 76: 11003–11011.
- Reed, J.C., K.D. Kasschau, A.I. Prokhnevsky, K. Gopinath, G.P. Pogue, J.C. Carrington, and V.V. Dolja. 2003. Suppressor of RNA silencing encoded by beet yellows virus. *Virology* 306: 203–209.
- Satyanarayana, T., S. Gowda, V.P. Boyko, M.R. Albiach-Marti, M. Mawassi, J. Navas-Castillo, A.V. Karasev, V. Dolja, M.E. Hilf, D.J. Lewandowski, P. Moreno, M. Bar-Joseph, S.M. Garnsey, and W.O. Dawson. 1999. An engineered closterovirus RNA replicon and analysis of heterologous terminal sequences for replication. *Proc. Natl. Acad. Sci. Proceedings of the National Academy of Sciences of the United States of America* 96: 7433–7448.
- Shabalina, S.A., and E.V. Koonin. 2008. Origins and evolution of eukaryotic RNA interference. *Trends in Ecology & Evolution* 23: 578–587.
- Sudarshana, M.R., K.L. Perry, and M.F. Fuchs. 2015. Grapevine red blotch-associated virus, an emerging threat to the grapevine industry. *Phytopathology* 105: 1026–1032.
- Tian, T., L. Rubio, H.-H. Yeh, B. Crawford, and B.W. Falk. 1999. Lettuce infectious yellows virus: In vitro acquisition analysis using partially purified virions and the whitefly, *Bemisia tabaci*. *The Journal of General Virology* 80: 1111–1117.
- van den Born, E., M.V. Omelchenko, A. Bekkelund, V. Leihne, E.V. Koonin, V.V. Dolja, and P.O. Falnes. 2008. Viral AlkB proteins repair RNA damage by oxidative demethylation. *Nucleic Acids Research* 36: 5451–5461.

- Vitushkina, M.V., I.B. Rogozin, W. Jelkmann, E.V. Koonin, and A.A. Agranovsky. 2007. Completion of the mapping of transcription start sites for the five-gene block subgenomic RNAs of Beet yellows Closterovirus and identification of putative subgenomic promoters. *Virus Research* 128: 153–158.
- Zhang, Y.P., J.K. Uyemoto, D.A. Golino, and A. Rowhani. 1998. Nucleotide sequence and RT-PCR detection of a virus associated with Grapevine *Rupestris* stem-pitting disease. *Phytopathology* 88: 1231–1237.

Chapter 32

Evolutionary Aspects of Grapevine Virology

V.V. Dolja, B. Meng, and G.P. Martelli

Abstract Previous analyses have shown that plant viruses represent a host-specific subset of eukaryotic viruses enriched in positive-strand RNA species from diverse families and devoid of the bona fide double-stranded DNA species (Dolja VV, Koonin EV, *Curr Opin Virol* 1:322–331, 2011). In this article, we briefly discuss the grapevine virome and its relationships with the virome of flowering plants. We also provide a comparative phylogenomic analysis of the three families of viruses that are involved in the most widespread and economically important grapevine diseases in a search of commonalities and evolutionary forces that shaped the virome of this plant host.

Keywords *Closteroviridae* • *Betaflexiviridae* • *Secoviridae* • ssRNA viruses • Genome structure • Evolution • Phylogeny • RNA-dependent RNA polymerase • Alkylation B domain • Woody perennials

Introduction

The currently characterized grapevine virome amounts to ~70 virus species and a handful of yet unnamed, poorly characterized viruses (Table 32.1) (Martelli 2014; Naidu et al. 2015). There is little doubt that this number will grow with ongoing comprehensive investigations of grapevine virus ecology using the rapidly progressing techniques of high-throughput sequencing (HTS) and metagenomics. The

V.V. Dolja (✉)

Department of Botany and Plant Pathology and Center for Genome Research and Biocomputing, Oregon State University, Corvallis, Oregon 97331, USA
e-mail: doljav@oregonstate.edu

B. Meng

Department of Molecular and Cellular Biology, University of Guelph, Guelph, ON, Canada
e-mail: bmeng@uoguelph.ca

G.P. Martelli

Department of Soil, Plant and Food Sciences, University of Bari Aldo Moro, Bari, Italy
e-mail: giovanni.martelli@uniba.it

Table 32.1 Grapevine-infecting viruses

Family	Genus	Species
Viruses with isometric particles (+)ssRNA genome		
<i>Secoviridae</i>	<i>Fabavirus</i> <i>Nepovirus</i> Unassigned in the family	<i>Broad bean wilt virus</i> (BBWV) <i>Artichoke Italian latent virus</i> (AILV), <i>Arabidopsis mosaic virus</i> (ArMV), <i>Blueberry leaf mottle virus</i> (BBLMV), <i>Cherry leafroll virus</i> (CLRV), <i>Grapevine Bulgarian latent virus</i> (GBLV), <i>Grapevine Anatolian ringspot virus</i> (GARSV), <i>Grapevine deformation virus</i> (GDeV), <i>Grapevine chrome mosaic virus</i> (GCMV), <i>Grapevine fanleaf virus</i> (GFLV), <i>Grapevine Tunisian ringspot virus</i> (GTRV), <i>Peach rosette mosaic virus</i> (PRMV), <i>Raspberry ringspot virus</i> (RpRSV), <i>Tobacco ringspot virus</i> (TRSV), <i>Tomato ringspot virus</i> (ToRSV), <i>Tomato black ring virus</i> (TBRV) <i>Strawberry latent ringspot virus</i> (SLRSV)
<i>Bromoviridae</i>	<i>Alfavirus</i> <i>Cucumovirus</i> <i>Illavirus</i>	<i>Alfalfa mosaic virus</i> (AMV) <i>Cucumber mosaic virus</i> (CMV) <i>Grapevine line pattern virus</i> (GLPV), <i>Grapevine angular mosaic virus</i> (GAMoV)
<i>Tombusviridae</i>	<i>Carmovirus</i> <i>Necrovirus</i> <i>Tombusvirus</i>	<i>Carnation mottle virus</i> (CarMV) <i>Tobacco necrosis virus D</i> (TNV-D) <i>Grapevine Algerian latent virus</i> (GALV), <i>Petunia asteroid mosaic virus</i> (PAMV)
<i>Tymoviridae</i>	<i>Marafivirus</i> <i>Maculavirus</i>	<i>Grapevine asteroid mosaic-associated virus</i> (GAMaV), <i>Grapevine rupestris vein feathering virus</i> (GRVfV), <i>Grapevine Syrah virus 1</i> (GSyV-1), <i>Blackberry virus S</i> (BVS), unnamed putative marafivirus-like virus <i>Grapevine fleck virus</i> (GFkV) <i>Grapevine redglobe virus</i> (GRGV)
<i>Luteoviridae</i>	<i>Enamovirus</i>	<i>Summer grape enamovirus</i> (SGEV)
Viruses unassigned to families	<i>Idaeovirus</i>	<i>Raspberry bushy dwarf virus</i> (RBDV)
	<i>Sobemovirus</i>	<i>Sowbane mosaic virus</i> (SoMV)
Viruses with isometric particles dsRNA genome		
<i>Reoviridae</i>	<i>Oryzavirus</i> (?)	<i>Summer grape latent virus</i> (SGLV) = <i>Grapevine Cabernet Sauvignon reovirus</i> (GCSV)
<i>Endornaviridae</i>	<i>Endornavirus</i>	<i>Grapevine endophyte endornavirus</i> (GEEV), three unnamed grapevine-associated endornaviruses
<i>Partitiviridae</i>	<i>Deltapartivirus</i>	<i>Grapevine cryptic virus 1</i> (GCV-1) = <i>Grapevine partitivirus 1</i> (GPV-1) An unnamed grapevine-associated partitivirus
<i>Amalgaviridae</i>	<i>Amalgavirus</i>	An unnamed amalgavirus
Viruses with enveloped particles (-)ssRNA genome		

(continued)

Table 32.1 (continued)

Family	Genus	Species
<i>Bunyaviridae</i>	<i>Tospovirus</i>	<i>Tomato spotted wilt virus</i> (TSWV)
Viruses with filamentous particles (+)ssRNA genome		
<i>Closteroviridae</i>	<i>Closterovirus</i> <i>Ampelovirus</i> <i>Velarivirus</i>	<i>Grapevine leafroll-associated virus 2</i> (GLRaV-2) <i>Grapevine leafroll-associated virus 1</i> (GLRaV-1), <i>Grapevine leafroll-associated virus 3</i> (GLRaV-3), <i>Grapevine leafroll-associated virus 4</i> (GLRaV-4) <i>Grapevine leafroll-associated virus 7</i> (GLRaV-7)
<i>Alphaflexiviridae</i>	<i>Potexvirus</i>	<i>Potato virus X</i> (PVX)
<i>Betaflexiviridae</i>	<i>Foveavirus</i>	<i>Grapevine stem pitting-associated virus</i> (GSPaV)
	<i>Trichovirus</i>	<i>Grapevine berry inner necrosis virus</i> (GINV), <i>Grapevine Pinot gris virus</i> (GPNV)
	<i>Vitivirus</i>	<i>Grapevine virus A</i> (GVA); <i>Grapevine virus B</i> (GVB); <i>Grapevine virus D</i> (GVD); <i>Grapevine virus E</i> (GVE); <i>Grapevine virus F</i> (GVF)
<i>Potyviridae</i>	<i>Potyvirus</i>	<i>Bean common mosaic virus</i> (BCMV) peanut strain; An unidentified <i>Potyvirus</i> -like virus isolated in Japan from a Russian cultivar
Viruses with rod-shaped particles (+)ssRNA genome		
<i>Virgaviridae</i>	<i>Tobamovirus</i>	<i>Tobacco mosaic virus</i> (TMV), <i>Tomato mosaic virus</i> (ToMV)
Viruses with a DNA genome		
<i>Geminiviridae</i>	Undetermined	<i>Grapevine red blotch-associated virus</i> (GRBV)
<i>Caulimoviridae</i>	<i>Badnavirus</i>	<i>Grapevine vein-clearing virus</i> (GVCV) <i>Grapevine Roditis leaf discoloration-associated virus</i> (GRLDaV)
Ill-defined, taxonomically unassigned viruses		Unnamed filamentous virus, <i>Grapevine Ajnashika virus</i> (GAgV), <i>Grapevine stunt virus</i> (GSV), <i>Grapevine labile rod-shaped virus</i> (GLRSV)

use of these techniques has already yielded interesting insights into the grapevine virome. For example, the virome of a South African vineyard was dominated by the well-known *Grapevine leafroll-associated virus 3* (GLRaV-3) and *Grapevine rupestris stem pitting-associated virus* (GRSPaV), whereas several viruses previously unreported in grapevines were also detected, including those apparently originating from endophytic or parasitic fungi (Coetzee et al. 2010a). Diverse fungal viruses were even more prevalent in a parallel study (Al Rwahnih et al. 2011), perhaps because the sequencing was done using double-stranded RNA (dsRNA) isolated

from stems as template for a cDNA library. This protocol likely resulted in an enrichment in viruses with dsRNA genome that are most common among viruses of fungi (Ghabrial et al. 2015).

It was recently argued that HTS will become a standard technology for virus identification, including the discovery of novel viruses and the characterization of viral disease complexes in grapevine (Al Rwahnih et al. 2015). This approach enabled the discovery of the first DNA-containing pararetrovirus of grapevine, *Grapevine vein-clearing virus* (GVCV) (Zhang et al. 2011), and the first single-stranded DNA virus ever identified in grapevine, *Grapevine red blotch-associated virus* (GRBaV), an apparently divergent member of the family *Geminiviridae* (Al Rwahnih et al. 2013; Poojari et al. 2013; Seguin et al. 2014; Sudarshana et al. 2015). Recently, another grapevine-infecting geminivirus was characterized (Al Rwahnih et al. 2016b). Less surprisingly, several novel positive-strand RNA viruses from virus families common in grapevine were also identified (Al Rwahnih et al. 2015), with *Grapevine Pinot gris virus* (GPGV) being one example (Giampetruzzi et al. 2012). For more comprehensive coverage of HTS applications in grapevine, the reader is referred to Saldarelli et al. (Chap. 30 of this book).

By and large, grapevine-infecting viruses provide a relatively fair representation of the evolutionary diversity of plant viruses. The grapevine virome is dominated by positive-strand RNA viruses that belong to each of the three major superfamilies: picornavirus-like, alphavirus-like, and flavivirus-like (Table 32.1) (Koonin et al. 2015). The rest of the grapevine virome is represented by a few double-stranded RNA viruses, one negative-strand RNA virus, two single-stranded DNA viruses, and two pararetroviruses. Although the latter virus class is characterized by a double-stranded DNA genome present in the virion, their replicating relies on the genome being converted to RNA and back to DNA by the virus-encoded reverse transcriptase. No bona fide double-stranded DNA virus that does not generate RNA during its replication cycle is known to infect grapevine or any other flowering plant (Dolja and Koonin 2011; Roossinck 2016).

As apparent from Table 32.1, a significant fraction of grapevine viruses do not possess names that include “grapevine,” e.g., *Cucumber mosaic virus* and *Tomato spotted wilt virus*. There are several reasons for this. First, plant viruses are named after the plant species in which the virus was originally discovered, even though that species may not be the only or even the most important natural host/reservoir for the virus. Second, some viruses including the two mentioned above do possess unusually broad host ranges covering many diverse plant species. Third, our understanding of virus ecology is rather sketchy with a limited comprehensive knowledge of the range of plant hosts for a given virus and the range of viruses present in particular host species. Furthermore, the current coverage of the plant virome is significantly biased toward viruses causing diseases in economically important crops, including grapevine, to the exclusion of asymptomatic infections and plant species that are outside managed agriculture ecosystems. This state of the plant virology field has only recently started to improve, with the substantial albeit gradual progress made by applying HTS to indiscriminate virus identification in various environments (Roossinck 2016).

Given these limitations, it is often difficult to determine what actually constitutes a “bona fide grapevine virus.” The critical factors in this consideration include knowledge of plant species that constitute natural reservoirs of a virus, means by which the virus is transmitted to grapevine, prevalence of virus infections in grapevine, and virus pathogenicity. All these questions related to the origin of viruses and their ecology contribute to our understanding of virus evolution.

Another important and intriguing question is how grapevine virus evolution is affected by the biology of this perennial woody host. This question is hardly addressed for any woody plant species, and the virome of woody plants is largely a terra incognita. Although we are not aware of a systematic investigation of the relationship between grapevine physiology and its ability to host viruses, the virology community recognizes that this plant is generally recalcitrant to mechanical inoculation by either rubbing leaves with a virus/abrasive suspension or injecting the virus into stems. An assumption is that this is due to physical hardness and chemical composition of grapevine leaf/stem. Analogously, agroinoculation of grapevine is also far from straightforward, as exemplified by a *Grapevine leafroll-associated virus 2* (GLRaV-2) cDNA clone that was successfully engineered to infect only tissue culture-grown grapevine of a limited number of cultivars (Kurth et al. 2012) (Dolja and Meng, Chap. 31 of this book). An additional aspect that can affect the ability of grapevine viruses to infect a woody perennial host is a potential to withstand repeated seasonal cycles of vegetative growth, veraison, defoliation, dormancy, etc., for long-term survival. Currently, it is not known how such long-term survival is accomplished despite the constant challenge from the antiviral defense systems of the grapevine host, including RNA interference (RNAi). Although grapevine closterovirids are known to possess strong suppressors of RNAi, others, like *Grapevine virus A* (GVA, a member of the genus *Vitivirus*), have only weak suppressors (Chiba et al. 2006; Gouveia and Nolasco 2012; Lu et al. 2004). Exploration of the interplay between the grapevine host defense mechanisms and viral counter-defense strategies represents a novel and exciting area of research.

What seems to be clear from comparative genomics studies is that there are no genes that are specific to and conserved among all grapevine viruses or woody plant-infecting viruses in general. Below we consider apparent commonalities and aspects of the evolution of the major taxa of grapevine-infecting viruses.

Positive-Strand RNA Viruses

Positive-strand RNA viruses dominate the virome of eukaryotes in general, as well as plants and grapevine in particular (Dolja and Koonin 2011; Koonin et al. 2015). Although the exact causes for such dominance are not known, it does not seem to be incidental. Sequestration of the DNA replication and transcription machineries in the nucleus mounts a significant barrier to smaller DNA viruses that require access to these machineries (Koonin et al. 2015). In contrast, the cytosol of the eukaryotic cell is an effective “RNA compartment” where the translation apparatus and

relatively long-lived mRNAs reside. One key point is that the cytosol itself harbors various endomembrane compartments capable of housing viral RNA replication complexes, with the endoplasmic reticulum being most frequently utilized to fulfill this role (Diaz and Ahlquist 2012). It appears that the dominance of RNA viruses in the eukaryotic domain of life has been established at the time of eukaryogenesis, an idea supported by the virtually universal conservation of the RNAi defense system among the diverse organisms populating this domain (Koonin et al. 2015; Shabalina and Koonin 2008). Plants offer a powerful and diversified RNAi machinery, in accord with a need to control the assault of numerous positive-strand RNA viruses.

Among 17 known families of grapevine-infecting viruses, ten families possess members with a positive-strand RNA genome, with the families *Betaflexiviridae*, *Closteroviridae*, and *Secoviridae* harboring a majority of grapevine viruses.

Family *Betaflexiviridae*

The family *Betaflexiviridae* comprises mostly viruses infecting woody perennials with two distinct types of genome structures. This family was established only recently as a result of a reclassification of the former family *Flexiviridae* (King et al. 2011). Members of the family *Betaflexiviridae*, together with those of the families *Alphaflexiviridae*, *Gammaflexiviridae*, and *Tymoviridae*, make up the order *Tymovirales*, one of the seven orders established by the International Committee on the Taxonomy of Viruses (ICTV). As of today, the family *Betaflexiviridae* comprises 11 genera of positive-sense, single-stranded RNA viruses with filamentous virion morphology (ICTV 2016).

The grouping of these four families of viruses into the order *Tymovirales* is mainly based on the presence of common domains in their replicase proteins (MTR, methyltransferase; HEL, helicase; and RdRP, RNA-dependent RNA polymerase) and the close phylogenetic relatedness of the RdRP domains among these viruses. Nevertheless, there are major differences among these four families of viruses. For instance, members of the family *Alphaflexiviridae* have smaller genomes and encode a replicase protein that lacks a protease domain. In contrast, members of the families *Tymoviridae* and *Betaflexiviridae* (with the exception of the genera *Trichovirus*, *Vitivirus*, and *Prunevirus*) all encode a replicase polyprotein that presumably undergoes proteolytic processing to produce more than one discrete final protein product (Fig. 32.1). This heterogeneity is also reflected in the family *Betaflexiviridae*. Based on differences in genome structure and number of open reading frames (ORFs), members of the family *Betaflexiviridae* are subdivided into two subfamilies: *Trivirinae* and *Quinvirinae*. The subfamily *Trivirinae* comprises eight genera of viruses (*Capillovirus*, *Chordovirus*, *Citrivirus*, *Divavirus*, *Prunevirus*, *Tepovirus*, *Trichovirus*, and *Vitivirus*) with three or more ORFs. In contrast, members of the subfamily *Quinvirinae* have five or more ORFs and include three genera: *Carlavirus*, *Foveavirus*, and *Robigovirus* (ICTV 2016). Common features of viruses in the subfamily *Quinvirinae* include a large replicase polyprotein

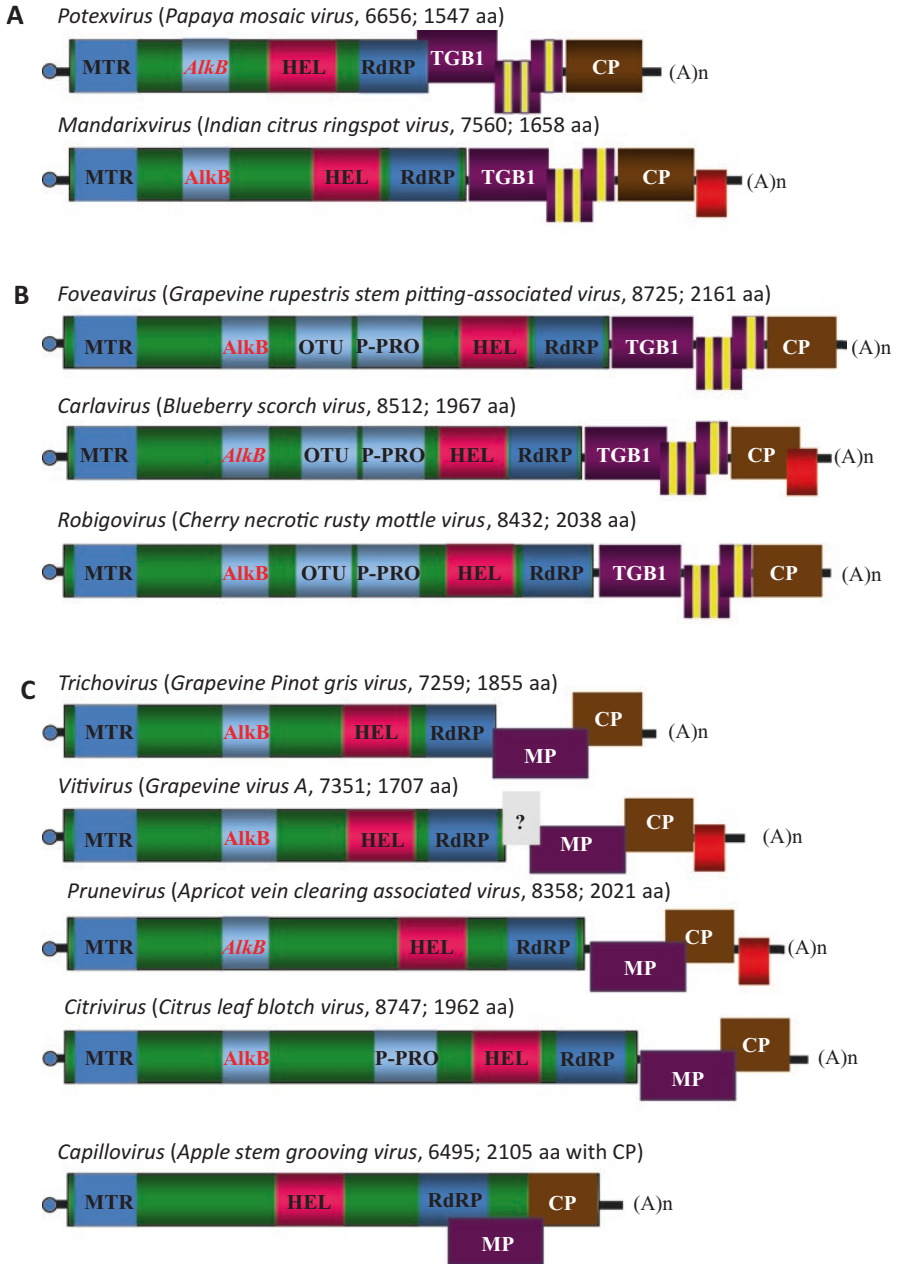

Fig. 32.1 Genome structure of viruses representing different genera of viruses within the family *Alphaflexiviridae* and *Betaflexiviridae*. (a) *Alphaflexiviridae*. (b) *Betaflexiviridae* subfamily *Quinvirinae*. (c) *Betaflexiviridae*, subfamily *Trivirinae*. The name of the select viral genus is given on top of each diagram. The name of a representative virus, the size of its genome (in nucleotides), as well as the size of its replicase protein (in amino acid residues) are provided in parentheses after the name of the genus. *MTR* methyltransferase, *HEL* RNA helicase, *RdRP* RNA-dependent RNA polymerase, *TGB* triple gene block, *MP* movement protein, *CP* capsid protein, *OTU* ovarian tumor gene-like protease, *P-PRO* papain-like protease, *AlkB* alkylation B. The *italicized AlkB* indicates that not all members of the genus contain an *AlkB* domain.

that contains, in addition to the three widely conserved domains described above, three additional domains that are unique: an AlkB domain, a cysteine protease domain designated as ovarian tumorlike (OTU), and a second cysteine protease domain commonly known as the papain-like protease (P-Pro). Another common feature of *Quinvirinae* is the set of three ORFs designated as the triple gene block (TGB), which encodes three proteins involved in virus movement. In sharp contrast, most members of the subfamily *Trivirinae* have genomes that are smaller than those of members of the subfamily *Quinvirinae* and encode replicase proteins that generally lack a protease domain (with the exception of the genus *Citrivirus*). Furthermore, they encode a single movement protein of the 30K superfamily of movement proteins (Fig. 32.1).

Interestingly, the vast majority of viruses within the family *Betaflexiviridae* naturally infect perennial plant species, most of which are woody plants. It is worth noting that three genera (*Foveavirus*, *Trichovirus*, and *Vitivirus*) of the family *Betaflexiviridae* contain viruses that naturally infect grapevine. Other hosts of viruses of the family *Betaflexiviridae* include citrus, cherry, apricot, apple, and blueberry. The genus *Carlavirus* is unique in that its members either infect herbaceous annual plants, herbaceous perennial plants, or woody perennials. The genus *Capillovirus* is unique in that it is the only genus in this family whose members lack an AlkB domain (Fig. 32.1c). To assess the evolutionary relatedness of members of the family *Betaflexiviridae* as well as other members of the order *Tymovirales*, phylogenetic analyses were performed using the highly conserved RdRP domain and the seemingly recently acquired AlkB domain. Results of these analyses are presented below.

Members of the family *Betaflexiviridae* possess closely related RdRp domains. The phylogenetic analysis of the core domain of RdRp fully supports the current taxonomy of viruses in the order *Tymovirales* (Fig. 32.2). The three genera (*Tymovirus*, *Maculovirus*, and *Marafivirus*) of the family *Tymoviridae* form a tight cluster.

In line with the findings of other researchers (Martelli et al. 2007; King et al. 2011), members of the family *Alphaflexiviridae* (*Potexvirus* and *Mandarivirus*) seem to be more closely related to those of the family *Tymoviridae* than to those of the family *Betaflexiviridae* (Fig. 32.2). It is also interesting to note that members of the genera *Carlavirus*, *Foveavirus*, *Robigovirus*, and *Prunovirus* cluster together.

Fig. 32.2 (continued) *CNRMV* Cherry necrotic rusty mottle virus, *ChTLaV* Cherry twisted leaf associated virus, *CPrV* Caucasus prunus virus, *PrVT* Prunus virus T, *GPGV* Grapevine Pinot gris virus, *PcMV* Peach mosaic virus, *PCMV* Peach chlorotic mottle virus, *APCLSV* Apricot pseudo-chlorotic leaf spot virus, *GVA* Grapevine virus A, *GVB* Grapevine virus B, *GVE* Grapevine virus E, *GVF* Grapevine virus F, *AcVA* Actinidia virus A, *AcVB* Actinidia virus B, *ShVX* Shallot virus X, *CYVCaV* Citrus yellow vein clearing virus, *PapMV* Papaya mosaic virus, *CIYMV* Clover yellow mosaic virus, *CVX* Cactus virus X, *HarVA* Hardenbergia virus A, *CBV-1* Carrot beteflexivirus 1, *TYMV* Turnip yellow mosaic virus, *GFkV* Grapevine fleck virus, *GRGV* Grapevine redglobe virus, *GSyV-1* Grapevine Syrah virus 1

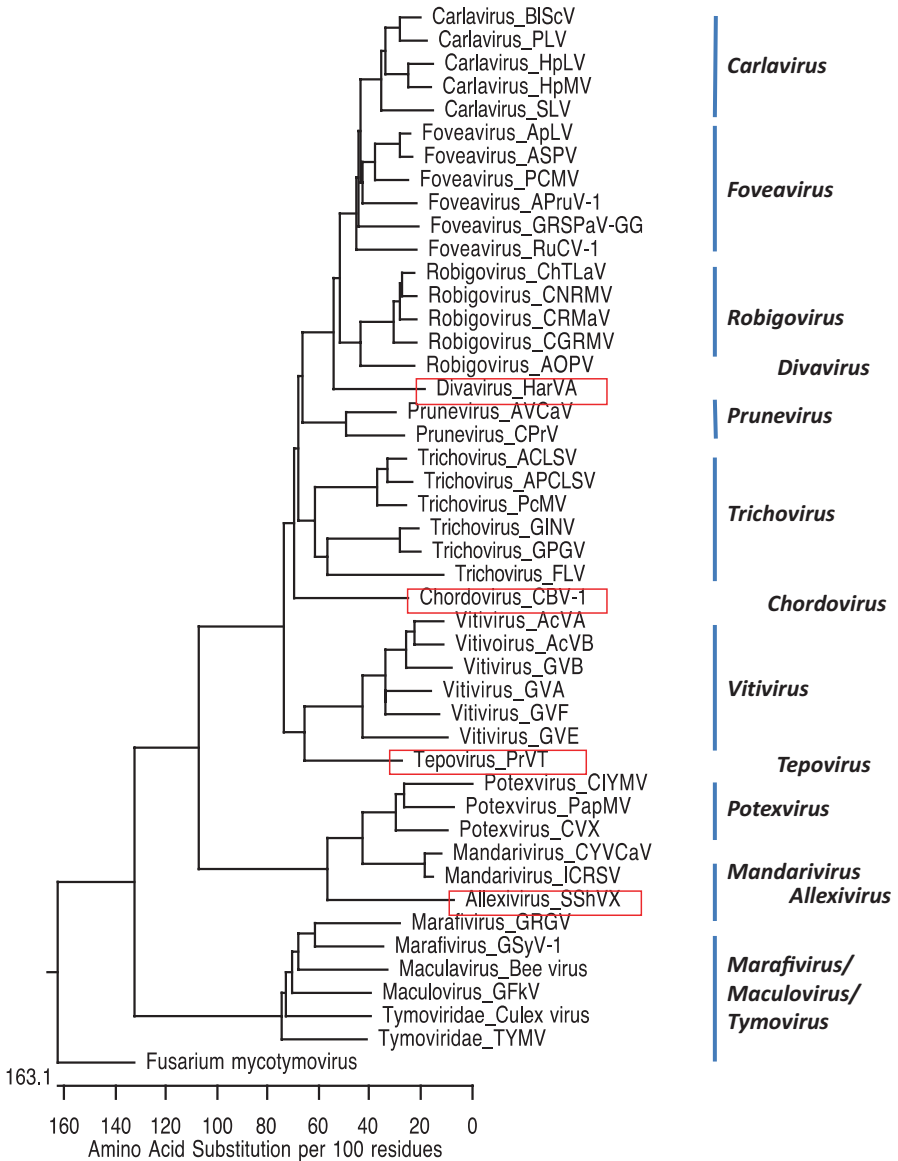

Fig. 32.2 Phylogenetic tree based on the amino acid sequence of the RdRP domain of select viruses representing families *Alphaflexiviridae*, *Betaflexiviridae*, and *Tymoviridae* of the order *Tymovirales*. Phylogenetic analyses were carried out using the neighbor-joining method. *Abbreviations of virus names*: *ICRSV* Indian citrus ringspot virus, *FLV* Fig latent virus, *GINV* Grapevine inner berry necrosis virus, *ACL SV* Apple chlorotic leafspot virus, *HpMV* Hop mosaic virus, *HpLV* Hop latent virus, *SLV* Shallot latent virus, *BIScV* Blueberry scorch virus, *PLV* Passiflora latent virus, *ASPV* Apple stem pitting virus, *ApLV* Apricot latent virus, *APruV-1* Asian prunus virus 1, *RuCV-1* Rubus Canadensis virus 1, *GRSPaV* Grapevine rupestris stem pitting-associated virus, *AOPRV* African oil palm ringspot virus, *CGRMV* Cherry green ring mottle virus,

Members of the genus *Vitivirus* and *Prunus virus T* (a member of the genus *Tepovirus*) appear to be closely related. Therefore, the results of phylogenetic analysis support the hypothesis that members of the order *Tymovirales* share a common ancestor that diversified into the family *Tymoviridae* with icosahedral capsids and a variety of virus genera sharing a filamentous capsid structure (Martelli et al. 2007).

It is interesting that the family *Tymoviridae* tree cluster also contains RdRP sequences retrieved from two tentative members of the *Tymoviridae*, the first from *Culex* mosquito (Wang et al. 2012) and the second from honeybee (De Miranda et al. 2015). It remains unknown, however, if these two sequences belong to novel viruses that infect these insects or to plant viruses that were ingested by the insect. Both honeybees and mosquitos are known to feed on plants for nectars as source of sugar (Foster 1995).

Phylogenetic analyses suggest a convoluted evolutionary history of the viral AlkB domain. Alkylation B (AlkB) is a member of the Fe(II)- and 2-oxoglutarate (2OG)-dependent dioxygenase superfamily of proteins and is involved in the removal of methyl groups from methylated nucleic acids through an oxidative reaction (Aas et al. 2003; Aravind and Koonin 2001; Bratlie and Drablos 2005; Martelli et al. 2007; van den Born et al. 2008). Genes encoding AlkB proteins are identified in all cellular organisms except archaea, suggesting a critical role played by AlkB enzymes in these vastly diverse cellular organisms. However, the discovery of AlkB homologues in viruses was a more recent event. Aravind and Koonin (2001) were the first to identify AlkB-encoding sequences from several genera of single-stranded, positive-sense RNA viruses. Subsequently, Bratlie and Drablos (2005) conducted a comprehensive search for AlkB homology sequence in viruses and obtained results that confirmed and further expanded the initial findings of Aravind and Koonin (2001). They detected AlkB homologues in a small subset of (+)ssRNA viruses, most of which belong to multiple genera of two viral families: *Alphaflexiviridae* (*Potexvirus*, *Allexivirus*, and *Mandarivirus*) and *Betaflexiviridae* (*Carlavirus*, *Foveavirus*, *Trichovirus*, and *Vitivirus*). In addition, similar AlkB homologues were also detected in viruses that belong to the genus *Ampelovirus* of the family *Closteroviridae* and a single virus each from the family *Potyviridae* (*Blackberry virus Y*, BIVY) and *Secoviridae* (*Black raspberry necrosis virus*, BRNV) (Halgren et al. 2007; Bratlie and Drablos 2005).

To identify AlkB sequences in the genome of all members of the family *Betaflexiviridae* for which sequences are available in databases, we used the amino acid sequence corresponding to the AlkB domain comprising the nucleic acid lid and the core domain from GRSPaV isolate GG (aa positions 736–877 of the replicase polyprotein) as the query in a blast search against the database. As a result, we identified AlkB domains in 11 genera of viruses that belong to three families of (+) ssRNA viruses. The three new genera of viruses we found to contain AlkB domain in this search are *Robigovirus*, *Prunevirus*, and *Tepovirus*, all of which were recently established by ICTV as new genera in the family *Betaflexiviridae*. Similar to previous findings, AlkB sequences were also identified in BIVY (Susaimuthu et al. 2007) and in BRNV (Halgren et al. 2007).

To obtain a more up-to-date understanding of the evolutionary relationship between the AlkB domains from these diverse viruses, we retrieved the corresponding AlkB sequences from a subset of these viruses representing each of the viral genera. Phylogenetic analyses were performed using both the neighbor joining (NJ) and maximum likelihood (ML) algorithms. These phylogenetic analyses revealed several interesting observations that we discuss below. The AlkB sequences from members of the genus *Carlavirus* form a tight cluster, suggesting their common ancestry. Similarly, AlkB homologues from members of the genus *Robigovirus* also form a distinct cluster. In contrast, the AlkB sequences of members of the genus *Vitivirus* seem to have originated from several independent sources. For example, the AlkB sequences from GVA and GVB were more closely related to each other and to that of GLRaV-1 (genus *Ampelovirus*, family *Closteroviridae*), whereas the AlkB of GVE forms a cluster with those from other members of the genus *Ampelovirus* (GLRaV-3 and GLRaV-4), as well as with those from members of the genera *Allexivirus* and *Potexvirus* (both of the family *Alphaflexiviridae*) (Fig. 32.3). It seems reasonable to suggest that the AlkB domain in GLRaV-1 has been derived from GVA or its close relative. Following similar reasoning, it is plausible that the AlkB sequence in GVE might have been acquired from a member of the *Ampelovirus* genus, such as GLRaV-3 or GLRaV-4 (Fig. 32.3). Interestingly, the AlkB domain of GVE isolate SA94 is located within the helicase domain (Coetzee et al. 2010b), whereas in other viruses, the AlkB domain is upstream of the helicase. This isolate was obtained from a cv. Shiraz vine exhibiting Shiraz disease symptoms that is also infected with *Grapevine leafroll-associated virus 3* (GLRaV-3), GVA, and GRSPaV. The unusual genomic position of the AlkB in GVE SA94 appears to be authentic because it was validated for a distinct GVE isolate, TvAQ7, originating from *Vitis labruscana* cv. Aki Queen OKY-AQ7 from Japan (Nakaune et al. 2008). It is interesting to point out that the source of this GVE isolate was also infected with GLRaV-3 and GRSPaV and exhibits stem-pitting symptoms (Nakaune et al. 2008).

Interestingly, AlkB domains were also found in single members of the large families *Potyviridae* and *Secoviridae*. As shown in Fig. 32.3, the AlkB sequence from BNRV (a member of the family *Secoviridae* that has yet to be assigned to a genus) is closely related to those from CYVCaV and ICRSV (both of the genus *Mandarivirus*). On the other hand, the AlkB sequence in BIVY (a newly identified virus of the genus *Brambyvirus*, family *Potyviridae*) clusters with those from *Prunus virus T* (PVT) (genus *Prunevirus*). The most obvious explanation for the isolated existence of AlkB sequences in these two families of viruses is horizontal gene transfer of the AlkB sequence from an AlkB-containing virus to the coinfecting virus that was a member of the family *Potyviridae* or *Secoviridae*. Indeed, mixed infections are common in woody perennial plants, especially in fruit crops (Prosser et al. 2007; Al Rwahnih et al. 2009; Coetzee et al. 2010a).

It is interesting that AlkB homologues are present in all the studied viruses of the family *Betaflexiviridae* except those of the genus *Capillovirus*. The reason for the lack of AlkB domain in members of the *Capillovirus* is unknown. It is also worth noting that AlkB sequences are present in only a small number of viruses from the genus *Potexvirus*, all of which are capable of infecting perennials. It appears that in

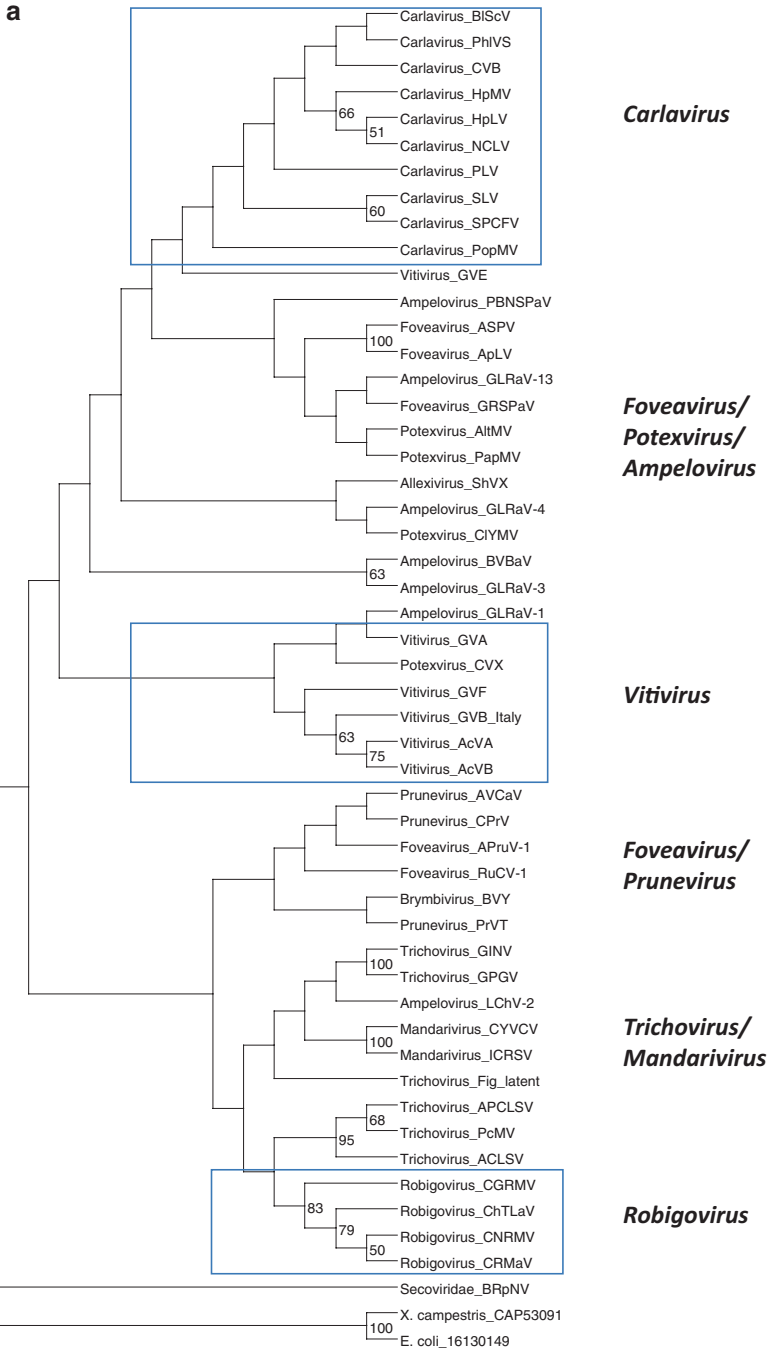

Fig. 32.3 (a) Phylogenetic (neighbor-joining) tree of AlkB sequences from RNA viruses. Select viruses belong to the family *Alphaflexiviridae*, *Betaflexiviridae*, or *Closteroviridae* (genus *Ampelovirus*).

b

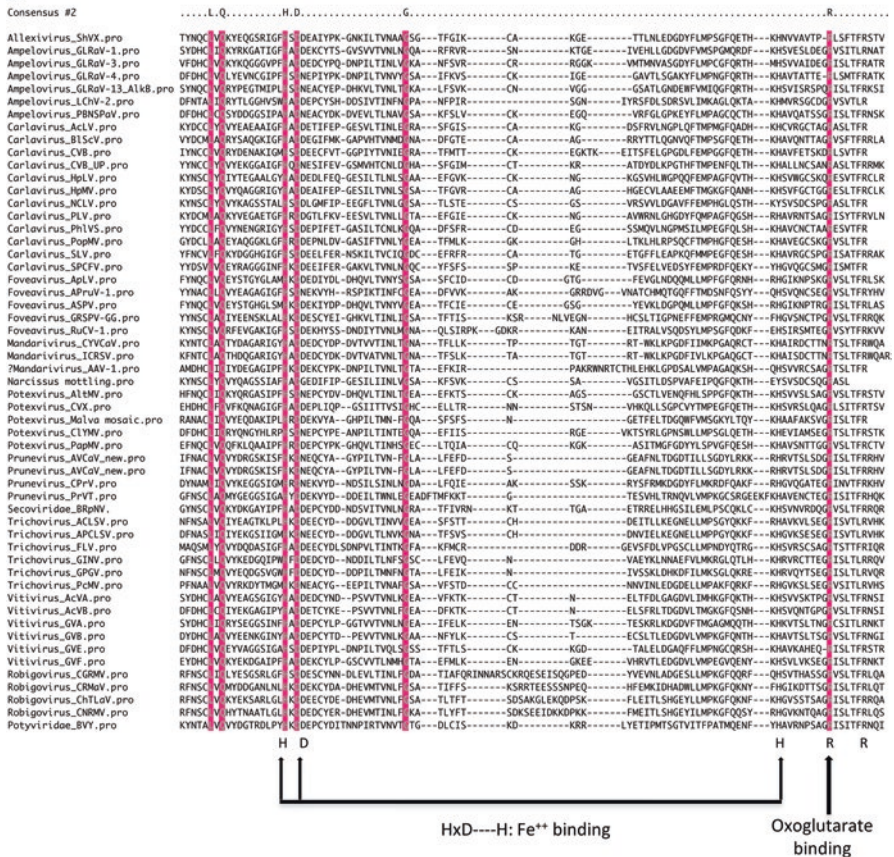

Fig. 32.3 (continued) The AlkB amino acid sequences from *Blackberry virus Y* (genus *Brambyvirus*, family *Potyviridae*) and *Black raspberry necrosis virus* (family *Secoviridae*) are also included. (a) The extended AlkB aa sequences of ~130 aa were used in the analysis. (b) Sequence alignment of AlkB domains showing the conserved amino acid residues involved in Fe⁺⁺ binding (HxD----H) and binding site for the co-substrate oxoglutarate. Full names of viruses are given in Fig. 32.3 legend *Abbreviations of virus names*: CVB Chrysanthemum virus B, NCLV Narcissus common latent virus, PopMV Poplar mosaic virus, PhIVS Phlox virus S, SPCFV Sweet potato chlorotic fleck virus, AcLV Aconitum latent virus, CRMaV Cherry rusty mottle-associated virus, AVCaV Apricot vein clearing-associated virus, AAVA Ambrosia asymptomatic virus, AltMV Alternanthera mosaic virus, GLRaV Grapevine leafroll-associated virus, LChV-2 Little cherry virus 2, PBNSpaV Plum bark necrosis stem pitting-associated virus, BRpNV Black raspberry necrosis virus, BYV Blackberry virus Y. Abbreviations for names of other viruses are given in Fig. 32.2 legend

some of the viruses in the genera *Carlavirus* (*Potato virus S*, *Potato virus M*, *Potato virus P*, and *Nerine latent virus*) and *Potexvirus* (*Asparagus virus 3*, *Narcissus mosaic virus* strain New Zealand), the AlkB domains are enzymatically inactive due to mutations affecting the active site (van den Born et al. 2008; and our unpublished data).

AlkB may have an important function that is unique for viruses of perennial plants. As stated earlier, AlkB proteins are widely distributed in diverse cellular organisms including bacteria, fungi, insects, plants, and animals and are essential for the protection of genome sequences against damage due to methylation. It was demonstrated that certain AlkB proteins, such as *E. coli* AlkB, and two AlkB homologues from humans (hABH2 and hABH3) are oxidative DNA demethylases. Importantly, it was also shown that both AlkB and hABH3 can repair methylated RNA of bacteriophage MS2 (Aas et al. 2003), suggesting a potential role of AlkB domains in virus-host interactions.

So far, the exact functions of the AlkB domains in the infection cycle of plant viruses within their perennial hosts remain unknown. One distinct possibility is that the viral AlkB proteins play a role in counter defense against methylation damage resulting from the yet uncharacterized host defense mechanism particularly important for woody and other perennial plants where virus infections persist for long time periods. This notion is supported by the fact that only those members of the genus *Potexvirus* that infect perennial plants contain AlkB, while the other members that infect annual plants lack this domain. Furthermore, a potentially inactive AlkB domain is detected in viruses of the genus *Carlavirus* that infect annual herbaceous plants, as well as in the GVB strain that was maintained in an herbaceous experimental host, *Nicotiana occidentalis* (Saldarelli et al. 1996). However, it is difficult to reconcile the above with the notion that all known members of a single genus of *Betaflexiviridae* (i.e., *Capillovirus*) and those of two genera of the *Closteroviridae* (i.e., *Closterovirus* and *Velarivirus*) lack AlkB domain altogether.

Given the broad conservation of the AlkB domain in bacteria and eukaryotes and its patchy distribution in a subset of plant RNA viruses, it seems likely that these viruses acquired the sequence encoding this domain via recombination with the corresponding cellular mRNA. The latter RNA could have been from either a plant virus host or from a coinfecting bacterial or fungal parasite (or symbiont). Although it is not clear if the initial acquisition of the AlkB domain by a virus occurred only once or on multiple independent occasions, the phylogenetic analysis of the viral AlkB domains strongly suggests an important role of horizontal gene transfer between viruses in subsequent, apparently ongoing dissemination of this domain.

Sequence conservation in the 3'-UTR of GRSPaV and vitiviruses suggests inter-genera recombination. A recent serendipitous finding offered evidence for a recombination event between three viral species that belong to two genera of the family *Betaflexiviridae*. When searching the NCBI nucleotide sequence database using the 3' untranslated sequence of GRSPaV isolate GG, significant similarity was found between GRSPaV (genus *Foveavirus*) and several isolates of GVB and GVE (genus *Vitivirus*). As shown in Fig. 32.4, this region of similarity is 63 nucleo-

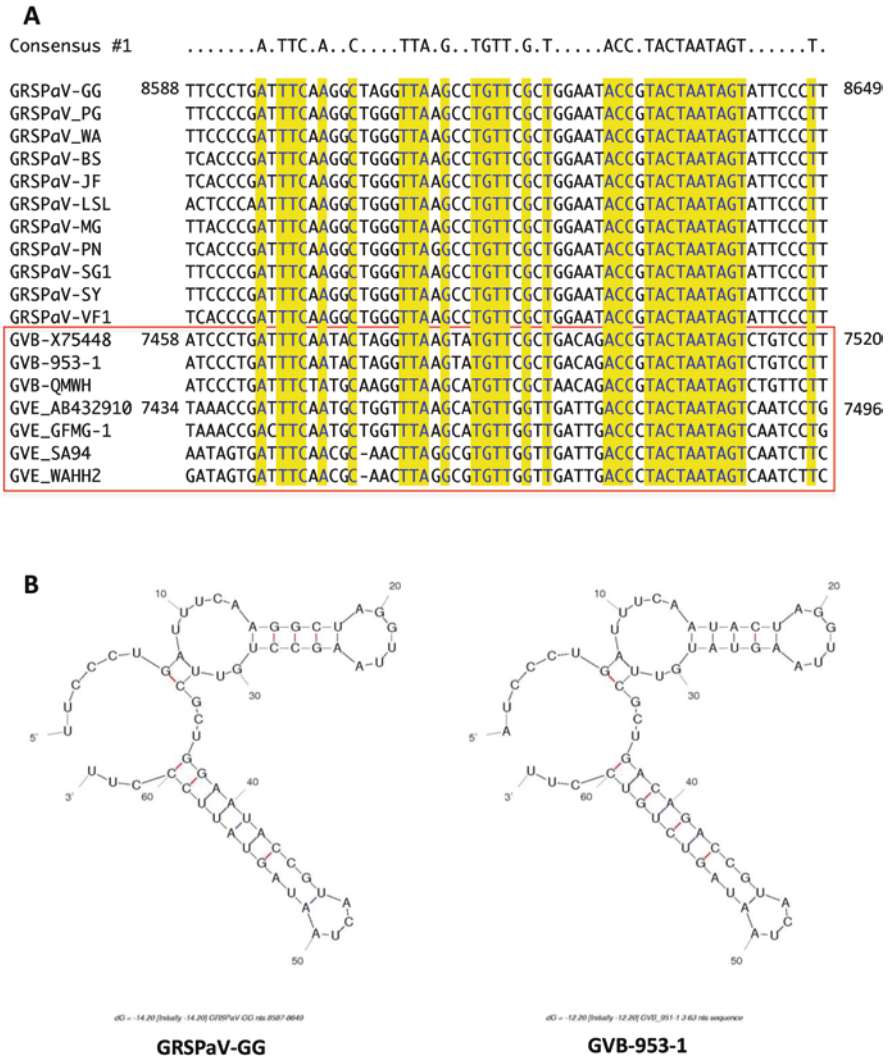

Fig. 32.4 Sequence conservation of a 63-nucleotide region within the 3' noncoding region of *Grapevine rupestris stem pitting-associated virus* (GRSPaV) isolates and several isolates of *Grapevine virus B* (GVB) and GVE. (a) Sequence alignment to depict conserved nucleotide sequences (highlighted in yellow). (b) Secondary structure of this region in GRSPaV isolate GG and GVB isolate 953-1 (KJ524452) deduced by MFold analysis

tides long, which corresponds to genomic position 8588–8649 in GRSPaV, and is part of the 3'-UTR. This region is 90.5–96.8% identical among GRSPaV isolates for which complete genomes are available (Fig. 32.4a, see Chap. 12 of this book for further details on GRSPaV). Interestingly, this region of sequence similarity is also found in three of the completely sequenced GVB isolates: the prototype isolate

[GenBank accession number X75448 sequenced from an isolate maintained in *Nicotiana occidentalis* from Italy; Minafra et al. (1994), Saldarelli et al. (1996)], isolate 953-1 [KJ524452 originated from hybrid grape LN33 from South Africa; Goszczynski (2015)], and isolate QMWH (KF700375 originated from an unknown grapevine from China; Hu et al. direct deposition in GenBank). This region corresponds to nts 7458–7520 of the Italian isolate of GVB, which is immediately downstream of ORF5. It also corresponds to genomic positions 7439–7500 of GVE (isolate SA94) [ORF5, 7112–7462 in SA94]. This region has 79.4–82.5% identity when compared to those in these three GVB isolates and 61.9–66.7% when compared to those in GVE isolates (Fig. 32.4a). Prediction of the secondary structure of this sequence region in GRSPaV-GG and GVB isolate 953–1 using Mfold revealed identical stem-loop structures (Fig. 32.4b), suggesting conservation in secondary structure and likely in biological function. It would be interesting to determine the function of this conserved sequence region in relation to genome replication and transcription of subgenomic mRNAs required for both viruses.

Family *Closteroviridae*

This diverse family of plant viruses with the largest RNA genomes is currently split into four genera, based on genome architecture and phylogenetic analyses, as well as on the insect transmission specificity (Dolja et al. 2006; Karasev 2000; Naidu et al. 2015). A detailed evolutionary scenario for the family origin and diversification has been developed in 2006 (Dolja et al. 2006). Here, we will provide a brief outlook for each of the six viruses from this family that infect grapevine (Fig. 32.5). For more in-depth analysis of the leafroll disease complex, the reader is referred to a comprehensive recent review (Naidu et al. 2015) as well as Chapters 6, 7, 8, 9 and 10 of this book.

The virus that arguably incites the most damage for the grape and wine industry worldwide is GLRaV-3 from the genus *Ampelovirus*, subgroup I (Maree et al. 2013). This subgroup of ampeloviruses also includes another highly pathogenic virus, *Grapevine leafroll-associated virus 1* (GLRaV-1), and recently described GLRaV-13 that is closely related to but still distinct from GLRaV-1 (Fig. 32.5) (Ito and Nakaune 2016). The third *Ampelovirus* that infects grapevine is *Grapevine leafroll-associated virus 4* (GLRaV-4), an umbrella name that encompasses a collection of diverse strains previously considered to be distinct viruses (Abou Ghanem-Sabanadzovic et al. 2012; Martelli et al. 2012; Naidu et al. 2015; Thompson et al. 2012). As is typical of ampeloviruses, GLRaV-1, GLRaV-3, and GLRaV-4 are transmitted by mealybugs and scale insects in a semi-persistent manner, although both the biological and molecular aspects of this process are still areas of active research.

From an evolutionary standpoint, the two subgroups of ampeloviruses exhibit unique features, including a clustering in phylogenetic trees for the RdRP, HSP70h, and major capsid protein (Dolja et al. 2006). Remarkably, the replication polyproteins of all three grapevine ampeloviruses contain an AlkB domain that possesses

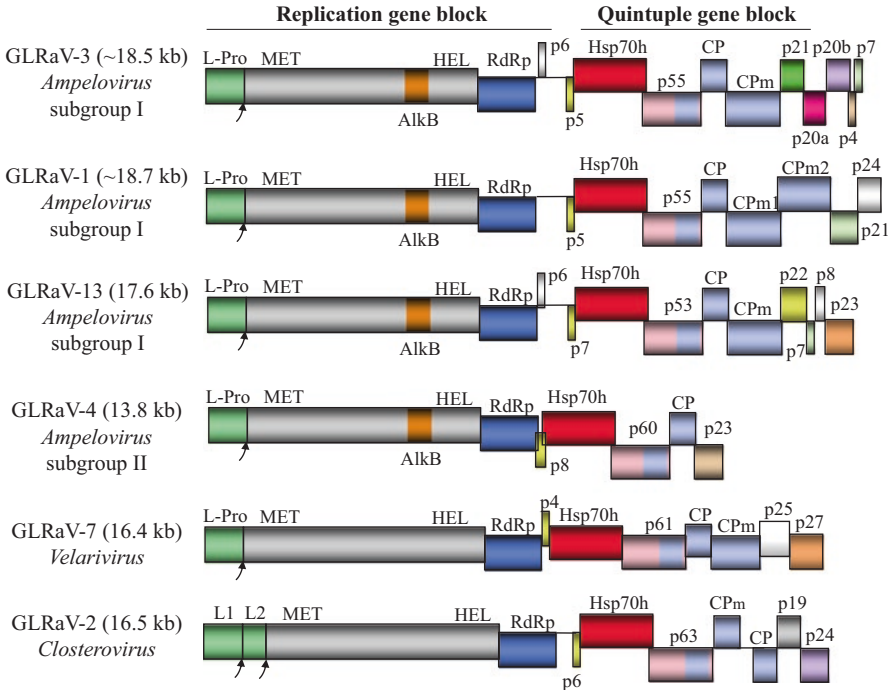

Fig. 32.5 Genome organization of the six grapevine-infecting members of the family *Closteroviridae*, approximately to scale. Colored boxes represent open reading frames with the protein name abbreviation shown. *L-Pro* papain-like leader protease, *MET* methyltransferase domain, *HEL* RNA helicase domain, *AlkB* the AlkB domain, *RdRp* RNA-dependent RNA polymerase, *Hsp70h* heat shock protein 70 homolog, *CP* coat protein, *CPm* minor coat protein. Note conservation of the CP-like domain in the C-terminal region of the ~60 kDa, minor tail proteins encoded downstream from HSP70h. The varying colors of the proteins encoded downstream from quintuple gene block (except for GLRaV-4 that lacks CPm) reflect the low or lacking conservation of their amino acid sequences. The p24 of GLRaV-2 and p20b of GLRaV-3 are the RNAi suppressors

RNA demethylase activity and was proposed to protect viruses from plant RNA methylation defense response (Fig. 32.5) (van den Born et al. 2008). Interestingly, this domain is not present in any other woody plant-infecting members of the family *Closteroviridae* sequenced so far.

The dissimilar features between two *Ampelovirus* subgroups include a clear separation into distinct branches in phylogenetic trees and even more striking differences in gene content. Subgroup I possesses a signature quintuple gene block encoding a small transmembrane protein, an HSP70h, an ~60 kDa protein with a capsid protein-like domain, a major capsid protein (CP), and a minor capsid protein (CPm) that is substantially larger than those of members from the genus *Closterovirus* (Fig. 32.5). The CP-CPm gene order in subgroup I ampeloviruses is reversed relative to that in the genus *Closterovirus*. Interestingly, GLRaV-1 is the only known family member in which there are two tandem copies of the CPm gene.

In contrast to subgroup I viruses, the subgroup II GLRaV-4-like viruses are an evolutionary curiosity among their kin within the family *Closteroviridae* with a genome of ~13,800 nucleotides that is ~5000 nucleotides shorter than that of the subgroup I GLRaV-3 (Abou Ghanem-Sabanadzovic et al. 2012; Naidu et al. 2015). The variable 3'-terminal region of the GLRaV-4 genome contains only one gene, whereas the other members of the family *Closteroviridae* have two to five genes in this region (Fig. 32.5). Uniquely among the entire family *Closteroviridae*, GLRaV-4 lacks the gene encoding CPm, although it encodes the remaining four genes of the family's signature quintuple gene block.

As has been originally shown for the prototype member of the family, *Beet yellows virus* (BYV), the CPm forms a short tail at the end of a filamentous virion (Agranovsky et al. 1995). It was demonstrated that although the tail encapsidates the 5'-terminal ~700 nucleotides of viral genomic RNA (Peremyslov et al. 2004; Satyanarayana et al. 2004), in the absence of CPm, the major capsid protein is capable of encapsidating the entire virus genome (Alzhanova et al. 2001). However, CPm is strictly required for cell-to-cell movement of BYV, as are the other minor tail components, HSP70h and p64 (Alzhanova et al. 2000, 2007), the latter possessing a diverged CP-like domain (Napuli et al. 2003). Such tight functional coupling of tail assembly and intercellular spread of BYV prompted the development of a concept according to which the tail is a specialized movement device that directs BYV virions toward and through plasmodesmata (Dolja 2003). If one assumes that the functions of the signature quintuple gene block proteins are conserved among viruses in the family *Closteroviridae*, the lack of CPm in GLRaV-4 could entail the lack of tail, in accord with experimental evidence (Abou Ghanem-Sabanadzovic et al. 2012), as well as defective cell-to-cell movement. Because mixed virus infections are common in grapevine (Al Rwahnih et al. 2009; Coetzee et al. 2010a, b; Seguin et al. 2014), such defect could be rescued by coinfecting helper viruses. It also seems possible that in GLRaV-4, the remaining conserved quintuple gene block proteins, namely, HSP70h and p60, a homologue of BYV p64, functionally compensate for the lack of CPm to enable movement.

Given that the last common ancestor of closterovirids likely possessed CPm that is missing in GLRaV-4 (Dolja et al. 2006), it seems plausible that the ancestor of GLRaV-4 and related subgroup II pineapple ampeloviruses (Sether et al. 2009) has evolved from a subgroup I virus via lineage-specific gene loss. The functional significance of this loss is yet to be understood.

Viruses in the genus *Closterovirus* possess a genome varying in length from ~15,500 nucleotides in BYV to nearly 20,000 nucleotides in *Citrus tristeza virus* (CTV) and are typically transmitted by aphids (Dolja et al. 2006). Although, based on genome architecture and phylogenetic analysis, *Grapevine leafroll-associated virus 2* (GLRaV-2) clearly belongs to this genus (Fig. 32.5), it has no known insect vector and is transmissible by grafting. The GLRaV-2 genome possesses apparent orthologs of all BYV genes including a potent RNAi suppressor, p24 (Chiba et al. 2006). Unlike BYV and similar to CTV, GLRaV-2 possesses two diverged copies of

the papain-like leader proteinase involved in establishment of the primary infection and subsequent systemic transport of this virus (Liu et al. 2009). For a comprehensive coverage of GLRaV-2 biology and pathogenicity, the reader is referred to Chap. 7 of this book by Angelini et al.

A good example of the vagaries in interpreting the evolution of grapevine viruses is *Grapevine leafroll-associated virus 7* (GLRaV-7) that belongs to the newly established genus *Velarivirus* (Al Rwahnih et al. 2012a). This virus causes no disease symptoms in several grapevine cultivars and therefore could be considered a well-adapted virus that coevolved with this host for a long time. However, there is no data on alternative GLRaV-7 hosts or natural reservoirs, thus making uncertain if GLRaV-7 was transmitted to wild or cultivated grapevine species from another host. Furthermore, GLRaV-7 is readily transmitted by grafting, but, similar to GLRaV-2, no transmission by vectoring insects is known for this virus. Because the grafting transmission pathway is limited to grapevine cultivation, it cannot account for natural virus evolution. This raises the question of grapevine being a dead-end host for GLRaV-7 and GLRaV-2 being reminiscent of *West Nile virus* that can infect people upon transmission by mosquitoes from natural hosts, birds, but is not transmitted from person to person by this natural route (Weaver and Barrett 2004).

The genome architecture of GLRaV-7 is typical for the family *Closteroviridae* (Al Rwahnih et al. 2012a) and appears to be most similar to those of viruses of the genus *Ampelovirus* subgroup I (Fig. 32.5). The N-terminal region of the replication polyprotein of GLRaV-7 harbors a papain-like leader proteinase, but unlike other ampeloviruses, it lacks AlkB domain. Similar to GLRaV-1, GLRaV-3, and GLRaV-13, it has a quintuple gene block in which the order of genes encoding CP and CPm is reversed relative to that in the genus *Closterovirus* including GLRaV-2 (Fig. 32.5). Both GLRaV-7 and GLRaV-1 possess only two genes in the variable 3'-terminal genome region, whereas GLRaV-3 has five genes in this region. Therefore, it seems likely that the genera *Velarivirus* and *Ampelovirus* have shared a common evolutionary ancestor.

Family *Secoviridae*

The family *Secoviridae*, established in 2009 within the order *Picornavirales* by grouping the former families *Sequiviridae* and *Comoviridae* and three unassigned genera, comprises plant viruses with icosahedral particles ca. 30 nm in diameter and a bipartite single-stranded positive-sense RNA genome (Sanfaçon et al. 2009). Three of the eight genera of the family, i.e., *Comovirus*, *Nepovirus*, and *Fabavirus*, belong in the subfamily *Comovirinae* (Sanfaçon et al. 2012), and two of these genera (*Nepovirus* and *Fabavirus*) have members infecting grapevines (Martelli 2014).

Genus *Nepovirus*

Nepoviruses have icosahedral particles constructed with a single type of protein subunits 56–60 kDa in size and a bipartite ssRNA genome 7–8 kb (RNA-1) and 3–7 kb (RNA-2) in size (Mayo and Robinson 1996). Based on the size of RNA-2 and the way in which it is encapsidated, nepoviruses have been divided into three subgroups denoted as A, B, and C (Sanfaçon et al. 2012) (Fig. 32.6). Both genomic RNAs have a single open reading frame (ORF) each coding for a large polyprotein (P1 and P2). RNA-1-encoded P1 is cleaved by a 3C-like proteinase into five smaller peptides: protease cofactor (Pro-Co), nucleotide-binding protein with helicase activity (Hel), genome-linked protein (VPg), 3C-like proteinase (Pro), and RdRP. RNA-2 expresses the homing protein (HP) involved in RNA-2 replication, the movement protein (MP), and the coat protein (CP) plus, in some subgroup C species, a sixth small product of unknown function that precedes the Pro-Co.

Of the 15 grapevine-infecting nepoviral species known to date (Martelli 2014), five belong to subgroup A, *Arabidopsis mosaic virus* (ArMV), *Grapevine fanleaf virus* (GFLV), *Grapevine deformation virus* (GDeV), *Raspberry ringspot virus* (RpRSV), and *Tobacco ringspot virus* (TRSV); four belong to subgroup B, *Artichoke Italian latent virus* (AILV), *Grapevine Anatolian ringspot virus* (GARSV), *Grapevine*

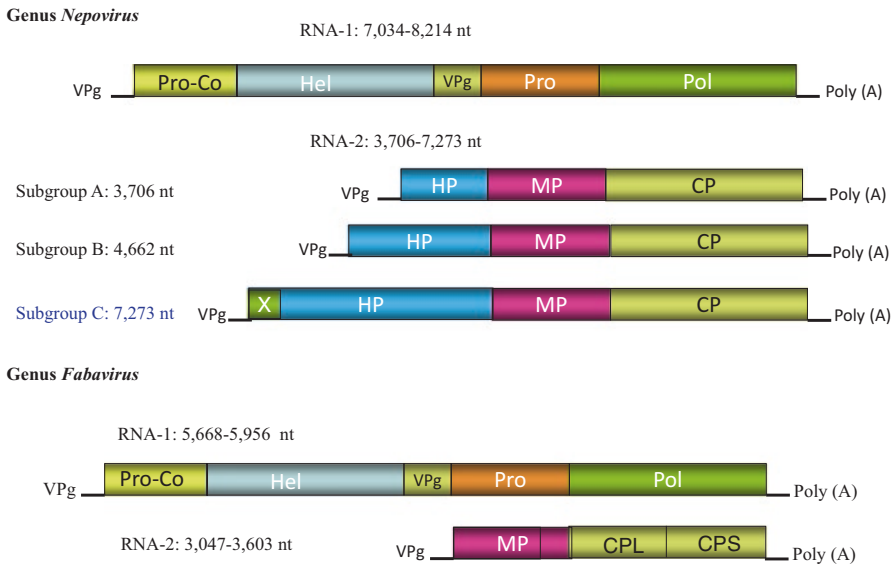

Fig. 32.6 Diagrammatic representation of the genome structure of the three subgroups of the genus *Nepovirus* and of the genus *Fabavirus*. The expression products are *Pro-Co* proteinase cofactor, *Hel* helicase domain, *VPg* viral genome-linked protein, *Pro* proteinase, *Pol* RNA-dependent RNA polymerase, *X* small protein of unknown function, *HP* homing protein, *MP* movement protein, *CP* capsid protein, *CPL* large capsid protein, *CPS* small capsid protein

chrome mosaic virus (GCMV), and *Tomato black ring virus* (TBRV); and six belong to subgroup C, *Blueberry leaf mottle virus* (BBLMV), *Cherry leafroll virus* (CLRV), *Grapevine Tunisian ringspot virus* (GTRV), *Grapevine Bulgarian latent virus* (GBLV), *Peach rosette mosaic virus* (PRMV), and *Tomato ringspot virus* (ToRSV). *Strawberry latent ringspot virus* (SLRSV), another grapevine-infecting and nematode-transmitted virus, is an unassigned species in the family *Secoviridae*.

Except for GFLV, which has been traveling extensively with infected grapevine-propagating material so as to turn into a cosmopolitan pathogen, all the other grapevine nepoviruses retain a diverse territorial distribution that suggests a differential geographic origin.

As detailed in Chap. 2 of this book, this likelihood was elaborated taking into account various kinds of supporting evidence, such as historical literature records; presence of symptomatic grape specimens in old herbaria; association with nematode vectors specific to determined geographic regions; occurrence in wild *Vitis* species, e.g., GFLV in *Vitis vinifera subsp. sylvestris* (Pacífico et al. 2016); exchange of genetic material among viral species of the same geographic area; etc.

The outcome of these investigations has led to the allocation of grapevine nepoviruses into groups comprising “Old World” species that occur in European (GFLV, ArMV, AILV, TBRV, CLRV, GBLV, GCMV, RpRSV, and SLRSV), Mediterranean (GTRSV) and Near East (GARSV and GDeV) countries, and “American” species (BLMoV, TRSV, PRMV, and ToRSV) that are largely confined to North America (Martelli 2014).

Regardless of their geographic distribution, most grapevine nepoviruses share a host range encompassing a number of different herbaceous and woody crops (Martelli and Uyemoto 2011). This allows different viral species and different strains of the same species to multiply together in the same hosts. Such promiscuity provides an opportunity for the exchange of genetic material, which may lead to reassortment and/or recombination of genomes belonging to the same species (intraspecific) or to different species (interspecific). These evolutionary mechanisms, which occur with high frequency in viruses with segmented genomes, take place also with grapevine nepoviruses, as documented by an extensive literature (see, among the others, Le Gall et al. 1995; Vigne et al. 2004, 2008; Olivier et al. 2010; Elbeaino et al. 2012; Lamprecht et al. 2012; Bashir and Melcher 2012; Lopez-Fabuel et al. 2013; Digiario et al. 2015; Walker et al. 2015; Gao et al. 2016). Intraspecific recombination increases the genomic variability of a given viral species, thus contributing to the already ample differentiation, which is intrinsic to its quasi-species nature (Domingo et al. 2012). Although this type of recombination may give rise to the appearance of viral strains with novel characters (e.g., increased virulence), its effects are less dramatic than those consequent to interspecific recombination events.

Examples of the latter type of recombination have been documented in closely related grapevine nepoviral species, e.g., GFLV/ArMV in subgroup A and TBRV/GCMV in subgroup B, whereas only intraspecific events have been reported so far for ToRSV, a member of subgroup C (Walker et al. 2015). RNA-2 seems to be a more frequent target than RNA-1 for interspecies recombination, and the results of this process may vary in function of the gene in which it takes place. For instance,

Vigne et al. (2008) identified recombination sites at the level of the 5' untranslated region, the homing protein, and the movement protein genes of RNA-2 of two strains of GFLV and ArMV, wondering whether their reduced virulence was associated with any of the detected recombination events. In another study, recombination at the level of the homing protein of the same two viruses appeared to be associated with the presence of the yellow mosaic phenotype in the investigated vines (Elbeaino et al. 2014). However, when recombination occurred at the level of the coat protein gene of GFLV/ArMV hybrids, the novel species GDeV arose (Elbeaino et al. 2012). Furthermore, recombinants between TBRV and GCMV were experimentally generated by mixing the genomic RNAs of the two viruses (Le Gall et al. 1995), whereas sequencing of the complete genome of TBRV and of the RNA-2 of grapevine isolates of GCMV disclosed that the origin of this virus was likely due to a recombination event at the movement protein level between GARSV and TBRV (Digiario et al. 2015).

In a recent study, Thompson et al. (2014) have applied computational methods to analyze the evolution of members of the family *Secoviridae* addressing the CP gene sequences of different viral species. Using Bayesian phylogenetic reconstruction methods, these authors were able to construct a time-measured phylogeny of the subfamily *Comovirinae*, estimating that divergence occurred less than 1000 years ago and that the extant virus species diversified between 50 and 250 years ago, in concomitance with the strengthening of agricultural practices in industrialized countries.

A similar investigation carried out by aligning the full nucleotide sequence of the CP genes (ca. 1500 nt at the 3'-terminal coding region of RNA-2) of all grapevine-infecting nepoviruses produced a dated tree constructed using the software BEAST 2.1.3 (Drummond et al. 2012) with the general time-reversible site model and a strict clock substitution rate (Fig. 32.7). The root representing the most recent common ancestor of the CP gene sequences is dated at 475 years ago (mean value). However, another analysis of the same sequence dataset done by Path-O-Gen (Rambaut et al. 2016) gave a more remote temporal signal, placing the root of the common ancestor at about 740 years ago, i.e., closer to the figure estimated by Thompson et al. (2014).

Genus Fabavirus

Virus particles of members of the genus *Fabavirus* conform morphologically to those of other secovirids, but their capsid is made of two distinct protein subunits 22 kDa and 44 kDa in size. The viral genome consists of two separately encapsidated ssRNA species 5.8–6.0 kb (RNA-1) and 3.1–4.0 kb (RNA-2) in size. Each RNA has a single ORF encoding a large polypeptide. As with nepoviruses, the RNA-1 expression product is processed into five proteins: proteinase cofactor (Pro-Co), helicase (Hel), genome-linked protein (VPg), proteinase (Pro), and RNA-dependent RNA

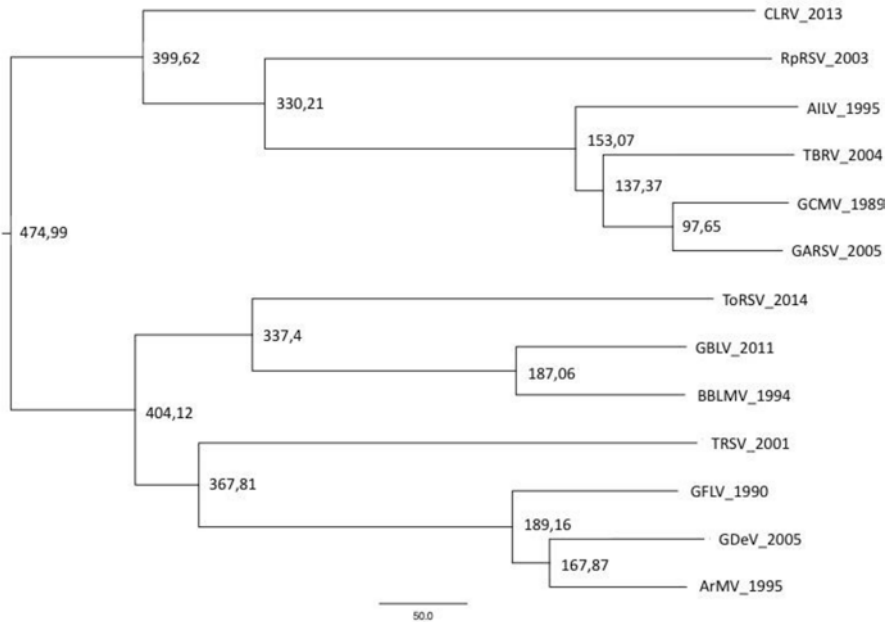

Fig. 32.7 Maximum clade credibility tree of CP genes (nucleotide sequences) of the grapevine-infecting nepoviruses. Bayesian elaboration with a strict molecular clock followed 10 million iterations of Markov Chain Monte Carlo. Nodes are labeled with the mean age, and the most recent common ancestor is indicated (root age). Tips of the tree are individual species with “time-stamped” indication of sampling and/or sequencing; the scale bar = 50 years. CLRV (*Cherry leaf roll virus*, KC937031), RpRSV (*Raspberry ringspot virus*, AY303788), AILV (*Artichoke Italian latent virus*, X87254), GBLV (*Grapevine Bulgarian latent virus*, NC_015493), ToRSV (*Tomato ringspot virus*, KM083895), TBRV (*Tomato black ring virus*, NC_004440), GCMV (*Grapevine chrome mosaic virus*, NC_003621), GARSV (*Grapevine Anatolian ringspot virus*, NC_018384), TRSV (*Tobacco ringspot virus*, AF461164), GFLV (*Grapevine fanleaf virus*, NC_003623), GDeV (*Grapevine deformation virus*, AY291208), ArMV (*Arabis mosaic virus*, X81814), and BBLMV (*Blueberry leaf mottle virus*, U20621)

polymerase (Pol). The RNA-2-encoded polyprotein is cleaved into three products: the movement protein (MP) and the large (CPL) and small (CPS) coat proteins (Fig. 32.6).

Fabaviruses are readily transmissible by mechanical inoculation of sap and by aphids in a nonpersistent manner and infect a wide range of plants worldwide (Lisa and Boccardo 1996). The genus comprises five definitive species, *Broad bean wilt virus 1* (BBWV-1), *Broad bean wilt virus 2* (BBWV-2), *Gentian mosaic virus* (GeMV), *Lamium mild mosaic virus* (LMMV), and *Cucurbit mild mottle virus* (CuMMV) (Sanfaçon et al. 2012; Dong et al. 2012). However, only two cases of fabavirus infections in grapevines have been reported, i.e., BBWV-1 from South Africa (Castrovilli et al. 1985), and a putative novel species denoted *Grapevine fabavirus* (GFabV) which was identified in table grape selections introduced from South Korea and India in a grapevine repository of the University of California,

Davis (USA) (Al Rwahnih et al. 2016a, b). In neither case, the infected vines appeared to exhibit symptoms that could be specifically ascribed to the presence of either one of these fabaviruses.

The occurrence of BBWV-1 in the grapevine, the same as that of GFabV, is puzzling and may be due to an incidental aphid-mediated transmission, as it may have happened with other aphid-transmitted viral species, such as *Cucumber mosaic virus* (CMV), *Bean common mosaic virus* (BCMV), and other potyviruses, whose occasional presence in grapevines has been documented (Martelli 2014). BBWV-1 has been reported in different hosts, primarily vegetables and weeds, from many countries (Lisa and Boccardo 1996). A phylogenetic analysis of the small CP gene of a population of 37 isolates of this virus from widely separated geographic areas (Europe, the Near East, the USA, New Zealand, and Singapore) revealed that high gene flow had occurred between Spanish and Near Eastern subpopulations and that isolates from distant geographic areas were genetically close, suggesting that the cosmopolitan nature of this virus is due to long-distance migration (Ferriol et al. 2014). The same study, in which different genomic regions were analyzed (5'UTR, Co-Pro, POL, MP, and CPS), disclosed that reassortment and recombination are evolutionary mechanisms operating also with BBWV-1. In this virus, however, recombination events were detected in RNA-1 (Ferriol et al. 2014), whereas with nepoviruses RNA-2 seems to be a more frequent site for this kind of events.

The unavailability of the sequence of the grapevine-infecting BBWV-1 isolate does not make it possible to infer its relationship with other molecularly characterized strains of the same virus, the same as for the newly described GFabV, which is phylogenetically separate from all the known *Fabavirus* species (Fig. 32.8). However, when the same type of analysis used for nepoviruses was applied to fabaviruses using the nucleotide sequences of the small coat protein gene (a 590 nt fragment), a root datation at about 205 years ago was obtained, with a divergence of GFabV, which split earlier than the other species, thus behaving substantially as an outgroup in the genus, in accordance with its position in the phylogenetic tree.

Conclusions and Future Directions for Grapevine Virology

The evidence suggests that the evolution of the grapevine-infecting viruses is driven by the same mechanisms as the rest of plant viruses. At the level of microevolution, it is the rapid accumulation of point mutations that, under proper conditions, result in isolate and strain diversification. Defined as changes in gene content and genome architecture, macroevolution is driven primarily by several recombination processes. One of these processes is a lineage-specific gene duplication that is best exemplified by amplification of the CP domain in closteroviruses that harbor two (GLRaV-4) to four (GLRaV-1) CP domains (Fig. 32.5). An opposite mechanism is a lineage-specific gene loss represented by GLRaV-4 that apparently lost the CPm gene conserved throughout the rest of family *Closteroviridae*. The third major process of virus genome evolution is horizontal gene transfer between viruses and

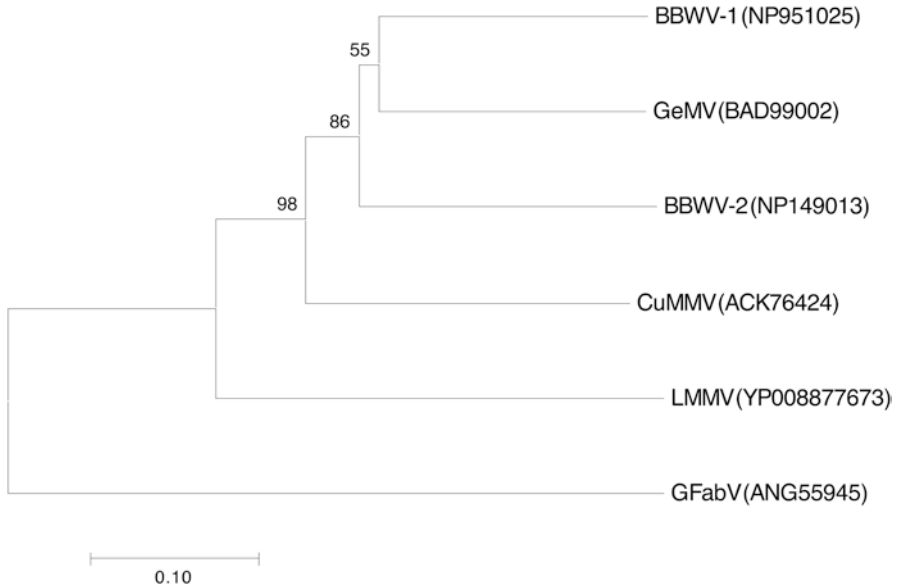

Fig. 32.8 Phylogenetic tree constructed using MEGA 7.0 (Kumar et al. 2016) with the small coat protein gene sequences of the extant members of the genus *Fabavirus*: *Broad bean wilt virus 1* (BBWV-1), *Broad bean wilt virus 2* (BBWV-2), *Lamium mild mosaic virus* (LMMV), *Gentian mosaic virus* (GeMV), *Cucurbit mild mosaic virus* (CuMMV), and the putative new species *Grapevine fabavirus* (GFabV). GenBank accession numbers are within brackets. Only values higher than 40% are shown at branch nodes

cellular organisms that is exemplified by acquisition of the HSP70 homologue by the common ancestor of member viruses of the family *Closteroviridae* and of the AlkB domain by many diverse viruses infecting woody and perennial plants. The distribution pattern of AlkB strongly suggests a significant contribution of the horizontal gene transfer among coinfecting viruses.

At the level of virus biology, one potential driving force for colonization of grapevine by diverse viruses is transmission of viruses from distinct hosts by vectoring organisms such as nematodes in the case of nepoviruses or mealybugs and scale insects in the cases of ampelo- and vitiviruses. Although technically humans cannot be considered as a vectoring organism in terms of virus evolution, agricultural practices such as germplasm dissemination and grafting also play a major role in global distribution and transmission of grapevine-infecting viruses. Arguably, the two least understood aspects of grapevine virus evolution are the origin of the grapevine-infecting viruses and contributions of grapevine biology into shaping virus-host interactions. It just happens that investigation of these aspects is also most challenging, both technically and funding-wise. To understand the natural source of grapevine-infecting viruses, a comprehensive census of viruses infecting not only grapevine species in the wild but also all other plants in the same ecological niches is required. HTS now provides us with powerful tool for such census.

Understanding grapevine biology in relation to virus infection also presents major technical obstacles; it is one of the reasons that most of the functional genomics, cell biology, and other areas of plant biology are investigated using model plants that are herbaceous, fast reproducing, and conducive to genetic modification, as is the case with *Arabidopsis thaliana*. However, larger investments in research might mitigate challenges for further progress toward understanding grapevine biology and virology.

Acknowledgments G. P. Martelli is indebted to Drs. A. Minafra and B. Navarro-Ramirez for help with the evolutionary analysis and the construction of trees of members of the family *Secoviridae*. B. Meng would like to thank Clayton Moore for help with the phylogenetic analyses and trees of members of the family *Betaflexiviridae*.

References

- Aas, P.A., M. Otterleil, P.O. Falnes, C.B. Vagba, F. Skorpen, M. Akbari, O. Sundhelm, M. Bjerås, G. Slupphaug, E. Seeberg, and H.E. Krokan. 2003. Human and bacterial oxidative demethylases repair alkylation damage in both RNA and DNA. *Nature* 421: 859863.
- Abou Ghanem-Sabanadzovic, N.A., S. Sabanadzovic, P. Gugerli, and A. Rowhani. 2012. Genome organization, serology and phylogeny of Grapevine leafroll-associated viruses 4 and 6: taxonomic implications. *Virus Research* 163: 120–128.
- Agranovsky, A.A., D.E. Lesemann, E. Maiss, R. Hull, and J.G. Atabekov. 1995. "Rattlesnake" structure of a filamentous plant RNA virus built of two capsid proteins. *Proceedings of the National Academy of Sciences of the United States of America* 92: 2470–2473.
- Al Rwahnih, M., S. Daubert, D. Golino, and A. Rowhani. 2009. Deep sequencing analysis of RNAs from a grapevine showing Syrah decline symptoms reveals a multiple virus infection that includes a novel virus. *Virology* doi:10.1016/j.virol.2009.02.028.
- Al Rwahnih, M., S. Daubert, J.R. Urbez-Torres, F. Cordero, and A. Rowhani. 2011. Deep sequencing evidence from single grapevine plants reveals a virome dominated by mycoviruses. *Archives of Virology* 156: 397–403.
- Al Rwahnih, M., V.V. Dolja, S. Daubert, E.V. Koonin, and A. Rowhani. 2012a. Genomic and biological analysis of Grapevine leafroll-associated virus 7 reveals a possible new genus within the family Closteroviridae. *Virus Research* 163: 302–309.
- Al Rwahnih, M., M.R. Sudarshana, J.K. Uyemoto, and A. Rowhani. 2012b. Complete genome sequence of a novel vitivirus isolated from grapevine. *Journal of Virology* 86: 9545. doi:10.1128/JVI.01444-12.
- Al Rwahnih, M., A. Dave, M.M. Anderson, A. Rowhani, J.K. Uyemoto, and M.R. Sudarshana. 2013. Association of a DNA virus with grapevines affected by red blotch disease in California. *Phytopathology* 103: 1069–1076.
- Al Rwahnih, M., S. Daubert, D. Golino, C. Islas, and A. Rowhani. 2015. Comparison of Next-Generation Sequencing Versus Biological Indexing for the Optimal Detection of Viral Pathogens in Grapevine. *Phytopathology* 105: 758–763.
- Al Rwahnih, M., O.J. Alabi, N.M. Westrick, D. Golino, and A. Rowhani. 2016a. Near-complete genome sequence of Grapevine fabavirus, a novel putative member of the genus Fabavirus. *Genome Announcements* 4: e00703–e00716.
- . 2016b. Description of a novel monopartite Geminivirus and its defective subviral genome in grapevine. *Phytopathology* PHYTO07160282R, [Epub ahead of print].
- Alzhanova, D.V., Y. Hagiwara, V.V. Peremyslov, and V.V. Dolja. 2000. Genetic analysis of the cell-to-cell movement of beet yellows closterovirus. *Virology* 268: 192–200.

- Alzhanova, D.V., A. Napuli, R. Creamer, and V.V. Dolja. 2001. Cell-to-cell movement and assembly of a plant closterovirus: roles for the capsid proteins and Hsp70 homolog. *The EMBO Journal* 20: 6997–7007.
- Alzhanova, D.V., A.I. Prokhnevsky, V.V. Peremyslov, and V.V. Dolja. 2007. Virion tails of Beet yellows virus: Coordinated assembly by three structural proteins. *Virology* 359: 220–226.
- Aravind, L., and E.V. Koonin. 2001. The DNA-repair protein AlkB, EGL-9, an dleprecan define new families of 2-oxoglutarate- and iron-dependent dioxygenases. *Genome Biology* 2, research0007.1–0007.8.
- Bashir, N.S., and U. Melcher. 2012. Population genetic analysis of grapevine fanleaf virus. *Archives of Virology* 157: 1919–1929.
- Bratlie, M.S., and F. Drablos. 2005. Bioinformatic mapping of AlkB homology domains in viruses. *BMC Genomics* 6: 1. doi:10.1186/1471-2164-6-1.
- Castrovilli, S., V. Savino, M.A. Castellano, and D.J. Engelbrecht. 1985. Characterization of a grapevine isolate of Broad bean wilt virus. *Phytopathologia Mediterranea* 24: 35–40.
- Chiba, M., J.C. Reed, A.I. Prokhnevsky, E.J. Chapman, M. Mawassi, E.V. Koonin, J.C. Carrington, and V.V. Dolja. 2006. Diverse suppressors of RNA silencing enhance agroinfection by a viral replicon. *Virology* 346: 7–14.
- Coetzee, B., M.J. Freeborough, H.J. Maree, J.M. Celton, D.J. Rees, and J.T. Burger. 2010a. Deep sequencing analysis of viruses infecting grapevines: Virome of a vineyard. *Virology* 400: 157–163.
- Coetzee, B., H.J. Maree, D. Stephan, M.J. Freeborough, and J.T. Burger. 2010b. The first complete nucleotide sequence of a grapevine virus E variant. *Archives of Virology* 155: 1357–1360.
- de Miranda, J.R., R.S. Cornman, J.D. Evans, E. Semberg, N. Haddad, P. Neumann, and L. Gauthier. 2015. Genome Characterization, prevalence and distribution of a Macula-Like virus from *Apis mellifera* and *Varroa destructor*. *Viruses* 7: 3586–3602.
- Diaz, A., and P. Ahlquist. 2012. Role of host reticulon proteins in rearranging membranes for positive-strand RNA virus replication. *Current Opinion in Microbiology* 15: 519–524.
- Digiario, M., E. Yahyaoui, G.P. Martelli, and T. Elbeaino. 2015. The sequencing of the complete genome of a Tomato black ring virus (TBRV) and of RNA2 of three Grapevine chrome mosaic virus (GCMV) isolates from grapevine reveals the possible recombinant origin of GCMV. *Virus Genes* 50: 165–171.
- Dolja, V.V. 2003. Beet yellows virus: The importance of being different. *Molecular Plant Pathology* 4: 91–98.
- Dolja, V.V., and E.V. Koonin. 2011. Common origins and host-dependent diversity of plant and animal viromes. *Current Opinion in Virology* 1: 322–331.
- Dolja, V.V., J.F. Kreuzer, and J.P. Valkonen. 2006. Comparative and functional genomics of closteroviruses. *Virus Research* 117: 38–51.
- Domingo, E., J. Sheldon, and C. Perales. 2012. Viral quasispecies evolution. *Microbiology and Molecular Biology Reviews* 76: 159–2016.
- Dong, S.W., H.Y. Xiang, Q.X. Shang, D.W. Li, J.L. Yu, and C.G. Han. 2012. Complete genomic sequence analysis reveals a novel fabavirus infecting cucurbits in China. *Archives of Virology* 157: 597–600.
- Drummond, A.J., M.A. Suchard, D. Xie, and A. Rambaut. 2012. Bayesian phylogenetics with BEAUti and the BEAST 1.7. *Molecular Biology and Evolution* 29: 1969–1973.
- Elbeaino, T., M. Digiario, S. Ghebremeskel, and G.P. Martelli. 2012. Grapevine deformation virus: completion of the sequence and evidence on its origin from recombination events between Grapevine fanleaf virus and Arabis mosaic virus. *Virus Research* 166: 136–140.
- Elbeaino, T., H. Kiyi, R. Boutarfa, A. Minafra, G.P. Martelli, and M. Digiario. 2014. Phylogenetic analysis of the homing protein domain of Grapevine fanleaf virus (GFLV) isolates associated with “yellow mosaic” and “infectious malformation” syndromes in grapevines. *Archives of Virology* 159: 2757–2764.
- Ferriol, I., R.M. Ferrer, M. Luis-Arteaga, J. Guerri, M. Moreno, and L. Rubio. 2014. Genetic variability and evolution of broad bean wilt virus 1: role of recombination, selection and gene flow. *Archives of Virology* 159: 779–784.

- Foster, W.A. 1995. Mosquito sugar feeding and reproductive energetics. *Annual Review of Entomology* 40: 443–473.
- Gao, F., W. Lin, J. Shen, and S. Liao. 2016. Genetic diversity and molecular evolution of arabis mosaic virus based on the CP gene sequence. *Archives of Virology* 161: 1047–1051.
- Ghabrial, S.A., J.R. Caston, D. Jiang, M.L. Nibert, and N. Suzuki. 2015. 50-Plus years of fungal viruses. *Virology* 479-480: 356–368.
- Giampetruzzi, A., V. Roumi, R. Roberto, U. Malossini, N. Yoshikawa, P. La Notte, F. Terlizzi, R. Credi, and P. Saldarelli. 2012. A new grapevine virus discovered by deep sequencing of virus- and viroid-derived small RNAs in Cv Pinot gris. *Virus Research* 163: 262–268.
- Goszczynski, D.E. 2015. Brief report of the construction of infectious DNA clones of South African genetic variants of grapevine virus A and grapevine virus B. *SpringerPlus* 4: 739.
- Gouveia, P., and G. Nolasco. 2012. The p19.7 RNA silencing suppressor from Grapevine leafroll-associated virus 3 shows different levels of activity across phylogenetic groups. *Virus Genes* 45: 333–339.
- Halgren, A., I.E. Tzanetakis, and R.R. Martin. 2007. Identification, characterization, and detection of Black raspberry necrosis virus. *Phytopathology* 97: 44–50.
- International Committee on Taxonomy of Viruses. 2016. <http://www.ictvonline.org/>
- Ito, T., and R. Nakaune. 2016. Molecular characterization of a novel putative ampelovirus tentatively named grapevine leafroll-associated virus 13. *Archives of Virology* 161: 2555–2559.
- Karasev, A.V. 2000. Genetic diversity and evolution of closteroviruses. *Annual Review of Phytopathology* 38: 293–324.
- King, A.M.Q., M.J. Adams, E.B. Carstens, and E.J. Lefkowitz. 2011. *Virus Taxonomy: 9th Report of the International Committee on Taxonomy of Viruses*. San Diego: Academic Press/Elsevier.
- Koonin, E.V., V.V. Dolja, and M. Krupovic. 2015. Origins and evolution of viruses of eukaryotes: The ultimate modularity. *Virology* 479-480: 2–25.
- Kumar, S., G. Stecher, and K. Tamura. 2016. MEGA7: Molecular Evolutionary Genetics Analysis version 7.0 for bigger datasets. *Molecular Biology and Evolution* 33: 1870–1874.
- Kurth, E.G., V.V. Peremyslov, A.I. Prokhnovsky, K.D. Kasschau, M. Miller, J.C. Carrington, and V.V. Dolja. 2012. Virus-derived gene expression and RNA interference vector for grapevine. *Journal of Virology* 86: 6002–6009.
- Lamprecht, R.L., H.J. Maree, D. Stephan, and J.T. Burger. 2012. Complete nucleotide sequence of a South African isolate of Grapevine fanleaf virus. *Virus Genes* 54: 406–410.
- Le Gall, O., T. Candresse, and J. Dunez. 1995. Transfer of the 3' non-translated region of Grapevine chrome mosaic virus RNA-1 by recombination to Tomato black ring virus RNA-2 in pseudo-recombinant isolates. *Journal of General Virology* 76: 1285–1289.
- Lisa, V., and G. Boccardo. 1996. Fabaviruses: Broad bean wilt and allied viruses. In *The Plant Viruses, Polyhedral Virions and Bipartite RNA Genomes, Vol. 5*, ed. B.D. Harrison and A.F. Murant, 229–250. New York: Plenum Press.
- Liu, Y.-P., V.V. Peremyslov, V. Medina, and V.V. Dolja. 2009. Tandem leader proteases of Grapevine leafroll-associated virus-2: host-specific functions in the infection cycle. *Virology* 383: 291–299.
- Lopez-Fabuel, I., A. Olmos, A. Bassler, L. Dupuis-Maguiraga, L.B. Torres, E. Bertolini, and T. Wetzel. 2013. Molecular analysis of the genomic RNAs 1 and 2 of the first Arabis mosaic virus isolate detected in Spanish grapevines. *Spanish Journal of Agricultural Research* 11: 199–203.
- Lu, R., A.S. Folimonov, M. Shintaku, W.X. Li, B.W. Falk, W.O. Dawson, and S.W. Ding. 2004. Three distinct suppressors of RNA silencing encoded by a 20-kb viral RNA genome. *Proceedings of the National Academy of Sciences of the United States of America* 101: 15742–15747.
- Maree, H.J., R.P. Almeida, R. Bester, K.M. Chooi, D. Cohen, V.V. Dolja, M.F. Fuchs, D.A. Golino, A.E. Jooste, G.P. Martelli, R.A. Naidu, A. Rowhani, P. Saldarelli, and J.T. Burger. 2013. Grapevine leafroll-associated virus 3. *Frontiers in Microbiology* 4: 1–21.
- Martelli, G.P. 2014. Directory of virus and virus-like diseases of the grapevine and their agents. *Journal of Plant Pathology* 96: 1–136.

- Martelli, G.P., M.J. Adams, J.F. Kreuze, and V.V. Dolja. 2007. Family Flexiviridae: A case study in virion and genome plasticity. *Annual Review of Phytopathology* 45: 73–100.
- Martelli, G.P., and Uyemoto J. K. 2011. Nematode-borne viruses of stone fruits. In: Hadidi, A., Barba, M., Candresse, T. Jelkmann W. Virus and virus-like diseases of pme and stone fruits, pp. 161–170, APS Press St. Paul
- Martelli, G.P., Ghanem-Sabanadzovic N. Abou, A.A. Agranovsky, Rwahnih M. Al, V.V. Dolja, C. Dovas, M. Fuchs, P. Gugerli, J.S. Hu, W. Jelkmann, N.I. Katis, V.I. Maliogka, M.J. Melzer, W. Menzel, A. Minafra, M.E. Rott, A. Rowhani, S. Sabanadzovic, and P. Saldarelli. 2012. Taxonomic revision of the family *Closteroviridae* with special reference to grapevine leafroll-associated members of the genus *Ampelovirus* and the putative species unassigned to the family. *Journal of Plant Pathology* 94: 7–19.
- Mayo, M.A., and D.J. Robinson. 1996. Nepoviruses: molecular biology and replication. In *The Plant Viruses: Polyhedral Virions and Bipartite RNA Genomes*, ed. B.D. Harrison and A.F. Murrant, vol. 5, 139–185. New York: Plenum Press.
- Minafra, A., P. Saldarelli, F. Grieco, and G.P. Martelli. 1994. Nucleotide sequence of the 3' terminal region of the RNA of two filamentous grapevine viruses. *Archives of Virology* 137: 249–261.
- Naidu, R.A., H.J. Maree, and J.T. Burger. 2015. Grapevine leafroll disease and associated viruses: a unique pathosystem. *Annual Review of Phytopathology* 53: 613–634.
- Nakaune, R., S. Toda, M. Mochizuki, and M. Nakano. 2008. Identification and characterization of a new vitivirus from grapevine. *Archives of Virology* 153: 1827–1832.
- Napuli, A.J., D.V. Alzhanova, C.E. Doneanu, D.F. Barofsky, E.V. Koonin, and V.V. Dolja. 2003. The 64-kDa capsid protein homolog of beet yellows virus is required for assembly of virion tails. *Journal of Virology* 77: 2377–2384.
- Olivier, J.E., E. Vigne, and M. Fuchs. 2010. Genetic structure and molecular variability of Grapevine fanleaf virus populations. *Virus Research* 152: 30–40.
- Pacifico, D., E. Stigliano, L. Sposito, P. Spinelli, G. Garfi, A.S. Gristina, I. Fontana, and F. Carimi. 2016. Survey of viral infections in spontaneous grapevine from natural environments in Sicily. *European Journal of Plant Pathology* 145: 189–197.
- Peremyslov, V.V., I.A. Andreev, A.I. Prokhnevsky, G.H. Duncan, M.E. Taliansky, and V.V. Dolja. 2004. Complex molecular architecture of beet yellows virus particles. *Proceedings of the National Academy of Sciences of the United States of America* 101: 5030–5035.
- Poojari, S., O.J. Alabi, V.Y. Fofanov, and R.A. Naidu. 2013. A leafhopper-transmissible DNA virus with novel evolutionary lineage in the family geminiviridae implicated in grapevine redleaf disease by next-generation sequencing. *PloS One* 8: e64194.
- Rambaut A., T.T. Lam, L. Max Carvalho, and O.G. Pybus. 2016. Exploring the temporal structure of heterochronous sequences using TempEst (formerly Path-O-Gen). *Virus Evolution* 9: doi: <http://dx.doi.org/10.1093/ve/vew0072>.
- Roossinck, M.J. 2016. Deep sequencing for discovery and evolutionary analysis of plant viruses. *Virus Research*. doi: [10.1016/j.virusres.2016.11.019](https://doi.org/10.1016/j.virusres.2016.11.019). [Epub ahead of print].
- Saldarelli, P., A. Minafra, and G.P. Martelli. 1996. The nucleotide sequence and genomic organization of grapevine virus B. *Journal of General Virology* 77: 2645–2652.
- Sanfaçon, H., J. Wellink, O. Le Gall, A. Karasev, R. van der Vlugt, and T. Wetzel. 2009. Secoviridae: a proposed family of plant viruses within the order Piconavirales that combines the families Sequiviridae and Comoviridae, the unassigned genera Cheravirus, and Sadwavirus, and the proposed genus Torradovirus. *Archives of Virology* 154: 899–907.
- Sanfaçon, H., T. Iwanami, A.V. Karasev, R. van der Vlugt, J. Wellink, T. Wetzel, and N. Yoshikawa. 2012. Family Secoviridae. In *Virus taxonomy*, Ninth report of the international committee on the taxonomy of viruses, ed. A.M.Q. King, M.J. Adams, E.B. Carstens, and E.J. Lefkowitz, 881–899.e11. Amsterdam: Elsevier/Academic Press.
- Satyanarayana, T., S. Gowda, M.A. Ayllon, and W.O. Dawson. 2004. Closterovirus bipolar virion: evidence for initiation of assembly by minor coat protein and its restriction to the genomic RNA 5' region. *Proceedings of the National Academy of Sciences of the United States of America* 101: 799–804.

- Seguin, J., R. Rajeswaran, N. Malpica-López, R.R. Martin, K. Kasschau, V.V. Dolja, P. Otten, L. Farinelli, and M.M. Pooggin. 2014. De novo reconstruction of consensus master genomes of plant RNA and DNA viruses from siRNAs. *PLoS One* 9: e88515.
- Sether, D.M., M.J. Melzer, W.B. Borth, and J.S. Hu. 2009. Genome organization and phylogenetic relationship of Pineapple mealybug wilt associated virus-3 with family Closteroviridae members. *Virus Genes* 38: 414–420.
- Shabalina, S.A., and E.V. Koonin. 2008. Origins and evolution of eukaryotic RNA interference. *Trends in Ecology & Evolution* 23: 578–587.
- Sudarshana, M.R., K.L. Perry, and M.F. Fuchs. 2015. Grapevine red blotch-associated virus, an emerging threat to the grapevine industry. *Phytopathology* 105: 1026–1032.
- Susaimuthu, J., I.E. Tzanetakis, R.C. Gergerich, and R.R. Martin. 2007. A member of a new genus in the Potyviridae infects *Rubus*. *Virus Research* 131: 145–151.
- Thompson, J.R., M. Fuchs, and K.L. Perry. 2012. Genomic analysis of grapevine leafroll associated virus-5 and related viruses. *Virus Research* 163: 19–27.
- Thompson, J.R., N. Kamath, and K.L. Perry. 2014. An evolutionary analysis of the Secoviridae family of viruses. *PLoS One* 9: e106305. doi:10.1371/journal.pone.0106305.
- van den Born, E., M.V. Omelchenko, A. Bekkelund, V. Leihne, E.V. Koonin, V.V. Dolja, and P.O. Falnes. 2008. Viral AlkB proteins repair RNA damage by oxidative demethylation. *Nucleic Acids Research* 36: 5451–5461.
- Vigne, E., M. Bergdoll, S. Guyader, and M. Fuchs. 2004. Multiple interspecies recombination events within isolates of grapevine fanleaf virus from a naturally infected vineyard in France: evidence for mixed infection and recombination. *Journal of General Virology* 85: 2435–2445.
- Vigne, E., A. Marmonier, and M. Fuchs. 2008. Multiple interspecies recombination events within RNA2 of grapevine fanleaf virus and arabis mosaic virus. *Archives of Virology* 153: 1771–1776.
- Walker, M., J. Chisholm, T. Wei, B. Ghoshal, H. Saeed, M. Rott, and H. Sanfaçon. 2015. Complete genome sequence of three Tomato ringspot virus isolates: evidence for reassortment and recombination. *Archives of Virology* 160: 543–548.
- Wang, L., X. Lv, Y. Zhai, S. Fu, D. Wang, S. Rayner, Q. Tang, and G. Liang. 2012. Genome characterization of a novel virus of the family Tymoviridae isolated from mosquitoes. *PLoS One* 7 (7): e39845. doi:10.1371/journal.pone.0039845.
- Weaver, S.C., and A.D.T. Barrett. 2004. Transmission cycles, host range, evolution and emergence of arboviral disease. *Nature Reviews. Microbiology* 2: 789–801.
- Zhang, Y., K. Singh, R. Kaur, and W. Qiu. 2011. Association of a novel DNA virus with the grapevine vein-clearing and vine decline syndrome. *Phytopathology* 101: 1081–1090.

Chapter 33

Concluding Remarks and Future Directions

G.P. Martelli

Abstract Since the discovery, in 1960, that a virus associated with grapevine fanleaf disease was made available for a thorough characterization upon transmission by manual inoculation to herbaceous hosts, the relentless investigations carried out in the major grapevine-growing countries have unveiled the complexity of the virus world of this crop. Nearly 70 different viruses have been identified, their properties and, to a great extent, their epidemiology determined, and their elimination from propagative material achieved. Thus, in perspective, it would have been reasonable to envisage a sanitarily improved world viticulture, if it were not for the still standing difficulty of protecting from reinfection the stands established with sanitized vines. Thus, future investigations, while not relinquishing the basic aspects of virological research, should aim at developing dependable strategies for preventing the sanitary deterioration of vineyards planted with certified materials.

The birth of modern grapevine virology can be traced back to the middle of the twentieth century, when a couple of British (C.H. Cadman and B.D. Harrison) and a Portuguese (H.F. Dias) scientist transmitted *Grapevine fanleaf virus* (GFLV) by manual inoculation to herbaceous hosts and determined it to be a close relative of *Arabis mosaic virus* (ArMV) (Chap. 2 of this book). This opened the way to the investigations that, in less than 60 years, have led to the discovery in *Vitis* and *Muscadinia* of nearly 70 different viruses throughout the world.

This list may not be exhaustive on the grounds that the ever-increasing use of next-generation sequencing (Chap. 30) is leading to the discovery of hitherto undetected members of grapevine viromes. In fact, 5 of the 85 or so novel viruses identified so far in plant hosts using viral metagenomics are from grapevines (Roossinck et al. 2015). Interestingly, two of these viruses, i.e. *Grapevine Pinot gris virus* (GPGV) (Chap. 17) and *Grapevine red blotch-associated virus* (GRBaV) (Chap. 14), seem to be primary pathogens recently found in vines displaying symptoms very much resembling those characterizing fanleaf and leaf roll diseases, respectively.

G.P. Martelli (✉)

Department of Soil, Plant and Food Sciences, University of Bari Aldo Moro, Bari, Italy
e-mail: giovanni.martelli@uniba.it

Over time, improved laboratory extraction and purification procedures, together with the extensive use of serological (Chap. 21) and nucleic acid-based techniques (Chap. 22), have allowed a reliable identification and characterization of most of the grapevine-infecting viruses and their taxonomic allocation. Ample circumstantial evidence is also available on the cause-effect relationship of many of the currently known grapevine viruses and the diseases they are associated with, as retained in the virus names (e.g. *Grapevine leafroll-associated viruses*, *Grapevine red blotch-associated virus*, *Grapevine Roditis leaf discoloration-associated virus*), although Koch's postulates have not experimentally been fulfilled. By contrast, the relationship of the viruses thought to be involved in the etiology of the different syndromes of the rugose wood complex seems to rest on a less solid ground. An emblematic example is the case of *Grapevine rupestris stem pitting-associated virus* (GRSPaV), one of the most widespread and molecularly differentiated grapevine-infecting virus, whose pathogenicity awaits demonstration, although a full-length cDNA clone of the virus that replicates in the grapevine has been synthesized (Meng et al. 2013).

The international trading of propagative material of *Vitis*, which has taken place since time immemorial in the Old World, has gained momentum in the nineteenth century, first with the exchanges between Europe and North America and then with the overseas countries where viticulture is expanding. Such an unrestricted movement of diseased nursery productions has resulted in the alarming sanitary deterioration of the world's viticultural germplasm, consequent to the dissemination and vector-mediated spreading of the viruses in the stands of the newly colonized areas.

The recognition of the progressive worsening of the vineyards' performance and the shortening of their productive life has called for the implementation of measures aimed at producing propagative materials with improved sanitary standards to be used for the establishment of new plantings. As discussed in Chap. 27, these measures consist in field selection (sanitary and clonal) and production of healthy stocks through an array of sanitizing laboratory procedures. The outcome of these operations has shown that even the most recalcitrant virus can successfully be knocked out when the appropriate therapeutic technique is used. Thus, most of the world leading viticultural countries are now implementing sanitary improvement plans (Chap. 28) and are turning out grapevine materials for propagation of high sanitary level.

The problem comes when these sanitized accessions are planted in the field. Since the available grapevine germplasm is, at large, not genetically equipped for resisting infection by the viruses of the main disease complexes (degeneration and decline, leaf roll, and rugose wood) (Martelli 2014), newly established vineyards are exposed to reinfection mediated by a variety of virus-carrying vectors (nematodes, pseudococcid mealybugs, soft scale insects, eryophyid mites, and treehoppers, such as the recently identified vector for *Grapevine red blotch-associated virus*). Thus, vector control is of paramount importance if the health status of newly established vineyards and their profitability is to be preserved. This is not, however, an easy task (Chaps. 25–26) and requires novel and more efficient approaches (Chap. 29).

Therefore, in agreement with a statement by Maliogka et al. (2015), it can be concluded that “The challenge and target of future research is not so much the development of more refined and highly performing techniques for the recognition and elimination of viruses but, rather, the design of dependable strategies for preventing a quick sanitary deterioration of vineyards planted with costly certified materials.” The realization of this goal will largely depend upon an integrated approach that includes a deeper understanding of the mechanisms for the replication cycle of important viruses, their pathogenesis, interactions between these viruses and the grapevine host, as well as the interactions among different viruses in mixed infections.

References

- Maliogka, V.I., G.P. Martelli, M. Fuchs, and N.I. Katis. 2015. Control of viruses infecting grapevine. *Advances in Virus Research* 91: 175–227.
- Martelli, G.P. 2014. Directory of virus and virus-like diseases of the grapevine and their agents. *Journal of Plant Pathology* 96 (Suppl. 1): 1–136.
- Meng, B., S. Venkataraman, C. Li, W. Wang, C. Dayan-Glick, and M. Mawassi. 2013. Construction and biological activities of the first infectious cDNA clone of the genus *Foveavirus*. *Virology* 435: 453–462.
- Roossinck, M.J., D.P. Martin, and P. Roumagnac. 2015. Plant virus metagenomics: Advances in virus discovery. *Phytopathology* 105: 716–727.

Index

A

- Adoption, 121, 230, 550, 601, 611–614, 637–639
- Alfamovirus*, 366, 660
- Alkylation B domain (AlkB), 130, 200–201, 261, 262
- Ampeloviruses, 15, 37, 39, 131, 134–136, 143, 144, 146, 168, 169, 172, 173, 201, 202, 212, 214, 222, 226, 241, 242, 345, 410, 415, 439, 460–468, 484, 485, 493–495, 532, 533, 602, 603, 634, 637, 645, 647, 661, 668–671, 674–677
- Anatolia, 10–13, 22, 230
- Angular mosaic, 366, 367, 660
- Antibodies, 57, 66, 70, 98, 132, 142, 151, 198, 204, 206, 207, 235, 239, 241, 261, 274, 308, 341, 358, 368, 410, 412–415, 420–425, 433, 435, 517, 600, 607, 615
- Antiviral strategies, 98
- Asteroid mosaic (AM), 332, 333, 338, 340, 341, 344, 399, 637, 660
- Australian grapevine viroid (AGVd), 41, 375, 377, 380, 381, 383–385, 433, 436, 439, 627, 628, 631

B

- Badnaviruses, 40, 316, 321, 324, 328, 369, 628, 631, 634, 661
- Betaflexiviridae*, 159, 232, 234, 260–262, 264, 280, 354, 356, 399, 466, 645, 651, 652, 661, 664–674
- Biological host indicators, 396, 398
- Bipartite RNA genome, 63

- Blueberry leaf mottle virus* (BLMoV), 48, 64, 110, 397, 459, 510, 591, 660, 679
- Bronze Age, 5, 7, 10–14

C

- Certification, 56, 68, 71, 98, 121, 133, 158, 176, 178, 226, 245, 329, 345, 397, 401, 403, 419, 434, 470, 532, 534, 538, 562–564, 582–597, 600, 602, 637–639
- Chip-bud inoculation, 400–401
- Chlorotic mottling, 51, 62, 118, 180, 353, 354, 359, 368, 383, 629
- Circular RNAs, 374, 379, 382, 384
- Citrus exocortis viroid (CEVd), 41, 375, 377, 381, 384, 385, 433, 439
- Clean stocks, 15, 16, 22, 68, 120, 122, 280, 312, 396, 403, 563–565, 572, 574–575, 582, 584, 585, 589, 596, 602, 637
- Closteroviridae*, 37, 131, 143, 144, 168, 169, 171–173, 200–202, 204, 205, 208, 214, 222, 223, 280, 399, 400, 403, 454, 460, 493, 494, 532, 533, 602, 645, 647, 650–652, 661, 664, 668–672, 674–677, 682
- Closteroviruses, 15, 32, 36–39, 128, 130, 131, 142–144, 154, 155, 168–173, 185, 202–204, 222, 223, 231, 232, 352, 397, 410, 417, 460–466, 484, 493, 494, 532, 602, 603, 629, 645–650, 661, 672, 675–677, 682
- Controls, 68–70, 89, 120–121, 135, 155, 168, 213–214, 226, 239, 292, 565, 600, 664

D

- Defense, 135, 144, 172, 179, 184, 185, 281,
468, 471, 600, 605, 606, 615,
644, 646, 653, 663, 664, 672, 675
- Detection, 51, 86, 118–119, 132–133,
149–152, 168, 198, 224–225, 238–240,
299, 564, 604
- Diagnosis, 41, 51, 56–57, 65–67, 118–119, 133,
149–154, 176–178, 181, 186, 206–210,
213, 224–225, 238–240, 274–277, 280,
305, 308, 316–321, 324–329, 340–343,
358, 360, 396, 401, 404, 410, 420, 424,
432, 516–517, 522, 584
- Diseases, 50, 84, 110, 128, 142, 168, 198, 226,
230, 291–294, 601, 662
- Double-stranded (ds), 88, 98, 99, 296, 321,
369, 382, 424, 436, 438, 606, 628, 644,
661, 662
- Double-stranded RNA (dsRNA), 98, 296, 369,
606, 628, 644, 661, 662

E

- Economic impacts, 41, 48, 50, 84, 116–118,
128, 168, 181, 279, 304–306, 382, 383,
415, 455, 465–466, 510, 574, 575,
601–602
- Economic importance, 365, 367–370
- Economic value, 463, 562, 574–575
- Enzyme-linked immunosorbent assays
(ELISA), 51, 86, 118, 132, 151, 176,
199, 224, 231, 292, 565
- Epidemics, 71, 115, 230, 366, 377, 600
- Epidemiology, 39, 41, 69, 119, 134, 136, 183,
231, 309–312, 345, 359, 360, 370,
385–386, 495, 532, 535–543, 584
- Etiology, 38, 129, 136, 143, 156, 168, 171,
177, 179, 198, 213, 244, 291–294, 299,
304, 332, 333, 352, 360, 402–405, 584,
593, 627–629, 631, 635, 638
- Evolution, 4–10, 37, 54, 71, 110, 111, 146,
201, 203, 205, 214, 238, 269, 281, 332,
357, 377, 379, 563, 626, 635, 659–666,
668–672, 674–676, 678–682, 684
- Evolution biology, 159, 281

F

- Fanleaf, 50, 84, 110, 563, 600, 678
- Fanleaf degeneration, 51, 85, 98, 99, 396, 506,
510, 520, 523, 583
- Flecks, 32, 40, 51, 117, 200–201, 332,
334–340, 342–345, 380, 399, 410, 439,
470, 566, 573, 585, 586, 589, 637, 660

- Foveaviruses, 39, 260, 262, 267, 276, 278,
439, 454, 466, 637, 645, 651–652, 664,
666, 668, 672
- Functional genomics, 158, 186, 281, 644, 646,
653, 684

G

- Geminiviridae*, 40, 306, 399, 629, 661, 662
- Gene expression vectors, 643, 646, 649, 650,
652–654
- Genetic diversity, 119–120, 132, 142, 143,
147–149, 173–176, 186, 204–206, 224,
236–238, 266–272, 276, 316–321,
324–329, 333, 339–340, 357, 360, 422,
630, 635
- Genome structures, 143–147, 170–173,
202–204, 223–224, 234–236, 260–265,
267, 306–307, 321–325, 356, 652, 664,
665, 678
- Graft incompatibility (GVF), 38, 39, 142, 150,
151, 156, 158, 290–299, 464–466, 629
- Grape performances, 128, 182–183, 214, 454,
456, 457, 464, 562, 572
- Grape phenolics, 18, 442, 458, 462, 469
- Grape physiology, 18–21, 182, 458, 462–463,
468, 472, 663
- Grape propagation, 464
- Grapevine, 48, 84–100, 110, 127–136, 142,
143, 145–149, 151, 152, 154–159,
168–174, 176–187, 197–214, 226,
230–232, 234–242, 244–247, 290, 365,
367–370, 561–576, 600, 659–666,
668–672, 674, 676, 678–682, 684
- Grapevine asteroid mosaic, 40
- Grapevine fanleaf virus (GFLV), 15, 18, 35,
48, 50, 51, 54–58, 62–71, 84, 91, 110,
307, 369, 380, 396, 410, 436, 455, 508,
563, 586, 600, 609, 611, 628, 645, 660,
678, 689
- Grapevine latent viroid (GLVd), 41, 375,
383, 385
- Grapevine leaf mottling and deformation
(GLMD), 352, 353, 359, 360, 470
- Grapevine leafroll, 15, 36, 128, 142, 168, 226,
267, 290, 403, 418, 436, 483, 532, 573,
582, 602, 627, 661
- Grapevine leafroll disease (GLD), 128, 129,
132, 143, 146, 159, 168, 169, 177,
179–181, 183–186, 198, 213, 403, 419,
531–535, 537, 538, 540–552, 602
- Grapevine leafroll-associated virus (GLRaVs),
36, 37, 127–136, 142, 143, 145–149,
151, 152, 154–159, 168–174, 176–187,

- 200–201, 214, 221–226, 397, 436, 438, 483–496, 586, 589, 627, 645, 661, 674, 676, 690
- Grapevine leafroll-associated virus-1 (GLRaV-1), 602
- Grapevine leafroll-associated virus 2 (GLRaV-2), 663
- Grapevine leafroll-associated virus 3 (GLRaV-3), 17, 19, 37, 38, 128, 135, 136, 144, 149, 155, 157, 159, 168, 169, 171–174, 176–187, 200–201, 203, 205, 206, 211, 212, 214, 222, 226, 237, 238, 241, 415, 417, 419–421, 423, 424, 433, 434, 438, 440, 442, 460–464, 468, 469, 471, 484, 485, 492, 493, 495, 532, 534, 535, 537, 538, 540–543, 545, 546, 550, 573, 574, 589, 602, 604, 605, 607, 627, 628, 630, 636, 650, 661, 669, 674, 677
- Grapevine leafroll-associated virus 4 (GLRaV-4), 37, 128, 134, 146, 157, 169, 170, 199, 201–214, 221, 419, 422, 433, 439, 460, 532, 533, 536, 602, 629, 631, 638, 661, 674, 676, 682
- Grapevine leafroll-associated virus 7 (GLRaV-7), 128, 170, 200–201, 213, 226, 400, 403, 433, 436, 460, 484, 532–534, 602, 629, 631, 638, 650, 661, 677
- Grapevine necrotic union (GNU), 295, 296
- Grapevine red blotch-associated virus (GRBaV), 40, 306, 399, 573, 582, 629, 645, 652, 661, 662, 689
- Grapevine rootstock stem lesion, 156, 292
- Grapevine rupestris stem pitting-associated virus* (GRSPaV), 39, 258, 260–267, 269, 275, 277–281, 466, 571, 582, 627, 673, 690
- Grapevine Syrah decline, 298, 333, 337–338, 370, 404, 436, 627, 660
- Grapevine virus (GVA) detection, 152, 424, 603
- Grapevine yellow speckle viroid 1 (GYSVd-1), 41, 375, 377–385, 438, 628, 631, 635
- Grapevine yellow speckle viroid 2 (GYSVd-2), 41, 375, 377–380, 383–385, 628
- Green grafting, 206, 291, 359, 397, 401
- H**
- High throughput, 118, 130, 133, 168, 177, 186, 210, 240, 258, 267, 274, 298, 313, 316, 351, 386, 402, 424, 472, 522, 567, 595, 626–631, 633–638, 659
- Hop stunt viroid (HSVd), 41, 375–377, 382, 384, 385, 439, 627–629, 631, 635
- Host factors, 99
- I**
- Idaeovirus*, 368, 510, 660
- Ilarvirus*, 367
- Indexing, 51, 56, 65, 133, 135, 149, 157, 176, 178, 206, 244, 245, 279, 384, 397, 399, 401, 403, 404, 419, 454, 466, 586, 588, 590
- Infectious degeneration, 32, 35–37, 40, 51–70, 85, 454–459
- Infectious full-genome clones, 111, 114, 231, 235, 236, 296, 298
- Infectious viral cDNA clones, 259, 260, 265, 646, 647, 649
- Interactions, 93–95, 97, 99, 133, 134, 136, 155, 159, 168, 174, 178–179, 181, 186, 214, 226, 241–242, 247, 258, 278, 294, 343–344, 361, 382, 420, 461, 471–472, 484, 494–495, 507, 518, 521, 522, 535, 614, 627, 638, 639, 653, 691
- Iron Age, 13–14
- L**
- Leafroll, 16, 32, 128, 142, 168, 213, 221, 231, 290, 304, 332, 369, 396, 410, 438, 454, 483, 510, 532, 565, 582, 601, 627, 674
- Line patterns, 31, 62, 66, 118, 366–368, 398, 660
- Longidorid nematode, 32, 50, 57, 69
- Longidoridae*, 67, 506–510, 512–514, 516, 519–522
- Longidorus*, 67, 69, 110, 368, 506, 507, 512–514, 516–518
- Loop-mediated isothermal amplification (LAMP), 433, 440
- M**
- Maculaviruses, 40, 334, 342, 397, 403, 410, 627, 639, 660
- Management, 85, 98, 99, 121, 134, 135, 157–158, 176, 183–185, 213–214, 226, 245–246, 280, 304, 306–309, 312, 313, 326, 328–329, 345, 360, 418, 424, 454, 457, 462, 466, 490, 517, 522, 523, 531–535, 537, 538, 540–552, 575, 585, 594, 600–616
- Marafiviruses, 334, 337, 338, 397, 403, 635, 639, 652, 660, 666

- Mealybugs, 14, 16, 22, 37, 39, 133–135, 169, 178, 183–185, 200–202, 210–212, 214, 226, 231, 232, 236, 240, 241, 328, 483, 485, 490–493, 495, 532, 533, 535, 536, 539, 541–546, 549–551, 575, 589, 602, 604, 683
- Mealybug transmission, 541, 645
- Mechanical inoculation, 38, 52, 85, 111, 114, 367, 368, 607, 645–647, 681
- Mesopotamia, 8, 10, 11, 13
- Microshoot tip culture, 566–573, 576
- Movement, 50, 53, 55, 64, 70, 71, 85, 88, 89, 93–95, 97, 99, 113, 114, 131, 134, 144, 146, 158, 172, 203, 210, 212, 232, 235, 236, 260, 262, 306, 321, 323, 356, 368, 369, 374, 416, 466, 511, 514, 531, 544, 570, 588, 590, 595, 596, 634, 639, 646, 648, 651, 666, 676, 678, 680, 681, 690
- Multiplex PCR, 66, 239, 307, 433, 438, 439, 517
- N**
- Nematode vectors, 58, 67, 68, 71, 94, 98, 110, 119, 121, 420, 506, 507, 509–523, 601, 603, 679
- Neolithic, 5, 7–10, 13, 14, 22
- Nepoviruses, 14, 17, 32, 35, 48, 50, 51, 54–58, 62–71, 84, 86–89, 92, 93, 95–97, 100, 110–121, 316, 352, 397, 398, 410, 415, 416, 418, 420, 436, 438, 441, 454, 455, 459–466, 506, 509–511, 520–522, 603, 627, 628, 633, 634, 637, 645, 652, 660, 677–680, 682, 683
- Nested PCR, 209, 433, 439, 440
- New strategies, 522, 602, 615
- Next generation sequencing (NGS), 40, 100, 168, 267, 277, 333, 375, 382, 425, 603, 689
- P**
- Paralongidorus*, 67, 506–509, 512, 514, 516, 518, 519
- Peach rosette mosaic virus* (PRMV), 36, 48, 110, 459, 508, 509, 591, 660, 679
- Perception, 611–614, 616
- Phloem, 66, 94, 100, 130, 133, 146, 155, 157, 158, 182, 183, 198, 212, 226, 230, 234, 239, 241–245, 308, 332, 343, 385, 416, 417, 420, 423, 438, 464, 494, 532, 573, 602, 603, 627, 634, 647, 649, 651, 653, 654
- Phylogeny, 232, 237, 357, 358, 635, 680
- Physiology, 458
- Plant viruses, 15, 54, 68, 93, 95, 168, 169, 171, 177, 210, 247, 280, 338, 404, 410, 412, 414, 415, 420, 432, 437, 441, 471, 494, 506, 522, 531, 537, 541, 546, 615, 644, 647, 649, 651–653, 662, 672, 674, 682
- Polymerase chain reaction (PCR), 21, 51, 118, 133, 149, 168, 209, 224, 237, 292, 305, 316, 342, 352, 367, 383, 403, 419, 432, 517, 542, 586, 606, 629
- Q**
- Quantitative real-time PCR (qPCR), 239, 437–438
- Quarantine clean stock, 596
- R**
- Red blotch, 21, 40, 181, 304, 306–309, 312, 313, 404, 423, 470, 567, 573, 582, 629, 645, 652, 661, 662, 690
- Regulatory program, 585, 591
- Resistance, 5, 17, 22, 36, 55, 70, 71, 98, 120, 121, 186, 245–247, 281, 290, 328, 386, 455, 511, 532, 550, 572, 600–608, 610, 611, 613–615, 654
- Reverse transcription PCR (RT-PCR), 51, 118, 133, 149, 151, 176, 209, 224, 237, 266, 292, 342, 352, 367, 383, 402, 421, 432, 517, 565, 606, 632
- RNAs, 35, 48, 84, 111, 130, 143, 168, 201, 222, 296, 307, 316, 332, 352, 366, 402, 421, 432, 455, 511, 600, 627, 662
- RNA-dependent RNA-polymerase, 50, 66, 70, 87, 113, 130, 131, 171, 200–201, 203, 222–225, 232, 234, 261, 262, 332, 336, 605, 644, 648, 664, 665, 674, 675, 678
- RNA interference (RNAi), 98, 144, 146, 172, 186, 600, 606, 615, 644, 646, 648, 649, 654, 663, 664, 676
- Roguing, 135, 184, 213, 312, 544, 546, 547, 550, 574, 575, 604
- Rootstocks, 5, 36, 62, 84, 120, 129, 151, 168, 212, 230, 290, 307, 328, 343, 355, 396, 432, 534, 562, 584, 600, 629
- Rugose wood (RW) complex, 32, 38–40, 230, 243, 440, 454, 461, 464, 466–470, 484, 495, 543, 585, 589, 651, 690

- Rupestris stem pitting (RSP), 21, 38, 244, 258, 260, 262–267, 269, 275, 277–281, 396, 397, 434, 466, 566, 585
- S**
- Sanitary selection, 136, 345, 576, 584, 602
- Scale insects, 16, 133–136, 178, 183, 185, 186, 210–213, 226, 232, 483–485, 490–492, 494, 495, 532, 533, 536, 543, 546, 549–551, 650, 674, 683, 690
- Secoviridae*, 48, 50, 65, 84, 90, 110, 112, 510, 652, 660, 664, 668–671, 677–682
- Sequencing, 40, 65, 100, 114, 118, 130, 152, 168, 208, 234, 258, 296, 308, 316, 332, 351, 375, 402, 421, 434, 471, 522, 567, 595, 603, 626, 659, 689
- Serology, 198, 410
- Small RNA (sRNA), 177, 235, 240, 242, 259, 267, 316, 352, 382, 472, 627, 628, 633
- Soft-scale insects, 32, 37, 133–136, 178, 210–213, 226, 232, 533, 546, 549, 550, 650, 690
- Specificity, 67, 89, 97, 132, 134, 151, 186, 206, 209, 211, 225, 239, 384, 404, 410, 412, 413, 423, 424, 433, 435, 436, 485, 493, 506, 520–521, 635
- Spread, 5, 37, 67, 89, 114, 128, 149, 171, 213, 236, 290, 306, 325, 343, 359, 366, 380, 396, 418, 460, 483, 507, 532, 575, 582, 601, 626, 676, 690
- ssRNA viruses, 356, 668
- Stem necrosis distortion, 296–297, 402–403
- Symptom determination, 90–92, 100, 242
- Syring decline, 156, 280, 297–299, 470, 627, 630, 631, 638
- T**
- Therapeutics, 562, 566, 582, 603, 690
- Tobacco ringspot virus* (TRSV), 35, 48, 89, 110, 113, 116, 397, 442, 459, 508, 509, 588, 660, 681
- Transcaucasia, 7, 8, 13
- Transgenics, 70, 98, 186, 247, 424, 532, 601, 603, 605–616
- Transmission, 15, 36, 50, 84, 114–115, 131, 146, 168, 210–212, 222, 235, 277–278, 290, 309–311, 326–328, 343, 359, 367, 380, 398, 420, 460, 484, 506, 533, 596, 600, 674
- Trichoviruses, 39, 232, 236, 260, 262, 352, 354, 356–358, 368, 629, 651, 661, 664, 668
- Tymovirales*, 232, 264, 334, 335, 354, 664, 666–667
- Tymoviridae*, 232, 264, 334–336, 338, 399, 627, 637, 660, 664, 666–667
- V**
- Vectors, 14, 32, 85, 110, 131, 143, 169, 211, 226, 230, 265, 290, 308, 325, 343, 359, 385, 396, 418, 434, 460, 483, 506, 532, 575, 588, 600, 676, 690
- Vein clearing, 316, 317, 320, 459
- Vein necrosis (VN), 261, 279, 280, 320, 469, 471, 566, 589
- Velarivirus*, 37, 128, 146, 169, 170, 222, 223, 226, 460, 484, 532, 602, 629, 645, 647, 650, 661, 672, 677
- Vinifera* phloem, 110, 120, 121, 226, 290, 292–294
- Viral diagnostics, 118
- Viroid-like RNAs, 41, 375, 382–386
- Viroids, 21, 41–42, 52, 112, 152, 181, 279, 299, 373, 432, 593, 603, 626
- Viromes, 100, 240, 333, 626–629, 631, 634–636, 639, 659, 662, 663, 689
- Viruses, 15, 31, 48, 84, 128, 142, 168, 198, 221, 226, 230, 258, 290, 304, 316, 332, 351, 365, 373, 396, 410, 432, 454, 484, 506, 531, 562, 582, 600, 626, 659, 689
- Virus assay, 115, 118
- Virus–host interactions, 131, 155, 178–179, 186, 212, 226, 241–242, 258, 278, 343–344, 359, 454, 605, 653, 672, 683
- Vitis vinifera*, 36, 87, 110, 117, 213, 226, 290, 309, 311, 332, 352, 367, 369, 432, 459, 534, 601, 602, 637, 679
- Vitis vinifera sylvestris*, 7, 8, 13, 21, 40, 679
- Vitaviruses, 32, 39, 134, 159, 230–232, 234–242, 244–247, 260, 262, 294, 345, 397, 403, 410, 413, 419, 434, 438, 439, 454, 466–469, 485, 494, 495, 603, 636, 645, 651–652, 661, 663, 664, 668, 669, 672, 683
- Vitis vinifera* phloem, 226, 230, 238

W

Wine quality, 128, 183, 562

Woody perennials, 262, 280, 443,
664, 666

X

Xiphinema, 50, 57, 67, 69, 84, 110, 508, 601,
609

Xiphinema americanum, 17, 67, 110, 115,
121, 509, 512, 513, 516, 519, 520

Y

Yellow mosaic (YM), 51, 54, 62, 63, 65, 90,
264, 336, 680

Young vine decline, 135, 156, 290–291, 293,
294, 296