

Steel in Multi-Storey Residential Buildings

R M Lawson BSc(Eng) PhD ACGI CEng MICE MIStructE

R G Ogden BA Dip Arch PhD MCSD

J W Rackham BSc(Eng) MSc DIC PhD CEng MICE

Published by:
The Steel Construction Institute
Silwood Park
Ascot
Berkshire SL5 7QN

Tel: 01344 623345

Fax: 01344 622944

© 2004 The Steel Construction Institute

Apart from any fair dealing for the purposes of research or private study or criticism or review, as permitted under the Copyright Designs and Patents Act, 1988, this publication may not be reproduced, stored or transmitted, in any form or by any means, without the prior permission in writing of the publishers, or in the case of reprographic reproduction only in accordance with the terms of the licences issued by the UK Copyright Licensing Agency, or in accordance with the terms of licences issued by the appropriate Reproduction Rights Organisation outside the UK.

Enquiries concerning reproduction outside the terms stated here should be sent to the publishers, The Steel Construction Institute, at the address given on the title page.

Although care has been taken to ensure, to the best of our knowledge, that all data and information contained herein are accurate to the extent that they relate to either matters of fact or accepted practice or matters of opinion at the time of publication, The Steel Construction Institute, the authors and the reviewers assume no responsibility for any errors in or misinterpretations of such data and/or information or any loss or damage arising from or related to their use.

Publications supplied to the Members of the Institute at a discount are not for resale by them.

Publication Number: SCI P332

ISBN 1 85942 154 7

British Library Cataloguing-in-Publication Data.

A catalogue record for this book is available from the British Library.

FOREWORD

This publication was prepared by Mark Lawson and Jim Rackham of The Steel Construction Institute (SCI), and Ray Ogden of Oxford Brookes University. They were assisted by Peter Lusby-Taylor of HTA Architects and Stephen Hicks of SCI. Comments were also received from Clive Challinor, Richard Dixon, Andrew Orton, Colin Smart, Jim Swindale, Matthew Teague, and Mike Webb, all of Corus.

The publication concentrates on the integration of steel technologies in multi-storey residential buildings. It includes case studies and details, and offers the designer a range of strategies by which to approach the ever-increasing burden of legislation and planning guidance directed at the residential sector. The project teams in the Case Study buildings are presented, and their collaboration is gratefully acknowledged.

It follows the series of SCI publications dealing with new technologies in the residential sector:

- Light steel framing in residential buildings (P301)
- Modular construction using light steel framing : Design of residential buildings (P302)
- Modular construction using light steel framing : An architect's guide (P272)
- Acoustic detailing for multi-storey residential buildings (P336)
- Acoustic performance of light steel framed systems (P320)
- Acoustic performance of composite floors (P322)
- Acoustic performance of *Slimdek* (P321)
- Multi-Storey Residential Buildings using *Slimdek* (P310)
- Case studies on multi-storey residential buildings in steel (P328)
- Case studies using *Slimdek* (P309)
- Case studies on modular steel framing (P271)
- Value-benefits of *Slimdek* (P279)
- Value and benefit assessment of light steel framing in housing (P260)

A related forthcoming publication, *Slimdek in multi-storey residential buildings*, to be published by Corus, provides specific information on using this technology, supplemented by case studies and details.

The preparation of this guide was funded by Corus, and their support is gratefully acknowledged.

Contents

	Page No.
FOREWORD	iii
SUMMARY	vii
1 INTRODUCTION	1
1.1 Introduction to steel technologies	1
1.2 Need for better value in the residential sector	6
1.3 Architectural opportunities in steel	6
1.4 Market opportunity	8
1.5 Registered social landlords	9
2 VALUE-BENEFITS OF STEEL IN RESIDENTIAL BUILDINGS	10
3 DESIGN CONSIDERATIONS	12
3.1 Space criteria	12
3.2 ODPM guidance	14
3.3 Sustainable construction	15
3.4 Building Regulations (England and Wales)	15
3.5 Structural Aspects	19
4 STEEL TECHNOLOGIES FOR THE RESIDENTIAL SECTOR	22
4.1 Composite construction	22
4.2 <i>Slimdek</i>	27
4.3 <i>Slimflor</i> beams with precast concrete slabs	31
4.4 Mixed use construction	35
4.5 Light steel framing	36
4.6 Modular construction	40
4.7 Light steel infill and separating walls	44
5 CLADDING OPTIONS FOR MEDIUM-RISE BUILDINGS	47
5.1 Introduction	47
5.2 Masonry	47
5.3 Insulated render	48
5.4 Composite panels or sheeting	49
5.5 Boards	49
5.6 Cassettes	50
5.7 Brick or clay tiles	52
5.8 Fully glazed façades	54
5.9 Metallic sheets	55
5.10 'Kalzip' roofing	56
6 STEEL BALCONIES AND PARAPETS	57
6.1 Types of balconies	57
6.2 Balcony attachments in <i>Slimdek</i>	61
7 WATER-TIGHT BASEMENTS	62
7.1 Construction methods	62
7.2 Design requirements for basements	62
7.3 Recent examples of basement construction	63
8 REFERENCES	66

1
r
2
y
p
h
o
c
r
s
a
i
M
0
3
a
i
n
o
e
t
d
a
e
E
t
s
e
i
r
E
C
T

SUMMARY

This publication presents the range of steel-intensive construction technologies that may be used successfully in the multi-storey residential building sector. It explains the need for achieving better value in residential construction, and describes the value-benefits of using these steel technologies.

The publication discusses the important regulatory requirements and other aspects influencing the design of residential buildings. It mentions aspects of compliance with the Building Regulations, including the recently enhanced requirements for acoustic and thermal insulation. It also gives information on the means of achieving robustness in multi-storey structures, to prevent disproportionate collapse.

The steel technologies covered in the publication are:

- Composite construction
- *Slimdek*
- *Slimflor* (using precast concrete slabs)
- Light steel framing
- Modular construction
- Light steel separating walls.

The main features and benefits of these technologies are described, together with recent examples of housing or residential buildings using these forms of construction.

The attributes and application of a range of cladding options is provided, with illustrations of their use. Details of balconies and parapet walls are also included. Basements are an increasingly common requirement for densely populated environments, and information on the construction of water-tight basements is given. A complementary publication (by Corus) reviews the application of *Slimdek* in a multi-storey residential building.

1 INTRODUCTION

The residential building sector demands more efficient, adaptable and higher quality buildings than in the past, especially to meet the constraints of construction in inner city locations. The greatest challenges and opportunities lie in the medium-rise sector, as pressure to build to higher density and on 'brown-field' sites increases. These challenges require a new way of building that reduces the impact of the construction process on the locality and maximises the benefits of pre-fabrication.

Steel construction is well placed to meet the demands of building in the urban environment where the well-known benefits of speed of construction, improved quality and less dependence on site trades can be realised.

1.1 Introduction to steel technologies

A wide range of well established steel technologies is available to meet the demands of the multi-storey residential sector; all of these technologies are covered in this publication. There is also the need to consider special requirements of 'mixed' residential and commercial developments, which are accommodated easily using these technologies.

The steel technologies which are most relevant to the urban residential sector are:

Light steel framing	Suitable for low-rise single family housing and social housing.
<i>Slimdek and Slimflor</i>	Used in multi-storey apartments with flexibility of internal planning and minimum floor zone.
Composite construction	Used in multi-storey apartments and 'mixed' developments, often with longer spans at commercial/retail level.
Modular construction	Suitable for medium-rise single- or two- person units (e.g. for key worker accommodation).
Light steel infill and separating walls	Constructed using light steel framing, and used extensively with <i>Slimdek</i> , <i>Slimflor</i> and composite construction technologies for its acoustic insulation and 'dry' construction benefits.

The publication covers the important aspects of these technologies, including:

- Forms of construction
- Application benefits
- Case examples of recent projects
- Structural design aspects
- Fire safety
- Acoustic requirements

- Façade treatments
- Balconies and parapets

The purpose of this publication is to give an over-view of the use of steel at the concept stage in design. Other SCI publications^[1,2,3,4,5] address detailed technical aspects, and acoustic design is covered in SCI Technical information sheets^[6,7,8].

Steel is increasingly used in major residential projects, where the benefits of speed of construction and column-free space can be realised. A typical urban project in steel is shown in Figure 1.1. A variety of cladding materials and façade treatments may be used, such as balconies, brise soleil, full height glazing, and mansards, as illustrated in Figure 1.2. Options for cladding are discussed in Section 5, and the construction of steel balconies is covered in Section 6.

The attributes of steel construction in the residential sector, which build on its successful application in other sectors, are listed in Table 1.1. Steel construction can also provide good acoustic and thermal performance, which is necessary to comply with the Building Regulations^[9]. A considerable amount of testing and monitoring of the acoustic performance of steel frames buildings has led to 'Robust Details' (see *Robust Details Handbook*)^[11] and other standard solutions.

Table 1.1 *Attributes of steel construction in the residential sector*

Sustainable Construction	Re-thinking Construction
<ul style="list-style-type: none"> • Energy efficient • Efficient materials use • Minimum waste • Re-cyclability • Future adaptability • Long life 	<ul style="list-style-type: none"> • Reduces costs • Reduces time on site • Increases productivity • Improves safety • Increases quality • Increases certainty of budget and time

Basement car parking is often a requirement in urban and densely populated environments, and the car parking bay sizes may determine the column layout throughout the building above. Steel-intensive water-tight basements are covered in Section 7.



Figure 1.1 *Steel framed apartments with pre-fabricated balconies in Manchester*



Figure 1.2 *Variety of façade treatments in a steel framed residential building in Glasgow*

Composite construction is now widely used in multi-storey residential buildings. The Manchester Deansgate project, (Figure 1.3), is the tallest residential building of the modern era since London's Barbican of the early 1970s. It uses a 16 storey composite frame with a fully glazed façade, all supported on inclined tubular steel columns supported at podium level.



Figure 1.3 *16-storey composite steel framed building in Manchester*

A large range of buildings using 'mixed' steel frames and modular construction is underway. Europe's largest modular building, also in Manchester shown in Figure 1.4, uses a composite structure for the retail and car parking floors and 8 storeys of modular units supported on the upper composite floor. Pairs of modules align with the column grid below.



Figure 1.4 *Eight-storey modular building in Manchester, supported on a composite frame at podium level*

All steel projects share in the benefit of being pre-fabricated, so that the primary structure can be erected rapidly and with the minimum of site storage and infrastructure. This is increasingly important for congested inner city locations where there is limited space for equipment, materials and site facilities. Steel construction is also a relatively quiet operation with little mess and wastage, which are important environmental benefits. Figure 1.5 shows a primary steel frame that is erected rapidly before concreting of the floors.



Figure 1.5 *Primary steel frame in a major residential project in Southampton*

1.2 Need for better value in the residential sector

There is growing demand for the construction industry to improve value by providing better quality, reliability and performance. The Egan Report '*Re-thinking Construction*'^[12] identified key initiatives for change and performance improvement. However, unlike other reports over the last 50 years, Government support for the Egan Report is combined with a willingness to change by the UK construction industry. It has called for a re-examination of all aspects of construction processes and greater innovation in product and system development, which steel construction can satisfy.

Registered Social Landlords (see Section 1.5) are required by the Government to demonstrate compliance with the Egan Report principles when procuring new housing with Housing Corporation funding.

Selection by 'best value' is implicit in modern procurement. Recent guidance by the Treasury states that UK Government policy is that all procurement should be on the basis of Value for Money and not lowest price alone. The Housing Corporation has issued guidance in *Best Value for Social Landlords*^[13].

1.3 Architectural opportunities in steel

Steel construction affords many opportunities for architectural expression through features such as:

- Shallow floor construction
- Variety of façade materials
- Storey-high glazing
- Slender tubular columns
- Long-span internal structure
- Balconies and walkways
- Penthouses and roof-top additions
- Mansard and other roof-detailing
- Exposed structural steelwork with intumescent coatings for fire protection.

Two examples of recent of planned projects that emphasise the visually striking nature of steel construction in residential and 'mixed use' buildings are illustrated in Figure 1.6 and Figure 1.7.



Figure 1.6 *'Mixed' use residential-retail building in Leeds*



Figure 1.7 *Proposed canal-side apartment building in Cheshire*

An example of the creation of an urban street-scape using mixed use of modules and frame components is illustrated in Figure 1.8.



Figure 1.8 *Building arrangement using mixed frame and modular units*
(Courtesy of HTA Architects)

1.4 Market opportunity

The size of the new-build residential housing market can be obtained from the number of housing starts given in Government (OPDM) and NHBC statistics. This data also gives a breakdown of the type of unit required in the market, including the number of rooms, and whether the buildings are family houses or apartments, and whether they are privately or publicly owned. Currently, the total number of housing starts is approximately 195,000 units a year, of which 27% are apartments (see Table 1.2). This proportion of apartments increases in metropolitan areas. Nearly 35% of all housing is for single person occupancy, and this will increase due to social and demographic changes and an ageing population. In addition, the rapidly expanding educational, health and defence sectors demand up to 20,000 new units a year, generally of single person accommodation.

Table 1.2 *Total housing starts in the UK 2003*

Bedrooms	Houses	Apartments
1	2,000	12,000
2	20,000	37,000
3	56,000	2,000
4+	66,000	< 1,000
Totals	144,000	51,000

Data: ODPM Housing and Construction Statistics

From NHBC statistics, approximately 60% of all housing projects in London are apartments (Table 1.3). Increasingly, in cities such as Manchester, Leeds, Cardiff and Glasgow, high quality apartments are being built on the waterfront

and former industrial areas, in which there is a premium for open plan space, high quality, panoramic views, and speed of construction.

Although public sector house building is relatively low as a percentage (approximately 11%), Registered Social Landlords are very influential in demonstrating new technologies, which provides an opportunity for steel-intensive construction. For example, the Peabody Trust has pioneered the use of modular construction in London.

It is a widely held view that the market for new housing will remain strong in the near future. New house-building in the UK represents only 3.1 per 1000 housing stock, which is much less than the EU average of 6.1 per 1000. The new build or replacement rate is not sufficient to meet demand, mainly due to control on the release of building land. Planning guidance emphasises use of 'brownfield' or post-industrial sites, and building to higher density in urban locations.

It is predicted that demand for building in urban locations will increase, so there will be pressure to build rapidly with minimum disruption to the locality. Pre-fabricated construction is seen as the greatest opportunity to meet future housing demand.

Table 1.3 *Proportion of new house building (NHBC)*

Region	Totals	Detached	Semi-detached	Terraced	Bungalow	Apartments
London	10%	6%	9%	25%	1%	59%
England (excluding London)	68%	49%	19%	15%	5%	12%
Scotland, Wales and Northern Ireland	22%	35%	19%	9%	9%	28%

Data: NHBC House Building Statistics

1.5 Registered social landlords

The top 20 Housing Associations or Registered Social Landlords (RSLs) are responsible for 70% of public (i.e. 8% of total) house building in the UK. The top four RSLs each have over 30,000 houses in management and expect to build approximately 2,000 new houses every year, excluding renovation of existing buildings (data from the National Housing Federation).

RSLs have a long term interest in their property, although they are not generally involved in construction. The Housing Corporation's Best Value framework for RSLs is required to deliver 'best value' rather than 'least cost'. Value for money guidance is issued by the Housing Corporation^[14].

2 VALUE-BENEFITS OF STEEL IN RESIDENTIAL BUILDINGS

The benefits of the use of steel construction systems for use in the urban residential sector derive from various design and construction aspects and can be grouped under a number of headings. The following summaries present benefits under six headings – note that some aspects appear under more than one heading. Further detailed information on the value-benefits of *Slimdek* is given in the SCI publication, *Value Assessment of Slimdek Construction*^[15].

Design related benefits

- Lightweight structure in comparison to other forms of structure, leading to reduced foundation costs.
- Long span beams, giving flexibility in layout of apartments.
- Minimum floor zone (by using *Slimflor* beams or *Slimdek*).
- Robust construction (enhances structural integrity).
- Easily meets acoustic and thermal performance requirements through the use of insulation.

In-Service related benefits

- Freedom from rot or shrinkage or long term movement.
- Long design life.
- Can be easily adapted to suit future changes in use.
- Openings can be formed easily in the floors and walls.
- Robust to damage and impact.
- Good acoustic insulation.

Construction-related benefits

- No temporary propping required for most steel options.
- Rapid construction technology.
- Decking acts as a working platform, when using a composite slab.
- Pre-fabrication leads to faster construction, less waste on site, and less site infrastructure.
- ‘Just in time’ delivery to site to meet local conditions.
- Reduced site preliminaries and personnel.
- Easy creation of openings in the structure.
- Low weather dependence.
- Accurate construction (facilitates later fit-out).

Financial benefits

- Savings in site preliminaries by up to 50% due to speed of construction.
- Improved cash flow due to early completion.
- Less financial risk due to reliable construction programme.
- Early rental or sale, and return on investment.

Environmental benefits

- Efficient use of materials in factory production.
- Less waste in materials use.
- Less disruption, waste and time on site.
- Light weight for use on 'brownfield' sites.
- Adaptable to future uses.
- All steel is re-usable and re-cyclable.
- Modular units can be re-used.

'Egan' related benefits

The '*Re-thinking Construction*' agenda seeks improvements in quality, reductions in waste and in construction time, lower capital costs and better predictability. Steel construction meets these demands in many ways, including:

- 'Just in time' delivery to site.
- Greater levels of pre-fabrication.
- Improved quality through prefabrication.
- Certainty of delivery and programme.
- Reduced waste in materials and re-work.
- Electronic transfer to data from design to manufacture.
- Reduction in construction time.

3 DESIGN CONSIDERATIONS

This Section outlines important aspects of design relating to residential buildings, including the space criteria for accommodation and parking requirements, and the application of the Building Regulations in terms of the thermal, acoustic, and fire safety requirements. Important structural aspects are covered, including bracing and new guidance on robustness.

3.1 Space criteria

3.1.1 Accommodation

Registered Social Landlords follow standard specifications in their procurement, generally to an equivalent or higher standard than private developers, and above the minimum required by the Building Regulations. The most well-known standards are:

- *Scheme Development Standards*^[14] (Housing Corporation)
- *Lifetime Homes*^[16] (Joseph Rowntree Foundation)
- *Standards and Quality in Development*^[17] (National Housing Federation)

The National Housing Federation (NHF) standards give minimum room sizes for different occupancy patterns, and other space, energy efficiency and performance requirements. The standards and *Lifetime Homes*, illustrate layouts compatible with the new requirements for disabled access in Building Regulations (Approved Document M)^[18].

Typical dwelling sizes to comply with the NHF layouts are in the range of:

1 bedroom 2 person	45-50 m ²
2 bedroom 3 person	65-70 m ²
2 bedroom 4 person	75-80 m ²
3 bedroom 5 person	85-90 m ²

Typical room sizes are summarised in Table 3.1 for various occupancy levels.

Table 3.1 *Typical space requirements*

	Space requirements (m ² floor area) for number of people per dwelling				
	1	2	3	4	5
Living Room	11	12	13	14	15
Living/Dining	13	13	15	16	17.5
Kitchen	5.5	5.5	5.5	7	7
Kitchen/Dining	8	9	11	11	12
Main Bedroom	8	11	11	11	11
Twin Bedroom	–	–	10	10	10
Single Bedroom	–	–	6.5	6.5	6.5

Acoustic insulation between dwellings is important and should meet the new Building Regulations (Approved Document E)^[19] - see Section 3.4. Similarly, energy usage is critical to the longer term efficiency of the building operation, and often RSLs demand up to 50% reduction in energy use in comparison to normal building standards (as defined in the Building Regulations (Approved Document L))^[20].

The design of residential developments for a secure environment is addressed in a police initiative called *Secured by design*^[21]. This is a scheme which is operated and managed by the Association of Police Officers (ACPO) and is concerned with promoting standards of design for security in building design and of the development layout which conform to ACPO guidelines. In practice, it means that doors and windows need to meet minimum standards of security and the development needs to make good use of natural surveillance and defensible space.

3.1.2 Parking

The amount of car parking required for residential developments is normally set by the Local Authority. Historically, many Local Authorities have adopted generous standards, normally expressed as minimum provision for each unit, based either on the number of bedrooms (e.g. for 1 bedroom units, 1.5 spaces; for 2 bedroom units, 2 spaces; and for 3 & 4 bedroom, units 3 spaces etc.), or on the floor area. For any particular schemes, the relevant Local Authority should be consulted in order to establish the amount of car parking required. It may be found that the requirement is now less than was previously needed.

The issue of Planning Policy Guidance Note 3 in March 2003^[22] represented a major shift in the approach to residential parking standards. The Note asks Local Authorities to lower the amount of parking provision required, not to adopt minimum standards, and not to have standards that result in average off-street provision of more than 1.5 spaces per dwelling. It states, for example, that lower levels of parking are appropriate in town centres (where services are readily accessible), and in housing for groups where car ownership may be relatively low (e.g. dwellings for elderly persons, students and single people). This may, or may not, be reflected in the current requirements set out by individual Local Authorities.

The layout of car parking bays will in part be determined by access arrangements, whether through the front, rear, or side of properties, and the consequent turning radii and sight lines that have to be accommodated. Selection of one- or two-way circulation regimes also has a major influence of space provision. Commonly, car park bays will be located on two sides of a central circulation route. Where car park bays are perpendicular to the long walls, this route will normally be a minimum of 6100 mm wide, and bay sizes will be in the range 2400 - 2800 mm wide × 4800 - 5800 mm long (the larger dimensions representing relatively generous provision).

It is advantageous from the point of view of 'swing-in' paths for columns to be placed slightly back from the front of the bay. This is particularly important where bay sizes and circulation route widths are at the lowest ends of the acceptable size ranges.

A typical car park arrangement for a basement in a multi-storey residential building is shown in Figure 3.1.

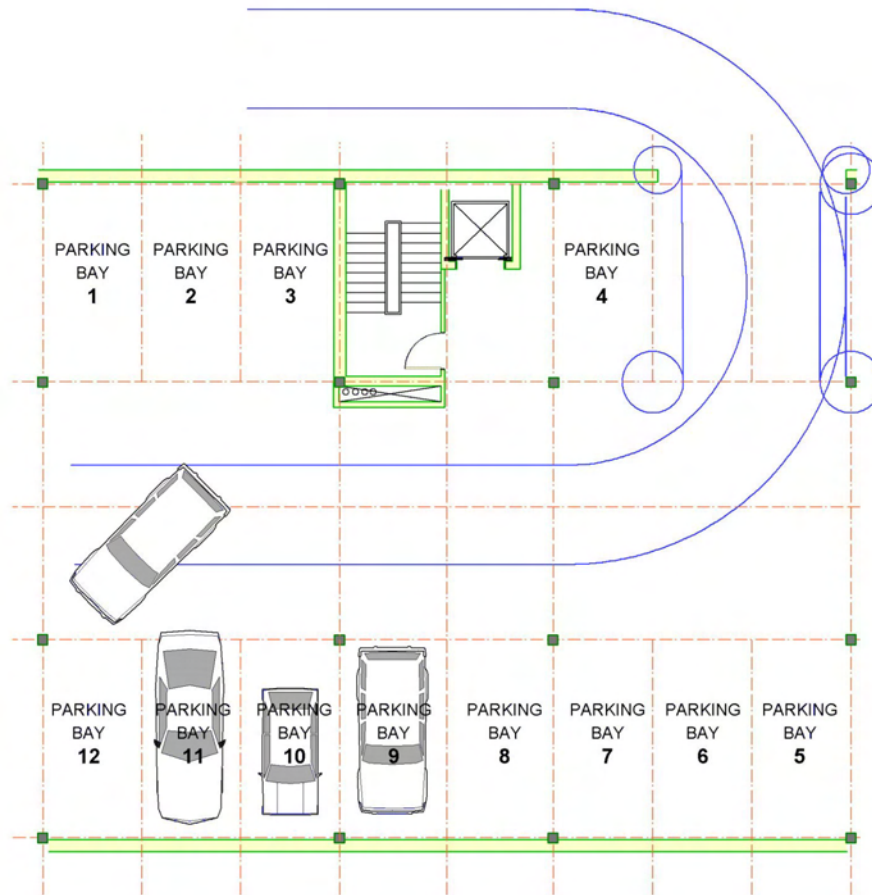

Figure 3.1 *Typical arrangement for a basement car park in a residential multi-storey building*

3.2 ODPM guidance

The Government's policies on different aspects of planning are set out in the Planning Policy Guidance Note 3: Housing^[22] (PPG 3) which encourages:

- Greater emphasis on re-use of derelict land and in urban locations to relieve pressure on the countryside.
- Local choice at the development plan level.
- Improvement in quality of design and performance.

This guidance has resulted in higher density in urban and post-industrial locations. Many social housing projects are now 6-7 storeys high in city centres, and can be part of mixed retail or commercial developments, which are ideally suited to buildings with steel-intensive construction.

3.3 Sustainable construction

Various major projects, such as the Greenwich Millennium Village in London, have adopted sustainability performance indicators which reflect savings in energy use, reduction in CO₂ production, and use of re-cycled or recyclable components. The BRE *Eco-Homes* document^[23] proposes sustainability criteria under the headings of:

- Energy Efficiency
- Minimising Transport
- Minimising Pollution
- Efficient Use of Materials and Resources
- Water Conservation
- Ecology and Land Use
- Health and Well-Being.

It is likely that larger future social housing projects will have to demonstrate a high level of sustainability through an Environmental Impact Assessment. *Eco-Homes* compliance is widely required in the social housing sector. All steel systems score highly in term of performance in service, and can be adapted, re-used and re-cycled (although recyclability is not fully recognised in BRE's Life Cycle Assessment methodology).

3.4 Building Regulations (England and Wales)

Guidance on meeting the Building Regulations in England and Wales is given in a series of Approved Documents. Recent changes to Approved Documents have introduced stricter requirement for thermal insulation and for acoustic insulation of separating floors and walls. Requirements for 'robustness' have been extended to all buildings.

3.4.1 Thermal Insulation

The thermal insulation requirements for residential buildings are given in Approved Document L1^[20]. The heat transmittance is characterised by the transmittance or U value of a unit area of the external envelope. The maximum permitted U values were reduced in the 2002 Edition, as presented in Table 3.2.

Table 3.2 *Maximum U values of elements of building envelope*

Element	U Value (W/m ² °C)	
	1995	2002
External Walls	0.45	0.35
Ground floors	0.45	0.25
Roofs	0.30	0.20

In all construction, it is necessary to ensure that 'cold bridging' does not cause disproportionate heat losses. This can occur if steel or other elements penetrate the building envelope, and in this case, more detailed calculations of local heat loss are required.

3.4.2 Acoustic insulation

The acoustic performance requirements for buildings for ‘residential purposes’ are given in Approved Document E^[19]. The minimum sound reduction levels now take into account a correction factor for low frequency sound C_{tr} to the basic airborne sound reduction and impact sound transmission values. It is not possible to directly compare the levels of sound reduction in the former 1995 version and the 2003 Edition, because C_{tr} is a negative value. The net effect is an apparent reduction in the sound reduction index, but the overall sound reduction level is slightly more severe for lightweight systems. For steel construction, C_{tr} can be -5 to -7 dB.

The guidance in the 1995 and 2003 Approved Documents are compared in Table 3.3 in terms of minimum sound reduction index. In-situ tests on composite slabs, *Slimdek* and modular construction confirm their excellent acoustic performance, so much so that common forms of steel construction have been accepted as *Robust Details*^[11] (which do not require on-site testing). The two forms of construction relevant to the medium-rise residential sector are:

- Composite or *Slimdek* slab of 300 mm minimum depth between the top of the slab and the base of the ceiling. A raised battened floor (or equivalent ‘platform’ floor) is required to satisfy the impact sound criterion, unless another form of permanent resilient floor material is provided.
- Double layer separating wall of minimum 250 mm width, comprising two layers of plasterboard and an insulating layer located between the studs.

Table 3.3 *Minimum standards for acoustic insulation in the Building Regulations (Approved Document E)*

	Separating walls		Separating floors		
	$D_{nT,w}$	$D_{nT,w} + C_{tr}$	$D_{nT,w}$	$D_{nT,w} + C_{tr}$	$L'_{nT,w}$
Former Approved Document E (1995 Edition)					
Average	> 53 dB	n/a	> 52 dB	n/a	< 61 dB
Single value	> 49 dB	n/a	> 48 dB	n/a	< 65 dB
Approved Document E (2003 Edition)					
New-build dwellings (Any test result)		> 45 dB		> 45 dB	< 61 dB
Conversions (Any test result)		> 43 dB		> 43 dB	< 61 dB
Rooms for residential purposes (Any test result)		> 43 dB		> 45 dB	< 61 dB

$D_{nT,w}$ is the airborne sound reduction

$L'_{nT,w}$ is the impact sound transmittance

C_{tr} is a correction factor for low frequency sound (negative value).

Further guidance on detailing for good acoustic performance in steel-framed multi-storey residential buildings can be found in SCI publications P320^[6], P321^[7], P322^[8] and P336^[10].

Fire safety and fire resistance

Fire safety and fire resistance are covered in (Approved Document B^[24]).

Fire safety

Fire safety is achieved by measures to prevent fire spread, to allow the occupants to escape and to ensure effective fire fighting. There is no regulatory requirement for sprinklers in residential buildings, except in hotels and 'mixed use' buildings.

Fire safety precautions in residential buildings are important because of their density of occupation, the potentially high combustible contents and their cellular nature, which makes the means of escape and effective compartmentation crucial to safety in fire. BS 5588-1: *Fire precautions in the design, construction and use of buildings. Code of practice for residential buildings*^[25] presents general requirements for single family houses and apartments.

Effective means of escape is achieved by one of the two main approaches in residential buildings with a corridor and fire protected lobby:

- By limiting the travel distance from the exit door of an apartment to a smoke-free area.
- By provision of alternative means of escape to a smoke-free area, including an external common balcony.

In addition, the combustible contents of the corridor should be kept to a minimum. Cross-corridor self-closing fire doors should be provided in long corridors. Other effective measures that may be considered are pressurisation of escape routes (to prevent smoke access) and use of sprinklers (to reduce fire spread).

Key to the design of residential buildings is the requirement for a maximum travel distance of 7.5 m from the exit of the dwelling to the entrance to a fire protected stairway or lobby. If this is not satisfied, separate fire protected doors are required in the corridor. Maximum travel distances are presented in Figure 3.2 for two typical floor layouts. Some relaxations are permitted for 'small buildings' less than 11 m high.

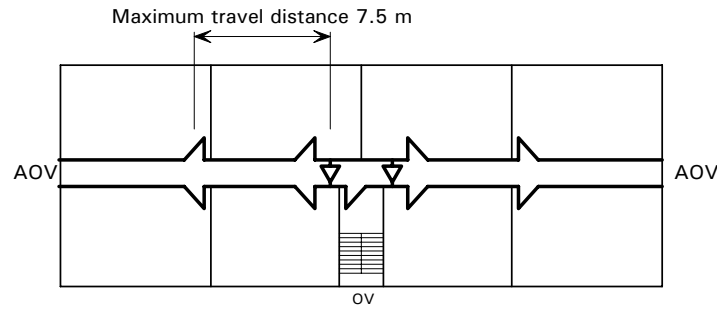

(a) Maximum travel distances for corridor access to lobby

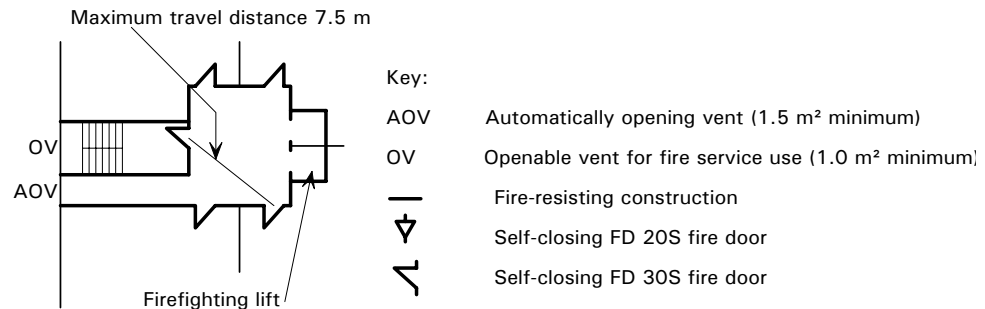

(b) Maximum travel distances for common access to lobby

NOTE 1. Where all dwellings on a storey have independent alternative means of escape the maximum distance may be increased to 30 m.

NOTE 2. Where a firefighting lift is required, it should be sited not more than 7.5 m from the door to the stair.

NOTE 3. The OV's to the stairway may be replaced by an openable vent over the stair.

Figure 3.2 Minimum escape distances in apartments with different floor layouts

Fire resistance

Fire resistance is required to ensure that the building remains stable and prevents spread of fire by effective compartmentation. The requirements for fire resistance of residential buildings are dependant primarily on the building height (defined as to the top of the highest floor), as set out in Table 3.4. Basements generally require 60 minutes fire resistance, but the ground floor over a basement requires the same resistance as the floors above, if that is greater than 60 minutes.

Table 3.4 Fire resistance requirements in Approved Document B

Parameter	Fire Resistance (mins)			
	R30	R60	R90	R120
Max height (m)*	≤ 5 m	< 18 m	< 30 m	≥ 30 m
Max no. of storeys**	2	7	11	> 11

* Defined to top of highest floor

** Typical depending on floor zone

These requirements apply to the load bearing elements of the structure, and generally also apply to compartment walls (which may be non-load bearing).

Typical fire loads in residential buildings are up to 50% higher than in offices and therefore fire engineering techniques are rarely used in the residential sector except in ‘mixed use buildings’.

3.5 Structural Aspects

A brief review of the design loading for residential buildings is given below. Robustness and bracing are important issues that need to be considered at the concept stage, and are also discussed.

3.5.1 Loading

There are three principal types of loading that need to be considered in the design of multi-storey residential buildings:

- Dead loading
- Imposed loading
- Wind loading.

Dead loading is permanent loading and consists of the self-weight of the structure. This includes the weight of the structural frame, the floor system, the services, the ceiling and the finishes.

Imposed loading is the non-permanent or variable loading that is likely to be applied to the structure during its life (other than wind load). Imposed loads include gravity loads due to occupants, furniture, snow, and horizontal loads on parapets, barriers and balustrades. BS 6399-1:1996^[26] gives minimum imposed design loads for floors in buildings, and BS 6399-3:1988^[27] gives values for roofs. Uniformly distributed imposed loads for floors in residential buildings vary from 1.5 to 3 kN/m², according to the use of the room. Minimum imposed roof loads depend on whether the roof provides access (other than for maintenance), but have a minimum value of 0.6 kN/m².

Wind loading is determined in accordance with BS 6399-2:1997^[28], and is dependent on the location and size of the building. BS 6399-2 generally leads to higher local wind pressures on cladding than its predecessor, CP3 Ch V Part 2.

3.5.2 Robustness

Structural codes include requirements for general robustness (or ‘structural integrity’) to ensure that frames have a minimum level of resistance, and secondly to limit the extent of any collapse following an unexpected extreme event, such as an explosion. The requirements were introduced following the progressive partial collapse of a block of flats at Ronan Point, Newham, in 1968. Following a gas explosion in a lower flat, several floors above collapsed in a progressive manner, as each floor was unable to support the structure above, once its own support had been lost – see Figure 3.3.



Figure 3.3 *Partial collapse of a precast concrete structure dueto a gas explosion (Ronan Point)*

Robustness rules generally require the columns to be tied into the rest of the structure, so that the floor systems can develop catenary action following a partial collapse. Rules covering structural integrity are provided in BS 5950-1:2000^[29] Clause 2.4.5. This Standard only specifies *how* buildings should be designed to avoid disproportionate collapse, and not *when* the provisions should be applied. Until recently, the guidance in the Document A was that buildings above five storeys must be designed to avoid disproportionate collapse. In the latest Edition, issued in July 2004^[31], the cut-off below five storeys is removed, and robustness rules are applied depending on the category of structure, regardless of building height. Detailed guidance on the application of the design rules to prevent disproportionate collapse of steel framed buildings is given in the SCI publication *Design of multi-storey braced frames*^[30].

3.5.3 Bracing

Both vertical and horizontal systems of bracing must be considered in multi-storey buildings. Vertical bracing resists the lateral loads and provides overall stability to the structure. Loads must be carried to the vertical bracing by ensuring that the floors and roof act as a horizontal diaphragm. Usually, the floor system will be sufficient to act as a diaphragm without the need for additional horizontal steel bracing.

Provision for vertical bracing needs to be considered at the conceptual stage, particularly to avoid potential conflict with the fenestration. Bracing is often located in the service cores to overcome this, but bracing in other areas is likely

to be necessary for the stability of the structure. Cross-flats provide a neat solution for residential buildings because they can be contained in the walls, and tubular struts may be used as an architectural feature in open areas.

It is possible to design the perimeter columns and edge beams on an external elevation as a continuous 'wind moment frame', by stiffening up the end connections and ensuring that the stiff axis of the column lies in the plane of the frame. This allows an uninterrupted space between the floors for balconies and complete freedom for the window layout. It may be possible to design internal wind moment frames where the columns align in the same vertical plane. However, column section sizes are likely to be larger than in a braced frame, so this is not recommended for buildings above four storeys, and is best used only in the longer direction of a rectangular building.

All floor solutions involving permanent formwork, such as the *Slimdek* system, provide an excellent rigid diaphragm to carry horizontal loads to the bracing system. Floor systems involving precast concrete planks require proper consideration to ensure adequate load transfers, and a more positive tying system will be required between the slabs and from the slabs to the steelwork.

4 STEEL TECHNOLOGIES FOR THE RESIDENTIAL SECTOR

A range of steel technologies can be used in the residential sector, of which the following are major forms:

- Composite construction
- *Slimdek*
- *Slimflor* (beams with precast slabs)
- Light steel framing
- Modular construction
- Light steel separating walls

A brief description of the features and benefits of these is given in this section. Case examples of each form of construction are presented, which show their application in the urban sector.

4.1 Composite construction

Composite construction generally refers to a form of construction with composite downstand beams supporting a composite slab spanning between the beams, as shown in Figure 4.1. The slab is formed by using shallow ribbed steel decking and a concrete topping. Shear connectors are welded to the top of the beams and are encased within the slab to provide the composite action. This action greatly increases the stiffness of the floor. Conventional UC or SHS columns may be used, but the choice of steel sections that can fit within the separating walls is recommended.

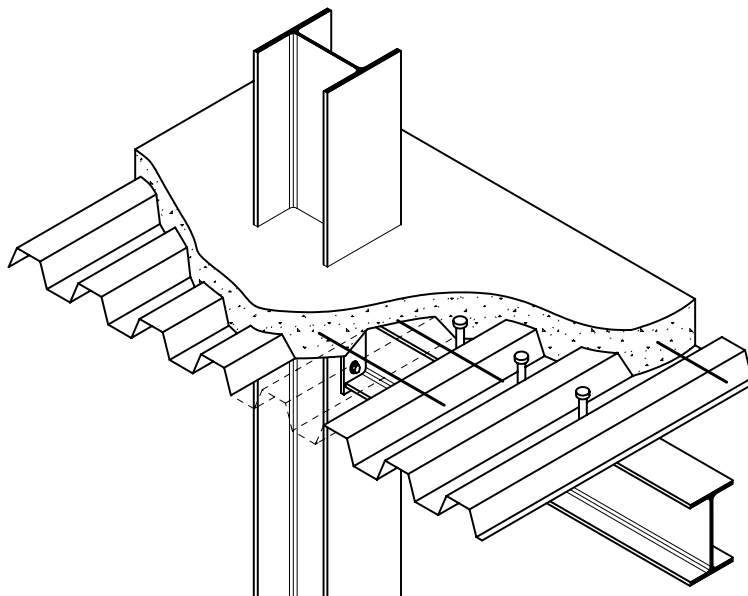

Figure 4.1 *Composite construction using steel decking*

Composite construction is more associated with multi-storey commercial buildings, but it is equally relevant to the residential sector. It has the following features:

- Downstand beams are located at the line of separating walls, or shallow sections are used to minimize the floor depth.
- Shallow slab (130 to 150 mm).
- Spans of 5 to 15 m (beams) and 2.5 to 4 m (slab).
- Total floor depth is typically 350 to 500 mm.
- Self weight of 3 to 4 kN/m².
- No limit on building height or width.
- Fire resistance of 30 minutes with a conventional suspended ceiling, or up to 120 minutes with spray, board or intumescent coating.
- Acoustic insulation is provided by a battened floor (or similar).

Composite construction has the following benefits for multi-storey residential buildings:

- Narrow beams can be located within separating walls – there are no projections outside the walls.
- UC sections used as beams lead to minimum floor zone.
- Slabs can span directly between separating walls.
- Long span construction – useful for ‘mixed’ residential and retail projects.
- Lower self weight than reinforced concrete flat slab.
- Stability can be provided through the stiffness of the frame (up to 4 storeys) or by bracing or by connection to a reinforced concrete core (taller buildings).
- Intumescent fire resistant coatings can be applied off-site.
- Excellent acoustic insulation.

The form of construction recommended for walls and floors is summarised below.

Walls	Floors
<ul style="list-style-type: none"> • Skeletal structure comprised of SHS or smaller UC columns to fit in separating walls. • Separating walls created using ‘double’ walls of light steel sections. • Infill walls using cold formed light steel sections supporting light weight cladding. • Brickwork supported on perimeter beams. 	<ul style="list-style-type: none"> • Narrow UB sections to fit within width of separating walls, or • UC sections of 200 to 300 mm depth to provide the minimum floor zone with ceiling below. • Shallow profiled steel decking of 46 to 80 mm depth to create a composite slab of 130 to 150 mm depth. • Single layer of plasterboard ceiling. • Battened floor for acoustic insulation.

Long span composite construction (for spans over 9 m) offers the benefit of column-free space for 'mixed use' buildings. A typical example is illustrated in Figure 4.2.

Composite construction may also be used with precast concrete slabs, as illustrated in Figure 4.3. In this case, the beams should be wide enough to provide adequate bearing for the precast units. Additional reinforcement is required in filled hollow-core units. Design guidance on this form of construction is given in SCI publication, *Design of composite beams using precast concrete slabs* (P287)^[3].



Figure 4.2 Long-span composite beams used in a multi-storey building





Figure 4.3 Composite beams supporting precast hollow-core units

Examples of buildings using composite construction are presented below:

Examples – Composite Construction

Sophia Gardens, Cardiff	
<p>Two 6-storey apartment buildings at Penarth adjacent to the rejuvenated Cardiff Docks were built using composite construction. Light steel infill walls were located below downstand beams. The façade was generally in form of a rendered insulation supported by the light steel infill walls at each floor level.</p> 	<p>Project Data Client: Taywood Homes/ Ty Gwalia Housing Association Architect: Broadway Malayan Contractor: Taywood Construction</p> <p>Application Benefits</p> <ul style="list-style-type: none"> • Speed of construction • Savings in foundation costs • Re-locatable internal light steel walls • Rendered cladding is lightweight

Deansgate, Manchester	
<p>A 16-storey ‘mixed’ residential and commercial building was constructed in the heart of Manchester to provide high quality apartments and street and podium level shopping. This was achieved using inclined tubular columns which supported the 14 upper floors. Floors were 4.5 m span, and aligned with the beams of separating walls. The façade consisted of ‘double skin’ glazing which met strict acoustic and thermal insulation requirements. The structure was also designed for tight deflection limits for the glazed façade and to avoid perceptible movements for this height of building.</p> 	<p>Project Data Client: Crosby Homes Architect: Ian Simpson Architects Contractor: MACE</p> <p>Application Benefits</p> <ul style="list-style-type: none"> • Residential building supported on inclined columns at podium level. • Double skin glazed façade. • Excellent acoustic insulation (based on tests.) • Speed of construction.

Ocean Village, Southampton	
<p>Eight 5 to 9 storey apartment buildings in the former dock area of Southampton.</p> <p>Built using composite construction comprising shallow UC sections in spans of 6 to 9 m. Ceilings fitted below the structure to avoid downstand beams.</p> <p>Light steel separating walls were installed. On-site tests confirmed excellent acoustic performance.</p> <p>Steel balconies were attached to the edge beams.</p> <p>A range of cladding materials varied from full-height glazing to brickwork, render and cedar wood. Retail outlets accommodated on the ground floor.</p>	<p>Project Data</p> <p>Client: Wilson Bowden City Homes</p> <p>Architect: Broadway Malyan</p> <p>Application Benefits</p> <ul style="list-style-type: none"> • Freedom in internal fit-out • Accommodates a variety of cladding materials • Balconies attached to edge beams • Speed of construction
	

Student Residence, Leeds	
<p>A 5 storey student residence in central Leeds built using composite construction with floor spans of 5 to 8 m. Ceilings fitted below downstand beams to allow for freedom in lay-out of study bedrooms.</p> <p>Cladding in brickwork to match existing buildings in the locality. Brickwork supported on stainless steel angles attached to edge beams.</p>	<p>Project Data</p> <p>Client: Unite Integrated Solutions</p> <p>Architect: Unite</p> <p>Contractor: Kier</p> <p>Application Benefits</p> <ul style="list-style-type: none"> • Speed to meet start of academic year • Brickwork supported by edge beams • Shallow floor beams • Good acoustic insulation
	

4.2 Slimdek

Slimdek is a floor system which comprises asymmetric *Slimflor* beams (ASBs), deep profiled metal decking and a concrete topping. The ASB supports the decking off its bottom flange and is encased by the concrete topping. This creates a floor of minimum depth, as shown in Figure 4.4. Rectangular Hollow Sections (RHS) may be used as edge beams and columns.

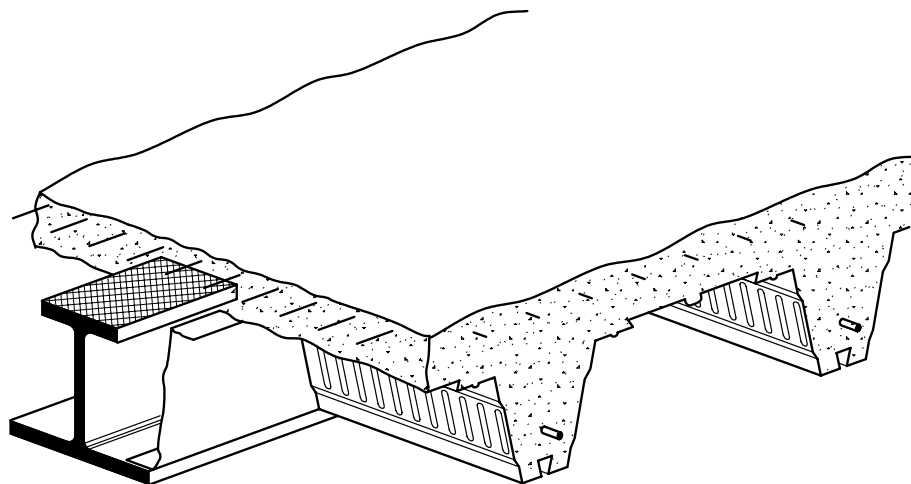

Figure 4.4 *Slimdek construction*

Slimdek offers considerable flexibility in layout and has the following features:

- Shallow floor (300 to 400 mm deep)
- Spans of 5 to 9 m
- Self weight of 3.5 to 4.5 kN/m²
- No limits on building height or width
- Fire resistance of 60 mins (unprotected) or up to 120 mins (protected)
- Acoustic insulation can be provided by various resilient floor layers.

It has the following benefits for the medium-rise residential sector:

- No downstand beams – no special detailing at beams
- Minimum floor zone
- Lower self weight (40% less than with a reinforced concrete flat slab)
- Excellent diaphragm action against wind loads
- Reduced fire protection costs – plasterboard ceiling is sufficient
- Excellent acoustic insulation
- Beams can support brickwork or full-height glazing.

The form of construction recommended for walls and floors is summarised below.

Walls	Floors
<ul style="list-style-type: none"> • Skeletal structure composed of SHS or smaller UC columns to fit in separating walls. • Separating walls created using 'double' walls of light steel sections. • Infill walls using light steel sections supporting light weight cladding (e.g. insulated render). • Brickwork supported on perimeter beams (often RHS). 	<ul style="list-style-type: none"> • ASB beams of 280 or 300 mm depth contained within floor zone. • Deep decking of 225 mm depth acting with in-situ concrete as a composite slab. • RHS or UB perimeter beams. • Single layer of plasterboard ceiling. • Battened floor for acoustic insulation, or • Screed on isolating layer may be acceptable.

The form of construction is illustrated in Figure 4.5. At edge beams, Rectangular Hollow Sections provide a neat edge to the slab and facilitate cladding and balcony attachments (see Sections 5 and 6). Small Square Hollow Section columns are often used to fit into supporting walls.

The use of *Slimdek* in residential construction is described in more detail in a forthcoming Corus publication^[32]. The design of ASBs is described in SCI publication P175^[2], and guidance on the design of RHS edge beams is provided in P169^[33]. Further information on *Slimdek* can be found in the Corus *Slimdek Manual*^[34].

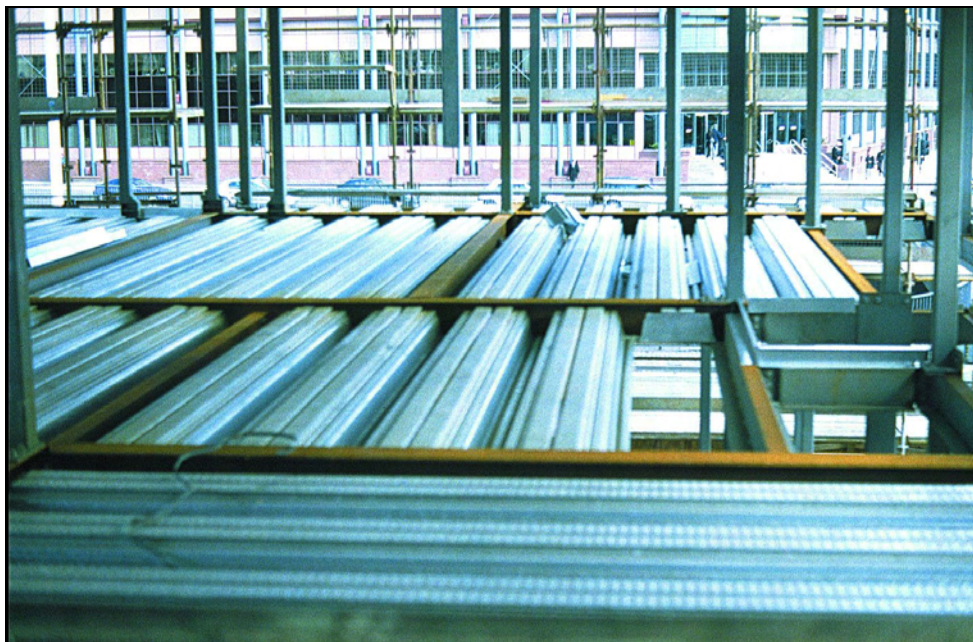





Figure 4.5 *Slimdek and SHS columns used in a residential building*

Examples of buildings using *Slimdek* construction are presented below:

Examples – Slimdek

Berkeley Street, Glasgow	
<p>An 8-storey residential building in the centre of Glasgow using 280 ASB beams spanning 9 m. RHS beams were used at the building perimeter. Small SHS columns fit within the separating walls. The client wished to avoid use of downstand beams in order to lay out the apartments for optimum space use. A raised battened floor achieved excellent acoustic insulation in on-site tests.</p>	<p>Project Data Client: Westpoint Homes Architect: Maxwell Design Consultants Contractor: Beechwood Developments Ltd</p> <p>Application Benefits</p> <ul style="list-style-type: none"> • Shallow floor construction. • SHS columns contained in walls. • Full height windows permitted by RHS edge beams. • Structurally efficient use of continuous beams over single storey columns. • Excellent acoustic insulation (confirmed by tests). • Speed of construction.
	

Apartments, Covent Garden, London	
<p>The 6-storey extension of London’s Strand Palace Hotel created a series of apartments in both new-build and renovation. <i>Slimdek</i> was chosen because of the strict floor zones to meet the planning requirement and to fit within the façade of the existing building. The complex apartment layout did not permit use of downstand beams. On-site acoustic tests confirmed the excellent acoustic performance of <i>Slimdek</i> with a battened floor.</p>	<p>Project Data Client: Artesian plc Architect: Goddard Manton Contractor: Miletrian</p> <p>Application Benefits</p> <ul style="list-style-type: none"> • Shallow floor to match the existing retained façade. • Excellent acoustic insulation (confirmed by tests). • Speed of construction.
	

Portishead Marina	
<p>This 6-storey apartment building, adjacent to the Marina complex in Portishead, was built to reflect the heavyweight masonry construction of a dock-side warehouse, but with a structure provided by <i>Slimdek</i>.</p> <p>A value engineering exercise by the client demonstrated that <i>Slimdek</i> offered better value in comparison to reinforced concrete or masonry construction when the benefits of reduced piling costs were taken into account. Another <i>Slimdek</i> building is underway on the same site.</p>	<p>Project Data</p> <p>Client: Crest Nicholson Homes</p> <p>Architect: Austin Smith Lord</p> <p>Application Benefits</p> <ul style="list-style-type: none"> • Columns aligned with below ground car park. • Large windows at lower levels (permitted by widely spaced columns). • Light weight relative to r.c. construction (reduced piling costs).
	

Student Residence, Southampton	
<p>This project for Unite consists of three distinct parts, from 5 to 16 storeys, and provides 562 study bedrooms and communal facilities.</p> <p>The shallow floor construction gained one extra storey in 16. Bathroom pods were installed on each floor and slid into place. <i>Slimdek</i> allowed for complete freedom in internal partitioning by light steel walls.</p>	<p>Project Data</p> <p>Client: Unite Integrated Solutions</p> <p>Architect: Rowbottom Architecture</p> <p>Contractor: Warings</p> <p>Structural Engineer: Gyoury Self</p> <p>Application Benefits</p> <ul style="list-style-type: none"> • Speed of construction to meet academic year start. • Variety of façade treatments achieved. • Pre-fabricated bathroom pods. • Shallow floor permits freedom in room layout.
	

4.3 *Slimflor* beams with precast concrete slabs

Slimflor beams are UC sections with a flange plate welded to the underside. The precast concrete units are supported by this flange plate, and the space around the beam at the end of the unit is filled with concrete to encase the beam. This creates a minimum structural floor zone. Reinforcement is placed across the *Slimflor* beam into discrete opened-out voids in the pc units for robustness purposes, and it can also be part of the fire requirements – see Figure 4.6. When the beams are encased as described and the side joints between the units are properly grouted and reinforced, the floor can act as an effective diaphragm to distribute wind loading to the bracing or cores. An in-situ concrete topping may be required for acoustic purposes.

ASB beams may also be used with precast slabs, provided that the ends of the precast units are chamfered or notched (where necessary) to allow them to be placed below the top flange of the ASB.

This form of construction has advantages over other systems because both the components of the steel frame and the precast units come from a manufacturing technology rather than a site based activity. Better quality control, accuracy and reliability can be achieved from this factory production. The system also provides a flat soffit between beams, and the pc units are manufactured with a pre-camber to reduce self-weight deflections, which are not possible with other systems.

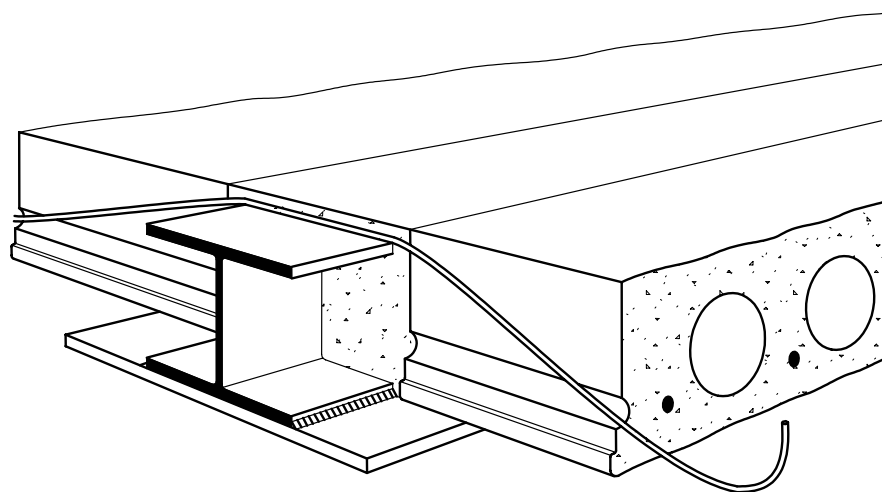

Figure 4.6 *Slimflor* construction using precast concrete slabs

Slimflor construction has the following features:

- Shallow floor (300 to 400 mm deep)
- Spans of 5 to 9 m (depending on the slab detail)
- Self weight of 5 to 6 kN/m² with in-situ topping
- Special detailing required to achieve ‘robustness’ for tall buildings (> 5 storeys)
- Fire resistance of 30-60 minutes (unprotected) or 90 minutes (protected)
- Acoustic insulation can be provided through battened floor and screed
- Flat soffit between beams.

Slimflor construction has the following benefits in the medium-rise residential sector:

- No downstand beams, except as an option at the perimeter
- No special detailing of beams
- Minimum floor zone internally
- Lower self weight (10-20% less) than reinforced concrete flat slab
- Floor can act as ‘diaphragm’ to distribute wind loads
- Reduced fire protection costs of the steelwork, if a concrete topping is used
- Good acoustic insulation can be achieved.

The form of construction recommended for walls and floors is summarised below.

Walls	Floors
<ul style="list-style-type: none"> • Skeletal structure, composed of SHS or smaller UC columns, to fit in separating walls. • Separating walls created using ‘double’ walls of light steel sections, (or blockwork). • Infill walls using light steel sections supporting lightweight cladding. • Brickwork supported on perimeter downstand beams. 	<ul style="list-style-type: none"> • UC or RHS sections with welded bottom plate, or ASB beams contained within floor zone. • Hollow-core precast concrete slabs typically of 150 to 260 mm depth. • RHS or UB perimeter beams. • Tying reinforcement required in hollow-cores, or in-situ concrete topping preferred. • Soffit can be directly painted but single layer plasterboard is preferred. • Battened floor for acoustic insulation.

Further guidance on the design of *Slimflor* beams is given in SCI publication P110^[1]. An example of the use of *Slimflor* beams is illustrated in Figure 4.7 and the installation process of the precast units is shown in Figure 4.8.



Figure 4.7 *Slimflor beams supporting precast concrete slabs*



Figure 4.8 *Installation of tying reinforcement in precast hollow core units*

4.4 Mixed use construction

A typical 'mixed' use building in an urban location may consist of many arrangements and floor configurations, depending on their use, as illustrated in Figure 4.9. A range of steel technologies may be employed, depending on the building scale and space provision that is required.

Composite steel frames and *Slimdek* are increasingly used in inner-city mixed residential and commercial projects, where typically there may be 2 or 3 floors of commercial or retail use with a multi-storey residential block above. An important design issue is the difference between the column grids that may be appropriate for commercial, retail, car parking and residential areas. Often, a concrete ground floor structure with a massive concrete transfer beam is used to support the closely spaced columns of the upper residential floors. Steel is rapidly increasing its range of application in the urban residential sector, particularly when supported on a transfer structure. For example, in the Manchester Deansgate project (see Figure 1.3), 5 floors of a concrete sub-structure supported a 14 storey composite steel frame. The steel structure was supported by a series of inclined tubular columns.

There are now a number of steel options that are appropriate for both long-span commercial and shorter-span residential buildings and in 'mixed' developments. Fabricated steel cellular beams give an opportunity to design both a transfer structure and long span beams with large service openings. Off-site intumescent coatings may be used to achieve up to 2 hours fire resistance.

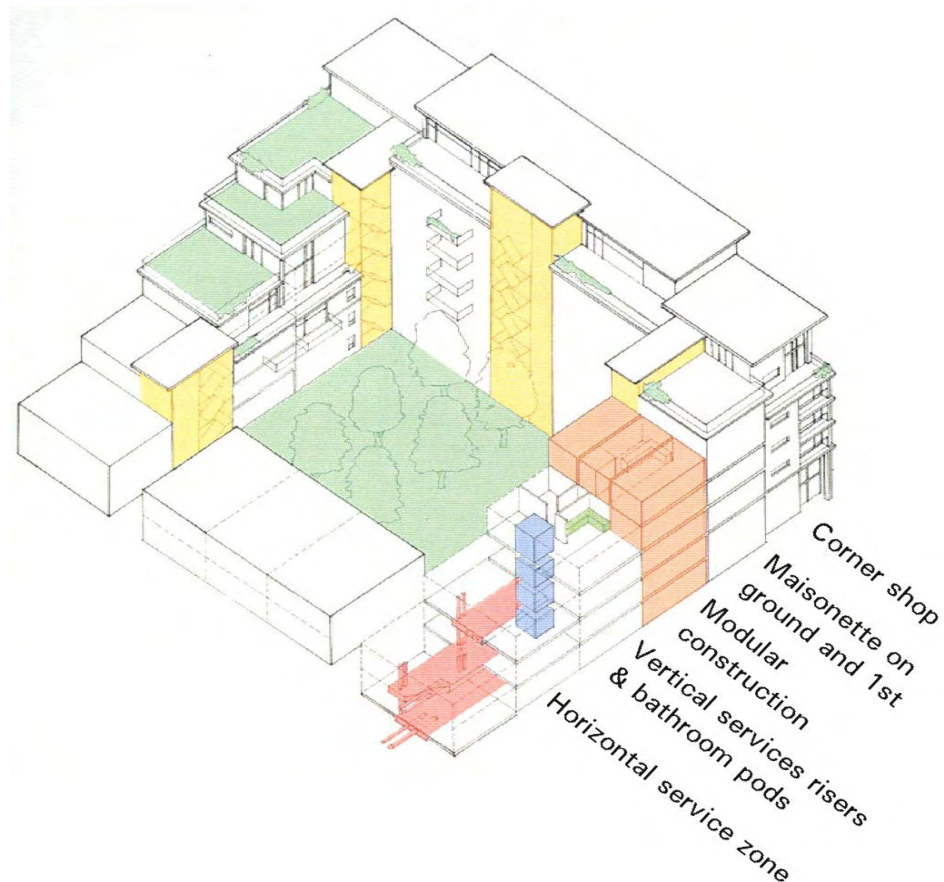

Figure 4.9 *Mixed use apartment building in an urban location*
(Courtesy of HTA Architects)

4.5 Light steel framing

Light steel framing is used for single family housing, terraced housing and smaller apartment buildings. It is also used in separating walls and infill walls in multi-storey steel or concrete framed buildings (see Section 4.7). It comprises light gauge cold-formed C or Z shaped galvanized steel sections in the walls and floors. Back-to-back sections or trusses can be used for additional strength. On-site connections between the light steel elements are made by self-drilling, self-tapping screws or bolts. Typical light steel framing construction is shown in Figure 4.10.

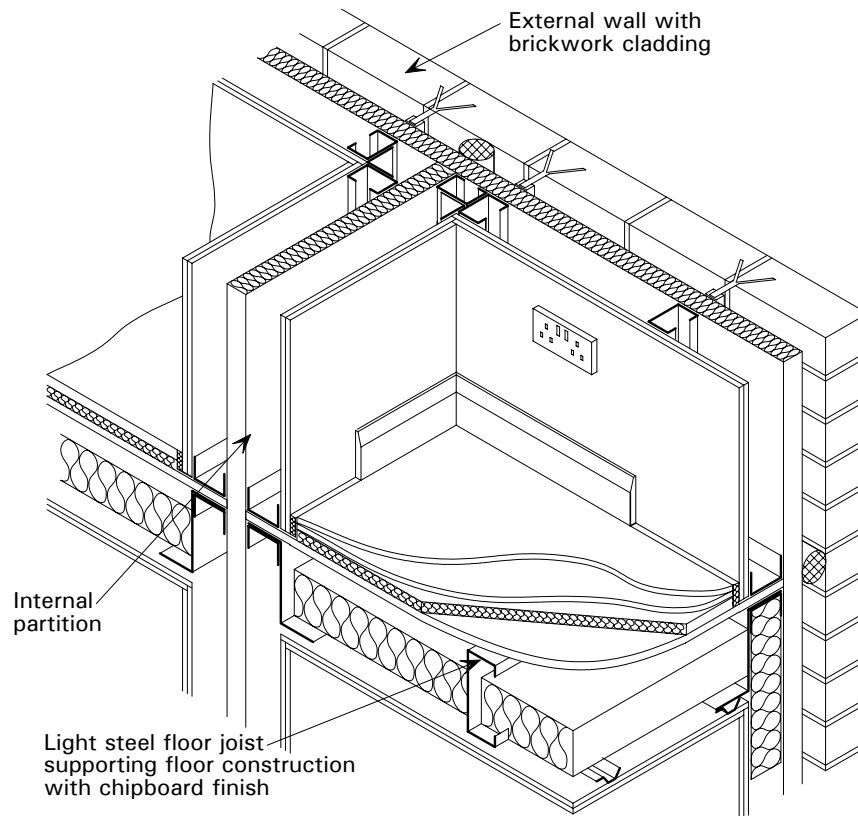

Figure 4.10 *Typical light steel framing construction*

Light steel framing has the following features:

- Floor depth of 250 to 300 mm using light steel joists, or 350 to 500 mm using lattice joists
- Spans of 3 to 6 m between load-bearing walls
- Self weight of 0.6 to 1.0 kN/m²
- Suitable for 2 to 6 storeys (4 is usually the optimum)
- Fire resistance of 30 or 60 minutes provided by plasterboard
- Acoustic insulation is provided through multiple layers of facing boards
- External walls are braced for stability.

It has the following benefits in application as a primary structure:

- No separate structure is required. Walls are load-bearing and support floors directly

- Wall panels and floor cassettes may be pre-fabricated
- Lattice joists achieve longer spans and allow for services in the floor zone
- Low self weight reduces loads
- Multiple inter-connections achieve ‘robustness’
- Fire resisting plasterboard provides fire resistance and acoustic insulation
- Useful for roofs and roof-top extensions, because of its light weight.

The form of construction for walls and floors is summarised below.

Walls	Floors
<ul style="list-style-type: none"> • Load-bearing walls comprise C sections of 75 to 150 mm depth, which are pre-fabricated into panels. • Walls support floor joists by Z sections or cleats. • Wall height of 2.4 to 3.6 m (typically). • Walls provide for building stability through internal bracing or ‘cross-flats’. • Diaphragm action can be provided by cement particle board etc. • External walls can support lightweight cladding. • Brickwork is generally ground supported. 	<ul style="list-style-type: none"> • Floor joists comprise C sections of 150 to 250 mm depth, or • Long span lattice joists of 250 to 400 mm depth. • Floor boarding of 19 mm thickness with ‘battened’ floor or mineral wool layer for acoustic insulation. • Double layer of plasterboard ceiling for acoustic insulation and fire resistance.

Further guidance on the design of light steel framing is available in SCI publications P301^[4] and P322^[8]. A typical use of light steel framing is in a single family house, and an example is shown in Figure 4.11. A light steel house during testing is illustrated in Figure 4.12.





Figure 4.11 *Light steel infill walls in a major housing development in Basingstoke*



Figure 4.12 *Light steel framing with open roof system under test*

Case examples of buildings using light steel framing are shown below.

Architects House, Oxford	
<p>A 3-storey town house built to the owner's specification which was constructed using light steel pre-fabricated wall panels and long span floors. A barrel-vaulted roof was also created in steel, which gave large open plan space and a panoramic river-side view. Significant savings in piling costs were achieved relative to traditional building.</p>	<p>Project Data Client: Adrian James Architect: Adrian James Framing: Metsec Framing</p>
	<p>Application Benefits</p> <ul style="list-style-type: none"> • Open plan space. • Interesting and sympathetic appearance essential for planning approval. • Lightweight for river-side foundations. • Speed of installation.

Apartments, Fulham, London	
<p>A 4-storey apartment building next to the Thames, which used long spanning floor joists to create open plan space with under-floor heating. Stability was provided by framing action and by diaphragm action of the floors. A lightweight insulated render cladding system was used to create an 'art deco' feel.</p>	<p>Project Data Client: Thursden Homes Contractor: Thursden Homes Framing: Framing Solutions</p>
	<p>Application Benefits</p> <ul style="list-style-type: none"> • Open plan space with riverside views. • Light weight for poor ground. • Highly glazed façade for river-side view. • Speed of construction.

4.6 Modular construction

'Modular construction' is a term used to describe the use of factory-produced pre-engineered building units that are delivered to site and assembled as large volumetric components or as substantial elements of a building. The modular units may form complete rooms, parts of rooms, or separate highly serviced units such as toilets or lifts. The collection of discrete modular units usually forms a self-supporting structure in its own right, or, for tall buildings, may rely on an independent structural framework.

Modular construction is most associated with cellular-type buildings for single occupancy, such as student residences or key-worker accommodation. It has the following features:

- Suitable for cellular buildings with multiple repeated units
- Size of units limited by transport (3.6 m × 8 m is typical)
- Open-sided units can be created (by changing the floor orientation)
- Modules are stacked with usually no independent structure
- Self weight of 1.5 to 2 kN/m²
- 4-8 storeys (6 is usually the optimum)
- Fire resistance of 30 to 60 minutes provided by plasterboard.
- Acoustic insulation is provided through double layer walls and floors

Modular construction has the following benefits for application in the medium-rise residential sector:

- Economy of scale in production for hotels, key worker accommodation, student residences
- Rapid installation on site (6-8 units per day)
- Two units can be placed together to create larger spaces
- Robustness can be achieved by attaching the units together at their corners
- Low self weight
- Stability of tall buildings can be provided by a braced steel core
- Fire stopping between the units prevents fire spread
- Excellent acoustic insulation
- Useful for roof-top extensions or difficult working areas.

The form of construction for walls and floors in modular construction is summarised below.

Walls	Floors
<ul style="list-style-type: none"> • Walls of modules comprise C sections of 75 to 150 mm depth. • Longitudinal walls are usually load-bearing and the end walls provide for stability. • Open-sided modules can be created by longitudinal floor and ceiling joists – end walls become load bearing. • Stability provided by cross-flats or diaphragm action of boarding. • Double skin walls provide excellent acoustic insulation. 	<ul style="list-style-type: none"> • Floors of modules comprise C sections of 150 to 250 mm depth. • Ceiling is manufactured as a wall panel. • Open-sided modules use deeper floor joists or lattice joists of 250 to 400 mm depth. • Corridor zone can be used to provide in-plane bracing in long buildings. • Double skin floor and ceiling provides excellent acoustic insulation. Mineral wool may be required between the joists.

Further guidance on modular construction can be found in other SCI publications^[35,36,5]. An example of the installation of modular units is illustrated in Figure 4.13.



Figure 4.13 *Modular units used in multi-storey social housing project in London*

Case examples of buildings using modular construction are given below.

Case Examples – Modular Construction

Royal Northern College of Music, Manchester	
<p>A 9-storey modular building constructed using the <i>Ayrframe</i> system. The 1,000 bedroom units were fully fitted out and delivered to site also with their lightweight cladding attached. The larger communal areas were constructed using light steel framing, and the access cores in steelwork provided the overall stability of this ‘horse-shoe’ shaped building. The building was constructed in only 9 months from foundation level.</p>	<p>Project Data</p> <p>Client: RNCM, Manchester</p> <p>Architect: Design Buro (for modules)</p> <p>Contractor: Jarvis Construction</p> <p>Modules: Ayrshire Steel Framing</p>
	<p>Application Benefits</p> <ul style="list-style-type: none"> • Met the tight construction programme for the academic year • 9-storey stacked modules achieved an efficient structure for this height • Stability provided by steel access core and does not rely on the modules for this • Cladding pre-attached to modules, so avoiding the need for scaffolding

Murray Grove, Hackney, London	
<p>A 5-storey building for social housing in a busy area of London. The 80 bedroom-living room units were fully fitted out and delivered to site at a rate of 6-8 per day on average. Two modular units formed a single apartment.</p> <p>A steel-glass access core added to the architectural appeal of this L shaped building. Lightweight terracotta tiles and cedar wood boarding were attached on site. Access walkways and balconies were also pre-fabricated.</p>	<p>Project Data</p> <p>Client: Peabody Trust</p> <p>Architect: Cartwright Pickard</p> <p>Contractor: Kajima</p> <p>Modules: Yorcon</p>
	<p>Application Benefits</p> <ul style="list-style-type: none"> • Speed of installation (60% faster than traditional building). • Minimum deliveries to site, timed to meet local traffic conditions. • Pre-fabricated balconies and access walkways. • High quality fully fitted-out units.

[Discuss me ...](#)

Wilmslow Road, Manchester	
<p>A 10-storey 'mixed' residential and commercial development comprised 2 floors in composite construction and 8 floors above in modular construction. The lower floors provided space for retail outlets and parking. The columns aligned with every third module. The podium level supported the 8 floors above. The modules had to be sufficiently light to avoid over-loading the beams at this level.</p> <p>Light weight cladding was attached on-site to hide the joints between the modules. The whole project was completed in 15 months.</p>	<p>Project Data</p> <p>Client: OPAL</p> <p>Architect: Design Buro (modules)</p> <p>Contractor: Watkins Jones</p> <p>Modules: Rollalong and Ayrshire Steel Framing</p> <p>Application Benefits</p> <ul style="list-style-type: none"> • Light weight for support by podium structure. • Speed of installation on site.
	

4.7 Light steel infill and separating walls

Light steel walls are made using a frame of galvanized cold-formed light gauge steel sections to which layers of plasterboard are attached. Insulation is placed within the wall construction to provide good acoustic performance. A typical light steel separating wall is shown in Figure 4.14.

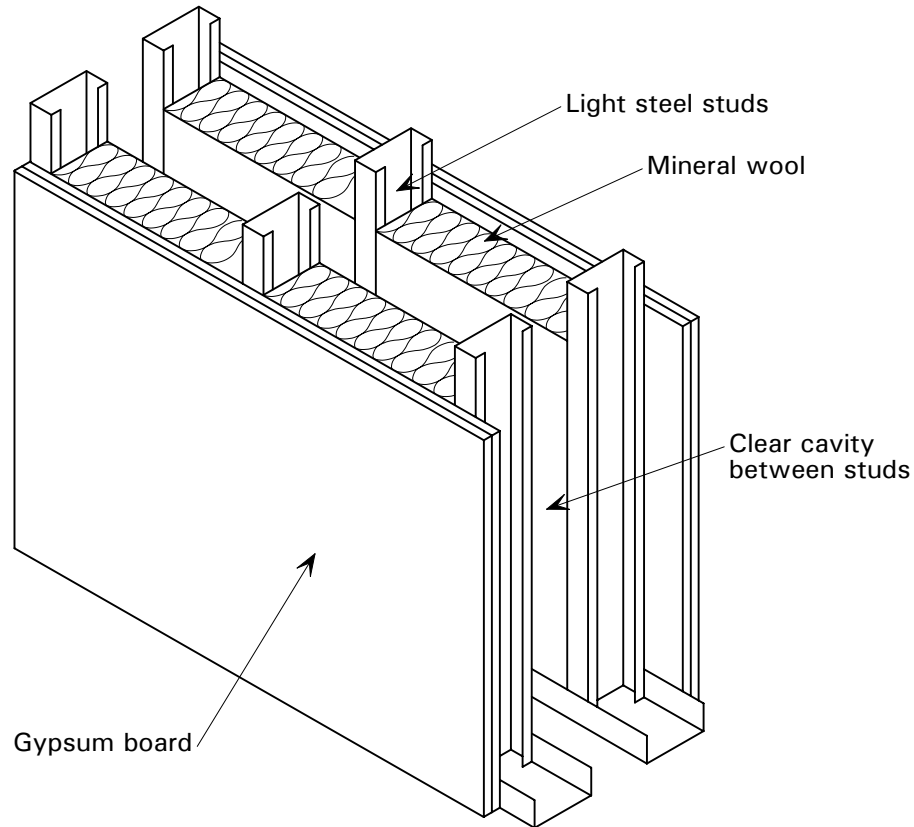

Figure 4.14 Typical light steel separating wall construction

Light steel walls may be used in the following applications in composite construction or in *Slimdek*:

- Infill walls at the periphery of the building, to create a 'rapid dry envelope' in the temporary condition and to provide for wind resistance and lateral support to the cladding in the permanent condition.
- Separating walls between units of accommodation internally, to provide both acoustic insulation and fire compartmentation functions.
- Partition walls within the units of accommodation.

The functional requirements of these three applications of light steel walls are listed below in Table 4.1.

Table 4.1 *Functional requirements for light steel walls in framed structures*

	Functional Requirements		
	Infill walls at façade	Separating walls	Partition walls
Lateral Loading	Resist wind loading, which may be high at the corners of tall buildings	Resist nominal internal wind pressure	No special requirements - resist nominal impact loads
Acoustic Insulation	Generally, no requirement for external noise reduction, but 40 dB reduction can be achieved by most cladding systems	Strict requirement for acoustic insulation to meet Part E	Less severe acoustic insulation requirements (typically 35 dB sound reduction)
Fire Resistance	Must prevent passage of smoke or flame between floors- important if lightweight cladding used	Fire resistance requirements depend on building height. Generally 60 mins. is specified	Nominal fire resistance requirements

The design of light steel infill walls depends on the wind loading and it is often necessary to reduce the spacing of the wall studs to resist the higher wind loading at the upper levels in a multi-storey building or at the corners of the building. Generally, 100 mm deep C sections are satisfactory for low or medium-rise buildings, increasing to 150 mm C sections in high-rise buildings.

Closed-cell insulation board may be attached directly to the wall studs, or alternatively water-resisting boards may be used to which the insulation is later attached. Additional insulation may be placed between the wall studs in this case.

Separating walls comprise two layers of light steel wall studs with either:

- Insulation placed in the cavity between the layers
- or
- Insulation placed between the studs in both wall layers.

Two layers of fire resisting board are required to achieve 60 minutes fire resistance. A sound reduction of 60-65 dB is achieved. Further information on the acoustic performance of light steel partitions and appropriate details for the interfaces between the partitions and separating floors is available in SCI publications P320^[6] and P336^[10]. Additional information can be obtained from *Robust Details Handbook*^[11].

Figure 4.15 and Figure 4.16 illustrate the use of light steel external infill walls in a multi-storey steel framed structure.



Figure 4.15 *Light steel infill walls in a multi-storey steel framed building*



Figure 4.16 *Light steel infill walls in a residential building in Southampton*

5 CLADDING OPTIONS FOR MEDIUM-RISE BUILDINGS

5.1 Introduction

Cladding types used in residential buildings may be grouped into various forms, as follows:

Masonry	– Brickwork
	– Heavy duty blockwork
Site-installed	– Composite panels or sheeting
	– Cassettes
	– Boards e.g. Eternit or Cape
	– Insulated render
	– Brick tiles e.g. <i>Corium</i>
	– Clay tiles e.g. <i>Argeton</i>
	– Metallic sheets
Pre-installed	– Cassettes or boards
	– Insulated render

The various attributes and applications of these cladding systems are addressed in the following Sections. Light steel infill walls may be used to provide lateral support and to create a rapid dry envelope early in the construction process.

5.2 Masonry

Brickwork or heavy duty blockwork is particularly well suited to low or medium-rise buildings where it can be supported off the foundations.

It has the following features:

- It is self-supporting (under vertical load) up to 12 m height, but requires a separate wind resisting supporting structure (e.g. a light steel infill panel).
- Brick walls and their cavity insulation are relatively thick (170 mm typically plus the inner supporting structure) which can lead to geometrical problems when interfacing with thinner claddings above or to the side.
- Brick or heavy duty blockwork walls are very resistant to impact and are preferred at ground floor level.
- For buildings more than 4 storeys tall, brickwork should be supported at each floor level.
- Brick panels can be pre-fabricated using a steel boundary frame. In this case, bricks can be ‘stack-bonded’ for visual effect.

- Wall ties connect the masonry to the supporting structure. Typical tie densities range from 2.5/m² to 4/m² wall area depending on the exposure (location). Light steel infill walls facilitate attachment of the ties through vertical ‘furring runners’ – see Figure 5.1.

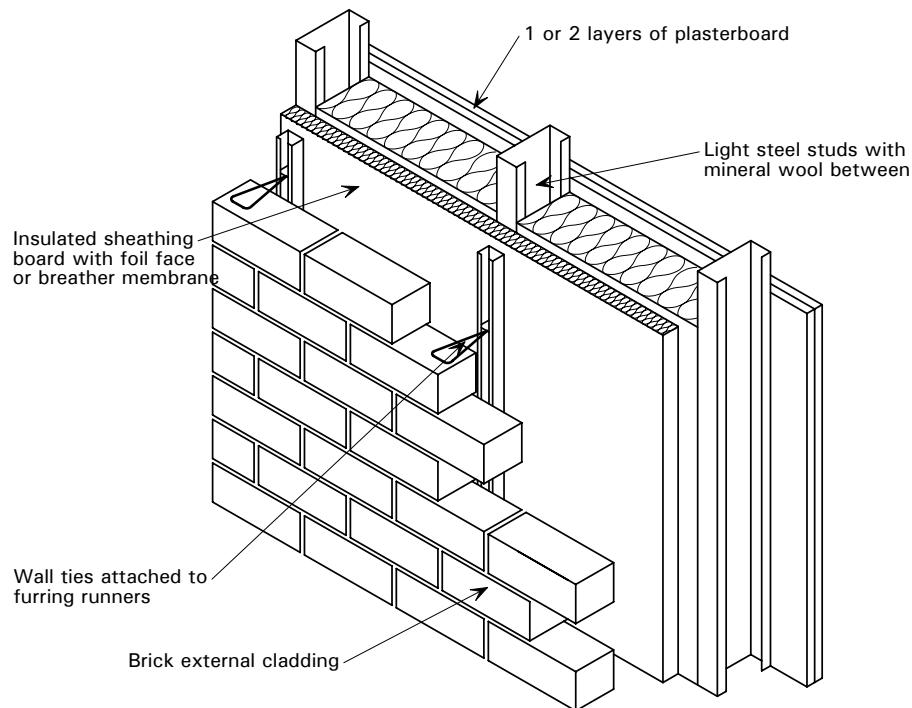

Figure 5.1 *Brickwork attachments to light steel infill walls*

5.3 Insulated render

Chemically modified cement render may be applied to various insulation layers which are attached to a supporting rigid board. Various proprietary systems exist which create different textures and colours, and which have the following features:

- A small cavity may be created behind the insulation layer as a ‘back-up’ in case of water.
- A rigid board, such as a cement particle board, provides the local support and wind resistance. It is screwed back to the supporting frame.
- Rendered cladding systems are relatively thin (80-100 mm). They are usually site applied. Special details are required at penetrations and interfaces with other materials.

An example of a building with insulated render cladding is illustrated in Figure 5.2. The use of rendered cladding is also effective visually in combination with other cladding materials, such as timber or clay tiles.



Figure 5.2 *Insulated render used with timber cladding*
(Courtesy of Feilden Clegg Bradley)

5.4 Composite panels or sheeting

Composite panels may be orientated horizontally below windows or vertically between regular windows. These panels are generally site-installed, and can be used for visual effect. They have the following features:

- Composite panels are produced in thicknesses of 35 to 90 mm with steel skins, and possess excellent thermal insulation properties.
- Both sheeting and composite panels are produced in long lengths (12 m typically) and can be cut and trimmed to suit particular applications.
- Supports may be installed at 1.2 m intervals, or at spacings up to the floor-to-floor height of 2.8 m.
- Metal fascias are not preferred at ground floor level because of the risk of local damage.

5.5 Boards

A variety of impregnated boards may be used such as *Trespa*, a coloured cement-fibre board, and *Eternit Resoplan*, a resin covered board, and *Cape*, a cementitious stone chip-bonded board.

They have the following features:

- Panels are produced up to 2.4 m wide.
- A separate support framework and insulation layer are required.
- Board systems are generally designed as ‘rain-screens’.
- External fixings are generally visible where they connect to the supporting framework.

The attachment of these ‘rain-screen’ cladding panels to ASB edge beams is illustrated in Figure 5.3.

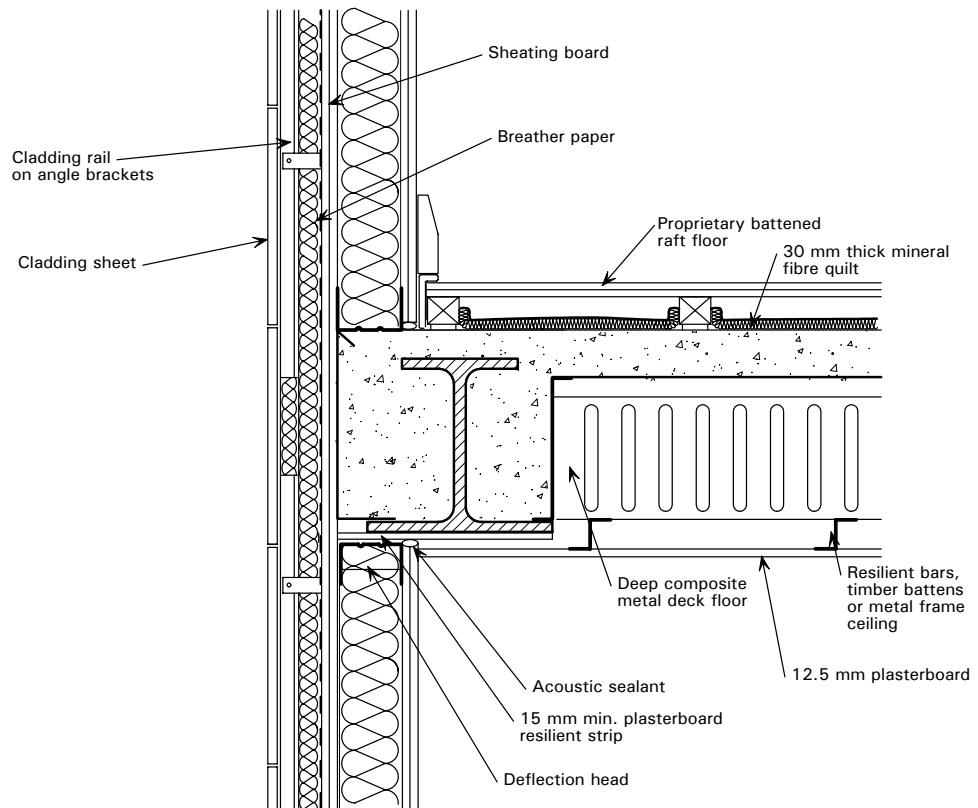

Figure 5.3 *Rain-screen cladding attached to Slimdek*

5.6 Cassettes

Steel or aluminium cassettes are produced in square or rectangular shapes, and are supported on sub-frames. Cassettes have the following features:

- Cassettes are produced by bending flat sheets from 0.9 to 1.5 m wide panels.
- Insulation or rigid backing boards may be attached.
- A separate framework is required to support the edges of the cassettes.
- Cassettes are generally used in ‘rain-screen’ applications with a weather-resisting board in the cavity behind. Tolerances are accommodated at the joists.
- Cassettes can be replaced if damaged.
- Fixing screws can be hidden in the joints between the cassettes.
- Cassettes can be produced in vitreous enamel.

An example of a large steel cassette panel used in a modular building is shown in Figure 5.4. The detail of the attachment to vertical rails is shown in Figure 5.5.



Figure 5.4 *Large cassette panels used at the Ashorne Hill Management College*



Figure 5.5 *Large steel cassette panel attached to vertical rails*

5.7 Brick or clay tiles

Brick or clay tiles are gaining in popularity. They are essentially flat elements that are supported on a separate backing layer. Various types existing which have the following features:

- The *Corium* system uses half bricks which are supported on a ribbed steel sheet, which is itself supported from the frame. It is mechanically fixed to the supporting sheet rather than bonded.
- The *Argeton* system uses clay tiles supported on an aluminium rail.
- The Hanson *Wonderwall* system uses brick slips bonded to a backing medium. The brick slip systems are mortared using pressure injection, and can be pre-installed into panels before delivery to site.
- Additional insulation is required to achieve the necessary U value of the wall.
- All these systems are much thinner (50-80 mm) than conventional brickwork.

A practical application of brick tiles in a 2 storey house is illustrated in Figure 5.6.

The use of clay tiles attached to supporting rails is gaining popularity, and Figure 5.7 shows a recent example of its use. Stack bonding creates interesting visual effects and allows for panelisation.

An example of the use of glued brickwork with a steel channel used for visual effect is shown in Figure 5.8.



Figure 5.6 *Brick-tiles used in a housing project*



Figure 5.7 *Clay tiled façade in a social housing project in Fulham*



Figure 5.8 *Glued brickwork at University of West of England, Bristol*

5.8 Fully glazed façades

Fully glazed façades can be used in steel construction although the heat loss through the glazing is responsible for the majority of the total heat loss. Although a recent development, double skin glass façades are gaining in popularity, based on their experience in Scandinavia where they provide a ‘thermal buffer’ in both winter and summer conditions.

The features of double skin glazed façades are:

- the external skin generally includes solar shading
- the internal skin provides the weather-resisting layer
- the space between the skins provides the thermal ‘buffer’ and louvres expel the warm air in the summer from the cavity
- sufficient space is allowed for maintenance and cleaning
- the external skin is supported by brackets attached to the edge beam or slab, and is continuous outside the line of the building.

A good example of a double skin façade is the Manchester Deansgate project illustrated in Figure 5.9.



Figure 5.9 Fully glazed double skin façade with external louvres

Curtain walling attachments to an RHS edge beam are illustrated in Figure 5.10. Precise details will depend on the chosen cladding system. The upper part of the slab should be reinforced and anchored to the top of the RHS edge beams in order that it can resist shear and tensile forces due to wind action.

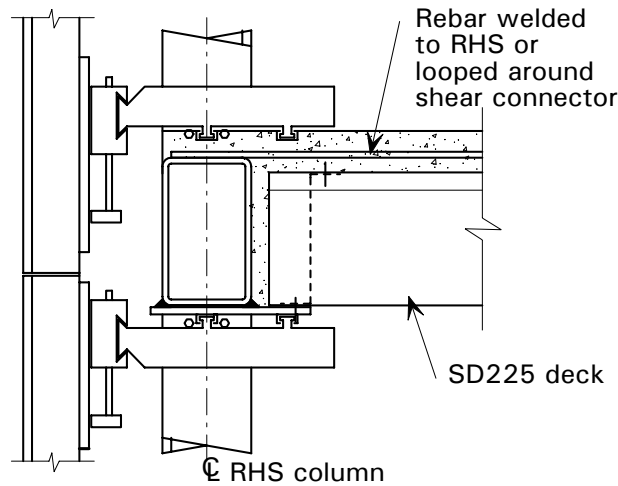

Note: Brackets have to fix to channels- these are welded to the underside of the steel plate and cast flush with the concrete.

Figure 5.10 *Bracket attachments for curtain walling system*

5.9 Metallic sheets

Metallic sheets may be in various forms, including stainless or coloured steel and pre-weathered zinc. Generally, these sheets are placed horizontally and detailed as ‘rain screens’ (i.e. some water penetration may occur). In this case, the inner lining to the light steel sub-frame should be weather-resisting, such as cement particle board. An example of zinc panels used in a modular building is illustrated in Figure 5.11. The panels were pre-attached to the modules in the factory in this project.



Figure 5.11 *Zinc sheets used at Raines Court, London*

5.10 'Kalzip' roofing

Kalzip[®] was used to form both the walls and roof in one interesting housing project in the Netherlands. *Kalzip* is an aluminium roofing system suitable for all roof types, and it offers an alternative option for mansard or shallow roof forms. It has been used in many residential projects, such as in Figure 5.12, to create curved roof profiles.



Figure 5.12 *Kalzip*[®] roofing used at *Albion Riverside, London*
(Courtesy of *Kalzip*[®])

6 STEEL BALCONIES AND PARAPETS

Balconies and terraces are important additions to modern urban living, which lead to interesting technical questions and architectural solutions.

In conventional concrete construction, the slab is continued outside the building envelope to form the balcony or other projection. However, this solution is now **not** preferred because of the need to prevent ‘cold bridging’ through the slab to meet the 2002 Edition of Approved Document L1^[20]. In such cases, it is necessary to provide a ‘thermal break’ in the slab, or to insulate it externally.

6.1 Types of balconies

The modern way of providing a balcony is by a prefabricated steel unit that is attached to the internal structure by brackets or through posts so that ‘thermal bridging’ effects can be minimised. The three generic balcony systems may be defined as follows:

1. Stacked ground-supported modules, which may be installed as a group by lifting into place. The columns extend to ground level (see examples in Figure 6.1 and Figure 6.2).
2. Cantilever balconies, achieved by either:
 - Moment connections to brackets attached to torsionally stiff edge beams.
 - Moment connections to ‘wind-posts’ connected between adjacent floors.
 Examples of cantilever balconies are shown in Figure 6.3 to Figure 6.5.
3. Tied balconies by either:
 - Ties back to wind-posts or to the floor above (see Figure 6.6).
 - Vertical ties to a supporting structure located at roof level (see Figure 6.7).

In the first case, no vertical load is transferred to the structure or façade of the building, except for horizontal restraints. In the second case, the size of the balcony is limited in order to reduce the moments that are transferred to the internal structure. Often balconies can be carefully positioned in re-entrant corners of the building to reduce these moments.

In the third case, the ties can be relatively unobtrusive, as illustrated in Figure 6.6 and Figure 6.7, but vertical ties will require a projecting structure such as a roof truss, which resists the loads on all the balconies.



Figure 6.1 *Stacked modular balconies (project in Sweden)*

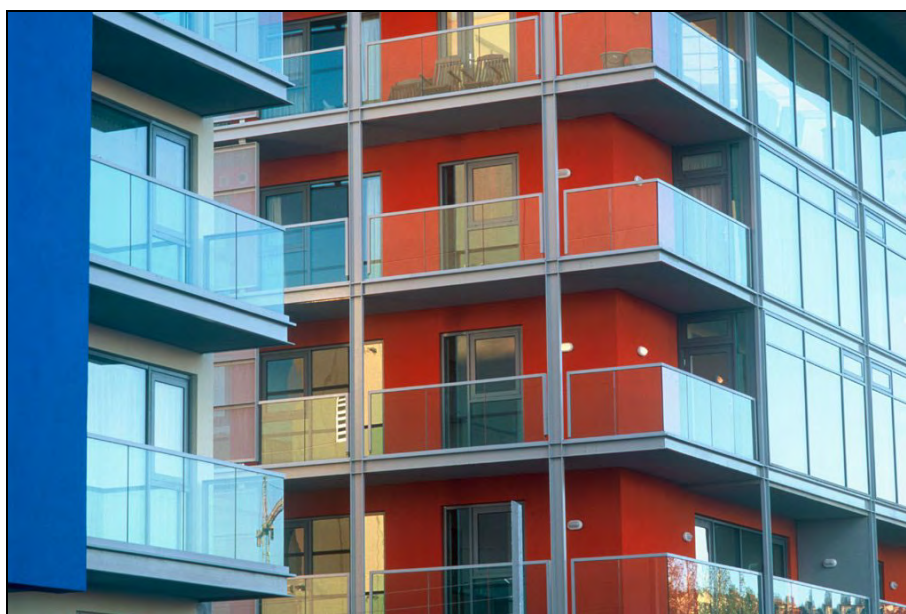

Figure 6.2 *Stacked steel balconies*
(courtesy of Feilden Clegg Bradley)



Figure 6.3 *Cantilever balconies in a composite structure, Deansgate Quay, Manchester*
(Courtesy of Stephenson Bell)



Figure 6.4 *Cantilever and integral balconies at Beaufort Court, Fulham*
(Courtesy of Feilden Clegg Bradley)



Figure 6.5 *Corner cantilevered balconies at Admiral's Quay, Southampton*
(Courtesy of Broadway Malyan)



Figure 6.6 *Tied balconies St Edmunds Terrace, Primrose Hill, London*
(Courtesy of HTA Architects)



Figure 6.7 *Suspended balconies (Piper Building, Fulham)*

6.2 Balcony attachments in *Slimdek*

In *Slimdek*, RHS edge beams are torsionally very stiff and are recommended for cantilever attachments of balconies, where brackets are welded to them. To minimise 'cold bridging', a single bracket at each side of the balcony should be used. Wind-posts may be bolted to the top and bottom of ASB edge beams or to fin plates welded to RHS edge beams. They are designed to resist moments developed by the cantilever balcony and can be relatively large. Again, RHS sections may be preferred.

Technically, it is possible to project the slab outside the building envelope but, in this case, it is recommended that the slab is insulated above and below. Expanded polystyrene (EPS) is a suitable insulant for use externally. The soffit should be protected by a fire resisting board. These general principles may also be extended to other forms of attachment external to the building envelope.

7 WATER-TIGHT BASEMENTS

Basements can be constructed by various methods depending on the ground conditions and water table level. Sheet pile walls are increasingly popular because they provide both temporary and permanent support. Sheet pile walls can be made water-tight by various measures, but in basement car parks or plant rooms some water seepage is permitted. Guidance is given in a recent SCI Publication P275: *Steel intensive basements*^[37].

7.1 Construction methods

The primary component in basement construction is the permanent sheet pile wall with inter-locks at the mid-thickness of the wall. The narrowest piling section available is 200 mm and the deepest is 460 mm. There are two design cases for which the sheet piling is designed:

- Temporary condition, as a cantilever embedded in the ground.
- Permanent condition, as a propped cantilever with lateral support at each floor level.

As a general approximation, the maximum unsupported height of the cantilever is 4.5 m for an embedded length of 10-12 m, depending on the ground conditions. The maximum unsupported length of a propped cantilever is 10 m, which suggests that the temporary condition will be most critical for the design of the sheet piling.

Sheet piling can be installed using a 'silent piling machine' such as Giken or Tosa which is supported by the previously driven piles and is effectively noise and vibration-free (see Figure 7.1). The only noise created is that of the diesel power pack.

7.2 Design requirements for basements

Design requirements are presented in BS 8002: Code of practice for earth retaining structures^[38] and BS 8102: Code of practice for protection of structures against water from the ground^[39]. BS 8102 presents four levels of acceptable water seepage: Level 1 being acceptable for basement car parks in which some water seepage is permitted, Level 2 is appropriate for plantrooms and similar areas, whereas Level 3 is required for residential uses (i.e. no water penetration).

The primary requirement of sheet piling is to act as a retaining wall in the temporary condition. Horizontal restraints can be introduced in the form of 'wallings' or 'struts'. Single level basements can be designed as pure cantilevers until the ground slab is installed.

The sheet piling can also be designed to resist the vertical load applied by the structure as well as acting as a retaining wall, which makes it very efficient in basement applications. Design advice is given in SCI Publication P156: *Steel bearing piles guide*^[40] and P275, *Steel intensive basements*^[37].

Water leakage is controlled by sealants placed in the joints of the sheet piling before driving or by welding the joints or an overlapping plate to seal the joints after driving. Methods depend on the ground conditions and the ground water pressure to be resisted. At the basement slab, a water-proof membrane and special welded fins to the sheet pile may be used to prevent water ingress. In some cases, a separate drained cavity may be introduced. Connection details of the floor slab to the sheet pile walls are given in P275^[37].

Durability is achieved by painting the internal surface and a sacrificial loss of steel of 0.035 mm/year is specified in BS 8002. For a 120 year design life, a loss of 4 mm of steel should be included in the design of the permanent structure. A fire resistance of 90 minutes can be achieved by intumescent coatings applied to the blast-cleaned steel.

7.3 Recent examples of basement construction

The Millennium Car Park in Bristol is 80 m × 90 m by 6 m deep, which was constructed using a ‘top-down’ method. Columns were placed on a 7.8 m grid and were installed by the ‘plunge-pile’ method. A steel tubular column was ‘plunged’ into wet concrete that had been ‘tremmied’ into a bentonite filled bored pile hole. Shear studs were welded to the base of the pile to improve shear transfer. Intermediate floors are 300 mm thick and are supported by ‘corbels’ pre-welded to the columns.

The ‘top-down’ method requires the floor slab to be constructed before excavating below the slab and sequentially constructing intermediate floors. In this project, two levels of basement car parking were provided (see Figure 7.2). Water-tightness was achieved by welding the joints in the sheet piles. No other waterproof membrane was used and the sheet piles were sand-blasted and painted. Columns were fire protected using intumescent coating.

In a hotel project in Cardiff, a top-down method of construction was also used but, in this case, a higher standard of water-proofing was required because the basement was used as a night club. A waterproof membrane was placed on the prepared ground on which the base slab was placed. A proprietary inflated tube system around the periphery of the slab prevented leakage between the slab and sheet pile wall.

A basement car par in Staines used a separate drained cavity system, because there was a high water table.

Figure 7.3 shows the construction of a two-level basement to a multi-storey residential building in Leeds. In this case, a *Slimflor* construction using precast concrete slabs was used for the suspended floors. The beams provided for strut action between the sheet piled walls.



Figure 7.1 *Silent piling machine*



Figure 7.2 *Millennium Car Park, Bristol showing sheet piling and the column head detail supporting the floor slab*



Figure 7.3 *Use of Slimflor beams in basement construction*

8 REFERENCES

1. MULLET, D.L
Slim floor design and construction (P110)
The Steel Construction Institute, 1991
2. LAWSON, R.M., MULLET, D.L and RACKHAM, J.W.
Design of asymmetric *Slimflor* beams using deep composite decking (P175)
The Steel Construction Institute, 1997
3. HICKS, S.J. and LAWSON, R.M
Design of composite beams using precast concrete slabs (P287)
The Steel Construction Institute, 2003
4. GORGOLEWSKI, M.T., GRUBB, P.J. and LAWSON, R.M.
Building design using cold formed sections - Light steel framing in residential construction (P301)
The Steel Construction Institute, 2001
5. GORGOLEWSKI, M.T., GRUBB, P.J. and LAWSON, R.M.
Modular Construction using light steel framing - Design of Residential Buildings (P302)
The Steel Construction Institute, 2001
6. GORGOLEWSKI, M.T. and COUCHMAN, G.H.
Acoustic performance of light steel framed systems - Meeting the new requirements of Part E of the Building Regulations (2003) (P320)
The Steel Construction Institute, 2003
7. GORGOLEWSKI, M.T. and LAWSON, R.M.
Acoustic performance of *Slimdek* – Meeting the new requirements of Part E of the Building Regulations (2003) (P321)
The Steel Construction Institute, 2003
8. GORGOLEWSKI, M.T. and LAWSON, R.M.
Acoustic performance of composite floors - meeting the new requirements of Part E of the Building Regulations (2003) (P322)
The Steel Construction Institute, 2003
9. The Building Regulations 2000 (SI 2000/2531)
(Plus Amendment Regulations in 2001, 2002, 2003, 2004)
The Stationery Office, 2000
(For the latest revisions, see the ODPM website: www.odpm.gov.uk)
10. WAY, A.G.J. and COUCHMAN, G.H.
Acoustic detailing for multi-storey residential buildings (P336)
The Steel Construction Institute, 2004
11. Robust Details Handbook
Robust Details Ltd, 2004
12. Rethinking Construction: The report of the Construction Task Force on the scope for improving the quality and efficiency of UK construction. (Egan Report). Report by Sir John Egan
The Stationery Office (TSO), 1988
13. Best Value for Registered Social Landlords
The Housing Corporation, 1999

14. Scheme Development Standards (5th edition)
The Housing Corporation, 2003
15. ROGAN, A.L. and LAWSON, R.M.
Better value in steel: Value and benefit assessment of *Slimdek* construction (P279)
The Steel Construction Institute, 2001
16. Lifetime Homes – a series of standards
Joseph Rowntree Foundation
17. Standards and Quality in Development: a good practice guide
National Housing Federation, 1998
18. Building Regulations 2000: Approved Document M Access to and use of buildings
The Stationery Office, 2004
19. Building Regulations 2002: Approved Document E Resistance to passage of sound
The Stationery Office, 2003
20. Building Regulations 2002 Approved Document L: Conservation of fuel and power in dwellings
The Stationery Office, 2002
21. Secured by Design – An initiative promoted by the Association of Chief Police Officers (ACPO)
(For a list of standards licensed under this initiative, visit www.securedbydesign.com)
22. Planning Policy Guidance Note 3: Housing (PPG-3)
The Stationery Office
23. Eco-Homes: The environmental rating for homes (revised)
The Building Research Establishment, 2003
24. Building Regulations 2000: Approved Document B Fire safety
The Stationery Office, 2004
25. BS 5588-1: 1990 Fire precautions in the design, construction and use of buildings - Part 1: Code of practice for residential buildings - incl AMD 1
British Standards Institution, 1990
26. BS 6399-1: 1996 Loading for buildings - Part 1 Code of practice for dead and imposed loads
British Standards Institution, 1996
27. BS 6399-3: 1988 Loading for buildings - Part 3 Code of practice for imposed roof loads
British Standards Institution, 1998
28. BS 6399-2: 1997 Loading for buildings - Part 2 Code of practice for wind loads
British Standards Institution, 1997
29. BS 5950-1: 2000 Structural use of steelwork in building - Part 1: Code of practice for design - rolled and welded sections (incl Corrigendum No. 1)
British Standards Institution, 2001
30. BROWN, D.G., KING, C.M., RACKHAM, J.W. and WAY, A.
Design of multi-storey braced frames (P334)
The Steel Construction Institute, 2004

31. Building Regulations 2000: Approved Document A Structure
The Stationery Office, 2004
32. *Slimdek* in multi-storey buildings
(to be published by Corus during 2004)
33. MULLET, D.L
Composite Construction - *Slimdek* - Design of RHS Slimflor Edge Beams
(P169)
The Steel Construction Institute, 1999
34. *Slimdek* Manual
Corus Construction Centre, 2001
35. Light steel – Case studies on modular steel framing (P271)
The Steel Construction Institute, 1999
36. LAWSON, R.M., GRUBB, P.J. PREWER, J. and TREBILCOCK, P.J.
Modular construction using light steel framing - An architect's guide (P272)
The Steel Construction Institute, 1999
37. YANDZIO, E. and BIDDLE, A.R.
Steel intensive basements (P275)
The Steel Construction Institute, 2001
38. BS 8002: 1994 - Code of practice for earth retaining structures
British Standards Institution, 1994
39. BS 8102:1990 - Code of practice for protection of structures against water
from the ground
British Standards Institution, 1990
40. BIDDLE, A.R.
Steel bearing piles guide (P156)
The Steel Construction Institute, 1997