

FOUNDATION DESIGN AND CONSTRUCTION

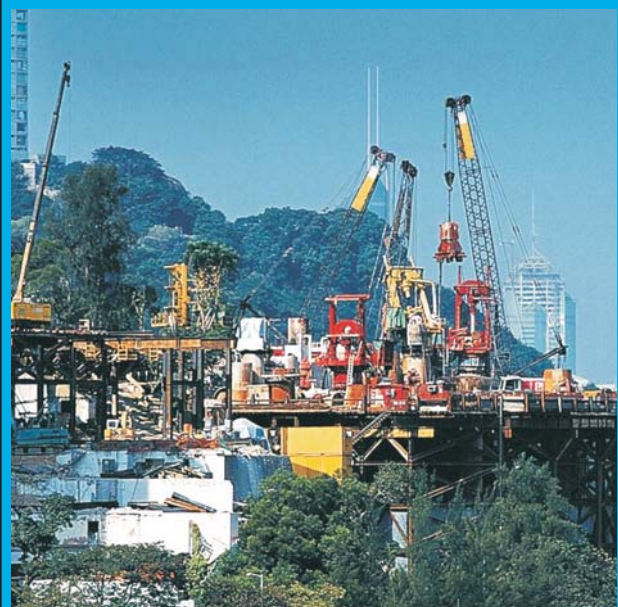
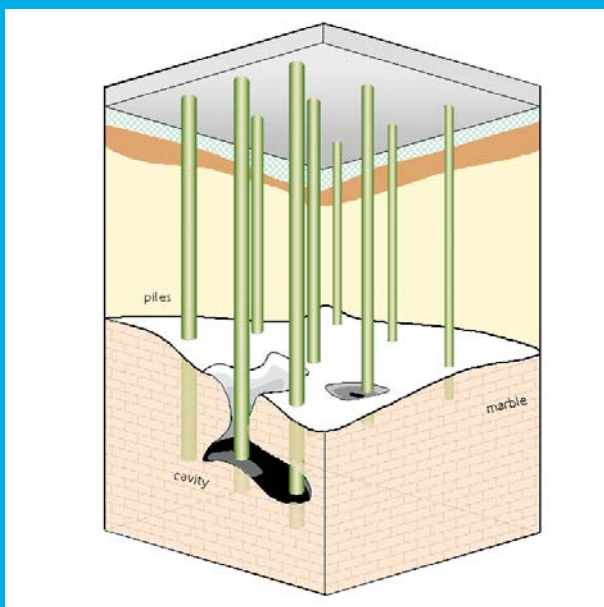
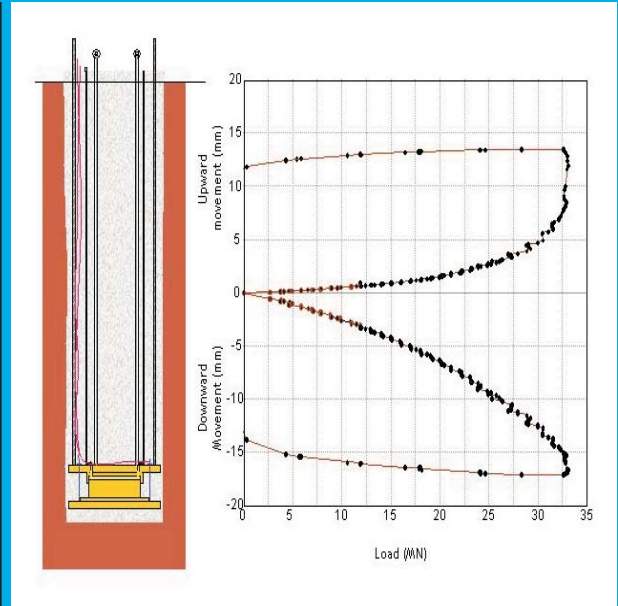

GEOTECHNICAL ENGINEERING OFFICE
Civil Engineering and Development Department
The Government of the Hong Kong
Special Administrative Region

© The Government of the Hong Kong Special Administrative Region

First published, 2006

Prepared by :

Geotechnical Engineering Office,
Civil Engineering and Development Department,
Civil Engineering and Development Building,
101 Princess Margaret Road,
Homantin, Kowloon,
Hong Kong.

Captions of Figures on the Front Cover

Top Left : Construction of Large-diameter Bored Piles
Top Right : Pile Loading Test Using Osterberg Load Cell
Bottom Left : Foundations in Marble
Bottom Right : Construction of Large-diameter Bored Piles on Slope

FOREWORD

This publication is a reference document that presents a review of the principles and practice related to design and construction of foundation, with specific reference to ground conditions in Hong Kong. The information given in the publication should facilitate the use of modern methods and knowledge in foundation engineering.

The Geotechnical Engineering Office published in 1996 a reference document (GEO Publication No. 1/96) on pile design and construction with a Hong Kong perspective. In recent years, there has been a growing emphasis on the use of rational design methods in foundation engineering. Many high-quality instrumented pile loading tests were conducted, which had resulted in better understanding of pile behaviour and more economic foundation solutions. The Geotechnical Engineering Office sees the need to revise the publication to consolidate the experience gained and improvement made in the practice of foundation design and construction. The scope of the publication is also expanded to cover the key design aspects for shallow foundations, in response to the request of the practitioners. Hence, a new publication title is used.

The preparation of this publication is under the overall direction of a Working Group. The membership of the Working Group, given on the next page, includes representatives from relevant government departments, the Hong Kong Institution of Engineers and the Hong Kong Construction Association. Copies of a draft version of this document were circulated to local professional bodies, consulting engineers, contractors, academics, government departments and renowned overseas experts in the field of foundation engineering. Many individuals and organisations made very useful comments, many of which have been adopted in finalising this document. Their contributions are gratefully acknowledged.

The data available to us from instrumented pile loading tests in Hong Kong are collated in this publication. Practitioners are encouraged to help expand this pile database by continuing to provide us with raw data from local instrumented pile loading tests. The data can be sent to Chief Geotechnical Engineer/Standards and Testing.

Practitioners are encouraged to provide comments to the Geotechnical Engineering Office at any time on the contents of the publication, so that improvements can be made in future editions.



Raymond K S Chan
Head, Geotechnical Engineering Office
January 2006

WORKING GROUP :

Architectural Services Department

Mr. Li W.W.

Buildings Department

Mr. Cheng M.L.

Civil Engineering and Development Department

Mr. Pun W.K. (Chairman)

Mr. Ken Ho K.S.

Dr. Richard Pang P.L.

Mr. Vincent Tse S.H.

Dr. Dominic Lo O.K.

Mr. Sammy Cheung P.Y. (Secretary)

Highways Department

Mr. Li W. (before 1 December 2004)

Mr. Yeung S.K. (between 1 December 2004 and 3 May 2005)

Mr. Anthony Yuen W.K. (after 3 May 2005)

Hong Kong Construction Association (Piling Contractor Subcommittee)

Mr. David Chiu C.H.

Hong Kong Institution of Engineers (Civil Division)

Mr. Timothy Suen

Hong Kong Institution of Engineers (Geotechnical Division)

Dr. Daman Lee D.M.

Hong Kong Institution of Engineers (Structural Division)

Mr. Kwan K.K.

Housing Department

Dr. John Lai Y.K.

Mr. Pang C.F.

CONTENTS

| | Page No. |
|--|---------------------|
| TITLE PAGE | 1 |
| FOREWORD | 3 |
| WORKING GROUP | 4 |
| CONTENTS | 5 |
| LIST OF TABLES | 15 |
| LIST OF FIGURES | 17 |
| LIST OF PLATES | 21 |
| 1. INTRODUCTION | 23 |
| 1.1 PURPOSE AND SCOPE | 23 |
| 1.2 GENERAL GUIDANCE | 24 |
| 2. SITE INVESTIGATION, GEOLOGICAL MODELS AND SELECTION OF DESIGN PARAMETERS | 25 |
| 2.1 GENERAL | 25 |
| 2.2 DESK STUDIES | 25 |
| 2.2.1 Site History | 25 |
| 2.2.2 Details of Adjacent Structures and Existing Foundations | 26 |
| 2.2.3 Geological Studies | 26 |
| 2.2.4 Groundwater | 33 |
| 2.3 EXECUTION OF GROUND INVESTIGATION | 33 |
| 2.4 EXTENT OF GROUND INVESTIGATION | 33 |
| 2.4.1 General Sites | 33 |

| | Page No. |
|--|---------------------|
| 2.4.2 Sites Underlain by Marble | 34 |
| 2.5 SOIL AND ROCK SAMPLING | 36 |
| 2.6 DETECTION OF AGGRESSIVE GROUND | 36 |
| 2.7 INSITU AND LABORATORY TESTING | 37 |
| 2.8 ESTABLISHING A GEOLOGICAL MODEL | 38 |
| 2.9 SELECTION OF DESIGN PARAMETERS | 39 |
| | |
| 3. SHALLOW FOUNDATIONS | 41 |
| 3.1 GENERAL | 41 |
| 3.2 DESIGN OF SHALLOW FOUNDATIONS ON SOILS | 42 |
| 3.2.1 Determination of Bearing Capacity of Soils | 42 |
| 3.2.1.1 General | 42 |
| 3.2.1.2 Empirical methods | 42 |
| 3.2.1.3 Bearing capacity theory | 42 |
| 3.2.2 Foundations On or Near the Crest of a Slope | 46 |
| 3.2.3 Factors of Safety | 46 |
| 3.2.4 Settlement Estimation | 48 |
| 3.2.4.1 General | 48 |
| 3.2.4.2 Foundations on granular soils | 49 |
| 3.2.4.3 Foundations on fine-grained soils | 50 |
| 3.2.5 Lateral Resistance of Shallow Foundations | 51 |
| 3.3 DESIGN OF SHALLOW FOUNDATIONS ON ROCK | 51 |
| 3.4 PLATE LOADING TEST | 52 |
| 3.5 RAFT FOUNDATIONS | 53 |
| | |
| 4. TYPES OF PILE | 55 |
| 4.1 CLASSIFICATION OF PILES | 55 |
| 4.2 LARGE-DISPLACEMENT PILES | 56 |
| 4.2.1 General | 56 |
| 4.2.2 Precast Reinforced Concrete Piles | 56 |
| 4.2.3 Precast Prestressed Spun Concrete Piles | 57 |
| 4.2.4 Closed-ended Steel Tubular Piles | 57 |

| | Page No. |
|--|---------------------|
| 4.2.5 Driven Cast-in-place Concrete Piles | 58 |
| 4.3 SMALL-DISPLACEMENT PILES | 58 |
| 4.3.1 General | 58 |
| 4.3.2 Steel H-piles | 58 |
| 4.3.3 Open-ended Steel Tubular Piles | 59 |
| 4.4 REPLACEMENT PILES | 59 |
| 4.4.1 General | 59 |
| 4.4.2 Machine-dug Piles | 59 |
| 4.4.2.1 Mini-piles | 60 |
| 4.4.2.2 Socketed H-piles | 60 |
| 4.4.2.3 Continuous flight auger piles | 60 |
| 4.4.2.4 Large-diameter bored piles | 61 |
| 4.4.2.5 Barrettes | 61 |
| 4.4.3 Hand-dug Caissons | 62 |
| 4.5 SPECIAL PILE TYPES | 65 |
| 4.5.1 General | 65 |
| 4.5.2 Shaft- and Base-grouted Piles | 65 |
| 4.5.3 Jacked Piles | 66 |
| 4.5.4 Composite Piles | 67 |
| 5. CHOICE OF PILE TYPE AND DESIGN RESPONSIBILITY | 69 |
| 5.1 GENERAL | 69 |
| 5.2 FACTORS TO BE CONSIDERED IN CHOICE OF PILE TYPE | 69 |
| 5.2.1 Ground Conditions | 69 |
| 5.2.2 Complex Ground Conditions | 71 |
| 5.2.3 Nature of Loading | 73 |
| 5.2.4 Effects of Construction on Surrounding Structures and Environment | 73 |
| 5.2.5 Site and Plant Constraints | 74 |
| 5.2.6 Safety | 74 |
| 5.2.7 Programme and Cost | 75 |
| 5.3 REUSE OF EXISTING PILES | 75 |
| 5.3.1 General | 75 |
| 5.3.2 Verifications of Conditions | 76 |
| 5.3.3 Durability Assessment | 76 |
| 5.3.4 Load-carrying Capacity | 77 |
| 5.3.5 Other Design Aspects | 77 |
| 5.4 DESIGN RESPONSIBILITY | 78 |

| | Page No. |
|---|---------------------|
| 5.4.1 Contractor's Design | 78 |
| 5.4.2 Engineer's Design | 78 |
| 5.4.3 Discussions | 79 |
| 6. DESIGN OF SINGLE PILES AND DEFORMATION OF PILES | 81 |
| 6.1 GENERAL | 81 |
| 6.2 PILE DESIGN IN RELATION TO GEOLOGY | 81 |
| 6.3 DESIGN PHILOSOPHIES | 82 |
| 6.3.1 General | 82 |
| 6.3.2 Global Factor of Safety Approach | 82 |
| 6.3.3 Limit State Design Approach | 82 |
| 6.3.4 Discussions on Design Approaches | 84 |
| 6.3.5 Recommended Factors of Safety | 85 |
| 6.3.6 Planning for Future Redevelopments | 87 |
| 6.4 AXIALLY LOADED PILES IN SOIL | 87 |
| 6.4.1 General | 87 |
| 6.4.2 Pile Driving Formulae | 88 |
| 6.4.3 Wave Equation Analysis | 91 |
| 6.4.4 Use of Soil Mechanics Principles | 91 |
| 6.4.4.1 General | 91 |
| 6.4.4.2 Critical depth concept | 91 |
| 6.4.4.3 Bored piles in granular soils | 93 |
| 6.4.4.4 Driven piles in granular soils | 97 |
| 6.4.4.5 Bored piles in clays | 98 |
| 6.4.4.6 Driven piles in clays | 99 |
| 6.4.4.7 Other factors affecting shaft resistance | 100 |
| 6.4.4.8 Effect of soil plug on open-ended pipe piles | 100 |
| 6.4.5 Correlation with Standard Penetration Tests | 101 |
| 6.4.5.1 General | 101 |
| 6.4.5.2 End-bearing resistance | 101 |
| 6.4.5.3 Shaft resistance | 101 |
| 6.4.6 Correlation with Other Insitu Tests | 103 |
| 6.5 AXIALLY LOADED PILES IN ROCK | 103 |
| 6.5.1 General | 103 |
| 6.5.2 Driven Piles in Rock | 104 |
| 6.5.3 Bored Piles in Rock | 104 |
| 6.5.3.1 General | 104 |
| 6.5.3.2 Semi-empirical methods | 105 |
| 6.5.3.3 Bearing capacity theories | 111 |
| 6.5.3.4 Insitu tests | 111 |

| | Page No. |
|---|---------------------|
| 6.5.3.5 Presumptive bearing values | 111 |
| 6.5.4 Rock Sockets | 114 |
| 6.6 UPLIFT CAPACITY OF PILES | 117 |
| 6.6.1 Piles in Soil | 117 |
| 6.6.2 Rock Sockets | 119 |
| 6.6.3 Cyclic Loading | 120 |
| 6.7 LATERAL LOAD CAPACITY OF PILES | 121 |
| 6.7.1 Vertical Piles in Soil | 121 |
| 6.7.2 Inclined Loads | 129 |
| 6.7.3 Raking Piles in Soil | 129 |
| 6.7.4 Rock Sockets | 129 |
| 6.7.5 Cyclic Loading | 131 |
| 6.8 NEGATIVE SKIN FRICTION | 131 |
| 6.8.1 General | 131 |
| 6.8.2 Calculation of Negative Skin Friction | 132 |
| 6.8.3 Field Observations in Hong Kong | 134 |
| 6.8.4 Means of Reducing Negative Skin Friction | 135 |
| 6.9 TORSION | 135 |
| 6.10 PRELIMINARY PILES FOR DESIGN EVALUATION | 135 |
| 6.11 PILE DESIGN IN KARST MARBLE | 137 |
| 6.12 STRUCTURAL DESIGN OF PILES | 141 |
| 6.12.1 General | 141 |
| 6.12.2 Lifting Stresses | 141 |
| 6.12.3 Driving and Working Stresses | 141 |
| 6.12.4 Bending and Buckling of Piles | 142 |
| 6.12.5 Mini-piles | 143 |
| 6.13 DEFORMATION OF SINGLE PILES | 143 |
| 6.13.1 General | 143 |
| 6.13.2 Axial Loading | 146 |
| 6.13.2.1 General | 146 |
| 6.13.2.2 Load transfer method | 146 |
| 6.13.2.3 Elastic continuum methods | 146 |
| 6.13.2.4 Numerical methods | 150 |
| 6.13.2.5 Determination of deformation parameters | 152 |
| 6.13.3 Lateral Loading | 155 |
| 6.13.3.1 General | 155 |
| 6.13.3.2 Equivalent cantilever method | 156 |
| 6.13.3.3 Subgrade reaction method | 156 |

| | Page No. |
|---|---------------------|
| 6.13.3.4 Elastic continuum methods | 159 |
| 6.14 CORROSION OF PILES | 160 |
| 7. GROUP EFFECTS | 165 |
| 7.1 GENERAL | 165 |
| 7.2 MINIMUM SPACING OF PILES | 165 |
| 7.3 ULTIMATE CAPACITY OF PILE GROUPS | 166 |
| 7.3.1 General | 166 |
| 7.3.2 Vertical Pile Groups in Granular Soils under Compression | 167 |
| 7.3.2.1 Free-standing driven piles | 167 |
| 7.3.2.2 Free-standing bored piles | 168 |
| 7.3.2.3 Pile groups with ground bearing cap | 169 |
| 7.3.3 Vertical Pile Groups in Clays under Compression | 169 |
| 7.3.4 Vertical Pile Groups in Rock under Compression | 171 |
| 7.3.5 Vertical Pile Groups under Lateral Loading | 171 |
| 7.3.6 Vertical Pile Groups under Tension Loading | 173 |
| 7.3.7 Pile Groups Subject to Eccentric Loading | 173 |
| 7.4 NEGATIVE SKIN FRICTION ON PILE GROUPS | 175 |
| 7.5 DEFORMATION OF PILE GROUPS | 179 |
| 7.5.1 Axial Loading on Vertical Pile Groups | 179 |
| 7.5.1.1 General | 179 |
| 7.5.1.2 Semi-empirical methods | 179 |
| 7.5.1.3 Equivalent raft method | 180 |
| 7.5.1.4 Equivalent pier method | 180 |
| 7.5.1.5 Interaction factor methods | 182 |
| 7.5.1.6 Numerical methods | 185 |
| 7.5.2 Lateral Loading on Vertical Pile Groups | 187 |
| 7.5.2.1 General | 187 |
| 7.5.2.2 Methodologies for analysis | 187 |
| 7.5.2.3 Effect of pile cap | 188 |
| 7.5.3 Combined Loading on General Pile Groups | 190 |
| 7.5.3.1 General | 190 |
| 7.5.3.2 Methodologies for analysis | 191 |
| 7.5.3.3 Choice of parameters | 192 |
| 7.6 DESIGN CONSIDERATIONS IN SOIL-STRUCTURE INTERACTION PROBLEMS | 192 |
| 7.6.1 General | 192 |
| 7.6.2 Load Distribution between Piles | 192 |

| | Page No. | |
|--------------|---|-----|
| 7.6.2.1 | General | 192 |
| 7.6.2.2 | Piles subject to vertical loading | 193 |
| 7.6.2.3 | Piles subject to lateral loading | 193 |
| 7.6.3 | Piled Raft Foundations | 195 |
| 7.6.3.1 | Design principles | 195 |
| 7.6.3.2 | Methodologies for analysis | 195 |
| 7.6.3.3 | Case histories | 197 |
| 7.6.4 | Use of Piles to Control Foundation Stiffness | 198 |
| 7.6.5 | Piles in Soils Undergoing Movement | 199 |
| 7.6.5.1 | General | 199 |
| 7.6.5.2 | Piles in soils undergoing lateral movement | 199 |
| 7.6.5.3 | Piles in heaving soils | 200 |
| 8. | PILE INSTALLATION AND CONSTRUCTION CONTROL | 201 |
| 8.1 | GENERAL | 201 |
| 8.2 | INSTALLATION OF DISPLACEMENT PILES | 201 |
| 8.2.1 | Equipment | 201 |
| 8.2.2 | Characteristics of Hammers and Vibratory Drivers | 203 |
| 8.2.2.1 | General | 203 |
| 8.2.2.2 | Drop hammers | 203 |
| 8.2.2.3 | Steam or compressed air hammers | 204 |
| 8.2.2.4 | Diesel hammers | 204 |
| 8.2.2.5 | Hydraulic hammers | 204 |
| 8.2.2.6 | Vibratory drivers | 205 |
| 8.2.3 | Selection of Method of Pile Installation | 205 |
| 8.2.4 | Potential Problems Prior to Pile Installation | 207 |
| 8.2.4.1 | Pile manufacture | 207 |
| 8.2.4.2 | Pile handling | 207 |
| 8.2.5 | Potential Problems during Pile Installation | 208 |
| 8.2.5.1 | General | 208 |
| 8.2.5.2 | Structural damage | 208 |
| 8.2.5.3 | Pile head protection assembly | 212 |
| 8.2.5.4 | Obstructions | 212 |
| 8.2.5.5 | Pile whipping and verticality | 213 |
| 8.2.5.6 | Toeing into rock | 214 |
| 8.2.5.7 | Pile extension | 214 |
| 8.2.5.8 | Pre-ignition of diesel hammers | 215 |
| 8.2.5.9 | Difficulties in achieving set | 216 |
| 8.2.5.10 | Set-up phenomenon | 217 |
| 8.2.5.11 | False set phenomenon | 217 |
| 8.2.5.12 | Piling sequence | 217 |
| 8.2.5.13 | Raking piles | 218 |
| 8.2.5.14 | Piles with bituminous or epoxy coating | 218 |

| | Page No. |
|---|---------------------|
| 8.2.5.15 Problems with marine piling | 219 |
| 8.2.5.16 Driven cast-in-place piles | 219 |
| 8.2.5.17 Cavernous marble | 220 |
| 8.2.6 Potentially Damaging Effects of Construction and Mitigating Measures | 220 |
| 8.2.6.1 Ground movement | 220 |
| 8.2.6.2 Excess porewater pressure | 222 |
| 8.2.6.3 Noise | 222 |
| 8.2.6.4 Vibration | 223 |
| 8.3 INSTALLATION OF MACHINE-DUG PILES | 226 |
| 8.3.1 Equipment | 226 |
| 8.3.1.1 Large-diameter bored piles | 226 |
| 8.3.1.2 Mini-piles and socketed H-piles | 227 |
| 8.3.1.3 Continuous flight auger (cfa) piles | 228 |
| 8.3.1.4 Shaft- and base-grouted piles | 228 |
| 8.3.2 Use of Drilling Fluid for Support of Excavation | 228 |
| 8.3.2.1 General | 228 |
| 8.3.2.2 Stabilising action of bentonite slurry | 229 |
| 8.3.2.3 Testing of bentonite slurry | 229 |
| 8.3.2.4 Polymer fluid | 230 |
| 8.3.3 Assessment of Founding Level and Condition of Pile Base | 230 |
| 8.3.4 Potential Problems during Pile Excavation | 231 |
| 8.3.4.1 General | 231 |
| 8.3.4.2 Bore instability and overbreak | 235 |
| 8.3.4.3 Stress relief and disturbance | 235 |
| 8.3.4.4 Obstructions | 236 |
| 8.3.4.5 Control of bentonite slurry | 236 |
| 8.3.4.6 Base cleanliness and disturbance of founding materials | 237 |
| 8.3.4.7 Position and verticality of pile bores | 238 |
| 8.3.4.8 Vibration | 239 |
| 8.3.4.9 Sloping rock surface | 239 |
| 8.3.4.10 Inspection of piles | 239 |
| 8.3.4.11 Recently reclaimed land | 239 |
| 8.3.4.12 Bell-outs | 240 |
| 8.3.4.13 Soft sediments | 240 |
| 8.3.4.14 Piles in landfill and chemically contaminated ground | 241 |
| 8.3.4.15 Cavernous marble | 241 |
| 8.3.5 Potential Problems during Concreting | 241 |
| 8.3.5.1 General | 241 |
| 8.3.5.2 Quality of concrete | 241 |
| 8.3.5.3 Quality of grout | 242 |
| 8.3.5.4 Steel reinforcement | 242 |
| 8.3.5.5 Placement of concrete in dry condition | 243 |
| 8.3.5.6 Placement of concrete in piles constructed under water or bentonite | 244 |

| | Page No. |
|--|---------------------|
| 8.3.5.7 Concrete placement in continuous flight auger piles | 244 |
| 8.3.5.8 Extraction of temporary casing | 245 |
| 8.3.5.9 Effect of groundwater | 246 |
| 8.3.5.10 Problems in soft ground | 246 |
| 8.3.5.11 Cut-off levels | 247 |
| 8.3.6 Potential Problems after Concreting | 247 |
| 8.3.6.1 Construction of adjacent piles | 247 |
| 8.3.6.2 Impact by construction plant | 247 |
| 8.3.6.3 Damage during trimming | 247 |
| 8.3.6.4 Cracking of piles due to thermal effects and ground movement | 248 |
| 8.4 INSTALLATION OF HAND-DUG CAISSONS | 248 |
| 8.4.1 General | 248 |
| 8.4.2 Assessment of Condition of Pile Base | 248 |
| 8.4.2.1 Hand-dug caissons in saprolites | 248 |
| 8.4.2.2 Hand-dug caissons in rock | 249 |
| 8.4.3 Potential Installation Problems and Construction Control Measures | 249 |
| 8.4.3.1 General | 249 |
| 8.4.3.2 Problems with groundwater | 249 |
| 8.4.3.3 Base heave and shaft stability | 250 |
| 8.4.3.4 Base softening | 250 |
| 8.4.3.5 Effects on shaft resistance | 251 |
| 8.4.3.6 Effects on blasting | 251 |
| 8.4.3.7 Cavernous marble | 252 |
| 8.4.3.8 Safety and health hazard | 252 |
| 8.4.3.9 Construction control | 252 |
| 8.5 INTEGRITY TESTS OF PILES | 253 |
| 8.5.1 Role of Integrity Tests | 253 |
| 8.5.2 Types of Non-destructive Integrity Tests | 254 |
| 8.5.2.1 General | 254 |
| 8.5.2.2 Sonic logging | 254 |
| 8.5.2.3 Vibration (impedance) test | 255 |
| 8.5.2.4 Echo (seismic or sonic integrity) test | 260 |
| 8.5.2.5 Dynamic loading tests | 263 |
| 8.5.3 Practical Considerations in the Use of Integrity Tests | 264 |
| 9. PILE LOADING TESTS | 267 |
| 9.1 GENERAL | 267 |
| 9.2 TIMING OF PILE TESTS | 267 |

| | Page No. | |
|----------------------------|---|-----|
| 9.3 | STATIC PILE LOADING TESTS | 268 |
| 9.3.1 | Reaction Arrangement | 268 |
| 9.3.1.1 | Compression tests | 268 |
| 9.3.1.2 | Uplift loading tests | 270 |
| 9.3.1.3 | Lateral loading tests | 271 |
| 9.3.2 | Equipment | 271 |
| 9.3.2.1 | Measurement of load | 271 |
| 9.3.2.2 | Measurement of pile head movement | 273 |
| 9.3.3 | Test Procedures | 274 |
| 9.3.3.1 | General | 274 |
| 9.3.3.2 | Maintained-load tests | 274 |
| 9.3.3.3 | Constant rate of penetration tests | 275 |
| 9.3.4 | Instrumentation | 275 |
| 9.3.4.1 | General | 275 |
| 9.3.4.2 | Axial loading tests | 277 |
| 9.3.4.3 | Lateral loading tests | 279 |
| 9.3.5 | Interpretation of Test Results | 280 |
| 9.3.5.1 | General | 280 |
| 9.3.5.2 | Evaluation of failure load | 280 |
| 9.3.5.3 | Acceptance criteria | 282 |
| 9.3.5.4 | Axial loading tests on instrumented piles | 286 |
| 9.3.5.5 | Lateral loading tests | 286 |
| 9.3.5.6 | Other aspects of loading test interpretation | 287 |
| 9.4 | DYNAMIC LOADING TESTS | 289 |
| 9.4.1 | General | 289 |
| 9.4.2 | Test Methods | 289 |
| 9.4.3 | Methods of Interpretation | 290 |
| 9.4.3.1 | General | 290 |
| 9.4.3.2 | CASE method | 290 |
| 9.4.3.3 | CAPWAP method | 291 |
| 9.4.3.4 | SIMBAT method | 291 |
| 9.4.3.5 | Other methods of analysis | 292 |
| 9.4.4 | Recommendations on the Use of Dynamic Loading Tests | 292 |
| REFERENCES | | 295 |
| APPENDIX A | SUMMARY OF RESULTS OF INSTRUMENTED PILE LOADING TESTS IN HONG KONG | 337 |
| GLOSSARY OF SYMBOLS | | 363 |
| GLOSSARY OF TERMS | | 373 |

LIST OF TABLES

| Table No. | | Page No. |
|------------------|--|-----------------|
| 3.1 | Bearing Capacity Factors for Computing Ultimate Bearing Capacity of Shallow Foundations | 45 |
| 3.2 | Values of C_α/C_c for Geotechnical Materials | 51 |
| 4.1 | Advantages and Disadvantages of Displacement Piles | 56 |
| 4.2 | Advantages and Disadvantages of Machine-dug Piles | 59 |
| 4.3 | Advantages and Disadvantages of Hand-dug Caissons | 62 |
| 6.1 | Minimum Global Factors of Safety for Piles in Soil and Rock | 86 |
| 6.2 | Minimum Mobilisation Factors for Shaft Resistance and End-bearing Resistance | 86 |
| 6.3 | Typical Values of Shaft Resistance Coefficient, β , in Saprolites and Sand | 96 |
| 6.4 | Rating Assigned to Individual Parameters using RMR Classification System | 109 |
| 6.5 | Allowable Bearing Pressure Based on Computed RMR Value | 110 |
| 6.6 | Presumed Allowable Vertical Bearing Pressure for Foundations on Horizontal Ground | 113 |
| 6.7 | Classification of Marble | 139 |
| 6.8 | Limits on Increase of Vertical Effective Stress on Marble Surface | 141 |
| 6.9 | Shape and Rigidity Factors for Calculating Settlements of Points on Loaded Areas at the Surface of an Elastic Half-space | 152 |
| 6.10 | Correlations between Drained Young's Modulus and SPT N Value for Weathered Granites in Hong Kong | 154 |
| 6.11 | Typical Values of Coefficient of Horizontal Subgrade Reaction | 158 |
| 7.1 | Tolerance of Installed Piles | 166 |
| 7.2 | Reduction Factor for Coefficient of Subgrade Reaction for a Laterally Loaded Pile Group | 188 |
| 8.1 | Typical Energy Transfer Ratio of Pile Hammers | 203 |
| 8.2 | Possible Defects in Displacement Piles Caused by Driving | 209 |

| Table No. | | Page No. |
|------------------|--|-----------------|
| 8.3 | Defects in Displacement Piles Caused by Ground Heave and Possible Mitigation Measures | 210 |
| 8.4 | Problems with Displacement Piles Caused by Lateral Ground Movement and Possible Mitigation Measures | 210 |
| 8.5 | Problems with Driven Cast-in-place Piles Caused by Groundwater and Possible Mitigation Measures | 211 |
| 8.6 | Limits on Driving Stress | 211 |
| 8.7 | Limits on Properties of Bentonite Slurry | 230 |
| 8.8 | Causes and Mitigation of Possible Defects in Replacement Piles | 232 |
| 8.9 | Interpretation of Vibration Tests on Piles | 259 |
| 8.10 | Classification of Pile Damage by Dynamic Loading Test | 264 |
| 9.1 | Loading Procedures and Acceptance Criteria for Pile Loading Tests in Hong Kong | 276 |
| 9.2 | Range of CASE Damping Values for Different Types of Soil | 291 |
| A1 | Interpreted Shaft Resistance in Loading Tests on Instrumented Replacement Piles in Hong Kong | 343 |
| A2 | Interpreted Shaft Resistance in Loading Tests on Instrumented Displacement Piles in Hong Kong | 347 |
| A3 | Interpreted Shaft Resistance in Loading Tests on Instrumented Replacement Piles with Shaft-grouting in Hong Kong | 350 |
| A4 | Interpreted Shaft Resistance and End-bearing Resistance in Loading Tests on Instrumented Replacement Piles Embedded in Rock in Hong Kong | 351 |

LIST OF FIGURES

| Figure No. | | Page No. |
|-------------------|--|-----------------|
| 2.1 | Principal Rock and Soil Types in Hong Kong | 28 |
| 2.2 | Geological Map of Hong Kong | 31 |
| 2.3 | Representation of a Corestone-bearing Rock Mass | 32 |
| 3.1 | Generalised Loading and Geometric Parameters for a Spread Shallow Foundation | 44 |
| 3.2 | Linear Interpolation Procedures for Determining Ultimate Bearing Capacity of a Spread Shallow Foundation near the Crest of a Slope | 47 |
| 5.1 | Suggested Procedures for the Choice of Foundation Type for a Site | 70 |
| 6.1 | Wave Equation Analysis | 92 |
| 6.2 | Relationship between N_q and ϕ' | 94 |
| 6.3 | Relationship between β and ϕ' for Bored Piles in Granular Soils | 96 |
| 6.4 | Design Line for α Values for Piles Driven into Clays | 99 |
| 6.5 | Correlation between Allowable Bearing Pressure and RQD for a Jointed Rock Mass | 105 |
| 6.6 | Determination of Allowable Bearing Pressure on Rock | 107 |
| 6.7 | Relationship between Deformation Modulus and RMR for a Jointed Rock Mass | 108 |
| 6.8 | Allowable Bearing Pressure Based on RMR Value for a Jointed Rock Mass beneath Piles | 110 |
| 6.9 | Determination of Allowable Bearing Capacity on Rock | 112 |
| 6.10 | Load Distribution in Rock Socketed Piles, $\phi' = 70^\circ$ | 115 |
| 6.11 | Load Distribution in Rock Socketed Piles, $\phi' = 40^\circ$ | 115 |
| 6.12 | Mobilised Shaft Resistance in Piles Socketed in Rock | 116 |
| 6.13 | Failure Mechanisms for Belled Piles in Granular Soils Subject to Uplift Loading | 120 |

| Figure No. | | Page No. |
|-------------------|---|-----------------|
| 6.14 | Failure Modes of Vertical Piles under Lateral Loads | 122 |
| 6.15 | Coefficients K_{qz} and K_{cz} at depth z for Short Piles Subject to Lateral Load | 123 |
| 6.16 | Ultimate Lateral Resistance of Short Piles in Granular Soils | 125 |
| 6.17 | Ultimate Lateral Resistance of Long Piles in Granular Soils | 126 |
| 6.18 | Influence Coefficients for Piles with Applied Lateral Load and Moment (Flexible Cap or Hinged End Conditions) | 127 |
| 6.19 | Influence Coefficients for Piles with Applied Lateral Load (Fixed against Rotation at Ground Surface) | 128 |
| 6.20 | Reduction Factors for Ultimate Bearing Capacity of Vertical Piles under Eccentric and Inclined Loads | 130 |
| 6.21 | Estimation of Negative Skin Friction by Effective Stress Method | 133 |
| 6.22 | Definition of Marble Quality Designation (MQD) | 138 |
| 6.23 | Bending of Piles Carrying Vertical and Horizontal Loads | 144 |
| 6.24 | Buckling of Piles | 145 |
| 6.25 | Load Transfer Analysis of a Single Pile | 147 |
| 6.26 | Closed-form Elastic Continuum Solution for the Settlement of a Compressible Pile | 149 |
| 6.27 | Depth Correction Factor for Settlement of a Deep Foundation | 151 |
| 6.28 | Analysis of Behaviour of a Laterally Loaded Pile Using the Elastic Continuum Method | 161 |
| 7.1 | Results of Model Tests on Groups of Instrumented Driven Piles in Granular Soils | 168 |
| 7.2 | Failure Mechanisms of Pile Groups | 170 |
| 7.3 | Results of Model Tests on Pile Groups in Clay under Compression | 172 |
| 7.4 | Results of Model Tests on Pile Groups for Bored Piles and Footings in Granular Soil under Tension | 174 |

| Figure No. | | Page No. |
|-------------------|--|-----------------|
| 7.5 | Polar Efficiency Diagrams for Pile Groups under Eccentric and Inclined Loading | 176 |
| 7.6 | Determination of Distribution of Load in an Eccentrically-loaded Pile Group Using the 'Rivet Group' Approach | 177 |
| 7.7 | Equivalent Raft Method | 181 |
| 7.8 | Typical Variation of Group Settlement Ratio and Group Lateral Deflection Ratio with Number of Piles | 183 |
| 7.9 | Group Interaction Factor for the Deflection of Pile Shaft and Pile Base under Axial Loading | 184 |
| 7.10 | Calculation of Stiffness Efficiency Factor for a Pile Group Loaded Vertically | 186 |
| 7.11 | Interaction of Laterally Loaded Piles Based on Elastic Continuum Method | 189 |
| 7.12 | Reduction of Lateral Load and Deflection of Piles in a Pile Group | 190 |
| 7.13 | Analysis of a Piled Raft Using the Elastic Continuum Method | 196 |
| 8.1 | Pile Head Protection Arrangement for Driven Concrete Piles | 202 |
| 8.2 | Measurement of Pile Set | 216 |
| 8.3 | Relationships between Peak Particle Velocity and Scaled Driving Energy | 224 |
| 8.4 | Typical Profile of Empty Bore Deduced from Ultrasonic Echo Sounding Test | 240 |
| 8.5 | Possible Defects in Bored Piles due to Water-filled Voids in Soils | 245 |
| 8.6 | Detection of Pile Defects by Sonic Coring | 256 |
| 8.7 | Typical Results of a Vibration Test | 257 |
| 8.8 | Examples of Sonic Integrity Test Results | 261 |
| 9.1 | Typical Arrangement of a Compression Test using Kentledge | 269 |
| 9.2 | Typical Arrangement of a Compression Test using Tension Piles | 270 |

| Figure No. | | Page No. |
|-------------------|--|-----------------|
| 9.3 | Typical Arrangement of an Uplift Test | 271 |
| 9.4 | Typical Arrangement of a Lateral Loading Test | 272 |
| 9.5 | Typical Instrumentation Scheme for a Vertical Pile Loading Test | 278 |
| 9.6 | Typical Load Settlement Curves for Pile Loading Tests | 281 |
| 9.7 | Comparison of Failure Loads in Piles Estimated by Different Methods | 283 |
| 9.8 | Definition of Failure Load by Brinch Hansen's 90% Criterion | 284 |
| 9.9 | Analysis of Lateral Loading Test | 288 |
| A1 | Relationship between Maximum Mobilised Average Shaft Resistance and Mean Vertical Effective Stress for Replacement Piles Installed in Saprolites | 356 |
| A2 | Relationship between Maximum Mobilised Average Shaft Resistance and Mean SPT N Values for Replacement Piles Installed in Saprolites | 357 |
| A3 | Relationship between Maximum Mobilised Average Shaft Resistance and Mean Vertical Effective Stress for Replacement Piles with Shaft-grouting Installed in Saprolites | 358 |
| A4 | Relationship between Maximum Mobilised Average Shaft Resistance and Mean SPT N Values for Replacement Piles with Shaft-grouting Installed in Saprolites | 359 |
| A5 | Relationship between Maximum Mobilised Average Shaft Resistance and Mean Vertical Effective Stress for Displacement Piles Installed in Saprolites | 360 |
| A6 | Relationship between Maximum Mobilised Average Shaft Resistance and Mean SPT N Values for Displacement Piles Installed in Saprolites | 361 |

LIST OF PLATES

| Plate No. | | Page No. |
|----------------------|---|---------------------|
| 4.1 | A Milling Machine | 62 |
| 4.2 | A Trench Scraping Unit in Barrette Construction | 62 |
| 4.3 | A Pile Jacking Machine | 66 |
| 8.1 | A Mechanical Bell-out Tool | 227 |
| 8.2 | Device for Ultrasonic Echo Sounding Tests | 240 |
| 8.3 | Sensor for Ultrasonic Echo Sounding Tests | 240 |

1. INTRODUCTION

1.1 PURPOSE AND SCOPE

The purpose of this document is to give guidance for the design and construction of foundations in Hong Kong. It is aimed at professionals and supervisory personnel involved in the design and construction of foundations. The document has been prepared on the assumption that the reader has some general knowledge of foundations.

Foundations can be classified as shallow and deep foundations, depending on the depth of load-transfer from the structure to the ground. The definition of shallow foundations varies in different publications. BS 8004 (BSI, 1986) adopts an arbitrary embedment depth of 3 m as a way to define shallow foundations. In the context of this document, a shallow foundation is taken as one in which the depth to the bottom of the foundation is less than or equal to its least dimension (Terzaghi et al, 1996). Deep foundations usually refer to piles installed at depths and are :

- (a) pre-manufactured and inserted into the ground by driving, jacking or other methods, or
- (b) cast-in-place in a shaft formed in the ground by boring or excavation.

Traditional foundation design practice in Hong Kong relies, in part, on the British Code of Practice for Foundations (BSI, 1954), together with empirical rules formulated some 40 years ago from local experience with foundations in weathered rocks. Foundation design and construction for projects that require the approval of the Building Authority shall comply with the Buildings Ordinance and related regulations. The Code of Practice for Foundations (BD, 2004a) consolidates the practice commonly used in Hong Kong. Designs in accordance with the code are 'deemed-to-satisfy' the Buildings Ordinance and related regulations. Rational design approaches based on accepted engineering principles are recognised practice and are also allowed in the Code of Practice for Foundations. This publication is intended as a technical reference document that presents modern methods in the design of foundation.

Rational design approaches require a greater geotechnical input including properly planned site investigations, field and laboratory testing, together with consideration of the method of construction. The use of rational methods to back-analyse results of loading tests on instrumented foundations or the monitored behaviour of prototype structures has led to a better understanding of foundation behaviour and enables more reliable and economical design to be employed. This should be continued to further enhance the knowledge such that improvements to foundation design can be made in future projects.

A thorough understanding of the ground conditions is a pre-requisite to the success of a foundation project. An outline of geological conditions in Hong Kong is given in Chapter 2, along with guidance on the scope of site investigations required for the design of foundations. Shallow foundations are usually the most economical foundation option. The feasibility of using shallow foundations should be assessed. Chapter 3 provides guidance on some key design aspects and clarifying the intent of the methods.

In Hong Kong, tall buildings in excess of 30 storeys are commonplace both on reclamations and on hillsides. Steel and concrete piles are generally used as building foundations. Timber piles, which were used extensively in the past to support low-rise buildings and for wharves and jetties, are not covered in this document. Guidance on the types of foundations commonly used in Hong Kong is given in Chapter 4.

Factors to be considered in choosing the most appropriate pile type and the issue of design responsibility are given in Chapter 5, along with guidance on assessing the suitability of reusing existing piles. Guidance on methods of designing single piles and methods of assessing pile movement are given in Chapter 6.

The design of pile groups and their movement are covered in Chapter 7. Given the nature of the geology of the urban areas of Hong Kong where granular soils predominate, emphasis has been placed on the design of piles in granular soil and weathered rock, although pile design in clay has also been outlined for use in areas underlain by argillaceous rock.

Consideration of the practicalities of pile installation and the range of construction control measures form an integral part of pile design, since the method of construction can have a profound influence on the ground and hence on pile performance. A summary of pile construction techniques commonly used in Hong Kong and a discussion on a variety of issues to be addressed during construction, together with possible precautionary measures that may be adopted, are given in Chapter 8.

In view of the many uncertainties inherent in the design of piles, it is difficult to predict with accuracy the behaviour of a pile, even with the use of sophisticated analyses. The actual performance of single piles is best verified by a loading test, and foundation performance by building settlement monitoring. Chapter 9 describes the types of, and procedures for, static and dynamic loading tests commonly used in Hong Kong.

1.2 GENERAL GUIDANCE

In this document, reference has been made to published codes, textbooks and other relevant information. The reader is strongly advised to consult the original publications for full details of any particular subject and consider the appropriateness of using the methods for designing the foundations.

The various stages of site investigation, design and construction of foundations require a coordinated input from experienced personnel. Foundation design is not complete upon the production of construction drawings. Continual involvement of the designer is essential in checking the validity of both the geological model and the design assumptions as construction proceeds. For deep foundations, the installation method may significantly affect the performance of the foundations, it is most important that experienced and competent specialist contractors are employed and their work adequately supervised by suitably qualified and experienced engineers who should be familiar with the design.

In common with other types of geotechnical structures, professional judgement and engineering common sense must be exercised when designing and constructing foundations.

2. SITE INVESTIGATION, GEOLOGICAL MODELS AND SELECTION OF DESIGN PARAMETERS

2.1 GENERAL

A thorough understanding on the ground conditions of a site is a pre-requisite to the success of a foundation project. The overall objective of a site investigation for foundation design is to determine the site constraints, geological profile and the properties of the various strata. The geological sequence can be established by sinking boreholes from which soil and rock samples are retrieved for identification and testing. Insitu tests may also be carried out to determine the mass properties of the ground. These investigation methods may be supplemented by regional geological studies and geophysical tests where justified by the scale and importance of the project, or the complexity of the ground conditions.

The importance of a properly planned and executed ground investigation cannot be over-emphasised. The information obtained from the investigation will allow an appropriate geological model to be constructed. This determines the selection of the optimum foundation system for the proposed structure. It is important that the engineer planning the site investigation and designing the foundations liaises closely with the designer of the superstructure and the project coordinator so that specific requirements and site constraints are fully understood by the project team.

An oversimplified site investigation is a false economy as it can lead to design changes and delays during construction and substantial cost overruns. The investigation should always be regarded as a continuing process that requires regular re-appraisals. For large projects or sites with a complex geology, it is advisable to phase the investigation to enable a preliminary geological assessment and allow appropriate amendments of the study schedule in response to the actual sub-surface conditions encountered. Significant cost savings may be achieved if development layouts can avoid areas of complex ground conditions. In some cases, additional ground investigation may be necessary during, or subsequent to, foundation construction. For maximum cost-effectiveness, it is important to ensure that appropriate tests are undertaken to derive relevant design parameters.

General guidance on the range of site investigation methods is given in Geoguide 2 : Guide to Site Investigation (GCO, 1987), which is not repeated here. Specific guidance pertinent to marine investigations is given in BS 6349-1:2000 (BSI, 2000a). This Chapter highlights the more important aspects of site investigation with respect to foundations.

2.2 DESK STUDIES

2.2.1 Site History

Information on site history can be obtained from various sources including plans of previous and existing developments, aerial photographs, old topographic maps, together with geological maps and memoirs. Useful information on the possible presence of old foundations, abandoned wells, tunnels, etc., may be extracted from a study of the site history. For sites on reclaimed land or within areas of earthworks involving placement of fill, it is

important to establish the timing and extent of the reclamation or the earthworks, based on aerial photographs or old topographic maps, to help assess the likelihood of continuing ground settlement that may give rise to negative skin friction on piles. Morrison & Pugh (1990) described an example of the use of this information in the design of foundations. Old piles and pile caps left behind in the ground from demolition of buildings may affect the design and installation of new piles. It is important to consider such constraints in the choice of pile type and in designing the pile layout.

Sites with a history of industrial developments involving substances which may contaminate the ground (e.g. dye factories, oil terminals) will require detailed chemical testing to evaluate the type, extent and degree of possible contamination.

2.2.2 Details of Adjacent Structures and Existing Foundations

Due to the high density of developments in Hong Kong, a detailed knowledge of existing structures and their foundations, including tunnels, within and immediately beyond the site boundaries is important because these may pose constraints to the proposed foundation construction. Records and plans are available in the Buildings Department for private developments, and in the relevant government offices for public works. Details of the existing foundation types and their construction and performance records will serve as a reference for the selection of the most appropriate foundation type for the proposed development. In certain circumstances, it may be feasible or necessary to re-use some of the existing foundations if detailed records are available and their integrity and capacity can be confirmed by testing (see Chapter 5).

Particular attention should be paid to the special requirements for working in the Mid-level areas, north shore of Lantau Island, Yuen Long and Ma On Shan, and in the vicinity of existing sewage tunnels, the Mass Transit Railway, West Rail and East Rail, possible presence of sensitive apparatus (e.g. computers, specialist machinery) within adjacent buildings, and locations of hospitals or other buildings having special purposes that may have specific requirements. Attention should also be paid to the other existing tunnels, caverns and service reservoirs and railways. All these may pose constraints on the construction works.

2.2.3 Geological Studies

An understanding of the geology of the site is a fundamental requirement in planning and interpreting the subsequent ground investigation. A useful summary of the nature and occurrence of rocks and soils in Hong Kong is contained in Geoguide 3 : Guide to Rock and Soil Descriptions (GCO, 1988). Detailed information about the varied solid and superficial geology of Hong Kong can be obtained from the latest maps and memoirs, published at several scales, by the Hong Kong Geological Survey. The broad divisions of the principal rock and soil types are summarised in Figure 2.1, and a geological map of Hong Kong is shown in Figure 2.2. Given the variability of the geology, it is inadvisable to universally apply design rules without due regard to detailed geological variations.

Typically, a mantle of insitu weathered rock overlies fresh rock, although on hillsides, this is commonly overlain by a layer of transported colluvium. The thickness and nature of

the weathering profiles vary markedly, depending on rock type, topographical location and geological history. Corestone-bearing profiles (Figure 2.3) are primarily developed in the medium- and coarse-grained granites and coarse ash tuffs (volcanic rocks), although they are not ubiquitous. Many volcanic rocks, such as the fine ash tuffs, and the fine-grained granites generally do not contain corestones. The incidence of corestones generally increases with depth in a weathering profile, although abrupt lateral variations are also common. The depth and extent of weathering can vary considerably with changes in rock type and spacing of discontinuity. Thus, the inherent spatial variability of the soil masses formed from weathering of rocks insitu and the undulating weathering front are important considerations in the design and construction of foundations in Hong Kong.

Granitic saprolites (i.e. mass that retains the original texture, fabric and structure of the parent rock) are generally regarded as granular soils in terms of their engineering behaviour. In addition, they may possess relict or secondary bonding, depending on the degree of weathering and cementation.

The lithological variability of volcanic rocks is considerable. They include tuffs, which vary in grain size from fine ash to coarse blocks, are massive to well-bedded, and may be welded, recrystallised or metamorphosed, and lava flows, which may be recrystallised or metamorphosed. Sedimentary rocks of volcanic origin are commonly interbedded with the volcanic rocks and these range in grain size from mudstones to conglomerates. The rate and products of weathering of these rocks vary widely. Most soils derived from volcanic rocks are silty. They may contain fragile, partially or wholly decomposed grains and possess relict bonding. In view of the diversity of rock types, their structure and complexities in the weathering profiles, generalisation about piling in volcanic rocks is inadvisable.

Colluvium, generally including debris flow and rockfall deposits, has commonly accumulated on the hillsides, and fills many minor valleys. Large boulders may be present within a generally medium-grained to coarse-grained matrix, which may impede pile driving. Clay profiles are generally rare in weathered rock in Hong Kong. However, clays may occur as alluvial deposits or as the fine-grained weathered products derived from the meta-siltstones of the Lok Ma Chau Formation (Figure 2.1).

Marble may be found in the northwest New Territories, the northwest coast of Ma On Shan and the northshore of Lantau Island. For sites underlain by marble, particular attention should be paid to the possible occurrence of karst features (GCO, 1990). Chan (1996) described different mechanisms leading to the development of karst features. They can be grouped as surface karst, pinnacles, overhangs and cliffs, dissolution channels and underground caves. Stability of the foundations will depend on the particular type and geometry of the karst features and the rock mass properties.

It is important to note the significance of careful geological field observations and experience in relation to the influence of geology on pile performance. Such an experience, built on a direct and empirical relationship between geology and engineering, can be invaluable, particularly in circumstances where observations cannot be adequately explained by the theory of mechanics. On the other hand, it must be cautioned that experience can become generalised as rules of thumb. It is advisable to be aware of the danger of these generalisations being invalidated by variations in the geology, or by differences in the mechanical behaviour of the range of materials in a given geological formation.

Geological (Ages -
Timeline Millions
of Years)

Superficial Deposits

| | |
|--|---|
| Beach sand, intertidal mud and sand, and estuarine mud, clayey silt and sand | Hang Hau Formation |
| Alluvial sand, silt gravel and colluvium | Fanling Formation Chek Lap Kok Formation |

Sedimentary Rocks

| | |
|---|------------------------|
| Thinly-bedded dolomitic and calcareous siltstone with rare chert interbeds | Ping Chau Formation |
| Dominantly calcareous breccia, conglomerate and coarse sandstone | Kat O Formation |
| Reddish-brown thickly bedded conglomerate and sandstone, with thinly bedded reddish siltstone | Port Island Formation |
| Reddish-brown thickly bedded conglomerate, greyish red sandstone and reddish purple siltstone | Pat Sin Leng Formation |

Volcanic Rocks

Kau Sai Chau Volcanic Group

| | |
|--|---------------------------|
| Dominantly welded fine ash vitric tuff with minor tuff breccia and tuffaceous sandstone | High Island Formation |
| Flow-banded porphyritic rhyolite lava, rhyolite breccia and eutaxitic vitric tuff | Clear Water Bay Formation |
| Dominantly eutaxitic block- and lapilli-bearing vitric tuff with minor flow-banded rhyolite lava | Undifferentiated |

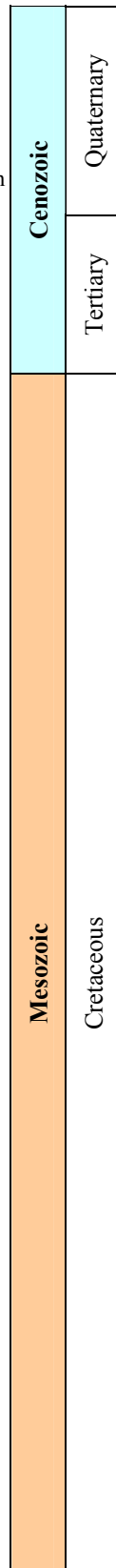

Granitoid Rocks

Lion Rock Suite

| | |
|--------------------------------|---|
| Mount Butler Granite | Equigranular fine- and fine- to medium-grained biotite granite |
| Po Toi Granite | Megacrystic coarse-grained to equigranular fine-grained biotite granite |
| Kowloon Granite | Equigranular medium-grained biotite granite |
| Fan Lau Granite | Porphyritic fine-grained biotite granite |
| Sok Kwu Wan Granite | Megacrystic medium-grained biotite granite |
| Tei Tong Tsui Quartz Monzonite | Porphyritic fine- to medium-grained quartz monzonite |
| Tong Fuk Quartz Monzonite | Porphyritic fine-grained quartz monzonite |
| D'Aguiar Quartz Monzonite | Porphyritic fine- to medium-grained quartz monzonite |

Figure 2.1 - Principal Rock and Soil Types in Hong Kong (Sheet 1 of 3) (Sewell et al, 2000)

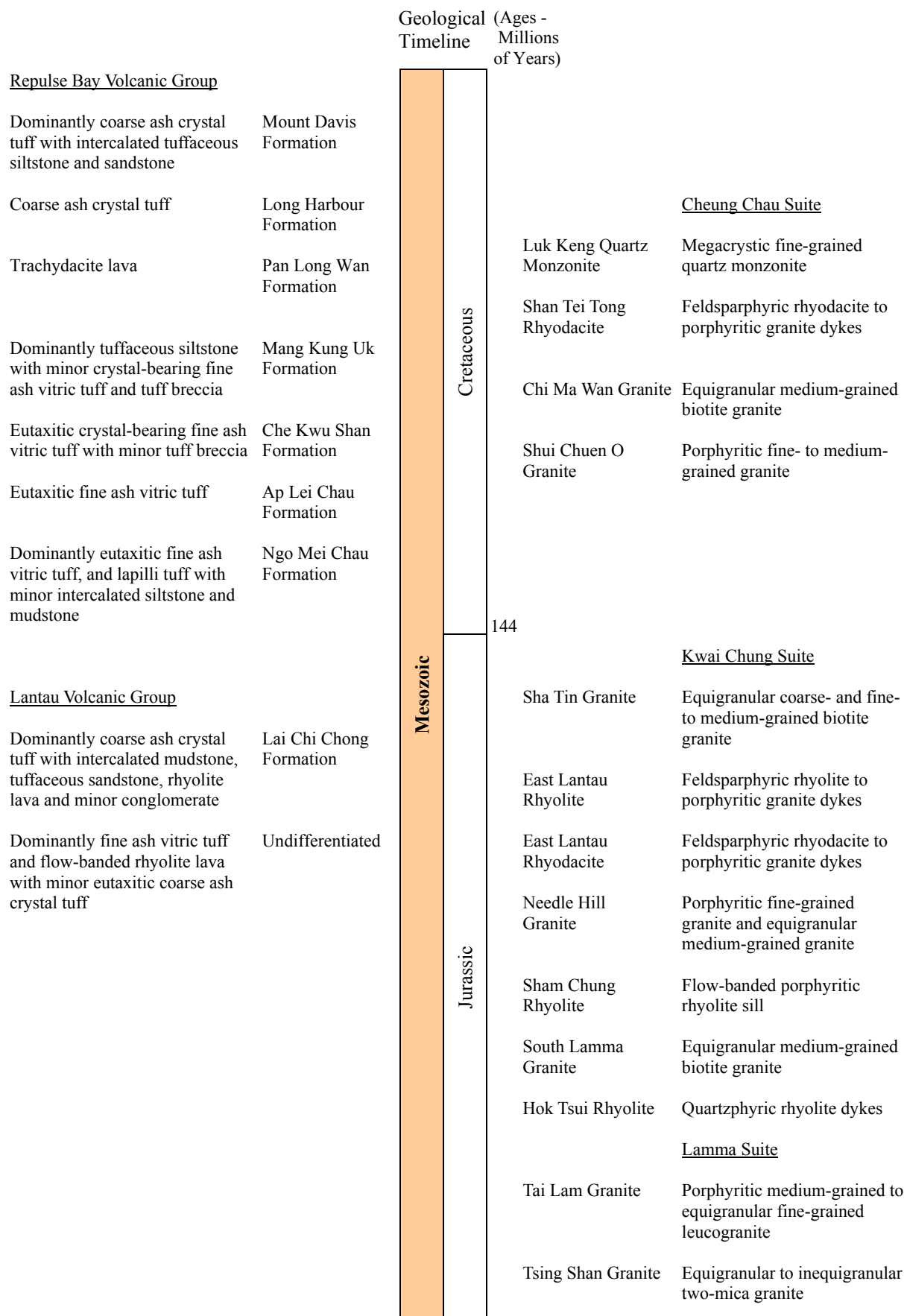

Figure 2.1 - Principal Rock and Soil Types in Hong Kong (Sheet 2 of 3) (Sewell et al, 2000)

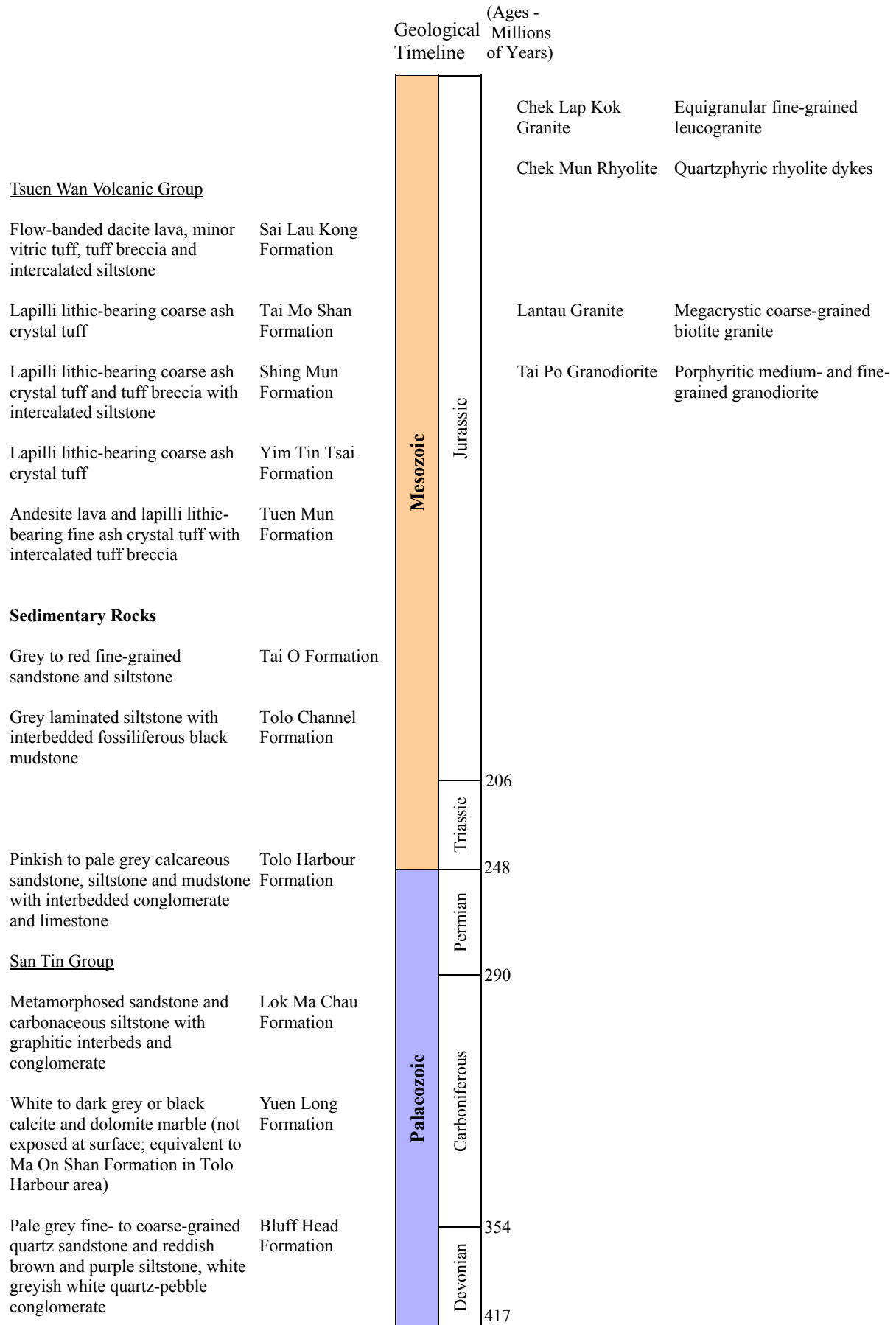

Figure 2.1 - Principal Rock and Soil Types in Hong Kong (Sheet 3 of 3) (Sewell et al, 2000)

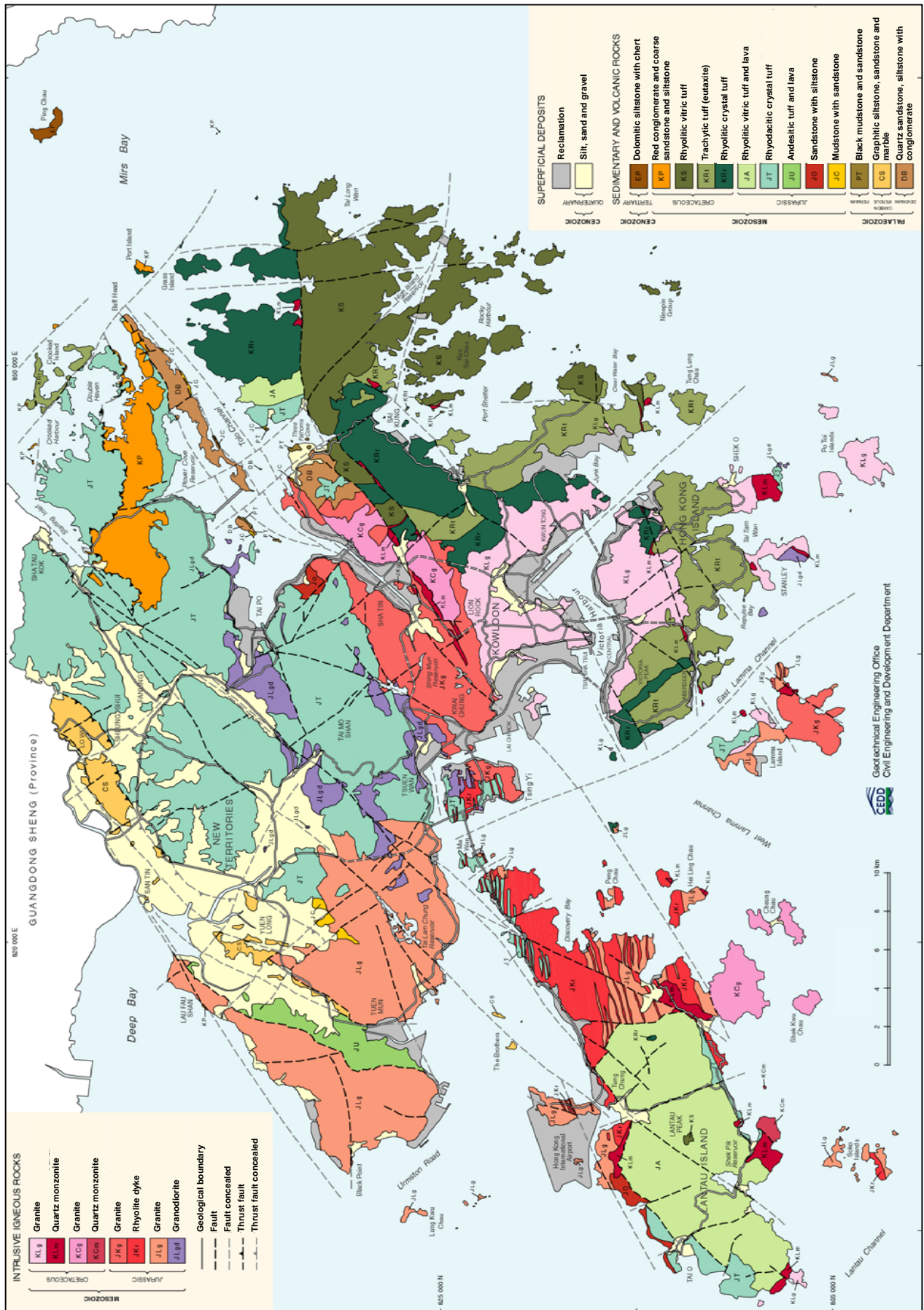
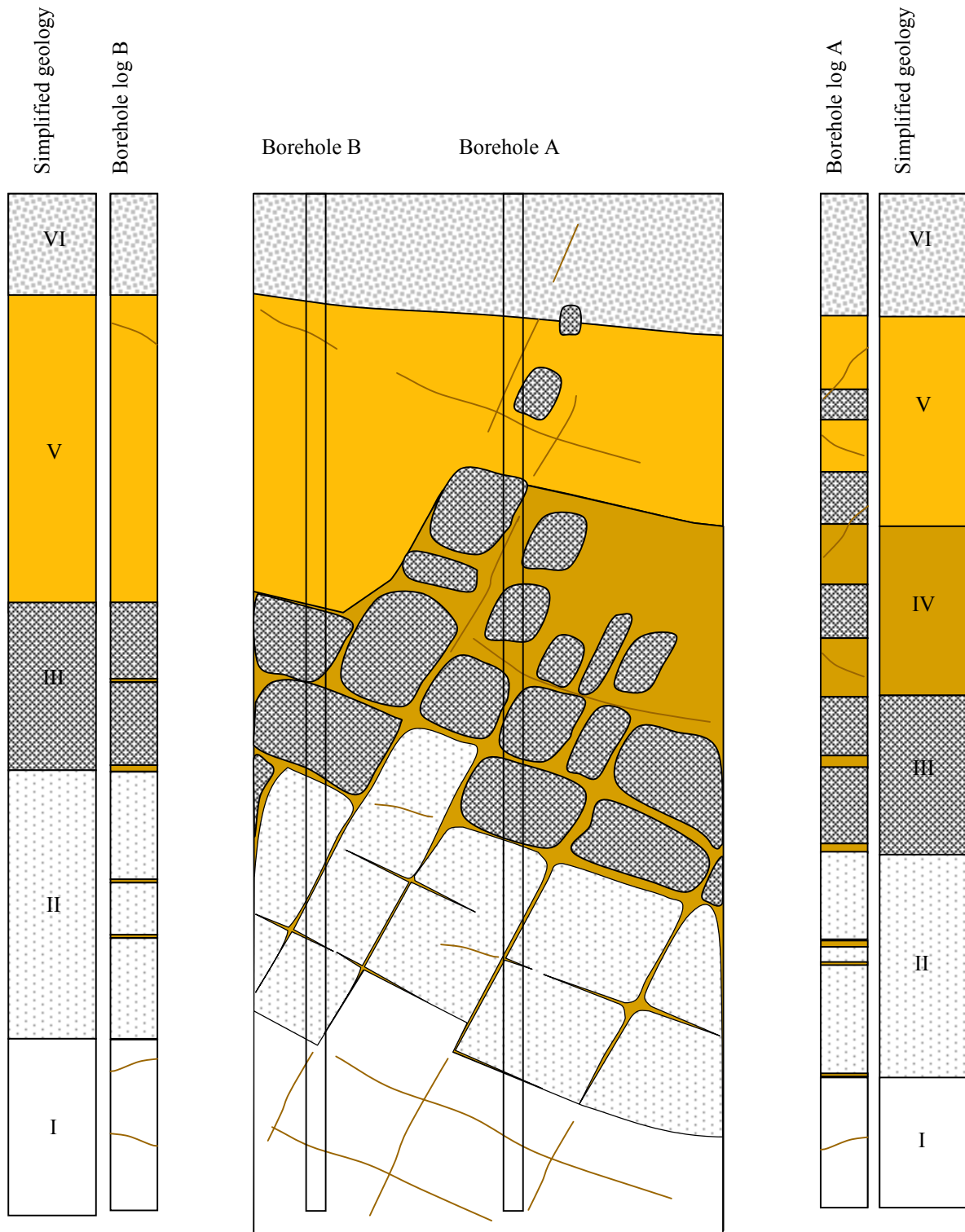

Figure 2.2 – Geological Map of Hong Kong



Note : (1) Refer to Geoguide 3 (GCO, 1988) for classification of rock decomposition grade I to grade VI.

Figure 2.3 – Representation of a Corestone-bearing Rock Mass (Malone, 1990)

2.2.4 Groundwater

Information on the groundwater regime is necessary for the design and selection of foundation type and method of construction. Artesian water pressures may adversely affect shaft stability for cast-in-place piles. For developments close to the seafront, the range of tidal variations should be determined. In a sloping terrain, there may be significant groundwater flow, and hence the hydraulic gradients should be determined as far as possible since the flow can affect the construction of cast-in-place piles, and the consideration of possible damming effects may influence the pile layout in terms of the spacing of the piles.

2.3 EXECUTION OF GROUND INVESTIGATION

It is essential that experienced and competent ground investigation contractors with a proven track record and capable of producing high quality work are employed in ground investigations. The Buildings Department and the Environment, Transport and Works Bureau manage the register of contractors qualified to undertake ground investigation works in private and public developments respectively. The field works should be designed, directed and supervised by a qualified and experienced engineer or engineering geologist, assisted by trained and experienced technical personnel where appropriate. Suitable levels of supervision of ground investigation works are discussed in Geoguide 2 : Guide to Site Investigation (GCO, 1987).

2.4 EXTENT OF GROUND INVESTIGATION

2.4.1 General Sites

The extent of a ground investigation is dependent on the complexity of the ground and, to a certain degree, the form of the proposed development and type of structures and the intended foundation types. Adequate investigation should be carried out to ensure no particular foundation options will be precluded due to a lack of information on ground conditions. Sufficient information should be obtained to allow engineers to have a good understanding of the ground conditions and material properties within the zone of influence of the foundations. Although no hard and fast rules can be laid down, a relatively close borehole spacing of say 10 m to 30 m will often be appropriate for general building structures. In reclamation areas, closely-spaced boreholes may be needed to delineate buried obstructions such as remnants of an old seawall where this is suspected from a desk study of the site history.

In general, boreholes should be extended through unsuitable founding materials into competent ground beyond the zone of influence of the proposed foundations. The zone of influence can be estimated using elasticity theory.

Where pile foundations are considered to be a possibility, the length of pile required usually cannot be determined until an advanced stage of the project. Some general guidance in this instance is given in Geoguide 2 : Guide to Site Investigation (GCO, 1987). The traditional ground investigation practice in Hong Kong is to sink boreholes to at least 5 m into grade III or better rock to prove that a boulder has not been encountered. This practice

should be backed by a geological model prepared by a suitably experienced professional.

It is good practice to sink sufficient boreholes to confirm the general geology of the site. Consideration should also be given to sinking boreholes immediately outside the loaded area of a development in order to improve the geological model. It is also important to continually review the borehole findings throughout the investigation stage to ensure adequate information has been obtained.

For piles founded on rock, it is common practice to carry out pre-drilling, prior to pile construction, to confirm the design assumption and predetermine the founding level of the piles. For large-diameter bored piles founded on rock, one borehole should be sunk at each pile position to a depth of 5 m into the types of rock specified for the piles or the bases of the rock sockets, whichever is deeper. In the case of diaphragm wall panels carrying vertical load by end-bearing resistance, the boreholes should be sunk at about 10 m spacings. For small-diameter piles, such as H-piles driven to bedrock, socketed H-piles and mini-piles, the density of the pre-drilling boreholes should be planned such that every pile tip is within a 5 m distance from a pre-drilling borehole. The above approaches should always be adopted in Hong Kong in view of the inherent variability of ground conditions and the possible presence of corestones in the weathering profile.

Where appropriate, geophysical methods may be used to augment boreholes. A range of surface, cross-hole and down-hole geophysical techniques (Braithwaite & Cole, 1986; GCO, 1987) are available. The undertaking and interpretation of geophysical surveys require a sound knowledge of the applicability and limitations of the different techniques, proper understanding of geological processes and the use of properly calibrated equipment. The data should be processed in the field as far as possible in order that apparent anomalies may be resolved or confirmed. Geophysical techniques are generally useful in helping to screen the site area for planning of the subsequent phases of investigation by drilling.

The design of foundations on or near rock slopes relies on a comprehensive study of the geology and a detailed mapping of exposed joint conditions. In some cases, the rock face cannot be accessed for detailed mapping for different reasons, e.g. the rock face is outside the development boundary. Adequate drillholes or inclined drillholes may be necessary to determine the continuity and orientation of discontinuities. The ground investigation should include measurement of discontinuities from drillholes, using impression packer tests or acoustic televiewer method. The presence of low strength materials, such as kaolin, should be carefully assessed. The strength of the such low strength materials could well dictate the stability of the rock slope under the foundation loads. Good quality rock core samples should be obtained and it may sometimes require the use of better sampling equipment, such as triple tube core barrels and air foam.

2.4.2 Sites Underlain by Marble

Given the possible extreme variability in karst morphology of the marble rock mass, the programme of ground investigation should be flexible. It is important that the borehole logs and cores are continuously reviewed as the works progress so that the investigation works can be suitably modified to elucidate any new karst features intercepted.

For high-rise developments on sites underlain by marble, the investigation should be staged and should be carried out under the full-time supervision of technical personnel. For preliminary investigation, it is recommended that there should be a minimum of one borehole per 250 m², drilled at least 20 m into sound marble rock, i.e. rock which has not been or is only slightly affected by dissolution (e.g. Marble Class I or II (Chan, 1994a)). The depth of boreholes should correspond with the magnitude of the load to be applied by the structure. The position of subsequent boreholes for determining the extent of dissolution features, such as overhanging pinnacles and deep cavities, should be based on the findings of the preliminary boreholes. It is anticipated that boreholes on a grid of about 7 m to 10 m centres will be required to intercept specific karst features. Boreholes in other parts of the site should be sunk on a grid pattern or at points of concentration of piles, to a depth of 20 m into sound marble. Attention should be given to logging the location and size of cavities, the nature of the cavity walls, infilling materials and discontinuities. If the infill is cohesive in nature, good quality tube samples of cavity infill may be obtained using a triple-tube sampler with preferably air foam as the flushing medium.

A lower density of borehole may be sufficient for low-rise developments. Where the loading is small or where the superficial deposits above the marble rock are very thick, drilling may be limited to a depth where there is a minimum of 20 m of competent founding material. Nevertheless, it is strongly recommended that at least one deep borehole is sunk at each site underlain by marble, say to 100 m below ground level, to obtain a geological profile.

Surface geophysical methods can produce useful results to identify the potential problematic areas. The cost of ground investigation can be reduced by targeting drilling over the problematic areas. The micro-gravity method works best in relatively flat ground and without any influence from high density objects in the surroundings. Leung & Chiu (2000) used this method to detect the presence of karst features in a site in Yuen Long. The ground investigation field works were carried out in phases using both conventional rotary drilling and micro-gravity geophysics to supplement each other in refining the geological model. Kirk et al (2000) described the investigation of complex ground conditions in the northshore of Lantau Island using gravity survey to identify areas of deeply weathered zones and supplement conventional ground investigation works. The accuracy of the gravity methods depends on careful calibration and interpretation of the field data.

Borehole geophysical techniques, including cross-hole seismic shooting and electromagnetic wave logging, have been found to give meaningful results. Lee et al (2000) described the use of tomography technique to analyse the images of cross-hole ground penetration radar and predict the karst location. This technique is suitable when there is a good contrast in the dielectric permittivity between sound marble and water (in cavities). It is not suitable in highly fractured marble or marble interbeds with other rocks, such as meta-siltstone and meta-sandstone (Lee & Ng, 2004).

While recent experiences in geophysics have demonstrated their capabilities in identifying karst features, geophysics should be regarded as supplementary ground investigation tools in view of their inherent limitations and the simplifications involved in the interpretation. The value of geophysical testing is that it gives a greater level of confidence in the adequacy of the ground investigation, particularly in relation to the ground conditions between adjacent boreholes. In addition, the results may be used to help positioning the boreholes of the subsequent phase of ground investigation.

All boreholes must be properly grouted upon completion of drilling. This is especially important in the case of drilling into cavernous marble in order to minimise the risk of ground loss and sinkhole formation arising from any significant water flow that may otherwise be promoted.

2.5 SOIL AND ROCK SAMPLING

Wash boring with no sampling is strongly discouraged. It is always recommended practice to retrieve good quality soil samples and continuous rock cores from boreholes for both geological logging and laboratory testing. A possible exception to this can be made for supplementary boreholes sunk solely for the purposes of investigating particular karst features in cavernous marble.

Good quality samples of soils derived from insitu rock weathering can be retrieved using triple-tube core barrels (e.g. Mazier samplers). Samples that are not selected for laboratory tests should be split and examined in detail. Detailed logging of the geological profile using such soil samples can help to identify salient geological features.

2.6 DETECTION OF AGGRESSIVE GROUND

In general, materials derived from the insitu weathering of rocks in Hong Kong are not particularly aggressive to concrete and steel. However, marine mud, estuarine deposits and fill can contain sulphate-reducing bacteria or other deleterious constituents that may pose a potential risk of damaging the foundation material. In reclaimed land, the content of sulphate or other corrosive trace elements may be up to levels that give cause for concern. The zone within the tidal or seasonal water table fluctuation range is generally most prone to corrosion because of more intensive oxidation. In industrial areas or landfill sites, the waste or contaminated ground may impede setting of concrete or attack the foundation material.

Basic chemical tests on soil and groundwater samples including the determination of pH and sulphate content (total and soluble) should be carried out where necessary. For sites close to the seafront, the saline concentration of groundwater should be determined. In sites involving landfills or which are close to landfills, the possible existence of toxic leachate or combustible gases (such as methane) or both, and the rates of emission should be investigated, paying due regard to the possibility of lateral migration. Enough information should be collected to assess the risk of triggering an underground fire or a surface explosion during foundation construction (e.g. during welding of pile sections) in such sites.

Where other deleterious chemicals are suspected (e.g. on the basis of site history), specialist advice should be sought and relevant chemical tests specified. For instance, heavy metal contamination (especially lead and mercury) can, depending on the degree of solubility or mobility in water, represent a health risk to site workers. The degree of contamination can dictate the means by which the spoil from excavation for foundation works will have to be disposed of. It should also be noted that high levels of organic compounds including oils, tars and greases (as reflected by, for instance, toluene extractable matter measurements) can severely retard or even prevent the setting of concrete, or alternatively can potentially cause

chemical attack of concrete at a later stage (Section 6.14). It should be noted that particular safety precautions should be taken when investigating a landfill or contaminated site.

Various classification systems have been proposed to assess the degree of contamination of a site, e.g. Kelly (1980) and Department of Environment, Food and Rural Affairs (DEFRA, 2002).

2.7 INSITU AND LABORATORY TESTING

For a rational design, it is necessary to have data on the strength and compressibility of the soil and rock at the appropriate stress levels within the zone of influence of the proposed foundations. Other relevant parameters include permeability, such as for foundation works involving dewatering or grouting, and the properties of rock joints for the design of a laterally loaded rock socket.

Insitu tests are usually carried out during the ground investigation. The range of commonly used tests includes Standard Penetration Test (SPT), Cone Penetration Test (CPT) and piezocone, pressuremeter, plate loading, vane shear, insitu permeability, impression packer and light weight probes. The CPT has the advantage of continuously collecting information on the properties of soils. It is therefore more accurate in determining soil profile when compared with SPT. However, CPT is not suitable in some ground conditions, such as in dense saprolites or gravelly soils, where it may be difficult to advance the cone. There is limited local experience using other methods to determine properties of soils and rocks, such as Goodman jack, high pressure dilatometer, cross-hole geophysics and self-boring pressuremeter (e.g. Littlechild et al, 2000; Schnaid et al, 2000).

It should be noted that the state and properties of the ground might change as a result of foundation construction. Where deemed appropriate, test driving or trial bore construction may be considered as an investigative tool to prove the feasibility of construction methods and the adequacy of quality control procedures.

Laboratory testing should be carried out to complement information obtained from insitu tests to help to characterise the material and determine the relevant design parameters. The tests may be grouped into two general classes :

- (a) Classification or index tests - for grouping soils with similar engineering properties, e.g. particle size distribution, Atterberg Limits, moisture content, specific gravity and petrographic examination.
- (b) Quantitative tests - for measurement of strength or compressibility of soil (e.g. triaxial compression tests, direct shear tests, oedometer tests), and for measurement of chemical properties of soil and groundwater (e.g. sulphate, pH).

Classification tests should always be carried out to provide general properties of the ground for foundation design. Quantitative tests are necessary for assessing relevant design

parameters if calculation methods based on soil and rock mechanics principles are used. It must be borne in mind that the design parameters obtained from laboratory testing relate to those of the samples tested, and may therefore be subject to size effects, sample disturbance, and sampling bias.

In situ tests can provide data for direct use in foundation design by employing established semi-empirical correlations (e.g. results from SPT, CPT or pressuremeter tests). However, the applicability of such relationships to the particular field conditions must be carefully scrutinised. Alternatively, more fundamental soil or rock parameters, such as the angle of shearing resistance ϕ' , may be derived from the results of in situ tests, either through empirical correlations, e.g. relationship between SPT N value and ϕ' for sands (Peck et al, 1974), or directly from the interpreted test results by theory, e.g. pressuremeter (Mair & Wood, 1987).

Standard laboratory tests can provide data on design parameters, such as ϕ' , for the assessment of shaft and end-bearing resistance of piles or bearing capacity of shallow foundations. Other special laboratory tests such as direct shear tests to investigate the behaviour of interface between soil and steel or soil and concrete may also be undertaken for foundation design as appropriate (e.g. Johnston et al, 1987; Lehane, 1992; Fahey et al, 1993). Oedometer tests are not commonly carried out on saprolitic soils because of their fairly coarse-grained nature, particularly for granites. They are more useful for clayey materials. In principle, stress path testing incorporating small strain measurements can be carried out to determine the yield loci and the behaviour under different stress paths. Data from such high quality tests for soils in Hong Kong are so far very limited because the tests are rarely required for routine foundation design.

2.8 ESTABLISHING A GEOLOGICAL MODEL

An appropriate geological model of a site is an essential requirement for safe foundation design. The interpretation of borehole data, site mapping and other geological information, should be carried out by an experienced geotechnical engineer or engineering geologist to establish a geological model that is suitable for engineering design.

There are inherent uncertainties in any geological models given that only a relatively small proportion of the ground can be investigated, sampled and tested. It is therefore important that all available information is considered in characterising the ground profile and compiling a representative geological model for the site. Additional information includes the geomorphological setting of the site, nearby geological exposures, construction records of existing foundations and experience from adjacent sites.

The representation on a borehole log of material, in a typical corestone-bearing rock mass weathering profile, uses the six-fold weathering grade classification for hand specimens (GCO, 1988). For general engineering purposes, the geological model for a corestone-bearing jointed rock mass should comprise a series of rock mass zones with differing proportions of relatively unweathered material, i.e. material grades I, II and III. Typical classification systems based on rock mass grades or classes are given in GCO (1988) and GCO (1990). However, it is customary in practice to adopt a simple layered ground model, consisting of a planar rock surface overlain by a sequence of soil layers. This process

requires a simplification of the borehole logs and judgement to delineate 'rockhead'. This procedure should be carried out cautiously in a corestone-bearing profile as illustrated in Figure 2.3. The possibility of establishing an over-simplified geological model or over-relying on computer-generated rockhead profile, which may be incapable of reflecting the highly complex ground conditions and therefore be potentially misleading, must be borne in mind. Continual vigilance during foundation construction is called for, particularly in areas of complex ground conditions such as deep weathering profiles and karst marble.

In view of the uncertainties and inherent variability of weathering profiles, the geological model must be reviewed in the light of any additional information. In this respect, the construction of each pile can be considered as a new stage of site investigation, to continually review and modify the geological model.

The ground conditions in areas of cavernous marble can be exceedingly complex. A detailed investigation is necessary to establish a reasonable geological model that is adequate for design purposes. A classification system for cavernous marble rock masses was proposed by Chan (1994a) (see Section 6.11).

2.9 SELECTION OF DESIGN PARAMETERS

The selection of parameters for foundation design should take into account the extent, quality and adequacy of the ground investigation, reliability of the geological and geotechnical analysis model, the appropriateness of the test methods, the representativeness of soil parameters for the likely field conditions, the method of analysis adopted for the design, and the likely effects of foundation construction on material properties. In principle, sophisticated analyses, where justified, should only be based on high quality test results. The reliability of the output is, of course, critically dependent on the representativeness and accuracy of the input parameters.

'Best-estimate' parameters, which are those representative of the properties of the materials in the field, should be selected for design. Guidance on the determination of 'best estimate' parameters can be found in Geoguide 1 : Guide to Retaining Wall Design (GEO, 1993).

Engineering judgement is always required in the interpretation of test results and in the choice of design parameters, having regard to previous experience and relevant case histories. In adopting well-established correlations for a given geological material, it is important to understand how the parameters involved in the database for the particular correlation have been evaluated. In principle, the same procedure in determining the parameters should be followed to safeguard the validity of the correlations.

3. SHALLOW FOUNDATIONS

3.1 GENERAL

Shallow foundations, where feasible, are generally more economical than deep foundations if they do not have to be installed deep into the ground and extensive ground improvement works are not required. They are often used to support structures at sites where subsurface materials are sufficiently strong. Unless a shallow foundation can be founded on strong rock, some noticeable settlement will occur. Design of shallow foundations should ensure that there is an adequate factor of safety against bearing failure of the ground, and that the settlements, including total and differential settlement, are limited to allowable values.

For shallow foundations founded on granular soils, the allowable load is usually dictated by the allowable settlement, except where the ultimate bearing capacity is significantly affected by geological or geometric features. Examples of adverse geological and geometrical features are weak seams and sloping ground respectively. For shallow foundations founded on fine-grained soils, both the ultimate bearing capacity and settlements are important design considerations.

High-rise structures or the presence of weak ground bearing materials do not necessarily prohibit the use of shallow foundations. Suitable design provision or ground improvement could be considered to overcome the difficulties. Some examples are given below :

- (a) Design the foundations, structures and building services to accommodate the expected differential and total settlements.
- (b) Excavate weak materials and replace them with compacted fill materials.
- (c) Carry out insitu ground improvement works to improve the properties of the bearing materials. The time required for the ground improvement can be offset by the time required for installing deep foundations.
- (d) Adopt specially designed shallow foundations, such as compensated rafts, to limit the net foundation loads or reduce differential settlement.

Chu & Yau (2003) reported the use of large raft foundations to support a hangar and workshops in reclamation fill. The fill was vibro-compacted and the allowable bearing pressure of the fill after compaction was taken as 300 kPa. The structures were designed to tolerate a total settlement of 300 mm to 450 mm with an angular distortion less than 1 in 300. This project demonstrated that structures can be designed to allow for large total settlement and a high bearing pressure on reclamation fill is feasible.

Wong et al (2003) described the design of a raft foundation supporting a 29-storey residential building and a 3-level basement. The raft was founded on completely to highly

decomposed granite with SPT N values greater than 80. An allowable bearing pressure of 700 kPa was adopted in the foundation design.

3.2 DESIGN OF SHALLOW FOUNDATIONS ON SOILS

3.2.1 Determination of Bearing Capacity of Soils

3.2.1.1 General

There are a variety of methods for determining the bearing capacity of shallow foundations on soils. A preliminary estimate of allowable bearing pressure may be obtained on the basis of soil descriptions. Other methods include correlating bearing pressures with results of insitu field tests, such as SPT N value and tip resistance of CPT. For example, the presumed allowable bearing pressures given in the Code of Practice for Foundations (BD, 2004a) are based on soil descriptions. Typical undrained shear strength and SPT N values of various material types are also provided. The presumed allowable bearing pressures are usually based on empirical correlations and are intended to be used without resorting to significant amount of testing and design evaluation.

Methods based on engineering principles can be used to compute the bearing capacity of soils and estimate the foundation settlement. This would require carrying out adequate ground investigation to characterise the site, obtaining samples for laboratory tests to determine geotechnical parameters and establishing a reliable engineering geological model. Designs following this approach normally result in bearing pressures higher than the presumed allowable bearing pressures given in codes of practice.

3.2.1.2 Empirical methods

The allowable bearing pressure of a soil can be obtained from correlations with SPT N values. For example, Terzaghi & Peck (1967) proposed bearing pressure of 10 N (kPa) and 5 N (kPa) for non-cohesive soils in dry and submerged conditions respectively. This was based on limiting the settlement of footings of up to about 6 m wide to less than 25 mm, even if it is founded on soils with compressible sand pockets. Based on back-analysis of more than 200 settlement records of foundations on soils and gravel, Burland & Burbidge (1985) proposed a correlation between soil compressibility, width of foundation and average SPT N value. This generally results in an allowable bearing pressure greater than that proposed by Terzaghi & Peck (1967).

3.2.1.3 Bearing capacity theory

The ultimate bearing capacity of a shallow foundation resting on soils can be computed as follows (GEO, 1993) :

$$q_u = \frac{Q_u}{B_f' L_f'} = c' N_c \zeta_{cs} \zeta_{ci} \zeta_{ct} \zeta_{cg} + 0.5 B_f' \gamma_s' N_\gamma \zeta_{\gamma s} \zeta_{\gamma i} \zeta_{\gamma t} \zeta_{\gamma g} + q N_q \zeta_{qs} \zeta_{qi} \zeta_{qt} \zeta_{qg} \quad [3.1]$$

where N_c, N_γ, N_q = general bearing capacity factors which determine the capacity of a long strip footing acting on the surface of a soil in a homogenous half-space

Q_u = ultimate resistance against bearing capacity failure

q_u = ultimate bearing capacity of foundation

q = overburden pressure at the level of foundation base

c' = effective cohesion of soil

γ_s' = effective unit weight of the soil

B_f = least dimension of footing

L_f = longer dimension of footing

$B_f' = B_f - 2e_B$

$L_f' = L_f - 2e_L$

e_L = eccentricity of load along L direction

e_B = eccentricity of load along B direction

$\zeta_{cs}, \zeta_{\gamma s}, \zeta_{qs}$ = influence factors for shape of shallow foundation

$\zeta_{ci}, \zeta_{\gamma i}, \zeta_{qi}$ = influence factors for inclination of load

$\zeta_{cg}, \zeta_{\gamma g}, \zeta_{qg}$ = influence factors for ground surface

$\zeta_{ct}, \zeta_{\gamma t}, \zeta_{qt}$ = influence factors for tilting of foundation base

Figure 3.1 shows the generalised loading and geometric parameters for the design of a shallow foundation. The bearing capacity factors are given in Table 3.1. Equation [3.1] is applicable for the general shear type of failure of a shallow foundation, which is founded at a depth less than the foundation width. This failure mode is applicable to soils that are not highly compressible and have a certain shear strength, e.g. in dense sand. If the soils are highly compressible, e.g. in loose sands, punching failure may occur. Vesic (1975) recommended using a rigidity index of soil to define whether punching failure is likely to occur. In such case, the ultimate bearing capacity of the foundation can be evaluated based on Equation [3.1] with an additional set of influence factors for soil compressibility (Vesic, 1975).

In selecting ϕ' value for foundation design, attention should be given to the stress-dependency of the strength envelope of soils.

Kimmerling (2002) suggested using the actual dimensions, B_f and L_f , to compute the influence factors for shape of shallow foundation. The equations for computing shape factors given in Table 3.1 use the full dimensions of a shallow foundation. No depth factors are included in Equation [3.1] as the beneficial effect of foundation embedment is unreliable because of possible construction activities in future (GEO, 1993).

The ultimate bearing capacity depends on the effective unit weight of the soil. Where the groundwater level is at a distance greater than B_f' below the base of the foundation, the effective unit weight of the soil can be taken as the bulk unit weight, γ . Where the groundwater level is at the same level as the foundation base, the effect of groundwater should be considered in bearing capacity evaluation. For static groundwater, the submerged unit weight of the soil can be used in Equation [3.1]. Where the groundwater flows under an upward hydraulic gradient, the effective unit weight of the soil should be taken as $\gamma - \gamma_w (1 + \hat{i})$ where \hat{i} is the upward hydraulic gradient and γ_w is the unit weight of water. For intermediate groundwater levels, the ultimate bearing capacity may be interpolated between the above limits.

An effective groundwater control measure is needed in case the groundwater is above the proposed excavated level of a shallow foundation. The effect of softening or loosening of foundation soils due to excessive ingress of groundwater into the excavations should be assessed. For fine-grained soils, the effect of softening due to swelling should be considered, which may occur in the foundation upon excavation resulting in a reduction of effective stress.

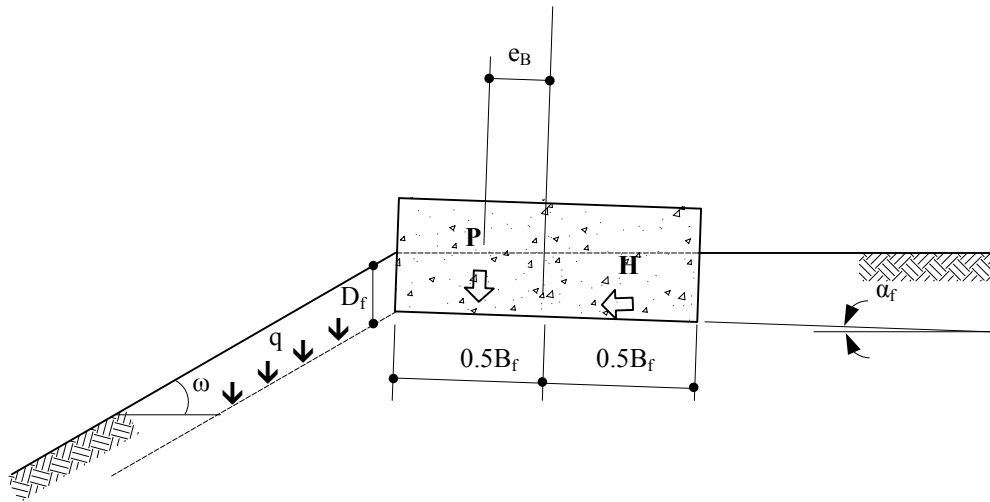

(a) Force Acting on a Spread Foundation

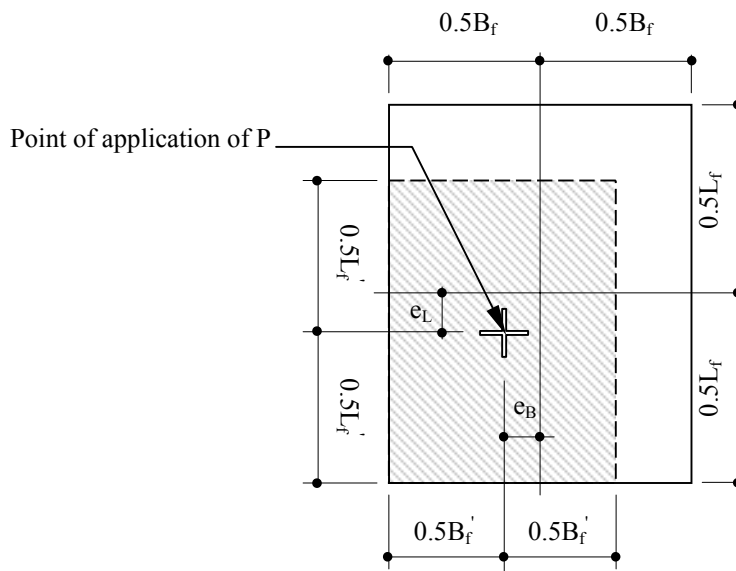

(b) Effective Dimensions of Foundation Base

Figure 3.1 – Generalised Loading and Geometric Parameters for a Spread Shallow Foundation

Table 3.1 – Bearing Capacity Factors for Computing Ultimate Bearing Capacity of Shallow Foundations

| Parameters | $c' - \phi'$ soil | For undrained condition ($\phi = 0$) |
|--------------------------|---|---|
| Bearing capacity factors | $N_c = (N_q - 1) \cot \phi'$ $N_\gamma = 2 (N_q + 1) \tan \phi'$ $N_q = e^{\pi \tan \phi'} \tan^2 \left(45^\circ + \frac{\phi'}{2} \right)$ | $N_c = 2 + \pi$ $N_\gamma = 0$ $N_q = 1$ |
| Shape factors | $\zeta_{cs} = 1 + \frac{B_f N_d}{L_f N_c}$ $\zeta_{\gamma s} = 1 - 0.4 \frac{B_f}{L_f}$ $\zeta_{qs} = 1 + \frac{B_f}{L_f} \tan \phi'$ | $\zeta_{cs} = 1 + 0.2 \frac{B_f}{L_f}$ $\zeta_{qs} = 1$ |
| Inclination factors | $\zeta_{ci} = \zeta_{qi} - \frac{1 - \zeta_{qi}}{N_c \tan \phi'}$ $\zeta_{\gamma i} = \left(1 - \frac{H}{P + B_f' L_f' c' \cot \phi'} \right)^{m_i + 1}$ $\zeta_{qi} = \left(1 - \frac{H}{P + B_f' L_f' c' \cot \phi'} \right)^{m_i}$ | $\zeta_{ci} = 0.5 + 0.5 \sqrt{1 - \frac{H}{c' B_f' L_f'}}$ $\zeta_{qi} = 1$ |
| Tilt factors | $\zeta_{ct} = \zeta_{qt} - \frac{1 - \zeta_{qt}}{N_c \tan \phi'}$ $\zeta_{\gamma t} = (1 - \alpha_f \tan \phi')^2 \text{ for } \alpha_f < 45^\circ$ $\zeta_{qt} \approx \zeta_{\gamma t}$ | $\zeta_{ct} = 1 - \frac{2\alpha_f}{\pi + 2}$ $\zeta_{qt} = 1$ |
| Ground sloping factors | $\zeta_{cg} = e^{-2\omega \tan \phi'}$ $\zeta_{\gamma g} \approx \zeta_{qg}$ $\zeta_{qg} = (1 - \tan \omega)^2 \text{ for } \omega \leq 45^\circ$ $\zeta_{qg} = 0 \text{ for } \omega > 45^\circ$ | $\zeta_{cg} = 1 - \frac{2\omega}{\pi + 2}$ $\zeta_{qg} = 1$ |

where B_f and L_f = dimensions of the footing
 B_f' and L_f' = effective dimensions of the footing
 P and H = vertical and horizontal component of the applied load
 ϕ' = angle of shearing resistance
 D_f = depth from ground surface to the base of shallow foundation
 α_f = inclination of the base of the footing
 ω = sloping inclination in front of the footing

$$m_i = \frac{2 + \frac{B_f'}{L_f'}}{1 + \frac{B_f'}{L_f'}} = \text{load inclination along dimension } B_f'; \quad m_i = \frac{2 + \frac{L_f'}{B_f'}}{1 + \frac{L_f'}{B_f'}} = \text{load inclination along dimension } L_f'$$

Equation [3.1] is generally applicable to homogenous isotropic soils. The presence of geological features such as layering or weak discontinuities can result in failure mechanisms different from that assumed for the derivation of the equation. Therefore, the presence of geological features, in particular weak soil layers, should be checked in ground investigations. The evaluation of bearing capacity should take into account the geological characteristics of the ground.

The effect of load inclination and eccentricity are approximated and included as influence factors in Equation [3.1]. In reality, the problem of bearing capacity under combined loading conditions is essentially a three-dimensional problem. Recent research work (Murff, 1994; Bransby & Randolph, 1998; Taiebat & Carter, 2000) have suggested that for any foundation, there is a surface in a three-dimensional load space that defines a failure envelope for the foundation. The axes of the three-dimensional space represent the vertical load, horizontal load and moment. Any combination of loads outside this envelope causes failure of the foundation. Solutions are largely applicable to undrained failure in fine-grained soils. Further work are needed to extend their applications to granular soils, which are more appropriate to local ground conditions.

3.2.2 Foundations On or Near the Crest of a Slope

An approximate method is given in Geoguide 1: Guide to Retaining Wall Design (GEO, 1993) to determine the ultimate bearing capacity of a foundation near the crest of a slope. The ultimate bearing capacity can be obtained by linear interpolation between the value for the foundation resting at the edge of the slope and that at a distance of four times the foundation width from the crest. Equation [3.1] can be used to estimate the ultimate bearing capacity for the foundation resting on the slope crest. Figure 3.2 summarises the procedures for the linear interpolation.

3.2.3 Factors of Safety

The net allowable bearing pressure of a shallow foundation resting on soils is obtained by applying a factor of safety to the net ultimate bearing capacity. The net ultimate bearing capacity should be taken as $q_u - \gamma D_f$ where D_f is the depth of soil above the base of the foundation and γ is the bulk unit weight of the soil. The selection of the appropriate factor of safety should consider factors such as :

- (a) The frequency and likelihood of the applied loads (including different combination of dead load, superimposed live loads) reaching the maximum design level. Some structures, e.g. silos, are more likely to experience the maximum design load.
- (b) Soil variability, e.g. soil profiles and shear strength parameters. Ground investigation helps increase the reliability of the site characterisation.

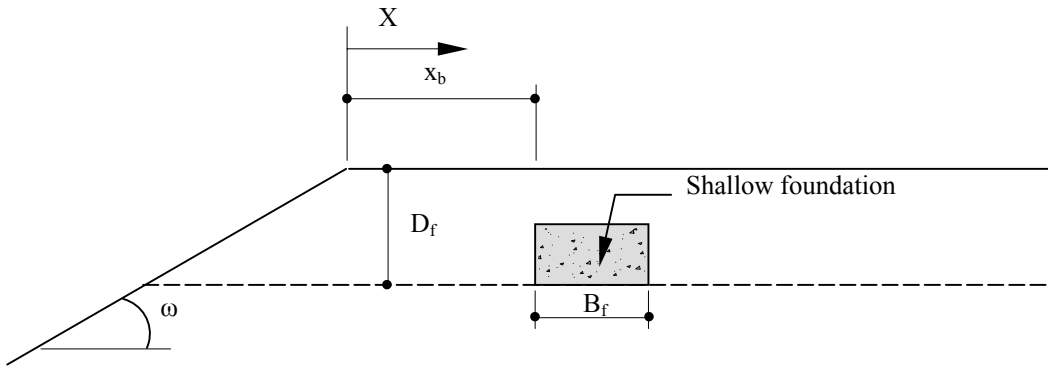

(a) Foundation at a Distance of x_b from Slope Crest

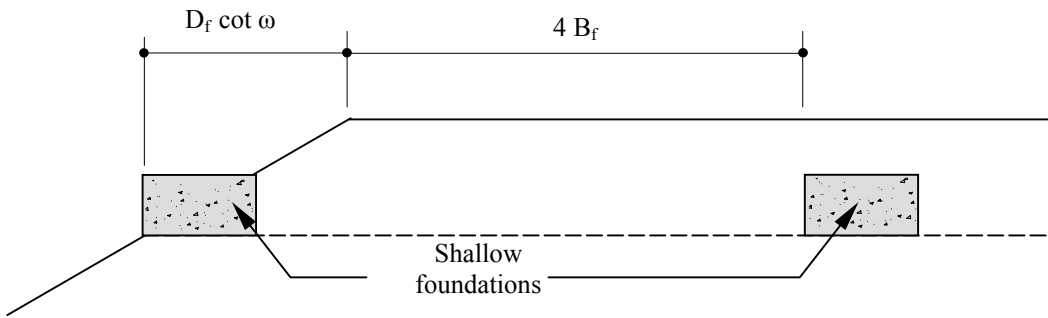

(b) Foundations at the Edge of Slope and at a Distance of $4B_f$ from Slope Crest

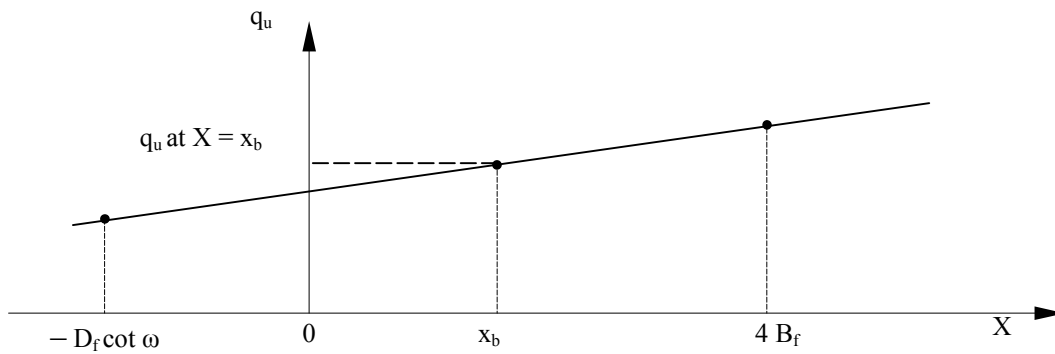

(c) Linear Interpolation of Ultimate Bearing Capacity of Foundation Near a Slope Crest

Figure 3.2 – Linear Interpolation Procedures for Determining Ultimate Bearing Capacity of a Spread Shallow Foundation near the Crest of a Slope

- (c) The importance of the structures and the consequences of their failures. Higher safety factors may be warranted for important structures, such as hospitals.

In general, the minimum required factor of safety against bearing failure of a shallow foundation is in the range of 2.5 to 3.5. For most applications, a minimum factor of safety of 3.0 is adequate. Although the factor of safety is applied to the bearing capacity at failure, it is frequently used to limit the settlement of the foundation. In granular soils, it is more direct to derive the allowable bearing pressure based on settlement consideration.

3.2.4 Settlement Estimation

3.2.4.1 General

Estimation of total and differential settlement is a fundamental aspect of the design of a shallow foundation. Differential settlement and relative rotation between adjacent structural elements should be evaluated. Settlements are considered tolerable if they do not significantly affect the serviceability and stability of the structures under the design load. These performance-based design criteria are best validated with building settlement monitoring.

The total settlement of a shallow foundation usually comprises primary and secondary settlement. The primary settlement results from the compression of the soil in response to the application of foundation loads. In granular soils, the primary settlement that results from an increase in stress is associated with immediate compression. Primary consolidation settlement in fine-grained soils depends on the rate of dissipation of excess pore water pressure caused by the application of foundation loads. The primary consolidation completes when excess pore water pressure is dissipated. Soils continue to deform after the primary settlement and this process is termed as secondary compression, or creep.

Foundation settlement may be estimated based on theory of elasticity or stress-strain behaviour. Most methods tend to over-predict the settlement, as the stiffness of the structure is seldom included in the computation. It is prudent to carry out sensitivity analysis to account for the variability of the ground and loading, and uncertainty of the settlement estimation.

Tilting of a rigid foundation base can be estimated by calculating the settlements at the front and rear edges of the foundation respectively, assuming a linear ground bearing pressure distribution. In addition, Poulos & Davis (1974) provided elastic solutions for assessing the rigidity of the foundation and tilting of the foundation due to an applied moment.

Ground heave due to excavation for foundation construction should be taken into account in evaluating the total settlement. Heave is caused by relief of vertical stress in soils, as the overburden is removed. The response is largely elastic. The net uplift is practically reduced to zero when a ground bearing pressure equal to that of the original overburden is applied. Therefore, the total settlement of a shallow foundation should be assessed using the net loading intensity.

3.2.4.2 Foundations on granular soils

Most methods for computing settlements of foundations on granular soils are based on elastic theory or empirical correlations. Empirical correlations between results of insitu tests and foundation settlement, such as that given by Burland & Burbidge (1985) based on standard penetration tests, generally provide an acceptable solution for predicting the settlement of a shallow foundation on granular soils.

Briaud & Gibbens (1997) reported the results of full-scale loading tests for five square footings founded on sands. The footings ranged in size from 1 m by 1 m to 3 m by 3 m. The measured settlement data from the loading tests were compared with the settlement estimated using various methods, which are empirical correlations based on different types of tests, including SPT, CPT, pressuremeter test, dilatometer test, triaxial test and borehole shear test. They opined that the methods proposed by Burland & Burbidge (1985) using SPT and Briaud (1992) using pressuremeter tests respectively gave reasonably conservative settlement estimation.

Poulos (2000) reviewed various methods for computing settlement of shallow foundations. He noted that although soil behaviour is generally non-linear and highly dependent on effective stress level and stress history and hence should be accounted for in settlement analysis, the selection of geotechnical parameters, such as the shear and Young's modulus of soils, and site characterisation are more important than the choice of the method of analysis. Simple elasticity-based methods are capable of providing reasonable estimates of settlements.

Based on elastic theory, the settlement, δ_f , of a shallow foundation can be calculated using an equation of the following general form :

$$\delta_f = \frac{q_{\text{net}} B_f' f}{E_s} \quad [3.2]$$

where q_{net} = mean net ground bearing pressure
 B_f' = effective width of the foundation
 E_s = Young's modulus of soil
 f = a coefficient whose value depends on the shape and dimensions of the foundation, the variation of soil stiffness with depth, the thickness of compressible strata, Poisson's ratio, the distribution of ground bearing pressure and the point at which the settlement is calculated

Poulos & Davis (1974) gave a suite of elastic solutions for determining the coefficient 'f' for various load applications and stress distributions in soils and rocks.

The increase of stress in soils due to foundation load can be calculated by assuming an angle of stress dispersion from the base of a shallow foundation. This angle may be approximated as a ratio of 2 (vertical) to 1 (horizontal) (Bowles, 1992; French, 1999). The settlement of the foundation can then be computed by calculating the vertical compressive strains caused by the stress increases in individual layers and summing the compression of the layers.

Schmertmann (1970) proposed to estimate the settlement based on a simplified distribution of vertical strain under the centre of a shallow foundation, expressed in the form of a strain influence factor. In this method, the compressive strain in each sub-layer due to the applied stress is evaluated. The settlement of the shallow foundation is then calculated by summing the compression in each sub-layer.

A time correction factor has been proposed by Burland & Burbidge (1985) for the estimation of secondary settlement. Terzaghi et al (1996) also give an equation for estimating secondary settlement in a similar form. The commencement of secondary settlement is assumed to commence when the primary settlement completes, which is taken as the end of construction.

3.2.4.3 Foundations on fine-grained soils

For fine-grained soils, an estimate of the consolidation settlement can be made using the settlement-time curve obtained from an oedometer test. Consolidation settlement may be considered to consist of primary consolidation and secondary consolidation stage. Reference may be made to Duncan & Poulos (1981) and Terzaghi et al (1996) on the methods for determining the primary consolidation of fine-grained soils beneath shallow foundations. The traditional approach of one-dimensional analysis (Terzaghi et al, 1996) has the limitations that only vertical strains are considered and lateral dissipation of excess porewater pressure is ignored. Despite these limitations, Poulos et al (2002) reported that the one-dimensional analysis gave reasonable estimate of the rate of consolidation settlement for soft clay or overconsolidated clay with a Poisson's ratio less than 0.35.

The three-dimensional effect can be simulated by using an equivalent coefficient of consolidation in the one-dimensional analysis (Davis & Poulos, 1972). The equivalent coefficient is obtained by multiplying the coefficient of consolidation with a geometrical rate factor. This method may be adopted where sophisticated three-dimensional analysis is not warranted.

The traditional method proposed by Buisman (1936) is practical in estimating secondary consolidation settlement (Terzaghi et al, 1996; Poulos et al, 2002). In this method, the magnitude of secondary consolidation is assumed to vary linearly with the logarithm of time. It is usually expressed as :

$$s_c = \frac{C_\alpha}{1 + e_o} H_o \log \frac{t_s}{t_p} \quad [3.3]$$

where s_c = secondary consolidation
 C_α = secondary compression index
 e_o = initial void ratio
 H_o = thickness of soils subject to secondary consolidation
 t_p = time when primary consolidation completes
 t_s = time for which secondary consolidation is allowed

Mesri et al (1994) proposed correlating the secondary compression index, C_α , with the

compression index, C_c , at the same vertical effective stress of a soil. They reported that the C_α/C_c ratio is constant for a soil deposit and falls within a narrow range for geotechnical materials (see Table 3.2).

The time at which secondary consolidation is assumed to commence is not well defined. A pragmatic approach is to assume that the secondary consolidation settlement commences when 95% of the primary consolidation is reached (Terzaghi et al, 1996).

Table 3.2 – Values of C_α/C_c for Geotechnical Materials (Mesri et al, 1994)

| Material | C_α/C_c |
|---------------------------|----------------------------------|
| Granular soils | 0.02 ± 0.01 |
| Shale and mudstone | 0.03 ± 0.01 |
| Inorganic clays and silts | 0.04 ± 0.01 |
| Organic clays and silts | 0.05 ± 0.01 |
| Peat and muskeg | 0.06 ± 0.01 |

3.2.5 Lateral Resistance of Shallow Foundations

Lateral resistance of a shallow foundation can be derived from a combination of the sliding resistance at the base and the lateral earth pressure acting on the side of the shallow foundation or drag walls in the direction of loading. Lateral earth pressure requires much larger displacement to be fully mobilised. The estimation of sliding resistance may have to be evaluated based on the residual coefficient of friction, instead of the peak value. Where a shallow foundation relies on the lateral earth pressure to resist lateral load, adequate provisions should be given to ensure that the soils in front of the foundation will not be removed. For these reasons, the design of most shallow foundations conservatively ignores the contribution of the lateral earth pressure. Poulos & Davis (1974) provide elastic solutions to estimate the horizontal displacement of a rectangular area loaded horizontally. These can be used to estimate the horizontal movement due to lateral load.

Sliding resistance between the base of a shallow foundation and granular soils is governed by the coefficient of friction ($\tan \phi$) at the foundation and soils interface. The available base shearing resistance depends on the nature and condition of the soils and the construction materials of the foundation. It is also dependent on the form of the base, e.g. the provision of a tilted base, a drag wall or a shear key affects the base shearing resistance. Guidance on the selection of coefficient of friction for design is given in Geoguide 1: Guide to Retaining Wall Design (GEO, 1993).

3.3 DESIGN OF SHALLOW FOUNDATIONS ON ROCK

The design of shallow foundations resting on rock is usually governed by settlement, sliding and overturning considerations. The bearing capacity of rock is generally not a critical factor in a foundation design. It can be obtained by multiplying the base area with the allowable bearing pressure of the rock. This can be assessed based on the methods given in Section 6.5.3.

Certain types of rock can deteriorate rapidly upon exposure or can slake and soften when in contact with water, e.g. weathered shale, sandstone, siltstone and mudstone. Final excavation to the founding level of a shallow foundation should be protected immediately after excavation with a blinding layer.

The settlement of a shallow foundation resting on rock can be estimated using the elastic theory (Poulos & Davis, 1974). Kulhawy (1978) proposed a geomechanical model for estimating the settlement of foundations on rock. This model provides a means for accounting for the presence of discontinuities and can be used to estimate settlement for foundations on isotropic, transversely isotropic or orthogonally jointed rock masses. The formulation can also be found in Kulhawy & Carter (1992a). Alternatively, the rock mass modulus can be determined from the rock mass rating (see Section 6.5.3.2).

3.4 PLATE LOADING TEST

Guidelines and procedures for conducting plate loading tests are given in BS EN 1997-1:2004 (BSI, 2004) and DD ENV 1997-3:2000 (BSI, 2000b). The test should mainly be used to derive geotechnical parameters for predicting the settlement of a shallow foundation, such as the deformation modulus of soil. It may be necessary to carry out a series of tests at different levels. The plate loading test may also be used to determine the bearing capacity of the foundation in fine-grained soils, which is independent of the footing size. The elastic soil modulus can be determined using the following equation (BSI, 2000b) :

$$E_s = q_{\text{net}} b \frac{(1-\nu_s^2)}{\delta_p} I_s \quad [3.4]$$

where q_{net} = net ground bearing pressure
 δ_p = settlement of the test plate
 I_s = shape factor
 b = width of the test plate
 ν_s = Poisson's ratio of the soil
 E_s = Young's modulus of soil

The method for extrapolating plate loading test results to estimate the settlement of a full-size footing on granular soils is not standardised. The method proposed by Terzaghi & Peck (1967) suggested the following approximate relationship in estimating the settlement for a full-size footing :

$$\delta_f = \delta_p \left(\frac{2B_f}{B_f + b} \right)^2 \quad [3.5]$$

where δ_p = settlement of a 300 mm square test plate
 δ_f = settlement of foundation carrying the same bearing pressure
 B_f = width of the the shallow foundation
 b = width of the test plate

However, the method implies that the ratio of settlement of a shallow foundation to that of a test plate will not be greater than 4 for any size of shallow foundation and this could

under-estimate the foundation settlement. Bjerrum & Eggstad (1963) compared the results of plate loading tests with settlement observed in shallow foundations. They noted that the observed foundation settlement was much larger than that estimated from the method of Terzaghi & Pack (1967). Terzaghi et al (1996) also commented that the method is unreliable and is now recognised to be an unacceptable simplification of the complex phenomena.

3.5 RAFT FOUNDATIONS

A raft foundation is usually continuous in two directions and covers an area equal to or greater than the base area of the structure. A raft foundation is suitable when the underlying soils have a low bearing capacity or large differential settlements are anticipated. It is also suitable for ground containing pockets of loose and soft soils. In some instances, the raft foundation is designed as a cellular structure where deep hollow boxes are formed in the concrete slab. The advantage of a cellular raft is that it can reduce the overall weight of the foundation and consequently the net applied pressure on the ground. A cellular raft should be provided with sufficient stiffness to reduce differential settlement.

Raft foundations are relatively large in size. Hence, the bearing capacity is generally not the controlling factor in design. Differential and total settlements usually govern the design. A common approach for estimating the settlement of a raft foundation is to model the ground support as springs using the subgrade reaction method. This method suffers from a number of drawbacks. Firstly, the modulus of subgrade reaction is not an intrinsic soil property. It depends upon not only the stiffness of the soil, but also the dimensions of the foundation. Secondly, there is no interaction between the springs. They are assumed to be independent of each other and can only respond in the direction of the loads. BSI (2004) cautions that the subgrade reaction model is generally not appropriate for estimating the total and differential settlement of a raft foundation. Finite element analysis or elastic continuum method is preferred for the design of raft foundations (French, 1999; Poulos, 2000).

4. TYPES OF PILE

4.1 CLASSIFICATION OF PILES

Piles can be classified according to the type of material forming the piles, the mode of load transfer, the degree of ground displacement during pile installation and the method of installation.

Pile classification in accordance with material type (e.g. steel and concrete) has drawbacks because composite piles are available. A classification system based on the mode of load transfer will be difficult to set up because the proportion of shaft resistance and end-bearing resistance that occurs in practice usually cannot be reliably predicted.

In the installation of piles, either displacement or replacement of the ground will predominate. A classification system based on the degree of ground displacement during pile installation, such as that recommended in BS 8004 (BSI, 1986) encompasses all types of piles and reflects the fundamental effect of pile construction on the ground which in turn will have a pronounced influence on pile performance. Such a classification system is therefore considered to be the most appropriate.

In this document, piles are classified into the following four types :

- (a) Large-displacement piles, which include all solid piles, including precast concrete piles, and steel or concrete tubes closed at the lower end by a driving shoe or a plug, i.e. cast-in-place piles.
- (b) Small-displacement piles, which include rolled steel sections such as H-piles and open-ended tubular piles. However, these piles will effectively become large-displacement piles if a soil plug forms.
- (c) Replacement piles, which are formed by machine boring, grabbing or hand-digging. The excavation may need to be supported by bentonite slurry, or lined with a casing that is either left in place or extracted during concreting for re-use.
- (d) Special piles, which are particular pile types or variants of existing pile types introduced from time to time to improve efficiency or overcome problems related to special ground conditions.

This Chapter describes the types of piles commonly used in Hong Kong together with their advantages and disadvantages. Other special piles that have been used in Hong Kong for particular site conditions are also described.

4.2 LARGE-DISPLACEMENT PILES

4.2.1 General

The advantages and disadvantages of large-displacement piles are summarised in Table 4.1.

Table 4.1 – Advantages and Disadvantages of Displacement Piles

| Advantages | Disadvantages |
|--|---|
| <u>Large displacement piles</u> | |
| <ul style="list-style-type: none"> (a) Material of preformed section can be inspected before driving. (b) Steel piles and driven cast-in-place concrete piles are adaptable to variable driving lengths. (c) Installation is generally unaffected by groundwater condition. (d) Soil disposal is not necessary. (e) Driving records may be correlated with insitu tests or borehole data. (f) Displacement piles tend to compact granular soils thereby improving bearing capacity and stiffness. (g) Pile projection above ground level and the water level is useful for marine structures and obviates the need to cast insitu columns above the piles. (h) Driven cast-in-place piles are associated with low material cost. | <ul style="list-style-type: none"> (a) Pile section may be damaged during driving. (b) Founding soil cannot be inspected to confirm the ground conditions as interpreted from the ground investigation data. (c) Ground displacement may cause movement of, or damage to, adjacent piles, structures, slopes or utility installations. (d) Noise may prove unacceptable in a built-up environment. (e) Vibration may prove unacceptable due to presence of sensitive structures, utility installations or machinery nearby. (f) Piles cannot be easily driven in sites with restricted headroom. (g) Excess pore water pressure may develop during driving resulting in false set of the piles, or negative skin friction on piles upon dissipation of excess pore water pressure. (h) Length of precast concrete piles may be constrained by transportation or size of casting yard. (i) Heavy piling plant may require extensive site preparation to construct a suitable piling platform in sites with poor ground conditions. (j) Underground obstructions cannot be coped with easily. (k) For driven cast-in-place piles, the fresh concrete is exposed to various types of potential damage, such as necking, ground intrusions due to displaced soil and possible damage due to driving of adjacent piles. |
| <u>Small displacement piles</u> | |
| <ul style="list-style-type: none"> (a) As (a), (b), (c), (d), (e) and (g) for large-displacement piles. (b) Cause less ground disturbance and less vibration. | <ul style="list-style-type: none"> (a) As (a), (b), (d), (e), (f), (i) and (j) for large-displacement piles. |

4.2.2 Precast Reinforced Concrete Piles

Precast reinforced concrete piles are not common nowadays in Hong Kong. These piles are commonly in square sections ranging from about 250 mm to about 450 mm with a maximum section length of up to about 20 m. Other pile sections may include hexagonal, circular, triangular and H shapes. Maximum allowable axial loads can be up to about 1 000

kN. The lengths of pile sections are often dictated by the practical considerations including transportability, handling problems in sites of restricted area and facilities of the casting yard.

These piles can be lengthened by coupling together on site. Splicing methods commonly adopted in Hong Kong include welding of steel end plates or the use of epoxy mortar with dowels. Specially fabricated joints have been successfully used in other countries, e.g. Scandinavia.

This type of pile is not suitable for driving into ground that contains a significant amount of boulders or corestones.

4.2.3 Precast Prestressed Spun Concrete Piles

Precast prestressed spun concrete piles used in Hong Kong are closed-ended tubular sections of 400 mm to 600 mm diameter with maximum allowable axial loads up to about 3 000 kN. Pile sections are normally 12 m long and are usually welded together using steel end plates. Pile sections up to 20 m can also be specially made.

Precast prestressed spun concrete piles require high-strength concrete and careful control during manufacture. Casting is usually carried out in a factory where the curing conditions can be strictly regulated. Special manufacturing processes such as compaction by spinning or autoclave curing can be adopted to produce high strength concrete up to about 75 MPa. Such piles may be handled more easily than precast reinforced concrete piles without damage.

Precast prestressed spun concrete piles have been successfully employed in Hong Kong for many projects in the past. This type of piles is generally less permeable than reinforced concrete piles and may be expected to exhibit superior performance in a marine environment. However, they may not be suitable for ground with significant boulder contents. In such cases, preboring may be required to penetrate the underground obstructions. Spalling, cracking and breaking can occur if careful control is not undertaken and good driving practice is not followed (see Section 8.2.5 for more details).

4.2.4 Closed-ended Steel Tubular Piles

The use of box-section steel piles is not common in Hong Kong but steel tubular piles are becoming increasingly popular, particularly for marine structures.

Steel tubular piles have high bending and buckling resistance, and have favourable energy-absorbing characteristics for impact loading. Steel piles are generally not susceptible to damage caused by tensile stresses during driving and can withstand hard driving. Driving shoes can be provided to aid penetration.

For corrosion protection, steel tubular piles installed in a marine environment may be infilled with reinforced concrete to a level below the seabed and adequate for load transfer between reinforced concrete and steel tube. The steel tube above such level can be considered as sacrificial and ignored for design purposes.

4.2.5 Driven Cast-in-place Concrete Piles

Driven cast-in-place concrete piles are formed by driving a steel tube into the ground to the required set or depth and withdrawing the tube after concrete placement. The tube may be driven either at the top or at the bottom with a hammer acting on an internal concrete or compacted gravel plug. A range of pile sizes is available, up to 600 mm in diameter. The maximum allowable axial load is about 1 400 kN. The maximum length of such piles constructed in Hong Kong is about 30 m.

Proprietary systems of top-driven, cast-in-place piles have been used in Hong Kong. In this method, the steel tube is provided with a loose conical or flat cast-iron shoe which keeps the tube closed during driving. Light blows are usually imparted to the tube during extraction, thus assisting concrete compaction.

For bottom-driven, cast-in-place piles with an expanded base, the tube does not have to withstand direct impact and can be of a smaller thickness. Also, the piling rig does not need to be as tall as rigs for other driven cast-in-place piling systems. When pile driving is completed, the tube is held against further penetration and the bottom plug is driven out by the hammer within the tube. An enlarged pile base is formed using 'dry' mix concrete, with a water/cement ratio of approximately 0.2, which is rammed heavily with the internal hammer.

4.3 SMALL-DISPLACEMENT PILES

4.3.1 General

Small-displacement piles are either solid (e.g. steel H-piles) or hollow (open-ended tubular piles) with a relatively low cross-sectional area. This type of pile is usually installed by percussion method. However, a soil plug may be formed during driving, particularly with tubular piles, and periodic drilling out may be necessary to reduce the driving resistance. A soil plug can create a greater driving resistance than a closed end, because of damping on the inner-side of the pile. The advantages and disadvantages of small-displacement piles are summarised in Table 4.1.

4.3.2 Steel H-piles

Steel H-piles have been widely used in Hong Kong because of their ease of handling and driving. Compared with concrete piles, they generally have better driveability characteristics and can generally be driven to greater depths. H-piles can be susceptible to deflection upon striking boulders, obstructions or an inclined rock surface. In areas underlain by marble, heavy H-pile section with appropriate strengthening at pile toe is commonly used to penetrate the karst surface and to withstand hard driving.

A range of pile sizes is available, with different grades of steel. Commonest allowable axial load is typically about 2 950 kN for Grade 43 steel. Grade 55C steel is gaining popularity and heavy H-pile sections of 223 kg/m with a working load of about 3 600 kN are common nowadays.

4.3.3 Open-ended Steel Tubular Piles

Driven open-ended tubular steel piles have been used in marine structures and in buildings on reclaimed land. This type of pile has been driven to over 50 m. A plug will form when the internal shaft resistance exceeds the end-bearing resistance of the entire cross sectional area the pile. Driving resistance can be reduced by pre-boring or by reaming out the plug formed within the pile. Typical diameters range from 275 mm to about 2 m with a maximum allowable axial load of about 7 000 kN. Maximum pile diameter is often governed by the capacity of the driving machine available.

4.4 REPLACEMENT PILES

4.4.1 General

Replacement, or bored, piles are mostly formed by machine excavation. When constructed in water-bearing soils which are not self-supporting, the pile bore will need to be supported using steel casings, concrete rings or drilling fluids such as bentonite slurry, polymer mud, etc. Excavation of the pile bore may also be carried out by hand-digging in the dry; and the technique developed in Hong Kong involving manual excavation is known locally as hand-dug caissons.

Machine-dug piles are formed by rotary boring, or percussive methods of boring, and subsequently filling the hole with concrete. Piles with 750 mm or less in diameter are commonly known as small-diameter piles. Piles greater than 750 mm diameter are referred to as large-diameter piles.

4.4.2 Machine-dug Piles

The advantages and disadvantages of machine-dug piles are summarised in Table 4.2.

Table 4.2 – Advantages and Disadvantages of Machine-dug Piles

| Advantages | Disadvantages |
|--|--|
| (a) No risk of ground heave induced by pile driving. | (a) Risk of loosening of sandy or gravelly soils during pile excavation, reducing bearing capacity and causing ground loss and hence settlement. |
| (b) Length can be readily varied. | (b) Susceptible to bulging or necking during concreting in unstable ground. |
| (c) Spoil can be inspected and compared with site investigation data. | (c) Quality of concrete cannot be inspected after completion except by coring. |
| (d) Structural capacity is not dependent on handling or driving conditions. | (d) Unset concrete may be damaged by significant water flow. |
| (e) Can be installed with less noise and vibration compared to displacement piles. | (e) Excavated material requires disposal, the cost of which will be high if it is contaminated. |
| (f) Can be installed to great depths. | (f) Base cleanliness may be difficult to achieve, reducing end-bearing resistance of the piles. |
| (g) Can readily overcome underground obstructions at depths. | |

4.4.2.1 Mini-piles

Mini-piles generally have a diameter between 100 mm and 400 mm. One or more high yield steel bars are provided in the piles.

Construction can be carried out typically to about 60 m depth or more, although verticality control will become more difficult at greater depths. Mini-piles are usually formed by drilling rigs with the use of down-the-hole hammers or rotary percussive drills. They can be used for sites with difficult access or limited headroom and for underpinning. In general, they can overcome large or numerous obstructions in the ground.

Mini-piles are usually embedded in rock sockets. Given the small-diameter and high slenderness ratio of mini-piles, the load is resisted largely by shaft resistance. The lengths of the rock sockets are normally designed to match the pile capacity as limited by the permissible stress of steel bars. A mini-pile usually has four 50 mm diameter high yield steel bars and has a load-carrying capacity of about 1 375 kN. Where mini-piles are installed in soil, the working load is usually less than 700 kN but can be in excess of 1 000 kN if post grouting is undertaken using tube-a-manchette.

Pile cap may be designed to resist horizontal loads. Alternatively, mini-piles can be installed at an inclination to resist the horizontal loads. Comments on this design approach are given in Sections 7.5.2.3 and 7.5.3. The structural design of mini-piles is discussed in Sections 6.12.4 and 6.12.5.

4.4.2.2 Socketed H-piles

Socketed H-piles are formed by inserting a steel H-pile section into a prebored hole in rock. The hole should have a diameter adequate to accommodate the steel section plus any necessary cover for corrosion protection. Cover to the pile tip is generally unnecessary and the H-pile section can be placed directly on the rock surface of the prebored hole. The common size of the prebored hole is about 550 mm. The hole is then filled with non-shrink cement grout.

The piles are embedded in rock socket, where shaft resistance is mobilised to support the foundation loads. The allowable working load is usually dictated by the structural capacity of the steel H-pile section. The socketed length can be designed to match the structural requirement. When high grade and heavy steel H-pile section is used, the load-carrying capacity can exceed 5 500 kN.

Socketed H-piles are stronger in flexural strength than mini-piles. They can be designed to resist horizontal loads by their bending stiffness.

4.4.2.3 Continuous flight auger piles

A common piling system of the continuous flight auger (cfa) type piles used in Hong Kong is known as the 'Pact-in-Place (PIP) Pile'. In this system, the bore is formed using a continuous flight auger and concrete or grout is pumped in through the hollow stem as the

auger is withdrawing from the bore. The cfa piles have advantages over conventional bored piles in water-bearing and unstable soils by eliminating the need of casing and the problems of concreting underwater. Sizes of PIP piles range from 300 mm to 700 mm in diameter and their lengths are generally less than 30 m.

PIP piles used in Hong Kong are normally 610 mm in diameter, with a load-carrying capacity up to about 1 500 kN. Once concreted, reinforcement bars or a steel H-pile section may be inserted to provide resistance to lateral load or to increase the load-carrying capacity. These piles can be installed with little noise and vibration and are therefore suited for sites in urban areas. However, this type of piles cannot cope with boulders. The lack of penetration under continuous rotation due to a hard layer or an obstruction can lead to soil flying up the auger causing ground loss and settlement.

4.4.2.4 Large-diameter bored piles

Large-diameter bored piles are used in Hong Kong to support heavy column loads of tall buildings and highways structures such as viaducts. Typical sizes of these piles range from 1 m to 3 m, with lengths up to about 80 m and working loads up to about 45 000 kN. The working load can be increased by socketing the piles into rock or providing a bell-out at pile base. The pile bore is supported by temporary steel casings or drilling fluid, such as bentonite slurry. For long piles, telescopic steel casings are sometimes used to facilitate their extraction during concreting.

Traditionally in Hong Kong, large-diameter bored piles are designed as end-bearing and founded on rock. In reality, for many such bored piles constructed in saprolites, the load is resisted primarily by shaft resistance. Where a pile is designed as frictional, shaft-grouting can be applied to enhance the shaft resistance (see Section 4.5.2 below).

4.4.2.5 Barrettes

A barrette of rectangular section is a variant of the traditional bored pile. The rectangular holes are excavated with the use of grabs or milling machines (Plate 4.1). In Hong Kong, common barrette sizes are 0.8 m x 2.2 m and 1.2 m x 2.8 m, with depths to about 80 m. The length of the barrette can be up to about 6 m, which depends on soil conditions and the stability of the trench supported in bentonite slurry. Because of their rectangular shape, barrettes can be oriented to give maximum resistance to moments and horizontal forces.

Loading tests on barrettes founded in saprolites have demonstrated that significant shaft resistance can be also mobilised (e.g. Pratt & Sims, 1990; Ng & Lei, 2003). A trench scraping unit may be used prior to concreting to reduce the thickness of filter cake that is formed on the soil surface of the trench (Plate 4.2).



Plate 4.1 A Milling Machine



Plate 4.2 A Trench Scraping Unit in Barrette Construction

4.4.3 Hand-dug Caissons

Hand-dug caissons were widely used in the past in Hong Kong as foundations or earth retaining structures. However, they are now used in situations where this is the only practicable solution or there is no safe engineered alternative, and all necessary precautionary measures are taken to safeguard workers against accidents and health hazards (WBTC, 1994; BD, 1995). Their diameters typically range from 1.5 m to 2.5 m, with an allowable load of up to about 25 000 kN. Hand-dug caissons of a much larger size, of between 7 m and 10 m in diameter, have also been constructed successfully (e.g. Humpheson et al, 1986; Barcham & Gillespie, 1988). The advantages and disadvantages of hand-dug caissons are summarised in Table 4.3.

Table 4.3 Advantages and Disadvantages of Hand-dug Caissons

| Advantages | Disadvantages |
|---|--|
| (a) As (a) to (e) for machine-dug piles. | (a) As (a), (c) and (e) for machine-dug piles. |
| (b) Base materials can be inspected. | (b) Hazardous working conditions for workers and the construction method has a poor safety record. |
| (c) Versatile construction method requiring minimal site preparation and access. | (c) Liable to base heave or piping during excavation, particularly where the groundwater table is high. |
| (d) Removal of obstructions or boulders is relatively easy through the use of pneumatic drills or, in some cases, explosives. | (d) Possible adverse effects of dewatering on adjoining land and structures. |
| (e) Generally conducive to simultaneous excavation by different gangs of workers. | (e) Health hazards to workers, as reflected by a high incidence rate of pneumoconiosis and damage to hearing of caisson workers. |
| (f) Not susceptible to programme delay arising from machine down time. | |
| (g) Can be constructed to large-diameters. | |

Hand-dug caisson shafts are excavated using hand tools in stages with depths of up to about 1 m, depending on the competence of the ground. Dewatering is facilitated by pumping from sumps on the excavation floor or from deep wells. Advance grouting may be carried out to provide support in potentially unstable ground. Each stage of excavation is lined with insitu concrete rings (minimum 75 mm thick) using tapered steel forms which

provide a key to the previously constructed rings. When the diameter is large, the rings may be suitably reinforced against stresses arising from eccentricity and non-uniformity in hoop compression. Near the bottom of the pile, the shaft may be belled out to enhance the load-carrying capacity.

The isolation of the upper part of hand-dug caissons by sleeving is sometimes provided for structures built on sloping ground to prevent the transmission of lateral loads to the slope or conversely the build-up of lateral loads on caissons by slope movement (GCO, 1984). However, there is a lack of instrumented data on the long-term performance of the sleeving.

Examples of situations where the use of caissons should be avoided include :

- (a) coastal reclamation sites with high groundwater table,
- (b) sites underlain by cavernous marble,
- (c) deep foundation works (e.g. in excess of say 50 m),
- (d) landfill or chemically-contaminated sites,
- (e) sites with a history of deep-seated ground movement,
- (f) sites in close proximity to water or sewerage tunnels,
- (g) sites in close proximity to shallow foundations, and
- (h) sites with loose fill having depths in excess of say 10 m.

Examples of situations where hand-dug caissons may be considered include :

- (a) steeply-sloping sites with hand-dug caissons of less than 25 m in depth in soil, and
- (b) sites with difficult access or insufficient working room where it may be impracticable or unsafe to use mechanical plant.

In all cases, the desirable minimum internal diameter of hand-dug caissons is 1.8 m.

Before opting for hand-dug caissons, a risk assessment should be carried out covering general safety, the cost of damage arising from dewatering, and the possibility of unforeseen ground conditions. The design of caisson linings should also be examined for suitability as for any other structural temporary works.

A guide to good practice for the design and construction of hand-dug caissons has been produced by the Hong Kong Institution of Engineers (HKIE, 1987). Further discussion on the potential problems during construction of hand-dug caissons is given in Section 8.4.3.

Where hand-dug caissons are employed, consideration should be given to the following precautionary measures and preventive works, as appropriate :

- (a) carrying out additional ground investigation to obtain best possible information about the ground conditions,
- (b) pre-grouting around each hand-dug caisson to reduce the risk of collapse and limit the groundwater drawdown,
- (c) installation of cut-off walls or curtain grouting around the site boundary or around groups of caissons to limit inflow of water,
- (d) installation of dewatering wells within the site, possibly supplemented by recharge wells around the periphery of the site to limit the groundwater drawdown in adjacent ground,
- (e) construction of the caissons in a suitable sequence,
- (f) reduction in the depth of each caisson digging stage,
- (g) provision of immediate temporary support for the excavated face prior to the casting of the concrete liner,
- (h) provision of steel reinforcement to the concrete liner,
- (i) driving dowels radially into the surrounding soil as reinforcement at the bottom of excavation to reduce the chance of heaving,
- (j) provision of a drainage or relief well at the position of each caisson in advance of manual excavation,
- (k) avoidance of the introduction of new caisson gangs into partly completed excavations,
- (l) completion of proper grouting of ground investigation boreholes and old wells in the vicinity of hand-dug caissons,
- (m) provision of good ventilation,
- (n) use of well-maintained and checked equipment,
- (o) safety inspections,
- (p) provision of safety equipment,

- (q) an assessment of the risks by a safety professional to the health and safety of the workers whilst at work in caissons and implementing, monitoring and reviewing the measures to comply with the requirements under all existing safety legislation,
- (r) monitoring and control of the potential health hazards, e.g. poisonous gases, oxygen deficiency, radon and silica dust, and
- (s) monitoring of the ground water table and possibly the ground and sub-soil movement by piezometers and inclinometers installed around the site boundary.

For general guidance on the practicable safety and health measures in the construction of hand-dug caissons, reference may be made to the 'Code of Safe Working Practices for Hand-dug Caissons' published by the Occupational Safety & Health Council (OSHC, 1993).

One of the most important elements in the success of a hand-dug caisson project is the engagement of suitably qualified and experienced professionals in the geotechnical assessment and investigation of the site to identify potentially unfavourable geological and hydrogeological conditions that may give rise to engineering and construction problems, and to implement the necessary precautionary and preventive measures. Likewise, the employment of suitably trained and experienced construction workers, together with adequate supervision to promote strict adherence to stringent safety and health requirements, is also a pre-requisite.

4.5 SPECIAL PILE TYPES

4.5.1 General

Three special pile types, viz. shaft- and base-grouted piles, jacked piles and composite piles, are discussed below.

4.5.2 Shaft- and Base-grouted Piles

Shaft-grouted piles are a variant form of barrettes or bored piles. The load-carrying capacity of these piles mainly relies on the resistance mobilised along the pile shaft. In these piles, grouting is carried out using tube-a-manchette in stages after casting the bored piles or barrettes. A number of foundations in Hong Kong have used shaft-grouting to enhance the shaft resistance in saprolites (e.g. Plumbridge et al, 2000b; Hines, 2000).

Site-specific instrumented trial piles are usually carried out to confirm the design parameters and verify the construction method. Shaft-grouting should not be regarded as a remedial measure to rectify poor construction. Best effort should be made to avoid excessive disturbance to the ground that could affect the development of the shaft resistance in the piles.

Francescon & Solera (1994) described the use of base-grouting to improve the load-carrying capacity of bored piles in London. The operation is similar to shaft-grouting except that the tube-a-manchette grout pipes are installed at the pile base. The grouting action can compact any loose materials at the pile base and slightly lift the pile shaft. However, there are also observations that the grout actually rises along the pile shaft, acting like a shaft-grouted pile (Francescon & Solera, 1994; Teperaksa et al, 1999).

4.5.3 Jacked Piles

Jacked piles are basically displacement piles pushed into ground by static load. While square and circular precast concrete piles are widely used in other countries, steel H-pile sections have dominated the limited local experience. Li et al (2003) summarised the local experience of using jacked piles. Most of them were installed in granitic saprolites.

A pile jacking machine carries tonnes of counterweight and is huge in size (Plate 4.3). It is suitable for sites with fairly large and flat ground. Jacked piles can be installed at a distance of 1.3 m from existing structures.



Plate 4.3 – A Pile Jacking Machine

In Hong Kong, the jacking process is very often taken as an installation method. The piles are then driven to final set by percussive driving. As such, the load-carrying capacity of the jacked piles can be up to about 3 600 kN for a steel H-pile section of 223 kg/m in weight. Li et al (2003) reported the installation of piles entirely by jacking at two sites in a research programme for establishing a termination criterion. These piles terminated in soils with SPT N values ranging between 100 and 200.

Unlike other piles installed by driving, jacked piles have the advantage that they cause little pollution to the environment, such as noise, air and vibration. Static pile loading tests can be conducted by the pile jacking machine but each test occupies the jacking machine for more than three days. The installation of jacked piles is a slow process, particularly when the jacking machine lies idle for cooling of welded joints during pile splicing.

4.5.4 Composite Piles

Some systems of composite piles have been developed to deal with special site conditions. Three types of composite piles that have been used in Hong Kong are discussed below.

The first type is essentially a combination of driven cast-in-place techniques with preformed pile sections in reclamation. In this system, a driven cast-in-place piling tube is installed and the expanded base is concreted. A steel H-pile is then inserted and bedded using light hammer blows. Further concrete is introduced to provide a bond length sufficient to transfer the load from the steel section. The concrete is terminated below the soft deposits and the remainder of the piling tube is filled with sand before it is extracted.

Similar composite construction has also been tried with other driven cast-in-place piling systems in combination with precast concrete sections, which may be sleeved with bitumen, in order to avoid the risk of damage to the coating during driving.

The second type of composite pile is the Steel-Concrete Composite (SC) Pile. This comprises a structural steel casing with a hollow spun concrete core and a solid driving shoe. By combining the advantages of good quality concrete and high strength external steel pipe casing, SC pipe piles can provide better driveability and lateral load resistance but more emphasis has to be placed on corrosion protection. Pile sizes are similar to precast prestressed piles with maximum working loads of about 2 800 kN. The piles can be installed with the centre-augering system (Fan, 1990), which is a non-percussive system with minimal noise and vibrations. The augering and drilling can be carried out in the centre hole of the pile which is jacked into the predrilled hole by a counter weight and hydraulic jack mounted on the machine. The final set can be obtained using a pile driving hammer.

The third type of composite pile is the drill-and-drive system whereby a tubular pile with a concrete plug at pile shoe is first driven close to bedrock. The concrete plug is then drilled out with a down-the-hole hammer. Drilling is continued until it reaches the predetermined founding level. The pile is driven to final set by percussive hammering. Such a system may, in principle, be used to facilitate penetration of cavernous marble in Hong Kong. This composite pile system had been tried in a cavernous marble site in Ma On Shan but was abandoned due to excessive ground settlement and slow progress (Lee & Ng, 2004). It is important to exercise stringent control on the drilling procedure to avoid excessive loss of ground.

If concrete is cast into a steel tube after it has been driven, the allowable capacity of the composite pile will be influenced by strain compatibility requirements. Consideration should be given to the possible effect of radial shrinkage of the concrete which can affect the bond with the steel tube. Shear keys may be used to ensure adequate shear transfer in the case where the upper part of an open-ended steel tube is concreted (Troughton, 1992).

5. CHOICE OF PILE TYPE AND DESIGN RESPONSIBILITY

5.1 GENERAL

This Chapter provides guidance on the factors that should be considered in choosing the most appropriate pile type or using existing piles, when deep foundations are considered necessary. Issues relating to the allocation of design responsibility are also discussed.

5.2 FACTORS TO BE CONSIDERED IN CHOICE OF PILE TYPE

The determination of the need to use piles and the identification of the range of feasible pile types for a project form part of the design process. In choosing the most appropriate pile type, the factors to be considered include ground conditions, nature of loading, effects on surrounding structures and environs, site constraints, plant availability, safety, cost and programme, taking into account the design life of the piles.

Normally, more than one pile type will be technically feasible for a given project. The selection process is in essence a balancing exercise between various, and sometimes conflicting, requirements. The choice of the most suitable type of pile is usually reached by first eliminating any technically unsuitable pile types followed by careful consideration of the advantages and disadvantages of the feasible options identified. Due regard has to be paid to technical, economical, operational, environmental and safety aspects. A flow chart showing the various factors to be considered in the selection of piles is given in Figure 5.1.

It should be noted that possible installation problems associated with the different pile types should not be the sole reason for rejection as these can generally be overcome by adherence to good piling practice and adoption of precautionary measures, albeit at a cost. However, from a technical viewpoint, the choice of piles should be such as to minimise potential construction problems in the given site and ground conditions, and limit the risk of possible delays. Delays are especially undesirable where the project owner is paying financing cost.

5.2.1 Ground Conditions

The choice of pile type is, in most instances, affected by the prevailing ground conditions. The presence of obstructions, existing piles, soft ground, depth of founding stratum, cavities, faults, dykes and aggressive ground can have a significant influence on the suitability of each pile type.

Problems caused by obstructions are common in old reclamations, public dump sites, and ground with bouldery colluvium or corestones in saprolites. Driven piles are at risk of being deflected or damaged during driving. Measures that can be adopted to overcome obstructions are described in Sections 8.2.5.4 and 8.3.4.4.

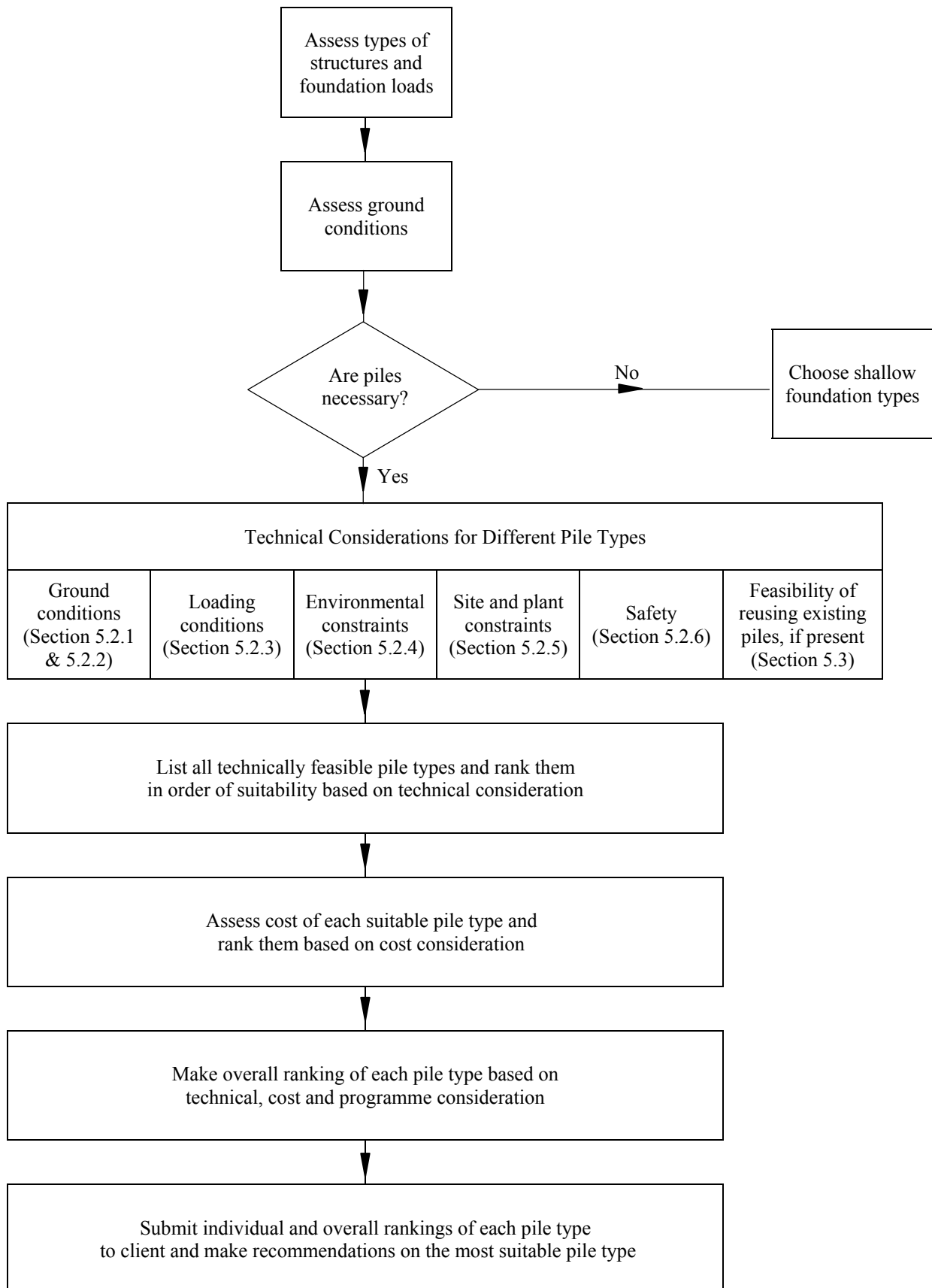

Figure 5.1 – Suggested Procedures for the Choice of Foundation Type for a Site

In soft ground, such as marine mud or organic soils, cast-in-place piles can suffer necking unless care is taken when extracting the temporary casing. Construction of hand-dug caissons can be particularly hazardous because of possible piping or heaving at the base. Machine-dug piles with permanent casings can be used to alleviate problems of squeezing. In these ground conditions, driven piles offer benefits as their performance is relatively independent of the presence of soft ground. However, soft ground conditions may exhibit consolidation settlement which will induce negative skin friction along the shafts of the driven piles. In case the settling strata are of substantial thickness, a large proportion of the structural capacity of the driven piles will be taken up by negative skin friction.

The depth of the founding stratum can dictate the feasibility of certain pile types. Advance estimates of the depth at which a driven pile is likely to reach a satisfactory 'set' are usually made from a rule-of-thumb which relies on SPT results. The SPT N value at which large-displacement piles are expected to reach 'set' is quoted by different practitioners in Hong Kong in the range of 50 to 100, whilst the corresponding N value for steel H-piles to reach 'set' is quoted as two to three times greater.

Barrettes and large-diameter machine-dug piles are generally limited to depths of 60 m to 80 m although equipment capable of drilling to depths in excess of 90 m is readily available.

5.2.2 Complex Ground Conditions

Parts of Ma On Shan and the Northwest New Territories areas are underlain by marble and marble-bearing rocks. The upper surface of marble can be karstic and deep cavities may also be present. The assessment of piling options requires a careful consideration of the karst morphology.

There are three marble-bearing geological units in the Northwest New Territories areas, including Ma Tin Member and Long Ping Member of the Yuen Long Formation and the Tin Shui Wai Member of the Tuen Mun Formation (Sewell et al, 2000; Frost, 1992). The Ma Tin Member is a massively bedded, white to light grey, medium- to coarse-grained crystalline marble, comprising more than 90% of carbonate rock. Karst features are most strongly developed in this pure marble rock.

The Long Ping Member dominantly comprises grey to dark grey, fine- to medium-grained crystalline marble with intercalated bands of calcareous meta-sedimentary rock. Karst features in the Long Ping Member are poorly developed. The impure marble contains up to one third of insoluble residues. These residues have the potential to accumulate and restrict the water flow paths that are opened up by dissolution, thus limiting the development of karst features.

Marble in the Tin Shui Wai Member of the Tuen Mun Formation exists as clasts in volcanoclastic rocks (Frost, 1992; Lai et al, 2004). The marble clasts in the volcanoclastic rocks are generally not interconnected. Dissolution of the marble clasts is localised, typically leading to a honeycomb structure of the rock. This structure does not usually develop into the karst features that are common in marble of the Yuen Long Formation. While large cavities are rare in the volcanoclastic rocks, there are in a few occasions where relatively large

cavities were encountered, which could have geotechnical significance to the design of foundation (Darigo, 1990).

Marble in the Ma On Shan area consists of bluish grey to white, fine- to medium-grained crystalline marble. The marble has been assigned to the Ma On Shan Formation (Frost, 1991; Sewell, 1996). Cavities in the Ma On Shan Formation indicate the development of karst features similar to those of the Ma Tin Member of the Yuen Long Formation in Northwest New Territories. The karstic top of the marble has caused significant engineering problems.

In sites traversed by faults, shear zones or dykes, the geology and the weathering profile can be highly variable and complex. Dykes are especially common in the Lantau Granite, Tai Lam Granite and Sha Tin Granite Formations in the western part of Hong Kong (Sewell et al, 2000).

Complex geological ground conditions may also be encountered in the Northshore Lantau. Weathering of granite and rhyolite dykes associated with faulting may lead to a very deep rockhead profile. In some locations, the rockhead is encountered at depths in excess of 160 m below ground level. In addition, large blocks of meta-sedimentary rock embedded within the intrusive rocks, may contain carbonate and carbonate-bearing rock, including marble. Cavities or infilled cavities can be found in these marble blocks. There have been cases where planned developments were abandoned because of the complex geological ground conditions in the Northshore Lantau area (GEO, 2004; ETWB, 2004).

The choice of piles will be affected by the need to cope with variable ground conditions and the feasibility of the different pile types will be dependent on the capability of the drilling equipment or driveability considerations.

Experience in Hong Kong indicates that heavy steel H-pile sections (e.g. 305 mm x 305 mm x 186 kg/m or 223 kg/m) with reinforced tips can generally be driven to seat on marble surface under hard driving. However, pre-boring may have to be adopted for sites with unfavourable karst features such as large overhangs. Large-diameter bored piles have also been constructed through cavernous marble (e.g. Li, 1992; Lee et al, 2000; Domanski et al, 2002).

Precast concrete piles are prone to being deflected where the rock surface is steeply inclined or highly irregular and may suffer damage under hard driving. Most types of driven cast-in-place piles are unsuitable because of difficulty in seating the piles in sound marble.

The use of hand-dug caissons should be avoided because of the risk of sinkholes induced by dewatering and potential inrush of soft cavity infill. Barrettes may be difficult to construct because of the possibility of sudden loss of bentonite slurry through open cavities.

Corrosion of piles should be a particular design consideration in situations such as those involving acidic soils, industrial contaminants, the splash zone of marine structures and in ground where there is a fluctuating groundwater level (Section 6.14). In general, precast prestressed spun concrete piles, which allow stringent quality control and the use of high strength material, are preferred in aggressive or contaminated ground.

5.2.3 Nature of Loading

Pile selection should take into account the nature and magnitude of the imposed loads. In circumstances where individual spacing between driven piles could result in the problem of 'pile saturation', i.e. piles are arranged in minimum spacing, the use of large-diameter replacement piles may need to be considered.

For structures subject to cyclic and/or impact lateral loading such as in jetties and quay structures, driven steel piles may be suitable as they have good energy-absorbing characteristics.

In the case of large lateral loads (e.g. tall buildings), piles with a high moment of resistance may have to be adopted.

5.2.4 Effects of Construction on Surrounding Structures and Environment

The construction of piles can have damaging or disturbing effects on surrounding structures and environs. These should be minimised by the use of appropriate pile type and construction methods. The constraints that such effects may impose on the choice of pile type vary from site to site, depending on ground conditions and the nature of surrounding structures and utilities.

Vibrations caused by piling are a nuisance to nearby residents and could cause damage to utilities, sensitive electronic equipment and vulnerable structures such as masonry works. Large-displacement piles are likely to produce greater ground vibration than small-displacement and replacement piles.

Construction activities, including percussive piling, are subject to the provisions of the Noise Control Ordinance (HKSARG, 1997). Percussive piling is banned within the restricted hours, i.e. from 7 p.m. to 7 a.m. on weekdays and whole day on Sundays and public holidays. It is only allowed in other times on weekdays provided that the generated noise level at the sensitive receivers does not exceed the acceptance noise level by 10 dB(A) (EPD, 1997). The use of diesel hammers, which are very noisy and prone to emit dark smoke, had been phased out for environmental reasons.

Excavation of hand-dug caissons below the groundwater table requires dewatering. The resulting ground movements may seriously affect adjacent utilities, roads and structures supported on shallow foundations. Closely-spaced piles below the groundwater may dam groundwater flow, leading to a rise in groundwater levels (Pope & Ho, 1982). This may be particularly relevant for developments on steeply-sloping hillsides, especially where grouting has been carried out, e.g. in hand-dug caisson construction. The effect of rise in groundwater on adjacent underground structures like MTR tunnels, e.g. increase in buoyancy, should also be considered.

Installation of displacement piles will result in heave and lateral displacement of the ground, particularly in compact fine-grained sandy silts and clayey soils (Malone, 1990), and may affect adjacent structures or piles already installed. The use of replacement piles will obviate such effects. Should displacement piles be used for other reasons, prefabricated piles,

as opposed to driven cast-in-place piles, may be considered as they offer the option that uplifted piles can be re-driven.

Spoil and contaminated drilling fluid, for replacement pile construction, especially those arising from reclamation area, cause nuisance to surrounding environment and would need to be properly disposed of (EPD, 1994).

5.2.5 Site and Plant Constraints

In selecting pile types, due consideration should be given to the constraints posed by the operation of the equipment and site access.

Apart from mini-piles, all other piles require the use of large piling rigs. The machine for jacking piles carries heavy weights. These may require substantial temporary works for sloping ground and sites with difficult access.

Headroom may be restricted by legislation (e.g. sites near airports) or physical obstructions such as overhead services. In such case, large crane-mounted equipment may not be appropriate. Special piling equipment, such as cranes with short booms and short rectangular grab, are available to construct barrette piles in area with restricted headroom. Alternatively, mini-piles will be a feasible option.

The construction of replacement piles may involve the use of drilling fluid. The ancillary plant may require considerable working space. On the other hand, prefabricated piles similarly will require space for storage and stockpiling. These two types of piles may therefore cause operational problems on relatively small sites.

5.2.6 Safety

Safety considerations form an integral part in the assessment of method of construction. Problems with hand-dug caissons include inhalation of poisonous gas and silica dust by workers, insufficient ventilation, base heave, piping, failure of concrete linings and falling objects (Chan, 1987). Their use is strongly discouraged in general.

Accidents involving collapse or overturning of the piling rigs, which can be caused by overloading, swinging loads, incorrect operation, wind gusts or working on soft or steeply-sloping ground, can result in casualties. Serious accidents may also occur when loads swing over personnel as a result of failure of chain or rope slings due to overloading, corrosion or excessive wear.

Notwithstanding the safety risks and hazards involved in pile construction, it should be noted that most of these can be minimised provided that they are fully recognised at the design stage and reasonable precautions are taken and adequate supervision provided. Vetting of contractor's method statements provides an opportunity for safety measures to be included in the contract at an early stage.

5.2.7 Programme and Cost

The design engineer frequently has a choice between a number of technically feasible piling options for a given site. The overall cost of the respective options will be a significant consideration.

The scale of the works is a pertinent factor in that high mobilisation costs of large equipment may not be cost effective for small-scale jobs. The availability of plant can also affect the cost of the works. Contractors may opt for a certain piling method, which may not be the most appropriate from a technical point of view, in order to optimise the material, equipment and plant available to them amongst the ongoing projects.

The cost of piling in itself constitutes only part of the total cost of foundation works. For instance, the cost of a large cap for a group of piles may sometimes offset the higher cost of a single large-diameter pile capable of carrying the same load. It is necessary to consider the cost of the associated works in order to compare feasible piling options on an equal basis.

A most serious financial risk in many piling projects is that of delay to project completion and consequential increase in financing charges combined with revenue slippage. Such costs can be much greater than the value of the piling contract. The relative vulnerability to delay due to ground conditions, therefore, ought to be a factor in the choice of pile type.

5.3 REUSE OF EXISTING PILES

5.3.1 General

Existing piles can be a significant constraint if they obstruct the installation of new foundations. Removing them can be expensive and time-consuming. In some cases, it is almost impractical or too risky to remove them from the ground. Therefore, reusing existing piles should always be examined. It has the benefits of reducing foundation cost, construction time, as well as construction waste. There were a number of local projects where existing piles, e.g. hand-dug caissons, bored piles, driven steel H- piles and precast concrete piles, were reused successfully.

A preliminary assessment of reusing existing piles should be conducted. The following conditions should be met before proceeding to conduct a detailed investigation of the feasibility of reusing existing piles (Chapman et al, 2004) :

- (a) the availability of reliable as-built records of the existing piles,
- (b) satisfactory performance of the existing piles, in terms of serviceability and durability, and
- (c) reasonable knowledge of the structural layout for the transfer of loads to the existing piles.

In Hong Kong, foundation records for most private developments are kept by the Buildings Department. For public projects, the respective government departments may be approached to obtain the information on existing foundations.

Existing buildings should be surveyed to identify the presence of any problems pertaining to the existing foundations. Repaired cracks or renovation works may conceal the problems. It is worthwhile to interview clients and tenants to understand any potential problems.

While there are obvious benefits in reusing existing piles, the investigation for confirming the conditions of the piles may carry a significant cost. There is a risk that such option would become impractical after the investigation. Reuse of existing piles may not be cost-effective for small developments.

Reuse of existing piles should include an assessment of the structural and geotechnical capacity of the piles (Chapman et al, 2001). The Code of Practice for Foundations (BD, 2004a) outlines the important aspects that need to be addressed when existing piles are to be reused. The as-built records must be verified, as this provides a measurement of the reliability of the existing foundations.

5.3.2 Verifications of Pile Conditions

Boreholes can be sunk to confirm the conditions of the ground and piles. Insitu tests, such as SPT and pressuremeter test, can be conducted for assessing the load-capacity of the piles.

For large-diameter replacement piles, a proofing borehole could be drilled into the shaft of the pile and beyond. This permits the length of the pile to be measured and cores to be recovered for assessing the structural strength and durability of the concrete. In Hong Kong, it is common practice to core-drill all large-diameter replacement piles intended for reuse to assess their load-carrying capacity.

For displacement piles, such as driven steel H-piles and precast prestressed concrete piles, their length can be assessed by dynamic loading tests or low-strain non-destructive tests.

Existing pile caps and ground slabs should be removed to expose the top of the piles. It is common practice to expose 1.5 m of the pile or excavate to a depth measured from the ground of at least twice the least lateral dimension of the piles, whichever is deeper. The piles intended for reuse should not be damaged during the demolition of the existing structure. Their dimensions and physical conditions should be examined. The positions of the existing piles should also be surveyed. Any discrepancy in the positions should be allowed for in subsequent design check.

5.3.3 Durability Assessment

Durability of materials can have a significant impact on the feasibility of reusing existing piles. Material standards may change over time and it is necessary to ensure that the

materials of the existing piles comply with the current standards. Soil and water samples should be collected for chemical tests. If aggressive ground conditions exist, the long-term durability of the piles may be affected. Satisfactory performance in terms of durability in the past does not necessarily guarantee the same performance in the future, particularly if the exposure conditions are changed in the redevelopment project.

In assessing the durability of concrete piles, investigation should uncover any evidence of sulphate and acidic attacks, alkali-aggregate reaction in concrete and corrosion in steel reinforcement. This may include petrographic and chemical analysis of concrete samples and examination of the carbonation depth in the concrete samples.

The discovery of deterioration does not necessarily rule out the possible reuse of existing piles. The extent and impact of the deterioration need to be investigated. Sometimes, remedial measures can reinstate the integrity of the existing piles. For steel piles and steel reinforcement immersed permanently below the groundwater table, excessive corrosion is unlikely due to a low oxygen level. At shallow depth, corroded steel piles and reinforcement can be repaired or replaced. The pile capacity can suitably be reduced to allow for the reduction in cross-sectional area of the steel.

5.3.4 Load-carrying Capacity

For large-diameter replacement piles that are designed as end-bearing piles on rock, the load-carrying capacity can be assessed based on the condition of the rock mass. It is common practice to extend the proofing boreholes below the founding level to check whether weak materials exist within the influence zone of the foundation load. This would enable a reassessment of the allowable bearing pressure of the rock mass.

In the case of small-diameter driven piles, the piles can be redriven to 'set' and then tested by low-strain non-destructive tests to confirm their integrity after redriving. The load-carrying capacity can also be checked by undertaking a CAPWAP analysis for the final set of redriving the piles.

Static loading tests can also be carried out on selected piles. In cases where site constraints prevent the erection of kentledge, reaction piles can be installed for the loading tests. However, it may be more cost-effective to install the new piles to support the new structure than to install reaction piles to load-test existing piles.

All existing piles are essentially load-tested to a certain degree. A reassessment of the structural loads helps to ascertain the actual load that has previously been applied to the existing piles. Such a reassessment is particularly useful when the load-carrying capacity of the existing piles is found to be less than the originally designed capacity, e.g. the rock mass beneath existing end-bearing piles is found to be weaker than the material originally assumed.

5.3.5 Other Design Aspects

If existing piles do not have adequate load-carrying capacity to carry the design load from a new development, new piles may be added. As piles with higher axial stiffness will

carry more loads, piles with very different stiffness should generally be avoided under the same pile cap, e.g. driven steel H-piles should be avoided to supplement existing large-diameter bored piles. The pile load distribution should take into consideration the difference in stiffness between the existing and the new piles. Factors to be considered include the difference in material properties, age effect, size and length of the piles and the deformation behaviour of the existing piles in a reload condition. The structural design should also take into consideration the differential settlements of the piles.

5.4 DESIGN RESPONSIBILITY

5.4.1 Contractor's Design

Traditionally in Hong Kong, 'Contractor's design' is the favoured contractual option for piling works. Under this system, the professional engaged by the client as the project designer provides the tenderers with the relevant information. This includes information on ground conditions, loading, acceptance criteria of the piles in the required loading tests, together with specific constraints on noise, vibration, headroom, access, pile length and verticality. The project designer may, in some instances, choose to rule out those pile types that are obviously unsuitable for the project in the specification.

Under this arrangement, the contractor is required to choose the pile type and design the layout of the piles (sometimes including the pile caps). The construction cost of the pile caps, which depends on the piling layout, should be considered when assessing the contractor's proposal. The contract is usually based on a lump sum under which the contractor undertakes to install the piles to meet the acceptance criteria and is required to bear all the risks in respect of design, construction, cost and programme of the works.

5.4.2 Engineer's Design

Under 'Engineer's design', the design responsibility rests with the project designer. This is the common approach for piling works in government civil engineering contracts and large private building developments. The methods of construction will not be specified in detail but good construction practice and quality control requirements are usually included in the specifications. The project designer will also supervise pile construction and monitor quality control tests, check the general compliance of the works with the specification and the drawings, assess the adequacy of the founding depth of each pile, and verify his design assumptions against field observations.

Where the piles are designed by the project designer, the assumptions made in the design, together with the ground investigation information, should be communicated to the tenderers. The method of construction selected by the contractor must be compatible with the design assumptions. It is essential that the designer is closely involved with the site works to ensure that the agreed construction method is followed and that the necessary design amendments are made promptly.

The contractor is responsible for the workmanship and method of construction, and is required to provide adequate supervision to ensure adherence to the agreed method statement.

Under this arrangement, the re-measurement form of contract is generally adopted and the contractor is reimbursed agreed costs arising from variations as defined in the contract.

The tenderers for a piling contract are usually allowed to submit alternative designs in order that a more cost-effective or suitable solution will not be overlooked. The alternative design will be subject to the agreement of the project designer. In practice, it is usual to undertake preliminary enquiries with potential specialist piling contractors prior to tendering to discuss the range of suitable piling options given the specific constraints on the project. This is particularly useful if the range of specialist piling contractors can be nominated by the project designer, and can help to avoid the submission of technically unsuitable alternative proposals.

5.4.3 Discussions

The benefits of the approach based on 'Contractor's design' include the following :

- (a) The contractor's experience, technical expertise and his knowledge on availability and costs of material, plant and labour associated with a particular pile type can be utilised. Aspects of buildability can be properly assessed by the contractor, particularly where proprietary piling systems are involved.
- (b) There is comparatively less ambiguity in terms of the respective liability of the project designer and the contractor for the performance of the works.
- (c) The client is more certain of the monetary liability involving the construction of the foundations and the contractor will take up the risk in any unforeseeable ground conditions.

The benefits of the approach based on 'Engineer's design' include the following :

- (a) Engineers, when choosing the pile type, may be more objective and are less likely to be restricted by plant availability and past experience in certain pile types, and therefore the best overall piling system will be considered.
- (b) Engineers are less influenced by cost considerations and can concentrate more on the technical grounds. For projects in difficult site and ground conditions requiring significant engineering input, the use of the 'Engineer's design' approach is particularly warranted. This is because the contractor's chosen scheme may involve undue risk of failing to comply with the specified performance criteria.

6. DESIGN OF SINGLE PILES AND DEFORMATION OF PILES

6.1 GENERAL

In Hong Kong, permissible soil and material stresses are prescribed in regulations and codes for the design of piles. In traditional local building practice, the settlement of the pile foundation is customarily not checked, with the implicit assumption that the settlement of a building with piles provided in accordance with the design rules will be tolerable. Empirical pile design rule works well within the database on which it has been developed. When new design requires extrapolating past experience beyond the database, such empirical design may be either needlessly over-conservative or unsafe.

Methods based on engineering principles of varying degrees of sophistication are available as a framework for pile design. All design procedures can be broadly divided into four categories :

- (a) empirical 'rules-of-thumb',
- (b) semi-empirical correlations with insitu test results,
- (c) rational methods based on simplified soil mechanics or rock mechanics theories, and
- (d) advanced analytical (or numerical) techniques.

A judgement has to be made on the choice of an appropriate design method for a given project. In principle, in choosing an appropriate design approach, relevant factors that should be considered include :

- (a) the ground conditions,
- (b) nature of the project, and
- (c) comparable past experience.

This Chapter covers the design philosophies including recommended factors of safety and outlines the various design methods for single piles. Emphasis is placed on pile design methods in granular soils given that granitic soils are generally regarded as granular soils in current Hong Kong practice as far as their general engineering behaviour is concerned. Appropriate design methods for piles in rocks, karstic conditions and clays are also outlined. Recommendations are given on the appropriate pile design methods that may be adopted for use in Hong Kong.

6.2 PILE DESIGN IN RELATION TO GEOLOGY

Geological input is crucial in foundation works and should commence at an early stage of planning of a project. The geology of Hong Kong has been briefly described in

Section 2.2.3. The importance of a representative geological model in the design of pile foundations is highlighted in Section 2.8.

Theoretical methods of pile design have been developed for simple cases such as piles in granular soils, or piles in rock. Judgement should be exercised in applying the simplified pile design methods, having regard to past experience with the use of these methods in specific local geological conditions.

6.3 DESIGN PHILOSOPHIES

6.3.1 General

The design of piles should comply with the following requirements throughout their service life :

- (a) There should be adequate safety against failure of the ground. The required factor of safety depends on the importance of the structure, consequence of failure, reliability and adequacy of information on ground conditions, sensitivity of the structure, nature of the loading, local experience, design methodologies, number of representative preliminary pile loading tests.
- (b) There should be adequate margin against excessive pile movements, which would impair the serviceability of the structure.

6.3.2 Global Factor of Safety Approach

The conventional global factor of safety approach is based on the use of a lumped factor applied notionally to either the ultimate strength or the applied load. This is deemed to cater for all the uncertainties inherent in the design.

The conventional approach of applying a global safety factor provides for variations in loads and material strengths from their estimated values, inaccuracies in behavioural predictions, unforeseen changes to the structure from that analysed, unrecognised loads and ground conditions, errors in design and construction, and acceptable deformations in service.

6.3.3 Limit State Design Approach

A limit state is usually defined as 'any limiting condition beyond which the structure ceases to fulfil its intended function'. Limit state design considers the performance of a structure, or structural elements, at each limit state. Typical limit states are strength, serviceability, stability, fatigue, durability and fire. Different factors are applied to loads and material strengths to account for their different uncertainty.

Both ultimate and serviceability limit states should be considered when undertaking a limit state design for foundations. The ultimate limit state governs the safety of a structure against collapse or excessive deformation of a foundation leading to the collapse of the structure it supports. It should have a very low probability of occurrence. Different failure mechanisms are considered in a limit state design as given below (BSI, 2004) :

- (a) loss of equilibrium of the structure or the ground, in which the strengths of structural materials and the ground are insignificant in providing resistance,
- (b) excessive deformation of foundations, in which the strength of soils are significant in providing resistance,
- (c) excessive deformation of the structure or structural elements, in which the structural strength is significant in providing resistance,
- (d) loss of equilibrium of the structure due to uplift pressure of water or other vertical forces, in which the strength of materials or the ground is not significant in providing resistance, and
- (e) hydraulic failure, internal erosion or piping caused by hydraulic gradients.

The serviceability limit state governs situations beyond which specified functions of a structure or structural elements can no longer be satisfied, e.g. deformation, settlement or vibration exceeding specific values under normal working conditions. The analysis usually involves estimation of deformation.

There are broadly two limit state design methods in geotechnical engineering, viz, the load and resistance factor design method and the load and material factor design method.

In principle, both design methods require the estimation of predicted actions (e.g. dead load, live load, superimposed load or prescribed deformation imposed on structures) and resistance. Uncertainties on the prediction of resistance include factors such as site characterisation, soil behaviour, design methodology and construction effects. Estimation in actions is very often based on structural analysis. The uncertainty in estimating actions is usually less than that in estimating resistance.

The load and resistance factor design method is becoming popular in North America, e.g. Standard Specifications for Highways & Bridges (AASHTO, 2002). In this design approach, resistance factors are applied to ultimate resistance components. The ultimate resistance components are computed based on unfactored material strengths or results of insitu tests. Resistance factors also depend on analytical models used and construction effects. Orr & Farrell (2000) considered that this approach is more reasonable in geotechnical design.

The load and material factor design method applies partial factors to reduce material strengths. Resistance is calculated based on these factored material strengths. This is sometimes known as the European approach, as it is adopted in the Eurocodes, e.g. BS EN 1997-1:2004 (BSI, 2004). Simpson (2000) considered that this approach is better, as it applies factors to the sources of uncertainties.

6.3.4 Discussions on Design Approaches

Many components affect the performance of a foundation, such as material properties, construction effects, and types of actions (e.g. relative movement between structural elements). The global safety factor approach applies a single factor to cater for uncertainties in all components. It inevitably adopts a conservative value. On the contrary, limit state design is more rational as individual components will have different partial factors to account for their uncertainties. In principle, design based on probabilistic methods can better ascertain the margin of safety and identify key parameters that contribute to the uncertainty. However, this requires knowledge of the probability distributions of the key parameters in order to assess the probability of each design criterion being exceeded.

In the past three decades, design codes for concrete structures are largely based on limit state design, e.g. BS 8110 (BSI, 1997) and Code of Practice for the Structural Use of Concrete (BD, 2004d). A partial factor is defined for each type of material and loading to reflect the relative uncertainties. There are merits in adopting limit state design for foundations such that a common design methodology is adopted both for the superstructure and substructure.

There is a growing trend internationally towards adopting limit state design in geotechnical engineering. Many countries have already developed limit state design codes for use in geotechnical engineering (Orr, 2002; Kulhawy & Phoon, 2002; Honjo & Kusakabe, 2002). A framework for adopting limit state design in the geotechnical design of foundations has not yet been developed for local conditions.

In the case of piling, there is the fundamental need to consider movement compatibility as a result of the difference in the rate of mobilisation of shaft and end-bearing resistance. Much larger movements are required to fully mobilise the end-bearing resistance than the shaft resistance. Thus, under working load, the proportion of mobilised shaft and end-bearing resistance will be different. The relative proportion of these two components, which are governed by the limiting movement at working load conditions, may be taken to be 'serviceability' or 'mobilisation' factors.

For practical purposes, piles can be designed on the basis of an adequate global factor of safety against ultimate failure for the time being. An additional check should be made using minimum 'mobilisation' factors to ensure there is a sufficient margin against excessive movement of the pile. It is necessary to estimate the deformation of the foundation to confirm that the serviceability requirements including total and differential movements are met.

6.3.5 Recommended Factors of Safety

The following considerations should be taken into account in the selection of the appropriate factors of safety :

- (a) There should be an adequate safety factor against failure of structural members in accordance with appropriate structural codes.
- (b) There must be an adequate global safety factor on ultimate bearing capacity of the ground. Terzaghi et al (1996) proposed the minimum acceptable factor of safety to be between 2 and 3 for compression loading. The factor of safety should be selected with regard to importance of structure, consequence of failure, the nature and variability of the ground, reliability of the calculation method and design parameters, extent of previous experience and number of loading tests on preliminary piles. The factors as summarised in Table 6.1 for piles in soils should be applied to the sum of the shaft and end-bearing resistance.
- (c) The assessment of working load should additionally be checked for minimum 'mobilisation' factors f_s and f_b on the shaft resistance and end-bearing resistance respectively as given in Table 6.2.
- (d) Settlement considerations, particularly for sensitive structures, may govern the allowable loads on piles and the global safety factor and/or 'mobilisation' factors may need to be higher than those given in (b) & (c) above.
- (e) Where significant cyclic, vibratory or impact loads are envisaged or the properties of the ground are expected to deteriorate significantly with time, the minimum global factor of safety to be adopted may need to be higher than those in (b), (c) and (d) above.
- (f) Where piles are designed to provide resistance to uplift force, a factor of safety should be applied to the estimated ultimate pile uplift resistance and should not be less than the values given in Table 6.1.

The minimum factors of safety recommended for pile design are intended to be used in conjunction with best estimates of resistance (Section 2.9).

Table 6.1 – Minimum Global Factors of Safety for Piles in Soil and Rock

| Method of Determining Pile Capacity | Minimum Global Factor of Safety against Shear Failure of the Ground | | |
|---|--|---------|---------|
| | Compression | Tension | Lateral |
| Theoretical or semi-empirical methods not verified by loading tests on preliminary piles | 3.0 | 3.0 | 3.0 |
| Theoretical or semi-empirical methods verified by a sufficient number of loading tests on preliminary piles | 2.0 | 2.0 | 2.0 |

Notes :

- (1) Assessment of the number of preliminary piles to be load-tested is discussed in Section 6.10.
- (2) Factor of safety against overstressing of pile materials should be in accordance with relevant structural design codes. Alternatively, prescribed allowable structural stresses may be adopted as appropriate.
- (3) In most instances, working load will be governed by consideration of limiting pile movement, and higher factors of safety (or 'serviceability' factors) may be required.

Table 6.2 – Minimum Mobilisation Factors for Shaft Resistance and End-bearing Resistance

| Material | Mobilisation Factor for Shaft Resistance, f_s | Mobilisation Factor for End-bearing Resistance, f_b |
|----------------|--|--|
| Granular Soils | 1.5 | 3 – 5 |
| Clays | 1.2 | 3 – 5 |

- Notes :
- (1) Mobilisation factors for end-bearing resistance depend very much on construction. Recommended minimum factors assume good workmanship without presence of debris giving rise to a 'soft' toe and are based on available local instrumented loading tests on friction piles in granitic saprolites. Mobilisation factors for end-bearing resistance also depend on the ratio of shaft resistance to end-bearing resistance. The higher the ratio, the lower is the mobilisation factor.
 - (2) Noting that the movements required to mobilise the ultimate end-bearing resistance are about 2% to 5% of the pile diameter for driven piles, and about 10% to 20% of the pile diameter for bored piles, lower mobilisation factor may be used for driven piles.
 - (3) In stiff clays, it is common to limit the peak average shaft resistance to 100 kPa and the mobilised base pressure at working load to a nominal value of 550 to 600 kPa for settlement considerations, unless higher values can be justified by loading tests.
 - (4) Where the designer judges that significant mobilisation of end-bearing resistance cannot be relied on at working load due to possible effects of construction, a design approach which is sometimes advocated (e.g. Toh et al, 1989; Broms & Chang, 1990) is to ignore the end-bearing resistance altogether in determining the design working load with a suitable mobilisation factor on shaft resistance alone (e.g. 1.5). End-bearing resistance is treated as an added safety margin against ultimate failure and considered in checking for the factor of safety against ultimate failure.
 - (5) Lower mobilisation factor for end-bearing resistance may be adopted for end-bearing piles provided that it can be justified by settlement analyses that the design limiting settlement can be satisfied.

6.3.6 Planning for Future Redevelopments

The pursuit of a sustainable development requires a good strategy to reduce uncertainties and constraints for future redevelopment. From the viewpoint of sustainable development, shallow foundations should be considered as far as practicable. At present, there is no distinction in term of design life for superstructure and substructure. Where a substructure, such as foundation and basement, is intended for reuse in the future, a longer design life may be specified. A foundation using a smaller number of large-diameter piles would leave more space for installing new piles in future redevelopment.

One of the major obstacles to the reuse of existing foundations is the lack of proper documentation and good records. This leads to many more tests and checks to confirm the integrity of existing piles. As a result, the option imposes more risks to the redevelopment programme. A good strategy for reusing existing piles in the future is to recognise the importance of good record preparation and keeping. The types of documents that should be preserved include :

- (a) ground investigation information and its interpretation,
- (b) material specifications and contractor's method statements,
- (c) as-built piling layout drawings showing locations and dimensions,
- (d) design assumptions and calculations,
- (e) relevant load takedown,
- (f) load and integrity test results, and
- (g) details of non-compliances and how they are overcome.

6.4 AXIALLY LOADED PILES IN SOIL

6.4.1 General

In the evaluation of the ultimate bearing capacity of an axially loaded pile in soil (in corestone-bearing weathering profiles, 'soil' may be taken as zones with a rock content not more than 50%), a number of methods are available :

- (a) pile driving formulae for driven piles,
- (b) wave equation analysis for driven piles,
- (c) calculation methods based on simplifying soil and rock mechanics principles,

- (d) correlation with standard penetration tests (SPT), and
- (e) correlation with other insitu tests such as cone penetration tests and pressuremeter tests.

The satisfactory performance of a pile is, in most cases, governed by the limiting acceptable deformation under various loading conditions. Hence, the settlement of piles should be checked where appropriate. Reference may be made to Section 6.13 for the recommended methods of assessing movements.

In addition to the above methods, the design of piles can also be based on results of preliminary pile loading tests. This is discussed in Section 6.10.

6.4.2 Pile Driving Formulae

Pile driving formulae relate the ultimate bearing capacity of driven piles to the final set (i.e. penetration per blow). Various driving formulae have been proposed, such as the Hiley Formula or Dutch Formula, which are based on the principle of conservation of energy. The inherent assumptions made in some formulae pay little regard to the actual forces, which develop during driving, or the nature of the ground and its behaviour.

Chellis (1961) observed that some of these formulae were based on the assumptions that the stress wave due to pile driving travels very fast down the pile and the associated strains in the pile are considerably less than those in the soil. As a result, the action of the blow is to create an impulse in the pile, which then proceeds to travel into the ground as a rigid body. Where these conditions are fulfilled, pile driving formulae give good predictions. As noted by Chellis, if the set becomes small such that the second condition is not met, then the formulae may become unreliable.

In Hong Kong, Hiley Formula has been widely used for the design of driven piles. The formula is as follow :

$$R_p = \frac{\eta_h \alpha_h W_h d_h}{s + 0.5(c_p + c_q + c_c)} \quad [6.1]$$

- where
- R_p = driving resistance
 - α_h = efficiency of hammer
 - η_h = efficiency of hammer blow (allowing for energy loss on impact)
 - = $\frac{W_h + e^2 (W_p + W_r)}{W_h + W_p + W_r}$
 - e = coefficient of restitution
 - W_p = weight of pile
 - W_r = weight of pile helmet
 - W_h = weight of hammer
 - d_h = height of fall of hammer
 - s = permanent set of pile
 - c_p = temporary compression of pile
 - c_q = temporary compression of ground at pile toe

c_c = temporary compression of pile cushion

The driving hammer should be large enough to overcome the inertia of the pile. In Hong Kong, the allowable maximum final set limit for driven piles in soils is often designed to be not less than 25 mm per 10 blows, unless rock is reached. A heavy hammer or a higher stroke may be used, but this would increase the risk of damaging the piles (Hannigan et al, 1998). Alternatively, a lower final set value (e.g. 10 mm per 10 blows) can be adopted, provided that adequate driving energy has been delivered to the piles. This can be done by measuring the driving stress by Pile Driving Analyzer (PDA), which can also be used to confirm the integrity of the piles under hard driving condition.

Hiley Formula suffers from the following fundamental deficiencies :

- (a) During pile driving, the energy delivered by a hammer blow propagates along the pile. Only the compressive waves that reach the pile toe are responsible for advancing the pile.
- (b) The rate at which the soil is sheared is not accounted for during pile driving. The high-strain rates in cohesive soils during pile penetration can cause the viscous resistance of the soil to be considerably greater than the static capacity of the pile. Poskitt (1991) shows that without considering soil damping, the driving resistance can be overestimated by several times.
- (c) It only considers the hammer ram and the pile as concentrated masses in the transfer of energy. In fact, the driving system includes many other elements such as the anvil, helmet, and hammer cushion. Their presence also influences the magnitude and duration of peak force being delivered to the pile.

Despite these shortcomings, Hiley Formula continues to be widely accepted in Hong Kong. While an adequate depth is usually achieved in fairly uniform soil profiles (Davies & Chan, 1981) using the Hiley Formula, this is not the case for piles driven through thick layers of soft marine clays to the underlying decomposed rocks, and there are a number of cases in Hong Kong of large building settlement and tilting occurring as a direct result of inadequate penetration of the piles into the bearing stratum (Lumb, 1972; Lumb, 1979). Yiu & Lam (1990) noted from five piles load-tested to failure that the comparison of the measured pile capacity with that predicted by Hiley Formula was variable and inconsistent. Extreme caution should be exercised in placing total reliance on the use of pile driving formulae without due regard to the ground conditions. Problems may also occur where a pile is driven to a set on a corestone, overlying medium dense saprolites, or where depth of soil is thin so the pile is driven to set on rock at shallow depth.

Some of the shortcomings of driving formulae can be overcome by a more sophisticated wave equation analysis. It is recommended that driving of selected piles should be measured using a Pile Driving Analyzer together with wave equation analysis, such as

CASE method and CAse Pile Wave Analysis Program (CAPWAP) (see Section 9.4.3.2 & 9.4.3.3). These can be used to supplement the information on the pile driving system, such as the rated energy of the hammer and dynamic response of soil.

HKCA (2004) proposed to measure directly the energy transfer of a hammer blow by PDA. Such an approach has the advantage that the actual energy impacted on the pile is measured. Variations on the temporary compression of the cushion, the efficiency of hammer and the coefficient of restitution are no longer relevant. This is sometimes termed as energy approach formula and is written as :

$$R_p = \frac{EMX}{s + 0.5 (c_p + c_q)} \quad [6.2]$$

where EMX = the maximum energy transferred

The EMX can be determined based on measurements taken in a number of PDA tests during trial piling and the measurements processed statistically to find an average value. PDA tests should also be carried out on a selected number of working piles at final set. This can confirm the validity of the EMX value used in the formula. This formula is also suitable for driving piles by hydraulic hammers. Fung et al (2005) compared the load-carrying capacity predicted by the energy approach formula with that determined by static loading tests. They concluded that the energy approach formula tends to overestimate the load-carrying capacity.

Paikowsky & Chernauskas (1992) discussed an approach similar to Equation [6.2]. This approach considers only the energy losses of the pile-soil system. As energy losses due to the dynamic action are not included, the energy approach formula may be regarded as the maximum possible resistance. In order to account for all dynamic related energy losses, they suggested using a correction factor of 0.8, to reduce the capacity obtained by Equation [6.2]. This correction factor should be used unless site-specific measurements are taken to verify other values.

Based on the comparison of results of static loading tests and dynamic loading tests with CAPWAP analysis, Fung et al (2004) concluded that CAPWAP analysis was a reasonably accurate tool in predicting load-carrying capacity of driven piles. They proposed using CAPWAP analysis to calibrate the e and η_h values in Hiley Formula. The selected combination in Hiley Formula should give a pile capacity not greater than 85% of the pile capacity determined by CAPWAP analysis. They also recommended that the efficiency of the hammer blow, η_h , should not be greater than 0.98. This approach is adopted in piling projects managed by Architectural Services Department (ArchSD, 2003). The procedures can be considered as fitting parameters to match the load-carrying capacity predicted by CAPWAP analysis. The piling study undertaken by Fung et al (2004) principally involved driving grade 55C H-pile sections of 305 x 305 x 180 kg/m in size. The reliability of extending this approach to other heavier pile sections needs to be further established (HKCA, 2004).

According to dynamic stress-wave theory, it is not rational to take into account the full weight of a pile in Hiley Formula where the pile length exceeds about 30 m. For very long piles, Cornfield (1961) proposed a modification of Hiley Formula that involves

assuming a constant effective pile length instead of the full pile length. For such piles, it would be more rational, in principle, to undertake a wave equation analysis as described in Section 6.4.3 below.

The final set of a pile, particularly where the pile driving formula has been calibrated against satisfactory static loading test results and corresponding borehole information, will be useful as a site control measure. Experience suggests that driving to a target set pre-determined by a pile driving formula can help to ensure no 'slack' in the pile-soil system compared to the case of driving the pile to a pre-determined length only. Li (2005) observed that piles driven to a set smaller than that pre-determined by pile driving formulae were more likely to have met the residual settlement criterion (BD, 2004a) in subsequent pile loading tests.

6.4.3 Wave Equation Analysis

A wave equation analysis based on the theory of wave propagation (Figure 6.1) can be undertaken to assess pile behaviour during driving. It simulates the hammering of a pile with generalised information of hammer characteristics. A bearing graph is usually produced, which depicts the pile capacity against penetration resistance. In this approach, the pile behaviour during driving is modelled, taking into account factors such as driving energy delivered to the pile at impact, propagation of compressive and tensile waves, soil static resistance along the pile shaft and resistance below the pile toe, as well as dynamic behaviour of soil as a viscous body. The actual pile penetration at final set is measured on site to determine the pile capacity, which is a function of pile penetration resistance as given in the bearing graph.

The pile capacity is pre-determined (e.g. based on allowable structural stresses or soil mechanics principles) and is used as an input parameter in the wave equation analysis (Hannigan et al, 1998). The reliability of the results depends on the appropriateness of the model and the accuracy of the input data, including the ground properties. It should be noted that some soil parameters pertaining to wave equation analysis are 'model dependent' empirical values and may not be measured directly. The rated hammer energy in commercial programs can differ substantially from actual performance, but it can be measured by PDA tests during trial piling.

6.4.4 Use of Soil Mechanics Principles

6.4.4.1 General

The ultimate bearing capacity of a pile may be assessed using soil mechanics principles. The capacity may be assumed to be the sum of shaft resistance and end-bearing resistance.

6.4.4.2 Critical depth concept

The shaft resistance and end-bearing resistance in a uniform soil may generally be

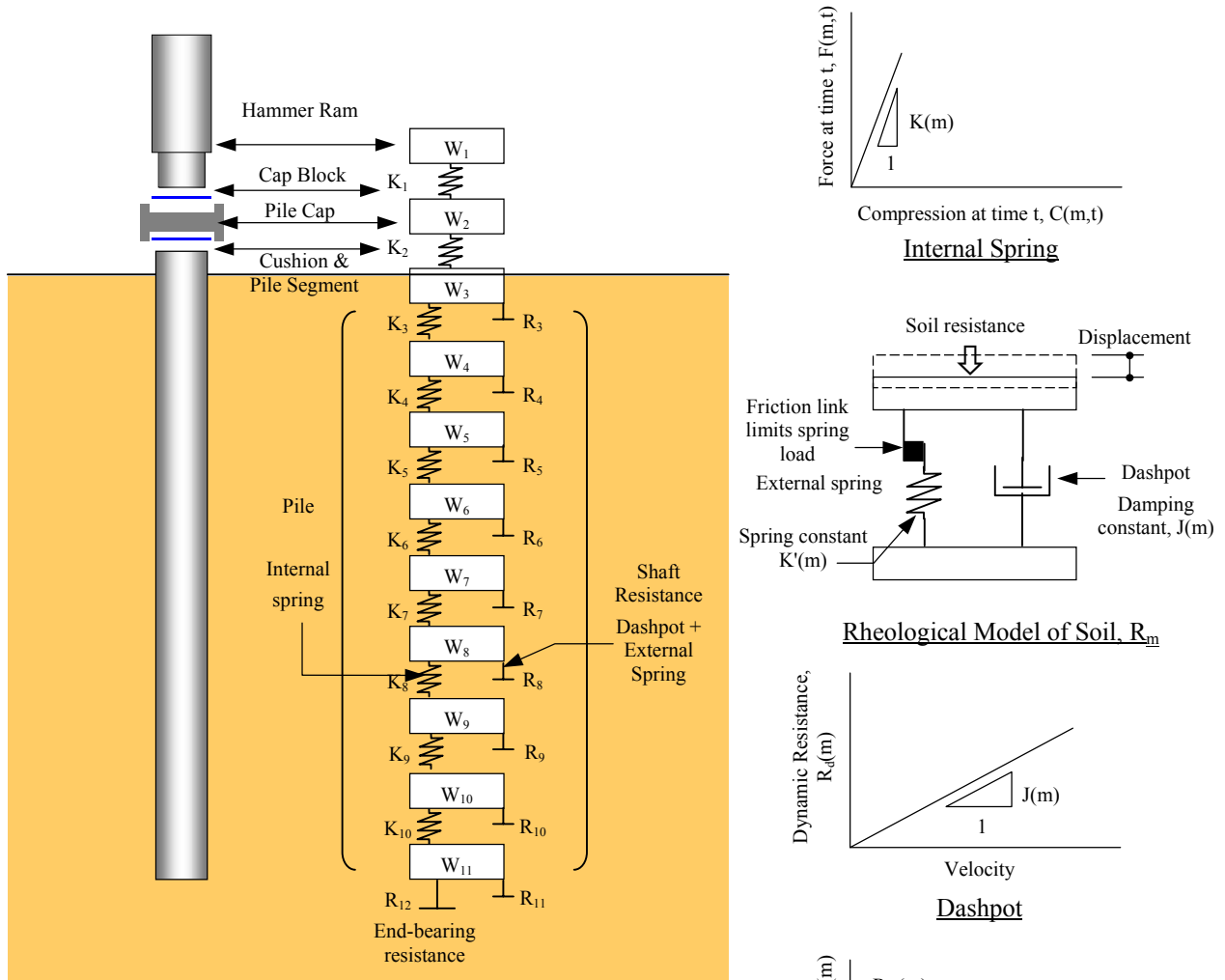

Basic wave equations generally adopted for pile driving analysis are :

$$D(m,t) = D(m,t-1) + \Delta t v(m,t-1)$$

$$C(m,t) = D(m,t) - D(m+1,t)$$

$$F(m,t) = C(m,t) K(m)$$

$$v(m,t) = v(m,t-1) + [F(m,t) + W(m) - F(m,t) - R(m,t)] \frac{g\Delta t}{W(m)}$$

With no damping, $R(m,t) = [D(m,t) - D'(m,t)] K'(m)[1 + J(m) v(m,t-1)]$

With damping, $D(m,t) = G'(m)$, $R(m,t) = [D(m,t) - D'(m,t)]K'(m) + J(m) R_{su}(m) v(m,t-1)$

Legend :

m = element number

t = time

g = acceleration caused by gravity

K(m) = spring constant for internal spring m

W(m) = weight of element m

v(m,t) = velocity of element m at time t

D(m,t) = displacement of element m at time t

D'(m,t) = plastic displacement of external spring (i.e. the surrounding ground) m at time t

R(m,t) = force exerted by external spring m on element m at time t

R_d(m) = dynamic resistance of element m

J(m) = soil-damping constant at element m

Δt = time interval considered

C(m,t) = compression of internal spring m at time t

K'(m) = spring constant for external spring m

F(m,t) = force in internal spring at time t

v(m,t-1) = velocity of element m at time t-1

D(m,t-1) = displacement of element m at time t-1

G'(m) = quake for external spring m (or maximum elastic soil deformation)

R_{su}(m) = ultimate static resistance of external soil spring m

Figure 6.1 – Wave Equation Analysis

expected to be directly proportional to vertical effective stress. Based on model tests on piles in granular materials, Vesic (1967) suggested that beyond a critical depth there will be little increase in both shaft resistance and end-bearing resistance.

However, Kulhawy (1984) concluded from theoretical considerations that the shaft resistance and end-bearing resistance do not reach a limit at the so-called critical depth. The shaft resistance generally increase with depth. The apparent limiting value in shaft resistance is due to the decreasing coefficient of at-rest pressure with depth, which is evident in overconsolidated sands. In examining the available test results, Kraft (1991) considered that there are no data from full-scale field tests that provide conclusive evidence of limiting values for shaft and end-bearing resistance. However, he found that the rate of increase in resistance, especially the end-bearing resistance, appears to decrease with increasing depth in a homogeneous sand. Similarly, Altaee et al (1992a & b) and Fellenius & Altaee (1995) concluded from analysis of instrumented piles that the critical depth concept is not valid when corrections are made for residual stresses in the piles. On the other hand, Kraft (1990) suggested that calcareous sands, which are prone to crushing due to pile driving, may lose strength with depth. This will offset the strengthening effect due to increases in overburden stresses. It will give a distribution of shaft resistance similar to that found if applying the critical depth concept. However, the phenomenon should not be attributed to the critical depth concept.

The critical depth phenomenon is now attributed to factors such as collapse of soil structures, variations of horizontal in-situ stresses in soils and residual stress in piles. For practical purposes, no specific allowance for critical depth effects on shaft resistance is needed. The effect of the variation in horizontal in-situ stresses with depth should be recognised, particularly for overconsolidated soils.

6.4.4.3 Bored piles in granular soils

Based on plasticity theories, the ultimate end-bearing resistance, q_b , for piles in granular soils may be expressed in terms of vertical effective stress, σ_v' , and the bearing capacity factor, N_q as :

$$q_b = N_q \sigma_v' \quad [6.3]$$

N_q is generally related to the angle of shearing resistance, ϕ' . Values of N_q factor quoted in the literature vary considerably. N_q can be determined based on the bearing capacity factor in Table 3.1. Davies & Chan (1981) suggested the values presented by Brinch Hansen (1970), while both Poulos & Davis (1980) and Fleming et al (1992) recommended the use of factors derived by Berezantzev et al (1961), which is also supported by Vesic (1967). Poulos & Davis (1980) further suggested that for the determination of N_q , the value of ϕ' should be reduced by 3° to allow for possible loosening effect of installation. For general design purposes, it is suggested that the N_q values based on Poulos & Davis (1980) as presented in Figure 6.2 may be used.

The calculated ultimate end-bearing resistance should conservatively be limited to 10 MPa, unless higher values have been justified by loading tests. It is prudent to apply an upper limit on the q_b value because the angle of shearing resistance and hence the end-

bearing resistance may be reduced due to suppressed dilation and possible crushing of soil grains at high pressure.

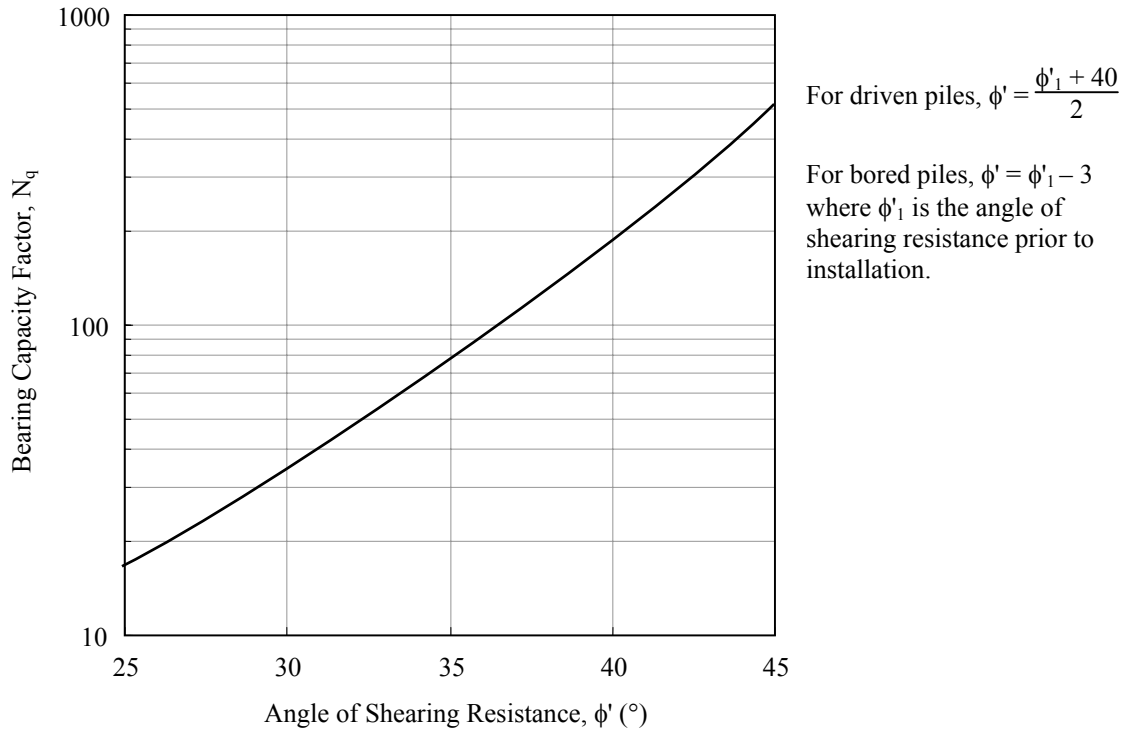

Figure 6.2 – Relationship between N_q and ϕ' (Poulos & Davis, 1980)

The ultimate shaft resistance (τ_s) for piles in granular soils may be expressed in terms of effective stresses as follows :

$$\tau_s = c' + K_s \sigma_v' \tan \delta_s \quad [6.4]$$

$$\tau_s = \beta \sigma_v' \text{ (where } c' \text{ is taken as zero)} \quad [6.5]$$

where K_s = coefficient of horizontal pressure which depends on the relative density and state of the soil, method of pile installation, and material, length and shape of the pile

σ_v' = mean vertical effective stress

δ_s = angle of interface friction along pile/soil interface

β = shaft resistance coefficient

The angle of interface friction is primarily a function of the nature of pile material and the state of the ground, and it can be reasonably determined in a shear box test (Lehane, 1992). For bored piles in granular soils, δ_s can be taken as equal to the friction angle of the shearing resistance, ϕ' . K_s may be related to the coefficient of earth pressure and the ratio K_s/K_0 varies between 0.67 and 1 (Kulhawy, 1984). The determination of K_0 is notoriously difficult as it is a function of stress history and not a fundamental soil property. In the case of

saprolites, the K_o value may be lower than that given by the conventional formula $K_o = 1 - \sin \phi'$ due to possible effects of bonding (Vaughan & Kwan, 1984). This is supported by deduction from field measurements in Hong Kong as reported by Endicott (1982) and Howat (1985).

It should be noted that the K_s value is a function of the method of pile construction. In view of the uncertainties associated with assessing K_o and the effects of construction method, it may be more reasonable to consider the combined effect as reflected by the β values deduced from loading tests on piles in saprolites. It must be noted that in relating τ_s to σ_v' with the use of the β factor, it is assumed that there is no cohesion component (c'). Although there may be some cohesion for undisturbed saprolites, the effect of construction on c' of the soil at the interface with the pile is difficult to evaluate and may be variable. The β values back analysed from pile loading tests would have included any contribution from c' in the measured τ_s .

So (1991) postulated that the shaft resistance of a pile in a bonded soil such as dense saprolites may be dominated by the increase in horizontal stresses due to its tendency to dilate during shearing. This may explain isolated loading test results (e.g. Holt et al, 1982; Sweeney & Ho, 1982) which indicated a continual increase in shaft resistance at large relative displacement of up to about 4% of pile diameter (viz. 39 mm). Based on cavity expansion theory, So (1991) suggested that the dilation and hence the shaft resistance in a small-diameter pile will be greater than that in a large-diameter pile. At present, this remains a conceptual model and has not been sufficiently validated by loading test results. However, it is possible that this dilation effect compensates the small insitu stresses in the saprolites such that pile capacity is broadly similar to that in a sedimentary granular deposit. On the other hand, Nicola & Randolph (1993) and Lehane & Jardine (1994) discussed the effect of pile stiffness on the mobilisation of shaft resistance.

Table 6.3 summarises the range of β values interpreted from the pile loading tests conducted in saprolites in Hong Kong. These values are comparable to those suggested by Meyerhof (1976) for bored piles in granular soils (Figure 6.3). These values may be used for bored piles in granular soils.

Available instrumented loading test data from large-diameter bored piles in saprolites (Appendix A) indicate that substantial shaft resistance is mobilised at a relative pile-soil movement of about 1% pile diameter (about 10 to 15 mm), in many cases. Based on the available loading test results in Hong Kong, it is suggested that the calculated average ultimate shaft resistance should be limited to 150 kPa for granitic saprolites unless a higher value can be justified by site-specific loading tests. Plumbridge et al (2000a) reported the results of loading tests on shaft-grouted bored piles and barrettes for the West Rail project. The maximum shaft resistance measured was 220 kPa. For preliminary design of piles in saprolites, the typical values given in Tables 6.3 may be used to calculate the shaft resistance using the effective stress method. It should be noted that values of β in Table 6.3, are based on back analysis of field test data. Therefore, the effective stress method is essentially a semi-empirical design approach.

Table 6.3 – Typical Values of Shaft Resistance Coefficient, β , in Saprolites and Sand

| Type of Piles | Type of Soils | Shaft Resistance Coefficient, β |
|---------------------------------------|---|---------------------------------------|
| Driven small displacement piles | Saprolites | 0.1 – 0.4 |
| | Loose to medium dense sand ⁽¹⁾ | 0.1 – 0.5 |
| Driven large displacement piles | Saprolites | 0.8 – 1.2 |
| | Loose to medium dense sand ⁽¹⁾ | 0.2 – 1.5 |
| Bored piles & barrettes | Saprolites | 0.1 – 0.6 |
| | Loose to medium dense sand ⁽¹⁾ | 0.2 – 0.6 |
| Shaft-grouted bored piles & barrettes | Saprolites | 0.2 – 1.2 |

Notes : (1) Only limited data is available for mobilised shaft resistance measured in loose to medium dense sand.

(2) Refer to Appendix A for details.

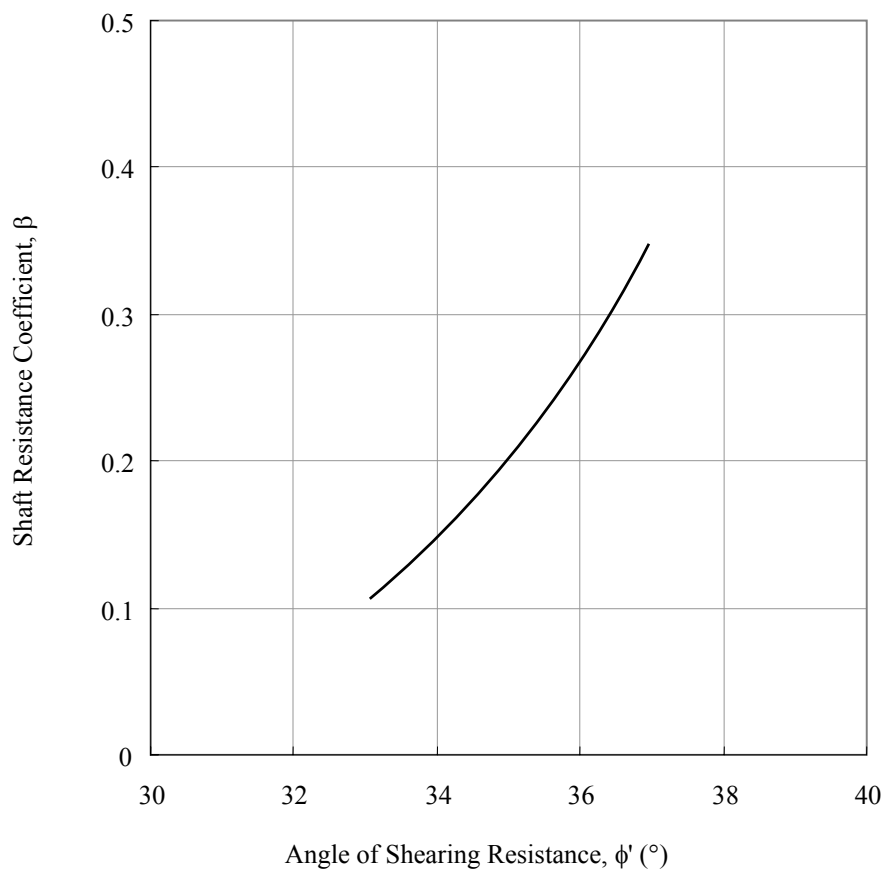

Figure 6.3 – Relationship between β and ϕ' for Bored Piles in Granular Soils (Figure adopted from Poulos & Davis (1980) based on interpretation of results given by Meyerhof (1976))

It should be cautioned that data also exist in Hong Kong for large-diameter bored piles showing very low shaft resistance in dense to very dense granitic saprolites, although it is possible that these were a result of problems associated with pile construction. In view of the possible adverse effects of construction, the assumptions concerning design parameters, construction method and workmanship should be verified by load testing of instrumented piles when friction bored piles are proposed, until sufficient local experience has been built up.

The behaviour of piles in colluvium may be greatly affected by the presence of boulders (e.g. Chung & Hui, 1990). However, a lower bound estimate may be made based on the properties of the matrix material and using the effective stress method for design.

6.4.4.4 Driven piles in granular soils

The concepts presented for the calculation of end-bearing and shaft resistance for bored piles in granular soils also apply to driven piles in granular soils. The main difference lies in the choice of design parameters, which should reflect the pile-soil system involving effects of densification and increase in horizontal stresses in the ground due to pile driving.

Methods have been put forward by Fleming et al (1992) and Randolph et al (1994) to account for the dependence of ϕ' on stress level in the determination of end-bearing resistance. Fleming et al's method, which involves an iterative procedure, relates ϕ' to the relative density of soil corresponding to the mean effective stress at failure at pile toe level, and critical state friction angle, ϕ_{cv}' . It should be cautioned that this approach involves generalization of the stress dilation behaviour of granular material. Experience of applying this approach to pile design in Hong Kong is limited.

For end-bearing capacity calculation, the N_q values given in Figure 6.2 can be used. Kishida (1967) suggested that for the determination of N_q , the value of ϕ' can be taken as the average of the ϕ' value prior to driving and 40° , to allow for the influence on ϕ' due to pile driving. The calculated ultimate end-bearing resistance should be limited to 15 MPa (Tomlinson, 1994). McNicholl et al (1989b) stated that limited loading tests on driven piles in Hong Kong suggested that the q_b values can range from 16 MPa to over 21 MPa. Apart from these observations, pile loading tests on driven piles are customarily loaded to twice the working load. The pile capacities proven in the loading tests suggest that higher q_b values can be achieved.

In the event that the pile is founded within a competent stratum but is within ten pile diameters from a weak stratum (either above or below the founding stratum), the calculated ultimate end-bearing capacity should be adjusted according to the procedure put forward by Meyerhof (1976; 1986).

The results of pile loading tests on driven piles in granular soils are subject to considerable scatter, generally more so than for bored piles (Meyerhof, 1976). There is a range of proposed design methods relating β values to ϕ' which can give very different results. For driven piles in saprolites, the design may be carried out using Table 6.3, having regard to the type of pile, consistency of material and previous experience. There is a distinct difference between β values for driven precast prestressed concrete piles and driven steel H-

piles (see Table 6.3).

6.4.4.5 Bored piles in clays

The shaft resistance of bored piles in clays develops rapidly with pile settlement and is generally fully mobilised when the pile settlement is about 0.5 percent of pile diameter. On the contrary, the end-bearing resistance is not mobilised until the pile settlement amounts to 4 percent of the base diameter (Whitaker & Cooke, 1966; Kulhawy & Hirany, 1989).

The ultimate end-bearing resistance for piles in clays is often related to the undrained shear strength, c_u as follows :

$$q_b = N_c c_u \quad [6.6]$$

where N_c may generally be taken as 9 when the location of the pile base below the ground surface exceeds four times the pile diameter. For shorter piles, the N_c factor may be determined following Skempton (1951).

The ultimate shaft resistance (τ_s) of piles in stiff overconsolidated clays can be estimated based on the semi-empirical method as follows :

$$\tau_s = \alpha c_u \quad [6.7]$$

where α is the adhesion factor. Based on back analyses of loading tests on instrumented bored piles, Whitaker & Cooke (1966) reported that the α value lies in the range of 0.3 to 0.6, while Tomlinson (1994) and Reese & O'Neill (1988) reported values in the range of 0.4 to 0.9. In the above correlations, the c_u is generally determined from unconsolidated undrained triaxial compression tests. Kulhawy & Phoon (1993) correlated α with undrained shear strength determined from isotropically consolidated undrained compression tests. The effects of sample size on c_u are discussed by Patel (1992).

The above design method suffers from the shortcoming that c_u is dependent on the test method and size of specimens. Caution should be exercised in extrapolating beyond the bounds of the database.

Burland (1973) suggested that an effective stress analysis is more appropriate for piles in stiff clays as the rate of pore-pressure dissipation is so rapid that for normal rates of load application, drained conditions generally prevail in the soil adjacent to the pile shaft. Burland & Twine (1989) re-examined the results of a large number of tests on bored piles in overconsolidated clays and concluded that the shaft resistance in terms of effective stress corresponds to angles of shearing resistance which are at or close to the residual angle of shearing resistance (ϕ_r'). The value of shaft resistance for bored piles in an overconsolidated clay may therefore be estimated from the following expression :

$$\tau_s = K_s \sigma_v' \tan \phi_r' \quad [6.8]$$

where K_s can be assumed to be K_0 and σ_v' is the vertical effective stress.

The above is also supported by instrumented pile loading test results reported by O' Riordan (1982).

Both the undrained and effective stress methods can generally be used for the design of piles in clays. The use of the undrained method relies on an adequate local database of test results. In the case where piles are subject to significant variations in stress levels after installation (e.g. excavation, rise in groundwater table), the use of the effective stress method is recommended, taking due account of the effects on the K_s values due to the stress changes.

6.4.4.6 Driven piles in clays

Field studies of instrumented model piles carried out to investigate the fundamental behaviour of driven cylindrical steel piles in stiff to very stiff clays (e.g. Coop & Wroth, 1989; Lehane, 1992) indicated that a residual shear surface is formed along or near the shaft of a pile during installation. Bond & Jardine (1991) found the shear surfaces to be discontinuous when the pile is driven or jacked into the ground rapidly but to be continuous when the jacking is carried out slowly. The observed instrumented model pile behaviour has been summarised by Nowacki et al (1992). A design curve is put forward by Nowacki et al (1992) as shown in Figure 6.4.

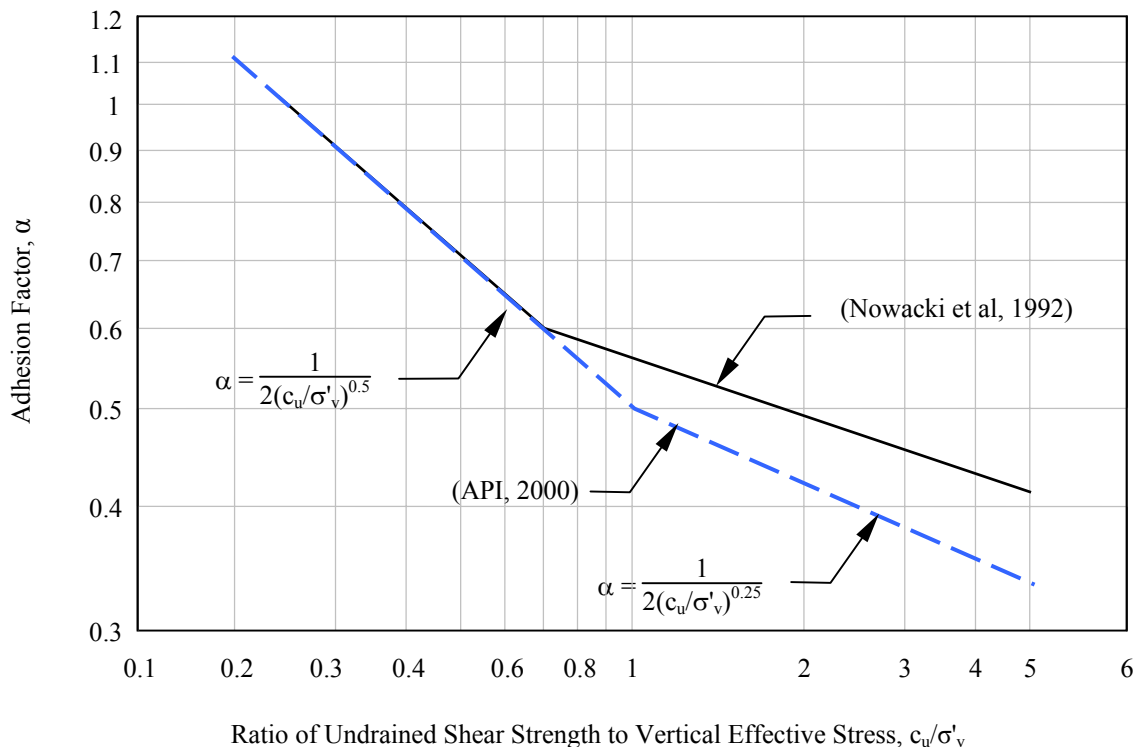

Figure 6.4 – Design Line for α Values for Piles Driven into Clays

The piling guide by American Petroleum Institute (API, 2000) included more recent instrumented pile loading tests to the pile database compiled by Randolph & Murphy (1985). The API method provides a correlation between α and c_u/σ'_v , which is widely used in offshore

infrastructures. σ'_v is the vertical effective stress. The shaft resistance for driven piles in clay can be determined by using Equation [6.7] with α based on the API method.

6.4.4.7 Other factors affecting shaft resistance

Fleming & Sliwinski (1977) suggested that the shaft resistance, as calculated from effective stress analysis, on bored piles constructed using bentonite slurry be reduced by 10% to 30% for prudence. In contrast to this observation, comparative studies of the ultimate shaft resistance of bored piles installed with or without bentonite slurry in granular and cohesive soils have been carried out (e.g. Touma & Reese, 1974; Majano et al, 1994). These studies showed no significant difference in performance with the two methods of installation. Experience with large-diameter bored piles and barrettes in saprolites in Hong Kong indicate that the use of bentonite slurry may not produce detrimental effects on pile performance, provided that its properties are strictly controlled. Caution concerning piles involving the use of bentonite slurry which indicate very low shaft resistance as noted in Section 6.4.4.3 above should however be noted.

The shaft resistance may also be affected by the concrete fluidity and pressure (Van Impe, 1991). The method and speed of casting, together with the quality of the concrete (water/cement ratio and consistency), may have a profound effect on the horizontal stresses and hence the shaft resistance that can be mobilised. Bernal and Reese (1984) reported that unless the slump of concrete is at least 175 mm and the rate of placement is at least 12 m per hour and a concrete mix with small-size aggregates is used, the pressures exerted by the fluid concrete will be less than the hydrostatic pressure, which can result in lower shaft resistance particularly in soils with high K_o values.

6.4.4.8 Effect of soil plug on open-ended pipe piles

For open-ended steel tubes, consideration will need to be given to assessing whether the pile will act in a plugged mode or unplugged mode.

When subject to working load, an open-ended pile with a soil plug does not behave in the same way as a closed-ended pile driven to the same depth. This is because in the former case, the soil around and beneath the open end is not displaced and compressed to the same extent as that beneath a closed-ended pipe. Tomlinson (1994) suggested that for open-ended pipe piles driven in cohesive materials, the ultimate bearing capacity can be taken as the sum of the shaft resistance along the external perimeter of the shaft and the ultimate end-bearing resistance, i.e. ignoring the internal shaft resistance between soil plug and pile. The shaft resistance and ultimate end-bearing resistance can be determined as if the pile was closed-ended, but a reduction factor of 0.8 and 0.5 respectively should be applied. The end-bearing resistance should be calculated using the gross cross-sectional area of the pile. An open-ended pile plugged with clay at the pile toe will have a softer response as compared to a closed-ended pile, even though they may have the same ultimate resistance.

The size of soil plug in a pipe pile driven into granular soil is very limited. The ultimate bearing capacity of the pile can be taken as the sum of the external and internal shaft resistance and the end-bearing resistance on the net cross-sectional area of the pile toe; or the

end-bearing resistance of the plug, whichever is less (API, 2000). Tomlinson (1994), based on field observations, suggested that the end-bearing resistance of open-ended pipe piles should be limited to 5 MPa irrespective of the diameter of the pile or the density of the soil into which they are driven. This limiting value should be used in conjunction with a safety factor of 2.5.

6.4.5 Correlation with Standard Penetration Tests

6.4.5.1 General

Semi-empirical correlations have been developed relating both shaft and end-bearing resistance of piles founded in granular soils to SPT N values. Such a procedure would provide an approximate means of allowing for variability of the strata across a site in normalising and extrapolating the results of loading tests. In most of the correlations that have been established, the N values generally refer to uncorrected values before pile installation.

Because of the varying degree of weathering of the parent rocks in Hong Kong, the local practice is that SPT is often continued to much higher N values than in most other countries (Brand & Phillipson, 1984). However, the carrying out of SPT to very high values may damage the shoe which can subsequently lead to erroneous results. The guidance given in Geoguide 2 : Guide to Site Investigation (GCO, 1987) concerning termination of the test in very dense soils should be followed.

6.4.5.2 End-bearing resistance

Malone et al (1992) analysed the results of pile loading tests carried out on instrumented large-diameter bored piles and barrettes embedded in saprolites in Hong Kong. They found that the end resistance (in kPa) mobilised at the base of the pile at a settlement corresponding to 1% pile diameter is in the range of 6 to 13 times the uncorrected average SPT N values at the base of the pile.

A rule-of-thumb method for use in the design of caissons and bored piles has been in use in Hong Kong for some years (Chan, 1981). This method is based on the correlation that the allowable end-bearing pressure is equal to 5 times the SPT N for soils below the groundwater table. The allowable end-bearing pressure can be doubled for soils in dry condition.

6.4.5.3 Shaft resistance

For caissons and bored piles, the allowable shaft resistance has been either ignored or limited to 10 kPa, so as to avoid the need to be justified by loading tests. However, as discussed by Malone (1987), this rule-of-thumb generally results in unrealistic distribution of mobilised resistance and gross over-design of large-diameter bored piles founded in saprolites. Similarly, Lumb (1983) showed, on the basis of his interpretation of pile tests in

Hong Kong, that significant shaft resistance can be developed in granitic saprolites. This is also evident from the instrumented pile loading tests carried out in bored piles and barrettes founded on saprolites (Figure A2).

For saprolites in Hong Kong, loading tests on instrumented large-diameter bored piles and barrettes (Appendix A) suggest that the ratio of the average mobilised shaft resistance (kPa) to \bar{N} value generally ranges between 0.8 and 1.4. It is found that the shaft resistance is, in some cases, practically fully mobilised at an average relative pile/soil settlement of about 1% pile diameter. The mobilised shaft resistance was found to be dependent largely on the construction method and workmanship, as well as the geology and undisturbed ground conditions. Compared to bored piles in other tropically weathered soils, it appears that the above observed ratio of τ_s / \bar{N} is low. For instance, Chang & Broms (1991) reported a ratio of τ_s / \bar{N} ranging from about 0.7 to 4 (kPa) for bored piles in residual soils and weathered rocks in Singapore for \bar{N} values up to 60, and suggested the relationship of τ_s / \bar{N} of 2 (kPa) for design purposes. This is also supported by Ho (1993) for piles in weathered granite in Singapore for \bar{N} values up to 75. The discrepancy may be due to differences in geology, methods for supporting empty bores during excavation, and methods of interpretation.

For preliminary design of large-diameter bored piles, barrettes and hand-dug caissons in sandy granitic saprolites below sea level in Hong Kong, the relationship of τ_s / \bar{N} of 0.8 to 1.4 (kPa) may be used, with N value limited to 200. Limited data suggest the ratio of τ_s / \bar{N} may be lower in volcanic saprolite (Appendix A).

Based on limited data in Hong Kong, the shaft resistance for small-displacement piles such as steel H-piles can be taken as $1.5 \bar{N}$ to $2 \bar{N}$ (kPa) for design, for a \bar{N} value up to about 80 (Appendix A). \bar{N} is the uncorrected mean SPT value in the soil strata where shaft resistance is being mobilised.

Based on observations of loading tests on precast prestressed concrete piles in Hong Kong, Ng (1989) proposed that τ_s in the range of $4 \bar{N}$ to $7 \bar{N}$ (kPa) may be taken for design in saprolites with a limiting average shaft resistance of 250 kPa. This is generally consistent with the 'rule-of-thumb' adopted in Hong Kong that $\tau_s = 4.8 \bar{N}$ (kPa) (Siu & Kwan, 1982) for \bar{N} values up to about 60 for driven piles. It is recommended that the relationship of $\tau_s = 4.5 \bar{N}$ (kPa) may be used for design of large-displacement driven piles in saprolites.

In traditional design of small-diameter bored piles involving pressure grouting or pressurising the concrete in Hong Kong, the empirical relationship of $\tau_s = 4.8 \bar{N}$ to $5 \bar{N}$ (kPa), ignoring the contribution from the base, is generally used for \bar{N} values up to about 40, usually with a factor of safety of 3 (Chan, 1981). Lui et al (1993) reported a design of post-grouted mini-piles based on the relationship of $\tau_s = 5 \bar{N}$ (kPa), where \bar{N} is limited to 100 and the factor of safety is taken to be 3, which has been satisfactorily verified by instrumented pile loading tests.

The design method involving correlations with SPT results is empirical in nature, and the level of confidence is not high particularly where the scatter in SPT N values is large. If loading tests on preliminary piles are not carried out, this design approach should be checked

using the effective stress method based on soil mechanics principles (Section 6.4.4.3), and the smaller calculated capacity adopted for design.

6.4.6 Correlation with Other Insitu Tests

Piles may be designed based on correlations with other types of insitu tests such as cone penetration tests (CPT), pressuremeter tests and dilatometer tests.

CPT are best suited for silts and sands that are loose to medium dense (such as hydraulically-placed fill and alluvial sands) but may meet premature refusal in dense sands and gravels. The test is generally unsuitable in weathered rocks.

Semi-empirical methods have been developed relating results of Static Cone Penetration Tests (i.e. Dutch Cone or piezocones) to the bearing capacity of piles, e.g. Meyerhof (1986), Tomlinson (1994). Jardine et al (2005) presented a new approach for predicting load-carrying capacity of piles driven in sand and clays. The shaft resistance of the pile depends on the effective radial stress, which is correlated to the tip resistance measured in cone penetration tests. The method generally gives a better prediction of the pile capacity for driven piles.

In Hong Kong, pressuremeter (e.g. Menard Pressuremeter) has occasionally been used to measure the deformation characteristics and limit pressure values of granitic saprolites for the design of foundations (Chiang & Ho, 1980). Baguelin et al (1978) presented curves relating ultimate shaft resistance and end-bearing resistance to the pressuremeter limit pressure, for both driven and cast-in-place piles. These may be used for a rough preliminary assessment but, due to lack of a reliable local database, they should be confirmed by loading tests.

Dilatometers may be used to provide an index for a number of properties including the insitu horizontal stress. These indices may, in principle, be used to correlate with pile capacity.

The use of correlations developed overseas based on insitu tests for Hong Kong conditions should be done with caution as a number of other factors may also influence the pile capacity, e.g. different geological formations (Tomlinson, 1994).

6.5 AXIALLY LOADED PILES IN ROCK

6.5.1 General

For the purpose of pile design in Hong Kong, rock is generally taken to be fresh to moderately decomposed rock or partially weathered rock having a rock content greater than 50%. For a short rigid pile founded on top of rock surface, it is acceptable to neglect the insignificant adhesion along its sides in the soil layers and assume that the applied load is transferred to the base. For piles socketed in rock, the shaft resistance of the rock socket could be significant and should be taken into account in the design (Section 6.5.4). Where

the rock surface is sloping, the lowest point intersected by the pile should be conservatively taken as the start of the rock socket.

For a long pile constructed through soil and founded on rock, the degree of load transfer in the portion of the pile shaft embedded in soil will depend on the amount of relative movement arising from base deflection and elastic compression of the shaft, i.e. it will be a function of the relative shaft and base stiffness. In a corestone-bearing weathering profile, the distribution of load in the pile is likely to be complex and may be highly variable.

The settlement of piles founded on rock which have been designed on the basis of bearing capacity theories should always be checked as this is generally the governing factor in, for example, weak rocks, closely-fractured rocks and moderately to highly decomposed rocks.

In the past the capacity of concrete piles in rock was generally limited by the strength of the concrete. With the use of high strength concrete, the capacity of piles in rock may now be controlled by the strength as well as the compressibility of the rock mass which needs to be assessed more accurately.

6.5.2 Driven Piles in Rock

Where the joints are widely-spaced and closed, very high loads can be sustained by the rock mass and the design is unlikely to be governed by bearing capacity of the ground. In such ground conditions, piles driven to refusal can be designed based on permissible structural stresses of the pile section. The Code of Practice for Foundations (BD, 2004a) recommended that the pile penetration at the final set should not be more than 10 mm for the last ten blows and the peak driving stress should be monitored by Pile Driving Analyzer. Shek (2004) measured the driving stress of a steel H-pile driven to rock. The peak driving stress was about 85% of the yield strength of the steel pile. Li & Lam (2001) observed a similar magnitude of driving stress and cautioned the use of an unduly conservative penetration limit that may overstress and damage the piles.

In specifying the penetration limit for piles driven to bedrock, it is sensible to include a requirement on the minimum driving stress in the piles. This ensures that adequate energy has been delivered in the driving of piles. Alternatively, the load-carrying capacity may be ascertained by dynamic pile loading tests using CAPWAP analysis (ArchSD, 2003).

Where the joints are open or clay-filled, the rock mass below the pile tip may compress under load. The assessment of the load deformation properties of such rock mass can be made using the rock mass classification developed by Bieniawski (1989) (see 6.5.3.2).

6.5.3 Bored Piles in Rock

6.5.3.1 General

The methods of designing bored piles founded on rock may be broadly classified as rational methods based on :

- (a) semi-empirical methods,
- (b) bearing capacity theories, and
- (c) insitu tests.

6.5.3.2 Semi-empirical methods

Peck et al (1974) suggested a semi-empirical correlation between allowable bearing pressure and Rock Quality Designation (RQD) as shown in Figure 6.5. The correlation is intended for a rock mass with discontinuities that are tight or are not open wider than a fraction of an inch; settlement of the foundation should not exceed half an inch. The use of such correlation should only be regarded as a crude first step in rock foundation design (Peck, 1976). It should be noted that RQD may be biased depending on the orientation of the boreholes in relation to the dominant discontinuities.

The use of RQD as the sole means of determining founding level can lead to erroneous results because it does not take into account the condition of joints, such as the presence of any infilling material. Also, RQD value is sensitive to joint spacing. The RQD value of a rock mass with a joint spacing slightly below the threshold value of 100 mm can differ significantly from a rock mass with a joint spacing slightly above 100 mm.

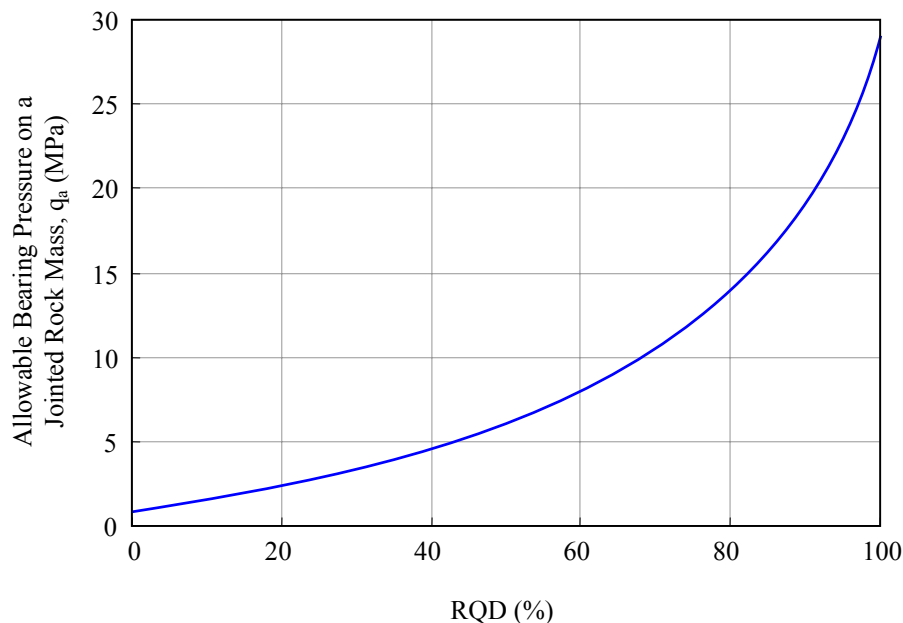

Notes :

- (1) If $q_a > \sigma_c$ (uniaxial compressive strength of rock), use σ_c instead of q_a .
- (2) If RQD is fairly uniform, use average RQD within $d_b = D_b$ where d_b = depth below base of foundation and D_b = width of foundation.
- (3) If RQD within $d_b = 0.25 D_b$ is lower, use the lower RQD.

Figure 6.5 – Correlation between Allowable Bearing Pressure and RQD for a Jointed Rock Mass (Peck et al, 1974)

An alternative semi-empirical method of assessing the allowable bearing pressure of piles founded in a rock mass has been proposed in the Canadian Foundation Engineering Manual (CGS, 1992). This method, described in Figure 6.6, assumes that the allowable bearing pressure is equal to the product of the average unconfined compressive strength and modification factors which account for spacing and aperture of discontinuities in the rock mass, width of the foundation and effect of socket depth (Ladanyi & Roy, 1971).

Irfan & Powell (1985) concluded that the use of a rock mass weathering classification system, in conjunction with simple index tests, will be superior to the use of RQD or total core recovery alone, and can enable limited engineering data to be applied successfully over a large site area. The strength parameters and allowable bearing pressure for the rock mass can be determined from rock mass rating (RMR) (Bieniawski, 1974) or the rock mass quality index Q (Barton et al, 1974).

Several authors have proposed to use RMR for classifying rock mass for engineering purpose. Bieniawski & Orr (1976) proposed that the RMR values can be adjusted to account for the effect of joint orientation on the load capacity and settlement of the foundations. Gannon et al (1999) used RMR to determine the rock modulus for jointed rock masses. Based on the instrumented pile loading tests for the West Rail project, Littlechild et al (2000) correlated the deformation modulus of rock masses with a modified form of RMR termed as RM^2 . The modified form assumed that groundwater and joint orientation are not relevant in the foundation evaluation. Allowable bearing pressures are prescribed using RMR values in the Standard Specifications for Highway Bridges (AASHTO, 2002). Kulhawy & Prakoso (1999) also suggested modifying RMR to exclude the effect of groundwater and the strike and dip of rock joints in assessing the allowable bearing pressures using RMR.

Assessment of Q index requires observations of exposed rock face. RMR is more suitable for piling works as it can be determined from borehole logging records. The RMR system considers in more detail the joint characteristics and the properties of infilled materials, which are more important to the performance of the foundations. It is also applicable to sedimentary and metamorphic rocks, except for those rock masses affected by dissolution features, e.g. in marble formation.

Figure 6.7 shows the correlation of the modulus of the rock mass as determined from the loading tests on instrumented piles conducted in recent years for local projects (Appendix A). The RMR values for the rock mass beneath the test piles are computed following the recommendations given in Table 6.4.

Allowable bearing pressure for a jointed rock mass can be assessed by specifying an acceptable settlement and using the rock mass modulus determined from the correlation given in Figure 6.7. The allowable bearing pressures given in Table 6.5 and Figure 6.8 generally give a settlement at the base of less than 0.5% of the pile base diameter, except for rock masses with $RMR < 40$. In the latter case, settlement analysis should be carried out using the correlation given in Figure 6.7. A bearing pressure higher than that derived from Table 6.5 can be used when justified by pile loading tests. In cases where the orientation of the discontinuities can affect the stability of the rock mass under foundation loads, (e.g. deep foundations founded on steeply inclined rock surface), it is necessary to assess the allowable bearing pressure taking into account the effect of joint orientation. The allowable bearing pressure under such circumstances should not be based on the RMR values given in Table 6.5.

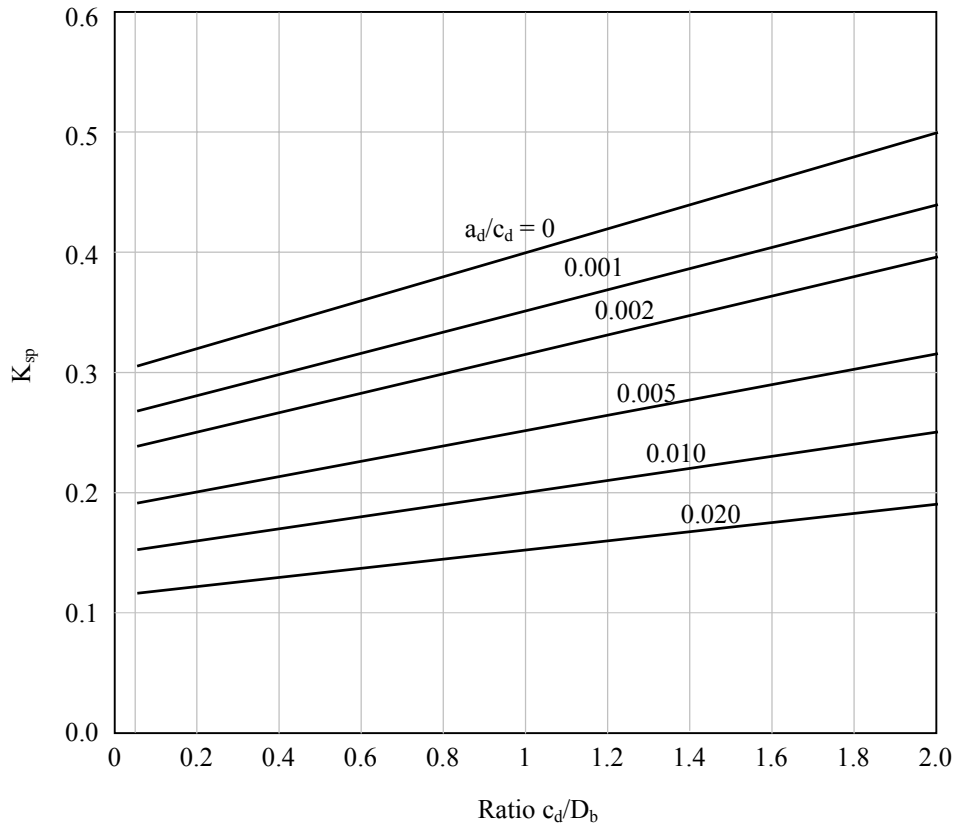

Notes :

- (1) Allowable bearing pressure may be estimated from the strength of rock cores as follows :

$$q_a = K_{sp} q_{u-core} d$$

$$K_{sp} = \frac{3 + \frac{c_d}{D_b}}{10\sqrt{1 + 300\frac{a_d}{c_d}}}$$

where q_a = allowable bearing pressure
 q_{u-core} = average unconfined compressive strength of rock core
 d = depth factor
 K_{sp} = bearing pressure coefficient
 c_d = spacing of discontinuities
 a_d = aperture of discontinuities
 D_b = base diameter

- (2) The equation is valid for $0.05 < \frac{c_d}{D_b} < 2.0$ and $0 < \frac{a_d}{c_d} \leq 0.02$; and $c_d > 300$ mm; $D_b > 300$ mm and $a_d < 5$ mm or 25 mm if infilled with debris.
(3) The coefficient K_{sp} takes into account size effects and presence of discontinuities and contains a factor of safety of at least ten against general shear failure.
(4) Depth factor (Ladanyi & Roy, 1971) can be applied to the allowable bearing pressure computed as $d = 1 + 0.4 \frac{L_s}{D_s} \leq 3.4$

where L_s = depth of socket in rock
 D_s = diameter of rock socket

Figure 6.6 – Determination of Allowable Bearing Pressure on Rock (CGS, 1992)

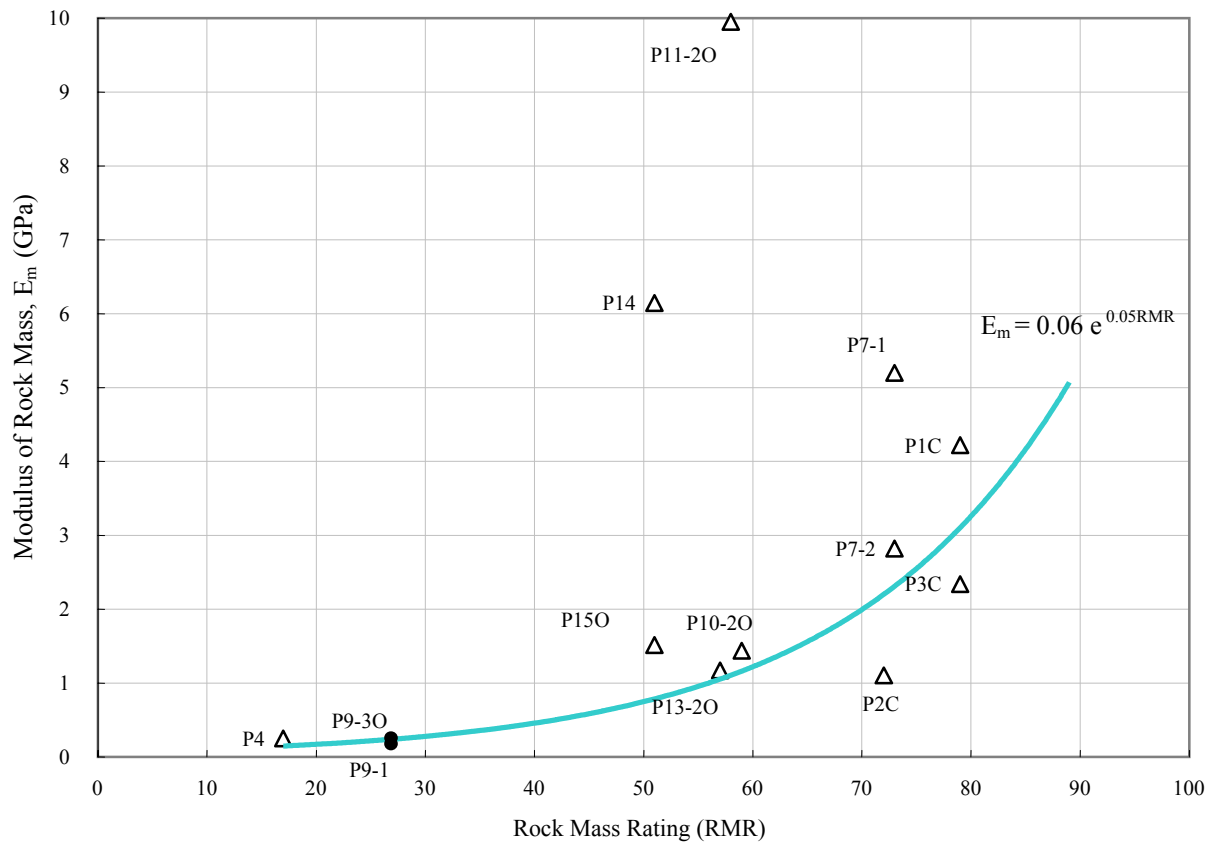

Legend :

- \bullet End-bearing resistance substantially mobilised
- Δ Degree of mobilisation of end-bearing resistance unknown (i.e. not fully mobilised)

Notes :

- (1) Refer to Appendix A for details of pile tests
- (2) Pile mark designation: prefix – P for bored piles or minipile and C for hand-dug caisson
suffix – C for compression test, T for tension test and 1 or 2 for stages of pile loading test, O denotes the use of Osterberg cell

Figure 6.7 – Relationship between Deformation Modulus and RMR for a Jointed Rock Mass

Table 6.4 – Rating Assigned to Individual Parameters using RMR Classification System (Based on Bieniawski, 1989)**(A) Strength of Intact Rock**

| | | | | | | | |
|---|-------|-----------|----------|---------|-------------------------|-------|-----|
| Uniaxial compressive strength, σ_c (MPa) | > 250 | 250 – 100 | 100 – 50 | 50 – 25 | 25 – 5 | 5 – 1 | < 1 |
| Point load strength index, PLI_{50} (MPa) | > 10 | 10 – 4 | 4 – 2 | 2 – 1 | σ_c is preferred | | |
| Rating | 15 | 12 | 7 | 4 | 2 | 1 | 0 |

(B) Rock Quality Designation (RQD)

| | | | | | |
|---------|----------|---------|---------|---------|------|
| RQD (%) | 100 – 90 | 90 – 75 | 75 – 50 | 50 – 25 | < 25 |
| Rating | 20 | 17 | 13 | 8 | 3 |

(C) Spacing of Joints

| | | | | | |
|---------|-------|-------------|---------------|-------------|---------|
| Spacing | > 2 m | 2 m – 0.6 m | 0.6 m – 0.2 m | 200 – 60 mm | < 60 mm |
| Rating | 20 | 15 | 10 | 8 | 5 |

(D) Conditions of Joints

| | | | | | |
|-------------------------------------|-------------|---------------------|----------------------|---------------------|---------------------|
| Discontinuity length ⁽¹⁾ | | | | | |
| Rating | 2 | | | | |
| Separation | None | < 0.1 mm | 0.1 – 1 mm | 1 – 5 mm | > 5 mm |
| Rating | 6 | 5 | 4 | 1 | 0 |
| Roughness | Very rough | Rough | Slightly rough | Smooth | Slickenside |
| Rating | 6 | 5 | 3 | 1 | 0 |
| Infilling (gouge) | None | Hard filling < 5 mm | Hard filling > 5 mm | Soft filling < 5 mm | Soft filling > 5 mm |
| Rating | 6 | 4 | 2 | 2 | 0 |
| Weathering | Unweathered | Slightly weathered | Moderately weathered | Highly weathered | Decomposed |
| Rating | 6 | 5 | 3 | 1 | 0 |

(E) Groundwater

| | |
|-----------------------|---|
| Rating ⁽¹⁾ | 7 |
|-----------------------|---|

Notes :

- (1) Rating is fixed as the parameter is considered not relevant to the evaluation of allowable bearing pressure of rock mass.
- (2) RMR is the sum of individual ratings assigned to parameters (A) to (E).

Table 6.5 – Allowable Bearing Pressure Based on Computed RMR Value

| Parameters | Rock Mass Rating (RMR) | | | |
|---|------------------------|-------|--------|--------|
| | < 40 | 50 | 70 | 88 |
| Allowable bearing pressure, q_a (kPa) | 3,000 | 5,000 | 10,000 | 14,500 |

- Notes :
- (1) For RMR < 40, the rock mass should comprise at least 50% of moderately decomposed, moderately strong to moderately weak rocks. Refer to Table 2 of Geoguide 3 (GCO, 1988) for classification of the strength of rock materials. In common granitic and volcanic rocks in Hong Kong, this corresponds to a weathering grade better than IV.
 - (2) The rock mass within the zone of influence of the foundation loads should be assessed when computing the RMR values. The minimum zone of influence should not be less than three times the diameter of the pile base.
 - (3) Interpolate between allowable bearing pressures for intermediate RMR values greater than 40.
 - (4) The ratings for individual parameters are given in Table 6.4.
 - (5) This table is applicable where the stability of the rock mass is not subject to the effect of adversely oriented discontinuities.
 - (6) If allowable bearing pressure, q_a , determined by RMR is greater than σ_c , use $q_a = \sigma_c$.

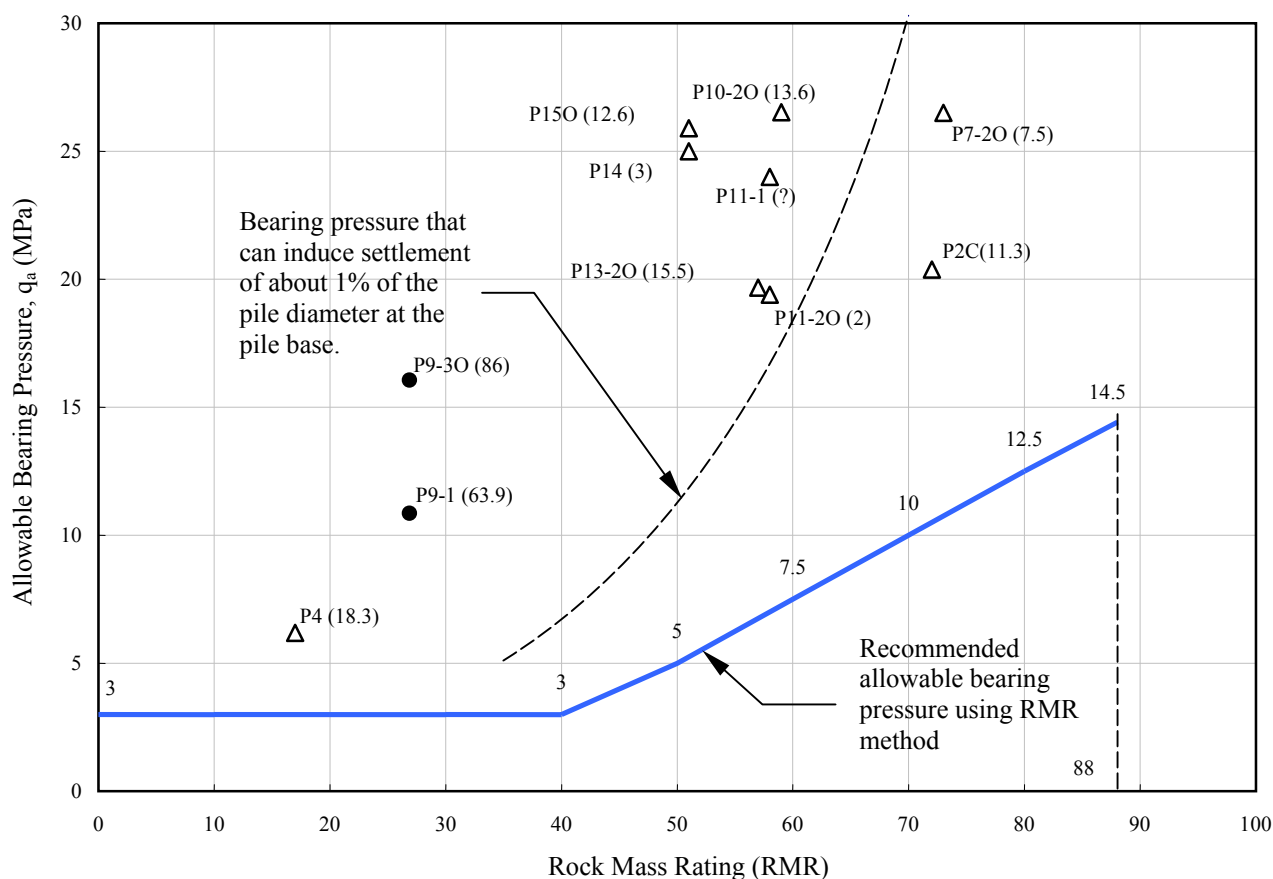

Legend :

- = End-bearing resistance substantially mobilised
- △ = Degree of mobilisation of end-bearing resistance unknown (i.e. not fully mobilised)
- (64) = denotes the measured settlement at pile base in mm

- Notes :
- (1) Refer to Appendix A for details of pile tests.
 - (2) Higher bearing pressure can be used when substantiated by pile loading tests.

Figure 6.8 – Allowable Bearing Pressure Based on RMR Value for a Jointed Rock Mass beneath Piles

In using the RMR method, emphasis should also be placed on good quality drilling to ensure high quality samples, especially the recovery of any infill materials in the discontinuities. The measures to obtain good recovery of samples may include better core sampling methods, such as triple tube core barrels, modest lengths of core runs and suitable flushing medium (e.g. air foam). Logging of the drillholes should follow Geoguide 3 (GCO, 1988). Particular attention should be given to the conditions of discontinuities, such as the aperture and roughness of the discontinuities, as well as the strength of the infill materials. All available ground investigation drillholes and pre-drilling records should be examined together when assessing the RMR value to determine the allowable bearing pressure.

6.5.3.3 Bearing capacity theories

Sowers (1979) proposed that the failure modes shown in Figure 6.9 should be considered in design. For a thick rigid layer overlying a weaker one, failure can be by flexure, with the flexural strength being approximately twice the tensile strength of the rock. For a thin rigid layer overlying a weak one, failure can be by punching, i.e. tensile failure of the rock mass. For both cases, bearing failure of the underlying weak layer should be checked. Failure in a rock mass with open joints is likely to occur by uniaxial compression of the rock columns. For rock mass with closed joints, a general wedge shear zone will develop. Where the rock mass is widely jointed, failure occurs by splitting of the rock beneath the foundation which eventually leads to a general shear failure. Reference may be made to Figure 6.9 for foundation design using bearing capacity theories. The relevant strength parameters (c' and ϕ') may be estimated on the basis of a semi-empirical failure criterion such as the modified Hoek & Brown criterion (Hoek et al, 1992).

Kulhawy & Carter (1992a) developed a lower bound bearing capacity solution for foundations on rock in terms of the Hoek & Brown's (1980) criterion for jointed rock mass.

6.5.3.4 Insitu tests

The load-deformation characteristics of the base of a rock foundation may be evaluated by insitu tests such as plate loading tests, Goodman Jack, pressuremeter or full-scale loading tests. Littlechild et al (2000) determined the modulus of rock mass by various insitu tests and compared them with full-scale pile loading tests. They concluded that results of Goodman Jack tests were more comparable to the modulus derived from full-scale pile loading tests. The modulus determined by cross-hole seismic geophysics was generally an order of magnitude higher. Tests using high pressure dilatometer were not successful, as the stiffness of the strong rocks exceeded the capacity of the dilatometer.

6.5.3.5 Presumptive bearing values

As an alternative to using rational methods, foundations for structures that are not unduly sensitive to settlement may be designed using presumed bearing values given in design codes. In Hong Kong, the Code of Practice for Foundations (BD, 2004a) specified presumptive bearing values for granitic and volcanic rocks. These range from 3 MPa to 10 MPa for different degrees of decomposition of igneous rocks (Table 6.6).

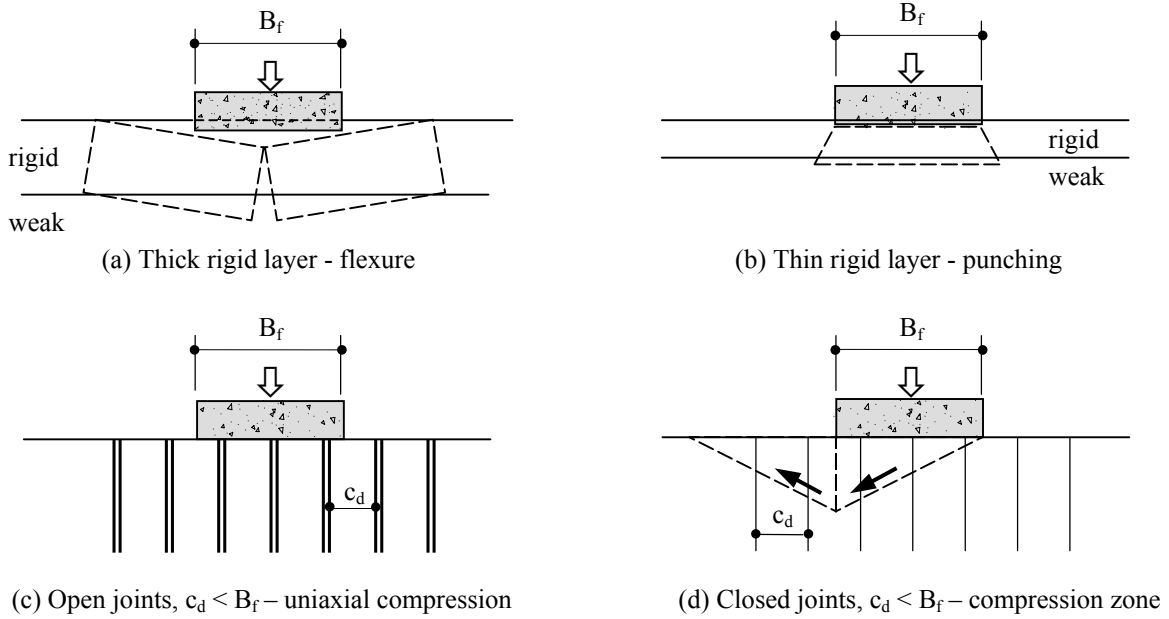

Notes :

(1) The ultimate end-bearing capacity (q_b) of foundations on jointed rock may be calculated as follows :

- (a) For a thick rigid rock layer overlying a weaker rock, the flexural strength of the rock slab can be taken as equal to twice the tensile strength of the upper rock material.
- (b) For a thin rigid rock layer overlying a weaker one, the ultimate end-bearing capacity is equal to the tensile strength of the upper rock material.
- (c) For open joints and $c_d < B_f$, q_b = sum of unconfined compressive strength of affected rock columns.
- (d) For closed joints, the ultimate end-bearing capacity is given by the Bell solution :

$$q_b = c' N_c + 0.5B_f \gamma_r' N_\gamma + \gamma_r' d_r N_q$$

- where
- B_f = width of foundation
 - d_r = foundation depth below rock surface
 - γ_r' = effective unit weight of rock mass
 - $N_c = 2 \sqrt{N_\phi} (N_\phi + 1)$
 - $N_\gamma = \sqrt{N_\phi} (N_\phi^2 - 1)$
 - $N_q = N_\phi^2$
 - $N_\phi = \tan^2 (45 + \phi'/2)$

(2) For case 1(d), c' and ϕ' are the shear strength parameters for the rock mass. These should be evaluated from insitu tests or estimated on the basis of semi-empirical failure criterion such as the modified Hoek-Brown criterion (Hoek et al, 1992). The following correction factors should be applied to N_c and N_γ for different foundation shapes :

| Foundation Shape | Correction Factor for N_c | Correction Factor for N_γ |
|------------------|-----------------------------|----------------------------------|
| Square | 1.25 | 0.85 |
| Rectangular | | |
| $L_f/B_f = 2$ | 1.12 | 0.90 |
| $L_f/B_f = 5$ | 1.05 | 0.95 |
| Circular | 1.20 | 0.70 |

L_f = length of foundation

(3) The load acting on a pile in rock should be proportioned between the base and shaft based on Section 6.5.4. The ultimate shaft resistance may be estimated from Figure 6.13 for preliminary design purposes. The allowable bearing capacity can be determined using factor of safety given in Table 6.1.

Figure 6.9 – Determination of Allowable Bearing Capacity on Rock (Based on Sowers, 1979)

Table 6.6 – Presumed Allowable Vertical Bearing Pressure for Foundations on Horizontal Ground (BD, 2004a)

| Category | Description of Rock | Presumed Allowable Bearing Pressure (kPa) |
|----------|---|---|
| | Rock (granitic and volcanic) : | |
| 1(a) | Fresh strong to very strong rock of material weathering grade I, with 100% total core recovery and no weathered joints, and minimum uniaxial compressive strength of rock material (σ_c) not less than 75 MPa (equivalent point load index strength PLI_{50} not less than 3 MPa). | 10,000 |
| 1(b) | Fresh to slightly decomposed strong rock of material weathering grade II or better, with a total core recovery of more than 95% of the grade and minimum uniaxial compressive strength of rock material (σ_c) not less than 50 MPa (equivalent point load index strength PLI_{50} not less than 2 MPa). | 7,500 |
| 1(c) | Slightly to moderately decomposed moderately strong rock of material weathering grade III or better, with a total core recovery of more than 85% of the grade and minimum uniaxial compressive strength of rock material (σ_c) not less than 25 MPa (equivalent point load index strength PLI_{50} not less than 1 MPa). | 5,000 |
| 1(d) | Moderately decomposed, moderately strong to moderately weak rock of material weathering grade better than IV, with a total core recovery of more than 50% of the grade. | 3,000 |

Notes :

- (1) The presumed values for allowable bearing pressure given are for foundations with negligible lateral loads at bearing level.
- (2) The self-weight of the length of pile embedded in soil or rock does not need to be included into the calculation of bearing stresses.
- (3) Minimum socket depth along the pile perimeter is 0.5 m for categories 1(a) and 1(b), and 0.3 m for categories 1(c) and 1(d).
- (4) Total Core Recovery is the percentage ratio of rock recovered (whether solid intact with no full diameter, or non-intact) to the length of 1.5 m core run and should be proved to a depth at least 5 m into the specified category of rock.
- (5) The point load index strength of rock quoted in the table is the equivalent value for 50 mm diameter cores.
- (6) Ground investigation should be planned, conducted and supervised in accordance with the Code of Practice for Foundations (BD, 2004a).

These presumptive bearing values reflect local experience and can be used without the need for significant amounts of justification and testing. Account should be taken of nearby excavation and/or orientation of discontinuities, together with the interaction effects of adjacent piles at different elevations in the case of rock with a sloping surface. The use of presumptive values should not be a substitute for consideration of settlement, particularly if the structure is susceptible to foundation movements. A design based on presumptive bearing pressures, while they are generally on the safe side, may not be the most cost-effective.

The use of the percentage total core recovery as the sole means of determining founding level in rock could be misleading because the value can be affected by the effectiveness of the drilling technique used in retrieving the core.

The potential problems associated with the construction of bell-out in bored piles are discussed in Section 8.3.4.12. For bored piles founded on rock, the bell-out is usually formed in rock. It would be preferable to design the piles as rock-socketed piles (Section 6.5.4) where shaft and end-bearing resistance in rock are mobilised together to carry the foundation loads. This could avoid the problem of constructing bell-out in bored piles.

6.5.4 Rock Sockets

A range of methods has been proposed in the literature for designing rock sockets (Irfan & Powell, 1991). Assuming full contact between the pile and the rock, the load distribution in a rock socket is primarily a function of its geometry, and the relative stiffness of concrete and the rock mass. As a first approximation, the load on the pile may be apportioned between end-bearing and shaft resistance due to bond in accordance with Pells & Turner (1979). This solution can be used when displacement at the socket is small and bond rupture has not occurred (Kulhawy & Goodman, 1987). The solution by Pells & Turner (1979) indicated that the percentage of pile load transmitted to the pile base is roughly constant for a pile with a 'socketed length to diameter' ratio (L_s/D_s) greater than 3. It may be prudent to carry out more detailed analyses for piles with a greater L_s/D_s ratio.

Kulhawy & Goodman (1987) proposed an analytical design approach to determine the load distribution along a rock socket. The method assumes an elastic shaft expanding into an infinitely thick hollow cylinder under an axial compressive load. The shaft resistance is based on an elastic-frictional model. The change in load transfer in the rock socket can be estimated by reducing the friction angle, as the shaft resistance goes from elastic to intermediate and to residual stages. The latter stages, i.e. intermediate and residual, are generally only relevant where significant movement at pile toe can be tolerated. Figures 6.10 and Figure 6.11 show the load distribution in rock-socketed piles with different friction angles.

Most empirical methods relate the shaft resistance to the uniaxial compressive strength of intact rocks, σ_c . Kulhawy et al (2005) summarised the evolution of methods for evaluating shaft resistance in rock sockets. They also observed that there are some cases where the shaft resistance in the rock socket is greater than the concrete bond strength. The concrete behaves better when it is confined and reinforced in a socket than it is unconfined and unreinforced. Serrano & Olalla (2004) developed a theoretical basis for computing the ultimate shaft resistance in rock sockets using the Hoek & Brown (1980) failure criterion for rock masses. This is expressed as $\tau_s = \alpha \sigma_c^{0.5}$, and the coefficient α ranges from 0.1 to 0.8, depending on the type of rock masses. This correlation is also supported by local pile loading test results (see Figure 6.12), where α is taken as 0.2.

A summary of the pile loading test results is given in Table A4 and the details of the pile loading tests are discussed in Hill et al (2000). It should be noted that shaft resistance in the rock socket was not fully mobilised in most cases (Table A4). There is also a wealth of local loading test results on rock anchors, which justify the conventional assumption in Hong Kong of an allowable shaft resistance of 0.5 to 1 MPa. The lower end of the range of shaft resistance applies to grade III rock while the upper end applies to grade II or better rock. There are cases where the shaft resistance exceeds the concrete bond strength.

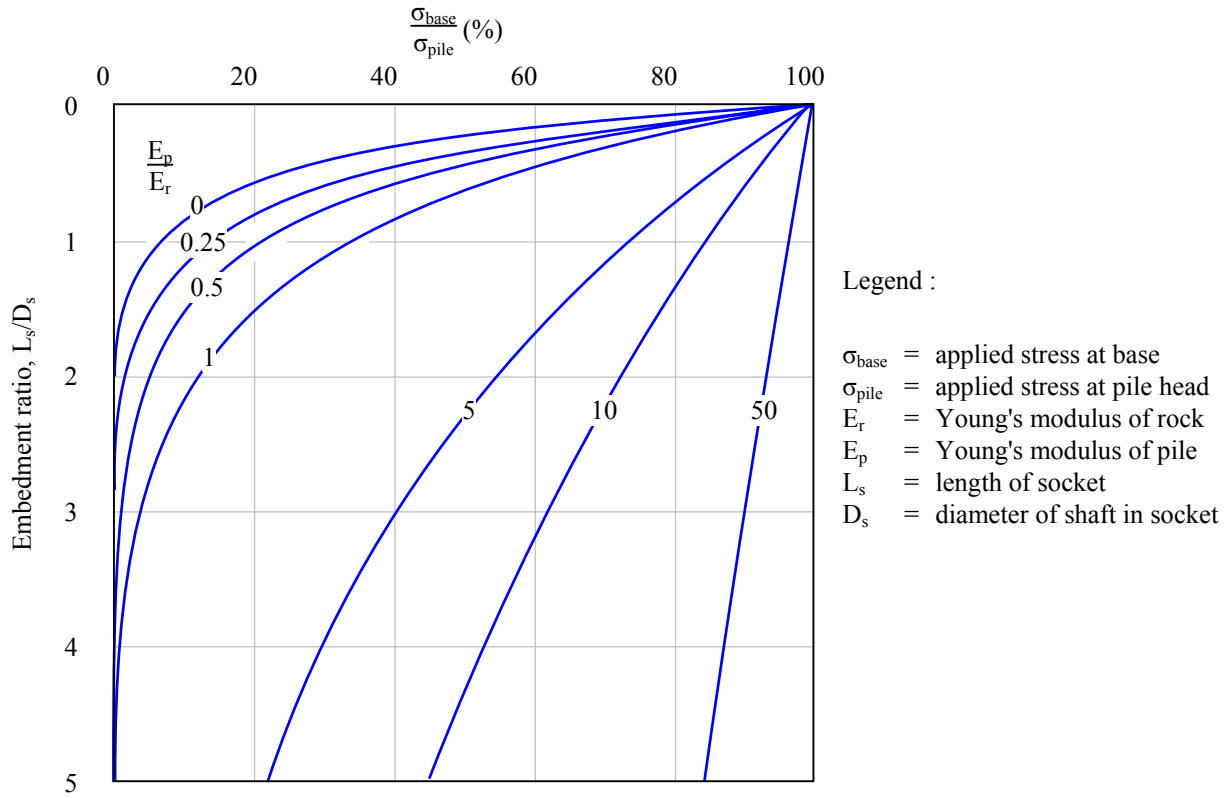

Figure 6.10 – Load Distribution in Rock Socketed Piles, $\phi' = 70^\circ$ (Based on Kulhawy & Goodman, 1987)

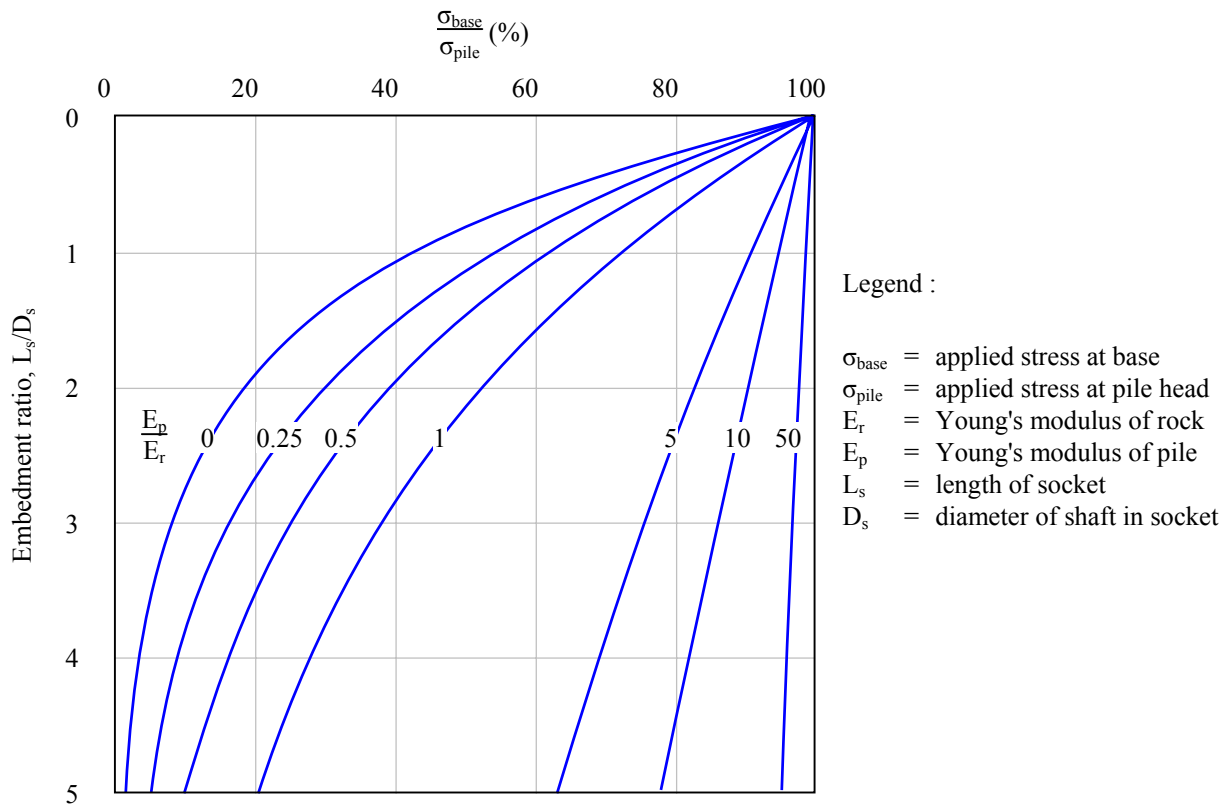
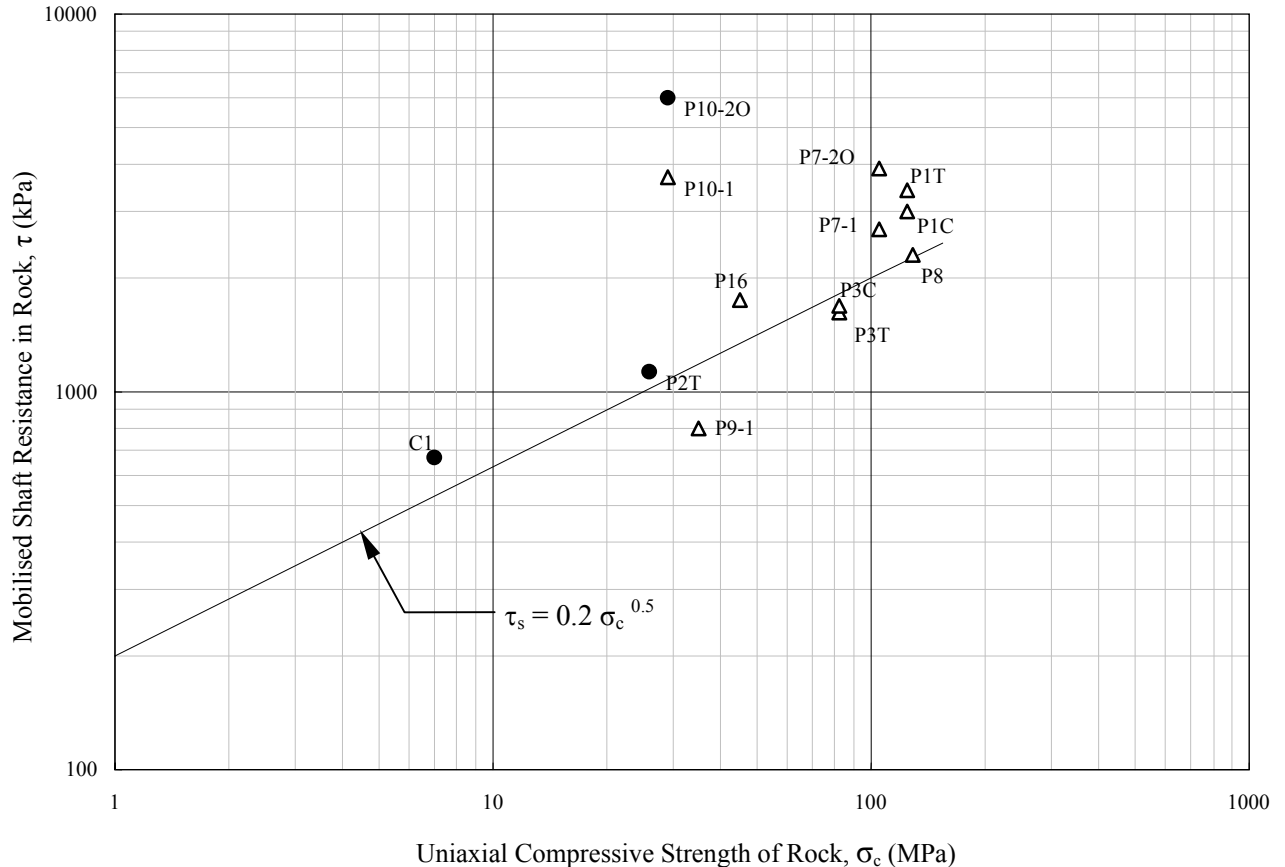

Figure 6.11 – Load Distribution in Rock Socketed Piles, $\phi' = 40^\circ$ (Based on Kulhawy & Goodman, 1987)



Legend :

- = Substantially mobilised
- △ = Degree of mobilisation unknown

Notes :

- (1) For details of tested materials and pile construction, see Table A4
- (2) Pile mark designation: prefix – P for bored piles or minipile and C for hand-dug caisson
 suffix – C for compression test, T for tension test and 1 or 2 for stages of pile loading test, O denotes the use of Osterberg cell

Figure 6.12 – Mobilised Shaft Resistance in Piles Socketed in Rock

For design of rock sockets in a widely jointed rock, the relationship given in Figure 6.12 can be used. The shaft resistance should be limited to the range of σ_c proven in the pile loading tests (Table A4). The rock sockets in the test piles were constructed with reverse circulation drill. If other construction techniques, e.g. chiselling, are used, their installation effect should be taken into account in the assessment of the shaft resistance. Where a particular design method predicts a much higher capacity than that in Figure 6.12, the design value should be justified by a sufficient number of loading tests. For piles socketed into rock, the safety margin against ultimate bearing failure of the ground is likely to be large, and should not control design. The allowable working load should be estimated based on a minimum mobilisation factor of 1.5 on the shaft resistance obtained from Figure 6.12.

Ng et al (2001) reviewed the results of 79 pile loading tests conducted locally and overseas. They observed that the mobilisation of shaft resistance in rock sockets usually exhibits a strain-hardening behaviour. Two piles socketed in granite indicated a strain-softening behaviour. However, there was only a slight reduction in mobilised shaft resistance and they occurred at a displacement much greater than 1% of the pile diameter. Such displacement indicated that the piles were founded on a weak rock stratum. Strain-hardening behaviour is also observed in some bored piles socketed into volcanic rocks (Zhan & Yin, 2000).

The load-carrying capacity of socketed piles can be estimated by summing the allowable resistance mobilised in the shaft and the base. The displacement at pile base should not be greater than 1% of the pile diameter. The Code of Practice for Foundations (BD, 2004a) limits the contribution of shaft resistance in a rock socket to a length equal to twice the pile diameter or 6 m, whichever is less. Otherwise, the mobilisation of shaft resistance should be justified in pile loading tests. Recent instrumented pile loading tests indicated that shaft resistance can be mobilised in rock sockets longer than twice the pile diameter (see Appendix A). Section 8.3 discusses good techniques in casting bored piles and possible remedial measures to rectify the entrapment of weaker materials in the pile bases.

The side resistance of a rock socket is significantly affected by the roughness of the interface (Seidel & Haberfield, 1994). Some attempts have been made to quantify the effect of the roughness of the interface (e.g. Seidel & Collingwood, 2001; Ng et al, 2001). While the wall profile of the rock socket can be measured with ultrasonic devices, much experience is needed to get accurate and reliable results from such techniques for design purposes.

For H-piles socketed in rock mass, the bond strength between the steel and concrete or grout can be a critical factor in determining the load-carrying capacity of rock-socketed piles. Wang et al (2005) conducted laboratory tests to investigate the load transfer mechanism along socketed H-piles. They observed that the average mobilised shaft resistance between the steel and grout interface was about 680 kPa. This ultimate bond strength was, however, greatly increased to 1950 kPa by welding shear studs on the web and flange of the steel section. In some tests, the steel H-pile sections were protruded from the base of the test specimen. As such, the stress state in the steel H-pile section did not entirely replicate that in a rock socketed pile. Compressive stress in a confined socket will cause the pile section to expand laterally due to the effect of Poisson's ratio of the pile. In addition, the embedment ratios adopted in the tests were less than the usual embedded length in rock-socketed piles, which are typically 3 m to 5 m long.

6.6 UPLIFT CAPACITY OF PILES

6.6.1 Piles in Soil

Some published test results (e.g. Radhakrishnan & Adams, 1973; Broms & Silberman, 1964; O'Neill, 2001) indicate that the uplift resistance in the pile shaft is less than the corresponding shaft resistance in compression, possibly by up to 50% less in a granular soil. O'Neill (2001) suggested that this may be due to the influence of the reduction in vertical effective stress in the ground and Poisson's ratio effect under tension loading. Kulhawy (1991) examined the pile test data for bored piles and found no discernible difference

between shaft resistance in uplift and compression. While both loading cases develop shaft resistance along a cylindrical shear surface, a breakout of soil cone may occasionally develop in the uplift loading cases.

Fellenius (1989) & Fleming et al (1992) considered that the interpretation of many pile loading tests took insufficient account of the residual stresses, which existed after pile installation. Consequently the end-bearing capacity of the pile was under-estimated and the shaft resistance over-estimated. They suggested that there is no systematic difference in the shaft resistance that may be mobilised by an unstressed pile loaded either in tension or compression.

Premchitt et al (1988) observed that the pattern of residual stresses developed after pile driving was complex and erratic. Therefore, it is difficult to generalise for design purposes. It was noted by Premchitt et al that the residual shaft resistance and end-bearing resistance locked in after pile driving were not associated with well-defined displacements or an applied loading. Furthermore, the consideration of the shaft resistance associated with the applied loading in a loading test (i.e. zeroing the instrumentation immediately prior to a loading test) represents the condition of actual working piles supporting superstructure loads. With driven piles, a number of researchers have also emphasized the importance of the dependence of radial horizontal stresses and shaft resistance on the relative position of the pile tip as the pile is advanced, based on observations made in instrumented piles (e.g. Lehané, 1992; Lehané et al, 1993, Jardine et al, 1998). Nicola & Randolph (1993) suggested that the ratio of uplift resistance and compression can be determined based on the relative compressibility and Poisson's ratio of the pile. The ratio typically ranges between 0.7 and 0.9 for piles installed in medium dense to dense sand.

For design purposes, it is recommended that the shaft resistance of bored piles under tension may be calculated in the same way as for shaft resistance for compression piles (Sections 6.4.4.3 & 6.4.4.5). For driven piles, in view of the uncertainties associated with the distribution of residual stresses after driving and the available capacity having already been partially mobilised, it is recommended that the shaft resistance under tension be taken conservatively as 75% of that under compression (Sections 6.4.4.4 & 6.4.4.6), unless higher values can be justified by a sufficient number of loading tests.

For relatively slender piles, such as mini-piles, contraction in the shaft under tension load may become significant. This leads to the reduction of radial stress and shaft resistance on the pile. Fleming et al (1992) estimated that this reduction may amount to 10% to 20%.

Any possible suction effects that may develop at the base of a pile should be disregarded for prudence as this may not be reliable.

The working load under tension loading, Q_{wt} is given by the following :

$$Q_{wt} = \frac{Q_s}{F_s} + W_p' \quad [6.9]$$

where Q_s = ultimate shaft resistance under tension
 F_s = factor of safety
 W_p' = effective self weight of the pile

It is recommended that a minimum factor of safety of 2.0 to 3.0 (Table 6.1) should be provided on the ultimate shaft resistance in tension.

For piles with an enlarged base, Dickin & Leung (1990) reviewed existing design methods and investigated the uplift behaviour of such piles embedded in sand using a centrifuge (Figure 6.13). For dense sand, they found reasonable agreement with earlier research on anchor plates and published field data. It was concluded that the best prediction for pile capacity in dense sand when compared with the centrifuge test results is that given by Vermeer & Sutjiadi (1985). For loose sand, the existing methods appear to over-predict the ultimate resistance to uplift with the exception of the simple vertical slip surface model proposed by Majer (1955). In the absence of relevant field data from instrumented piles, it is suggested that the above recommendations may be adopted for preliminary design. However, the design methods are based on model test results with embedded lengths less than seven times the pile diameter. The design should be confirmed by a pull-out test.

Due consideration should be given to the difficulty in enlarging the base of a bored pile in soil to form a bell-out section. The uplift resistance also depends on the integrity of the bell-out section under tension. The possibility of breaking off of the bell-out section along the pile shaft should be considered.

6.6.2 Rock Sockets

Kulhawy & Carter (1992b) observed that there is no significant difference in shaft resistance between piles under tension and compression, provided that the piles are relatively rigid when compared to the rock mass. They defined a rigidity factor as $E_c/E_m (D_s/L_s)^2$, in which E_c and E_m is the Young's modulus of the concrete in pile shaft and the rock mass respectively, D_s is the pile diameter and L_s is the pile embedment length in rock. A pile is considered as rigid if the rigidity factor is greater than 4. In case where this is less than 4, the shaft resistance developed in a rock socket under tension should be taken as 0.7 of the shaft resistance in compression.

The pile data presented in Figure 6.12 include bored piles socketed into rock, which were subject to tension and compression loads in successive loading stages. The results also indicated that there is no significant difference between shaft resistances mobilised in either tension or compression loads. The rigidity factor of the test piles are generally greater than 4. For designing rock-socketed piles to resist uplift load, the correlation given in Figure 6.12 can be used to estimate the shaft resistance, provided that the rigidity factor is greater than 4. Otherwise, a reduction of 30% of the shaft resistance in compression should be assumed, unless a higher value is justified by loading tests.

The cone failure mode of a rock mass is normally the governing criterion under pull out. The actual shape of the mass of rock lifted depends on the degree of jointing, fissuring and the inclination of the bedding planes of the rock. For a heavily jointed or shattered rock, a cone with a half angle of 30° will give a conservative estimate for the pull-out resistance (Tomlinson, 1994). Shear at the interface between the cone surface and the surrounding rock should be neglected. For rock mass with steeply inclined joint sets, the weight of the rock cone should be conservatively assessed.

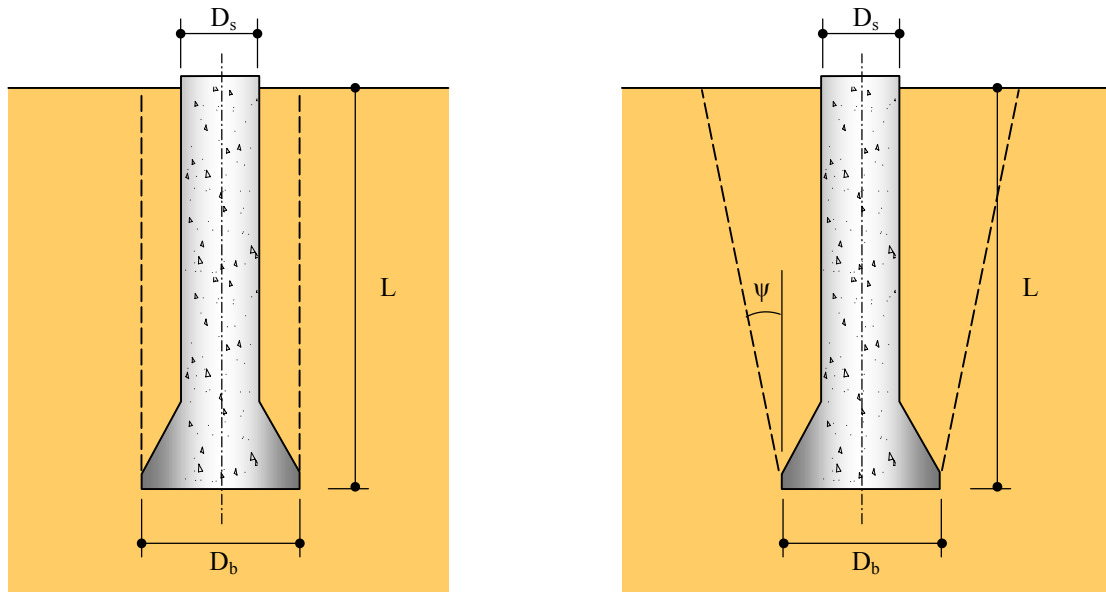

(a) For Pile in Loose Sand (Majer, 1955)

$$\text{Breakout factor, } N_u = 1 + 2 K_s \frac{L}{D_b} \tan \phi'$$

where K_s = coefficient of earth pressure
 D_b = diameter of base
 D_s = diameter of shaft
 ϕ' = angle of shearing resistance of soil

(b) For Pile in Dense Sand (Vermeer & Sutjiadi (1985))

$$\text{Breakout factor, } N_u = 1 + 2 \frac{L}{B_e} \tan \phi' \cos \phi'_{cv}$$

where equivalent width of bell,

$$B_e = \sqrt{\frac{\pi D_b^2}{4}}$$

ϕ'_{cv} = critical state angle of shearing resistance of soil
 ψ = angle of dilation of soil

The ultimate shaft resistance for a belled pile in tension is given by : $Q_s = N_u A_b \gamma'_s L$

where A_b = area of pile base
 L = embedment length of pile
 γ'_s = effective unit weight of soil

Figure 6.13 – Failure Mechanisms for Belled Piles in Granular Soils Subject to Uplift Loading (Dickin & Leung, 1990)

Bonding at the base of the socket will be governed by the tensile strength of the weaker of the rock or concrete. However, given the potential construction problems due to difficulties in achieving proper base cleanliness, possible intermixing of tremie concrete and water and bentonite, etc, it is suggested that this should be conservatively ignored in design.

Rock anchors are sometimes provided for tension piles to increase their uplift capacity. The uplift resistance of the rock anchors depends on the permissible stress in the anchor, bond strength between the anchor, the grout, and the rock, and the weight of rock mass and overlying soil lifted by the anchor or a group of anchors (Tomlinson, 1994).

6.6.3 Cyclic Loading

Cyclic loading leads to at least three aspects of soil response that are not encountered

under static loading conditions (Poulos, 1989a), namely :

- (a) degradation of pile-soil resistance,
- (b) loading rate effects, and
- (c) accumulation of permanent displacements.

Detailed studies using full-scale instrumented piles (e.g. Ove Arup & Partners, 1986; Karlsrud & Nadim, 1992) suggest that the reduction in the static capacity is much greater in two-way type cyclic loading (i.e. load reversed between tension and compression) compared to one-way cyclic loading (i.e. both maximum and minimum loads applied in the same sense or direction). A useful review of piles in granular soils subjected to cyclic loading is given by Poulos (1989a) and Turner & Kulhawy (1990). Jardine (1992) summarised the state-of-the-art on pile behaviour in clays under cyclic loading.

6.7 LATERAL LOAD CAPACITY OF PILES

6.7.1 Vertical Piles in Soil

The lateral load capacity of a pile may be limited in three ways :

- (a) shear capacity of the soil,
- (b) structural (i.e. bending moment and shear) capacity of the pile section, and
- (c) excessive deformation of the pile.

For piles subject to lateral loading, the failure mechanisms of short piles under lateral loads as compared to those of long piles differ, and different design methods are appropriate. The stiffness factors as defined in Figure 6.14 will determine whether a pile behaves as a rigid unit (i.e. short pile) or as a flexible member (i.e. long pile).

As the surface soil layer can be subject to disturbance, suitable allowance should be made in the design, e.g. the resistance of the upper part of the soil may be ignored as appropriate.

Brinch Hansen (1961) proposed a method of calculating the ultimate lateral resistance of a $c' - \phi'$ material, which can be used for short rigid piles (Figure 6.15).

Methods of calculating the ultimate lateral soil resistance for fixed-head and free-head piles in granular soils and clays are put forward by Broms (1964a & b). The theory is similar to that of Brinch Hansen except that some simplifications are made in respect of the distribution of ultimate soil resistance with depth. The design for short and long piles in granular soils are summarised in Figures 6.16 and 6.17 respectively. Kulhawy & Chen (1992) compared the results of a number of field and laboratory tests on bored piles. They found that Brom's method tended to underestimate the ultimate lateral load by about 15% to 20%.

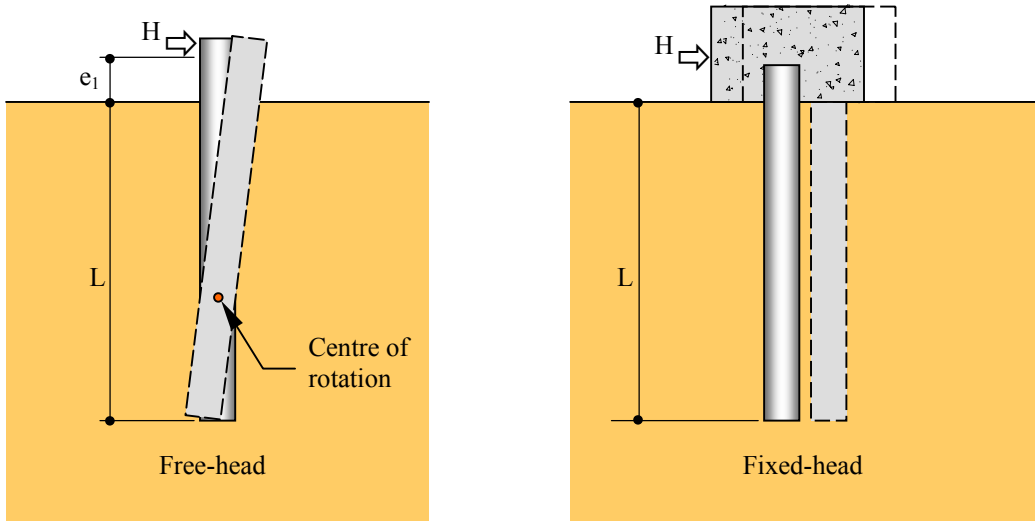

(a) Short Vertical Pile under Horizontal Load

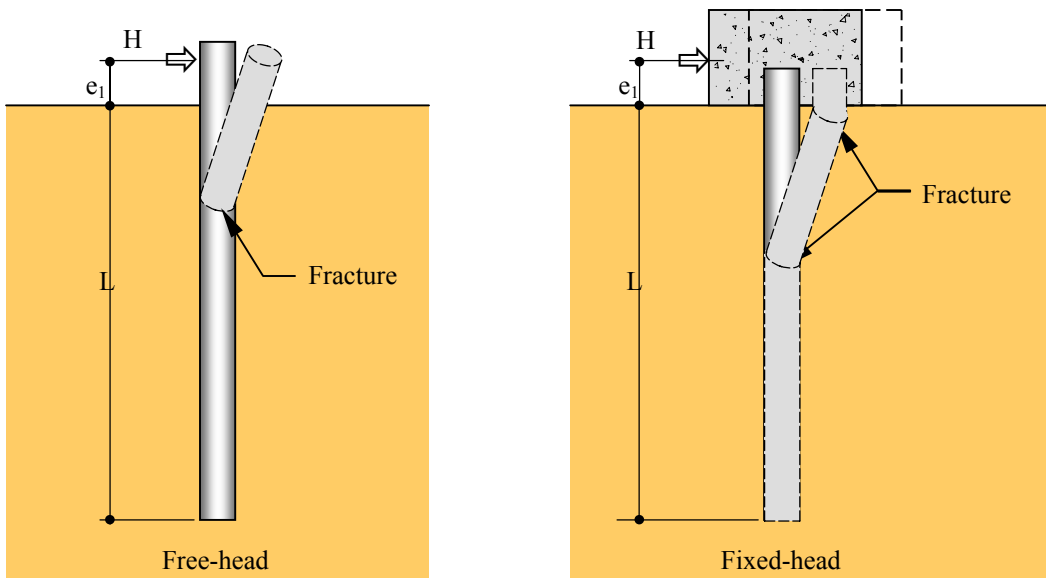

(b) Long Vertical Pile under Horizontal Load

Notes : (1) For constant soil modulus with depth (e.g. stiff overconsolidated clay), pile stiffness factor

$R = \sqrt[4]{\frac{E_p I_p}{k_h D}}$ (in units of length) where $E_p I_p$ is the bending stiffness of the pile, D is the width of the pile, k_h is the coefficient of horizontal subgrade reaction (Section 6.13.3.3).

(2) For soil modulus increases linearly with depth (e.g. normally consolidated clay & granular

soils), pile stiffness factor, $T = \sqrt[5]{\frac{E_p I_p}{n_h}}$ where n_h is the constant of horizontal subgrade reaction given in Table 6.11.

(3) The criteria for behaviour as a short (rigid) pile or as a long (flexible) pile are as follows :

| Pile Type | Soil Modulus | |
|-----------------------|---------------------|---------------|
| | Linearly increasing | Constant |
| Short (rigid) piles | $L \leq 2T$ | $L \leq 2R$ |
| Long (flexible) piles | $L \geq 4T$ | $L \geq 3.5R$ |

Figure 6.14 – Failure Modes of Vertical Piles under Lateral Loads (Broms, 1964a)

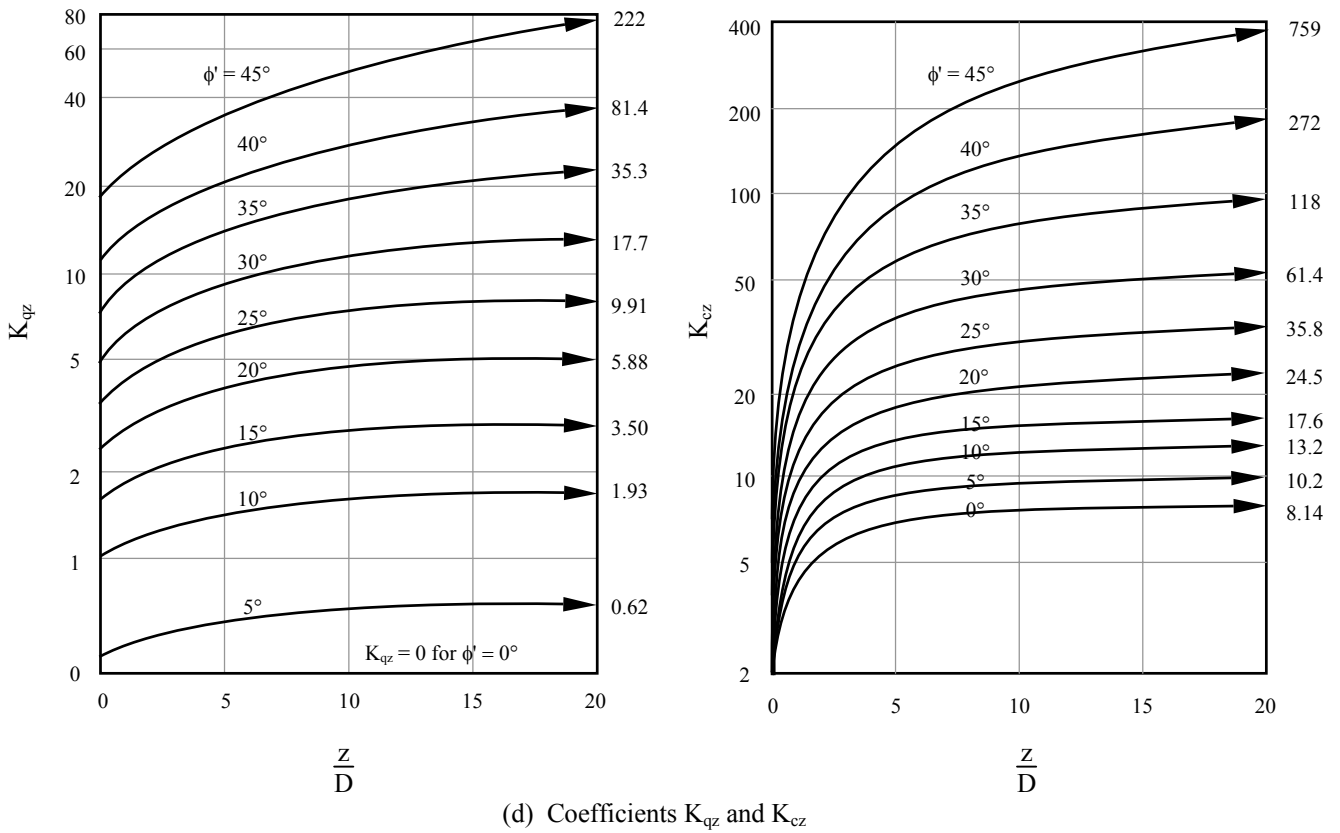
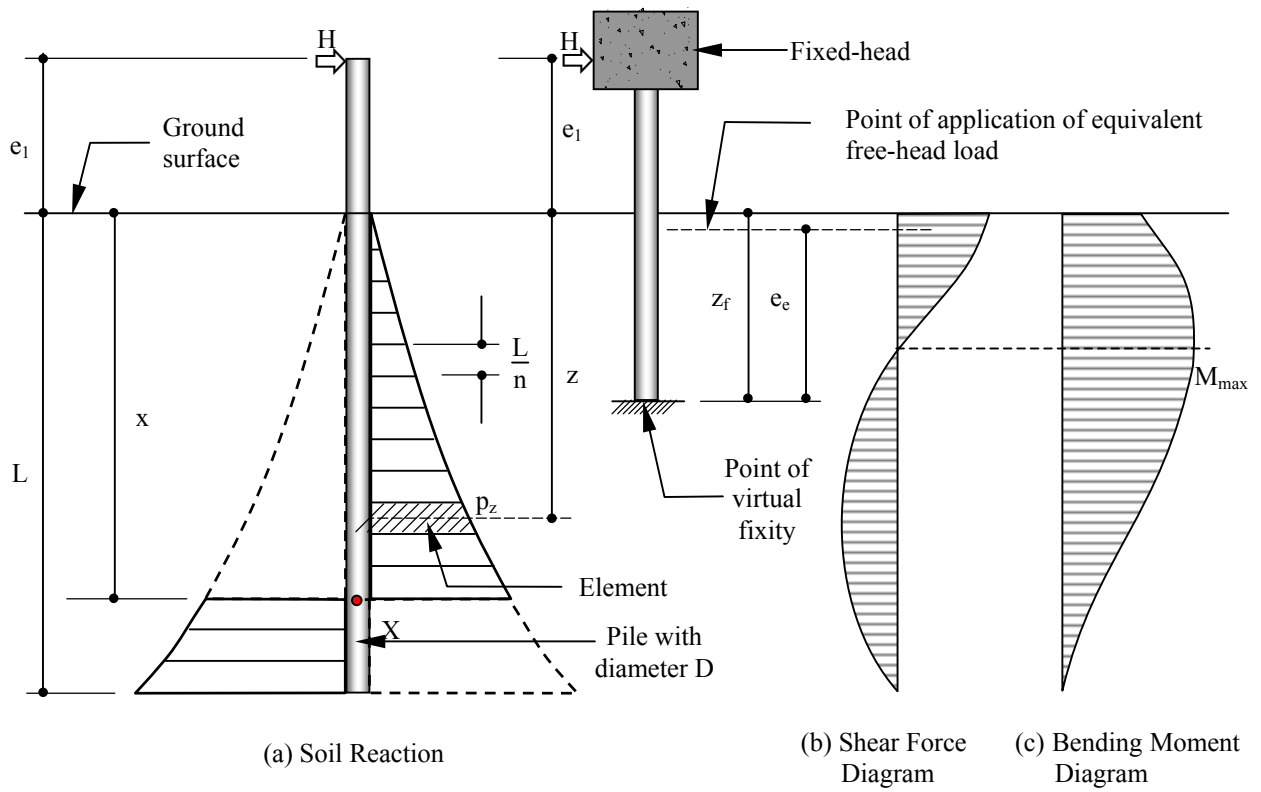

Figure 6.15 – Coefficients K_{qz} and K_{cz} at depth z for Short Piles Subject to Lateral Load (Brinch Hansen, 1961) (Sheet 1 of 2)

Notes :

- (1) The above passive pressure coefficients K_{qz} and K_{cz} are obtained based on the method proposed by Brinch Hansen (1961). Unit passive resistance per unit width, p_z , at depth z is :

$$p_z = \sigma_v' K_{qz} + c' K_{cz}$$

where σ_v' is the effective overburden pressure at depth z , c' is the apparent cohesion of soil at depth z .

- (2) The point of rotation (Point X) is the point at which the sum of the moment (ΣM) of the passive pressure about the point of application of the horizontal load is zero. This point can be determined by a trial and adjustment process.

$$\Sigma M = \sum_{z=0}^{z=x} p_z \frac{L}{n} (e_1 + z) D - \sum_{z=x}^{z=L} p_z \frac{L}{n} (e_1 + z) D$$

- (3) The ultimate lateral resistance of a pile to the horizontal force H_u can be obtained by taking moment about the point of rotation, i.e.

$$H_u(e_1+x) = \sum_{z=0}^{z=x} p_z \frac{L}{n} D (x - z) + \sum_{z=x}^{z=L} p_z \frac{L}{n} (z - x) D$$

- (4) An applied moment M can be replaced by a horizontal force H at a distance e_1 above the ground surface where $M = H e_1$.
- (5) When the head of a pile is fixed against rotation, the equivalent height, e_e above the point of fixity of a force H acting on a pile with a free-head is given by $e_e = 0.5 (e_1 + z_f)$ where z_f is the depth from the ground surface to point of virtual fixity. ACI (1980) recommended that z_f should be taken as 1.4R for stiff, overconsolidated clays and 1.8T for normally consolidated clays, granular soils and silts, and peat. Pile stiffness factors, R and T, can be determined based on Figure 6.14.

Figure 6.15 – Coefficients K_{qz} and K_{cz} at depth z for Short Piles Subject to Lateral Load (Brinch Hansen, 1961) (Sheet 2 of 2)

Broms' methods have been extended by Poulos (1985) to consider the lateral load capacity of a pile in a two-layer soil.

The design approaches presented above are simplified representations of the pile behaviour. Nevertheless, they form a useful framework for obtaining a rough estimate of the likely capacity, and experience suggests that they are generally adequate for routine design. Where the design is likely to be governed by lateral load behaviour, loading tests should be carried out to justify the design approach and verify the design parameters.

The bending moment and shearing force in a pile subject to lateral loading may be assessed using the method by Matlock & Reese (1960) as given in Figures 6.18 and 6.19. The tabulated values of Matlock & Reese have been summarised by Elson (1984) for easy reference. This method models the pile as an elastic beam embedded in a homogeneous, or non-homogeneous soil. The structural capacity of along flexible pile is likely to govern the ultimate capacity of a laterally-loaded pile.

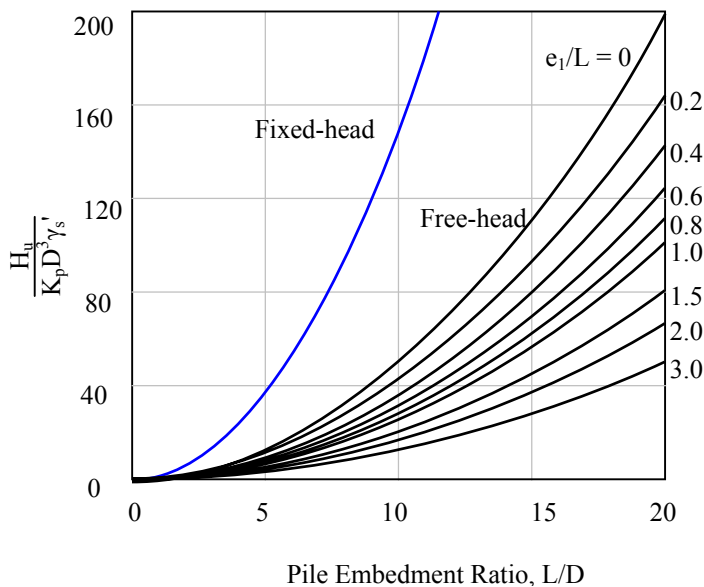
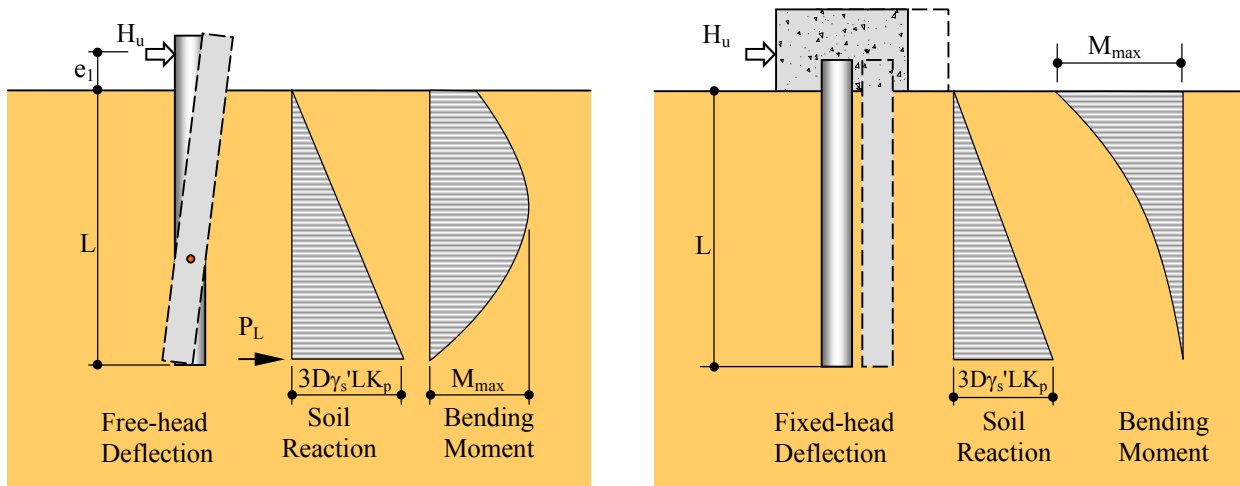

Notes :

- (1) For free-head short piles in granular soils (see definition in Figure 6.14),

$$H_u = \frac{0.5 D L^3 K_p \gamma_s'}{e_1 + L}$$

where K_p = Rankine's coefficient of passive pressure = $\frac{1 + \sin \phi'}{1 - \sin \phi'}$

D = width of the pile

ϕ' = angle of shearing resistance of soil

γ_s' = effective unit weight of soil

- (2) For fixed-head short piles in granular soils (see definition in Figure 6.14),

$$H_u = 1.5 D L^2 K_p \gamma_s'$$

The above equation is valid only when the maximum bending moment, M_{max} , develops at the pile head is less than the ultimate moment of resistance, M_u , of the pile at this point. The bending moment is given by $M_{max} = D L^3 K_p \gamma_s'$.

- (3) P_L is the concentrated horizontal force at pile tip due to passive soil resistance.

Figure 6.16 – Ultimate Lateral Resistance of Short Piles in Granular Soils (Broms, 1964b)

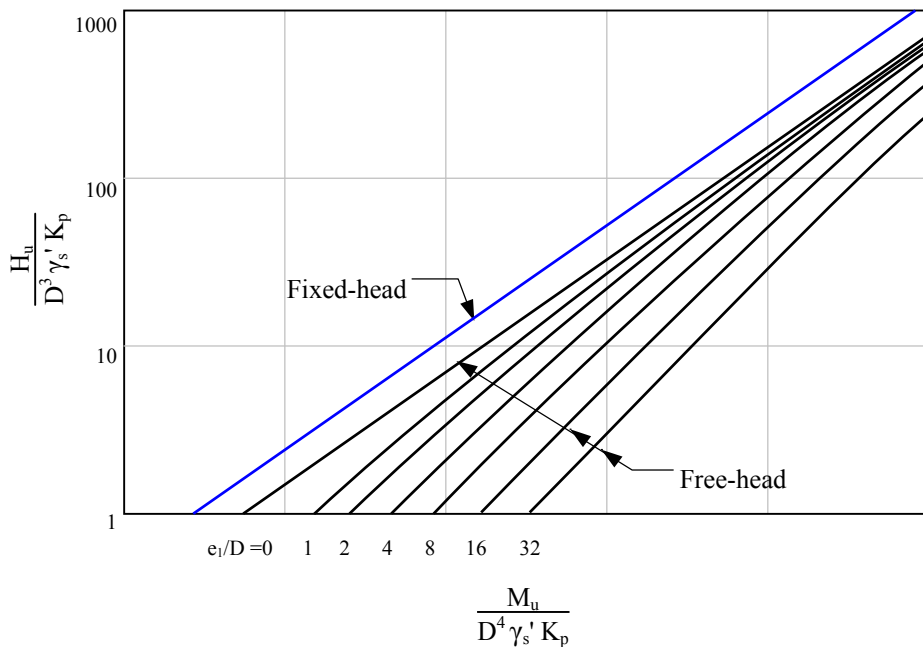
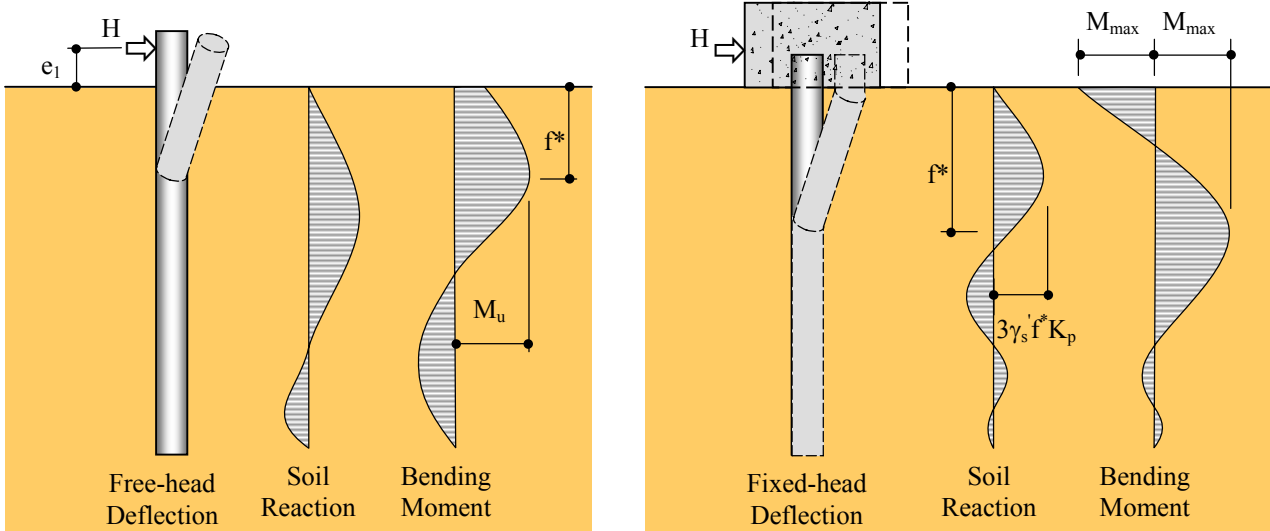

Notes :

- (1) For free-head long piles in granular soils (see definition in Figure 6.14), $M_{\max} = H (e_1 + 0.67f^*)$

$$\text{where } f^* = 0.82 \sqrt{\frac{H}{\gamma_s' D K_p}}$$

D = width of the pile in the direction of rotation

ϕ' = angle of shearing resistance

γ_s' = effective unit weight of soil

$$K_p = \text{Rankine's coefficient of passive pressure} = \frac{1 + \sin \phi'}{1 - \sin \phi'}$$

- (2) For fixed-head short piles in granular soils (see definition in Figure 6.14), the maximum bending moment occurs at the pile head and at the ultimate load. It is equal to the ultimate moment of resistance of pile shaft.

$$M_{\max} = 0.5 H (e_1 + 0.67f^*)$$

For a pile of uniform cross-section, the ultimate value of lateral load H_u is given by taking M_{\max} as the ultimate moment of resistance of the pile, M_u .

Figure 6.17 – Ultimate Lateral Resistance of Long Piles in Granular Soils (Broms, 1964b)

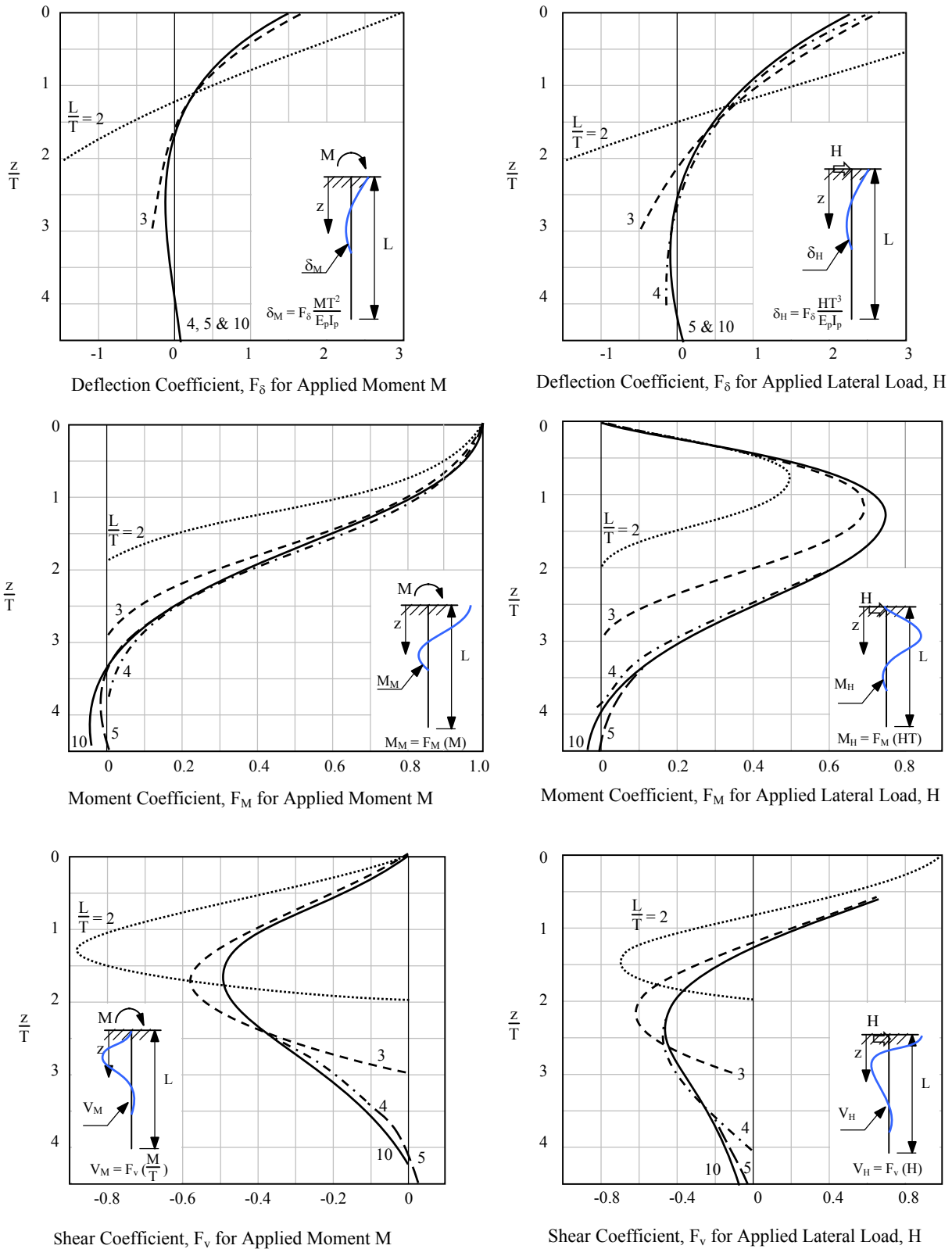

- Notes : (1) $T = \sqrt[5]{\frac{E_p I_p}{n_h}}$ where $E_p I_p$ = bending stiffness of pile and n_h = constant of horizontal subgrade reaction (Table 6.11).
- (2) Obtain coefficients F_δ , F_M and F_V at appropriate depths desired and compute deflection, moment and shear respectively using the given formulae.

Figure 6.18 – Influence Coefficients for Piles with Applied Lateral Load and Moment (Flexible Cap or Hinged End Conditions) (Matlock & Reese, 1960)

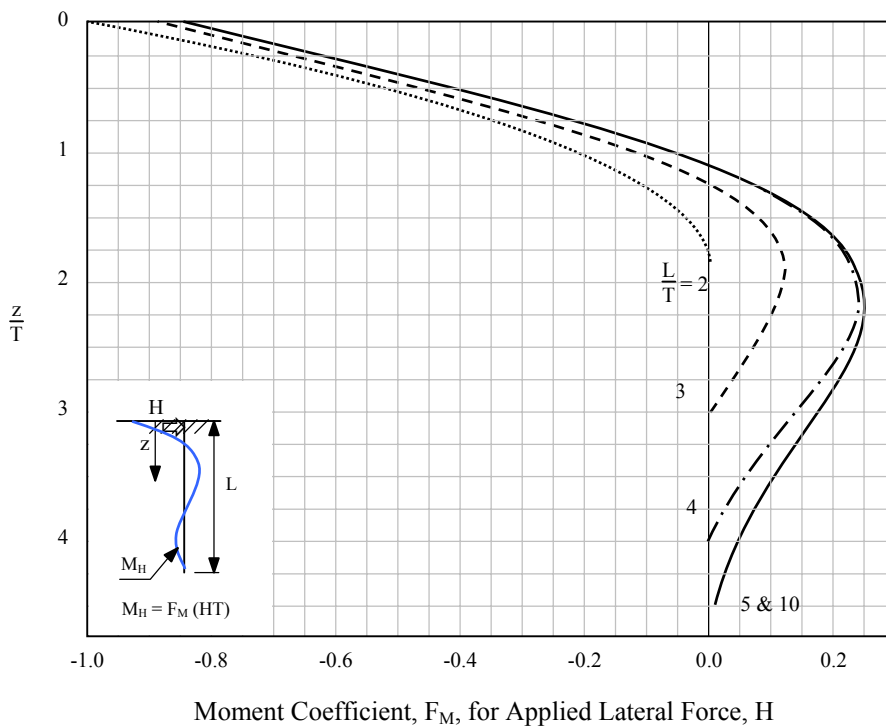
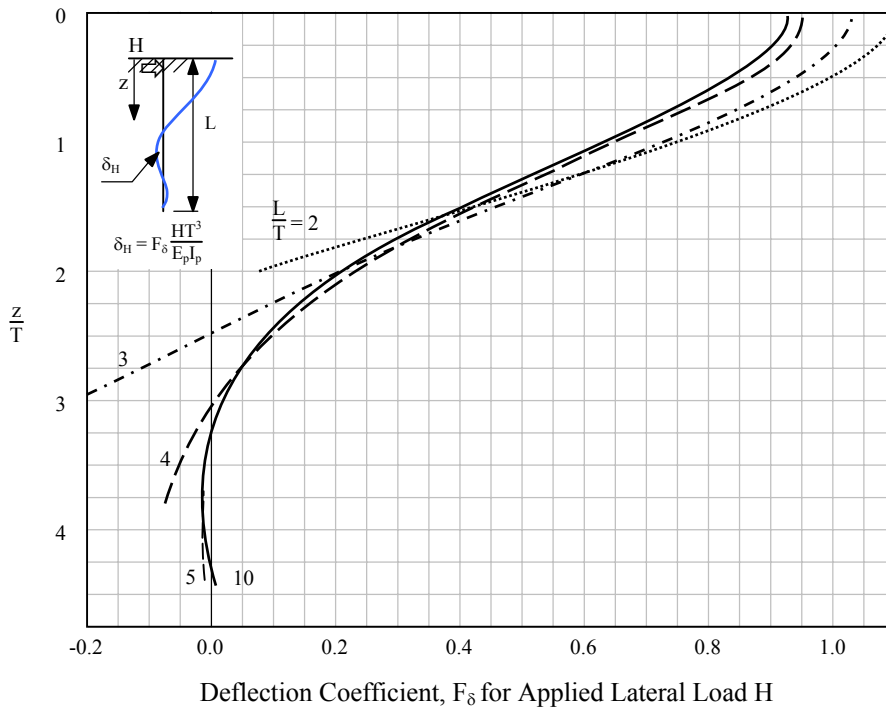

- Notes : (1) $T = \sqrt[5]{\frac{E_p I_p}{n_h}}$ where $E_p I_p$ = bending stiffness of pile and n_h = constant of horizontal subgrade reaction (Table 6.11).
 (2) Obtain coefficients F_δ , and F_M at appropriate depths desired and compute deflection, moment and shear respectively using the given formulae.
 (3) Maximum shear occurs at top of pile and is equal to the applied load H.

Figure 6.19 – Influence Coefficients for Piles with Applied Lateral Load (Fixed against Rotation at Ground Surface) (Matlock & Reese, 1960)

For relatively short (less than critical length given in Section 6.13.3.3) end-bearing piles, e.g. piles founded on rock, with toe being effectively fixed against both translation and rotation, they can be modelled as cantilevers cast at the bottom and either fixed or free at the top depending on restraints on pile head. The lateral stiffness of the overburden can be represented by springs with appropriate stiffness.

The minimum factors of safety recommended for design are summarised in Table 6.1. The design of a vertical pile to resist lateral load is usually governed by limiting lateral deflection requirements.

For piles in sloping ground, the ultimate lateral resistance can be affected significantly if the piles are positioned within a distance of about five to seven pile diameters from the slope crest. Based on full-scale test results, Bhushan et al (1979) proposed that the lateral resistance for level ground be factored by $1/(1 + \tan \theta_s)$, where θ_s is the slope angle. Alternatively, Siu (1992) proposed a simplifying method for determining the lateral resistance of a pile in sloping ground taking into account three-dimensional effects.

6.7.2 Inclined Loads

If a vertical pile is subjected to an inclined and eccentric load, the ultimate bearing capacity in the direction of the applied load is intermediate between that of a lateral load and a vertical load because the passive earth pressure is increased and the vertical bearing capacity is decreased by the inclination and eccentricity of the load. Based on model tests, Meyerhof (1986) suggested that the vertical component Q_v , of the ultimate eccentric and inclined load can be expressed in terms of a reduction factor r_f on the ultimate concentric vertical load Q_o , as given in Figure 6.20.

The lateral load capacity can be estimated following the methods given in Section 6.7.1. Piles, subjected to inclined loads, should be checked against possible buckling (Section 6.12.4), pile head deflection (Section 6.13.3) and induced bending moments.

6.7.3 Raking Piles in Soil

A common method of resisting lateral loads is to use raking piles. For the normal range of inclination of raking piles used in practice, the raking pile may be considered as an equivalent vertical pile subjected to inclined loading.

Comments on the method of determining the applied load on raking piles are given in Section 7.5.3.

6.7.4 Rock Sockets

Based on elastic analyses, Poulos (1972) has shown that a rock socket constructed through soil has little influence on the lateral behaviour under working loading unless the pile is relatively stiff (i.e. with a pile stiffness factor under lateral load, K_r , of greater than 0.01, see Section 6.13.3). For such stiff piles, e.g. large-diameter bored piles, the contribution of

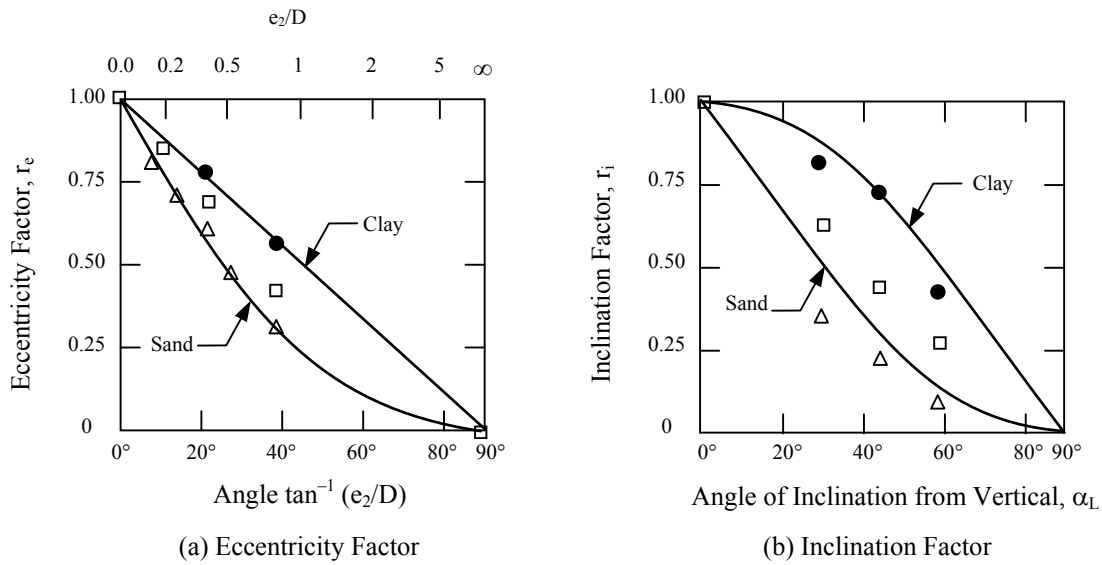

Legend :

- Δ = measured values in loose sand
- \bullet = measured values in soft clay
- \square = measured values in clay overlying sand ($d_c/D = 0.5$)
- = theoretical relationship
- e_2 = eccentricity of vertical load from centre of pile
- α_L = angle of inclination from vertical
- d_c = thickness of clay layer
- D = pile width

Notes :

$$(1) \quad Q_v = r_f Q_o = r_e r_i Q_o$$

- where Q_v = vertical component of the ultimate eccentric inclined load
 Q_o = ultimate concentric vertical load
 r_e = reduction factor for eccentricity
 r_i = reduction factor for inclination of load from vertical

- (2) The values of r_e and r_i may be obtained from Figures (a) and (b) above or from the following equations :

$$\text{For granular soil, } r_e = \left[1 - \frac{\tan^{-1}(e_2/D)}{90^\circ} \right]^2$$

$$r_i = (1 - \alpha_L/90^\circ)^2$$

$$\text{For clay, } r_e = 1 - \frac{\tan^{-1}(e_2/D)}{90^\circ}$$

$$r_i = \cos \alpha_L$$

Figure 6.20 – Reduction Factors for Ultimate Bearing Capacity of Vertical Piles under Eccentric and Inclined Loads (Meyerhof, 1986)

the socket to the lateral load capacity may be accounted for using the principles presented by Poulos & Davis (1980) assuming a distribution of ultimate lateral resistance mobilised in the rock. Where the rock level dips steeply, consideration should be given to assuming different ultimate resistance in front of and behind the pile.

In a heavily jointed rock mass with no dominant adversely-orientated joints, a wedge type analysis may be carried out using c' , ϕ' values determined based on the modified Hoek & Brown failure criterion (Hoek et al, 1992). Alternatively, Carter & Kulhawy (1992) presented a theoretical method for determining the lateral load capacity of a pile socketed in a rock mass, based on the consideration of a long cylindrical cavity in an elasto-plastic, cohesive-frictional, dilatant material. In assessing the ultimate lateral resistance, due consideration must be given to the rock mass properties including the nature, orientation, spacing, roughness, aperture size, infilling and groundwater conditions of discontinuities.

The possibility of a joint-controlled failure mechanism should be checked (GEO, 1993). Joint strength parameters reported in Hong Kong have been summarised by Brand et al (1983). Alternatively, the rock joint model presented by Barton et al (1985) may be used.

6.7.5 Cyclic Loading

Cyclic or repeated loading may lead to problems of degradation of soil resistance and stiffness, or 'post-holing' where gaps may form near the ground surface. Long et al (1992) reviewed the methods of analysing cyclic loading on piles in clays. Reference may be made to Poulos (1988a) for the design of piles in granular soils subjected to cyclic loading.

6.8 NEGATIVE SKIN FRICTION

6.8.1 General

Piles installed through compressible materials (e.g. fill or marine clay) can experience negative skin friction. This occurs on the part of the shaft along which the downward movement of the surrounding soil exceeds the settlement of the pile. Negative skin friction could result from consolidation of a soft deposit caused by dewatering or the placement of fill. The dissipation of excess pore water pressure arising from pile driving in soft clay can also result in consolidation of the clay.

The magnitude of negative skin friction that can be transferred to a pile depends on (Bjerrum, 1973) :

- (a) pile material,
- (b) method of pile construction,
- (c) nature of soil, and
- (d) amount and rate of relative movement between the soil and the pile.

In determining the amount of negative skin friction, it would be necessary to estimate the position of the neutral plane, i.e. the level where the settlement of the pile equals the settlement of the surrounding ground. For end-bearing piles, the neutral plane will be located close to the base of the compressible stratum.

6.8.2 Calculation of Negative Skin Friction

Design of negative skin friction should include checks on the structural and geotechnical capacity of the pile, as well as the downward movement of the pile due to the negative skin friction dragging the pile shaft (CGS, 1992; Fellenius, 1998; Liew, 2002). A pile will settle excessively when geotechnical failure occurs. As the relative displacement between the soil and the pile shaft is reversed, the effect of negative skin friction on pile shaft would be eliminated. Therefore, the geotechnical capacity of the pile could be based on the shaft resistance developed along the entire length of pile. The dragload need not be deducted from the assessed geotechnical capacity when deciding the allowable load carrying capacity of the pile. On the other hand, the structural capacity of the pile should be sufficient to sustain the maximum applied load and the dragload. The dragload should be computed for a depth starting from the ground surface to the neutral plane.

The estimation of downward movement of the pile (i.e. downdrag) requires the prediction of the neutral plane and the soil settlement profile. At the neutral plane, the pile and the ground settle by the same amount. The neutral plane is also where the sustained load on the pile head plus the dragload is in equilibrium with the positive shaft resistance plus the toe resistance of the pile. The total pile settlement can therefore be computed by summing the ground settlement at the neutral plane and the compression of the pile above the neutral plane (Figure 6.21). For piles founded on a relatively rigid base (e.g. on rock) where pile settlement is limited, the problem of negative skin friction is more of the concern on the structural capacity of the pile.

This design approach is also recommended in the Code of Practice for Foundations (BD, 2004a) for estimating the effect of negative skin friction.

For friction piles, various methods of estimating the position of the neutral plane, by determining the point of intersection of pile axial displacement and the settlement profile of the surrounding soil, have been suggested by a number of authors (e.g. Fellenius, 1984). However, the axial displacement at the pile base is generally difficult to predict without pile loading tests in which the base and shaft responses have been measured separately. The neutral plane may be taken to be the pile base for an end-bearing pile that has been installed through a thick layer of soft clay down to rock or to a stratum with high bearing capacity. Liew (2002) presented a methodology using simple analytical closed-form equations to determine the neutral plane and the negative skin friction on a pile shaft. Step-by-step examples are also given by O'Neill & Reese (1999). The method includes the effect of soil-structure interaction in estimating the neutral plane and dragload on a pile shaft. Alternatively, the neutral plane can be conservatively taken as at the base of the lowest compressible layer (BD, 2004a).

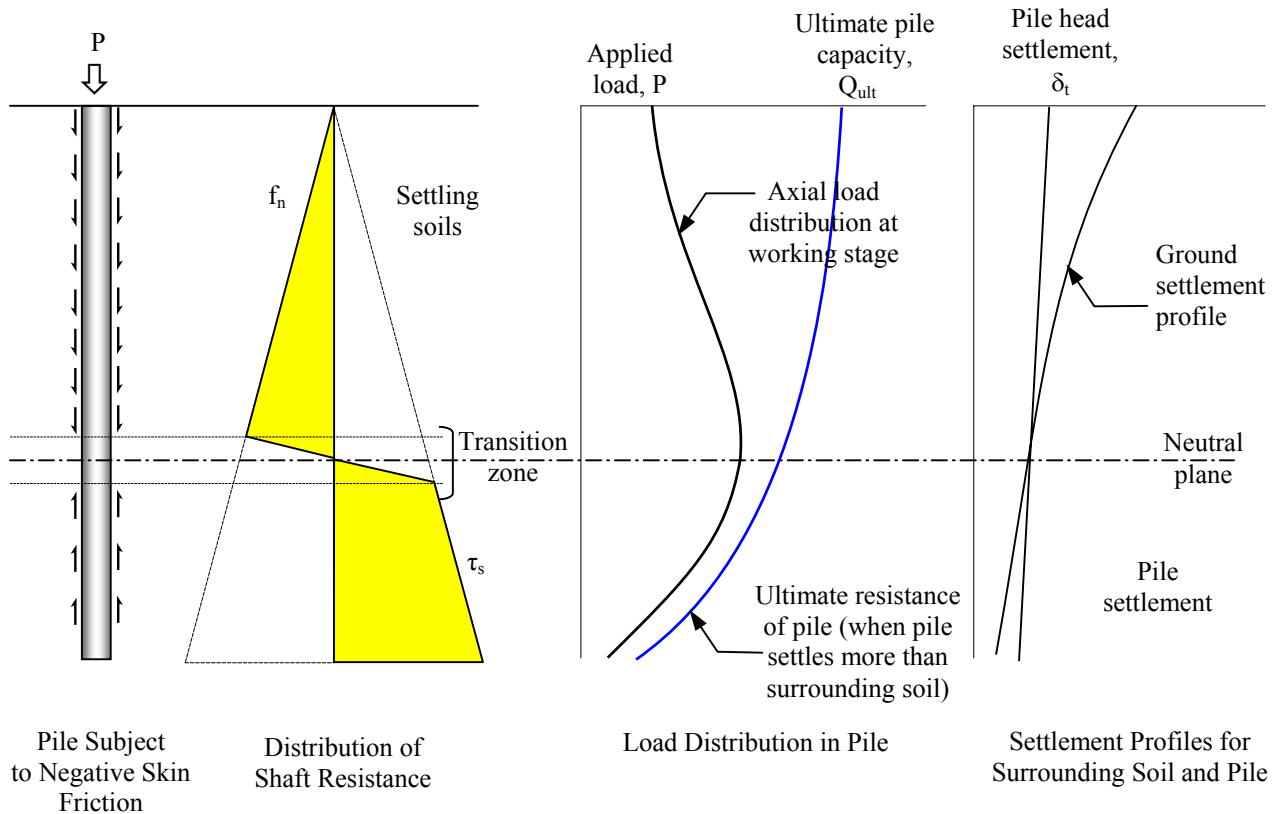

Notes :

- (1) The negative skin friction, f_n , in granular soils and cohesive soils is determined as for positive shaft resistance, τ_s . The effective stress approach can be used to estimate the negative skin friction as follows :

$$f_n = \beta \sigma_v'$$

where f_n = negative skin friction
 σ_v' = vertical effective stress
 β = empirical factor obtained from full-scale loading tests or based on the soil mechanics principle (see Section 6.4.4):

- (2) Ultimate load-carrying capacity of pile will be mobilised when pile settles more than the surrounding soil. In such case, the geotechnical capacity of the pile can be calculated based on the entire length of pile.

Figure 6.21 – Estimation of Negative Skin Friction by Effective Stress Method

The mobilised negative skin friction, being dependent on the horizontal stresses in the ground, will be affected by the type of pile. For steel H-piles, it is important to check the potential negative skin friction with respect to both the total surface area and the circumscribed area relative to the available resistance (Broms, 1979).

The effective stress, or β method (Section 6.4.4.3) may be used to estimate the magnitude of negative skin friction on single piles (Bjerrum et al, 1969; Burland & Starke, 1994). For design purposes, the range of β values given in Tables 6.3 may be used for assessing the negative skin friction.

In general, it is only necessary to take into account negative skin friction in combination with dead loads and sustained live load, without consideration of transient live load or superimposed load. Transient live loads will usually be carried by positive shaft resistance, since a very small displacement is enough to change the direction of the shaft resistance from negative to positive, and the elastic compression of the piles alone is normally sufficient. In the event where the transient live loads are larger than twice the negative skin friction, the critical load condition will be given by (dead load + sustained live load + transient live load). The above recommendations are based on consideration of the mechanics of load transfer down a pile (Broms, 1979) and the research findings (Bjerrum et al, 1969; Fellenius, 1972) that very small relative movement will be required to build up and relieve negative skin friction, and elastic compression of piles associated with the transient live load will usually be sufficient to relieve the negative skin friction. Caution needs to be exercised however in the case of short stubby piles founded on rock where the elastic compression may be insufficient to fully relieve the negative skin friction. In general, the customary local assumption of designing for the load combination of (dead load + full live load + negative skin friction) is on the conservative side.

Poulos (1990b) demonstrated how pile settlement can be determined using elastic theory with due allowance for yielding condition at the pile/soil interface. If the ground settlement profile is known with reasonable certainty, due allowance may be made for the portion of the pile shaft over which the relative movement is insufficient to fully mobilise the negative skin friction (i.e. movement less than 0.5% to 1% of pile diameter).

The effect of soil-slip at the pile-soil interface has been investigated by many authors (e.g. Chow et al, 1996; Lee et al, 2002 and Jeong et al, 2004). Negative skin friction and dragload tend to be overestimated if the effect of soil-slip is not considered. On the other hand, negative skin friction near the neutral plane is usually partially mobilised, as the relative movement between the soil and pile is smaller than that required for full mobilisation (Lee et al, 2002). As such, negative skin friction estimated by effective stress or β method is conservative.

6.8.3 Field Observations in Hong Kong

Lee & Lumb (1982) reported the results of an instrumented closed-ended tubular pile loaded by a 2 m high embankment for about a year. The back-analysed β values for downdrag in the fill/marine sand and in the marine clay were about 0.61 and 0.21, respectively, which are broadly consistent with the recommended values given in Tables 6.3.

Available long-term monitoring data on piles driven into saprolites (i.e. friction piles) through an old reclamation (i.e. fill placed more than 20 years ago) indicates that no significant negative skin friction builds up in the long-term after building occupation (Ho & Mak, 1994). This is consistent with the fact that primary consolidation under the reclamation fill is complete, and that no significant settlement and negative skin friction will result unless large reductions in the water level are imposed (Lumb, 1962), or soft clays with a potential for developing large secondary consolidation settlement are present.

6.8.4 Means of Reducing Negative Skin Friction

Possible measures that can be adopted to reduce negative skin friction include coating with bitumen or asphalt, using an enlarged point or collar at the position near the neutral plane, using sacrificial protection piles around the structure, and various ground improvement techniques such as electro-osmosis (Broms, 1979).

Field tests carried out by Lee & Lumb (1982) for a site in Tuen Mun indicate that coating of steel tubular piles can be effective in reducing negative skin friction. In this case, loading tests demonstrated that dragload with coating was only 14% of that with no coating.

Steel tubular piles which are protected with an inner coating of 2 mm thick bitumen, and an outer protective coating of polyethylene plastic of minimum thickness 3.5 mm were also reported to have been effective in reducing negative skin friction when driven through reclaimed land in Japan (Fukuya et al, 1982).

In Norwegian practice, a minimum bitumen coating of 1 mm is used for steel piles and 2 mm for concrete piles (Simons & Menzies, 1977).

The effectiveness of any slip coating will depend on the extent of damage sustained during pile handling and driving and should be confirmed by site trials. The durability of the coating must also be considered as bitumen has been observed to be attacked by bacteriological action in marine clays (Simons & Menzies, 1977).

6.9 TORSION

It is rarely necessary to design piles for torsion loading. Reference may be made to Randolph (1981a) for piles subject to torsion.

6.10 PRELIMINARY PILES FOR DESIGN EVALUATION

The best way to determine pile behaviour is to carry out full-scale loading tests on representative preliminary piles to obtain suitable parameters to verify the design assumptions. It would be necessary to characterise the ground conditions so as to permit generalisation and extrapolation of the test results to other areas of the site. The need for preliminary piles should be carefully assessed by the designer, having regard to familiarisation with the ground conditions, the type of pile, previous experience and the scale of the project.

The preliminary piles should preferably be load-tested to the ultimate state or at least to sufficient movements beyond those at working conditions. The use of internal instrumentation will provide valuable information on the load transfer mechanism and will facilitate back analysis. Instrumented piles should be considered particularly in unfamiliar or difficult ground conditions and when novel pile types are being proposed. Load testing of preliminary piles can enhance the reliability of the design and can, in some cases, lead to considerable savings.

Where possible, the preliminary piles should be located in the area with the most adverse ground conditions. They should be constructed in the same manner using the same plant and equipment as for working piles so as to evaluate the adequacy of workmanship and the method of construction. It is recommended that at least one exploratory borehole be sunk at or in the vicinity of the preliminary pile position for retrieving undisturbed samples and appropriate insitu tests prior to the pile construction in order to characterise the ground conditions and facilitate back-analysis of test results.

The number of preliminary piles should be selected on the basis of a range of considerations including :

- (a) ground conditions and their variability across the site,
- (b) type of pile and method of construction,
- (c) previous documented evidence of the performance of the same type of pile in similar ground conditions,
- (d) total number of piles in the project, and
- (e) contractor's experience.

As a rough guide, it is recommended that at least two preliminary piles for the first 100 piles (with a minimum of one preliminary pile for smaller contracts) should be load-tested when there is a lack of relevant experience (e.g. in unfamiliar ground conditions or use of novel pile types). Where the pile performance is particularly prone to the adequacy of quality control and method of construction (e.g. large-diameter bored piles in saprolites), at least one preliminary pile should be load-tested for the first 100 piles. In both instances, where a contract involves a large number of piles when the total number of piles exceeds 200, the number of additional preliminary piles may be based on the frequency of one per every 200 piles after the first 100 piles.

If any of the preliminary piles fail the loading test marginally, the pile capacity should be downgraded as appropriate. However, if the piles fail the test badly and the failure is unlikely to be due to over-optimistic design assumptions, the reasons for the failure should be investigated in detail. The number of piles to be further tested should be carefully considered.

For large-diameter bored piles or barrettes, it may be impractical to carry out a loading test on a full size preliminary pile. Loading tests on a smaller diameter preliminary pile may be considered, provided that :

- (a) it is constructed in exactly the same way as piles to be used for the foundation, and
- (b) it is instrumented to determine the shaft and end-bearing resistance separately.

Details of pile instrumentation and interpretation of loading tests are covered in Chapter 9.

6.11 PILE DESIGN IN KARST MARBLE

The design of piles founded in karst marble requires consideration of the karst morphology, loading intensity and layout of load bearing elements. The main problem affecting the design is the presence of overhangs and cavities, which may or may not be infilled. The stability of the piled foundation will depend on the particular geometry of such karst features, and the rock mass properties, particularly of the discontinuities.

McNicholl et al (1989b) reported the presence of a weak, structureless soil layer above the marble rock surface in the Tin Shui Wai area and suggested that this might have been affected by slumping and movement of fines into the underlying cavities. Mitchell (1985) reported similar findings in Malaysia. The significance of this weaker material on the pile design should be carefully considered.

Chan et al (1994) proposed a system for classifying the marble rock mass in Hong Kong. An index termed Marble Quality Designation (MQD) is put forward. This index is a combined measure of the degree of dissolution voids, and the physical and mechanical implications of fractures or a cavity-affected rock mass (Figure 6.22). The marble rock mass is classified in terms of MQD values. This marble rock mass classification system is used in the interpretation of the karst morphology, and offers a useful means for site zoning in terms of the degree of difficulties involved in the design and construction of foundations. A summary of the proposed classification system, together with comments on its engineering significance, is given in Table 6.7. An approach to the design of piles on karst marble in Hong Kong, which makes use of the classification system, is described by Ho et al (1994).

Foundations on karst marble in Yuen Long and Ma On Shan areas have successfully been constructed using bored piles, steel H-piles and small-diameter cast-in-place piles. However, it must be stressed that no simple design rules exist which could overcome all the potential problems associated with karst formation.

Large-diameter bored piles are usually designed as end-bearing piles founded on sound marble that has not been or is only slightly affected by dissolution, such as rock mass with Marble Class I or II. The founding level of the piles and allowable bearing pressure of the marble beneath the pile base should be assessed taking into consideration the sizes and distribution of dissolution and the increase of stresses due to foundation load. The assessment of the allowable bearing pressure of volcanoclastic rocks should take into account any honeycomb structure as a result of preferential weathering of marble clasts.

The concept of 'angle of dispersion' is sometimes used to determine the founding level of end-bearing piles (Chan, 1996). This concept requires that there should be no major cavities within a zone below the pile base as defined by a cone of a given angle to the vertical, within which sensible increase in vertical stress would be confined. This approach is acceptable as an aid to judgement in pile design. Careful consideration should be given to the nature and extent of the adverse karst features and of their positions, in plan and elevation, in relation to nearby piles and to the foundation as a whole, together with the quality of the intervening rock.

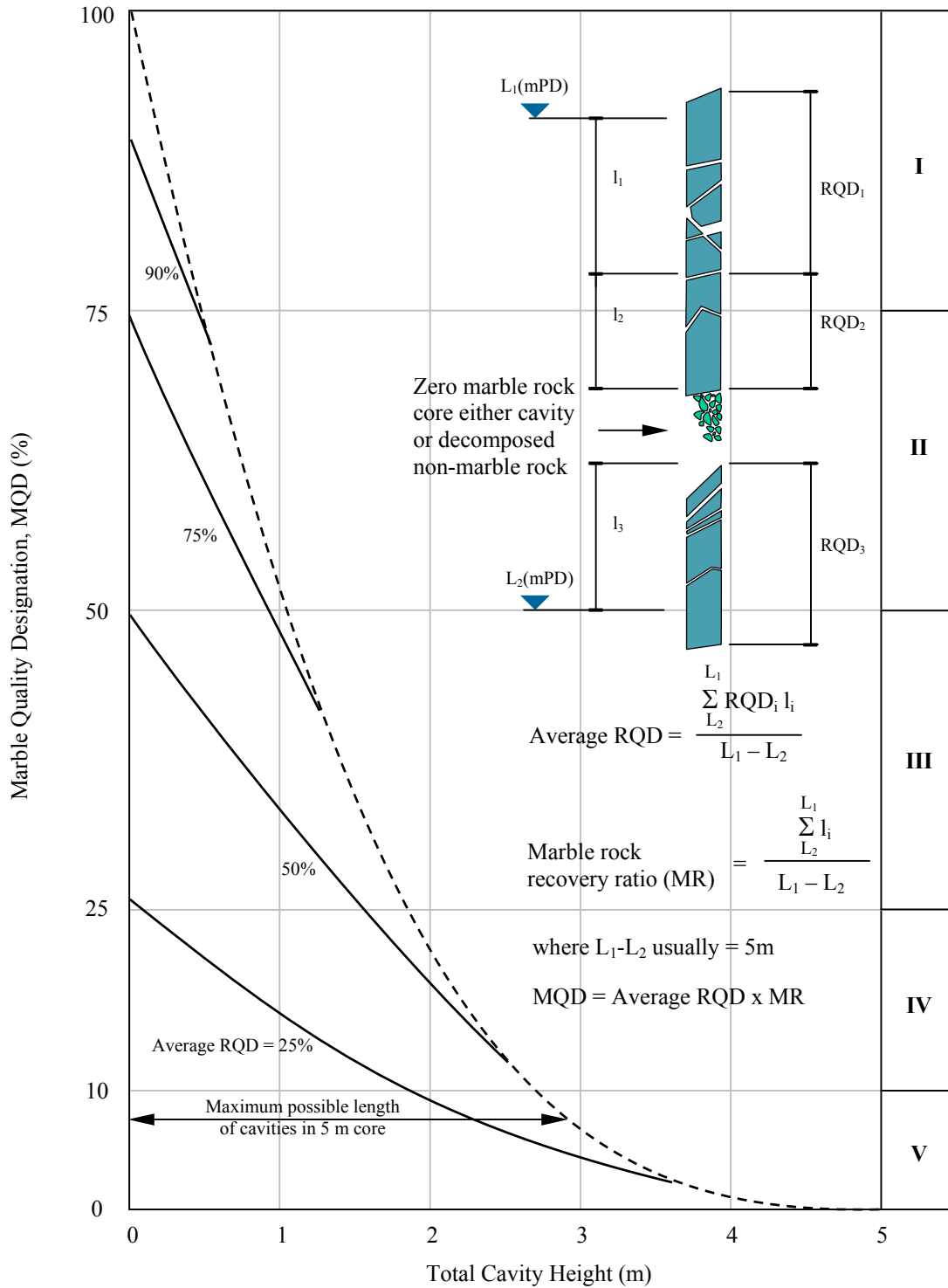

Note : At the rockhead, where the top section is shorter than 5 m but longer than or equal to 3 m, the MQD is calculated for the actual length and designated as a full 5 m section. If the top section is shorter than 3 m, it is to be grouped into the section below. Likewise, the end section is grouped into the section above if it is shorter than 3m.

Figure 6.22 - Definition of Marble Quality Designation (MQD)

Table 6.7 – Classification of Marble (Chan, 1994a)

| Marble Class | MQD Range (%) | Rock Mass Quality | Features |
|--------------|----------------------------|-------------------|---|
| I | $75 < \text{MQD} \leq 100$ | Very Good | Rock with widely spaced fractures and unaffected by dissolution |
| II | $50 < \text{MQD} \leq 75$ | Good | Rock slightly affected by dissolution, or slightly fractured rock essentially unaffected by dissolution |
| III | $25 < \text{MQD} \leq 50$ | Fair | Fractured rock or rock moderately affected by dissolution |
| IV | $10 < \text{MQD} \leq 25$ | Poor | Very fractured rock or rock seriously affected by dissolution |
| V | $\text{MQD} \leq 10$ | Very Poor | Rock similar to Class IV marble except that cavities can be very large and continuous |

- Notes : (1) In this system, Class I and Class II rock masses are considered to be a good bearing stratum for foundation purposes, and Class IV and Class V rock masses are generally unsuitable.
- (2) Class III rock mass is of marginal rock quality. At one extreme, the Class III rating may purely be the result of close joint spacings in which case the rock may be able to withstand the usual range of imposed stresses. At the other extreme, the Class III rating may be the result of moderately large cavities in a widely-jointed rock mass. The significance of Class III rock mass would need to be considered in relation to the quality of adjacent sections and its proximity to the proposed foundations.

Domanski et al (2002) reported the use of shaft-grouted large-diameter bored piles socketed in a marble formation. The formation contains a series of small cavities with infilled materials, and is generally without significant voids. Grouting was carried out in two stages. The grouting at the pre-treatment stage was used to increase the strength of infill materials in the cavities. It also prevented the chances of excessive loss of bentonite during subsequent bored pile excavation. After casting the pile, post-grouting was applied in the second stage to enhance the shaft resistance. Results of pile loading tests indicated that the ultimate shaft resistance could reach 970 kPa, which is comparable to the shaft resistance measured in piles socketed in other types of rock.

For driven steel H-piles, they are commonly designed to be driven to sound marble, such as rock mass with Marble Class I or II. Despite the requirement of hard driving, there are chances that the driven piles can be affected by karst features beneath the pile toe or damaged during driving. A pile redundancy is provided for these uncertainties (GEO, 2005). No definite guidelines can be given for the percentage of redundancy as this depends on the extent, nature and geological background of the karst features and the type of pile. Each site must be considered on its own merits. Some discussion on the consideration of redundancy factors (i.e. the factor by which the pile capacity is reduced) is given by Chan (1994a). Where redundant piles are provided for possible load redistribution, the effect of this possible re-distribution should be considered in the design of the pile cap. Where the foundation consists of a number of pile caps rather than the usual single raft, it may be necessary to increase the redundancy, and to ensure adequate load transfer capacity between the pile caps by means of inter-connecting ground beams.

Pre-boring may be used if the piles have to penetrate overhangs or roofs and install at great depths. In such circumstances, the piles are less likely to be underlain by karst features and the pile redundancy can be adjusted accordingly.

The final set for driven piles on marble bedrock is usually limited to not greater than 10 mm in the last ten blows. Past experience indicated that such a hard driving criterion may result in pile damage. It is prudent to measure the driving stress when taking the final set of the piles. Li & Lam (2001) reported other termination criteria that had been used successfully for seating piles on a marble surface. These included 30 mm per 30 blows and 25 mm per 17 blows. Chan (1996) discussed the forms of blow count records that indicate possible damage of installed piles. Blow counts should be recorded for every 500 mm penetration when the driving is easy and every 100 mm penetration when the driving is hard (e.g. penetration rate smaller than 100 mm for every 10 blows).

Due to the uncertainty and variability of karst features in marble and the requirement of hard driving, non-destructive tests should be carried out to ensure the integrity of installed driven piles. The Code of Practice for Foundations (BD, 2004a) requires 10% of installed piles that are driven to bedrock to be checked by Pile Driving Analyzer (PDA). A higher percentage should be used on sites underlain by marble. Kwong et al (2000) reviewed some piling projects in the Ma On Shan area. The percentage of installed driven piles subject to PDA tests ranged between 12% and 28%. Piles might rebound from the hammer impact when they are driven hard against the marble bedrock. This could lead to extra settlement in static pile loading tests. In such case, re-tapping of the piles may be necessary to avoid the extra settlement.

For driven piles that are sitting on surface karst, it may be prudent to carry out re-strike test of the installed piles. This is to ensure that the marble supporting the installed piles does not collapse or become weakened due to the driving and setting of piles in the vicinity.

A performance review of foundation construction is usually required for piling works on sites underlain by marble (ETWB, 2004). This should include a review of the ground conditions experienced during pile driving, pile installation or foundation construction, and an assessment of pile driving or construction records. Blake et al (2000) described the design and construction problems encountered for driving piles at Ma On Shan and the mitigation measures taken after reviewing the piling records. In the performance review, pile caps were re-analysed using grillage models with the actual length of piles. Additional piles were installed to maintain the local redundancy where piles were found to be damaged. The verticality of driven piles was measured with inclinometers attached to the steel H-sections. They observed that the majority of the piles were deflected from the vertical alignment on contact with marble surface. A minimum radius of curvature of 23 m was measured in one case. Despite the observed deflection, the load-carrying capacity of the pile was not adversely affected when it was load-tested.

Small-diameter cast-in-place piles 'floating' in the soil strata well above the top of marble surface have also been used. They are mostly for low-rise buildings such as school blocks, whose superstructure loads are comparatively smaller. There were a few occasions where such a foundation system was designed to support up to 15-storey high building (Wong & Tse, 2001). The design for a 'floating' foundation usually allows the spreading of foundation loads in the soil and limits the increase of vertical effective stress on the marble surface to a small value, so as to prevent the collapse of any cavities due to the imposition of foundation loads. Meigh (1991) suggested the allowable limit of increase in vertical effective stress in marble affected by different degree of dissolution features (Table 6.8). Alternatively, the allowable increase of vertical effective stress can be determined by a rational design

approach to demonstrate that the deformation of the marble rock and the infilled materials within cavities would not adversely affect the performance of the foundation.

Table 6.8 – Limits on Increase of Vertical Effective Stress on Marble Surface (Meigh, 1991)

| Site Classification ⁽¹⁾ | Limits on Increase of Vertical Effective Stress at Marble Surface |
|------------------------------------|---|
| A | Design controlled by settlement in soil stratum |
| B | 5 – 10 % |
| C | 3 – 5 % |
| D | < 3 % |

Note : (1) Site classification is based on Chan (1994a).

Chan (1996) highlighted the difficulties in using numerical tools to predict the bearing capacity of rock mass over a dissolution feature or adjacent to a pinnacle or cliff because of the lack of understanding of the extent and conditions of the dissolution features and the degree of dissolution along the joint system. This remains the case despite recent advancement in the degree of sophistication of numerical modelling. A pragmatic approach using simple calculations, rules of good practice and engineering judgement remains the best available solution in designing pile foundations in marble.

For local areas with adverse karst features, it may be feasible to design a thickened pile cap to cantilever from or span across the problematic area, provided that the outline of the area is well defined by site investigation.

6.12 STRUCTURAL DESIGN OF PILES

6.12.1 General

Structural design of piles should be carried out in accordance with the requirements in local structural codes and regulations. The piles should be capable of withstanding both the stresses induced during handling and installation as well as during their service life.

6.12.2 Lifting Stresses

The adequacy of reinforcement in precast reinforced (including prestressed) concrete piles to resist bending should be checked for the case of bending stresses induced by lifting.

6.12.3 Driving and Working Stresses

The stresses induced in a pile during driving may be calculated using a wave equation analysis (Section 6.4.3). The maximum driving stresses must not exceed the acceptable limiting stresses (Table 8.6) on the pile material.

An alternative and simplified approach, which is commonly adopted, is to limit the working stresses under static loading such that hard driving is not required to achieve the penetration resistance necessary for the calculated ultimate bearing capacity. Many codes

limit the working structural stresses, which can be carried by a pile. In Hong Kong, the limiting average compressive stresses (BD, 2004a) on the nominal cross-sectional area at working load are :

- (a) precast reinforced concrete piles : $0.2 f_{cu}$.
- (b) steel piles :
 - (i) $0.3 f_y$ where piles are driven.
 - (ii) $0.5 f_y$ where piles are installed in pre-bored hole or jacked to required depth.
 - (iii) combined axial and bending stress should not exceed $0.5 f_y$.
- (c) cast-in-place concrete piles :
 - (i) The appropriate limitations of design stresses of the concrete in the case of concreting in dry conditions.
 - (ii) 80% of the appropriate limitations of design stresses of the concrete, in the case where groundwater is likely to be encountered during concreting or constructed under water or drilling fluid.

where f_{cu} is the specified grade strength of concrete and f_y is characteristic yield strength of the steel.

More guidance on precautions to be taken during construction is given in Section 8.2.5.2.

In a widely jointed strong rock, the allowable load on the pile will be governed by the permissible structural stresses of the pile section. In principle, the use of very high strength concrete ranging from, say, 60 to 75 MPa (Kwan, 1993) will increase the allowable pile capacity. However, there may be practical problems associated with achieving such high concrete strength given the requirements for high workability for self compaction of piling concrete, and possible concrete placement by means of tremie under a stabilising fluid. Other potential problems, such as thermal effects and creep, will also need to be considered. Sufficient field trials, including testing of cores of the pile, will be required to prove the feasibility of very high strength concrete for piling.

6.12.4 Bending and Buckling of Piles

H-piles and steel tubular piles are flexible and may deflect appreciably from the intended alignment during driving. Specifications normally allow tolerances in alignment and plan position at cut-off level, e.g. 1 in 75 deviation from vertical and 75 mm deviation in plan for vertical piles. A method of calculating the bending stresses caused by eccentric

loading is explained in Figure 6.23. In general, pile buckling should be checked assuming the pile is at maximum allowable tolerance in alignment and plan. In situations where there are significant horizontal loads (and/or moments) applied at pile head, the combined effects should be considered in pile design.

Piles rarely buckle except for long slender piles (e.g. mini-piles) in very soft ground, jacked piles or where piles have been installed through significant cavities in karstic marble. Studies on this problem have been carried out by a number of researchers (e.g. Davisson & Robinson, 1965; Reddy & Valsangkar, 1970). Analyses indicate that buckling will be confined to the critical length of the pile under lateral loading (Figure 6.24).

6.12.5 Mini-piles

In Hong Kong, the allowable structural capacity of a mini-pile has generally been assessed conservatively by ignoring the contribution of the grout even under compression. The allowable stress of the steel will be that given by local structural codes or building regulations. It would be more rational, and in line with overseas practice, to make a suitably cautious allowance for the contribution by the grout. Available instrumented pile tests (Lui et al, 1993) indicated that the grout did contribute to the load-carrying capacity.

Provided that strict site control and testing of the grouting operation (Section 8.3.5.3) are implemented, the design strength of the grout may be taken notionally as 75% of the measured characteristic cube strength. The allowable compressive stress of grout contributing to the allowable structural capacity of the pile may be taken as 25% of the design strength. Where necessary, the contribution of grout to the load-carrying capacity of the pile can be investigated by instrumented pile loading tests.

Where very high strength steel bars (e.g. Dywidag bars) are used, care should be taken to consider the effect of strain compatibility between the steel and the grout, as the available strength of the steel may not be mobilised due to failure of the grout.

6.13 DEFORMATION OF SINGLE PILES

6.13.1 General

Various analytical techniques have been developed to predict pile deflections. These techniques provide a convenient framework for deriving semi-empirical correlations between equivalent stiffness parameters back-analysed from loading tests and index properties of the ground. Some of the analytical methods can also be extended to evaluate pile interaction effects in an approximate manner, thus enabling an assessment of pile group behaviour to be made within the same framework.

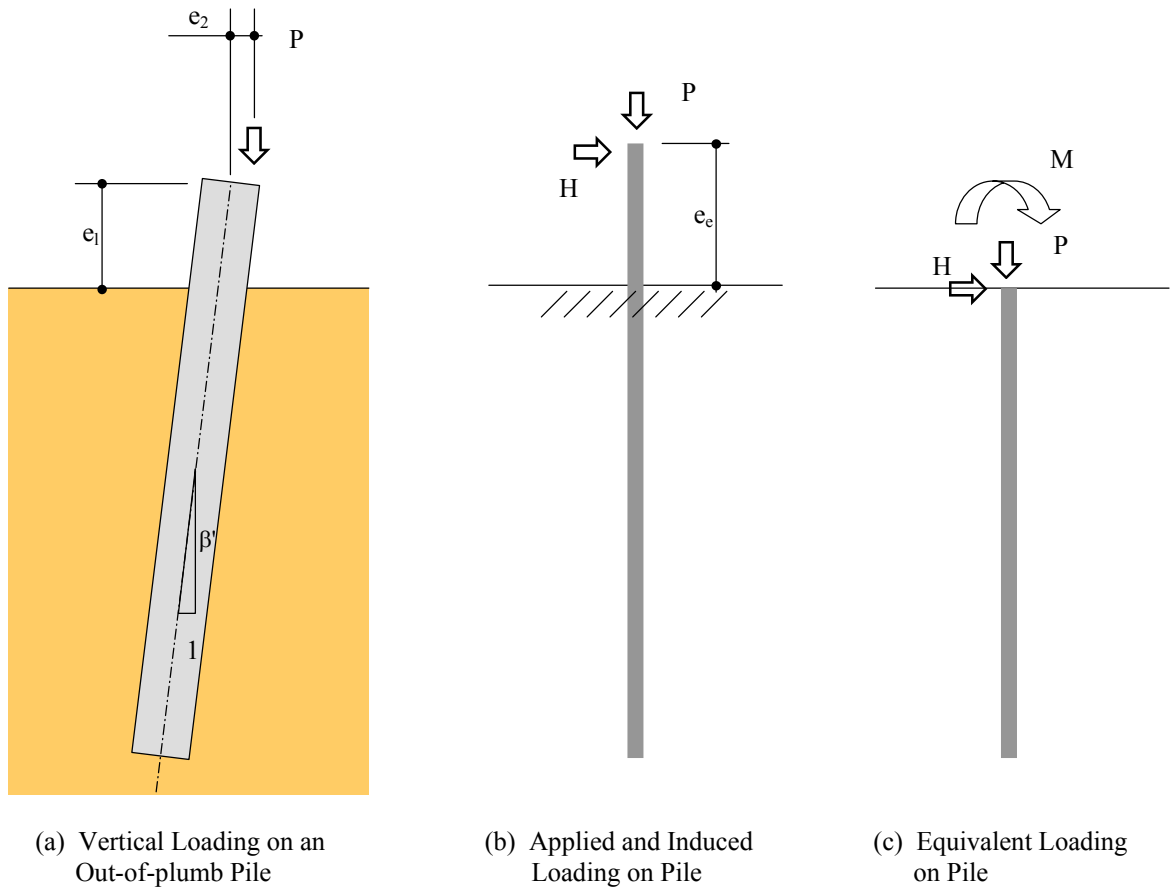

$$H = \frac{P}{\beta'}$$

$$e_e = e_1 + \frac{P}{H} e_2$$

$$M = H e_e$$

Legend :

- e_e = effective eccentricity of load
- P = applied vertical load
- H = induced horizontal load due to non-verticality of pile
- e_1 = free length of pile above ground level
- e_2 = eccentricity of load application
- M = moment on pile
- β' = inclination of pile

Notes :

- (1) The analysis of a pile subject to moment and lateral load can be made using Figure 6.18 or 6.19 as appropriate.
- (2) The depth of any near-surface weak material should be included as part of the eccentricity e_1 .

Figure 6.23 – Bending of Piles Carrying Vertical and Horizontal Loads

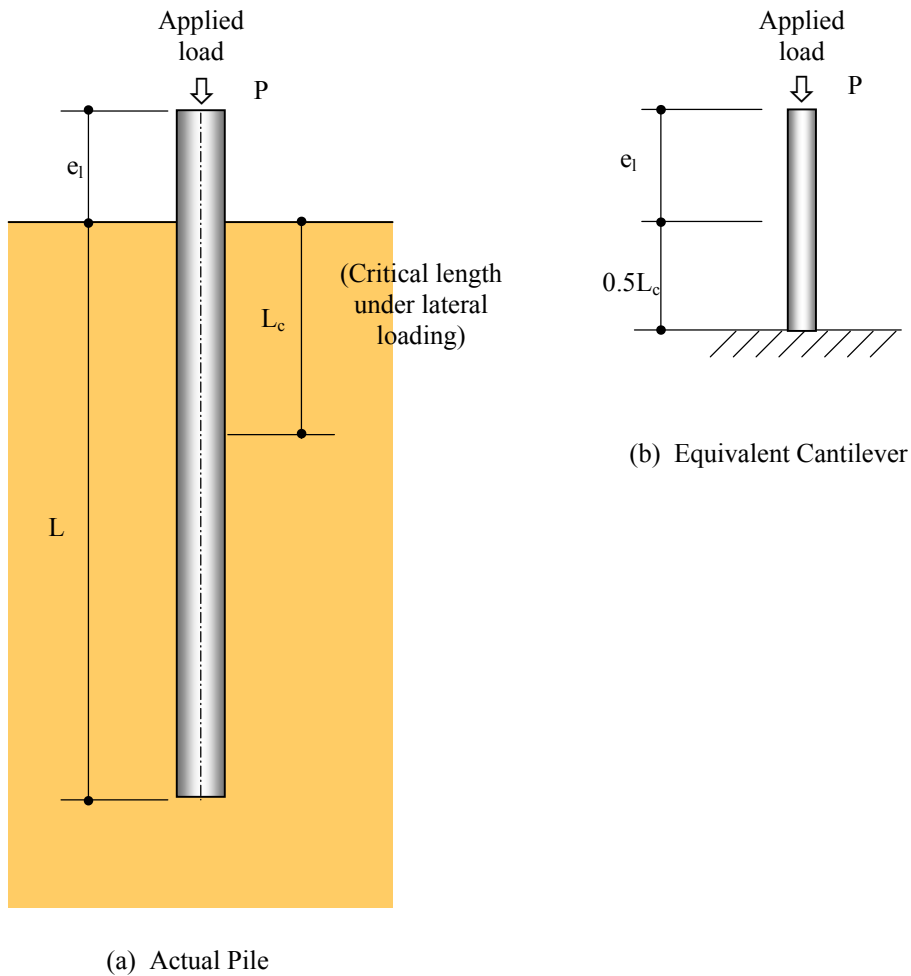

For free-head piles, $P_{cr} = \frac{\pi^2 E_p I_p}{4(e_1 + 0.5L_c)^2}$

For fixed-head piles, $P_{cr} = \frac{\pi^2 E_p I_p}{(e_1 + 0.5L_c)^2}$

where $L_c = \frac{D}{2} \left(\frac{E_p}{G_c} \right)^{2/7} \approx 4 \sqrt[4]{\frac{E_p I_p}{K_h}}$ for soils with constant K_h
 $\approx 4 \sqrt[5]{\frac{E_p I_p}{n_h}}$ for soils with a linearly increasing K_h

Legend :

| | |
|---|--|
| P_{cr} = critical buckling load | G_c = mean value of G^* over L_c |
| E_p = Young's modulus of piles | $G^* = G(1 + 0.75v_s)$ |
| I_p = moment of inertia of pile | G = shear modulus of soil |
| e_1 = free length of pile above ground | v_s = Poisson's ratio of soil |
| L_c = critical pile length for lateral load | K_h = modulus of horizontal subgrade reaction |
| L = total pile length | n_h = constant of horizontal subgrade reaction |
| D = pile diameter | |

Figure 6.24 – Buckling of Piles (Fleming et al, 1992)

6.13.2 Axial Loading

6.13.2.1 General

The various approaches that have been proposed for predicting pile settlement can be broadly classified into three categories :

- (a) load transfer method,
- (b) elastic continuum methods, and
- (c) numerical methods.

In calculating movements, the stiffness of the founding materials at the appropriate stress level needs to be determined. For normal pile working loads (of the order of 40% to 50% of ultimate capacity), Poulos (1989b) has shown that the non-linear nature of soil behaviour generally does not have a significant effect on the load-settlement relationship for single piles.

6.13.2.2 Load transfer method

In the load transfer method proposed by Coyle & Reese (1966) for piles in soil, the pile is idealised as a series of elastic discrete elements and the soil is modelled by elasto-plastic springs. The load-displacement relationship at the pile head, together with the distribution of load and displacement down the pile, can be calculated using a stage-by-stage approach as summarised in Figure 6.25.

The axial load transfer curves, sometimes referred to as 't-z' curves, for the springs may be developed from theoretical considerations. In practice, however, the best approach to derive the load transfer curves is by back analysis of an instrumented pile test because this takes into account effects of pile construction.

The load transfer method provides a consistent framework for considering the load transfer mechanism and the load-deformation characteristics of a single pile.

6.13.2.3 Elastic continuum methods

The elastic continuum method, sometimes referred to as the integral equation method, is based on the solutions of Mindlin (1936) for a point load acting in an elastic half-space. Different formulations based on varying assumptions of shaft resistance distribution along the shaft may be used to derive elastic solutions for piles. Solutions using a simplified boundary element method formulation are summarised by Poulos & Davis (1980) in design chart format.

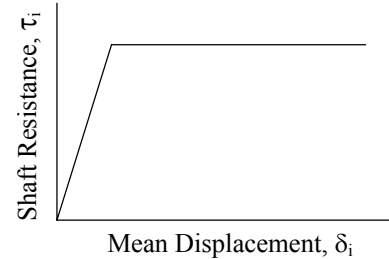
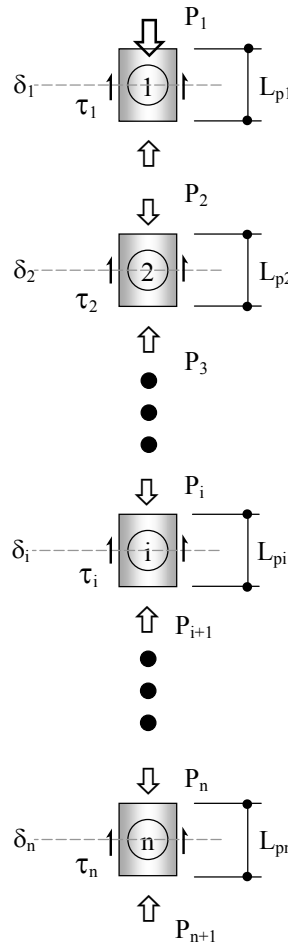
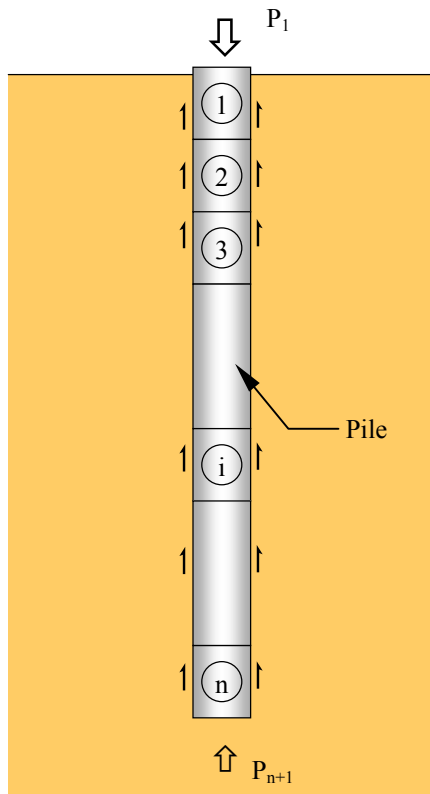

Typical Assumption of Shaft Resistance and Displacement Relationship for Element i

Legend :

- P_i & P_{i+1} = load acting on element i
- τ_i = shaft resistance on element i
- δ_i = movement at the middle of element i
- L_{pi} = length of element i
- ② = element number (2)

Procedures:

- (1) Compute tip load P_{n+1} corresponding to a given base movement, δ_b , based on an assumed end-bearing stress-displacement relationship.
- (2) Estimate midpoint movement, δ_n for bottom element n; for the first trial, take $\delta_n = \delta_b$.
- (3) Given δ_n , the shear stress, τ_n can be determined for a given shear stress-displacement curve.
- (4) Calculate $P_n = P_{n+1} + \tau_n p_n L_{pn}$ where p_n is the pile perimeter.
- (5) Assuming a linear distribution of load along the pile element, compute the elastic deformation, δ_{elas} , for the bottom half of the element

$$\delta_{elas} = \frac{0.5 \{ 0.5(P_n + P_{n+1}) + P_{n+1} \} \cdot 0.5L_{pn}}{A_n E_{pn}}$$

where A_n is the pile area and E_{pn} is the Young's modulus of pile of element n.

- (6) Compute $\delta_n = \delta_b + \delta_{elas}$.
- (7) Compare new δ_n with that initially assumed in Step 2. Adjust and repeat analysis until specified tolerance is achieved.
- (8) When required convergence is achieved, proceed to next element up and repeat the procedure. Continue until the load at the top of the pile, P_1 , is computed corresponding to a given value of δ_b .
- (9) Repeat the calculation procedure using a different assumed δ_b and establish the complete load settlement relationship at the top of pile.

Figure 6.25 – Load Transfer Analysis of a Single Pile (Coyle & Reese, 1966)

In the method by Poulos & Davis (1980), the pile head settlement, δ_t , of an incompressible pile embedded in a homogeneous, linear elastic, semi-infinite soil mass is expressed as follows :

$$\delta_t = \frac{P I_{ps}}{E_s D} \quad [6.10]$$

where P = applied vertical load
 I_{ps} = influence factor for pile settlement
 E_s = Young's modulus of founding material
 D = pile diameter

The pile settlement is a function of the slenderness ratio (i.e. pile length/diameter, L/D), and the pile stiffness factor, K , which is defined as follows :

$$K = \frac{E_p R_A}{E_s} \quad [6.11]$$

where E_p = Young's modulus of pile
 R_A = ratio of pile area A_p to area bounded by outer circumference of pile

Influence factor, I_{ps} , can be applied to allow for the mode of load transfer (i.e. friction or end-bearing piles), effects of non-homogeneity, Poisson's ratio, pile compressibility, pile soil slip, pile base enlargement and nature of pile cap. Reference should be made to Poulos & Davis (1980) for the appropriate values.

The ratio of short term (immediate) settlement to long-term (total) settlement can be deduced from elastic continuum solutions. For a single pile, this ratio is typically about 0.85 to 0.9 (Poulos & Davis, 1980).

In a layered soil where the modulus variation between successive layers is not large, the modulus may be taken as the weighted mean value (E_{av}) along the length of the pile (L) as follows :

$$E_{av} = \frac{1}{L} \sum_{i=1}^n E_i d_i \quad [6.12]$$

where E_i = modulus of soil layer i
 d_i = thickness of soil layer i
 n = number of different soil layers along the pile length

An alternative formulation also based on the assumption of an elastic continuum was put forward by Randolph & Wroth (1978). This approach uses simplifying assumptions on the mode of load transfer and stress distribution to derive an approximate closed-form solution for the settlement of a compressible pile (Figure 6.26). A method of dealing with a layered soil profile based on this approach is given by Fleming et al (1992).

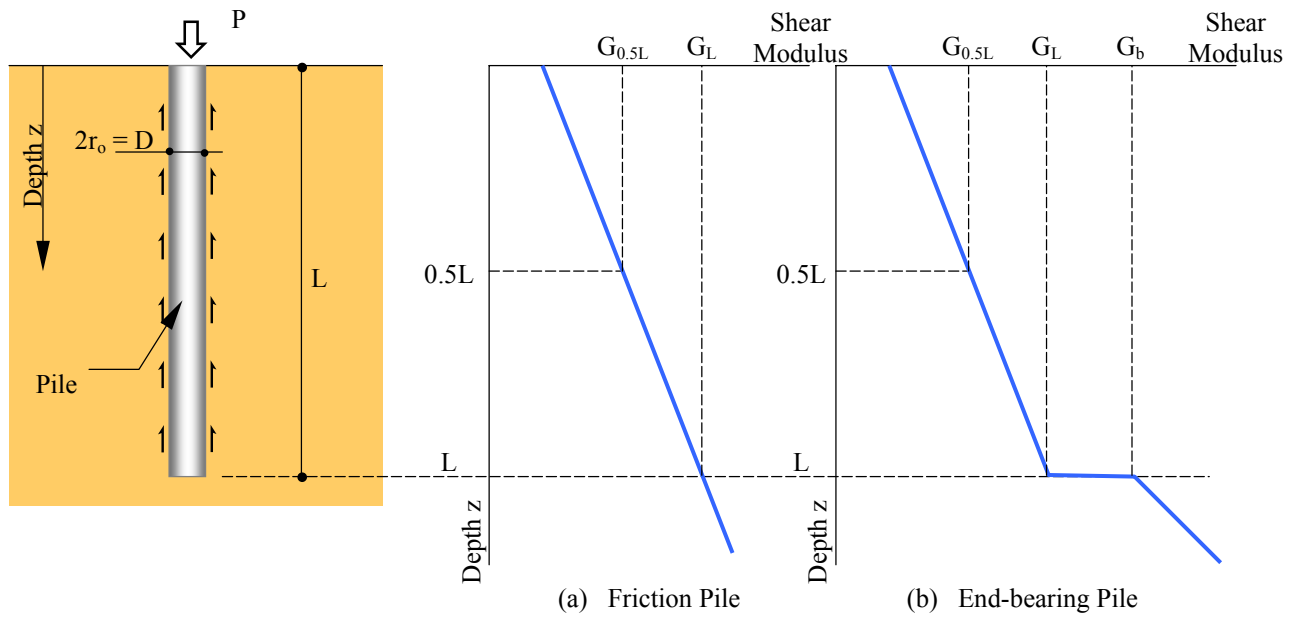

Assumed Variation in Shear Modulus with Depth

For an applied load, P, the pile head settlement, δ_t , of a compressible pile is given by the following approximate closed form solution :

$$\frac{P}{\delta_t r_o G_L} = \frac{\frac{4\eta_r}{(1-\nu_s)\xi} + \frac{2\pi\rho L \tanh(\mu L)}{\zeta r_o \mu L}}{1 + \frac{1}{\pi\lambda} \frac{4 \eta_r L \tanh(\mu L)}{(1-\nu_s) \xi r_o \mu L}}$$

- where $\eta_r = r_b/r_o$ (r_b and r_o is the radius of pile base and shaft respectively)
- $\xi = G_L/G_b$ (G_L & G_b is the shear modulus of soil at depth L and at base respectively)
- $\rho = G_{0.5L}/G_L$ (rate of variation of shear modulus of soil with depth)
- $\lambda = E_p/G_L$ (pile stiffness ratio)
- $\mu L = \sqrt{\frac{2}{\zeta\lambda}} \frac{L}{r_o}$
- $\zeta = \ln \{ [0.25 + (2.5\rho(1-\nu_s) - 0.25)\xi] \frac{L}{r_o} \}$
- $\nu_s =$ Poisson's ratio of soil

The settlement profile with depth may be approximated as

$$\delta = \delta_b \cosh (\mu(L-z)) \text{ where } \delta_b = \frac{P_b(1-\nu_s)}{4 r_b G_b}, P_b = \text{load at pile base}$$

For a non-circular pile with outer dimension of p_b and p_w , radius, r_o , may be taken such that $\pi r_o^2 = p_b \times p_w$ and E_p may be modified by the factor, $A_p/\pi r_o^2$

| Pile Slenderness Ratio, $L/D \leq 0.25 \sqrt{E_p/G_L}$ | Pile Slenderness Ratio, $L/D \geq 1.5 \sqrt{E_p/G_L}$ |
|--|---|
| Pile may be treated as effectively rigid and pile head stiffness is given by: | Pile may be treated as infinitely long and pile head stiffness is given by : |
| $\frac{P}{\delta_t r_o G_L} = \frac{4\eta_r}{(1-\nu_s)\xi} + \frac{2\pi\rho L}{r_o}$ | $\frac{P}{\delta_t r_o G_L} = \pi \rho \sqrt{\frac{2\lambda}{\zeta}} \text{ or } P_t \approx 2 \rho r_o \sqrt{E_p G_{Lac}}$ |
| | G_L is the soil shear modulus at the bottom of active pile length L_{ac} where $L_{ac} = 3 r_o \sqrt{E_p/G_L}$ |

Figure 6.26 – Closed-form Elastic Continuum Solution for the Settlement of a Compressible Pile (Fleming et al, 1992)

It should be noted that the above elasticity solutions are derived assuming the soil is initially unstressed. Thus, pile installation effects are not considered explicitly except in the judicious choice of the Young's modulus. Alternative simplified elastic methods have been proposed by Vesic (1977) and Poulos (1989b) including empirical coefficients for driven and bored piles respectively in a range of soils. Similar approximate methods may be used for a preliminary assessment of single pile settlement provided that a sufficient local database of pile performance is available.

For piles founded on rock, the settlement at the surface of the rock mass can be calculated by the following formula assuming a homogeneous elastic half space below the pile tip :

$$\delta_b = \frac{q(1-\nu_r^2)D_b}{E_m} C_d C_s \quad [6.13]$$

where δ_b = settlement at the surface of the rock mass
 q = bearing pressure on the rock mass
 C_d = depth correction factor
 C_s = shape and rigidity correction factor
 ν_r = Poisson's ratio of rock mass
 D_b = pile base diameter
 E_m = Young's modulus of rock mass

The depth correction factor may be obtained from Figure 6.27, which has been reproduced from Burland & Lord (1970). The shape and rigidity factor is shown in Table 6.9 (Perloff, 1975).

For piles founded in a jointed rock, Kulhawy & Carter (1992a & b) have also put forward a simplified method for calculating settlements.

6.13.2.4 Numerical methods

Fleming (1992) developed a method to analyse and predict load-deformation behaviour of a single pile using two hyperbolic functions to describe the shaft and base performance individually under maintained loading. These hyperbolic functions are combined with the elastic shortening of the pile. By a method of simple linkage, based on the fact that the hyperbolic functions require only definition of their origin, their asymptote and either their initial slope or a single point on the function, elastic soil properties and ultimate loads may be used to describe the load-deformation behaviour of the pile.

The load-deformation behaviour of a pile can also be examined using numerical methods including rigorous boundary element analyses (e.g. Butterfield & Bannerjee, 1971a & b) or finite element analyses (e.g. Randolph, 1980; Jardine et al, 1986). Distinct element methods (e.g. Cundall, 1980) may be appropriate for piles in a jointed rock mass.

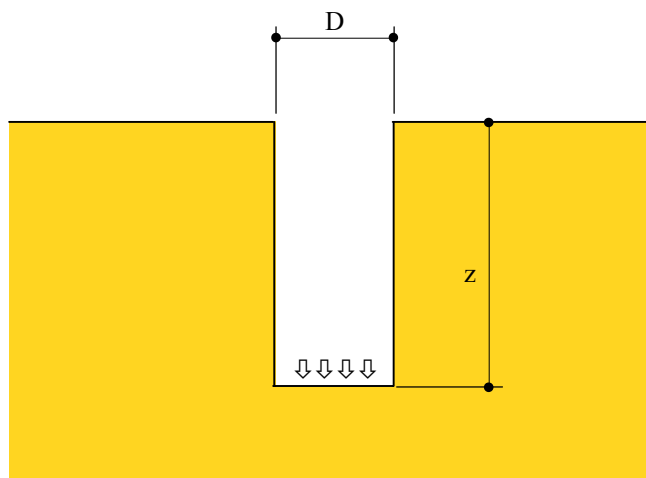
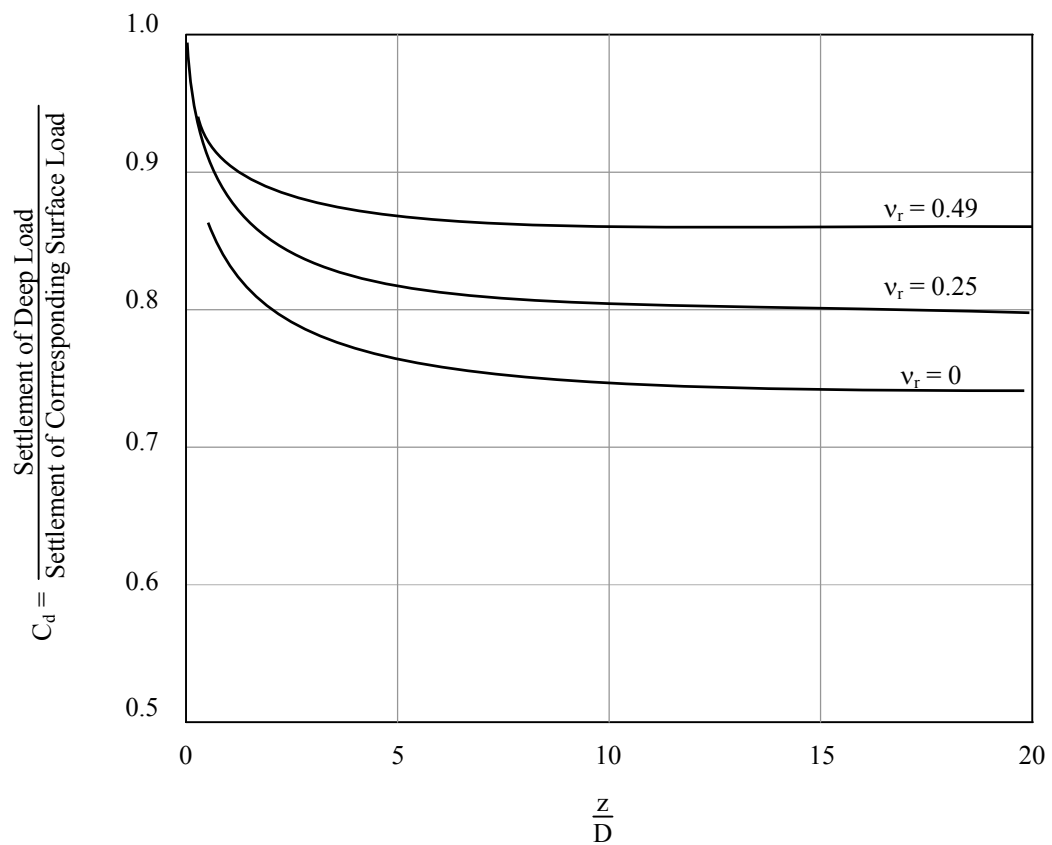

Uniform Circular Load at Base of Unlined Shaft

Legend :

- v_r = Poisson's ratio of rock
- D = pile diameter
- C_d = depth correction factor
- z = depth below ground

Note :

- (1) Settlement in the figure refers to the settlement of the centroid of the loaded area.

Figure 6.27 – Depth Correction Factor for Settlement of a Deep Foundation (Burland & Lord, 1970)

Table 6.9 – Shape and Rigidity Factors for Calculating Settlements of Points on Loaded Areas at the Surface of an Elastic Half-space (Perloff, 1975)

| Shape | Shape and Rigidity Factor, C_s | | | | |
|----------------|----------------------------------|--------|----------------------|---------------------|---------|
| | Centre | Corner | Middle of Short Side | Middle of Long Side | Average |
| Circle | 1.00 | 0.64 | 0.64 | 0.64 | 0.85 |
| Circle (rigid) | 0.79 | 0.79 | 0.79 | 0.79 | 0.79 |
| Square | 1.12 | 0.56 | 0.76 | 0.76 | 0.95 |
| Square (rigid) | 0.99 | 0.99 | 0.99 | 0.99 | 0.99 |
| Rectangle : | | | | | |
| length/width | | | | | |
| 1.5 | 1.36 | 0.67 | 0.89 | 0.97 | 1.15 |
| 2 | 1.52 | 0.76 | 0.98 | 1.12 | 1.30 |
| 3 | 1.78 | 0.88 | 1.11 | 1.35 | 1.52 |
| 5 | 2.10 | 1.05 | 1.27 | 1.68 | 1.83 |
| 10 | 2.53 | 1.26 | 1.49 | 2.12 | 2.25 |
| 100 | 4.00 | 2.00 | 2.20 | 3.60 | 3.70 |
| 1000 | 5.47 | 2.75 | 2.94 | 5.03 | 5.15 |
| 10000 | 6.90 | 3.50 | 3.70 | 6.50 | 6.60 |

These numerical tools are generally complicated and time consuming, and are rarely justified for routine design purposes, particularly for single piles. The most useful application of numerical methods is for parametric studies and the checking of approximate elastic solutions.

An application of the finite element method is reported by Pells & Turner (1979) for the solution derivation and design chart compilation for the settlement of rock-socketed piles based on linear elastic assumptions. This work has been extended by Rowe & Armitage (1987a & b) to consider effects of pile-soil slip on the settlement. More work has been reported by Kulhawy & Carter (1992a & b). Gross approximations would have been necessary if this boundary value problem were to be solved by the integral equation method. The above simplified design charts may reasonably be used for detailed design purposes.

The above simplified design charts may reasonably be used for detailed design purposes.

6.13.2.5 Determination of deformation parameters

A useful review of the assessment of soil stiffness is given by Wroth et al (1979). In principle, the stiffness can be determined using a range of methods including directly from insitu tests, such as plate loading tests, pressuremeters and flat dilatometers (Baldi et al, 1989) or indirectly from insitu tests based on empirical correlations (e.g. SPT, CPT), surface geophysical methods using Rayleigh waves (Clayton et al, 1993), back analysis of instrumented prototype structures.

The general practice in Hong Kong has been to obtain stiffness parameters for saprolites using correlations with SPT N values. Table 6.10 summarises the correlations

reported in the literature for weathered granite in Hong Kong.

The stiffness of the soil under the action of a pile will be dependent on the pile installation method and workmanship, and stress level. For preliminary design of bored piles founded in saprolites, the following correlation may be used in the absence of any site-specific data :

$$E_v' = 0.8 N \text{ to } 1.2 N \text{ (MPa)} \quad [6.14]$$

where E_v' is the drained vertical Young's modulus of the soil, and N is the uncorrected SPT value.

Vesic (1969) suggested that the stiffness for a driven pile system in sands may be taken to be approximately four times that for a corresponding bored pile system.

Based on available loading test results in Hong Kong, the following correlation may be used for preliminary analysis of driven piles in granitic saprolites :

$$E_v' = 3.5 N \text{ to } 5.5 N \text{ (MPa)} \quad [6.15]$$

Densification during pile driving will lead to an increase in soil stiffness but the effect may be variable and site dependent. Limited data in Hong Kong have shown that the E_v'/N_f ratio may be in the order of about 2.5 to 3 where N_f is the SPT blow count after pile driving.

In determining the relevant rock mass deformation parameters, consideration should be given to influence of non-homogeneity, anisotropy and scale effects. Deformation of a rock mass is often governed by the characteristics of discontinuities. There are a number of methods that can be used to assess the deformation properties including :

- (a) correlations of the modulus of the rock mass to the modulus of the intact rock (the latter can be correlated to the uniaxial compressive strength, σ_c) by means of a mass factor denoted as 'j' factor (BSI, 1986),
- (b) semi-empirical correlations with the Rock Mass Rating, RMR (Figure 6.7), and
- (c) semi-empirical relationships with properties of the rock joints (Barton, 1986), which can be used in complex computer codes based on distinct element models of the rock mass (Cundall, 1980).

In Barton's model, the surface roughness, shear and dilation behaviour of a rock joint is represented by semi-empirical relationships, which are characterized by the properties of the joint and are also functions of the normal stress and displacement at the joint. The parameters required by the model can be determined in the laboratory using tilt tests, Schmidt hammer tests and simple rock joint profiling techniques.

Table 6.10 - Correlations between Drained Young's Modulus and SPT N Value for Weathered Granites in Hong Kong

| Drained Young's Modulus of Weathered Granites (MPa) | Range of SPT N Values | Basis | Reference |
|--|-----------------------------------|---|------------------------------|
| 0.2 N - 0.3 N | 35 - 250 | Plate loading tests at bottom of hand-dug caissons | Sweeney & Ho (1982) |
| 0.6 N - 1 N | 50 - 200 | Pile and plate loading tests | Chan & Davies (1984) |
| 1.8 N - 3 N | 37 - >200 | Pile loading tests | Fraser & Lai (1982) |
| 0.6 N - 1.9 N | 12 - 65 | Pile loading tests | Evans et al (1982) |
| 0.4 N - 0.8 N | 50-100 | Pile loading tests | Holt et al (1982) |
| 0.55 N - 0.8 N | 100 - 150 | | |
| < 1.05 N | > 150 | | |
| 1 N - 1.4 N | 50 - 100 | Pile loading tests | Leung (1988) |
| 2 N - 2.5 N | 25 - 160 | Pile loading tests | Lam et al (1994) |
| 3 N | 20 - 200 | Pile loading tests | Pickles et al (2003) |
| 1 N - 1.2 N | N/A | Settlement monitoring of buildings on pile foundations | Ku et al (1985) |
| 1 N | 50 - 100 | Settlement monitoring of buildings on pile foundations | Leung (1988) |
| 0.7 N - 1 N | 50 - 75 | Back analysis of settlement of Bank of China Building | Chan & Davies (1984) |
| 3 N | 47 - 100 | Horizontal plate loading tests in hand-dug caissons (unload-reload cycle) | Whiteside (1986) |
| 0.6 N - 1.9 N (average 1.2 N) | 47 - 100 | Horizontal plate loading tests in hand-dug caissons (initial loading) | Whiteside (1986) |
| 0.8 N 1.6 N at depth | up to 170 | Back analysis of retaining wall deflection | Humpheson et al (1986, 1987) |
| 1 N | 8 - 10 (fill and marine deposits) | Back analysis of movement of diaphragm wall of Dragon Centre | Chan (2003) |
| 1.5 N - 2 N | 35 - 200 (CDG) | | |
| 1.1 N | 25 - 50 | Multiple well pumping test and back analysis of retaining wall deflection | Davies (1987) |
| 1.4 N | 50 - 75 | | |
| 1.7 N | 75 - 150 | | |

For practical design, an estimate of the order of magnitude of rock mass deformation is adequate as a sensitivity check. The elastic continuum method is widely used and is generally adequate for routine design problems in assessing the pile head settlement at working conditions. The appropriate deformation parameters should be derived using more than one assessment method or be obtained directly from loading tests.

6.13.3 Lateral Loading

6.13.3.1 General

The response of piles to lateral loading is sensitive to soil properties near the ground surface. As the surface layers may be subject to disturbance, reasonably conservative soil parameters should be adopted in the prediction of pile deflection. An approximate assessment of the effects of soil layering can be made by reference to the work by Davisson & Gill (1963) or Pise (1982).

Poulos (1972) studied the behaviour of a laterally-loaded pile socketed in rock. He concluded that socketing of a pile has little influence on the horizontal deflection at working load unless the pile is sufficiently rigid, with a stiffness factor under lateral loading, K_r , greater than 0.01, where $K_r = \frac{E_p I_p}{E_s L^4}$, and I_p and L are the second moment of area and length of the pile respectively.

The effect of sloping ground in front of a laterally-loaded pile was analysed by Poulos (1976) for clayey soils, and by Nakashima et al (1985) for granular soils. It was concluded that the effect on pile deformation will not be significant if the pile is beyond a distance of about five to seven pile diameters from the slope crest.

The load-deflection and load-rotation relationships for a laterally-loaded pile are generally highly non-linear. Three approaches have been proposed for predicting the behaviour of a single pile :

- (a) equivalent cantilever method,
- (b) subgrade reaction method, and
- (c) elastic continuum method.

Alternative methods include numerical methods such as the finite element and boundary element methods as discussed in Section 6.13.2.4. However, these are seldom justified for routine design problems.

A useful summary of the methods of determining the horizontal soil stiffness is given by Jamiolkowski & Garassino (1977).

It should be noted that the currently available analytical methods for assessing deformation of laterally-loaded piles do not consider the contribution of the side shear stiffness. Some allowance may be made for barrettes loaded in the direction of the long side

of the section with the use of additional springs to model the shear stiffness and capacity in the subgrade reaction approach.

Where the allowable deformation is relatively large, the effects of non-linear bending behaviour of the pile section due to progressive yielding and cracking together with its effect on the deflection and bending moment profile should be considered (Kramer & Heavey, 1988). The possible non-linear structural behaviour of the section can be determined by measuring the response of an upstand above the ground surface in a lateral loading test.

6.13.3.2 Equivalent cantilever method

The equivalent cantilever method is a gross simplification of the problem and should only be used as an approximate check on the other more rigorous methods unless the pile is subject to nominal lateral load. In this method, the pile is represented by an equivalent cantilever and the deflection is computed for either free-head or fixed-head conditions. Empirical expressions for the depths to the point of virtual fixity in different ground conditions are summarised by Tomlinson (1994).

The principal shortcoming of this approach is that the relative pile-soil stiffness is not considered in a rational framework in determining the point of fixity. Also, the method is not suited for evaluating profiles of bending moments.

6.13.3.3 Subgrade reaction method

In the subgrade reaction method, the soil is idealised as a series of discrete springs down the pile shaft. The continuum nature of the soil is not taken into account in this formulation.

The characteristic of the soil spring is expressed as follows :

$$p = k_h \delta_h \quad [6.16]$$

$$\begin{aligned} P_h &= K_h \delta_h & [6.17] \\ &= k_h D \delta_h \text{ (for constant } K_h\text{)} \\ &= n_h z \delta_h \text{ (for the case of } K_h \text{ varying linearly with depth)} \end{aligned}$$

where

- p = soil pressure
- k_h = coefficient of horizontal subgrade reaction
- δ_h = lateral deflection
- P_h = soil reaction per unit length of pile
- K_h = modulus of horizontal subgrade reaction
- D = width or diameter of pile
- n_h = constant of horizontal subgrade reaction, sometimes referred to as the constant of modulus variation in the literature
- z = depth below ground surface

It should be noted that k_h is not a fundamental soil parameter as it is influenced by the pile dimensions. In contrast, K_h is more of a fundamental property and is related to the Young's modulus of the soil, and it is not a function of pile dimensions. Soil springs determined using subgrade reaction do not consider the interaction between adjoining springs. Calibration against field test data may be necessary in order to adjust the soil modulus to derive a better estimation (Poulos et al, 2002).

Traditionally, overconsolidated clay is assumed to have a constant K_h with depth whereas normally consolidated clay and granular soil is assumed to have a K_h increasing linearly with depth, starting from zero at ground surface.

For a uniform pile with a given bending stiffness ($E_p I_p$), there is a critical length (L_c) beyond which the pile behaves under lateral load as if it were infinitely long and can be termed a 'flexible' pile.

The expressions for the critical lengths are given in the following

$$L_c = 4 \sqrt[4]{\frac{E_p I_p}{K_h}} \quad [6.18]$$

$$= 4 R \text{ for soils with a constant } K_h$$

$$L_c = 4 \sqrt[5]{\frac{E_p I_p}{n_h}} \quad [6.19]$$

$$= 4 T \text{ for soils with a } K_h \text{ increasing linearly with depth}$$

The terms 'R' and 'T' are referred to as the characteristic lengths by Matlock & Reese (1960) for homogeneous soils and non-homogeneous soils, respectively. They derived generalised solutions for piles in granular soils and clayey soils. The solutions for granular soils as summarized in Figures 6.18 and 6.19 have been widely used in Hong Kong.

A slightly different approach has been proposed by Broms (1964a & b) in which the pile response is related to the parameter L/R for clays, and to the parameter L/T for granular soils. The solutions provide the deflection and rotation at the head of rigid and flexible piles.

In general, the subgrade reaction method can give satisfactory predictions of the deflection of a single pile provided that the subgrade reaction parameters are derived from established correlations or calibrated against similar case histories or loading test results.

Typical ranges of values of n_h , together with recommendations for design approach, are given in Table 6.11.

The parameter k_h can be related to results of pressuremeter tests (CGS, 1992). The effects of pile width and shape on the deformation parameters are discussed by Siu (1992).

Table 6.11 – Typical Values of Coefficient of Horizontal Subgrade Reaction

| Consistency | Loose (N value 4-10) | Medium Dense (N value 11-30) | Dense (N value 31-50) |
|---|-------------------------|---------------------------------|--------------------------|
| n_h for dry or moist sand (MN/m ³) | 2.2 | 6.6 | 17.6 |
| n_h for submerged sand (MN/m ³) | 1.3 | 4.4 | 10.7 |

- Notes :
- (1) The above n_h values are based on Terzaghi (1955) and are valid for stresses up to about half the ultimate bearing capacity with allowance made for long-term movements.
 - (2) For sands, Elson (1984) suggested that Terzaghi's values should be used as a lower limit and the following relationship as the upper limits :

$$n_h = 0.19 D_r^{1.16} \text{ (MN/m}^3\text{)}$$

where D_r is the relative density of sand in percent. D_r can be related to SPT N values and effective overburden pressure (see Figure 6 of Geoguide 1 : Guide to Retaining Wall Design (GEO, 1993)). The above equation is intended for sands and should be used with caution for saprolites. If this equation is used as a first approximation, it would be prudent to determine the design value of D_r involving the use of insitu and laboratory density tests. In critical cases where the design is likely to be dominated by the behaviour under lateral loading, it is advisable to carry out full-scale loading tests in view of the design uncertainties.

- (3) Limited available loading test results on piles in saprolitic soils in Hong Kong suggest that the n_h values can be bracketed by the recommendations by Terzaghi and the above equation by Elson.
- (4) Other observed values of n_h , which include an allowance for long-term movement, are as follows (Tomlinson, 1994) :

Soft normally consolidated clays : 350 to 700 kN/m³
Soft organic silts : 150 kN/m³

- (5) For sands, n_h may be related to the drained horizontal Young modulus (E_h') in MPa as follows (Yoshida & Yoshinaka, 1972; Parry, 1972) :

$$n_h = \frac{0.8E_h' \text{ to } 1.8E_h'}{z}$$

where z is depth below ground surface in metres.

- (6) It should be noted that empirical relationships developed for transported soils between N value and relative density are not generally valid for weathered rocks. Corestones, for example, can give misleading high values that are unrepresentative of the soil mass.

The solutions by Matlock & Reese (1960) apply for idealised, single layer soil. The subgrade reaction method can be extended to include non-linear effects by defining the complete load transfer curves or 'p-y' curves. This formulation is more complex and a non-linear analysis generally requires the use of computer models similar to those described by Bowles (1992), which can be used to take into account variation of deformation

characteristics with depth. In this approach, the pile is represented by a number of segments each supported by a spring, and the spring stiffness can be related to the deformation parameters by empirical correlations (e.g. SPT N values). Due allowance should be made for the strength of the upper, and often weaker, soils whose strength may be fully mobilised even at working load condition.

Alternatively, the load-transfer curves can be determined based on instrumented pile loading tests, in which a series of 'p-y' curves are derived for various types of soils. Nip & Ng (2005) presented a simple method to back-analyse results of laterally loaded piles for deriving the 'p-y' curves for superficial deposits. Reese & Van Impe (2001) discussed factors that should be considered when formulating the 'p-y' curves. These include pile types and flexural stiffness, duration of loading, pile geometry and layout, effect of pile installation and ground conditions. Despite the complexities in developing the 'p-y' curves, the analytical method is simple once the non-linear behaviours of the soils are modelled by the 'p-y' curves. This method is particularly suitable for layered soils.

6.13.3.4 Elastic continuum methods

Solutions for deflection and rotation based on elastic continuum assumptions are summarised by Poulos & Davis (1980). Design charts are given for different slenderness ratios (L/D) and the dimensionless pile stiffness factors under lateral loading (K_r) for both friction and end-bearing piles. The concept of critical length is however not considered in this formulation as pointed out by Elson (1984).

A comparison of these simplified elastic continuum solutions with those of the rigorous boundary element analyses has been carried out by Elson (1984). The comparison suggests that the solutions by Poulos & Davis (1980) generally give higher deflections and rotations at ground surface, particularly for piles in a soil with increasing stiffness with depth.

The elastic analysis has been extended by Poulos & Davis (1980) to account for plastic yielding of soil near ground surface. In this approximate method, the limiting ultimate stress criteria as proposed by Broms (1965) have been adopted to determine factors for correction of the basic solution.

An alternative approach is proposed by Randolph (1981b) who fitted empirical algebraic expressions to the results of finite element analyses for homogeneous and non-homogeneous linear elastic soils. In this formulation, the critical pile length, L_c (beyond which the pile plays no part in the behaviour of the upper part) is defined as follows :

$$L_c = 2 r_o \left(\frac{E_{pc}}{G_c} \right)^{2/7} \quad [6.20]$$

where G^* = $G(1 + 0.75 v_s)$
 G_c = mean value of G^* over the critical length, L_c , in a flexible pile
 G = shear modulus of soil
 r_o = radius of an equivalent circular pile
 v_s = Poisson's ratio of soil
 $E_p I_p$ = bending stiffness of actual pile

$$E_{pe} = \text{equivalent Young's modulus of the pile} = \frac{4E_p I_p}{\pi r_o^4}$$

For a given problem, iterations will be necessary to evaluate the values of L_c and G_c .

Expressions for deflection and rotation at ground level given by Randolph's elastic continuum formulation are summarised in Figure 6.28.

Results of horizontal plate loading tests carried out from within a hand-dug caisson in completely weathered granite (Whiteside, 1986) indicate the following range of correlation :

$$E_h' = 0.6 \text{ N to } 1.9 \text{ N (MPa)} \quad [6.21]$$

where E_h' is the drained horizontal Young's modulus of the soil.

The modulus may be nearer the lower bound if disturbance due to pile excavation and stress relief is excessive. The reloading modulus was however found to be two to three times the above values.

Plumbridge et al (2000b) carried out lateral loading tests on large-diameter bored piles and barrettes in fill and alluvial deposits. Testing arrangement on five sites included a 100 cycle bi-directional loading stage followed by a five-stage maintained lateral loading test. The cyclic loading indicated only a negligible degradation in pile-soil stiffness after the 100 cycle bi-direction loading. The deflection behaviour for piles in push or pull directions was generally similar. Based on the deflection profile of the single pile in maintained-load tests, the correlation between horizontal Young's modulus, E_h' and SPT N value was found to range between 3 N and 4 N (MPa).

Lam et al (1991) reported results of horizontal Goodman Jack tests carried out from within a caisson in moderately to slightly (grade III/II) weathered granite. The interpreted rock mass modulus was in the range of 3.1 to 8.2 GPa.

In the absence of site-specific field data, the above range of values may be used in preliminary design of piles subject to lateral loads.

6.14 CORROSION OF PILES

The maximum rate of corrosion of steel piles embedded in undisturbed ground and loaded in compression can be taken to be 0.02 to 0.03 mm/year based on results of research reported by Romanoff (1962, 1969) and Kinson et al (1981). Moderate to severe corrosion with a corrosion rate of up to about 0.08 mm/year may occur where piles are driven into disturbed soils such as fill and reclamation, particularly within the zone of fluctuating groundwater level. It should be noted that Romanoff's data suggest that special attention needs to be exercised in areas where the pH is below about 4.

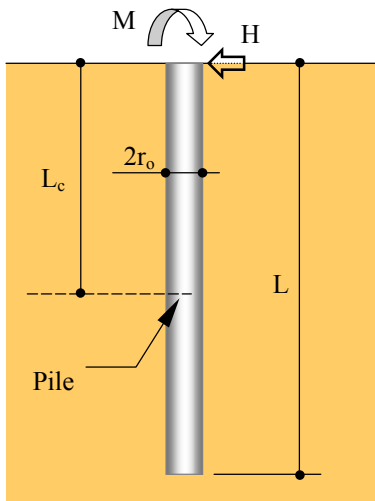

Free-head Piles

$$\delta_h = \frac{(E_p/G_c)^{1/7}}{\rho_c' G_c} \left(\frac{0.27H}{0.5L_c} + \frac{0.3M}{(0.5L_c)^2} \right)$$

$$\theta = \frac{(E_p/G_c)^{1/7}}{\rho_c' G_c} \left(\frac{0.3H}{(0.5L_c)^2} + \frac{0.8\sqrt{\rho_c'} M}{(0.5L_c)^3} \right)$$

The maximum moment for a pile under a lateral load H occurs at depth between $0.25L_c$ (for homogenous soil) and $0.33L_c$ (for soil with stiffness proportional to depth). The value of the maximum bending moment M_{\max} may be approximated using the following expression :

$$M_{\max} = \frac{0.1}{\rho_c'} H L_c$$

Fixed-head Piles

In this case, the pile rotation at ground surface, θ , equals zero and the fixing moment, M_f , and lateral deflection, δ_h , are given by the following expression :

$$M_f = -\frac{0.375H(0.5L_c)}{\sqrt{\rho_c'}}$$

$$\delta_h = \frac{(E_p/G_c)^{1/7}}{\rho_c' G_c} \left(0.27 - \frac{0.11}{\sqrt{\rho_c'}} \right) \frac{H}{0.5L_c}$$

The lateral deflection of a fixed-head pile is approximately half that of a corresponding free-head pile.

Legend :

- δ_h = lateral pile deflection at ground surface
- θ = pile rotation at ground surface
- G_c = characteristic shear modulus, i.e. average value of G^* over the critical length L_c of the pile
- L_c = critical pile length for lateral loading = $2 r_o \frac{E_{pe}}{G_c}^{2/7}$
- E_{pe} = equivalent Young's modulus of pile = $\frac{4E_p I_p}{\pi r_o^4}$
- ρ_c' = degree of homogeneity over critical length, $L_c = \frac{G^*_{0.25L_c}}{G_c}$
- G^* = $G(1 + 0.75v_s)$
- $G^*_{0.25L_c}$ = value of G^* at depth of $0.25L_c$
- v_s = Poisson's ratio of soil
- G = shear modulus of soil
- H = horizontal load
- M = bending moment
- $E_p I_p$ = bending stiffness of pile
- r_o = pile radius

Figure 6.28 – Analysis of Behaviour of a Laterally Loaded Pile Using the Elastic Continuum Method (Randolph, 1981a)

Ohsaki (1982) reported the long-term study of over 120 steel piles driven into a variety of soil conditions and found that the above recommended corrosion rates are generally conservative. Wong & Law (2001) reported the conditions of steel H-piles exposed after being buried in undisturbed decomposed granite for 22 years. The presence of groundwater was found to have only a small effect on the corrosion rate. The observed maximum rate of corrosion in this case was about 0.018 mm/year.

For maritime conditions, the results of research overseas should be viewed with caution as the waters in Hong Kong are relatively warm and may contain various pollutants or anaerobic sulphate-reducing bacteria, which greatly increases the risk of pitting corrosion. Faber & Milner (1971) reported fairly extensive underwater corrosion of the foundations to a 40-year old wharf in Hong Kong, involving pitting corrosion of the 3.2 mm thick steel casing and cavities on the surface of the hearing concrete which required extensive underwater repair works.

It is recommended that steel piles above seabed, whether fully immersed, within the tidal or splash zone, or generally above the splash zone, should be fully protected against corrosion for the design life (CEO, 2002). This precaution should also extend to precast piles where the sections are welded together with the use of steel end plates. Below the sea-bed level, an allowance for corrosion loss of 0.05 mm per year on the outer face of steel pile is considered reasonable. BS EN 14199:2005 (BSI, 2005) put forward some guidance on the rate of corrosion in different types of soils.

Possible corrosion protection measures that may be adopted include use of copper bearing or high-yield steel, sacrificial steel thickness, protective paints or coatings (made of polyethylene, epoxy or asphalt), together with cathodic protection consisting of sacrificial galvanic anodes or impressed currents. In a marine environment, steel tubular piles may be infilled with concrete from pile head level to at least below seabed level and the steel casing above seabed be regarded as sacrificial. For onshore situations, steel piles may be protected with coating or concrete surround within the zone of groundwater fluctuation or fill material. The most appropriate measures need to be assessed on a site-by-site basis.

In the case of concrete piles, the best defence against the various possible forms of attack as summarised by Somerville (1986) is dense, low permeability concrete with sufficient cover to all steel reinforcement. Bartholomew (1980) classified the aggressiveness of the soil conditions and provided guidance on possible protective measures for concrete piles. Further recommendations are given in BS 8500-1:2002 (BSI, 2002) for specifying concrete grade and cover to reinforcement to improve corrosion resistance for different soil environments. However, high strength concrete may not necessarily be dense and homogeneous. Specifying high strength concrete is no guarantee for durability.

For concrete piles in maritime conditions, the recommended limits on the properties of concrete are as follows (CEO, 2004) :

- (a) Minimum characteristic strength should be 45 MPa.
- (b) Maximum free water/cement ratio should not exceed 0.38.

- (c) The cementitious content should be within 380 – 450 kg/m³, of which the dry mass of condensed silica fume shall be within 5 – 10% range by mass of the cementitious content.
- (d) Cover to all reinforcement should not be less than 75 mm for concrete exposed to seawater.

Criteria (a), (b) and (c) above should apply irrespective of whether the concrete is fully immersed, within the tidal or splash zones or located above the splash zone. For concrete within the tidal and splash zones, crack widths under typical average long-term conditions should be limited to 0.1 mm. Where protected from direct exposure to the marine atmosphere, reinforced concrete should comply with the recommendations given in BS 8110 (BSI, 1997) for 'moderate' conditions.

With grouted piles such as mini-piles, the minimum cover to steel elements depends on factors such as the aggressiveness of the environment, magnitude of tension or compression load, steel type used (BSI, 2005). This may need to be increased in contaminated ground or alternatively a permanent casing may be required.

For piles under permanent tension, the concrete or grout is likely to be cracked under working conditions and should not be considered as a barrier to corrosion. It is prudent to include at least one level of corrosion protection to ensure long-term integrity of the steel elements. The use of sacrificial thickness is permissible, except in aggressive ground conditions. The presence of leachate and gas in contaminated grounds such as landfills and industrial areas may pose serious hazards to the construction and functional performance of piles (Section 2.6).

The durability of concrete could be affected by alkali silica reaction (ASR). Chak & Chan (2005) reviewed the effect of ASR, the practice of ASR control and use of alkali-reactive aggregate in concrete. A control framework was proposed by the authors and should be followed for foundation design.

7. GROUP EFFECTS

7.1 GENERAL

Piles installed in a group to form a foundation will, when loaded, give rise to interaction between individual piles as well as between the structure and the piles. The pile-soil-pile interaction arises as a result of overlapping of stress (or strain) fields and could affect both the capacity and the settlement of the piles. The piled foundation as a whole also interacts with the structure by virtue of the difference in stiffness. This foundation-structure interaction affects the distribution of loads in the piles, together with forces and movements experienced by the structure.

The analysis of the behaviour of a pile group is a complex soil-structure interaction problem. The behaviour of a pile group foundation will be influenced by, inter alia :

- (a) method of pile installation, e.g. replacement or displacement piles,
- (b) dominant mode of load transfer, i.e. shaft resistance or end-bearing,
- (c) nature of founding materials,
- (d) three-dimensional geometry of the pile group configuration,
- (e) presence or otherwise of a ground-bearing cap, and
- (f) relative stiffness of the structure, the piles and the ground.

Traditionally, the assessment of group effects is based on some 'rules-of-thumb' or semi-empirical rules derived from field observations. Recent advances in analytical studies have enabled more rational design principles to be developed. With improved computing capabilities, general pile groups with a combination of vertical and raking piles subjected to complex loading can be analysed in a fairly rigorous manner and parametric studies can be carried out relatively efficiently and economically.

This Chapter firstly considers the ultimate limit states for a range of design situations for pile groups. Methods of assessing the deformation of single piles and pile groups are then presented. Finally, some design considerations for soil-structure interaction problems are discussed.

7.2 MINIMUM SPACING OF PILES

The minimum spacing between piles in a group should be chosen in relation to the method of pile construction and the mode of load transfer. It is recommended that the following guidelines on minimum pile spacing may be adopted for routine design :

- (a) For bored piles which derive their capacities mainly from shaft resistance and for all types of driven piles, minimum

centre-to-centre spacing should be greater than the perimeter of the pile (which should be taken as that of the larger pile where piles of different sizes are used); this spacing should not be less than 1 m as stipulated in the Code of Practice for Foundations (BD, 2004a).

- (b) For bored piles which derive their capacities mainly from end-bearing, minimum clear spacing between the surfaces of adjacent piles should be based on practical considerations of positional and verticality tolerances of piles. It is prudent to provide a nominal minimum clear spacing of about 0.5 m between shaft surfaces or edge of bell-outs. For mini-piles socketed into rock, the minimum spacing should be taken as the greater of 0.75 m or twice the pile diameter (BD, 2004a).

The recommended tolerances of installed piles are shown in Table 7.1 (HKG, 1992). Closer spacing than that given above may be adopted only when it has been justified by detailed analyses of the effect on the settlement and bearing capacity of the pile group. Particular note should be taken of adjacent piles founded at different levels, in which case the effects of the load transfer and soil deformations arising from the piles at a higher level on those at a lower level need to be examined. The designer should also specify a pile installation sequence within a group that will assure maximum spacing between shafts being installed and those recently concreted.

Table 7.1 – Tolerance of Installed Piles (HKG, 1992)

| Description | Tolerance | |
|---|------------|--------------|
| | Land Piles | Marine Piles |
| Deviation from specified position in plan, measured at cut-off level | 75 mm | 150 mm |
| Deviation from vertical | 1 in 75 | 1 in 25 |
| Deviation of raking piles from specified batter | | 1 in 25 |
| Deviation from specified cut-off level | | 25 mm |
| The diameter of cast in-place piles shall be at least 97% of the specified diameter | | |

7.3 ULTIMATE CAPACITY OF PILE GROUPS

7.3.1 General

Traditionally, the ultimate load capacity of a pile group is related to the sum of ultimate capacity of individual piles through a group efficiency (or reduction) factor η , defined as follows :

$$\eta = \frac{\text{ultimate load capacity of a pile group}}{\text{sum of ultimate load capacities of individual piles in the group}} \quad [7.1]$$

A number of empirical formulae have been proposed, generally relating the group efficiency factor to the number and spacing of piles. However, most of these formulae give no more than arbitrary factors in an attempt to limit the potential pile group settlement. A comparison of a range of formulae made by Chellis (1961) shows a considerable variation in the values of η for a given pile group configuration. There is a lack of sound theoretical basis in the rationale and field data in support of the proposed empirical formulae (Fleming & Thorburn, 1983). The use of these formulae to calculate group efficiency factors is therefore not recommended.

A more rational approach in assessing pile group capacities is to consider the capacity of both the individual piles (with allowance for pile-soil-pile interaction effects) and the capacity of the group as a block or a row and determine which failure mode is more critical. There must be an adequate factor of safety against the most critical mode of failure.

The degree of pile-soil-pile interaction, which affects pile group capacities, is influenced by the method of pile installation, mechanism of load transfer and nature of the founding materials. The group efficiency factor may be assessed on the basis of observations made in instrumented model and field tests as described below. Generally, group interaction does not need to be considered where the spacing is in excess of about eight pile diameters (CGS, 1992).

7.3.2 Vertical Pile Groups in Granular Soils under Compression

7.3.2.1 Free-standing driven piles

In granular soils, the compacting efforts of pile driving generally result in densification and consequently the group efficiency factor may be greater than unity. Lambe & Whitman (1979) warned that for very dense sands, pile driving could cause loosening of the soils due to dilatancy and η could be less than unity in this case. This effect is also reflected in the model tests reported by Valsangkar & Meyerhof (1983) for soils with an angle of shearing resistance, ϕ' , greater than 40° . However, this phenomenon is seldom observed in full-scale loading tests or field monitoring.

Figure 7.1 shows the findings of model tests on instrumented driven piles reported by Vesic (1969). The ultimate shaft capacity of a pile within the pile group was observed to have increased to about three times the capacity of a single pile.

It is generally accepted that, for normal pile spacing, the interaction arising from overlapping of stress fields affects only the shaft capacity and is independent of the type of pile and the nature of the soil. Therefore, it would be more rational to consider group efficiency factors in terms of the shaft resistance component only.

The behaviour of a driven pile may be affected by the residual stresses built up during pile driving. In practice, pile driving in the field could affect the residual stresses of the neighbouring piles to a different extent from that in a model test as a result of scale effects,

which could partially offset the beneficial effects of densification. For design purposes, it is recommended that a group efficiency factor of unity may be taken conservatively for displacement piles.

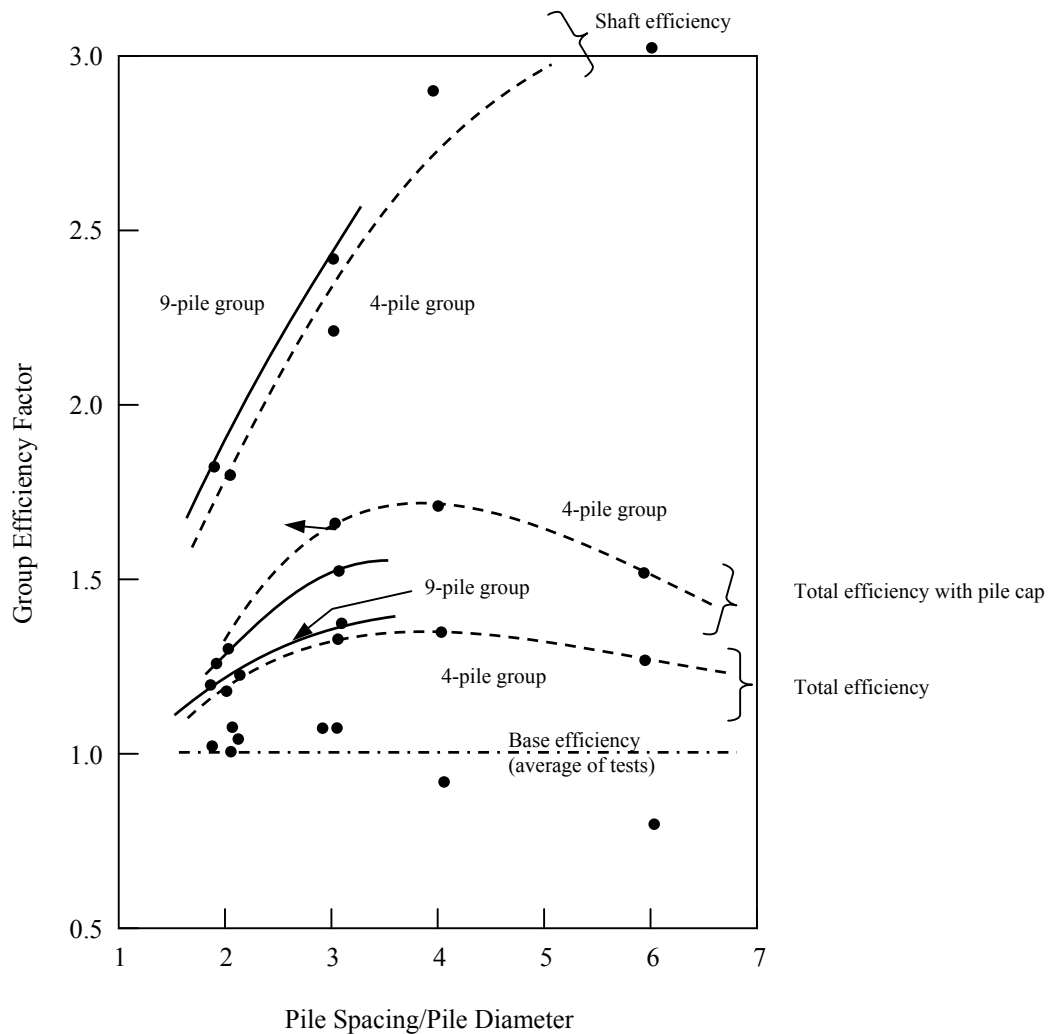

Notes :

- (1) Efficiency denotes the ratio of ultimate load capacity of a pile group to the sum of ultimate load capacities of individual piles in the group. Shaft efficiency denotes the above ratio in terms of shaft resistance only. Base efficiency denotes the ratio in terms of end-bearing resistance only.
- (2) Vesic (1969) noted that in view of the range of scatter of individual test results, there was probably no meaning in the apparent trend towards lower base efficiency at large pile spacings.

Figure 7.1 – Results of Model Tests on Groups of Instrumented Driven Piles in Granular Soils (Vesic, 1969)

7.3.2.2 Free-standing bored piles

Construction of bored piles may cause loosening and disturbance of granular soils. In

practice, the design of single piles generally has made allowance for the effects of loosening and the problem is therefore to assess the additional effect of loosening due to pile group installation. This may be affected to a certain extent by the initial stresses in the ground but is principally a question of workmanship and construction techniques and is therefore difficult to quantify.

Meyerhof (1976) suggested that the group efficiency factor could be taken conservatively as $2/3$ at customary spacings but no field data were given to substantiate this. The results of some loading tests on full-scale pile groups were summarised by O'Neill (1983), who showed that the lower-bound group efficiency factor is 0.7. For design purposes, the group efficiency factor may be taken as 0.85 for shaft resistance and 1.0 for end-bearing, assuming average to good workmanship.

If an individual pile has an adequate margin against failure, there would be no risk of a block failure of a pile group supported purely by end-bearing on a granular soil which is not underlain by weaker strata. Where the piles are embedded in granular soils (i.e. shaft and end-bearing resistance), both individual pile failure and block failure mechanisms (Figure 7.2) should be checked. The block failure mechanism should be checked by considering the available shaft resistance and end-bearing resistance of the block or row as appropriate. Suitable allowance should be made in assessing the equivalent angle of pile/soil interface friction for the portion of failure surface through the relatively undisturbed ground between the piles.

7.3.2.3 Pile groups with ground bearing cap

In the case where there is a ground-bearing cap, the ultimate load capacity of the pile group should be taken as the lesser of the following (Poulos & Davis, 1980) :

- (a) Sum of the capacity of the cap (taking the effective area, i.e. areas associated with the piles ignored) and the piles acting individually. For design purposes, the same group efficiency factors as for piles without a cap may be used.
- (b) Sum of the capacity of a block containing the piles and the capacity of that portion of cap outside the perimeter of the block.

Care should be exercised in determining the allowable load as the movements required to fully mobilise the cap and pile capacities may not be compatible and appropriate mobilisation factors for each component should be used. In addition, the designer should carefully consider the possibility of partial loss of support to the cap as a result of excavation for utilities and ground settlement.

7.3.3 Vertical Pile Groups in Clays under Compression

The extent of installation effects of both driven and bored piles in clay on pile-soil-pile interaction is generally small compared to that in a granular soil. It should be noted that

the rate of dissipation of excess pore water pressures set up during driving in clays will be slower in a pile group than around single piles. This may need to be taken into account if design loads are expected to be applied prior to the end of the re-consolidation period.

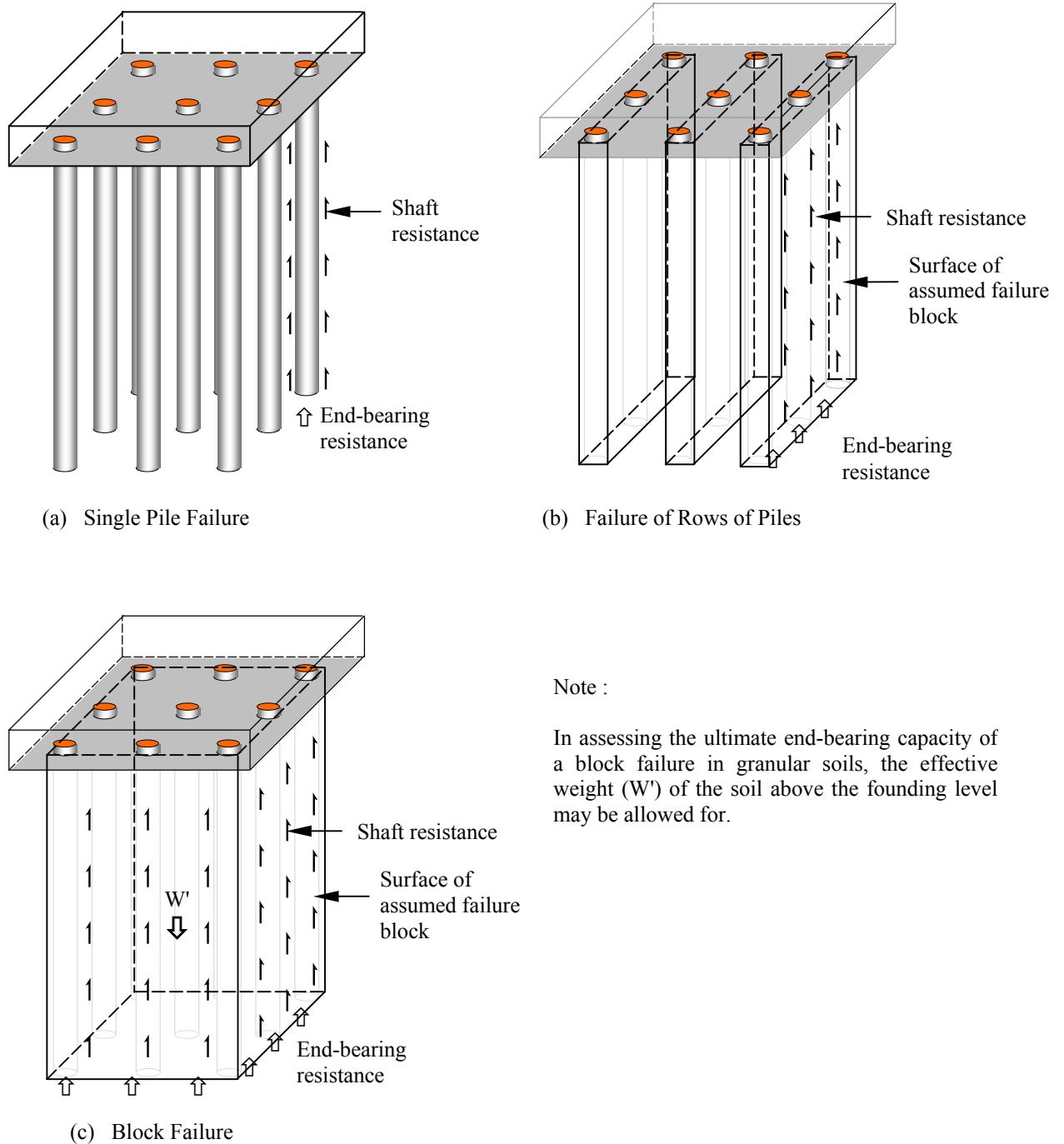

Figure 7.2 – Failure Mechanisms of Pile Groups (Fleming et al, 1992)

For a free-standing group of either driven or bored piles, the capacity should be taken as the lesser of the sum of the ultimate capacity of individual piles with allowance for a group efficiency factor and the capacity of the group acting as a block (Figure 7.2). Reference to the results of a number of model tests summarised in Figure 7.3 shows that the group efficiency factor for individual pile failure is generally less than unity and is dependent on the spacing, number and length of piles. These results may be used to assess the effects of group interaction in relation to pile spacing. It should be noted that the model piles were not instrumented to determine the effects of interaction on shaft and end-bearing capacity separately and the observed group efficiency factors have been defined in terms of overall capacity.

The contribution of a ground-bearing cap to the group capacity may be calculated using the approximate method given in Section 7.3.2.3.

7.3.4 Vertical Pile Groups in Rock under Compression

The overall capacity of a pile group founded on rock or a group of rock sockets can be taken as the sum of the individual pile capacities (i.e. with a group efficiency factor of unity).

7.3.5 Vertical Pile Groups under Lateral Loading

For a laterally-loaded group of vertical piles, similar checks for the sum of individual pile lateral capacities and for block or row failure should be made as for vertical loading.

Prakash (1962) found from model tests in sand that piles behave as individual units if the centre-to-centre spacing is more than three pile widths in a direction normal to the line of the loading and where they are spaced at more than six to eight pile widths measured along the loading direction. These findings are supported by results of finite element analyses reported by Yegian & Wright (1973) who showed that, for a given pile spacing, the group efficiency factor of a row of piles is smaller (i.e. greater interaction) when the horizontal loading is applied along the line joining the piles, compared to that when the loading is perpendicular to the line joining the piles.

Poulos & Davis (1980) summarised the results of model tests carried out on pile groups in sand and clay soils respectively. These indicate a group efficiency factor for lateral loading of about 0.4 to 0.7 for a spacing to diameter ratio of between 2 and 6. Results of instrumented full-scale tests on a pile group in sand reported by Brown et al (1988) indicate that the lateral load of piles in the leading row is about 90% of that of a single pile; however, the measured load of the piles in the trailing row is only about 40% of a single pile. This is attributed to the effects of 'shadowing', i.e. effects of interaction of stress fields in the direction of the load (see also discussion in Section 7.6.2.3).

The effect of possible interaction of piles constructed by different techniques in a group on the lateral capacity of a pile group has not been studied systematically.

Both Elson (1984) and Fleming et al (1992) suggested that a pragmatic approach may be adopted and recommended that the group efficiency factor may be taken as unity where

the centre-to-centre pile spacing is equal to or greater than three pile diameters along directions parallel and perpendicular to the loading direction. For a group of closely-spaced piles (spacing/diameter less than 3), the group may be considered as an equivalent single pile.

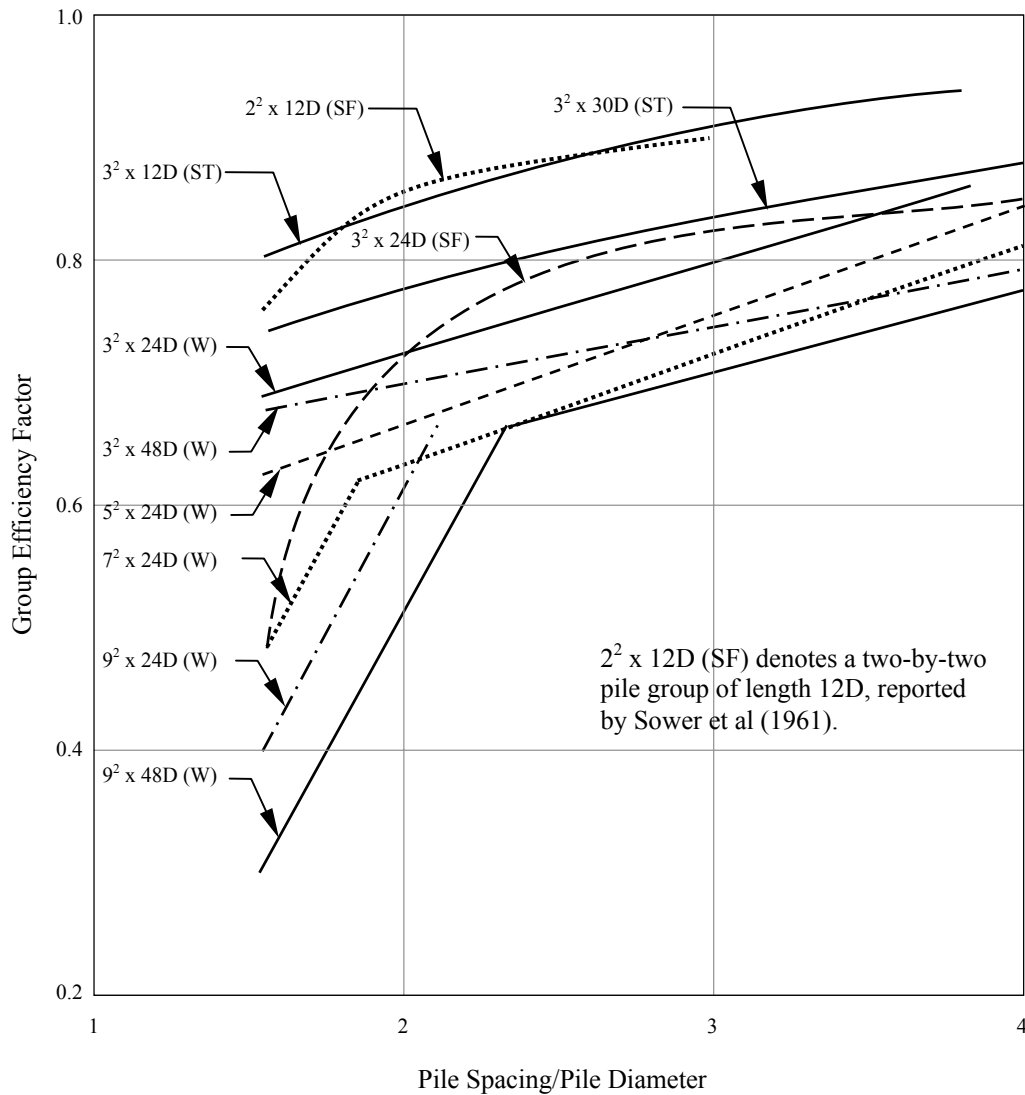

Legend :

D = diameter of pile

W = Whitaker (1957)

ST = Saffery & Tate (1961)

SF = Sowers et al (1961)

Figure 7.3 – Results of Model Tests on Pile Groups in Clay under Compression (de Mello, 1969)

There are clearly differing views in the literature on the group efficiency factor for a laterally-loaded pile group. In practice, it is the group lateral deflection or the structural capacity of the pile section that governs the design, with the possible exception of short rigid piles. It is therefore considered that the recommendations by Fleming et al (1992) can reasonably be adopted for practical purposes, except for short rigid piles (see Figure 6.14 for criteria for short rigid piles), where reference may be made to the findings by Poulos &

Davies (1980) described above.

In evaluating the block or row failure mechanism, both the side shear and the base shear resistance should be considered.

For rock-socketed piles, possible joint-controlled failure mode should be considered and a detailed assessment of the joint pattern must be made.

The bending moment and shear force induced in the piles should be checked to ensure that the ultimate resistance is not governed by the structural capacity. For routine design of pile groups with piles having similar bending stiffness, the simplifying assumption that each pile will carry an equal share of the applied horizontal load may be made. Where the pile stiffnesses vary significantly, a detailed frame analysis may be carried out to assess the force distributions.

7.3.6 Vertical Pile Groups under Tension Loading

The uplift capacity of a pile group is the lesser of the following two values :

- (a) the sum of uplift resistance of individual piles with allowance for interaction effects, and
- (b) the sum of the shear resistance mobilised on the surface perimeter area of the group and the effective weight of soil/piles enclosed by this perimeter.

In assessing the block failure mechanism, the group effect could reduce the vertical effective stress in the soil and the influence of this on the shaft resistance may need to be considered.

For driven piles in granular soils, densification effects as discussed in Section 7.3.2.1 will be relevant. It is considered that the group efficiency factor in this case may be assumed to be unity. For bored piles in granular soils, the results of model tests carried out by Meyerhof & Adams (1968) as summarised in Figure 7.4 may be used to help assess the appropriate group efficiency factor.

For piles in clays, results of model tests carried out by Meyerhof & Adams (1968) indicate that the group efficiency factors for uplift are in reasonable agreement with those reported by Whitaker (1957) for piles under compression. The results shown in Figure 7.3 may therefore be used for pile groups in clays under tension.

7.3.7 Pile Groups Subject to Eccentric Loading

Where the applied load is eccentric, there is a tendency for the group to rotate, which will be resisted by an increase in horizontal soil pressures. However, when the passive soil pressure limits are reached, a substantial reduction in the group capacity could occur.

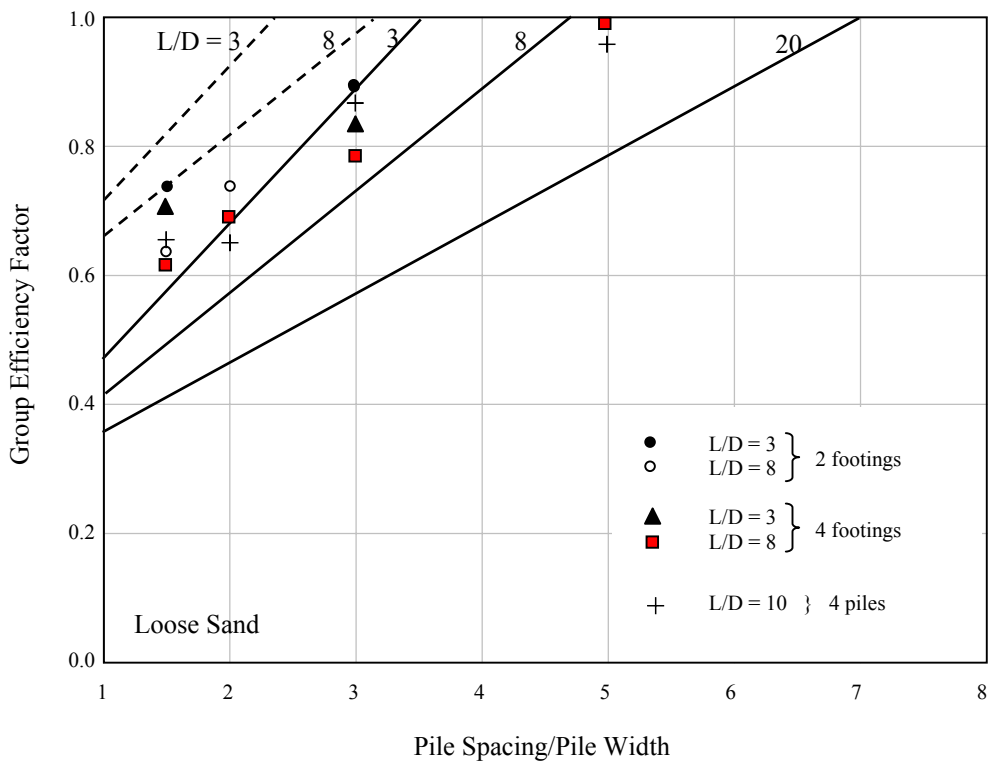
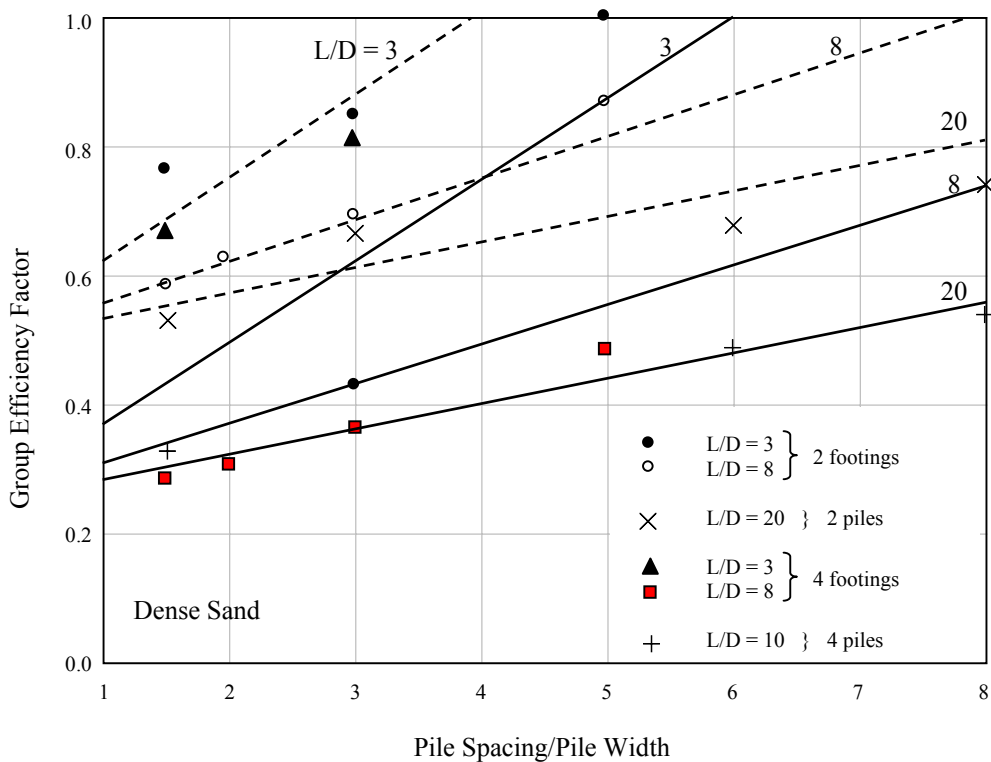

Legend :

- | | | |
|--------------------|---------------|-----------------------------|
| L = length of pile | ----- 2 piles | } theoretical relationships |
| D = pile width | ————— 4 piles | |

Figure 7.4 – Results of Model Tests on Pile Groups for Bored Piles and Footings in Granular Soil under Tension (Meyerhof & Adams, 1968)

Broms (1981) suggested an approximate method for determining the ultimate capacity of a general pile group, which comprises a combination of vertical and raking piles, when it is subject to an eccentric vertical load. This formulation reduces the problem to a statically determinate system and is a gross simplification of the interaction problem. The applicability of this proposed methodology is uncertain and is not proven.

Early model tests were carried out by Meyerhof (1963) for pile groups in clays and by Kishida & Meyerhof (1965) for pile groups in granular soils. These were supplemented by model tests reported by Meyerhof & Purkayastha (1985) on the ultimate capacity of pile groups under eccentric vertical loading and inclined loading. These tests were carried out in a layered soil consisting of clay of varying thicknesses over sand. The results were expressed as polar group efficiency diagrams for different ratios of clay to sand thickness. In the absence of field data, the test results summarised in Figure 7.5 may be used as a basis for making an approximate allowance for the reduction in ultimate capacity of a pile group subjected to eccentric and/or inclined loading.

Alternatively, the load and capacity of individual piles may be considered. A simplified and commonly-used method for determining the distribution of loads in individual piles in a group subject to eccentric loading is the 'rivet group' approach (Figure 7.6). This is based on the assumption that the pile cap is perfectly rigid. It should be noted that the load distribution in the piles determined using this method may not be a good representation of the actual distribution in the group due to interaction effects, particularly where there are raking piles. Computer programs are usually required for determining the distribution of pile load in a 'flexible cap', e.g. PIGLET. In this 'flexible cap' approach, the flexibility of the pile cap is included in the numerical solution. The stiffness of the piles can be modelled as purely structural members based on their axial stiffness or piles with soil-pile interaction.

In assessing the effects of pile-soil-pile interaction on individual pile capacities, the guidance given in Sections 7.3.3 to 7.3.6 for group efficiency factors for vertical pile groups subject to axial loads and lateral loads respectively may also be taken to apply to general pile groups for practical purposes.

When a pile group is subject to an eccentric horizontal load, torsional stresses in combination with bending stresses will be transmitted to the piles. The behaviour of an eccentrically-loaded pile group is poorly understood. Where there is a pile cap, a proportion of the load effect will be supported by mobilisation of passive pressure on the cap without being transferred to the piles. Reference may be made to Randolph (1981a) for analysis of pile behaviour under torsional loading.

7.4 NEGATIVE SKIN FRICTION ON PILE GROUPS

As far as negative skin friction is concerned, group interaction effects are beneficial in that the dragload acting on individual piles will be reduced. The possible exception is for small pile groups (say less than five piles) in very soft soils undergoing substantial settlement such that slip occurs in all the piles, resulting in no reduction in dragload compared to that of a single pile. It should be noted that the distribution of dragload between piles will not be uniform, with the centre piles experiencing the least negative skin friction due to interaction effects.

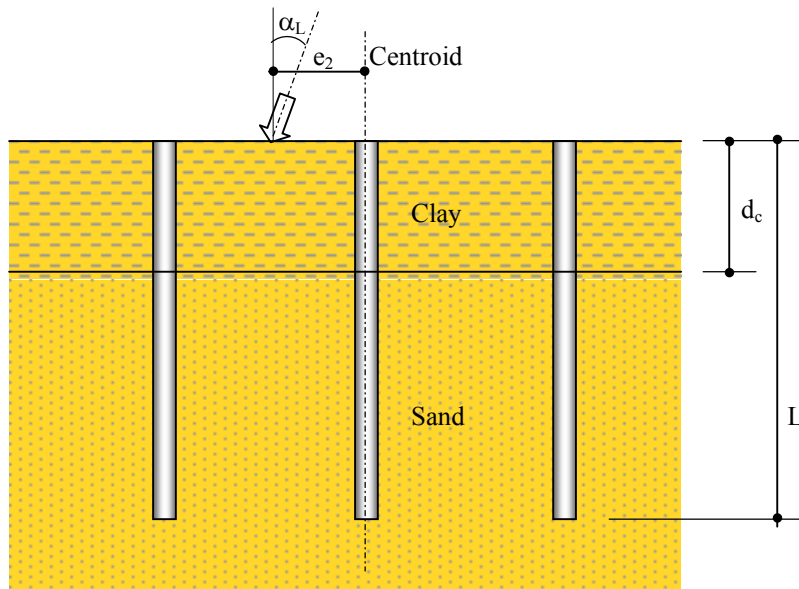
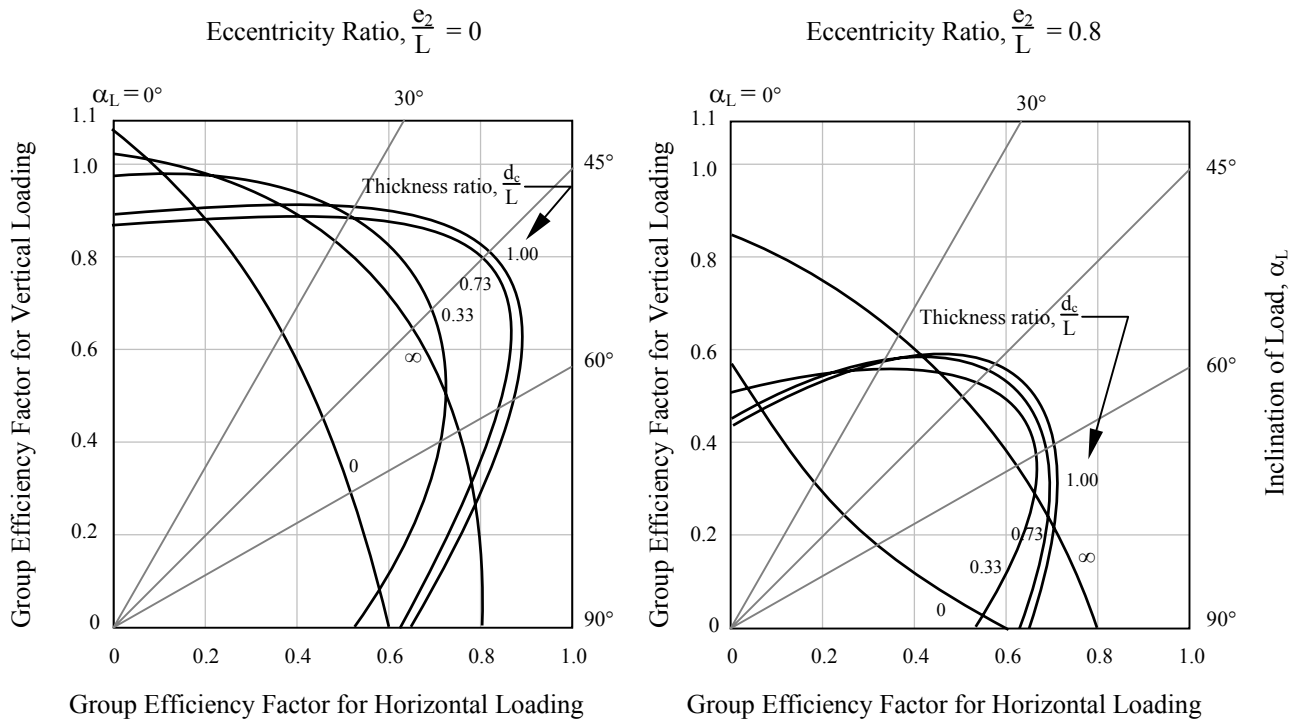

Legend :

- e_2 = eccentricity of applied load from centroid of pile group
- α_L = angle of inclination of applied load
- d_c = thickness of clay stratum
- L = embedded length of pile

Note : These model test results form a consistent set of data on the relative effect of eccentricity and inclination of the applied load. The recommended group efficiency factors given in Section 7.3.2, 7.3.3 & 7.3.5 for concentric and vertical loading (i.e. $e_2 = 0$ & $\alpha_L = 0$) should be scaled using the ratio deduced from this Figure to take into account the load eccentricity and inclination effects.

Figure 7.5 – Polar Efficiency Diagrams for Pile Groups under Eccentric and Inclined Loading (Meyerhof & Purkayastha, 1985)

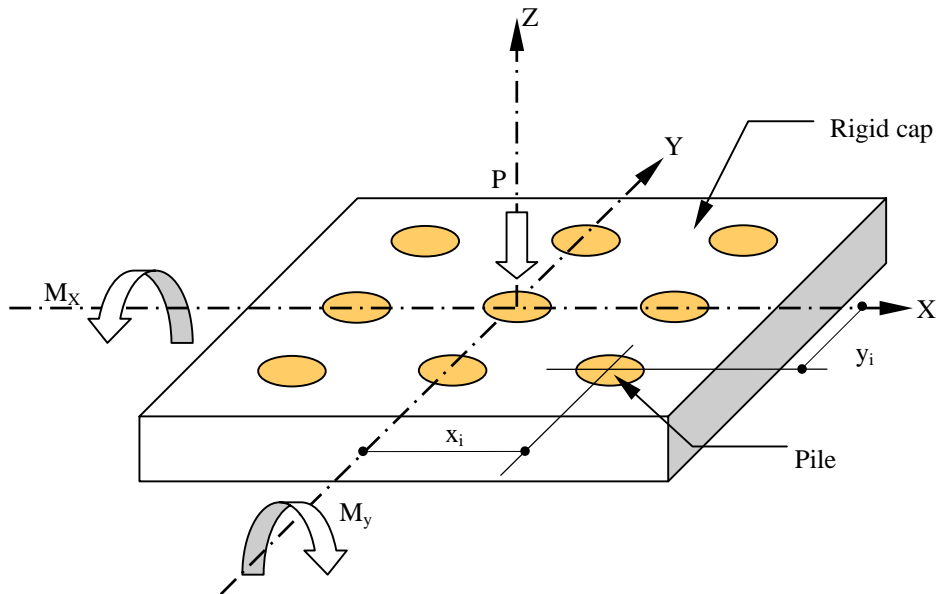

$$P_{ai} = \frac{P}{n_p} + \frac{M_y^* x_i}{I_x} + \frac{M_x^* y_i}{I_y}$$

$$M_x^* = \frac{M_x - \frac{M_y I_{xy}}{I_y}}{1 - \frac{I_{xy}^2}{I_x I_y}} \quad \text{and} \quad M_y^* = \frac{M_y - \frac{M_x I_{xy}}{I_x}}{1 - \frac{I_{xy}^2}{I_x I_y}}$$

Legend :

| | | |
|----------------|---|---|
| P_{ai} | = | axial load on an individual pile, i |
| P | = | total vertical load acting at the centroid of the pile group |
| n_p | = | number of piles in the group |
| M_x, M_y | = | moment about centroid of pile group with respect to x and y axes respectively |
| I_x, I_y | = | moment of inertia of pile group with respect to x and y axes respectively |
| I_{xy} | = | product of inertia of pile group about the centroid |
| x_i, y_i | = | distance of pile i from y and x axes respectively |
| M_x^*, M_y^* | = | principal moment with respect to x and y axes respectively, taking into account the non-symmetry of the pile layout |

$$I_x = \sum_{i=1}^{n_p} x_i^2$$

$$I_y = \sum_{i=1}^{n_p} y_i^2$$

$$I_{xy} = \sum_{i=1}^{n_p} x_i y_i$$

For a symmetrical pile group layout, $I_{xy} = 0$ and $M_x^* = M_x$ and $M_y^* = M_y$

Notes : The assumptions made in this method are :

- (1) Pile cap is perfectly rigid,
- (2) Pile heads are hinged to the pile cap and no bending moment is transmitted from the pile cap to the piles, and
- (3) Piles are vertical and of same axial stiffness.

Figure 7.6 – Determination of Distribution of Load in an Eccentrically-loaded Pile Group Using the 'Rivet Group' Approach

For practical purposes, the limiting dragload may be taken as the lesser of :

- (a) the sum of negative skin friction around pile group perimeter and effective weight of ground enclosed by the perimeter, and
- (b) the sum of negative skin friction on individual piles (with a cautious allowance for interaction effects).

Wong (1981) reviewed the various analytical methods and put forward an approach based on the assumption that the settling soil is in a state of plastic failure as defined by the Mohr-Coulomb criterion. In this method, allowance can be made for group action, effect of pile spacing and arching on the vertical effective stress, together with the different stress condition for piles at different positions in a group.

For an internal pile (i.e. piles not along the perimeter of the group), the negative skin friction will be limited to the submerged weight of the soil column above the neutral plane (Section 6.8.2) as this is the driving force.

Kuwabara & Poulos (1989) carried out a parametric study on the magnitude and distribution of dragload using the boundary element method. It was shown that the method gave reasonable agreement with observed behaviour for a published field experiment in Japan.

The above methods are capable of predicting the distribution of negative skin friction in a large pile group and hence assess the average dragload on the group. For pile groups of five piles or more at a typical spacing of three to five pile diameters, interaction effects will result in a reduction in the average dragload. Analysis using the above methods together with available overseas instrumented full-scale data (e.g. Okabe, 1977; Inoue, 1979) indicates that the reduction can be in the range of 15% to 30%. Lee et al (2002) carried out numerical analyses to investigate the distribution of dragload in a pile group. The soil model allowed soil slip at the pile-soil interface. The analyses indicated that reduction in dragload varied from 19% to 79% for a 5 x 5 pile group with piles at a spacing of 2.5 times the pile diameter. Piles at the centre carried less dragload as the soils arched between the piles.

In the absence of instrumented data in Hong Kong, it is recommended that a general reduction of 10% to 20% on the negative skin friction in a single pile within a group may be conservatively assumed for design purposes, for a pile group consisting of at least five piles at customary spacing. The appropriate value to be adopted will depend on the spacing and number of piles in a group.

Where the calculated reduction in negative skin friction due to group effects is in excess of that observed in field monitoring, consideration should be given to making a more cautious allowance or instrumenting the piles in order to verify the design assumptions.

The effect of negative skin friction may lead to reduction in the effective overburden pressure and hence the capacity of the bearing stratum. Davies & Chan (1981) developed an analysis put forward by Zeevaert (1959), which makes allowance for the reduction in effective overburden pressure acting on the bearing stratum as a result of arching between piles within a pile group.

7.5 DEFORMATION OF PILE GROUPS

7.5.1 Axial Loading on Vertical Pile Groups

7.5.1.1 General

Based on linear elastic assumptions, the ratio of immediate settlement to total settlement of a pile group is expected to be less than that for a single pile. Generally, the ratio is in the range of 2/3 to 3/4 for typical friction-pile group configurations in granular soils (Poulos & Davis, 1980). For end-bearing groups, the relative amount of immediate settlement is generally greater than for friction pile groups. Pile interaction generally results in a higher percentage of the total load being transferred to the base of piles compared to that in isolated piles.

The settlement of a pile group subject to a given average load per pile is generally larger than that in a single pile under the same load. The corresponding ratio is termed the group settlement ratio (R_{gs}). Group settlement ratios observed in full-scale tests on pile groups founded in granular soils are summarised by O'Neill (1983). It was found that R_{gs} is generally larger than unity, except where driven piles have been installed into loose sand, increasing the ground stiffness due to densification effects.

The guidance given in Section 6.13.2.5 on soil stiffness also applies to settlement predictions for a pile group. The stress bulb associated with a pile group will be larger than that for a single pile and the settlement characteristics will therefore be influenced by soils at greater depths.

The various approaches which have been proposed for assessing pile group settlement may be categorised as follows :

- (a) semi-empirical methods,
- (b) equivalent raft method,
- (c) equivalent pier method,
- (d) interaction factor methods, and
- (e) numerical methods.

The analysis of the settlement of a pile group incorporating a ground-bearing cap is discussed in Section 7.6.3.

7.5.1.2 Semi-empirical methods

Various semi-empirical formulae derived from limited field observations (e.g. Skempton, 1953; Vesic, 1969; Meyerhof, 1976) have been proposed for predicting settlement of pile groups in sand. A commonly-used rule-of-thumb is to assume the differential settlement of the pile group is up to half the maximum group settlement in uniform soils.

The empirical formulae suffer from the drawback that they have not been calibrated against observations made in Hong Kong and their formulation lacks a sound theoretical basis, and therefore their use is not recommended for detailed design.

7.5.1.3 Equivalent raft method

The equivalent raft method is a widely-used simplified technique for the calculation of pile group settlement. In this method, the pile group is idealised as an equivalent raft that is assumed to be fully flexible. The location and size of the equivalent raft is dependent on the mode of load transfer, i.e. whether the applied load is resisted primarily in shaft resistance or end-bearing (Figure 7.7). Further development of the equivalent raft concept is reported by Randolph (1994).

The settlement of the equivalent raft can be calculated using elasticity solution for granular soils and consolidation theory for clays. The settlement at pile top is obtained by summing the raft settlement and the elastic compression of the pile length above the equivalent raft. An assessment may be made of the influence of the relative rigidity of a raft on settlement following Fraser & Wardle (1976). Depth and rigidity corrections factors may be applied to the calculated settlement as appropriate (Tomlinson, 1994; Davis & Poulos, 1968).

The equivalent raft method is generally adequate for routine calculations involving simple pile group geometries to obtain a first order estimate of group settlement. However, it does not consider the influence of pile spacing or effect of pile interaction in a rational manner. Also, the effects of relative stiffness between the structure and foundation are accounted for in only an approximate manner with the use of a rigidity correction factor. Thus, the method should be used with caution for the analysis of pile groups with a complex geometry, greatly different pile lengths, or where the loading is highly non-uniform.

7.5.1.4 Equivalent pier method

The equivalent pier method is applicable to analysing settlement caused by underlying compressible layers beneath an equivalent single pier. In this method, the pile group is replaced by an equivalent pier of similar length to the piles. The pier diameter is taken as square root of the plan area of the pile group (Poulos, 1993). Poulos et al (2002) proposed that a factor of 1.13 to 1.27 should be applied to the square root to give the equivalent diameter. The larger value is applicable to pile groups with predominately floating piles supported on shaft resistance. Methods given in Section 6.13 can be used for calculating the settlement of the equivalent pier.

Castelli & Maugeri (2002) extended the equivalent pier method to allow for the non-linear response of vertically loaded pile groups. In this method, the non-linear response of a single pile is modelled by hyperbolic load-transfer functions. The transfer functions can be determined based on either elastic theory (Randolph & Wroth, 1978) or full-scale loading tests. The behaviour of a pile group is then obtained by applying modification factors to these load-transfer functions. The modification factors allow for the reduction in stiffness due to pile group effect.

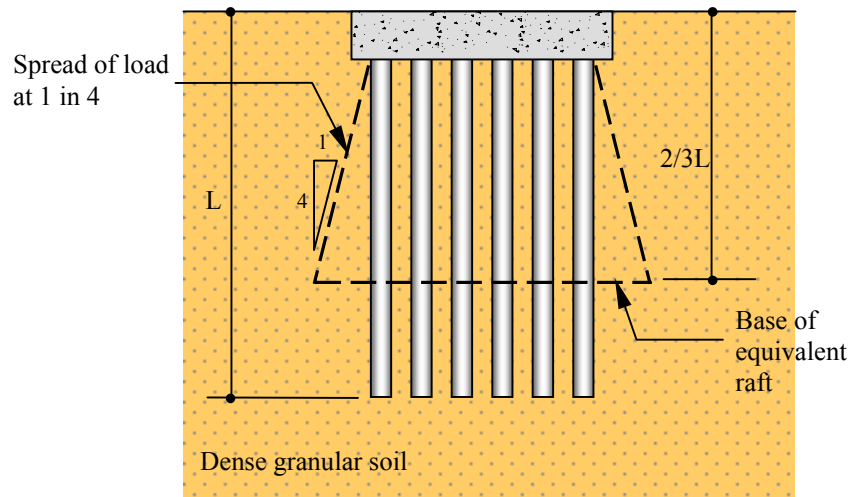

(a) Group of Piles Supporting Predominately by Shaft Resistance

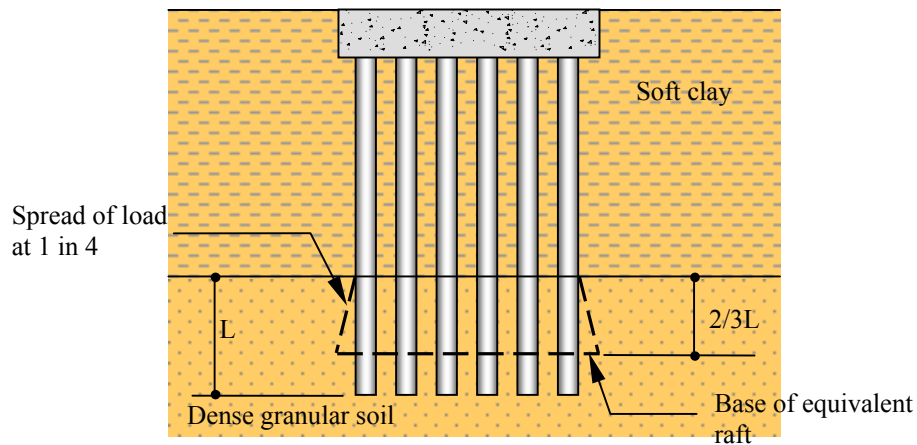

(b) Group of Piles Driven through Soft Clay to Combined Shaft and End-bearing Resistance in Dense Granular Soil

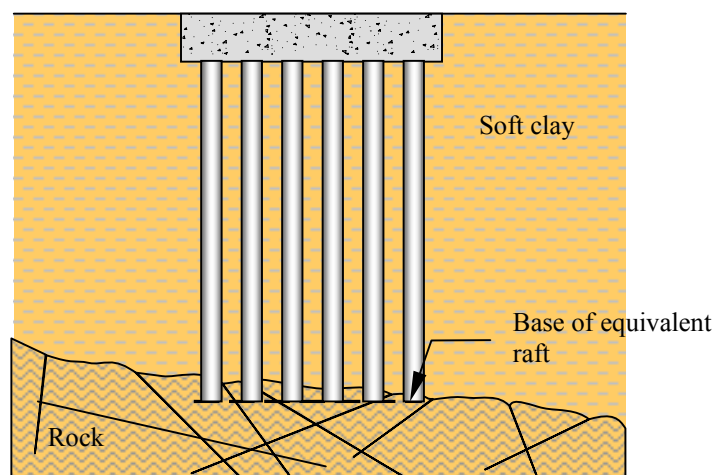

(c) Group of Piles Supported by End-bearing on Hard Rock Stratum

Figure 7.7 – Equivalent Raft Method (Tomlinson, 1994)

7.5.1.5 Interaction factor methods

A widely used method of analysing the pile group settlement is based on the concept of interaction factors (Φ) defined as follows :

$$\Phi = \frac{\text{additional settlement caused by an adjacent pile under load}}{\text{settlement of pile under its own load}} \quad [7.2]$$

This is an extension of the elastic continuum method for analysis of settlement of single piles where the interaction effects in a pile group are assessed by superposition. Basic solutions for the group settlement ratio (R_{gs}) for incompressible friction or end-bearing pile groups are summarised by Poulos & Davis (1980). Correction factors can then be applied for base enlargement, depth to incompressible stratum, non-homogeneous soil, effect of pile slip, interaction between piles of different sizes, pile compressibility and rigidity of the bearing stratum. The relationship between group settlement ratio, R_{gs} and the number of piles derived by Fleming et al (1992) for two simple cases is shown in Figures 7.8(a) & (b). The solutions given are for key piles in uniformly loaded pile groups and also for pile groups loaded through a rigid pile cap. It can be seen that interaction effects are less pronounced in a soil with increasing stiffness with depth than in a homogeneous soil.

An alternative and simplified form of the interaction factor method was proposed by Randolph & Wroth (1979). Equations have been derived for shaft and base interaction factors for equally loaded rigid piles, which are summarised in Figure 7.9. For compressible piles installed in homogenous or non-homogenous soils, the base and shaft settlements are not equal. The pile head settlement should be adjusted according to the approach by Randolph & Wroth (1979).

Poulos (1988b) has modified the interaction factor method to incorporate the effects of strain-dependency of soil stiffness. The modified analysis shows that the presence of stiffer soils between piles results in a smaller group settlement ratio and a more uniform load distribution than that predicted based on the assumption of a linear elastic, laterally homogeneous soil.

The reinforcing effect of the piles on the soil mass is disregarded in the formulation of interaction factors. This assumption becomes less realistic for sizeable groups of piles with a large pile stiffness factor, K . This effect can be modelled by using a diffraction factor (Mylonakis & Gazetas, 1998) that will lead to a reduction of the interaction factor. Randolph (2003) expanded the solution to include pile groups with piles in different diameters.

The assumption of linear elasticity for soil behaviour is known to over-estimate interaction effects in a pile group. Jardine et al (1986) demonstrated the importance of non-linearity in pile group settlement and load distribution with the use of finite element analyses.

Mandolini & Viggiani (1997) incorporated the non-linear response of a single pile into the formulation of interaction factors. The method allows for modelling of piles with variable sectional area and in horizontally layered elastic soils. The procedures use boundary element method to calibrate soil model against load-settlement behaviour of a single pile. This is then used to determine the interaction factor for pairs of piles at different spacing. It also establishes a limiting pile spacing, beyond which the effect of interaction is insignificant.

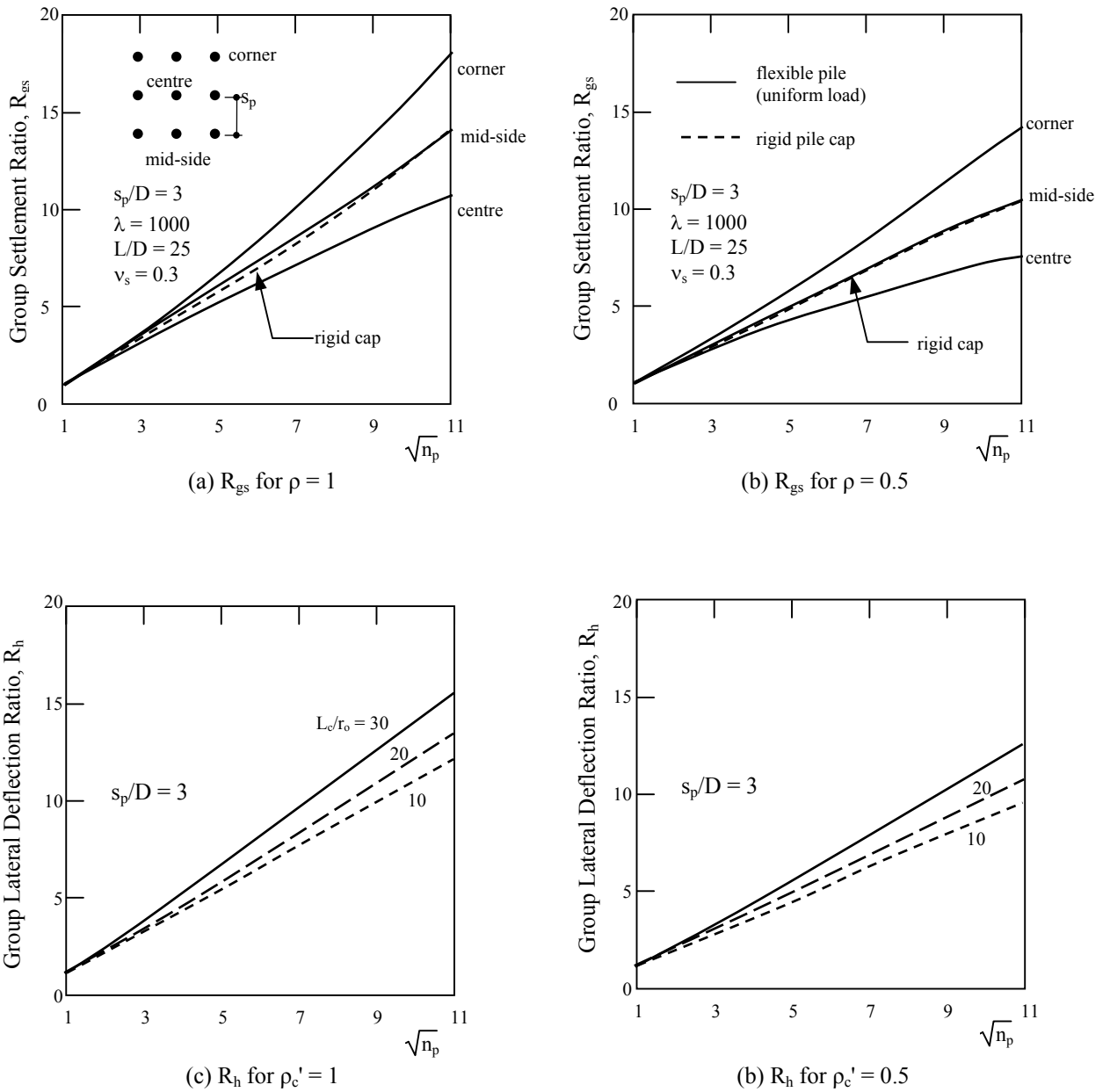

Legend :

- | | | | | | |
|-----------------|---|-----------------------------------|------------|---|---|
| n_p | = | number of piles in the group | ρ | = | variation of soil modulus with depth = $G_{0.5L}/G_L$ |
| G^* | = | $G(1+0.75v_s)$ | ρ_c' | = | degree of homogeneity over $L_c = G^*_{0.25L_c}/G_c$ |
| r_o | = | pile radius | G | = | shear modulus of soil |
| L | = | pile length | L_c | = | critical pile length for lateral loading |
| v_s | = | Poisson's ratio of soil | G_c | = | average value of G^* over L_c |
| D | = | pile diameter | s_p | = | pile spacing |
| G_L | = | value of G at depth L | $G_{0.5L}$ | = | value of G at depth $0.5L$ |
| $G^*_{0.25L_c}$ | = | value of G^* at depth $0.25L_c$ | λ | = | pile stiffness ratio (= E_p/G_L) |
| E_p | = | Young's modulus of pile | | | |

Figure 7.8 – Typical Variation of Group Settlement Ratio and Group Lateral Deflection Ratio with Number of Piles (Fleming et al, 1992)

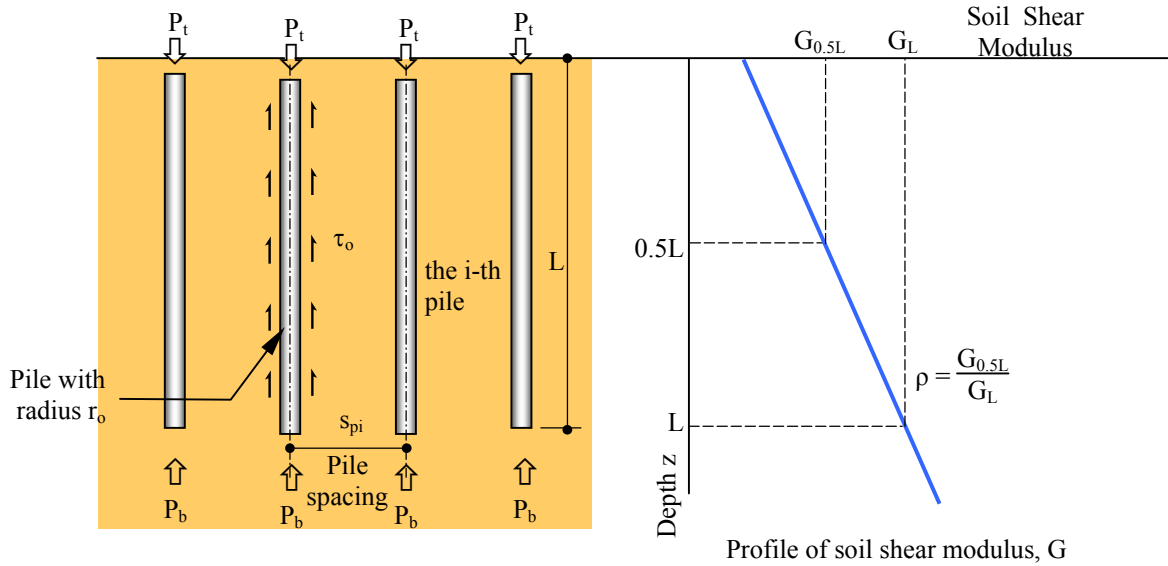

For axial loading on rigid piles with similar loading, the interaction between the pile shafts and the pile bases can be treated separately :

Pile shafts: $\delta_1 = \sum_{i=1}^{n_p} \delta_{1i}$ where δ_{1i} is the shaft settlement due to interaction from the i -th pile $= \frac{\tau_o r_o}{G} \ln \frac{r_m}{s_{pi}}$

and τ_o is the average shear resistance along pile shaft $= \frac{2\pi r_o L}{P_s}$. P_s is the load along pile shaft. n_p is number of piles.

$$\frac{P_s}{G_L r_o \delta_1} = \frac{2\pi\rho}{\left[\ln \frac{r_m}{r_o} + \sum_{i=2}^{n_p} \ln \frac{r_m}{s_{pi}} \right]} \frac{L}{r_o}$$

Pile bases: $\delta_b = \sum_{i=1}^{n_p} \delta_{bi}$ where δ_{bi} is the base settlement due to interaction from the i -th pile $= \frac{P_b(1-\nu_s)}{4r_o G_L} \frac{2}{\pi} \frac{r_o}{s_{pi}}$

$$\frac{P_b}{G_L r_o \delta_b} = \frac{4}{1-\nu_s} \frac{1}{\left[\frac{2}{\pi} + \sum_{i=2}^{n_p} \frac{2}{\pi} \frac{r_o}{s_{pi}} \right]}$$

Total pile head settlement can be computed by assuming compatibility of pile base and shaft stiffness :

$$P_t = \delta_t \left(\frac{P_b}{\delta_b} + \frac{P_s}{\delta_1} \right)$$

Interaction factor from adjacent piles can be computed by rearranging the above equation and expressed as :

$$\delta_t = \frac{(1 + \alpha') P_t}{G_L r_o} \quad \text{where } \alpha' \text{ is the interaction factor}$$

- Legend :
- δ_t = settlement at pile head due to load at pile head, P_t
 - δ_b = settlement at pile base due to load at pile base, P_b
 - δ_1 = settlement due to shaft resistance in response to load along pile shaft, P_s
 - r_m = maximum radius of influence of pile under axial loading, empirically this is expressed in term of the order of pile length, $r_m = 2.5 \rho L (1 - \nu_s)$
 - ν_s = Poisson's ratio of soil

Figure 7.9 – Group Interaction Factor for the Deflection of Pile Shaft and Pile Base under Axial Loading (Randolph & Wroth, 1979 and Fleming et al, 1992)

Fraser & Lai (1982) reported comparisons between the predicted and monitored settlement of a group of driven piles founded in granitic saprolites. The prediction was based on the elastic continuum method, which was found to over-estimate the group settlement by up to about 100% at working load even though the prediction for single piles compares favourably with results of static loading tests. Similar findings were reported by Leung (1988). This may be related to the densification effect associated with the installation of driven piles or the over-estimation in the calculated interaction effect by assuming a linear elastic soil.

In general, the interaction factor method based on linear elastic assumptions should, in principle, give a conservative estimate of the magnitude of the pile group settlement. This is because the interaction effects are likely to be less than assumed.

7.5.1.6 Numerical methods

A number of approaches based on numerical methods have been suggested for a detailed assessment of pile group interaction effects. They usually provide a useful insight into the mechanism of behaviour. The designers should be aware of the capability and limitations of the available methods where their use is considered justifiable for complex problems. Examples of where numerical methods can be applied more readily in practice include design charts based on these methods for simple cases, which may be relevant for the design problem in hand. Some such design charts are discussed in the following, together with the common numerical methods that have been developed for foundation analysis.

A more general solution to the interaction problem was developed by Butterfield & Bannerjee (1971a) using the boundary element method. Results generally compare favourably with those derived using the interaction factor method (Hooper, 1979). An alternative approach is to replace the pile group by a block of reinforced soil in a finite element analysis (Hooper & Wood, 1977).

Butterfield & Douglas (1981) summarised the results of boundary element analyses in a collection of design charts. The results are related to a stiffness efficiency factor (R_g), which is defined as the ratio of the overall stiffness of a pile group to the sum of individual pile stiffness. This factor is equal to the inverse of the group settlement ratio (i.e. $R_g = 1/R_{gs}$). Fleming et al (1992) noted that the stiffness efficiency factor is approximately proportional to the number of piles, n_p , plotted on a logarithmic scale, i.e. $R_g = n_p^{-a}$. Typical design charts for calculating the value of the exponent a are given in Figure 7.10. For practical problems, the value of a usually lies in the range of 0.4 to 0.6. It is recommended that this simplified approach may be used for pile groups with simple geometry, i.e. regular arrangement of piles in a uniform soil.

Other numerical methods include the infinite layer method for layered soils (Cheung et al, 1988) and the formulation proposed by Chow (1989) for cross-anisotropic soils. Chow (1987) also put forward an iterative method based on a hybrid formulation which combines the load transfer method (Section 6.13.2.2) and elastic continuum approach (Section 6.13.2.3) for single piles using Mindlin's solution to allow for group interaction effects.

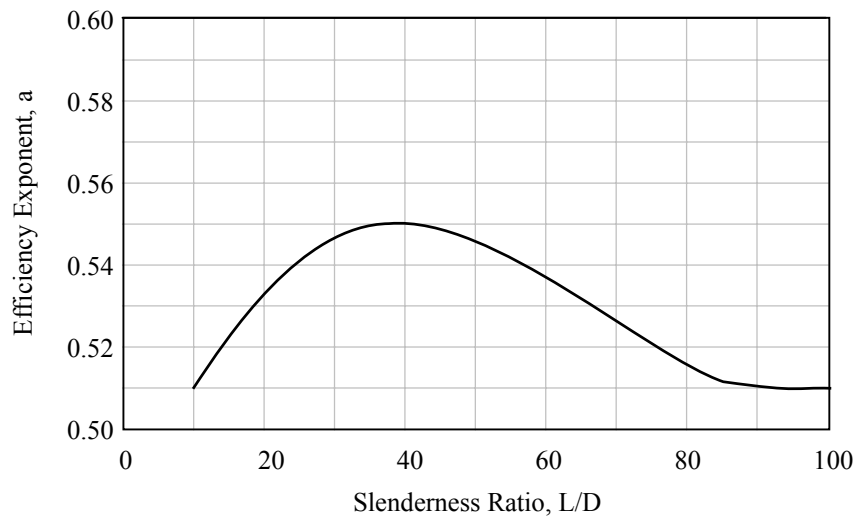

(a) Base Value

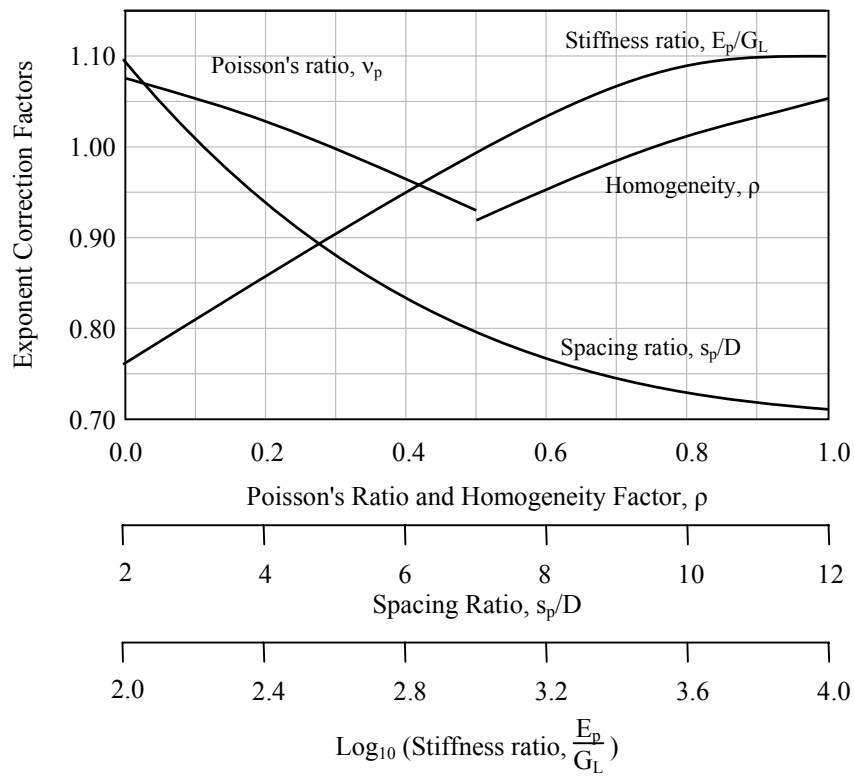

(b) Correction Factors

Legend :

- | | |
|--|---|
| E_p = Young's modulus of pile | R_g = stiffness efficiency factor |
| a = exponent for stiffness efficiency factor | L = length of pile |
| D = pile diameter | v_p = Poisson's ratio of pile |
| s_p = pile spacing | G_L = shear modulus of soil at pile base |
| n_p = number of piles in a group | ρ = rate of variation of shear modulus of soil with depth (homogeneity factor) |

Note :

- (1) $R_g = n_p^{-a}$ where the efficiency exponent, a, is obtained by multiplying the base value from (a) and the correction factors selected from (b).

Figure 7.10 – Calculation of Stiffness Efficiency Factor for a Pile Group Loaded Vertically (Fleming et al, 1992)

Results of numerical analyses of the settlement of a pile group that are socketed into a bearing stratum of finite stiffness are presented by Chow et al (1990) in the form of design charts.

Computer programs based on the 'beam (or slab) on spring foundation' model may be used where springs are used to model the piles and the soil (Sayer & Leung, 1987; Stubbings & Ma, 1988). This approach can reasonably be used for approximate foundation-structure interaction analysis. For a more detailed and rational assessment of the foundation-structure interaction and pile-soil-pile interaction, iterations will be necessary to obtain the correct non-uniform distribution of spring stiffness across the foundation to obtain compatible overall settlement profile and load distribution between the piles.

There is a relatively wide range of approaches developed for detailed studies of interaction effects on the settlement of a pile group. Different formulations are used and it is difficult to have a direct comparison of the various methods. The applicability and limitations of the methods for a particular design problem should be carefully considered and the chosen numerical method should preferably be calibrated against relevant case histories or back analysis of instrumented behaviour. In cases where a relatively unfamiliar or sophisticated method is used, it would be advisable to check the results are of a similar magnitude using an independent method.

7.5.2 Lateral Loading on Vertical Pile Groups

7.5.2.1 General

The assessment of the lateral deflection of a pile group is a difficult problem. The response of a pile group involves both the lateral load-deformation and axial load-deformation characteristics as a result of the tendency of the group to rotate when loaded laterally. Only when the rotation of the pile cap is prevented would the piles deflect purely horizontally.

7.5.2.2 Methodologies for analysis

There are proposals in the literature for empirical reduction factors for the coefficient of subgrade reaction, n_h (Table 7.2) to allow for group effects in the calculation of deflection, shear force, bending moment, etc. using the subgrade reaction method. Although these simplifying approximations do not have a rational theoretical basis in representing the highly interactive nature of the problem, in practice they are generally adequate for routine design problems and form a reasonable basis for assessing whether more refined analysis is warranted.

An alternative approach, which may be used for routine problems, is the elastic continuum method based on the concept of interaction factors as for the calculation of pile group settlement. Elastic solutions for a pile group subject to horizontal loading are summarised by Poulos & Davis (1980).

Table 7.2 – Reduction Factor for Coefficient of Subgrade Reaction for a Laterally Loaded Pile Group (CGS, 1992)

| Pile spacing/ Pile Diameter | Reduction Factor, R_n , for n_h |
|-----------------------------|-------------------------------------|
| 3 | 0.25 |
| 4 | 0.40 |
| 6 | 0.70 |
| 8 | 1.00 |

Notes : (1) Pile spacing normal to the direction of loading has no influence, provided that the spacing is greater than 2.5 pile diameter.
 (2) Subgrade reaction is to be reduced in the direction of loading.

As a general guideline, it may be assumed that piles can sustain horizontal loads of up to 10% of the allowable vertical load without special analysis (CGS, 1992) unless the soils within the upper 10% of the critical length of the piles (see Sections 6.13.3.2 & 6.13.3.3 for discussion on critical length) are very weak and compressible.

Based on the assumptions of a linear elastic soil, Randolph (1981b) derived expressions for the interaction factors for free-head and fixed-head piles loaded laterally (Figure 7.11). It can be deduced from this formulation that the interaction of piles normal to the applied load is only about half of that for piles along the direction of the load. The ratio of the average flexibility of a pile group to that of a single pile for lateral deflection under the condition of zero rotation at ground level can also be calculated. This ratio, defined as the group lateral deflection ratio (R_h), is analogous to the group settlement ratio (R_{gs}). As an illustration, results for typical pile group configurations are shown in Figure 7.8 which illustrates that the degree of interaction under lateral loading is generally less pronounced compared to that for vertical loading. This approach by Randolph (1981b) is simple to use and is considered adequate for routine problems where the group geometry is relatively straight forward.

An alternative is to carry out an elasto-plastic load transfer analysis using the subgrade reaction method with an equivalent pile representing the pile group. In this approach, the group effect can be allowed for approximately by reducing the soil resistance at a given deflection or increasing the deflection at a given soil pressure (Figure 7.12). In practice, the actual behaviour will be complex as the effective H - δ_h curve for individual piles may be different and dependent on their relative positions in the pile group. Considerable judgement is required in arriving at the appropriate model for the analysis for a given problem.

7.5.2.3 Effect of pile cap

Where there is a pile cap, the applied horizontal loads will be shared between the cap and the pile as a function of the relative stiffness. The unit displacement of the pile cap can be determined following the solution given by Poulos & Davis (1974), whereas the unit displacement of the piles may be determined using the methods given in Sections 6.13.3 and 7.5.2.2. From compatibility considerations, the total displacement of the system at pile head level can be calculated and the load split between the cap and the piles determined. Care should be taken to make allowance for possible yielding of the soil where the strength is fully mobilised, after which any additional loading will have to be transferred to other parts of the system.

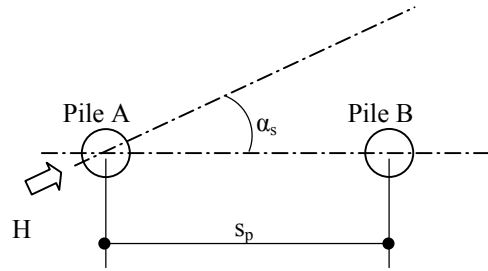
Definition of Departure Angle, α_s

If the stiffness of a single pile under a given form of loading is K_L , then a horizontal load H will give rise to a deformation δ_h given by :

$$\delta_h = \frac{H}{K_L}$$

If two identical piles are each subjected to a load H , then each pile will deform by an amount δ_h given by :

$$\delta_h = (1 + \alpha') \frac{H}{K_L}$$

For fixed-head piles

$$\alpha' = 0.6 \rho_c' \left(\frac{E_p}{G_c} \right)^{1/7} r_o \frac{(1 + \cos^2 \alpha_s)}{s_p}$$

At close spacing, the above expression over-estimates the amount of interaction. When the calculated value of α' exceeds 0.33, the value should be replaced by the expression $1 - \frac{2}{\sqrt{27\alpha'}}$

For free-head piles

$$\alpha' = 0.4 \rho_c' \left(\frac{E_p}{G_c} \right)^{1/7} r_o \frac{(1 + \cos^2 \alpha_s)}{s_p}$$

Legend :

- α' = interaction factor for deflection of piles
- α_s = angle of departure that the pile makes with the direction of loading
- ρ_c' = degree of homogeneity = $\frac{G_{0.25L_c}}{G_c}$
- G = shear modulus of soil
- G^* = $G(1 + 0.75 v_s)$
- $G_{0.25L_c}$ = value of G^* at depth of $0.25L_c$
- G_c = average value of G^* over L_c
- L_c = critical pile length for lateral loading = $2 r_o \left(\frac{E_{pe}}{G_c} \right)^{2/7}$
- v_s = Poisson's ratio of soil
- s_p = spacing between piles
- r_o = radius of pile
- E_p = Young's modulus of pile
- I_p = moment of inertia of pile
- E_{pe} = equivalent Young's modulus of pile = $\frac{4E_p I_p}{\pi r_o^4}$

Figure 7.11 – Interaction of Laterally Loaded Piles Based on Elastic Continuum Method (Randolph, 1981a and Randolph, 1990)

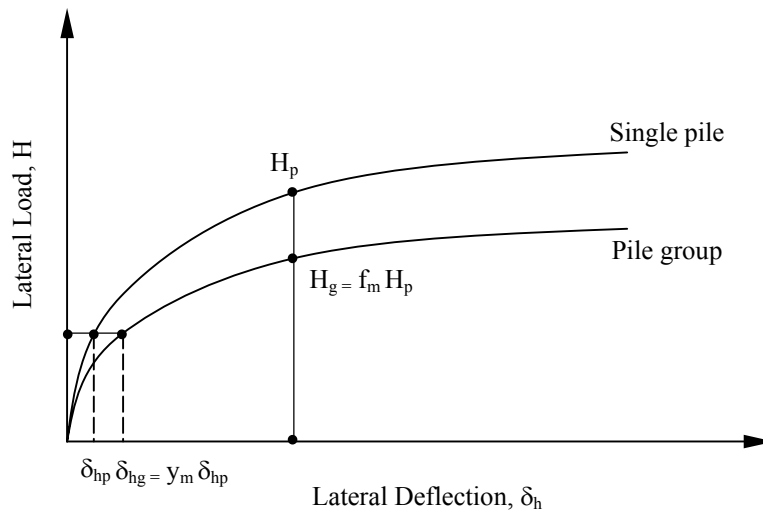

Legend :

- δ_{hp} = lateral deflection of a single pile
- δ_{hg} = lateral deflection of a pile group
- f_m = multiplier to convert load from pile to pile group
- y_m = multiplier to convert deflection from pile to pile group
- H_p = lateral load of a single pile
- H_g = lateral load of a pile in a pile group

Notes :

- (1) Use a multiplier (f_m or y_m) to modify the $H - \delta_h$ curve for a single pile to obtain an effective $H - \delta_h$ for the pile group.
- (2) This can be achieved by either reducing the soil resistance mobilised at a given deflection or increase in deflection at a given soil resistance.
- (3) This method requires sufficient data from loading tests.

Figure 7.12 – Reduction of Lateral Load and Deflection of Piles in a Pile Group (Brown et al, 1988)

Kim et al (1977) observed from full-scale tests on a group of vertical piles that the effect of contact between a ground-bearing cap and the soil is to reduce the group deflection by a factor of about two at working conditions. However, it was reported by O'Neill (1983) that the effect of cap contact is found to be negligible where the majority of the piles are raked.

7.5.3 Combined Loading on General Pile Groups

7.5.3.1 General

Deformations and forces induced in a general pile group comprising vertical and raking piles under combined loading condition are not amenable to presentation in graphical or equation format. A detailed analysis will invariably require the use of a computer.

Zhang et al (2002) conducted centrifuge tests to investigate the effect of vertical load on the lateral response of a pile group with raking piles. The results of the experiments indicated that there was a slight increase in the lateral resistance of the pile groups with the application of a vertical load.

7.5.3.2 Methodologies for analysis

Historically, simple groups of piles have been analysed by assuming that the piles act as structural members. In this method, either a direct resolution of forces is made where possible or a structural frame analysis is carried out (Hooper, 1979). The presence of soil can be accounted for by assuming an effective pile length; this is a simplification of the complex relative stiffness problem in a soil continuum and should be used with extreme caution.

Stiffness method can be used to analyse pile groups comprising vertical piles and raking piles installed to any inclination. In this method, the piles and pile cap form a structural frame to carry axial, lateral and moment loading. The piles are assumed to be pin-jointed and deformed elastically. The load on each pile is determined based on the analysis of the structural frame. The lateral restraint of the soil is neglected and this model is not a good representation of the actual behaviour of the pile group. The design is inherently conservative and other forms of analyses are preferred for pile groups subjected to large lateral load and moment (Elson, 1984).

A more rational approach is to model the soil as an elastic continuum. A number of commercial computer programs have been written for general pile group analysis based on idealising the soil as a linear elastic material, e.g. PIGLET (Randolph, 1980), DEFPIG (Poulos, 1990a), PGROUP (Bannerjee & Driscoll, 1978). which have been applied to problems in Hong Kong. The first two programs are based on the interaction factor method while the last one uses the boundary element method. A brief summary of the features of some of the computer programs developed for analysis of general pile groups can be found in Poulos (1989b) and the report by the Institution of Structural Engineers (ISE, 1989). Computer analyses based on the elastic continuum method generally allow more realistic boundary conditions, variation in pile stiffness and complex combined loading to be modelled.

Comparisons between results of different computer programs for simple problems have been carried out, e.g. O'Neill & Ha (1982) and Poulos & Randolph (1983). The comparisons are generally favourable with discrepancies which are likely to be less than the margin of uncertainty associated with the input parameters. Comparisons of this kind lend confidence in the use of these programs for more complex problems.

Pile group analysis programs can be useful to give an insight into the effects of interaction and to provide a sound basis for rational design decisions. In practice, however, the simplification of the elastic analyses, together with the assumptions made for the idealisation of the soil profile, soil properties and construction sequence could potentially lead to misleading results for a complex problem. Therefore, considerable care must be exercised in the interpretation of the results.

The limitations of the computer programs must be understood and the idealisations and assumptions made in the analyses must be compatible with the problem being considered.

It would be prudent to carry out parametric studies to investigate the sensitivity of the governing parameters for complex problems.

7.5.3.3 Choice of parameters

One of the biggest problems faced by a designer is the choice of appropriate soil parameters for analysis. Given the differing assumptions and problem formulation between computer programs, somewhat different soil parameters may be required for different programs for a certain problem. The appropriate soil parameters should ideally be calibrated against a similar case history or derived from the back analysis of a site-specific instrumented pile test using the proposed computer program for a detailed analysis.

7.6 DESIGN CONSIDERATIONS IN SOIL-STRUCTURE INTERACTION PROBLEMS

7.6.1 General

In practice, piles are coupled to the structure and do not behave in isolation. Soil-structure interaction arises from pile-soil-pile interaction and pile-soil-structure interaction. The interaction is a result of the differing stiffness which governs the overall load-deformation characteristics of the system as movements and internal loads re-adjust under the applied load.

Interaction also occurs in situations where piles are installed in a soil undergoing movements. The presence of stiff elements (i.e. the piles) will modify the free-field ground movement profile which in turn will induce movements and forces in the piles.

The proper analysis of a soil-structure interaction problem is complex and generally requires the use of a computer, which must incorporate a realistic model for the constitutive behaviour of the soil. The computational sophistication must be viewed in perspective of the applicability of the simplifying assumptions made in the analysis and the effects of inherent heterogeneity of the ground, particularly for saprolites and rocks in Hong Kong. The results of the analyses should be used as an aid to judgement rather than as the sole basis for design decisions.

In practice, it is unusual to carry out detailed soil-structure interaction analyses for routine problems. However, a rational analytical framework is available (e.g. elasto-plastic finite element analysis) and could be considered where time and resources permit and for critical or complex design situations. In addition, the analysis could be used for back calculation of monitored behaviour to derive soil parameters.

7.6.2 Load Distribution between Piles

7.6.2.1 General

A knowledge of the load distribution in a pile group is necessary in assessing the profile of movement and the forces in the pile cap. Linear elastic methods are usually used

for this purpose although the predictions tend to over-estimate the load differentials.

7.6.2.2 Piles subject to vertical loading

The distribution of vertical loads in a free-standing pile group with a rigid pile cap is predicted to be non-uniform by continuum analyses assuming a linear elastic soil (Poulos & Davis, 1980). Piles near the centre of a group are expected to carry less loads than those at the edges. It is, however, incorrect to design for this load re-distribution by increasing the capacity of the outer piles in order to have the same factor of safety as for a pile loaded singly. This is because the stiffness of the outer piles would then increase, thereby attracting more load.

The general predicted pattern of load distribution has been confirmed by measurements in model tests and field monitoring of prototype structures for piles founded in clayey soils. Typically, the measurements suggest that the outer piles could carry a load which is about three to four times that of the central piles at working load conditions in a large pile group (Whitaker, 1957; Sowers et al, 1961; Cooke, 1986).

For groups of displacement piles in granular soils, a different pattern was reported. Measurements made by Vesic (1969) in model tests involving jacked piles indicate a different load distribution to that predicted by elastic theory, with the centre piles carrying between 20% and 50% more load than the average load per pile. The distribution of the shaft resistance component is however more compatible with elastic continuum predictions (i.e. outer piles carrying the most load). The effects of residual stresses and proximity of the boundaries of the test chambers on the results of these model tests are uncertain (Kraft, 1991). Beredugo (1966) and Kishida (1967) also studied the influence of the order of installing driven piles and found that, at working conditions, piles that have been installed earlier tend to carry less load than those installed subsequently.

At typical working loads, the load distribution for a pile group in granular soils is likely to be similar to that in clays, particularly for bored piles. This is supported qualitatively by results of model tests on instrumented strip footings bearing on sand reported by Delpak et al (1992). Their model test results indicate that at working load conditions the distribution of contact pressure is broadly consistent with elastic solutions, whereas at the condition approaching failure the central portion shows the highest contact pressure.

The non-uniform load distribution can be important where the mode of pile failure is brittle, e.g. for piles end-bearing in granular soils overlying a weaker layer where there is a risk of punching failure. The possibility of crushing or structural failure of the pile shaft should also be checked for piles, particularly for mini-piles.

7.6.2.3 Piles subject to lateral loading

For piles subject to lateral loading, centrifuge tests on model pile groups in sand showed that the leading piles carried a slightly higher proportion of the overall applied load than the trailing piles (Barton, 1982). The load split was of the order of 40% to 60% at

working conditions. Similar findings were reported by Selby & Poulos (1984) who concluded that elastic methods are not capable of reproducing the results observed in model tests.

Ochoa & O' Neill (1989) observed from full-scale tests in sand that 'shadowing' effects (i.e. geometric effects that influence the lateral response of individual piles), together with possible effects due to the induced overturning moment, can significantly affect the distribution of forces in the piles. Both the soil resistance and the stiffness of a pile in a trailing row are less than those for a pile in the front row because of the presence of the piles ahead of it. These effects are not modelled in conventional analytical methods, i.e. elastic continuum or subgrade reaction methods. Nevertheless, it was found that the elastic continuum method gave reasonable predictions of the overall group deflection, although not so good for predictions of load and moment distribution for structural design under working conditions. An empirically-based guideline is given by the New Zealand Ministry of Works and Development (1981) for the reduction in the modulus of horizontal subgrade reaction (K_h) for the trailing piles where the pile spacing is less than eight pile diameters along the loading direction.

Brown et al (1988) found from instrumented field tests that the applied load was distributed in greater proportion to the front row than to the trailing row by a factor of about two at maximum test load but the ratio is less at smaller loads. This resulted in larger bending moment in the leading piles at a given loading.

In contrast, results of model pile tests in clay indicate an essentially uniform sharing of the applied load between the piles (Fleming et al, 1992). Brown et al (1988) also found that the 'shadowing' effect is much less significant in the case of piles in clay than in sand.

The actual distribution of loads between piles at working condition is dependent on the pile group geometry and the relative stiffness between the cap, the piles and the soil. This is important in evaluating the deflection profile and structural forces in the cap and the superstructure.

For design purposes, the assumption that the applied working load is shared equally by the piles may be made for a uniform pile group. Where the pile group consists of piles of different dimensions, the applied lateral load should be distributed in proportion to the stiffness as follows :

$$H_{xi} = \frac{H_x I_{yi}}{\sum_{i=1}^{n_p} I_{yi}} \quad [7.3]$$

where H_{xi} = horizontal load on pile i in x -direction
 H_x = total horizontal load in x -direction
 I_{yi} = moment of inertia of i -th pile about its y -axis
 n_p = number of piles in the pile group

In general, as long as the pile length is larger than the critical pile length under lateral loading for a given soil (Section 6.13.3.3), the group behaviour under lateral loading of a group of piles of differing lengths will not be different from a group of piles of equal lengths.

7.6.3 Piled Raft Foundations

7.6.3.1 Design Principles

A piled raft takes into account the contribution of both the piles and the cap acting as a raft footing in carrying the imposed load. Poulos (2001a) summaries the different design philosophies for piled raft foundations :

- (a) Piles are mainly designed to take up the foundation loads and the raft only carries a small proportion.
- (b) The raft is designed to resist the foundation loads and piles carry a small proportion of the total load. They are placed strategically to reduce differential settlement.
- (c) The raft is designed to take up majority of the foundation loads. The piles are designed to reduce the net contact pressure between the raft and the soils to a level below the pre-consolidation pressure of the soil.

Piled raft foundation has received considerable attention overseas. It has not been used in Hong Kong but the current practice of ignoring the contribution of pile cap in contact with the ground can be viewed as a conservative simplification of design philosophy (a) above.

7.6.3.2 Methodologies for analysis

The settlement analysis of a piled raft foundation can be based on relatively simple methods or complex three-dimensional finite element or finite difference analyses. Fleming et al (1992) presented a simple method of analysing the combined stiffness of the raft and the piles, which allows for interaction between the piles and the raft (Figure 7.13). The effect of alternative piling layout on foundation settlement can be assessed. The interaction factor approach discussed in Section 7.5.1.5 can be used (Poulos & Davis, 1980). For most practical problems, the influence of pile cap contact on the overall foundation stiffness is not significant at working condition.

Other simple analytical methods include methods suggested by Burland (1995) and Poulos (2001b). The Burland method is suitable for piles that are designed as settlement reducers. The raft is designed to take a portion of the foundation loads such that the settlement of the raft itself is within the acceptable limit of the structure. An adequate number of piles would then be designed to carry the remaining foundation loads. The geotechnical capacity of the piles is fully utilised at the design load. The settlement of the piled raft can be estimated based on the method suggested by Randolph (1994).

In Poulos' method, the vertical bearing capacity of a piled raft is estimated by :

- (a) taking the sum of the ultimate capacity of the raft and all the piles, or

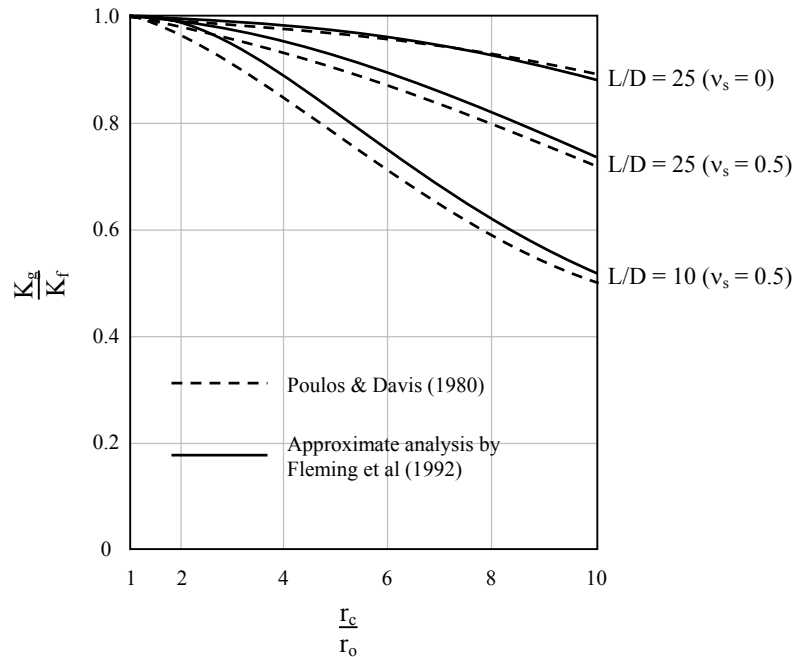

For a piled raft where the raft bears on a competent stratum, the approach of combining the separate stiffness of the raft and the pile group using the elastic continuum method is based on the use of average interaction factor, α_{cp} , between the pile and the piled raft (or cap).

The overall foundation stiffness, K_f , is given by the following expression :

$$K_f = \frac{K_g + K_c (1 - 2\alpha_{cp})}{1 - \alpha_{cp}^2 \frac{K_c}{K_g}}$$

The proportion of load carried by the pile cap (P_c) and the pile group (P_g) is given by :

$$\frac{P_c}{P_c + P_g} = \frac{K_c(1 - \alpha_{cp})}{K_g + K_c(1 - 2\alpha_{cp})}$$

Legend :

| | |
|---|--|
| K_g = stiffness of pile group = $R_g n_p K_v$ | G = shear modulus of soil |
| K_c = stiffness of pile cap = $\frac{2G\sqrt{A_{cap}}}{I(1-\nu_s)}$ | α_{cp} = average interaction factor = $\frac{\ln(r_m/r_c)}{\ln(r_m/r_o)}$ |
| r_m = radius of influence of pile \approx length of pile | r_o = radius of pile |
| R_g = stiffness efficiency factor for pile group (Section 7.5.1.6) | D = pile diameter |
| K_v = stiffness of individual pile under vertical load | L = length of pile |
| ν_s = Poisson's ratio of soil | A_{cap} = area of pile cap |
| n_p = number of piles | r_c = equivalent radius of the pile cap associated with each pile = $\sqrt{\frac{A_{cap}}{\pi n_p}}$ |
| I = influence factor, see Poulos & Davis (1974) or BSI (1986) | |

Figure 7.13 – Analysis of a Piled Raft Using the Elastic Continuum Method (Fleming et al, 1992)

- (b) taking the ultimate capacity of a block containing the piles and the raft, plus that of the portion of the raft outside the periphery of the piles, whichever is less.

The settlement behaviour is predicted by methods given in Poulos & Davis (1980). The load sharing between the piles and the raft is given by Randolph (1994).

There are other computer-based analyses based on simplified models (Poulos, 2001b). One of these models simulates the raft as a strip in one dimension and the piles as springs. Allowance is made for the interaction between various components, such as pile-pile and pile-raft elements. Such a model does not consider the torsional moments within the piled raft and may give inconsistent settlement at points where strips in the orthogonal directions have been analysed.

Another simplified model is to represent the raft as an elastic plate supported on an elastic continuum and the piles are modelled as interacting springs (Poulos, 1994). More rigorous solutions can also be carried out with three-dimensional finite difference or finite element analyses, e.g. the work of Katzenbach et al (1998).

For simplicity, most numerical analyses assume a uniformly distributed load over the piled raft. Such an assumption may not be correct since the pattern of the loading depends upon the structural layout and the piles. This may affect the local distribution of bending moment and shear force in the piled raft, particularly at locations subject to concentrated loads. Based on elastic theory, Poulos (2001a) proposed simple methods for determining bending moment, shear force and local contact pressure due to a concentrated column load on a piled raft. Where a sophisticated solution is required, a finite element mesh corresponding to the layout of columns, walls and piles may be necessary.

Poulos (2001b) found that simple methods could give reasonable accuracy in predicting settlement. An exception is the analysis using two-dimensional plane-strain method that can over-predict the settlement of the foundations. This could be attributed to the inherent nature of the plane-strain solution, which is not suitable for modelling non-symmetrical square or rectangular raft foundations.

Prakoso & Kulhawy (2001) proposed a simplified approach for designing the preliminary configuration of a piled raft. This approach assumes that the piles are used as settlement reducers. The deflected shape of the raft is first estimated to facilitate the selection of size of the raft and the ratio between the width of the pile group and the pile depth. Design charts are developed to evaluate the bending moment of the raft and the proportion of foundation load taken by the piles. This method may overestimate the average settlement in most cases and underestimates the differential settlement. It has better accuracy in estimating pile loads and the bending moments in the piled raft.

7.6.3.3 Case histories

Field measurements of the load taken by the raft and the piles at working conditions are summarised by Hooper (1979) and Cooke (1986). These suggest that the ratio of load in the most heavily loaded piles in the perimeter of the group to that in the least heavily loaded

pile near the centre could be about 2.5. Leung & Radhakrishnan (1985) reported the behaviour of an instrumented piled raft founded on weathered sedimentary rock in Singapore. The load distribution between the raft and the piles was found to be about 60% and 40% respectively at the end of construction. The measured raft pressures were highest below the centre of the raft. However, the degree of non-uniformity of the applied load is not known.

Radhakrishnan & Leung (1989) reported, for a raft supported on rock-socketed piles, that the load transfer behaviour during construction differed from the behaviour during the loading test, with less shaft resistance mobilised over the upper three diameters of the pile shaft under construction load. It was postulated by Radhakrishnan & Leung (1989) that the presence of the rigid pile cap might have inhibited the development of shaft resistance over the upper pile shaft. The end-bearing resistance mobilised under long-term structural loads was also noted to be significantly higher than that under the pile test. This may be due to group interaction effects or creep of the concrete. To a certain extent, the behaviour will also be affected by the ground conditions of the test pile site.

7.6.4 Use of Piles to Control Foundation Stiffness

The use of optimal pile configuration to control the overall foundation stiffness in order to minimise differential settlement and variations in the structural forces was developed for piled rafts. This concept is based on controlling the re-distribution of load through the introduction of a limited number of piles positioned judiciously. The concept can be applied to cases where the raft bears on a competent stratum and the piles are only required for controlling settlements, not for overall bearing capacity. In this case, the resistance of the piles can be designed to be fully mobilised at working condition, thus taking a proportion of the applied load away from the raft. Piles may also be positioned below concentrated loads in order to minimise the bending of the raft by taking a share of the applied load. In principle, the concept also works for a free-standing pile group with a rigid cap where piles can be positioned judiciously such that a more uniform load distribution and hence settlement profile is achieved. Experimental studies of the behaviour of piled rafts are described by Long (1993).

Burland & Kalra (1986) described a successful field application of this concept but warned that the approach should be considered only for friction piles in clays and not for piles bearing on a strong stratum such as rock or gravel where the mode of failure could be brittle and uncontrolled. In areas where there is significant drawdown of the water table due to ongoing pumping, Simpson et al (1987) further warned that the use of these 'settlement-reducer' type piles may give rise to problems of large local differential movements in the case of a general rise in the groundwater table.

The concept of using piles to manipulate the overall foundation stiffness has also been applied to the design of approach embankments for bridges. In this case, piles with small caps are similarly designed to have their resistance fully mobilised. These piles are referred to as the BASP (Bridge Approach Support Piling) system by Reid & Buchanan (1983) and are used in conjunction with a continuous geotextile mattress over the tops of the pile caps in order to reduce the embankment settlement.

Hewlett & Randolph (1988) developed a method of analysis for piled embankments

based on assumed arching mechanisms. This method can be used to optimise the number of piles required to reduce the settlement of an embankment.

Poulos (2004) described the use of stiffness inserts in a local building project. The purpose of the stiffness inserts was to adjust the overall stiffness of individual piles, such that the piles within a pile group were uniformly loaded. The stiffness inserts were made of elastic polymers (e.g. urethane elastomer) and installed at the head of selected heavily loaded piles. The size and thickness of the polymers were chosen to suit the required stiffness. Such design required rigorous settlement analysis and good site characterisation to ensure reliable prediction of pile settlement.

In general, the concept of using piles to control foundation stiffness requires an accurate assessment of the distribution of pile loads and settlement profile. In view of the highly heterogeneous nature of the corestone-bearing weathering profiles in Hong Kong, such concepts should be applied with caution. The validity of the approach will need to be verified by means of sufficient loading tests and monitoring of prototype structures.

7.6.5 Piles in Soils Undergoing Movement

7.6.5.1 General

Loads can be induced in piles installed in a soil that undergoes deformation after pile construction. A common situation arises where bridge abutment piles interact with the soft soil which deforms both vertically and laterally as a result of embankment construction. The use of raking piles in such situations should be avoided as there is a risk of the structural integrity of the piles being impaired due to excessive ground settlements. Stabilising piles that work by virtue of their bending stiffness are sometimes used to enhance the factor of safety of marginally-stable slopes (Powell et al, 1990) and forces will be mobilised in these piles when there is a tendency for the ground to move.

This class of interaction problem is complicated and the behaviour will, in part, be dependent on the construction sequence of the piles and the embankment, pile group geometry, consolidation behaviour, free-field deformation profile, relative stiffness of the pile and the soil.

7.6.5.2 Piles in soils undergoing lateral movement

For the problem of bridge abutment piles, Hambly (1976) discussed various methods of analysis and cautioned against the use of simple elastic continuum methods for problems involving large deformation.

Poulos & Davis (1980) proposed a simplified elastic approach based on interaction of the moving soil and the piles with allowance made for the limiting pressure that the soil may exert on the pile. The use of this method requires an estimate of the free field horizontal soil movement profile. The Unified Facilities Criteria Report No. UFC-320-10N (DoD, 2005) suggested a simplified hand method of calculating the distribution of pressure along 'stabilizing' piles based on the work reported by De Beer & Wallays (1972). These methods

can be used for conceptual designs.

Based on observations made in centrifuge tests, simple design charts have been put forward by Springman & Bolton (1990) for assessing the effect of asymmetrical surcharge loading adjacent to piles. It is suggested that this approach can be used for routine design problems in so far as they are covered by the charts.

Stewart et al (1992) reviewed a range of available simplified design methods and concluded that they are generally inconsistent although some aspects of the observed behaviour can be accounted for to a varying degree by the different methods. For complex problems, a more sophisticated numerical analysis (e.g. finite element method) may be necessary. Goh et al (1997) carried out numerical analyses and parametric studies for piles subjected to embankment induced lateral soil movements. Empirical correlations were derived to determine the maximum bending moment induced in a pile embedded in a clay layer. The results were found to be in general agreement with the centrifuge test data by Stewart et al (1992).

The ground movement caused by excavation may induce substantial bending moment in nearby piles and axial dragload.

7.6.5.3 Piles in heaving soils

Tension forces will be developed in piles if the soil heaves subsequent to pile installation (e.g. piles in a basement prior to application of sufficient structural load). The simplified method of analysis presented by O'Reilly & Al-Tabbaa (1990) may be used for routine design. The analysis can also take into account progressive cracking in a pile with increase in loading by making allowance for possible reduction in pile stiffness (and hence reduction in pile tension).

8. PILE INSTALLATION AND CONSTRUCTION CONTROL

8.1 GENERAL

There are uncertainties in the design of piles due to the inherent variability of the ground conditions and the potential effects of the construction process on pile performance. Test driving may be considered at the start of a driven piling contract to assess the expected driving characteristics.

Adequate supervision must be provided to ensure the agreed construction method is followed and enable an assessment of the actual ground conditions to be carried out during construction. It is necessary to verify that the design assumptions are reasonable.

Foundation construction is usually on the critical path and the costs and time delay associated with investigating and rectifying defective piles could be considerable. It is therefore essential that pile construction is closely supervised by suitably qualified and experienced personnel who fully understand the assumptions on which the design is based. Detailed construction records must be kept as these can be used to identify potential defects and diagnose problems in the works.

This chapter summarises the equipment used in the construction of the various types of piles commonly used in Hong Kong. Potential problems associated with the construction of piles are outlined and good construction practice is highlighted. The range of control measures and available engineering tools, including integrity testing, that could be used to mitigate construction problems and identify anomalies in piles are presented. It should be noted that the range of problems discussed is not exhaustive. It is important that the designers should carefully consider what could go wrong and develop a contingency plan, which should be reviewed regularly in the light of observations of the works as they proceed.

8.2 INSTALLATION OF DISPLACEMENT PILES

8.2.1 Equipment

Displacement piles are installed by means of a driving hammer or a vibratory driver. There are a range of hammer types including drop hammer, steam or air hammer, diesel hammer and hydraulic hammer. Use of these hammer types are classified as percussive piling, which is subject to the requirements of Noise Control Ordinance (HKSARG, 1997). The use of noisy diesel, pneumatic and steam hammers for percussive piling is generally banned in built-up areas surrounded by noise sensitive receivers.

It is important to exercise directional control and maintain the pile in alignment during initial pitching and driving. Leaders held in position by a crane are suitable for support of both the pile and the hammer during driving, and may be used for vertical and raking piles. Alternatively, vertical piles may be supported in a trestle or staging and driven with a hammer fitted with guides and suspended from a crane.

Where a hammer is used to produce impacts on a precast concrete pile, the head

should be protected by an assembly of dolly, helmet and packing or pile cushion (Figure 8.1). The purpose of the assembly is to cushion the pile from the hammer blows and distribute the dynamic stresses evenly without allowing excessive lateral movements during driving. In addition, the life of the hammer would be prolonged by reducing the impact stresses. Pile cushion (or packing) is generally not necessary for driving steel piles.

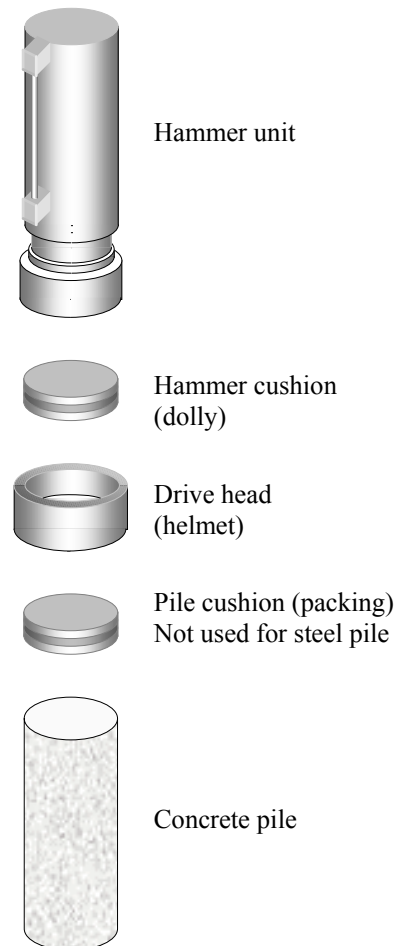

Figure 8.1 – Pile Head Protection Arrangement for Driven Concrete Piles

A follower is used to assist driving in situations where the top of the pile is out of reach of the working level of the hammer. The use of a follower is accompanied by a loss of effective energy delivered to the pile due to compression of the follower and losses in the connection. Wong et al (1987) showed that where the impedance of the follower matches that of the pile, the reduction in the energy transferred to the pile will be minimal, with impedance, Z , being defined as follows :

$$Z = \frac{E_p A_p}{c_w} \quad [8.1]$$

where E_p = Young's modulus of pile
 A_p = cross-sectional area of pile
 c_w = velocity of longitudinal stress wave through the pile

The actual reduction in energy transfer can be measured by dynamic pile testing (Section 9.4) and should be taken into account when taking a final set.

The length of the follower should be limited as far as possible because the longer the follower, the more difficult it will be to control the workmanship on site. Furthermore, limited site measurements indicated that for follower longer than 4 m, reduction in energy transferred to the pile may occur, even if it is of the same material as the pile section.

Near-shore marine piles in Hong Kong are typically precast prestressed concrete piles or driven steel tubular piles. Pile driving from a fixed staging is possible for small to medium-sized piles in waters as deep as 15 m. Alternatively, pile installation may be carried out with the use of a piling barge or pontoon. Special manipulators and mooring anchorages are usually required to achieve precise positioning of piles from a barge in deep waters.

8.2.2 Characteristics of Hammers and Vibratory Drivers

8.2.2.1 General

The rating of a piling hammer is based on the gross energy per blow. However, different types of hammers have differing efficiencies in terms of the actual energy transmitted through the pile being driven. The range of typical efficiencies of different types of hammers is shown in Table 8.1.

The operational principles and characteristics of the various types of driving equipment are briefly summarised in the following sections.

Table 8.1 – Typical Energy Transfer Ratio of Pile Hammers

| Type of Hammer | Typical Energy Transfer Ratio |
|-------------------|-------------------------------|
| Drop hammers | 0.45 - 0.6 |
| Hydraulic hammers | 0.7 - 1 |

- Notes :
- (1) Energy transfer ratio corresponds to the ratio of actual energy transferred to the pile to the rated capacity of the hammer.
 - (2) Actual amount of energy transferred to the pile is best determined by dynamic pile testing.
 - (3) The above are based on general experience in Hong Kong.

8.2.2.2 Drop hammers

A drop hammer (typically in the range of 8 to 16 tonnes) is lifted on a rope by a winch and allowed to fall by releasing the clutch on the drum. The stroke is generally limited to about 1.2 m except for the case of 'hard driving' into marble bedrock where drops up to 3 m have been used in Hong Kong. The maximum permissible drop should be related to the type of pile material.

The drawback to the use of this type of hammer is the slow blow rate, the difficulty in effectively controlling the drop height, the relatively large influence of the skill of the operator on energy transfer, and the limit on the weight that can be used from safety considerations.

8.2.2.3 Steam or compressed air hammers

Steam or compressed air hammers are classified as single-acting or double-acting types depending on whether the hammer falls under gravity or is being pushed down by a second injection of propellant. A chiselling action is produced during driving as a result of the high blow rate. Some single-acting steam hammers are very heavy, with rams weighing 100 tonnes or more.

A double-acting air hammer is generally not suitable for driving precast concrete piles unless the pile is prestressed.

For maximum efficiency, these hammers should be operated at their designed pressure. The efficiency decreases markedly at lower pressures; excessive pressure may cause the hammer to 'bounce' off the pile (a process known as 'racking') which could damage the equipment.

8.2.2.4 Diesel hammers

In a diesel hammer, the weight is lifted by fuel combustion. The hammer can be either single-acting or double-acting. Usually, only a small crane base unit is required to support the hammer. Due to the high noise level and pollutant exhaust gases associated with diesel hammers, the use of diesel hammers has been phased out in populated areas.

The driving characteristics of a diesel hammer differ appreciably from those of a drop or steam hammer in that the pressure of the burning gases also acts on the anvil (i.e. driving cap) for a significant period of time. As a result, the duration of the driving forces is increased. The length of the stroke varies with the driving resistance, and is largest for hard driving. In soft soils, the resistance to pile penetration may be inadequate to cause sufficient compression in the ram cylinder of a 'heavy' hammer to produce an explosion, leading to stalling of hammer. In this case, a smaller hammer may be necessary in the early stages of driving.

The ram weight of a diesel hammer is generally less than a drop hammer but the blow rate is higher. The actual efficiency is comparatively low (Table 8.1) because the pressure of the burning gas renders the ram to strike at a lower velocity than if it were to fall freely under gravity. The efficiency is dependent upon the maintenance of the hammer. Furthermore, as the hammer needs to exhaust gas and dissipate heat, shrouding to reduce noise can be relatively difficult.

Where a diesel hammer is used to check the final set on re-strike at the beginning of a working day, results from the first few 'cold' blows may be misleading in that the hammer is not heated up properly and the efficiency may be very low. This source of error may be avoided by warming the hammer up through driving on an adjacent pile.

8.2.2.5 Hydraulic hammers

A hydraulic hammer is less noisy and does not produce polluting exhaust. Modern

hydraulic hammers, e.g. double-acting hydraulic hammers, are more efficient and have high-energy transfer ratios. The ram of the hammer is connected to a piston, which is pushed upward and downwards by hydraulic power. Some complex models have nitrogen charged accumulator system, which stores significant energy allowing a shortened stroke and increased blow rate. As such, the kinetic energy of the hammer depends not only on the height of the stroke but also the acceleration due to the injection of hydraulic pressure. Most new hydraulic hammers are equipped with electronic sensors that directly measure the velocity of the ram and calculate the kinetic energy just before impact. An “equivalent stroke height” is computed by dividing the measured kinetic energy by the weight of the ram and is used in the pile driving formulae. HKCA (2004) reported that the energy transfer ratio of hydraulic hammers ranges between 0.8 and 0.9.

8.2.2.6 Vibratory drivers

A vibratory driver consists of a static weight together with a pair of contra-rotating eccentric weights such that the vertical force components are additive. The vibratory part is attached rigidly to the pile head and the pulsating force facilitates pile penetration under the sustained downward force.

The vibratory driver may be operated at low frequencies, typically in the range of 20 to 40 Hz, or at high frequencies around 100 Hz (i.e. 'resonance pile driving').

Vibratory drivers are not recommended for precast or prestressed concrete piles because of the high tensile stresses that can be generated.

8.2.3 Selection of Method of Pile Installation

A brief summary of the traditional pile driving practice in Hong Kong is given by Malone (1985).

For displacement piles, two criteria must be considered : bearing capacity and driveability. Successful pile installation relies on ensuring compatibility between the pile type, pile section, the ground and method of driving.

When choosing the size of a hammer, consideration should be given to whether the pile is to be driven to a given resistance or a given depth.

The force applied to the head of the pile by the driving equipment must be sufficient to overcome inertia of the pile and ground resistance. However, the combination of weight and drop of hammer must be such as to avoid damage to a pile when driving through soft overburden soils. In this case, the use of a heavy hammer coupled with a small drop (longer duration impact and hence larger stress wavelength) and a soft packing is advisable in order to limit the stresses experienced by the pile head. Conversely, for hard driving conditions, pile penetration will be increased more effectively by increasing the stress amplitude than by increasing the impact duration.

The weight of the hammer should be sufficient to ensure a final penetration of not

more than 5 mm per blow unless rock has been reached. It is always preferable to employ the heaviest hammer practicable and to limit the stroke, so as not to damage the pile. When choosing the size of the hammer, attention should be given to whether the pile is to be driven to a given resistance or to a given depth. The stroke of a single-acting or drop hammer should be limited to 1.2 m, preferably 1 m. A shorter stroke and particular care should be used when there is a danger of damaging the pile. (BSI, 1986).

If the hammer is too light, the inertial losses will be large and the majority of the energy will be wasted in the temporary compression of the pile. This may lead to over-driving (i.e. excessive number of blows) causing damage to the pile.

Other factors, which can affect the choice of the type of piling hammer, include special contract requirements and restrictions on noise and pollution.

The force that can be transmitted down a pile is limited by a range of factors including pile and hammer impedance, hammer efficiency, nature of the impulse, characteristics of the cushion and pile-head assembly, and pattern of distribution of soil resistance. If the impedance is too large relative to that of the hammer, there will be a tendency for the ram to rebound and the driving energy reflected.

Piles with too low an impedance will absorb only a small proportion of the ram energy, giving rise to inefficient driving. In addition, pile impedance also has a significant influence on the peak driving stresses. Higher impedance piles (i.e. heavier or stiffer sections) result in shorter impact durations and generate higher peak stresses under otherwise similar conditions.

In granular soils, the rate of penetration increases with a higher rate of striking, whereas for stiff clays, a slower and heavier blow generally achieves better penetration rate.

Commercial computer programs exist for driveability studies based on wave equation analysis (Section 6.4.3). These can provide information on the stresses induced in the pile and the predicted profile of resistance or blow count with depth.

If a conventional pile driving formula (e.g. Hiley Formula) is used to assess the criteria for termination of driving, the use of drop hammers or hydraulic hammers (which are more efficient) could reach the calculated set at greater depths compared to diesel hammers because of differences in hammer efficiencies.

The installation of piles using a vibrator is not classified as percussive piling under the Noise Control Ordinance (HKSARG, 1997) and therefore it does not require a Construction Noise Permit for percussive piling during normal working hours. Caution should be exercised in ensuring that the induced vibrations are acceptable for the surrounding environment and will not result in undue settlement or damage of adjacent structures. This may need to be confirmed by field trials where appropriate.

Jetting may be used to install piles into a granular soil but it is generally difficult to assess the disturbance effects on the founding material. This technique is not commonly used in Hong Kong. Jacking may be considered, particularly for installing piles at vibration or settlement sensitive areas. Preboring may be required to overcome obstructions in the ground.

8.2.4 Potential Problems Prior to Pile Installation

8.2.4.1 Pile manufacture

Spalling of concrete during driving may result from sub-standard pile manufacture procedure, particularly where the concrete cover is excessive. Tight control on material quality, batching, casting and curing is necessary to ensure that satisfactory piles are manufactured. Lee (1983) noted segregation of concrete in samples from prestressed concrete tubular piles and attributed this to the spinning operation. However, the results showed that the design cube strength was not adversely affected.

Recently-cast concrete pile units may crack due to excessive shrinkage as a result of inadequate curing or due to lifting from the moulds before sufficient strength is achieved.

8.2.4.2 Pile handling

Piles may bend considerably during lifting, transportation, stacking and pitching. A bent pile will be difficult to align in the leaders and is likely to be driven eccentrically.

Piles should be lifted by slinging at the prescribed points, and they should not be jerked upwards or allowed to drop abruptly.

Whilst in transit, piles should be adequately supported by blocks to minimise movements and prevent damage by impact. The blocks between successive layers of piles should be placed vertically above the preceding blocks in order to prevent the imposition of bending forces in the bottom piles.

In stacking piles on site, consideration should be given to the possibility of differential settlements between block positions. If the piles are coated with a bitumen layer, particular care should be taken to avoid damage to the coating by solar heat, by means of shading and/or lime washing. The manufacturer's instructions should be strictly adhered to.

A thorough inspection should be made of significant cracks in the piles as delivered. Longitudinal cracking may extend and widen during driving and is generally of greater concern than transverse cracking.

If slightly cracked piles are accepted, it is advisable to monitor such sections during driving to check if the cracks develop to the point where rejection becomes necessary. It should also be noted that when driving under water, crack propagation by hydraulic action is possible, with water sucked into the cracks and ejected at high pressure.

The criterion for acceptable crack width prior to driving should be considered in relation to the degree of aggressiveness of the ground and groundwater and the need for making allowance for possible enlargement of cracks as a result of pile driving. In general, cracks up to 0.3 mm are normally considered acceptable (BSI, 1997), although for bridge design, the local practice has been to adopt a limiting crack width of 0.2 mm for buried structures.

For concrete within the inter-tidal or splash zone of marine structures, it is suggested that the crack width is limited to 0.1 mm (CEO, 2004).

8.2.5 Potential Problems during Pile Installation

8.2.5.1 General

A variety of potential problems can arise during installation of displacement piles as outlined in the following. Some of the problems that can affect pile integrity are summarised in Tables 8.2 to 8.5.

8.2.5.2 Structural damage

Damage to piles during driving is visible only near the pile head, but the shaft and toe may also be damaged.

Damage to a pile section or casing during driving can take the form of buckling, crumbling, twisting, distortion and longitudinal cracking of steel, and shattering, shearing, cracking and spalling of concrete.

Damage may be caused by overdriving due to an unsuitable combination of hammer weight and drop, and misalignment of the pile and the hammer resulting in eccentric stresses. The hammer blow should be directed along the axis of the pile, but the pile head should be free to twist and move slightly inside the driving helmet to avoid the transmission of excessive torsion or bending forces.

Failure due to excessive compressive stress most commonly occurs at the pile head. Tensile stresses are caused by reflection of the compressive waves at a free end and may arise when the ground resistance is low or when the head conditions result in hammer rebound, i.e. with hard packing and a light hammer. Damage can also occur when driving from a dense stratum into weaker materials. Tensile stresses can result if the pile is driven too fast through the transition into the weaker soil. If damage to the head of a steel pile is severe, it may be necessary to have it cut back and an extension welded on.

The driving stresses must not exceed the limiting values that will cause damage to the pile. The following limits on driving stresses suggested by BS EN 12699:2001 (BSI, 2001) are given in Table 8.6.

The General Specification for Civil Engineering Works (HKG, 1992) stipulates that the driving stresses in precast reinforced concrete piles and prestressed concrete piles should not exceed one half of the specified grade strength of the concrete, which is much more restrictive than the limits proposed by BS EN 12699:2001.

Problems at the pile toe may sometimes be detected from the driving records. The beginning of easier penetration and large temporary compression (i.e. a 'spongy' response) may indicate the initiation of damage to the lower part of the pile. The blow count logs should be reviewed regularly.

Table 8.2 - Possible Defects in Displacement Piles Caused by Driving

| Pile Type | Problems | Possible Causes |
|------------------|---|---|
| Steel piles | Damaged pile top (head) (e.g. buckling, longitudinal cracking, distortion) | (a) Unsuitable hammer weight (b) Incorrect use of dollies, helmets, packing (c) Rough cutting of pile ends (d) Overdriving |
| | Damaged pile shaft (e.g. twisting, crumpling, bending) | (a) Unsuitable hammer weight (b) Inadequate directional control of driving (c) Overdriving (d) Obstructions |
| | Collapse of tubular piles | (a) Insufficient thickness |
| | Damaged pile toe (e.g. buckling, crumpling) | (a) Overdriving (b) Obstructions (c) Difficulty in toeing into rock |
| | Base plate rising relative to the casing, loss of plugs or shoes in cased piles | (a) Poor welding (b) Overdriving (c) Incorrect use of concrete plugs |
| Concrete piles | Damaged pile head (e.g. shattering, cracking, spalling of concrete) | (a) Unsuitable reinforcement details (b) Insufficient reinforcement (c) Poor quality concrete (d) Excessive concrete cover (e) Unsuitable hammer weight (f) Incorrect use of dollies, helmets, packing (g) Overdriving |
| | Damaged pile shaft (e.g. fracture, cracking, spalling of concrete) | (a) Excessive restraint on piles during driving (b) Unsuitable hammer weight (c) Poor quality concrete (d) Excessive or incorrect concrete cover (e) Obstructions (f) Overdriving (g) Incorrect distribution of driving stresses from use of incorrect dollies, helmets, or packing |
| | Damaged pile toe (e.g. collapsing, cracking, spalling of concrete) | (a) Overdriving (b) Poor quality concrete (c) Insufficient reinforcement (d) Inadequate or incorrect concrete cover (e) Obstructions (f) Absence of rock shoe where required |

Table 8.3 – Defects in Displacement Piles Caused by Ground Heave and Possible Mitigation Measures

| Problems | Remedial Measures | Precautionary Measures |
|--|---|---|
| Uplift causing squeezing, necking or cracking of a driven cast-in-place pile | None | (a) Provide adequate reinforcement (b) Plan driving sequence (c) Avoid driving at close centres (d) Pre-bore (e) Monitor ground movements |
| Uplift resulting in loss of bearing capacity | Redrive piles | (a) Plan driving sequence (b) Allow for re-driving (c) Avoid driving at close centres (d) Pre-bore (e) Drive tubes before concreting for driven cast-in-place piles (f) Monitor pile movements |
| Ground heave lifting pile bodily | May not be necessary for friction piles | (a) Use small displacement piles |
| Ground heave resulting in separation of pile segments or units or extra tensile forces on the joints | May be gently tapped or redriven. | (a) Plan driving sequence (b) Allow for re-driving (c) Avoid driving at close centres (d) Pre-bore (e) Consider other piling systems |

Table 8.4 – Problems with Displacement Piles Caused by Lateral Ground Movement and Possible Mitigation Measures

| Problems | Remedial Measures | Precautionary Measures |
|--|--|---|
| Squeezing or waisting of piles or soil inclusion forced into a driven cast-in-place pile | None | (a) Avoid driving at close centres (b) Allow concrete to set before driving nearby (c) Pre-bore |
| Shearing of piles or bends in joints | None | (a) Plan the driving sequence (b) Avoid driving at close centres (c) Pre-bore (d) Monitor pile movements |
| Collapse of casing prior to concreting | None, but if damage is minor, the pile may be completed and used, subject to satisfactory loading test | (a) Avoid driving at close centres (b) Pre-bore (c) Ensure that casing is thick enough |
| Movement and damage to neighbouring structures | Repair the structure. Change to a small-displacement or replacement piling system | (a) Plan the driving sequence (b) Isolate the structure from driving (c) Use small-displacement piles (d) Pre-bore |

Table 8.5 – Problems with Driven Cast-in-place Piles Caused by Groundwater and Possible Mitigation Measures

| Problems | Causes | Remedial Measures | Precautionary Measures |
|--|--|---|--|
| Water ingress during driving casing and subsequent difficulties in concreting | Loss of shoe or base plate during driving | Replug with concrete and continue driving | (a) Use of gasket on shoe to exclude water during driving (b) Use of pressure cap to exclude water |
| | Failure of welds or joints of tube | None | (a) Check integrity of welds prior to driving (b) Take care in driving to avoid hammer clipping any joint rings |
| | Failure of seal on joints | None | (a) Good supervision to ensure the joints are formed properly |
| | Cracking of casing sections because of incorrect distribution of driving stresses | None | (a) Care in driving and use of correct packing |
| Bulging of pile and associated waisting above | Soft ground conditions (undrained shear strength <15 kPa). Displacement of ground under hydrostatic head of concrete | None | (a) Use of a pile type employing a permanent liner |
| Water entering the casing, causing softening of the base (this may become apparent on concreting the shaft when the reinforcement moves down the pile, possibly disappearing from the pile head) | Water-bearing sands and gravels | May be necessary to redrive another pile | (a) Good supervision is essential (b) Check for water ingress by leaving the hammer resting on the base before concreting the shaft. If there is water ingress, this will be apparent when the hammer is lifted |

Table 8.6 – Limits on Driving Stress (BSI, 2001)

| Pile Type | Maximum Compressive Stress | Maximum Tensile Force |
|--|-----------------------------------|--|
| Steel piles | $\leq 0.9f_y$ | - |
| Prefabricated concrete piles (including prestressed piles) | $\leq 0.8 f_{cu}$ | $\leq 0.9 f_y A_s - \text{Prestressing force}$ |

Notes : (1) f_y is the yield stress of steel, A_s is the area of steel reinforcement and f_{cu} is the specified grade strength of concrete.

(2) If driving stress is actually monitored during driving, the limits can be increased by 10% and 20% for prefabricated concrete piles and steel piles respectively.

Where long slender piles are installed, there is an increased risk of distortion and bending during driving because of their susceptibility to influence of the stress field caused by adjacent piles and excavations.

Where the bore of prestressed concrete tubular piles is filled with water, Evans (1987) suggested that the hammer impact could generate high pressure in the trapped water and excessive tensile hoop stresses leading to vertical cracks. In order to detect any dislocation of the pile shoe, the depth of the inner core of each pile should be measured.

A pile with its toe badly-damaged during driving may be incapable of being driven to the design level, particularly when the piles are driven at close spacings. However, the static load capacity of such individual piles may be met according to loading tests due to local compaction of the upper strata and the creation of a high soil stress at shallow depth due to pile driving. The satisfactory performance of any piles during the loading test is no guarantee that the long-term settlement characteristics of the pile group will be acceptable where it is underlain by relatively compressible soil.

8.2.5.3 Pile head protection assembly

Badly fitted helmets or the use of unsuitable packing over a pile can cause eccentric stresses that could damage the pile or the hammer.

The materials used for the dolly and the packing affect the stress waves during driving, depending on whether it is 'hard' or 'soft'. For a given hammer and pile, the induced stress wave with a soft assembly is longer and exhibits a smaller peak stress than if the assembly is hard. The packing material may be sufficiently resilient initially but could harden after prolonged use, whereupon it should be replaced. The packing should fit snugly inside the helmet – too loose a fit will result in rapid destruction of the cushion and hence an undesirable increase in its stiffness.

The helmet may rock on the pile if the packing thickness is excessive, which could induce lateral loads and damage the pile. It is advisable to inspect the pile head protection assembly regularly for signs of damage.

It should be noted that by manipulation of the packing material, an inadequate pile may be made to appear acceptable to an unwary inspector in accordance with the pile driving formula. Only materials with known characteristics should be used for the packing. Peck et al (1974) suggested that wood chips or coiled steel cable are undesirable because their properties cannot be controlled.

When a final set is being taken, the packing and dolly should not be new but should have already taken about 500 to 600 blows in order to avoid a misleading set being obtained as suggested by Healy & Weltman (1980).

8.2.5.4 Obstructions

Obstructions in the ground may be in the form of man-made features or boulders and

corestones.

Obstructions could cause the piles to deflect and break. A steel or cast-iron shoe with pointed or flat ends may be useful, depending on the nature of the obstruction. Where the obstruction is near ground surface, it may be dug out and the excavation backfilled prior to commencement of driving. If the obstruction is deep, pre-boring may be adopted. Consideration should be given to assessing the means of maintaining stability of the pre-bore and its effect on pile capacity. It should be noted that damaging tensile stresses may result where a precast concrete pile is driven through an open pre-bored hole of slightly smaller diameter than the pile.

Experience indicates that 250 mm is the approximate upper limit in rock or boulder size within the fill or a corestone-bearing profile below which there will be no significant problems with the installation of driven piles, such as steel H-piles and steel tubular piles.

Alternative options that could be considered include re-positioning of piles, and construction of a bridging structure over the obstruction by means of a reinforced concrete raft.

8.2.5.5 Pile whipping and verticality

Piles may become out-of-plumb during driving, causing bending and possible cracking. Periodic checks on the verticality of piles should be carried out during driving. The practice of placing wedges between an inclined pile section and the next segment to try to correct the alignment should be strongly discouraged.

Where a long slender pile is driven through soft or loose soils, it may be liable to 'whip' or wander. This lateral movement during driving may result in a fractionally oversized hole and affect the shaft resistance. Pile whipping also reduces the efficiency of the hammer. If the acceptance is based on a final set criterion, it is important to ensure that there are no extraneous energy losses due to whipping. Failure to do so could result in a pile with inadequate capacity.

Proper directional control and alignment of the hammer and the pile are essential to alleviate the problems. Experience shows that a pointed pile shoe may cause the pile to be deflected more easily than a flat-ended point.

Broms & Wong (1986) reported a case history involving damage to prestressed concrete piles due to bending arising from misalignment and non-verticality. A method is proposed to calculate the secondary bending moment that will be induced in a bent pile.

In cases of concern, it may be prudent to cast in or weld on inclinometer ducts for measurement of pile profile after driving.

Based on results of model tests, Hanna & Boghosian (1989) reported that small kinks can give higher ultimate load capacity at a larger pile top settlement than that in a straight pile, provided that the pile section is capable of withstanding the bending stresses. For piles with bends greater than about 10° , it was found that under loading, the increase in stress

concentration and bending may result in overstressing of the adjacent soil and the formation of a hinge, which could lead to a structural failure.

8.2.5.6 Toeing into rock

A pile is liable to deflect when it encounters the rock surface, particularly where it is steeply-sloping or highly irregular.

A properly reinforced toe is of particular importance when piles are driven into karstic marble rock surface. Daley (1990) reported his experience with pile driving in marble where the toes of H-piles were pointed and the bottom 4 m were stiffened by welded steel plates. Mak (1991) suggested that an abrupt change in stiffness could lead to undesirable stress concentrations and potential damage, and proposed that a more gradual change in stiffness be adopted.

It is advisable to reduce the driving energy temporarily when bedrock is first met to minimise pile deflection. In general, the use of a drop hammer or hydraulic hammer is preferred to help the pile to 'bite' into the sloping rock surface by gentle tapping followed by hard driving, as a diesel hammer may be difficult to control at high resistance.

8.2.5.7 Pile extension

Pile joints could constitute points of weakness if the coupling is not done properly. The joints should be at least as strong as the pile section. Particular care needs to be exercised when connecting sections for raking piles.

Steel piles, including H-pile and tubular pile sections, are commonly joined by welding. It is important that all welding is executed by qualified welders to appropriate standards (e.g. HKG, 1992). Each weld should be inspected visually and, where appropriate, a selection of the welds should be tested for integrity by means of mechanical or radiographic methods. Alignment of sections must be maintained after welding and special collars are available as a guide.

In prestressed concrete piles, pile segments are joined by welding together the steel end plates onto which the prestressing bars are fitted by button heads or screws and nuts, and the reinforcing bars are anchored.

Lengths of precast concrete piles cannot be varied easily. In this case, piles can be lengthened by stripping the head and casting on an extension, but this can cause long delays as the extension must be allowed to gain strength first. Alternatively, special mechanical pile joints can be used or vertical sections spliced with the use of epoxy mortar dowels. It is important to ensure that the abutting ends remain in close contact at all stages of handling and driving.

Mismatch between the driven section and the extension can occur due to manufacturing tolerances or the head of the driven section having sustained damage in the

driving process. It may be necessary to cut off the damaged portion and prepare the end in order to achieve a satisfactory weld.

Lack of fit can result in high bending stresses. Joints with a misalignment in excess of 1 in 300 should be rejected (Fleming et al, 1992).

8.2.5.8 Pre-ignition of diesel hammers

Diesel hammers are seldom used nowadays because of tightened environmental controls (Section 8.2.1). Nevertheless, when they are used for taking final set, precaution should be paid to the problem of overheating, which may lead to pre-ignition when combustion of fuel occurs prior to impact. This leads to a reduction of the impact velocity and cushioning of the impact even with a large stroke. Pre-ignition may be difficult to detect without electronic measurements but possible signs of pre-ignition may include black smoke at large strokes, flames in exhaust ports, blistering paint (due to excessive heat), and lack of metal-to-metal impact sound. Pre-ignition could considerably affect hammer performance and, where suspected, driving should be suspended and the hammer allowed to cool down before re-starting.

In order to function at maximum energy, fuel injected should be adjusted to the optimum amount and the exhaust set to the correct setting for the appropriate hammer. For single-acting and double-acting diesel hammers, the stroke and bounce chamber pressure will give a reasonably good indication of actual hammer performance. The stroke may be measured by attaching a jump stick or barber pole to the hammer for visual inspection or by high-speed photographic method.

The hammer performance in terms of energy output per blow (E) may be checked indirectly by the blow rate. Based on energy considerations, the number of blows per minute (N_b) corresponding to the energy output of a ram weight (W) can be expressed as :

$$N_b \approx 66\sqrt{\frac{W}{E}} \quad [8.2]$$

where W is in kN and E is in kN-m.

If the measured blow rate is higher than that in the specified energy output, the effects on the energy output should be allowed for in the calculation of the final set. The reduction in energy output may be assumed to correspond to the square of the ratio of N_b to the actual blow count measured.

It should be cautioned that a hammer in a very poor state of maintenance may have friction losses of such magnitude that the blow rate will not be an accurate indication of hammer performance. It is advisable to carry out dynamic loading tests to confirm the actual hammer performance, particularly when the use of followers is proposed or when problems are encountered on site (e.g. premature set at a high level or inability to obtain the required set).

8.2.5.9 Difficulties in achieving set

A method of final set measurement and typical results are shown in Figure 8.2. The supports for the stakes should preferably be at least 1.2 m away from the face of the pile being driven. Difficulties associated with achieving final set have been reported in the literature for piles driven into silt, sand and shale (Healy & Weltman, 1980). In these circumstances a hammer with a known impact energy should be used so that the actual pile capacity can be assessed. Alternatively pile-head transducers can be installed to measure hammer impact energy.

George et al (1977) suggested that 'wings' may be fitted to the toes of H-piles in order to increase the surface area and hence resistance. In principle, where additional steel is to be welded on near the bottom of a section, it is preferable to have this on the inside of the section rather than the outside as the latter arrangement may possibly lead to a reduction in shaft resistance in the long-term because of creating an oversized hole.

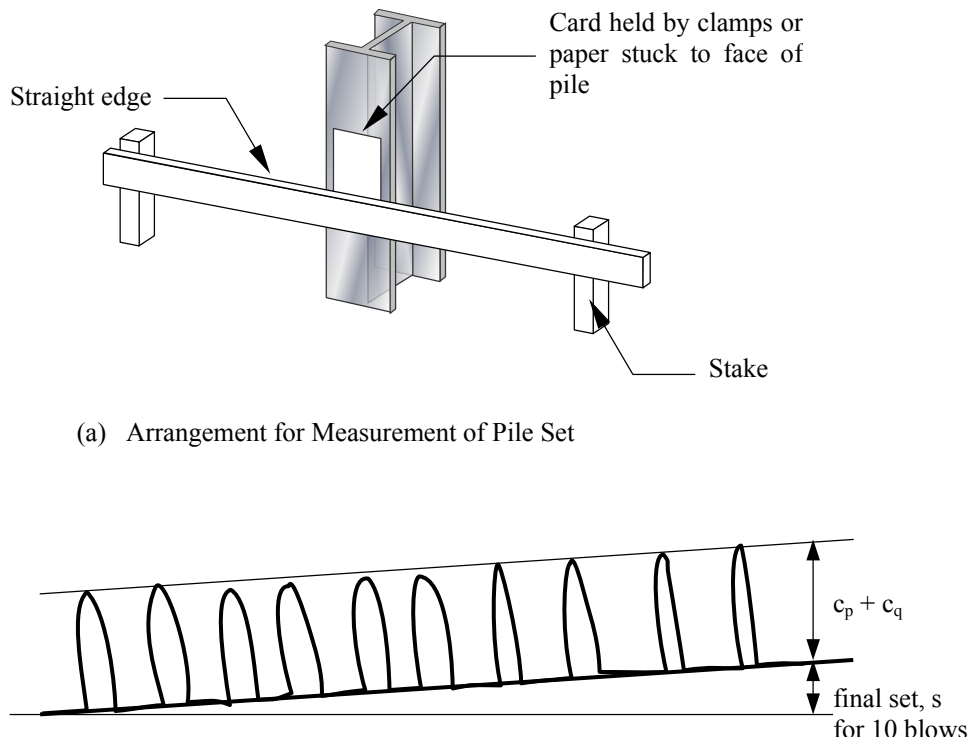

(a) Arrangement for Measurement of Pile Set

(b) Typical Record of Final Set in Driven Pile in Hong Kong

Figure 8.2 – Measurement of Pile Set

It should be remembered that the inability to achieve the required set may be attributed to breakage of pile or connections. Chan (1996) discussed the forms of blow count records that can be used to assess possible breakage or damage of pile.

For certain geological formations, the pile capacity may increase with time and become satisfactory. In this case, it may be necessary initially to drive the pile to the

minimum required penetration and subsequently return to check the final set after a suitable pause.

8.2.5.10 Set-up phenomenon

There have been a number of documented local case histories in which piles exhibited an increase in driving resistance when re-driven (Makredes & Likins, 1982; Ng, 1989; Mak, 1990; Lam et al, 1994; Chow et al, 1998). In each case, the increase in capacity was assessed on the basis of results of repeated dynamic pile tests.

It is postulated that the set-up phenomenon is related to dissipation of positive excess pore water pressure generated during driving; alternatively, this may be a result of re-establishment of horizontal stresses on the pile after soil relaxation brought about by pile whipping. Further work will be required before this effect can be quantified and taken into account in design.

Where a soil exhibits significant set-up, it could lead to problems in achieving the required penetration length when there are delays to completion of pile installation. Experience has shown that a series of rapidly applied hammer blows using a small drop is sometimes successful in 're-starting' a pile after pause.

8.2.5.11 False set phenomenon

Case histories of problems of false set where the penetration resistance reduces with time (e.g. Malone, 1977; Thompson & Thompson, 1985) may be associated with the generation of negative pore water pressure during driving of piles, particularly in dense soils or sandy silt that dilation can occur. Relaxation of high 'lock-in' stresses in the ground can also occur due to the presence of a disturbed zone associated with pile driving. The presence of significant cracks in the pile section could also dampen the stress waves to the extent that false refusal occurs. In some cases, however, the apparent 'relaxation' may not be real in that the difference in penetration resistance is caused by changes in hammer performance. The comment about hammer performance is also relevant for apparent set-up as discussed above.

Evans et al (1987) reported that a dynamic loading test carried out on a steel tubular pile driven into crushed rock showed a 19% reduction in capacity compared to that estimated upon completion of driving. However, tests on other piles in the same site indicated an increase in load capacity.

It is recommended that re-drive tests be carried out on a selection of piles to check for the possibility of false set and this should be carried out at least 24 hours after the previous set.

8.2.5.12 Piling sequence

Where piles are installed in a large group at close spacing (e.g. saturation piling), consideration should be given to assessing the appropriate piling sequence, with due regard to

the possibility of the ground squeezing and effects of pile uplift. Observations of increase in penetration resistance and increase in SPT N values with pile driving have been reported by Philcox (1962) and Evans (1987). It is preferable to drive roughly from the centre of a large group and work outwards.

There may be a systematic difference in the pile lengths within a group due to local densification effects in granular soils. The difference in pile lengths should not be significant as appreciable differential settlements may result. If necessary, extra boreholes may be sunk to confirm the nature of the founding material after pile installation.

For driven cast-in-place piles, there is the possibility of damaging a newly cast pile as a result of pile driving. Fleming et al (1992) suggested that a minimum centre-to-centre spacing of five pile diameters can be safely employed when driving adjacent to a pile with concrete less than seven days old. On the other hand, the General Specification for Civil Engineering Works (HKG, 1992) stipulates that piles, including casings, should not be driven within a centre-to-centre distance of 3 m or five times the diameter of the pile or casing, whichever is less, from an unfilled excavation or from an uncased concrete pile which has been cast for less than 48 hours. In case of doubt, integrity tests may be undertaken to provide a basis for formulating the appropriate guidelines.

8.2.5.13 Raking piles

Raking piles are comparatively more difficult to install. Whilst raking piles can be driven with a suspended hammer, considerable care is required and suspended leaders or a piling rig on a crane base may be preferred. Machines that generally carry the pile driving equipment on a long mast will become intrinsically less stable when driving raking piles. This is exacerbated by the need to increase the hammer drop in order to overcome the higher friction involved. Alternatively, the acceptance set may be relaxed where appropriate.

For long piles driven through soft or loose soils, it is possible that a raking pile may tend to bend downward.

Tight control on the alignment of the hammer and the pile is essential. The standard of pile jointing may be affected and the frequency of checking may need to be increased.

8.2.5.14 Piles with bituminous or epoxy coating

Piles may be coated to minimise negative skin friction or load transfer to adjacent structures such as underground tunnels. The manufacturers instructions with regard to the application of coatings, together with recommendations on the level of protection required, should be adhered to. Extreme care should be taken to avoid damage to the coating. Pre-drilling may be required to minimise damage to the coating.

Some guidance on the application of surface protective coating to piles is given in the General Specification for Civil Engineering Works (HKG, 1992).

8.2.5.15 Problems with marine piling

Problems that may arise with marine piles include difficulties with piling through obstructions such as rubble mounds, necking, buckling and instability associated with piling through water or through a thick layer of very soft marine deposit and the need for pile extension over water.

A relatively stable working platform is essential for pile installation. Piles may be driven from a temporary staging, spudded pontoon or floating craft. The latter will be subject to tidal effects and regular adjustments may be necessary to maintain a pile in line. It is generally inadvisable to use a drop hammer on a floating craft because of potential problems of directional control.

There is the likelihood of damage to precast concrete piles driven from a barge, especially at exposed sites. Under certain circumstances, pile driving from a barge may be acceptable for relatively protected sites, particularly where steel piles are to be used. Large piling barges should be used to minimise the possibility of piles being damaged due to barge movements.

Gates or clamps may be necessary to assist alignment and facilitate pile extension. Care needs to be exercised in the design of such devices to maintain pile position and tolerances, particularly in the case of raking piles, as there is a tendency for the pile to shift laterally. This, coupled with the weight of the hammer and the freestanding portion of the pile, may lead to damage of the gates.

For marine piles, it is important to ensure that adequate bracing to pile heads, in two directions at right angles, is provided immediately after installation to prevent the possibility of oscillation in the cantilever mode due to current and wave forces.

Typical case histories of marine piling in Hong Kong are reported by Construction and Contract News (1983) and Hazen & Horner (1984).

Practical aspects and considerations related to maintenance of marine piles in service are discussed in CEO (2002).

8.2.5.16 Driven cast-in-place piles

For top-driven tubes with a flat or conical cast iron shoe, the shoe is liable to be damaged by an obstruction and it should be checked during driving by sounding with a weight.

For a casing driven by an internal drop hammer, it is important that the dry concrete plug at the base is of the correct consistency. Otherwise, driving may not cause the plug to lock in the casing, leading to ingress of soil and water. As a general guideline, the water/cement ratio should not exceed 0.25 and the plug should have a compacted height of not less than 2.5 times the pile shaft diameter. Heavy driving may result in bulging of the casing or splitting of the steel if the plug is of inadequate thickness. Fresh material should be

added after prolonged driving (e.g. two hours of normal driving and one hour of hard driving) to ensure that the height of the plug is maintained.

The relatively thin bottom-driven steel casing is liable to collapse when piles are driven too close to each other simultaneously, and can result in loss of the hammer. The risk of this happening is increased when piles are installed within a cofferdam where there may be high locked-in stresses in the ground.

Problems could arise during the course of concreting of driven cast-in-place piles (Section 8.3.5.2).

A useful discussion on the construction control of driven cast-in-place piles is given by Curtis (1970).

8.2.5.17 Cavernous marble

In cavernous marble, buried karst features that could give rise to design and construction difficulties include pinnacles, solution channels and slots, cliffs, overhangs, cavities, rock slabs or blocks, collapsed or infilled cavities. Potential problems associated with driven piles include large variation in pile lengths, pile deflection, local over-stressing due to inclined rock surface, inability to penetrate thin slabs which may be underlain by weaker materials, damage to pile toe, uncertain effects of driving and loading of a pile group on cavity roofs, bending and buckling of piles in the overburden and the possibility of sinkhole formation as a result of collapse of cavities induced by pile driving (Houghton & Wong, 1990).

Due to the uncertainties in ground conditions associated with buried karst, it is common in Hong Kong to continue with 'hard driving' after the pile has keyed into rock. The aim is to facilitate penetration through thin roof slabs that may be present. However, overdriving leading to toe damage and bending should be avoided and a heavy section is essential to prevent buckling during driving. Better control may be exercised by using a drop hammer for hard driving in conjunction with a strengthened pile shoe.

Re-driving tests should be carried out because of the possibility of damage to the founding stratum caused by hard driving which may affect adjacent piles previously installed.

A case history of piling in faulted marble is described by Yiu & Tang (1990).

8.2.6 Potentially Damaging Effects of Construction and Mitigating Measures

8.2.6.1 Ground movement

Ground movements induced by the installation of displacement piles causing damage to piles already installed have been reported in Hong Kong (Short & Mills, 1983). Significant ground heave is possible and could lead to pile uplift. A useful summary of the mechanism of ground movements is given by Hagerty & Peck (1971). Premchitt et al (1988) reported ground heave of 150 mm near each prestressed concrete tubular pile after driving

through marine clay and clayey alluvium. Siu & Kwan (1982) observed up to 600 mm ground heave during the installation of over 200 driven cast-in-place piles into stiff silts and clays of the Lok Ma Chau Formation. Mackey & Yamashita (1967b) stated that problems of foundation heave due to construction of driven cast-in-place piles had been encountered where the ground consisted of colluvial decomposed granites, but that this was rare with insitu decomposed rock.

The installation of jacked piles requires heavy machine rig that typically weighs more than 400 tonnes. The machine weight can give rise to vertical and lateral ground movements that will influence installed piles in the vicinity. Poulos (2005) reported that there were two cases in Hong Kong where noticeable additional settlement was caused by the presence of the machine rig.

Uplift of piles can cause unseating of an end-bearing pile, leading to reduced stiffness, or breaking of joints and/or pile shaft, particularly if the pile is unreinforced or only lightly reinforced.

The problem of ground heave and pile uplift may be alleviated by pre-boring. Alternatively, a precast pile may be redriven after it has been uplifted. Experience has shown that it may not be possible to redrive uplifted piles to their previous level and that a similar set may be acceptable at a slightly higher level. As driven cast-in-place piles cannot be easily redriven once concreted, Cole (1972) suggested the use of the 'multi-tube' technique whereby the temporary liners for all the piles within eight diameters of each other are installed first and reseated prior to commencement of concreting. The technique was found to be effective in reducing pile uplift. However, it requires careful planning and the availability of a number of temporary liners. These two elements may render the technique costly and less attractive to large piling projects.

Uplift trials may be carried out during loading test to assess the effect of uplift on pile performance (Hammon et al, 1980).

Ground movements induced by driving could affect retaining structures due to an increase in earth pressures. Lateral ground movements can also take place near river banks, on sloping sites, at the base of an excavation with an insufficient safety margin against base failure or near an earth-retaining system (e.g. sheetpiles) with shallow embedment. The effect of such potentially damaging ground movement on a pile depends on the mode of deflection, i.e. whether it behaves as a cantilever with high bending stresses or whether it rotates or translates bodily. In addition, twisting of a pile may induce undesirable torsional stresses.

Levelling and surveying of pile heads and possibly the ground surface should be instigated if significant ground movement is expected or suspected. Consideration should be given to assessing the optimum piling sequence and the need for pre-boring. The spacing of the piles could also be increased to minimise the problem. The sequence of driving does not appear to have an appreciable effect on the total amount of uplift but it may be varied so that any uplift is distributed in a manner more favourable to the structure. Alternatively, a small-displacement pile solution may be adopted. In extreme cases, the risk of damage to sensitive structures could be minimised by constructing a 'relieving' trench filled with compressible material, although the effectiveness of such proposals will need to be confirmed by field trials.

It should be borne in mind that pile top deflection cannot be regarded as the sole factor in assessing the integrity of a displaced pile. Tools that can be used for investigation include integrity tests, re-driving, dynamic and static loading test, and exhumation of piles for inspection where practicable. Broms (1984) described methods as rough guides to determine the reduced capacity of bent piles.

It is generally inadvisable to attempt to correct laterally displaced piles by jacking at the pile heads as this could lead to failure of the section in bending.

8.2.6.2 Excess porewater pressure

Siu & Kwan (1982) and Lam et al (1994) reported observations of generation of positive excess pore water pressure during pile driving. The dissipation of the excess pore pressures could lead to the phenomenon of pile set-up (Section 8.2.5.10).

In soft clays and marine mud, the dissipation of excess pore pressures may give rise to negative skin friction (Lumb, 1979). Small-displacement piles with vertical drains attached may be considered to minimise this effect in extremely sensitive clays.

Where piles are driven on a slope, the excess pore pressure could result in slope instability. Where soft clays are involved, the induced pore pressures may lead to hydraulic fracture of the ground giving rise to crack formation. This may in turn increase the capacity for infiltration.

In soft sensitive clays, the effects of excess pore pressure and remoulding may result in a significant reduction in shear strength. This will be important in the case of piles for abutments where the clay will induce horizontal loading and hence stresses in the pile.

8.2.6.3 Noise

Percussive piling is inherently noisy and the operation is subject to the Noise Control Ordinance (HKSARG, 1997). The Ordinance stipulates that percussive piling requires a Construction Noise Permit. Percussive piling is generally prohibited and is allowed in certain times on weekdays provided that the generated noise level at sensitive receivers does not exceed the acceptable noise level by a specific amount (Section 5.2.4). Useful background discussions on the nature of various types of noise, the methods of measurement and means of noise reduction are given by Weltman (1980a) and Kwan (1985). Sources of noise from percussive piling operations include radiation of noise from the hammer exhaust and impact of hammer. Shrouds are normally used for noise control which can result in reduced hammer efficiency and increased cost. Cockerell & Kan (1981) suggested that noise radiated from the pile itself may be comparable to that from the hammer and exhaust such that even an effective shroud fitted over the hammer will reduce the total noise by only about 50%.

It should be noted that bottom-driven piles will generate less noise than piles which are driven at the top.

The Technical Memorandum on Noise from Percussive Piling (EPD, 1997)

summarises the typical range of noise levels associated with different types of piles and the use of related construction equipment based on local measurements.

8.2.6.4 Vibration

The prediction of the vibration level, which may be induced for a particular combination of plant, pile and soil condition is fraught with difficulties. The nature and effects of ground-borne vibrations caused by piling are discussed by Head & Jardine (1992).

Vibration due to pile driving (or installation of a temporary casing for replacement piles) may lead to compaction of loose granular soils or loose voided fill and cause the ground surface or utilities to settle (O' Neill, 1971; Esrig et al, 1991). In addition, dynamic stresses will be induced on underground utilities and structural members of buildings. The response of different forms of construction will vary and certain structural details may lead to a magnification of the vibration effect (Heckman & Hagerty, 1978).

The most commonly used index for assessing the severity of vibration is the peak particle velocity, ppv. As the problem of wave propagation and attenuation is complex, the most practical approach is to make reference to results of field monitoring of similar construction in similar ground conditions. Figure 8.3 summarizes some of the published design lines derived from monitoring results. Luk et al (1990) reported results of vibration monitoring carried out during driving of prestressed concrete tubular piles in the Tin Shui Wai area. They concluded that the following equation proposed by Attewell & Farmer (1973) can be used as a conservative upper bound estimate of the free-field vector sum peak particle velocity, ppv (in mm/sec) :

$$\text{ppv} = \frac{k\sqrt{E}}{\Delta h} \quad [8.3]$$

where k = constant
 E = driving energy per blow or per cycle in joules
 Δh = horizontal distance from the pile axis in metres

The above recommendation may be used with a k value of 1.5 as a first approximation but it will be more satisfactory to develop site-specific correlations. Limited monitoring results in Hong Kong suggest that the upper limit can be refined to correspond to a k value of unity for precast concrete piles, and a k value of 0.85 for H-piles.

BS 5228:4-1992 (BSI, 1992) gives some guidance on the control of vibration due to piling operations. The method for estimating peak particle velocity takes similar form as Equation [8.3], with the exception that it is based on radial distance between the source and the receiver. The coefficient k can be taken as 0.75 for hammer-driven piles, but this should be confirmed with field measurements (BSI, 1992).

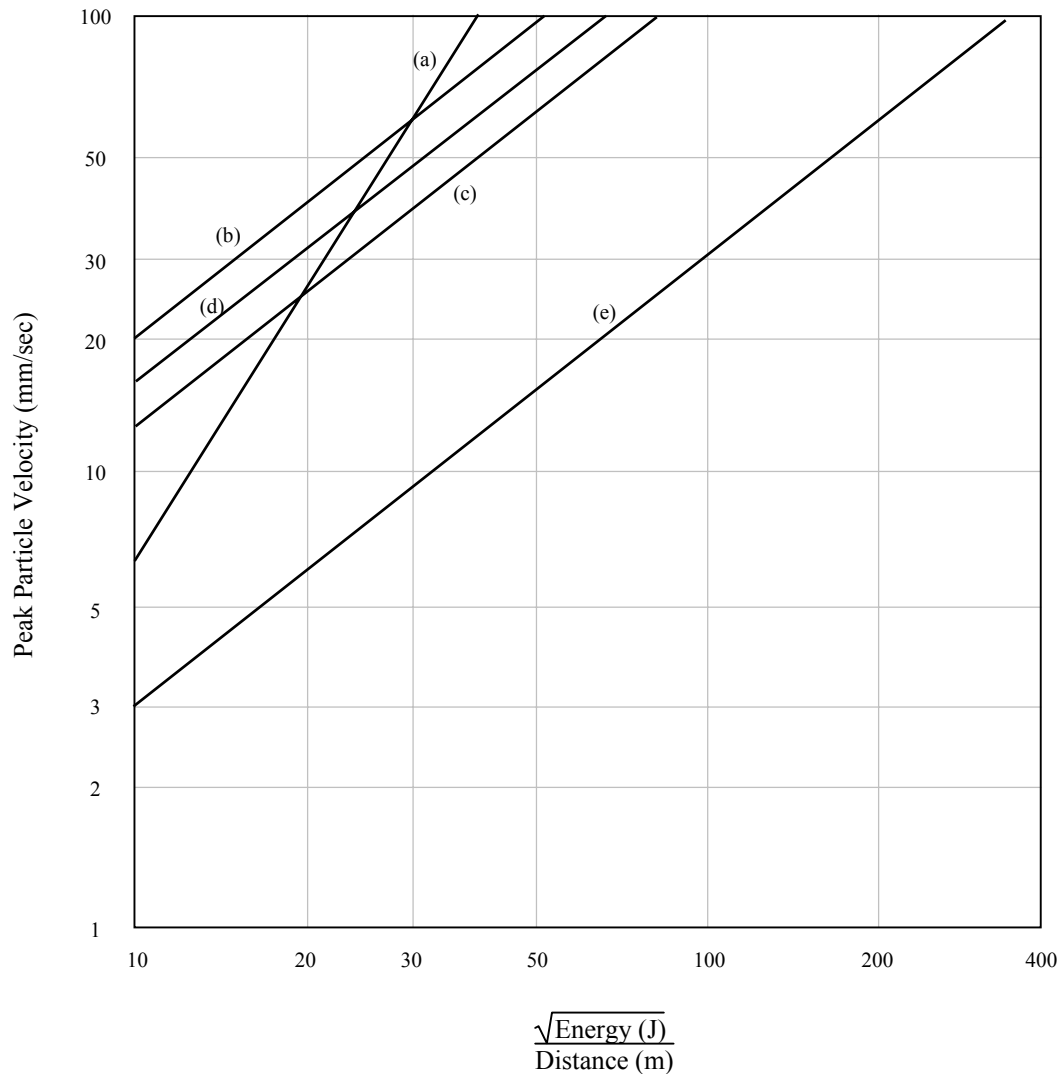

Legend :

- (a) Wiss (1967) – Clay
- (b) Wiss (1967) – Wet sand
- (c) Wiss (1967) – Dry sand
- (d) Attewell & Farmer (1973) – Sand & gravel, silt, clay
- (e) Brenner & Chittikuladilok (1975) – Clayey sand or stiff clay

Notes :

- (1) Criteria (a) to (c) relate to seismic distance, i.e. distance from pile tip to point of measurement.
- (2) Criteria (d) & (e) relate to the horizontal distance between the pile axis and the point of measurement.
- (3) Criteria (a) to (d) relate to vertical component of velocity whereas criterion (e) relates to the resultant velocity.

Figure 8.3 – Relationships between Peak Particle Velocity and Scaled Driving Energy

The transmission of vibration energy from the pile to the soil is controlled by pile impedance, and during wave propagation in the ground the vibration attenuation is influenced by the damping characteristics of the soil, wave propagation velocity and vibration frequency (Massarch, 1993; Schwab & Bhatia, 1985). These factors are not directly considered in most empirical relationships.

In Hong Kong, there is no official legislation or code of practice on vibration control. However, some guidance on the limits of vibration on sensitive receivers is given in the Buildings Department's Practice Note for Authorized Persons and Registered Structural Engineers No. 77 (BD, 2004b), 279 (BD, 2004c) and 289 (BD, 2005). The peak particle velocity at any railway structures resulting from driving or extraction of piles or other operations, which can produce 'prolonged' vibration, shall be limited to 15 mm/sec.

Without detailed engineering analysis and as a general guideline, a limiting ppv of 15 mm/sec is acceptable for buildings, sewerage tunnel and major public utilities, which are likely to be conservative. A more stringent limit of 7.5 mm/sec is required for more sensitive structures such as water retaining structures, water tunnels, masonry retaining walls and dilapidated buildings (BD, 2005). An additional criterion in terms of a limiting dynamic displacement (e.g. 200 μm in general and 100 μm for water retaining structures) may be imposed as appropriate. Detailed assessment of the effects of ground-borne vibrations on adjacent buildings and structures can be carried out in accordance with BS 7385 Part 1:1990 (BSI, 1990).

For buildings of historical significance, the limiting ppv values recommended in various overseas codes are in the range of 2 to 3 mm/sec. Limited experience in Hong Kong indicates that a ppv of 6 to 8 mm/sec can be acceptable. In principle, consideration should also be given to the duration over which the peak vibration takes place in assessing the limiting ppv values.

The allowable ppv and pseudo-dynamic ground movements have been considered in a number of overseas codes although most of the recommendations have not been drawn up specifically for ground vibrations induced by piling. The behaviour is strongly affected by local conditions and extreme caution needs to be exercised in extrapolating these criteria.

Due to the complexities involved, it may not always be appropriate to rely on the above generalised guidelines. It is advisable that each site is assessed on its merits, taking into consideration the existing condition of the structures, possible amplification effects and potential consequence of failure. In critical cases, it would be advisable to carry out trial piling combined with vibration monitoring to assess the potential effects and define a more appropriate and realistic limit on acceptable piling-induced vibration. In determining the acceptable threshold limits, consideration may also be given to the dominant frequency of excitation and the duration of vibration (Selby, 1991). It has been found that larger ppv values will be acceptable at a higher frequency of vibration (Head & Jardine, 1992). Also, the limiting ppv value may be lower for continuous vibration than for intermittent vibration.

Where significant vibration is envisaged or where the surrounding structures are sensitive (e.g. pressurised water mains or computers in buildings), it will be prudent to carry out vibration monitoring during test driving and installation of trial piles. A settlement survey is also helpful in monitoring settlement resulting from pile driving. Based on the

initial measurements, the suitable course of action, including the need for continual monitoring during site works, can be assessed. A comprehensive dilapidation survey of the adjacent structures with good quality photographs of sensitive areas or existing defects should be carried out prior to commencement of the works. A case history on an engineered approach in assessing and designing for potential vibration problems is described by Grose & Kaye (1986).

Measures which may be considered to reduce piling vibration include :

- (a) control of number of piles being driven at any one time,
- (b) pre-boring,
- (c) change of piling system,
- (d) 'active' isolation - screening by means of a wave barrier (e.g. trench, air cushion) near the energy source, and
- (e) 'passive' isolation - screening by means of a wave barrier near the affected structures.

The effectiveness of a wave barrier is related to the amplitude and energy of the waves, and the barrier dimensions. A design method is put forward by Wood (1968). Liao & Sangery (1978) discussed the possible use of piles as isolation barriers. The effectiveness of the barriers should be confirmed by field trials as theoretically it is possible for amplification to take place for a certain combination of conditions.

Provided that the accepted method of installation is proved by instrumented test driving, the sequence of piling may be stipulated to have the piles driven in a direction away from the sensitive structures so that stresses are not built up.

8.3 INSTALLATION OF MACHINE-DUG PILES

8.3.1 Equipment

8.3.1.1 Large-diameter bored piles

The range of drilling equipment developed for constructing large-diameter bored piles has been reviewed by Stotzer et al (1991). Two main techniques can be recognised on the basis of the method of excavation and means of ground support. The 'casing-support' technique involves excavation by a high table rotary rig or grabs and chisels within a steel casing, which is advanced progressively with the use of an oscillator, vibrator or rotator. With the advent of hydraulic rigs with the ability to insert tools over protruding casing, rotary methods are faster than grabs and chisels in most soil conditions. Telescopic casings may be used for cases where bored piles are founded on rock at great depths or where cavities are encountered in marble. However, a single layer of casing is preferred because it is difficult to control the installation of multiple layers of casings.

A proprietary system involving the use of a pneumatically-powered 'swinghead' may be adopted, which can be time-consuming but would be particularly useful for piling on a steeply-sloping site. Where excavation is carried out beyond the casing, the bore will need to be supported by an excess head of water (Au & Lo, 1993) or, where necessary, by drilling fluids such as bentonite slurry.

The 'slurry-support' technique involves excavation of a shaft under a drilling fluid with the use of a reverse-circulation drill, rotary auger or rotary drilling bucket. In less weathered zones, a reverse-circulation drill incorporating rock roller bits may be used. Alternatively, a core barrel can be employed using air or water circulation. A multi-head hammer drill incorporating down-the-hole hammers has been used in Hong Kong. With proper control measures implemented, this can result in increased drilling rates. For this system, each drill requires a compressor (Buckell & Levy, 2004).

Recently, rock core buckets with high torque rotary drilling rigs have been used in a number of infrastructure projects in Hong Kong. The system uses hydraulic rotary equipment to turn a telescopic Kelly bar mounted with rock drills. The advantage of the system is that it does not require water to flush out the debris, which can reduce disturbance to the ground (Buckell & Levy, 2004).

Barrettes may be formed in short trenches using conventional diaphragm walling equipment of grab and chisel. A milling machine powered by down-the-hole motors with reverse mud circulation can also be used to form barrettes in less weathered rock.

Bell-outs may be formed with the use of a reverse circulation drill incorporating an under-reaming head (Plate 8.1).



Plate 8.1 – A Mechanical Bell-out Tool

8.3.1.2 Mini-piles and socketed H-piles

These piles are usually constructed with the use of rotary direct-circulation drilling, although reverse-circulation drilling equipment is also available. A 'duplex system' is sometimes employed where the rod and the casing are advanced together. The drilling principle is based on a pilot drill bit and an eccentric reamer. When drilling starts, the reamer

swing out to ream the pilot hole wide enough for the casing tube to slide down. When the required depth is reached, the reamer swing in by reversing the rotation. This allows the drill bit and the reamer to be pulled up through the casing. Debris is carried with the return flush and travels up within the casings, thereby minimising soil erosion along the shaft. Sometimes, down-the-hole hammers may be used to break up boulders. Alternatively, a down-the-hole hammer incorporating a reaming tool may be used, particularly in poor ground conditions.

8.3.1.3 Continuous flight auger (cfa) piles

These piles are installed by drilling with a rotary continuous flight auger to the required depth, which is generally less than 30 m. After reaching the required depth, grout (or highly workable concrete in larger diameter piles) is pumped down the hollow stem and fills the void as the auger is slowly withdrawn, with or without being rotated. The walls of the borehole are continuously supported by the spiral flights and the cuttings within them. On completion of grouting, reinforcement cage up to 20 m long or a steel H-pile section is pushed into the grouted hole.

8.3.1.4 Shaft- and base-grouted piles

Shaft-grouting or base-grouting can be used in bored piles and barrettes. Tube-a-manchette grout pipes are installed in the piles. Within 24 hours of casting the piles, a small amount of water is injected at high pressure to crack the concrete surrounding the grout pipes. This creates an injection path for subsequent bentonite-cement grouting. In both grouting stages, a double packer is inserted into the tube-a-manchette to control the cracking and grout intake at specific depth.

It is important that the grout intake is properly monitored and controlled during the grouting operation. Re-grouting may be necessary if the grout intake in the first pass is less than the specified volume. Tube-a-manchette pipes are regroutable if used correctly. Extra tube-a-manchette grout pipes are installed as a backup in case some tubes become blocked.

8.3.2 Use of Drilling Fluid for Support of Excavation

8.3.2.1 General

Construction of bored piles and barrettes involves shaft excavation and adequate support must be provided to prevent bore collapse and minimise the effects of stress relief and disturbance of the surrounding ground. Some loosening of the soils is inevitable during excavation but if the degree of disturbance is uncontrolled, the effect on pile performance may be significant and variable.

Drilling fluids may be used to provide bore support in an unlined hole. This may be in the form of bentonite slurry, polymer mud or water where appropriate. The use of drilling fluid to support pile excavations in a steeply-sloping site should be viewed with caution and a sufficient length of lead casing should be advanced where possible to minimise the risk of hole collapse due to differential earth pressures.

Because of the larger volume of drilling fluid needed to be treated prior to reintroduction into the bore, all reverse circulation drills require control of the suspension system.

8.3.2.2 Stabilising action of bentonite slurry

The successful use of bentonite slurry as a means of excavation support relies on the tight control of its properties. A comprehensive summary of the stabilising action of bentonite slurry and polymer fluids is given by Majano & O'Neill (1993).

The inherent characteristics of bentonite slurry are its ability to swell when wetted, its capability in keeping small sediments in suspension, and thixotropy, i.e. it gels when undisturbed but flows when it is agitated.

The slurry penetrates the walls of the bore and gels to form a filter cake that acts as a sufficiently impervious diaphragm to allow the transmission of hydrostatic slurry pressure. To ensure bore stability, the hydrostatic pressure of the bentonite slurry must be greater than the sum of the water pressure and the net pressure of the soil.

8.3.2.3 Testing of bentonite slurry

The essential properties of bentonite slurry include density, viscosity, fluid loss, sand content, pH and filter cake thickness. Conventional requirements on the shear strength of the slurry developed for oil drilling purposes are of less relevance to civil engineering works. Generally speaking, density, viscosity and fluid loss are the more relevant control parameters for general piling works whereas pH is a useful indicator on the degree of contamination of the slurry, although experience exists of poor pile performance where the sand content or the filter cake thickness is excessive. It is advisable to adopt a flexible approach in determining the range and extent of compliance testing required for each site, which should be reviewed as the works proceed. Although the pressure on site for concreting is inevitably great, it is important to ensure compliance of the bentonite slurry properties with the specification requirements, as otherwise the integrity or the resistance of the pile or both may be compromised.

Bentonite slurry will become contaminated with soil sediments during excavation. Limits on slurry properties are normally stipulated for slurry as supplied to the pile, and for bentonite immediately prior to concreting. A useful background discussion can be found in Hutchinson et al (1974).

Specifications on properties of bentonite slurry are given in the General Specification for Civil Engineering Works (HKG, 1992) and BS EN 1536:2000 (BSI, 2000c). These specifications are summarised in Table 8.7. Some local contractors have adopted more stringent control on properties of bentonite.

Table 8.7 – Limits on Properties of Bentonite Slurry

| Bentonite Property at 20°C | Method of Testing | General Specification for Civil Engineering Works (HKG, 1992) | BS EN1536:2000 (BSI, 2000c) | Common Specifications by Local Contractors |
|--------------------------------------|--|---|---|---|
| Density as supplied to excavation | Mud density balance | ≤ 1.10 g/ml ≤ 1.25 g/ml ⁽¹⁾ | ≤ 1.10 g/ml ≤ 1.15 g/ml ⁽¹⁾ | ≤ 1.015 to 1.03 g/ml ≤ 1.15 to 1.2 g/ml ⁽¹⁾ |
| Viscosity | Marsh cone method (946ml flow through cone) | 30 to 50 sec | 32 to 50 sec | ≤ 32 sec ≤ 40 sec to 45 sec |
| | Fann viscometer | ≤ 0.02 Pa. s (i.e. ≤ 20 cP) | NA | NA |
| Fluid loss | Baroid filter press (in 30 minute test) | NA | < 30 NA ⁽¹⁾ | ≤ 25 ≤ 35 to 40 ⁽¹⁾ |
| Shear strength (10 min gel strength) | Shearometer | 1.4 to 10 N/m ² | NA | 1.4 to 10 N/m ² |
| | Fann viscometer | 4 to 40 N/m ² | NA | NA |
| pH value | pH indicator paper strips or electrical pH meter | 8 to 12 | 7 to 11 NA ⁽¹⁾ | 8 to 11 |
| Sand content | | - | $< 4\%$ ⁽¹⁾ | $< 3\%$ ⁽¹⁾ |

Notes : (1) Denotes condition before concreting. Other values refer to bentonite in fresh or recycled condition.
(2) NA denotes no requirement imposed.

8.3.2.4 Polymer fluid

Polymer fluids have been used to maintain bore stability during excavation as an alternative to bentonite slurry (Corbet et al, 1991). Unlike bentonite slurry, polymer fluid forms a barrier by blocking the pores within the soil. The polymers consist of a number of individual molecules joined together and can penetrate deep into sandy or silty soils. The advantages of polymer fluids include simpler site logistics, rapid hydration, less requirement for storage, less disposal problems, inertness to cement and absence of a filter cake. Polymer fluids are biodegradable and therefore do not require special disposal measures. However, polymers can be difficult to mix. The shearing action must be sufficiently high to disperse the polymers but not so great as to break down the polymers. In addition, polymer fluid can be susceptible to becoming wet and forming a slime.

Beresford et al (1987) discussed the testing of polymer fluid and suggested acceptance criteria for the results.

8.3.3 Assessment of Founding Level and Condition of Pile Base

For piles bearing on rock or socketed in rock, pre-drilling is necessary to establish the

required founding level. Cores (minimum of NX size) are normally taken to at least 5 m below the proposed pile base level, except for sites underlain by marble, in order to prove the nature of the founding material. The acceptable values of index parameters, such as total core recovery, unconfined compressive strength (or point load strength), RQD, joint spacing and the nature of discontinuities and any infilling below the founding level, must be determined in relation to the design method. Comments have been given in Section 6.5.3.2 on the potential shortcoming in the use of total core recovery or RQD as the sole means of determining suitable founding level. More than one criterion may dictate the required founding level, e.g. the required strength of rock mass, design socketed length and interaction between adjacent piles. During pile construction, the chippings should be inspected carefully to confirm the nature of the material when the proposed founding level is reached.

In principle, geophysical testing techniques can be used to assess the appropriate founding level. In practice, such indirect techniques may not be sufficiently reliable for detailed foundation design.

For large-diameter bored piles bearing on rock, it is common for core sampling to be stipulated for a selection of contract piles. This involves the retrieval of minimum 100 mm diameter cores through the concrete shaft which may be extended to at least 1 m or a distance of half a pile diameter below the base in order to assess the condition of the pile/rock interface and confirm the nature and state of the founding material. The frequency of retrieving cores of the full length of piles may vary between sites, depending on the contractor's experience and the designer's confidence. As general guidance, it is suggested that a minimum of one to two cores should be taken for every 100 piles, but judgement should be exercised for individual projects, taking into account the complexity of ground conditions, the problems encountered during pile construction and the scale of the work.

If cores are taken only to assess the base interface, NX size core taken through a 'reservation tube' cast into the pile would generally be adequate. The reservation tubes are usually of diameter not less than 150 mm and are cast in the shaft at about 1 m above the interface to facilitate the core-drilling of the interface. It is common practice to carry out interface coring for all bored piles (BD, 2004a). The provision of reservation tubes should be carefully planned as they could obstruct the flow of concrete during casting of the piles.

For rock-socketed piles, the adequacy of the bonding can be investigated by means of a loading test on an instrumented pile.

For piles founded in saprolites, Standard Penetration Tests are normally carried out to enable the required founding level to be assessed. Plate loading tests (Sweeney & Ho, 1982) or pressuremeter tests (Chiang & Ho, 1980) can also be used to characterise the ground and determine design parameters.

8.3.4 Potential Problems during Pile Excavation

8.3.4.1 General

The construction of bored piles involves many processes that require good design detailing and workmanship. A range of potential problems can arise during the installation of

bored piles. Lee et al (2004a) discussed some of the common defects in bored piles in Hong Kong. Some of the problems that can affect the structural integrity of piles are summarised in Table 8.8.

Table 8.8 – Causes and Mitigation of Possible Defects in Replacement Piles (Based on Thorburn & Thorburn, 1977 and Lee et al, 2004a) (Sheet 1 of 3)

| Defect | Possible Cause of Defect | Precautionary Measures |
|---|--|---|
| Hollow on the surface of pile shaft with associated small bulbous projection some short distance beneath hollow | (a) Overbreak in unstable strata | (a) Advancing temporary casing ahead of bore (b) Drilling using bentonite slurry (c) Use of permanent casing |
| | (b) Use of double temporary casings and extraction of outer casing before inner casing resulting in local cavitation | Extraction of inner casing before outer casing |
| | (c) Intrusion of very soft peat or organic layers | Provision of permanent casing |
| Discontinuity in pile shaft with associated large bulbous projection some short distance beneath cavity | (a) Overbreak in unstable strata | (a) Advancing temporary casing ahead of bore (b) Drilling using bentonite slurry (c) Use of permanent casing |
| Soil or debris embedded in concrete near top of pile | (a) Overbreak in coarse gravel or fill near ground surface producing sudden loss of concrete when casing is extracted | (a) Advancing temporary casing ahead of bore (b) Drilling using bentonite slurry (c) Use of permanent casing |
| | (b) 'Topping up' operations, i.e. additional concrete discharged on top of previous lift after casing is removed, or insufficient displacement of poor quality concrete above the cut-off level by tremie method | 'Topping up' after removal of casing should not be allowed and sufficient concrete must be placed to ensure sound concrete at and below 'cut-off' level |
| Debris embedded in pile shaft | Poor workmanship or lack of short length of temporary casing at top of pile bore | (a) Provision of short length of temporary casing which projects sufficiently above ground surface |
| | | (b) Improve workmanship by educating and training workers |
| Local reduction in diameter of shaft of bored piles (necking) with associated bulbs at greater depths | Insufficient confinement of concrete in cohesive soils with very low shear strength | (a) Problem may sometimes be alleviated by careful slow extraction of the temporary casing (b) Provision of permanent casing |

Table 8.8 – Causes and Mitigation of Possible Defects in Replacement Piles (Based on Thorburn & Thorburn, 1977 and Lee et al, 2004a) (Sheet 2 of 3)

| Defect | Possible Cause of Defect | Precautionary Measures |
|---|---|---|
| Soil or rock debris at base of piles | (a) Dislodgement of small blocks of soil or rock material from sides of bore, sometimes caused by delay in concreting the shaft | (a) Concrete shaft with minimum delay (b) Use of temporary casing (c) Drilling using bentonite slurry |
| | (b) Deposition of soils that remain in suspension after airlifting | (a) Removal of soils in suspension by air-lifting (b) Avoid unnecessarily prolonged air-lifting that may increase the risk of soil collapse in pile bore |
| | (c) Closely spaced or double layers of reinforcing bars that can trap soils between bars | (a) Avoid bend-up bars at the bottom of reinforcement cage (b) Optimise the reinforcement bars at bottom of cage |
| | (d) Collapse of rock fragment from rock socket | (a) Avoid chiselling to prevent fracturing the rock |
| Local reduction in diameter of shaft of bored piles (necking) without associated bulbs at greater depths | Insufficient head of concrete within steel casing during extraction | Adequate head and workability of concrete within casing |
| Discontinuities in pile shaft | (a) Low-workability concrete | Use of high workability concrete mixes |
| | (b) Premature setting of concrete or excessive period of time between mixing concrete and extraction of casing | Care should be taken in hot weather |
| | (c) Low-workability concrete in lower portion of pile shaft as a result of lack of continuity in placement of concrete | Proper planning of supply of ready-mix concrete; use of retarders |
| | (d) Aggregate interlock and raising of concrete within casing during extraction from use of poker vibrator | (a) Proper design of concrete mix to ensure self-compaction (b) Prohibit use of poker vibrator |
| Distortion of pile shaft | Lateral movements of steel casing during extraction | (a) Adequate ground restraint to minimise plant movement (b) Provision of adequate granular working platform |
| Containment of concrete within cage with resultant lack of cover to reinforcement or lack of concrete in bell-out | (a) Excessive quantity of reinforcement in cage | Use of a few heavy steel sections rather than a large number of closely-spaced reinforcing bars |
| | (b) Low-workability concrete | Use of high workability concrete mixes |

Table 8.8 – Causes and Mitigation of Possible Defects in Replacement Piles (Based on Thorburn & Thorburn, 1977 and Lee et al, 2004a) (Sheet 3 of 3)

| Defect | Possible Cause of Defect | Precautionary Measures |
|---|---|---|
| Collapse of reinforcement cage | Inadequate design or construction of cage | Proper design of cage which should be sufficiently rigid and capable of withstanding normal site handling |
| Dilution of cement paste and formation of soft cement paste | Penetration of groundwater into body of pile because of incorrect mix design | Proper design of concrete mix |
| Excessive bleeding of water from the exposed surface at top of pile | Concrete mix with a high water-cement ratio | Proper design of concrete mix |
| Weak and partially segregated concrete near pile base | (a) Significant accumulation of groundwater at base of bore prior to placing of first batch of concrete | Use of tremie for concreting |
| | (b) Turbulent flow of water creates fast-moving concrete during the initial pour of concrete | Use cementitious materials in the first charge of concrete to separate the concrete from direct contact with water |
| Inclusions of clay lumps within pile shaft | Clay lumps adhering to temporary casing which are subsequently displaced by the viscous concrete and incorporated in the body of the pile | Use of clean casing |
| Occasional segregation of concrete in pile shaft | Concrete impinging on reinforcement cage during placing | Use of short length of trunk to direct concrete. (Note : full length tremie pipe must be used with raking piles) |
| Segregation of concrete with dilution of cement paste and formation of soft cement paste; sometimes layers of sand and gravel are found within body of pile | (a) Uncontrolled activation of trip mechanism in concrete placers used to place concrete in water-filled bores | Use of tremie |
| | (b) Raising of tremie pipe above surface of concrete either accidentally or in an attempt to re-start placing after interruption of free flow of concrete down tremie | Proper use of tremie (Note : tremie pipe must be water-tight and a buoyant plug of material should be used as a separation layer between the first batch of concrete and water or bentonite slurry in the tremie) |
| | (c) Significant groundwater flow through relatively permeable strata | Use of permanent casing |
| Disintegration of concrete | Chemical attack | Proper site investigation including chemical testing |

8.3.4.2 Bore instability and overbreak

Overbreak arises where there are local collapses of the walls of the bore resulting in cavities. These cavities, particularly if they are water filled or slurry-filled and concealed behind a temporary casing, pose a potential risk of contamination of the concrete when the casing is extracted. Surging of the casing should be avoided as this will increase the likelihood of ground loss and hence settlement. The profile of the excavation and the degree of overbreak may be assessed approximately with the use of a mechanical or sonic calliper measuring device. However, it is not possible to calliper the overbreak, which is concealed by a temporary casing. Alternatively, the profile of excavation can be roughly estimated by back-calculating from the volume of concrete used in constructing the pile.

It is important to ensure that there is a sufficient excess hydraulic head within the casing against base blowing and to prevent shaft instability where excavation proceeds below the casing. In the case where water is used to support an excavation below the casing, consideration should be given to the risk of bore instability when the excess water head reduces due to breakdown of pumps or seepage into the ground between shifts, e.g. over weekends.

Rapid withdrawal of a drilling bucket or hammer grab during pile excavation should be avoided as this may give rise to undercutting beneath the casing as well as a 'piston effect' resulting in significant reduction in pressure and bore collapse. Specially-designed buckets which have a by-pass arrangement to allow the flow of bentonite fluid to take place to reduce any severe damage to the wall of the pile shaft (Fleming & Sliwinski, 1977) may be used.

8.3.4.3 Stress relief and disturbance

Pile bore excavation will result in stress relief of the ground. Stroud & Sweeney (1977) observed from a trial diaphragm wall panel that at an apparent excess slurry head of 1.5 m, completely weathered granite exhibits considerable swelling and ground loss and settlement. A minimum excess slurry head of 3.5 m was specified for the diaphragm wall for the Hong Kong & Shanghai Bank Building (Nicholson, 1987). Excessive swelling and loosening could also affect the stiffness and capacity of piles.

Where a full length temporary casing is used, the process of oscillating or vibrating the casing may cause disturbance to the soil structure. Excavation below the casing or the tendency for seepage flow to occur towards the bottom of the excavation will lead to further disturbance and loosening of the soil in the pile shaft by stress relief or seepage forces.

Where the piles are bearing on rock, the above disturbance effects may not be of significance. However, for piles founded in saprolites, the effects should be considered in the assessment of the available shaft capacity. The stress relief and disturbance effects can be minimised by maintaining a sufficient excess hydraulic head at all times or ensuring that the casing is always advanced to beyond the excavation level.

Where existing piles are intended for reuse, the effect of constructing new piles on adjacent existing piles should be considered. For example, excavation for bored piles close to existing friction piles may affect their load-carrying capacity due to the stress relief. Where

extraction of existing piles is necessary to make way for new piles, the extraction operation should avoid affecting other adjacent piles and structures.

8.3.4.4 Obstructions

With reverse-circulation drills or down-the-hole tools, the presence of obstructions can generally be overcome relatively easily. It should be noted however that the use of the airlift technique as a means of flushing (which relies on the suction effect due to the difference in density between the air-water mixture and the surrounding fluid) requires a hydraulic head of about 10 m and therefore shallow obstructions cannot be easily removed with reasonable performance by reverse-circulation drills. This problem can be alleviated by using suction pump together with a down-the-hole hammer drill. With the casing-support method, chisels are usually used. For obstructions and boulders with a sloping surface, it should be borne in mind that the chisel may skid sideways upon impact and could damage the steel casing.

For major obstructions, a possible option will be to remove the soils around the obstruction by grabbing or airlifting and to place lean mix concrete to encase the obstruction to facilitate subsequent drilling by reverse-circulation drills. Small-diameter drillholes may also be sunk to perforate the obstruction to facilitate subsequent breaking up by a chisel. However, careful consideration needs to be given to the possibility of contamination of the bentonite slurry by the cement in the lean mix.

Manual excavation has sometimes been resorted to for relatively shallow excavations above the water table. For obstructions at depth, the extent of ground treatment required to minimise the safety hazard and effects of dewatering needs to be carefully assessed prior to consideration of manual excavation.

8.3.4.5 Control of bentonite slurry

The quality and level of the bentonite slurry must be kept under tight control during bore excavation. The bentonite should be mixed with fresh water by means of a properly-designed mixer and left for a sufficient time to achieve effective hydration. In the presence of seawater or in areas affected by saline intrusion, suitable additives may be necessary to maintain the properties of bentonite slurry as a stabilising fluid.

Contamination by clay minerals (e.g. in marine mud), particularly in the form of calcium or aluminium ions, could promote ion exchange with the slurry such that the filter properties are markedly changed. In this case, the filter cake could become thicker and have a far higher fluid loss, which can cause the gel structure of the slurry to collapse leading to base instability. Contamination by cement will result in similar effects together with a large increase in the pH value. Bentonite slurry with high viscosity could also increase the thickness of filter cake. The increase in filter cake thickness may not endanger bore stability but could affect the mobilised shaft resistance as the filter cake may not be effectively scoured and removed by the concrete. The presence of a filter cake will create a lubricating surface and prevent the cement milk from penetrating the disturbed soil. A scraping tool may be employed to reduce the filter cake thickness prior to casting of the pile.

The pH of the slurry should be kept in the alkaline range but this may be influenced by the minerals present in the water and the soil. In particular, organic soils could cause the bentonite to become thin and watery, and cease to perform its functions (Reese & Tucker, 1985).

Bentonite slurry is liable to 'run away' in very permeable (e.g. $k_s > 10^{-2}$ m/s) strata. The nature of some reclamation fill may pose a risk of sudden loss of bentonite leading to bore collapses. Pre-trenching is a common technique to prevent the loss of bentonite, e.g. Craft (1983). This technique involves constructing a trench and filling it with lean-mix concrete prior to the excavation for the barrettes. Similar problems of risk of sudden loss of bentonite can arise in cavernous marble, landfill sites and in the vicinity of underground utility service pipes or ducts.

Nicholson (1987) reported results of piezometric measurements that show outward flow of water from a diaphragm wall trench at the end of a day's excavation and restoration of the equilibrium groundwater level by the following morning. It was conjectured that where the excess bentonite head is insufficient to prevent excessive swelling of some of the weathered granites, the inward movement coupled with the continual raising and lowering of the grab could cause disturbance or shaving-off of the filter cake, which re-developed overnight. It is therefore important to maintain a sufficient excess bentonite head and use bentonite slurry that forms a filter cake rapidly. It may be possible that the use of reverse circulation drilling may lead to less disturbance of the filter cake compared to that of a grab, leaving potentially a relatively smooth bore profile along the shaft.

The built-up of filter cake thickness varies with the square root of time (Nash, 1974). Hence a pile bore should not be left open for an excessive period of time as this could lead to a thick filter cake developing on the sides of the excavation. Ng & Lei (2003) observed that maximum mobilised shaft resistance on barrettes decreased when duration of trench standing time increased. The trench standing time should be minimised as far as practicable, particularly for friction piles. Careful consideration should be given to the programming of excavation and concreting.

8.3.4.6 Base cleanliness and disturbance of founding materials

Debris accumulated at the base of a pile is undesirable as this may lead to intermixing and inclusions in the concrete or a layer of soft material at the base of the pile. Debris may comprise soft and loose sediments that settle to the base after completion of excavation. Alternatively, foreign materials could be deposited accidentally into the pile. It will be prudent to ensure that a sufficient projection of the temporary casing is left above ground level and that empty bores are properly covered.

The final cleaning of the pile base may be done with the use of a cleaning bucket followed by airlifting (Sliwinski & Philpot, 1980). The use of a skirted airlift in which debris would be drawn in over a larger area may be more effective (Fleming et al, 1985). On some occasions, the reverse-circulation drill has been used for this purpose. Opinions differ as to the effectiveness and potential disturbance between the use of an airlift pipe and the reverse-circulation flush, particularly in weathered rocks which may be susceptible to disturbance or damage of the bonding inherent in the grain structure. Thorough base cleanliness may be

difficult to achieve in practice, particularly with raking piles. If base cleaning is not done properly, potential problems including plastering of the filter cake and presence of large pieces of debris at the pile base may occur.

Even if the base is free from significant debris, the soil below the base may be disturbed and loosened as a result of digging, stress relief or airlifting (Section 8.3.4.3). Special techniques may be adopted to consolidate and compact the loosened soil. These include pressure grouting with the use of a stone fill pack (Tomlinson, 1994) or tube-a-manchette (Sherwood & Mitchell, 1989). In addition, shaft-grouting may be carried out to enhance the shaft stiffness and capacity (Morrison et al, 1987). However, Mojabi & Duffin (1991) reported that no significant gain in shaft resistance was achieved by shaft-grouting in sandstone and mudstone. Experience with such construction expedients is limited in Hong Kong.

Rock-socketed piles are liable to base-cleanliness problems arising from fine rock materials. If the debris is not removed properly, a 'soft toe' may form at the base of the pile. Fresh concrete may also force the base debris up the socket wall thereby reducing the shaft resistance in the lower region of the socket. A possible remedial measure is to use high pressure water jetting to remove the loose sediments at the base, if the sediments or segregations are not greater than 50 mm in thickness or 100 mm for piles longer than 30 m. Pressurised grout is then used to fill up any voids. Several holes may be required to facilitate the flushing of the debris. Further cores should be taken to verify the effectiveness of remedial grouting in each pile.

The potential problem of trapping debris at the pile base can be minimised by lifting the tremie pipe with a hydraulically operated equipment. In this system, the lifting of concrete skip and tremie pipe is carefully controlled to maintain a constant distance between the tremie pipe and the pile base. Cementitious materials with a very high cement content or grout are used in the first charge to prevent direct contact of concrete with water in the first pour.

8.3.4.7 Position and verticality of pile bores

The position of pile bores should be checked as piles significantly out of position may necessitate a reassessment of the pile cap carrying capacity. Non-verticality of a pile bore will induce additional bending and may necessitate extra reinforcement if it is seriously in error. It is common practice in Hong Kong to routinely check the verticality of the casing to ensure acceptable verticality of the pile bore. This could involve the use of a dummy reinforcement cage, or a sonic or mechanical calliper device.

For barrettes, it is important to ensure that a guide wall of sufficient depth is constructed to guide the grab.

For piles installed close to tunnels or which are required to be constructed to very tight tolerances (e.g. piles for top-down deep excavation), precautions may need to be adopted in the construction including the use of precise instruments for control and verification of the verticality (Triantafyllidis, 1992).

8.3.4.8 Vibration

Vibration may be caused when a temporary casing is vibrated into the ground. The problems of excessive vibration are discussed in Section 8.2.6.4. Where a vibratory driver is used, adjusting its operating frequency may in some cases help to reduce the level of excited ground vibrations.

8.3.4.9 Sloping rock surface

The installation of temporary casings to obtain a seal in rock may be fraught with difficulties where the rock surface is sloping. A possible construction expedient was described by Mckenna & Palmer (1989) involving the use of weak mass concrete to plug the gap between the casing and the rock surface followed by further drilling into rock after the concrete has hardened.

8.3.4.10 Inspection of piles

The use of a video camera to inspect a rock socket in lieu of inspection by descent may be considered provided that the designer is satisfied that this technique is sufficiently reliable.

In case the pile shaft is filled with water, the visibility in water may be low and video camera may not produce clear pictures. The use of television or video camera for inspecting piles in clays can be unreliable and is not recommended because the clay may be smeared by the drilling tool.

Machine-dug bored piles constructed under water have also been inspected by divers (Mckenna & Palmer, 1989).

Ultrasonic echo sounding tests (Plate 8.2) are commonly used to measure the excavated profile of cast-in-place piles or barrettes. A sensor (Plate 8.3) emits ultrasonic pulses in four directions at orthogonal orientation, as it is lowered into the pile bore. The time lapsed between the emitted and reflected pulses are used to compute the wall dimensions. The shape of the bell-out or any collapse of the wall can be determined (Figure 8.4). The relative density of the drilling fluid in the excavation should be between 1.0 and 1.2. The strength of the reflected pulses can be affected by the amount of bubbles and sediments in the drilling fluid. This may cause diffusion of ultrasonic pulses and in the worst case, no reflection can be obtained.

8.3.4.11 Recently reclaimed land

In the case of piles constructed through a recent reclamation where marine mud may be trapped and disturbed with excess (possibly artesian) pore water pressure, a stable bore may be difficult to achieve. Raised guide walls, or the use of a full length casing through the soft areas as appropriate, may be required to prevent bore collapse.



Plate 8.2 – Device for Ultrasonic Echo Sounding Tests



Plate 8.3 – Sensor for Ultrasonic Echo Sounding Tests

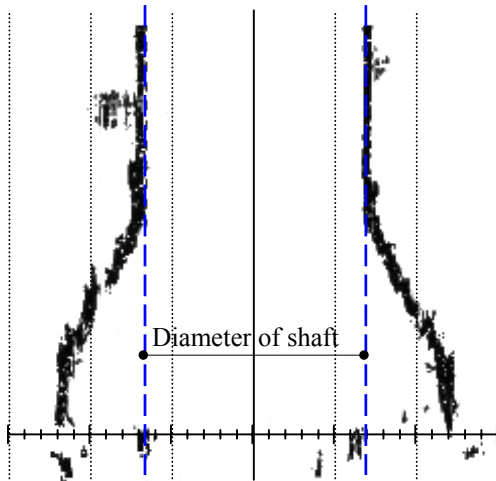

Figure 8.4 – Typical Profile of Empty Bore Deduced from Ultrasonic Echo Sounding Test

8.3.4.12 Bell-outs

Mechanical under-reaming tools should be used in forming bell-outs (BSI, 2000b). The dimensions of the bell-outs can be calibrated at the ground surface by stretching the cutting arm fully and recording the vertical displacement of drill string. The use of offset-chiselling to form the bell-outs is not encouraged because of difficulty in controlling the chisel. It is not easy to form the enlargement in a full diameter.

8.3.4.13 Soft sediments

For sites with a deep layer of very soft sediments, sufficient adhesion may develop such that the casing may become stuck and may break at the connections if excessive torque is applied during extraction.

8.3.4.14 Piles in landfill and chemically contaminated ground

Bored pile construction in landfill has potential problems associated with venting of methane gas, disposal of contaminated spoil, sudden loss of drilling fluids in voided ground and hazards of underground fire and surface explosion.

8.3.4.15 Cavernous marble

The potential problems of pile construction in karstic ground include risk of necking at locations of weak superficial deposits, difficulty of seating on an inclined rock surface, the possible need to ream through thin slabs or treat weak materials underlying the slabs, potential loss of drilling fluid leading to bore instability, base heave, oozing in of soft cavity infill giving rise to sinkholes and excessive erosion of soil under high fluid pressure. Expedients, which may be adopted to assist pile construction in these ground conditions, have been given in the literature (e.g. Chiu & Perumalswamy, 1987; Mitchell, 1985; Tan et al, 1985; Tang, 1986; Li, 1992).

8.3.5 Potential Problems during Concreting

8.3.5.1 General

The final concreted level should be at a sufficient distance above the required trimmed level to allow removal of the surface laitance. The concreted level should preferably be higher than the groundwater level to ensure concrete integrity. Where the trimmed level is at depth and the concreted level is below the groundwater level, the problem of the water head exceeding the concrete head can be alleviated by partially filling the empty bore with granular material and topping up with water where a permanent liner is left in, or filling the bore with spoil prior to extracting the temporary casing. If either bentonite slurry or water is added and mixed with the soil in the ground by the drilling equipment to assist with the installation of the temporary casing (i.e. 'mudding-in'), the concreted level should be coincident with the piling platform level.

Regardless of the method of concrete placement, it is difficult to properly place additional concrete on top of the previous lift after the temporary casing has been withdrawn.

8.3.5.2 Quality of concrete

A high-slump, self-compacting mix is necessary in order to ensure that the concrete flows between the reinforcement bars and fills the entire cross section of the bore. Concrete with low workability is a major cause of defects. To minimise segregation, honeycombing and bleeding resulting from high water content, the use of a plasticizer additive may be beneficial.

In bored pile construction, the radial effective stress in soil may be significantly reduced, such as in the pile section bored under water and ahead of casing. For such cases, the concrete pressure plays a pivotal role in restoring the radial effective stress, and the slump

of concrete and the time during which concrete remains fluid will control the shaft resistance that can be achieved.

For piles where concreting is carried out in an unlined bore free of water and with ample room for free movement of aggregates between bars, a typical concrete slump of 100 to 150 mm will generally be acceptable. Where concrete is placed by tremie, a minimum slump of about 150 mm or 175 mm should be adopted.

It would be advisable to check the slump of every concrete load. Flow table tests may be a more appropriate method for assessing the flow properties and cohesiveness of a high workability mix in tremie concrete. No extra water or other constituent materials should be allowed to be added to ready-mix concrete on or off site.

Concrete in pile shaft should not be vibrated. If this were done, there would be a risk of the vibrated concrete arching onto the side of the casing and being lifted during casing extraction. Reliance is therefore placed on the energy of the free-falling concrete to achieve self-compaction.

8.3.5.3 Quality of grout

Grout constituents for mini-piles, socketed H-piles and continuous flight auger piles should be mixed thoroughly to produce a consistent colloidal grout. In general, a high-speed mixer is preferred to a low speed paddle type mixer.

A useful discussion on the design of a grout mix is given by Bruce & Yeung (1984). Strict quality control of the constituent materials and the grouting procedure is essential because the effect of improper grouting will be accentuated by the small-diameter of the piles.

The range of quality control tests includes measurements of fluidity (or viscosity), strength, bleeding and free expansion. The requirements for the tests are given in Geospec 1 : Model Specification for Prestressed Ground Anchors (GCO, 1989). In addition, the density of the liquid grout may be checked with the use of a mud balance where appropriate. The setting time should also be noted.

Guidance on the acceptable limits of grout property, such as cementitious content, bleeding, free expansion, strength and fluidity, are given in the General Specification for Civil Engineering Works (HKG, 1992).

The volume of grout injected should be determined using a calibrated flowmeter, preferably cross-checked by means of a stroke counter on the pumping equipment.

8.3.5.4 Steel reinforcement

Careful thought needs to be given to avoid closely-spaced reinforcement, which may impede the flow of concrete, leading to integrity problems. It would be advisable to use a smaller number of larger bars with a minimum spacing of at least 100 mm.

Proper design and fabrication of cages is necessary to ensure that failure of hoop reinforcement does not occur as the concrete is being placed in the pile. The case of a cage being grossly distorted by the wet concrete is usually evidenced by downward movement of the projecting bars. Fleming et al (1992) suggested the possible use of welded steel bands in lieu of the normal helical binding to help prevent twisting of the cage during concreting.

In the case of mini-piles where special reinforcement couplers are used, it would be prudent to stagger these such that the minimum spacing between couplers is about 200 mm.

8.3.5.5 Placement of concrete in dry condition

Experience in Hong Kong indicates that concrete of exceptionally low strength of the order of 7 to 10 MPa can result if concrete placement is not controlled properly. The concrete must be placed in such a manner as to prevent segregation. The 'free-fall' method of placing concrete has been found to be generally satisfactory for piles up to about 40 m length provided that the concrete falls directly onto the base without striking the reinforcement or the sides of the bore. This requires the discharge of concrete to be confined in a rigid delivery tube positioned centrally over the pile. It is good practice to use a full-length delivery tube but experience suggests that the concrete may be placed successfully with the use of a short length of delivery tube provided that the concrete is not deflected or impeded during the fall. For raking piles, a full-length delivery pipe should always be used to minimise the risk of segregation.

The interior surface of any temporary casing must not have lumps of fines adhering to it as a result of penetration of cohesive strata, and this can be checked by visual inspection. The lumps are liable to be dislodged by the concrete and form inclusions.

Ideally, the concreting should be carried out in one continuous operation. In the case where concrete delivery is delayed, the concrete already placed may start to bleed or partially set and laitance may be formed. This will lead to poor joints between successive lifts.

Where water has accumulated at the base of the pile, there is a risk of the cement being leached out leading to weaker concrete (Pratt, 1986). Thorburn & Thorburn (1977) suggested that if the depth of water accumulating within the bore exceeds 50 mm between the time of removal of the downhole pump and deposition of the first batch of concrete, the water level should be permitted to reach equilibrium and a tremie pipe used for concreting. Expedients sometimes adopted such as depositing some dry cement prior to discharge of concrete should be discouraged. It is a fallacy to assume that the greater density of concrete will resist the water, as the hydraulic balance will only operate whilst the concrete retains its fluidity. The Hong Kong Institution of Engineers (HKIE, 1987) recommended that where the water inflow rate exceeds 0.3 litres/second, the tremie method should be used for concreting. In certain cases, instead of waiting for the water level to reach steady-state, it may be worthwhile to consider filling the bore with water, as valuable time can be saved and the bore would suffer less from stress relief and disturbance under the seepage forces.

8.3.5.6 Placement of concrete in piles constructed under water or bentonite

Concrete placement in piles constructed under water or bentonite is invariably carried out using a tremie and requires good workmanship and close supervision. Problems have been reported in the literature (e.g. Humpheson et al, 1986) with inferior concrete at the base of piles where the concreting operation is not properly controlled. Care should be taken to ensure that the concrete flows freely and continuously through the tremie pipe. The tremie pipe should be watertight and of sufficient strength. It is important to maintain the discharge end of the tremie pipe below the upper surface of the rising concrete at all times. The tremie pipe should preferably be placed at a depth of between 2 m to 3 m below the concrete surface. Surging (i.e. lifting and lowering) of the tremie pipe should be minimised.

In the case of barrettes, a sufficient number of tremie pipes should be used to ensure that the surface of the concrete rises uniformly within the excavation to minimise the risk of bentonite slurry being trapped.

A plug of vermiculite or other suitable material should be used as an initial separation layer between the first batch of concrete and the water in the open-ended tremie pipe to minimise the risk of segregation.

If the tremie pipe is lifted too high off the pile bottom at the start of concreting, the sudden discharge of concrete could cause intermixing and segregation, resulting in a soft base. Fleming & Sliwinski (1977) suggested the initial lifting should be limited to 100 mm. The use of cementitious materials in the first charge of concrete can minimise the risk of forming a soft base (see Section 8.3.4.6).

The concrete must retain sufficient workability for 'plug' flow to take place, i.e. the already-placed concrete is displaced by the newly-placed concrete as a whole. If the concrete partially sets, the newly-placed concrete may tend to rise above the 'old' concrete by flowing along the side of the tremie pipe (e.g. Littlechild & Plumbridge, 1998). In this case, the filter cake on the wall of the bore will not be scoured effectively and the concrete may contain inclusions.

In the case where the concrete mix is of insufficient workability or there is a long delay in concrete delivery, the tremie pipe could become blocked. The time lapse between batching and placement of concrete should be minimised as far as practicable. If the tremie pipe is raised to clear the blockage and attempts are made to re-insert into the concrete to continue concreting, the pile will be certain to contain inclusions.

8.3.5.7 Concrete placement in continuous flight auger piles

In continuous flight auger piles, the skill of the operator is important during the concreting stage in ensuring pile integrity. The rate of concrete or grout injection and the rate of extraction of the auger must be properly co-ordinated to avoid necking. Likins et al (2004) described an automatic monitoring system that can provide a real-time monitoring of grout injected to the pile bore while extracting the auger. Any deficiency of grout volume from the theoretical value indicates possible necking of the auger piles and immediate action can be taken while the grout is still wet.

8.3.5.8 Extraction of temporary casing

The temporary casing should be clean and smooth and free from distortions that may affect pile integrity during casing removal. The casing must be extracted along the axis of the pile.

The workability of concrete will reduce if the time taken for concreting is excessive. Premature stiffening of the concrete is also possible when there is water absorption into dry aggregates or when too finely-ground or recently-ground cement is used. If this occurs, there is a risk that the partially set concrete is lifted or damaged as the casing is removed. The casing may have to be left in to avoid potential damage to the concrete. In this case, an assessment of potential loss of pile capacity that results from the unintentional leaving of the temporary casing should be made.

Defects could arise if water-filled or slurry-filled cavities created during excavation exist outside the casing and the casing is extracted too rapidly with insufficient concrete head. In this case, as concrete flows to partially fill the cavities, a bulb with a neck on top may result if the water within the cavities cannot flow away rapidly (Figure 8.5). This problem will be exacerbated if the concrete mix is of insufficient workability and may necessitate the use of a permanent liner in stratum where such cavities are likely to form.

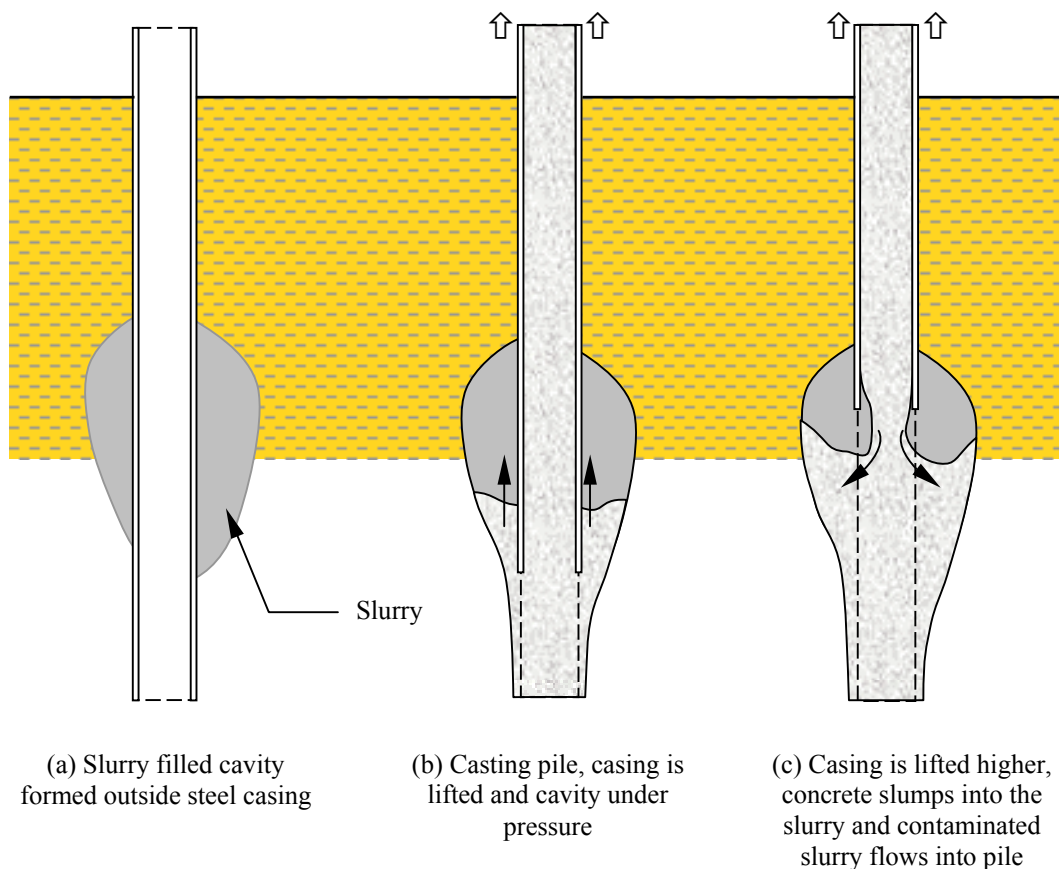

Figure 8.5 – Possible Defects in Bored Piles due to Water-filled Voids in Soils (Sliwinski & Fleming, 1984)

Where a permanent casing is required inside the temporary casing, care should be taken to ensure that concrete or debris does not become lodged between the two casings. Otherwise, the permanent casing could also be lifted. Depending on the nature of the overburden materials, consideration should be given to backfilling the void between the permanent casing and the soil with a suitable material. The permanent casing, in particular the joint, should have adequate strength to avoid possible bursting or collapse. The use of permanent casing may result in lower shaft resistance

Where there are significant hydraulic gradients in highly permeable ground (e.g. tidal conditions near a river or piling in the vicinity of groundwater pumping), there is a risk of leaching of cement and washing out of aggregates in newly-placed concrete. Steep interfaces between permeable strata and cohesive soils along which groundwater flows under significant hydraulic head can also provide the conditions necessary for such attack (Thorburn & Thorburn, 1977). When groundwater leaching is deemed to be a potential problem, a permanent casing of sufficient length should be used.

A case history of necking resulting from the combined effect of an upward flow of artesian water and the presence of loose sand is discussed by Hobbs (1957). Relief pipes attached to the reinforcement cage have been used successfully in projects elsewhere to relieve artesian water pressures during concreting.

8.3.5.9 Effect of groundwater

An unusual case history concerning problems with rock-socketed piles in mudstone and siltstone is reported by Stroud (1987). In this case, the relatively small amount of water seepage during pile bore excavation was sufficient to work the mudstone spoil into a paste but insufficient to wash it off the walls. The paste was subsequently plastered around the bore by the cleaning bucket and caused a substantial reduction in shaft resistance. The remedial solution adopted was to replace the piles, taking due care to add water to the shaft to ensure washing action as the cleaning bucket was introduced.

8.3.5.10 Problems in soft ground

Defects may arise when forming bored piles in very soft ground with undrained shear strengths of less than about 15 to 20 kPa. The lateral pressure of the wet concrete could exceed the passive resistance of the soft soils and bulges on the pile shaft may occur. On the other hand where the concrete head within the casing is insufficient, there is a possibility of the formation of 'necked' shaft due to concrete arching across the casing or due to soil pushing into the concrete.

Near the head of the pile, the lateral pressure of the wet concrete may be low and further reductions are possible due to friction as the casing is extracted. Under such circumstances, it is possible for the very soft soil to squeeze into the pile section and cause necking. The risk of this happening may be overcome by a permanent casing or ensuring a high workability concrete and sufficient head at all stages of the temporary casing extraction.

8.3.5.11 Cut-off levels

The concreted level should be such that when the concrete with laitance is cut down to the cut-off (or trimmed) level, the concrete will be homogeneous and sound. Where the specified cut-off level is low and at depth below ground surface, it may be difficult to achieve the least length of concrete to be trimmed consistent with minimising wastage and the time involved in cutting down. In the case of concrete being placed under bentonite, the top portion of the concrete column may be particularly prone to intermixing with the bentonite cake scoured off the side of the bore. Therefore, a minimum concreting level is usually taken as at least 1m above the required cut-off level.

8.3.6 Potential Problems after Concreting

8.3.6.1 Construction of adjacent piles

Relatively 'green' concrete may be damaged by driving piles in close proximity or due to ground movements associated with excavations.

When adjacent large-diameter replacement piles are constructed close to a newly-concreted pile, there is a risk of 'pile connection', i.e. the relief of stresses upon bore excavation may be sufficient to allow the partially set concrete to flow laterally, particularly where there is soft ground.

Careful thought should be given to planning the sequence of pile construction.

8.3.6.2 Impact by construction plant

Cases have been known where cracks are induced in the piles due to impacts by construction plant. Piles are particularly vulnerable when the piling platform level is subsequently reduced exposing the tops of the piles. Piles can also be cracked when the projecting reinforcement bars are hit, sometimes by the piling rig itself or the service crane during moves. Close supervision is necessary to prevent impact by construction plant.

8.3.6.3 Damage during trimming

Damage may be caused to the concrete when ill-considered means are adopted to trim the pile. This could give rise to disputes as to whether it is the main contractor or the piling subcontractor who is responsible for the cracks.

Where mechanical-controlled means are used to trim the pile head, it is recommended that the last half a metre or so of the concrete should be trimmed by hand-held pneumatic tools for better control to minimise the possibility of the pile column being damaged.

8.3.6.4 Cracking of piles due to thermal effects and ground movement

Large-diameter piles are liable to crack under thermal stresses. Where the pile is adequately reinforced, the cracks are likely to be distributed throughout the depth of the section and are generally of no concern. However, problems of interpretation of integrity tests may arise as to whether the cracks are structurally significant.

Excavation of basements after pile installation will give rise to ground movement and hence tension forces and moments in the piles. Where piles are not adequately reinforced, significant horizontal cracks may occur, affecting the settlement characteristics of the piles. Piles constructed beneath basements prior to excavation should be provided with adequate full length reinforcement to take the potential tension loading that may be generated by the excavation.

8.4 INSTALLATION OF HAND-DUG CAISSONS

8.4.1 General

The construction of hand-dug caissons has been described in detail by Mak (1993) and outlined in Section 4.4.3.

Guidance notes on standard good practice on the construction of hand-dug caissons are published by the Hong Kong Institution of Engineers (HKIE, 1987). This document covers key aspects of construction considerations as well as supervision and safety.

8.4.2 Assessment of Condition of Pile Base

8.4.2.1 Hand-dug caissons in saprolites

For hand-dug caissons founded in saprolites, insitu tests that can be carried out to assess the condition of the founding material upon completion of excavation include plate loading tests (Sweeney & Ho, 1982) and continuous penetration tests using a GCO probe (a lightweight probing test) (Evans et al, 1982). Ku et al (1985) suggested that at least three penetration tests should be made in the base of each hand-dug caisson to assess the degree and depth of any softening.

In carrying out the GCO probing test, standard equipment and testing procedure as detailed in Geoguide 2 : Guide to Site Investigation (GCO, 1987) should be adopted. The tests should be undertaken to at least 1 m below the pile base and the results reported as the number of blows for each 100 mm penetration (designated as the GCO probe blow count, N_p). Evans et al (1982) suggested that N_p is roughly equivalent to SPT N value. This approximate correlation enables an assessment of whether the base condition is consistent with the design assumptions.

Core drilling may be carried out through tubes cast into a pile with the use of a triple tube core barrel to assess the condition of the base interface. The coring is typically extended to not less than 600 mm below the pile base. It is important that attention is given to the use

of an adequate flushing medium and its proper control for success in retrieving the core.

8.4.2.2 Hand-dug caissons in rock

The discussion given in Section 8.3.3 concerning machine-dug piles founded in rock is also relevant to hand-dug caissons. Thomas (1984) suggested that closed circuit television inspection can be carried out to confirm the interface condition for hand-dug caissons.

For hand-dug caissons bearing on rock, the base should be inspected to examine if there are sub-vertical seams of weaker rock or weathered material. Where present, these should be excavated to sufficient depth below the bottom and the local excavation plugged with suitable grout or concrete, prior to commencement of concreting of the pile shaft.

8.4.3 Potential Installation Problems and Construction Control Measures

8.4.3.1 General

There are a number of case histories in Hong Kong involving the use of hand-dug caissons in unfavourable ground conditions. In these cases, the hand-dug caissons were abandoned part way through the contract and replaced with an alternative pile type (Mak et al, 1994).

Potential problems during concreting relate to the quality of the concrete and adequacy of the reinforcement cage, together with the procedure of concrete placement. Reference may be made to Section 8.3.5.

8.4.3.2 Problems with groundwater

The construction of a hand-dug caisson below the groundwater table might induce piping failure (i.e. hydraulic base failure). In coastal reclamation sites where the groundwater table is high and soft or loose superficial deposits extend to considerable depths, excessive inflow and bore instability may occur, leading to ground loss and settlement around the site (Mackey & Yamashita, 1967b), and possible casualties within the hand-dug caissons. Sudden base failure, probably due to an excessive differential hydraulic head between the outside and the inside of the excavation has also been observed in very dense granitic saprolites with average SPT N values of about 70 to 80 prior to construction.

It is often difficult to assess the porewater pressure distribution and seepage gradients because of the heterogeneity of the weathering profile and possible presence of structural discontinuities including relict joints, erosion pipes, fault and dykes. As reported by Morton et al (1980), the measured differential heads between the inside and the outside of a caisson can be between 10% and 97% higher than that estimated based on the assumption of an isotropic, homogeneous aquifer and a simplified flow pattern.

Heavy seepage flow into the bottom of a caisson may cause weakening of the soil through slaking, leaching and dispersion. Loosening (or possible damage of bonding

between soil grains) of initially dense to very dense saprolites can take place under significant groundwater flows, as observed by Haswell & Umney (1978).

Dewatering during caisson construction can cause extensive groundwater drawdown resulting in excessive ground settlement and may result in damage to surrounding utility services and structures. Chan & Davies (1984) observed that the average settlement of buildings supported on piles founded in completely weathered granite is 2 to 3 mm for every metre head of drawdown.

The water discharged from the pumps should be collected in a sedimentation tank and checked regularly to determine the quantity of fines being removed. This would assist in the identification of zones with excessive loss of fines and give an early warning of the possibility of subsidence or collapse of caisson rings in that area. Such ground loss may also lead to excessive settlement of the ground surface.

8.4.3.3 Base heave and shaft stability

Excessive differential head or hydraulic gradient and unstable ground could lead to collapse of the excavated face, rapid inflow of mud and water, and heaving of the caisson base. In extreme situations, voids can be created in the ground adjacent to the caissons and can lead to formation of sinkholes if ground loss is excessive.

The rate of base heave has been found to be variable between sites, and between piles in any one site (Shirlaw, 1987). In some cases, heave occurs quickly and can only be recognised by counting the number of buckets of arising for each working shift. The mechanism of base heave is generally thought to be related to slaking, swelling and softening of the soils which are a function of the degree of weathering and can be promoted by stress relief and high seepage gradient (Chan, 1987). Alternatively, the bonded structure of the saprolites may collapse as the material starts to yield under low effective stresses and therefore softening in situations where the material is in a metastable state (Lam, 1990).

Some weathered granites have been observed to exhibit a pronounced tendency for swelling and loosening at low effective stresses (Stroud & Sweeney, 1977; Davies & Henkel, 1980). Mackey & Yamashita (1967a) observed that the zone of loss of soil strength was as much as 9 m away from the caisson. A possible cause of significant base heave and shaft instability could be improperly backfilled site investigation boreholes or the presence of old wells.

If excavation has to proceed below the apparent rock surface where caisson rings will not be constructed, the risk of caisson instability arising from the presence of weathered rocks outside the unsupported shaft possibly under a high water head should be carefully considered. Local grouting of the soil-rock interface may be necessary in order to minimise this problem.

8.4.3.4 Base softening

It is common for softening to occur rapidly in granitic saprolites in the base of

excavations below the water table (Philcox, 1962; Mackey & Yamashita, 1967a). The susceptibility to softening is related to the degree of weathering. Some completely weathered granites swell rapidly when the effective stress is reduced to a low value (Davies & Henkel, 1980).

Evans et al (1982) observed significant softening of a caisson base down to a depth of 0.8 m, about 70% of the shaft diameter. The degree of softening increased with the length of time between completion of excavation and commencement of concreting. It was further observed that upon concreting, re-compression of the softened base took place to a depth of about 50% of the pile diameter over a period of 10 days. Grouting of the pile base was carried out at a maximum pressure of 300 kPa but the re-compression of the softened material was not significant in this instance. If there are lengthy delays to the placement of reinforcement and concrete, consideration may be given to constructing a concrete plug at the bottom of the pile in order to limit the effects of stress relief.

Endicott (1980) reported similar findings of base softening but found from loading tests on short length concrete plugs that the base stiffness was satisfactory, with the load resisted by shaft resistance. However, to improve confidence level and alleviate the concern of long-term behaviour of caissons with a soft base, the pile base was grouted to achieve a given probe test resistance.

Even in the situation where the general groundwater table has been drawn down, some disturbance to the shaft of the bore will be inevitable due to stress relief and possible seepage gradient built up around the pile. This is highlighted by the results of horizontal plate loading tests in completely decomposed granite reported by Whiteside (1986). In these tests, the disturbed zone appeared to be fully re-compressed at a stress level ranging from 400 to 500 kPa, and it is notable that this stress level is substantially in excess of the vertical effective stress and the likely pressure of the wet concrete.

8.4.3.5 Effects on shaft resistance

In difficult ground conditions, forepoling stakes may be driven into the ground ahead of the excavation to provide temporary support prior to the casting of concrete liner for each lift. These timber stakes are typically left in the ground and could potentially result in reduced shaft resistance.

Where there is a tendency for high seepage gradients and base heave, the ground may be subject to softening around the hand-dug caisson and hence result in reduction in shaft resistance. If the bore is allowed to cave in, loosening of the surrounding ground will result. Tests to evaluate the available frictional resistance of the caisson rings can be carried out from within caissons using a special jacking frame (Sweeney & Ho, 1982; Sayer & Leung, 1987).

8.4.3.6 Effects on blasting

Where blasting is used to break up obstructions or expedite excavation in rock, consideration should be given to assessing the effects on relatively green and mature concrete

in adjacent caissons, as well as on caisson ring stability where bore excavation is not complete.

8.4.3.7 Cavernous marble

Houghton & Wong (1990) discussed the potential problems associated with construction of hand-dug caissons in karstic ground conditions. The principal problem is the need for dewatering during construction, which could lead to sinkhole formation (Chan, 1994b). The use of hand-dug caissons in karstic marble is strongly discouraged.

8.4.3.8 Safety and health hazard

The particular nature and procedure adopted in hand-dug caisson construction have rendered this operation one of the most accident-prone piling activities in Hong Kong. The most common causes of accidents include persons falling into the excavation, falling objects, failure of lifting gear, electrocution, ingress of water/mud flow, concrete ring failure, and asphyxiation. Furthermore, the working environment constitutes significant health hazards arising principally from the inhalation of silica dust that may cause pneumoconiosis.

Concern for safety and health hazards must start at the design stage and continue until completion of the works. Training courses for workers and their supervisors should be promoted. General guidance aimed at site operatives is provided by the HKIE (1987).

8.4.3.9 Construction control

Precautionary measures which could be adopted to minimise the effects of groundwater drawdown and ground loss include the construction of a groundwater cut-off (e.g. sheet piles or perimeter curtain grouting coupled with well points or deep wells) which encloses the site, the use of recharge wells in the aquifer undergoing drawdown (Morton et al, 1981), and advance grouting at each caisson position prior to excavation. Reference may be made to Shirlaw (1987) on the choice of grout for caisson construction. Care should be taken to control the grouting pressures to avoid excessive ground movement.

Where deep well dewatering is deemed to be unwarranted, the use of pressure relief wells constructed prior to commencement of excavation may be considered to reduce the risk of high hydraulic gradients developing during construction. This is particularly relevant where there is a risk of artesian water pressure at depth.

The presence of old wells or underground stream courses will affect the effectiveness of the pre-grouting operation. In addition, where fractures are induced in the ground during grouting as a result of using an inappropriate grout type or lack of control of the grouting process, the permeability and hence the rate of softening may increase which could lead to base heave.

An alternative means of control is phasing of caisson construction sequence in order to limit ground movements and groundwater drawdown. Where caissons are sunk on a group

basis, one or two caissons may be advanced first to serve as deeper dewatering points for the other caissons.

Where poor ground is encountered, grouting may be carried out locally to help stabilise the soil for further excavation. Alternatively a steel casing may be installed through the soft ground. Any voids resulting from over-excavation or caving should be backfilled with concrete of similar quality as the lining.

Where significant base heave has been observed, the surrounding ground is likely to have been disturbed and both the shaft resistance and the end-bearing resistance may be affected. A careful review of the design for the affected caissons will need to be made.

The design of the linings should be examined for suitability and may need to be examined after construction, as for any other structural temporary works. In assessing the effects of blasting on relatively 'green' concrete, reference may be made to Mostellor (1980) who suggested limiting ppv values of 6, 13 and 25 mm/sec for a concrete age of 12, 24 and 48 hours respectively as a very rough guide.

In addition to ensuring strict compliance with safety requirements and implementation of precautionary measures, it is important that sufficient instrumentation comprising piezometric and movement monitoring of the adjacent ground and structures is included to control the excavation operation. The monitoring results should be regularly reviewed to assess the need for remedial measures.

Possible early signs of instability should be taken seriously and investigated thoroughly. Excessive excavation depths and hence the risk of base heave will be reduced if rational design methods are adopted to avoid overly-conservative pile designs.

8.5 INTEGRITY TESTS OF PILES

8.5.1 Role of Integrity Tests

The most direct tests of pile integrity and performance under load are physical coring and static pile loading tests. Both methods have limitations. Static loading tests are not very effective in determining pile integrity (Section 8.5.3). Physical coring can provide samples for visual examination and for compression testing. However, physical coring can only examine a small portion of the cross-sectional area and usually cannot sample important areas such as areas outside the reinforcement and hence, it can only provide a partial check. Non-destructive integrity testing has been used to augment these tests in assessing structural integrity of piles. Provided that the limitations of integrity tests are understood and allowed for, these tests can provide a useful engineering tool for quality control. Although the tests are intrinsically indirect, they are relevant as comparative tests and can act as a means of screening large numbers of nominally similar piles. This allows a reasoned and logical approach in the selection of piles for further investigation or compliance tests.

The tests can generally be carried out rapidly and without causing significant disruption to the works. They can be cost-effective in that defective works or inadequate procedures may be identified at an early stage of foundation construction. The test results

can usually be displayed on site and a qualified operator can judge the validity of the data and recognise any potential defects from a preliminary assessment.

As a large number of piles can be tested, integrity testing can play an important role in encouraging higher construction standards and promoting self-imposed improvements in installation techniques and quality control.

8.5.2 Types of Non-destructive Integrity Tests

8.5.2.1 General

The most commonly-used types of integrity testing in Hong Kong include sonic logging (sometimes referred to as sonic coring), vibration (sometimes referred to as impedance or transient dynamic response) tests, echo (or seismic or sonic integrity) tests, and dynamic loading tests.

The principles and limitations of these tests are briefly summarised in the following sections. Other types of integrity tests include radiometric and electrical methods and stress wave tests (Fleming et al, 1992) which have been suggested and used with limited success elsewhere but have not yet been introduced in Hong Kong. Reference may be made to Weltman (1977) for a summary of the principles of these tests.

8.5.2.2 Sonic logging

Sonic logging is generally used in cast-in-place piles or barrettes. This test is based on acoustic principles and essentially measures the propagation time of sonic transmission between two piezoelectric probes placed in plastic tubes, or more usually metal tubes, cast into a pile. In general, the concrete/tube coupling is better with metal tubes. Plastic tubes, if used, must be sufficiently robust under the head and temperature of the wet concrete and during the lifting of the reinforcement cage. Plastic tubes have also been found to be more prone to erroneous readings.

It is common practice that sonic tubes are pre-installed in individual bored piles or barrettes. This allows sonic logging to be carried out whenever necessary. Alternatively, the 150 mm 'reservation tube' used for interface coring (Section 8.3.3) can be used for sonic logging.

The tubes (usually 40 to 50 mm in diameter) are filled with water to provide acoustic coupling for the transmission. Both the emitter and receiver probes are lowered to the base of the tubes and raised by a hand winch calibrated for depth at a rate of about 200 mm/sec. With the transmission frequency of about 10 Hz, this corresponds to a sonic pulse every 20 mm. Alternatively, metal wheels with a depth encoder can be used.

Each arriving signal is used to produce a variation in intensity of an oscilloscope scan and is modulated to a series of black-and-white lines. Alternatively, the output can be in the form of a printout consisting of a plot of pulse time against depth. Any increase in propagation time or loss of signal, which are indicative of poor quality concrete or defects,

can be easily detected by comparing the signals one above the other. The complete trace can be recorded on a digital camera or the results can be stored digitally. The scale of any part of the display may be blown up to allow a detailed examination. The emitter and receiver probes may be lifted up to different levels so as to better define the extent of the defects. This arrangement should be used to check for the presence of horizontal cracks.

As the recorded signal is, to a certain extent, a function of the sensitivity of the signal conditioning equipment and the pre-selection of the threshold strength of the arriving signal, standardisation of equipment is essential.

Guidance on the number of tubes to be employed for different pile sizes is given by Tijou (1984). The positions of the emitter and receiver probes can be varied in the tests to improve the accuracy in the identification of the extent of defects (Figure 8.6). Tests using a single tube can also be carried out. In this case, the tube should be made of plastic instead of steel because the latter is a better transmitter of acoustic energy than concrete, and hence it is liable to affect the acoustic paths and give false results about the integrity of the concrete.

The main objective of sonic logging is to check the homogeneity of the concrete. Sonic logging can detect the presence of defects including honeycombing and segregation, necking, presence of foreign material (i.e. inclusions) and cracks. However, it is not capable of identifying the nature of the defects. Moreover since the tubes are normally placed inside the reinforcement cage, sonic logging is generally not capable of identifying problems with inadequate peripheral concrete cover to reinforcement.

Controlled laboratory and field tests have been reported by Stain & Williams (1991) in the assessment of the effects of various types and sizes of anomalies on sonic logging results, and the effect of signal 'skipping' round the anomaly via the access tubes.

As the test relies on a cross-hole method, there is no depth limitation associated with signal damping problems. However, there is a limit on the maximum distance between tubes for a reliable sonic trace to be obtained. Also, poor bonding between the tube and the concrete may result in anomalous response.

8.5.2.3 Vibration (impedance) test

These tests are based on the measurement of the dynamic response of piles in the frequency domain. In its original form, the test involves the use of an electro-dynamic vibrator to impose a sinusoidal force of constant amplitude containing energy over a broad frequency band, preferably from 0 to 5 000 Hz. A development of this test is the transient dynamic response (also known as Impulse Response Test) method in which the transient frequency response of the pile to a single blow is analysed using a Fast Fourier Transform technique. In this method, a small hand-held hammer fitted with an internal load cell is used in lieu of the vibrator, and a vibration transducer (either an accelerometer or a geophone) determines the resulting velocity at the pile head. The hammer must be able to generate an impulse of the above frequencies. The results and the method of interpretation are identical for both types of test.

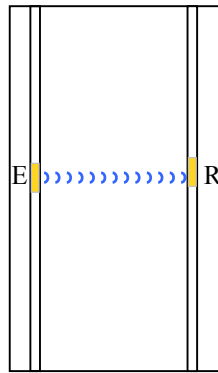

(a) Horizontal Test

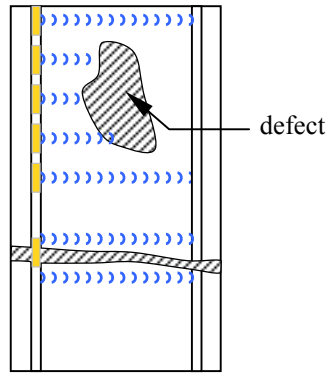

(b) Influence of Irregularities

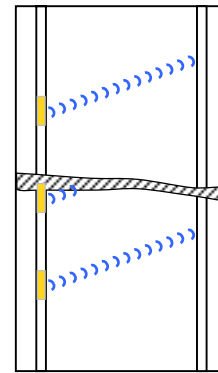

(c) Inclined Test

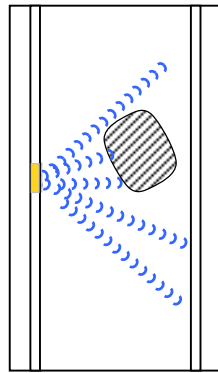

(d) Fan-shaped Test

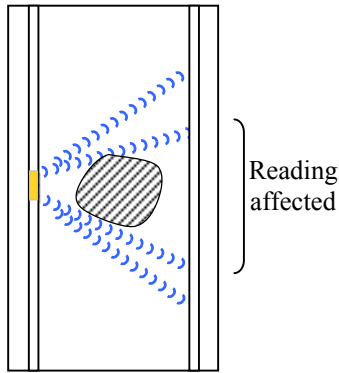

(e) Zone of Influence

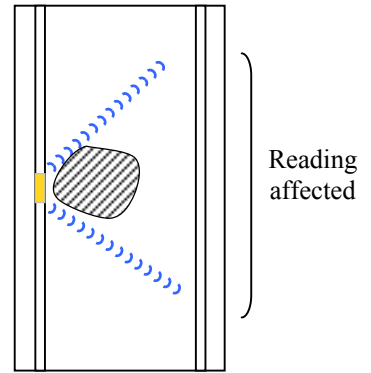

(f) Irregularity near the Sonic Tube

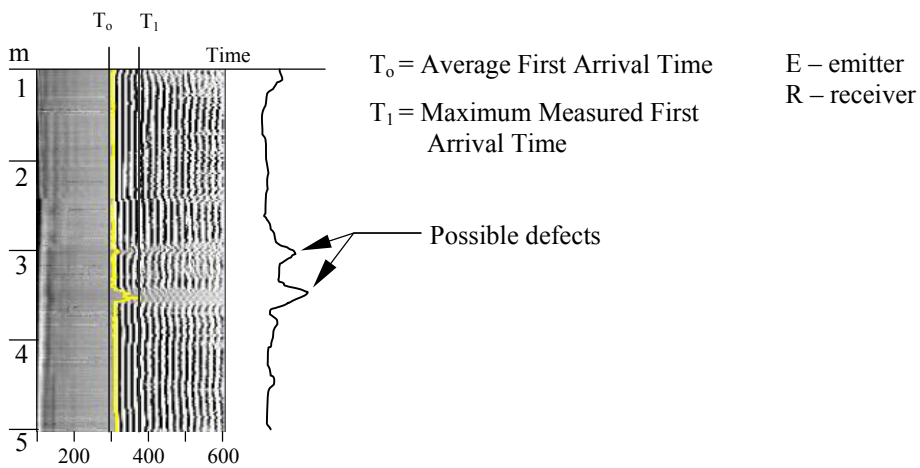

(g) Typical Trace Profile

Figure 8.6 – Detection of Pile Defects by Sonic Coring (Based on Tijou, 1984)

For the tests, the pile head should be prepared by trimming to sound concrete, and sometimes a layer of cement mortar is cast over the pile head. Preparation of the pile head should be done at least one day before the test if mortar is used. The test is normally carried out at least four days after casting of the pile.

The results are presented in the form of a mobility diagram in which the mechanical admittance (pile head velocity, v_t , per unit applied force, F_{pu}) is plotted against excitation frequencies, f . A typical trace is shown in Figure 8.7.

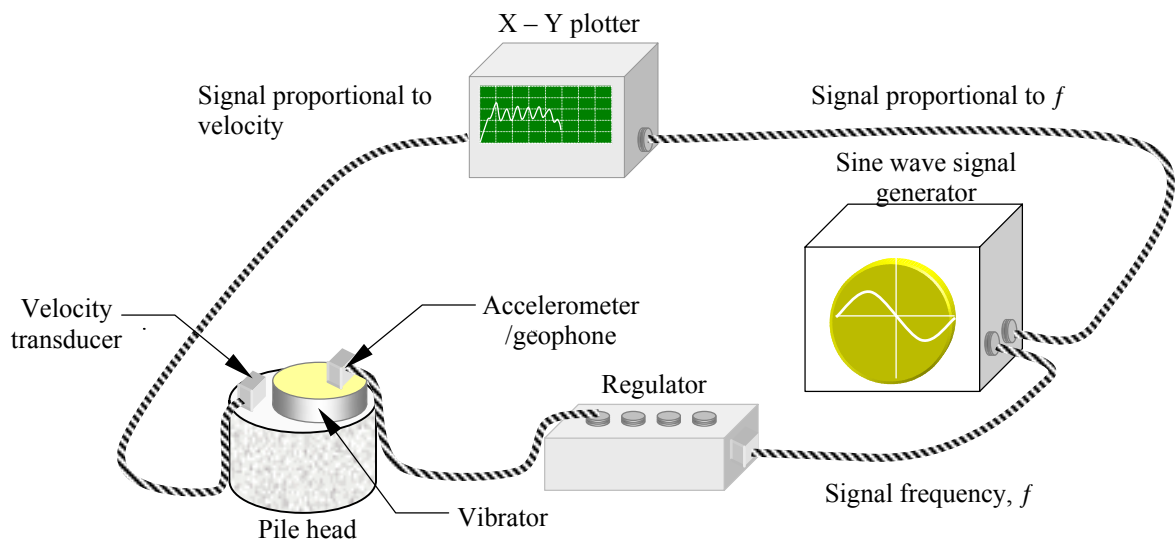

(a) Schematic Arrangement in a Vibration Test

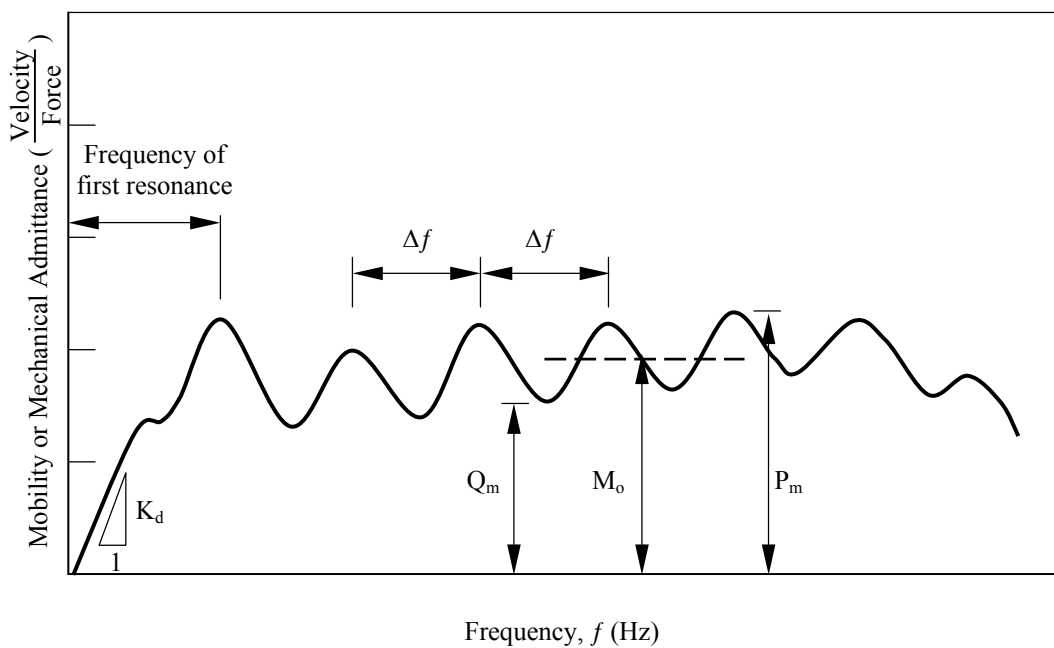

(b) Idealised Results of a Vibration Test

Figure 8.7 – Typical Results of a Vibration Test

In principle, the physical characteristics that can be derived from the results are :

- (a) Dynamic pile head stiffness (K_d) - This is the slope of the low frequency (i.e. < 100 Hz) linear portion of the graph from the origin to the first peak. This value is sensitive to the stiffness of the pile shaft under compression.
- (b) Condition of anchorage at pile toe - The position of the first resonant frequency (or peak on the trace) depends on the end condition of the pile. For a pile toe that is rigidly constrained (end-bearing pile), the first resonant frequency is given by $\frac{v_c}{L_{res}}$ where v_c is the average wave velocity in concrete and L_{res} is the resonating length. For an unconstrained pile toe (friction pile), the first resonant frequency is $\frac{v_c}{2L_{res}}$.
- (c) Resonating length (L_{res}) - Resonant peaks at high frequencies occur at frequency intervals of $\frac{v_c}{2L_{res}}$.
- (d) Characteristic mobility (M_o) - The average value of $\frac{v_t}{F_{pu}}$ from the trace is termed the characteristic mobility. This is given by the expression $M_o = \frac{1}{\rho_c v_c A_c}$, where ρ_c is the concrete density and A_c is the concrete cross-sectional area. For a given force, piles with a smaller section will have a greater mobility. Thus, the relative concrete quality (or conversely the cross-sectional area if the strength is known) can be assessed.
- (e) Damping factor (D_c) - Damping of the signal by the interaction of soil and pile is described by the ratio of the mobility, $\frac{v_t}{F_{pu}}$, at resonance (peaks) to that at anti-resonance (troughs) on the trace. Hence the greater the amplitude of the sinusoidal wave form, the less the damping.

Vibration tests are suitable for identifying anomalies such as cracks, poor jointing and necking of piles. A guide to the interpretation of the test results is given in Table 8.9.

Table 8.9 – Interpretation of Vibration Tests on Piles (Robertson, 1982)

| Dynamic Stiffness, K_d | Resonating Pile Length, $\frac{v_c}{2\Delta f}$ | Characteristic Mobility, M_o | Pile Integrity Assessment |
|--------------------------|---|--------------------------------|---|
| As expected | As built | As expected | Regular pile |
| Very high | Short | Low | Possible bulb at depth |
| High | Near as built | Low | General oversized pile section |
| | Multiple length | Variable/low | Irregular pile section in pile shaft (enlargements) |
| Low | As built | As expected | Regular pile with strong anchorage and low settlement expected |
| | As built | High | Possible reduction in pile section or lower grade concrete in pile |
| | As built | As expected | Regular pile with weak anchorage and high settlement expected |
| Very low | Multiple length | Variable/high | Irregular pile section in pile shaft (constrictions), or changeable quality of concrete |
| | Short | Very high | Possible defect at depth |

Vibration testing, although based on sound theory, is not a precise analytical tool. The limitations of the test may be summarised as follows :

- (a) The signal is easily damped for piles with a length to diameter ratio of about 20 in stiff and dense soils and 30 in loose soils. Resonant peaks may be difficult to identify in practice. For tubular piles, closed circuit television inspection may provide an alternative means of assessing pile integrity where signal damping is excessive (Evans et al, 1987).
- (b) The wave velocity in concrete, v_c , has to be assumed in order to calculate the resonating length, L_{res} . If L_{res} is known, the average value of v_c can be calculated. The assessment will not identify small but perhaps structurally significant variations in v_c through weak concrete zones.
- (c) Small but abrupt changes in pile cross section (e.g. transition from the cased to the uncased bore) can often generate resonant behaviour that is not structurally significant. On the other hand, the test may not be sensitive to gradual changes in pile section.

- (d) The test is unable to quantify the vertical extent of section changes or the lateral position of defects.
- (e) The test may not be able to detect vertical cracks.
- (f) Subjective errors are possible, particularly for piles with complex and multiple resonance. A range of digital signal processing techniques, including digital integration and signal averaging, may be adopted to aid interpretation (Chan et al, 1987). These advanced techniques must be used with extreme caution to avoid spurious results.

Where the number of joints in a precast pile is small and the condition of the splicing is good, the presence of joints is not necessarily a limitation to the use of vibration tests.

It is possible to carry out a computer simulation of the pile geometry and ground characteristics in advance of site testing. This simulation may be useful in enabling the engineer to correlate a doubtful curve with the probable kind of irregularity.

8.5.2.4 Echo (seismic or sonic integrity) test

The test is suitable for bored piles and precast concrete piles. The principle of echo tests is based on the detection of a reflected echo or longitudinal wave returning from some depth down the pile. The measured time of travel of the vibration wave together with an assumed propagation velocity enable the acoustic length to be determined. The test is normally carried out at least seven days after casting of the concrete.

There are two generic time domain echo type tests, namely sonic echo and pulse echo. Reference may be made to Ellway (1987) and Reiding et al (1984) for a summary of the principles of operation and interpretation of the tests. Forde et al (1985) also described the improvements in time domain analysis of echo traces through the use of an auto-correlation function to detect reflections in the velocity-time signal.

In the echo test, the pile is struck by a hammer and the resulting vibration signal (e.g. velocity) is measured at the pile head by means of a geophone or an accelerometer. In general, longer pulses are used to detect defects at greater depths whilst shorter pulses are used for possible defects at shallow depths. After digital filtering of extraneously low and high frequency oscillations, the signals can be range-amplified to magnify the response. Random noise can also be reduced by signal-averaging techniques. Identification of reflection time and determination of echo phase can be done using signal processing techniques including auto-correlation and cross-correlation methods.

Examples of typical test results are given in Figure 8.8. The phase of the reflected wave provides a means of discriminating reflections from large bulbs or severe necks (or cracks), which constitute fixed and free surfaces respectively.

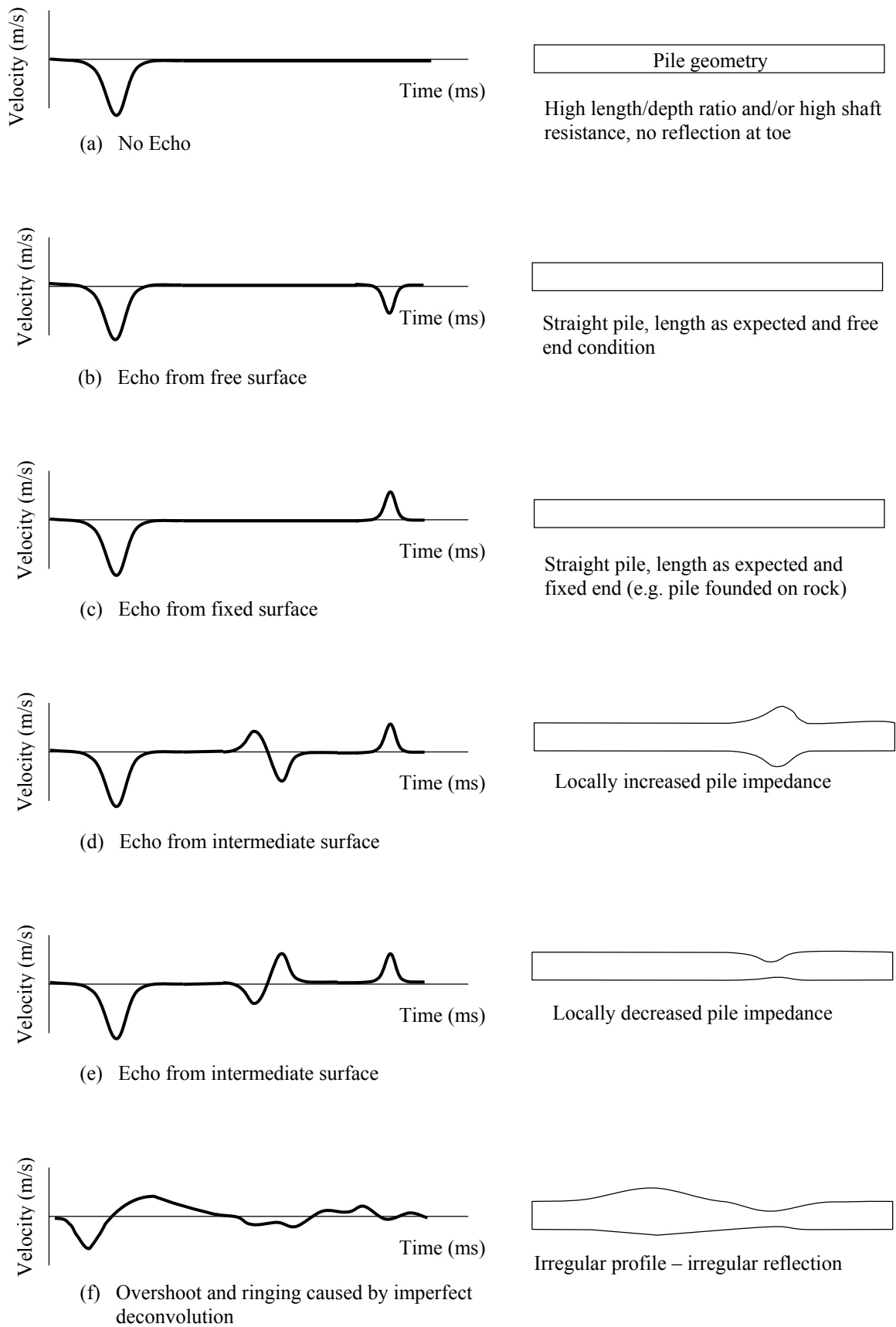

Figure 8.8 – Examples of Sonic Integrity Test Results (Based on Ellway, 1987)

The limitations of the test may be summarised as follows :

- (a) Multiple reflections from mechanical joints or severe cracks may limit the propagation of the stress wave. The test may not be suitable for prefabricated piles with many jointed sections (Hannigan et al, 1998).
- (b) Reflections from surfaces of intermediate stiffness such as small bulbs or necks can cause frequency-dependent phase distortions of the signal making interpretation more difficult.
- (c) In the case of anomalies near the pile head, the response can be distorted to such an extent as to give rise to problems of signal filtering.
- (d) The penetration of the signal into the pile is limited by shaft resistance. A high shaft resistance will reduce pile length that can be tested. Under normal circumstances, it is generally unlikely that a reflection can be detected for a pile with a length to diameter ratio of greater than 30 or at depth greater than 20 m (O'Neill & Reese, 1999). The accuracy in determining the pile length depends on the accuracy of the prediction of speed of wave propagation. Wave speed variation of 10% is not uncommon (Hannigan et al, 1998).
- (e) Site vibrations (e.g. from construction plant) could affect the signal. This effect may be minimised by analysing repeated hammer blows and by signal averaging.
- (f) It is capable of identifying well-defined cracks, particularly near the pile head. However, the signal is less clear for diagonal cracks.
- (g) It is insensitive to changes in concrete quality as an average sonic velocity for concrete has to be assumed in the interpretation. Any inclusion needs to be significant enough to cause a reflection of the signal and this depends more on its dynamic and acoustic properties than on its strength.
- (h) The long wave length generated from a hammer blow makes it difficult to detect defects of small thickness. Samman & O'Neill (1997) reported that a defect of less than 25 mm cannot be reliably identified.

Both the echo tests and vibration tests involve excitation of the pile head and measurement of the dynamic response to vibration. In principle, a single signal of a hammer

blow can be analysed both in the time and frequency domains. There is an attempt to combine the results to produce a trace referred to as an impedance log, which provides a vertical section through the pile (Paquet, 1992). However, this should be treated with caution as the number of variables involved are such that the impedance log may not be unique and precise.

8.5.2.5 Dynamic loading tests

Dynamic loading tests are high-strain tests whereby stress waves are generated by the impact of the pile with a piling hammer. Apart from detecting defects in piles, dynamic loading tests can be used to predict pile capacity. In the tests, sufficient force should be delivered to the pile such that a minimum pile penetration of about 2 to 3 mm/blow is achieved where practicable, particularly if it is required to provide a prediction of the pile capacity. The stress wave will be reflected from the pile toe and any irregularities in the pile shaft. The hammer impact and wave reflections are monitored with the use of strain gauges and accelerometers. Further details of the tests and its application in the prediction of pile capacity are given in Section 9.4.

The results from the instrumentation are expressed as time history plots of the force and velocity. Rausche & Goble (1979) suggested the use of a damage classification factor, β_z , which is defined in terms of changes in impedance (Equation [8.1]) as follows :

$$\beta_z = \frac{Z_2}{Z_1} \quad [8.4]$$

where Z_2 = pile impedance above a given level where there is a significant change in impedance
 Z_1 = pile impedance below the same given level

Impedance, Z , is defined as follows :

$$Z = \frac{E_p A_p}{c_w} = \frac{F_p}{v} \quad [8.5]$$

where E_p = Young's modulus of pile
 A_p = cross-sectional area of pile
 c_w = velocity of longitudinal stress wave through the pile
 F_p = force at a given pile section
 v = particle velocity

The tentative classification scheme proposed by Rausche & Goble (1979) is reproduced in Table 8.10. This simplified method is related to the extent of pile cross-section that is left after the damage, and is based on the tacit assumption that the soil resistance immediately below the point of damage is negligible.

The limitation of this method of integrity testing is that small cracks tend to close up during the hammer blow, and only major damage can be identified. The presence of small

cracks can be detected using the sonic logging tests.

Broms & Bredenberg (1982) showed that if the time required to close a crack and the reflected stress wave are measured, the width of the crack may be calculated. An important distinction between a crack and significant damage is that the latter will become worse while a crack will diminish as driving becomes harder. Fleming et al (1992) suggested that a crack of about 1 mm width would be a lower bound of detection by dynamic pile testing.

Table 8.10 - Classification of Pile Damage by Dynamic Loading Test (Rausche & Goble, 1979)

| Factor β_z | Severity of Damage |
|------------------|--------------------|
| 1.0 | Undamaged |
| 0.8 - 1.0 | Slightly damaged |
| 0.6 - 0.8 | Damaged |
| Below 0.6 | Broken |

Note : Factor β_z is the ratio of impedance of the pile section above and that below a given level.

8.5.3 Practical Considerations in the Use of Integrity Tests

The choice of the appropriate type of integrity tests should be made in relation to the type of pile, the ground conditions, and the anticipated construction defects. It is essential to have a basic understanding of the principles of the tests and their limitations.

Integrity tests are generally indirect tests and therefore cannot definitively identify whether the defects, if any, will significantly affect the pile behaviour under load. Thus, the results alone cannot serve as the basis for a sound engineering decision on the acceptability or otherwise of the pile. In all cases, experienced interpretation is required and the results of the interpretation must be considered in conjunction with the pile construction records.

Prior to conducting integrity testing, it is prudent to plan the course of actions that need to be taken if anomalies are detected.

It should be noted that integrity tests cannot be used to predict pile capacity. The running of integrity tests is valuable in that the results that exhibit anomaly could be used as the basis in selection of piles for loading tests, thus permitting a much better appreciation of the relative performance of the pile population.

Dynamic loading tests are somewhat special in that the tests can be used as integrity tests and can predict pile capacity. However, dynamic loading tests have not yet been accepted for acceptance tests, unless they are calibrated with the appropriate static loading tests. The Pile Driving Analyzer (PDA) testing associates with dynamic loading tests may be used for the following purposes :

- (a) to identify in conjunction with piling records, doubtful piles for investigation or static loading tests,
- (b) to check the consistency of hammer efficiency,
- (c) to assess the structural integrity of a pile, and

- (d) to check the adequacy of the final set criterion as derived from a pile-driving formula.

Tijou (1984) reported typical correlations established in Hong Kong between dynamic and static pile head stiffness for various types of driven and bored piles, and between propagation velocity from sonic logging and unconfined compressive strength of concrete. These correlations should however be treated with caution as the database may not be sufficiently representative for firm conclusions to be drawn.

It is important that a proper specification is drawn up which should clearly state the performance requirements of the tests, the parameters to be measured, the means of interpretation and how the results should be reported. If the test data are presented in a standardised way, the results can be easily compared and contrasted.

It is essential that careful thought be given to the planning of an integrity testing programme. The testing should be properly integrated into the works construction programme with suitable stop or hold points included to allow the results to be fully assimilated, examined and interpreted. Time should also be allowed for the possible need for additional testing or investigation to supplement the integrity tests. Normally, a minimum of five percent of piles in one project are subject to integrity tests.

It should be recognised that only an acoustic anomaly may be identified by integrity tests and this may not necessarily correspond to a structural defect. Despite the fact that cracks and other minor defects may not influence the load-settlement performance of a pile in the short term, the long-term performance may be impaired as a result of corrosion of reinforcement, spalling of concrete or reduction in effective concrete sections. The engineer should consider appropriate means of investigating possible anomalies identified by integrity tests including exposing the pile sections where practicable.

9. PILE LOADING TESTS

9.1 GENERAL

Given the many uncertainties inherent in the design and construction of piles, it is difficult to predict with accuracy the performance of a pile. The best way is to carry out a loading test. Loading tests can be carried out on preliminary piles to confirm the pile design or on working piles as a proof loading tests. Although pile loading tests add to the cost of foundation, the saving can be substantial in the event that improvement of to the foundation design can be materialised.

There are two broad types of pile loading tests, namely static and dynamic loading tests. Static loading tests are generally preferred because they have been traditionally used and also because they are perceived to replicate the long-term sustained load conditions. Dynamic loading tests are usually carried out as a supplement to static loading tests and are generally less costly when compared with static loading tests. The failure mechanism in a dynamic loading test may be different from that in a static loading test.

The Statnamic loading test is a quasi-static loading test with limited local experience. In this test, a pressure chamber and a reaction mass is placed on top of the pile. Solid fuel is injected and burned in the chamber to generate an upward force on the reaction mass. An equal and opposite force pushes the pile downward. The pile load increases to a maximum and is then reduced when exhausted gases are vented from the pressure chamber. Pile displacement and induced force are automatically recorded by laser sensors and a load cell. The load duration for a Statnamic loading test is relatively long when compared with other high energy dynamic loading tests. While the additional soil dynamic resistance is usually minimal and a conventional static load-settlement curve can be produced, allowance will be required in some soil types such as soft clays. Section 9.3.3.3 discusses load rate effects in more detail. Reference may be made to Birmingham & Janes (1989), Janes et al (1991) and Middendorp et al (1992) for details of the testing technique and the method of interpretation.

Lee et al (1993) described a 'simple pile loading test' system for driven tubular piles which comprises a separable pile shoe and a reduced-size sliding core for a rapid determination of the separate components of shaft and end-bearing resistance, however, the experience with this in Hong Kong is limited.

In this Chapter, the different types of loading tests, which are commonly used, are described. Details of pile instrumentation and information that can be derived from the instrumented loading tests are given.

9.2 TIMING OF PILE TESTS

For cast-in-place piles, the timing of a loading test is dictated by the strength of the concrete or grout in the pile. Weltman (1980b) recommended that at the time of testing, the concrete or grout should be a minimum of seven days old and have a strength of at least twice the maximum applied stress.

With driven piles, there may be a build-up of pore water pressure after driving but data in Hong Kong are limited. Lam et al (1994) reported that for piles driven into weathered meta-siltstone the excess pore water pressure built up during driving took only one and a half days to dissipate completely.

Results of dynamic loading tests reported by Ng (1989) for driven piles in loose granitic saprolites (with SPT N values less than 30) indicated that the measured capacities increased by 15% to 25% in the 24 hours after installation. The apparent 'set up' may have resulted from dissipation of positive excess pore water pressure generated during pile driving.

As a general guideline, Weltman (1980b) recommended that a driven pile should be tested at least three days after driving if it is driven into a granular material and at least four weeks after driving into a clayey soil, unless sufficient local experience or results of instrumentation indicate that a shorter period would be adequate for dissipation of excess pore pressure.

9.3 STATIC PILE LOADING TESTS

9.3.1 Reaction Arrangement

To ensure stability of the test assembly, careful consideration should be given to the provision of a suitable reaction system. The geometry of the arrangement should also aim to minimise interaction between the test pile, reaction system and reference beam supports. It is advisable to have, say, a 10% to 20% margin on the capacity of the reaction against maximum test load.

9.3.1.1 Compression tests

Kentledge is commonly used in Hong Kong (Figure 9.1). This involves the use of dead weights supported by a deck of steel beams sitting on crib pads. The area of the crib should be sufficient to avoid bearing failure or excessive settlement of the ground. It is recommended that the crib pads are placed at least 1.3 m from the edge of the test pile to minimise interaction effects (ICE, 1988). If the separation distance is less than 1.3 m, the surcharge effect from the kentledge should be determined and allowed for in the interpretation of the loading test results.

Tension piles used to provide reaction for the applied load (Figure 9.2) should be located as far as practicable from the test pile to minimise interaction effects. A minimum centre-to-centre spacing of 2 m or three pile diameters, whichever is greater, between the test pile and tension piles is recommended. If the centre spacing between piles is less than three pile diameters, there may be significant pile interaction and the observed settlement of the test pile will be less than what should have been. If a spacing of less than three pile diameters is adopted, uplift of the tension piles should be monitored and corrections should be made for the settlement of the test pile based on recognised methods considering pile interaction, such as Poulos & Davis (1980). A minimum of three reaction piles should be used to prevent instability of the set up during pile loading tests. Alternatively some form of lateral support should be provided.

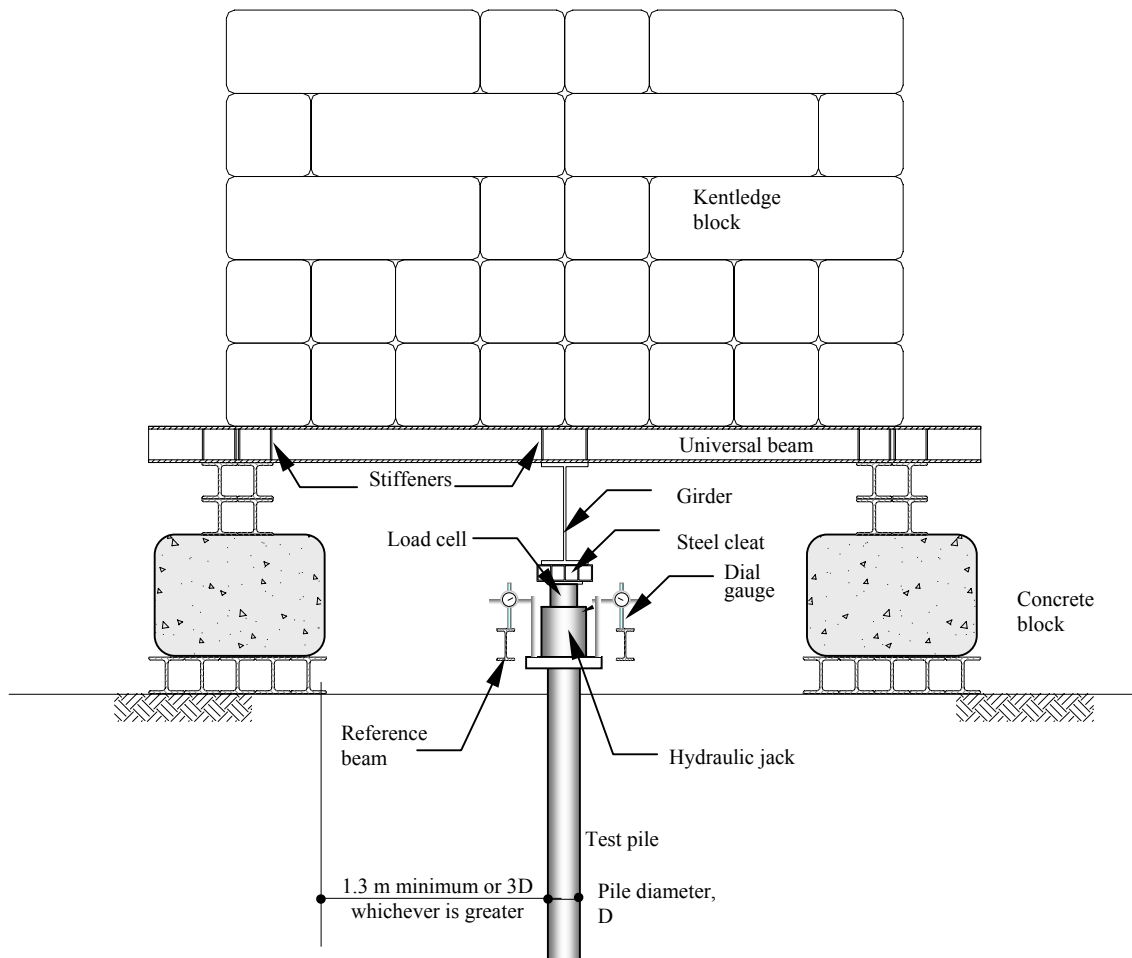

Figure 9.1 – Typical Arrangement of a Compression Test using Kentledge

To reduce interaction between the ground anchors and the test pile, the fixed lengths of the anchors should be positioned a distance away from the centre of the test pile of at least three pile diameters or 2 m, whichever is greater. Ground anchors may be used instead of tension piles to provide load reaction. The main shortcomings with ground anchors are the tendon flexibility and their vulnerability to lateral instability.

The provision of a minimum of four ground anchors is preferred for safety considerations. Installation and testing of each ground anchor should be in accordance with the recommendations as given in GCO (1989) for temporary anchors. The anchor load should be locked off at 110% design working load. The movements of the anchor should be monitored during the loading tests to give prior warning of any imminent abrupt failure.

The use of ground anchors will generally be most suitable in testing a raking pile because the horizontal component of the jacking may not be satisfactorily restrained in other reaction systems. They should be inclined along the same direction as the raking pile.

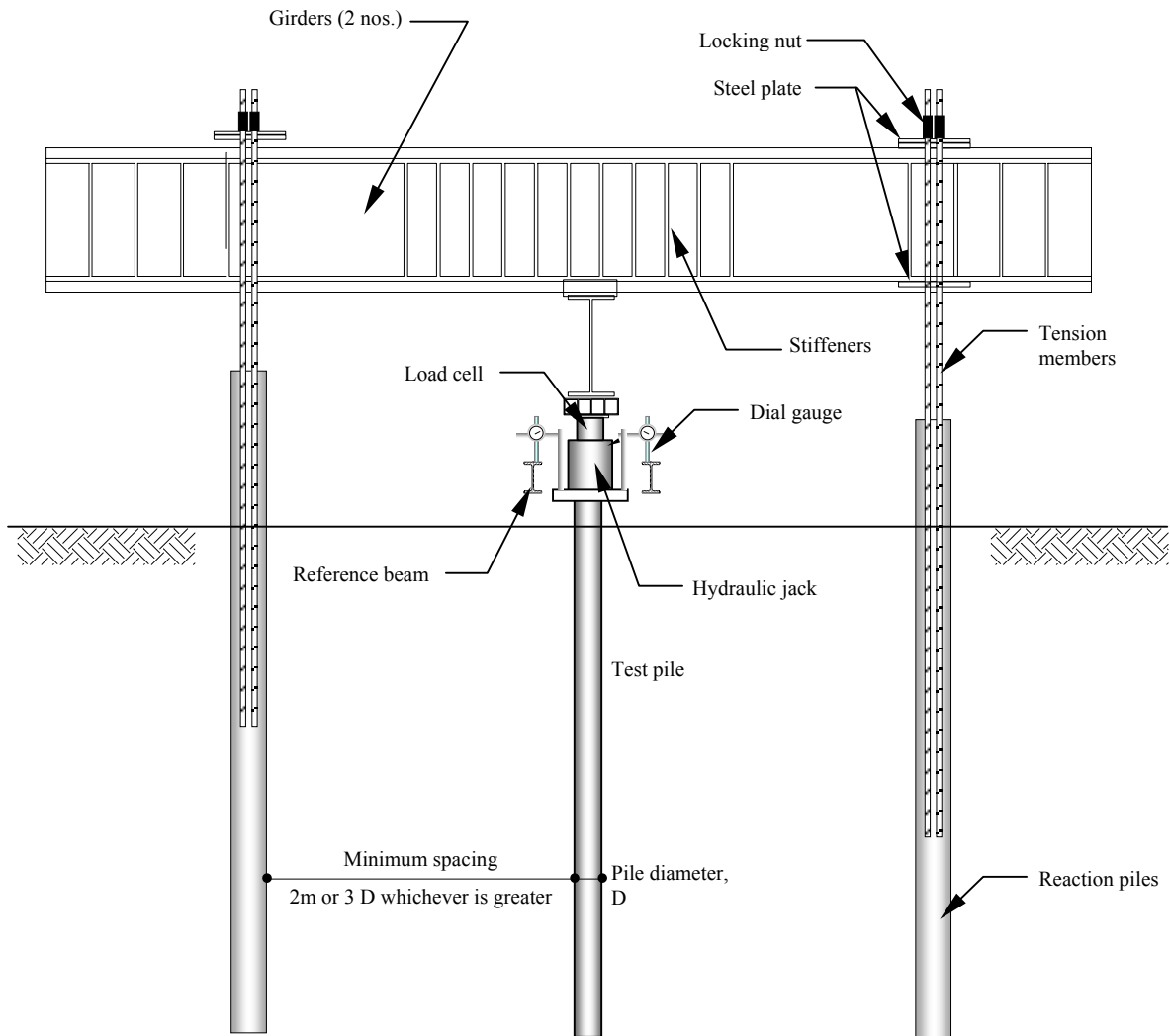

Figure 9.2 – Typical Arrangement of a Compression Test using Tension Piles

Traditionally, a static loading test is carried out by jacking a pile against a kentledge or a reaction frame supported by tension piles or ground anchors. In recent years, Osterberg load cell (O-cell) has been widely adopted for static loading tests for large-diameter cast-in-place concrete piles. It can also be used in driven steel piles.

An O-cell is commonly installed at or near the bottom of the pile. Reaction to the upward force exerted by the O-cell is provided by the shaft resistance. For such testing arrangement, the shaft resistance mobilised in the pile will be in upward direction. A smaller kentledge may be assembled in case the shaft resistance alone is not adequate to resist the applied load. The maximum test load is governed by either the available shaft resistance, the bearing stress at the base or the capacity of the O-cell itself. A maximum test load of 30 MN has been achieved in some pile loading tests in Hong Kong.

9.3.1.2 Uplift loading tests

A typical arrangement for uplift loading tests is shown in Figure 9.3. The arrangement involving jacking at the centre is preferred because an even load can be applied

to the test pile. The arrangement of applying load at one end of the beam is not recommended because of risk of instability.

Reaction piles should be placed at least three test pile diameters, or a minimum of 2 m, from the centre of the test pile. Where the spacing is less than this, corrections for possible pile interaction should be made (Section 9.3.1.1). Alternatively, an O-cell installed at the base of pile can also be used in an uplift test.

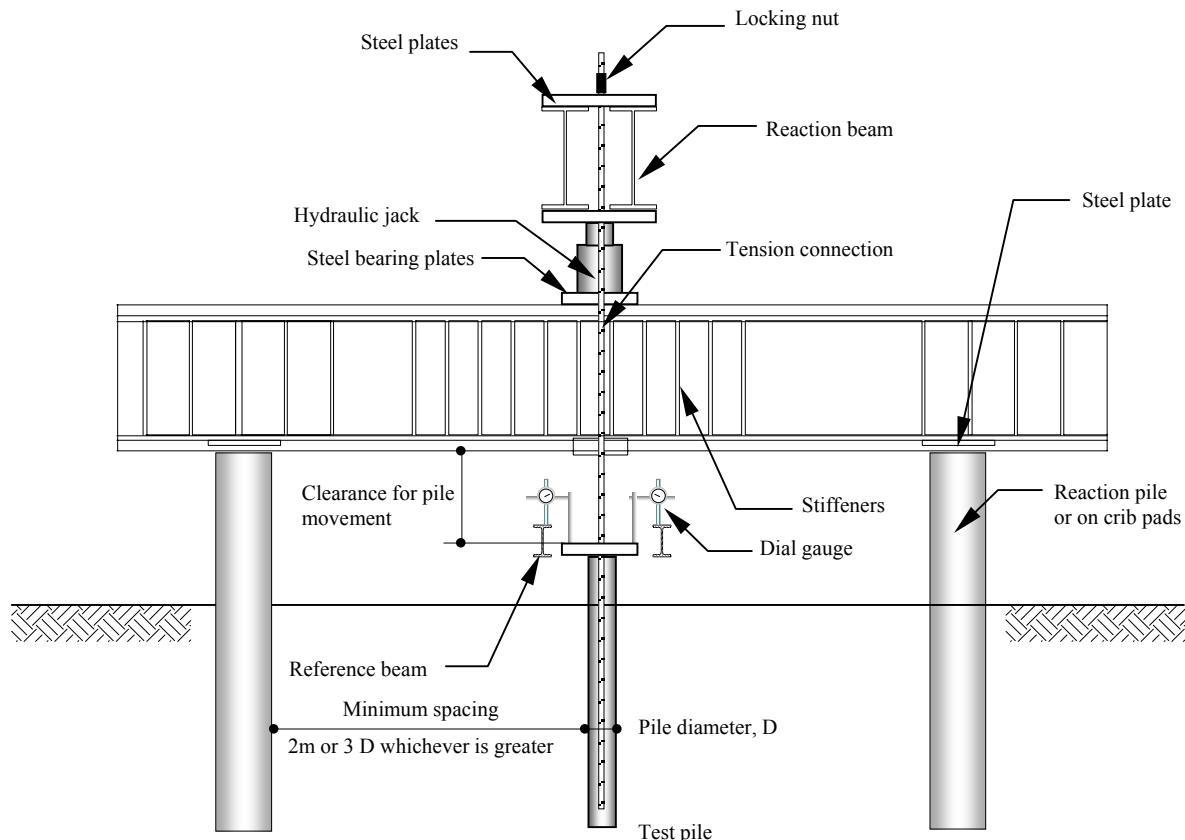

Figure 9.3 – Typical Arrangement of an Uplift Test (based on Tomlinson, 1994)

9.3.1.3 Lateral loading tests

In a lateral loading test, two piles or pile groups may be jacked against each other (Figure 9.4). It is recommended that the centre spacing of the piles should preferably be a minimum of ten pile diameters (CGS, 1992).

Alternative reaction systems including a 'deadman' or weighted platform are also shown in Figure 9.4 (b) and (c).

9.3.2 Equipment

9.3.2.1 Measurement of load

A typical load application and measurement system consists of hydraulic jacks, load measuring device, spherical seating and load bearing plates (Figure 9.1).

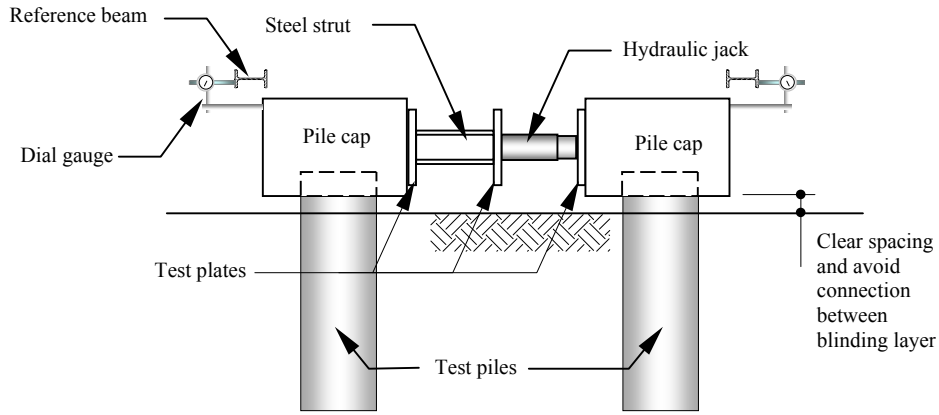

(a) Reaction Piles

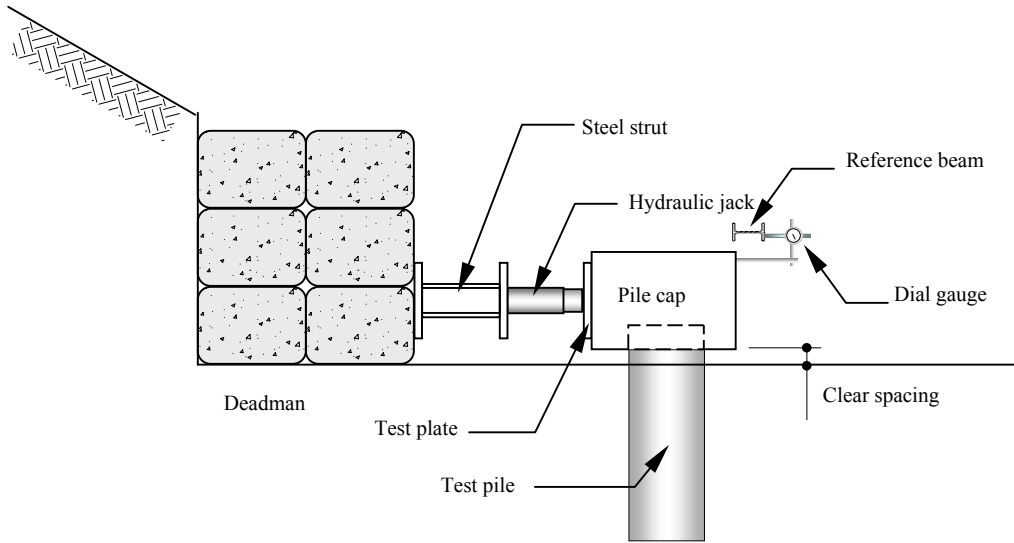

(b) Deadman

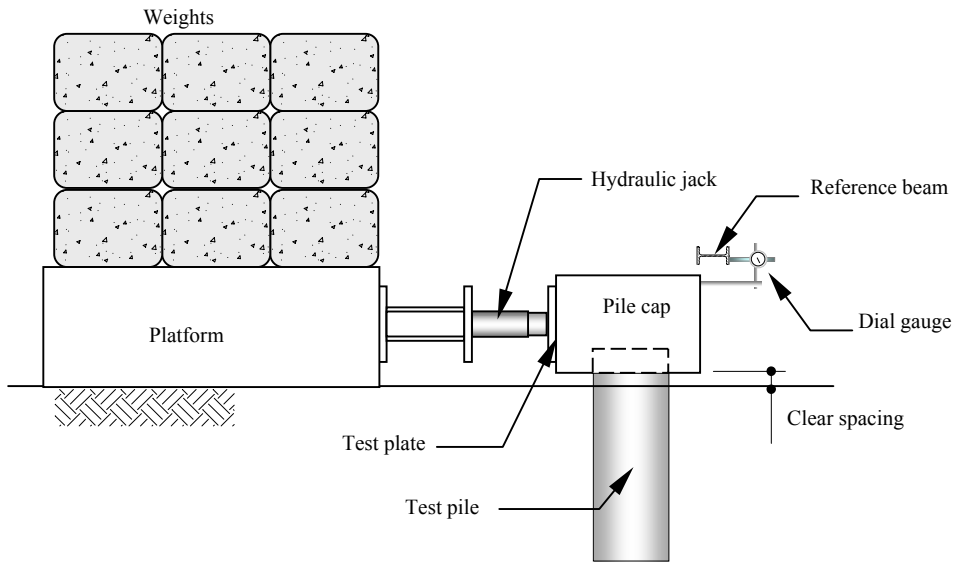

(c) Weighted Platform

Note : Load cells with appropriate plates can be inserted between test plate and hydraulic jack.

Figure 9.4 – Typical Arrangement of a Lateral Loading Test

The jacks used for the test should preferably be large-diameter low-pressure jacks with a travel of at least 15% of the pile diameter (or more if mini-piles are tested). A single jack is preferred where practicable. If more than one jack is used, then the pressure should be applied using a motorised pumping unit instead of a hand pump. Pressure gauges should be fitted to permit a check on the load. The complete jacking system including the hydraulic cylinder, valves, pump and pressure gauges should be calibrated as a single unit.

It is strongly recommended that an independent load-measuring device in the form of a load cell, load column or pressure cell is used in a loading test. The device should be calibrated before each series of tests to an accuracy of not less than 2% of the maximum applied load (ASTM, 1995a).

It is good practice to use a spherical seating in between the load measuring device and bearing plates in a compression loading test in order to minimise angular misalignment in the system and ensure that the load is applied coaxially to the test pile. Spherical seating is however only suitable for correcting relatively small angular misalignment of not more than about 3° (Weltman, 1980b).

A load bearing plate should be firmly bedded onto the top of the pile (or the pile cap) orthogonal to the direction of applied load so as to spread the load evenly onto the pile.

An O-cell consists of two steel plates between which there is an expandable pressurised chamber. Hydraulic fluid is injected to expand the chamber, which pushes the pile segment upward. At the same time, the bearing base (or lower pile segment if the O-cell is installed in middle of the pile) is loaded in the downward direction. Pressure gauges are attached to fluid feed lines to check the applied load and it is necessary to calibrate the O-cell. Correction may be needed to allow for the level difference between the pressure gauges, which is located at the ground surface and the load cell, which is usually installed at the base of the piles.

9.3.2.2 Measurement of pile head movement

Devices used for measuring pile head settlement in a loading test include dial gauges (graduated to 0.01 mm), linear variable differential transducers (LVDT) and optical levelling systems. A system consisting of a wire, mirror and scale is also used in lateral loading tests.

In a compression or tension test, measurements should be taken by four dial gauges evenly spaced along the perimeter of the pile to determine whether the pile head tilts significantly. The measuring points of the gauges should sit on the pile head or on brackets mounted on the side of the pile with a glass slide or machined steel plate acting as a datum for the stems. Care should be taken to ensure that the plates are perpendicular to the pile axis and that the dial gauge stems are in line with the axis.

In a lateral loading test, dial gauges should be placed on the back of the pile with the stems in line with the load for measuring pile deflection (Figure 9.4). A separate system involving the use of a wire, mirror and scale may be used as a check on the dial gauges. The wire should be held under constant tension and supported from points at a distance not less than five pile diameters from the test pile and any part of the reaction system (SAA, 1995).

Rotational and transverse movement of the pile should also be measured.

LVDT can be used in place of dial gauges and readings can be taken remotely. However, they are susceptible to dirt and should be properly protected in a test.

The reference beams to which the dial gauges or LVDT are attached should be rigid and stable. A light lattice girder with high stiffness in the vertical direction is recommended. This is better than heavy steel sections of lower rigidity. To minimise disturbance to the reference beams, the supports should be firmly embedded in the ground away from the influence of the loading system (say 2 m from piles or 1 m from kentledge support). It is recommended that the beam is clamped on one side of the support and free to slide on the other. Such an arrangement allows longitudinal movement of the beam caused by changes in temperature. The test assembly should be shaded from direct sunlight.

In an axial loading test, levels of the test pile and reference beam supports should be monitored by an optical levelling system throughout the test to check for gross errors in the measurements. The optical levelling should be carried out at the maximum test load of each loading cycle and when the pile is unloaded at the end of each cycle. The use of precision levelling equipment with an accuracy of at least 1 mm is preferred. The datum for the optical levelling system should be stable and positioned sufficiently far away from the influence zone of the test.

In loading tests using O-cell, rod extensometers are connected to the top and bottom plates of the O-cell (Figure 9.5). They are extended to the ground surface such that the movement of the plates can be measured by dial gauges or displacement transducers independently.

9.3.3 Test Procedures

9.3.3.1 General

Two types of loading test procedures are commonly used, namely maintained-load (ML) and constant-rate-of-penetration (CRP) tests. The ML method is applicable to compression, tension and lateral loading tests, whereas the CRP method is used mainly in compression loading tests.

The design working load (W_L) of the pile should be pre-determined where W_L is defined as the allowable load for a pile before allowing for factors such as negative skin friction, group effects and redundancy.

9.3.3.2 Maintained-load tests

In a maintained-load test, the load is applied in increments, each being held until the rate of movement has reduced to an acceptably low value before the next load increment is applied. It is usual practice to include a number of loading and unloading cycles in a loading test. Such cycles can be particularly useful in assessing the onset of plastic movements by observing development of the residual (or plastic) movement with increase in load. Based on

this information, Butler & Morton (1971) deduced critical load ratios for piles in difficult geological formations. This concept can be used to assess the acceptance criteria for loading tests on contract piles as discussed by Cole & Patel (1992).

Loading procedures commonly used in Hong Kong include those recommended in the General Specification for Civil Engineering Works (HKG, 1992) for government civil engineering projects and the Code of Practice for Foundations (BD, 2004a) for private and public housing developments. Details of the common loading procedures used in Hong Kong are summarised in Table 9.1.

When testing a preliminary pile, the pile should, where practicable, be loaded to failure or at least to sufficient movement (say, a minimum of 5% of pile diameter). If the pile is loaded beyond $2 W_L$, a greater number of small load increments, of say 0.15 to 0.2 W_L as appropriate, may be used in order that the load-settlement behaviour can be better defined before pile failure. However, the test load should not exceed the structural capacity of the pile.

In principle, the same loading procedures suggested for compression tests may be used for lateral and uplift loading tests.

9.3.3.3 Constant rate of penetration tests

The constant-rate-of-penetration test has the advantage that it is rapid. However, the mobilised pile capacity may be influenced by strain rate effects, particularly in cohesive soils.

A constant strain rate of 0.25 to 1.25 mm/min and 0.75 to 2.5 mm/min is commonly used for clays and granular soils respectively (ASTM, 1995a). The load should be supplied by a hydraulic power pack and by regulating the rate of oil flow to the jack and monitoring the pile movement with dial gauges. This procedure can control the rate of pile penetration better.

Experience with the use of CRP tests in Hong Kong is limited. Tsui (1968) reported that two piles at the Ocean Terminal Building site which have been subjected to a maintained-load test followed by a CRP test showed similar capacities although the load-settlement characteristics are different. In general, CRP tests are less suitable for piles founded on rock or granular soils and can constitute a safety hazard if the increase in loading becomes excessive. CRP tests are not suggested in Hong Kong given the ground conditions.

9.3.4 Instrumentation

9.3.4.1 General

Information on the load transfer mechanism can be derived from a loading test if the pile is instrumented. To ensure that appropriate and reliable results can be obtained, the pile instrumentation system should be compatible with the objectives of the test. Important aspects including selection, disposition and methods of installation should be carefully considered.

Table 9.1 – Loading Procedures and Acceptance Criteria for Pile Loading Tests in Hong Kong

| Reference Document | Loading Procedure | Acceptance Criteria | Remarks |
|--|---|--|--|
| General Specification for Civil Engineering Works (HKG, (1992) | Cycle 1 – 25% Q_{max} | (1) $\delta_Q < 2 \times \delta_{90\%Q}$ and | (1) Load increments/decrements to be in 25% of the design working load; pile to be unloaded at the end of each cycle. |
| | Cycle 2 – 50% Q_{max} | (2) $\delta < 20$ mm for buildings at working load and 10 mm for other structures (e.g. bridges) at working load | (2) Preliminary piles are to be tested to not less than twice the design working load (i.e. $Q_{max} > 2W_L$); working piles to be tested to not less than 1.8 times design working load (i.e. $Q_{max} > 1.8 W_L$). |
| | Cycle 3 – 100% Q_{max} | | (3) Load increments/decrements not to be applied until rate of settlement or rebound of pile is less than 0.1 mm in 20 minutes. |
| | | | (4) Full load at each cycle to be maintained for at least 24 hours after rate of settlement has reduced to less than 0.1 mm per hour. |
| Code of Practice for Foundations (BD, 2004a) | Loading schedule for piles with a diameter or least lateral dimension not exceeding 750 mm : | (1) $\delta_{max} < \frac{Q_{max}L}{A_p E_p} + \frac{D}{120} + 4$ (mm) | (1) Load increment/decrements to be in 50% of the design working load; pile to be unloaded at the end of each cycle. |
| | | (2) The greater of : $\delta_{res} < \frac{D}{120} + 4$ or $0.25 \delta_{max}$ (in mm) | (2) Piles are to be tested to twice design working load. |
| | Cycle 1 – 100% W_L | | (3) Increments of load not to be applied until rate of settlement or recovery of pile is less than 0.05 mm in 10 minutes. |
| | Cycle 2 – 200% W_L (= Q_{max}) | | (4) Full load at cycle 2 should be maintained for at least 72 hours. |
| | | | (5) The residual settlement, δ_{res} , should be taken when the rate of recovery of the pile after removal of test load is less than 0.1mm in 15 minutes. |
| Legend : | δ_Q = pile head settlement at failure or maximum test load | | |
| | $\delta_{90\%Q}$ = pile head settlement at 90% of failure or maximum test load | | |
| | δ_{max} = maximum pile head settlement | | |
| | δ = pile head settlement | | |
| | δ_{res} = residual (or permanent) pile head settlement upon unloading from maximum test load | | |
| | Q_{max} = maximum test load | | |
| | W_L = design working load of pile | | |
| | L = pile length | | |
| | A_p = cross-sectional area of pile | | |
| | E_p = Young's modulus of pile | | |
| | D = least lateral dimension of pile section (mm) | | |

It is essential that sufficient redundancy is built in to allow for possible damage and malfunctioning of instruments. Where possible, isolated measurements should be made using more than one type of equipment to permit cross-checking of results. An understanding of the ground profile, proposed construction technique and a preliminary assessment of the probable behaviour of the pile will be helpful in designing the disposition of the instruments. Limitations and resolutions of the instruments should be understood.

9.3.4.2 Axial loading tests

Information that can be established from an instrumented axial loading test includes the distribution of load and movement, development of shaft resistance and end-bearing resistance with displacement. A typical instrumentation layout is given in Figure 9.5.

Strain gauges (electrical resistance and vibrating wire types) can be used to measure local strains, which can be converted to stresses or loads. Vibrating wire strain gauges are generally preferred, particularly for long-term monitoring, as the readings will not be affected by changes in voltage over the length of cable used, earth leakage, corrosion to connection and temperature variation. In case measurements need to be taken rapidly, e.g. in simulation dynamic response of piles, electrical resistance type strain gauges are more suitable (Sellers, 1995).

There are two types of vibrating wire strain gauges, namely surface mounting gauges and embedment gauges for the measurement of steel and concrete strains respectively. These gauges generally have a maximum strain range of 3 000 microstrain ($\mu\epsilon$) and a sensitivity of about $1\mu\epsilon$. Surface mounting gauges consist of a plucking coil, end blocks and a stem. The end blocks are welded onto the pile body or reinforcement and the stem is fixed in between the blocks. Embedment gauges consist of a plucking coil and a stem with a flange at each end and are usually mounted between supports fixed to the pile or cast in concrete briquettes prior to mounting. With the latter method, the gauges are better protected but there is a danger that the concrete used for the briquette has a different consistency to that of the pile, giving rise to uncertainties when converting strains to stress. The use of strain gauges cast in concrete briquettes is therefore liable to give unreliable results.

A variant form of vibrating wire strain gauges is the 'sister bar' or 'rebar strain meter'. This is commonly used in cast-in-place concrete piles. It consists of a vibrating strain gauge assembled inside a high strength steel housing that joins two reinforcement bars at both ends by welding or couplers. The sister bar can replace a section of the steel in the reinforcement cage or be placed alongside it. Such an arrangement minimises the chance that a strain gauge is damaged during placing of concrete. The electrical wirings should be properly tied to the reinforcement cage at regular intervals.

To measure axial loads, the strain gauge stems are orientated in line with the direction of the load (i.e. vertical gauges). One set of gauges should be placed near the top of the pile, and preferably in a position where the pile shaft is not subject to external shaft resistance, to facilitate calculation of the modulus of the composite section. Gauges should also be placed close to the base of the pile (practically 0.5 m) with others positioned near stratum boundaries and at intermediate levels. A minimum of two and preferably four gauges should be provided at each level where practicable.

Refer to Figure 9.1 for setting up kentledge and measuring devices at top of the pile

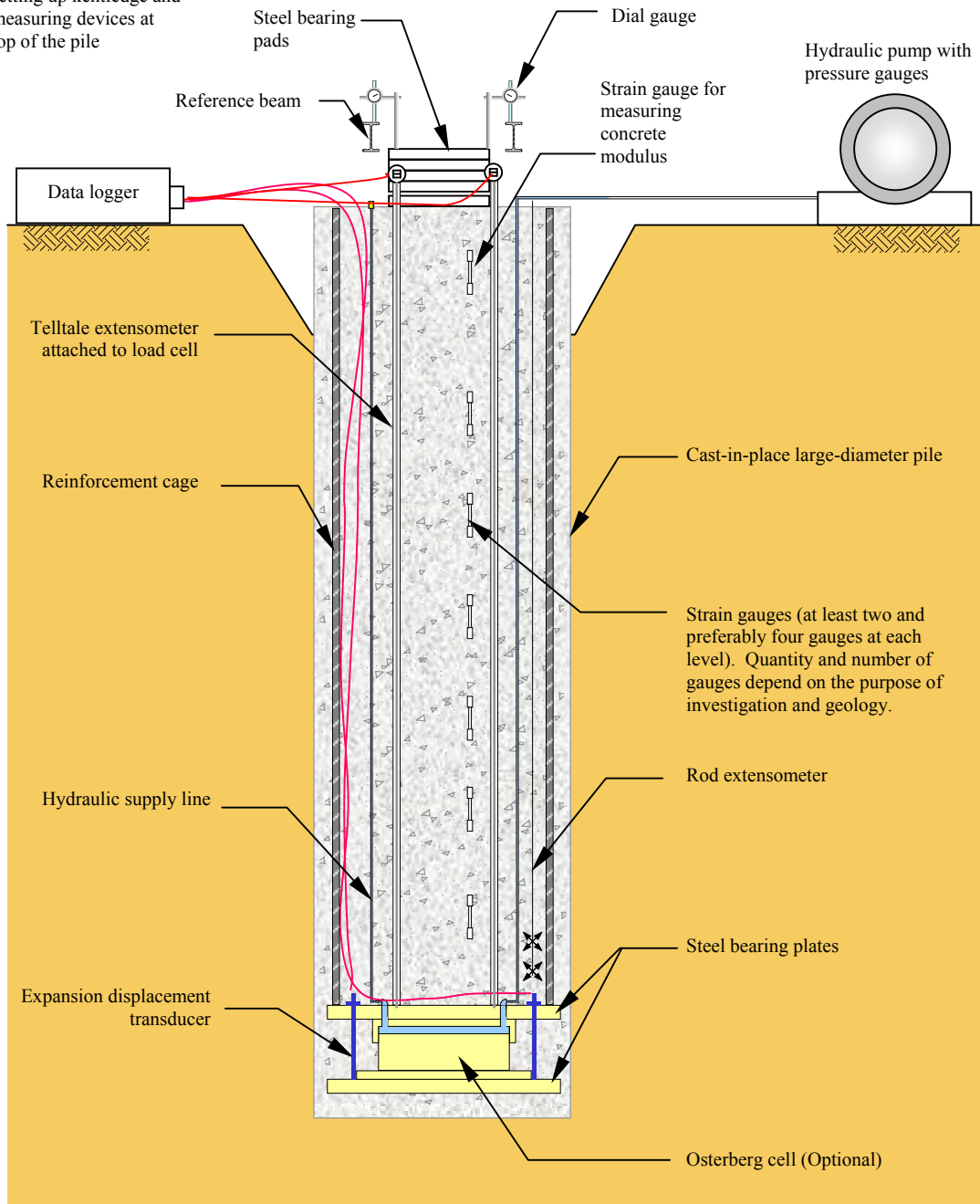

Figure 9.5 – Typical Instrumentation Scheme for a Vertical Pile Loading Test

For cast-in-place piles, provisions should be made to take a core through the pile shaft after the loading test. The concrete cores should be tested to determine the uniaxial compression strength, Young's modulus and Poisson's ratio. Bonded or unbonded sensing device, such as electrical strain gauges or LVDT are recommended for measuring the Young's modulus and Poisson's ratio (ASTM, 1992). The Young's modulus of the composite section can be established from the moduli of concrete and steel reinforcement. This provides a means of checking the Young's modulus back-calculated from the strain gauges near the top of the pile.

If measurement of the development of normal stress at pile-soil interface is required, additional strain gauges can be orientated to have their stems perpendicular to the direction of load application (i.e. horizontal gauges), with one of their ends as close as possible to the pile-soil interface.

Other devices are available for measuring axial loads such as shaft load cells (Price & Wardle, 1983) and Mustran cells (Owens & Reese, 1982) but these are not commonly used in Hong Kong.

The load cell developed by Price & Wardle (1983) may be used for measuring the load at pile base. The load transducer for the cell comprises a steel tube fitted with an internal vibrating wire gauge. Load is transferred to the transducer by steel bars bonded into the concrete. Alternatively, a hydraulic load cell can also be used for measuring the base load.

Rod extensometers which are mechanically operated can be used for measuring pile shaft movements at designated levels. The system consists of a PVC sleeve and an aluminium or glass fibre rod with an anchor attached to its end. Monitoring the movement of the rod gives the corresponding pile shaft compression. It should be cautioned that extensometers can easily get twisted or damaged during installation because of the slenderness of the rods. Placing the rods on opposite sides of the pile can offer a better chance of successful installation. Extensometers using standard steel pipes as the casing, and steel bars alternating with ball bearings as the inner rods, are also not so easily damaged.

In general, it is advisable to assess whether the results of the instruments correspond to the expected behaviour under the applied load at an early stage of the test. Any discrepancies noted during load application may be rectified and the test may be restarted where appropriate.

9.3.4.3 Lateral loading tests

The common types of internal instrumentation used in a lateral loading test are inclinometers, strain gauges and electro-levels.

The deflected shape of a pile subject to lateral loading can be monitored using an inclinometer. The system consists of an access tube and a torpedo sensor. For cast-in-place piles, the tube is installed in the pile prior to concreting. For displacement piles such as H-piles, a slot can be reserved in the pile by welding on a steel channel or angle section prior to pile driving. The tube is grouted into the slot after driving. During the test, a torpedo is used to measure the slope, typically in 0.5 m gauge lengths, which can be converted to deflections.

Care needs to be exercised in minimising any asymmetrical arrangement of the pile section or excessive bending of the pile during welding of the inclinometer protective tubing. In extreme cases, the pile may become more prone to being driven off vertical because of these factors.

Strain gauges with their stems orientated in line with the pile axis can be used for measuring direct stresses and hence bending stresses in the pile. They can also be oriented horizontally to measure lateral stresses supplemented by earth pressure cells.

Electro-levels measure changes in slope based on the inclination of an electrolytic fluid that can move freely relative to three electrodes inside a sealed glass tube (Price & Wardle, 1983; Chan & Weeks, 1995). The changes in slope can be converted to deflections by multiplying the tangent of the change in inclination by the gauge length. The devices are mounted in an inclinometer tube cast into the pile and can be replaced if they malfunction after installation.

Earth pressure cells can also be used to measure the changes in normal stresses acting on the pile during loading. It is important that these pressure cells are properly calibrated for cell action factors, etc. to ensure sensible results are being obtained.

9.3.5 Interpretation of Test Results

9.3.5.1 General

A considerable amount of information can be derived from a pile loading test, particularly with an instrumented pile. In the interpretation of test results for design, it will be necessary to consider any alterations to the site conditions, such as fill placement, excavation or dewatering, which can significantly affect the insitu stress level, and hence the pile capacity, after the loading test.

9.3.5.2 Evaluation of failure load

Typical load-settlement curves, together with some possible modes of failure, are shown in Figure 9.6. Problems such as presence of a soft clay layer, defects in the pile shaft and poor construction techniques may be deduced from the curves where a pile has been tested to failure.

It is difficult to define the failure load of a pile when it has not been loaded to failure. In the case where ultimate failure has not been reached in a loading test, a limiting load may be defined which corresponds to a limiting settlement or rate of settlement. A commonly-used definition of failure load is taken to be that at which settlement continues to increase without further increase in load; alternatively, it is customarily taken as the load causing a settlement of 10% of pile diameter (BSI, 1986). However, it should be noted that elastic shortening of very long pile can already exceed 10% of the pile diameter. O'Neill & Reese (1999) suggested using the load that gives a pile head settlement of 5% of the diameter of bored piles as the ultimate end-bearing capacity, if failure does not occur. Ng et al (2001) suggested taking the failure load to be the load that gives a pile head settlement of 4.5% of

the pile diameter plus 75% of the elastic shortening of pile. In practice, the failure or ultimate load represents no more than a benchmark such that the safe design working load can be determined by applying a suitable factor of safety.

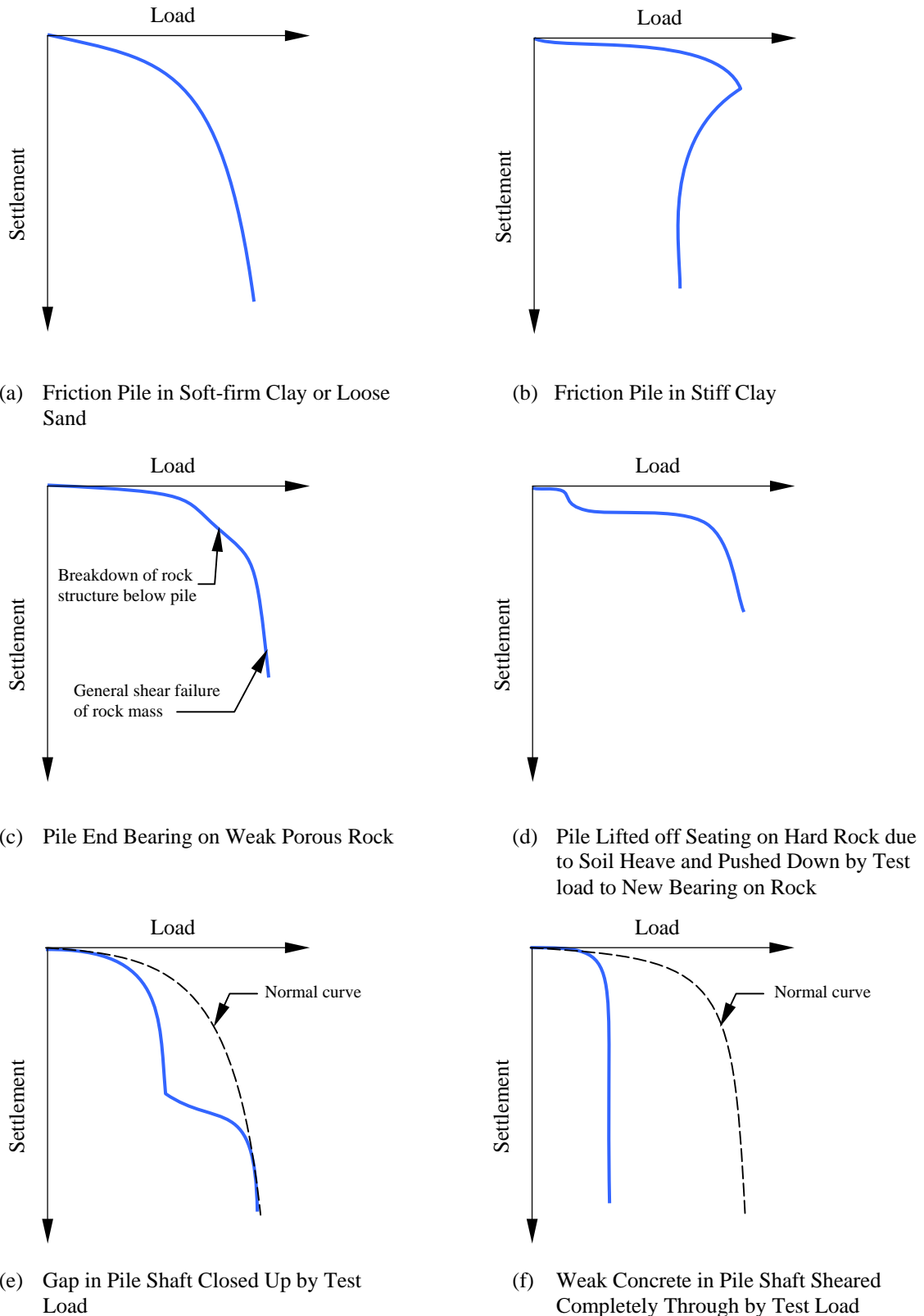

Figure 9.6 – Typical Load Settlement Curves for Pile Loading Tests (Tomlinson, 1994)

An estimate of the ultimate or failure load may also be made by hyperbolic curve-fitting as proposed by Chin (1970). However, such a procedure can be inherently unreliable even if the extrapolation is carried out to a movement of only 10% pile diameter, especially where a pile has not been tested to exhibit sufficient plastic movement. In addition, it also has drawbacks as it does not deal with the end-bearing resistance and shaft resistance load separately nor does it take into account elastic shortening, (Fleming, 1992). The danger associated with gross extrapolation is highlighted by the results of loading tests reported by Yiu & Lam (1990). Notwithstanding the above, the method proposed by Chin (1978) may be useful in the diagnosis of whether a pile has suffered structural damage during a loading test. Figure 9.7 shows the comparison of various definitions of ultimate loads that can be derived in a pile loading test.

Methods have been proposed in the literature for separating the shaft resistance and end-bearing resistance components from the load-settlement relationship at the pile head (e.g. Van WHEEL, 1957; Hobbs & Healy, 1979). These methods are approximate and may not be appropriate for long slender piles or in complex and variable ground conditions. Hirany & Kulhawy (1989a) proposed a method for interpreting the load-settlement curve in a pile loading test for a straight-sided bored pile in soils. In this method, the shaft and end-bearing resistance is taken as a proportion of the failure load and elastic load. The failure load and elastic load are taken as the load where pile head settlement equals to 4% and 0.4% of the diameter of the pile base respectively. Fleming (1992) proposed a method for single pile settlement prediction and analysis based on an improvement on the use of hyperbolic functions. However, the experience in using this prediction method in Hong Kong is still very limited.

The use of an O-cell to load-test a pile does not produce the load-movement curve of the pile head, which is common in a conventional loading test. Instead, a load-movement curve at the pile head is constructed based on the records of the upward and downward displacement of the steel plates in the O-cell (Osterberg, 1998).

9.3.5.3 Acceptance criteria

From the load-settlement curve, a check of pile acceptability in terms of compliance with specified criteria can be made. In Hong Kong, two sets of acceptance criteria are generally used (see Table 9.1) :

- (a) the 90% criterion proposed by Brinch Hansen (1963) adopted in the General Specification for Civil Engineering Works (HKG, 1992) and mainly used for public developments (Figure 9.8), and
- (b) the acceptance criteria given in Code of Practice for Foundations (BD, 2004a).

Although the acceptance criteria specified in the Code of Practice for Foundations (BD, 2004a) look similar to the 'off-set' limit method proposed by Davisson (1972), there are differences in the acceptance criteria as well as loading procedures between the two methods.

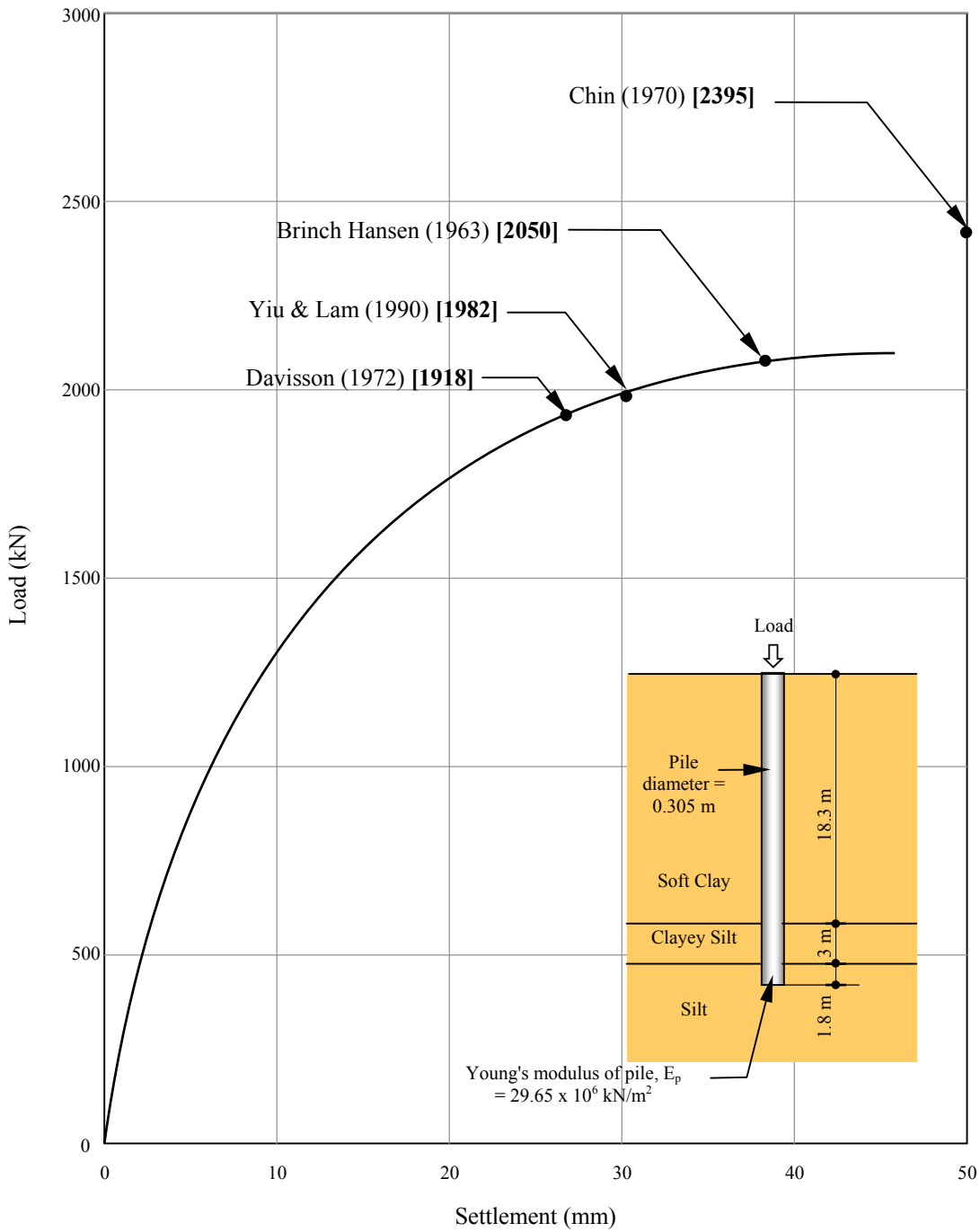

Note : Numbers in [] are the ultimate loads estimated by the method given in the reference.

Figure 9.7 – Comparison of Failure Loads in Piles Estimated by Different Methods (Fellenius, 1980)

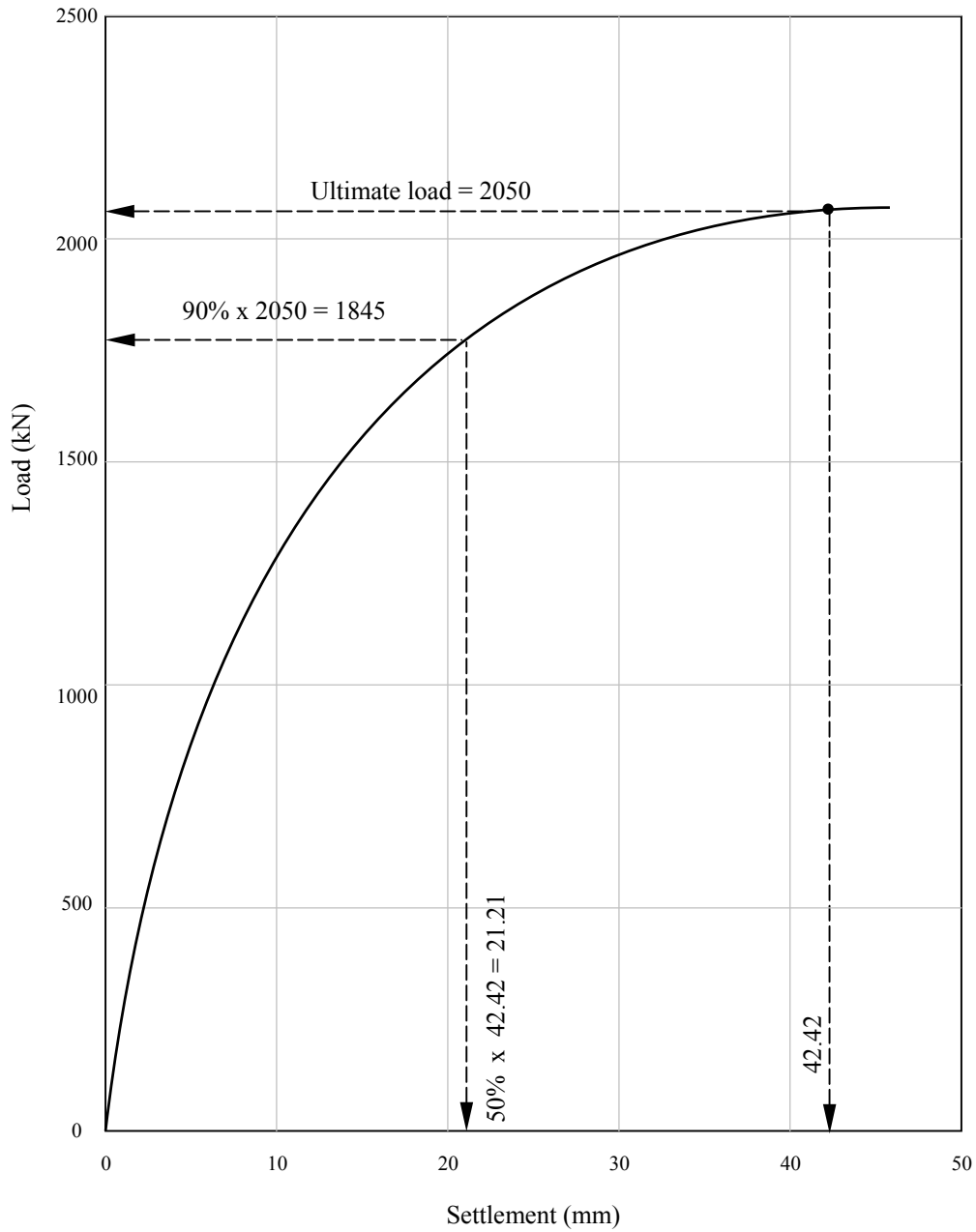

Note :

Ultimate load, Q_{ult} , in accordance with the 90% criterion of Brinch Hansen (1963) is given by the following:

$$Q_{ult} = 2050 \text{ kN, where } \frac{\text{Settlement at } Q_{ult}}{\text{Settlement at } 90\% Q_{ult}} = 2$$

Figure 9.8 – Definition of Failure Load by Brinch Hansen's 90% Criterion

The acceptance criteria specified in the Code of Practice for Foundations (BD, 2004a) are generally adopted for private and public housing developments. The acceptance criteria adopted by Architectural Services Department (ArchSD, 2003) are basically the same as that those given in the Code of Practice for Foundations, with variations in the rate of recovery of settlement and magnitude of allowable residual settlement after removal of test load.

Non-compliance with the criterion on acceptance criteria does not necessarily imply non-acceptance of the pile. Where this criterion is not met, it is prudent to examine the pile behaviour more closely to find out the reasons of non-compliance.

In principle, a designer should concentrate on the limiting deflection at working load as well as the factor of safety against failure or sudden gross movements. The limiting settlement of a test pile at working load should be determined on an individual basis taking into account the sensitivity of the structure, the elastic compression component, effects of pile group interaction under working condition, and expected behaviour of piles as observed in similar precedents.

In analysing the settlement behaviour of the pile under a pile loading test, it is worth noting that the applied load will be carried in part or entirely by the shaft resistance, although the shaft resistance may be ignored in the pile design. Consequently, the elastic compression component of pile could be smaller than that estimated based on the entire length of the pile, particularly for long friction pile. Fraser & Ng (1990) suggested that upon removal of the maximum test load, the recovery of the pile head settlement may be restricted by the 'locked in' stress as a result of reversal of shaft resistance upon removal of the test load.

In a tension test, reference may be made to Kulhawy & Hirany (1989) for a general discussion of the background considerations. The use of Brinch Hansen's (1963) criterion may not be suitable for tension piles which may fail abruptly in the absence of an end-bearing component. A modified form of Davisson's (1972) criterion was suggested as follows (Kulhawy & Hirany, 1989) and is also adopted in the Code of Practice for Foundations (BD, 2004a) :

$$\delta_{\max} = \text{elastic extension} + 4 \text{ mm} \quad [9.1]$$

A slightly different expression, where the second term is 2.5 mm instead of 4 mm, was used by Davie et al (1993). The determination of the elastic extension is subject to uncertainties associated with the load distribution down the pile, progressive cracking of the concrete or grout, etc. It is suggested that Equation [9.1] may be adopted, where the elastic extension is taken to be given by the initial linear portion of the load-extension curve. Based on the observations of uplift loading test results of bored piles, Kulhawy & Hirany (1989) proposed to use the load corresponding to a pile head displacement of 13 mm as the uplift capacity of the pile.

Different factors of safety may be appropriate when different definitions of failure load are used. It would be rational to unify the definition of ultimate loads to permit comparison and extrapolation of test results.

9.3.5.4 Axial loading tests on instrumented piles

The profile of shaft movement along a pile as determined by extensometers allows the shaft compression between any two points in the pile to be calculated from which the load distribution can be deduced (Tomlinson, 1994).

The load distribution down a pile can also be determined by strain gauges. From this, the mobilisation of shaft resistance and end-bearing resistance can be assessed.

The existence of residual stresses prior to application of test load, particularly for driven piles, should be considered when the instrumentation results are back-analysed in deriving 'fundamental' soil parameters. Significant residual stresses will affect the profile of load distribution with depth and the apparent stiffness of the pile under compression or tension loading (Poulos, 1987). Altaee et al (1992a & b) highlighted the importance of making proper allowance for residual stresses in the interpretation of an instrumented pile driven into sand. Fellenius (2002a & b) described a method for determining residual stresses based on static loading tests on instrumented piles and dynamic loading tests. Alawneh & Malkawi (2000) developed an approach to calculate the residual stresses along driven piles in sand based on the relative density of soil, the pile stiffness and the pile embedded length.

Hayes & Simmonds (2002) discussed the factors that can make interpretation of strain gauge measurements difficult. In the case of cast-in-place concrete piles, the temperature variation during hardening of concrete can generate noticeable residual stresses in a pile shaft. The determination of load distribution along concrete shaft also relies on accurate estimation of stress in concrete. This is influenced by variation in the cross-sectional area of the pile shaft, modulus of concrete and presence of cracked concrete section. Deflection of the reinforcement cage and the position of strain gauges may also lead to seemingly strange measurements.

9.3.5.5 Lateral loading tests

No performance criteria have been specified in the Code of Practice for Foundations (BD, 2004a) and the General Specification for Civil Engineering Works (HKG, 1992) for piles under lateral loading. The limiting criteria on displacement and/or rotation have to be assessed by designers for individual cases, taking into account factors such as sensitivity of structures and nature of loading. A lateral loading test is best used to back-analyse the properties of the soil or rock materials in respect of lateral load behaviour, such as the 'p-y' curve or horizontal subgrade reaction. Reference can be made to ASTM 3966-90 (ASTM, 1995c) that provides guidelines on testing procedures for lateral loading tests.

The lateral resistance of a pile is highly influenced by the overburden pressure acting in the ground. It is therefore essential that the ground elevation in the testing arrangement can replicate the configuration of the working piles. Otherwise, allowance should be made to cater for the difference in the overburden pressure between the working piles and the test pile.

The nature of the loading used in the lateral loading test should simulate the actual loading pattern as closely as possible. In the case of static lateral load, the load can be applied in small increments. To simulate wind load, wave action and seismic load, two-way

cyclic loading such as repeatedly pushing and pulling the shaft through its initial position may be the most appropriate loading pattern. Lateral loading test can seldom duplicate the usual load combinations, such as a pile group subject to axial load, lateral load and overturning moment. A fixed-head condition can be simulated by embedding test piles into a pile cap. Where a pile cap is used to connect a group of test piles, the arrangement should avoid having the pile cap in contact with the ground, unless this is the intended design model. It is worth noting that the blinding layer may inadvertently connect the test pile with other piles or pile caps in the vicinity.

The profiles of deflection, slope, bending moment, shear force and soil reaction are interrelated and may be represented by differential equations. For instance, the profile of pile deflection and soil resistance may be deduced from the bending moment profile by double differentiation and double integration respectively, allowing for the effect of bending stiffness. In practice, however, the accuracy of the measurements can have a profound influence on the parameters derived by this method and the results should be treated with caution.

Hirany & Kulhawy (1989b) proposed an approach for evaluating lateral loading test results. This consists of determining the variation of the apparent depth of rotation, defined as the ratio of the lateral displacement to the tangent of the slope of the upper part of the deflected pile, with the applied load (Figure 9.9). This method can only be used if both the displacement and rotation of the pile top have been recorded. The variation in the apparent depth of rotation will give a hint on the mode of failure, i.e. structural failure, rigid rotation of the shaft, yielding of soil in front, or yielding of soil behind the pile with a 'kick-out' of the tip (Figure 9.9).

9.3.5.6 Other aspects of loading test interpretation

Care should be taken in ensuring that the test load is maintained for a sufficient period since redistribution of load down the pile shaft may take place as observed by Promboon et al (1972). Premchitt et al (1988) also reported an increase of up to 10% in axial strains at points along the pile as time dependent load transfer moving progressively downwards took place when the test load was maintained for three days.

Endicott (1980) presented results of loading tests carried out on caissons founded in granitic saprolites at different times after construction. A significant increase in stiffness was observed after a six month delay which may be related to a recovery of strength of the soil with time; however, the results may have been affected to a certain extent by the previous loading/unloading cycles.

Based on the findings of Tomlinson & Holt (1953), Malone (1990) cautioned about the potential discrepancies in the building settlement and the rate of settlement as observed in a pile test.

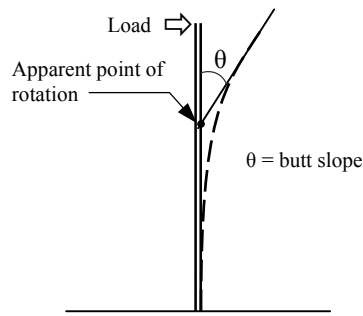

(a) Definition of Apparent Point of Rotation

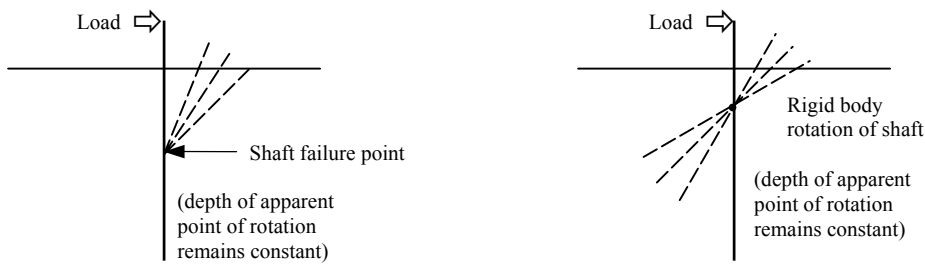

(b) Conditions for Constant Depth of Apparent Point of Rotation

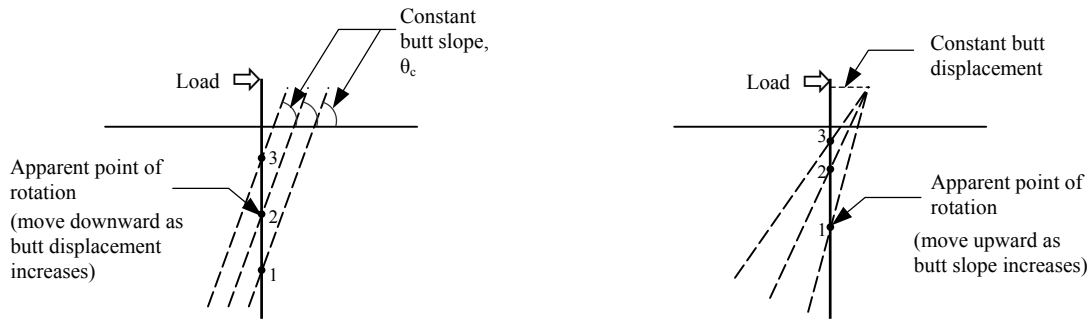

(c) Illustration of Increase in Depth of Apparent Point of Rotation

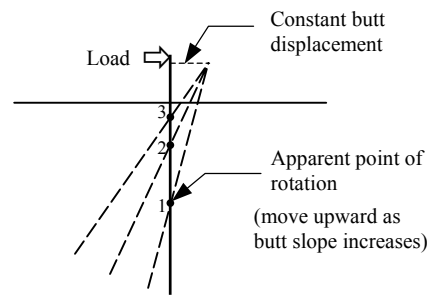

(d) Illustration of Decrease in Depth of Apparent Point of Rotation

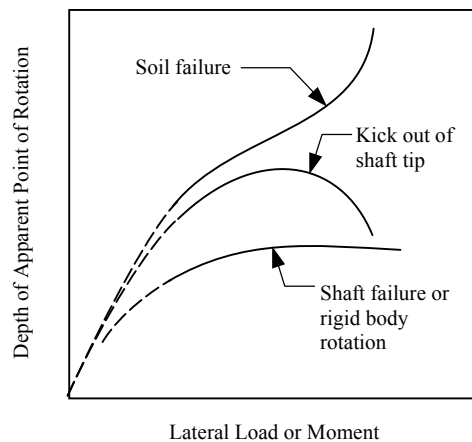

(e) Typical Variation of Apparent Point of Rotation with Load

Figure 9.9 – Analysis of Lateral Loading Test (Hirany & Kulhawy, 1989b)

9.4 DYNAMIC LOADING TESTS

9.4.1 General

Various techniques for dynamic loading tests are now available. These tests are relatively cheap and quick to carry out compared with static loading tests. Information that can be obtained from a dynamic loading test includes :

- (a) static load capacity of the pile,
- (b) energy delivered by the pile driving hammer to the pile,
- (c) maximum driving compressive stresses (tensile stress should be omitted), and
- (d) location and extent of structural damage.

9.4.2 Test Methods

The dynamic loading test is generally carried out by driving a prefabricated pile or by applying impact loading on a cast-in-place pile by a drop hammer. A standard procedure for carrying out a dynamic loading test is given in ASTM (1995b).

The equipment required for carrying out a dynamic pile loading test includes a driving hammer, strain transducers and accelerometers, together with appropriate data recording, processing and measuring equipment.

The hammer should have a capacity large enough to cause sufficient pile movement such that the resistance of the pile can be fully mobilised. A guide tube assembly to ensure that the force is applied axially on the pile should be used.

The strain transducers contain resistance foil gauges in a full bridge arrangement. The accelerometers consist of a quartz crystal which produces a voltage linearly proportional to the acceleration. A pair of strain transducers and accelerometers are fixed to opposite sides of the pile, either by drilling and bolting directly to the pile or by welding mounting blocks, and positioned at least two diameters or twice the length of the longest side of the pile section below the pile head to ensure a reasonably uniform stress field at the measuring elevation. It should be noted that change of cross-section of the pile due to connection may affect the proportionality of the signals and hence the quality of the data. An electronic theodolite may also be used to record the displacements of the pile head during driving (Stain & Davis, 1989).

In the test, the strain and acceleration measured at the pile head for each blow are recorded. The signals from the instruments are transmitted to a data recording, filtering and displaying device to determine the variation of force and velocity with time.

9.4.3 Methods of Interpretation

9.4.3.1 General

Two general types of analysis based on wave propagation theory, namely direct and indirect methods, are available. Direct methods of analysis apply to measurements obtained directly from a (single) blow, whilst indirect methods of analysis are based on signal matching carried out on results obtained from one or several blows.

Examples of direct methods of analysis include CASE, IMPEDANCE and TNO method, and indirect methods include CAPWAP, TNOWAVE and SIMBAT. CASE and CAPWAP analyses are used mainly for displacement piles, although in principle they can also be applied to cast-in-place piles. SIMBAT has been developed primarily for cast-in-place piles, but it is equally applicable to displacement piles.

In a typical analysis of dynamic loading test, the penetration resistance is assumed to be comprised of two parts, namely a static component, R_s , and a dynamic component, R_d . Three methods of analysis that are commonly used in Hong Kong are described below.

9.4.3.2 CASE method

This method assumes that the resistance of the soil is concentrated at the pile toe. In the analysis, the dynamic component is given by :

$$R_d = j_c Z v_b \quad [9.2]$$

where j_c = the CASE damping coefficient

$$Z = \text{impedance} = \frac{E_p A_p}{c_w}$$

A_p = cross sectional area of the pile

E_p = Young's modulus of the pile

c_w = wave speed through the pile

v_b = velocity of pile tip

The appropriate j_c is dependent on the type of soil at the pile toe and the actual pile dimensions. A range of j_c values appropriate to different soil types was proposed by Rausche et al (1985) and has been further refined by Pile Dynamics Inc. (PDI, 1996). Typical ranges of j_c are given in Table 9.2. These represent the damping factors at pile toe and are correlated with dynamic and static loading tests. In practice, j_c values can vary significantly, particularly in layered and complex ground conditions, causing potential errors in pile capacity prediction. For large piling projects where CASE method is to be used to ascertain the load-carrying capacity of piles, site-specific tests can be conducted to determine the appropriate damping factors by correlating the CASE results with static loading tests or results of CAPWAP analysis.

Table 9.2 – Range of CASE Damping Values for Different Types of Soil

| Soil Type at Pile Toe | CASE Damping (Rausche et al, 1985) | Updated CASE Damping (PDI, 1996) |
|-------------------------|---------------------------------------|-------------------------------------|
| Clean sand | 0.05 – 0.20 | 0.10 – 0.15 |
| Silty sand, sand silt | 0.15 – 0.30 | 0.15 – 0.25 |
| Silt | 0.20 – 0.45 | 0.25 – 0.40 |
| Silty clay, clayey silt | 0.40 – 0.70 | 0.40 – 0.70 |
| Clay | 0.60 – 1.10 | 0.70 or higher |

9.4.3.3 CAPWAP method

In a CAPWAP (CAsE Pile Wave Analysis Program) analysis, the soil is represented by a series of elasto-plastic springs in parallel with a linear dashpot similar to that used in the wave equation analysis proposed by Smith (1962). The soil can also be modelled as a continuum when the pile is relatively short. CAPWAP measures the acceleration-time data as the input boundary condition. The program computes a force versus time curve which is compared with the recorded data. If there is a mismatch, the soil model is adjusted. This iterative procedure is repeated until a satisfactory match is achieved between the computed and measured force-time diagrams.

The dynamic component of penetration resistance is given by :

$$R_d = j_s v_p R_s \quad [9.3]$$

where j_s = Smith damping coefficient
 v_p = velocity of pile at each segment
 R_s = static component of penetration resistance

Input parameters for the analysis include pile dimensions and properties, soil model parameters including the static pile capacity, Smith damping coefficient, j_s and soil quake (i.e. the amount of elastic deformation before yielding starts), and the signals measured in the field. The output will be in the form of distribution of static unit shaft resistance against depth and base response, together with the static load-settlement relationship up to about 1.5 times the working load. It should be noted that the analysis does not model the onset of pile failure correctly and care should be exercised when predicting deflections at loads close to the ultimate pile capacity.

Results of CAPWAP analysis also provide a check of the CASE method assumptions since the ultimate load calculated from the CAPWAP analysis can be used to calculate the CASE damping coefficient.

Sound engineering judgement is required in determining whether a satisfactory match has been achieved and whether the corresponding combination of variables is realistic.

9.4.3.4 SIMBAT method

SIMBAT is developed mainly for cast-in-place piles. This method is different from the other methods in that in addition to strain transducers and accelerometers, an electronic

theodolite is used for monitoring the temporary and permanent pile head movement during driving.

In the SIMBAT analysis,

$$R_d = R_s f(v_b) \quad [9.4]$$

where $f(v_b)$ = function of the velocity of the pile tip

An alternative formulation was suggested by Hansen & Denver (1980) for pile driving analysis as follows :

$$R_d = Z (v_o - 0.5 v_1) \quad [9.5]$$

where v_o = first peak in velocity after the falling mass contacts the pile top

v_1 = second peak in velocity upon arrival of the reflected wave at the pile top

Z = pile impedance (see Equation [9.2])

In this method, the soil is represented by a series of springs and dashpots (Stain & Davis, 1989). A series of impacts is applied to the pile using a drop hammer with the drop height being progressively increased and decreased. The method of analysis is the same as in CAPWAP except that the displacement record obtained by the theodolite is used to verify and correct the velocity data derived from the first integral of the acceleration data. The upward and downward forces for each hammer blow are separated and the dynamic soil resistance for each blow is calculated. Experience with the use of this method in Hong Kong is, as yet, limited.

9.4.3.5 Other methods of analysis

There are other methods of analysis such as that proposed by Simons & Randolph (1985) and Lee et al (1988). These are generally based on input of conventional soil mechanics parameters such as Young's modulus and density and do not rely on empirical constants (i.e. damping factors and soil quake) as used in the above formulations. Experience with the use of these methods for practical problems is however limited.

9.4.4 Recommendations on the Use of Dynamic Loading Tests

Traditionally, pile driving formulae are used as a mean to assess pile capacity from a measurement of 'set per blow' and are supplemented with static loading tests on selected piles. Although such an approach is the norm in local practice for driving piles, driving formulae are considered fundamentally incorrect and quantitative agreement between static pile capacities predicted by driving formulae and actual values cannot be relied upon (CGS, 1992; Likins et al, 2000; Poulos & Davis, 1980).

Dynamic load testing using CASE method, CAPWAP or SIMBAT is preferred for pile capacity predictions. Dynamic load testing can be applied to non-homogeneous soils or piles with a varying cross-sectional area. The static load-settlement response of a pile can also be predicted. In practice, static load test or CAPWAP analysis may be used to calibrate

the damping coefficients in CASE method. This permits more piles to be tested by the less expensive CASE method. As the field data collected for a CASE method analysis will be sufficient for a CAPWAP analysis, the latter should be carried out when the results of CASE method analysis are in doubt. In complex ground conditions, it is preferable to undertake CAPWAP analysis.

Dynamic pile loading tests can supplement the design of driven piles provided that they have been properly calibrated against static loading tests and an adequate site investigation has been carried out. It should be noted that such calibration of the analysis model has to be based on static loading tests on piles of similar length, cross section and under comparable soil conditions and loaded to failure. A static loading test, which is carried out to a proof load, is an inconclusive result for assessing the ultimate resistance of the pile.

The reliability of the prediction of dynamic loading test methods is dependent on the adequacy of the wave equation model and the premise that a unique solution exists when the best fit is obtained within the limitation of the assumption of an elasto/rigid plastic soil behaviour (Rausche et al, 1985). In addition, there are uncertainties with the modelling of effects of residual driving stresses in the wave equation formulation.

In Hong Kong, dynamic pile loading tests are mainly used as a quality control tool to detect pile defects and monitor driving stresses. They are also used for checking the efficiency of hammers (BD, 2004a; HKCA, 2004). More positive use of dynamic loading tests (CAPWAP) has been adopted (ArchSD, 2003) (see Section 6.4.2).

Fung et al (2004) compared the load-carrying capacity of driven piles predicted by dynamic loading tests using CAPWAP analysis with that determined by static loading tests. They concluded that dynamic loading tests with CAPWAP analysis give reasonable accuracy in predicting the load-carrying capacity of driven piles. Likins & Rausche (2004) also reviewed more than 300 piles subject to dynamic loading tests with CAPWAP analysis and static loading tests. The load-carrying capacity of the driven piles predicted by CAPWAP analysis is generally conservative when compared with that predicted by static loading tests using Davisson's criterion. Li (2005) observed that the CAPWAP analysis may underestimate the capacities of steel H-piles of high capacity. Notwithstanding that, dynamic loading tests with CAPWAP analysis can be considered as an alternative to static loading tests for driven piles, particularly when static loading tests cannot be carried out due to site constraints.

REFERENCES

- AASHTO (2002). *Standard Specifications for Highway Bridges. (Seventeenth edition)*. American Association of State Highway and Transportation Office, 749 p.
- ACI (1980). *Recommendations for design, manufacture and installation of concrete piles. Report ACI 5438-74*. American Concrete Institute.
- Alawneh, A.S. & Malkawi, A.I.H. (2000). Estimation of post-driving residual stresses along driven piles in sand. *Geotechnical Testing Journal*, American Society for Testing and Materials, vol. 23, pp 313-326.
- Altaee, A., Fellenius, B.H. & Evgin, E. (1992a). Axial load transfer for piles in sand. I. Tests on an instrumented precast pile. *Canadian Geotechnical Journal*, vol. 29, pp 11-20.
- Altaee, A., Evgin, E. & Fellenius, B. H. (1992b). Axial load transfer for piles in sand. II. Numerical analysis. *Canadian Geotechnical Journal*, vol. 29, pp 21-30.
- API (2000). *Recommended Practice for Planning, Designing and Constructing Fixed Offshore Platform – Working Stress Designs, API RP 2A-WSD*. American Petroleum Institute, 277 p.
- ArchSD (2003). *General Specification for Building. (2003 edition)*. Architectural Services Department, Hong Kong, 521 p.
- ASTM (1992). Standard test method for static modulus of elasticity and Poisson's ratio of concrete in compression, C 469-87a. *1992 Annual Book of ASTM Standards*, vol. 04.02, American Society for Testing and Materials, New York, pp 245-248.
- ASTM (1995a). Standard test method for piles under static axial compressive load, D 1143-81. *1995 Annual Book of ASTM Standards*, vol. 04.08, American Society for Testing and Materials, New York, pp 87-97.
- ASTM (1995b). Standard test method for high-strain dynamic testing of piles, D 4945-89. *1995 Annual Book of ASTM Standards*, vol. 04.09, American Society for Testing and Materials, New York, pp 10-16.
- ASTM (1995c). Standard test method for piles under lateral load, D 3966-90. *1995 Annual Book of ASTM Standards*, vol. 04.09, American Society for Testing and Materials, New York, pp 1-15.
- Attewell, P.B. & Farmer, I.W. (1973). Attenuation of ground vibrations from pile driving. *Ground Engineering*, vol. 6, pp 26-29.
- Au, S.W.C. & Lo, S.C.R. (1993). Use of water head support in the construction of large diameter bored piles : potential savings and problems. *Proceedings of the Eleventh*

Southeast Asian Geotechnical Conference, Singapore, pp 489-494.

- Baguelin, F., Jezequel, J.F. & Shields, D.H. (1978). *The Pressuremeter and Foundation Engineering*. Trans Tech Publications, Clausthal, Germany, 617 p.
- Baldi, G., Bellotti, R., Ghionna, V.N., Jamiolkowski, M. & Lo Presti, D.C (1989). Modulus of sands from CPT's and DMT's. *Proceedings of the Twelfth International Conference on Soil Mechanics and Foundation Engineering*, Rio de Janeiro, vol. 1, pp 165-170.
- Bannerjee, P.K. & Driscoll, R.M.C. (1978). *Program for the analysis of pile groups of any geometry subjected to horizontal and vertical loads and moments, PGROUP*. HECB/B/7, Department of Transport, HECB, London, 188 p.
- Barcham, M.C. & Gillespie, B.J. (1988). New Bank of China : Hong Kong foundations and substructure design. *Proceedings of the Fourth International Conference on Tall Buildings*, Hong Kong & Shanghai, vol. 1, pp 128-135.
- Bartholomew, R.F. (1980). The protection of concrete piles in aggressive ground conditions : an international appreciation. *Proceedings of the Conference on Recent Developments in the Design and Construction of Piles*. The Institution of Civil Engineers, London, pp 131-141.
- Barton, N.R. (1986). Deformation phenomena in jointed rock. *Géotechnique*, vol. 36, pp 147-167.
- Barton, N.R., Bandis, S. & Bakhtar, K. (1985). Strength, deformation and conductivity coupling of rock joints. *International Journal of Rock Mechanics & Mining Sciences and Geomechanics Abstract*, vol. 22, pp 121-140.
- Barton, N.R., Lien, R. & Lunde, J. (1974). Engineering classification of rock masses for the design of tunnel support. *Rock Mechanics*, vol. 6, pp 189-236.
- Barton, Y.O. (1982). *Laterally Loaded Model Piles in Sand : Centrifuge Tests and Finite Element Analyses*. PhD thesis, University of Cambridge, 242 p. (Unpublished).
- BD (1995). *Ban on Hand-dug Caissons (Practice Note for Authorized Persons and Registered Structural Engineers, No. 158)*. Buildings Department, Hong Kong, 2 p.
- BD (2004a). *Code of Practice for Foundations*. Buildings Department, Hong Kong, 57 p.
- BD (2004b). *Mass Transit Railway Protection, Railway Ordinance, Mass Transit Railway (Land Resumption and Related Provisions) Ordinance, Buildings Ordinance Scheduled Area No. 3 (Practice Note for Authorized Persons and Registered Structural Engineers, No. 77)*. Buildings Department, Hong Kong, 8 p.
- BD (2004c). *Kowloon-Canton Railway Corporation Railway Protection, Railway Ordinance, Buildings Ordinance Scheduled Area No. 3 (Practice Note for Authorized Persons and Registered Structural Engineers, No. 279)*. Buildings Department, Hong Kong, 7 p.

- BD (2004d). *Code of Practice for Structural Use of Concrete*. Buildings Department, Hong Kong, 183 p.
- BD (2005). *Ground-borne Vibration Arising from Pile Driving and Similar Operations (Practice Note for Authorized Persons and Registered Structural Engineers, No. 289)*. Buildings Department, Hong Kong, 5 p.
- Bernal, J.B. & Reese, L.C. (1984). *Drilled Shafts and Lateral Pressure of Fresh Concrete. Geotechnical Engineering Report GR B4-4*. Geotechnical Engineering Centre, Bureau of Engineering Research, University of Texas at Austin, 126 p.
- Beredugo, Y.O. (1966). An experimental study of the load distribution in pile groups in sand. *Canadian Geotechnical Journal*, vol. 3, pp 145-166.
- Beresford, J.J., Rashman, P.M. & Hollamby, R.G. (1987). The merits of polymeric fluids as support slurries. *Proceedings of the International Conference on Piling and Deep Foundations*, London, vol. 1, pp 3-10.
- Berezantzev, V.G., Khristoforov, V. & Golubkov, V. (1961). Load bearing capacity and deformation of piled foundations. *Proceedings of the Fifth International Conference on Soil Mechanics and Foundation Engineering*, Paris, vol. 2, pp 11-15.
- Bhushan, K., Haley, S.C. & Fong, P.T. (1979). Lateral load tests on drilled piers in stiff clays. *Journal of the Geotechnical Engineering Division*, American Society of Civil Engineers, vol. 105, pp 969-985.
- Bieniawski, Z.T. (1974). Geomechanics classification of rock masses and its application in tunnelling. *Proceedings of the Third International Congress of the International Society for Rock Mechanics*, Denver, vol. 2A, pp 27-32.
- Bieniawski, Z.T. (1989). *Engineering Rock Mass Classification*. John Wiley, New York, 251 p.
- Bieniawski, Z.T. & Orr, C.M. (1976). Rapid site appraisal for dam foundations by the Geomechanics Classification. *Transactions of the Twelfth International Congress on Large Dams*, Mexico, vol. 2, Q46, R32, pp 483-500.
- Birmingham, P. & Janes, M. (1989). An innovative approach to load testing of high capacity piles. *Proceedings of the International Conference on Piling and Deep Foundations*, London, vol. 1, pp 409-413.
- Bjerrum, L. (1973). Problems of soil mechanics and construction on soft clays. *Proceedings of the Eighth International Conference on Soil Mechanics & Foundation Engineering*, Moscow, vol. 3, pp 111-159.
- Bjerrum, L. & Eggstad, A. (1963). Interpretation of loading test on sand. *Proceedings of European Conference in Soil Mechanics*, Wiesbaden, 1, pp 199-203.
- Bjerrum, L., Johannessen, I.J. & Eide, O. (1969). Reduction of negative skin friction on steel

- piles to rock. *Proceedings of the Seventh International Conference on Soil Mechanics and Foundation Engineering*, Mexico City, vol. 2, pp 27-33.
- Blake, G., Chan, E. & Wright, M. (2000). The design and site supervision of driven piling for high rise buildings on marble. *Proceedings of the Nineteenth Annual Seminar*, Geotechnical Division, Hong Kong Institution of Engineers, pp 87-96.
- Bond, A.J. & Jardine, R.J. (1991). Effects of installing displacement piles in a high OCR clay. *Géotechnique*, vol. 41, pp 341-364.
- Bowles, J.E. (1992). *Foundation Analysis and Design. (Fourth edition)*. McGraw-Hill International, New York, 1004 p.
- Braithwaite, P.A. & Cole, K.W. (1986). Subsurface investigations of abandoned limestone workings in the West Midlands of England by use of remote sensors. *Proceedings of the Conference on Rock Engineering and Excavation in an Urban Environment*, Hong Kong, pp 27-39.
- Brand, E.W., Hencher, S.R. & Youdan, D.G. (1983). Rock slope engineering in Hong Kong. *Proceedings of the Fifth International Rock Mechanics Congress*, Melbourne, vol. 1, pp C17-C24. (Discussion, vol. 3, pp G126).
- Brand, E.W. & Phillipson, H.B. (1984). Site investigation and geotechnical engineering practice in Hong Kong. *Geotechnical Engineering*, vol. 15, pp 97-153.
- Bransby, M.F. & Randolph, M.F. (1998). Combined loading of skirted foundations. *Géotechnique*, vol. 48, pp 637-655.
- Brenner, R.P. & Chittikuladilok, B. (1975). Vibration from pile driving in the Bangkok area. *Geotechnical Engineering*, vol. 6, pp 167-197.
- Briaud, J.L. (1992). *The Pressuremeter*. A.A. Balkema Publishers, Brookfield, Vermont, 336 p.
- Briaud, J.L. & Gibbens, R. (1997). *Large-scale Load Tests and Database of Spread Footings on Sand*. United States Department of Transportation, Federal Highways Association, 228 p.
- Brinch Hansen, J. (1961). The ultimate resistance of rigid piles against transversal forces. *Danish Geotechnical Institute Bulletin*, no. 12, pp 5-9.
- Brinch Hansen, J. (1963). Discussion. Hyperbolic stress-strain response. Cohesive soils. *Journal of Soil Mechanics and Foundations*, American Society of Civil Engineers, vol. 89, pp 241-242.
- Brinch Hansen, J. (1970). A revised and extended formula for bearing capacity. *Danish Geotechnical Institute Bulletin*, no. 28, pp 5-11.
- Broms, B.B. (1964a). The lateral resistance of piles in cohesive soils. *Journal of the Soil*

- Mechanics and Foundations Division*, American Society of Civil Engineers, vol. 90, no. SM2, pp 27-63.
- Broms, B.B. (1964b). The lateral resistance of piles in cohesionless soils. *Journal of the Soil Mechanics and Foundations Division*, American Society of Civil Engineers, vol. 90, no. SM3, pp 123-156.
- Broms, B.B. (1965). Design of laterally loaded piles. *Journal of the Soil Mechanics and Foundations Division*, American Society of Civil Engineers, vol. 91, no. SM3, pp 79-99.
- Broms, B.B. (1979). Negative skin friction. *Proceedings of the Sixth Asian Regional Conference on Soil Mechanics & Foundation Engineering*, Singapore, vol. 2, pp 41-75.
- Broms, B.B. (1981). *Precast Piling Practice*. Thomas Telford Ltd., 126 p.
- Broms, B.B. (1984). Bearing capacity of initially bent piles. *Proceedings of Second International Geotechnical Seminar - Pile Foundations*, Singapore, pp BB/1-15.
- Broms, B.B. & Bredenberg, H. (1982). Application of stress wave theory on pile driving - a state-of-the-art report. *Proceedings of the Seventh Southeast Asian Geotechnical Conference*, Hong Kong, vol. 2, pp 195-238.
- Broms, B.B. & Chang, M.F. (1990). Engineering practice for bored piles in residual soils and weathered rocks in Singapore. *Proceedings of the Conference on Deep Foundation Practice*, Singapore, pp 13-26.
- Broms, B.B. & Silberman, J.O. (1964). Skin friction resistance for piles in cohesionless soil. *Sole-Soils*, no. 10, pp 33-41.
- Broms, B.B. & Wong, I.H. (1986). Damage to initially bent piles. *Proceedings of the International Conference on Deep Foundations*, Beijing, vol. 2, pp 2.104-2.108.
- Brown, D.A., Morrison, C. & Reese, L.C. (1988). Lateral load behaviour of pile groups in sand. *Journal of Geotechnical Engineering*, American Society of Civil Engineers, vol. 114, pp 1261-1276.
- Bruce, D.A. & Yeung, C.K. (1984). A review of minipiling with particular regard to Hong Kong applications. *Hong Kong Engineer*, vol. 12, no. 6, pp 31-54.
- BSI (1954). *British Standard Code of Practice for Foundations (CP4 : 1954)*. British Standards Institution, London, 173 p.
- BSI (1986). *British Standard Code of Practice for Foundations (BS 8004 : 1986)*. British Standards Institution, London, 149 p.
- BSI (1990). *Evaluation and Measurement for Vibration in Buildings – Part 1: Guide for Measurement of Vibrations and Evaluation of Their Effects on Buildings (BS 7385-1 :*

- 1990). British Standards Institution, London, 18 p.
- BSI (1992). *Noise Control on Construction and Open Sites – Code of Practice for Noise and Vibration Control Applicable to Piling Operations (BS5288-4 : 1992)*. British Standards Institution, London, 70 p.
- BSI (1997). *Structural Use of Concrete. Part 1 - Code of Practice for Design and Construction (BS8110-1 : 1997)*. British Standards Institution, London, 163 p.
- BSI (2000a). *Maritime Structures, Part 1 – Code of Practice for General Criteria (BS 6349-1 : 2000)*. British Standards Institution, London, 239 p.
- BSI (2000b). *Eurocode 7: Geotechnical Design – Part 3: Design Assisted by Field Testing (DD ENV 1997-3:2000)*. British Standards Institution, London, 146 p.
- BSI (2000c). *Execution of Special Geotechnical Work – Bored Piles (BS EN 1536 : 2000.)* British Standards Institution, London, 87 p.
- BSI (2001). *Execution of Special Geotechnical Work – Displacement Piles (BS EN 12699 : 2001)*. British Standards Institution, London, 46 p.
- BSI (2002). *Concrete – Complimentary British Standard to BS EN 206-1: Part 1 – Method of Specifying and Guidance for Specifier (BS 8500-1 : 2002)*. British Standards Institution, London, 44 p.
- BSI (2004). *Eurocode 7: Geotechnical Design – Part 1: General Rules (BS EN 1997-1 : 2004)*. British Standards Institution, London, 167 p.
- BSI (2005). *Execution of Special Geotechnical Works – Micropiles (BS 14199 : 2005)*. British Standards Institution, London, 48 p.
- Buckell, R. & Levy, S. (2004). New techniques for large diameter bored piles drilling operations in rock. *Proceedings of the Conference on Foundation Practice in Hong Kong*, Centre for Research and Professional Development, Hong Kong, pp H1-H8.
- Buisman, A.S.K. (1936). Results of long duration settlement tests. *Proceedings of the First International Conference on Soil Mechanics and Foundation Engineering*, Cambridge, Massachusetts, vol. 1, pp 103-106.
- Burland, J.B. (1973). Shaft friction of piles in clay - a simple fundamental approach. *Ground Engineering*, vol. 6, no. 3, pp 30-42.
- Burland, J.B. (1995). Piles as settlement reducers, keynote address. *Proceedings of the Eighteenth Italian Congress on Soil Mechanics*, Pavia, Italy, pp 21-34.
- Burland, J.B. & Burbidge, M.C. (1985). Settlement of foundations on sand and gravel. *Proceedings of Institution of Civil Engineers*, Part 1, vol. 78, pp 1325-1381.
- Burland, J.B. & Kalra, J.C. (1986). Queen Elizabeth II Conference Centre. *Proceedings of*

the Institution of Civil Engineers, Part 1, vol. 80, pp 1479-1503.

- Burland, J.B. & Lord, J.A. (1970). Discussion on papers in Session A. *Proceedings of the Conference on In-situ Investigations in Soils and Rocks*, London, pp 61-62.
- Burland, J.B. & Starke, W. (1994). Review of measured negative pile friction in terms of effective stress. *Proceedings of the Thirteenth International Conference on Soil Mechanics and Foundation Engineering*, New Delhi, vol. 2, pp 493-496.
- Burland, J.B. & Twine, D. (1989). The shaft friction of bored piles in terms of effective strength. *Proceedings of the First International Geotechnical Seminar on Deep Foundations on Bored and Auger Piles*, Ghent, pp 411-420.
- Butler, F.G. & Morton, K. (1971). Specification and performance of test piles in clay. *Proceedings of the Conference on Behaviour of Piles*, London, pp 17-26.
- Butterfield, R. & Bannerjee, P.K. (1971a). The elastic analysis of compressible piles and pile groups. *Géotechnique*, vol. 21, pp 43-60.
- Butterfield, R. & Bannerjee, P.K. (1971b). The problem of pile group-pile cap interaction. *Géotechnique*, vol. 21, pp 135-142.
- Butterfield, R. & Douglas, R.A. (1981). *Flexibility Coefficients for the Design of Piles and Pile Groups (CIRIA Report No. 108)*. Construction Industry Research & Information Association, London, 79 p.
- Carter, J.P. & Kulhawy, F.H. (1992). Analysis of laterally loaded shafts in rock. *Journal of Geotechnical Engineering*, American Society of Civil Engineers, vol. 118, pp 839-855. (Discussion, vol. 119, pp 2014-2019).
- Castelli, F. & Maugeri, M. (2002). Simplified nonlinear analysis for settlement prediction of pile groups. *Journal of Geotechnical and Geoenvironmental Engineering*, American Society of Civil Engineers, vol. 129, pp 76-84.
- CEO (2002). *Port Works Design Manual - Part 1*. Civil Engineering Office, Hong Kong, 164 p.
- CEO (2004). *Port Works Design Manual - Part 2*. Civil Engineering Office, Hong Kong, 124 p.
- CGS (1992). *Canadian Foundation Engineering Manual. (Third edition)*. Canadian Geotechnical Society, Ottawa, 512 p.
- Chak, Y.H. & Chan, Y.C. (2005). *The 2004 Review on Prevention of Alkali Silica Reaction in Concrete (GEO Report No. 167)*. Geotechnical Engineering Office, Hong Kong, 76 p.
- Chan, A.K.C. & Davies, J.A. (1984). Some aspects of design and construction of foundations for high rise buildings in Hong Kong. *Proceedings of the Third International*

Conference on Tall Buildings, Hong Kong and Guangzhou, pp 107-113.

- Chan, C.C. (1981). *A Review on the Types of Building Foundations Commonly Used in Hong Kong with Practical Examples*. M. Sc. Dissertation, University of Hong Kong, 141 p. (Unpublished).
- Chan, H.F.C., Heywood, C., Forde, M.C. & Batchelor, A.J. (1987). Developments in transient shock pile testing. *Proceedings of the International Conference on Foundations and Tunnels*, London, pp 245-261.
- Chan, H.F.C. & Weeks, R.C. (1995). Electrolevels or servo-accelerometers? *Proceedings of the Fifteen Annual Seminar*, Geotechnical Division, Hong Kong Institution of Engineers, pp 97-105.
- Chan, P.W.F., Chan, W.K.H. & Tse, C.M. (2002). Design and construction of bored piles in completely or moderately decomposed rock for the KCRC Ma On Shan Rail. *Proceedings of the Twenty-second Annual Seminar*, Geotechnical Division, Hong Kong Institution of Engineers, pp 73-86.
- Chan, R.K.S. (1987). Case histories on base heave with hand-dug caissons in Hong Kong. *Proceedings of the Ninth European Conference on Soil Mechanics and Foundation Engineering*, Dublin, vol. 3, pp 1316-1317.
- Chan, Y.C. (1994a). *Classification and Zoning of Marble Sites (GEO Report No. 29)*. Geotechnical Engineering Office, Hong Kong, 46 p.
- Chan, Y.C. (1994b). *Factors Affecting Sinkhole Formation (GEO Report No. 28)*. Geotechnical Engineering Office, Hong Kong, 46 p.
- Chan, Y.C. (1996). Foundations in karst marble in Hong Kong. *Proceedings of the Twelfth Southeast Asian Conference on Geotechnical Engineering and Foundations*, Kuala Lumpur, vol. II, pp 169-199.
- Chan, Y.C., Ho, K.K.S. & Pun, W.K. (1994). A new marble rock mass classification system for the interpretation of karst morphology in Hong Kong. *Transactions of the Hong Kong Institution of Engineers*, vol. 1, no. 2, pp 1-12.
- Chan, A.K.C. (2003). Observations from excavation – a reflection. *Proceedings of the Twenty-third Annual Seminar*, Geotechnical Division, Hong Kong Institution of Engineers, pp 83-102.
- Chang, M.F. & Broms, B.B. (1991). Design of bored piles in residual soils based on field performance data. *Canadian Geotechnical Journal*, vol. 28, pp 200-209.
- Chapman, T.J.P., Butcher, A. & Fernie, R. (2004). *A Generalised Strategy for Reuse of Old Foundations*. (Unpublished), 6 p.
- Chapman, T.J.P., Marsh, B. & Foster, A. (2001). Foundations for the future. *Proceeding of Institution of Civil Engineers*, vol. 144, pp 36-41.

- Chellis, R.D. (1961). *Pile Foundations. (Second edition)*. McGraw-Hill Inc., New York, 704 p.
- Cheung, Y.K., Tham, L.G. & Guo, D.J. (1988). Analysis of pile group by infinite layer method. *Géotechnique*, vol. 38, pp 415-431.
- Chiang, Y.C. & Ho, Y.M. (1980). Pressuremeter method for foundation design in Hong Kong. *Proceedings of the Sixth Southeast Asian Conference on Soil Engineering*, Taipei, vol. 1, pp 31-42.
- Chin, F.K. (1970). Estimation of the ultimate load of piles not carried to failure. *Proceedings of the Second Southeast Asian Conference on Soil Engineering*, Singapore, vol. 1, pp 81-90.
- Chin, F.K. (1978). Diagnosis of pile condition. *Geotechnical Engineering*, vol. 9, no. 2, pp 85-104.
- Chiu, H.K. & Perumalswamy, R. (1987). Foundation for Capital Square, Phase I, Kuala Lumpur. *Proceedings of the Ninth Southeast Asian Geotechnical Conference*, Bangkok, vol. 1, pp 6/177-194.
- Chow, F.C., Jardine, R.J., Brucy, F. and Nauroy, J.F. (1998). Effects of time on capacity of pipe piles in dense marine sand. *Journal of Geotechnical and Geoenvironmental Engineering*, vol. 124, American Society of Civil Engineers, pp 254-264.
- Chow, Y.K. (1987). Iterative analysis of pile-soil-pile interaction. *Géotechnique*, vol. 37, pp 321-333.
- Chow, Y.K. (1989). Axially loaded piles and pile groups embedded in a cross-anisotropic soil. *Géotechnique*, vol. 39, pp 203-212.
- Chow, Y.K., Chin, J.T., Kog, Y.C. & Lee, S.L. (1990). Settlement analysis of socketed pile groups. *Journal of the Geotechnical Engineering Division*, American Society of Civil Engineers, vol. 116, pp 1171-1184.
- Chow, Y.K., Lim, C.H. & Karunaratne, G.P. (1996). Numerical modelling of negative skin friction on pile group. *Computers and Geotechnics*, vol. 18, pp 201-244.
- Chu, R.P.K. & Yau, P.K.F. (2003). Raft foundation on newly reclaimed land. *Proceedings of the Twenty-third Annual Seminar*, Geotechnical Division, Hong Kong Institution of Engineers, pp 114-121.
- Chung, E.K.F. & Hui, T. (1990). Trial friction bored piles in Hong Kong. *Proceedings of the Conference on Deep Foundation Practice*, Singapore, pp 47-54.
- Clayton, C.R.I., Gunn, M.J. & Hope, V.S. (1993). An assessment of seismic tomography for determining ground geometry and stiffness. *Proceedings of the Wroth Memorial Symposium*, Oxford, pp 173-185.

- Cockerell, M.J. & Kan, K.K. (1981). The control of noise from piling operations. *Hong Kong Engineer*, vol. 9, no. 3, pp 73-76.
- Cole, K.W. (1972). Uplift of piles due to driving displacement. *Civil Engineering and Public Works Review*, no. 3, pp 263-269.
- Cole, K.W. & Patel, D. (1992). Review of prediction of pile performance in London Clay under the action of service loads. *Proceedings of the Conference on Piling - European Practice and Worldwide Trends*, London, pp 80-87.
- Construction & Contract News (1983). Marine piling for Eastern Island Corridor Stage II. *Construction and Contract News (Hong Kong)*, January 1983, pp 25-29.
- Cooke, R.W. (1986). Piled raft foundations on stiff clays - a contribution to design philosophy. *Géotechnique*, vol. 36, pp 169-203.
- Coop, M.R. & McAuley, J. (1992). The shaft friction of piles in carbonate soils. *Proceedings of the International Conference on Offshore Site Investigation and Foundation Behaviour*, London, pp 645-660.
- Coop, M.R. & Wroth, C.P. (1989). Field studies of an instrumented model pile in clay. *Géotechnique*, vol. 39, pp 679-696.
- Corbet, S.P., Culley, D.S., Sherwood, D.E. & Cockcroft, J.E.M. (1991). Testing and analysis of preliminary test piles in very weak chalk. *Proceedings of the Fourth International Conference on Piling and Deep Foundations*, Stresa, vol. 1, pp 57-63.
- Cornfield, G.M. (1961). Discussion on 'Pile driving analysis by the wave equation' by Smith. *Journal of the Soil Mechanics and Foundations Division*, American Society of Civil Engineers, vol. 87, no. SM1, pp 63-75.
- Coyle, H.M. & Reese, L.C. (1966). Load transfer for axially loaded piles in clay. *Journal of the Soil Mechanics and Foundations Division*, American Society of Civil Engineers, vol. 92, no. SM2, pp 1-26.
- Craft, J.R. (1983). Diaphragm walls for the support of deep excavations. *Hong Kong Engineer*, vol. 11, no. 9, pp 23-31.
- Cundall, P.A. (1980). *UDEC - A generalised distinct element program for modelling jointed rock (Report PCAR-1-80)*. Peter Cundall Associates, Report prepared for European Research Office, US Army, 69 p.
- Curtis, R.J. (1970). Construction control affecting the behaviour of driven in situ concrete piles. *Proceedings of the Conference on Behaviour of Piles*, London, pp 167-174.
- Daley, P. (1990). A review of pile driving records at three sites in Hong Kong. *Proceedings of the Conference on Karst Geology in Hong Kong*, Hong Kong, pp 123-134.

- Darigo, N.J. (1990). Marble-bearing Jurassic volcanics of the western New Territories, Hong Kong. *Proceedings of the Conference on Karst Geology in Hong Kong*, Hong Kong, pp 61-72.
- Davie, J.R., Lewis, M.R. & Young, L.W. (1993). Uplift load tests on driven piles. *Proceedings of the Third International Conference on Case Histories in Geotechnical Engineering*, St Louis, vol. 1, pp 97-104.
- Davies, E.H. & Poulos, H.G. (1972). Rate of settlement under three dimensional conditions, *Géotechnique*, vol. 22, pp 95-114.
- Davies, J.A. (1987). Groundwater control in the design and construction of a deep excavation. *Proceedings of the Ninth European Conference on Soil Mechanics and Foundation Engineering*, Dublin, vol. 1, pp 139-144.
- Davies, R.V. & Chan, A.K.C. (1981). Pile design in Hong Kong. *Hong Kong Engineer*, vol. 9, no. 3, pp 21-28.
- Davies, R.V. & Henkel, D.J. (1980). Geotechnical problems associated with the construction of Chater Station, Hong Kong. *Proceedings of the Conference on Mass Transportation in Asia*, Hong Kong, paper J3, 31 p.
- Davis, E.H. & Poulos, H.G. (1968). The use of elastic theory for settlement prediction under three-dimensional conditions. *Géotechnique*, vol. 18, pp 67-91.
- Davisson, M.T. (1972). High capacity piles. *Proceedings and Lecture Series in Innovations in Foundation Construction*, American Society of Civil Engineers, Illinois Section, 52 p.
- Davisson, M.T. & Gill, H.L. (1963). Laterally loaded piles in a layered soil system. *Journal of the Soil Mechanics and Foundations Division*, American Society of Civil Engineers, vol. 89, no. SM3, pp 63-94.
- Davisson, M.T. & Robinson, K.E. (1965). Bending and buckling of partially embedded piles. *Proceedings of the Sixth International Conference on Soil Mechanics and Foundation Engineering*, Montreal, vol. 2, pp 243-246.
- De Beer, E.E. & Wallays, M. (1972). Forces induced in piles by unsymmetrical surcharge on the soil and the pile. *Proceedings of the Fifth European Conference on Soil Mechanics and Foundation Engineering*, Madrid, vol. 1, pp 325-332.
- de Mello, V.F.B. (1969). Foundations of buildings on clay. State of the Art Report. *Proceedings of the Seventh International Conference on Soil Mechanics and Foundation Engineering*, Mexico City, State of the Art Volume, pp 49-136.
- DEFRA (2002). *Assessment of Risks of Human Health from Land Contamination*. Department of Environment, Food and Rural Affairs, United Kingdom, 40 p.
- Delpak, R., Rowlands, G.O. & Siraty, A. (1992). Modelling of strip foundations for

- serviceability assessment. *The Structural Engineer*, vol. 70, no. 23/24/8, pp 412-420.
- Dickin, E.A. & Leung, C.F. (1990). Performance of piles with enlarged bases subject to uplift forces. *Canadian Geotechnical Journal*, vol. 27, pp 546-556.
- DoD (2005). *Unified Facilities Criteria, Design : Soil Mechanics (UFC-3-220-10N)*. Department of Defense, United States, 394 p.
- Domanski, T., Lee, D.M., Boyd, H. & Leung, F. (2002). The design and construction of bored pile socketed in infilled marble. *Proceedings of the Twenty-second Annual Seminar, Geotechnical Division*, Hong Kong Institution of Engineers, Hong Kong, pp 131-141.
- Duncan, J.M. & Poulos, H.G. (1981). Modern techniques for the analysis of engineering problems in soft clay. *Soft Clay Engineering*, Elsevier, New York, pp 367-414.
- Ellway, K. (1987). Practical guidance on the use of integrity tests for the quality control of cast-in-situ piles. *Ground Engineering*, vol. 20, no. 7, pp 8-13.
- Elson, W.K. (1984). *Design of Laterally-loaded Piles (CIRIA Report No. 103)*. Construction Industry Research & Information Association, London, 86 p.
- Endicott, L.J. (1980). Aspects of design of underground railway structures to suit local soil conditions in Hong Kong. *Hong Kong Engineer*, vol. 8, no. 3, pp 29-38.
- Endicott, L.D. (1982). Temporary walls for deep excavations. *Proceedings of the Second Conference on Structural Engineering*, Bangkok, paper D1, 13 p.
- EPD (1994). *Construction Site Drainage*. Pro PECC PN 1/94, 26 p.
- EPD (1997). *Technical Memorandum on Noise from Percussive Piling*. Environmental Protection Department, Hong Kong, 17 p.
- Esrig, M.I., Leznicki, J.K. & Gaibrois, R.G. (1991). Building displacements resulting from pile installation in New York City. *Proceedings of the International Conference of Deep Foundations*, ENPC/DFCAI, Paris, France, pp 559-565.
- ETWB (2004). *Checking of Foundation Works in the Scheduled Areas of Northwest New Territories and Ma On Shan and the Designated Area of Northshore Lantau (Environment, Transport & Works Bureau Technical Circular No. 4/2004)*. Environment, Transport & Works Bureau, Government Secretariat, Hong Kong, 15 p.
- Evans, G.L. (1987). The performance of driven prestressed concrete piles. *Hong Kong Engineer*, vol. 15, no. 2, pp 9-16.
- Evans, G.L., McNicholl, D.P. & Leung, K.W. (1982). Testing in hand dug caissons. *Proceedings of the Seventh Southeast Asian Geotechnical Conference*, Hong Kong, vol. 1, pp 317-332.

- Evans, G.L., Wong, P.P. & Sanders, H. (1987). The performance of driven piles in a crushed rock-filled reclamation. *Hong Kong Engineer*, vol. 15, no. 4, pp 29-42.
- Faber, J.C. & Milner, D.H. (1971). Strengthening of No. 5 wharf at Tsim Sha Tsui. *Proceedings of the Engineering Society of Hong Kong*, vol. 25, pp 4.1-4.26.
- Fahey, M., Jewell, R. J., Randolph, M.F. & Khorshid, M.S. (1993). Parameter selection for pile design in calcareous sediments. *Proceedings of the Wroth Memorial Symposium*, Oxford, pp 261-278.
- Fan, S.K. (1990). Recent development in piling technology. *Proceedings of the Seminar on Quiet Piling Technologies*, Hong Kong, 4 p.
- Fellenius, B.H. (1972). Downdrag on long piles in clay due to negative skin friction. *Canadian Geotechnical Journal*, vol. 9, pp 323-337.
- Fellenius, B.H. (1980). The analysis of results from routine pile load tests. *Ground Engineering*, vol. 13, no. 6, pp 19-36.
- Fellenius, B.H. (1984). Negative skin friction and settlement of piles. *Proceedings of the Second International Seminar on Pile Foundations*, Singapore, pp BHF 1-18.
- Fellenius, B.H. (1989). Unified design of piles and pile groups. *Transportation Research Board Record*, no. 1169, pp 75-82.
- Fellenius, B.H. (1998). Recent advances in the design of piles for axial loads, dragload, downdrag and settlement. *Proceedings of the Seminar Organised by American Society of Civil Engineers and Port of New York and New Jersey*, 19 p.
- Fellenius, B.H. (2002a). Determining the resistance distribution in piles. Part 1: Notes on shift of no-load reading and residual load. *Geotechnical News*, vol. 20, No. 2, pp 35-38.
- Fellenius, B.H. (2002b). Determining the resistance distribution in piles. Part 2: Method for determining the residual load. *Geotechnical News*, vol. 20, No. 3, pp 25-29.
- Fellenius B.H. & Altaee A.A (1995). Critical depth : how it came into being and why it does not exist. *Proceedings of the Institution of Civil Engineers, Geotechnical Engineering*, vol. 113, pp 107-111.
- Fleming, W.G.K. (1992). A new method for single pile settlement prediction and analysis. *Géotechnique*, vol. 42, pp 411-425.
- Fleming, W.G.K., Reiding, F. & Middendorp, P. (1985). Faults in cast-in-place piles and their detection. *Proceedings of the Second International Conference on Structural Faults and Repair*, London, pp 301-309.
- Fleming, W.G.K. & Sliwinski, Z.J. (1977). *The Use and Influence of Bentonite in Bored Pile Construction (CIRIA Report No. PG3)*. Construction Industry Research &

Information Association, London, 93 p.

- Fleming, W.G.K. & Thorburn, S. (1983). Recent piling advances. *Proceedings of the Conference on Advances in Piling and Ground Treatment for Foundations*, London, pp 1-16.
- Fleming, W.G.K., Weltman, A.J., Randolph, M.F. & Elson, W.K. (1992). *Piling Engineering. (Second edition)*. Surrey University Press, London, 390 p.
- Forde, M.C., Chan, H.F. & Batchelor, A.J. (1985). Interpretation of non-destructive tests on piles. *Proceedings of the Second International Conference on Structural Faults and Repair*, London, pp 333-348.
- Francescon, M. & Solera, S. (1994). Base grouting to improve performance of piles bored under bentonite in the Thanet Sands, *Grouting in the Ground*, Thomas Telford, London, pp 273-296.
- Fraser, R.A. & Kwok, D. (1986). Mobilisation of skin friction in bored piles in Hong Kong. *Proceedings of the International Conference on Deep Foundations*, Beijing, vol. 2, pp 2.65-2.74.
- Fraser, R.A. & Lai, K.C. (1982). Theoretical settlements of piles and pile groups compared with observations. *Hong Kong Engineer*, vol. 10, no. 5, pp 53-60.
- Fraser, R.A. & Ng, H.Y. (1990). Pile failure. *Proceedings of the Ninth Annual Seminar on Failures in Geotechnical Engineering*, Geotechnical Division, Hong Kong Institution of Engineers, Hong Kong, pp 75-94.
- Fraser, R.A. & Wardle, L.J. (1976). Numerical analysis of rectangular raft on layered foundations. *Géotechnique*, vol. 26, pp 613-630.
- French, S.E. (1999). *Design of Shallow Foundations*, American Society for Civil Engineers Press, 374 p.
- Frost, D.V. (1992). *Geology of Yuen Long (Hong Kong Geological Survey Sheet Report No. 1)*. Geotechnical Engineering Office, Civil Engineering Department, Hong Kong, 69 p.
- Fukuya, T., Todoroki, T. & Kasuga, M. (1982). Reduction of negative skin friction with steel tube NF pile. *Proceedings of the Seventh Southeast Asian Geotechnical Conference*, Hong Kong, vol. 1, pp 333-347.
- Fung, W.K., Wong, C.T. and Wong, M.K. (2004). A study on capacity predictions for driven piles. *Transactions of Hong Kong Institution of Engineers*, vol. 11, No. 3, pp 10-16.
- Fung, W.K., Wong, C.T. & Wong, M.K. (2005). Observations on using the energy obtained from stress-wave measurements in the Hiley Formula, *Transactions of Hong Kong Institution of Engineers*, vol. 12, No. 4, pp 19-22.
- Gannon, J.A., Masterton, G.G., Wallace, W.A. & Wood, D.M. (1999). *Piled Foundation in*

- Weak Rock (CIRIA Report No. 181)*. Construction Industry Research & Information Association, United Kingdom, 80 p.
- GCO (1984). *Geotechnical Manual for Slopes. (Second edition)*. Geotechnical Control Office, Hong Kong, 295 p.
- GCO (1987). *Guide to Site Investigation (Geoguide 2)*. Geotechnical Control Office, Hong Kong, 362 p.
- GCO (1988). *Guide to Rock and Soil Descriptions (Geoguide 3)*. Geotechnical Control Office, Hong Kong, 189 p.
- GCO (1989). *Model Specification for Prestressed Ground Anchors (Geospec 1)*. Geotechnical Control Office, Hong Kong, 168 p.
- GCO (1990). *Foundation Properties of Marble and Other Rocks in the Yuen Long - Tuen Mun Area (GCO Publication No. 2/90)*. Geotechnical Control Office, Hong Kong, 117 p.
- GEO (1993). *Guide to Retaining Wall Design (Geoguide 1). (Second edition)*. Geotechnical Engineering Office, Hong Kong, 267 p.
- GEO (2004). *The Designated Area of Northshore Lantau (Technical Guidance Note No. 12)*. Geotechnical Engineering Office, Hong Kong, 4 p.
- GEO (2005). *Supplementary Guidelines for Foundation Design in Areas underlain by Marble and Marble-bearing Rocks (Technical Guidance Note No. 26)*. Geotechnical Engineering Office, Hong Kong, 4 p.
- George, A.B., Sherrell, F.W. & Tomlinson, M.J. (1977). The behaviour of H-piles in slaty mudstones. *Proceedings of the Conference on Piles in Weak Rock*, London, pp 95-104.
- Goh, A.T.C., Teh, C.I. & Wong, K.S. (1997). Analysis of piles subjected to embankment induced lateral soil movements. *Journal of Geotechnical and Geoenvironmental Engineering*, American Society of Civil Engineers, vol. 123, pp 792-801.
- Grose, W.J. & Kaye, D. (1986). Driving piles adjacent to vibration-sensitive structures. *Ground Engineering*, vol. 19, no. 4, pp 23-31.
- Hagerty, D.J. & Peck, R.B. (1971). Heave and lateral movements due to pile driving. *Journal of the Soil Mechanics and Foundations Division*, American Society of Civil Engineers, vol. 97, pp 1513-1532.
- Hambly, E.C. (1976). *A Review of Current Practice in the Design of Bridge Foundations*. Report for the Department of the Environment, Building Research Establishment, United Kingdom, 93 p.
- Hammon, A.J., Mitchell, J.M. & Lord, J.A. (1980). Design and construction of driven cast-

- in-situ piles in stiff fissured clays. *Proceedings of the Conference on Recent Developments in the Design and Construction of Piles*, London, pp 157-168.
- Hanna, T.H. & Boghosian, H.H.A. (1989). The behaviour of single bent piles. *Proceedings of the Second International Conference on Deep Foundations and Tunnels*, London, pp 119-127.
- Hannigan, P.J., Goble, G.G., Thendean, G., Likins, G.E. & Rausche, F. (1998). *Design and Construction of Driven Pile Foundations – Workshop Manual, Part II*. Federal Highway Administration, 480 p.
- Hansen, B. & Denver, H. (1980). Wave equation analysis of a pile - an analytic model. *Proceedings of the International Seminar on the Application of Stress-wave Theory on Piles*, Stockholm, Sweden, pp 3-22.
- Haswell, C.K. & Umney, A.R. (1978). Trial tunnels for the Hong Kong Mass Transit Railway. *Hong Kong Engineer*, vol. 6, no. 2, pp 15-23.
- Hayes, J. & Simmonds, T. (2002). Interpreting strain measurements from load tests in bored piles. *Proceedings of the Ninth International Conference on Piling and Deep Foundations*, Nice, France.
- Hazen, J.C. & Horner, G. (1984). Marine piers and deck for the Hong Kong Macau ferry terminal. *Hong Kong Engineer*, vol. 12, no. 10, pp 9-15.
- Head, J.M. & Jardine, F.M. (1992). *Ground-borne Vibrations Arising from Piling (CIRIA Technical Note 142)*. Construction Industry Research & Information Association, London, 83 p.
- Healy, P.R. & Weltman, A.J. (1980). *Survey of Problems Associated with the Installation of Displacement Piles (CIRIA Report No. PG8)*. Construction Industry Research & Information Association, London, 54 p.
- Heckman, W.S. & Hagerty, D.J. (1978). Vibrations associated with pile driving. *Journal of the Construction Division*, American Society of Civil Engineers, vol. 104, pp 385-394.
- Hewlett, W.J. & Randolph, M.F. (1988). Analysis of piled embankments. *Ground Engineering*, vol. 22, no. 3, pp 12-18.
- Hill, S.J., Littlechild, B.D., Plumbridge, G.D. & Lee, S.C. (2000). End bearing and socket design for foundations in Hong Kong. *Proceedings of the Nineteenth Annual Seminar*, Geotechnical Division, Hong Kong Institution of Engineers, pp 167-178.
- Hines, P.J. (2000). Presentation on the practical aspects of shaft grouting deep foundation. *Proceedings of the HKIE Workshop on Full-Scale Deep Foundation Loading Test Programme, KCRC West Rail Phase I*, Hong Kong Institution of Engineers, 8p.
- Hirany, A. & Kulhawy, F.H. (1989a). Interpretation of load tests on drilled shafts. Part 1 Axial compression. *Proceedings of the Conference on Foundation Engineering*

- Current Principles and Practices*, New York, vol. 2, pp 1132-1149.
- Hirany, A. & Kulhawy, F.H. (1989b). Interpretation of load tests on drilled shafts. Part 3 Lateral and moment. *Proceedings of the Conference on Foundation Engineering Current Principles and Practices*, New York, vol. 2, pp 1160-1172.
- HKCA (2004). *Use of Hydraulic Hammer for Driven Piles*. Hong Kong Construction Association, 111 p.
- HKG (1992). *General Specification for Civil Engineering Works. (1992 edition)*. Hong Kong Government, vol. 1, 280 p.
- HKIE (1987). *Guidance Notes on Hand-dug Caissons*. Hong Kong Institution of Engineers, Hong Kong, 15 p.
- HKSARG (1997). *Noise Control Ordinance. Laws of Hong Kong, Chapter 400. (1997 edition)*. Government of the Hong Kong Special Administrative Region, 43 p.
- Ho, C.E. (1993). Deep barrette foundations in Singapore weathered granite. *Proceedings of the Eleventh Southeast Asian Geotechnical Conference*, Singapore, pp 529-534.
- Ho, J.L.P. (1992). *The Assessment of Shaft Friction of Bored Piles in Hong Kong*. M.Sc. Dissertation, University of London, 181 p. (Unpublished).
- Ho, K.K.S., Chan, Y.C. & Pun, W.K. (1994). Foundations on karst marble in Hong Kong. *Proceedings of the International Symposium on New Development in Rock Mechanics and Engineering*, Shenyang, pp 164-169.
- Ho, K.K.S. & Mak, S.H. (1994). Long-term monitoring of negative skin friction in driven piles in reclaimed land. *Proceedings of the Fifth International Conference on Piling and Deep Foundations*, Bruges, pp 5.4.1-5.4.10.
- Hobbs, N.B. (1957). Unusual necking of cast-in-situ concrete piles. *Proceedings of the Fourth International Conference on Soil Mechanics and Foundation Engineering*, London, vol. 2, pp 40-42.
- Hobbs, N.B. & Healy, P.R. (1979). *Piling in Chalk (CIRIA Report No. PG6)*. Construction Industry Research & Information Association, London, 126 p.
- Hoek, E. & Brown, E.T. (1980). *Underground Excavations in Rock*. Institution of Mining and Metallurgy, London, 527 p.
- Hoek, E., Wood, D. & Shah, S. (1992). A modified Hoek-Brown failure criterion for jointed rock masses. *Proceedings of the International ISRM Symposium on Rock Characterisation, Eurock '92*, Chester, pp 209-214.
- Holt, D.N., Lumb, P. & Wong, P.K.K. (1982). Site control and testing of bored piles at Telford Gardens, an elevated township at Kowloon Bay, Hong Kong. *Proceedings of the Seventh Southeast Asian Geotechnical Conference*, Hong Kong, vol. 1, pp 349-361.

- Honjo, J. & Kusakabe, O (2002). Proposal of a comprehensive foundation design code: Geo-code 21 ver. 2. *Proceedings of the International Workshop on Foundation Design Codes and Soil Investigation in view of International Harmonization and Performance Based Design*, Japan, pp 95-101.
- Hooper, J.A. (1979). *Review of Behaviour of Piled Raft Foundations (CIRIA Report No. 83)*. Construction Industry Research & Information Association, London, 79 p.
- Hooper, J.A. & Wood, L.A. (1977). Comparative behaviour of raft and piled foundations. *Proceedings of the Ninth International Conference on Soil Mechanics and Foundation Engineering*, Tokyo, vol. 1, pp 545-550.
- Hope, S., Young, S. & Dauncy, P. (2000). Airport railway pile tests. *Proceedings of Nineteenth Annual Seminar*, Geotechnical Division, Hong Kong Institution of Engineers, pp 145-156.
- Houghton, D.A. & Wong, C.M. (1990). Implications of the karst marble at Yuen Long for foundation investigation and design. *Hong Kong Engineer*, vol. 18, no. 6, pp 19-27.
- Howat, M.D. (1985). Active and at rest pressures in granitic saprolites. *Proceedings of the First International Conference on Geomechanics in Tropical Lateritic and Saprolitic Soils*, Brasilia, vol. 3, pp 297-299.
- Humpheson, C., Fitzpatrick, A.J. & Anderson, J.M.D. (1986). The basements and substructure for the new headquarters of the Hongkong and Shanghai Banking Corporation, Hong Kong. *Proceedings of the Institution of Civil Engineers*, Part 1, vol. 80, pp 851-883. (Discussion, vol. 82, 1987, pp 831-858).
- Hutchinson, M.T., Daw, G.P., Shotton, P.G. & James, A.N. (1974). The properties of bentonite slurries in diaphragm walling and their control. *Proceedings of the Conference on Diaphragm Walls and Anchorages*, London, pp 33-39.
- ICE (1988). *Specification for Piling*. The Institution of Civil Engineers, London, 60 p.
- Inoue, Y. (1979). Behaviour of negative skin friction on steel pipe pile driven in alluvial deposits. *Proceedings of the Conference on Recent Developments in the Design and Construction of Piles*, London, pp 237-244.
- Irfan, T.Y. & Powell, G.E. (1985). Engineering geological investigations for pile foundations on a deeply weathered granitic rock in Hong Kong. *Bulletin of the International Association of Engineering Geology*, no. 32, pp 67-80.
- Irfan, T.Y. & Powell, GE. (1991). *Foundation Design of Caissons on Granitic and Volcanic Rocks (GEO Report No. 8)*. Geotechnical Engineering Office, Hong Kong, 92 p.
- ISE (1989). *Soil-structure Interaction : The Real Behaviour of Structures*. The Institution of Structural Engineers, London, 120 p.

- Jamiolkowski, M. & Garassino, A. (1977). Soil modulus for laterally loaded piles. *Proceedings of the Specialty Session on the Effect of Horizontal Loads on Piles due to Surcharge or Seismic Effects, Ninth International Conference on Soil Mechanics and Foundation Engineering*, Tokyo, pp 43-58.
- Janes, M., Birmingham, P. & Horvath, B. (1991). Pile load test results using the Statnamic method. *Proceedings of the Fourth International Conference on Piling and Deep Foundations*, Stresa, Italy, vol. 1, pp 481-490.
- Jardine, R.J. (1992). The cyclic behaviour of large piles with special reference to offshore structures. Chapter 5 in *Cyclic Loading of Soils*, edited by M.P. O'Reilly & S.F. Brown, Blackie Academic & Professional, pp 174-248.
- Jardine, R.J., Chow, F., Overy, R.F. & Standing, J. (2005). *ICP Design Methods for Driven Piles in Sands and Clays*. Thomas Telford, 106 p.
- Jardine, R.J., Potts, D.M., Fourie, A.B. & Burland, J.B. (1986). Studies of the influence of non-linear stress-strain characteristics in soil-structure interaction. *Géotechnique*, vol. 36, pp 377-396.
- Jardine, R.J., Overy, R.F. & Chow, C.F. (1998). Axial capacity of offshore piles in dense North Sea sand. *Journal of Geotechnical and Geoenvironmental Engineering*, American Society of Civil Engineers, vol. 124, pp 171-178.
- Jeong, S., Lee, J.Y. & Lee, C.J. (2004). Slip effect at the pile-soil interface on dragload. *Computers and Geotechnics*, vol. 31, pp 115-126.
- Johnston, I.W. , Lam, T.S.K. & Williams, A.F. (1987). Constant normal stiffness direct shear testing for socketed pile design in weak rock. *Géotechnique*, vol. 37, pp 83-89.
- Katzenbach, R., Arslan, U., Moormann, C. & Reul, O. (1998). Pile raft foundation – interaction between piles and raft. *Darmstadt Geotechnics*, Darmstadt University of Technology, no. 4, pp 279-296.
- Karlsrud, K. & Nadim, F. (1992). Axial capacity of offshore piles in clay. *Norwegian Geotechnical Institute Publication*, no. 188, pp 1-12.
- Kelly, R.T. (1980). Site investigation and materials problems. *Proceedings of the Conference on Reclamation of Contaminated Land*, Eastbourne, pp B2/1-B2/14.
- Kim, J.B., Singh, L.P. & Brungraber, R.J. (1977). Pile cap-soil interaction from full-scale lateral load tests. *Journal of the Geotechnical Engineering Division*, American Society of Civil Engineers, vol. 105, pp 643-653.
- Kimmerling, R.E. (2002). *Geotechnical Engineering Circular No. 6, Shallow Foundations*. Federal Highway Administration, United States, 310 p.
- Kinson, K., Lloyd, C.P. & Eadie, G.R. (1981). Steel piling in Australia. *BHP Technical Bulletin*, vol. 25, no. 2, pp 8-15.

- Kirk, P., Brown, C. & Collar, F. (2000). Use of gravity surveys in preliminary and detailed site investigation at North Lantau. *Proceedings of the Nineteenth Annual Seminar, Geotechnical Division, Hong Kong Institution of Engineers*, pp 27-36.
- Kishida, H. (1967). Ultimate bearing capacity of piles driven into loose sand. *Soils and Foundations*, vol. 7, no. 3, pp 20-29.
- Kishida, H. & Meyerhof, G.G. (1965). Bearing capacity of pile groups under eccentric loads in sand. *Proceedings of the Fifth International Conference on Soil Mechanics and Foundation Engineering*, Paris, vol. 2, pp 270-274.
- Kraft, L.M. (1990). Computing axial pile capacity in sands for offshore conditions. *Marine Geotechnology*, vol. 9, pp 61-92.
- Kraft, L.M. (1991). Performance of axially loaded pipe piles in sand. *Journal of Geotechnical Engineering*, American Society of Civil Engineers, vol. 117, pp 272-296.
- Kramer, S.L. & Heavey, E.J. (1988). Lateral load analysis of non-linear piles. *Journal of Geotechnical Engineering*, American Society of Civil Engineers, vol. 114, pp 1045-1049.
- Ku, J.C., Evans, G.L. & McNicholl, D.P. (1985). Caisson design and acceptance. *Hong Kong Engineer*, vol. 13, no. 2, pp 35-39.
- Kulhawy, F.H. (1978). Geomechanical model for rock foundation settlement. *Journal of the Geotechnical Engineering Division*, American Society of Civil Engineers, vol. 104, pp 221-227.
- Kulhawy, F.H. (1984). Limiting tip and side resistance : Fact or fallacy? *Proceedings of a Symposium on Analysis and Design of Pile Foundations*, San Francisco, pp 80-98.
- Kulhawy, F.H. (1991). Drilled shaft foundations. *Foundation Engineering Handbook*, edited by Fang, H.Y. & Reinhold, V.N., New York, pp 537 -552.
- Kulhawy, F.H. & Carter, J.P. (1992a). Settlement and bearing capacity of foundations on rock masses. Chapter 12 in *Engineering in Rock Masses*, edited by F.G. Bell, Butterworth-Heinemann, Oxford, pp 231-245.
- Kulhawy, F.H. & Carter, J.P. (1992b). Socketed foundations in rock masses. Chapter 25 in *Engineering in Rock Masses*, edited by F.G. Bell, Butterworth Heinemann, Oxford, pp 509-529.
- Kulhawy, F.H. & Chen, Y.J. (1992). A thirty-year perspective of Broms' lateral loading models, as applied to drilled shaft. *Proceedings of the Bengt B. Broms Symposium on Geotechnical Engineering*, Singapore, pp 225-240.
- Kulhawy, F.H. & Goodman, R.E. (1987). Foundations in rock. Chapter 55 in *Ground Engineer's Reference Book*, edited by F.G. Bell, Butterworths, London, pp 55/1-13.

- Kulhawy, F.H. & Hirany, A. (1989). Interpretation of load tests on drilled shafts - Part 2 : Axial uplift. *Proceedings of the Conference on Foundation Engineering : Current Principles and Practices*, Evanston, USA, vol. 2, pp 1150-1159.
- Kulhawy, F.H. & Prakoso, W.A. (1999). Discussion on end bearing capacity of drilled shafts in rock. *Journal of Geotechnical and Geoenvironmental Engineering*, American Society of Civil Engineers, vol. 125, pp 1106-1110.
- Kulhawy, F.H. & Phoon, K.K. (1993), Drilled shaft side resistance in clay soil to rock. *Design & Performance of Deep Foundations: Piles & Piers in Soil & Soft Rock (Geotechnical Special Publication No. 38)*, edited by Nelson, P.P., Smith, T.D. & Clukey, E.C., American Society for Civil Engineers, New York, pp 172-183.
- Kulhawy, F.H. & Phoon, K.K. (2002). Observations on geotechnical reliability-based design development in North America. *Proceedings of the International Workshop on Foundation Design Codes and Soil Investigation in view of International Harmonization and Performance Based Design*, Japan, pp 31-48.
- Kulhawy, F.H., Prakoso, W.A. & Akbas, S.O. (2005). Evaluation of capacity of rock foundation sockets. *Proceedings of the 40th United States Symposium on Rock Mechanics*, Anchorage, 8 p.
- Kuwabara, F. & Poulos, H.G. (1989). Downdrag forces in group of piles. *Journal of Geotechnical Engineering*, American Society of Civil Engineers, vol. 115, pp 806-818.
- Kwan, A.K.H. (1993). High strength concrete for in-situ construction in Hong Kong. *Transactions of the Hong Kong Institution of Engineers*, no. 2, pp 5-12.
- Kwan, S.H.A. (1985). Piling noise in Hong Kong. *Proceedings of the Polmet 85 Conference*, Hong Kong, pp 371-376.
- Kwong, J.S.M., Lee, M.K. & Tse, S.H. (2000). Foundation design and construction aspects in marble (Ma On Shan) – An overview of geotechnical control. *Proceedings of the Nineteenth Annual Seminar*, Geotechnical Division, Hong Kong Institution of Engineers, Hong Kong, pp 231-238.
- Ladanyi, B. & Roy, A. (1971). Some aspects of bearing capacity of rock mass. *Proceedings of the Seventh Canadian Symposium on Rock Mechanics*, Edmonton, pp 161-190.
- Lai, K.W., Chan, H.H.K., Choy, C.S.M. & Tsang, A.L.Y. (2004). The characteristics of marble clast-bearing volcanic rock and its influence of foundation in Hong Kong. *Proceedings of the Conference on Foundation Practice in Hong Kong*, Centre for Research and Professional Development, Hong Kong, pp E1-E10.
- Lam, C.H. (1990). *A Review of Base Heave Problems with the Formation of Large Diameter (1 - 5 m) Hand-dug Caissons*. M.Sc. Dissertation, University of London, 152 p. (Unpublished).

- Lam, T.S.K., Tse, S.H., Cheung, C.K. & Lo, A.K.Y. (1994). Performance of two steel H-piles founded in weathered meta-siltstone. *Proceedings of the Fifth International Conference on Piling and Deep Foundations*, Brugge, pp 5.6.1-5.6.10.
- Lam, T.S.K., Yau, J.H.W. & Premchitt, J. (1991). Side resistance of a rock-socketed caisson. *Hong Kong Engineer*, vol. 19, no. 2, pp 17-28.
- Lambe, T.W. & Whitman, R.V. (1979). *Soil Mechanics (SI Version)*. John Wiley & Sons, New York, 553 p.
- Lee, C.J., Bolton, M.D. & Al-tabbaa, A. (2002). Numerical modelling of group effects on the distribution of drag loads in pile foundations. *Géotechnique*, vol. 52, pp 325-335.
- Lee, D.M. & Ng, M. (2004). Design strategies for deep foundation in areas of marble in Hong Kong. *Proceedings of the Conference on Foundation Practice*, Centre for Research and Professional Development, Hong Kong, pp C1-C17.
- Lee, D.M., Pascall, D., Lui, Y.H. & Chan, Y.W. (2000). The use of borehole geophysics in the foundation design in cavernous marble. *Proceedings of the Nineteenth Annual Seminar*, Geotechnical Division, Hong Kong Institution of Engineers, Hong Kong, pp 17-26.
- Lee, M.W., Paik, S.W., Lee, W.J., Yi, C.T., Kim, D.Y. & Yoon, S.J. (1993). The simple pile load test (SPLT). *Geotechnical Testing Journal*, vol. 16, pp 198-206.
- Lee, P.K.K. (1983). The driving and loading tests of SS prestressed concrete piles. *Hong Kong Engineer*, vol. 11, no. 4, pp 35-37.
- Lee, P.K.K., Lam, J. & Li, K.S. (2004a). Some common defects of bored piles in Hong Kong. *Proceedings of International Conference on Structural and Foundation Failures*, Singapore, pp 422-431.
- Lee, P.K.K. & Lumb, P. (1982). Field measurements of negative skin friction on steel tube piles in Hong Kong. *Proceedings of the Seventh Southeast Asian Geotechnical Conference*, Hong Kong, vol. 1, pp 363-374.
- Lee, S.K., Tham, L.G., Chan, S.T., Yu, F. & Yang, F. (2004b). Recent field study on the behaviour of jacked piles. *Proceedings of Joint Structural Division Annual Seminar 2004*, Hong Kong Institution of Engineers, pp 52-69.
- Lee, S.L., Chow, Y.K., Karunaratne, G.P. & Wong, K.Y. (1988). Rational wave equation model for pile-driving analysis. *Journal of Geotechnical Engineering*, American Society of Civil Engineers, vol. 114, pp 306-325.
- Lehane, B.M. (1992). *Experimental Investigations of Pile Behaviour Using Instrumented Field Piles*. PhD thesis, University of London, 615 p. (Unpublished).
- Lehane, B.M. & Jardine, R.J. (1994). Shaft capacity of driven piles in sand : a new approach. *Proceedings of the Seventh International Conference on Behaviour of Offshore*

Structures, vol. 1, pp 23-36.

- Lehane, B.M., Jardine, R.J., Bond, A.J. & Frank, R. (1993). Mechanisms of shaft friction in sand from instrumented pile tests. *Journal of Geotechnical Engineering*, American Society of Civil Engineers, vol. 119, pp 19-35.
- Leung, C.F. & Radhakrishnan, R. (1985). The behaviour of a pile-raft foundation in weak rock. *Proceedings of the Eleventh International Conference on Soil Mechanics and Foundation Engineering*, San Francisco, vol. 3, pp 1429-1432.
- Leung, K.W. (1988). Settlement of buildings founded on caissons bearing on soil. *Proceedings of the Fourth International Conference on Tall Buildings*, Hong Kong & Shanghai, vol. 1, pp 377-383.
- Leung, K.W. & Chiu, D.C.K. (2000). Ground investigation for a redevelopment site in the North Western New Territories. *Proceedings of the Nineteenth Annual Seminar*, Geotechnical Division, Hong Kong Institution of Engineers, Hong Kong, pp 7-14.
- Li, K.S. (1992). Risk associated with construction of large diameter bored piles in cavernous marble. *Proceedings of the Sixth Australian-New Zealand Conference on Geomechanics*, Christchurch, pp 169-172.
- Li, K.S. (2005). A critical review of the current practice of formulating the final set table for driven piles in Hong Kong. *Presentation to Working Group on Review of GEO Publication No. 1/96*, 12 p. (Unpublished).
- Li, K.S., Ho, N.C.L., Tham, L.G. & Lee, P.K.K. (2003). *Case Studies of Jacked Piling in Hong Kong*. Centre for Research & Professional Development, 153 p.
- Li, K.S. & Lam, J. (2001). Driven piles founded on rock. *Proceedings of the Fifth International Conference on Deep Foundation Practice*, Singapore, pp 288-296.
- Liao, S. & Sangery, D.A. (1978). Use of piles as isolation barriers. *Journal of the Geotechnical Engineering Division*, American Society of Civil Engineers, vol. 104, pp 1139-1152.
- Liew, S.S. (2002). Pile design with negative skin friction. *Course Manual for Tripartite Meeting and Technical Courses - Geotechnical Engineering*, Malaysia, 22 p.
- Likins, G. E., Piscalko, G., Rausche, F. & Hussein, M.H. (2004). Monitoring Quality Assurance for Deep Foundations. *Current Practices and Future Trends in Deep Foundations*, *Geotechnical Special Publication No. 125*, edited by DiMaggio, J. A. & Hussein, M. H., American Society of Civil Engineers, pp 222-238.
- Likins, G. E. & Rausche, F. (2004). Correlation of CAPWAP with static load tests. *Proceedings of the Seventh International Conference on the Application of Stress-wave Theory to Piles*, Malaysia, pp 153-165.
- Likins, G.E., Rausche, F. & Goble, G.G. (2000) High strain dynamic pile testing, equipment,

- and practice. *Proceedings of the Sixth International Conference on the Application of Stress-wave Theory to Piles*, São Paulo, Brazil, pp 327-333.
- Linney, L.F. (1983). A review of the geotechnical aspects of the construction of the first phase of the Mass Transit Railway, Hong Kong. *Quarterly Journal of Engineering Geology*, vol. 16, pp 87-102.
- Littlechild, B.D., Hill, S.J., Statham, I. & Plumbridge, G.D. (2000). Stiffness of Hong Kong rocks for foundation design. *Proceedings of the Nineteenth Annual Seminar, Geotechnical Division, Hong Kong Institution of Engineers*, pp 181-190.
- Littlechild, B.D. & Plumbridge, G.D. (1998). Effects of construction technique on the behaviour of plain bored cast-in-situ piles constructed under drilling slurry. *Proceedings of the Seventh International Conference and Exhibition on Piling and Deep Foundation*, Vienna, Austria, 8 p.
- Lo, D.O.K. (1997). *Behaviour of the Instrumented Test Barrette for the West Kowloon Corridor Phase IV Project (Special Project Report No. SPR 2/97)*. Geotechnical Engineering Office, Hong Kong, 45 p.
- Long, M.M., Lambson, M.D., Clarke, J. & Hamilton, J. (1992). Cyclic lateral loading of an instrumented pile in over-consolidated clay at Tilbrook Grange. *Proceedings of the Conference on Recent Large Scale Fully Instrumented Pile Tests in Clay*, London, pp 16/1-21.
- Long, P.D. (1993). Footings with settlement-reducing piles in non-cohesive soil. *Swedish Geotechnical Institute, Report No. 43*, 179 p.
- Lui, J.Y.H., Cheung, S.P.Y. & Chan, A.K.C. (1993). Pressure grouted minipiles for a 12-storey residential building at the Mid-levels Scheduled Area in Hong Kong. *Proceedings of the International Conference on Soft Clay Engineering*, Guangzhou, pp 419-424.
- Luk, S.T., Ko, J.M. & Cheng, C.Y. (1990). Ground vibrations induced by driving concrete piles. *Proceedings of the Conference on Vibration and Noise*, Sydney, pp 245-249.
- Lumb, P. (1962). *Report on the Settlement of Buildings in the Mong Kok District of Kowloon, Hong Kong*. Hong Kong Government Printer, 21 p, plus 8 drawings.
- Lumb, P. (1972). Building settlements in Hong Kong. *Proceedings of the Third Southeast Asian Conference on Soil Engineering*, Hong Kong, vol. 1, pp 115-121.
- Lumb, P. (1979). Building foundations in Hong Kong. *Proceedings of the Sixth Asian Regional Conference in Soil Mechanics and Foundation Engineering*, Singapore, vol. 2, pp 211-215.
- Lumb, P. (1983). Engineering properties of fresh and decomposed igneous rocks from Hong Kong. *Engineering Geology*, vol. 19, pp 81-94.

- Mackey, S. & Yamashita, T. (1967a). Experience with caissons and pier foundations in Hong Kong. *Proceedings of the First Southeast Asian Regional Conference on Soil Engineering*, Bangkok, pp 301-302.
- Mackey, S. & Yamashita, T. (1967b). Soil conditions and their influence on foundations of waterfront structures in Hong Kong. *Proceedings of the Third Asian Regional Conference on Soil Mechanics and Foundation Engineering*, Haifa, vol. 1, pp 220-224.
- Mair, R.J. & Wood, D.M. (1987). *Pressuremeter Testing Method and Interpretation*. Construction Industry Research & Information Association, Butterworths, 156 p.
- Majano, R.E. & O'Neill, M.W. (1993). *Effect of Mineral and Polymer Slurries on Perimeter Load Transfer in Drilled Shafts*. Report submitted to ADSC: The International Association of Foundation Drilling, University of Houston, 325 p.
- Majano, E.M., O'Neill, M.W., & Hassan, K.H. (1994). Perimeter load transfer in model drilled shafts formed under slurry. *Journal of Geotechnical Engineering*, American Society of Civil Engineers, vol. 120, no. GT12, pp 2136-2154.
- Majer, J. (1955). Zur Berechnung von Zugfundamenten. (On the design of railway foundations). *Osterreichische Bauzeitschrift*, vol. 10, no. 5, pp 85-90. (In German).
- Mak, C.M. (1991). *Deep Foundations in Marble and Associated Strata at Yuen Long*. M.Sc. Dissertation, University of Hong Kong, 124 p. (Unpublished).
- Mak, J.C.H. (1990). *Driven Pile Capacity Prediction and Observation*. M. Sc. Dissertation, University of Hong Kong, 125 p. (Unpublished).
- Mak, S.H., Ho, K.K.S. & Lam, C.H. (1994). Hand-dug caissons in Hong Kong. *Proceedings of the Third International Conference on Deep Foundation Practice*, Singapore, pp 169-175.
- Mak, Y.W. (1993). Hand-dug caissons in Hong Kong. *The Structural Engineer*, vol. 71, pp 204-205.
- Makredes, H.S. & Likins, G.E. (1982). Bearing capacity of piles from dynamic measurements. *Proceedings of the Seventh Southeast Asian Geotechnical Conference*, Hong Kong, vol. 2, pp 249-271.
- Malone, A.W. (1977). Contribution to discussion. *Proceedings of the Symposium-in-Print on Piles in Weak Rock*, London, pp 201-202.
- Malone, A.W. (1985). Hong Kong practice on driven piles. *Proceedings of the International Symposium on the Penetrability and Driveability of Piles*, San Francisco, vol. 2, pp 32-34.
- Malone, A.W. (1987). A note on the design of large-diameter excavated piles in Hong Kong. *Hong Kong Engineer*, vol. 15, no. 9, pp 15-17.

- Malone, A.W. (1990). Geotechnical phenomena associated with piling in Hong Kong. *Quarterly Journal of Engineering Geology*, vol. 23, pp 289-305.
- Malone, A.W., Ho, K.K.S. & Lam, T.S.K. (1992). Piling in tropically weathered granite - Keynote Paper. *Proceedings of the International Conference in Geotechnical Engineering - GEOTROPIKA '92*, Kuala Lumpur, 48 p.
- Mandolini, A. & Viggini, C. (1997). Settlement of piled foundations. *Géotechnique*, vol. 47, pp 791-816.
- Massarch, K.R. (1993). Man-made vibrations and solutions. *Proceedings of the Third International Conference on Case Histories in Geotechnical Engineering*, St Louis, vol. 2, pp 1393-1405.
- Matlock, H. & Reese, L.C. (1960). Generalised solutions for laterally-loaded piles. *Journal of the Soil Mechanics and Foundations Division*, American Society of Civil Engineers, vol. 86, no. SM3, pp 63-91.
- McKenna, B.R. & Palmer, G. (1989). Tsing Yi Bridge North : construction. *Proceedings of the Institution of Civil Engineers*, vol. 86, pp 491-511.
- McNicholl, D.P., Yiu, M., Mak, L.M., Clover, A.W. & Ho, H.Y.S. (1989b). Piled foundations in Tin Shui Wai Area 5, Yuen Long marble area, Hong Kong. *Proceedings of the Second International Conference on Foundations and Tunnels*, London, vol. 1, pp 181-193.
- Meigh, A.C. (1991). *General Report on Foundation in Areas Underlying by Marble and Associated Rock (Technical Note No. 3/91)*. Geotechnical Engineering Office, Hong Kong, 193 p.
- Mesri, G., Lo, D.O.K. & Feng, T.W. (1994). Settlement of embankments on soft clays. *Geotechnical Special Publication 40*, American Society of Civil Engineers, vol. 1, pp 8-56.
- Meyerhof, G.G. (1963). Some recent research on the bearing capacity of foundations. *Canadian Geotechnical Journal*, vol. 1, pp 16-26.
- Meyerhof, G.G. (1976). Bearing capacity and settlements of piled foundations. *Journal of the Geotechnical Engineering Division*, American Society of Civil Engineers, vol. 102, pp 197-228.
- Meyerhof, G.G. (1986). Theory and practice of pile foundations. *Proceedings of the International Conference on Deep Foundations*, Beijing, vol. 2, pp 1.77-1.86.
- Meyerhof, G.G. & Adams, J.I. (1968). The ultimate uplift capacity of foundations. *Canadian Geotechnical Journal*, vol. 5, pp 225-244.
- Meyerhof, G.G. & Purkayastha, R.D. (1985). Ultimate pile capacity in layered soil under eccentric and inclined loads. *Canadian Geotechnical Journal*, vol. 22, pp 399-402.

- Middendorp, P., Birmingham, P. & Kuiper, B. (1992). Statnamic load testing of foundation piles. *Proceedings of the Fourth International Conference of Stress Wave*, The Hague, pp 581-588.
- Mindlin, R.D. (1936). Force at a point in the interior of a semi-infinite solid. *Physics*, vol. 77, pp 195-202.
- Mitchell, J.M. (1985). Foundations for the Pan Pacific Hotel on pinnacled and cavernous limestone. *Proceedings of the Eighth Southeast Asian Geotechnical Conference*, Kuala Lumpur, vol. 1, pp 29-43.
- Mojabi, M.S. & Duffin, M.J. (1991). Large diameter, rock socket, base grouted piles in Bristol. *Proceedings of the Fourth International Conference on Piling and Deep Foundations*, Stresa, Italy, vol. 1, pp 97-100.
- Morrison, I.M., Freeman, R.A., Paveenchana, T. & Ferguson, D.R. (1987). Bored piles foundations for Chao Phya river crossing at Wat Sai, Bangkok. *Proceedings of the Ninth Southeast Asian Geotechnical Conference*, Bangkok, vol. 2, pp 6-207 - 6-218.
- Morrison, J. & Pugh, E. (1990). Tsim Sha Tsui Cultural Centre : Foundation & Superstructure. *Proceedings of the Institution of Civil Engineers*, vol. 88, pp 765-781.
- Morton, K., Cater, R.W. & Linney, L. (1980). Observed settlements of buildings adjacent to stations constructed for the Modified Initial System of the Mass Transit Railway, Hong Kong. *Proceedings of the Sixth Southeast Asian Conference on Soil Engineering*, Taipei, vol. 1, pp 415-429.
- Morton, K., Lam, K.M. & Tsui, K.W. (1981). Drawdown and settlement resulting from the construction of hand-dug caissons. *Hong Kong Engineer*, vol. 9, no. 3, pp 31-38.
- Mostellor, J. (1980). Techniques of precision blasting in the excavation of drilled piers. *Proceedings of the Sixth Conference on Explosives and Blasting Technique*, Tampa, Florida, pp 242-259.
- Murff, J.D. (1980). Pile capacity in a softening soil. *International Journal of Numerical and Analytical Methods in Geomechanics*, vol. 4, pp 185-189.
- Murff, J.D. (1994). Limit analysis of multi-footing foundation systems. *Proceedings of the International Conference on Computer Methods and Advanced Geomechanics*, edited by Siriwardane & Zaman, Rotterdam, Balkema, pp 232-244.
- Mylonakis, G. & Gazetas, G. (1998). Settlement and additional internal forces of grouped piles in layered soil. *Géotechnique*, vol. 48, pp 55-72.
- Nakashima, E., Tabara, K. & Maeda, Y.C. (1985). Theory and design of foundations on slopes. *Proceedings of Japan Society of Civil Engineers*, no. 355, pp 46-52. (In Japanese).

- Nash, K.L. (1974). Stability of trenches filled with fluids. *Proceedings of American Society of Civil Engineers*, vol. 100, pp 533-542.
- New Zealand Ministry of Works and Development (1981). *Pile Foundation Design Notes*. Civil Engineering Division, CDP 812/B :1981, Ministry of Works and Development, New Zealand, 70 p.
- Ng, C.W.W. & Lei, G.H. (2003). Performance of long rectangular barrettes in granitic saprolites. *Journal of Geotechnical and Geoenvironmental Engineering*, American Society of Civil Engineers, vol. 129, pp 685-699.
- Ng, C.W.W., Yau, T.L.Y., Li, J.H.M. & Tang, W.H. (2001). Side resistance of large diameter bored piles socketed into decomposed rocks. *Journal of Geotechnical and Geoenvironmental Engineering*, American Society of Civil Engineers, vol. 127, pp 642-657.
- Ng, H.Y.F. (1989). *Study of the Skin Friction of a Large Displacement Pile*. M.Sc. Dissertation, University of Hong Kong, 200 p. (Unpublished).
- Nicholson, D.P. (1987). Discussion on 'The basements and substructure for the new headquarters of the Hongkong and Shanghai Banking Corporation, Hong Kong' by Humpheson et al. *Proceedings of the Institution of Civil Engineers*, Part 1, vol. 82, pp 840-846.
- Nicola, D.N. & Randolph, M.F. (1993). Tensile and compressive shaft capacity of piles in sand. *Journal of the Geotechnical Engineering Division*, American Society of Civil Engineers, vol. 119, pp 1952-1973.
- Nip, D.C.N. & Ng, C.W.W (2005). Back-analysis of laterally loaded piles. *Proceedings of the Institution of Civil Engineers*, Geotechnical Engineering, vol. 158, pp 63 - 73.
- Nowacki, F., Karlsrud, K. & Sparrevik, P. (1992). Comparison of recent tests on over-consolidated clay and implications for design. *Proceedings of the Conference on Recent Large Scale Fully Instrumented Pile Tests in Clay*, London, pp 22/1-22.
- Ochoa, M. & O'Neill, M.W. (1989). Lateral pile interaction factors in submerged sand. *Journal of Geotechnical Engineering*, American Society of Civil Engineers, vol. 115, pp 359-378.
- Ohsaki, Y. (1982). Corrosion of steel piles driven in soil deposits. *Soils and Foundations*, vol. 22, pp 57-76.
- Okabe, T. (1977). Large negative friction and friction-free pile methods. *Proceedings of the Ninth International Conference on Soil Mechanics and Foundation Engineering*, Tokyo, vol. 2, pp 679-682.
- Orr, T.L.L. & Farrell, E.R. (2000). Different approaches for ultimate limit state geotechnical designs. *Proceedings of the LSD 2000 : International Workshop on Limit State Design in Geotechnical Engineering*, Australia, pp 125-136.

- Orr, T.L.L. (2002). Eurocode 7 – a code for harmonised geotechnical design. *Proceedings of the International Workshop on Foundation Design Codes and Soil Investigation in view of International Harmonization and Performance Based Design*, Japan, pp 3 –15.
- OSHC (1993). *Code of Safe Working Practices for Hand-dug Caissons*. Occupational Safety & Health Council, Hong Kong, 42 p.
- Osterberg, J (1998). The Osterberg load test method for bored and driven piles: The first ten years. *Proceedings of the Seventh International Conference & Exhibition on Piling and Deep Foundations*, Vienna, Austria, pp 1-17.
- Ove Arup & Partners (1986). *Comparison of British and Norwegian Research on the Behaviour of Piles as Anchors for Buoyant Structures*. Summary report prepared by Ove Arup & Partners for the Department of Energy, Offshore Technology Report, OTH 86215, 43 p.
- Owens, M.J. & Reese, L.C. (1982). *The Influence of a Steel Casing on the Axial Capacity of a Drilled Shaft (Research Report 255-1F)*. Centre for Transportation Research, University of Texas, Austin, U.S.A., 204 p.
- O'Neill, D.B. (1971). Vibration and dynamic settlement from pile driving. *Proceedings of the Conference on Behaviour of Piles*, London, pp 135-140.
- O'Neill, M.W. (1983). Group action in offshore piles. *Proceedings of the Conference on Geotechnical Practice in Offshore Engineering*, Austin, USA, pp 25-64.
- O'Neill, M.W. (2001). Side resistance in piles and drilled shafts. *Journal of Geotechnical and Geoenvironmental Engineering*, American Society of Civil Engineers, vol. 127, pp 3-16.
- O'Neill, M.W. & Ha, H.B. (1982). Comparative modelling of vertical pile groups. *Proceedings of the Second International Conference on Numerical Methods in Offshore Piling*, Austin, pp 399-418.
- O'Neill, M.W. & Reese, L.C. (1999). *Drilled Shaft : Construction Procedures and Design Methods*. Federal Highway Administration, United States, 790 p.
- O'Reilly, M. & Al-Tabbaa, A. (1990). Heave induced pile tension : A simple one-dimensional analysis. *Ground Engineering*, vol. 23, no. 5, pp 28-33.
- O'Riordan, N.J. (1982). The mobilisation of shaft adhesion down a bored, cast-in-situ pile in the Woolwich and Reading beds. *Ground Engineering*, vol. 15, no. 3, pp 17-20 & 23-26.
- Paikowsky, S.G. & Chernauskas, L.R. (1992). Energy approach for capacity evaluation of driven piles. *Proceedings of the Conference on Application of Stress-wave Theory to Piles*, Balkema, pp 595-601.

- Paquet, J. (1992). Pile integrity testing - The CEBTP reflectogram. *Proceedings of the Conference on Piling : European Practice and Worldwide Trends*, London, pp 206-216.
- Parry, R.G. H. (1972). A direct method of estimating settlement in sands from SPT values. *Proceedings of the Symposium on Interaction of Structures and Foundations*, Midland Soil Mechanics and Foundation Engineering Society, Birmingham, pp 29-37.
- Patel, D. (1992). Interpretation of results of pile tests in London Clay. *Proceedings of the Conference on Piling : European Practice and Worldwide Trends*, London, pp 100-110.
- PDI (1996). *Pile Driving Analyzer, Model PAK*. Pile Dynamic Inc., Cleveland, Ohio, 22 p.
- Peck, R.B. (1976). Rock foundations for structures. *Proceedings of the Speciality Conference on Rock Engineering for Foundations & Slopes*, Boulder, Colorado, pp 1-21.
- Peck, R.B., Hanson, W.E. & Thornburn, T.H. (1974). *Foundation Engineering. (Second edition)*. John Wiley and Sons, New York, 514 p.
- Pells, P.J.N. & Turner, R.M. (1979). Elastic solutions for design and analysis of rock socketed piles. *Canadian Geotechnical Journal*, vol. 16, pp 481-487.
- Perloff, W.H. (1975). Pressure distribution and settlement. *Foundation Engineering Handbook*, edited by H.F. Winterkorn & H.Y. Fang, Van Nostrand Reinhold, New York, pp 148-196.
- Philcox, K.T. (1962). Some recent developments in the design of high buildings in Hong Kong. *The Structural Engineer*, vol. 40, pp 303-323.
- Pickles, A.R., Lee, S.W. & Tosen, R. (2003). Shaft capacity of friction piles constructed in saprolite under bentonite and implications for end bearing piles. *Proceedings of the Twenty-third Annual Seminar*, Geotechnical Division, Hong Kong Institution of Engineers, pp 213-222.
- Pise, P.J. (1982). Laterally loaded piles in a two-layer soil system. *Journal of Geotechnical Engineering*, American Society of Civil Engineers, vol. 108, pp 1177-1181.
- Plumbridge, G.D., Littlechild, B.D., Hill, S.J. & Pratt, M. (2000a). Full-scale shaft grouted piles and barrettes in Hong Kong – A First. *Proceedings of the Nineteenth Annual Seminar*, Geotechnical Division, Hong Kong Institution of Engineers, pp 159-166.
- Plumbridge, G.D., Sze, J.W.C. & Tham, T.T.F. (2000b). Full-scale lateral load tests on bored piles and a barrette. *Proceedings of the Nineteenth Annual Seminar*, Geotechnical Division, Hong Kong Institution of Engineers, pp 211-220.
- Pope, R.G. & Ho, C.S. (1982). The effect of pile and caissons on groundwater flow. *Hong Kong Engineer*, vol. 10, no. 11, pp 25-27.

- Poskitt, T.J. (1991). Energy loss in pile-driving due to soil rate effects and hammer misalignment. *Proceedings of Institution of Civil Engineers*, Part 2, vol. 91, pp 823-851.
- Poulos, H.G. (1972). Behaviour of laterally loaded piles : III - socketed piles. *Journal of the Soil Mechanics and Foundations Division*, American Society of Civil Engineers, vol. 98, pp 341-366.
- Poulos, H.G. (1976). Behaviour of laterally loaded piles near a cut slope. *Australian Geomechanics Journal*, vol. G6, no. 1, pp 6-12.
- Poulos, H.G. (1985). Ultimate lateral pile capacity in a two-layer soil. *Geotechnical Engineering*, vol. 16, no. 1, pp 25-37.
- Poulos, H.G. (1987). Analysis of residual stress effects in piles. *Journal of the Geotechnical Engineering*, American Society of Civil Engineers, vol. 113, pp 216-229.
- Poulos, H.G. (1988a). *Marine Geotechnics*. Unwin Hyman, London, 473 p.
- Poulos, H.G. (1988b). Modified calculation of pile group settlement interaction. *Journal of the Geotechnical Engineering Division*, American Society of Civil Engineers, vol. 114, pp 697-706.
- Poulos, H.G. (1989a). Cyclic axial loading of piles in sand. *Journal of the Geotechnical Engineering*, American Society of Civil Engineers, vol. 115, pp 836-852.
- Poulos, H.G. (1989b). Pile behaviour - theory and application. *Géotechnique*, vol. 39, pp 365-415.
- Poulos, H.G. (1990a). *DEFPIG Users' Manual*. Centre for Geotechnical Research, University of Sydney, 55 p.
- Poulos, H.G. (1990b). Design of piles for negative friction. *Proceedings of the Conference Piletalk International '90*, Jakarta, pp 123-129.
- Poulos, H.G. (1993). Settlement of bored pile groups. *Proceedings of the Second International Geotechnical Seminar on Deep Foundations on Bored and Augered Piles*, edited by Van Impe W.F., Balkema, Rotterdam, pp 103-117.
- Poulos, H.G. (1994). An approximate numerical analysis of pile raft interaction. *International Journal of Numerical and Analytical Methods in Geomechanics*, vol. 18, pp 73-92.
- Poulos, H.G. (2000). *Foundation Settlement Analysis – Practice versus Research*. The Eighth Spencer J Buchanan Lecture, Texas, 34 p.
- Poulos, H.G. (2001a). Piled raft foundations : design and applications. *Géotechnique*, vol. 51, pp 95-113.

- Poulos, H.G. (2001b). *Methods of Analysis of Piled Raft Foundations. Report to Technical Committee TC 18 on Piled Foundations*. International Society on Soil Mechanics and Geotechnical Engineering, 46 p.
- Poulos, H.G. (2004). Control of settlement and load distribution in pile groups via stiffness inserts. *Proceedings of the Conference on Foundation Practice in Hong Kong*, Centre for Research and Professional Development, Hong Kong, pp D1-D9.
- Poulos, H.G. (2005). The influence of construction 'side effect' on existing pile foundations. *Journal of Southeast Asian Geotechnical Society*, April, pp 51-67.
- Poulos, H.G., Carter, J.P. & Small, J.C. (2002). Foundations and retaining structures – research and practice. *Proceedings of the Fifteenth International Conference on Soil Mechanics and Foundation Engineering*, Istanbul, vol. 4, pp 2527-2606.
- Poulos, H.G. & Davis, E.H. (1974). *Elastic Solutions for Soil and Rock Mechanics*. John Wiley & Sons, New York, 411 p.
- Poulos, H.G. & Davis, E.H. (1980). *Pile Foundation Analysis and Design*. John Wiley & Sons, New York, 397 p.
- Poulos, H.G. & Randolph, M.F. (1983). Pile group analysis : a study of two methods. *Journal of Geotechnical Engineering*, American Society of Civil Engineers, vol. 109, pp 355-372.
- Powell, G.E., Tang, K.W. & Au-Yeung, Y.S. (1990). The use of large diameter piles in landslide prevention in Hong Kong. *Proceedings of the Tenth Southeast Asian Geotechnical Conference*, Taipei, vol. 1, pp 197-202.
- Prakash, S. (1962). *Behaviour of Pile Groups Subjected to Lateral Loads*. PhD thesis, University of Illinois, Urbana, Illinois. (Unpublished).
- Prakoso, W.A. & Kulhawy, F.H. (2001). Contribution to piled raft foundation design. *Journal of Geotechnical and Geoenvironmental Engineering*, American Society of Civil Engineers, vol. 127, pp 17-24.
- Pratt, M. (1986). Some problems associated with the construction of large diameter bored piles in Hong Kong. *Construction and Contract News*, August, pp 55-56.
- Pratt, M. (1989). The bore pile Olympics. *Hong Kong Engineer*, vol. 17, no. 12, pp 12-16.
- Pratt, M. & Sims, M.J. (1990). The application of new techniques to solve deep basement and foundation problems. *Proceedings of the Conference on Deep Foundation Practice*, Singapore, pp 189-195.
- Premchitt, J., Gray, I. & Ho, K.K.S. (1994). *Skin Friction on Piles at the New Public Works Central Laboratory (GEO Report 38)*. Geotechnical Engineering Office, Hong Kong, 167 p.

- Premchitt, J., Gray, I. & Massey, J.B. (1988). Initial measurements of skin friction on some driven piles in reclamation. *Hong Kong Engineer*, vol. 16, no. 5, pp 25-38. (Discussion, vol. 16, no. 9, pp 8). (Reprinted in *Hong Kong Institution of Engineers, Transactions (Group 1)*, vol. 1, 1989, pp 15-26).
- Price, G. & Wardle, I.F. (1983). Recent developments in pile/soil instrumentation systems. *Proceedings of the International Symposium on Field Measurements in Geomechanics*, Zurich, vol. 1, pp 2.63-2.72.
- Promboon, S., Brand, E.W. & Buckli, C. (1972). Observations on the deep bored piles for the Tha Chang Bridge, Bangkok. *Proceedings of the Third Southeast Asian Conference on Soil Engineering*, Hong Kong, pp 135-140.
- Radhakrishnan, H.S. & Adams, J.I. (1973). Long-term uplift capacity of augered footings in fissured clay. *Canadian Geotechnical Journal*, vol. 10, pp 647-652.
- Radhakrishnan, H.S. & Leung, C.E. (1989). Load transfer behaviour of rock-socketed piles. *Journal of Geotechnical Engineering*, American Society of Civil Engineers, vol. 115, pp 755-768.
- Randolph, M.F. (1980). *PIGLET : A Computer Program for the Analysis and Design of Pile Groups under General Loading Conditions (Cambridge University Engineering Department Research Report, Soils TR 91)*. 33 p.
- Randolph, M.F. (1981a). Piles subjected to torsion. *Journal of Geotechnical Engineering*, American Society of Civil Engineers, vol. 107, pp 1095-1111.
- Randolph, M.F. (1981b). The response of flexible piles to lateral loading. *Géotechnique*, vol. 31, pp 247-259.
- Randolph, M.F. (1990). *Lecture Notes Prepared for Course on Pile Foundations*. Course sponsored by KA Construction Company Limited, Hong Kong, 178 p.
- Randolph, M.F. (1983). Design considerations for offshore piles. *Proceedings of the Conference on Geotechnical Practice in Offshore Engineering*, Austin, USA, pp 422-439.
- Randolph, M.F. (1994). Design methods for pile groups and piled rafts. *Proceedings of the Thirteenth International Conference on Soil Mechanics and Foundation Engineering*, New Delhi, vol. 5, pp 61-82.
- Randolph, M.F. (2003). Science and empiricism in pile foundation design. *Géotechnique*, vol. 53, pp 847-875.
- Randolph, M.F., Dölwin, J. & Beck, R. (1994). Design of driven piles in sand. *Géotechnique*, vol. 44, pp 427-448.
- Randolph, M.F. & Murphy, B.S. (1985). Shaft capacity of driven piles in clay. *Proceedings of the Offshore Technology Conference*, vol. 1, Houston, pp 371-378.

- Randolph, M.F. & Wroth, C.P. (1978). Analysis of deformation of vertically loaded piles. *Journal of the Geotechnical Engineering Division*, American Society of Civil Engineers, vol. 104, pp 1465-1488.
- Randolph, M.F. & Wroth, C.P. (1979). An analysis of the vertical deformation of pile groups. *Géotechnique*, vol. 29, pp 423-439.
- Rausche, F. & Goble, G.G. (1979). Determination of pile damage by top measurements. *ASTM Special Technical Publication No. 670, Behaviour of Deep Foundations*, American Society for Testing and Materials, pp 500-506.
- Rausche, F., Goble, G.G. & Likins, G.E. (1985). Dynamic determination of pile capacity. *Journal of Geotechnical Engineering*, American Society of Civil Engineers, vol. 111, pp 367-383.
- Reddy, A.S. & Valsangkar, A.J. (1970). Buckling of fully and partially embedded piles. *Journal of the Soil Mechanics and Foundations Division*, American Society of Civil Engineers, vol. 96, pp 1951-1965.
- Reese, L.C. & O' Neill, M.W. (1988). *Drilled shafts : Construction Procedures and Design Methods (Report No. FHWA-HI-88-042)*. U.S. Department of Transportation, 564 p.
- Reese, L.C. & Tucker, K.L. (1985). Bentonite slurry in constructing drilled piers. *Drilled Piers and Caissons II*, edited by C.N. Baker. American Society of Civil Engineers, New York, pp 1-15.
- Reese, L.C. & Van Impe, W.F. (2001). *Single Piles and Pile Group under Lateral Loading*. Rotterdam, Balkema, 463 p.
- Reid, W.M. & Buchanan, N.W. (1983). Bridge approach support piling. *Proceedings of the Conference on Advances in Piling and Ground Treatment for Foundations*, London, pp 267-274.
- Reiding, F.J., Middendorp, P. & Van Brederode, P.J. (1984). A digital approach to sonic pile testing. *Proceedings of the Second International Conference of the Application of Stress Wave Theory on Piles*, Stockholm, pp 85-93.
- Robertson, S.A. (1982). Integrity and dynamic testing of deep foundations in S.E. Asia 1979-82. *Proceedings of the Seventh Southeast-Asian Geotechnical Conference*, Hong Kong, vol. 1, pp 403-421.
- Romanoff, M. (1962). *Corrosion of Steel Piling in Soils*. US National Bureau of Standards, Monograph 58, Washington D.C., 22 p.
- Romanoff, M. (1969). Performance of Steel Piling in Soils. *Proceedings of the Twenty-fifth Conference of the National Association of Corrosion Engineers*, pp 14-22.
- Rowe, R.K. & Armitage, H.H. (1987a). Theoretical solutions for axial deformation of drilled

- shafts in rock. *Canadian Geotechnical Journal*, vol. 24, pp 114-125.
- Rowe, R.K. & Armitage, H.H. (1987b). A design method for drilled piers in soft rock. *Canadian Geotechnical Journal*, vol. 24, pp 126-142.
- SAA (1995). *Piling-design and Installation (AS 2159-1995)*. Standards Association of Australia, Sydney, 51 p.
- Saffery, M.R. & Tate, A.P.K. (1961). Model tests on pile groups in a clay soil with particular reference to the behaviour of the group when it is loaded eccentrically. *Proceedings of the Fifth Conference on Soil Mechanics and Foundation Engineering*, Paris, vol. 2, pp 129-134.
- Samman, M. M. & O'Neill, M. W. (1997), The reliability of sonic testing of drilled shafts. *Concrete International*, vol. 19, no. 1, American Concrete Institute, Michigan, pp 49-54.
- Sayer, P.R. & Leung, K.W. (1987). Design aspects of caisson foundations bearing on soils. *Proceedings of the Ninth Southeast Asian Geotechnical Conference*, Bangkok, vol. 2, pp 145-154.
- Schnaid, F., Ortigao, J.A.R., Mantaras, F.M., Cunha, R.P. & MacGregor, I. (2000). Analysis of self-boring pressuremeter (SBPM) and Marchetti dilatometer (DMT) tests in granite saprolites. *Canadian Geotechnical Journal*, vol. 37, pp 796-810.
- Schwab, J.P. & Bhatia, S.K. (1985). Pile driving influence on surrounding soil and structures. *Civil Engineering for Practicing and Design Engineers*, Pergamon, vol. 4, pp 641-684.
- Schmertmann, J. (1970). Static cone to compute static settlement over sand. *Journal of Soil Mechanics and Foundation Division*, American Society for Civil Engineers, vol. 96, pp 1011-1043.
- Seidel, J & Collingwood, B. (2001). A new socket roughness factor for prediction of rock socket shaft resistance. *Canadian Geotechnical Journal*, vol. 38, pp 138-153.
- Seidel, J.P. & Haberfield, C.M. (1994). A new approach to the prediction of drilled pier performance in rock. *Proceedings of the International Conference on Design and Construction of Deep Foundations*, Orlando, vol. 2, pp 556-570.
- Selby, A.G. & Poulos, H.G. (1984). Lateral load tests on model pile groups. *Proceedings of the Fourth Australia-New Zealand Conference on Geomechanics*, Perth, vol. 1, pp 154-158.
- Selby, A.R. (1991). Ground vibrations caused by pile installation. *Proceedings of the Fourth International Conference on Piling and Deep Foundations*, Stresa, Italy, vol. 1, pp 497-502.
- Sellers, J.B. (1995). Pile load test instrumentation, instrumentation in geotechnical engineering. *Proceedings of the Fourteenth Annual Seminar*, Geotechnical Division,

- Hong Kong Institution of Engineers, pp 23-33.
- Serrano, A. & Olalla, C. (2004). Shaft resistance of a pile embedded in rock. *International Journal of Rock Mechanics & Mining Sciences*, vol. 41, pp 21-35.
- Sewell, R.J., Campbell, S.D.G., Fletcher, C.J.N., Lai, K.W. & Kirk, P.A. (2000). *The Pre-Quaternary Geology of Hong Kong*. Geotechnical Engineering Office, Hong Kong, 181 p.
- Shek, L.M.P. (2004). Investigation and analysis of a well instrumented small displacement pile founded on rock. *Transactions of the Hong Kong Institution of Engineers*, vol. 11.2, pp 8-12.
- Sherwood, D.E. & Mitchell, J.M. (1989). Base grouted piles in Thanet Sands, London. *Proceedings of the International Conference on Piling and Deep Foundations*, London, vol. 1, pp 463-472.
- Shirlaw, J.N. (1987). The choice of grouts for hand-dug caisson construction. *Hong Kong Engineer*, vol. 15, no. 2, pp 11-22.
- Shiu, Y.K. & Chung, W.K. (1994). Case studies on prediction and modelling of the behaviour of foundations on rock. *Proceedings of the Eighth International Congress on Rock Mechanics*, Tokyo, vol. 3, pp 1243-1247.
- Short, A.F. & Mills, H. (1983). Sha Tin sewage treatment works - Stage 1 design and construction. *Hong Kong Engineer*, vol. 11, no. 2, pp 7-17.
- Silva, S.D., Cheung, C.T., Pratt, M. & Walsh, N. (1998). Instrumented bored and barrette pile load tests for Western Harbour Crossing. *Proceedings of the Seventeenth Annual Seminar*, Geotechnical Division, Hong Kong Institution of Engineers, pp 77-94.
- Simons, H.A. & Randolph, M.F. (1985). A new approach to one dimensional pile driving analysis. *Proceedings of the Fifth International Conference on Numerical Methods in Geomechanics*, Nagoya, Japan, vol. 3, pp 1457-1464.
- Simons, N.E. & Menzies, B.K. (1977). *A Short Course in Foundation Engineering*. Butterworth & Co. Ltd, London, 159 p.
- Simpson, B. (2000). Partial factors : where to apply them? *Proceedings of the LSD 2000 : International Workshop on Limit State Design in Geotechnical Engineering*, Australia, pp 125-136.
- Simpson, B., Lance, G.A. & Wilkinson, W.B. (1987). Engineering implications of rising groundwater levels beneath London. *Proceedings of the Ninth European Conference on Soil Mechanics and Foundation Engineering*, Dublin, vol. 1, pp 331-336.
- Siu, K.L. (1992). Review of design approaches for laterally-loaded caissons for building structures on soil slopes. *Proceedings of the Twelfth Annual Seminar*, Geotechnical Division, Hong Kong Institution of Engineers, Hong Kong, pp 67-89.

- Siu, K.L. & Kwan, S.H. (1982). Case history of a pile foundation in unusual ground in Hong Kong. *Proceedings of the Seventh Southeast Asian Geotechnical Conference*, Hong Kong, vol. 1, pp 423-438.
- Skempton, A.W. (1951). The bearing capacity of clays. *Building Research Congress*, London, pp 180-189.
- Skempton, A.W. (1953). Discussion on piles and pile foundations : settlement of pile foundations. *Proceedings of the Third International Conference on Soil Mechanics and Foundation Engineering*, Switzerland, vol. 3, pp 172.
- Sliwinski, Z.J. & Fleming, W.G.K. (1984). The integrity and performance of bored piles. *Proceedings of the Conference on Advances in Piling and Ground Treatment for Foundations*, London, pp 211-223.
- Sliwinski, Z.J. & Philpot, T.A. (1980). Conditions for effective end bearing of bored cast in situ piles. *Proceedings of the Conference on Recent Developments in Design and Construction of Piles*, London, pp 73-80.
- Smith, E.A.L. (1962). Pile-driving analysis by the wave equation. *Transactions of the American Society of Civil Engineers*, vol. 127, pp 1145-1193.
- So, C.W. (1991). *Large-section Excavated Piles in Hong Kong*. MSc Dissertation, University of London, 163 p. (Unpublished).
- Somerville, G. (1986). The design life of concrete structures. *The Structural Engineer*, vol. 64A, no. 2, pp 60-71.
- Sowers, G.F. (1979). *Introductory Soil Mechanics and Foundations. (Fourth edition)*. MacMillan, New York, 621 p.
- Sowers, G.F., Martin, C.B., Wilson, L.L. & Fausold, M. (1961). The bearing capacity of friction pile groups in homogeneous clay from model studies. *Proceedings of the Fifth International Conference on Soil Mechanics and Foundation Engineering*, Paris, vol. 2, pp 155-159.
- Springman, S.M. & Bolton, M.D. (1990). *The Effect of Surcharge Loading Adjacent to Piles (Contract Report No. 196)*. Transport Road & Research Laboratory, 73 p.
- Stain, R.T. & Davis, A.G. (1989). An improved method for the prediction of pile bearing capacity from dynamic testing. *Proceedings of the International Conference on Piling and Deep Foundations*, London, pp 429-433.
- Stain, R.T. & Williams, H.T. (1991). Interpretation of sonic coring results. A research project. *Proceedings of the Fourth International Conference on Piling and Deep Foundations*, Stresa, Italy, vol. 1, pp 633-640.
- Stewart, D.P., Jewell, R.J. & Randolph, M.F. (1992). Piled bridge abutments on soft clay -

- experimental data and simple design methods. *Proceedings of the Sixth Australia-New Zealand Conference on Geomechanics*, Christchurch, pp 199-204.
- Stotzer, E., Beyer, M. & Schwank, S. (1991). Drilling equipment for large diameter bored piles. *Proceedings of the Fourth International Conference on Piling and Deep Foundations*, Stresa, Italy, vol. 1, pp 503-515.
- Strange, P.L. & Shaw, R. (1986). *Geology of Hong Kong Island and Kowloon (Geological Memoir No.2)*. Geotechnical Engineering Office, Hong Kong, 134 p.
- Stroud, M.A. (1987). The control of groundwater - general report. *Proceedings of the Ninth European Conference on Soil Mechanics and Foundation Engineering*, Dublin, vol. 3, pp 983-1007.
- Stroud, M.A. & Sweeney, D.J. (1977). Discussion (Description of a diaphragm wall test panel). *Proceedings of the Conference on a Review of Diaphragm Walls*, London, pp 142-148.
- Stubblings, B.J. & Ma, G.T.M. (1988). An analysis of Trident Block Type 3 on soil caissons considering soil-structure interaction. *Proceedings of the Fourth International Conference on Tall Buildings*, Hong Kong & Shanghai, vol. 1, pp 136-142.
- Sweeney, D.J. & Ho, C.S. (1982). Deep foundation design using plate load tests. *Proceedings of the Seventh Southeast Asian Geotechnical Conference*, Hong Kong, vol. 1, pp 439-452.
- Taiebat, H. & Carter, J.P. (2000). Numerical studies of the bearing capacity of shallow foundations on cohesive soil subjected to combined loading. *Géotechnique*, vol. 50, pp 409-418.
- Tan, G.Y., Ting, W.H. & Toh, C.T. (1985). Foundation for Srimara Complex, Kuala Lumpur. *Proceedings of the Eighth Southeast Asian Geotechnical Conference*, Kuala Lumpur, vol. 1, pp 68-72.
- Tang, T.S. (1986). The use of small diameter piles as a solution to foundation problems in limestone areas. *Proceedings of IEM-ISSMFE Joint Symposium on Geotechnical Problems*, Kuala Lumpur, pp 123-137.
- Teparaksa, W., Thasnani, N. & Anwar, M.A. (1999). Base grouting of wet process bored piles in Bangkok soils. *Proceeding of the Eleventh Asian Regional Conference on Soil Mechanics and Geotechnical Engineering*, Balkema, pp 269-272.
- Terzaghi, K. (1955). Evaluation of coefficients of subgrade reaction. *Géotechnique*, vol. 5, pp 297-326.
- Terzaghi, K. & Peck, R.B. (1967). *Soil Mechanics in Engineering Practice. (Second edition)*. Wiley, New York, 729 p.
- Terzaghi, K., Peck, R.B. & Mesri, G. (1996) *Soil Mechanics in Engineering Practice. (Third*

- edition). John Wiley & Sons, New York, 549 p.
- Thomas, R.L. (1984). Acceptance criteria for large diameter piles. *Hong Kong Engineer*, vol. 12, no. 12, pp 29-39.
- Thompson, C.D. & Thompson, D.E. (1985). Real and apparent relaxation of driven piles. *Journal of Geotechnical Engineering*, American Society of Civil Engineers, vol. 111, pp 225-237.
- Thorburn, S. & Thorburn, J.Q. (1977). *Review of Problems Associated with the Construction of Cast-in-place Concrete Piles (CIRIA Report No. PG2)*. Construction Industry Research & Information Association, London, 42 p.
- Tijou, J.C. (1984). Integrity and dynamic testing of deep foundations - recent experiences in Hong Kong (1981-83). *Hong Kong Engineer*, vol. 12, no. 9, pp 15-22.
- Toh, C.T., Ooi, T.A., Chiu, H.K., Chee, S.K., & Tang, W.H. (1989). Design parameters for bored piles in a weathered sedimentary formation. *Proceedings of the Twelfth International Conference on Soil Mechanics and Foundation Engineering*, Rio de Janeiro, vol. 1, pp 1073-1078.
- Tomlinson, M.J. (1994). *Pile Design and Construction Practice. (Fourth edition)*. Spon, 411 p.
- Tomlinson, M.J. & Holt, J.B. (1953). The foundations of the Bank of China Building, Hong Kong. *Proceedings of the Third International Conference on Soil Mechanics and Foundation Engineering*, Zurich, vol. 1, pp 466-472.
- Touma, F.T. & Reese, L.C. (1974). Behaviour of bored piles in sand. *Journal of the Geotechnical Engineering Division*, American Society of Civil Engineers, vol. 100, pp 749-761.
- Triantafyllidis, T. (1992). Construction methods and technical aspects for deep basements in Hong Kong. *Proceedings of the Twelfth Annual Seminar*, Geotechnical Division, Hong Kong Institution of Engineers, Hong Kong, pp 1-20.
- Troughton, V. (1992). The design and performance of foundations for the Canary Wharf development in London Docklands. *Géotechnique*, vol. 42, pp 381-393.
- Tsui, K.K. (1968). *Analysis of Pile Loading Tests in Hong Kong*. MSc (Eng) Thesis, University of Hong Kong, 145 p. (Unpublished).
- Turner, J.P. & Kulhawy, F.H. (1990). Drained uplift capacity of drilled shafts under repeated axial loading. *Journal of Geotechnical Engineering*, American Society of Civil Engineers, vol. 116, pp 470-491.
- Valsangkar, A.J. & Meyerhof, G.G. (1983). Model studies of the collapse behaviour of piles and pile groups. *Developments in Soil Mechanics and Foundation Engineering - 1*, edited by P.K. Banerjee & R. Butterfield, Applied Science Publishers, London and

- New York, pp 65-109.
- Van Impe, W.F. (1991). Deformation of deep foundations. *Proceedings of the Tenth European Conference on Soil Mechanics and Foundation Engineering*, Florence, vol. 3, pp 1031-1062.
- Van WHEELER, A.F. (1957). A method of separating the bearing capacity of a test pile into skin friction and point resistance. *Proceedings of the Fourth International Conference on Soil Mechanics and Foundation Engineering*, London, vol. 2, pp 76-80.
- Vaughan, P.R. & Kwan, C.Y. (1984). Weathering, structure and in situ stress in residual soils. *Géotechnique*, vol. 34, pp 43-59.
- Vermeer, P.A. & Sutjiadi, W. (1985). The uplift resistance of shallow embedded anchors. *Proceedings of the Eleventh International Conference on Soil Mechanics and Foundation Engineering*, San Francisco, vol. 4, pp 1635-1638.
- Vesic, A.S. (1967). *A Study of Bearing Capacity of Deep Foundations. Final Report, Project B-189*. Georgia Institute of Technology, Atlanta, pp 231-236.
- Vesic, A.S. (1969). Experiments with instrumented pile groups in sand. *ASTM Special Technical Publication No. 444, Performance of Deep Foundations*, American Society for Testing and Materials, pp 177-222.
- Vesic, A.S. (1975). Bearing capacity of shallow foundations. *Foundation Engineering Handbook*, edited by Winterkorn, H.F. & Fang, H.Y., Van Nostrand Reinhold, New York, pp 121-147.
- Vesic, A.S. (1977). *Design of Pile Foundations*. National Co-operative Highway Research Program, Synthesis of Highway Practice No. 42, Transportation Research Board, National Research Council, Washington D.C., 41 p.
- Wang, Y.H., Tham, L.G. Lee, P.K.K. & Yang, J. (2005). A study on rock-socketed piles. *Proceedings of the Seminar on Design of Rock-socketed Piles*, Centre for Research and Professional Development, Hong Kong, pp 1-18.
- WBTC (1994). *Restrictions on the Use of Hand-dug Caissons for Foundations and Geotechnical Works*. Works Branch, Government Secretariat, Hong Kong, 2 p.
- Weltman, A.J. (1977). *Integrity Testing of Piles : A Review (CIRIA Report No. PG4)*. Construction Industry Research & Information Association, London, 36 p.
- Weltman, A.J. (1980a). *Noise and Vibration from Piling Operations (CIRIA Report No. PG9)*. Construction Industry Research & Information Association, London, 68 p.
- Weltman, A.J. (1980b). *Pile Load Testing Procedures (CIRIA Report No. PG7)*. Construction Industry Research & Information Association, London, 53 p.
- Whitaker, T. (1957). Experiments with model piles in groups. *Géotechnique*, vol. 7, pp 147-

167.

- Whitaker, T. & Cooke, R.W. (1966). An investigation of the shaft and base resistance of large bored piles on London clay. *Proceedings of the Symposium on Large Bored Piles*, London, pp 7-49.
- Whiteside, P.G. (1986). Horizontal plate loading tests in completely decomposed granite. *Hong Kong Engineer*, vol. 14, no. 10, pp 7-14.
- Wiss, J.F. (1967). Damage effects of pile driving vibrations. *Highway Research Record*, no. 155, pp 14-20.
- Wong, C.M. & Tse, Y.P. (2001). Auger-injection piles floating above karstic marble. *Proceedings of the Fourteenth Southeast Asian Geotechnical Conference*, Hong Kong, pp 1067-1070.
- Wong, I.H. & Law, K.H. (2001). Corrosion of steel H piles in decomposed granite. *Journal of Geotechnical and Environmental Engineering*, American Society for Civil Engineers, vol. 125, pp 529-532.
- Wong, H.Y. (1981). Some theoretical considerations of negative skin friction on piles in a pile group. *Hong Kong Engineer*, vol. 9, no. 3, pp 45-52.
- Wong, K.Y., Chow, Y.K., Karunaratne, G.P. & Lee, S.L. (1987). Driveability of piles and the effects of followers. *Geotechnical Engineering*, vol. 18, pp 167-184.
- Wong, W.Y., Ng, A.L.K. & Chan, M.K.T. (2003). Multi-storey building on raft foundation in Hong Kong. *Proceedings of the Twenty-third Annual Seminar*, Geotechnical Division, Hong Kong Institution of Engineers, pp 284-293.
- Wood, R.D. (1968). Screening of elastic waves by trenches. *Journal of the Soil Mechanics and Foundations Division*, American Society of Civil Engineers, vol. 94, pp 951-979.
- Wright, S.J. & Reese, L.C. (1979). Design of large diameter bored piles. *Ground Engineering*, vol. 12, no. 8, pp 17-51.
- Wroth, C.P., Randolph, M.F., Houlsby, G.T. & Fahey, M. (1979). *A Review of the Engineering Properties of Soils, with Particular Reference to the Shear Modulus. (Cambridge University Research Report, CUED/D - Soils TR 75)*. 94 p.
- Yegian, M. & Wright, S.G. (1973). Lateral soil resistance-displacement relationships for pile foundations in soft clays. *Proceedings of the Fifth Offshore Technology Conference*, Houston, vol. 2, pp 663-676.
- Yiu, T.M. & Lam, S.C. (1990). Ultimate load testing of driven piles in meta-sedimentary decomposed rocks. *Proceedings of the Conference on Deep Foundation Practice*, Singapore, pp 293-300.
- Yiu, T.M. & Tang, H.K. (1990). Case study of pile construction problems in faulted marble

bedrock in the Tin Shui Wai Area 5, Hong Kong. *Proceedings of the Conference on Deep Foundation Practice*, Singapore, pp 281-292.

Yoshida, I. & Yoshinaka, R. (1972). A method to estimate soil modulus of horizontal subgrade reaction for a pile. *Soils and Foundations*, vol. 12(3), pp 1-16.

Zeevaert, L. (1959). Reduction of point bearing capacity of piles because of negative friction. *Proceedings of the First Pan-American Conference on Soil Mechanics and Foundation Engineering*, Mexico City, vol. 3, pp 1145-1151.

Zhan, C. & Yin, J.H. (2000). Field static load tests on drilled shaft founded on or socketed into rock. *Canadian Geotechnical Journal*, vol. 37, pp 1283-1294.

Zhang, L.M., McVay, M.C., Han, S.J., Lai, P.W. & Gardner, R. (2002). Effect of dead loads on the lateral response of battered pile groups. *Canadian Geotechnical Journal*, vol. 39, pp 561-575.

APPENDIX A

**SUMMARY OF RESULTS OF INSTRUMENTED
PILE LOADING TESTS IN HONG KONG**

A.1 GENERAL

This appendix gives a summary of results of instrumented pile loading tests in soils and rocks in Hong Kong. The data were obtained from published papers and from local developers, consultants and piling contractors. Based on these data, the shaft and end-bearing resistance mobilised in soils or rock during piling loading tests has been assessed and discussed below.

A.2 MOBILISED SHAFT RESISTANCE ON PILES

A.2.1 Replacement Piles

The mobilised shaft resistance values as determined from instrumented loading tests are summarised in Tables A1 and A2 for replacement piles and displacement piles respectively. Table A3 summarises the loading test data for shaft-grouted bored piles or barrettes, which have higher shaft resistance responses when compared with conventional friction piles.

A number of tests on large-diameter bored piles and barrettes founding in soils in Table A1 indicated that shaft resistance component is usually fully or substantially mobilised at a relative displacement between the pile and soil of about 1% pile diameter.

The test results indicate a complex and erratic distribution of 'local' shaft resistance with depth. Some of the results are known or suspected to have been a result of pile construction, e.g. filter cake problems. Relevant construction details, including excavation method, measures for supporting empty bore and time used in completing the piles are tabulated as far as possible.

The average mobilised shaft resistance in saprolites have been plotted in Figure A1 to A4 for replacement piles. Different symbols have been used in the figures to delineate the quality of data, which is described below.

In Figures A1 to A6, results of pile loading tests for which the shaft resistance are fully or substantially mobilised are plotted as solid circles. In cases where the interpreted maximum shaft resistance is not substantially mobilised, they are indicated as open triangle and marked as degree of mobilisation unknown.

The tests results derived from three bored piles C8-6-4 in Site 1 and TP1, TP2 in Site 6 were suspected to have been affected by construction problems and may not be representative. The results are shown as open circle in the figures.

For the shaft resistance values reported by Fraser & Kwok (1986), Davies & Chan (1981) and Evans et al (1982), information regarding the shaft movement is not available. Therefore, the degree of mobilisation of shaft resistance is not known. They are also annotated with an open triangle marked as degree of mobilisation unknown.

The test results reported in Sayer & Leung (1987) have not been included in the Figures A1 to A2 because the SPT N values of saprolites at each caisson were not known.

It can be seen in the figures that there is considerable scatter in the test results. The variability may be related to the different method of construction and workmanship, and the heterogeneous nature of the saprolites with intrinsic weak bonding which may be susceptible to influence of pile construction (e.g. from stress relief and mechanical remoulding). However it is noteworthy that the scattering of the results, although considerable, is comparable to that for loading tests conducted in granular soils as reported by Meyerhof (1976) and Wright & Reese (1979).

A.2.2 Displacement Piles

The results of instrumented loading tests on displacement piles are shown in Figures A5 and A6. The symbols used are the same as for the replacement piles. For displacement piles, the relative movements required to fully mobilise the shaft resistance range typically from 5 mm to 15 mm (say about 1 to 3% pile diameter).

In a number of the tests, the shaft resistance was not fully mobilised due to insufficient settlement. No extrapolation of the data to ultimate shaft resistance was made in view of the findings of Yiu & Lam (1990), which shows the problem of extrapolation of test results for driven piles (see also Section 6.4.2). In addition, it should be noted that a post-peak drop in the strength along the interface between a pile and a bonded material can be significant (Coop & McAuley, 1992). Such strain-softening characteristics, particularly in the case of long piles, will lead to a lower average mobilised strength. This type of behaviour can be assessed within the framework proposed by Murff (1980) or Randolph (1983). However, to quantify the effects, good quality information would be required on the interface behaviour, such as direct shear tests of the interface under constant normal stiffness conditions (Coop & McAuley, 1992).

The test results given by Lee et al (2004b) are not included in Figure A5 as the mean effective overburden pressures are not available. The degree of mobilisation cannot be assessed because information on the load-displacement curve or relative movement between the pile and the soil interface is not available. These points are shown as open triangles in Figure A6.

A.2.3 Piles Embedded in Rock

The results of loading tests for piles embedded in rock are summarised in Table A4. Except Pile P22, which is a mini-pile socketed into rock, the embedment ratio (L/D) of the test piles ranges from 0.5 to 3.0. Majority of shaft resistance mobilised in the rock socket portion is not fully mobilised. In a number of tests, Osterberg load cells were installed at the base of the piles and the loading mechanism was different from that provided by kentledge. The uplift of the piles due to the use of an Osterberg load cell would result in a reduction of overburden pressure. The test results are shown in Figures 6.8 and 6.9 in the main text.

The end-bearing resistance for all piles, except Pile P9, is not fully mobilised. The measured pile base settlements ranged between 2 and 14 mm. The maximum settlement is about 1% of pile diameter. The low mobilisation of pile base movements is attributed to the limitation of the loading equipment rather than the founding material itself. Pile P9 is

founded on granodiorite that has an average uniaxial compressive strength of 15 MPa. On the other hand, Pile P4 is founded on grade III/IV granite with a total core recovery of less than 50%. The low mobilisation of end-bearing resistance for these two piles is expected.

A.3 DATABASE ON INSTRUMENTED PILE LOADING TESTS RESULTS

The use of rational design to back-analyse results of pile loading tests on instrumented piles will lead to a better understanding of pile behaviour. However, it is evident that more pile loading test data are required to improve the understanding of the pile behaviour, particularly for those piles that have gained popularity in recent years, such as jacked piles and shaft-grouted piles. The Geotechnical Engineering Office of the Civil Engineering and Development Department has established a database of instrumented pile loading test results and regularly updates the plots, such as those given in Figures A1 to A6.

Practitioners are encouraged to submit such data to the Geotechnical Information Unit of the Civil Engineering Library to facilitate access to pile loading test data by all interested parties.

Table A1 – Interpreted Shaft Resistance in Loading Tests on Instrumented Replacement Piles in Hong Kong (Sheet1 of 4)

| Reference | Pile Length (m) | Pile Dimension (m) | Pile Construction | Stratum | Maximum Mobilised Average Shaft Resistance τ_{max} (kPa) | Relative Pile/Soil Movement (mm) | Mean SPT N value | Mean σ_v' (kPa) | $\frac{\tau_{max}}{N}$ (kPa) | $\beta_{max} = \frac{\tau_{max}}{\sigma_v'}$ | Mark in Figures |
|----------------------|-----------------|--------------------|--|-----------------------------------|---|----------------------------------|------------------|------------------------|------------------------------|--|-----------------|
| Holt et al (1982) | 36.9 | 1.0 | Bored pile – reverse circulation drill with water flush | Fill | 31* | 6 | NA | 83.0 | NA | 0.37 | |
| | | | | Marine deposit + alluvium | 32* | 5 | NA | 175.0 | NA | 0.18 | |
| | | | | Decomposed granite | 129* | 39 | > 100 | 267.5 | 1.30 | 0.48 | P1 |
| Linney (1983) | 363.5 | 1.0 | Bored pile – construction method unknown | Fill + marine sand & clay | 35* | 10 | NA | 54.0 | NA | 0.65 | |
| | | | | Alluvial sand | 42* | 29 | NA | 140 | NA | 0.30 | |
| | | | | Decomposed granite | 98* | 23 | NA | 251 | NA | 0.39 | P3 |
| Ho (1992) | 32.8 | 1.2 | Bored pile (Pile PP/F14) – constructed by hammer, grab & casing under water | Decomposed volcanics | 30* | 3 | 35 | 194.2 | 0.86 | 0.15 | P11 |
| | 36.8 | 1.2 | Bored pile (Pile 14FB8) – constructed by hammer, grab & casing under water | Decomposed volcanics | 25 | 5 | 78 | 205.2 | 0.32 | 0.12 | P12 |
| Fraser & Kwok (1988) | 30 | 1.5 | Bored pile (Pile 72/2) – constructed by hammer, grab & casing under water. Reverse circulation drill (RCD) was used for the bottom 5 m | Alluvium + 2 m decomposed granite | 26 | NA | NA | 63.3 | NA | 0.41 | |
| | | | | Decomposed granite | 21.5 | NA | 55 | 184.0 | 0.39 | 0.12 | P8 |
| | 22.6 | 1.5 | Bored pile (Pile 86/1) – constructed by hammer, grab & casing under water with a concrete plug at the pile base | Alluvium | 16 | NA | 15 | 48.0 | 1.10 | 0.33 | |
| | | | | Decomposed granite | 80 | NA | 80 | 133.7 | 1.00 | 0.60 | P9 |
| | 22 | 1.5 | Bored pile (Pile 99/2) – constructed using hammer, grab & casing under water | Alluvium | 8 | NA | 28 | 38.4 | 0.29 | 0.21 | |
| | | | | Decomposed granite | 23 | NA | 65 | 120.1 | 0.35 | 0.19 | P10 |
| Davies & Chan (1981) | NA | NA | Bored piles | Decomposed granite | 50 | NA | 42 | NA | 1.20 | NA | P16 |
| Sweeny & Ho (1982) | 39 | 1.0 | Hand-dug caisson – jacking tests on caisson rings | Decomposed granite | 235* | 22 | 200 | 665.0 | 1.20 | 0.35 | C3 |

Table A1 – Interpreted Shaft Resistance in Loading Tests on Instrumented Replacement Piles in Hong Kong (Sheet 2 of 4)

| Reference | Pile Length (m) | Pile Dimension (m) | Pile Construction | Stratum | Maximum Mobilised Average Shaft Resistance τ_{max} (kPa) | Relative Pile/Soil Movement (mm) | Mean SPT N value | Mean σ_v' (kPa) | $\frac{\tau_{max}}{N}$ (kPa) | $\beta_{max} = \frac{\tau_{max}}{\sigma_v'}$ | Mark in Figures |
|----------------------|-----------------|--------------------|---|--------------------------------------|---|----------------------------------|------------------|------------------------|------------------------------|--|-----------------|
| Sayer & Leung (1987) | NA | 2.1 | Hand-dug caisson – jacking tests on caisson rings. | Decomposed granite | 70 – 100 | 3 – 12 | 140(?) | NA | NA | NA | |
| | | | | | 130 – 170 | 1 – 11 | 200(?) | NA | NA | NA | |
| Evans et al (1982) | 11.5 | 1.2 | Hand-dug caisson (Pile P45) – timber stakes driven ahead for stability | Fill + alluvium + decomposed granite | 34 | NA | 27 | 142.0 | 1.26 | 0.24 | |
| | 14 | 1.3 | Hand-dug caisson (Pile P54)– timber stakes driven ahead for stability | Alluvium + decomposed granite | 18 | NA | 19 | 86.9 | 0.95 | 0.21 | |
| | | | | Decomposed granite | 27 | NA | 43 | 126.3 | 0.63 | 0.21 | C1 |
| | 13.2 | 1.3 | Hand-dug caisson (Pile P141) – timber stakes driven ahead for stability | Alluvium | 58 | NA | 28 | 49.5 | 2.10 | 1.20 | |
| Decomposed granite | | | | 52 | NA | 60 | 253.4 | 0.87 | 0.21 | C2 | |
| Malone et al (1992) | 36 | 0.6 x 2.2 | Barrette – constructed using rectangular grabs under bentonite | Decomposed granite | 126.7* | 13 | 132 | 276.0 | 0.96 | 0.46 | B3 |
| Pratt (1989) | 56 | 0.8 x 2.2 | Barrette – constructed using rectangular grabs under bentonite | Decomposed granite | 152* | 33 | 65 | 370.0 | 2.30 | 0.41 | B2 |
| Site 1 | 49.3 | 1.5 | Bored pile (Pile C8-6-4) – constructed using hammer, grab & casing under water | Decomposed granite | 54*# | 32 | 106 | 290.0 | 0.51 | 0.19 | P4 |
| | 52.1 | 1.5 | Bored pile (Pile C8-7-1) – constructed using hammer, grab & casing under water | | 36 | 8 | 80 | 360.0 | 0.45 | 0.10 | P5 |
| | 40.6 | 1.5 | Bored pile (Pile C8-17-3) – constructed using hammer, grab & casing under water | | 58 | 4 | 107 | 302.0 | 0.54 | 0.19 | P6 |
| | 42.2 | 1.5 | Bored pile (Pile C8-17-4) – constructed using hammer, grab & casing under water | | 87 | 10 | 65 | 270.0 | 1.30 | 0.32 | P7 |

Table A1 – Interpreted Shaft Resistance in Loading Tests on Instrumented Replacement Piles in Hong Kong (Sheet 3 of 4)

| Reference | Pile Length (m) | Pile Dimension (m) | Pile Construction | Stratum | Maximum Mobilised Average Shaft Resistance τ_{max} (kPa) | Relative Pile/Soil Movement (mm) | Mean SPT N value | Mean σ_v' (kPa) | $\frac{\tau_{max}}{N}$ (kPa) | $\beta_{max} = \frac{\tau_{max}}{\sigma_v'}$ | Mark in Figures |
|-----------|-----------------|--------------------|--|--|---|----------------------------------|------------------|------------------------|------------------------------|--|-----------------|
| Site 2 | 48.2 | 1.5 | Bored pile (Pile WP13) – constructed using hammer, grab & casing under water | Decomposed granite | 45.3 | ~1 | 104 | 318.6 | 0.44 | 0.14 | P13 |
| Site 3 | 65 | 1.0 | Bored pile (Pile TP1) – constructed using reverse circulation drill and under bentonite | Fill + alluvium | 46* | 1.6 | 21 | 108.3 | 2.20 | 0.42 | |
| | | | | Colluvium | 48* | 7.2 | 18 | 268.5 | 2.70 | 0.18 | |
| | | | | Colluvium + residual soil + decomposed granite | 55* | 2.2 | 41 | 451.0 | 1.32 | 0.12 | |
| | | | | Decomposed granite | 155* | 3 | 92 | 623.5 | 1.70 | 0.25 | P14 |
| | 75 | 1.0 | Bored pile (Pile TP2) – constructed using reverse circulation drill and under bentonite | Fill + colluvium + residual soil | 161 | 7 | 26 | 277.0 | 6.20 | 0.58 | |
| | | | | Decomposed granite | 72 | 6 | 68 | 627.2 | 1.10 | 0.11 | P15 |
| Site 4 | 40 | 0.8 x 2.2 | Barrette – constructed using rectangular grabs under water | Decomposed granite | 104* | 18 | 80 | 281.3 | 1.30 | 0.37 | B4 |
| Site 5 | 48 | 1.0 | Bored pile – constructed using hammer, grabs and casing under water. Test section at 5.2 m from base | Decomposed granite | 77* + | 10 | 140 | 397.5 | 0.55 | 0.19 | P2 |
| Site 6 | 42.6 | 1.5 | Bored pile (Pile TP1) – constructed by reverse circulation drill under bentonite | Decomposed granite | 19*# | 19 | 97 | 250.0 | 0.20 | 0.08 | P17 |
| | 59.1 | 1.5 | Bored pile (Pile TP2) – constructed by reverse circulation drill under bentonite | Decomposed granite | 28*# | 18 | 77 | 222.5 | 0.36 | 0.13 | P18 |
| | | | | | 82*# | 20 | 200 | 456.5 | 0.41 | 0.18 | P19 |
| Site 7 | 56.8 | 0.8 x 2.2 | Barrette – constructed using rectangular grabs under bentonite | Alluvium | 94* | 21 | 14 | 248.0 | 6.70 | 0.38 | |
| | | | | Decomposed granite | 89* | 17 | 61 | 410.0 | 1.50 | 0.22 | B5 |

Table A1 – Interpreted Shaft Resistance in Loading Tests on Instrumented Replacement Piles in Hong Kong (Sheet 4 of 4)

| Reference | Pile Length (m) | Pile Dimension (m) | Pile Construction | Stratum | Maximum Mobilised Average Shaft Resistance τ_{max} (kPa) | Relative Pile/Soil Movement (mm) | Mean SPT N value | Mean σ_v' (kPa) | $\frac{\tau_{max}}{N}$ (kPa) | $\beta_{max} = \frac{\tau_{max}}{\sigma_v'}$ | Mark in Figures |
|------------------------------------|-----------------|--------------------|--|---|---|----------------------------------|------------------|------------------------|------------------------------|--|-----------------|
| Site 8 | 53.0 | 0.6 x 2.2 | Barrette – constructed using rectangular grabs under bentonite | Decomposed granite | 51 | 8 | 66 | 328.1 | 0.77 | 0.16 | B1 |
| Lo (1997) | 53.1 | 1 x 2.2 | Barrette – constructed by rectangular grabs under bentonite | Decomposed granite | 78 | 5 | 65 | 371 | 1.2 | 0.21 | B9 |
| Silva et al (1998) | 41.0 | 0.8 x 2.2 | Barrette – constructed by rectangular grab under bentonite | Decomposed granite | 117 | 80.8 | 95 | 330 | 1.45 | 0.35 | B10 |
| | 52.5 | 0.6 x 2.2 | Barrette – constructed by rectangular grabs under bentonite. Construction time ~ 72 hours | Decomposed granite | 156 | 45 | 110 | 386 | 1.42 | 0.40 | B11 |
| Chan et al (2002) | 72.0 | 1.5 | Bored pile – constructed by grabs under bentonite | Decomposed granite | 96 | 12.8 | 91 | 403.2 | 1.05 | 0.24 | P20 |
| West Rail, Yen Chow Street Station | 49.4 | 1.5 | Bored pile – constructed by grabs, RCD for socket under bentonite. Construction time ~ 527 hours | Decomposed granite (Stage 1) | 39 | 9.5 | 69 | 415.0 | 0.60 | 0.09 | P21-1 |
| | | | | Decomposed granite (Stage 2) | 128 | 15.5 | 69 | 415.0 | 1.90 | 0.31 | P21-2 |
| Hope et al (2000) | 38.9 | 0.8 x 2.8 | Barrette – constructed by rectangular grabs under bentonite. Construction time ~ 42 hours | Decomposed granite (Stage 1 compression test) | 50 | 101 | 84 | 246.0 | 0.60 | 0.20 | B6C |
| | | | | Decomposed granite (Stage 1 tension test) | 18 | 172 | 84 | 246.0 | 0.20 | 0.07 | B6T |
| Airport Railway, Central Station | 42.8 | 0.8 x 2.8 | Barrette – constructed by rectangular grabs under bentonite. Scraper used to roughen exposed surface. Construction time ~ 27 hours | Decomposed granite (Stage 1 compression test) | 100 | 24.9 | 88 | 278.1 | 1.10 | 0.36 | B7C |
| | | | | Decomposed granite (Stage 2 tension test) | 117 | 61.3 | 88 | 278.1 | 1.30 | 0.42 | B7T |
| | 49.1 | 0.8 x 2.8 | Barrette – constructed by rectangular grabs under bentonite. Construction time ~ 37 hours | Decomposed granite (Stage 1 compression test) | 44 | 50 | 43 | 319.0 | 1.00 | 0.14 | B8C |
| | | | | Decomposed granite (Stage 2 tension test) | 30 | 55.3 | 43 | 319.0 | 0.70 | 0.09 | B8T |
| West Rail, Tin Shui Wai Station | 30.2 | 1.5 | Bored pile – constructed by grabs and RCD for socket in rock with casing under water | Decomposed meta-siltstone (grade V) | 55 | 125 | 40 | 120.0 | 1.38 | 0.45 | P22 |
| | 39.4 | 1.35 | Bored pile – constructed by grabs and RCD for socket in rock with casing under water | Decomposed meta-siltstone (grade V) | 84 | 17 | 50 | 257.6 | 1.70 | 0.33 | P23 |

Notes : (1) * denotes substantially mobilised (2) + denotes erratic strain gauge data (3) NA denotes information not available (4) # denotes construction problems

Table A2 – Interpreted Shaft Resistance in Loading Tests on Instrumented Displacement Piles in Hong Kong (Sheet 1 of 3)

| Reference | Pile Length (m) | Pile Dimension (m) | Pile Construction | Stratum | Maximum Mobilised Average Shaft Resistance τ_{max} (kPa) | Relative Pile/Soil Movement (mm) | Mean SPT N value | Mean σ_v' (kPa) | $\frac{\tau_{max}}{N}$ (kPa) | $\beta_{max} = \frac{\tau_{max}}{\sigma_v'}$ | Mark in Figures |
|------------------------|-----------------|--------------------|---|--------------------------------------|---|----------------------------------|------------------|------------------------|------------------------------|--|-----------------|
| Premchitt et al (1994) | 42.6 | 0.5 | Precast prestressed concrete pile (Pile P118) | Fill +marine deposits (silt) | 110 | 15 | 15 | 72.9 | 7.33 | 1.50 | |
| | | | | Marine clay + alluvial sand | 57 | 9 | 9 | 129.0 | 6.33 | 0.44 | |
| | | | | Alluvium (sand & clay) | 101 | 5.5 | 20 | 177.0 | 5.05 | 0.57 | |
| | | | | Alluvial sand | 52 | 3 | 20 | 237.0 | 2.60 | 0.22 | |
| | | | | Decomposed granite | 116 | 1 | 22 | 317.0 | 5.27 | 0.37 | D1 |
| | 43.8 | 0.5 | Precast prestressed concrete pile (Pile P58) | Fill | 111* | 12.5 | 17 | 80.9 | 6.53 | 1.40 | |
| | | | | Marine clay | 88* | 6.5 | 12 | 146.5 | 7.33 | 0.60 | |
| | | | | Marine clay + alluvial sand | 88 | 3.5 | 15 | 187.0 | 5.86 | 0.47 | |
| | | | | Alluvial sand | 96 | 2 | 17 | 242.0 | 5.65 | 0.40 | |
| | | | | Alluvial sand + decomposed granite | 37 | 0.5 | 18 | 322.0 | 2.05 | 0.11 | D2 |
| Lam et al (1994) | 50.7 | 0.36 x 0.38 | Steel H pile (Pile PP1) | Fill + alluvium | 64* | 13 | 18 | 53.1 | 3.56 | 1.20 | |
| | | | | Alluvium | 61* | 10 | 34 | 153.4 | 1.79 | 0.40 | |
| | | | | Completely decomposed meta-siltstone | 45* | 5 | 36 | 331.9 | 1.25 | 0.14 | D3 |

Table A2 – Interpreted Shaft Resistance in Loading Tests on Instrumented Displacement Piles in Hong Kong (Sheet 2 of 3)

| Reference | Pile Length (m) | Pile Dimension (m) | Pile Construction | Stratum | Maximum Mobilised Average Shaft Resistance τ_{max} (kPa) | Relative Pile/Soil Movement (mm) | Mean SPT N value | Mean σ_v' (kPa) | $\frac{\tau_{max}}{N}$ (kPa) | $\beta_{max} = \frac{\tau_{max}}{\sigma_v'}$ | Mark in Figures |
|----------------------|--------------------|-----------------------|--|--------------------------------------|---|-------------------------------------|------------------|---------------------------|---------------------------------|--|-----------------|
| Lam et al (1994) | 40.4 | 0.36 x 0.38 | Steel H pile (Pile PP2) | Fill + alluvium | 7* | 5 | 15 | 68.7 | 0.47 | 0.10 | |
| | | | | Alluvium | 67 | 9 | 35 | 143.6 | 1.91 | 0.47 | |
| | | | | Completely decomposed meta-siltstone | 54.8 | 5 | 45 | 295.1 | 1.21 | 0.19 | D4 |
| Ng (1989) | 29 | 0.5 | Precast prestressed concrete pile (Pile B29) | Decomposed granite | 174 | 6 | 16 | 142.0 | 10.88 | 1.20 | D5 |
| | 29 | 0.5 | Precast prestressed concrete pile (Pile B34) | Decomposed granite | 129 | 6 | 23 | 146.0 | 5.61 | 0.88 | D6 |
| Davies & Chan (1981) | NA | NA | Driven cast-in-place piles | Decomposed granite | 100* | NA | 30 | NA | 3.33 | NA | D7 |
| Lee & Lumb (1982) | 29.6 | 0.61 | Steel tubular pile | Marine clay | 32* | NA | 4 | 163.0 | 8.0 | 0.20 | |
| | | | | Decomposed meta-siltstone | 63.7 | NA | 30 | 239.0 | 2.12 | 0.27 | D8 |
| Site 9 | 21.7 | 0.5 | Precast prestressed concrete pile | Alluvium + decomposed granite | 137 | 12 | 20 | 125.0 | 6.85 | 1.10 | D9 |
| Lee et al (2004b) | 31.8 | 0.306 | Driven steel H-pile (Pile PD1) | Completely decomposed granite | 129.1 | NA | NA | NA | NA | NA | |
| | 39.6 | 0.305 | Driven steel H-pile (Pile PD2) | Completely decomposed granite | 56.6 | NA | 29 | NA | 1.95 | NA | D10 |
| | 33.2 | 0.305 | Driven steel H-pile (Pile PD3) | Completely decomposed granite | 80.6 | NA | 67 | NA | 1.20 | NA | D11 |

Table A2 – Interpreted Shaft Resistance in Loading Tests on Instrumented Displacement Piles in Hong Kong (Sheet 3 of 3)

| Reference | Pile Length (m) | Pile Dimension (m) | Pile Construction | Stratum | Maximum Mobilised Average Shaft Resistance τ_{max} (kPa) | Relative Pile/Soil Movement (mm) | Mean SPT N value | Mean σ_v' (kPa) | $\frac{\tau_{max}}{N}$ (kPa) | $\beta_{max} = \frac{\tau_{max}}{\sigma_v'}$ | Mark in Figures |
|-------------------|--------------------|-----------------------|--------------------------------|-------------------------------|---|-------------------------------------|------------------|---------------------------|---------------------------------|--|-----------------|
| Lee et al (2004b) | 37.9 | 0.305 | Driven steel H-pile (Pile PD4) | Completely decomposed granite | 75.9 | NA | NA | NA | NA | NA | |
| | 31.8 | 0.305 | Driven steel H-pile (Pile PD5) | Completely decomposed granite | 116.9 | NA | 82 | NA | 1.40 | NA | D12 |
| | 39.6 | 0.305 | Driven steel H-pile (Pile PD6) | Completely decomposed granite | 52.6 | NA | 40 | NA | 1.30 | NA | D13 |
| | 31.8 | 0.305 | Driven steel H-pile (Pile PD7) | Completely decomposed granite | 103.8 | NA | 62 | NA | 1.75 | NA | D14 |
| | 39.6 | 0.305 | Driven steel H-pile (Pile PD8) | Completely decomposed granite | 59 | NA | 25 | NA | 2.36 | NA | D15 |

Notes : (1) * denotes substantially mobilised
(2) NA denotes information not available

Table A3 – Interpreted Shaft Resistance in Loading Tests on Instrumented Replacement Piles with Shaft-grouting in Hong Kong

| Reference | Pile Length (m) | Pile Dimension (m) | Pile Construction | Stratum | Maximum Mobilised Average Shaft Resistance τ_{max} (kPa) | Relative Pile/Soil Movement (mm) | Mean SPT N value | Mean σ_v' (kPa) | $\frac{\tau_{max}}{N}$ (kPa) | $\beta_{max} = \frac{\tau_{max}}{\sigma_v'}$ | Mark in Figures |
|------------------------------|--------------------|-----------------------|---|---------------------------------|---|-------------------------------------|------------------|---------------------------|---------------------------------|--|-----------------|
| Lui et al (1993) | 40 | 0.219 | Minipile – constructed by overburdening drilling. Shaft grouting in 2 stages | Decomposed granite | 270 | 4 | 50 | 315 | 5.5 | 0.85 | P3 |
| West Rail, Yuen Long Station | 30 | 1.8 | Bored pile – constructed by grabs with casing under water. Construction time ~ 65 hours | Decomposed rhyolite | 190 | 47 | 40 | 177.6 | 4.8 | 1.07 | B1 |
| West Rail, Yen Chow Street | 51.4 | 0.8 x 2.8 | Barrette – constructed using hydrofraise under bentonite. Construction time ~ 51 hours | Decomposed granite | 220 | 62 | 160 | 215.7 | 1.4 | 1.02 | B2 |
| | 39.7 | 0.8 x 2.8 | Barrette – constructed using hydrofraise under bentonite. Construction time ~ 36 hours | Decomposed granite (upper zone) | 145 | 63 | 40 | 254.0 | 3.6 | 0.57 | B3 |
| | | | | Decomposed granite (lower zone) | 205 | 63 | 95 | 324.0 | 2.2 | 0.63 | B4 |
| | 54 | 1.2 | Bored pile – constructed by grabs with casing under water | Decomposed granite (upper zone) | 113 | 59 | 30 | 329.0 | 3.8 | 0.34 | P1 |
| | | | | Decomposed granite (lower zone) | 205 | 59 | 125 | 473.0 | 1.6 | 0.43 | P2 |
| Kowloon Station, Package 7 | 61 | 1.5 x 2.8 | Barrette – constructed using hydrofraise under bentonite and surface roughen by scraper. Construction time ~ 72 hours | Decomposed granite | 104.9 | 71 | 53 | 528.1 | 2.0 | 0.20 | B5 |
| | 36.1 | 1.5 x 2.8 | Barrette – constructed using hydrofraise under bentonite and surface roughen by scraper | Alluvial sand + clay | 82.2 | 46 | 18 | 162.8 | 4.6 | 0.50 | B6 |

Notes : (1) * denotes substantially mobilised
(2) NA denotes information not available

Table A4 – Interpreted Shaft Resistance and End-bearing Resistance in Loading Tests on Instrumented Replacement Piles Embedded in Rock in Hong Kong (Sheet 1 of 5)

| Reference | Pile Length (m) | Pile Dimension (m) | Pile Construction | Stratum | Test Arrangement | Maximum Mobilised Average Shaft Resistance in Rock Socket τ_{max} (kPa) | Pile Head Movement (mm) | Mobilised End-bearing Resistance (kPa) | Measured Pile Base Movement (mm) | Average σ_c of Rock Material along Shaft (MPa) | Average RQD of Rock beneath Pile Base (%) | Average Spacing of Joints below Pile Base (mm) | Average σ_c of Rock below Pile Base (MPa) | Mark in Figures |
|---|-----------------|--------------------|---|--|--|--|-------------------------|--|----------------------------------|---|---|--|--|-----------------|
| Hope et al (2000) Airport Railway, Central Station | 43.1 | 1.0 | Bored pile – constructed with grabs and RCD for forming 0.9 m rock socket under bentonite | Grade II granite for socket and base | Stage 1 – compression test loaded by kentledge | 3000 | 20.3 | 8250 | 1.2 | $I_{50} = 5.2$ | 95 | 227 – 556 | 98 | P1C |
| | | | | | Stage 2 – tension test loaded by kentledge | 3417 | 16.4 | NA | NA | | | | | P1T |
| | 49.3 | 1.0 | Bored pile – constructed with grabs and RCD for forming 2.5 m rock socket under bentonite | Rock socket: 1.12 m grade III/IV granite and 1.38 m in grade II granite. Pile base: grade III granite | Stage 1 – tension test loaded by kentledge | 1130* | 24.6 | NA | NA | 25.9 | 91 | 159 ~ 217 | $I_{50} = 2.84$ | P2T |
| | | | | | Stage 2 – compression test loaded by kentledge | NA | 33.8 | 20370 | 11.3 | | | | | P2C |
| Airport Railway, Kowloon Station | 38.6 | 1.2 | Bored pile – constructed with grabs and RCD for forming 1.1 m rock socket under bentonite | Grade II granite for socket and base | Stage 1 – tension test loaded by kentledge | 1620 | 15.2 | NA | NA | 82.5 | 96 | 294 - 435 | 91.7 | P3T |
| | | | | | Stage 2 – compression test loaded by kentledge | 1688 | 20.7 | 7950 | 2.5 | | | | | P3C |

Table A4 – Interpreted Shaft Resistance and End-bearing Resistance in Loading Tests on Instrumented Replacement Piles Embedded in Rock in Hong Kong (Sheet 2 of 5)

| Reference | Pile Length (m) | Pile Dimension (m) | Pile Construction | Stratum | Test Arrangement | Maximum Mobilised Average Shaft Resistance in Rock Socket τ_{max} (kPa) | Pile Head Movement (mm) | Mobilised End-bearing Resistance (kPa) | Measured Pile Base Movement (mm) | Average σ_c of Rock Material along Shaft (MPa) | Average RQD of Rock beneath Pile Base (%) | Average Spacing of Joints below Pile Base (mm) | Average σ_c of Rock below Pile Base (MPa) | Mark in Figures |
|-----------------------------------|--------------------|-----------------------|---|---|--|--|----------------------------|---|-------------------------------------|--|--|---|---|-----------------|
| Airport Railway, Kowloon Station | 60.3 | 1.2 | Bored pile – constructed with grabs and RCD for forming 3.5 m rock socket under bentonite | Grade III/IV granite for socket and base | Stage 2 – compression test loaded by kentledge | 1230 | 47.3 | 6192 | 18.3 | NA | 29 | < 60 | NA | P4 |
| Airport Railway, Tsing Yi Station | 24.7 | 1.2 | Bored pile – constructed with grabs and RCD for forming 1.5 m rock socket under bentonite | Grade II/III granite for rock socket and base | Stage 1 – tension test loaded by Osterberg cell at base | 914 | 16.6 | NA | NA | NA | NA | NA | 200 | |
| | | | | | Stage 2 – compression test loaded by kentledge | 806 | 23.8 | 11614 | NA | | | | | |
| | 24.5 | 1.2 | Bored pile – constructed with grabs and RCD for forming 3.0 m rock socket under bentonite | Grade III granite for rock socket and base | Stage 1 – compression test loaded by kentledge with soft toe | 821 | 5.5 | NA | NA | 35 | NA | NA | 40 | |
| | | | Stage 2 – compression test loaded by kentledge after soft toe was grouted | 1258 | 17.4 | 5208 | negligible | | | | | | | |

Table A4 – Interpreted Shaft Resistance and End-bearing Resistance in Loading Tests on Instrumented Replacement Piles Embedded in Rock in Hong Kong (Sheet 3 of 5)

| Reference | Pile Length (m) | Pile Dimension (m) | Pile Construction | Stratum | Test Arrangement | Maximum Mobilised Average Shaft Resistance in Rock Socket τ_{max} (kPa) | Pile Head Movement (mm) | Mobilised End-bearing Resistance (kPa) | Measured Pile Base Movement (mm) | Average σ_c of Rock Material along Shaft (MPa) | Average RQD of Rock beneath Pile Base (%) | Average Spacing of Joints below Pile Base (mm) | Average σ_c of Rock below Pile Base (MPa) | Mark in Figures |
|----------------------------------|--------------------|-----------------------|--|--|--|--|----------------------------|---|-------------------------------------|--|--|---|---|-----------------|
| West Rail, Tuen Mun Centre | 28.1 | 1.3 | Bored pile – constructed by grabs with casing under water. RCD used to form 2.1 m rock socket. Construction time ~ 792 hours | Grade II tuff for rock socket and base | Stage 1 – compression test loaded by kentledge | 2690 | 16.7 | 2820 | 0.4 | 105 | 56 – 63 | 88 – 263 | 202 | P7-1 |
| | | | | | Stage 2 – compression and tension test loaded by Osterberg cell at pile base | 3900 | 4.6 | 26500 | 7.5 | | | | | P7-20 |
| | 32.5 | 1.2 | Bored pile – constructed by grabs with casing under water. RCD used to form 1.9 m rock socket. Construction time ~ 120 hours | Rock socket formed in grade III/IV tuff. Pile base founded on grade II tuff. | Compression test loaded by kentledge | 2300 | 30 | Not mobilised | NA | 129 | 90 | 223 – 1000 | 190 | P8 |
| West Rail, Tsuen Wan West | 23.1 | 1.32 | Bored pile – constructed by grabs with casing under water. RCD used to form 2.0 m rock socket | Rock socket formed in grade III/IV granodiorite. Pile base founded on grade III granodiorite. | Stage 1 – compression test loaded by kentledge | 800 | 80 | 10800* | 63.9 | 35 | 49 | <60 | 15 | P9-1 |
| | | | | | Stage 3 – compression test loaded by Osterberg cell | Strain gauges not working | NA | 16000* | 86 | | | | | P9-30 |

Table A4 – Interpreted Shaft Resistance and End-bearing Resistance in Loading Tests on Instrumented Replacement Piles Embedded in Rock in Hong Kong (Sheet 4 of 5)

| Reference | Pile Length (m) | Pile Dimension (m) | Pile Construction | Stratum | Test Arrangement | Maximum Mobilised Average Shaft Resistance in Rock Socket τ_{max} (kPa) | Pile Head Movement (mm) | Mobilised End-bearing Resistance (kPa) | Measured Pile Base Movement (mm) | Average σ_c of Rock Material along Shaft (MPa) | Average RQD of Rock beneath Pile Base (%) | Average Spacing of Joints below Pile Base (mm) | Average σ_c of Rock below Pile Base (MPa) | Mark in Figures |
|--|--------------------|-----------------------|--|---|---|--|----------------------------|---|-------------------------------------|--|--|---|---|-----------------|
| West Rail, Tin Shui Wai Station | 39.9 | 1.2 | Bored pile – constructed by grabs with casing under water. RCD used to form 1.5 m rock socket. Construction time ~ 600 hours | Rock socket and base constructed at grade II meta-siltstone | Stage 1 – compression test loaded by kentledge with soft toe | 3700 | 24.8 | 2200 | 8.4 | 29 | 50 | <60 | 62 | P10-1 |
| | | | | | Stage 2 – compression and tension test loaded by Osterberg cell | 6000* | 17 | 26530 | 13.6 | | | | | P10-2O |
| | 39.4 | 1.35 | Bored pile – constructed by grabs with casing under water. RCD used to form a nominal 0.7 m rock socket. Construction time ~ 360 hours | Pile base founded on grade II meta-siltstone. | Stage 1 – compression test loaded by kentledge | NA | 19 | 19400 | NA | NA | 88 | 357 | 25.9 | P11-1 |
| | | | | Pile shaft in grade V meta-siltstone | Stage 2 – compression test loaded by Osterberg cell | NA | 17 | 24000 | 2 | | | | | P11-2O |
| West Rail, Yen Chow Street | 49.4 | 1.5 | Bored pile – constructed by grabs with casing under water. RCD used to form 2.0 m rock socket | Pile base founded on grade III granite. | Stage 1 – compression test loaded by kentledge | NA | 21 | 1906 | 9.5 | 35 | 49 | <60 | 15 | P13-1 |
| | | | | Pile shaft in grade V granite. | Stage 2 – compression test loaded by Osterberg cell | NA | 10 | 19675 | 15.5 | | | | | P13-2O |

Table A4 – Interpreted Shaft Resistance and End-bearing Resistance in Loading Tests on Instrumented Replacement Piles Embedded in Rock in Hong Kong (Sheet 5 of 5)

| Reference | Pile Length (m) | Pile Dimension (m) | Pile Construction | Stratum | Test Arrangement | Maximum Mobilised Average Shaft Resistance in Rock Socket τ_{max} (kPa) | Pile Head Movement (mm) | Mobilised End-bearing Resistance (kPa) | Measured Pile Base Movement (mm) | Average σ_c of Rock Material along Shaft (MPa) | Average RQD of Rock beneath Pile Base (%) | Average Spacing of Joints below Pile Base (mm) | Average σ_c of Rock below Pile Base (MPa) | Mark in Figures |
|------------------------------|-----------------|--------------------|--|---|---|--|-------------------------|--|----------------------------------|---|---|--|--|-----------------|
| West Rail, Yuen Long Station | 40.6 | 1.2 | Bored pile – constructed with grabs and RCD for forming a nominal 0.7 m rock socket. Construction time ~ 264 hours | Pile base founded on grade II marble and marble mass class I Pile shaft in karstic deposit comprising clayey silty sand | Compression test loaded by kentledge | NA | 23 | 25000 | 3 | NA | 83 | 167 - 263 | 42 | P14 |
| West Rail, Long Ping Station | 69.89 | 1.2 | Bored pile – constructed with grabs with casing under water. RCD was used to form a nominal 0.6 m rock socket. Construction time ~ 792 hours | Pile base founded on grade II marble and marble mass class III Pile shaft in completely decomposed meta-siltstone and karstic deposit. | Compression test loaded by Osterberg cell with kentledge at ground to resist uplift of pile | NA | 14.5 | 25900 | 12.6 | NA | 84 | 83 – 227 | 29.7 | P150 |
| Lam et al (1991) | 10.4 | 1.0 | Hand-dug caisson with 0.75 m rock socket | Grade II/III granite with a soft toe at pile base | Compression test loaded by kentledge | 670* | 1.6 | NA | NA | 7 | 70 | NA | NA | C1 |
| Shiu & Chung (1994) | 33.4 | 0.19 | Mini-piles with 4.3 m rock socket | Grade II/III granite | NA | 1750 | 19 | NA | NA | 45 | NA | NA | NA | P16 |

Notes : (1) * denotes substantially mobilised shaft resistance and end-bearing resistance
(2) NA denotes information not available

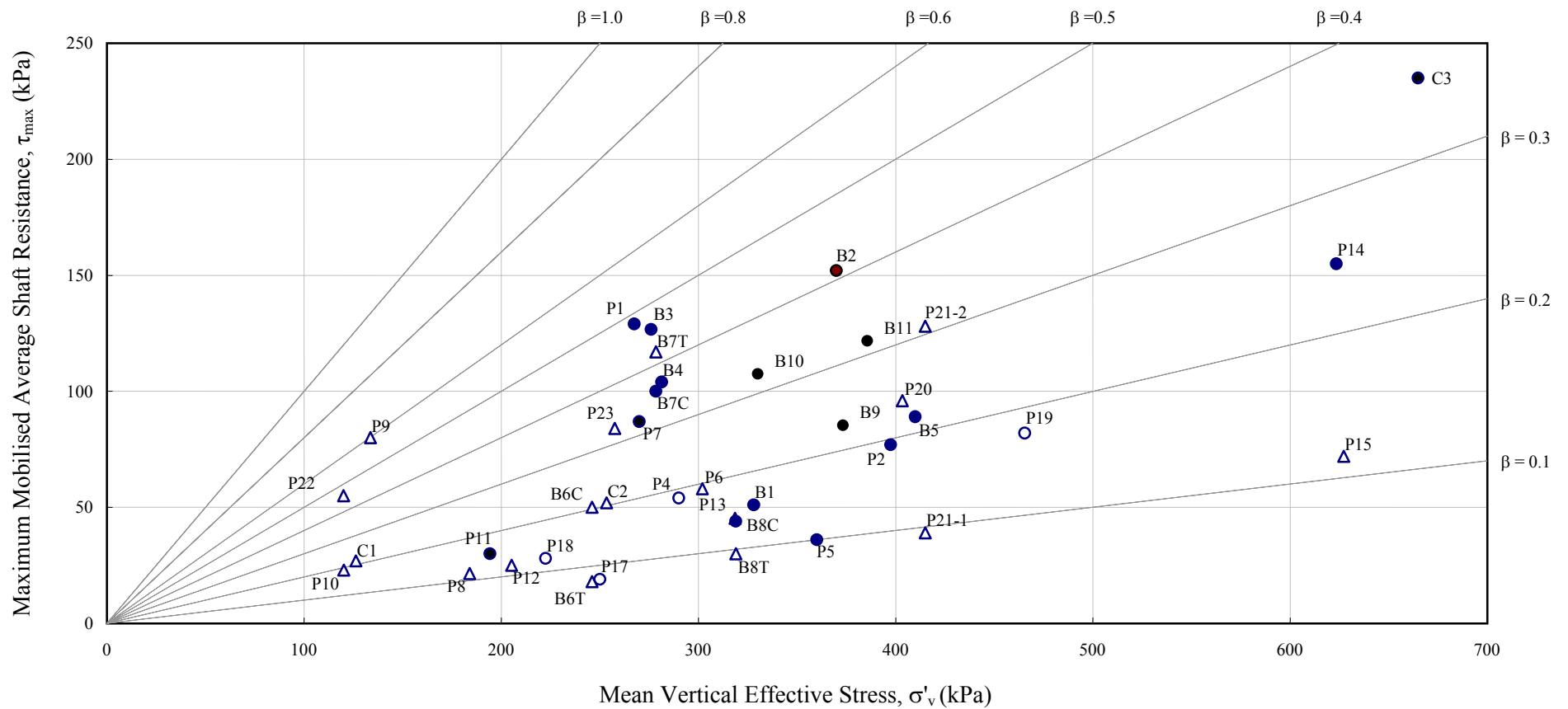

Legend :

- Substantially mobilised
- Affected by construction problems
- △ Degree of mobilisation unknown

Notes :

- (1) Possible problem with bentonite in filter cake, P17, P18 & P19.
- (2) Erratic strain gauge data in P2.
- (3) For details of tested materials and pile construction, see Table A1.
- (4) Pile mark designation: prefix – B for barrettes, P for bored piles and C for hand-dug caissons.
 suffix – C for compression test, T for tension test and 1 or 2 for stages of pile loading test.

Figure A1 – Relationship between Maximum Mobilised Average Shaft Resistance and Mean Vertical Effective Stress for Replacement Piles Installed in Saprolites

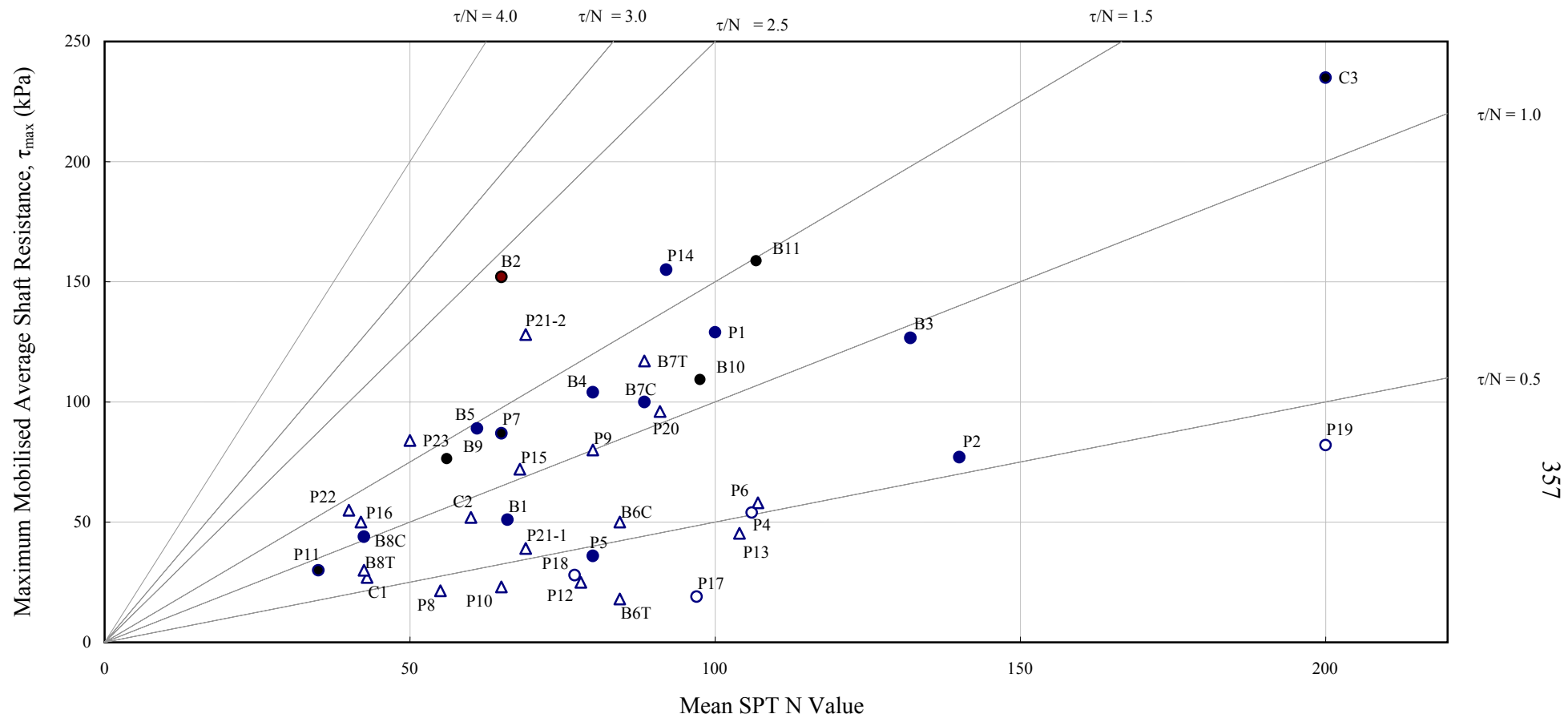

Legend :

- Substantially mobilised
- Affected by construction problems
- △ Degree of mobilisation unknown

Notes :

- (1) Possible problem with bentonite in filter cake, P17, P18 & P19.
- (2) Erratic strain gauge data in P2.
- (3) For details of tested materials and pile construction, see Table A1.
- (4) Pile mark designation: prefix – B for barrettes, P for bored piles and C for hand-dug caissons.
suffix – C for compression test, T for tension test and 1 or 2 for stages of pile loading test.

Figure A2 – Relationship between Maximum Mobilised Average Shaft Resistance and Mean SPT N Values for Replacement Piles Installed in Saprolites

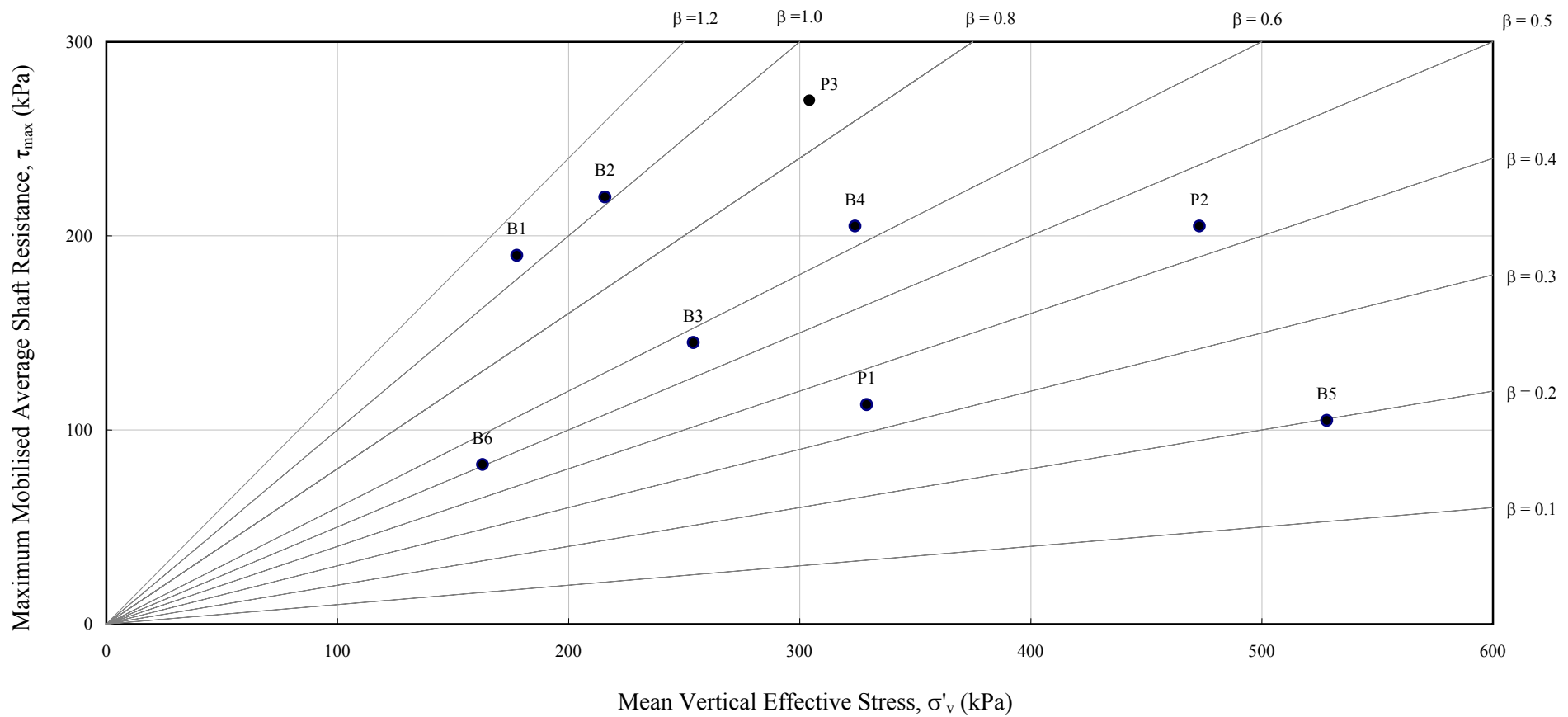

Legend :

- Substantially mobilised

Notes :

- (1) For details of tested materials and pile construction, see Table A2.
- (2) Pile mark designation: prefix – B for barrettes, P for bored piles.

Figure A3 – Relationship between Maximum Mobilised Average Shaft Resistance and Mean Vertical Effective Stress for Replacement Piles with Shaft-grouting Installed in Saprolites

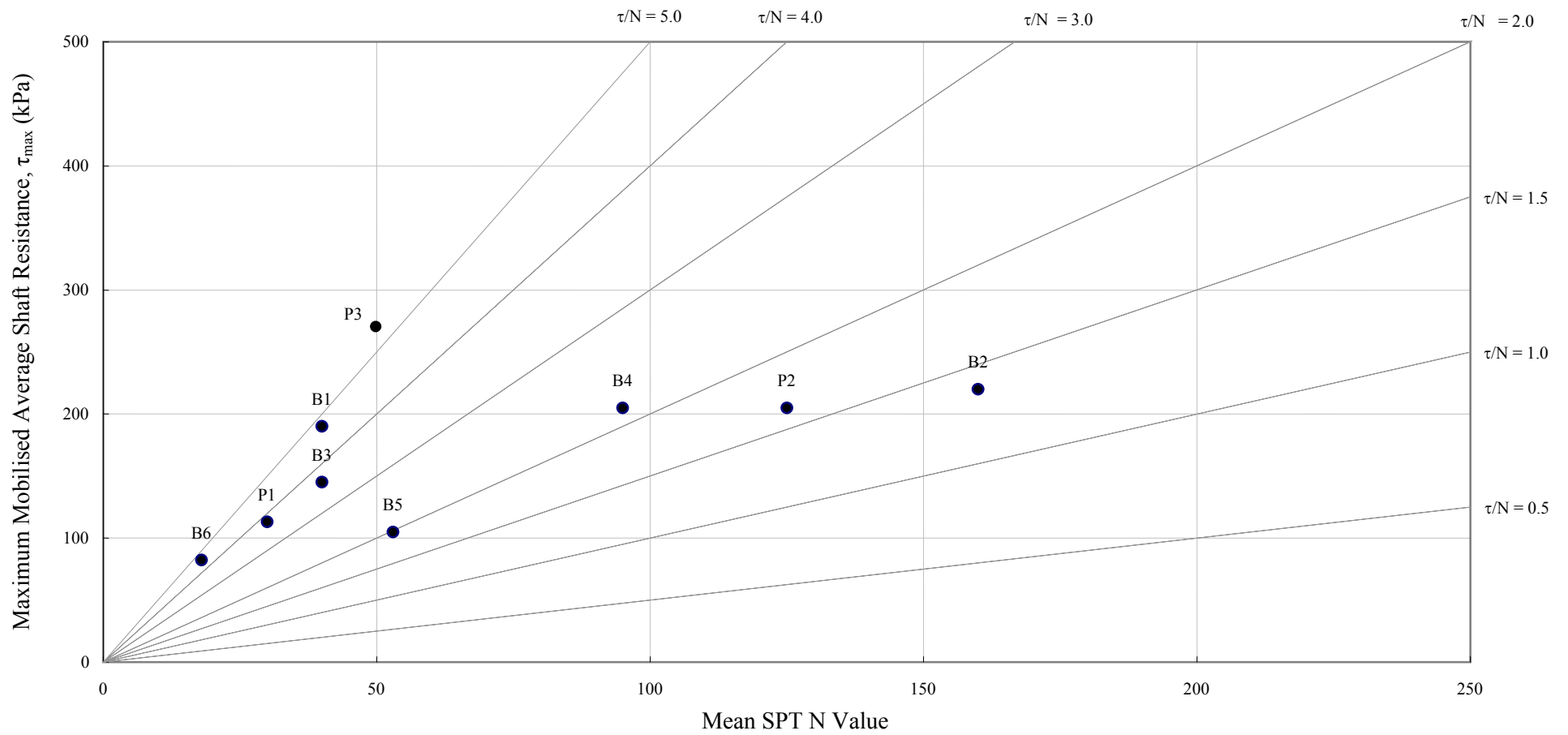

359

Legend :

● Substantially mobilised

Notes :

- (1) For details of tested materials and pile construction, see Table A2.
- (2) Pile mark designation: prefix – B for barrettes, P for bored piles.

Figure A4 – Relationship between Maximum Mobilised Average Shaft Resistance and Mean SPT N Values for Replacement Piles with Shaft-grouting Installed in Saprolites

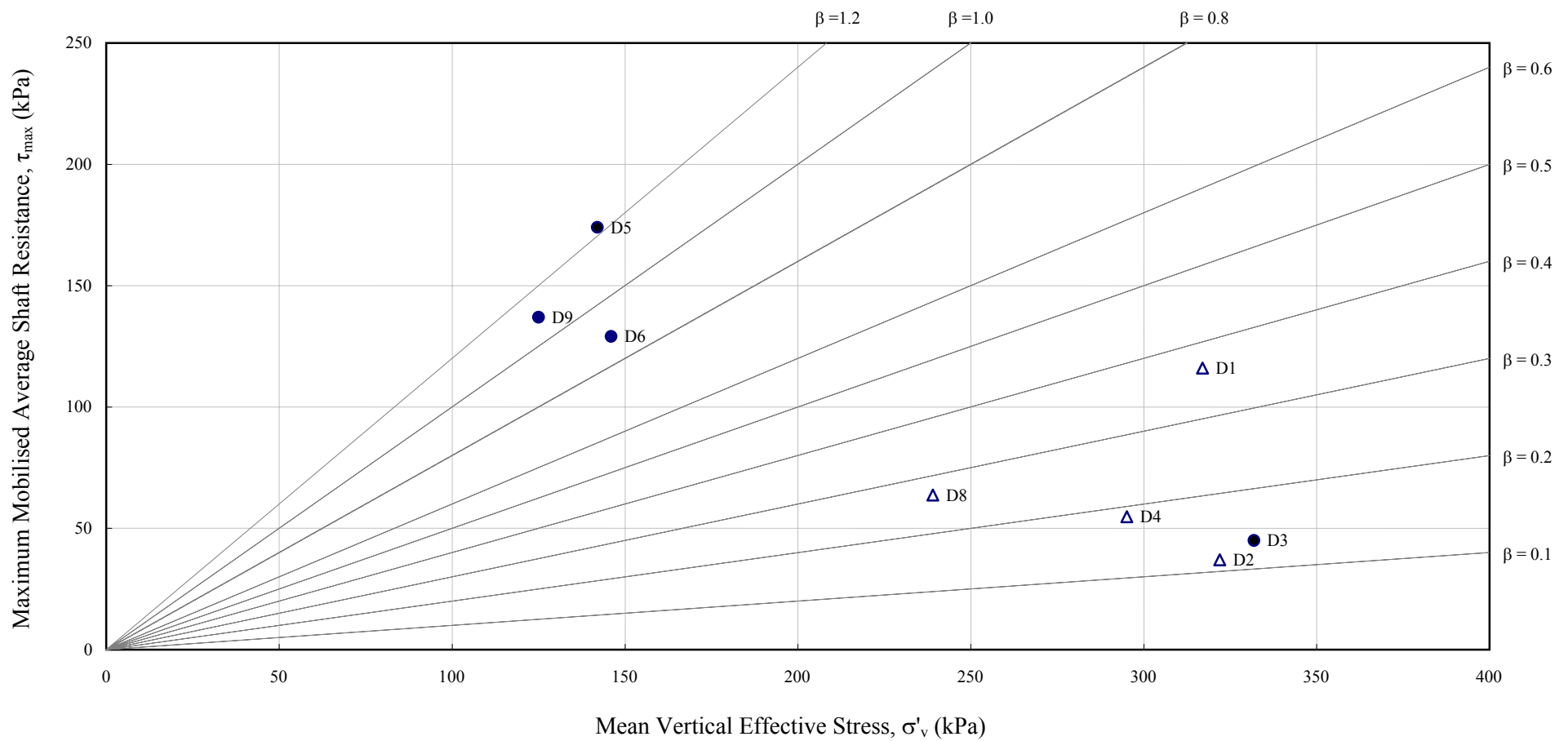

Legend :

- Substantially mobilised
- △ Degree of mobilisation unknown

Notes:

- (1) For details of tested materials and pile construction, see Table A3.
- (2) All piles in decomposed granite except D3, D4 & D8, which are installed in decomposed meta-siltstones.
- (3) Piles D3 & D4 were driven steel H piles installed to specified depths instead of driven to set.

Figure A5 – Relationship between Maximum Mobilised Average Shaft Resistance and Mean Vertical Effective Stress for Displacement Piles Installed in Saprolites

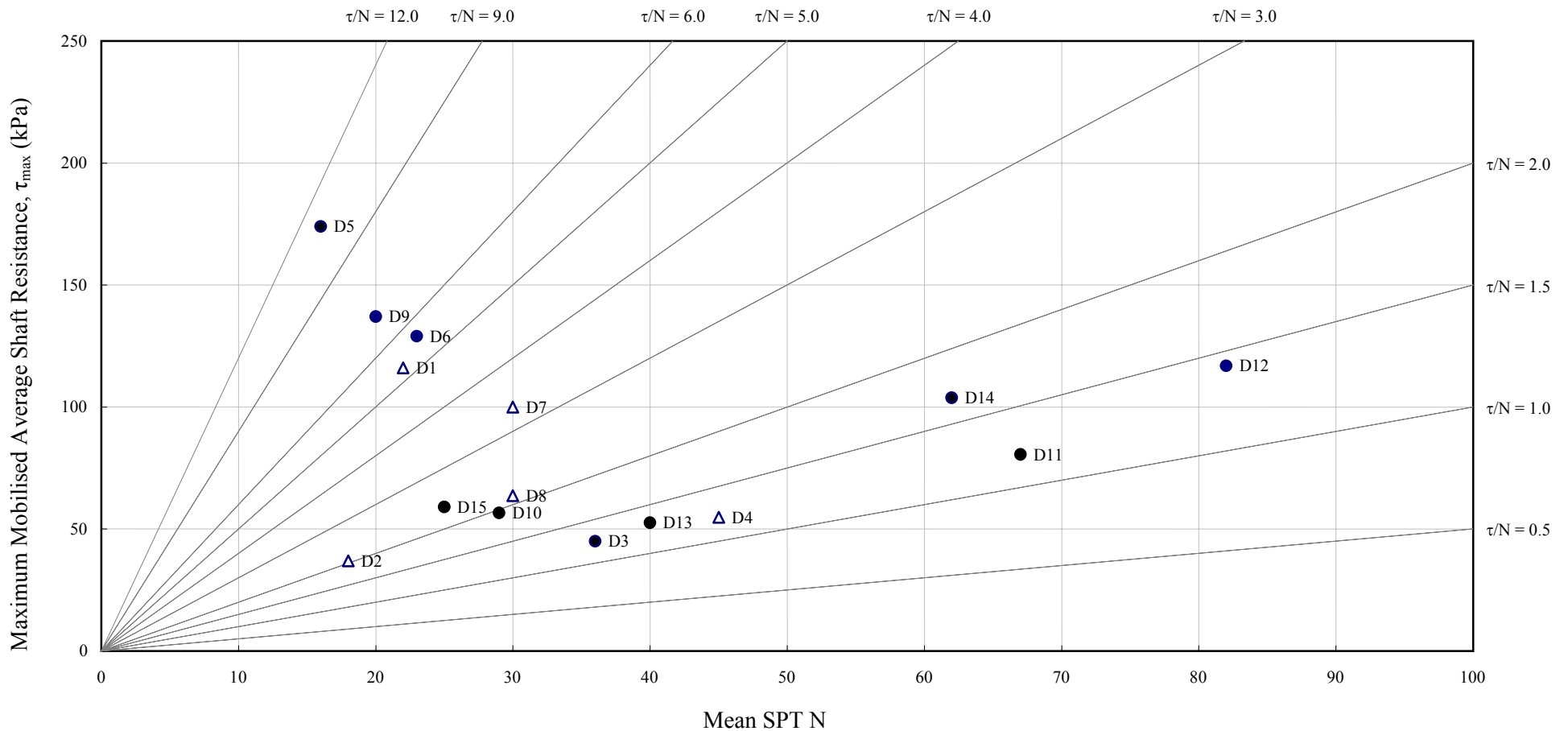

Legend :

- Substantially mobilised
- △ Degree of mobilisation unknown

Notes :

- (1) For details of tested materials and pile construction, see Table A3.
- (2) All piles in decomposed granite except D3, D4 & D8, which are installed in decomposed meta-siltstones.
- (3) Piles D3 & D4 were driven steel H piles installed to specified depths instead of driven to set.
- (4) Piles D10 – D15 were driven steel H piles in decomposed granites.

Figure A6 – Relationship between Maximum Mobilised Average Shaft Resistance and Mean SPT N Values for Displacement Piles Installed in Saprolites

GLOSSARY OF SYMBOLS

GLOSSARY OF SYMBOLS

| | |
|------------|---|
| A_b | cross-sectional area of pile base |
| A_c | concrete cross-sectional area of pile |
| A_{cap} | area of pile cap |
| A_n | cross-sectional area of pile element n |
| A_p | cross-sectional area of pile |
| A_s | area of steel reinforcement in concrete pile |
| a | exponent for stiffness efficiency factor |
| a_d | aperature of discontinuities |
| B_e | equivalent width of bell |
| B_f | width of shallow foundation |
| B_f' | effective width of shallow foundation |
| b | width of test plate in plate loading tests |
| C_c | compression index of soil |
| C_α | secondary compression index of soil |
| $C(m,t)$ | compression of internal spring m at time t |
| C_d, C_s | correction factors for depth and shape |
| c | cohesion of soil |
| c' | cohesion of soil or rock joint in terms of effective stress |
| c_c | temporary compression of pile cuhsion |
| c_d | spacing of discontinuities |
| c_p | temporary compression of pile during pile driving |
| c_q | temporary compression of ground at pile toe during pile driving |
| c_u | undrained shear strength of soil |
| c_w | velocity of longitudinal stress wave through pile |
| D | pile width or width of pile foundation in the direction of rotation |
| D_b | foundation base width or base diameter |
| D_c | damping factor |
| D_f | depth from ground surface to the base of shallow foundation |
| D_r | relative density of sand |
| D_s | diameter of shaft in soil or rock socket |
| $D(m,t)$ | displacement of pile element m at time t |
| $D'(m,t)$ | plastic displacement of external spring m at time t |
| d | depth factor |
| d_b | depth below base of foundation |
| d_c | thickness of clay layer |
| d_h | height of hammer fall |
| d_i | thickness of soil layer i |
| d_r | foundation depth below rock surface |

| | |
|------------|--|
| E | pile driving energy |
| E_{av} | weighted mean value of Young's modulus of founding material along length of pile |
| E_c | Young's modulus of concrete |
| E_h' | drained horizontal Young's modulus of soil |
| E_i | modulus of soil layer i |
| E_m | modulus of rock mass |
| EMX | average energy transferred in pile driving measured by pile driver analyzer |
| E_{pn} | Young's modulus of pile at element n |
| E_p | Young's modulus of pile |
| E_{pe} | equivalent Young's modulus of pile |
| E_r | Young's modulus of rock |
| E_s | Young's modulus of soil |
| E_v' | drained vertical Young's modulus of soil |
| e | coefficient of restitution |
| e_1 | eccentricity of horizontal load measured from ground level |
| e_2 | eccentricity of vertical load from centre of pile or pile group |
| e_e | effective eccentricity of load or equivalent free length of fixed-head piles above point of virtual fixity |
| e_B | eccentricity of load along B direction |
| e_L | eccentricity of load along L direction |
| e_o | initial void ratio |
| F_M | moment coefficient |
| F_p | force at a given pile section |
| F_{pu} | unit applied force in pile section |
| F_s | (global) factor of safety |
| F_v | shear coefficient |
| $F(m,t)$ | force in internal spring m at time t |
| F_δ | deflection coefficient |
| f | coefficient for calculating foundation settlement |
| f_b | mobilisation factor for base resistance |
| f_{cu} | specified grade strength of concrete |
| f_m, y_m | multipliers to convert load and deflection of a single pile to a pile group |
| f_n | ultimate negative skin friction |
| f_s | mobilisation factor for skin friction |
| f_y | yield stress of steel |
| f^* | depth of maximum bending moment on laterally loaded pile |
| G | shear modulus of soil |
| G_b | shear modulus of soil at pile base |
| G_c | characteristic shear modulus of soil |
| G_L | shear modulus of soil at depth of pile length |
| $G'(m)$ | quake for external spring m (or maximum elastic soil deformation) |

| | |
|------------------|---|
| G^* | equivalent shear modulus = $G(1 + 0.75v_s)$ |
| $G^*_{0.25L_c}$ | equivalent shear modulus at depth equal to a quarter of critical pile length, L_c |
| g | gravitational acceleration |
| H | horizontal load |
| H_g, H_p | lateral load of a group pile and a single pile |
| H_o | thickness of soils subject to secondary consolidation |
| H_u | ultimate value of lateral load |
| H_x | total applied horizontal load in x-direction |
| H_{xi} | horizontal load on pile i |
| I | influence factor for computing pile cap stiffness |
| I_p | moment of inertia of pile |
| I_s | shape factor of shallow foundation |
| I_{ps} | influence factors for pile settlement computation |
| I_x, I_y | moment of inertia of pile group with respect to x and y axes respectively |
| I_{xy} | product of inertia of pile group about its centroid |
| I_{yi} | moment of inertia of i^{th} pile about its y-axis (orthogonal to the direction of applied force) |
| $J(m)$ | soil-damping constant at element m |
| j_c | damping coefficient in CASE analysis |
| j_s | Smith damping coefficient |
| K | pile stiffness factor |
| K_c | stiffness of pile cap |
| K_d | dynamic stiffness of pile head |
| K_f | overall foundation stiffness |
| K_g | stiffness of pile group |
| K_h | modulus of horizontal subgrade reaction of pile |
| K_L | pile stiffness under lateral loads |
| K_o | coefficient of earth pressure at rest |
| K_p | coefficient of passive pressure |
| K_{qz}, K_{cz} | passive pressure coefficients for short piles subject to lateral loading |
| K_r | stiffness factor of rock socket under lateral loading |
| K_s | coefficient of earth pressure |
| K_{sp} | bearing pressure coefficient |
| K_v | pile stiffness under vertical loads |
| $K(m)$ | spring constant for internal spring m |
| $K'(m)$ | spring constant for external spring m |
| k | proportionality constant for the estimation of peak particle velocity due to pile driving |
| k_h | coefficient of horizontal subgrade reaction |
| k_s | coefficient of permeability of soil |

| | |
|----------------------|---|
| L | embedded length of pile |
| L_{ac} | active pile length |
| L_c | critical pile length |
| L_f | length of foundation |
| L_f' | effective length of shallow foundation |
| L_{pi} | length of element i |
| L_{res} | resonating length |
| L_s | length of rock socket |
| L_1 | top elevation of rock core in marble for computing MQD |
| L_2 | bottom elevation of rock core in marble for computing MQD |
| l_1, l_2, l_3, l_i | length of marble cores for computing MQD |
| M | applied bending moment on pile |
| M_f | moment in fixed-head piles induced by lateral force |
| M_{max} | maximum bending moment |
| M_o | characteristic mobility |
| M_u | ultimate moment of resistance of pile |
| M_x, M_y | moment about centroid of pile group with respect to the x and y axes respectively |
| M_x^*, M_y^* | effective moment with respect to x and y axes respectively, taking into account the symmetry of the pile layout |
| m | pile element number |
| m_i | coefficient for inclination factors |
| N | uncorrected SPT blowcount |
| \bar{N} | mean SPT N value |
| N_b | number of blows of hammer per minute |
| N_c, N_q, N_γ | bearing capacity factors |
| N_f | SPT blowcount after pile driving |
| N_p | GCO probe blowcount |
| N_u | breakout factor |
| N_ϕ | $\tan^2 (45^\circ + \phi' / 2)$ |
| n | number of observations, elements or entities |
| n_h | constant of horizontal subgrade reaction |
| n_p | number of piles in pile groups |
| P | applied vertical load |
| P_{ai} | axial load on an individual pile i |
| P_b | applied load at pile base |
| P_c | load carried by pile cap |
| P_{cr} | critical buckling load of pile |
| P_g | load carried by pile group |
| P_h | soil reaction per unit length of pile |
| P_i | axial load on an individual pile segment i |

| | |
|--------------|---|
| P_L | concentrated horizontal force at pile tip due to passive soil resistance |
| PLI_{50} | point load index strength of rock specimen of 50 mm diameter |
| P_m | mobility at resonance (peak) |
| P_n | load due to ultimate negative skin friction |
| P_s | load along pile shaft |
| P_t | load applied at pile head |
| p_z | unit passive resistance per unit width of pile at depth z |
| p | soil pressure |
| p_b | depth of the outer dimension of pile section |
| p_n | perimeter length of pile element n |
| ppv | peak particle velocity |
| p_w | width of the outer dimension of pile section |
| Q_m | mobility at anti-resonance (trough) |
| Q_{max} | maximum test load |
| Q_o | ultimate concentric vertical load |
| Q_s | ultimate skin friction capacity under tension |
| Q_u | ultimate load on shallow foundation |
| Q_{ult} | ultimate load capacity or ultimate resistance below the neutral point when considering negative skin friction |
| Q_v | vertical component of the ultimate eccentric and inclined load |
| Q_{wt} | working load under tension loading |
| q | bearing pressure on rock masses or soils |
| q_a | allowable bearing pressure |
| q_b | ultimate end-bearing resistance |
| q_{net} | mean net ground bearing pressure |
| q_u | ultimate bearing capacity of shallow foundation |
| q_{u-core} | average unconfined compressive strength of rock core |
| R | characteristic length or stiffness factor of pile in clay |
| R_A | ratio of pile cross-sectional area to area bounded by outer circumference of pile |
| R_d | dynamic component of pile penetration resistance or driving resistance |
| $R_d(m)$ | dynamic resistance of pile element m |
| R_g | stiffness efficiency factor which is an inverse of the group settlement ratio |
| R_{gs} | group settlement ratio of pile |
| R_h | group lateral deflection ratio |
| R_n | reduction factor for n_h |
| R_p | driving resistance at pile toe |
| R_s | static component of pile penetration resistance |
| $R_{su}(m)$ | ultimate static resistance of external soil spring m |
| $R(m,t)$ | force exerted by external spring m on element m at time t |
| r_b | radius of pile base |

| | |
|------------|---|
| r_c | equivalent radius of pile cap for each pile |
| r_e | reduction factor for load eccentricity |
| r_f | reduction factor for ultimate bearing capacity of vertical piles under eccentric and inclined loads |
| r_i | reduction factor for inclination of load |
| r_m | radius of influence of pile under axial loading |
| r_o | pile radius or radius of an equivalent circular pile |
| s | permanent set of pile |
| s_c | secondary compression |
| s_i | allowable settlement of shallow foundation |
| s_p | centre-to-centre spacing of pile |
| T | characteristic length or stiffness factor of pile in granular soils |
| T_0 | average first arrival time of sonic pulse |
| T_1 | maximum measured first arrival time of sonic pulse |
| t | time |
| t_p | time when primary consolidations completed |
| t_s | time for which secondary consolidation is allowed |
| v | particle velocity |
| v_b | velocity of pile tip |
| v_c | wave velocity in concrete |
| v_o | first peak in velocity after falling mass contacts pile top |
| v_p | velocity of pile at each segment |
| v_t | pile head velocity |
| v_1 | second peak in velocity upon arrival of reflected wave at pile top |
| $v(m,t)$ | velocity of pile element m at time t |
| W | weight of ram |
| W' | effective self weight of the soil above the founding level |
| W_h | weight of hammer |
| W_L | design working load of pile |
| W_p | weight of pile |
| W_r | weight of pile helmet |
| W_p' | effective self weight of pile |
| $W(m)$ | weight of element m |
| x | distance between point of rotation and ground surface |
| x_b | distance of shallow foundation from slope crest |
| x_i, y_i | distance of pile i from y and x axes respectively |
| Z | pile impedance |
| Z_1, Z_2 | pile impedance below and above a given level where there is a significant change in impedance |
| z | depth below ground surface |
| z_f | vertical distance between point of virtual fixity and ground surface |

| | |
|----------------------------|---|
| Δh | horizontal distance from pile axis |
| Δt | time interval |
| Δf | frequency interval |
| Φ | interaction factor for settlement analysis of pile groups |
| α | adhesion factor |
| α_{cp} | average pile interaction factor between pile and piled raft |
| α_f | inclination of the base of shallow foundation |
| α_h | efficiency of pile hammer |
| α_L | angle of inclination of applied load |
| α_s | angle of departure that the pile makes with the direction of loading |
| α' | interaction factor for deflection of pile |
| β | shaft friction coefficient |
| β_{max} | maximum shaft friction coefficient determined in pile loading tests |
| β_z | damage classification factor = ratio of impedance of the pile section above and below a given level |
| β' | angle of inclination of pile |
| δ | relative pile/soil settlement or pile settlement |
| δ_b | pile base movement |
| δ_{bi} | base settlement due to interaction from the i-th pile |
| δ_{elas} | elastic deformation of pile element |
| δ_f | settlement of shallow foundation |
| δ_h | lateral deflection of pile |
| δ_{hg}, δ_{hp} | lateral deflection of a pile group and a single pile |
| δ_i | movement at the middle of pile element i |
| δ_H, M_H, V_H | lateral pile movement, moment and shear force in pile due to applied horizontal load |
| δ_M, M_M, V_M | lateral pile movement, moment and shear force in pile due to applied moment |
| δ_{max} | maximum pile head settlement |
| δ_p | settlement of test plates |
| δ_Q | pile head settlement at failure or maximum test load |
| δ_{res} | residual (or permanent) pile head settlement upon unloading from maximum test load |
| δ_s | angle of interface friction at pile/soil interface |
| δ_t | pile head settlement |
| δ_l | settlement due to shaft resistance along pile shaft |
| δ_{li} | shaft settlement due to interaction from the i-th pile |
| $\delta_{90\%Q}$ | pile head settlement at 90% of failure or maximum test load |
| ϕ' | angle of shearing resistance of founding material |
| ϕ_{cv}' | critical state friction angle of soil |
| ϕ_r' | residual angle of shearing resistance of soil |

| | |
|--|--|
| ϕ_1' | angle of shearing resistance of soil prior to pile installation |
| γ | bulk unit weight of soil |
| γ_r' | effective unit weight of rock mass |
| γ_s' | effective unit weight of soil |
| γ_w | unit weight of water |
| η | group reduction or efficiency factor |
| η_h | efficiency of hammer (allowing for energy loss on impact) |
| η_r | ratio of underream for underream piles |
| i | upward hydraulic gradient |
| ϕ | angle of shearing resistance between base of shallow foundation and soil |
| λ | pile stiffness ratio |
| ν_p | Poisson's ratio of pile |
| ν_r | Poisson's ratio of rock |
| ν_s | Poisson's ratio of soil |
| θ | pile rotation at ground surface, or butt slope |
| θ_c | constant butt slope |
| θ_s | slope angle |
| ρ | Rate of variation of shear modulus of soil with depth |
| ρ_c | density of concrete |
| ρ_c' | degree of soil homogeneity over critical length L_c |
| $\mu\epsilon$ | microstrain |
| ζ | measure of radius of influence of pile |
| $\zeta_{cs}, \zeta_{\gamma s}, \zeta_{qs}$ | influence factors for shape of shallow foundation |
| $\zeta_{ci}, \zeta_{\gamma i}, \zeta_{qi}$ | influence factors for inclination of load |
| $\zeta_{cg}, \zeta_{\gamma g}, \zeta_{qg}$ | influence factors for ground surface |
| $\zeta_{ct}, \zeta_{\gamma t}, \zeta_{qt}$ | influence factors for tilting of foundation base |
| σ_{base} | applied stress at pile base |
| σ_c | uniaxial compressive strength of rock |
| σ_{pile} | applied stress at pile head |
| σ_v' | vertical effective stress |
| τ_i | shear stress on pile element i |
| τ_{max} | maximum mobilised average shaft resistance |
| τ_{ult} | ultimate shaft resistance in rock socket |
| τ_o | average shaft resistance along pile shaft |
| τ_s | ultimate shaft resistance (or skin friction) |
| τ | mobilised shaft resistance in rock socket |
| ω | slope inclination in front of shallow foundation |
| ξ | Ratio of G_L/G_b |
| ψ | angle of dilation of soil |
| f | signal or excitation frequency |

GLOSSARY OF TERMS

GLOSSARY OF TERMS

- Barrettes. A variant of the traditional bored pile with rectangular cross-section. The rectangular holes are excavated with the use of grabs.
- End-bearing resistance. Load-carrying capacity of pile due to bearing capacity of the soil below pile tip.
- Best-estimate parameter. Value of parameter which is representative of the properties of material in the field.
- Composite piles. Special piles of various combinations of materials in driven piles or combinations of bored piles with driven piles.
- Continuous-flight auger (cfa) piles. A proprietary piling system in which the bore is formed using a flight auger and concrete or grout is pumped in through the hollow stem.
- Downdrag. The downward movement of a pile due to negative skin friction and is expressed in terms of settlement.
- Dragload. The load transferred to a pile due to negative skin friction.
- Driven cast-in-place piles. Piles formed by driving a steel tube into the ground to the required set or depth and withdrawing the tube after concrete placement.
- Hand-dug caisson. A bored pile in which the bore is formed manually by using hand tools in stages.
- Large-diameter bored piles. Bored piles of diameter greater than about 750 mm, e.g. machine bored piles.
- Large-displacement piles. All solid driven piles, including precast concrete piles, and steel or concrete tubes closed at the lower end by a driving shoe or a plug.
- Mini-piles. Small diameter piles which are formed by small drilling rigs with the use of down-the-hole hammers, rotary or rotary percussive drills and are subsequently grouted.
- Mobilisation factors. Factors applied to shaft resistance and end-bearing resistance to estimate the allowable capacity of pile, taking into account different amounts of movement to mobilise shaft resistance and end-bearing resistance.

Negative skin friction. Soil traction act downward along the pile shaft as a result of a downdrag and induce compression in pile.

Neutral plane. The depth where there is no relative movement between the pile and the surrounding soil.

Precast concrete piles. Reinforced concrete piles, with or without prestress, cast and then driven into ground.

Replacement pile. Pile formed by machine boring, grabbing or hand digging.

Saprolites. Soil derived from insitu rock weathering, which retains evidence of the original rock texture, fabric and structure.

Shaft resistance. Load-carrying capacity of pile due to soil resistance developed at pile/soil interface in response to applied load.

Small-diameter bored piles. Bored piles of small diameter less than about 750 mm.

Small-displacement piles. Driven rolled steel sections such as H-piles and open-ended tubular piles.

Special piles. Particular pile types or variants of existing pile types introduced to improve efficiency or overcome problems related to special ground conditions.

Steel H-piles. Piles of rolled steel section of H-shape in cross-section.

Steel tubular piles. Preformed hollow steel piles of circular section.