

Methods in Molecular Biology™

VOLUME 137

# Developmental Biology Protocols

*Volume III*

*Edited by*

Rocky S. Tuan

Cecilia W. Lo



HUMANA PRESS

## Developmental Biology Protocols

### *Overview III*

**Rocky S. Tuan and Cecilia W. Lo**

#### **1. Introduction**

The marriage of cell and molecular biology with embryology has produced remarkable advances for the field of developmental biology. In this third volume of *Developmental Biology Protocols*, contemporary, practical methods are first presented for the analysis and manipulation of developmental gene expression. To illustrate how such techniques, as well as procedures of experimental embryology including those described in the first two volumes of the series, may be applied in the study of development, a panoramic collection of experimental models of morphogenesis, development, and cellular differentiation are detailed. Both *in vivo* and *in vitro* systems are included. The volume concludes with various examples of developmental models of diseases and their molecular basis.

#### **2. Manipulation of Developmental Gene Expression and Function**

*Drosophila* has been and remains one of the most versatile model systems for the manipulation of developmental gene expression. Chapter 2 focuses on a description of the experimental approaches currently used in ectopic gene expression in *Drosophila* to examine the function of a given gene in the desired tissue. Chapter 3 deals with the utilization of the highly efficient FLP/FRT yeast site-specific recombination system to generate somatic and germline clones in *Drosophila* for phenotypic analysis and screening.

Chapters 3 and 4 address the methods used to alter gene expression as well as gene function in another experimentally highly accessible system, the developing chick embryo. Chapter 3 describes the application of antisense oligonucleotides to “knock down” gene expression in somitic stage chick embryos, whereas Chapter 4 discusses how functional neutralizing monoclonal antibodies may be used to block the activity of a specific gene product, N-cadherin, in the developing chick embryonic limb bud.

#### **3. Analysis of Gene Expression**

The first step in analyzing the molecular basis of any developmental event is to characterize and compare gene expression profiles, both spatial and temporal, as a function

of development. A comprehensive list is provided in this section. Classic methods such as Northern blotting is not presented here, because relevant protocols are readily available in many technical manuals of molecular biology. Quantitative methods include ribonuclease protection assay (Chapter 6), and polymerase chain reaction (PCR) based methods (Chapters 7 and 8). *In situ* hybridization (Chapters 9–15) has gained wide application in visualizing the spatial aspects of gene expression in the developing embryo, particularly in mapping the dynamics of tissue morphogenesis. In particular, the ability to carry out multiple *in situ* hybridizations (Chapter 14), or sequential *in situ* hybridization and immunohistochemistry (Chapters 12 and 15), on a given specimen should be invaluable for analyzing the potential roles of genes and gene products in development.

The potential of the green fluorescent protein (GFP) of the jellyfish, *Aequoria victoria*, as a vital recombinant tag for genes of interest has produced a great deal of excitement in developmental biology; Chapter 16 provides a thorough discussion of the principles and techniques in the application of the GFP. Finally, the basic strategy in the application of monoclonal antibodies, one of the most powerful technical advances in modern biomedical research that has enjoyed a distinguished history, in the study of embryonic development is presented (Chapter 17).

#### **4. Models of Morphogenesis and Development**

This section presents a number of developmental model systems under active investigation to illustrate the multitude of experimental questions currently being addressed in the field of developmental biology. The inductive events of embryogenesis and means for their analyses are described in Chapters 18 and 19. Techniques for whole or partial embryo explant cultures for the somitic stage embryos for the analysis of mesodermal and neural crest studies are covered in Chapters 20 and 21. Other models of morphogenesis include those for angiogenesis (Chapter 22), vasculogenesis (Chapter 23), and epithelial–mesenchyme interactions (Chapter 24). Specific organogenesis models are also included—limb bud (Chapter 25) and palate (Chapter 26).

#### **5. In Vitro Models and Analysis of Differentiation and Development**

Regulation of cell differentiation is one of most active research areas of developmental biology. With the advent of cell and molecular biology, and the identification of differentiation-associated genes, cell differentiation is often interpreted in terms of regulation of gene expression. Both *cis* and *trans* modes of gene expression regulation have been found to operate during cell differentiation, leading to active investigation on structure/function of gene promoters and transcription factors.

This section is a collection of many *in vitro* cell differentiation systems currently under active investigation. Early events in development include fertilization (Chapter 27) and trophoblastic differentiation (Chapter 28). Bone marrow-derived mesenchymal progenitor cells have received a great deal of recent attention as candidate cells for cell-based tissue engineering. It is generally believed that the differentiation potentials of these cells represent a partial recapitulation of the characteristics of embryonic mesodermal cells. Techniques for their isolation, culture, and characterization are described in Chapter 29. Another cell type important for studying cell differentiation are germ cells; methods for their isolation and culture are included in Chapter 30. Prostate cell

differentiation is discussed in Chapter 30. Cell differentiation in connective tissues is presented in the following chapters: striated muscle differentiation (Chapter 31), somitic myogenesis (Chapter 32), mesenchymal chondrogenesis (Chapters 33–35), and bone cell differentiation (Chapter 36).

In addition to specific examples and systems of cellular differentiation, methods for three crucial aspects of cellular activities are also presented. Cell–cell interaction is illustrated in Chapter 39, which deals with cadherin-mediated events. Cell–matrix interactions as mediated by hyaluronan binding are discussed in Chapter 40. The dynamic regulation of cytoskeletal architecture, visualized and analyzed by the microinjection of fluorescently-labeled  $\alpha$ -actinin into living cells, is presented in Chapter 41.

## 6. Developmental Models of Diseases

The experimental paradigms gained from developmental biology lend readily to the mechanistic analysis of diseases. Several examples are included here. *Pax 3*, a member of the vertebrate *Pax* gene family containing a DNA-binding domain known as the paired domain, is important for proper formation of the nervous, cardiovascular, and muscular systems. The molecular analysis of *Pax 3* mutations and how the pathways affected lead to the pathogenesis of specific dysmorphogenic consequences is the subject of Chapter 42. Finally, one of the most powerful contributions of molecular developmental biology to the study of diseases is the application of transgenic methodologies to create animal models of human diseases. The three examples included here all deal with various aspects of skeletal defects, including both trunk as well as craniofacial malformations. The methods involve studies utilizing a structural gene (collagen type X, Chapter 43), cell specific promoter ( $\alpha 1(\text{II})$  procollagen gene, Chapter 44), as well as transcription factors (*Msx2*, Chapter 44).

## Ectopic Expression in *Drosophila*

Elizabeth L. Wilder

### 1. Introduction

Ectopic expression in *Drosophila* has been used extensively to examine the capabilities of a given gene in virtually any tissue. Three general approaches are described here, and the choice of which to use is determined by the needs of the particular experiment. Certain aspects of each approach can also be combined, providing powerful tools for the examination of gene function. Because ectopic expression does not involve a protocol, but rather generation of certain types of transgenic strains, this chapter focuses on a description of the approaches and in what circumstances each is likely to be useful.

### 2. Materials

For each of the methods of ectopic expression described here, the production of transgenic strains is required. The vectors that are widely used in these experiments are available (1–3).

### 3. Methods

#### 3.1. Expression Through Defined Promoters

The simplest means of ectopic expression is through the construction of a promoter-cDNA fusion in which a gene of interest is driven by a defined promoter or enhancer. Transgenic strains carrying this construct then ectopically express the gene of interest in the defined pattern.

One of the most commonly used promoters for this purpose is the heat shock protein 70 (hsp70) promoter (1). This promoter allows ubiquitous expression to be induced in any tissue of the fly through a simple heat shock at 37°C. The inducible nature of this approach is a great advantage. However, basal levels of expression can be problematic, and heat shock itself can induce developmental defects. In addition, short bursts of ectopic expression ubiquitously is often not ideal. Therefore, sustained expression in defined domains may be preferred.

To achieve ectopic expression within a defined domain, transcriptional regulatory regions from characterized genes have been linked to genes of interest (4,5). The advantage of this approach is its simplicity. Its primary limitation is that lethality can result from the ectopic expression. This makes it impossible to establish stable transgenic

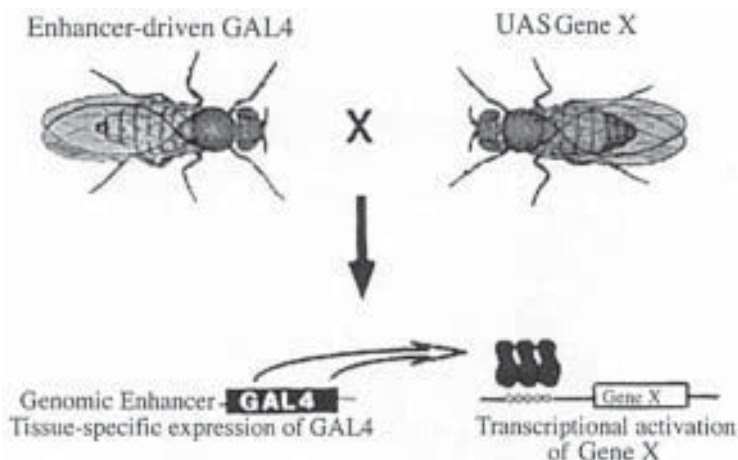

Fig. 1. The GAL4 system of ectopic expression (modified from **ref. 2**). This system allows the ectopic expression of any gene of interest (Gene X) in a pattern determined by the expression of the transcriptional activator, GAL4. Hundreds of lines in which GAL4 is expressed in a variety of patterns have been generated through enhancer trapping or by linking the GAL4 coding sequence to defined regulatory elements. These are crossed to flies carrying the gene of interest under the transcriptional control of the GAL4 Upstream Activating Sequence (UAS). The progeny of this cross express the gene of interest in the pattern of choice.

lines. Enhancers that drive expression during late stages of development or in tissues that are nonessential have been particularly useful, because lethality owing to ectopic expression is avoided.

The lethality associated with sustained expression of transgenes during development, the effort required to generate transgenic strains in which the transgene is expressed in multiple patterns, and the lack of defined enhancers driving expression in certain tissues prompted the development of alternative strategies for ectopic expression.

### 3.2. The GAL4 System

The identification of the yeast transcriptional activator, GAL4, as a highly active, specific transcription factor that can activate transcription in *Drosophila* (6) led to the development of a system of ectopic expression referred to as the GAL4 system (2). This two-part system is shown in **Fig. 1** and involves a cross between a fly expressing GAL4 in particular cells and a fly carrying a gene of interest under the transcriptional control of the GAL4 upstream activating sequence, or UAS. In the progeny of such a cross, the gene of interest will be expressed in cells where GAL4 is synthesized. Targeted ectopic expression of the gene of interest can therefore be achieved by choosing among many strains that express GAL4 in defined patterns.

Three vectors are generally useful for investigators using this system (2). pGaTB/N provides either a *Bam*HI site or a *Not*I site upstream of GAL4, allowing a defined promoter to drive GAL4 expression. The second, pGawB, is an enhancer-trapping vector that directs GAL4 expression from genomic enhancers. Finally, pUAST includes multiple cloning sites behind five copies of an ideal GAL4 binding sequence. Genes of interest are easily cloned into this vector for GAL4-mediated expression.

Hundreds of GAL4 strains have been generated through the process of enhancer trapping. These strains have been characterized by crossing newly generated lines to a UAS-LacZ strain and characterizing the expression pattern. Many of these strains are now available through the *Drosophila* Stock Center at Bloomington, IN. The expression patterns that have been detected through these enhancers vary from very broad expression to highly specific patterns. They, thus, offer the possibility of driving ectopic expression in virtually any tissue.

In addition to the strains generated through enhancer trapping, many lines have been generated by fusing the GAL4 coding sequence to defined promoters, such as the *hsp70* promoter. The latter offers the advantage mentioned above of inducible expression. The construction of strains expressing GAL4 in defined domains allows any UAS transgene to be examined within the particular region of interest.

The GAL4 system has contributed to the utility of the FLP-FRT system of inducing mutant clones (*see* Chapter 3) (7). In this system, mitotic recombination is induced via flip recombinase (FLP), which is under the control of a heat shock promoter. The resulting mutant clones are then generated in all mitotically active cell populations. However, if FLP is placed under the control of GAL4-UAS, mutant clones are only generated within the GAL4 expression domain. This allows the investigator to determine whether a particular gene has an endogenous function within cells defined by GAL4 expression.

The GAL4 system addresses many of the problems associated with simple transgenes. First, since the UAS transgenic lines are produced in the absence of GAL4 activity, ectopic expression of the transgene does not occur. Therefore, lethality associated with ectopic expression is avoided until the transgenic flies are crossed to a GAL4 expressing strain. Second, defined enhancers are not required for expression in a particular set of cells. Sites of expression are only limited by the number of enhancer trapped strains available, the number of which is continually growing. Finally, the GAL4 system allows ectopic expression in any number of patterns and conditions with the construction of only a single UAS transgene.

This system of ectopic expression is extremely powerful for these reasons, but it does have limitations. First, for undefined reasons, GAL4 does not seem to function in the germline (A. Brand, personal communication). For experiments where germline expression is needed, other methods must be used. A more universal limitation of the GAL4 system is the fact that it is not inducible. Many enhancers drive expression during early phases of development, so that GAL4-mediated ectopic expression of certain UAS transgenes results in embryonic lethality. For investigators interested in later aspects of development, this has been a serious limitation of the GAL4 system.

This problem can be partially addressed through modulation of temperature. The optimal temperature for GAL4 activity appears to be the ambient temperature for yeast, which is 30°C. By rearing flies at lower temperature, GAL4 activity is reduced (8,9), and in some instances, early lethality associated with higher levels of ectopic expression from the UAS transgene is avoided. The flies can be shifted at later stages of development to increase GAL4-mediated expression.

In at least one instance, an inductive ability has been added to the GAL4 system through the construction of a UAS transgene carrying a cDNA encoding a temperature sensitive protein (9). Thus, progeny of the GAL4-UAS cross are maintained at the

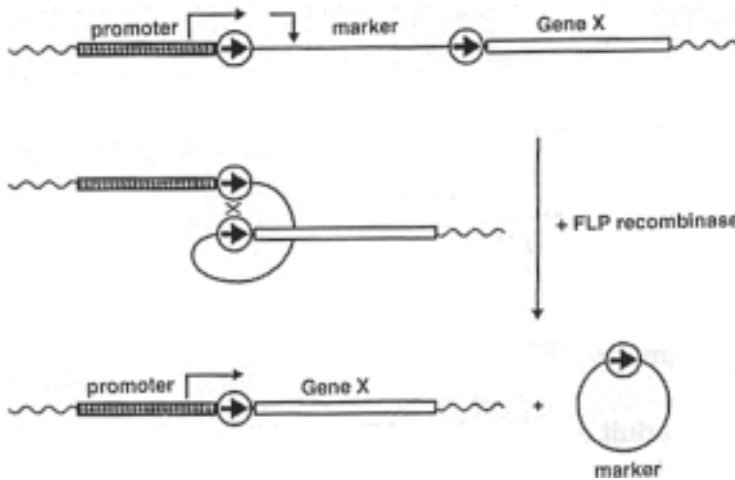

Fig. 2. The Flip-out system of ectopic expression (*see ref. 3*). Flip recombinase (FLP) target sites (FRTs) are arranged as direct repeats flanking a visible marker. The expression of this marker is under the control of the promoter element. However, in the presence of FLP, recombination between the FRTs is induced, resulting in deletion of the marker gene. The gene of interest is now juxtaposed to the promoter element, resulting in ectopic expression of the gene of interest. This is an efficient but stochastic process, resulting in clones of cells that express the gene. The area over which the clones are induced is defined by the region in which the promoter is active.

restrictive temperature during embryogenesis and shifted to the permissive temperature at the relevant stages. This permits ectopic activity to begin at the desired stage. However, since temperature sensitive lesions have not been defined for most genes, the inability to control expression temporally remains a problem with the GAL4 system in analysis of postembryonic development.

### 3.3. Ectopic Expression in Clones

The temporal control of ectopic expression has been critical for the analysis of gene activity during imaginal development. An ingenious method of ectopically expressing genes in any region of the imaginal discs was developed by Struhl and Basler (3) (**Fig. 2**) and has come to be called the flip-out system. This method involves the generation of random clones in which the coding region of a gene of interest comes to lie adjacent to a ubiquitous promoter. In these clones, the gene is ectopically expressed, whereas in the surrounding tissue, a gene encoding a visible marker is adjacent to the ubiquitous promoter, separating it from the gene of interest. This is accomplished through the use of flip recombinase target (FRT) sites flanking the marker gene. In the presence of the recombinase, the marker is removed, bringing the promoter and the gene of interest together. The resulting clone of cells is marked by the absence of the marker, which is ubiquitously present elsewhere in the fly.

This technique requires the generation of a construct in which the gene of interest is placed within the context of the promoter-FRT-marker-FRT construct (3,10,11). Two vectors are available that utilize either the Actin-5C promoter or the  $\beta$ -Tubulin pro-



moter. Both of these produce ubiquitous expression, so clones can be generated in any tissue. Levels of expression produced by the Actin-5C promoter are generally higher than those produced by the  $\beta$ -Tubulin promoter. A third vector uses the Ultrabithorax (Ubx) promoter, which produces clones in a more restricted pattern. Transgenic lines carrying the flip-out construct as well as a FLP transgene under the control of the hsp70 promoter (hs-FLP) must be generated. This is done through standard genetic manipulations using any of a number of hsFLP insertions on various chromosomes.

A variation on this method of ectopic expression involves a combination of the GAL4 system and the flip-out system (12). The promoter-driving expression of the FRT cassette, in this instance, is the GAL4 UAS. Clones induced via hs-FLP, therefore, fall only within the domain of GAL4 expression. The advantage of this combination lies in the strength of GAL4 as a transcriptional activator. Clones induced in this way express very high levels of the gene of interest.

The strengths of the flip-out technique are as follows.

1. The clones are efficiently generated randomly throughout the animal. By analyzing a number of animals, it is very likely that clones will be found in a region of interest.
2. Ectopic expression is completely inducible. Lethality because of early expression is avoided.
3. The clones are marked molecularly by the ectopic expression of the gene of interest, and they are marked in the adult cuticle by the absence of the visible marker.

As with any form of clonal analysis, this technique is limited to mitotically active cells, because cell division is required to generate a clone. A second limitation is that randomly generated clones are not reproducible; therefore, clones analyzed in the imaginal discs cannot be analyzed later in the adult cuticle. This contrasts with GAL4-driven expression that generates reproducible phenotypes. In this instance, one can precisely correlate imaginal disc phenotypes with the later phenotypes produced in the adult. Although these limitations need to be considered, the strengths of the flip-out system make it a very useful way to analyze gene activity during imaginal development.

#### 4. Notes

The foregoing approaches provide enormous temporal and spatial control over ectopic expression in *Drosophila*, allowing investigators to analyze gene activity in virtually any cell at any stage of development. However, in addition to the caveats mentioned for each of these methods, a few general concerns should be noted.

1. Positional effects can alter the levels of ectopic expression produced from any transgene. Thus, a transgene under the control of a given regulatory element may not express at the same level as a different transgene under the control of the same element. Therefore, multiple transgenic strains should be generated for any experiment to control for positional effects.
2. Variability in phenotypes produced by ectopic expression is common. The reason for this is apparent with the flip-out system, because clones are randomly generated. Variation can be controlled, however, by inducing the clones within a narrow window of development. By collecting embryos over a short period before aging them and inducing the clones, clone size is kept more constant, as is the timing of ectopic expression relative to other developmental events. Variation in phenotypes using the GAL4 system is less pronounced, but can still be a problem. This can be minimized by rearing flies at a consistent temperature and by maintaining cultures in uncrowded conditions.

## References

1. Struhl, G. (1985) Near-reciprocal phenotypes caused by inactivation or indiscriminate expression of the *Drosophila* segmentation gene *ftz*. *Nature* **318**, 677–680.
2. Brand, A. and Perrimon, N. (1992) Targeted gene expression as a means of altering cell fates and generating dominant phenotypes. *Development* **118**, 401–415.
3. Struhl, G. and Basler, K. (1993) Organizing activity of wingless protein in *Drosophila*. *Cell* **72**, 527–540.
4. Zuker, C. S., Mismer, D., Hardy, R., and Rubin, G. M. (1988) Ectopic expression of a minor *Drosophila* opsin in the major photoreceptor cell class: distinguishing the role of primary receptor and cellular context. *Cell* **53**, 475–482.
5. Parkhurst, S. M. and Ish-Horowicz, D. (1991) Mis-regulating segmentation gene expression in *Drosophila*. *Development* **111**, 1121–1135.
6. Fischer, J. A., Giniger, E., Maniatis, T., and Ptashne, M. (1988) GAL4 activates transcription in *Drosophila*. *Nature* **332**, 853–856.
7. Duffy, J. B., Harrison, D. A., and Perrimon, N. (1998) Identifying loci required for follicular patterning using directed mosaics. *Development* **125**, 2263–2271.
8. Staehling-Hampton, K., Jackson, P. D., Clark, M. J., Brand, A. H., and Hoffmann, F. M. (1994) Specificity of bone morphogenesis protein (BMP) related factors: cell fate and gene expression changes in *Drosophila* embryos induced by decapentaplegic but not 60A. *Cell Growth Diff.* **5**, 585–593.
9. Wilder, E. L. and Perrimon, N. (1995) Dual functions of wingless in the *Drosophila* leg imaginal disc. *Development* **121**, 477–488.
10. Diaz-Benjumea, F. J. and Cohen, S. M. (1995) Serrate signals through Notch to establish a Wingless-dependent organizer at the dorsal/ventral compartment boundary of the *Drosophila* wing. *Development* **121**, 4215–4225.
11. Zecca, M., Basler, K., and Struhl, G. (1995) Sequential organizing activities of engrailed, hedgehog, and decapentaplegic in the *Drosophila* wing. *Development* **121**, 2265–2278.
12. Nellen, D., Burke, R., Struhl, G., and Basler, K. (1996) Direct and Long Range action of a Dpp morphogen Gradient. *Cell* **85**, 357–368.

## Clonal Analysis in the Examination of Gene Function in *Drosophila*

Jenny E. Rooke, Nicole A. Theodosiou, and Tian Xu

### 1. Introduction

Clonal analysis in *Drosophila* has been successfully used to address numerous biological questions of fundamental importance, including issues of cell lineage, fate determination, autonomy of gene action and pattern formation (1,2). Clonal analysis has been particularly useful for the study of genes that would be lethal in a homozygous mutant state; this approach also makes it possible to recover essential genes in mosaic screens (3).

Among the methods traditionally used by researchers to generate clones in *Drosophila*, the most frequent technique has been the induction of mitotic recombination through ionizing radiation such as X-rays (4–6). X-ray irradiation causes chromosomal breaks that can lead to the exchange of homologous chromosome arms; at mitosis, daughter cells may inherit a homozygous region distal to the point of recombination (see Fig. 1). Mitotic recombination events induced by X-rays take place at low frequencies, a factor that cripples the efficiency of most clonal analyses using this technique.

Use of the FLP–FRT yeast site-specific recombination system provides an efficient method for generating clones at high frequencies for phenotypic analysis and screening (see Fig. 2; [7–9]). Strains have been constructed such that expression of the site-specific FLP recombinase can be driven by a heat-inducible promoter (see Table 1). Clones for almost any gene of the *Drosophila* genome can be produced once the gene of interest has been recombined onto specially engineered FRT-carrying chromosome arms (see Tables 2 and 3). And a sizable array of markers is available, facilitating the choice of a genetic marker appropriate for the tissue and developmental stage being studied (see Tables 4–6).

Protocols for using the FLP/FRT system to generate both somatic and germline clones are given below. Because some genes are not amenable to FLP/FRT clonal analysis, equivalent protocols for X-ray-induced clone production are also provided. Successful clone production for both protocols critically depends upon the timing of clone induction, as mitotic recombination can be induced only in cells that are actively dividing. For this reason, a timeline of cell divisions in specific tissues of the developing

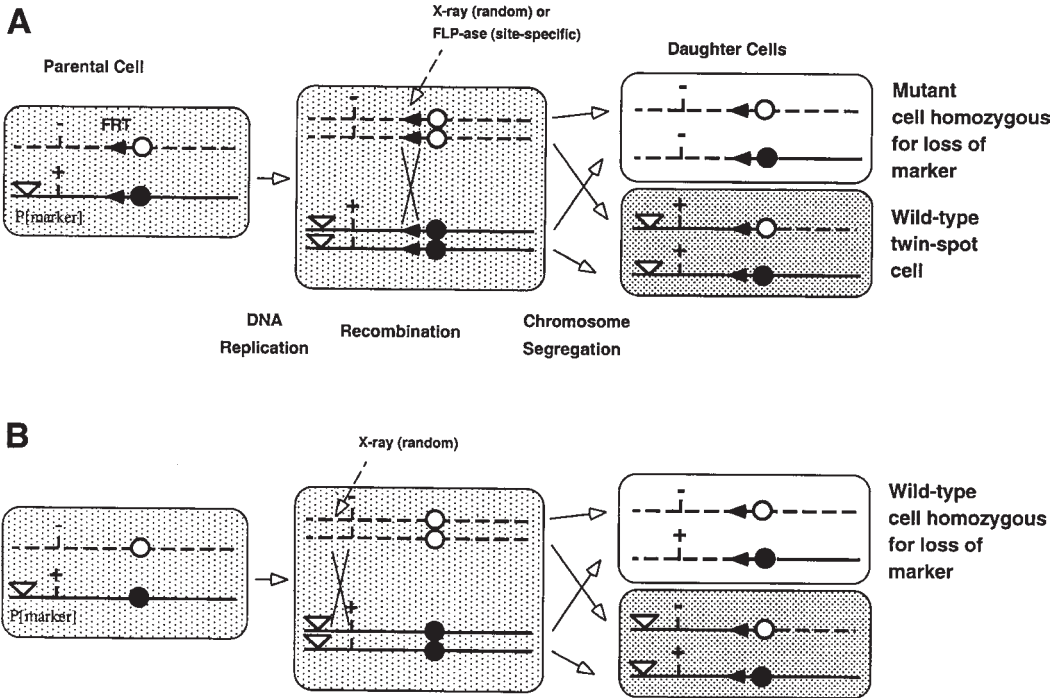

Fig. 1. **(A)** Use of the FLP–FRT system or X-rays to induce mitotic recombination and clone formation. Mutant clones are identifiable by concomitant loss of a marker gene. **(B)** Because X-rays induce recombination at random points along the chromosome, the marker gene must be located more proximal to the centromere than the mutation under study in X-ray induced clonal analysis. If the marker is more distal, some random X-ray events will generate marked wild-type clones (false positives). Because the action of FLP-ase is site-specific, proximity of the marker relative to the mutation is not important in FLP-FRT analysis.

fruit fly (*see Fig. 3*) is included to aid the researcher in designing successful clonal analyses.

## 2. Materials

Information for *Drosophila* strains is provided in **Tables 1–6**.

## 3. Methods

### 3.1. Induction of Somatic Clones

#### by (a) FLP/FRT or (b) X-rays (*see Note 1*)

1. Set up crosses of the appropriate genotypes at 25°C (**Fig. 2**; *see Notes 2–4*).
2. Collect eggs for 12 h at 25°C.
3. Age eggs for 24 h (large adult clones) to 48 h (smaller, more frequent adult clones) at 25°C (*see Note 5*).
- 4a. Heat shock vials for 60 min in a 38°C water bath (*see Notes 6 and 7*).
- 4b. Place vials containing larvae close to X-ray source and expose to 1000R dose (*see Note 6*).
5. Return vials to 25°C for recovery.

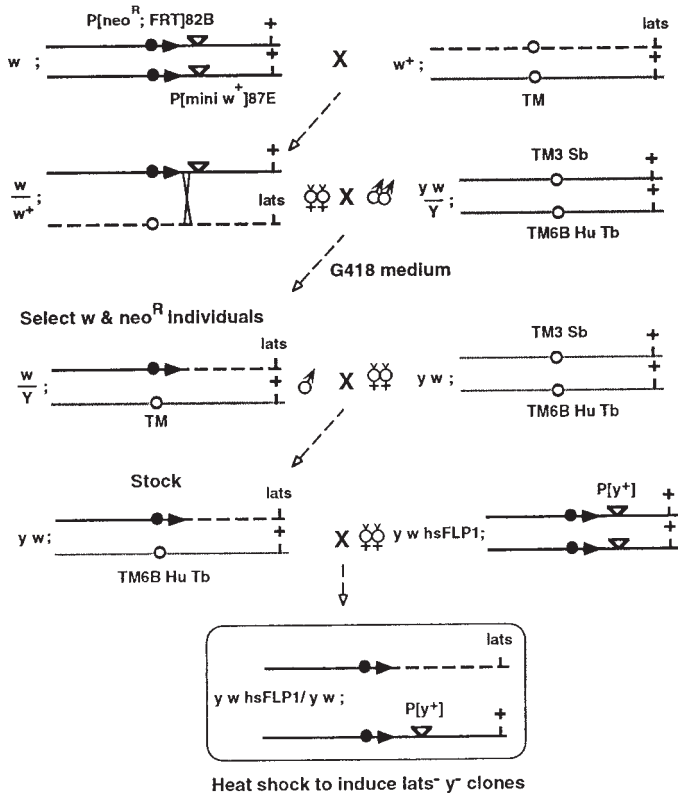

Fig. 2. An example scheme of crosses for recombining an allele of *lats* onto an FRT chromosome for FLP-FRT analysis.

**Table 1**  
**FLP Chromosomes**

Chromosomes	Strains	Footnotes
X	<i>y w hsFLP1; Adv/CyO</i>	<i>a-c</i>
	<i>y w hsFLP1; TM3, Sb/TM6B, Hu</i>	<i>a-c</i>
	<i>y hsFLP1; Bc; kar<sup>2</sup> ry<sup>506</sup></i>	<i>a,g</i>
	<i>y w hsFLP122</i>	<i>d</i>
	<i>y w hsFLP122; TM3, ry<sup>RK</sup> Sb/TM6B, Hu</i>	<i>d,e</i>
	<i>y w hsFLP<sup>12</sup>; Sco/CyO</i>	<i>a,f</i>
	<i>y w hsFLP<sup>22</sup>; CxD/TM3, Sb</i>	<i>a,f</i>
	<i>w; UAS-FLP</i>	<i>c</i>
	<i>yw; Ey-FLP</i>	<i>i</i>
2	<i>y; hsFLP38 Bc/CyO; Ki kar<sup>2</sup> ry<sup>506</sup> Tb</i>	<i>a,g</i>
	<i>pr pwn hsFLP38/CyO; Ki kar<sup>2</sup> ry<sup>506</sup></i>	<i>a,g</i>
	<i>w; UAS-FLP</i>	<i>c</i>
	<i>yw; Ey-FLP</i>	<i>i</i>
3	<i>hsFLP3, MKRS/TM6B</i>	<i>a,b,h</i>
	<i>w; UAS-FLP</i>	<i>c</i>

<sup>a</sup>Golic and Lindquist, 1989; <sup>b</sup>Xu and Rubin, 1993; <sup>c</sup>Xu, T., et al., unpublished; <sup>d</sup>Struhl and Basler, 1993; <sup>e</sup>Ito, N., et al., unpublished; <sup>f</sup>Chou and Perrimon, 1996; <sup>g</sup>Heitzler, P., unpublished; <sup>h</sup>Jan, Y. N., et al., unpublished; <sup>i</sup>Dickson, B., unpublished.

**Table 2**  
**FRT Elements**

Chromosomes	Insertions	Code	Frequencies of recombination	Footnotes
X	<i>P[mini w<sup>+</sup>; FRT]14A-B</i>	FRT <sup>101</sup>	High	<i>a,c</i>
	<i>P[ry<sup>+</sup>, hs-neo; FRT]11A</i>	FRT11A	ND	<i>b</i>
	<i>P[mini w<sup>+</sup>; FRT]18E-F</i>	FRT <sup>9-2</sup>	High	<i>a,c</i>
	<i>P[ry<sup>+</sup>, hs-neo; FRT]18A</i>	FRT18A	High	<i>b</i>
	<i>P[ry<sup>+</sup>, hs-neo; FRT]19A</i>	FRT19A	High	<i>b</i>
	<i>P[ry<sup>+</sup>, hs-neo; FRT]19F</i>	FRT19F	Low	<i>b</i>
2L	<i>P[ry<sup>+</sup>, hs-neo; FRT]29D</i>	FRT29D	ND	<i>b</i>
	<i>P[ry<sup>+</sup>, hs-neo; FRT]34B</i>	FRT34B	ND	<i>b</i>
	<i>P[ry<sup>+</sup>, hs-neo; FRT]40A</i>	FRT40A	High	<i>b</i>
2R	<i>P[mini w<sup>+</sup>; FRT]42B</i>	FRT <sup>2R-G13</sup>	High	<i>a,c</i>
	<i>P[ry<sup>+</sup>, hs-neo; FRT]42B</i>	FRT42B	Low	<i>b</i>
	<i>P[ry<sup>+</sup>, hs-neo; FRT]42C</i>	FRT42C	Low	<i>b</i>
	<i>P[ry<sup>+</sup>, hs-neo; FRT]42D</i>	FRT42D	Medium	<i>b</i>
	<i>P[ry<sup>+</sup>, hs-neo; FRT]43D</i>	FRT43D	High	<i>b</i>
	<i>P[ry<sup>+</sup>, hs-neo; FRT]50B</i>	FRT50B	ND	<i>b</i>
3L	<i>P[ry<sup>+</sup>, hs-neo; FRT]69A</i>	FRT69A	ND	<i>b</i>
	<i>P[ry<sup>+</sup>, hs-neo; FRT]72D</i>	FRT72D	High	<i>b</i>
	<i>P[mini w<sup>+</sup>; FRT]79D-F</i>	FRT <sup>3L-2A</sup>	High	<i>a,c</i>
	<i>P[ry<sup>+</sup>, hs-neo; FRT]80B</i>	FRT80B	Medium	<i>b</i>
3R	<i>P[ry<sup>+</sup>, hs-neo; FRT]82B</i>	FRT82B	High	<i>b</i>
	<i>P[ry<sup>+</sup>, hs-neo; FRT]89B</i>	FRT89B	ND	<i>b</i>
	<i>P[ry<sup>+</sup>, hs-neo; FRT]93D</i>	FRT93D	ND	<i>b</i>

ND = Not determined.

<sup>a</sup>Golic and Lindquist, 1989; <sup>b</sup>Xu and Rubin, 1993; <sup>c</sup>Chou and Perrimon, 1993 and 1996.**Table 3**  
**Strains for Recombining Mutation onto FRT Arms**

Chromosomes	Strains	Footnotes
X	<i>w P[mini-w<sup>+</sup> hsπF]17B FRT18A</i>	<i>a</i>
	<i>y w P[mini-w<sup>+</sup> hsπM]5A, 10D FRT19A</i>	<i>a</i>
	<i>f<sup>36a</sup> FRT19A; mwh kar<sup>2</sup> ry<sup>506</sup></i>	<i>a,b</i>
2L	<i>w; P[mini-w<sup>+</sup> hsπM]36F FRT40A</i>	<i>a</i>
	<i>y; P[y<sup>+</sup> ry<sup>+</sup>]25F ck<sup>CH52</sup> FRT40A/CyO; kar<sup>2</sup> ry<sup>506</sup></i>	<i>a,b</i>
2R	<i>w; FRT42D P[mini-w<sup>+</sup>, hsπM]45F</i>	<i>a</i>
	<i>y; FRT42D pwn P[y<sup>+</sup>, ry<sup>+</sup>]44B/CyO; kar<sup>2</sup> ry<sup>506</sup></i>	<i>a,b</i>
	<i>w; FRT43D P[mini-w<sup>+</sup>, hsπM]45F</i>	<i>a</i>
3L	<i>y w; P[mini-w<sup>+</sup> hsπM]75C FRT80B</i>	<i>a</i>
	<i>yy; mwh (FRT73D?) FRT80B kar<sup>2</sup> ry<sup>506</sup></i>	<i>a,b</i>
3R	<i>w; FRT82B P[mini-w<sup>+</sup> hsπM] 87E</i>	<i>a</i>

<sup>a</sup>Xu and Rubin, 1993; <sup>b</sup>Heitzler, P., unpublished.

**Table 4**  
**Strains for Adult Cuticular Clones**

Chromosomes	Strains	Footnotes
X	<i>FRT18A; hsFLP3, MKRS/TM6B</i>	<i>a</i>
	<i>FRT19A; hsFLP3, MKRS/TM6B</i>	<i>a,b</i>
	<i>y w FRT19A</i>	<i>a,b</i>
	<i>w sn<sup>3</sup> FRT19A</i>	<i>a,b</i>
	<i>f<sup>36a</sup> FRT19A; mwh kar<sup>2</sup> ry<sup>506</sup></i>	<i>a,d</i>
	<i>Dp(3;Y;1)M2 y FRT19A/FM7; emc<sup>FX119</sup> mwh kar<sup>2</sup> ry<sup>506</sup></i>	<i>a,d</i>
	<i>Dp(3;Y;1)M2 y M(1)o<sup>Sp</sup> FRT19A/FM7; kar<sup>2</sup> ry<sup>506</sup></i>	<i>a,d</i>
2L	<i>y w hsFLP1; P[y<sup>+</sup> ry<sup>+</sup>]25F P[w<sup>+</sup> ry<sup>+</sup>]30C FRT40A</i>	<i>a,b</i>
	<i>y; P[y<sup>+</sup> ry<sup>+</sup>]25F ck<sup>CH52</sup> FRT40A/CyO; kar<sup>2</sup> ry<sup>506</sup></i>	<i>a,d</i>
2R	<i>y w hsFLP1; FRT42D P[y<sup>+</sup>, ry<sup>+</sup>]44B P[w<sup>+</sup>, ry<sup>+</sup>]47A/CyO</i>	<i>a,b</i>
	<i>y; FRT 42D pwn P[y<sup>+</sup>, ry<sup>+</sup>]44B/CyO; kar<sup>2</sup> ry<sup>506</sup></i>	<i>a,d</i>
	<i>y w; FRT42D P[mini-w<sup>+</sup>, hsπM]45F M(2)S7/CyO; kar<sup>2</sup> ry<sup>506</sup></i>	<i>a,d</i>
	<i>y w hsFLP1; FRT43D P[w<sup>+</sup>, ry<sup>+</sup>]47A</i>	<i>a,b</i>
	<i>y w hsFLP1; FRT43D P[y<sup>+</sup>, ry<sup>+</sup>]44B</i>	<i>a,b</i>
3L	<i>w hsFLP122; P[w<sup>+</sup>]70C FRT80B</i>	<i>a,c</i>
	<i>y w hsFLP122; P[ry<sup>+</sup> y<sup>+</sup>]66E P[w<sup>+</sup>]70C FRT80B</i>	<i>a,c</i>
	<i>y; mwh (FRT73D?) FRT80B kar<sup>2</sup> ry<sup>506</sup></i>	<i>a,d</i>
	<i>y; trc FRT80B kar<sup>2</sup> ry<sup>506</sup>/TM6C ry<sup>CB</sup> Sb Tb</i>	<i>a,d</i>
	<i>y w; jv P[ry<sup>+</sup> y<sup>+</sup>]66E P[mini-w<sup>+</sup> hsπM]75C FRT80B</i>	<i>a,d</i>
	<i>kar<sup>2</sup> ry<sup>506</sup>/TM3 ry<sup>RK</sup> Sb</i>	
<i>y w; M(3)i<sup>55</sup> P[mini-w<sup>+</sup> hsπM]75C FRT80B</i>	<i>a,d</i>	
<i>kar<sup>2</sup> ry<sup>506</sup>/TM3 ry<sup>RK</sup> Sb</i>		
3R	<i>y w hsFLP1; FRT82B P[w<sup>+</sup>; ry<sup>+</sup>]90E P[y<sup>+</sup> ry<sup>+</sup>]96E</i>	<i>a,b</i>
	<i>y w hsFLP1; FRT82B P[mini-w<sup>+</sup> hsπM]87E Sb<sup>63b</sup> P[y<sup>+</sup> ry<sup>+</sup>]96E</i>	<i>a</i>
	<i>FRT82B kar<sup>2</sup> ry<sup>506</sup></i>	<i>a,d</i>
	<i>pr pwn; FRT82B kar<sup>2</sup> ry<sup>506</sup> bx<sup>34e</sup> Dp(2;3)P32/FRT82B kar<sup>2</sup> ry<sup>506</sup></i>	<i>a,d</i>

<sup>a</sup>Xu and Rubin, 1993; <sup>b</sup>Xu, T., et al., unpublished; <sup>c</sup>Ito, N., et al., unpublished; <sup>d</sup>Heitzler, P., unpublished.

Note that most eye clones marked with *w<sup>-</sup>* will appear as dark or black patches against the background of a wild-type red eye. Only very large clones or clones located at the edge of the eye will appear white.

### 3.2. Induction of Germline Clones by FLP/FRT or X-rays

1. Set up crosses at 25°C such that progeny will be trans-heterozygous for a dominant female-sterile mutation (such as *Ovo<sup>D1</sup>*) and the mutant gene or marker of interest (*see* **Notes 2, 3, and 8**).
2. Collect eggs for 24 h at 25°C.
- 3a. Heat-shock vials for 60 min in a 38°C water bath twice over a period of several days while progeny are in first and second larval instar stages. Adult virgin females collected from these crosses may be heat-shocked again before mating to initiate mitotic recombination in ovariole germline cells.
- 3b. X-ray twice, once during first and once during second larval instar stage. Place vials containing progeny close to X-ray source and expose to 1000R dose. Adult virgin females collected from these crosses may be X-rayed again before mating to initiate mitotic recombination in ovariole germline cells.
4. Allow females to recover at 25°C for a day before mating.

**Table 5**  
**Strains for Clones in Developing and Internal Tissues**

Chromosomes	Strains	Footnotes
X	<i>w P[mini-w+ hsπM]5A, 10D FRT18A; hsFLP3, MKRS/TM6B</i>	<i>a</i>
	<i>w P[mini-w+ hsNM]8A FRT18A</i>	<i>a</i>
	<i>w P[mini-w+ hsπF]17B FRT18A</i>	<i>a</i>
	<i>y w P[mini-w+ hsπM]5A, 10D FRT19A</i>	<i>a</i>
	<i>y w P[mini-w+ hsπM]5A, 10D M(1)<i>o</i><sup>Sp</sup> FRT19A/FM7</i>	<i>a,c</i>
2L	<i>w hsFLP1; P[mini-w<sup>+</sup> hsπM]21C, 36F FRT40A</i>	<i>a</i>
	<i>w hsFLP1; P[mini-w<sup>+</sup> hsNM]31E FRT40A</i>	<i>a</i>
2R	<i>w hsFLP1; FRT42D P[mini-w<sup>+</sup>, hsπM]45F/CyO</i>	<i>a</i>
	<i>y w; FRT42D P[mini-w<sup>+</sup>, hsπM]45F M(2)S7/CyO; kar<sup>2</sup> ry<sup>506</sup></i>	<i>a,c</i>
	<i>y w hsFLP1; FRT42D P[mini-w<sup>+</sup>, hsNM]46F</i>	<i>a</i>
	<i>w hsFLP1; FRT43D P[mini-w<sup>+</sup>, hsπM]45F,47F</i>	<i>a</i>
	<i>y w hsFLP1; FRT43D P[mini-w<sup>+</sup>, hsNM]46F</i>	<i>a</i>
3L	<i>y w hs FLP122; P[mini-w<sup>+</sup> hsπM]75C FRT80B</i>	<i>a,b</i>
	<i>y w hsFLP1; P[mini-w<sup>+</sup> hsNM]67B (FRT73D?) FRT80B</i>	<i>a</i>
	<i>y w; jv P[ry<sup>+</sup> y<sup>+</sup>]66E P[mini-w<sup>+</sup> hsπM]75C FRT80B kar<sup>2</sup> ry<sup>506</sup>/TM3 ry<sup>RK</sup> Sb</i>	<i>a,c</i>
	<i>y w; M(3)<i>i</i><sup>55</sup> P[mini-w<sup>+</sup> hsπM]75C FRT80B kar<sup>2</sup> ry<sup>506</sup>/TM3 ry<sup>RK</sup> Sb</i>	<i>a,c</i>
3R	<i>w hsFLP1; FRT82B P[mini-w<sup>+</sup> hsπM]87E,97E</i>	<i>a</i>
	<i>y w hsFLP1; FRT82B P[mini-w<sup>+</sup> hsNM]88C</i>	<i>a</i>

<sup>a</sup>Xu and Rubin, 1993; <sup>b</sup>Ito, N., et al., unpublished; <sup>c</sup>Heitzler, P., unpublished.

Detailed protocols for dissection of imaginal disc tissues and staining of the π-myc and N-myc markers can be found in refs. 3 and 13.

**Table 6**  
**Strains for Generating Germline Clones**

Chromosomes	Strains	Footnotes
X	<i>C(1)DX, y f/w ovo<sup>D1</sup> v<sup>24</sup> FRT<sup>101</sup>/Y; hsFLP38</i>	<i>a,b</i>
	<i>C(1)DX, y f/ovo<sup>D2</sup> v<sup>24</sup> FRT<sup>9-2</sup>/Y; hsFLP38</i>	<i>a,b</i>
2L	<i>P[mini w<sup>+</sup>; ovo<sup>D1</sup>]2L-13X13 FRT40 A/S Sp Ms(2)M bw<sup>D</sup>/CyO</i>	<i>a,c</i>
2R	<i>FRT<sup>2R-G13</sup> P[mini w<sup>+</sup>; ovo<sup>D1</sup>]2R-32X9/S Sp Ms(2)M bw<sup>D</sup>/CyO</i>	<i>a,b</i>
3L	<i>w; P[mini w<sup>+</sup>; ovo<sup>D1</sup>]3L-2X48 FRT<sup>3L-2A</sup>/ru h st βTub85D<sup>D</sup> ss e<sup>S</sup>/TM3, Sb</i>	<i>a,b</i>
3R	<i>w; FRT82B P[mini w<sup>+</sup>; ovo<sup>D1</sup>]3R-C13a31 n9/ru h st βTub85D<sup>D</sup> ss e<sup>S</sup>/TM3, Sb</i>	<i>a,c</i>

<sup>a</sup>Chou and Perrimon, 1993; 1996; <sup>b</sup>Golic and Lindquist, 1989; <sup>c</sup>Xu and Rubin, 1993.

#### 4. Notes

1. The heat shock promoter is apparently not active in early embryo divisions. Workers wishing to produce clones in the embryo may need to use X-ray induction.
2. All crosses and egg collections should be carried out on well-yeasted rich medium such as the standard molasses-agar substrate.
3. It is important to culture flies at 25°C as heat shocking often kills larvae grown at 18°C.



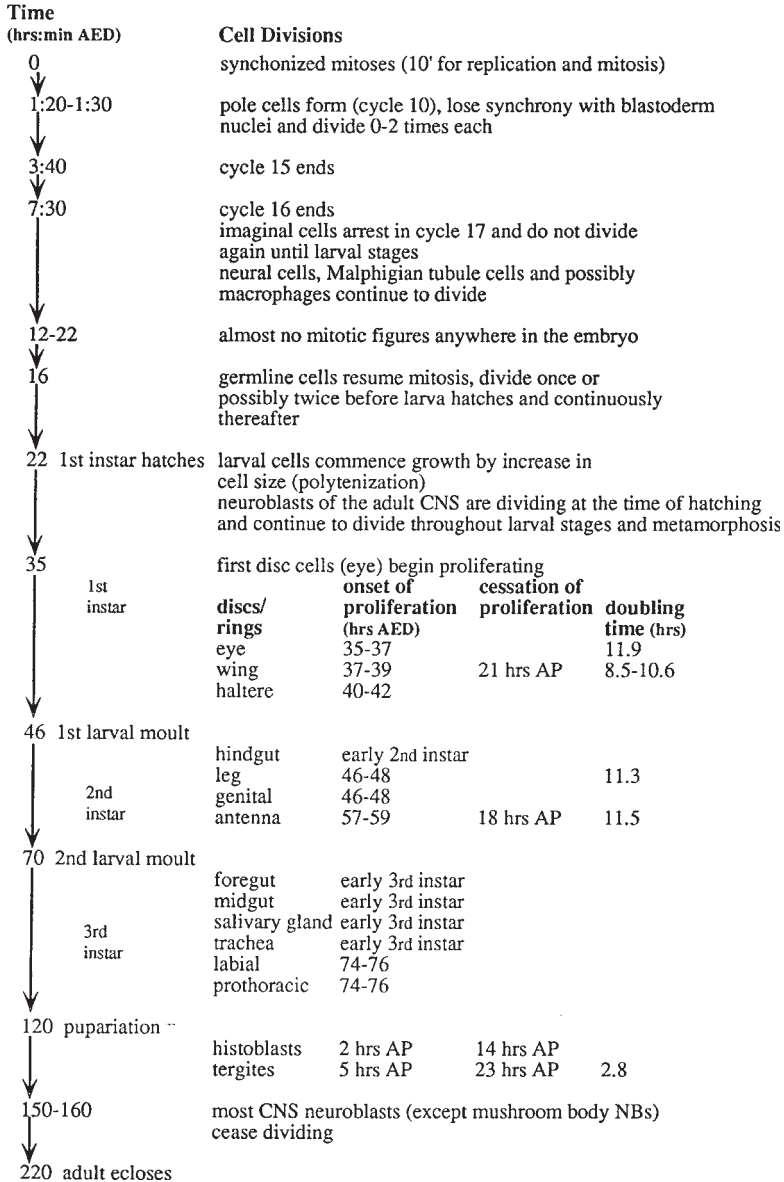

Fig. 3. Timeline of cell divisions in different tissues during *Drosophila* development. Times are given as hours after egg deposition (AED), except where noted. All times are for 25°C. Adapted from text and tables in 14–16. AP, after pupariation.

- Crowded vials will produce divergent development rates among the progeny and thereby decrease the efficiency with which clones are produced at the precise desired developmental stage. If an experiment calls for large numbers of progeny, set up additional crosses in individual vials rather than crowd more females into a vial.
- The production of clones using mitotic recombination is restricted to cells which are dividing at the time of heat shock (or X-ray). Thus, it is essential to induce FLP expression/ expose to X-rays when cells in the tissues of interest are actively dividing. Know the

developmental profile of the tissue(s) you wish to study (see **Fig. 3**). For Ey-FLP or GAL4/UAS-FLP, FLP is expressed and will get large clones.

6. When heat-shocking or X-raying older larvae or adult flies, push the cotton stopper down into the vial to restrict the animals' movement to as small a space as possible. Then ensure that this space is fully submerged (in the case of heat-shock) or placed very near the X-ray source; this will increase the frequency of clone production.
7. The temperature of the water bath for heat-shocking must be at 38°C. One degree less will dramatically decrease the clone frequency. On the other hand, temperatures higher than 40°C will kill the animals.
8. Remember that only a fraction of females collected from a germline clone experiment involving a dominant sterile mutation such as *Ovo<sup>D1</sup>* will be fertile. It is useful to set up more than enough crosses to produce an excess of the required virgins, and to then be fastidious about maintaining a daily heat-shock (or X-ray) regimen and frequent collection of virgins.

## References

1. Postlethwait, J. H. (1976) Clonal analysis of *Drosophila* cuticular patterns, in *The Genetics and Biology of Drosophila*, vol. 2c (Ashburner, M. and Wright, T. R. F., eds.), Academic, New York, pp. 359–441.
2. Ashburner, M. (1989) *Drosophila: A Laboratory Handbook*. Cold Spring Harbor, New York.
3. Xu, T. and Harrison, S. D. (1994) Mosaic analysis using FLP recombinase. *Methods Cell Biol.* **44**, 655–681.
4. Patterson, J. T. (1929) The production of mutations in somatic cells of *Drosophila melanogaster* by means of X-rays. *J. Exp. Zool.* **53**, 327–372.
5. Friesen, H. (1936) Spermatogoniales crossing-over bei *Drosophila*. *Z. Indukt. Abstammungs. Vererbungsl.* **71**, 501–526.
6. Lawrence, P. A., Johnston, P., and Morata, G. (1986) Methods of marking cells, in *Drosophila: A Practical Approach* (Roberts, D. B., ed.), IRL, Oxford, UK, pp. 229–242.
7. Golic, K. G. and Lindquist, S. (1989) The FLP recombinase of yeast catalyzes site-specific recombination in the *Drosophila* genome. *Cell* **59**, 499–509.
8. Golic, K. G. (1991) Site-specific recombination between homologous chromosomes in *Drosophila*. *Science* **252**, 958–961.
9. Xu, T. and Rubin, G. M. (1993) Analysis of genetic mosaics in developing and adult *Drosophila* tissues. *Development* **117**, 1223–1237.
10. Struhl, G. and Basler, K. (1993) Organizing activity of wingless protein in *Drosophila*. *Cell* **72**, 527–540.
11. Chou, T. B. and Perrimon, N. (1992) Use of a yeast site-specific recombinase to produce female germline chimeras in *Drosophila*. *Genetics* **131**, 643–653.
12. Chou, T. B. and Perrimon, N. (1996) The autosomal FLP-DFS technique for generating germline mosaics in *Drosophila melanogaster*. *Genetics* **144**, 1673–1679.
13. Theodosiou, N. A. and Xu, T. (1998) Use of the FLP-FRT system to study *Drosophila* development. *Methods*, in press.
14. Roberts, D. B. (1986) Basic *Drosophila* care and techniques, in *Drosophila: A Practical Approach* (Roberts, D. B., ed.), IRL, Oxford, UK, pp. 1–38.
15. Foe, V. E., Odell, G. M., and Edgar, B. A. (1993) Mitosis and morphogenesis in the *Drosophila* embryo: Point and counterpoint, in *The Development of Drosophila melanogaster* (Bate, M. and Martinez-Arias, A., eds.), Cold Spring Harbor, New York, pp. 149–300.
16. Cohen, S. M. (1993) Imaginal disc development, in *The Development of Drosophila melanogaster* (Bate, M. and Martinez-Arias, A., eds.), Cold Spring Harbor, New York, pp. 747–842.

## Application of Antisense Oligodeoxynucleotides in Developing Chick Embryos

Peter G. Alexander, George L. Barnes, and Rocky S. Tuan

### 1. Introduction

Perturbing the expression level of a specific gene *in vivo* provides a powerful approach towards explaining its function during embryonic development. One technique used for perturbing the level of expression of a specific gene is the application of gene-specific antisense oligodeoxyribonucleotides (ODNs). ODNs are a quick, affordable, and effective means to “knock down” the expression of a gene in order to learn more of its function *in vivo*. It is a particularly useful tool to study the function of a gene in a specific target tissue, as it acts in a spatially (i.e., site of injection) and temporally (i.e., time of treatment) restricted manner.

Antisense ODNs are short DNA sequences designed to be complementary to unique regions of target mRNAs (*1*). Upon entering individual cells, ODNs disrupt the expression of the target gene product by at least three different mechanisms (*2–5*). The first, and probably most prevalent, is by binding the antisense ODN to the complementary mRNA sequences, forming a DNA/RNA hybrid duplex that is degraded by endogenous RNase H activity within the cytoplasm. The second postulated mechanism involves the entry of the ODN into the nucleus of the cell where it binds to the complementary genomic sequence, thus disrupting gene transcription. The third pathway is for the ODN to bind and physically perturb the mRNA in the translation process. The specific degradation of gene specific mRNAs is generally considered to be the most probable mechanism of action for antisense ODN perturbation of gene expression events.

The primary limitation in the use of ODNs in a given developmental system is the degree of its use is the accessibility of the system to the investigator. For this reason, antisense ODN studies are frequently performed on embryonic systems maintained *in vitro* or using oviparous animal models such as *Xenopus*, zebrafish and chicken. In this chapter, we describe protocols we have developed for the application of antisense ODNs to developing chick embryos by two routes of administration—topical treatment and microinjection—for the study of somite development.

## 2. Materials

1. Fertilized white leghorn chicken eggs from a commercial source (e.g., Truslow Farms Inc., Chestertowne, MD or SPAFAS Inc., Preston, CT).
2. Forced-draft commercial egg incubator (e.g., Model 1202, G.Q.F. Manufacturing Co., Savannah, GA or Favorite Incubator Leahy Manufacturing Co. Inc., Higginsville, MO).
3. Warm humidified incubator maintained at 38°C for *ex ovo* embryo culture (see **Note 1**).
4. Laminar flow hood or otherwise sterile area for manipulating eggs and embryo cultures and for performing microinjections.
5. Dissection stereo microscope.
6. Pure cellulose chromatography paper for embryo explant rings (Fisher Scientific, Pittsburgh, PA, cat. no. 05-714-40).
7. Two- or three-hole paper hole punch (see **Note 2**).
8. Glass Petri dishes (Fisher cat. no. 08-747C).
9. Autoclaved Spratt Ringers solution (**6**). A 1X solution contains 120 mM NaCl, 56 mM KCl, and 2 mM CaCl<sub>2</sub> in ddH<sub>2</sub>O. We prepare 20X stock solutions.
10. Large weigh boats (Fisher cat. no. 02-202D).
11. Parafilm (Fisher cat. no. 13-347-10).
12. 35 mm Petri dishes (Fisher cat. no. 08-757-11YZ).
13. 100 mm Petri dishes (Fisher cat. no. 08-757-12).
14. 150 mm Petri dishes (Fisher cat. no. 08-757-14).
15. Low-melt agarose (Fisher cat. no. BP1360-100).
16. Sterilized Erlenmeyer flasks.
17. Sterilized 30 mL capped polystyrene centrifuge tubes (Fisher cat. no. 3138-0030).
18. Phenol red (Sigma cat. no. P-2417).
19. Metal insert of a heat block.
20. Sterilized thermometer.
21. 50°C Water bath.
22. Rubbermaid storage container (16 in. × 6 in. × 12 in., optional).
23. Microinjector system such as the Drummond Nanoject Variable automatic injector (cat. no. 3-000-203-XV, see **Note 3**) (Drummond, Broomall, PA or via the IVD Suppliers Directory Inc. on the Internet at [www.devicelink.com](http://www.devicelink.com). Similar products are also provided by World Precision Instruments, Sarasota FL, or [sales@wpiinc.com](mailto:sales@wpiinc.com)).
24. A micromanipulator such as the Marzhauser MM33 micromanipulator available through Drummond (cat. no. 3-000-025, see **Note 4**).
25. Straight or angled micromanipulator base such as those offered by Drummond (cat. no. 3-000-025-SB, see **Note 5**).
26. Micropipet puller from suppliers such as Narishige (cat. no. PN-30). Narishige (Tokyo, Japan) can be contacted at [www.narishige.co.jp](http://www.narishige.co.jp).
27. 7 in. Glass capillaries (Drummond cat. no. 3-00-203-G/XL).
28. Microsurgical scissors (e.g., ROBOZ Surgical Instruments Co. Inc., Rockville MD, cat. no. RS-5914SC or World Precision Instruments).
29. Microsurgical tweezers (e.g., ROBOZ, cat. no. RS-5045 or similar instrument from World Precision Instruments).
30. Nile Blue, vital dye (Sigma, St. Louis, MO, cat. no. N 5383).

## 3. Methods

### 3.1. Designing ODNs

The design and quality of ODN synthesis are crucial considerations in the design of an antisense ODN experiment. In designing our ODNs, we begin with the following

parameters: an ODN length between 15 and 20 nucleotides (nt) (preferably 18), a cytosine/guanine (GC) content between 45 and 55% and a  $T_m$  between 50 and 60°C. Adhering to these parameters will maximize the ODNs' penetration into target cells and hybridization to target mRNAs while minimizing their cytotoxicity. There are several good reviews addressing basic ODN design in the literature (7–10).

The first and foremost consideration in ODN design is targeting the ODN to a unique portion of the target mRNA (11,12). This decreases the possibility of nonspecific ODN cross hybridization and undesirable results (see Note 6). In order to address the issue of cross hybridization with other mRNA species, we routinely perform BLAST searches with candidate ODN sequences against the GeneBank prior to synthesis (see Note 7). We have had the best success with ODNs targeted to sequences within the 5' untranslated regions of target genes, specifically those that lie adjacent to or overlap the ATG translational start site (see Notes 8 and 9).

A second consideration is how best to modify the ODN in order to maximize its effective half-life within the cell while minimizing its toxic side effects (11,13,14). Although there are several options, we routinely use phosphorothioate modified ODNs to minimize spontaneous and enzymatic degradation (15–17). Because the phosphorothioates themselves can be toxic (see Note 10), we only have the terminal 2–3 bases on both ends of the antisense ODN phosphorothioated.

Choosing a reliable facility for synthesis is very important because apart from proper ODN synthesis and modification, the ODNs must be properly purified and free from unbound modifiers, organics, and salts. We routinely use the services provided by either IDT (Coralville, IA, www.idtna.com) or Oligos Etc. Inc. (Wilsonville, OR, www.Oligosetc.com; see Note 10).

Once choices have been made in terms of the variables discussed above, the proper controls must also be designed (7,9,10). We routinely use at least two types of basic controls. The first is a sense strand ODN of the complementary sequence to the antisense. This ODN is designed to provide a control for DNA-based effects of ODNs, particularly on entry into the nucleus and binding of genomic sequences. The second control is a base-matched random sequence ODN that controls primarily for nonspecific ODN effects. A third important control involves the use of fluorescently labeled ODNs that provide proof of ODN localization with respect to the phenotype produced by the treatment. Although other detection methods are possible, such as the use of radiolabeled probes, we use fluorescein isothiocyanate (FITC)-conjugated ODNs followed by viewing under at 10X under appropriate fluorescence optics (18, Fig. 1). All control ODNs are phosphorothioated like the antisense ODN in order to control for the nonspecific effects of applying modified ODNs to a developing embryo.

### 3.2. Preparing ODN Stock Solutions

We treat lyophilized ODN stocks from the manufacturer as sterile and make concentrated stocks in sterile water at 50 mg/mL. ODNs are aliquoted in small volumes and stored at –20°C to maintain stability (up to a year). This concentration constitutes a 100X solution for topical applications and 10X solutions for injection applications. Immediately prior to use, the stock is diluted to a working concentration in sterile Spratt Ringers solution.

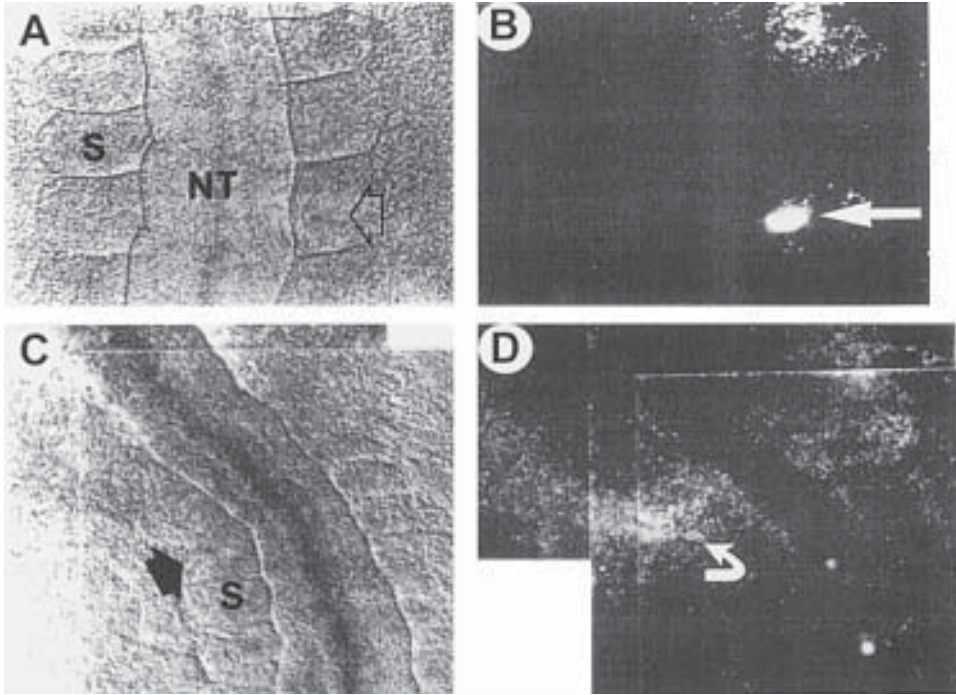

Fig. 1. Assessment of the distribution of ODN administered to chick embryos. To assess the distribution of fluorescently labeled ODN after several hours in culture, embryos were either injected with 50 nL of ODN or treated with a direct topical application of 1  $\mu$ L of the labeled ODN. The embryos were allowed to develop under normal culture conditions and were observed immediately after injection (**A** and **B**) and after another 6 h (**C** and **D**). Arrows indicate the site of ODN injection. Embryos in (**A**) and (**C**) are viewed in Nomarski differential interference optics and embryos in (**B**) and (**D**) are viewed with appropriate fluorescence optics. Immediately after injection, the fluorescent signal was evident in discrete areas of the somite (**B**). After 6 h, embryos that had been injected were found to have a localized area of very bright fluorescence at the injection site, as well as a diffuse fluorescence over a wider area of the embryo (**D**). NT, neural tube; S, somite. Adapted from **ref. 18**.

### 3.3. Preparing the Embryo Explant Rings

Make embryo explant rings by cutting 3MM Whatman filter paper (Whatman, Clifton, NJ) into approximately 3/4 in. squares with a central opening large enough to surround the chick embryos of desired developmental stage for experimental manipulation. We create the opening by using a two-hole hole punch and punching two partially overlapping holes. Explant rings are sterilized by autoclaving (10 min dry cycle) in a covered glass Petri dish with cover.

### 3.4. Preparing Albumen-Agar Embryo Culture Plates

1. Ringer-albumen component: Separate the yolk from the albumen of one fresh, unincubated egg (**12**). Add the albumen to 50 mL of sterilized Spratt Ringers solution in sterilized Erlenmeyer flask. Add 0.5 mg of phenol red (*see Note 13*). Seal the flask with Parafilm and shake the contents vigorously for 1 min. Centrifuge the mixture in 30 mL capped

polystyrene centrifuge tubes at 10,000g for 10 min at 4°C. Pour the supernatant into another sterilized Erlenmeyer flask and place in a preheated 50°C water bath.

2. Ringer-agar component: Autoclave-sterilize (15 min moist cycle) 120 mL of 2% low-melt agarose dissolved in 1X Spratt Ringers solution. After autoclaving, place the Ringer-agar mixture in a preheated 50°C water bath. Place a sterilized thermometer into the Ringer-agar.
3. Albumen-agar medium: Once the temperatures of both Ringer-agar and Ringer-albumen components are equilibrated at 50°C, mix the two together at a ratio of 2 parts Ringer-albumen to 3 parts Ringer-agar mixtures. Gently mix the two components while maintaining the 50°C temperature in the 50°C water bath. Place 2–3 mL of medium in each 35 mm Petri dish and allow the mixture to gel at room temperature (*see Note 14*). Plates can be stored for up to 1 wk at 4°C in a humidified storage container.

### 3.5. Pulling the Glass Capillary Microinjection Needles

For the purpose of injecting antisense ODNs into the segmental plate and somites, we pull needles with tip diameters of approximately 20  $\mu\text{m}$ , the minimal tip diameter for our model injector system. The strength of the magnet and the intensity of the heating element of the pipet puller should be adjusted such that the tapered portion is about 2–3 cm long with the final 0.2–0.5 cm being of almost uniform, minimal diameter (*see Note 15*). The closed tips of the pulled needles are not cut off until just before use. Pulled injection needles are kept in a 150-mm Petri dish held in place with plasticine keeping the tips suspended above the surface. Just before use, a pulled tip is dipped in 70% ethanol for sterilization. The ethanol will evaporate by the time the injection needle is mounted on the plunger. Drummond (Broomall, PA) provides an excellent description of the mounting procedure with their product, which includes a troubleshooting guide.

### 3.6. Microinjector Setup

Before the injection procedure is begun, a mock plate is placed on the stage, and the plane of focus is set upon the surface of the plate. Adjust the height of the manipulator such that when the infection tip is advanced to three-fourths of its maximal extension the tip of the injection needle is in the center of the plane of focus just above the embryo culture albumen-agar plate surface. We set the angle of the injection needle to approximately 45–60°. Remember to retract the injection needle completely before removing the plate.

### 3.7. Harvesting Embryos

Preheat a 500-mL bottle of 1X Spratt Ringer's solution to 37°C.

Incubate fresh fertilized chicken eggs and harvest appropriately aged chick embryos are harvested by cracking the egg open and dropping the contents into a sterile 100 mm Petri dish. We stage embryos according to Hamburger and Hamilton (19) (*see Note 16*). An excellent morphological description is given by Bellairs and Osmond (20).

Before the eggs are cracked, rinse and wipe them clean with 70% ethanol to remove contaminants. We break the eggs by gently cracking the egg about 180° around its center (*see Note 17*). Drop the contents of the egg into an open, sterile 100 mm Petri dish so that the embryo is on top (exposed) surface of the yolk (*see Note 18*). Lift the embryo from the yolk by placing an explant ring onto the surface of the yolk sac with the embryo located in the center of the ring opening. Trim the extra-embryonic mem-

branes along the outer edge of explant ring and lift the embryo from the underlying yolk. Embryos are rinsed twice by slowly passing them through prewarmed, 38°C Spratt Ringers solution (*see Note 19*). The washed embryos are placed onto prewarmed, 38°C albumen-agar plates and quickly transferred to the embryo incubator (*see Note 20*). For these procedures, embryos are cultured in an inverted orientation so that the ventral side of the embryo is exposed (facing up, *see Note 21*).

### **3.8. Delivery of ODN by Topical Application and Injection (*see Note 22*)**

Prepare and prewarm ODN working solutions. We prepare 5  $\mu\text{g}/\mu\text{L}$  dilutions of ODN in Spratt Ringer's solution (*see Note 23*). Remove harvested embryos from the embryo incubator in small numbers and examine for condition and health. Discard abnormal or damaged embryos (*see Note 24*).

#### **3.8.1. Topical Application**

The ODNs are administered with a pipet in a 10- $\mu\text{L}$  drop containing 5  $\mu\text{g}/\mu\text{L}$  of ODNs suspended in sterile Spratt Ringers solution (*see Note 25*). After making the appropriate observations of the pretreated embryo, choose the area to which the ODN will be applied and position it in the center of the visual field. Under the dissection scope, bring the pipet tip as close to the embryo as possible. While slowly administering the drop of ODN, lay the drop on the embryo at close proximity but without touching to the desired location (*see Note 26*). Immediately place the treated embryo back in the incubator for 16–24 h (*see Note 27*).

#### **3.8.2. Application by Injection (*see Note 28*)**

Place selected embryos onto the stage of the dissecting microscope with the microinjector set up, observed and positioned as described earlier. Advance the tip of the injection needle slowly until it begins to come into the plane of focus. Again advance the tip of the injection needle so that it enters the field of view and comes into focus. Continue to slowly advance the tip towards the embryo using the fine advancement control so that it gently comes in contact with the endoderm of the embryo just to the side of the desired point of injection (*see Note 29*).

To inject into the segmental plate, use a swift but controlled 10° turn of the fine adjustment control to penetrate the endoderm. Slowly retract the needle several degrees (*see Note 30*). See that the endoderm is slightly pulled. Upon injection, you should see a slight movement of the loose segmental plate mesenchymal cells. Several microliters of a saturated Nile Blue (a vital dye) may be added to aid in visualizing the injected material. Retract the needle smoothly and gently out of the embryo (**Fig. 2**; *see Note 31*).

In the case of somitocoel injection, continue to advance the injection needle tip until it makes contact with the outside of the chosen desired somite. With the fine advancement control, test this contact by nudging the somite gently and seeing that the somite moves. As described earlier, use a swift but controlled 10° turn of the fine adjustment control to penetrate the somite and retract. Upon injection, the somite should be seen to swell (*see Note 32*). Retract the needle smoothly and gently out of the embryo. Minimal leaking should be seen (**Fig. 3**).



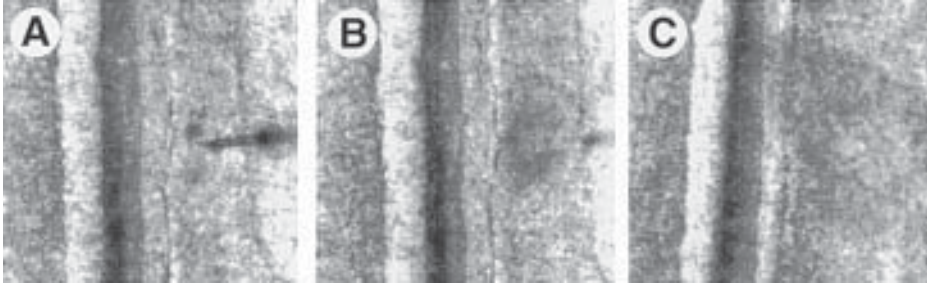

Fig. 2. Sequential views of segmental plate injection. Embryos were injected with 50 ng *Paraxis* antisense ODNs in 10 nL Ringers solution plus 2% Nile Blue sulfate into a stage 13 chick embryo segmental plate (A–C). In (A) the microinjection needle is positioned inside the segmental plate ready for injection. After injection and retraction of the needle, the dark, injected ODN solution remains confined in the segmental plate (B). If the ectoderm on the underside of the inverted, explanted embryo had been punctured, the dark solution would bleed into a wider area and would be visible under the neural tube as well as lateral to the segmental plate (C).

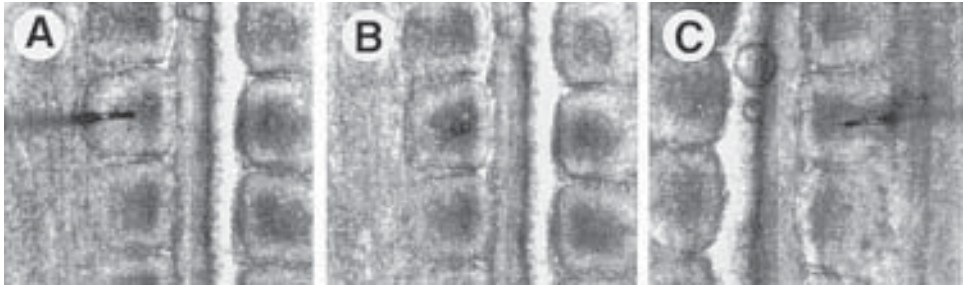

Fig. 3. Sequential views of somite injection. Embryos were injected with 50 ng *Paraxis* antisense ODNs in 10 nL Ringers solution plus 2% Nile Blue sulfate into stage 13 chick embryo somites (A–C). In (A) the microinjection needle is positioned inside the somitocoel of the third epithelialized somite (the 6th somite caudal-rostrally) ready for injection. Part (B) shows the same somite after injection and retraction of the microinjection needle. The dark ODN suspension remains contained within the somite. In (C) a different embryo has been injected, this time into a damaged somite. Evidence of the excessive damage was only apparent after the dark ODN suspension began to leak from the somite.

### 3.9. Analysis

Remove treated and control embryos from the incubator and examine under the dissecting microscope to determine the condition of the embryo. Only embryos that have remained in good health are gently lifted from the albumen-agar plates, rinsed twice in Spratt Ringers solution, and prepared for subsequent analysis.

There are several ways to control the effectiveness of the ODN. Although Northern blots or reverse transcriptase-polymerase chain reaction (RT-PCR) could be used to assay for the reduction of a specific message after ODN treatment, we prefer using whole-mount *in situ* hybridization (WISH) (Figs. 4 and 5). This procedure provides

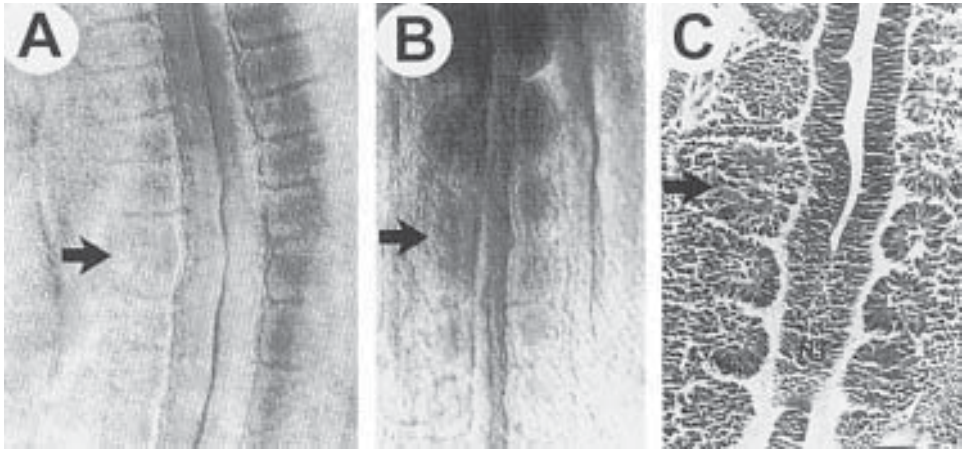

Fig. 4. Somite fusion resulting from the injection of *Pax-1* paired-box antisense ODN. (A) A stage 13 embryo exhibiting a fused somite. Abnormalities occurred in somites that developed just caudal to the injection site. (B) Whole-mount *in situ* hybridization of *Pax-1* expression in a fused somite resulting from injection of *Pax-1* paired-box antisense. Note that expression of *Pax-1* in this fused somite is less than in the normal contra-lateral somites. (C) A hematoxylin-eosin stained horizontal section of a chick embryo displaying a *Pax-1* antisense ODN-induced somite fusion. The arrow in each of the figures indicates the fused somite. This fused somite is situated directly across from two somites of normal size. Note the fused somite retains the normal histology displayed by the smaller normally segmented somites. Adapted from **ref. 18**.

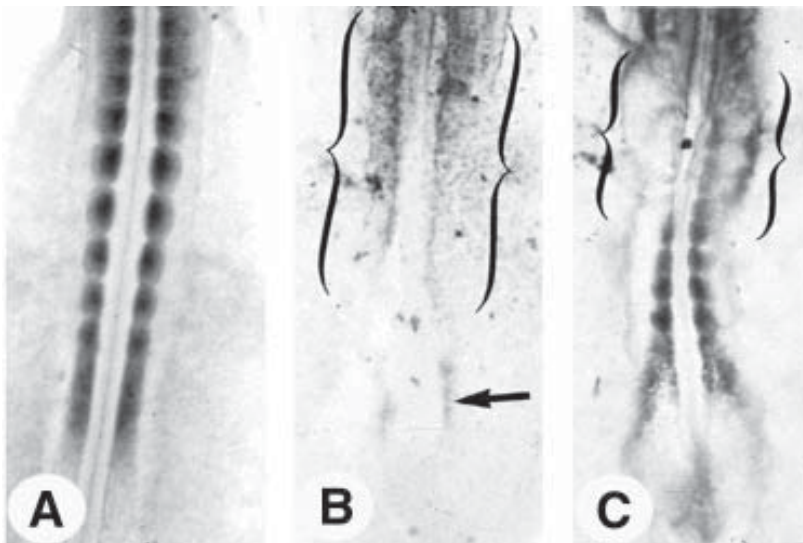

Fig. 5. Effect of topical application of *Paraxis* antisense ODN on somite development and *Paraxis* expression. (A) A normal Hamburger and Hamilton stage 14 embryo (54 h) stained for *Paraxis* by whole-mount *in situ* hybridization. (B and C) Two different stage 13 chick embryos topically treated with 50  $\mu$ g *Paraxis* antisense ODN in 50  $\mu$ L of Ringer's solution. The brackets in both (B) and (C) indicate regions in which somite formation is disrupted. *Paraxis* expression is either absent (B) or very reduced (C). The arrow in (B) indicates a region in the segmental plate in which *Paraxis* expression is reappearing (adapted from **ref. 24**).

both temporal and spatial information regarding the production of the target mRNA that can be directly compared to any “induced” phenotype (*see Note 33*). One could also complement the WISH with immunoanalysis, preferably *in situ* immunohistochemistry, to confirm a reduction in protein level.

For WISH, fix the embryos in 4% paraformaldehyde in phosphate-buffered saline (PBS) for 2–4 h at room temperature or overnight at 4°C. If the embryos are to be processed for *in situ* immunohistochemistry, the embryos may need to be fixed with either ethanol or Histochoice (Amresco Inc., Solon, OH, cat. no. H120). Wash the embryos twice in PBS for 15 min and pass them through a graded methanol dehydration process. We trim the embryos and perform our morphological analyses of the embryos while they are in the 100% methanol. Embryos can be stored in 100% methanol inside a closed container wrapped in Parafilm for up to 1 mo. Otherwise the embryos are rehydrated in a graded fashion for subsequent processing.

#### 4. Notes

1. Humidity is generated by passing air through a pan of sterile water in the incubator. We use a fish tank air pump available at pet supply stores to bubble air through the water.
2. We use a two-hole paper hole punch, as it does not have page guards on either side. This allows 3/4 in. strips of the thick chromatography paper to slide freely along the track of hole punch and facilitates offset hole punching.
3. The injector chosen should operate with positive displacement to avoid backfilling, a significant problem when injecting volumes in the nanoliter range.
4. The micromanipulator chosen should have mobility in all three planes and a fine adjustment knob for advancement. Note that they come in right- and left-handed configurations.
5. Stands with magnetic clamps that are more stable are also available through other vendors (e.g., World Precision Instruments).
6. We now work exclusively with digital sequences obtained from our sequencing facility or from “ENTREZ” nucleotide sequence searches on GeneBank accessed via the Internet at [www.ncbi.nlm.nih.gov](http://www.ncbi.nlm.nih.gov). The design of ODNs can be facilitated by programs such as MacVector (Oxford Molecular Biology Group, Inc., Campbell, CA, at [www.oxmol.com](http://www.oxmol.com)) or Oligo (from NBI/Genovus, Plymouth, MN). These programs allow direct comparison of sequences to avoid cross-reactivity, and screen for ODNs within desired stretches of the target mRNA.
7. To effectively search in GeneBank with short sequences, it is important to use the “Advanced BLAST Search” option while changing the default “expect value” parameter to 1000.
8. On occasion, we have had to design several ODNs before arriving at an effective sequence. ODNs against other positions along the target mRNA have also been used successfully. It may also be advantageous to apply two different ODNs versus the same message to more effectively block expression (**21**).
9. It has been reported that antisense ODNs containing the sequence TCCC anywhere within the ODN enhances the effectiveness of the ODN (**22**).
10. Unbound modifiers (sulfur groups in the case of phosphorothioated ODNs) are one of the primary causes of nonspecific toxic effects (**16**).
11. These ODN stock solutions can be kept for up to 12 mo at –20°C. Repeated freeze thawing of ODN solutions should be kept to a minimum.
12. We allow the albumen to pour into a large weigh boat and use the flexibility of the weigh boat to create a spout to pour the albumen into the Erlenmeyer flask.

13. Add just enough phenol red so that when the embryo culture plates are made, they have a medium pink color. The phenol red is added to monitor the acidity of the plate during culturing and to create contrast to visualize the embryo better.
14. Be consistent with the amount of albumen agar mixture added to each plate in order to better “standardize” the height of the explanted embryos. This will facilitate injection later in the procedure, as the embryos will be in a more consistent focal plane.
15. To achieve this, we favor magnetic strength slightly over heat intensity (3:2 ratio). Under 40X magnification, we cut the tip of the pulled needle with microsurgical scissors just behind the point at which the interior walls of the pulled needle fuse. The resulting width of the injection tip should be between 20 and 30  $\mu\text{m}$ .
16. Whether studying somite formation or maturation, it is advantageous to administer the ODN to a stage 12 or 13 embryo. At this time the embryo has between 16–20 somites, which together represent a full complement of all the elements of the early stages of somitogenesis: paraxial mesoderm, segmental plate, condensed somites, epithelial somites, and somites undergoing primary somite differentiation (sclerotomal migration). More importantly, the circulatory system and the dorsal aortae have not yet formed and are not transporting large amounts of fluid. There is little threat that the topically applied ODN will be washed away prior to reaching its target. After injection, the punctured endoderm of the future dorsal aorta will have time to heal, minimizing hemorrhage that can either kill an embryo or induce malformations. In addition, the escaping circulatory fluid will not wash away the injected ODN and will not be diluted or washed away by the circulation.
17. We do this by tapping it along a sharp metal edge such as that provided by an inverted heat block insert.
18. In order to facilitate the proper orientation of the embryo for explantation, eggs are placed on their sides for 45–60 min at 38°C prior to cracking. This allows the embryo to orient itself on the top side of the yolk so that when the egg contents are dropped into the dish the embryo is easily accessible.
19. It is preferable to remove as much residual yolk as possible from the embryo. However, it is equally important to be gentle during the washes to impose minimal physical stresses on the embryo, which themselves can cause developmental axial anomalies.
20. Keeping the embryos at physiological temperature (38°C) increases the viability and overall condition of the embryo cultures.
21. The inverted orientation of the embryo is advantageous to both topical and injected applications. Penetrance of topically applied ODNs to target tissues may be facilitated by the absence of the vitelline membrane. In addition, only the endoderm needs to be traversed by the microinjection needle to access the target tissue. Control experiments indicate that embryos survive longer in this orientation under these culture conditions.
22. We use injection for spatially controlled reduction of gene expression, i.e., injection of 50 ng antisense ODN affects only one or two somites. This was shown by observing the distribution of fluorescently labeled ODNs in the embryo as a control during the treatment protocol (18). We use topical ODN applications to reduce gene expression in a broader area.
23. The dose of ODN applied must be titrated to minimize any toxic effects of the ODN while reliably disturbing gene expression. In the case of topical ODN application, we begin with 5  $\mu\text{g}$  ODN in 10  $\mu\text{L}$  of vehicle (Spratt Ringer’s solution): for injections into the somitocoel or segmental plate, 50 ng in a 10-nL vol.
24. The stringency of embryo selection prior to treatment is a critical component of these experiments. Only those embryos that are clearly robust and completely normal in terms of morphology should be used. Careful observation and staging of individual embryos both before and after treatment will facilitate the interpretation of experimental results.

25. The mechanism of delivery is an important consideration. In our system, we have found that naked ODNs are quite effective in entering target tissue and blocking specific gene expression (18,23–25). Several other options exist including delivery with cationic lipids and conjugation to fusogenic proteins (14,26–28). The use of lipid delivery systems introduces new variables into the treatment protocol that must be properly controlled for.
26. If the drop is allowed to fall too far, it will damage the embryo. Damaged embryos should be discarded. In general, the site at which the ODNs penetrate the embryonic tissue is quite well restricted to the point of administration (18).
27. Embryos between 36 and 48 h old may be cultured on the plates to a maximum age of 72 h without producing significant developmental anomalies. In some cases turning the head to the right relative to the trunk may be prevented; however, axial and vascular development remains normal. Development on these plates beyond 72 h is delayed, inconsistent, and essentially unachievable due to the limitations in vascular development imposed by the filter ring. Thus, for embryos to be cultured to 72 h or slightly beyond, larger explant rings can be used to provide greater surface area and slightly longer normal development on these plates.
28. ODNs delivered by injection appear to act in a more immediate fashion than those applied topically. Injected anti-*Pax-1* ODN appears to take effect within 90–120 min (18,23). Topically applied anti-*Paraxis* ODN appears to take effect within 6–8 h (24). This may be a function of penetrance of the ODN to the target tissue. Topically applied ODN must pass through the endoderm before reaching the target, i.e., segmental plate. The consequence of this is that the observed phenotype will be observed 3–4 somites caudal to the last formed somite observed pretreatment in the case of topically applied ODNs.
29. The endoderm is a delicate structure at the level of the segmental plate and somites. A 20- $\mu$ m injection needle tip should be sharp enough to pass through this germ layer easily.
30. We have found that injection of ODNs works better if the microinjector needle is slightly retracted just before injection. Injected volumes should be kept as small as possible in order to minimize mechanical disruption of the tissue surrounding the injection site.
31. In an ideal setting, the same injection needle may be used for all injections of the same ODN. The needle must be changed between injecting different ODNs. Therefore, it is a good idea to sort the embryos into the various experimental and control groups before the injections are begun. However, occasionally the injection needle can become clogged and needs to be changed.
32. The somite will return to its original size shortly (Fig. 5). Control experiments have shown that the somite will return to its original size and heal itself in a timely manner so that injection of controls produces no observable defect 18 h later (after considerable somite differentiation).
33. The effectiveness of a chosen ODN in knocking down the expression of a gene of interest varies not only between ODNs of different design, but also as a function of slight or imperceptible differences in ODN delivery and penetrance combined with variability in the genetic background between chick embryos treated (see Figs. 5 and 6).
34. The ODNs appear to exert their effect over a 12–16 h period as indicated by the recovery of target gene expression, e.g., *Paraxis*, in the segmental plate representing a distance equivalent to 8–10 somites caudal to the first observed mRNA reduction and coincident somitic defect (Fig. 3).
35. In vivo, one new somite pair forms every 90–100 min. In our culture system, new somite pairs form at a slightly slower rate of one new somite pair per 100–110 min. For example, a stage 13 embryo that has been cultured for 16 h has formed 10 somite pairs instead of the expected 12.

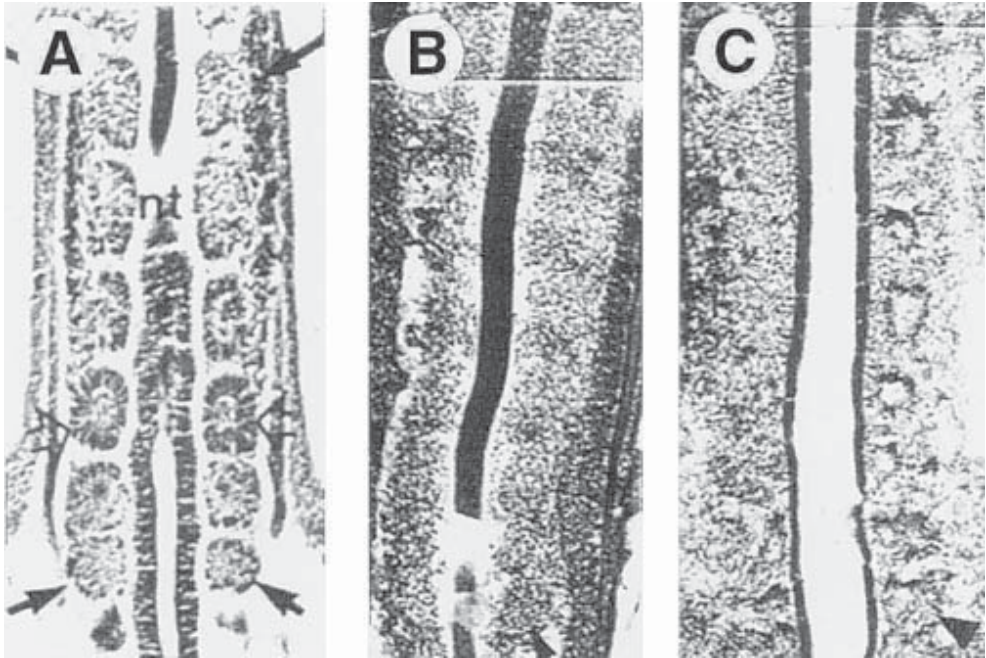

Fig. 6. Somite histology of embryos treated with topically applied *Paraxis* antisense ODN. Horizontal sections of control (A), and embryos treated with topically applied ODN (B and C) were stained with hematoxylin-eosin. Somitogenesis is absent in the somitic region of the embryo depicted in (B), consistent with absent epithelialization. Note that in this embryo there remain alternating bands of less and more cell condensation, consistent with anterior-posterior patterning of more mature sclerotome indicating that segmentation may be retained. Although somite structures are apparent in (C), their size and shape are irregular, consistent with poor condensation and/or epithelialization during their formation. (Note that the embryo in [C] is not sectioned along a true frontal plane.) Notice the varying phenotypes in different individuals resulting from apparently identical treatments of *Paraxis* antisense ODN. Figures adapted from ref. 24.

### Acknowledgment

Supported in part by National Institutes of Health (NIH) grants ES07005, DE11327, AR44501, and DE12864. AMD was supported by NIH training grant T32-ES07282.

### References

1. Toulme, J. J. and Helene, C. (1988) Antimessenger oligodeoxynucleotides: an alternative to antisense RNA for artificial regulation of gene expression—a review. *Gene* **72**, 51–58.
2. Dagle, J. M., Weeks, D. L., and Walder, J. A. (1991) Pathways of degradation and mechanism of action of antisense oligonucleotides in *Xenopus laevis* embryos. *Antisense Res. Dev.* **1**, 11–20.
3. Eckstein, F. (1985) Investigations of enzyme mechanisms with nucleoside phosphorothioates. *Ann. Rev. Biochem.* **54**, 367–402.
4. Loke, J. W., Stein, C., Zhang, X., Mori, K., and Nakanishi, C. (1989) *Proc. Natl. Acad. Sci. USA* **86**, 3474–3478.

5. Lorenz, P., Baker, B. F., Bennett, C. F., and Spector, D. L. (1998) Phosphorothioate antisense oligonucleotides induce the formation of nuclear bodies. *Mol. Biol. Cell* **9**, 1007–1023.
6. Spratt, N. (1947) A simple method for explanting and cultivating early chick embryos in vitro. *Science* **106**, 452.
7. Augustine, K. (1997) Antisense approaches for investigating mechanisms of abnormal development. *Mutat. Res.* **396**, 175–193.
8. Brysch, W. and Schlingensiepen, K. H. (1994). Design and application of antisense oligonucleotides in cell, culture, in vivo, and as therapeutic agents. *Cell Mol. Neurobiol.* **14**, 557–568.
9. Sczakiel, G. (1997) The design of antisense RNA. *Antisense Nucleic Acid Drug Dev.* **7**, 439–444.
10. Stein, C. A. (1998) How to design an antisense oligodeoxynucleotide experiment: a consensus approach. *Antisense Nucleic Acid Drug Dev.* **8(2)**, 129–132.
11. Altmann, K. H., Fabbro, D., Dean, N. M., Geiger, T., Monia, B. P., Muller, M., and Nicklin, P. (1996) Second-generation antisense oligonucleotides: structure-activity, relationships and the design of improved signal-transduction inhibitors. *Biochem. Soc. Trans.* **24**, 630–637.
12. Toulme, J. J., Tinevez, R. L., and Brossalina, E. (1996) Targeting RNA structures by antisense oligonucleotides. *Biochimie* **78**, 663–673.
13. De Mesmaeker, A., Altmann, K. H., Waldner, A., and Wendeborn, S. (1995) Backbone modifications in oligonucleotides and peptide nucleic acid, systems. *Curr. Opin. Struct. Biol.* **5**, 343–355.
14. Gewirtz, A. M., Stein, C. A., and Glazer, P. M. (1996) Facilitating oligonucleotide delivery: helping antisense deliver on its promise. *Proc. Natl. Acad. Sci. USA* **93**, 3161–3163.
15. Eckstein, F. (1979) Phosphorothioate analogs of nucleotides. *Acc. Chem. Res.* **12**, 204–210.
16. Stein, C., Subasinghe, C., Shinozuka, K., and Cohen, J. (1988) Physicochemical properties of phosphorothioated oligodeoxynucleotides. *Nucleic Acids Res.* **16**, 3209–3221.
17. Zon, G. (1995) Antisense phosphorothioate oligodeoxynucleotides: introductory concepts and possible molecular mechanisms of toxicity. *Toxicol. Lett.* **82–83**, 419–424.
18. Smith, C. A. and Tuan, R. S. (1995) Functional involvement of Pax-1 in somite development: somite dysmorphogenesis in chick embryos treated with Pax-1 paired-box antisense oligodeoxynucleotide. *Teratology* **52**, 333–345.
19. Hamburger, V. and Hamilton, L. (1951) A series of normal stages in the development of the chick embryo. *J. Morphol.* **88**, 49–52.
20. Bellairs, R. and Osmond, M. (1998) *The Atlas of Chick Development*, Academic, New York.
21. Kandimalla, E. R., Manning, A., Lathan, C., Byrn, R. A., and Agrawal, S. (1995) Design, biochemical, biophysical and biological properties of cooperative antisense oligonucleotides. *Nucleic Acids Res.* **23**, 3578–3584.
22. Tu, G. C., Cao, Q. N., Zhou, F., and Isreal, Y. (1998) Tetranucleotide GGGA motif in primary RNA transcripts—novel target site for antisense design. *J. Biol. Chem.* **273**, 25,125–25,131.
23. Barnes, G. L., Jr., Mariani, B. D., and Tuan, R. S. (1996) Valproic acid-induced somite teratogenesis in the chick embryo: relationship with Pax-1 gene expression. *Teratology* **54**, 93–102.
24. Barnes, G. L., Alexander, P. G., Hsu, C. W., Mariani, B. D., and Tuan, R. S. (1997) Cloning and characterization of chicken *Paraxis*: a regulator of paraxial mesoderm development and somite formation. *Dev. Biol.* **189**, 95–111.

25. Love, J. M. and Tuan, R. S. (1993) Pair-rule gene expression in the somitic stage chick embryo: association with somite segmentation and border formation. *Differentiation* **54**, 73–83.
26. Miller, K. J. and Das, S. K. (1998) Antisense oligonucleotides: strategies for delivery. *Pharmaceut. Sci. Tech. Today* **1**, 377–386.
27. Monkkonen, J. and Urt, A. (1998) Lipid fusion in oligonucleotide and gene delivery with cationic lipids. *Adv. Drug Delivery Rev.* **34**, 37–49.
28. Spiller, D. G., Giles, R. V., Grzybowski, J., and Clark, R. E. (1998) Improving the intracellular delivery and molecular efficacy of antisense oligonucleotides in chronic myeloid leukemia cells: a comparison of streptolysin-O permeabilization, electroporation, and lipophilic conjugation. *Blood* **91**, 4738–4746.



## Application of Functional Blocking Antibodies

### *N-Cadherin and Chick Embryonic Limb Development*

**Steven A. Oberlender and Rocky S. Tuan**

#### 1. Introduction

The current trend in developmental biology research is to identify candidate functional genes and then manipulate their expression or activity by either gain or loss of function to elucidate the specific roles of their protein products. One such procedure is the introduction of antigen-specific antibodies that are capable of precisely interfering with the function of a particular protein in a specific anatomical structure of the developing embryo. This technique, when performed correctly, proves to be a very powerful tool when investigating the presumed function of a specific protein.

Monoclonal antibodies have the unique characteristic of interacting with a single epitope of a given antigen such as a protein. The ability to produce such monoclonal antibody has proven to be one of the most important modern scientific advances (1). Here we describe the procedure we have developed in administering a specific monoclonal antibody to the cell adhesion protein, N-cadherin (2), to the developing chicken embryonic limb bud to investigate the functional importance of N-cadherin (3). A key method required for this technique is the establishment of shell-less chick embryo cultures (4). Although this chapter covers a specific protocol for N-cadherin in the developing chick limb, the procedure may be modified appropriately for application to investigate other developmental systems.

#### 2. Materials

1. Ethanol: 95% for washing down cell culture hoods, rubber bands, and glass stirring rod; 70% for cleaning off eggs.
2. Phosphate buffered saline (PBS), pH 7.4: composition per liter, 8 g NaCl, 0.2 g KCL, 1.15 g Na<sub>2</sub>HPO<sub>4</sub> and 0.2 g KH<sub>2</sub>PO<sub>4</sub>.
3. PBS-buffered 10% formalin: Pure formaldehyde is ~38% w/v, which is equivalent to 100% formalin. Therefore, one part pure formaldehyde (Sigma Chemical Co., St. Louis, MO) added to nine parts PBS will yield 10% formalin buffered with PBS. Formaldehyde should be used within 3 mo of purchase.
4. Vital dye Nile Blue sulfate; add to antibody solution just prior to use.

5. Mineral oil; keep isolated and as clean as possible. Only pour out of the jar; do not dip tubes into the jar.
6. Acid-alcohol Alcian Blue.
7. 2% KOH: 2 g KOH per 100 mL distilled, filtered water.
8. Glycerin 50% (1:1 with distilled water) and 100%.
9. 10  $\mu$ L micropipets (Drummond, Broomall, PA).
10. For shell-less chick embryo culture (*see Methods*): culture stand, plastic wrap, and rubber bands.
11. Microinjector (e.g., Drummond).
12. Micropipet puller (e.g., Narashige, Tokyo, Japan).
13. Dissection tools: precision-curved forceps, blunt forceps.

### 3. Methods

#### 3.1. Shell-less Chick Embryo Cultures

1. Fertilized White Leghorn chicken eggs (*see Note 1*) are incubated in a humidified egg incubator at 99°F for 3 d. The eggs are then removed and placed on their sides in an egg crate, previously sterilized by autoclaving, for ~10–15 min. This allows the embryos to float to the top of the egg (**3**).
2. The entire procedure is then carried out in a sterile culture hood. Because the eggs are set on their sides, the culture apparatus is prepared. Three inch diameter PVC (polyvinyl chloride) conduit tubes are obtained and previously cut in cross section to obtain ~3 in sections when stood on end (*see Note 2*). The tube sections are then autoclaved and allowed to cool prior to using them. A piece of plastic food wrap (i.e., polyethylene kitchen wrap; *see Note 3*) is then placed over the top or up end of the tube with at least 2 in of overhang around the tube. A slight depression is made in the center of the wrap with a blunt end, sterile glass rod. This will form a concave surface in which the embryo will sit. Be careful not to create any small tears in the food wrap. A rubber band which has been soaked in ethanol is then placed around the outside of the top of the tube, making sure the overhanging food wrap is underneath the rubberband. This will serve to secure the food wrap in place with the pouch preserved in the center of the tube.
3. The eggs are then sprayed with ethanol to decrease the likelihood of contamination. The first egg is then carefully cracked along a sharp edge, similar to the way in which one would crack an egg when making breakfast, making sure to keep the egg in the same orientation as it has been in for the last several minutes (*see Note 4*). The egg shell is then slowly separated just above the tube, and the contents are allowed to gently slide onto the food wrap. If done correctly, the embryo, with its attached vasculature and yolk, should be floating on top. A 100-mm Petri dish lid is then placed on top of the tube (it should sit on top of the tube without sliding off, but it does not have to be a perfect fit). The entire culture apparatus is then placed in a humidified incubator at 37.5°C with constant air flow and allowed to continue to develop.

#### 3.2. Injection of Antibodies into Chick Limb Buds

1. When the chick embryos have reached Hamburger–Hamilton (H–H) stage 22–24 (*see Note 5*), the time period in which the limb mesenchyme condenses and differentiates into chondrocytes, the shell-less chick cultures are removed from the incubator and placed into a sterile culture hood (**1**).
2. Two antibody preparations were used in our study. For the control antibody, rat IgG antibodies were obtained commercially from Sigma and diluted to a concentration of 10 mg/mL in PBS at physiological pH. NCD-2, a rat-derived monoclonal antibody directed against

the extracellular binding region of N-cadherin and capable of blocking N-cadherin-mediated homophilic interaction, was purified from an NCD-2 rat hybridoma cell line (2) using a standard procedure involving ammonium sulfate precipitation and DEAE ion-exchange chromatography (1), and stored as a lyophilized preparation at  $-20^{\circ}\text{C}$  (4). The antibody was reconstituted prior to its use in PBS at physiologic pH to a working concentration of 10 mg/mL.

3. In order to visualize the efficacy of each injection, a small quantity of the vital dye Nile Blue sulfate was added to each of the antibody preparations (*see Note 6*).
4. Prior to the procedure, you must prepare the injection apparatus, especially the injection micropipets. For this procedure, 10  $\mu\text{L}$  micropipets are used for impalement and injection into the limb bud. These injection pipets may be prepared by handpulling the micropipets in a Bunsen flame (see later). However, a commercially available micropipet puller is preferred for more controlled and reproducible production. Occasionally, the end of the injector is sealed, but this can be cut open using a fine pair of sharpened surgical scissors (*see Note 7*). If the automated pipet puller is not readily available, similar microinjectors may be produced by holding a capillary tube in the thumb and index fingers of both hands and slowly rolling it with its center over a Bunsen flame. Gently apply even tension in opposite directions with your hands. As the middle section of glass melts and softens, move it away from the flame and the capillary tube will pull apart, creating fine tapered ends. These may also need to be cut open with fine scissors (*see Note 8*).
5. A microsyringe must be used to inject the limb buds. You may use either a mechanical or electronically operated syringe that allows you to reproducibly inject quantities in 1–2  $\mu\text{L}$  increments. For our experiments, we used two types of microsyringes. One type was a hand-engineered mechanical burette plunger connected to a syringe. The burette scale needs to be calibrated to correspond to exact quantities of solution (*see Note 9*). The automated device we used was an electronically operated microsyringe manufactured by Drummond equipped with an operating pad with options for injection quantities and plungers that fit into 10  $\mu\text{L}$  capillary tubes. The microsyringe is mounted onto a micromanipulator with the capability of precision micromovements in all three planes (*see Note 10*). A pulled capillary microinjector pipet is then removed from its holding case and the tip is dipped into an ethanol-filled beaker. The blunt, back end of the capillary is then placed into a thin layer of mineral oil and the oil is allowed to back-fill by capillary diffusion to a height of  $\sim 0.5$ – $1.0$  cm (*see Note 11*). The microinjection needle is then placed onto the microsyringe. At this time, the plunger is passed into the needle and the excess ethanol is purged from the tip. The tip is then lowered into a microcentrifuge tube containing the suspended antibody preparation and the plunger is pulled back, thus filling the needle (*see Note 12*).
6. Retrieve a shell-less cultured chick embryo from the incubator. After removing the Petri dish lid under the culture hood, it will become readily evident that the embryo is lying on one side, almost always exposing its right side, i.e., only one forelimb and one hindlimb. Physically turning the embryo over to inject the other limb should be avoided, as such a harsh manipulation inevitably results in the death of the embryo.
7. Place the entire shell-less culture apparatus on the stage of a stereoscopic dissecting microscope with good optics and fiber optics illumination. To maintain a clean and sterile technique, the base and stage of the microscope should be wiped down with ethanol prior to its use and introduction into the hood.
8. Overlying the embryo are the clear embryonic membranes. Using fine forceps, gently tease away the membranes so as to gain access to both exposed limbs (*see Note 13*).
9. Carefully position the microsyringe and injection pipet at an angle of about  $45$ – $60^{\circ}$  to the limb bud, and using the micromanipulator, bring the tip of the pipet in close proximity to

the limb bud. The syringe is then advanced until contact of the tip of the needle is made with the limb bud. The point of injection should be as close to the center of the limb bud as possible. If the tip of the injection pipet is very sharp (which is preferable), then it will easily pass into the tissue. At this point, you only want to advance it a few microns past the outer, epithelial layer. Because you will be looking head-on at the tissue in its long axis, it is not possible to visually gage how far into the tissue the tip has penetrated. However, after performing several passes, it will be possible to get the feel of where to place the pipet tip. If the tip is not extra sharp, the tissue may begin to depress inward at the point of contact. Advancing slightly further will usually create enough pressure so that the tissue gives and the pipet tip penetrates the outer surface.

10. When you feel that your positioning is correct, start to inject the antibody solution into the limb bud. You should then visualize active filling of the antibody solution into the limb bud as you are injecting (*see Note 14*). If done correctly, a “blue ball” should be situated within the central region of the limb bud. The total volume injected should range from 0.5–1.0  $\mu\text{L}$  per limb bud.
11. Because it is not advisable to turn the embryo to gain access to the contralateral limb buds, and because forelimbs should not be compared to hindlimbs, modifications have to be made as far as experimental controls are concerned. In our study, for all experiments, either the right forelimb or right hindlimb was injected with NCD-2, and the other right limb was injected with the same volume of control rat IgG. All comparisons are made between the injected limb and the contralateral, uninjected limb. In addition, the rat IgG injected limbs serve as both a control for possible effects due to the injection buffer or the presence of rat IgG, as compared to the contralateral, uninjected limb. Provided enough injections are done, differences may be considered significant.
12. After both injections are made (*see Note 15*), there is no need to try and replace the membranes that have been teased away. Simply replace the Petri dish lid, place the culture vessel back in the incubator, and leave undisturbed.

### **3.3. Whole-Mount Alcian Blue Staining of Chick Limb Buds**

1. Two days after the limb buds are injected, remove the shell-less cultures from the incubator (the rest of the protocol does not necessitate the use of a culture hood). The Petri dish lids are removed and the embryo is gently separated from the extra embryonic membranes and placed into a Petri dish by grasping the embryo gently, but firmly on the torso with a pair of fine forceps. Any attached blood vessels and membranes are gently teased away from the embryo.
2. The entire embryo is then placed in a 7-mL glass or polypropylene vial and then filled with PBS-buffered 10% formalin for fixation. The embryo may be stored in this manner until whole-mount staining is performed (*see Note 16*).
3. The fixative is carefully decanted and then acid-alcohol Alcian blue is poured in and left to stand for 17 h (5).
4. The Alcian blue is poured off and 2% KOH is added in order to clear and macerate the soft tissue (*see Note 17*).
5. After the desired result is obtained, the KOH is decanted and a 50% solution of glycerin is added for several hours. This is then replaced with 100% glycerin, which allows the specimen to be stored until analysis can be performed.
6. For observation, the embryos are poured from the vials into a Petri dish and the limbs are carefully separated from the torso by using fine surgical microscissors and fine forceps. This should be done using the stereo dissecting microscope with a fiber-optic light source. The torso is then discarded. Again, it is critical to keep the correct orientation of the limbs.

7. Each set of limbs, the injected (NCD-2 or rat IgG) and contralateral control, is then analyzed by observation using a stereo microscope. A good specimen should be cleared of soft tissues, allowing the cartilaginous structures to be clearly visualized. Specimens may be photographed using black and white or color photography.

#### **4. Notes**

1. The farm where you obtain the eggs should have a good record of reliability. Over 95% of the eggs should be fertilized and delivered to the lab refrigerated and unincubated. In this manner, you can refrigerate the eggs (at 45–50°F) up to several days and then begin the incubation at a convenient time point.
2. The PVC tubes that we used are obtained in the form of drainage pipes from a plumbing supplier and then cut with a circular saw. Cut edges are smoothed by sanding.
3. In our experience, generic plastic wraps (i.e., store-brand) obtained at the food market yield better than brand name products.
4. One must crack the egg very gently. We use a rectangular block of stainless steel and crack the eggs on a sharp edge, creating a precise split in the eggshell.
5. Each egg incubator will vary slightly in temperature and humidity, and one must calibrate the length of time that corresponds to specific Hamburger–Hamilton stages.
6. There is no exact amount of dye that needs to be added. Simply add a few microliters of a saturated solution so that the color is visible and keep this amount constant throughout all of your experiments.
7. The capillary microinjectors, once prepared, should be carefully stored in a large Petri dish until they are used. We added a piece of clay to the bottom of the dish and placed the microinjectors lengthwise into the clay, making sure the ends were suspended just above the bottom of the dish. In this manner, the microinjectors remain relatively secure until their use.
8. If performing a manual capillary tube pull, do not stop applying tension when the tube begins to separate. Pull the ends evenly and fully apart.
9. The buret may be calibrated by weighing quantities of water delivered according to specific calibration marks on an analytical balance. The volume is calculated based on the density of water ( $1\ \mu\text{g} = 1\ \mu\text{L}$ ).
10. Before attempting any experiments, become completely familiar with the correct operation of the micromanipulator. Failure to do so will likely result in damage to the embryo when performing the experiment.
11. The mineral oil creates a tight seal so that the plunger operates correctly. Without the oil, the plunger will move and not deliver the correct amount of solution because of air pockets.
12. Be very careful not to damage or contaminate the tip of the microinjection pipet.
13. The embryonic membranes must be penetrated prior to injection. This can be done by fine manipulation with precision-curved forceps. Sometimes, using two pairs of forceps and creating small tears in the membranes, while avoiding blood vessels and embryonic movement, will allow you to gain access as well.
14. If the pipet accidentally passes through the entire limb bud, the blue dye will be seen dispersing under the embryo. If this happens, stop injecting, back up the pipet slightly into the limb bud, and begin injecting again. Another possible outcome is that the pipet contacts a blood vessel. If this happens, the blue dye will be seen to circulate up the limb bud and into the embryonic vasculature. Once again, repositioning the syringe should resolve this problem. Because of these potential situations, only inject a very small quantity of antibody once the pipet tip is thought to be in the correct position. Once verified, you may finish the injection. It is important to note that any repositioning of the syringe should be

done in an “in and out” manner and not in a “side to side” fashion, to minimize trauma to the embryo.

15. The same injection pipet may be used for about five injections before replacement because of dulling of the tip. One must never use the same pipet for different antibody solutions. Therefore, we generally filled a pipet with a particular antibody solution and then used it to inject five embryos (forelimbs) that were placed in the hood at the same time. We then switched pipets and injected the other limbs (hindlimbs) of the same five embryos, and then placed all of them back into the incubator.
16. In order to maximize efficiency, a large number of embryos should be stored and processed for whole-mount staining. The crucial point here is to keep the orientation of the embryos correct. Remember, only one side of the embryos is injected, and because it is usually the right side, it may also be the left side at times. A good labeling system is a key feature to proper interpretation of the results.
17. Unfortunately, there is no exact time to use for this step. Therefore, the embryos have to be periodically examined to assess the amount of clearing that is taking place. When a sufficient amount of clearing is obtained, the next step is performed. If the embryos are left in too long, they will “dissolve,” rendering the experiment uninterpretable. Generally, several hours are needed, but the time fluctuates from experiment to experiment. However, leaving them unattended overnight is strongly discouraged.

### Acknowledgment

This work is supported in part by grants from the NIH (HD15822, HD29937, and DE11327).

### References

1. Harlow, E. and Lane, D. (1988) *Antibodies: A Laboratory Manual*, Cold Spring Harbor Laboratory, Cold Spring Harbor, New York.
2. Hatta, K. and Takeichi, M. (1986) Expression of N-cadherin adhesion molecules associated with early morphogenetic events in chick development. *Nature* **320**, 447–449.
3. Oberlender, S. A. and Tuan, R. S. (1994) Expression and functional involvement of N-cadherin in embryonic limb chondrogenesis. *Development* **120**, 177–187.
4. Tuan, R. (1980) Calcium transport and related functions in the chorioallantoic membrane of cultured shell-less chick embryos. *Dev. Biol.* **74**, 196–204.
5. Kimmel, C. A. and Trammell, C. (1981) A rapid procedure for routine double staining of cartilage and bone in fetal and adult animals. *Stain Technol.* **56**, 271–273.

## Gene Expression Analyzed by Ribonuclease Protection Assay

Vickie D. Bennett

### 1. Introduction

The ribonuclease (RNase) protection assay provides a highly sensitive method for the detection and quantitation of specific RNAs from tissues and cells as well as for the analysis of mRNA and gene structure (**1**). This solution hybridization approach is at least 10-fold more sensitive than Northern blot analysis, and thus is useful for the evaluation of low-abundance mRNAs. Furthermore, the greater stability of the RNA duplex structure over RNA–DNA hybrids used in S1 nuclease protection assays provides the greatest sensitivity among the solution hybridization approaches. Structurally, these assays also provide a useful means of determining the size of specific exons (**2,3**) in a gene and for the quantitative analysis of specific alternative splicing events occurring in homogeneous tissues (*see Note 1*), as well as the mapping of transcription start site (**4,5**).

### 2. Materials

1. Hybridization mix: 80% (v/v) deionized formamide in 40 mM PIPES, pH 6.4, 0.4 M NaCl, 1 mM EDTA. Prepare 40 mM PIPES from the disodium salt of PIPES (piperazine-N,N-bis [2-ethanesulfonic acid]), add salts, adjust the pH with 1 N HCl, and filter sterilize the solution prior to formamide addition. Store completed hybridization mix at  $-20^{\circ}\text{C}$ .
2. RNase digestion buffer: 50 mM Tris-HCl, pH 7.5, 0.5 M NaCl containing 40 mg/mL RNase A (Sigma Chemical Co., St. Louis, MO, boiled, 10 mg/mL stock) and 2 mg/mL RNase T1 (Life Technologies, Bethesda, MD). Prepare fresh prior to use from stock RNase-free solutions.
3. 10% SDS: 10% (w/v) sodium dodecyl sulfate. Filter sterilize and store at room temperature.
4. Proteinase K solution: 10 mg/mL Proteinase K (Boehringer Mannheim, Mannheim, Germany). Prepare fresh prior to use.
5. Formamide loading buffer: 80% (v/v) formamide, 10 mM EDTA, pH 8.0 containing 1 mg/mL xylene cyanol FF and 1 mg/mL bromophenol blue. Store at  $-20^{\circ}\text{C}$ .
6. Phenol equilibrated with diethylpyrocyanate-treated water.
7. General RNase-free stock solutions:
  - a. 2.5 M ammonium acetate.
  - b. 3 M sodium acetate.

- c. 100 mM EDTA, pH 8.0.
- d. TE: 10 mM Tris-HCl, pH 8.0 10 mM EDTA.
- e. Absolute ethanol.
8. Ethanol/dry-ice bath.
9. 8% denaturing polyacrylamide gel.
10. TBE (Tris-borate/EDTA) electrophoresis buffer: Prepare 10X stock solution with 108 g Tris base, 27.5 g boric acid, and 20 mL 0.5 M EDTA, pH 8.0 in 1 L. Use at 1X (1:10 dilution) working strength for polyacrylamide gel electrophoresis. A precipitate often forms in concentrated solutions of TBE over time; filter sterilize the 10X stock solution and store in a clean glass bottle at room temperature to avoid precipitate formation for as long as possible. Discard if precipitate develops before use.

### 3. Methods

#### 3.1. Preparation of Probe

RNase protection assays require the use of a uniformly labeled RNA probe that is completely complementary to the RNA to be analyzed. Generally, this probe, because of the sensitivity of the RNase digestion, should be species-specific (*see Note 2*).

1. Subclone a cDNA fragment containing the sequence of interest into the multiple cloning site of a plasmid vector containing the cloned copies of two different bacteriophage DNA-dependent RNA polymerase promoters (derived from bacteriophage SP6, T7, or T3) arranged in opposite orientations and separated by the multiple cloning site (*see Note 3*). This subcloning can be done directionally or the orientation can be determined subsequent to subcloning.
2. Linearize the plasmid with a restriction enzyme that will result in a 100- to 500-base runoff transcript that is complementary to the sequence of interest (antisense RNA) when the plasmid is transcribed with the appropriate bacteriophage polymerase. The linearized plasmid should be phenol/chloroform extracted to minimize RNase contamination. Complete digestion of the plasmid is essential to prevent generation of very long transcripts containing substantial vector-derived sequences that incorporate significant amounts of the radiolabeled ribonucleotide during in vitro transcription. Thus, a portion of the linearized product should be run on an agarose gel to check for complete digestion of the plasmid prior to in vitro transcription.
3. Synthesize a uniformly labeled, antisense RNA probe by in vitro transcription of the linearized template with the appropriate bacteriophage DNA-dependent RNA polymerase. We currently use a commercially available in vitro transcription kit (Promega, Madison, WI) in a 20-mL reaction volume containing 0.3–0.4 pmole linear template DNA and 50 mCi [ $\alpha$ - $^{32}$ P] CTP (Amersham, specific activity of 800 Ci/mmole; 20 mCi/mL) according to the directions supplied by the manufacturer.
4. Add 10 U RNase-free DNase (Promega, 1000 U/mL) and incubate at 37°C for 15 min to digest the template DNA in the transcription reaction. Stop the reaction by adding 10 mL 0.2 M EDTA, pH 8.0.
5. Add 100 mL RNase-free water and 5 mg carrier RNA (nuclease-free, yeast tRNA; Life Technologies) and phenol/chloroform extract to remove enzymes.
6. Precipitate the labeled RNA with 0.25 M ammonium acetate and 2.5 vol RNase-free 100% ethanol in an ethanol/dry-ice bath for 45 min. Centrifuge in a microcentrifuge for 15 min, remove the supernatant, dry the pellet under vacuum for 5 min, and then resuspend the labeled RNA in 100  $\mu$ L hybridization mix (*see Note 4*). The probe should be used within a few days, preferably immediately, to avoid radiochemical damage to the RNA.



### 3.2. Preparation of RNA Samples

1. Aliquot a known amount of total cellular or poly(A)+ RNA from each sample RNA that you wish to analyze into individual microcentrifuge tubes. The amount of unlabeled sample RNA depends upon the concentration of the mRNAs of interest. For most applications in our experience, 1–10  $\mu\text{g}$  of RNA provides a strong hybridization signal in an overnight exposure of the completed gel to X-ray film with intensifying screens. However, up to 150  $\mu\text{g}$  in a 30  $\mu\text{L}$  hybridization reaction can be utilized for detection of very low copy RNAs. A preliminary experiment designed to determine an acceptable range of RNA concentrations for the particular RNA of interest is often a good idea. An equal amount of each sample RNA should be used if the purpose for the experiment is to quantify the relative abundance of a particular RNA in various samples (*see Note 5*).
2. Add carrier yeast tRNA to each sample in order to maintain a constant amount of RNA (generally 30 mg) in each reaction.
3. Include a “no RNA” sample, containing only carrier RNA, to monitor for complete RNase digestion of the RNA probe and background hybridization later in the experiment. The sample should result in the absence of any protected probe following RNase digestion.
4. Dry down the RNA mixtures in each microcentrifuge tube under vacuum until they are “just dry.”
5. Redissolve each RNA pellet in 30  $\mu\text{L}$  hybridization mix. Either pipet up and down vigorously or heat the samples to 60°C if dissolving the RNA presents a problem.

### 3.3. Hybridization of Probe to RNA

1. Add 5  $\mu\text{L}$  (containing  $1\text{--}5 \times 10^5$  cpm) of radiolabeled RNA probe to each sample (*see Note 6*).
2. Vortex to mix thoroughly. Centrifuge in microcentrifuge for 5 s to bring all of the sample to the bottom of the tube.
3. Incubate samples at 85°C for 5–10 min to denature the RNAs.
4. Immediately transfer samples to a water bath preset to the appropriate annealing temperature. A good beginning temperature to try is 45–50°C, but the optimal temperature for hybridization may range from 30 to 65°C depending upon the probe.
5. Incubate the hybridization mixtures at the annealing temperature for 8–16 h (overnight is generally a convenient incubation time).

### 3.4. RNase Digestion

1. Microcentrifuge each sample for 5–10 s to bring the condensate in each tube to the bottom.
2. Add 250  $\mu\text{L}$  of RNase digestion buffer containing RNases A and T1.
3. Mix each sample gently by tapping the side of the microcentrifuge tube or by pipetting. Do not vortex.
4. Microcentrifuge each sample for 5 s.
5. Incubate the samples at 27–30°C for 30 min.
6. Microcentrifuge each sample for 5 s.
7. Add 20  $\mu\text{L}$  of 10% SDS and 10  $\mu\text{L}$  of 10 mg/mL Proteinase K to each sample.
8. Mix each sample gently by tapping the side of the microcentrifuge tube. Do not vortex.
9. Incubate the samples at 37°C for 30 min.
10. Add 200  $\mu\text{L}$  phenol. Vortex.
11. Microcentrifuge at room temperature for 5 min to separate phases.
12. Carefully transfer the aqueous phase from each sample into a new microcentrifuge tube.
13. Add 30  $\mu\text{L}$  3 M sodium acetate and 700  $\mu\text{L}$  ethanol to each sample. tRNA may also be added in sodium acetate as carrier.

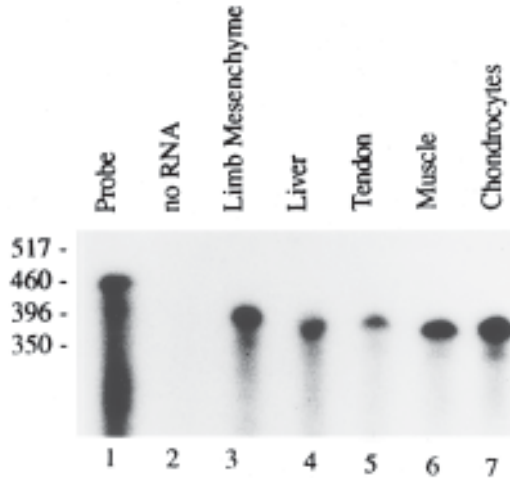

Fig. 1. RNase protection assay for determination of fibronectin mRNA in various chick embryonic tissues. Poly(A)<sup>+</sup> RNA, isolated from each of the embryonic tissue, was analyzed as described in the text.

14. Incubate in ethanol/dry-ice bath for 30 min.
15. Microcentrifuge at 4–6°C for 15 min to precipitate the RNA.
16. Remove the supernatant from each sample. Dry the resulting pellet under a vacuum until “just dry” (usually 5–10 min in a Speed-Vac).

### 3.5. Separation of Products by Gel Electrophoresis

1. Redissolve each pellet in 10  $\mu$ L TE.
2. Add 10  $\mu$ L Formamide Dyes to 5  $\mu$ L of each sample in a new microcentrifuge. Prepare a “Probe Alone” sample that contains undigested probe only (1  $\mu$ L of a 1:10 dilution of the probe mixed with 4  $\mu$ L TE and 10  $\mu$ L formamide dyes generally gives a good signal). As molecular weight markers, use end-labeled fragments of DNA (for general size determinations) or end-labeled RNA markers (for exact size determinations) of known size.
3. Boil all samples for 3 min or heat at 95°C for 5 min and then transfer all tubes immediately to an ice bath.
4. Load each sample into a single lane of an 8% denaturing polyacrylamide gel (or agarose gel of the appropriate percentage for larger probes). Immediately prior to loading each sample, carefully clear the lane of urea leaching from the gel using excess electrophoresis buffer (1X TBE) in a syringe; the sample should then fall to the bottom of the lane to allow for the crisp, even separation of the labeled strands across the gel.
5. Perform electrophoresis at 30 mAmp/gel constant current for 2–4 h, depending on expected sizes of the protected fragments.
6. Dry the gel completely under vacuum on a gel dryer and then subject the dried gel to autoradiography (*see Note 7*).

### 3.6. Analysis of Results

1. Determine the relative band intensities using a densitometer or PhosphoImager. As an example, we have performed RNase protection assays designed to determine the relative abundance of fibronectin mRNAs in various chick embryonic tissues (*see Fig. 1*). The

plasmid pchFN01 is a 397-base Pst I fragment of chick fibronectin cDNA, derived from clone 58 (6) and then subcloned into pGEM2. For preparation of a uniformly labeled antisense RNA probe, pchFN01 was linearized with Hind III and then transcribed with SP6 polymerase as described in **Subheading 3.1**. Equal amounts of total cellular RNA (10  $\mu$ g) from each tissue were then subjected to the RNase protection assay procedure described earlier. The resulting autoradiogram was scanned on a densitometer (various manufacturers) to determine the relative intensity of each band.

#### 4. Notes

1. In most cases, the use of homogeneous tissues for the isolation of the sample RNA is advisable, especially for the determination of tissue-specific alternative splicing events, because the percent recovery of RNA from a specific subset of a heterogeneous tissue can vary to a large degree.
2. In general, an appropriate concentration of RNases A and T1 will tolerate single-base mismatches. However, two or more mismatches in a row are generally perceived by the enzymes as single-stranded RNA and are thus cleaved. To minimize such effects, a species-specific probe is advisable. Polymorphisms between the probe and the particular cellular RNA sample may result in cleavage at the mismatch to produce smaller than expected protected fragments even with a species-specific probe, especially if higher than necessary RNase A and T1 concentrations are utilized during the digestion step.
3. Ideally, the cloned sequence should include a short vector-derived sequence so that the resulting transcript, as the undigested probe, is clearly larger than the protected region.
4. Gel purification of the full-length probe prior to hybridization is not generally necessary. However, gel purification of the probe often eliminates background (excessive signal in the no RNA control sample) resulting from incomplete RNA transcripts or contaminating template DNA present within the probe mixture. A protocol for gel purification has been described (7).
5. This semiquantitative method only provides comparative information on the relative amounts of a particular mRNA in various tissues or resulting from various treatments. However, the use of internal controls such as multiple probe hybridizations in a single sample can provide more accurate information regarding the specific amounts of a particular mRNA per the amount of total RNA in the sample (8).
6. The amount of probe used for hybridization should always be in excess of the amount of RNA so that you achieve a linear increase in signal with the amount of input RNA. Background increases with the amount of probe present in the hybridization reaction. Therefore, only the least amount of probe necessary to achieve probe-excess should be included in the hybridization mixture. Probe excess can be determined empirically by completing RNase digestions on a series of hybridization mixtures containing different ratios of probe RNA to target RNA. Multiple probes can be added to a single sample. Each should be in probe-excess and background will increase with each additional probe.
7. The protocol as written takes about 1.5 days of hands-on experimental time. The first half day includes the labeling of the RNA probe and preparation of the RNA samples for hybridization. The hybridization then proceeds overnight. The second full day includes the RNase digestion, template DNA digestion, Proteinase K digestion, and phenol extraction of all of the samples. The samples are then subjected to electrophoresis on a denaturing polyacrylamide gel for 2–4 h, depending upon the expected sizes of the protected fragments. Protocols are available from commercial sources (Ambion, Inc., Austin, TX) that allow for a shorter hybridization time.

## Acknowledgments

The author gratefully acknowledged Drs. Pamela Norton (Thomas Jefferson University) and Richard Hynes (Massachusetts Institute of Technology) for the gift of the recombinant plasmid, pchFN01; Denise White, Amy Gehris, and Tatyana Uporova for the preparation of RNAs from various chicken embryonic tissues and cells; and Drs. Pamela Norton, Howard Hershey, and Rocky Tuan for constructive criticism of the manuscript. This work was supported in part by grants from the National and Eastern Pennsylvania Chapters of the Arthritis Foundation, and the National Institutes of Health (AR40184 and AR42887). Manuscript completed by Rocky S. Tuan and dedicated to the memory of the late Dr. Vickie D. Bennett.

## References

1. Zinn, K., DiMaio, D., and Maniatis, T. (1983) Identification of two distinct regulatory regions adjacent to the human b-interferon gene. *Cell* **34**, 865–879.
2. Melton, D. A., Krieg, P. A., Rebagliati, M. R., Maniatis, T., Zinn, K., and Green, M. R. (1984) Efficient in vitro synthesis of biologically active RNA and RNA hybridization probes from plasmids containing a bacteriophage SP6 promoter. *Nucl. Acids Res.* **12**, 7035–7056.
3. Lau, E. T., Kong, R. Y. C., and Cheah, K. S. E. (1993) A critical assessment of the RNase protection assay as a means of determining exon sizes. *Anal. Biochem.* **209**, 360–366.
4. Bennett, V. D., Pallante, K. M., and Adams, S. L. (1991) The splicing pattern of fibronectin mRNA changes during chondrogenesis resulting in an unusual form of the mRNA in cartilage. *J. Biol. Chem.* **266**, 5918–5924.
5. Gehris, A. L., Brandli, D. W., Lewis, S. D., and Bennett, V. D. (1996) The exon encoding the fibronectin type III-9 repeat is constitutively included in the mRNA from chick limb mesenchyme and cartilage. *Biochim. Biophys. Acta* **1311**, 5–12.
6. Norton, P. A. and Hynes, R. O. (1987) Alternative splicing of chicken fibronectin in embryos and in normal and transformed cells. *Mol. Cell. Biol.* **7**, 4297–4307.
7. Gilman, M. (1993) Gel purification of RNA probes, in *Current Protocols in Molecular Biology*, Wiley, New York, pp. 4.7.3–4.7.4.
8. Davis, M. J. J., Bailey, C. S., and Smith, C. K. (1997) Use of internal controls to increase quantitative capabilities of the ribonuclease protection assay. *Biotechniques* **23**, 280–285.

## Relative Reverse Transcription-Polymerase Chain Reaction

Troy A. Giambernardi and Robert J. Klebe

### 1. Introduction

A number of methods are available for assessing messenger ribonucleic acid (mRNA) levels, namely, reverse-transcription polymerase chain reaction (RT-PCR), Northern blot analysis, primer extension, and RNA protection assays (1). Because of the PCR amplification step, RT-PCR has the important advantage that little RNA is required. In addition, RT-PCR is a relatively simple procedure that does not have an absolute requirement for the use of radioisotopes. Northern blot analysis requires at least ten times as much sample, radioisotopes, and the results obtained are, at best, semiquantitative. Northern blot analysis also is technically more difficult since electrophoresis of mRNA, a blotting step, and autoradiography are required.

Nuclease S1 mapping, ribonuclease protection, and primer extension methods differ fundamentally from RT-PCR in that they are solution hybridization-based procedures that allow information to be obtained about the amount and structure of the test transcript, however, each method has potential pitfalls. For example, the S1 nuclease protection method is simple, but is rarely used because of a lack of sensitivity. In addition, the nuclease reaction is somewhat difficult to control due to digestion of double-stranded regions of deoxyribonucleic acid (DNA) in areas that are AT-rich (10,14). A potential disadvantage of the RNase protection procedure is the need to generate specific subclones (12). The main limitation of primer extension is that it is extremely insensitive and prone to considerable background problems. Furthermore, the 5' ends of mRNAs are often highly structured, with the result that reverse transcriptase does not copy these sequences (2).

RT-PCR can avoid these potential problems and is considered a more sensitive assay. Because of the sensitivity of RT-PCR, it is the method of choice for detection of rare transcripts and cloning of difficult regions such as the extreme 5' ends of transcripts. In addition, semiquantitation of transcripts can be easily and efficiently carried out.

Two major variants of RT-PCR exist. The semiquantitative (or relative) RT-PCR method described in this chapter permits one to determine relative differences in mRNA levels between samples while the quantitative (or absolute) RT-PCR procedure allows one to determine the absolute amount of a given species of mRNA in a sample (see [13]). The relative RT-PCR method involves determination of the levels of both the target

mRNA and an internal control mRNA (generally, a housekeeping enzyme). Comparison of housekeeping mRNA levels in different samples is used to standardize samples such that the each sample contains the same amount of the housekeeping enzyme mRNA. Based on the assumption that the level of housekeeping enzyme is constant, the relative levels of target mRNA in each sample can be determined. The major technical difference between the relative and absolute RT-PCR methods involves the use of a second control in the absolute method, namely, an external control, which is identical to the target mRNA, except for the addition (or deletion) of a small amount of sequence. Different amounts of the external control are added to the sample and the RT-PCR procedure is carried out. Because the relative RT-PCR procedure can be performed with one reading (performed in triplicate), the absolute RT-PCR method requires at least eight readings (one reading for each of eight different amounts of external standard). The amount of external control that gives an identical amount of PCR product as the unknown sample is taken to be the amount of mRNA in the sample. Hence, by knowing the absolute amount of external standard employed, one can deduce the absolute amount of target mRNA/sample.

Both the relative and absolute RT-PCR methods require the use of an internal control to account for pipetting errors and problems involved in the precise determination of RNA in each sample. Thus, both RT-PCR methods have similar advantages as well as disadvantages. Both methods are extremely sensitive because of the PCR amplification step; however, both methods suffer from potential PCR-related problems (false priming leading to spurious PCR product bands, primer dimer formation, differences in PCR reaction efficiencies, etc.). Basically, the major difference between the relative and absolute RT-PCR methods is the use of the additional external control. When the determination of the absolute mass of mRNA is required, the absolute RT-PCR method is required. If the relative amounts of mRNA in two samples are desired, either method can be used and careful quantitative studies have shown that the relative and absolute RT-PCR methods yield comparable results (3). That the relative and absolute methods yield comparable results is expected since both methods are identical other than the incorporation of an external control in the absolute method. The relative RT-PCR method has the advantage of requiring only one reading in contrast to the eight readings needed for the absolute method.

In this chapter, we will present details of the relative RT-PCR assay. The RT-PCR assay can be performed with the use of only six reagents; namely, a. the total RNA sample, b. an A-mix containing reagents for the reverse transcription step c. sense primer, d. antisense primer, e. a T-mix that contains all reagents needed for the PCR step, and f. water. We have found that the use of reagents aliquoted in unit of use quantities increases the ease and reliability of the assay (5). We will also present an alternative method for extracting total RNA (11).

## 2. Materials

1. Solution D: To make 53 mL stock (stable 3 mo). 25 g guanidine thiocyanate, 29.3 mL DEPC-H<sub>2</sub>O (see **Subheading 2.4.**), 1.76 mL 0.75 M sodium citrate, pH 7.0, 2.64 mL of 10% Sarcosyl (L-Lauryl Sarcosine).
2. RNA sample dissolved in DEPC-treated water (about 0.5 µg/assay).
3. Antisense primer dissolved in DEPC-treated water (200 ng/assay; stock solution = 200 ng/µL).

**Table 1**  
**Aliquoted Reverse Transcription Reagents (A-mix)**

Solution	Conc./assay	200 assays ( $\mu\text{L}$ )	1 assay ( $\mu\text{L}$ )
a. 10 $\times$ RT buffer (Cetus PCR buffer)	0.8 $\times$	160	0.800
b. 1 M Tris-HCl (pH 8.3)	50.0 mM	84	0.420
c. 5 mg/mL BSA (BRL)	5.0 $\mu\text{g}$	100	0.500
d. 0.5 M dithiothreitol (DTT)	12.5 mM	50	0.250
e. 0.1 M MgCl <sub>2</sub> (or as required by primer set)	8.0 mM	136	0.680
f. 40 U/ $\mu\text{L}$ Rnasin (Promega)	20.0 U	50	0.250
g. dNTPs (25 mM each) (Pharmacia, Uppsala, Sweden)	2.0 mM	40	0.200
h. 20 U/ $\mu\text{L}$ AMV (Life Sciences, St. Petersburg, FL)	1.0 U	5	0.025
	Final volume	625	3.125

Store AMV stock solution frozen at  $-70^{\circ}\text{C}$  in tubes containing 12.5 assays/tube (40  $\mu\text{L}$  A-mix/tube) and use 3.2  $\mu\text{L}$  A-mix/assay. The RT reaction is carried out in a final volume of 10  $\mu\text{L}$ . To ensure reproducibility, do not reuse unused A-mix.

4. Diethylpyrocarbonate (DEPC)-treated water.
5. Aliquoted reverse transcription reagents (A-mix) (*see Subheading 3.*): A premixed, aliquoted and frozen solution that contains all reagents for the RT step, except primers.
6. The 10 $\times$  RT buffer is Cetus 10 $\times$  PCR buffer which consists of 500 mM KCl, 100 mM Tris-HCl (pH 8.3), 15 mM MgCl<sub>2</sub>, and 0.1% gelatin (wt/vol).
7. Sense primer (either 200 ng of cold primer/assay or 100 ng of cold primer/assay + 100 ng <sup>32</sup>P-labeled primer/assay; working solution = 100 ng/ $\mu\text{L}$ ).
8. PCR-reagents (T-mix) (*see Subheading 3.*): A premixed, aliquoted and frozen solution that contains all reagents for the PCR step, except primers.
9. The 10 $\times$  Taq DNA polymerase buffer used in preparing T-mix is Promega (Madison, WI) 10 $\times$  PCR buffer which consists of 500 mM KCl, 100 mM Tris-HCl (pH 9.0), 15 mM MgCl<sub>2</sub>, 0.1% gelatin (wt/vol), and 1% Triton X-100.
10. Solutions for RT-PCR using frozen-thawed cells (alternative RNA extraction approach).
  - a. Freezing solution: 0.15 M NaCl + 10 mM Tris-HCl, pH 8.0.
  - b. 2 $\times$  RNase inhibitor stock: Add 2  $\mu\text{L}$  of RNase inhibitor (40 U/ $\mu\text{L}$ ) (Promega) to 18  $\mu\text{L}$  of 0.15 M NaCl + 10 mM Tris-HCl (pH 8.0) + 5 mM DTT (store at  $-20^{\circ}\text{C}$  in 10  $\mu\text{L}$  aliquots) Note that we have developed a facile method for purification of bovine liver RNase inhibitor, the most expensive RT-PCR reagent (7).

### 3. Methods

#### 3.1. Preparation of Aliquoted Reagents

Presented below are the solutions needed for RT-PCR, their source, the final concentration of each reagent in the RT-PCR assay, the volume of each stock solution used to prepare 200 assays, and the volume of the assay mix sufficient for 12 assays. We have found that the concentrations for MgCl<sub>2</sub>, dNTPs, primers, *Taq*, and AMV given in **Tables 1** and **2** can be used successfully for many mRNA species; nevertheless, if problems occur, one should optimize MgCl<sub>2</sub> and buffer conditions for the primer set employed. Other considerations about RT-PCR stock solutions are discussed later (*see Note 1*).

**Table 2**  
**PCR-Reagents (T-mix)**

Solution	Conc./assay	200 assays (μL)	1 assay (μL)
a. Water		6870	34.35
b. 10× <i>Taq</i> DNA polymerase buffer (Promega)	0.8×	800	4.00
c. 25 mM dNTPs (Pharmacia)	0.8 mM	80	0.40
d. 5 U/μL <i>Taq</i> DNA polymerase (Promega)	2.5 U	50	0.25
	Final volume	7800	39.00

Store *Taq* stock solution frozen at  $-70^{\circ}\text{C}$  in tubes containing 12.5 assays/tube (487.5 μL T-mix/tube) and use 39 μL T-mix/assay + 1 μL sense primer/assay + 10 μL RT = 50 μL/assay. The PCR final volume is 10 μL RT + 40 μL PCR reagents (see above) = 50 μL final volume.

### 3.2. RNA Isolation

Total RNA was isolated from cultured cells by adding a guanidine thiocyanate solution (solution D) directly into the culture vessel followed by extraction with phenol and chloroform (9). In **Subheading 6.**, an alternative method for RNA extraction (11), which employs freeze/thaw treatment of cells, is described.

### 3.3. Reverse Transcription Step

The RT step can be performed in 0.2 mL tubes under optimized conditions that employ standardized unit-of-use stock reaction solutions as previously described (5). Briefly, a 10-μL reverse transcription reaction is carried out at  $42^{\circ}\text{C}$  for 60 min using 0.5 μg total RNA, 5.3 μL DEPC-treated  $\text{H}_2\text{O}$ , 0.5 μL 200 ng/μL antisense primer, and 3.2 μL A-mix (see Note 2).

### 3.4. PCR Step

PCR is performed in a final volume of 50 μL: 39 μL T-mix and 1 μL 100 ng/μL sense primer are added to the previous 10 μL RT reaction (see **Subheading 3.3.**). The standard cycling conditions used are as follows: initial denaturation at  $94^{\circ}\text{C}$  for 30 s, annealing at  $X^{\circ}\text{C}$  (optimized  $T_m$ ) for 60 s, elongation at  $72^{\circ}\text{C}$  for 110 s, and  $94^{\circ}\text{C}$  for 20 s (see Note 2).

### 3.5. Analysis of Data

#### 3.5.1. Adjustment of the Amount of Total RNA Amount Employed by Standardization with an Aldolase Internal Control

In order to compare mRNA levels in different cell lines or tissues, results can be standardized with respect to the housekeeping gene, aldolase, as previously described (5). Briefly, the amount of total RNA used in each assay is adjusted such that each RNA sample has an identical amount of aldolase mRNA. Standardization is carried out by performing RT-PCR with  $^{32}\text{P}$ -end-labeled aldolase primers. All samples are amplified to PCR cycle 16, which is in the exponential range of amplification for aldolase. Following separation on 5% polyacrylamide gels (PAGE), PCR product bands are visualized by ethidium bromide staining, the bands are excised with a razor blade, and the radioactivity in each band is determined by scintillation counting. If the amount of



radioactivity in aldolase PCR products in different cell lines is not comparable, the amount of total RNA employed is increased (or decreased) such that the amount of total RNA employed yields equal amounts of radioactivity in all aldolase PCR products. Hence, in comparison of samples, the amount of total RNA employed yielded comparable levels of aldolase mRNA.

### 3.5.2. Semiquantitative Analysis of mRNA Levels in Different Samples

Initially, total RNA from all cell lines or tissues of interest is amplified for 45 PCR cycles with primer sets specific for a given target sequence. If no PCR product is observed at PCR cycle 45 after two repetitions, the cells are considered to be negative for the transcript in question. Those cell lines (or tissues) positive for a given transcript at PCR cycle 45 are amplified again and 15  $\mu$ L aliquots are withdrawn at PCR cycles 25, 30, 35, and 40. The cycle at which a PCR product can first be detected is determined (*see Note 3*). Results are presented as follows: PCR product observed at cycle 20-25 = 5+ (highest level of expression); cycle 26-30 = 4+; cycle 31-35 = 3+; cycle 36-40 = 2+; cycle 41-45 = 1+ (lowest level of expression); 0 = no expression noted after 45 cycles. This procedure allows one to compare samples in a facile fashion (**8**) (*see Note 4*).

### 3.5.3. Procedure to Compare Relative Amount of Transcripts Between Treatments

Data are analyzed by use of the following equation that states that the ratio of treated/untreated mRNA levels =  $(\text{target mRNA}_{\text{exp}}/\text{aldolase}_{\text{exp}})/(\text{target mRNA}_{\text{con}}/\text{aldolase}_{\text{con}})$ , where *exp* is the experimental condition (treated) and *con* is the control (untreated). Because of potential differences in the efficiencies of different primer sets, the equation should be applied to one transcript of interest at a time, i.e., experimental and control levels of a given integrin subunit mRNA can be compared with one another, however, levels of different subunits should not be compared to one another. The constitutively expressed mRNA (i.e., aldolase) levels, which appear in the denominator of the equation, are assumed to be constant under experimental and control conditions and are used as a correction factor to account for possible errors in RNA quantitation and/or pipetting. Again, since the same primer set is used for this comparison, the efficiencies of the primers employed are identical.

## 3.6. Alternative Approach for RT-PCR Without RNA Extraction

The time required for extraction of total RNA often exceeds the time involved in the RT-PCR procedure itself (**6**). Described below is a simple alternative method for performing RT-PCR that involves 1. lysis of cells by a rapid freeze-thaw cycle in the presence of RNase inhibitor plus 5 mM DTT and 2. the use of extracts of 250 or fewer cells directly in the RT-PCR assay. The method described (**11**) entirely avoids RNA extraction and thereby, eliminates the most time consuming and error prone step in RT-PCR. The method bases comparisons on cell number, which can be determined quite accurately with an electronic cell counter. RT-PCR results are usually reported as the amount of PCR product generated per microgram of total RNA (**4**). The procedure described here enables one to use cell number, rather than RNA mass, to standardize results.

The procedure for a 50- $\mu$ L RT-PCR reaction using freeze-thawed cells (*II*) is as follows: a. trypsinize and count cells; b. add  $10^5$  cells to a culture tube and spin at approx 400g for 4 min to gently pellet cells; c. resuspend cells in 0.5 mL Freezing Solution to adjust cell concentration to  $2 \times 10^5$  cells/mL; d. place 10  $\mu$ L of resuspended cells in a 0.2-mL microfuge tube and add 10  $\mu$ L of  $2\times$  RNase Inhibitor stock (note: final cell concentration is now  $10^5$  cells/mL); e. freeze immediately in a pipet tip box containing 95% ethanol at  $-70^\circ\text{C}$ . An empty 10  $\mu$ L pipet tip box will allow a 0.2-mL tube to be about 50% submerged in ethanol; f. to a new 0.2 mL PCR tube add 3.2  $\mu$ L A-mix + 0.5  $\mu$ L antisense primer (200 ng/ $\mu$ L) (maintain at  $4^\circ\text{C}$  until cells are added); g. thaw cells rapidly in a room temperature water bath, vortex for 10 s, spin tubes for a few seconds to collect all liquid in the bottom of tubes; h. add desired number of cells to tubes (note that 2.5  $\mu$ L of  $10^5$  cells/mL = 250 cells, etc.); i. bring volume to 10  $\mu$ L with DEPC-treated water; j. place tubes at  $42^\circ\text{C}$ ; incubate for 1 h to complete the reverse transcription step; k. add 39  $\mu$ L of T-mix and 1  $\mu$ L of sense primer (100 ng/ $\mu$ L) to perform the PCR step at a 50  $\mu$ L final volume; l. Analyze PCR products on a 5% PAGE gel.

As we have shown, it is possible to obtain semiquantitative information about specific mRNA levels using RT-PCR. The ability to obtain accurate measurements of gene expression in small amounts of tissue or in mixed cell populations will considerably expand future applications of PCR, both in research laboratories as well as in clinical settings.

#### 4. Notes

1. use of aliquoted A- and T-mix: (To ensure reproducibility, do not reuse unused A-mix.).
  - a. The Tris-HCl in the  $10\times$  RT buffer plus the 1 M Tris-HCl supplement yields a final concentration of 50 mM Tris-HCl.
  - b. The  $\text{MgCl}_2$  in the  $10\times$  RT buffer plus the 0.1 M  $\text{MgCl}_2$  supplement yields a final concentration of 8 mM  $\text{MgCl}_2$  (6 mM free  $\text{MgCl}_2$  plus 2 mM dNTP bound  $\text{MgCl}_2$ ).
  - c. Recommend using 1 U of AMV reverse transcriptase per assay for low to moderate abundance mRNAs and 10 U per assay for high-abundance mRNAs.
  - d. 0.8 mM dNTPs in 100  $\mu$ L final volume (note that the final volume will also contain unreacted dNTPs from the RT step).
2. Following RT-PCR using  $^{32}\text{P}$ -end-labeled primers, bands visualized by ethidium bromide staining are excised from 5% polyacrylamide electrophoresis gels and radioactivity in each band determined by scintillation counting. The use of PCR-incorporated labeled nucleotides can be problematic. High levels of unincorporated, labeled nucleotides in PCR products can lead to high background levels of radioactivity throughout a lane of a PAGE gel. Even a relatively small amount of "trailing" can make it difficult to measure small amounts of incorporated label. For this reason, it is advisable to end-label PCR primers rather than use labeled nucleotides during the PCR reaction.
3. Data should be obtained at a PCR cycle number that is in the exponential range of amplification for each mRNA species analyzed. Experimentally, the amount of product generated during PCR deviates from the theoretical or ideal. The amount of PCR product produced initially increases exponentially; however, a plateau phase occurs beyond a certain PCR cycle. One must determine which PCR cycles are in the exponential range when employing semiquantitative RT-PCR. Use this PCR cycle to obtain data from all samples studied.

4. The method described above uses two separate PCR reactions to determine the levels of constitutive transcripts. However, an endogenous standard sequence can be coamplified along with the transcript of interest in the same reaction tube. The efficiency of amplification between the two transcripts must not differ significantly or one may risk one reaction reaching plateau whereas the other has not been amplified sufficiently. Therefore, we strongly advise not using a one-tube reaction in doing comparisons of different samples.

Notwithstanding the advantages to this approach, several complications may arise when amplification of endogenous mRNAs is used for semiquantitative analysis. For this method to be reliable, the level of expression of the reference standard must be the same in each sample to be compared and must not change as a result of the experimental treatment. Unfortunately few, if any, genes are expressed in a strictly constitutive manner. Therefore, the level of the mRNA used as the endogenous standard must be examined very carefully to ensure its level remains constant during all of the experimental conditions studied.

## Acknowledgment

This study was supported in part by the National Institutes of Health, under Grant DE08144.

## References

1. Ausubel, F. M., Brent, R., Kingston, R. E., Moore, D. D., Seidman, J. G., Smith, J. A., and Struhl, K. (1996) *Current Protocols in Molecular Biology*, 6th Ed., Wiley-Interscience, New York.
2. Bailey, J. M. and Davidson, N. (1976) Methylmercury as a reversible denaturing agent for agarose gel electrophoresis. *Anal. Biochem.* **70**, 75–85.
3. Bouaboula, M., Legoux, P., Pesseque, B., Delpech, B., Dumont, X., Piechaczyk, M., Casellas, P., and Shire, D. (1992) Standardization of mRNA titration using a polymerase chain reaction method involving co-amplification with a multispecific internal control. *J. Biol. Chem.* **267**, 21,830–21,838.
4. Chen, D., Magnuson, V. L., Steffensen, B., and Klebe, R. J. (1993) Use of stock solutions to simplify mRNA quantitation by reverse transcription-polymerase chain reaction (RT-PCR) assays. *PCR Methods Appl.* **2**, 351–353.
5. Chen, D. and Klebe, R. J. (1993) Controls for validation of relative reverse transcription-polymerase chain reaction (RT-PCR) assays. *PCR Methods Appl.* **3**, 127–129.
6. Chomczynski, P. and Sacchi, N. (1987) Single-step method of RNA isolation by acid guanidinium thiocyanate-phenol-chloroform extraction. *Anal. Biochem.* **162**, 156–159.
7. Garcia, M. A. and Klebe, R. J. (1997) Affinity chromatography of RNase inhibitor. *Molecular Biol. Rep.* **24**, 231–233.
8. Giambernardi, T. A., Grant, G. M., Maher, V. M., McCormick, J. J., Taylor, G. P., and Klebe, R. J. (1998) Overview of matrix metalloproteinase expression in transformed cells. *Matrix Biol.* **16**, 483–496.
9. Grant, G. M., Cobb, J. K., Castillo, B., and Klebe, R. J. (1996) Regulation of matrix metalloproteinases following cellular transformation. *J. Cellular Physiol.* **167**, 177–183.
10. Johnson, P. H. and Laskowski, M. (1970) Mung bean nuclease I. Resistance of double stranded deoxyribonucleic acid and susceptibility of regions rich in adenosine and thymidine to enzymatic hydrolysis. *J. Biol. Chem.* **245**, 891–898.
11. Klebe, R. J., Grant, G. M., Grant, A. M., Garcia, M. A., Giambernardi, T. A., and Taylor, G. P. (1996) RT-PCR without RNA Isolation. *BioTechniques* **21**, 1094–1100.

12. Skennan, K. I., Taylor, N. A., Jermany, J. L., Matthews, G., and Docherty, K. (1995) Differences in pH optima and calcium requirements for maturation of the prohormone convertases PC2 and PC3 indicates different intracellular locations for these events. *J. Biol. Chem.* **270**, 1402–1407.
13. Souaze, F., Ntodou-Thome, A., Tran, C. Y., Rostene, W., and Forgez, P. (1996) Quantitative RT-PCR: Limits and Accuracy. *BioTechniques*, 21, 280–285.
14. Zinn, K., Dimaio, D., and Maniatis, T. (1983) Identification of two distinct regulatory regions adjacent to the human b-interferon gene. *Cell* **34**, 865–879.

## Gene Expression Analysis Using Quantitative Reverse Transcription-Polymerase Chain Reaction and a Multispecific Internal Control

David Shire and Pascale Legoux

### 1. Introduction

Quantitation of very small amounts of specific messenger ribonucleic acids (mRNAs) extracted from tissues or cell cultures is a difficult and time-consuming task that necessitates the use of carefully controlled amplification procedures. Reverse transcription (RT) of the mRNA to cDNA followed by amplification using the polymerization chain reaction (RT-PCR) is widely used for simple detection purposes, but the procedure can be employed for accurate quantitation provided an appropriate internal control is present throughout the process. The choice of an internal control depends on the number of mRNAs that are to be quantitated, but it is essential that it incorporates exactly the same PCR priming sites as those chosen in the target mRNA. The amplification efficiency of the PCR is rarely 100% and often far lower and it is the primer pair that contributes the most towards PCR efficiency. In addition, because the RT step is also well under 100% efficient, it is highly desirable that the control be in the form of an RNA and that it be added to the total RNA before RT.

Two main categories of control have been developed in recent years. The simplest control is one that is identical to the cellular target, except for a small internal deletion or insertion, so that one has one control for each target. The second category is made up of multispecific internal controls in which the priming sites for several targets are lined up head-to-tail so that a single control can be used to measure all the targets simultaneously (*1*). For each category the final control and target amplification products have to be distinguished in some way, in the first category by the presence or absence of a restriction site, for example, and in the multispecific control by a size difference between the target and the control. In each category, quantitation is achieved by varying the initial quantities of either total RNA or control RNA and correlating these quantities with the quantities of the amplicons obtained, as will be described later.

In this chapter, we will detail the use of multispecific internal controls we (*2–4*) (see **Note 1** and **Tables 1–4**) and others (*1,5–12*) have developed for the quantitation of certain cytokine and neurotrophic factor mRNAs (see **Note 2**). The controls also contain priming sites for housekeeping genes (see **Note 3**). Several standards have

**Table 1**  
**Oligonucleotide Primers for pQA-1 (Human)**

mRNA	Sense primer		Antisense primer		Cell-amplicon length bp	5'-positions <sup>5</sup>		Position(s) of intron(s) in amplified regions <sup>4</sup>	6 <sub>F</sub>
	5'	3'	5'	3'		Sense	Antisense		
IL-1 $\beta$	GGATATGGAGCAACAAGTGG		ATGTACCAGTTGGGGAAGCTG		263	536	799	552, 683	1.17
IL-2(2) <sup>1</sup>	GTCACAAACAGTGACCTAC		CCCTGGGTCTTAAGTGAAAG		262	95	357	194, 254	1.30
IL-3	GGGAAGACCAAGACATTCTG		TCAAAGTCGCTCTGTTGAGCC		260	191	451	21, 303, 345 (?)	1.01
IL-4	TGCCTCCAAGAACAACAAGTGG		AACGTAAGTCTGGTTGGCTTC		224	237	461	246, 423	0.87
IL-5	CTTGGCACTGCTTTCTACTC		GCAGGTAGTCTAGGAATTGG		259	142	401	187, 220, 349	1.19
IL-6	TCAATGAGGAGACTTGCCTG		GATGAGTTGTCATGTCCTGC		260	380	640	388, 534 (?)	1.05
IL-8	TTGGCAGCCTTCTGATT		AACTTCTCCACAACCCTCTG		247	118	365	167, 302	1.10
TNF $\alpha$	ACAAGCCTGTAGCCCATGTT		AAAGTAGACCTGCCAGACT		427	342	769	365 <sup>3</sup>	0.82
IFN- $\gamma$	GCAGAGCCAAATTGTCTCCT		ATGCTCTTCGACCTCGAAAC		290	332	621	494	1.25
GM-CSF	AGCATGTGAATGCCATCCAG		ATAGTCTGGGTTGCACAGGA		261	100	362	167, 210, 335	0.87
G-CSF	AGAAGCTGGTGAGTGAGTG		CCATCCCAGTTCTTCCATC		290	219	509	235, 351, 490	0.79
CSF-1	TTGACAGTCAGATGGAGACC		CTCATAGAAAGTTCGGACGC		256	269	525	403	1.06
$\beta$ 2 $\mu$ glob	CCAGCAGAGAATGGAAAGTC		GATGCTGCTTACATGTCTCG		268	73	341	319	1.16
IL-2rec	GTGAAATGGAGACCAGTCAG		TCTACTCTTCTCTGTCTCC		250	731	981	757, 829, 901, 968	0.94
PBR <sup>2</sup>	TCTGGAAAGAGCTGGGAGG		AAGGCCAGCCAGGCCAGGT		239	261	498	382 (?)	0.70

<sup>1</sup>There are two IL-2 antisense primers in pQA-1 to IL-2(2) gives a standard amplicon of 352 bp, all the others being of 370 bp.

<sup>2</sup>PBR is the peripheral benzodiazepine receptor.

<sup>3</sup>The TNF $\alpha$  intron (300 bp) is extremely useful for determining whether the sample is contaminated or not with genomic DNA.

<sup>4</sup>? Introns from homologies with mouse (IL-3 and IL-6) or rat (PBR).

<sup>5</sup>From GenEMBL sequences, as are those in Tables 2-4.

<sup>6</sup>The F factor is defined in Subheading 3.

**Table 2**  
**Oligonucleotide Primers for pQB-1/3 (Human)**

mRNA	Sense primer		Antisense primer		Amplicon length bp	5' positions		Position(s) of intron(s) in amplified regions	F
	5'	3'	5'	3'		Sense	Antisense		
β2μglob	CCAGCAGAGAATGGAAAGTC		GATGCTGCTTACATGTCTCG		268	73	341	319	1.16
β-actin	GGGTCAGAAGGATTCCTATG		GGTCTCAAACATGATCTGGG		237	225	443	447	0.84
c-fos	GAGCTGACTGATACACTCCA		GCTCTTGACAGGTTCCACTG		296	633	929	656	0.89
Krox-20	GCTGTCTGACAACATCTACC		ACTGTGGGTCAATGGAGAAC		244	113	357	222 (?)	0.90
Krox-24	ATTGTGAGGGACATGCTCAC		ACAAAAATCGCCGCTACTC		246	2711	2956	-	1.26
jun B	GCAGCTACTTTTCTGGTCAG		GTCACGTGGTTCATCTTGTG		261	197	458	-	0.77
<sup>3</sup> Groα/β	ACTCAAGAATGGGCGGAAAG		AGACTTCTCCTAAGCGATGC		235	248	483	?	1.00
Groα	ACTCAAGAATGGGCGGAAAG		TGGCATGTTGCAGGCTCCT		468	248	715	?	-
Groβ/γ	AAGtGTGAAGGTGAAGTCCC		tGCAGCTGTGTCTCTCTTTC		240	249	490	?	0.98
Groβ	AAGtGTGAAGGTGAAGTCCC		GGCCATTTTCTTGGATTCCTC		574	249	823	?	-
Groy	AAGTGTGAATGTAAGGTCCCC		CTTCCAGCTGTCCCTAGAA		270	207	477	?	1.0
IL-8	TTGGCAGCCTTCCTGATT		AACTTCTCCACAACCCTCTG		247	118	365	167, 302	1.09
MCP-3	TGCTCAGCCAGTTGGGATTA		GCTTCATAAAGTCCTGGACC		199	136	335	?	1.03
<sup>4</sup> MCP-1	TCCAgCATGAAAGTCTCTGC		TGGAATCCTGAACCCACTTC		274	48	312	?	0.99
MIP1α	GTCATCTTCCTAACCAAGCG		TGTGGCTGTTTGGCAACAAC		228	267	495	271	0.84
MIP1↓	AGGAAGCTTCCTCGCAACTT		AGTCTGAGTATGGAGGAGA		244	201	445	?	0.95
IL-4	TGCCTCCAAGAACAACAAGT		AACGTAAGTCTGGTTGGCTTC		224	663	923	246, 423	0.87
<sup>1</sup> c-jun	CCAAGAACGTGACAGATGAG		AGTTGCTGAGGTTTGCCTAG		228	1559	1786	-	0.71
<sup>1</sup> jun D	ATGAAGAAGGACGCGCTGAC		TAGAGGAAGTGTGAGCTCGT		242	1	242	?	0.70
<sup>2</sup> IL-10	ATGCTTCGAGATCTCCGAGA		AAATCGATGACAGCGCCGTA		269	148	417	195, 255, 408	0.89
<sup>2</sup> IL-12p40	ATTGAGGTCATGGTGGATGC		AATGCTGGCATTTCGCGGC		296	663	923	?	
<sup>2</sup> IL-13	TGCAATGGCAGCATGGTATG		GCAGGTCCTTTACAAACTGG		214	198	411	242, 347	0.83

<sup>1</sup>c-jun and jun-D primers are in pQB-1, <sup>2</sup>IL-10, IL-12p40, and IL-13 primers are in pQB-3. <sup>3</sup>The Groα primers are not specific and will amplify both Groα and Groβ. Both Groβ priming regions are mutated (small characters) and are nonspecific. <sup>4</sup>The MCP-1 sense priming site contains a dG to dC mutation at position 16. <sup>5</sup>The Groα(2) and Groβ(2) antisense primers are not in the construction, but can be used with the sense primers for diagnostic purposes.

The standard amplicons are 370 bp and 410 bp in length for pQB-1 and pQB-3, respectively.

**Table 3**  
**Oligonucleotides Primers for pMus-3**

mRNA	Sense primer		Antisense primer		Cell-amplicon length (bp)	5'-positions		<sup>2</sup> Position(s) of intron(s) in amplified regions	F
	5'	3'	5'	3'		Sense	Anti		
IL-1 $\alpha$	CAGTTCTGCCATTGACCATC		TCTCACTGAAACTCAGCCGT		219	123	341	156 (?)	1.08
IL-1 $\beta$	TTGACGGACCCCAAAAGATG		AGAAGGTGCTCATGTCCTCA		205	151	355	173	0.96
IL-2	GACACTTGTGCTCCTTGTC		TCAATTCTGTGGCCTGCTTG		228	83	310	236	0.93
IL-3	GACCCTCTCTGAGGAATAAG		CTCCAGATCGTTAAGGTGGA		233	220	452	233, 329, 371	1.06
IL-4	TCGGCATTGTAACGAGGTC		GAAAAGCCCGAAAGAGTCTC		217	156	372	186, 235	1.03
IL-5	TCACCGAGCTCTGTTGACAA		CCACACTTCTTTTTGGCG		202	157	358	184, 218, 346	1.15
IL-6	GTTCTCTGGGAAATCGTGGA		TGTACTCCAGGTAGCTATGG		209	205	413	237, 351	1.29
TNF $\alpha$	TCTCATCAGTTCTATGGCCC		GGGAGTAGACAAGGTACAAC		213	370	582	404, 452	0.90
IFN $\gamma$	GCTCTGAGACAATGAACGCT		AAAGAGATAATCTGGCTCTGC		227	59	285	180, 247 (?)	1.12
TGF $\beta$ 1	ACCGCAACAACGCCATCTAT		GTAACGCCAGGAATTGTTGC		201	696	896	707, 868 (?)	1.08
GM-CSF	TGAACCTCCTGGATGACATG		GTGTTTCACAGTCCGTTTCC		219	150	368	181, 223, 349	0.98
IL-2rec	GCAACTCCCATGACAAATCG		ATCCCGGAATACACTCGTAG		220	375	594	380, 494 (?)	1.08
<sup>1</sup> PBR	TCTGGAAAAGACTGGGAGG		AAGGCCAGCCAGGCCAGG		238	230	467	351 (?)	0.82
$\beta$ 2 $\mu$ glob	TGACCGGCTTGTATGCTATC		CAGTGTGAGCCAGGATATAG		223	96	318	119 (?)	1.09
IL-12p35	GATCATGAAGACATCACACGG		AGAATGATCTGCTGATGGTTG		257	322	578	?	1.02
IL-12p40	CAGTACACCTGCCACAAAGGA		GTGTGACCTTCTCTGCAGACA		277	293	569	?	1.06
IFN $\gamma$ rec	ATTCACCCTGAAGTCGTTGTGA		ATGGAAAGGAGGGATACAGACGT		289	557	823	?	1.15
IL-10	ATGCAGGACTTTAAGGGTACTTG		TAGACACCTTGGTCTTGAGCTTA		254	286	539	300, 453, 519	1.02
IL-13	GACCCAGAGGATATTGCATG		CCAGCAAAGTCTGATGTGAG		214	320	533	<sup>3</sup> 368	0.96

<sup>1</sup>PBR is the peripheral benzodiazepine receptor.

<sup>2</sup>? Introns unknown or, where given, are based on homology with identified human or rat (PBR) introns.

<sup>3</sup>The IL-13 intron (310 bp) is extremely useful for determining whether or not the sample is contaminated with genomic DNA. The length of the standard amplicon is 440 bp.



**Table 4**  
**Oligonucleotide Primers<sup>1</sup> for pRat-6**

mRNA	Sense primer		Antisense primer		Amplicon length bp	5' position of primers		F
	5'	3'	5'	3'		Sense	Antisense	
IFN- $\gamma$	TGGATATCTGGAGGAACTGG		CGACTCCTTTTCCGCTTCT		310	164	473	0.90
IL-10	GCAGGACTTTAAGGGTTACT		TTCATGGCCTTGTAGACACC		264	257	520	1.06
IL-1ra	GACCCTGCAAGATGCAAGCC		AGAGGAACCATCCTGGACAG		348	95	442	1.02
IL-1 $\beta$	TCCATGAGCTTTGTACAAGG		GGTGCTGATGTACCAGTTGG		246	551	796	1.03
IL-6	TGTTCTCAGGGAGATCTTGG		TCCAGGTAGAAACGGAACTC		204	235	438	1.26
$\beta$ 2- $\mu$ glob	ATCTTTCTGGTGCTTGCTC		AGTGTGAGCCAGGATGTAGT		243	29	271	0.95
$\beta$ -actin	CAATGTGGCTGAGGACTTTG		ACAGAAGCAATGCTGTCACC		195	3380	3574	1.04
MBP	TGTTTCCTCTCAGAGCCTAG		CTTGATTCAGCGACAGGAAC		238	1170	1407	0.94
BDNF	TCACAGTCCTGGAGAAAAGTC		ATGAACCGCCAGCCAATTCT		202	569	770	1.03
NT-3	ACGAGGTGTAAAGAAGCCAG		TGGGGACAGATGCCAATTCA		215	670	884	1.00
VEGF	TTACATTGAGCACGTGCTGC		CAGGATCAGACCCCAAAGAA		224	2058	2281	1.45
NT-4	GCTCTCAGAATGCAAGGCTA		TCAGTTCACAGTCAGAAGGC		247	701	947	0.85
IL-2	GCAGGCCACAGAATTGAAAC		AGATGGCTATCCATCTCCTC		233	218	450	1.15
CSF-1	AGTGGTCTGTAAGCTCCATC		GAGCTTCTTGCAATGGGTTG		239	3439	3677	0.82
IL-1 $\alpha$	AACTGGGTCAGTCTTTTGCC		TTGTGACACCCTGGTTTGAG		207	1718	1924	1.18
IL-6	TAGAGTCACAGAAGGAGTGG		GCCAGTTCTTCGTAGAGAAC		210	597	806	1.18
MCP-1	AGCCAGATGCAGTTAATGCC		TGATCTCACTTGGTTCTGGT		221	110	330	1.04
TGFmp	TTCTCTGTGCTGTGCAGATC		CCCACCCACTCTAAATGTAG		210	5836	6045	0.84
NGF $\beta$	CGGACACTCTGGATTTAGAC		TCCACTCTCTACAGGATTTG		272	305	596	1.02
TNF $\alpha$	AAATGGGCTCCCTCTCATCA		AGCCTTGTCCCTTGAAGAGA		248	195	442	1.12
TGF $\beta$ 1	ACCAACTACTGCTTCAGCTC		TGTTGGTTGTAGAGGGCAAG		194	1256	1449	0.92

<sup>1</sup>Special care must be taken with this plasmid, as it was constructed not knowing the positions of introns. The length of the standard amplicon is 480 bp.

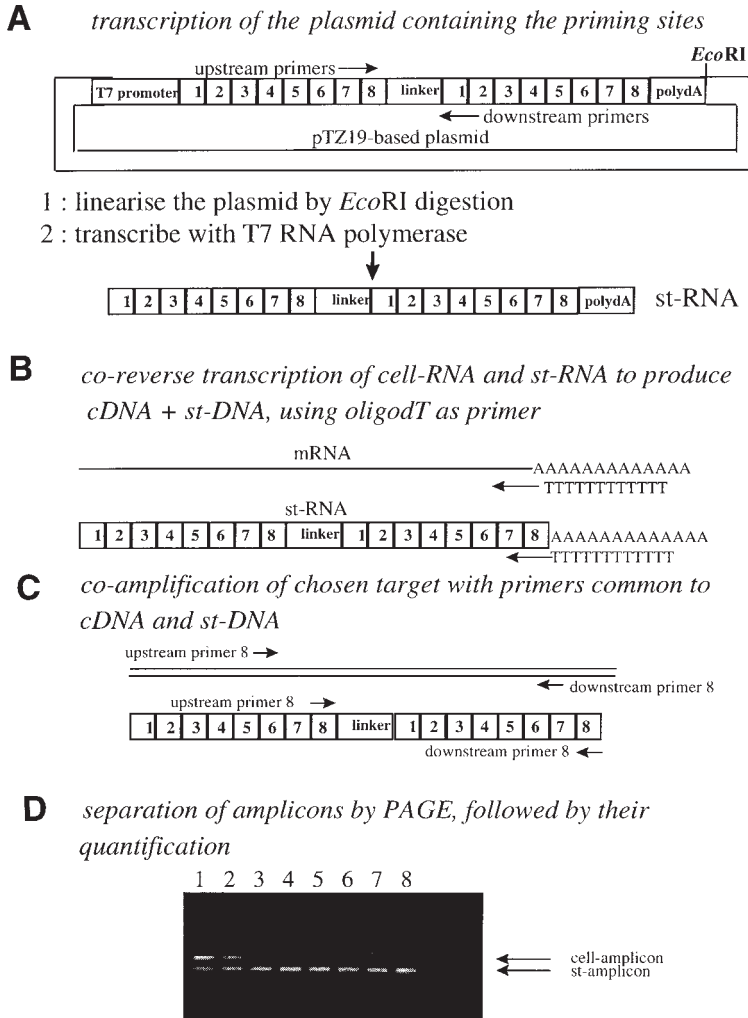

Fig. 1. Quantitative RT-PCR method using an internal multispecific control.

been constructed and their structure is shown schematically in **Fig. 1**. All have the same basic design. The boxes represent priming sites for the targets shown inside the boxes and listed in **Tables 1–4**. The top series of boxes represent sense primers, the lower series, antisense primers. The primers are highly standardized in that nearly all are 20 nt in length and of 50% dC/dG content. Because the primers have similar  $T_m$  values a single set of amplification conditions can be used. Wherever possible, the primers were selected from different exons of the cellular targets. Each pair of primers is separated by the same distance in each construction, e.g., 410 bp in pQB-3. Exactly the same priming sites are found in the respective mRNAs, but the distance between them differs from that in the standard. This size difference allows good chromatographic or electrophoretic separation of the amplicons after PCR. The priming sites are inserted in the polylinker region of a pTZ19 plasmid, between a T7 promoter and a polydA stretch ending in a unique *Eco*RI site. The constructions contain other unique

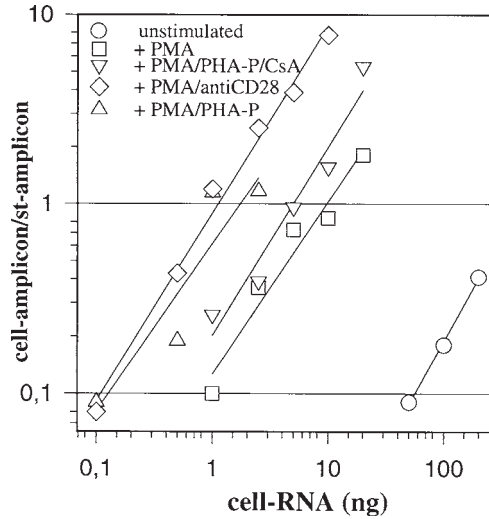

Fig. 2. Log–log plot of the cellular amplicon/control amplicon (cell-amplicon/st-amplicon) ratio against the quantity of total cellular RNA (cell-RNA) for determining the quantity of IL-13 mRNA in peripheral blood mononuclear cells. From the graph it can be seen that the quantity in unstimulated cells is too low to be measured (*see Note 12*). After stimulation with PMA, PMA + PHA-P + CsA, PMA + PHA-P or PMA + anti-CD28, 20 fg of IL-13 mRNA are found in 10, 6, 3, and 1 ng, respectively, of total RNA.

restriction sites, facilitating modifications (*see Note 2*). The 21 bp linker regions in all of the constructions are identical and a “universal” probe can be used to identify standard amplicons. The *EcoRI* site allows linearization of the plasmid before transcription by T7 RNA polymerase to produce standard RNA (st-RNA).

The principle of the method is shown in **Fig. 1**. A known quantity of st-RNA is added to a known quantity of total cellular or tissular RNA (cell-RNA). Co-reverse transcription gives a mixture of standard cDNA, denoted as st-cDNA, and cellular cDNA, denoted as such. The primer pair is added and PCR co-amplifies st-cDNA and cDNA. The two amplicons that result (st-amplicon and cell-amplicon) are separated electrophoretically and the bands are quantitated. By separating the st-DNA/cDNA mixture into several aliquots different primer pairs can be used in parallel PCRs and separated on the same gel. By using different known quantities of cell-RNA and keeping st-RNA at a known constant amount, one or more mRNAs can be quantitated simultaneously, as shown in **Fig. 2**.

Provided the RT and PCR steps are equally efficient for both standard and cellular RNAs, the intensity of the bands is directly related to the quantity of the original mRNAs. The objective of the method is to find the point of equivalence, where the two bands are of equal intensity, showing that the st-RNA added at the outset matches the quantity of the mRNA contained in the extracted RNA. In order to achieve this, further rounds of RT-PCR may be necessary, keeping st-RNA constant and using different quantities of cell-RNA. Finally, a log–log plot of [cell-amplicon]/[st-amplicon] against [cell-RNA] should give a straight line of slope 1 (**2,13**) as shown in **Fig. 2**. The amount of cell-RNA containing the quantity of mRNA equivalent to st-RNA is obtained from

the graph from the point where [cell-amplicon]/[st-amplicon] = 1 on the log–log scale. A good theoretical treatment of competitive quantitative PCR has been published (14).

Although the method is simple in principle, in practice, certain precautions have to be taken to ensure success and these will be discussed throughout the following protocols.

## 2. Materials

1. *Eco*RI buffer: Mix 50 mM NaCl, 0.1 M Tris-HCl, pH 7.9, 10 mM MgCl<sub>2</sub>, 0.025% Triton X100.
2. 20× RNA buffer: Prepare a buffer containing 40 mL 1 M MOPS, pH 7.4, 4 mL 0.5 M EDTA and 156 mL water, filter and store at –20°C.
3. 10× Tris-borate buffer: 121.1 g Tris, 61.84 g boric acid, 7.46 g ethylene diamine tetraacetic acid (EDTA) in 1 L water, adjusted to pH 8.3, and autoclaved for 20 min at 120°C.
4. TE buffer: Mix 10 mM Tris pH 8 and 1 mM EDTA.
5. Blue RNA dye buffer: Prepare formamide (674 μL, deionized biotechnology grade, e.g., Fisher), formaldehyde (216 μL), 5% ethidium bromide solution (8 mg/L), 1 M MOPS pH 7.4 (30 μL), 0.5 M EDTA (3 μL), 10% sodium dodecyl sulfate (10 μL), e.g., Ultrapure grade, Gibco-BRL, 1% bromophenol blue solution (10 μL), and glycerol (57 μL).
6. Blue DNA dye buffer: 0.25% xylene cyanol, 0.25% bromophenol blue, 5% ethidium bromide solution (8 mg/L), 30% glycerol and 65% water.
7. Ampliscribe T7 High Yield Transcription Kit: Contains T7 enzyme solution with RNase inhibitor, 10× buffer solution, 100 mM ATP, CTP, GTP, and UTP solutions, 100 mM dithiothreitol and RNase-free DNase I (Epicentre Technologies, Madison, WI).
8. DNA polymerization mixture: 20 mM/dNTP (LKB-Pharmacia, Uppsala, Sweden).
9. Superscript II RNase H<sup>-</sup> reverse transcriptase kit: Contains 5× buffer solution, 100 mM dithiothreitol and enzyme (200 U/μL) (Gibco BRL, Gaithersburg, MD).
10. AmpliTaq thermostable DNA polymerase kit: Contains 10× PCR buffer, 10 mM each dNTP, 25 mM MgCl<sub>2</sub> solution and enzyme (5 U/μL) (Perkin-Elmer, Norwalk, CT).
11. 1% and 2% nondenaturing agarose gels: Dissolve 1 g or 2.0 g of agarose in 1× Tris-borate buffer (100 mL).
12. 1% denaturing agarose gel: Dissolve 0.5 g of agarose in 2.5 mL 20× RNA buffer and 43.5 mL autoclaved Millipore-purified water in a microwave oven. Cool to about 40°C and, under a fume hood, add formaldehyde (4 mL)
13. Biogel P10 gel fine 45–90 μm (wet) (Bio-Rad Laboratories, Richmond, CA).
14. Brosilicate glass beads of 100–200 μm diameter (OSI, France) (ref. A10585.10).
15. Phenol saturated with TE, pH 7.9 (Amresco, Solon, OH).
16. Phenol saturated with chloroform 5:1 at pH 4.7 (Amresco).
17. RNase inhibitor (40 U/μL) (Promega, Madison, WI).
18. [α-<sup>32</sup>P]dCTP (Amersham, Arlington Heights, IL), 3000 Ci/mmol (10 μCi/μL).
19. Diethylpyrocarbonate (Sigma Chemical Co., St. Louis, MO).
20. 10% polyacrylamide gel: Miniprotean II Ready gel (Bio-Rad).

## 3. Methods

1. Plasmid linearization: Dissolve the plasmid (4 μg; see **Note 4**) in *Eco*RI buffer (30 μL) and incubate with 2 μL *Eco*RI (40 U) for 1 h at 37°C. Add a further 10 μL of the above buffer and 2 μL of *Eco*RI and leave the mixture for a further 1 h at 37°C (see **Note 5**). Extract with 1 vol phenol saturated with TE, then with 1 vol chloroform (see **Note 6**), precipitate with 2 vol ethanol at –20°C and dry the pellet in a Speedvac. Dissolve in 40 μL water and electrophorese 1 μL mixed with blue DNA dye (1 μL) on a 1% nondenaturing agarose gel

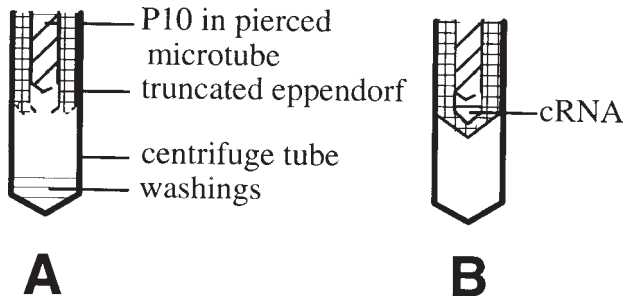

Fig. 3. The setup used to purify cRNA.

- using  $1\times$  Tris-borate buffer, together with 100 ng of the original plasmid to ensure complete linearization and to assess the quantity of recovered plasmid. The linearized plasmid is stored lyophilized or in aqueous solution at  $-20^{\circ}\text{C}$ .
2. Transcription of st-DNA to cRNA: Mix linearized plasmid (1  $\mu\text{g}$  in 8  $\mu\text{L}$  water),  $10\times$  T7 reaction buffer (2  $\mu\text{L}$ ), NTP mixture (6  $\mu\text{L}$ , final concentration of each NTP is 7.5 mM), 100 mM, dithiothreitol (2  $\mu\text{L}$ , 10 mM final), and Ampliscribe T7 RNA polymerase (2  $\mu\text{L}$ ), (all contained in the Epicentre Technologies kit [see Note 7]). After incubation for 2 h at  $37^{\circ}\text{C}$  add the RNase-free DNase I (1  $\mu\text{L}$ ) and continue the incubation for 15 min at  $37^{\circ}\text{C}$ . Cool the solution in ice and extract with the phenol saturated with chloroform.
  3. cRNA purification (see Note 8): Swell Biogel P10 (2 g) in 100 mL TE buffer, decant the supernatant and add 100 mL TE. The suspension of 2/3 gel, 1/3 buffer in two 50 mL Falcon tubes is heated for 5 min in a pressure cooker (do not autoclave), then stored at  $4^{\circ}\text{C}$ . In a 50 mL tube wash borosilicate glass beads (10 mL) successively with 1 M HCl, 1 M NaOH, and 1 M Tris pH 8, decanting floating glass debris at each washing. The beads are treated with diethylpyrocarbonate (10  $\mu\text{L}/100$  mL water) overnight at room temperature before autoclaving for 20 min at  $120^{\circ}\text{C}$ . For the setup used for the cRNA purification see Fig. 3. Pierce the bottom of a 0.7 mL microtube with a hot sterile needle. Cut off the tip of a sterile plastic cone and use it to pipette 10  $\mu\text{L}$  of the borosilicate glass beads into the tube, with a minimum of liquid. Completely fill the tube with P10 resin, place the microtube on a truncated Eppendorf tube inserted into a conventional centrifuge tube and centrifuge for 5 min at  $3000g$  on a swinging rotor. Make sure that the resin remains moist. Place the microtube on a sterile 1.5 mL Eppendorf tube posed on the centrifuge tube. Pipet 20–30  $\mu\text{L}$  of cRNA solution onto the resin and centrifuge the tube for 5 min at  $3000g$  on a swinging rotor. Lyophilize the eluant.
  4. cRNA quantification and quality control: Dissolve the pellet in 100  $\mu\text{L}$  autoclaved, Millipore-treated water. Pipet 2  $\mu\text{L}$  into 98  $\mu\text{L}$  water and take a UV spectrum in a 50- $\mu\text{L}$  quartz cuvette. The 260 nm/280 nm ratio should be near 1.8. The quantity of cRNA =  $\text{OD}_{260\text{nm}}/1000 \times 50/2 \times 40 \mu\text{g}/\mu\text{L}$  (assuming one  $\text{OD}_{260\text{nm}}/\text{mL} = 40 \mu\text{g}$ ). In several preparations from different plasmids we have obtained yields of between 50 and 90  $\mu\text{g}$  of pure cRNA from 1  $\mu\text{g}$  of plasmid. Pipet a volume of cRNA solution containing 1–2  $\mu\text{g}$  into the blue RNA dye buffer (15  $\mu\text{L}$ ). Denature the mixture for 5 min at  $65^{\circ}\text{C}$  and cool quickly in ice. The totality of the cRNA and a size ladder are separated on a 1% agarose gel for 30 min at 50 V. A single band of pure cRNA that should be obtained. The purified cRNA is stored at  $-20^{\circ}\text{C}$  (see Note 9). It is used at 20 fg/PCR in all experiments, the number of molecules being calculated from an extinction of 35,900 at 260 nm (pH 7), the molecular mass of the cRNA and Avogadro's number.

## 5. Total RNA preparation:

## a. Homogenization.

- i. Tissues (for precautions *see* **Note 10**): Large amounts (>10 mg) of fresh tissue must be immediately cooled in liquid nitrogen or dry ice. Cool a metal box in dry ice, add the tissue, and crush it with a pestle to obtain a coarse powder. Transfer the powder to a Corning tube and store it at  $-80^{\circ}\text{C}$ . The extraction of total RNA from both the tissues and cells (next paragraph) follows the TRIZOL Reagent procedure reproduced here (Gibco BRL), based on the Chomczynski and Sacchi method (**15**). Homogenize the powdered tissue in 1 mL of TRIZOL (*see* **Note 11**) per 50–100 mg of tissue using a glass-Teflon or power homogenizer (Polytron or equivalent). Small amounts (<10 mg) of tissue can be immediately homogenized in TRIZOL. The sample volume should not exceed 10% of the volume of the Reagent.
- ii. Cells grown in monolayer: Lyse cells directly in a culture dish by adding 1 mL of TRIZOL Reagent to a 3.5 cm dish and passing the cell lysate several times through a pipet. The amount of TRIZOL Reagent is based on the area of the dish (1 mL/10 cm<sup>2</sup>) and not on the number of cells present. An insufficient quantity of TRIZOL may result in contamination of the isolated RNA with DNA.
- iii. Cells grown in suspension: Pellet cells by centrifugation. Lyse cells in TRIZOL Reagent by repetitive pipetting. Use 1 mL of the reagent per  $5\text{--}10 \times 10^6$  of animal cells. Do not wash cells before adding the TRIZOL Reagent to avoid mRNA degradation.

b. Phase separation: The homogenized samples are transferred into clear polypropylene disposable tubes for volumes less than 2 mL. For larger volumes polypropylene or glass (Corex) can be used. Incubate the homogenized samples for 5 min at  $15\text{--}30^{\circ}\text{C}$ , add 0.2 mL of chloroform per 1 mL of TRIZOL Reagent, cap the tubes securely, shake vigorously for 15 s then incubate for 2–3 min at  $15\text{--}30^{\circ}\text{C}$ . Centrifuge at no more than 12,000g for 15 min at  $2\text{--}8^{\circ}\text{C}$ . Following centrifugation, the mixture separates into a lower red, phenol-chloroform phase, an interphase, and a colorless upper aqueous phase. RNA remains exclusively in the aqueous phase.

c. RNA precipitation and recovery: Transfer the aqueous phase to a fresh tube. To precipitate the RNA add 0.5 mL of isopropanol per 1 mL of TRIZOL Reagent used for the initial homogenization. Incubate at  $15\text{--}30^{\circ}\text{C}$  for 10 min and centrifuge at no more than 12,000g for 10 min at  $2\text{--}8^{\circ}\text{C}$ . Remove the supernatant and wash the RNA pellet once with 75% ethanol (in DEPC treated water), adding at least 1 mL of ethanol per 1 mL of TRIZOL Reagent used for the initial homogenization. Mix the sample by vortexing and centrifuge at no more than 7500g for 5 min at  $2\text{--}8^{\circ}\text{C}$ . Remove the supernatant and briefly air-dry the RNA pellet for about 10 min. Dissolve the pellet in RNase-free water by incubating for 10 min at  $55\text{--}60^{\circ}\text{C}$ . Quantitate by measuring the absorption at 260 nm. The 260 nm/280 nm ratio should approach 1.8.

d. Quality control: Pipet a volume of total RNA containing about 1  $\mu\text{g}$  into the blue RNA buffer to a total volume of 15  $\mu\text{L}$  and separate by electrophoresis on a 1% nondenaturing agarose gel for 30 min at 50 V. Examine the gel at 265 nm to verify that the 28s and 18s ribosomal RNA bands are of roughly equal intensity.

6. Preliminary test before RT-PCR quantification (*see* **Note 12**):

- a. Reverse transcription: An aqueous solution (14  $\mu\text{L}$ ) of total RNA (50 ng), and dT<sub>12–18</sub> (100 ng) (*see* **Note 13**) is heated for 15 min at  $65^{\circ}\text{C}$ . After allowing it to cool to room temperature (approx 15 min), add reverse transcriptase buffer (4  $\mu\text{L}$ ), 0.1 M dithiothreitol (2  $\mu\text{L}$ ), 20 mM of each dNTP (0.5  $\mu\text{L}$  of DNA polymerization mixture), RNase

inhibitor (0.5  $\mu\text{L}$ ) and Superscript II reverse transcriptase (1  $\mu\text{L}$ ) and warm the solution for 1 h at 37°C. Stop the reaction by heating at 95°C for 5 min, then cool in ice.

- b. PCR: Mix primers (100 ng of each), PCR buffer (5  $\mu\text{L}$ ), 25 mM  $\text{MgCl}_2$  (4  $\mu\text{L}$ ), dNTP mix (0.8  $\mu\text{L}$  of DNA polymerization mixture), AmpliTaq (0.2  $\mu\text{L}$ ) and water to 50  $\mu\text{L}$ . Amplify for 30 cycles at 94°C for 1 min, at 55°C for 1 min and at 72°C for 1 min (see **Note 14**). Concentrate the solution in a Speedvac and separate on a 2% nondenaturing agarose gel at 100 V. The intensity of the band at 265 nm gives an idea of the quantity of total RNA necessary for the quantification experiments.
7. Quantification: The appropriate quantity of total RNA (multiplied by the number of PCRs to be carried out) containing 20 fg cRNA (multiplied by the number of PCRs to be carried out) is reverse transcribed as above (see **Note 15**). The mixture of control cDNA (st-cDNA) and cellular cDNA (cell-cDNA) is then divided into  $x$  fractions in PCR tubes. Carry out the PCR reactions as described above in the presence of [ $\alpha$ - $^{32}\text{P}$ ]dCTP (1  $\mu\text{Ci}/\text{PCR}$ ) (see **Note 16**). Separate half the PCR mixture containing 10% blue DNA dye solution on a 10% polyacrylamide gel at 60 V for about 3 h (see **Note 17**). Expose the gel in a PhosphorImager cassette for at least 2 h and measure the intensity of the bands obtained, remembering to subtract background values. Alternatively, excise the amplicons and measure the incorporated radioactivity by Cerenkov counting. For each lane, the ratio  $R$  is calculated, where

$$R = \frac{\text{no. of pixels (or cpm) of the cellular amplicon}}{\text{no. of pixels (or cpm) of the control amplicon}} \times F$$

and

$$F = \frac{\text{amplicon length for cell-cDNA}}{\text{no. of dC + dG in cell-cDNA}}$$

If  $R < 1$  repeat the RT-PCR using a larger quantity of total RNA; if  $R > 1$  reduce the quantity of total RNA. The objective is to obtain  $R$  as near 1 as possible. Treatment of the results: Draw a graph of  $R$  against total RNA (ng) on a log–log scale as shown in **Fig. 2**. A straight line of slope near unity should be obtained. From the point of equivalence, where  $R = 1$ , a vertical line to the abscissa gives the quantity of total RNA that contains 20 fg of the mRNA targeted. Quantification of the mRNA from a housekeeping gene, of unvariable quantity under ideal conditions (but see **Note 3**), allows one to correlate mRNA quantities from different tissues or cell cultures.

#### 4. Notes

1. The plasmids pQA-1, pQB-3, pMus3, and pRat6, together with full sequence details, are available from the authors. The constructs been thoroughly tested and used with success in a large number of laboratories worldwide. The primers give single bands with cellular RNAs, all of which have been authenticated by Southern blot analysis or sequencing.
2. The cytokine network constitutes a vast number of interesting mRNA targets not present in the present controls. The controls can readily be adapted for the incorporation of new targets, especially using overlap extension PCR (**16**). Such modifications are not within the scope of the present protocol, but advice on how to achieve them can be obtained from the authors.
3. To correlate the mRNA quantities present in the total RNA extracted from different tissues or cell lines, it is normal practice to use a housekeeping gene, supposedly present in an unvarying quantity throughout the material being investigated, as an internal control.

The choice of such a gene has long been the subject of debate and controversy and it would seem that the solution is that it depends on the material being examined. (For a discussion *see* **ref. (17)** and also consult an internet newsgroup: [bionet.molbio.mthds-reagnts@mail.mcgill.ca](mailto:bionet.molbio.mthds-reagnts@mail.mcgill.ca) archives.)

4. The plasmids furnished by the authors are in amounts of 5  $\mu\text{g}$ , of which 1  $\mu\text{g}$  should be kept in reserve for control purposes and for possibly growing up a fresh supply.
5. The enzymatic digestion is repeated since it is essential that the plasmid is fully linearized in order to avoid run-through and to have a homogeneous st-RNA of correct length.
6. To be carried out under a fume hood because of solvent toxicity.
7. Several years ago, we found that the Epicentre Ampliscribe T7 transcription kit was by far the best of several that were commercially available, but others may now be comparable. It is highly desirable to obtain a high quantity of st-RNA in order to quantitate it accurately by optical density measurements.
8. The purification step is essential to avoid contamination with nonincorporated NTPs, which would seriously affect the st-RNA quantification. We favor P10 chromatography for the purification, rather than an oligodT affinity method, because recoveries are much higher.
9. A stock solution of 200  $\text{fg}/\mu\text{L}$  in autoclaved Millipore-treated water (1  $\mu\text{L}$  for 10 simultaneous PCRs) has been used for several years without cRNA deterioration despite repeated freezing and defreezing, normal care being taken, however, to avoid contamination.
10. Tissue homogenization must be carried out in a cold room. To avoid RNA degradation the tissues must be kept very cold. The operator should wear two pairs of gloves, an overall, hat, and a mask. After the homogenization procedure the working surface and the metal tin and pestle should be washed successively with disinfectant, hot water, ethanol, and demineralized water.
11. When working with TRIZOL Reagent use gloves and eye protection (shield, safety goggles). Avoid contact with skin or clothing. Use in a chemical fume hood and avoid breathing vapor.
12. Before undertaking the quantification as such, it is highly advisable to ascertain the presence of the targeted RNA in the mixture to be analyzed, together with its approximate quantity. The objective is to obtain an easily visible ethidium bromide-stained band on a gel after 30 amplification cycles. We generally fix the quantity of total RNA for this preliminary test at 50 ng (or about 0.5 ng polyA<sup>+</sup> RNA) per target. This allows one to distinguish between poorly and well-expressed mRNAs. If the resulting band is very intense or weak, further preliminary tests with 5 or 500 ng, respectively, are advisable. If more than 500 ng appears to be necessary, then it must be concluded that the RNA is too rare to be quantifiable and the results will be meaningless. For cytokine messengers in stimulated cells, the preliminary test can be carried out on 5 ng of total RNA. In each case, the total RNA sample may be spiked with 20 fg cRNA. The total RNA can be tested for the presence of many mRNAs by multiplying the initial quantities by the number of mRNAs to be assessed and dividing up the resulting cDNA mixture in consequence before adding the appropriate primers. Grouping together mRNAs of similar abundance can be timesaving during quantification experiments. The usual control reaction of PCR without RT can be carried out here to verify the absence of contaminating genomic DNA in the RNA preparations. Contamination may also be evident during amplicon separations, because most of the primers are situated in different exons of the cellular targets. Some of the introns are very large, but the TNF $\alpha$  intron of 300 bp, for example, gives rise to a supplementary band on a gel that is easily seen in DNA contaminated samples.



13. There are several possibilities for the choice of primer for the reverse transcription, dT<sub>12-18</sub>, random hexamer priming, specific priming with the antisense primer, or a combination of primers. We have adopted dT<sub>12-18</sub> priming. The use of this primer assumes the presence of a polyA stretch in the mRNA to be assayed (it is present in the internal standard cRNA), which is generally the case in functional mRNAs. An objection may be raised that mRNAs may be incompletely reverse-transcribed because of long 3'-UTR or because of pauses caused by secondary structures. The distances between the polyA region and the sense primers we have chosen range from 400 to 1600 nt, with the great majority being less than 900 nt. (The exceptions are c-jun (2100 nt), Krox20 (2600 nt) and CSF-1 (3600 nt).) The maximum distance in the controls is 600 nt. As to the second point, our experience with preparing cDNA libraries has shown us that Superscript II reverse transcriptase is highly efficient at producing full-length transcripts from mRNA up to at least 7 kb in length. A 1 h reaction time should be more than adequate. If random priming with hexamers is chosen for the reverse transcription, it must be remembered that the whole RNA population will be transcribed, not just the 1–2% polyA<sup>+</sup> RNA, possibly resulting in increased nonspecific amplification. However, satisfactory results can apparently be obtained if hexamer concentrations are kept low (approx 1 ng/2.5 µg cellular RNA).
14. The PCR conditions may have to be modified according to the apparatus used.
15. In our experience the st-DNA/cDNA mixture has to be freshly prepared in order to obtain reproducible results.
16. The present protocol only describes amplicon assays using radioactivity. Many other assays have been described in the literature, for example, gel-based assays using Southern blot analysis (18) and fluorescence intensity measurements after ethidium bromide staining (19), (for the latter we have found that weak bands give unsatisfactory results), capture strategies using paramagnetic beads and chemiluminescence assays (20,21), microplate assays after sandwich-base amplicon quantification (22,23), capillary gel electrophoresis (24) and HPLC (25).
17. Separation of amplicons can be accomplished on agarose. This is quite acceptable once it is certain that both st-cDNA and cell-cDNA amplify with equal efficiency. A plot of slope 1, obtained on polyacrylamide gel separation, will probably not be observed, as we have previously demonstrated (2). However, the point of equivalence, where st-amplicon = cell-amplicon, has been shown to be identical (2).

## References

1. Wang, A. M., Doyle, M. V., and Mark, D. F. (1989) Quantitation of mRNA by the polymerase chain reaction. *Proc. Natl. Acad. Sci. USA* **86**, 9717–9721.
2. Bouaboula, M., Legoux, P., Pességué, B., Delpech, B., Dumont, X., Piechaczyk, M., Casellas, P., and Shire, D. (1992) Standardization of mRNA titration using a polymerase chain reaction method involving co-amplification with a multispecific internal control. *J. Biol. Chem.* **267**, 21,830–21,838.
3. Shire, D., et al. (1993) An invitation to an open exchange of reagents and information useful for the measurement of cytokine mRNA levels by PCR. *Eur. Cytokine Net.* **4**, 161–162.
4. Pousset, F., Fournier, J., Legoux, P., Keane, P., Shire, D., and Bloch, B. (1996) The effect of serotonin on the expression of cytokines by rat hippocampal astrocytes. *Mol. Brain Res.* **38**, 54–62.
5. Platzter, C., Richter, G., Überla, K., Müller, W., Blöcker, H., Diamantstein, T., and Blankenstein, T. (1992) Analysis of cytokine mRNA levels in interleukin-4-transgenic mice by quantitative polymerase chain reaction. *Eur. J. Immunol.* **22**, 1179–1184.

6. Feldman, A. M., Ray, P. E., Silan, C. M., Mercer, J. A., Minobe, W., and Bristow, M. R. (1991) Selective gene expression in failing human heart. Quantification of steady-state levels of messenger RNA in endomyocardial biopsies using the polymerase chain reaction. *Circulation* **83**, 1866–1872.
7. Platzer, C., Ode-Hakim, S., Reinke, P., Döcke, W.-D., Ewert, R., and Volk, H.-D. (1994) Quantitative PCR analysis of cytokine transcription patterns in peripheral mononuclear cells after anti-CD3 rejection therapy using two novel multispecific competitor fragments. *Transplantation* **58**, 264–268.
8. Jia, G. Q. and Gutierrez-Ramos, J. C. (1995) Quantitative measurement of mouse cytokine mRNA by polymerase chain reaction. *Eur. Cytokine Net.* **6**, 253–255.
9. Siegling, A., Lehmann, M., Platzer, C., Emmrich, F., and Volk, H.-D. (1994) A novel multispecific competitor fragment for quantitative PCR analysis of cytokine gene expression in rats. *J. Immunol. Methods* **177**, 23–28.
10. Farrar, J. D. and Street, N. E. (1995) A synthetic standard DNA construct for use in quantification of murine cytokine mRNA molecules. *Mol. Immunol.* **32**, 991–1000.
11. Tarnuzzer, R. W., Macauley, S. P., Farmerie, W. G., Caballero, S., Ghassemifar, M. R., Anderson, J. T., Robinson, C. P., Graut, M. B., Humphreys-Beher, M. G., Franzen, L., Peck, A. B., and Schultz, G. S. (1996) Competitive RNA templates for detection and quantitation of growth factors, cytokines, extracellular matrix components and matrix metalloproteinases by RT-PCR. *BioTechniques* **20**, 670–674.
12. Pitossi, F. J. and Besedovsky, H. O. (1996) A multispecific internal control (pRat6) for the analysis of rat cytokine mRNA levels by quantitative RT-PCR. *Eur. Cytokine Net.* **7**, 377–379.
13. Legoux, P., Minty, C., Delpech, B., Minty, A. J., and Shire, D. (1992) Simultaneous quantitation of cytokine mRNAs in interleukin-1 $\beta$  stimulated U373 human astrocytoma cells by a polymerisation chain reaction method involving co-amplification with an internal multi-specific control. *Eur. Cytokine Net.* **3**, 553–563.
14. Raeymaekers, L. (1993) Quantitative PCR: Theoretical considerations with practical implications. *Anal. Biochem.* **214**, 582–585.
15. Chomczynski, P. and Saachi, N. (1987) Single-step method of RNA isolation by acid guanidinium thiocyanate-phenol-chloroform extraction. *Anal. Biochem.* **162**, 156–159.
16. Horton, R. M., Hunt, H. D., Ho, S. N., Pullen, J. K., and Pease, L. R. (1989) Engineering hybrid genes without the use of restriction enzymes: Gene splicing by overlap extension. *Gene* **77**, 61–68.
17. Kidd, V. and Lion, T. (1997) Appropriate controls for RT-PCR. *Leukemia* **11**, 871–881.
18. Bickel, M., Nothen, S. M., Freiburghaus, K., and Shire, D. (1996) Chemokine expression in human oral keratinocyte cell lines and keratinized mucosa. *J. Dental Res.* **75**, 1827–1834.
19. Kopf, M., Brombacher, F., Kohler, G., Kienzle, G., Widmann, K. H., Lefrang, K., Humborg, C., Ledermann, B., and Solbach, W. (1996) Il-4-deficient balb/c mice resist infection with leishmania major. *J. Exp. Med.* **184**, 1127–1136.
20. Vandevyver, C. and Raus, J. (1995) Quantitative analysis of lymphokine mRNA expression by an automated, non-radioactive method. *Cell. Mol. Biol.* **41**, 683–694.
21. Motmans, K., Raus, J., and Vandevyver, C. (1996) Quantification of cytokine messenger RNA in transfected human T cells by RT-PCR and an automated electrochemiluminescence-based post-PCR detection system. *J. Immunol. Methods* **190**, 107–116.
22. Hockett, R. D., Jr., Janowski, K. M., and Bucy, R. P. (1995) Simultaneous quantitation of multiple cytokine mRNAs by RT-PCR utilizing plate based EIA methodology. *J. Immunol. Methods* **187**, 273–285.

23. Zou, W. P., Durand-Gasselín, I., Dulioust, A., Maillot, M. C., Galanaud, P., and Emilie, D. (1995) Quantification of cytokine gene expression by competitive PCR using a colorimetric assay. *Eur. Cytokine Net.* **6**, 257–264.
24. Williams, S. J., Schwer, C., Krishnarao, A. S. M., Heid, C., Karger, B. L., and Williams, P. M. (1996) Quantitative competitive polymerase chain reaction: analysis of amplified products of the HIV-1 *gag* gene by capillary electrophoresis with laser-induced fluorescence detection. *Anal. Biochem.* **236**, 146–152.
25. Hayward-Lester, A., Oefner, P. J., and Doris, P. A. (1996) Rapid quantification of gene expression by competitive RT-PCR and ion-pair reversed-phase hplc. *BioTechniques* **20**, 250–257.

## ***In Situ* PCR Detection of HIV Expression in the Human Placenta**

**Asad U. Sheikh, Bruno M. Polliotti, and Richard K. Miller**

### **1. Introduction**

Control of vertical transmission of HIV-1 has progressed remarkably despite a lack of understanding of precise mechanisms by which infection may occur (*1*). The latter situation partially resulted from inadequate tools for *in vitro* analysis. However, *in utero* data suggest that placental infection coincides with vertical transmission. In many cases of fetal infection, placental infection is also present; detection of fetal infection without placental infection is relatively rare. An interesting observation is that not all placentae of HIV-1-infected women are infected (*2–5*). This raises the possibility that understanding how the placenta becomes infected will give insight into mechanisms of vertical transmission and may lead to therapies to prevent infection.

Use of an organ culture system, placental explants, provides a model, which maintains many *in vivo* characteristics and is useful to study infection (*6–9*). The key to evaluation of infection in this system is accurate detection and localization of infection. A group of techniques collectively known as *in situ* polymerase chain reaction (IS-PCR) have been developed to amplify DNA within intact cells (*10–13*). IS-PCR provides an extremely useful approach to detect very low amounts of targets of interest. Thus, this assay is particularly well suited for detection of virus within tissues, the concentration of which is frequently low (*13*).

IS-PCR continues to evolve as no single methodology is useful for all tissues or targets. IS-PCR appears to be more robust for analysis of cell preparations, but we and others have demonstrated its utility in detection of targets within paraffin embedded tissue sections (*14–16*). Success in using this assay depends upon optimization of conditions, use of appropriate controls and the ability to troubleshoot when the technique is not working. In the following pages, we will describe our development of an approach to IS-PCR for detecting HIV-1 in the placental explant, an approach we have also used for identification of placental tissues infected *in utero*.

### **2. Material**

#### **2.1. Explant Culture**

1. Six-well and 24-well culture plates and Transwell™ inserts (Corning Costar, Cambridge, MA).
2. RPMI 1640 and Hams F-12 (Mediatech, Herndon, VA).

From: *Methods in Molecular Biology*, Vol. 137: *Developmental Biology Protocols*, Vol. III  
Edited by: R. S. Tuan and C. W. Lo © Humana Press Inc., Totowa, NJ

3. Fetal calf serum (Mediatech).
4. Matrigel (Collaborative Biologics, Bedford, MA).
5. Penicillin (Mediatech).
6. Streptomycin (Mediatech).
7. L-Glutamine (Gibco-BRL, Gaithersburg, MD).
8. Pyruvate (Cellgro, through Fisher Scientific, Fair Lawn, NJ).

## 2.2. Tissue Preparation

1. 10% buffered formaldehyde (Sigma, St. Louis, MO).
2. 10% paraformaldehyde (Sigma)—100 g paraformaldehyde in 900 mL of PBS, heated to 60°C for 1 h while stirring. Solution is cooled to room temperature and pH adjusted to 7.4 with NaOH. Volume is adjusted to 1000 mL with PBS and filtered through 315 grade fluted filter paper (VWR, Rochester, NY) (*see Note 2*). The stock solution is diluted to the desired concentration in PBS.
3. Silane coated slides (Polysciences, Warrington, PA).
4. Xylene (Fisher Scientific, Fair Lawn, NJ).
5. Graded Ethanol baths (100%, 95%, 80%, 70%).
6. PBS: Phosphate buffered saline: 8 g NaCl, 0.2 g KCl, 1.15 g Na<sub>3</sub>HPO<sub>4</sub>, 0.2 g KH<sub>2</sub>PO<sub>4</sub>, 800 mL distilled deionized (dd) H<sub>2</sub>O. Stir until dissolved and adjust pH to 7.4 with HCl. Bring final volume to 1000 mL with ddH<sub>2</sub>O.
7. 3% H<sub>2</sub>O<sub>2</sub>: 10 mL 30% H<sub>2</sub>O<sub>2</sub> (Fisher Scientific reagent grade, Fair Lawn, NJ) stored in refrigerator, 90 mL methanol (Fisher Scientific Baker grade, Fair Lawn, NJ), prepared immediately prior to use.

## 2.3. Amplification

1. Proteinase K: (Gibco-BRL, Gaithersburg, MD) final concentrations of 6–24 µg/mL in PBS, freshly prepared and prewarmed to 37°C.
2. Self-seal (MJ Research, Watertown, MA).
3. Glass coverslips—#1.5 and #2 (Corning, Corning, NY).
4. Frame Seal (MJ Research, Watertown, MA).
5. Nail polish—Wet and Wild Clear Nail Protector (Pavilion Ltd., Nyack on the Hudson, NY).
6. Nucleotides—100 mM stock dATP, dCTP, dGTP, dTTP (Gibco-BRL, Gaithersburg, MD).
7. Tissue amplification mixture: 10 mM Tris-HCl, pH 8.3, 50 mM KCl, 3–4 mM MgCl<sub>2</sub>, 0.2 mM dATP, 0.2 mM dTTP, 0.2 mM dGTP, 0.2 mM dCTP, 0.5–1.25 mM of each primer, 0.05U/µL *Taq* polymerase (Boehringer Mannheim, Indianapolis, IN), 0.1% bovine serum albumin (Boehringer Mannheim, Indianapolis, IN).
8. Final concentrations of primers: 0.25 µM β-globin1, 0.25 µM β-globin2; 1.25 µM of each *gag* primer (SK 38, SK39); 1.25 µM of each *pol* primer (HPOL1 Outer, HPOL2 Outer); 1.25 µM of each LTR primer (LTR1 Outer, LTR2 Outer [*see Table 1*]).
9. Dedicated slide thermal cycler: PTC-100™ MS-16 (MJ Research, Watertown, MA), Omnislide Cycler (Hybaid, Franklin, MA).
10. Chloroform (Amresco, Solon, OH).

## 2.4. Detection

1. 20XSSC: 175.3 g NaCl, 88.2 g sodium citrate, 900 mL ddH<sub>2</sub>O. Adjust pH to 7.0 with NaOH and bring the final volume to 1000 mL with ddH<sub>2</sub>O. This stock solution is diluted to the desired concentration in ddH<sub>2</sub>O.
2. Hybridization buffer: 50% deionized formamide (Boehringer Mannheim, Indianapolis, IN), 0.1% sodium dodecylsulfate, 2X Denhardt's solution (Amresco, Solon, OH), 1 mg/mL sheared salmon sperm DNA (Gibco-BRL, Gaithersburg, MD).

**Table 1**  
**Primer Sequences Used for Amplification *In Situ***

Primer	Sequence	Size of expected product
$\beta$ -globin1	CAACTTCATCCACGTTCCACC	268
$\beta$ -globin2	GAAGAGCCAAGGACAGGTAC	
SK38	ATAATCCACCTATCCCAGTAGGAGAAA	115
SK39	TTGGTCCTTGTCTTATGTCCAGAATGC	
LTR1 Outer	CTAACCAGAGAGACCCAGTACAGGC	441
LTR2 Outer	AGACAAGATATCCTTGATCTGTGG	
HPOL1 Outer	CCCTACAATCCCCAAAGTCAAGG	324
HPOL2 Outer	TACTGCCCTTCACCTTTCCA	

**Table 2**  
**Oligonucleotides and Primers Used for Generation of Labeled Probes for *In Situ* Hybridization**

Probe	Sequence	Size of expected product
$\beta$ -globin	ACACAACCTGTGTTCACTAGC	
SK19	ATCCTGGGATTAAATAAAATAGTAAGAAT GTATAGCCCTAC	
LTR1 Inner	CCACACACAAGGCTACTTCCCTGA	312
LTR2 Inner	GTCCCCAGCGGAAAGTCCCTTGT	
HPOL1 Inner	TAAGACAGCAGTACAAATGGCAG	175
HPOL2 Inner	GCTGTCCCTGTAATAAACCCG	

3. Probe cocktails:
  - a. Alu: 1–2 ng/ $\mu$ L biotin Alu probe (Alu1/Alu2 probe, Research Genetics, Huntsville, AL) in hybridization buffer.
  - b.  $\beta$ -globin: the oligonucleotide probe (*see Table 2*) is 3' end labeled with biotin 16-dUTP or digoxigenin 1-dUTP (Boehringer Mannheim, Indianapolis, IN) is added to the hybridization mixture. Dig Oligonucleotide 3'-end Labeling kit (Boehringer Mannheim, Indianapolis, IN).
  - c. HIV-1 probes: in the hybridization buffer, 2 ng/mL of digoxigenin or biotin labeled genomic probe and 5 pmol/100  $\mu$ L of 3' tailed oligonucleotide probe is added. Primer (*see Table 2*); HPOL1 Inner, HPOL2 Inner; LTR1 Inner, LTR2 Inner. Oligonucleotide SK19 (*see Table 2*). Plasmid pNL4-3 (AIDS Research and Reference Reagent Program, Division of AIDS, NIAID, NIH: pNL4-3 from Dr. Malcom Martin) (17).
4. Gel extraction: QIAquick Gel Extraction Kit (Qiagen, Valencia, CA).
5. Signal detection: Vectastain ABC Elite kits for alkaline phosphatase and horseradish peroxidase systems (Vector laboratories, Burlingame, CA), DAB Substrate kit (Vector Laboratories, Burlingame, CA), AEC Substrate kit (Vector Laboratories, Burlingame, CA), NBT/BCIP Substrate kit (Vector Laboratories, Burlingame, CA).
6. Counterstain: methyl green (Chroma-Gesellschaft, Germany), eosin (Sigma), Nuclear Fast Red (Vector Laboratories, Burlingame, CA), Mayers hematoxylin (Sigma).
7. n-Butanol: (Fisher Scientific, Fair Lawn, NJ)
8. Mounting media: PermOUNT for insoluble stains (Fisher Scientific, Fair Lawn, NJ); Glycergel for soluble stains (Dako, Carpinteria, CA).
9. Pap hydrophobic markers: 4 mm and 1 mm (Kiyota, Japan).

### 3. Methods

#### 3.1. Explant Culture

1. Small pieces ( $<1 \text{ mm}^3$ , approximately 100 mg) of villous tissue from first and third trimester healthy, serologically negative patients are collected immediately after elective surgical abortions or delivery.
  - a. The tissues are extensively rinsed in sterile PBS supplemented with 1% penicillin/streptomycin, to remove contaminating maternal blood.
  - b. For first trimester tissues (approximately 10 mg), the explants are grown on Matrigel with Hams F-12 (**18,19**). All term and some first trimester placentae are incubated in RPMI 1640 with 10% fetal calf serum, 2 mM L-glutamine, 1 mM pyruvate, penicillin (100 IU/mL) and 100 mg streptomycin for 24 h following harvesting to allow recovery (**9**). Cultures in liquid media are shaken on an orbital shaker whereas Matrigel cultures are not shaken. All cultures are maintained in a humidified chamber with 95%  $\text{O}_2$  and 5%  $\text{CO}_2$  at 37°C (*see Note 1*).
  - c. The recovery period is followed by exposure for 24 h to free virus at a concentration 1000X higher than required to infect peripheral blood mononuclear cells (PBMCs).
  - d. The tissue is rinsed and cultured for an additional 5 d at 37°C with 95%  $\text{pO}_2$  and 5%  $\text{pCO}_2$ . The tissue is collected at the end of the experiments.
  - e. An aliquot of tissue is stored at  $-80^\circ\text{C}$  for standard PCR analysis.

#### 3.2. Tissue Preparation

1. The remainder of tissue is fixed in buffered formalin for 12 h at 4°C and stored in 70% ethanol at 4°C until embedded in paraffin (*see Note 2*).
2. The explants are paraffin-embedded and sectioned onto silane-coated slides (*see Note 3*).
3. Two widely separated, 5  $\mu\text{m}$  thick sections are placed on each slide for all analysis. The microtome blade is cleaned with xylene on clean Kimwipes™ prior to cutting of the next block of tissue. The sections are air dried at least 24 h prior to use.

#### 3.3. In Situ Amplification

1. The slides are placed at 60°C in an oven for 30–120 min to allow the tissue to adhere to the slide.
2. Slides are dipped in three xylene baths for 5 min each. The sections are rehydrated through graded ethanol washes: two changes of 100% ethanol for 5 min each, two washes of 95% ethanol for 5 min each, one 80% ethanol bath for 5 min, one 70% ethanol bath for 5 min and immersion into  $\text{dH}_2\text{O}$  for 5 min.
3. When using the horseradish-peroxidase conjugate for detection, endogenous peroxidase activity is quenched by soaking slides in 3%  $\text{H}_2\text{O}_2$  for 5 min at room temperature. The hydrogen peroxide is removed by two rinses in  $\text{dH}_2\text{O}$  for 5 min each (*see Note 4*).
4. Prior to digestion, the tissues are soaked in PBS for 5 min. The slides are transferred to the prewarmed proteinase-K solution and soaked at 37°C for 20–30 min. To stop digestion, the slides are transferred to heating blocks at 92°C where they are kept for 2 min. This is followed by one wash in PBS for 5 min and two washes in  $\text{dH}_2\text{O}$  for 5 min each. The slides are air dried (*see Notes 5 and 6*).
5. The amplification mixture (25–65  $\mu\text{L}$ ) is applied to each section of tissue. The cover slips are placed onto the sections and sealed. The sections are denatured at 94°C for 5 min and then undergo 20–25 cycles of 94°C for 30 s, 55°C for 1 min, 72°C for 1 min. Following the final extension step is a 6-min extension at 72°C and then storage at 4°C until further analysis (*see Notes 7–10*).

### 3.4. In Situ Hybridization

Although various approaches are available for detection of the amplified product, we have had the best results with using labeled genomic and oligonucleotide probes (see **Notes 11** and **12**). Probes may be kept at  $-20^{\circ}\text{C}$  for at least one year without significant deterioration in quality.

1. Both the  $\beta$ -globin and SK19 oligonucleotide probes are 3' tailed according to the instructions provided with the Dig Oligonucleotide 3'-end Labeling kit.
2. Both HIV-1 genomic probes (LTR and pol) are prepared by PCR. Separate 100  $\mu\text{L}$  PCR reaction mixtures (100  $\mu\text{M}$  dATP, 100  $\mu\text{M}$  dGTP, 100  $\mu\text{M}$  dCTP, 70  $\mu\text{M}$  dTTP and 30  $\mu\text{M}$  of biotin 16-dUTP or digoxigenin 11-dUTP, 1.5 mM  $\text{MgCl}_2$  and 10 mM Tris-HCl (pH 8.3), 50 mM KCl, 1.25 M of each primer, 0.05  $\mu\text{g}/\mu\text{L}$  *Taq* polymerase and 1 ng/ $\mu\text{L}$  of DNA template (plasmid pNL4-3) were made for each primer set. The reaction is performed by denaturing 2 min at  $95^{\circ}\text{C}$  followed by 35 cycles of denaturation at  $94^{\circ}\text{C}$  for 30 s, at annealing  $55^{\circ}\text{C}$  for 30 s and extension at  $72^{\circ}\text{C}$  for 2 min. The PCR products are gel purified on a 1.5% agarose gel and extracted using QIAquick Gel Extraction Kit<sup>®</sup> according to the manufacturer's instruction.
3. The coverslips are removed, and slides heated to  $95^{\circ}\text{C}$  for 1 min (see **Note 13**). The slides are washed in two changes of 2XSSC for 5 min each.
4. The tissue edges are blotted followed by addition of probe mixture (10–25  $\mu\text{L}$ ) to each section of tissue and placement of coverslips. The tissue with the probe cocktail is denatured for 10 min at  $95^{\circ}\text{C}$ . Hybridization is carried out at  $40^{\circ}\text{C}$  for 4 h in a humidified chamber and then tissue maintained at  $4^{\circ}\text{C}$  until further analysis (see **Note 14**).
5. Following hybridization, slides are washed in two changes of 2XSSC for 5 min each.
6. Antibody is freshly prepared according the instructions with the Vectastain ABC Elite<sup>®</sup> kit, and remains at room temperature for 30 min prior to use. Antibody is applied to each section and then evenly spread by covering the section with a plastic or Parafilm<sup>™</sup> coverslip. The tissue is exposed for 30–60 min at room temperature in a humid chamber (see **Note 15**).
7. The slides are washed in PBS for 5 min. Fresh DAB substrate is prepared according to the manufacturer's protocol (Vector Laboratories, Burlingame, CA). Generally nickel is added to the DAB substrate according to the manufacturer's protocol, to provide a dark gray to black stain. Excess substrate is applied and color allowed to develop protected from light for 5–10 min (until color is grossly detectable).
8. The substrate is removed in  $\text{dH}_2\text{O}$  and the tissue counterstained. With DAB, we prefer counterstaining for 10 min in 0.25% methyl green followed by three washes in  $\text{dH}_2\text{O}$ , three washes in n-butanol, clarification through three changes of xylene and mounting coverslips with Permount (see **Note 16**).

### 3.5. Development and optimization of IS-PCR

IS-PCR is an extremely sensitive technique that we have used to identify low levels of HIV-1 within *in utero* and *in vitro* infected human placenta tissue (see **Fig. 1**). It is a costly ( $\$1$ – $2$ /slide) and lengthy (2–3 d) assay with many potential sources for error. We have found in order to develop the assay, testing conditions for targets that could be readily detected and inclusion of numerous types of controls within the same run were critical.

$\beta$ -globin is an ubiquitous gene, present in two copies per cell. Our experience has been that with the set of primers used, product could be detected under a wide range of



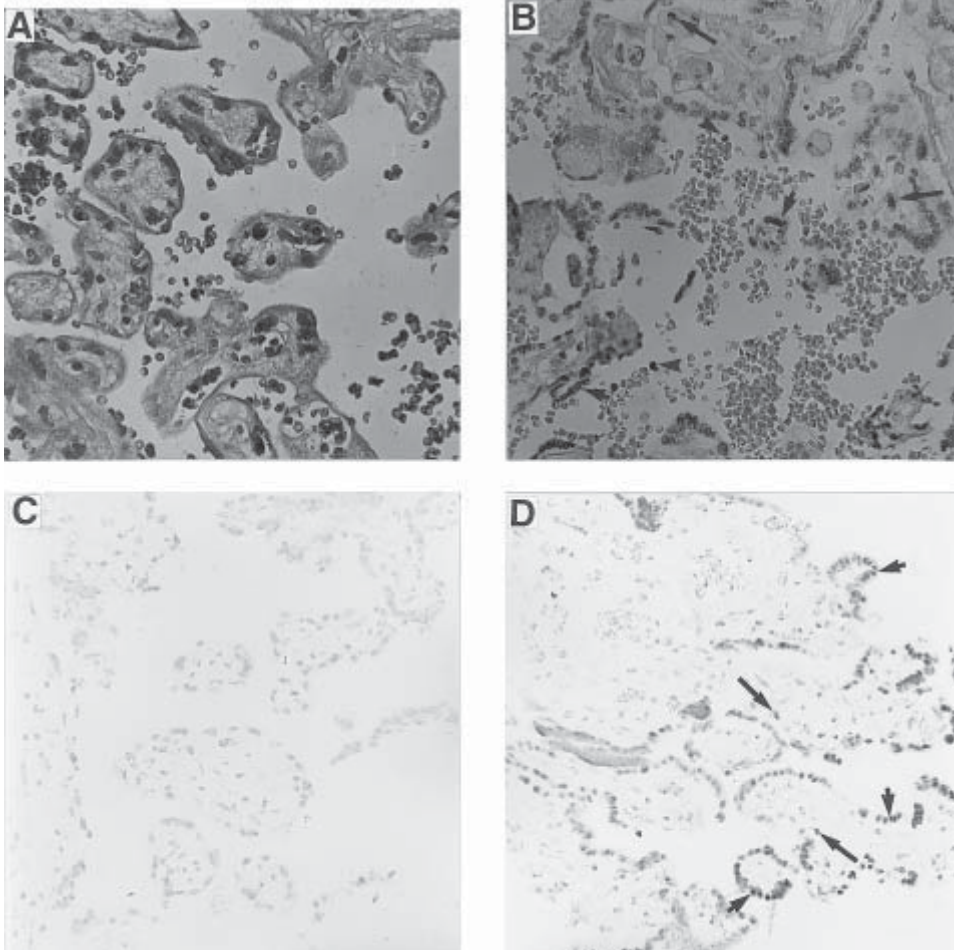

Fig. 1. (See color plate 1 appearing after p. 262.) (A) Uninfected term human placenta. (B) Infected term human placenta with signal detected within PBMCs (arrow head) in the intervillous space, syncytiotrophoblast (short arrows), and Hofbauer cells (long arrows). (C) Uninfected third trimester human placental explant. (D) Infected third trimester human explant with signal identified in syncytiotrophoblast (short arrows) and Hofbauer cells (long arrows). All sections were eosin counterstained and are at 200X magnification.

cycling and hybridization conditions as well as with a range of concentrations of reagents. This has permitted us to develop conditions that are optimal for the HIV-1 targets and simultaneously include a control for amplification.

The key to accurate interpretation with IS-PCR is inclusion of the appropriate control specimens. Typical controls included in each assay are the following.

1. Unamplified sections on the same slide to control for background in *in situ* hybridization;
2. uninfected tissues;
3. known infected tissues;
4. amplification of  $\beta$ -globin in a section of the sample of interest to account for specimen conditions that may impair amplification;

5. solution phase amplification (the MJ Research slide thermal cycler apparatus permits thermal cycling on slides and tubes on the same block) to verify that cycling parameters were sufficient to allow for amplification; and
6. *in situ* hybridization with Alu to confirm the occurrence of adequate digestion and hybridization.

Additional positive and negative controls included analysis of other infected tissues (brain, lymph node and PBMC cytospin) and uninfected tissues (tonsil and PBMC cytospin). Further controls for specificity of PCR amplification substitution of unrelated primers and destruction of DNA template by pretreatment of tissues with DNase (Gibco, Gaithersburg, MD). Controls for the *in situ* hybridization step included probes applied singly and application of no probes or nonspecific probe (human papilloma virus).

#### 4. Notes

1. It is essential to obtain the tissue fresh and to place the tissue fragments into PBS. Selection of tissue from the term placenta should be from regions devoid of both red and white infarcts. For best results, a dissecting microscope should be used. For first trimester placentae, two different techniques are used: a. in free culture of RPMI 1640 and, b. on a collagen matrix (Matrigel). The advantage of using Matrigel is the ability to study trophoblast column proliferation and differentiation into extravillous trophoblast (20). It is noted that compared with the RPMI cultures, Matrigel provides a surface within which the tissue can attach and proliferate. However, Matrigel also provides a surface for the HIV virus to bind. Thus, extensive washing of the Matrigel surfaces are required. Also in studying the placental explants on the Matrigel, it is important to monitor the growth of the tissue and to carefully remove the tissue from the inserts in the following manner. Place the entire insert with tissue attached in 10% buffered formaldehyde for 12–24 h. Cut the membrane with Matrigel and tissue and place in a tube with 1% liquid agarose added to stabilize the preparation. Add 70% ethanol. The tissue can then be embedded as a normal tissue specimen. The advantage of this procedure is that loss of the small placental explants is avoided.
2. Proper fixation of tissue is critical to successful preservation, amplification and detection of nucleic acids. Critical parameters include the length of fixation and fixative (13,21). We have been successful in demonstrating good signal detection in tissues fixed 12–24 h in 10% buffered formaldehyde for tissue and in cytospin preparations, 10 min in 1–4% paraformaldehyde in PBS. (The paraformaldehyde solution should not be stored longer than 2 wk at 4°C and is best if prepared freshly.) Other investigators have had varying degrees of success with other fixatives including 100% ethanol, Bouin's solution, Streck's Tissue Fixative, and glutaraldehyde (22). Overfixation of tissues also limits success in amplification of nucleic acids. The duration of fixation is critical with under 24 h being preferable. One exception to this is human brain, which is easier to manipulate if fixed for longer periods. We have been successful in identifying HIV-1 in thalamus that was fixed for at least 2 wk.
3. Use of many different types of slides have been described (13,23). The primary consideration when choosing a slide is the adhesion of tissues through digestion and multiple cycles of heating and cooling. We have had good success with a commercially prepared silane-coated slide as well as positively charged slides generally available in the surgical pathology laboratory. Commercially prepared slides are expensive and silane-coated slides can be inexpensively prepared (soak glass slides for 30 min in 1% HCl, (v/v) with 70% ethanol, rinse thoroughly in running tap water followed by dH<sub>2</sub>O and air-dry;

immerse in acetone for 10 min then transfer to 2% (v/v) aminopropyltriethoxysilane (Sigma) in acetone for 5 min in a fume hood. Rinse in three changes of dH<sub>2</sub>O for 5 min each, air-dry, and use within 2–4 wk). Other adhesion systems have included use of Elmer's Glue® (white) (Borden, Columbus, OH), agarose gel, poly-L-lysine, and albumin.

4. Reduction of endogenous alkaline phosphatase activity when using an alkaline phosphatase detection system, following the proteinase-K digestion, step the slides are immersed in 20% acetic acid at 4°C for 15 s and rinsed in two changes of PBS for 5 min each. Additional reduction of endogenous alkaline phosphatase activity can be achieved with use of Levamisole (Sigma, St. Louis, MO) 100  $\mu$ M in the NBT/BCIP substrate solution.
5. A significant source of difficulty is proper digestion of tissues to increase cellular permeability. Inadequate digestion restricts entry of components necessary for amplification. Overdigestion produces leakage of the amplicons (products of PCR amplification) out of the appropriate cellular context resulting in signal present in the cytoplasm or extracellular matrix. Parameters often adjusted to optimize digestion include the specific protease used, the length of digestion, the temperature of digestion (11,13). We have used proteinase-K for most of our work. Concentrations are tissue dependent and need to be tested for each particular tissue type and fixation condition prior to proceeding with amplification. One investigator has described optimal digestion based upon the appearance of 10–20 “peppery dots” on the majority of cells of interest (as identified under 400X magnification) (23). However, we have not been able to consistently identify these findings in paraffin embedded tissues. An alternative approach described by Sullivan et al. (personal communication) indicates optimal digestion present when more than 50% of cells have nuclear signal when probed with Alu (a repetitive DNA sequence composing up to 5% of the human genome). In this setting, a range of proteinase-K concentrations and digestion times can be quickly tested. The 1 ng/ $\mu$ L of probe is applied, sections covered with a glass coverslip, the tissue denatured at 95°C for 5 min and then hybridized for 1 h at 40°C. The signal detection is conducted with a biotin detection system. Permeabilization of our cytospin preparations has been successful with immersion for 5 min in 2:1 absolute ethanol/glacial acetic acid at –20°C followed by two washes in PBS for 5 min each and one wash in dH<sub>2</sub>O. Additional reagents used have included pretreatment with 0.01% Triton X-100 (Sigma, St. Louis, MO), 0.25 % Triton X-100 and Nonidet P-40 (Sigma, St. Louis, MO) as well as use of alternative proteases including pepsin, trypsin, and pronase. Pepsin and proteinase-K appear to have comparable results; selecting one protease and becoming most familiar with its characteristics is ideal.
6. Inactivation of proteinase-K activity is easily accomplished by heating at 95°C for 2 min. Concern occasionally arises regarding distortion of morphology due to heating. An alternative is to perform two rinses in PBS for 5 min each also works well, especially for thin sections. Alternatively, following digestion, proteinase-K activity can be terminated by two washes in PBS with 2 mg/mL of glycine, for 5 min each.
7. Although a number of variations for detection of the PCR product have been described, these approaches can be divided into two categories: direct or indirect detection (13,24). With direct detection, the label is incorporated into the PCR product either by through use of labeled nucleotides or by use of 5' labeled primers. Direct IS-PCR reduces the time for processing and avoids the need for production of probes used in *in situ* hybridization. A significant disadvantage is the production of false products due to mispriming (11). Others have reported success in reducing this process by using a Hot Start technique or Taq polymerase antibodies (TaqStart™, Clontech, Palo Alto, CA). Greater specificity can be achieved with indirect detection of the amplicon by using labeled probes and adjusting

the stringency of hybridization and posthybridization conditions. However, this adds to the cost and time of IS-PCR.

8. Sequestration of PCR components within tissues requires increased concentrations of  $MgCl_2$ , primers and *Taq* polymerase compared with solution PCR. A very useful maneuver is to simultaneously perform solution PCR with concentrations of components the same as that on the tissue, on the same thermal cycler block. The solution products can be analyzed on an agarose gel, confirming the presence of amplification. The MJ Research MS16 slide cycler apparatus permits carrying out combined solution and tissue PCR.
9. Critical to successful amplification is maintenance of the correct concentrations of PCR components within the tissue. Evaporation is a devastating complication. We use Self Seal to reduce evaporative losses (25,26). However, a disadvantage to this system is loss of the ability to perform a Hot Start approach to reduce mispriming. An alternative is application of nail polish to the coverslip. Typically, nail polish is first applied to the corners. Excess solution oozing from the edges of the coverslip are blotted away. Nail polish is painted onto all remaining sides and the slide allowed to dry for five minutes at room temperature. Following amplification, the slides are soaked for 5 min in 100% ethanol and the nail polish scraped away with a surgical blade. An alternative to nail polish, which is technically demanding and messy, is placement of double-sided sticky tape to create reaction chambers. We have used Frame Seal, an example of a commercially available tape system, with some success. The disadvantages include requirement of large volumes of reagents and difficulties removing small bubbles from the solution (which enlarge during heating) leading to uneven distribution of the amplification mixture across the tissue. To reduce the presence of bubbles, we have had some success with degassing the solution at 70°C for 5 min prior to application to the tissue, and evenly spreading the solution over the tissue by slowly flexing the plastic coverslip while advancing. Another approach with which we have had limited success is encircling the tissue section with a 4 mm PAP™ hydrophobic marker, layering on the amplification mixture and then applying the coverslip (27). Each corner of the coverslip has a dab of a silicone lubricant that acts as a pillar. Sealing is complete by pipeting mineral oil (Sigma, St. Louis, MO) at the edge of the coverslip and allowing capillary action to carry it around the entire specimen. Following amplification, the oil is removed by soaking the slide for 5 min in either xylene or chloroform.
10. An estimate for the number of cycles for amplification can be determined by running solution PCR on the slide cycler and determining after how long the product is detectable. In our hands, 20–25 cycles is sufficient. Above this range, deterioration of morphology becomes apparent and the likelihood of loss of signal as a result of leakage of amplicons from the destroyed cells increases (24).
11. For many experiments, amplification and detection of a single target is sufficient. However, our experience with solution-phase amplification for HIV-1 has demonstrated that sensitivity is improved by amplification of at least two different regions in the HIV-1 genome. We had chosen nonoverlapping regions and tested by multiplex solution-phase PCR for the presence of nonspecific products. For some specimens, equivalent levels of signal were seen following amplification of one region (*gag*) compared with all three regions. However, this has not been true for all regions and thus, we have tended to amplify at least two regions (LTR and *gag*).
12. A number of investigators have reported success in amplification and detection of products ranging from 100 to 500 bp. Amplification of larger regions potentially reduces loss of amplicons by diffusion, but potentially smaller regions are amplified more efficiently. We have chosen a range of product sizes to address both considerations.

13. Some investigators have suggested that additional processing of tissue is necessary to prevent loss of amplicons from the site of production (23,28). Frequently no fixation is necessary, but a short exposure to 95°C may be useful and is unlikely to significantly disrupt tissue morphology. We have also tried incorporation of digoxigenin as a ballast as described elsewhere, in the initial amplification mixture and found no significant increase in yield of detectable product following hybridization with a biotin labeled probe (29). We have also successfully fixed tissue in 100% ice-cold ethanol for 10 min. Some investigators have used 2–4% buffered paraformaldehyde for 10 min for postamplification fixation purposes.
14. Numerous buffer conditions, temperature ranges for hybridization and stringency conditions for posthybridization washes have been described for *in situ* hybridization. Many approaches are empirical, but all share the same goal of specific localization of signal and the lowest possible background. An area that remains unclear is the need for sealing coverslips for hybridization, to prevent loss of reagents. We have not tended to seal coverslips and have not had significant difficulties with background or loss of signal as long adequate humidity was maintained during denaturation and hybridization. We have found that the Omnislide cyler from Hybaid is useful in maintaining humidity. However, in those experiments where the results were suboptimal, we have sealed slides with rubber cement. Others have used a sealed system like Frame Seal, or sealed with agarose.
15. The detection system and substrate used is entirely dependent on the investigator's goals and preference. We have found the horseradish peroxidase system robust and rapid. The alkaline phosphatase system appears to be more sensitive, but has a small tendency to diffuse over time so that care needs to be taken to monitor development of color.
16. Counterstaining is useful for demonstrating tissue morphology. The specific counter-stain selected is dependent upon the color produced by the detection system used, but methyl green, Mayers hematoxylin and Nuclear Fast Red are useful for DAB and AEC substrates. Eosin is useful for NBT/BCIP.

## Acknowledgments

This work was supported by NIAID (AI 32319) and the Mae Stone Goode Foundation. The authors would like to thank Todd Laughlin and Kimberly Craig for their excellent technical assistance during development of the culture and detection systems.

## References

1. Connor, E. M., Sperling, R. S., Gelber, R., Kiselev, P., Scott, G., O'Sullivan, M. J., VanDyke, R., Bey, M., Shearer, W., Jacobson, R. L., Jimenez, E., O'Neill, E., Bazin, B., Delfraissy, J. F., Culnane, M., Coombs, R., Elkins, M., Moye, J., Stratton, P., and Balsley, J. (1994) Reduction of maternal-infant transmission of human immunodeficiency virus type 1 with zidovudine treatment. *N. Engl. J. Med.* **331**, 1173–1180.
2. Zevallos, E. A., Anderson, V. M., Bard, E., and Gu, J. (1994) Detection of HIV-1 sequences in placentas of HIV-infected mothers by *in situ* PCR. *Cell Vision* **1**, 116–121.
3. Anderson, V. M. (1997) The placental barrier to maternal HIV infection. *Obstetr. Gynecol. Clin. North America* **24**, 797–820.
4. Polliotti, B. M., Sheikh, A. U., Craig, K., and Miller, R. K. (1997) HIV-1 transmission *in utero*: critical role for the placenta. *Placenta* **18**, -A45(Abstract).
5. Popek, E. J., Lewis, D. E., Hammill, H. A., Langston, C., Kozinetz, C. A., and Shearer, W. T. (1997) Placental pathology of 100 infants born to HIV + women. *Placenta* **18**, -A46(Abstract).

6. Amirhessami-Aghili, N., Manalo, P., Hall, M. R., Tibbitts, F. D., Ort, C. A., and Afsari, A. (1987) Human cytomegalovirus infection of human placental explants in culture: histologic and immunohistochemical studies. *Am. J. Obstet. Gynecol.* **156**, 1365–1374.
7. Ahmed, N. A. and Murphy, B. E. (1988) The effects of various hormones on human chorionic gonadotropin production in early and late placental explant cultures. *Am. J. Obstet. Gynecol.* **159**, 1220–1227.
8. Maury, W., Potts, B. J., and Rabson, A. B. (1989) HIV-1 infection of first-trimester and term human placental tissue: a possible mode of maternal-fetal transmission. *J. Infect. Dis.* **160**, 583–588.
9. Polliotti, B. M., Sheikh, A. U., Subbarao, S., Keesling, S. S., Lee, G. R., Caba, J., Panigel, M., Reichman, R., Nahmias, A. J., and Miller, R. K. (1998) HIV-1 infection of human placental villous tissue in vitro. *Troph. Res.* **12**, 205–223.
10. Bagasra, O., Haptuman, S. P., Lischner, H. W., Sachs, M., and Pomerantz, R. J. (1992) Detection of human immunodeficiency virus type I provirus in mononuclear cells by in situ polymerase chain reaction. *N. Engl. J. Med.* **326**, 1385–1391.
11. Komminoth, P. and Long, A. A. (1993) In-situ polymerase chain reaction. An overview of methods, applications and limitations of a new molecular technique. *Virchows Archiv.* **64**, 67–73.
12. Long, A. A., Komminoth, P., and Wolfe, H. J. (1992) Detection of HIV provirus by in situ polymerase chain reaction. *N. Engl. J. Med.* **327**, 1529–1530.
13. Nuovo, G. J. (1997) *PCR In Situ Hybridization: Protocols and Application*, Lippincott-Raven, New York.
14. Muciaccia, B., Uccini, S., Filippini, A., Ziparo, E., Paraire, F., Baroni, C. D., and Stefanini, M. (1998) Presence and cellular distribution of HIV in the testes of seropositive subjects: an evaluation by in situ PCR hybridization. *FASEB J.* **12**, 151–163.
15. Sheikh, A. U., Polliotti, B. M., and Miller, R. K. (1998) In situ PCR discriminates between infected and uninfected human placental explants after in vitro exposure to HIV-1. *Troph. Res.* **12**, 191–204.
16. Strappe, P. M., Wang, T. H., McKenzie, C. A., Lowrie, S., Simmonds, P., and Bell, J. E. (1998) In situ polymerase chain reaction amplification of HIV-1 DNA in brain tissue. *J. Virol. Methods* **70**, 119–127.
17. Adachi, A., Gendelman, H. E., Koenig, S., Golks, T., Willey, R., Rabson, A., and Martin, M. A. (1986) Production of acquired immunodeficiency syndrome-associated retrovirus in human and non-human cells transfected with an infectious molecular clone. *J. Virol.* **59**, 284–291.
18. Genbacev, O., Schubach, S. A., and Miller, R. K. (1992) Villous cultures of first trimester human placenta-model to study extravillous trophoblast (EVT) differentiation. *Placenta* **13**, 439–461.
19. Genbacev, O. and Miller, R. K. (1993) Three-dimensional culture of placental villous tissue explants—an in vitro model for implantation. *Meth. Toxicol.* **3**, 204–245.
20. Genbacev, O., Jensen, K. D., Powlin, S. S., and Miller, R. K. (1993) In vitro differentiation and ultrastructure of human extravillous trophoblast (EVT) cells. *Placenta* **14**, 463–475.
21. Greer, C. E., Lund, J. K., and Manos, M. M. (1991) PCR amplification from paraffin-embedded tissues: recommendations on fixatives for long-term storage and prospective studies. *Genome Res.* **1**, 46–50.
22. Greer, C. E., Peterson, S. L., Kiviat, N. B., and Manos, M. M. (1991) PCR amplification from paraffin-embedded tissues Effects of fixative and fixation of time. *Am. J. Clin. Pathol.* **95**, 117–124.
23. Bagasra, O., Mukhtar, M., Shaheen, F., and Pomerantz, R. J. (1997) In situ PCR. Current protocol. *Methods Mol. Biol.* **63**, 275–303.

24. O'Leary, J. J. (1998) In Situ Amplification, in *Clinical Applications of PCR* (Lo, Y. M. D., ed.), Humana Press, Totowa, NJ, pp. 109–144.
25. Sullivan, D. E., Bobroski, L. E., Bagasra, O., and Finney, M. (1997) Self-seal reagent: evaporation control for molecular histology procedures without chambers, clips or fingernail polish. *Biotechniques* **23**, 320–325.
26. Simon, S., Reipert, B., Eibl, M. M., and Steinkasserer, A. (1997) Detection of phosphatidylinositol glycan class A gene transcripts by RT in situ PCR hybridization. A comparative study using fluorescein, Texas Red, and digoxigenin-11 dUTP for color detection. *J. Histochem. Cytochem.* **45**, 1659–1664.
27. Vogel, P. and Kell, W. M. (1994) A method for controlling evaporation losses from specimens on glass slides during *in situ* PCR. *Cell Vision* **1**, 336–338.
28. Nuovo, G. J., Gallery, F., MacConnell, P., and Braun, A. (1994) *In situ* detection of polymerase chain reaction-amplified HIV-1 nucleic acids and tumor necrosis factor- $\alpha$  RNA in the central nervous system. *Am. J. Pathol.* **144**, 659–666.
29. Sharer, L. R., Saito, Y., Da Cunha, A., Ung, P. C., Gelbard, H. A., Epstein, L. G., and Blumberg, B. M. (1996) In situ amplification and detection of HIV-1 DNA in fixed pediatric AIDS brain tissue. *Hum. Pathol.* **27**, 614–617.

## Gene Expression Analysis by *In Situ* Hybridization

### *Radioactive Probes*

Stefan Wawersik and Jonathan A. Epstein

#### 1. Introduction

Over the last several decades, an understanding of the events involved in embryonic pattern formation has been extended from an anatomic to a molecular level. In particular, the ability to examine the spatial and temporal expression of specific genes has aided greatly the analysis of their function. One of the most powerful techniques for determining gene-expression patterns is *in situ* hybridization, a method that relies on the hybridization of labeled antisense RNA probes to detect endogenous RNA transcripts at their sites of expression (1).

There are several variations of the basic principle of *in situ* hybridization, each with advantages and disadvantages. Whole-mount *in situ* hybridization is used to examine gene expression in intact embryos or organs, relying on a colorimetric reaction to determine the location of nonradioactively labeled probe (2,3). This method allows three-dimensional visualization of gene expression, but difficulties arise in larger embryos when the probe cannot completely penetrate the tissues. This obstacle can be overcome by sectioning the embryo and placing the sections onto slides. The use of nonradioactively labeled probes to examine sectioned tissue allows excellent determination of the spatial distribution of transcripts, but the thin sections often make it difficult to detect the expression of weakly or moderately expressed genes. For such genes, the high sensitivity of probes radioactively labeled with  $^{35}\text{S}$  is required. Though the time needed to get complete data is longer and the fine localization of transcript is slightly less accurate than with nonradioactive probes, use of  $^{35}\text{S}$  labeled probes is an excellent all-purpose method for performing *in situ* hybridizations. Here, we outline a straightforward protocol for *in situ* hybridization using radioactive probes. Though described specifically for mouse embryos, this procedure has worked equally well in chick (4–7) and is likely to be applicable to most vertebrate tissues.

#### 2. Materials

##### 2.1. Embryo Collection, Fixation, and Dehydration

1. Phosphate-buffered saline (PBS) pH 7.6: per liter, 8 g NaCl, 0.2 g KCl, 1.15 g  $\text{Na}_2\text{HPO}_4$ , and 0.2 g  $\text{KH}_2\text{PO}_4$ .

From: *Methods in Molecular Biology*, Vol. 137: *Developmental Biology Protocols*, Vol. III  
Edited by: R. S. Tuan and C. W. Lo © Humana Press Inc., Totowa, NJ



2. RNaseZap (Ambion<sup>1</sup>).
3. 4% Paraformaldehyde (PFA): for 100 mL, heat 90 mL H<sub>2</sub>O and 100  $\mu$ L 2 M NaOH to 62–65°C in a microwave. Add 4 g paraformaldehyde (Sigma, St. Louis, MO) and shake/stir vigorously until the PFA dissolves. Add 10 mL 10X PBS and 100  $\mu$ L 2 M HCl, filter through Whatman #1 filter paper (or similar) and cool to RT, then check that the pH is 7.0–7.4. Store at 4°C for no longer than 3–4 d.
4. Dehydration: 30% and 50% EtOH in PBS, 70% EtOH in H<sub>2</sub>O, 100% EtOH.

## 2.2. Embedding

1. Paraffin wax (Paraplast M—Oxford Labware). Melt in 56–60°C oven for several hours prior to use. Wax should not be left at melting temperature for longer than 1 wk.
2. Xylenes

## 2.3. Sectioning

1. Microscope slides (Fisher Superfrost Plus)<sup>2</sup>
2. DEPC-treated H<sub>2</sub>O: Add 0.5 mL diethyl pyrocarbonate (DEPC—Sigma) to 1 L. H<sub>2</sub>O. Stir for 1 h, then autoclave 45 min.
3. Silica gel desiccant (Sigma).

## 2.4. Probe Transcription

1. RNA polymerase (T3, T7, or SP6 as required—Boehringer Mannheim, Mannheim, Germany).
2. 10 mM ribonucleotides: ATP, CTP, GTP (from 100 mM stock—Boehringer Mannheim).
3.  $\alpha$ -[<sup>35</sup>S]-UTP (12.5 mCi/mL, 1250 Ci/mM—Dupont NEN, Boston, MA).
4. RNase inhibitor (RNasin—Boehringer Mannheim).
5. DNaseI (RNase Free—Boehringer Mannheim).
6. Yeast tRNA (Boehringer Mannheim) made up to 1 mg/mL in DEPC H<sub>2</sub>O.
7. Hybridization buffers
  - a. 10X salts in DEPC-H<sub>2</sub>O: 3 M NaCl, 100 mM Tris-HCl pH 7.6, 100 mM NaH<sub>2</sub>PO<sub>4</sub>, 50 mM EDTA, 2% Ficoll 400 (Sigma), 2% polyvinyl pyrrolidone (Sigma).
  - b. Hybridization mix (10 mL): 1 mL 10X salts, 0.5 mL DEPC H<sub>2</sub>O, 0.5 mL 1 M DTT, 0.5 mL poly ribo A (10 mg/mL) (Sigma), 0.5 mL yeast tRNA (1 mg/mL), 2 mL Dextran sulfate (50% w/v solution in H<sub>2</sub>O, autoclaved 45 min), 5 mL formamide (Boehringer Mannheim, molecular biology grade). Store 1 mL aliquots at –80°C.

## 2.5. Pretreatment of Slides

1. Staining dishes: Wheaton 20 slide dishes with removable racks. Keep the dishes used in RNase steps separate from those used for RNase free washes. Two RNase free dishes should be prepared for dewaxing and rehydration and three for pretreatment. RNase-free dishes and racks are prepared by washing with RNaseZap and rinsing with DEPC-H<sub>2</sub>O, then autoclaving for 45 min. Dishes should be allowed to warm slowly to avoid cracking, so leave them for 20–30 min in the warm autoclave before starting the cycle. Alternatively, a Tissue-Tek slide staining set (Tissue-Tek #4451) with twelve 250-mL staining dishes and a 25-slide holder can be used. These dishes should be washed with RNaseZap and rinsed with DEPC-H<sub>2</sub>O, but they cannot be autoclaved.
2. The following solutions should be prepared from 10X stocks ahead of time and autoclaved 45 min:
  - a. 1X PBS (4 L)
  - b. 0.2 M HCl (250 mL).

<sup>1</sup>We have tried to indicate the source of most of the critical reagents that we have used. Similar products are often available from other sources and may work equally well.

<sup>2</sup>We have found that the type of slide is critical for maintaining intact sections through the many washes required by this protocol, especially for small tissue sections (e.g., E10.5 and earlier).

- c. Proteinase K digestion buffer (250 mL): 50 mM Tris-HCl pH 7.6, 5 mM EDTA. Add Proteinase K (Sigma) to 20 µg/mL (from 20 mg/mL stock solution) immediately before use.
- d. 0.4% glycine in PBS (500 mL).
- e. 0.2 M triethanolamine-HCl (pH 8.0) (two bottles of 250 mL each). 0.5 mL acetic anhydride (Sigma) is added immediately before use.

## 2.6. Washes

1. FSM: 50% formamide, 2X SSC, 20 mM β-mercaptoethanol (added just prior to use).
2. STE: 4X SSC, 20 mM Tris-HCl, pH 7.6, 1 mM EDTA.
3. STEM: STE with 20 mM β-mercaptoethanol (added just prior to use).
4. Ribonuclease A (RNase A) (Boehringer Mannheim) 10 mg/mL stock in H<sub>2</sub>O.

## 2.7. Autoradiography and Developing

1. Autoradiography film.
2. Kodak NTB2 photographic emulsion: warm the emulsion to 40–42°C in a water bath for 30–35 min to liquefy the emulsion, then dilute 1:1 in H<sub>2</sub>O. Aliquot into 50 mL plastic screw top vials (30–40 mL/vial) or plastic slide mailers, wrap each aliquot in two layers of aluminum foil, and store SHIELDED FROM RADIOACTIVITY and phenol containing solutions at 4°C. NOTE: NTB2 emulsion is extremely light sensitive. The normal safelights in most darkrooms will expose the emulsion. A dark-red number 2 safelight (Kodak) is required. Caution should also be taken to cover any indicator lights or light leaks which might be present in the darkroom, as they will lead to increased background in the emulsion.
3. Black light-tight slide boxes.
4. Kodak fixer and D-19 developer (available as powder from most photographic shops or through VWR).
5. Counterstaining solution: 2 µg/mL Hoescht 33258 (Sigma) in H<sub>2</sub>O (Hoechst dye stock is prepared as a 10 mg/mL solution in DMSO. Aliquot and store at –80°C protected from light).
6. Mounting medium: 5 g Canada Balsam (Sigma) in 10 mL methyl salicylate (Sigma). Store at RT.

## 3. Methods

1. Embryo fixation and dehydration: Mouse embryos are collected by standard methods in ice-cold PBS. Instruments for dissection are treated against RNase using RNase Zap. The embryos are transferred to glass scintillation vials and fixed in 4% PFA at 4°C with constant rocking overnight. Wash twice in PBS, then dehydrate through a series of ethanols (30%, 50%, 70%, 100%—see **Subheading 2., step 1d**) while rocking at 4°C. The length of each dehydration step varies with the size of the embryo (see **Note 1**). Properly dehydrated embryos will begin to turn white in the 70% EtOH wash. Embryos can be stored in their scintillation vials for at least 1 yr in 100% EtOH at –20°C.
2. Embedding: In order to section the embryos, they must first be embedded in paraffin. Beakers filled with paraffin chips should be placed at 56–60°C well before the wax is needed, as the wax takes several hours to melt. Wax should not be left at melting temperature for more than a week.

To aid in the visualization of small embryos once they are in the hardened wax, stain the embryos in 0.5% Eosin dye, followed by three washes in 100% EtOH. The slightly pink embryos are then carried through the following steps (still in glass scintillation vials): one wash each EtOH/xylene (1:1) and xylene while rocking at RT, three washes in wax at

56–60°C. The same time guidelines as for each dehydration step hold true here, though long (>45 min) washes in xylene should be avoided.

Once in wax, each embryo is embedded by pouring it into a small plastic weigh boat or mold. This is done by gently inverting the glass vial and allowing the embryo to settle towards the lid. Hold the inverted vial over the weigh boat and remove the cap. The tissue should slide out easily, but if it sticks, simply add more wax, allow it to melt, and try again. Position the embryo with a hot forceps, then allow the wax to cool with minimal disturbance (*see Note 2*). Embedded tissue can be stored in paraffin blocks indefinitely.

3. Sectioning: Shave down the wax block around the embryo with a razor blade so that it is slightly larger than the embryo itself. Do not cut off large chunks at a time, or the wax may crack. Melt some wax onto the top of a block that is accepted by the microtome chuck and use this as an adhesive to stick the embryo onto the block. A heated spatula can be used to shape the wax around the base of the wax block to increase stability. Using this method, embryos can be mounted in any orientation to obtain the desired sections (e.g., sagittal, coronal, or transverse) and this decision need not be made at the time of embedding.

Prepare ribbons of 7  $\mu\text{m}$  sections and lay them on a sheet of clean notebook paper (*see Note 3*). A fine paintbrush and the point of a scalpel are useful for manipulating the ribbons. Small sections (e.g., E11.5 embryos) can be placed onto slides by laying down a line of DEPC-treated sterile deionized water onto the slide, then carefully placing short (2–3 section) segments of the wax ribbon onto the water. For larger sections (e.g., adult brain or E17.5 embryos) *see Note 4*. The two faces of the ribbon are not equal, so put the side which faced the blade as it came off the microtome (the shiny side) in contact with the water. When the slide is filled, underlay the sections with additional water and place them on a 42°C slide warmer overnight or until the water has completely evaporated (*see Note 5*). Do not leave slides on the warmer for more than 12–14 h. Sections can be stored in a sealed box with desiccant at 4°C for up to 1 yr.

4. Preparation of radioactively labeled riboprobe: The template for RNA transcription should be cDNA cloned into a plasmid which has promoter elements for T3, T7, or SP6 polymerase flanking the insert site (*see Fig. 1*). The plasmid preparation should be of high quality, either CsCl purified or from a QIAGEN or similar column prep. The plasmid should be linearized with an enzyme that gives a blunt or protruding 5' end. 3' overhangs may cause transcript initiation in the wrong direction. Probes of 250 to 800 bp are optimal, though shorter and longer probes have sometimes been used successfully. Run an aliquot of the digest on a gel to make sure that it has been fully linearized, then phenol extract once, chloroform extract twice and ethanol precipitate. Adjust the concentration to 1  $\mu\text{g}/\mu\text{L}$  by resuspending in DEPC- $\text{H}_2\text{O}$ .

Transcription reaction (keep reagents on ice, mix at RT);

1.0 $\mu\text{L}$	linearized plasmid, 1 $\mu\text{g}/\mu\text{L}$
11.0 $\mu\text{L}$	DEPC- $\text{H}_2\text{O}$
3.0 $\mu\text{L}$	10X Transcription Buffer
1.5 $\mu\text{L}$	0.75 M DTT
1.0 $\mu\text{L}$	RNasin
1.0 $\mu\text{L}$	10 mM ATP
1.0 $\mu\text{L}$	10 mM CTP
1.0 $\mu\text{L}$	10 mM GTP
10.0 $\mu\text{L}$	$\alpha$ -[ $^{35}\text{S}$ ]-UTP
0.5 $\mu\text{L}$	RNA polymerase

Mix gently, then centrifuge for 5 s.

Incubate at 30°C for 3 h

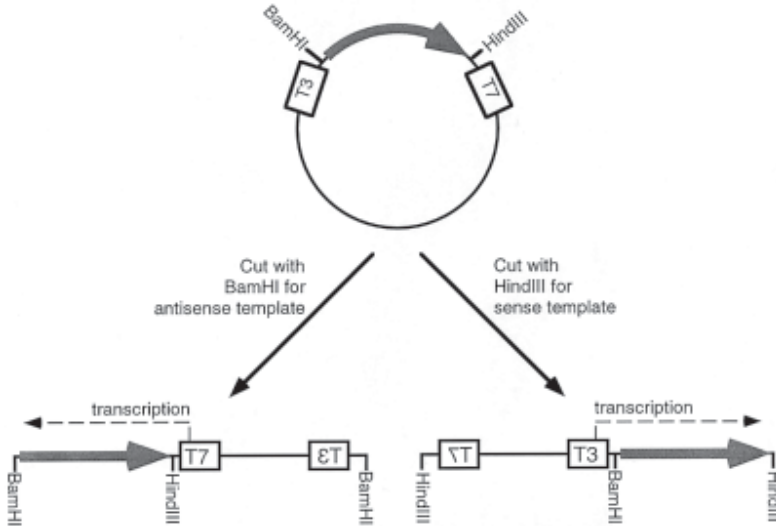

Fig. 1. Preparation of riboprobe and DNA template for RNA transcription. Prepare high-quality circularized plasmid containing template cDNA for the gene of interest (gray arrow, arrowhead at 3' end of gene). The insert should be flanked by T7 and T3 (or SP6) RNA polymerase promoter elements, and by restriction enzymes that are unique to the vector and yield 5' protruding or blunt ends after digestion (in this case, BamHI and HindIII). To make an antisense probe, linearize the vector with BamHI leaving the insert adjacent to the T7 promoter element. Transcription with T7 RNA polymerase (dotted arrow) gives RNA transcripts that will hybridize to sense (coding) RNAs in the tissue of interest. Linearize with HindIII and transcribe with T3 RNA polymerase to synthesize a sense (control) probe that should not hybridize to endogenous RNAs and serves as a negative control.

Destroy template with DNaseI

Add:

19.0 $\mu$ L	DEPC- $H_2O$
1.7 $\mu$ L	$MgCl_2$ , 0.3 M
1.1 $\mu$ L	DTT, 0.2 M
2.0 $\mu$ L	DNaseI, 1 U/ $\mu$ L

Incubate at 37°C, 10 min.

then add:

100 $\mu$ L	water, DEPC treated
100 $\mu$ L	yeast tRNA, 1 mg/mL
250 $\mu$ L	ammonium acetate, 4 M
1 mL	EtOH

vortex well, precipitate 5 min @ RT, centrifuge at 15,800g (14,000 rpm) in a microfuge for 5 min, remove supernatant

Resuspend pellet in:

200 $\mu$ L	Water, DEPC treated
200 $\mu$ L	ammonium acetate, 4 M

then add:

1 mL EtOH

vortex well, precipitate and centrifuge as before

Resuspend air-dried pellet in 100  $\mu\text{L}$  hybridization mix. Vortex vigorously. RNA pellets can be difficult to resuspend, especially if over-dried. Count a 2  $\mu\text{L}$  aliquot in 2 mL water soluble scintillation fluid using the 14C channel of the scintillation counter.

5. Pretreatment of slides: Dishes for these steps should be prepared ahead of time (*see Sub-heading 2., step 5a*). Each dish can be used for multiple washes and rinsed with deionized water between each wash. All washes are at room temperature.

Up to 18 slides can fit into a 10-slot glass slide rack in a laced fashion (one slide straight, the next slide diagonal with one end in the same slot as the first slide, the next straight, etc.). Slides are dewaxed and rehydrated through a series of 10 min washes: twice in xylene, twice in EtOH, and once each in 95% EtOH, 70% EtOH in  $\text{H}_2\text{O}$ , 50% EtOH in PBS, and PBS. The slides are then acid treated in 0.2M HCl for 15 min, followed by three rinses in PBS for 1 min each. Permeabilization of the tissue is accomplished by treatment with 20  $\mu\text{g}/\text{mL}$  Proteinase K for 7 min in Proteinase K buffer, followed by two washes in 0.4% glycine in PBS and two washes in PBS, each for 2 min. Subsequently, the tissue is fixed in cold 4% PFA-PBS for 15 min, followed by three washes in PBS for 1 min each. Acetylation of the amino-termini of proteins in the tissue significantly reduces background. This is carried out by two treatments with acetic anhydride (0.5 mL in 250 mL 0.2 M triethanolamine-HCl, added immediately before use) for 5 min each. The slides are then rinsed twice in DEPC- $\text{H}_2\text{O}$ , then air-dried face up on paper towels (*see Note 7*). Pretreated slides can be stored at RT for several hours or for 1–2 d at  $-80^\circ\text{C}$  in a sealed box with desiccant.

6. Prehybridization: If slides were frozen after pretreatment, remove them from the freezer and allow them to reach RT while sealed (30–45 min). For  $25 \times 75$  mm slides with  $24 \times 50$  mm coverslips, 110  $\mu\text{L}$  of hybridization mix per slide is sufficient for prehybridization. Be sure to prepare extra mix, because the viscosity of the hyb mix leads to significant loss on pipet tips. Hyb mix is heated in boiling or near boiling water for 2 min and placed at RT. Carefully place hyb mix onto the dry slide in drops, then lower a cover slip onto the slide with a forceps. This is easiest if you place one end of the coverslip onto the slide, then slowly lower the rest. Try to avoid bubbles, but if they do form, make sure that there is hyb mix on the entirety of every section. Prehybridize for 1 h at  $50^\circ\text{C}$  in a sealed 50% formamide/2X SSC humidified chamber (*see Note 8*).
7. Hybridization mix is identical to the solution used for prehybridization except for the addition of the [ $^{35}\text{S}$ ]-RNA probe. Though the optimal concentration is probe specific, a starting point of  $1\text{--}1.2 \times 10^6$  CPM/ $\mu\text{L}$  for a 1 kb probe (proportionately less for a smaller probe) usually works well. To add the probe, remove the coverslip from the prehybridization step by tilting the slide and letting the coverslip slide off (this should require minimal coaxing). Add 50  $\mu\text{L}$  hybridization mix, distribute it as best you can by tilting the slide, then replace the coverslip. Hybridization is carried out for 5 h to overnight at  $50^\circ\text{C}$  in a sealed 50% formamide/2X SSC humidified chamber.
8. Washes: After hybridization, the slides are placed in 4X SSC, 20 mM  $\beta$ -mercaptoethanol until the coverslips float off. Excess riboprobe is then removed by the following sequence of washes: twice in FSM at  $55\text{--}65^\circ\text{C}$  (*see Note 9*) for 30 min each, twice in STE at  $37^\circ\text{C}$  for 10 min each, once at  $37^\circ\text{C}$  in STE containing 10  $\mu\text{g}/\text{mL}$  RNase A for 30 min, once in STEM at  $37^\circ\text{C}$  for 10 min, twice in FSM at  $55\text{--}65^\circ\text{C}$  for 30 min each, once in 2X SSC at  $37^\circ\text{C}$  for 10 min, and once in water for 5 min. The slides are then air-dried face up on paper towels (*see Note 7*).
9. Autoradiography: In order to determine whether the experiment worked, as well as to gain some preliminary results, the slides are exposed to autoradiography film for 2–3 d. To do this, tape slides to cardboard or a previously exposed piece of autoradiography film using Scotch tape (cover the very edge of each slide only). Then place slides in a film cassette

with an unexposed piece of autoradiography film and expose at room temperature for 1–3 d. If the slides are labeled using pencil, the writing will lightly expose the film, providing a permanent record. The level of intensity of the signal as seen on the autoradiography film can be used to determine the length of exposure to photographic emulsion in the following steps.

Promising slides are dipped in diluted Kodak NTB2 emulsion (*see Subheading 2., step 7b*). Melt an aliquot of emulsion by immersing the vial in a water bath at 42–45°C for 12–15 min. Be sure to cover any indicator lights on the bath to prevent exposure of the emulsion. The tube should be held upright in the water bath by standing it in a 150-mL beaker and inverted gently and occasionally during melting to help the process. Once the emulsion is melted, each slide is dipped individually into the tube for 3–4 s, allowed to drain in a vertical position for 3 s, and then left flat to dry. Wipe the excess emulsion off the back of the slide immediately after dipping, as it becomes much more difficult to remove once it has dried. Be sure to dip each slide completely, as sections which are not covered with emulsion will not give signal. Forty or more slides can be dipped at a time, with the only limitations being amount of emulsion per aliquot and the time for which each aliquot is exposed to heat. Keeping aliquots at 45°C for longer than 50 min can lead to significant increases of background.

The slides are dried in the dark for 1 h, then placed in a sealed black box (*see Note 10*). The box should then be wrapped in aluminum foil, and stored at 4°C. This should be done in a refrigerator where no radiation is stored or the slides should be shielded by a plexiglass box.

Use the exposure of the autoradiography film to determine the length of emulsion exposure. Three to five days is sufficient for most highly expressed genes, while 7–10 d or longer is required for others.

After exposure to emulsion, the slides are removed from the refrigerator and equilibrated to RT (20–30 min). Under the safelight, the box is opened, slides placed in a rack and taken through the following sequence in slide staining dishes:

Kodak D-19 developer, 2 min (should not be warmer than 20°C);

Water, 10–15 s, *not longer*;

Fixer, 5 min;

Water, 5–10 min.

(Fitting 18 slides in a laced pattern into glass slide racks causes emulsion to remain at the end of the slide, so use two racks for each set, or use the Tissue Tek slide staining rack and dishes.)

After developing, counterstain the slides by incubating for 2 min in counterstaining solution and then wash in water for at least 2 min. Dry for 30–45 min at 37°C and mount the slides with 50 µL mounting medium and a coverslip. Keep slides flat for 1 wk, but you can view them immediately.

10. Viewing and photography: Examine the slides using a darkfield condenser for the silver grains. We have found that the use of a special darkfield light source (Fostec #P/NA08647) instead of the usual pseudo-darkfield condenser found on most microscopes greatly aids sensitivity and the quality of the darkfield image. The nuclei can be viewed simultaneously with ultraviolet (UV) fluorescence optics (*see Fig. 2*). The Hoescht dye slowly bleaches under these conditions, so try to minimize exposure. Before taking photographs, the slide must be cleaned carefully. Wipe off the dust from both sides of the slide with a Kimwipe, then use a Q-tip and 100% acetic acid to remove excess emulsion from the back of the slide.

Sections can be photographed with Kodak Ektachrome 64T or 160T (or similar tungsten) film. The optimal exposure time will vary, depending on the amount of signal in the field of view, so take several different exposures (*see Note 11*).

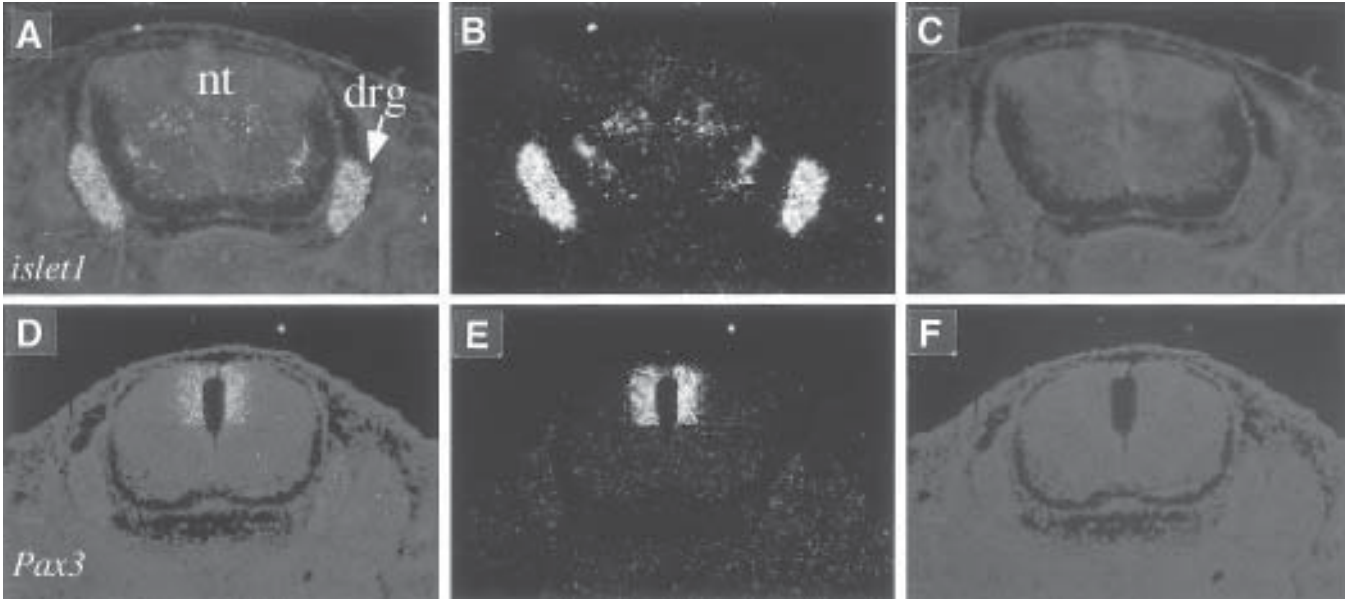

Fig. 2. (See color plate 4 appearing after p. 262.) Radioactive *in situ* hybridization of  $^{35}\text{S}$  labeled RNA probes to transverse sections of paraffin-embedded E13.5 mouse embryos. A single section hybridized to a probe specific for *islet1* (A–C) or a second section hybridized to a probe specific for Pax3 (D–F), is photographed with both darkfield and UV illumination (A,D), darkfield illumination alone (B, E) or UV illumination alone (C, F). The sections are counterstained with Hoechst 33258 nuclear dye (nt = neural tube, drg = dorsal root ganglia).

#### 4. Notes

1. E9.5 embryos and smaller can be dehydrated for as short as 10 min per wash. For E10.5–12.5, 20–30 min each step is sufficient. For older embryos, longer washes (45 min–1 h) are necessary. Dehydration of larger embryos is also aided by opening the chest cavities and cutting off the heads. Proper dehydration can also be ensured by leaving embryos in the 70% EtOH wash overnight.
2. Small bubbles sometimes form in the solidified wax block that can hinder sectioning by causing the wax ribbons to tear easily and by allowing the tissue to wrinkle while being cut. Bubbles are the result of excessive shaking of the wax immediately before pouring it.
3. Sections should be cut in a cool room on a microtome that is not in direct sunlight. The speed with which the sections are cut is important: too fast and you get lots of wrinkles, too slow and the ribbon will stick to the block on the upstroke. Experiment to see what works best. Keep an eye out for scratches in the wax. They are generally a result of dust particles on the block, and you can get rid of them by cutting a couple of sections very fast, by wiping the blade and the block with a Kimwipe, or by simply changing the section of the microtome blade with which you are cutting.
4. For large sections (e.g., adult brain or E17.5 sagittal sections) the surface tension provided by drops of water on the slide is not enough to adequately flatten the section. Therefore, another method is required: place an RNase free casserole dish into a water bath and heat 500 mL–1 L DEPC-H<sub>2</sub>O to 42–45°C inside the dish. Cut ribbons of sections as previously described, then take 2–3 section pieces and float them on the surface of the DEPC-H<sub>2</sub>O for 1–2 min. Once the sections have spread flat (but before the wax becomes clear), dip a slide into the water and use a forceps to coax the sections onto the slide. Leave the slides with sections on a slide warmer at 37–42°C for 12–14 h, then store as previously described.
5. As water evaporates from under the sections, holes sometimes form in the wax. This is the result of small gas bubbles in the water which grow and puncture the wax over the course of incubation. Bubble formation can be avoided by putting the water in a bottle, capping it, shaking vigorously, and then uncapping. Repeating this several times will help much of the gas in the water evolve and should alleviate the problem of holes in the wax.
6. In most cases, hydrolysis of the probe should not be necessary, since probes of up to 1 kb work well without it, and since it often leads to increased background. However, should hydrolysis be required, after the DNase I digestion step of probe transcription add 50 µL of a solution of 80 mM NaHCO<sub>3</sub> and 120 mM Na<sub>2</sub>CO<sub>3</sub>. Incubate at 60°C for  $t$  minutes ( $t = (L - 0.1)/0.011L$  where  $L$  is the original probe length in kb), then proceed with probe precipitation.
7. Because the viewing of the finished *in situ* is done under darkfield illumination, any dust or other large particles which collect on the slide will show up as large blotches. Therefore, it is important to keep the slides as dust-free as possible. During the drying steps, when they are lying face up, store the slides in a cabinet or drawer where they will be protected from dust.
8. Prehybridization requires the manual removal of a coverslip from each slide. This procedure can sometimes damage the sections on the slide, particularly sections from smaller embryos (E10.5 and younger). Eliminating the prehyb step does not usually result in a substantial increase in background on the slide but does avoid damaging the sections and should therefore be considered.
9. The wash temperature for each probe is empirically derived. Most probes have an optimum that falls between 60 and 65°C. As 65°C is very close to the melting temperature of RNA:RNA hybrids, washing above this temperature will cause a considerable loss of signal. It is generally a better idea to increase the stringency of washes by increasing the



concentration of RNase in the RNase wash than by raising the wash temperature much above 64°C.

10. Dipped slides will not be completely dry after only an hour, so if possible, allow them to dry flat for longer (4–5 h). However, concerns about accidental exposure of the emulsion and tying up a common-use darkroom for such a long period of time often make longer drying times impossible. Therefore, to keep the emulsion from running to one side of the slide, all the slides should be placed in the box facing the same direction. Once the box is sealed, it should be stored on its end so that the slides are lying flat.
11. Difficulties can arise when photographing highly expressed genes, as the exposure time required for the darkfield signal is sometimes too short to record the blue counterstain. This can be overcome by photographing the two colors separately using a double exposure.

## References

1. Wilkinson, D. G. (1992) *In Situ Hybridization: A Practical Approach*. IRL, Oxford, UK.
2. Li, H.-S., Yang, J.-M., Jacobson, R. D., Pasko, D., and Sundin, O. (1994) *Pax-6* is first expressed in a region of ectoderm anterior to the early neural plate: implications for stepwise determination of the lens. *Dev. Biol.* **162**, 181–194.
3. Rosen, B. and Beddington, R. S. P. (1993) Whole mount in situ hybridization in the mouse embryo: gene expression in three dimensions. *Trends Genet.* **9**, 162–168.
4. Epstein, J. A., Shapiro, D. N., Cheng, J., Lam, P. Y., and Maas, R. L. (1996) *Pax3* modulates expression of the c-Met receptor during limb muscle development. *Proc. Natl. Acad. Sci. USA* **93**, 4213–4218.
5. Xu, P. X., Cheng, J., Epstein, J. A., and Maas, R. L. (1997) Mouse *Eya* genes are expressed during limb tendon development and encode a transcriptional activation function. *Proc. Natl. Acad. Sci. USA* **94**, 11,974–11,979.
6. Lutz, B., Kuratani, S., Cooney, A. J., Wawersik, S., Tsai, S. Y., Eichele, G., and Tsai, M. J. (1994) Developmental regulation of the orphan receptor COUP-TFII gene in spinal motor neurons. *Development* **120**, 25–36.
7. Kuratani, S., Martin, J. F., Wawersik, S., Lilly, B., Eichele, G., and Olson, E. N. (1994) The expression pattern of the chick homeobox gene *gMHox* suggests a role in patterning of the limbs and face and in compartmentalization of somites. *Dev. Biol.* **161**, 357–369.

## Radio-Isotopic *In Situ* Hybridization on Tissue Sections

### *Practical Aspects and Quantification*

**Antoon F. M. Moorman, Piet A. J. De Boer, Jan M. Ruijter,  
Jaco Hagoort, Diego Franco, and Wouter H. Lamers**

### 1. Introduction

*In situ* hybridization has become a powerful tool for the analysis of gene expression within a topographical context and has become indispensable in developmental studies. Different strategies are to be used for different purposes. Whole mount *in situ* hybridization allows the rapid global analysis of changes in the spatiotemporal patterns of gene expression. Its use is limited to early developmental stages owing to penetration problems with increasing size of the embryo. Analysis of the precise location of the expressing cells requires subsequent sectioning of the stained embryo. Provided its sensitivity would be high enough, nonradioactive *in situ* hybridization would be the preferred choice owing to its superior resolving power. With the possible exception of early embryonic stages, it is our experience that the sensitivity of nonradioactive *in situ* hybridization on sections is inferior to that of the radio-isotopic procedure. Moreover, the sensitivity seems probe-dependent and the signal is difficult to quantify.

To date the use of [<sup>35</sup>S]-labeled riboprobes on frozen or paraffin sections represents the most sensitive strategy for the *in situ* detection of messenger ribonucleic acid (mRNA). Almost all key steps of the radio-isotopic hybridization protocol have been varied to achieve this aim (1–3). The autoradiographic process, however, has been seriously underexposed. This, in turn, has led to an insufficient appreciation of the quantitative character of the radioactive *in situ* hybridization procedure (4). Eventually, quantification is at the heart of our understanding of biological processes. The significance of quantitative data is, however, limited if these data are generated from homogenates derived from highly heterogeneous tissues. Unfortunately, this is unavoidable if we deal with developing embryos. The size of embryonic organs and, particularly of their component parts, prevents reliable determination of RNA levels by conventional methods. Moreover, if within an organ the contribution of expressing cells relative to nonexpressing cells changes with development, mRNA measurements in total RNA derived from homogenates, are not informative about changes in cellular RNA accumulation and thus about changes in the underlying regulatory mechanisms.

A second issue, also related to the change in tissue base with development, deserves serious attention. It is common use to express levels of a specific mRNA species per amount of total RNA. Changes in this fraction do not necessarily imply changes in the level of the specific mRNA species; total RNA might change as well. This is the case during development indeed, as with development the synthetic capacity of the embryonic tissues generally decreases concomitant with an increase in their functional capacity. With development total liver RNA decreases one third (5) and total heart RNA almost three- to fourfold (6). Adult rat slow muscle fibers accumulate almost sixfold more ribosomal RNA than the fast fibers (6a). This has to be taken into account when comparing Northern analyses that yield signal per amount of RNA and by that mask changes in total RNA, with quantitative *in situ* hybridization analyses that yield signal per amount of tissue.

This chapter describes a routine hybridization protocol that allows the quantitative assessment of relative RNA levels. Similar to quantification of mRNA levels by Northern blot analysis, the density of grains in a distinct area due to specific hybridization is related to the density of grains in a control area not expressing the RNA of interest. The protocol is mainly based on experience with developing, adult, experimental, and pathologic heart and liver tissue from mouse, rat, and human, but should be applicable on other tissues as well.

## 2. Materials

### 2.1. Prevent RNase Contamination (see Note 4.1)

### 2.2. Solutions for Preparation of Microscope Slides, Tissue Fixation, and Sectioning

1. DEPC/ethanol: 0.1% diethylpyrocarbonate in 96% ethanol. DEPC-containing solutions should be prepared just before use.
2. AAS: 2% aminoalkylsilane [3-aminopropyltriethoxysilane (Sigma, St. Louis, MO, A-3648) or 3-(triethoxy-silyl) propylamine (Merck, Darmstadt, Germany, 821619)] in acetone (dry, 99,5% pure). *Aminoalkylsilane should be stored at 4°C in a tightly closed vial containing anhydrous calcium sulfate or another drying agent. Let the container warm to room temperature before opening.*
3. PBS (10X stock solution): 1.5 M NaCl, 0.1 M Na-Phosphate, pH 7.4.
4. 4% FA (formaldehyde) fixative (see Note 4.2): dissolve 4% paraformaldehyde in sterile PBS at 60–70°C while stirring; dissolving takes about 1.5 h; cool to room temperature and check the pH before use.
  - a. *The fumes of FA are very toxic, the solution should be handled in a fumehood.*
  - b. *Use only freshly prepared FA fixative for the fixation of embryos and tissues.*
  - c. *If desired, the solution may be stored at –20°C, permitting instant access, while maintaining its crosslinking properties.*

### 2.3. Preparation of Aminoalkylsilane-Coated Glasses (see Note 4.3)

1. Put the slides in plastic racks; soak overnight in 1% NaOH (discard after 1 mo); rinse for 15 min in running warm tap water; rinse in demineralized water; soak for 1 h in 2% HCl; rinse for 15 min in running warm tap water; rinse in demineralized water. *From here on, wear gloves.*
2. Place the racks in plastic boxes, filled with DEPC/ethanol for 2 min; repeat this step once. *The racks with slides are now RNase free.*

3. Put the racks on an RNase-free surface and dry them in an air stream for approx 1 h.
4. Place the racks for 30 s in 2% AAS (250 mL solution suffices for about 200 slides).
5. Rinse in double-distilled water; move the racks 10 times up and down; repeat this step six times.
6. Place the racks on an RNase-free surface in an air stream for a few hours or overnight until all slides are dry.
7. Store the slides in an RNase-free box at room temperature.

#### **2.4. Preparation of [<sup>35</sup>S]-Calibration Slides**

1. [<sup>35</sup>S]-calibration solution: Dissolve at 50°C 5% high gel-strength gelatin (48724, Fluka, Bachs, Switzerland) in 10 mM Tris-HCl (pH 7.8), containing various concentrations [<sup>35</sup>S]-radioactivity. We use [ $\alpha$ -<sup>35</sup>S]-dCTP labeled random-primed cDNA, because of its stability.
2. Draw two rows of five circles (7-mm diameter) on the back side of AAS-coated microscope slides.
3. Apply with a positive displacement pipet, e.g., Gilson M25, a 4  $\mu$ L drop of [<sup>35</sup>S]-calibration solution containing varying amounts of radioactivity, evenly over each circle and place the slide immediately on an ice cooled plate for a maximum of 1 min. Longer cooling results in cracks along the outside of the spots. Repeat the procedure for the preparation of a next calibration slide.
4. Dry the slides in an air stream for about 30 min and let the spots further affix overnight at 50°C.
5. Take three 4  $\mu$ L-samples for liquid scintillation counting to determine the amount of radioactivity applied on a spot.
6. Fix the drops in 4% FA fixative containing in addition 1% glutaraldehyde (4 mL per slide), to prevent swelling of the spots later in the procedure.
7. Take a 0.5 mL sample of the fixative of each slide for liquid scintillation counting to determine the loss of <sup>35</sup>S in the fixation procedure.
8. Dehydrate in 96% ethanol for 10 min; use 4 mL per slide, repeat once, and dry in a stream of air.
9. Process the slides for autoradiography (see **Subheading 3.6.**).

#### **2.5. Solutions for In Vitro Transcription**

1. 100 mM DTT (dithiothreitol): store in small aliquots.
2. RNA Pol-buffer: commercial preparation delivered with the RNA polymerase.
3. RNA Polymerase: commercial T3, T7, and SP6 polymerase preparation.
4. RNasin: RNase inhibitor (Promega, Madison, WI).
5. Ribonucleotides: A-, C-, G-triphosphate (for single-label transcription assays) and A-, G- triphosphate (for double-label transcription assays) are mixed from commercial solutions with a neutral pH and diluted in double-distilled water.
6. [ $\alpha$ -<sup>35</sup>S]-CTP, UTP (1000 Ci/mmol) Amersham, Arlington Heights, IL.
7. Alkaline hydrolysis mix (2X stock solution): 80 mM NaHCO<sub>3</sub>, 120 mM Na<sub>2</sub>CO<sub>3</sub>, pH 10.2. Store in aliquots at -20°C and discard after use.
8. TE (100X stock solution): 1 M Tris-HCl (pH 8.0), 0.1 M EDTA.
9. tRNA 10 mg/mL: dissolve commercially available yeast tRNA at a concentration of 10 mg/mL in TE, 0.1 M NaCl. Extract twice with phenol (TE-saturated) and twice with chloroform. Precipitate with 2.5 volumes ethanol at room temperature. Centrifuge at 5000g for 15 min at 4°C. Redissolve in TE, measure the concentration spectrophotometrically and store at a concentration of 10 mg/mL at -20°C in small aliquots.
10. 3 M Sodium acetate (pH 5.2)

## 2.6. Solutions for Pretreatments and Hybridization

1. SSC (20X stock solution): 3 M NaCl, 0.3 M Na-citrate (pH 7.2).
2. 2 N HCl: Add 20 mL 36% HCl (12 N) to 100 mL double-distilled water.
3. Pepsin (10% stock solution): Make a 10% Pepsin (Sigma P7000 800–2500 U/mg) solution in double-distilled water and predigest for 2 h at 37°C.
4. Pepsin (0.1% working solution in 0.01 N HCl): Add 0.5 mL 2 N HCl to 100 mL double-distilled water; put it at 37°C and add 1 mL Pepsin stock solution approx 15 min before use. The capacity of this solution is about 40 slides with sections when used within 3 h after preparation.
5. Glycine: 10% stock solution in PBS.
6. DTT: 10 mM dithiothreitol, stored at –20°C and kept on ice during use; the solution can be safely frozen and thawed five times.

## 2.7. Hybridization Solutions

1. SSC: (20X stock solution): 3 M NaCl, 0.3 M Na-citrate (pH 7.2).
2. 50% Dextran sulfate/10X SSC: Add approximately 3 mL double-distilled water to 10 mL 20X SSC and slowly dissolve 10 g of dextran sulfate by stirring and heating (60°C). Wait until the Dextran sulfate is dissolved before adding new powder. During this process add as much double-distilled water as possible, but beware not to exceed the final volume of 20 mL. Autoclave for 20 min only.
3. Deionized formamide: Add 5 g of Biorad AG 501-X8 mixed-bed resin (20–50 mesh) to 100 mL formamide; stir for 1 h. Filter through a Whatman no. 1 filter and store in batches at –20°C.
4. 50X Denhardt's solution: 1% Ficoll 400, 1% polyvinylpyrrolidone, 1% bovine serum albumin (Fraction V) in double-distilled water. Sterilize by filtration and store in batches at –20°C.
5. 10% Triton X-100: Dilute Triton X-100 in sterile double-distilled water and store at 4°C.
6. 1.25X hybridization mix: 5 mL formamide deionized; 2 mL 50% dextran sulfate/10X SSC; 0.4 mL 50X Denhardt's solution; 0.1 mL 10% Triton X-100; 0.5 mL double-distilled water (sterile); store in batches at 4°C.
7. DTT: Make a 1 M stock solution and store in small batches at –20°C.
8. 10 mg/mL salmon sperm DNA: Make a 10 mg/mL solution in double-distilled water by stirring it overnight at 4°C. Adjust the NaCl concentration to 0.1 M. Extract the solution once with phenol and once with phenol:chloroform. Recover the aqueous phase and shear the DNA by passing it 12 times rapidly through a 17-gauge hypodermic needle. Precipitate the DNA by adding two volumes of ice-cold ethanol. Centrifuge, dry and dissolve the pellet in double-distilled water, measure the OD<sub>260nm</sub>, and adjust the concentration to 10 mg/mL. Boil for 10 min and chill on ice, store in batches at –20°C.
9. 50% formamide/1X SSC: If the formamide used for this wash-solution is not deionized, check the pH.
10. 5X RNase buffer: 50 mM Tris-HCl pH 8, 25 mM EDTA, 2.5 M NaCl
11. RNase A 10 mg/mL: To make RNase that is free of DNase; dissolve RNase A at a concentration of 10 mg/mL in 10 mM Tris-HCl pH 7.5, 15 mM NaCl and heat it for 15 min at 100°C. Cool slowly to room temperature. Dispense into aliquots and store at –20°C.

## 2.8. Solutions to be Used for Autoradiography

1. Photographic emulsion: Ilford Nuclear Research Emulsion G-5.
2. Glycerol-water: Add to 59 mL double-distilled water 1.2 mL glycerol. Filter through a 0.22 µm filter and store at 4°C.
3. 10% KBr.

4. Amidol-developer: Prepare a fresh solution just before developing. Dissolve 1.13 g Amidol (4-Hydroxy 1,3-phenylenediammoniumdichloride) in 200 mL double-distilled water, add 4.5 g  $\text{Na}_2\text{SO}_3$  and bring it to a final volume of 250 mL with double-distilled water. Filter the solution through a normal paper filter and add 2 mL 10% KBr.
5. Fixer: 30%  $\text{Na}_2\text{S}_2\text{O}_3 \cdot 5\text{H}_2\text{O}$  in double-distilled water.
6. Nuclear Fast-Red (stock solution): 0.1% nuclear fast-red (kernechtrot) + 5% aluminum sulfate; dissolve in double-distilled water and filter. Store at 4°C.
7. Nuclear-Fast Red (working solution): Dilute the stock solution 1:5 with double-distilled water. This solution can be used for several weeks.

### 3. Methods

#### 3.1. Tissue Fixation (see Note 4.2)

1. Small tissue samples (e.g., rat embryo's up to nine embryonic days) are fixed in 4% FA for 4 h at 4°C with agitation.
2. Larger samples and older embryos (embryos of 18 and 20 embryonic days are decapitated and the skin is removed) are fixed overnight at 4°C, but not exceeding 16 h, as this may harden the tissue giving problems with sectioning.

#### 3.2. Paraffin Embedding, Mounting, and Sectioning

1. After fixation the tissue is passed through an approximately 50-fold volume of a graded series of ethanol (70%, 80%, 90%, 96%, and 100%) with mild agitation, for about 2 h each, followed by an overnight ethanol exchange in 1-butanol. Note: Explosion hazard! Use closed containers, handle in fume hood.
2. Impregnate the tissue with paraffin at 60°C, three times for 2 h, the last 2 h under vacuum, if necessary.
3. Pour melted paraffin in a mold and carefully position the tissue.
4. Solidify at room temperature and store until use.
5. Cut 7  $\mu\text{m}$  sections and humidify with double-distilled water if necessary. RNase free conditions are not necessary during sectioning.
6. Collect the sections on a tray. The sections can be stored at room temperature for a few weeks before they are mounted onto the slides. Mounting of the sections is done under RNase free conditions. Wipe the warm plates with an RNase surface decontaminant.
7. Stretch the sections by laying them on sterile double-distilled water on AAS-coated slides placed on a warm plate at 45–50°C; suck away the water as much as possible, assuring that no air bubbles are present underneath the tissue and keep the slides at 30°C for a few hours.
8. Dry overnight at 37°C and store the slides.

#### 3.3. Probe Labeling for In Situ Hybridization (see Note 4.4)

1. Template linearization: The plasmid containing the deoxyribonucleic acid (DNA) insert of interest should be linearized to allow the production of “run-off” transcripts derived from the insert sequence only. The enzyme used for this linearization must produce a 5' overhang or a blunt end. Use of templates with a 3' overhang can result in erroneous transcripts containing sequences complementary to the expected transcript. The restriction digestion should be complete. Undigested plasmid DNA present in the transcription assay produces unwanted vector sequences. After linearization of the template a phenol-chloroform extraction must be performed.
2. Transcription: The buffer used for in vitro transcription is dependent on the source of RNA polymerase and is provided by the manufacturer of the RNA polymerase. The com-

**Table 1**  
**RNA Transcription Assay**

Addition	“Single label”	“Double label”	Final concentration
Linearized DNA-template (approx 1 µg/µL)	0.25 µL	0.25 µL	approx 25 ng/µL
T3/T7 or SP6 Buffer (5×)	2.00 µL	2.00 µL	
DTT 100 mM	1.00 µL	1.00 µL	10.0 mM
RNAsin 40 U/µL	0.25 µL	0.25 µL	1.0 U/µL
A-, C-, G-triphosphate 5 mM	1.00 µL	—	500.0 µM
A-, G-triphosphate 5 mM	—	1.00 µL	500.0 µM
[α- <sup>35</sup> S]-UTP (1000 Ci/mmol)	—	5 µL (freeze-dried) <sup>a</sup>	5.0 µM
[α- <sup>35</sup> S]-CTP (1000 Ci/mmol)	5.00 µL	5.00 µL	5.0 µM
RNA polymerase (50 U/µL)	0.50 µL	0.50 µL	2.5 U/µL
Total volume	10.00 µL	10.00 µL	

<sup>a</sup>The limitations of the final volume may necessitate drying of the label. Label can be dried in a Speedvac centrifuge within 30 min. The dried label can be stored at -20°C overnight before use. When the probes are used for a few *in situ* hybridization experiments only, the assay can be performed with half the volumes.

position of the final transcription assay is indicated in **Table 1**. Incubation is for 2 h at 37°C, or for 4 h at 30°C for templates longer than 1500 bp to produce more full length transcripts. Template is removed by the addition of 1 µL DNase I (RNase-free) 1 U/µL and incubation for 15 min at 37°C. Add 90 µL double-distilled water to the reaction and put it on ice; 1 µL can be used to establish the length of the transcripts by polyacrylamide gel electrophoresis.

3. RNA hydrolysis: one volume alkaline hydrolysis mix (2X stock solution) is added to the assay and the RNA is hydrolyzed at 60°C for about 12 min (for a 300 bp probe), 15 min (for a 500 bp probe), 16 min (for a 800 bp probe), 17 min (for a 1500 bp probe), and 18 min (for a 5000 bp probe).
4. Probe purification: After hydrolysis of the RNA, 1 µL tRNA (10 mg/mL) is added and the incubation is extracted with 100 µL phenol (TE saturated). 100 µL chloroform/isoamylalcohol (24:1) is added, the volume is mixed again and centrifuged a few minutes to separate the water phase. To assess the <sup>35</sup>S input value, 2 µL of the water phase is counted in a liquid scintillation counter. Subsequently 20 µL 3 M sodium acetate (pH 5.2) and 440 µL ethanol 100% (RT) are added, stored overnight at -20°C and centrifuged for 30 min (Savant swing out, 5°C). 500 µL 70% ethanol (RT) is added to the pellet and after storage for 10 min at -20°C centrifuged for 10 min. The supernatant is carefully removed and the pellet is dried in a Speedvac centrifuge for 10 min and subsequently dissolved in TE, containing 10 mM DTT to a final concentration of about 10<sup>6</sup> cpm/µL. One µL of this solution is used to determine the incorporation of radioactivity. The probe is stored at -20°C.

### 3.4. Pretreatment of Paraffin Sections

1. Slides are rinsed three times in xylene for 5 min, in xylene/ethanol (1:1) for 5 min, twice in 100% ethanol for 3 min and dried for at least 30 min in a stream of air. The pretreatments are carried out in 150 mL stainless steel vessels that can hold one slide tray for 12 slides.
2. Incubate the slides in 2X SSC at 70°C for 10 min and wash with double-distilled water for 5 min. *Although the action of this step is unknown, it is essential. After this step the sec-*

tions are swollen, which may increase the accessibility of the sections for protease and the target RNA for the labeled cRNA probe.

3. Pepsin-treatment: The time of digestion must be determined empirically for each specific tissue. Each new batch of Pepsin should be tested on a known combination of tissue(s) and probe(s); 0.1% Pepsin dissolved in 0.01 *N* HCl is used. The incubation temperature is 37°C. When different incubation times within one experiment are used you can leave the slides in the double-distilled water-wash solution that is used between the SSC/70°C step and the Pepsin treatment, so that all the slides come together in the glycine stop solution. Representative incubation times are for adult and neonatal rat liver and heart: 20 min and for rat embryos of embryonic day (ED) 20: 15 min, ED16/18: 10 min, ED13/14: 5 min, ED11, 3 min; ED12/11: 2 min. The protease reaction is stopped with 0.2% glycine in PBS for 30 s followed by two washes with double-distilled water for 30 s and 5 min, respectively.
4. Incubate in 10 mM dithiothreitol for 5 min and dry the slides as short as possible to prevent oxidation. Hybridize the sections the same day. *This step, carried out just before the hybridization, is extremely important when [<sup>35</sup>S]-labeled probes are used as it reduces the background considerably.*

### 3.5. Hybridization (see Notes 4.5, 4.6, and 4.7)

1. Composition of the hybridization mix: 50% formamide, 10% Dextran sulfate, 2X SSC, 2X Denhardt's, 0.1% Triton X-100, 50 mM DTT, 200 ng/μL salmon sperm DNA.
2. Preparation of the hybridization mix:
  - a. Bring the 1.25 × hybridization mixture at room temperature.
  - b. For 100 μL hybridization mix pipet carefully 80 μL 1.25 × hybridization mix (the solution is very viscous).
  - c. Put the solution on ice.
  - d. Add 5 μL 1 *M* DTT.
  - e. Add 2 μL denatured salmon sperm DNA (10 mg/mL), heated for 5 min at 100°C and quenched on ice just before use.
  - f. Keep the solution on ice, it can be used for 2 h.
  - g. Add double-distilled water to the probe to a final volume of 13 μL.
  - h. Heat the cRNA probes for 3 min at 80°C and quench on ice.
    - i. Add the denatured probe to the hybridization solution and keep on ice until use.
3. Hybridization (see Notes 4.7 and 4.8):
  - a. Pipet approx 6 μL of the hybridization mix onto each section of approx 5 × 5 mm. Larger sections may require more mix. No coverslips have to be used.
  - b. Put the slides in a tightly closed box containing paper towels that are freshly soaked in 50% formamide/1X SSC to prevent evaporation of the hybridization mix.
  - c. Put the box overnight at 54°C.
4. Posthybridization washes:
  - a. Discard the paper towels.
  - b. Rinse the slides with a few milliliters of 1X SSC to remove the bulk of the hybridization mix, and wash the slides by gently shaking in 250 mL (sufficient for 25 slides) of the following.
    - c. 50% formamide/1X SSC for 2 × 15 min at 54°C.
    - d. 1X SSC for 10 min at room temperature (RT).
    - e. Rinse with 1X SSC.
    - f. 10 μg RNase/mL in RNase buffer for 30 min at 37°C.
    - g. Rinse with 1X SSC.



- h. 10 min 1X SSC at RT.
- i. 10 min 0.1X SSC at RT.
- j. Dehydrate for 3 min each in successively 50, 70, 96% ethanol, containing 0.3 M ammonium acetate.
- k. Dry the slides in an air stream for at least 1 h before applying the emulsion. Be sure that there are no droplets left on the slides.

### **3.6. Probe Detection (see Notes 4.9 and 4.10)**

1. Preparation of batches of the photographic emulsion:
  - a. Melt the batch of emulsion at 42°C; it takes at least 20–25 min.
  - b. Carefully mix the emulsion by turning it head-over-head several times during melting.
  - c. Divide the batch in portions by transferring 5 mL of the melted emulsion each to a 20 mL vial containing 7.5 mL glycerol-water. Use of an automatic pipet will lead to considerable retention of emulsion in the tip; dark room illumination is insufficient to see the divisions on a syringe. To circumvent this type of problems, a syringe and a block to stop the plunger at a fixed point, leaving 5 mL in the syringe.
  - d. Aspirate the emulsion into the syringe. Put the block between the syringe and the plunger. Push the plunger down, remove the block, and push the plunger completely down.
  - e. Store the batches at 4°C in a light-tight box. Ilford guarantees the emulsion for at least 2 mo without melting; we did not observe elevated background after half a year of storage.
2. Application of the photographic emulsion to the slides:
  - a. Melt the batch of diluted emulsion for 10 min at 42°C.
  - b. Mix carefully without trapping air bubbles by turning the batch head-over-head.
  - c. Pour the emulsion into a specially made 10 mL stainless steel cuvette and keep it at 42°C.
  - d. Slowly lower a slide into the emulsion.
  - e. Slowly move the slide up and down twice.
  - f. Hold the slide as horizontally as possible and wipe the back; be sure you got the right side.
  - g. Place the slide horizontally at room temperature for the time needed to dip the following slide.
  - h. Place the slide on a horizontal ice-cooled glass plate for 10 min.
  - i. Dry the slides horizontally for 60 min at room temperature.
  - j. Put the slides in a horizontal position in a light-tight box at 4°C, containing silica-gel as desiccant and allow them to expose for approx 4–10 d.
  - k. Immediately after use remove the emulsion from the water bath, pour it back into the container and store it at 4°C. The used emulsion can be used a second time for normal experiments; if the lowest possible background is required a new batch should be used.
    - l. Carefully clean the cuvette; any emulsion that remains gets exposed to light and introduces a lot of background into the following experiment.
3. Development of the autoradiographic signal:
  - a. Bring all solutions at 18°C.
  - b. Put the box with slides for at least 30 min at room temperature.
  - c. Develop for 4 min in Amidol-developer with agitation.
  - d. Stop for 1 min in double-distilled water.
  - e. Fix for 10 min in fixer with agitation.
  - f. Wash for at least 60 min in running tap water at about 20°C (watch the temperature); the first 30 min in the dark.

4. Counter-staining: Staining with nuclear-fast-red gives a reproducible result.
  - a. 5 min double-distilled water.
  - b. 1.5 min 1:5 nuclear-fast-red solution.
  - c. Rinse in double-distilled water for 5 min.
  - d. 5 min each of 50%, 70%, 96%, 100%, and 100% ethanol.
  - e. 3 × 5 min xylene. *The grains will disappear by long stay in xylene.*
  - f. Mount under a cover glass in Malinol. *Grains may disappear with other embedding media (e.g., Eukitt).*
  - g. Slides can be examined by now; before storage, they have to be dried for several weeks at 37°C.

### 3.7. Image Analysis (see Note 4.11)

1. System specification:
  - a. Record the images with a digital CCD camera attached to a microscope, using normal bright field illumination.
  - b. Use a light source provided with a stabilized power supply, a monochromatic band-pass filter, and an infrared block filter to exclude spectral response dependencies of the camera.
  - c. Use a scientific grade camera with a high spatial resolution, a high-dynamic range and a linear response over the whole range (e.g., Photometrics cooled CCD, 1317 × 1035 pixels, 12 bit = 4096 gray levels) and use software that can handle images of this resolution and dynamic range.
  - d. Assess, using a micrometer slide, the dimensions of the object plane that correspond to the CCD size at different objective magnifications and calculate the corresponding object sizes per pixel.
2. Image recording:
  - a. Put your specimen on the stage, choose the desired magnification and adjust the condenser and field diaphragm for correct illumination.
  - b. Focus the specimen on the camera display.
  - c. Remove the specimen and adapt the illumination and shutter time for optimal use of the dynamic range of the camera, do not overexpose.
  - d. Record a reference image ( $I_o$ ); this image is recorded without a slide on the stage.
  - e. Do not change illumination, magnification or shutter time.
  - f. Put the specimen on the stage, focus it on the camera display and record your image ( $I_i$ ).
  - g. Repeat **step f** for a series of images, repeat **steps a–e** when illumination is changed to record a new reference image ( $I_o$ ).
  - h. Record the calibration spots in the same way.
  - i. Convert each recorded image ( $I_i$ ) pixel-wise in an optical density image using the reference image ( $I_o$ ) and the formula:

$$OD_{i(x,y)} = -10 \log \frac{I_{i(x,y)}}{I_{o(x,y)}}$$

This calculation incorporates implicitly an illumination-shading correction.

3. Calibration
  - a. Acquire an OD image of each calibration spot as described.  
For each spot:
    - b. Use the built-in features of an appropriate image analysis program to determine the radius and the center of gravity of the spot.

- c. Divide the radius into 15 or 20 equally spaced concentric zones and measure the mean OD and the area in each of these zones.
- d. Calculate the volume fraction of each zone using the formula:

$$\text{Volume fraction}_i = \frac{(i^2 - n^2)^2 - [(i + 1)^2 - n^2]^2}{n^4}$$

with  $n$  = number of zones and  $i$  = zone number (see **Fig. 1B,C** and **Note 11**).

- e. Calculate from this volume fraction, from the measured area per zone and from the known radioactivity for each spot, the radioactivity (in cpm/mm<sup>2</sup>) associated with each zone.
  - f. Draw a scatter plot with cpm/mm<sup>2</sup> on the  $X$ -axis and mean OD on the  $Y$ -axis (**Fig. 1A**).
  - g. Use curvilinear regression to fit a calibration curve to the resulting point cloud. Note that the intercept of this curve with the  $Y$ -axis should coincide with the blank density ( $b$ ), i.e., the mean OD of an area of the slide not covered by a spot.
  - h. Use the calibration curve to convert the OD images of the specimens into cpm images. In this conversion the blank density is set to zero.
4. Measurements:
- a. Process the images with an appropriate image analysis program; determine, using the built-in features of the program, the following values in each cpm image:
    - i. Nonspecific signal ( $n$ ): Radioactivity, due to nonspecific binding of the probe, in a tissue not expressing the mRNA of interest.
    - ii. Specific signal ( $s$ ): Radioactivity, due to specific hybridization, in a tissue expressing the mRNA of interest.
  - b. Calculate the absolute specific signal:  $S_a = s - n$ . This value, multiplied by the area in which it is measured, can be used to calculate total expression.

---

Fig. 1. (See color plate 2 appearing after p. 262.) (opposite page) Construction of a calibration curve from gelatin calibration spots. (A) Slide with gelatin calibration spots exposed for 6 d and developed for 4 min. The scatterplot shows the result of the measurement of each spot using a series of 10–15 concentric rings per spot. Note that the radioactivity–OD relation is linear up to about OD value 0.8. The intersection of this line with the  $y$ -axis coincides with the measurement of the spot without added radioactivity ( $\square$ ). This value represents the so-called blank density ( $b$ )—the mean OD value in areas on the slide not covered by a spot or specimen. (B) Illustration of the reasoning behind the measurement of the calibration spots. From the OD values measured along a profile through the center of a blue-stained nonradioactive gelatin spot (outer rim of the figure), it can be concluded that the physical shape of the spot is parabolic. The radius of the spot can be found by searching, from both sides of a profile, for the point where the OD values of the profile clearly deviate from the blank density level ( $b$ ). The spot can then be divided along the radius into concentric rings. The contribution of each ring to the total volume of the spot is displayed in the bar graph on the right. For example: ring 6, which is highlighted, contributes 15% to the total volume and, therefore, 15% of the radioactivity of the spot is located in ring 6. Measurement of the mean optical density and calculation of the radioactivity per ring, provides points for the calibration curve (panel A). (C) Derivation of the formula for the calculation of the volume fraction of a ring in a parabolic spot. Note that in the final equation the parameters of the parabola, and, therefore, the height and radius of the spot have disappeared: the volume fraction per ring only depends on the ring number  $i$  and the number of rings  $n$ .

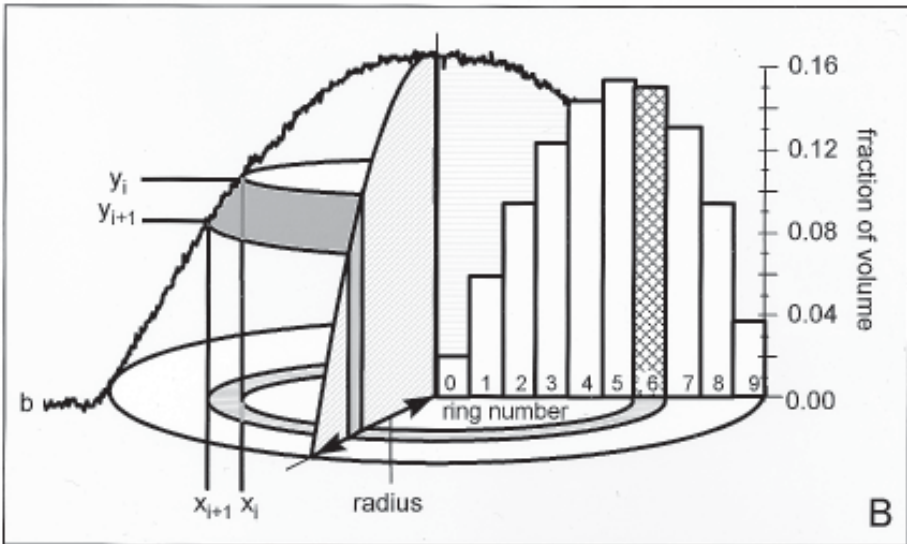
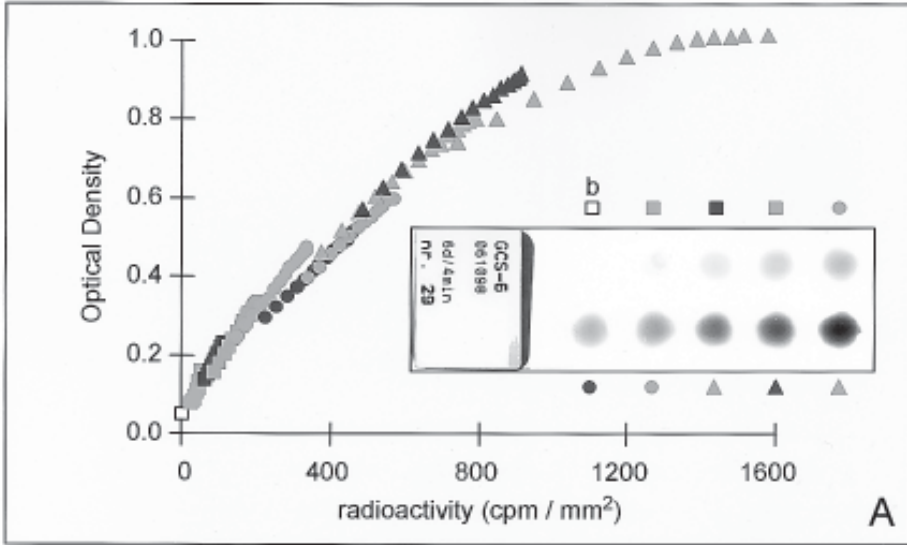

Parabola, centered around the origin:  $y = ax^2 + c$  (1)

Intersection with  $x$  plane, for  $y = 0$ , is at radius  $R$ :  $c = -aR^2$  (2)

Total volume of a parabolic spot: total volume =  $-\pi c^2/2a$

Volume of a "ring" bound by  $x_i$  and  $x_{i+1}$ : volume ring <sub>$i$</sub>  =  $-\pi(y_i^2 - y_{i+1}^2)/2a$

Volume fraction of ring: volume fraction <sub>$i$</sub>  =  $(y_i^2 - y_{i+1}^2)/c^2$  (3)

The total radius  $R$  of the spot is divided into  $n$  zones,

then the ring margins are  $x_i = iR/n$  (4a)

and  $x_{i+1} = (i+1)R/n$  (4b)

in which  $i$  can take values from 0 to  $n-1$ .

Substitution of Eqs. 1, 2, 4a, and 4b into Eq. 3 gives:

Volume fraction <sub>$i$</sub>  =  $(i^2 - n^2)^2 - [(i+1)^2 - n^2]^2/n^4$  (C)

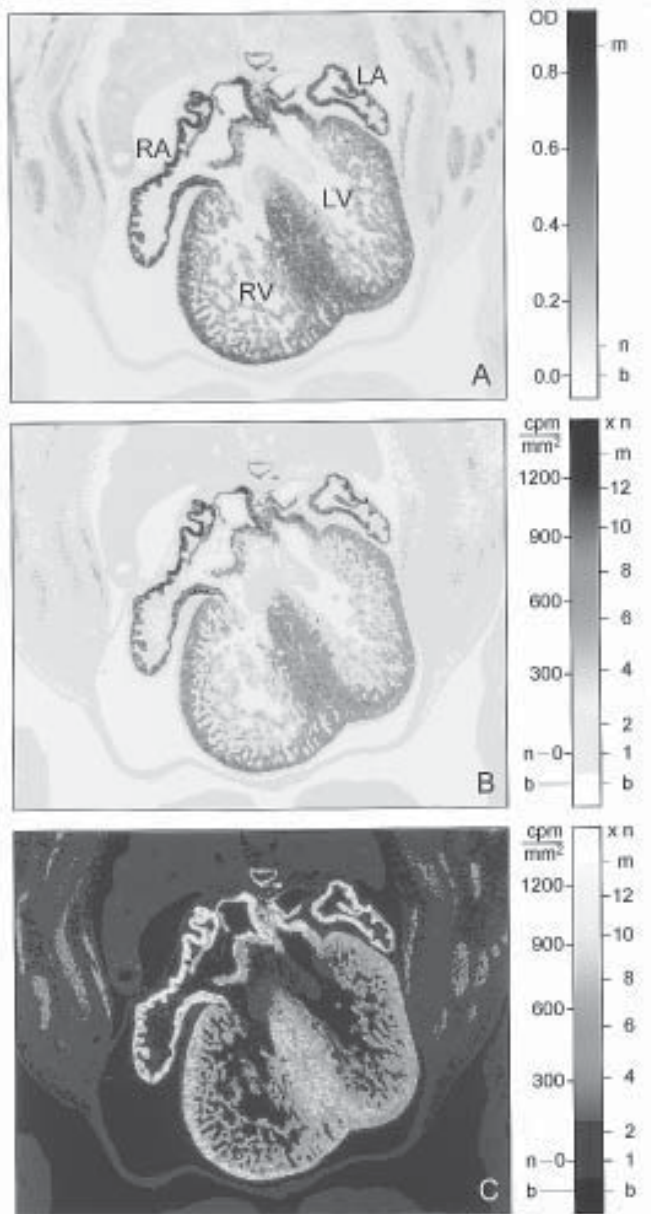

Fig. 2. (See color plate 3 appearing after p. 262.) Illustration of image visualization. (A) Optical density image of a section of a 13-d-old rat embryo hybridized to a 1700-bp cRNA probe for SERCA2a mRNA, encoding the cardiac sarcoplasmic Calcium pump (9); R/LA: right/left atrium; R/LV: right/left ventricle. Signal is highest in the atrial compartment, intermediate in the exteriorly localized compact ventricular component, and lowest in the interiorly localized trabecular ventricular component. Low signal is also observed in the developing skeletal muscle. An optical density (OD) scale bar is given at the right of the panel. **b**: blank density in the areas not covered by tissue; **m**: maximal optical density in the image. (B and C) “Bright field”- and “dark-field”-colored cpm representations of the density image presented in panel (A), using the calibration curve presented in Fig. 1A. The scale bars indicate absolute specific values in  $\text{cpm}/\text{mm}^2$  ( $S_a = s - n$ ) and the relative specific signal ( $S_r = s/n$ ), representing the signal relative to the nonspecific signal (**n**) in background tissue, not expressing the RNA of interest (fold **n**). **n**: mean nonspecific signal (gray); **m**: maximum detectable signal in the expressing tissue (black).

or

- c. Calculate the relative specific signal ( $S_r = s/n$ ). This value can be used to compare expression levels of specific signal between sections, even if the sections are not prepared in a uniform way.
5. Visualization: For visual presentation of the data constructing a “cpm lookup table,” with the use of the OD–radioactivity calibration curve (**Fig. 1A**), is, in principle, sufficient. To permit easy appreciation of the differences in radioactivity levels, the image should be presented as a color image. Depending on the choice of a color table, the resulting image can give the impression of a bright-field (**Fig. 2B**) or a dark-field image (**Fig. 2C**). The resulting image may either be provided with an absolute index of radioactivity and  $n$  (nonspecific signal) set to zero, or with a relative index (fold  $n$ ) with  $n$  (nonspecific signal) set to 1.

#### 4. Notes

1. RNase: Successful *in situ* RNA detection requires that great care is taken to avoid contamination of the specimen with RNase. Bear in mind that the biggest source of RNases comes from ourselves and therefore gloves are to be worn during the whole procedure. All materials to be used, glasswork, pipet tips, slide trays, and solutions need to be sterilized. “Dry materials” should be heated for 3 h at 140°C and solutions can be autoclaved for 30 min at 120°C, or made with sterile buffer or double-distilled water, e.g., pepsin and dithiothreitol. The “dry material” that cannot be sterilized by heating, and surfaces must be wiped with a fresh solution of DEPC/ethanol or a commercial RNase decontaminant “RNase away” (MBP Inc., San Diego, CA) and air-dried.
2. Fixation: Fixation is essential to preserve the tissue morphology and to anchor the RNA within the tissue. Underfixation generally results in weak and/or artificial hybridization. The target RNA is very sensitive to degradation by RNase and is easily washed away. Therefore, it is essential to start fixation as soon as possible after isolation of the tissue. This can be done by direct freezing of the tissue in nitrogen-cooled isopentane, or by fixation. We prefer fixation followed by paraffin embedment, as the unfixed frozen tissue is very sensitive to RNase during the process of making cryostat sections. Moreover, the morphology of paraffin sections is superior to that of frozen sections. FA fixation at 4°C prevents artefacts because of too rapid fixation, causing gradients toward the interior of the specimen.

Storage of the fixed tissue for longer periods is possible in 70% ethanol; higher ethanol concentrations make the tissue too hard to be cut. Paraffin-embedded tissue blocks can be stored at room temperature for several years.

3. Slide-coating: 3-Aminopropyltriethoxysilane (AAS), also known as 3(triethoxysilyl)propylamine (TESPA) reacts with silica glass to produce aminoalkyl groups on the glass surface that may bind either ionically or covalently with aldehyde or ketone groups in the tissue. Both for frozen and Paraffin sections, AAS-treated slides are far superior to poly-L-lysine-coated slides with respect to their binding characteristics of tissue sections (7).
4. Probe length and labeling: Although the optimal size of a probe for *in situ* hybridization is about 50–200 nucleotides it is important to make full-length transcripts, as the total length of unique sequences determines the sensitivity of hybridization. Transcripts can subsequently be reduced in size by limited hydrolysis. Transcripts should be of high specific activity. Therefore, in the transcription assay [ $\alpha$ -<sup>35</sup>S]-CTP is not diluted with unlabeled CTP. A specific activity of  $1.67 \times 10^9$  cpm/ $\mu$ g is obtained with a new batch of [ $\alpha$ -<sup>35</sup>S]-CTP (1000 Ci/mmol). The only way to get a higher specific activity of the transcripts is to use more than one labeled nucleotide in the assay. The concentration(s) of the [ $\alpha$ -<sup>35</sup>S]-nucleotide(s)

must be at least 5  $\mu\text{M}$  to guarantee full-length transcription. Although the use of two-labeled nucleotides results in less full-length transcripts the signal from hybridizations using double-labeled probes is about twice as strong compared to that obtained from hybridizations using single-labeled probes. Use of [ $\alpha$ - $^{35}\text{S}$ ]-CTP is to be preferred above [ $\alpha$ - $^{35}\text{S}$ ]-UTP as at the optimal nucleotide concentration transcription of poly(U) stretches in the DNA is hampered, preventing the synthesis of full-length transcripts.

5. Hybridization protocol: The hybridization protocol is based on our experience with the detection and localization of a variety of mRNAs in rat, mouse, and human tissues (adult, fetal, and embryonic) initially using [ $\alpha$ - $^{35}\text{S}$ ]-labeled cDNA probes (3). The protocol essentially follows that described by Holland (8), but is laced with small modifications found to be beneficial or more practical over the years. We have adapted this protocol for the use of [ $^{35}\text{S}$ ]-labeled cRNA probes (4,9,10) and evaluated the quantitative aspects of the procedure (4).

The hybridization mixture contains 10% dextran sulfate, a compound that is strongly hydrated in aqueous solutions. Because of this effect macromolecules (such as the probe) have no access to the hydrating water, leading to an apparent increase in probe concentration. Furthermore, the mixture contains 50% formamide to lower the melting temperature of the duplex, and Denhardt's, Triton X-100, and competitor DNA to lower the background by preventing nonspecific binding of the probe to the tissue or target RNA.

To reduce background it is crucial to hybridize under reducing conditions by the presence of DTT. Use of [ $\alpha$ - $^{33}\text{P}$ ]-labeled probes is worth trying if persistent background problems occur that cannot be overcome by the abundant use of reducing solutions.

Shorter hybridization times (i.e., 4 h), do not improve the signal-to-noise ratio, and led, in our experience, to a considerable lower absolute signal of hybridization, which is difficult to measure.

6. Probe concentration: At a [ $\alpha$ - $^{35}\text{S}$ ]-labeled cRNA probe concentration of  $4 \times 10^4$  cpm/ $\mu\text{L}$  hybridization mix, a good signal is being achieved for most probes. For abundant messengers the probes can be used for a period of three months. To get the highest possible signal, especially with double-labeled probes to detect low abundant messengers, the hybridization should be performed as soon as possible after the labeling with a new batch of nucleotides. Longer exposure is better than using a higher concentration of probe. A "single"-labeled RNA probe made with new radioactivity gives a specific activity of  $1.7 \times 10^9$  cpm/ $\mu\text{g}$ . At a concentration of  $4 \times 10^4$  cpm/ $\mu\text{L}$  hybridization mix the RNA concentration is 24 pg/ $\mu\text{L}$  hybridization mix. For "double"-labeled RNA probes the specific activity is  $3.3 \times 10^9$  cpm/ $\mu\text{g}$ , thus at a concentration of  $4 \times 10^4$  cpm/ $\mu\text{L}$  hybridization mix, it is 12 pg RNA/ $\mu\text{L}$ .
7. Stringency of hybridization: The stringency of hybridization is dependent on the temperature in relation to the  $T_m$  of the hybrid to be formed at which the probe is allowed to hybridize with the complementary target mRNA in the section. The  $T_m$  is the temperature at which 50% of the nucleic acid is in the double-stranded form. The  $T_m$  is influenced by a number of factors.
  - a. Temperature: the rate of renaturation has a broad maximum between  $16^\circ$ – $32^\circ\text{C}$  below the  $T_m$ .
  - b. pH: the  $T_m$  is independent of the pH in a broad range varying from pH 5 to 9.
  - c. Ionic strength: monovalent cations (e.g.,  $\text{Na}^+$ ) interact electrostatically with nucleic acids. Higher salt concentrations increase the stability of the hybrid and, hence, increase the  $T_m$ . At  $\text{Na}^+$  concentrations higher than 0.4 M there is only a slight effect on the  $T_m$ .
  - d. Formamide: formamide reduces the thermal stability of double-stranded nucleic acid and, hence, hybridization can occur at a lower temperature. The effect of formamide

depends on the duplex formed. The reduction of the  $T_m$  for RNA–RNA hybrids is 0.35°C for each percent increase in the concentration of formamide.

- e. Percentage GC: every 1% of G/C content increases the melting temperature by approx 0.41°C.
- f. Length of the probe: the thermal stability of the duplex is also related to the length of the probe. Long fragments yield more stable hybrids than short ones. For *in situ* hybridization, the use of short fragments facilitates penetration of the probe into the tissue section. 100 bp fragments constitute a good compromise.
- g. Percentage of similarity: Mismatch of base pairs decreases the  $T_m$  with 1°C for each percent of mismatch. The  $T_m$  of RNA–RNA hybrids can be calculated using the following formula:  

$$T_m = 81.5 + 16.6 \log M + 0.41(\%G+C) - 0.35(\% \text{ formamide}) - (500/n) - \% \text{ mismatch}$$
 in which  $M$  = molar concentration of monovalent ions;  $n$  = length of the labeled probe fragments. For  $M = 0.39 \text{ M Na}^+$ ; G+C = 40%; percentage formamide = 50;  $n = 125$  bases the  $T_m$  value is 70°C using homologous probes.
8. Coverslips: There is no need to use cover-slips to prevent evaporation provided a proper moist box is used (3). Drops of hybridization mixture containing the probe can conveniently be applied on the sections and several probes can be easily compared on consecutive sections.
9. Autoradiography: The radioactive hybrids are detected by their ability to form a latent image in a photographic emulsion, that is applied onto the sections (see [11] for a meticulous review).
  - a. The range of  $^{35}\text{S}$  allows the localization of a message at the cellular level within one week and for that very reason is widely used. After developing, the sections can be stained to allow localization of the silver grains indicating hybridization, within the tissue. Great care must be taken with the choice of staining and mounting media, as they can have detrimental effects on the developed silver grains; the image can fade or even completely disappear (negative chemography).
  - b. The grade of the emulsion determines its sensitivity. Finer grades of emulsion give a better resolution but are less sensitive. We use Ilford Nuclear Research Emulsion G-5 that is generally used for the detection of  $^{35}\text{S}$ .
  - c. The dilution of the emulsion, and thus the thickness of the emulsion layer, has a great effect on the signal and the background. Normally, we use a dilution of 2.5×; this gives a good signal and resolution with a low background. Using less diluted emulsion gives more blackening but less resolution. Undiluted emulsion can give more than 20× the signal of that of a 2.5× diluted emulsion, but the resolution is very poor and depending on the probe the background is high.
  - d. The emulsion must be stored protected from radiation at 4°C. Ilford emulsions can be handled under safelight conditions. We use an indirect illumination with a 15 W dark-room light fitted with a #902 Ilford filter, 1.5 m above the working area. This illumination is safe for the duration of the normal procedure. Nevertheless, work fast to keep the exposure time of the emulsion to the light as short as possible. Extinguish the light if you do not need it. Warming of the emulsion will lead to more background grains, as does mechanical stress. So work fast to keep the emulsion exposed to higher temperatures as short as possible, treat the liquid emulsion gently, and dry the slides slowly. Avoid trapping of air bubbles in the emulsion during melting and dipping, as this will prevent precise allocating of the emulsion and give white spots in the final image.
  - e. The standard developing time is 4 min at 18°C, while agitating to prevent exhaustion of the developer at the emulsion surface. The higher the temperature, the faster the



process. To avoid swelling of the emulsion, the temperature is kept 18°C. The temperature of all solutions should be the same, otherwise swelling or contraction of the emulsion may lead to cracks in or even loss of the emulsion. Longer times of development up to 16 min, increase the signal proportional to the time of development, permitting proportionally lower exposure times (4). It results, however, in a lower resolution owing to the development of larger silver grains. Nevertheless, it may be extremely convenient in a rapid screen of many different probes. On the other hand, longer exposure times result in a sensitive detection with superior resolution. Background signal is acceptable up to about 24 days of exposure.

10. Controls: Worries about the specificity of the *in situ* hybridization can easily develop into a nightmare for frequent users of the *in situ* hybridization technique, who have to cope with the certainty, that absolute specificity does not exist. Several artefacts, possible causes, and controls are listed below.
  - a. High general background, with grains all over the slide, is most likely owing to inaccuracies in one of the steps of the autoradiographic procedures. Check the procedure using blank slides.
  - b. High tissue background indicates nonspecific binding of the probe. To distinguish whether this is because of the procedure or the probe, use a positive control probe that should be positive with some tissues and negative with others. We have dubbed such a control a “tissue-intrinsic control” (3). Such a control is more informative than negative controls, because it comprises in a single section both positive and negative controls. Moreover, a negative control, such as sense probes, is not a good control, even if it is negative, because many other reasons can be envisioned why a probe is negative. It is the authors’ experience that sense probes and probes to low-abundant mRNAs tend to display relatively high backgrounds. Apparently, low concentrations of substrates favor binding of the probe to unrelated sequences. This may be reminiscent to artefacts seen in PCR reactions in the presence of low substrates.
  - c. If the tissue-intrinsic control displays uniform background over the tissue, the quality of the probe has to be assessed. Check whether the plasmid sequences have illegally been transcribed and whether the probe has the correct length. Subsequently, check several steps in the procedure such as the concentration of the probe, the stringency of hybridization, the washing, and RNase treatment. Increase the DTT concentrations to guarantee that reducing conditions are being used.
  - d. If the tissue-intrinsic control displays specific hybridization and the probe of interest does not, check the quality of the probe and check whether the sequence contains GC-stretches or T-stretches that may cause artificial hybridization. Check by RT-PCR of RNA from a tissue extract whether the probe reacts with a single-molecular species. If possible use a probe with more unique sequences and/or double label.
  - e. If the probe displays a specific pattern of hybridization, the correctness of the pattern can be strengthened by the use of probes to different parts of the mRNA of interest, that should yield the same pattern. In all cases, the signal has to disappear when the sections are pretreated with RNase.
11. Measurement of the calibration spots: The radioactivity–OD relation starts as a straight line for low cpm and OD values. However, OD cannot increase indefinitely and for high cpm values the measured OD value will be too low. When a whole calibration spot, with a range from low to high OD values is measured at once, the resulting mean OD will be averaged over this nonlinear relation and, therefore, this mean will be biased downward. The resulting calibration curve will lead to an underestimation of the usable range of the radioactivity–OD relationship and misinterpretation of high OD values. To avoid this bias,

the calibration curve has to be measured in areas which display only a narrow range of OD values. In such a narrow range a linear relation of radioactivity and OD can be assumed and the resulting mean OD will be unbiased. In practice this means that the calibration spots should be measured in a series of concentric rings. By calculating the radioactivity associated with each ring, a number of unbiased calibration points can then be derived from each spot.

From a separate series of gelatin spots, prepared in the same way as the radioactive ones, but with a blue stain instead of radioactivity, we determined that the shape of these spots is circular with a parabolic cross-sectional profile (**Fig. 1B**). This constant shape allows the calculation of the contribution of each part of the spot to the total volume (**Fig. 1C**).

The derivation in **Fig. 1C** shows that in the formula for the volume fraction of a ring the parameters  $c$  and  $a$  of the parabola and the total radius of the spot have disappeared. In other words: the volume fraction of a ring of a parabolic spot is only dependent on the ring number  $i$  and the total number of rings  $n$  and is independent of spot radius or spot height (**Fig. 1B**). This means that every calibration spot can be subdivided in the same number of rings and that then for each spot the same table of volume fractions suffices to calculate the radioactivity associated with each ring.

In this way, each calibration spot will provide a number of calibration points which together can be used to calculate a calibration curve. **Figure 1A** shows the results of the measurement of the 10 calibration spots, each measured in 10–15 rings. Note that the measurements of the individual spots closely follow each others paths, together forming a continuous cloud that can be fitted to a straight line ( $OD = 0.07 + 0.001 \times \text{cpm}/\text{mm}^2$ ;  $R^2 = 0.979$ ) up to an OD value of about 0.8. Therefore, for this calibration slide, and for all the slides with specimens that were processed in the same autoradiographic session, all OD values up to 0.8 are linearly related to the radioactivity bound locally to the spot or specimen. OD values between 0.8 and 1.0 can be converted to cpm values but OD values above 1.0 cannot be interpreted quantitatively. Although the shape of the radioactivity–OD relation depends on exposure and development time, it can be said that, when performing *in situ* hybridization for quantitative purposes, one should always try to avoid OD values above 0.8.

12. Quantitative aspects: Radioactive *in situ* hybridization is more quantitative than generally thought (**4**). In fact, it is comparable with Northern blot quantification, with the same (dis)agreements about the proper control tissues and the processing of the data from the phosphor-imager data. An essential prerequisite of the radioactive *in situ* hybridization is that the optical density in the sections is within the same range as assessed with the gelatin calibration spots. These spots should be processed for autoradiography in the same way as the sections, and the optical density owing to the development of silver grains should display a good relationship with the amount of radioactivity applied on the spots (see **Note 11**). The great advantage of the quantitative character of the radioactive *in situ* hybridization is (i) that relative differences in the levels of an mRNA species within the embryo or an organ can be provided; (ii) that it can be assessed whether changes in the hybridization signal are owing to changes in the cells that express the mRNA species, or are due to changes in the number of cells that accumulate the mRNA (**4**); and finally (iii) that changes in the relative mRNA levels can be related to changes in ribosomal RNA levels, permitting comparison with Northern blot analyses (**6**). Moreover, absolute mRNA levels per area can be determined, as the quantitative *in situ* hybridization allows the assessment of the distribution of relative mRNA concentrations in a tissue, whereas the quantitative Northern blot or polymerase chain reaction (PCR) analyses permit the assessment of absolute mRNA levels.

Two technical aspects deserve short comment. First, instead of an expensive digital CCD camera, an analog video system can be used, provided it is calibrated with optical density calibration filters (12). Second, reliable optical density measurements require homogeneous distribution of the absorbing product in the image. By definition the autoradiographic image is not homogeneous and optical density measurements should, at first thought, necessarily lead to a so-called distributional error (13). Fortunately, this is not the case. Optical density values are calculated values based on the transmission observed by a single detector element (in this case a pixel). Inhomogeneous transmissions in that field lead to an improper calculation of the optical density, because it is calculated as the negative logarithm of the weighted average of these transmissions, rather than being calculated as the average of the negative logarithms of the individual transmissions, which cannot be measured in the field of a single detector element (pixel). In the case of optical density measurements of autoradiographic images, the optical density is zero (100% transmission) when no silver grains are present and the optical density is infinite (0% transmission) when the area is covered with silver grains. In that very special situation, the transmittance is proportional to the area covered with silver grains and so the OD is not affected by distributional error.

## Acknowledgment

The authors thank Gertien Smits for her help with the mathematics of the calibration spots. Diego Franco was supported by NWO (902-16-219) and NHS (97206).

## References

1. Wilkinson, D. G. (1992) *In Situ Hybridization: A Practical Approach*, IRL, Oxford, UK.
2. Wilcox, J. N. (1993) Fundamental principles of in situ hybridization. *J. Histochem. Cytochem.* **41**, 1725–1733.
3. Moorman, A. F. M., de Boer, P. A. J., Vermeulen, J. L. M., and Lamers, W. H. (1993) Practical aspects of radio-isotopic in situ hybridization on RNA. *Histochem. J.* **25**, 251–260.
4. Jonker, A., de Boer, P. A. J., van den Hoff, M. J. B., Lamers, W. H., and Moorman, A. F. M. (1997) Towards quantitative in situ hybridisation. *J. Histochem. Cytochem.* **45**, 413–423.
5. de Groot, C. J., Zonneveld, D., de Laaf, R. T. M., Dingemans, M. A., Mooren, P. G., Moorman, A. F. M., Lamers, W. H., and Charles, R. (1986) Developmental and hormonal regulation of carbamoylphosphate synthetase gene expression in rat liver: evidence for control mechanisms at different levels in the perinatal period. *Biochim. Biophys. Acta* **866**, 61–67.
6. van den Hoff, M. J. B., Lekan dit Deprez, R. H., Monteiro, M., de Boer, P. A. J., Charles, R., and Moorman, A. F. M. (1997) Developmental changes in rat cardiac DNA, RNA and protein tissue base: Implications for the interpretation of changes in gene expression. *J. Mol. Cell. Cardiol.* **29**, 629–639.
- 6a. Habets, P. E. M. H., Franco, D., Ruijter, J. M., Sargent, A. J., Sant'Ana Pereira, J. A. A., and Moorman, A. F. M. (1999) RNA content differs in slow and fast fibers: Implications for interpretation of changes in muscle gene expression. *J. Histochem. Cytochem.* **47**, 995–1004.
7. Henderson, C. (1989) Aminoalkylisane: an inexpensive, simple preparation for slide adhesion. *J. Histotechnol.* **12**, 123–124.
8. Holland, P. (1986) *Manipulating the Mouse Embryo: A Laboratory Manual* (Hogan, B., Constantini, F., and Lacy, E. eds.), Cold Spring Harbor Laboratory, Cold Spring Harbor, NY, pp. 228–242.

9. Moorman, A. F. M., Vermeulen, J. L. M., Koban, M. U., Schwartz, K., Lamers, W. H., and Boheler, K. R. (1995) Patterns of expression of sarcoplasmic reticulum Ca<sup>2+</sup>ATPase and phospholamban mRNAs during rat heart development. *Circ. Res.* **76**, 616–625.
10. Franco, D., Kelly, R., Moorman, A. F. M., and Buckingham, M. (1997) Regionalised transcriptional domains of myosin light chain 3F transgenes in the embryonic mouse heart: morphogenetic implications. *Dev. Biol.* **188**, 17–33.
11. Rogers, A. W. (1979) *Techniques of Autoradiography*, Elsevier, Amsterdam, The Netherlands.
12. Chieco, P., Jonker, A., Melchiorri, C., Vanni, G., and van Noorden, C. J. F. (1994) A user's guide for avoiding errors in absorbance image cytometry: a review with original experimental observations. *Histochem. J.* **26**, 1–19.
13. Ornstein, L. (1952) The distributional error in microspectrophotometry. *Lab. Invest.* **1**, 250–262.

## mRNA and Protein Co-Localization on Tissue Sections by Sequential, Colorimetric *In Situ* Hybridization and Immunohistochemistry

Rocky S. Tuan

### 1. Introduction

Two methods are commonly employed to characterize the spatiotemporal aspect of gene expression: 1. *in situ* hybridization (ISH), which localizes mRNA transcripts using a labeled nucleotide probe and 2. immunohistochemistry (IMH), which detects protein gene products by means of labeled primary or secondary antibodies. Because these methods may be, and often are, done with whole-mount specimens to obtain resolution at the cellular level, they are performed on histological sections. Generally, by using adjacent, serial sections, cellular staining patterns for messenger ribonucleic acid (mRNA) may be compared to that of the corresponding protein product. This chapter outlines a combination of the two procedures performed on the same tissue sections to provide immediate, direct visualization of the expression pattern of a particular gene at both the mRNA and protein levels.

Previous published procedures of combined ISH and IMH have described the performance of ISH first (1–7), or IMH first (8–14), using various combinations of all of the above protocols. The main drawback of performing IMH first is the risk of mRNA degradation (5), and steps to block ribonuclease activity are thus required. The primary risk in doing ISH first is the loss of antigenicity as a result of harsh denaturation treatment steps needed to facilitate mRNA hybridization (14). Procedures based on formalin-fixed, Paraffin-embedded specimens, which promise better morphology than cryosections, for example, require proteinase digestion to remove interfering proteins and their crosslinking formed during fixation to allow the hybridization probe access to target mRNA (2,3). Such a step significantly increases the risk of antigen degradation and loss of morphology.

Recently, new noncrosslinking fixatives have become available, including Histochoice® (Amresco Inc., Solon, OH) and Optiprope® (Oncor Inc., Gaithersburg, MD), that retain excellent tissue and cellular morphology in histological specimens. These fixatives obviate the need for a proteinase digestion step for ISH, thereby lending themselves well to combined ISH and IMH on the same tissue section. In this chapter, a protocol based on Paraffin-embedded specimens fixed in Histochoice® is described.

The first step of ISH uses nick-translated biotinylated DNA probes, as visualized by streptavidin alkaline phosphatase NBT/BCIP detection (purple color). IMH is next carried out with detection using the AEC horseradish peroxidase system (red color).

The procedure described here is an extrapolation of our previous experience with both ISH and IMH (15–24) and has been found to yield results comparable to those obtained using the individual protocols separately.

## 2. Materials

### 2.1. Embedding and Sectioning

1. Histochoice® (Amresco).
2. 50% Ethanol (EtOH).
3. 70% EtOH
4. 95% EtOH
5. 100% EtOH dehydrated, 200 proof (Pharmco, Brookfield, CT).
6. Amyl acetate (Polysciences, Warrington, PA).
7. Paraplast X-tra® (Fisher, Pittsburgh, PA).
8. Peel-Away® molds (Polysciences, VWR).
9. Reichert-Jung 2050 Supercut Microtome.
10. Superfrost Plus® slides (Fisher).

### 2.2. Nick Translation (see Notes 1 and 2)

1. H<sub>2</sub>O (deionized, distilled, and autoclaved).
2. 1 M Tris-HCl, pH 7.5
3. 1 M MgCl<sub>2</sub>
4. dATP, dTTP, dCTP, dGTP, 20 mM: Dilute 100 mM stock dNTPs, Ultrapure dNTP Set, 2'-deoxynucleoside-5'-triphosphate (Pharmacia-LKB, Uppsala, Sweden) 1:5 in 0.1 M Tris pH 7.5
5. Bovine serum albumin, fraction V (BSA) (Sigma, St. Louis, MO) 10% in H<sub>2</sub>O.
6. β-Mercaptoethanol (Sigma).
7. β-Mercaptoethanol working dilution: 4 μL β-Mercaptoethanol + 67 μL H<sub>2</sub>O.
8. Cloned DNA and DNA for quality control (QC) assessment: Double-stranded plasmid DNA containing various inserts.
9. Biotin-14-dATP (Gibco-BRL, Gaithersburg, MD).
10. dATP-<sup>3</sup>H (ICN Radiochemicals, UK).
11. DNA Polymerase I (Promega, Madison, WI).
12. DNase, RQ1 RNase-free, (Promega).
13. DNase working dilution: 2 μL DNase + 16 μL H<sub>2</sub>O.
14. 0.5 M Ethylene diamine tetraacetate tetrasodium salt (EDTA) pH 7.5.
15. Centricon-30® Microconcentrators (Amicon Division, W. R. Grace, Danvers, MA).
16. 0.1 M EDTA.
17. Ecolume® liquid scintillation fluid (ICN Radiochemicals).

### 2.3. In Situ Hybridization (see Notes 1 and 2)

1. H<sub>2</sub>O.
2. 1 M KOH.
3. 100% EtOH.
4. Slide dipping chambers, 25 slide, 140 mL capacity (Tissue-Tek, Baxter, Muskegon, MI).

5. Histo-Clear<sup>®</sup> (National Diagnostics, Atlanta, GA).
6. Xylene (Fisher).
7. 95% EtOH.
8. 75% EtOH.
9. 50% EtOH.
10. 2X SSC: 0.3 N NaCl, 30 mM sodium citrate, pH 7.0.
11. 0.2 N HCl.
12. Deionized formamide (DI-formamide) (Fisher) (*see Note 3*).
13. Mixed-bed ion exchange resin, AG 501-X8 (Bio-Rad)
14. 95% DI-formamide/0.1X SSC.
15. 0.1X SSC.
16. 0.1 M EDTA.
17. 10X SSCP: 1.2 N NaCl, 0.15 M sodium citrate, 0.19 M sodium phosphate, pH 6.0.
18. Dextran sulfate (Fisher) 50% in dd H<sub>2</sub>O.
19. DNA probes: 125 μL/slide assembly; 100 ng nick translated, biotinylated DNA probe (approximately 20 μL nick translation product from above) in 1.2X SSCP containing 7% Dextran sulfate and 24% formamide.
20. Sigmacote<sup>®</sup> (Sigma).
21. Probe-On<sup>®</sup> slides (Fisher).
22. Carter's Rubber Cement.
23. Humid chamber (Medical Packaging Corp., Camarillo, CA).
24. 12.5% DI-formamide/2X SSC.
25. 1X Phosphate buffered saline (PBS).
26. 10% Triton X-100 in H<sub>2</sub>O.
27. Blocking buffer: PBS containing 1.0% Triton X-100.
28. DETEK<sup>®</sup> I-alk signal generating complex (ENZO Biochem, Inc., New York).
29. Bovine serum albumin, fraction V (BSA) (Sigma) 10% in dd-H<sub>2</sub>O.
30. Streptavidin-alkaline phosphatase (SAP) solution: DETEK<sup>®</sup> (1:100) in 1X PBS, 5 mM EDTA, 0.5% Triton X-100, and 0.1% BSA.
31. 1 M Potassium phosphate, pH 6.5.
32. 4 M NaCl.
33. Washing buffer: 10 mM potassium phosphate, 0.5 M NaCl, 1.0 mM EDTA, pH 7.5, 0.5% Triton X-100, 0.1% BSA.
34. 1 M Tris-HCl, pH 8.8.
35. 1 M MgCl<sub>2</sub>.
36. Substrate buffer: 42 mM Tris-HCl, pH 8.8, 0.1 M NaCl, 0.1 M MgCl<sub>2</sub>.
37. Dimethylformamide (DMF) (Sigma).
38. 5-Bromo-4-chloro-3-indolyl phosphate p-toluidine salt (BCIP) (Sigma).
39. Nitro blue tetrazolium (NBT), grade III (Sigma).
40. Substrate solution: 0.8 mM BCIP and 4.5 mM NBT in substrate buffer (*see Note 4*).

## 2.4. Immunohistochemistry

1. PBS.
2. Primary antibodies (selected by investigator per specific need).
3. Zymed Histostain SP<sup>®</sup> Kit (Zymed Laboratories Inc., South San Francisco, CA).
4. Mouse IgG (Sigma).
5. Crystal/Mount<sup>®</sup> (Biomedica Corp., Foster City, CA).
6. Cytoseal 100<sup>®</sup> (Stephens Scientific, Riverdale, NJ).

### 3. Methods

#### 3.1. Sample Fixation and Dehydration, Embedding, and Sectioning

1. Place samples in Histochoice<sup>®</sup> fixative for 2–4 h, 5°C (*see Note 5*).
2. Transfer to 50% EtOH for 1 h, 5°C (*see Note 6*).
3. Transfer to 70% EtOH for 1 h, –20°C.
4. Transfer to 95% EtOH for 1 h, –20°C.
5. Transfer to 95% EtOH for 1 h, –20°C.
6. Transfer to 100% EtOH for 1 h, –20°C.
7. Store specimens in 100% EtOH, room temperature (RT) (*see Note 7*).
8. Transfer specimens to 100% amyl acetate for 1 h, RT.
9. Transfer to 100% amyl acetate for 1 h, 56°C (*see Note 8*).
10. Transfer to 50% amyl acetate/50% Paraplast X-tra<sup>®</sup> for 1 h, 56°C.
11. Transfer to 50% amyl acetate/50% Paraplast X-tra<sup>®</sup> for 1 h, 56°C.
12. Transfer to 100% Paraplast X-tra<sup>®</sup> for 1 h, 56°C.
13. Transfer to 100% Paraplast X-tra<sup>®</sup> overnight, 56°C.
14. Transfer to 100% Paraplast X-tra<sup>®</sup> for 1–2 h, 56°C.
15. Position specimen in Peel-Away<sup>®</sup> mold and allow to solidify overnight. Samples may be sectioned the following day.
16. Cut serial sections at 10 µm thickness (*see Note 9*).
17. Mount the sections by flotation in water at 42°C onto glass Superfrost Plus<sup>®</sup> slides (*see Note 10*).
18. Bake mounted sections to dryness at 45°C for 1–2 d.
19. Store slides at RT for combined ISH/IMH.

#### 3.2. Preparation of Biotinylated DNA Probes by Nick Translation

1. Thaw reagents and hold on ice (*see Note 11*).
2. Sample and quality control (QC) DNA reaction mixtures (*see Note 12*).

To a sterile 1.5 mL Eppendorf tube held on ice, add as follows.

- |         |   |
|---------|---|
| 4.0 µL  | 1 M Tris-HCl, pH 7.5  |
| 2.0 µL  | 1 M MgCl <sub>2</sub>   |
| 2.0 µL  | 20 mM dCTP  |
| 2.0 µL  | 20 mM dGTP  |
| 2.0 µL  | 20 mM dATP (to QC sample only)                                      |
| 2.0 µL  | 20 mM dTTP  |
| 1.0 µL  | 10% BSA   |
| 1.0 µL  | <u>β-Mercaptoethanol working dilution</u>                           |
| x.x µL  | Sample or QC DNA: volume to give 10 µg total ( <i>see Note 13</i> ) |
| 25.0 µL | dATP-Biotin-14, omit in QC sample ( <i>see Note 14</i> )            |
| 2.0 µL  | <sup>3</sup> H-dATP ( <i>see Note 14</i> )                          |
| 3.5 µL  | DNA Polymerase I  |
| 3.0 µL  | <u>DNase working dilution</u>                                       |
| x.x µL  | Sterile dd-H <sub>2</sub> O to bring total volume to 100 µL)        |

3. Vortex, pulse spin, and cool on ice. Avoid warming to RT.
4. Transfer to 16°C water bath, and incubate for 2 h.
5. Terminate the reaction with 5 µL 0.5 M EDTA, vortex and hold on ice.
6. Purify product: Carefully transfer the reaction mixture to a Centricon-30<sup>®</sup> Microconcentrator; add 900 µL 0.1 M EDTA; spin at 5000g. Final concentrated volume is usually between 35–50 µL.



7. Measure final volume of retentate and transfer to a 1.5-mL Eppendorf tube.
8. Take aliquots for scintillation counting: 3  $\mu\text{L}$  from the top retentate (labeled product) and 5  $\mu\text{L}$  from the bottom filtrate (unincorporated label). Dilute each with 5 mL Ecolume<sup>®</sup> (ICN) scintillation cocktail and count.
9. Calculate percent incorporation: Multiply the top and bottom counts by their respective dilution factors. Add the dilution corrected top and bottom counts to derive total counts. Divide the corrected top counts by the total counts and multiply by 100 to obtain percent incorporation (*see Note 15*).
10. Dilute labeled product with 1.5 mL 0.1 M EDTA for use in ISH. This yields a final probe of 200–500 base pairs in length, at a concentration of approximately 5–7 ng/ $\mu\text{L}$ .

### 3.3. In Situ DNA–mRNA Hybridization (*see Notes 11, 16, 17*)

#### 3.3.1. Day 1

1. Deparaffinize and rehydrate specimens: Histo-Clear<sup>®</sup>, 20 min; xylene, 20 min; 100% EtOH, 20 min; 95% EtOH, 1 min; 70% EtOH, 1 min; 50% EtOH, 1 min; 2X SSC, 1 min.
2. Denature by incubating in 0.2 N HCl, 20 min.
3. H<sub>2</sub>O wash  $\times$  3 (brief dips only).
4. Dehydrate in 70% EtOH, 2 min followed by 95% EtOH, 2 min.
5. Prehybridization: 95% formamide, 0.1X SSC, 15 min at 70°C; 0.1X SSC, ice cold, 2 min; H<sub>2</sub>O, 2 min.
6. De-hydrate: 70% EtOH, 2 min; 95% EtOH 1 min; 100% EtOH, 1 min.
7. Prepare DNA probes (*see Note 18*).
8. Denature probes by heating at 65°C for 5 min and immediately cool on ice.
9. Hybridization: Apply 120  $\mu\text{L}$  DNA probe per slide; add a siliconized coverslip (*see Note 19*); seal with Carter's Rubber Cement using a 5-cc disposable plastic syringe; place in humidified slide chamber (containing H<sub>2</sub>O) for 36 h at 37°C.

#### 3.3.2. Day 3

1. Very carefully disassemble slide assembly under H<sub>2</sub>O.
2. Remove nonspecifically bound probe with the following washes: 12.5% DI-formamide/2X SSC: 3  $\times$  3 min at 39°C; 2X SSC, 3  $\times$  2 min at 39°C. The remaining hybridization detection steps are carried out at RT.
3. Wash in blocking buffer: 2  $\times$  4 min.
4. Wash in 1X PBS: 5 min.
5. SAP labeling: Add 125  $\mu\text{L}$  SAP solution per slide. Place siliconized coverslips or Probe-On<sup>®</sup> slides on specimen slide without rubber cement; avoid trapping air bubbles. Incubate for 1 h at RT in a humidified slide chamber.
6. Remove coverslips.
7. Wash in washing buffer: 5  $\times$  5 min.
8. Wash in substrate buffer: 2  $\times$  2 min.
9. Histochemical reaction: Incubate in substrate solution for up to 48 h, to yield optimal signal to noise ratio.
10. Stop development by rinsing in 1X PBS.
11. Hold in 1X PBS for immunostaining.

### 3.4. Immunohistochemistry

1. React with primary antibodies (concentration to be optimized by investigator), 30 min (*see Note 20*).
2. PBS rinses, 3  $\times$  2 min.

3. Visualize immunolabeling by means of the Histostain-SP<sup>®</sup> kit (Zymed Laboratories), which employs biotinylated wide-spectrum secondary antibodies, a horseradish peroxidase-streptavidin conjugate and AEC substrate using the manufacturer's protocol.
4. Mount slides with Crystal/Mount<sup>®</sup> (Biomedica) and coverslip with Cytoseal 100<sup>®</sup>.

### 3.5. Microscopic Observation

Mounted specimens are best observed using either bright-field or Nomarski differential interference contrast optics and photographed in color with appropriate correction filters (e.g., Kodak Wratten 80B filter). As a general rule for color photography, using either film or digital/analog imaging devices, exposure time should be kept as constant as possible by adjusting image brightness, to ensure uniform color temperature.

## 4. Notes

1. Solutions that are underlined are to be made fresh each run.
2. All reagents are prepared in accordance with protocols in (25) and (26) where applicable, and are molecular biology grade.
3. To make DI-formamide, mix 50 mL reagent grade formamide and 5 g of mixed-bed ion exchange resin (e.g., Bio-Rad, Richmond, CA, AG501-X8, 20-50 mesh). Stir for 30 min at RT. Filter twice through Whatman #1 filter paper using a Buchner funnel. Dispense into aliquots and store at  $-20^{\circ}\text{C}$ .
4. Weigh out 47 mg NBT, suspend in 0.43 mL DMF and add 0.19 mL H<sub>2</sub>O to fully dissolve. Weigh out 23 mg BCIP and dissolve in 2.3 mL DMF. Add both to 140 mL substrate buffer. Protect from light.
5. Histochoice<sup>®</sup> fixed specimens generally appear to be more "raw" than those fixed with conventional, aldehyde-based fixatives.
6. Dehydration performed at  $5^{\circ}\text{C}$  to  $-20^{\circ}\text{C}$  vs room temperature (RT) prevented shrinkage and deformation of the specimens. For denser tissue specimens, for example, human skin or other connective tissues, isopropanol may be substituted for EtOH to reduce the degree of hardening.
7. Specimens are stable for up to 2 yr in 100% EtOH.
8. For harder specimens, times may be reduced by half to minimize hardening.
9. For Histochoice<sup>®</sup> fixed samples, add 2  $\mu\text{m}$  to normal sectioning thickness.
10. Superfrost Plus<sup>®</sup> slides are electrostatically charged to adhere sections directly without having to use an adhesive.
11. Gloves should be worn throughout to avoid introduction of RNase from contact. All pipet tips, Eppendorf tubes, etc., must be autoclaved prior to use.
12. To monitor performance of the enzymes, a clone that has been successfully nick translated previously should be run again as QC sample. The QC sample is prepared by replacing the biotin label with unlabeled dATP.
13. Routinely, 10  $\mu\text{g}$  of total DNA is processed at a time. As little as 0.5  $\mu\text{g}$  may be labeled by scaling down the reaction volume.
14. Labeled nucleotide triphosphates: The choice of which nucleotides carry the tritium and biotin labels is not critical. In the system described here, dATP carries both labels. The other dNTPs are present in excess and are not rate limiting. The biotinylated dNTP is held close to the minimum concentration needed for 100% replacement in order to conserve the biotin label. A minimum concentration of 50  $\mu\text{M}$  must be present in the incubation mixture for 10  $\mu\text{g}$  DNA. The final nucleotide concentrations are: <sup>3</sup>H-dATP, 0.8  $\mu\text{M}$ ; biotin-14-dATP, 100  $\mu\text{M}$ ; dCTP, dGTP, and dUTP, 400  $\mu\text{M}$  each.
15. Using this procedure, typical values for percent incorporation range from 15 to 25%.

16. All glassware and plasticware are cleaned by washing with soap and water, followed by rinses with 1 M KOH, 100% EtOH and Rnase-free H<sub>2</sub>O.
17. Up to 25 slides can be processed together using the slide chamber system from Tissue-Tek (Baxter).
18. Negative controls include biotinylated plasmids without inserts, and 0.1 M EDTA in place of biotinylated plasmid.
19. Probe-On® slides siliconized with Sigmacote® maybe used as coverslips to create a chamber, protecting sections mounted on standard slides.
20. Negative controls for IMH include the omission of primary antibodies, appropriate preimmune sera for polyclonal antibodies, or nonimmune mouse IgG for monoclonal primary antibodies.

### Acknowledgment

This work was supported in part by grants from the NIH (HD15822, HD29937, ES07005, DE11327, and DE12618) and the Arcadia Foundation.

### References

1. Kriegsmann, J., Keyszer, G., Geiler, T., Gay, R. E., and Gay, G. (1994) A new double labeling technique for combined *in situ* hybridization and immunohistochemical analysis. *Lab. Invest.* **71**, 911–917.
2. Hindrek, M., Lindh, A., and Sundler, F. (1993) Islet amyloid polypeptide gene expression in the endocrine pancreas of the rat: a combined *in situ* hybridization and immunocytochemical study. *Cell Tiss. Res.* **274**, 467–474.
3. Brousset, P., Butet, V., Chittal, S., Selves, J., and Delsol, G. (1992) Comparison of *in situ* hybridization using different nonisotopic probes for detection of Epstein-Barr virus in nasopharyngeal carcinoma and immunohistochemical correlation with anti-latent membrane protein antibody. *Lab. Invest.* **67**, 457–464.
4. Bugnon, C., Bahjaoui, M., and Fellmann, D. (1991) A simple method for coupling *in situ* hybridization and immunocytochemistry: application to the study of peptidergic neurons. *J. Histochem. Cytochem.* **39**, 859–862.
5. Chan-Palay, V., Yasargil, G., Hamid, Q., Polak, J. M., and Palay, S. L. (1987) Simultaneous demonstrations of neuropeptide Y gene expression and peptide storage in single neurons of the human brain. *Proc. Natl. Acad. Sci. USA* **85**, 3213–3215.
6. Hoefler, H., Childers, H., Montminy, M. R., Lechan, R. M., Goodman, R. H., and Wolf, H. J. (1986) *In situ* hybridization methods for the detection of somatostatin mRNA in tissue sections using antisense RNA probes. *Histochem. J.* **18**, 597–604.
7. Schalling, M., Hokfelt, T., Wallace, B., Goldstein, M., Filer, D., Yamin, C., and Schlesinger, D. H. (1986) Tyrosine 3-hydroxylase in rat brain and adrenal medulla: hybridization histochemistry and immunohistochemistry combined with retrograde tracing. *Proc. Natl. Acad. Sci. USA* **83**, 6208–6212.
8. Robben, H., Van Dekken, Poddighe, P. J., and Vooijs, G. P. (1994) Identification of aneuploid cells in cytological specimens by combined *in situ* hybridization and immunocytochemistry. *Cytopathol.* **5**, 384–391.
9. Coouwenhoven, R. I., Luo, W., and Snead, M. L. (1990) Co-localization of EGF transcripts and peptides by combined immunohistochemistry and *in situ* hybridization. *J. Histochem. Cytochem.* **38**, 1853–1857.
10. Watts, A. G. and Swanson, L. W. (1989) Combination of *in situ* hybridization with immunohistochemistry and retrograde tract-tracing, in *Methods in Neurosciences, Vol. 1* (Conn, P. M., ed.), Academic, San Diego, CA, pp. 127–135.

11. Van Der Loos, C. M., Volkers, H. H., Rook, R., Van Den Berg, F. M., and Houthoff, H. (1989) Simultaneous application of *in situ* DNA hybridization and immunohistochemistry on one tissue section. *Histochem. J.* **21**, 279–284.
12. Shivers, B. D., Harlan, R. E., Pfaff, D. W., and Schachter, B. S. (1986) Combination of immunocytochemistry and *in situ* hybridization in the same tissue section of rat pituitary. *J. Histochem. Cytochem.* **34**, 39–43.
13. Brahic, M., Haase, A. T., and Cash, E. (1984) Simultaneous *in situ* detection of viral RNA and antigens. *Proc. Natl. Acad. Sci. USA* **81**, 5445–5448.
14. Gendelman, H. E., Moench, T. R., Narayan, O., Griffin, D. E., and Clements, J. E. (1985) A double labeling technique for performing immunocytochemistry and *in situ* hybridization in virus infected cell cultures and tissues. *J. Virol. Meth.* **11**, 93–103.
15. Tuan, R. S., Shepley, K. J., Mulligan, M. M., Abraham, D., and Perler, F. B. (1991) Histochemical localization of gene expression in *Onchocerca volvulus*: *in situ* DNA histo hybridization and immunocytochemistry. *Mol. Biochem. Parasitol.* **49**, 191–204.
16. McDonald, S. A. and Tuan, R. S. (1989) Expression of collagen type transcripts in chick embryonic bone detected by *in situ* cDNA-mRNA hybridization. *Develop. Biol.* **133**, 221–234.
17. Oshima, O., Leboy, P. S., McDonald, S. A., Tuan, R. S., and Shapiro, I. M. (1989) Developmental expression of genes in chick growth cartilage detected by *in situ* hybridization. *Calcif. Tiss. Int.* **45**, 182–192.
18. Tuan, R. S. (1993) *In situ* hybridization analysis of gene expression in skeletal tissues. *Bone* **14**, 309–314.
19. Jakowlew, S. B., Ciment, G., Tuan, R. S., Sporn, M. B., and Roberts, A. B. (1994) Expression of transforming growth factor- $\beta$ 2 and 3 mRNAs and proteins in the developing chicken embryo. *Differentiation* **55**, 105–118.
20. Bernstein, E. F., Chen Y. Q., Tamai, K., Shepley, K. J., Resnik, K. S., Zhang, H., Tuan, R., Mauviel, A., Uitto, J. (1994) Enhanced elastin and fibrillin gene expression in chronically photodamaged skin. *J. Invest. Dermatol.* **103**, 182–186.
21. Triteraprapab, S., Richie, T. L., Tuan, R. S., Shepley, K. J., Dinman, J. D., Neubert, T. A., and Scott, A. L. (1995) Molecular cloning of a gene expressed during early embryonic development in *Onchocerca volvulus*. *Mol. Biochem. Parasitol.* **69**, 161–171.
22. Gehris, A. L., Oberlender, S. A., Shepley, K. J., Tuan, R. S., and Bennett, V. D. (1996) Fibronectin mRNA alternative splicing is temporally and spatially regulated during chondrogenesis *in vivo* and *in vitro*. *Develop. Dynam.* **206**, 219–230.
23. Barnes, G. L., Alexander, P. G., Hsu, C. W., Mariani, B. D. and Tuan, R. S. (1997) Cloning and characterization of chicken Paraxis: A regulator of paraxial mesoderm development and somite segmentation. *Develop. Biol.* **189**, 95–111.
24. Henkle-Duhrsen, K., Tuan, R. S. Wildenburg, G., Eschbach, M. L., Tawe, W., Zipfel, P., and Walter, R. D. (1997) Localization and functional analysis of the CuZn superoxide dismutases in *Onchocerca volvulus*. *Mol. Biochem. Parasitol.* **88**, 187–202.
25. Sambrook, J., Fritsch, E. F., and Maniatis, T. (1989) *Molecular Cloning: A Laboratory Manual, Second Edition*, Cold Spring Harbor Laboratory, Cold Spring Harbor, NY.
26. Ausubel, F. M., Brent, R., Kingston, R. E., Moore, D. D., Seidman, J. G., Smith, J. A., and Struhl, K. (1995) *Current Protocols in Molecular Biology*, Wiley, Seacaucus, NJ.

## Whole Mount *In Situ* Hybridization to Study Gene Expression During Mouse Development

Linda A. Lowe and Michael R. Kuehn

### 1. Introduction

Whole mount *in situ* hybridization (WMISH) is a method for detecting specific messenger ribonucleic acids (mRNAs) at their site of expression within an embryo or intact tissue fragment. Like conventional *in situ* hybridization, WMISH depends upon the availability of a complementary nucleic acid probe which can be labeled, annealed to the mRNA fixed within the tissue, and subsequently detected. Whereas the conventional approach uses radioactive probes hybridized to tissue sections, WMISH refers to hybridization to intact tissue or embryos using nonradioactive probes that are detected using standard immunohistochemical methods. For developmental biologists, WMISH offers the advantage of visualizing the domain of expression of a gene within the context of the entire embryo. In addition, WMISH can be used to study more than one gene in the same embryo, allowing spatial and temporal overlaps in expression to be clearly discerned (**Fig. 1**). Similar to conventional *in situ* hybridization, one can determine the precise cellular distribution of expression by embedding and sectioning embryos following WMISH. For these reasons WMISH has become an essential and standard tool for studying gene expression during embryonic development (e.g., *see I*).

Many WMISH protocols designed for vertebrate embryos have been published (**2–10**). In this chapter, we provide a simplified protocol for the analysis of two different genes which is applicable to mouse embryos from embryonic day (E) 6.5 to 10.5. In an effort to reduce time, requirements and overall streamline the process, we advocate the use of baskets for holding and supporting embryos (**11**). Used in conjunction with multiwell plates, baskets simplify the many solution changes that are part of this protocol thereby saving considerable time. Further, because several baskets can be manipulated simultaneously, a large scale experiment is easily done. Finally, compared to handling embryos in vials, the use of baskets dramatically reduces embryo damage and loss. An additional aspect of our protocol is the inclusion of a step for plastic embedding and sectioning embryos following WMISH. We have found that the quality of sections is far superior compared to paraffin embedded embryos.

There are four major parts to the procedure: 1. embryo dissection followed by fixation and protease treatment to make the embryo permeable to the probe, 2. generation



Fig. 1. (See color plate 5 appearing after p. 262.) An example of a two-color WMISH. The E8.5 embryo has been hybridized with a DIG-labeled probe to the *Paraxis* gene (**15**) and a fluorescein-labeled probe to the *Brachyury* gene (**16**). Color detection was done using BM Purple for *Brachyury* and BCIP for *Paraxis*. The embryo is viewed from its ventral side with anterior (rostral) towards the top. The light blue color marks the somites and the dark blue/purple marks the developing notochord in the middle of the embryo as well as marking the posterior (caudal) end.

by *in vitro* transcription of a hapten-labeled RNA probe (riboprobe), 3. incubation of the embryo with the riboprobe to allow hybridization to its complementary mRNA, 4. immunohistochemical detection of the hapten on the riboprobe. For this last step, the embryo is incubated with an antihapten antibody, which is coupled to alkaline phosphatase. Detection is done by incubating in an alkaline phosphatase substrate, which is converted to a visible colored precipitate. For analyzing two genes (two-color WMISH), a second probe is synthesized incorporating a different hapten as label. Both probes are hybridized simultaneously, and separate antibody detection steps are done in succession using different substrates that produce different colored precipitates.

## 2. Materials

Although the list is long, most solutions can be prepared in bulk and stored in aliquots. After this initial outlay of effort, very little preparation then is required to set up an experiment. Always use sterile plasticware or that designated by the manufacturer as RNase-free. The use of commercially prepared tissue culture grade solutions also is recommended (*see Note 1*).

### 2.1. Embryo Preparation

1. Dissection tools (*see Note 2*):
  - a. Dissection of uterus from animal and removal of decidua: curved shank Dumont Forceps and fine angled scissors (Fine Science Tools, Foster City, CA, 11270-20 and 14063-11).
  - b. Removal of embryo from decidua: two Dumont 5/4 MC INOX forceps with 45° angled tips (Fine Science Tools, 11253-25).
  - c. Fine dissection of yolk sac and amnion away from embryo: two Dumont #5 INOX forceps with Biologie tip (Fine Science Tools, 11252-20).
2. Baskets (*see Note 3*):
  - a. 2 mL polypropylene tube (e.g., Sarstedt, Newton, NC, 72.694.006).
  - b. 100–200  $\mu\text{m}$  nylon mesh (e.g., PGC Scientific, Gaithersburg, MD, 34-1800-04).
3. Sterile plasticware (*see Note 4*):
  - a. Sterile transfer pipets (Falcon, Los Angeles, CA, 7575).
  - b. 7 mL Sterilin “Bijou” tubes (Dynalab Corp., Rochester, NY, 2637-0007).
  - c. 24-well cell culture plates.
  - d. Organ culture dishes (Falcon 3037).
  - e. Sterile plastic pipets of various volumes.
4. Embryo dissection and wash solutions:
  - a. PBS: Phosphate-buffered saline without  $\text{CaCl}_2$  and  $\text{MgCl}_2$ .
  - b. PCM: Phosphate-buffered saline with  $\text{CaCl}_2$  and  $\text{MgCl}_2$ .
  - c. PCMF: PCM supplemented with 10% fetal calf serum.
  - d. PBT: Phosphate-buffered saline without  $\text{CaCl}_2$  and  $\text{MgCl}_2$ , supplemented with 0.1% Tween-20 (Sigma, St. Louis, MO, P 9416).
5. Solutions for fixing embryos:
  - a. Paraformaldehyde fixative (PF): 4% paraformaldehyde (Fluka, Buchs, Switzerland, 76240) in PBS; prepare by heating at 60–65°C while stirring (use magnetic stirrer/hot plate); make 200–300 mL, then aliquot 4 mL into Falcon 2063 polypropylene tubes and store at –20°C; thaw aliquot immediately before use; discard unused portion.
  - b. Paraformaldehyde/glutaraldehyde fixative (PGF): 4% paraformaldehyde, 0.025% glutaraldehyde in PBS; dilute 25% glutaraldehyde stock solution (Sigma G5882) 1:1000 into PF.

6. Solutions for dehydrating and rehydrating embryos:
  - a. 25%, 50%, 75% methanol in PBT.
  - b. 25%, 50%, 75% methanol in water.
  - c. 100% methanol.
7. Solutions for proteinasing embryos (*see Note 5*):
  - a. Proteinase K (PK) stock solution: 100  $\mu\text{g}/\text{mL}$  PK (Boehringer Mannheim, Mannheim, Germany, 1 000 144) in PBT; prepare 100 mL of concentrated stock, aliquot 10 mL per tube (e.g., Falcon or Corning, Corning, NY, 15 mL polypropylene centrifuge tube), and store at  $-20^{\circ}\text{C}$ .
  - b. PK working solution: 5, 10, or 20  $\mu\text{g}/\text{mL}$  in PBT; make up from stock solution, aliquot 1.5 mL into 1.7 mL microfuge tubes (e.g., PGC 505-111, Rnase/Dnase Free) and store at  $-20^{\circ}\text{C}$ . Thaw aliquot immediately before use; discard unused portion.

## 2.2. Riboprobe Preparation

1. T7, SP6, and/or T3 in vitro transcription kits (e.g., Epicenter Technologies, Madison, WI, AS2607, AS2606, AS2603, respectively).
2. 10X DIG RNA labeling mix (Boehringer Mannheim 1 227 073).
3. 10X fluorescein RNA labeling mix (Boehringer Mannheim 1 685 619).
4. 100% ethanol; 80% ethanol; 5 M NaCl; TE buffer (10 mM Tris-HCl, pH 8.0, 1 mM EDTA); 0.4 M EDTA; 4 M LiCl.

## 2.3. Hybridization

1. PIPES stock: make a 1 M solution of PIPES (Sigma P8655) and store in 10 mL aliquots at  $-20^{\circ}\text{C}$ .
2. 10X PE: 100 mM PIPES and 10 mM EDTA; thaw an aliquot of PIPES stock and make a 100 mL batch of 10X PE; store 10X PE at  $4^{\circ}\text{C}$ .
3. Hybridization buffer: 50% formamide (Boehringer Mannheim 1 814 320), 0.75 M NaCl, 1X PE, 100  $\mu\text{g}/\text{mL}$  tRNA (Sigma R-5636, 10 mg/mL solution), 0.1% BSA, 1% SDS, 0.1% Tween-20, in DEPC water; make fresh each time.

## 2.4. Antibody Detection

1. Solutions
  - a. 10X TBS: 8 g NaCl and 0.2 g KCl per 100 mL 0.2 M Tris-HCl, pH 7.6; store at  $4^{\circ}\text{C}$ .
  - b. TBST: 1X TBS, 0.1% Tween-20; make fresh each time.
  - c. Blocking reagent stock: prepare a 10% suspension of Boehringer Blocking Reagent (BBR) (Boehringer Mannheim 1 096 176) in 1X TBS by heating at  $70^{\circ}\text{C}$  for 30 min; aliquot 10 mL per tube and store at  $-20^{\circ}\text{C}$  (*see Note 6*); may be refrozen if an entire aliquot is not used.
  - d. Goat Serum (e.g., Sigma G 6767): heat inactivate at  $70^{\circ}\text{C}$  for 30 min; store in 10 mL aliquots at  $-20^{\circ}\text{C}$ ; may be refrozen if an entire aliquot is not used.
  - e. Blocking buffer A: TBST with 2% BBR.
  - f. Blocking buffer B: TBST with 2% BBR and 20% goat serum.
  - g. Alkaline phosphatase (AP) inactivation buffer: 100 mM glycine, pH 2.2, 0.1% Tween-20.
2. Antibodies
  - a. AP coupled antidigoxigenin (DIG) antibody, Fab fragment (Boehringer Mannheim 1 093 274).
  - b. AP coupled antiluorescein antibody, Fab fragment (Boehringer Mannheim 1 426 338).
3. AP substrates (*see Note 7*).
  - a. BM Purple AP Substrate (Boehringer Mannheim 1 442 074).
  - b. BCIP (Boehringer Mannheim 1 383 221): dilute just before use to 250  $\mu\text{g}/\text{mL}$  in 0.1 M Tris, pH 9.5, 0.05 M  $\text{MgCl}_2$ , 0.1 M NaCl, 0.1% Tween-20.



## 2.5. Embedding and Sectioning Embryos

1. Solutions
  - a. JB-4 infiltration solution (JB-4 A + C): for every 100 mL JB-4 (Polysciences, Inc., Warrington, PA, 00226) component A add 0.9 g of catalyst (JB-4 component C) and mix until in solution; after dissolved, may be stored in the dark at 4°C for at least 1 mo.
  - b. JB-4 embedding solution: mix 1 mL JB-4 A + C with 40  $\mu$ L JB-4 component B; use immediately.
  - c. Nuclear fast red solution (Vector, Burlingame, CA, H 3403).
  - d. Gel-mount mounting medium (Biomedica, Foster City, CA, M01).
2. Supplies
  - a. BEEM size 00 capsules (Polysciences Inc., 00224).
  - b. Mounting studs (Electron Microscopy Sciences, Fort Washington, PA, 70145-10).
  - c. Silanated glass slides (Digene, Beltsville, MD, 1010-1001).

## 3. Methods

The protocol is divided into four parts: 1. embryo dissection, 2. riboprobe preparation, 3. the actual WMISH, and 4. embedding and sectioning. The third part is divided into probe hybridization, antibody reaction and detection steps that are conveniently done over 3 d. The entire procedure may be carried out at room temperature unless otherwise stated. Rinse steps should be done for a few seconds, whereas washes should be done for 5 min unless otherwise stated.

### 3.1. Embryo Dissections

1. Dissect embryos in PCM (*see Note 8*). Keep dissected embryos in an organ culture dish containing PCMF, on ice (*see Note 9*).
2. After all embryos are dissected, transfer them to one or more baskets as appropriate (*see Note 3*) using a plastic transfer pipet (cut to enlarge the opening for older embryos).
3. For each basket of embryos set up 2 rows (12 successive wells) of a 24-well plate with 2 mL of the following solutions: 3 wells with PBT, 2 wells PF, 3 wells with PBT, 1 well with 25% methanol in PBT, 1 well with 50% methanol in PBT, 1 well with 75% methanol in PBT, and 1 well with 100% methanol. Keep the plate on ice (*see Note 9*).
4. Put the basket into the first PBT well to rinse the embryos, then take the basket through the next 2 PBT wells to wash the embryos twice before fixing.
5. Put the basket into the first PF well to rinse the embryos, then transfer to the second PF well and fix for the appropriate length of time (*see Note 10*).
6. Take the basket through the second set of 3 PBT wells to rinse (once) and wash (twice) the embryos after fixation.
7. Dehydrate the embryos by taking the basket through the wells with 25%, 50%, and 75% methanol in PBT (5 min in each), then into 100% methanol. Place basket in a Bijou vial with 1 mL 100% methanol. Embryos can be stored at  $-20^{\circ}\text{C}$  for at least 1 mo (*see Note 11*).

### 3.2. Riboprobe Preparation (*see Note 12*)

1. Set up a restriction enzyme reaction to linearize the plasmid DNA. Check for complete digestion, then incubate at 80°C for 20 min. Recover by ethanol precipitation. Wash the pelleted plasmid DNA with 80% ethanol. Redissolve at a concentration of 1 mg/mL in Rnase-free TE buffer.
2. Set up a labeling reaction in a total volume of 20  $\mu$ L, using 1  $\mu$ L (1  $\mu$ g) of prepared plasmid DNA (*see Note 12*), 2  $\mu$ L of 10X DIG RNA labeling mix, 2  $\mu$ L of 10X transcription buffer,

5  $\mu\text{L}$  of 100 mM DTT, 2  $\mu\text{L}$  of T7, SP6 or T3 polymerase and 8  $\mu\text{L}$  of Rnase-free water. The last four components can be obtained from a kit (e.g., Epicenter Technologies T7 transcription kit). Incubate the reaction at 37°C for 2 h, then add an additional 1  $\mu\text{L}$  of 10X DIG RNA labeling mix, 1  $\mu\text{L}$  of 10X transcription buffer, 2.5  $\mu\text{L}$  of 100 mM DTT, 1  $\mu\text{L}$  of polymerase, and 4.5  $\mu\text{L}$  of Rnase-free water. Incubate at 37°C for 1 h, then add 1.5  $\mu\text{L}$  0.4 M EDTA and 3.75  $\mu\text{L}$  4 M LiCl. Mix, then add 112.5  $\mu\text{L}$  100% ethanol and put at -20°C. Pellet labeled RNA by spinning at top speed in a microfuge. Wash the pellet with 80% ethanol and dissolve in 110  $\mu\text{L}$  Rnase-free water (at 55°C if necessary). Reprecipitate using 12.5  $\mu\text{L}$  4 M LiCl and 250  $\mu\text{L}$  100% ethanol at -20°C. Again, spin at top speed in microfuge and wash the pellet with 80% ethanol. Dissolve labeled RNA in 25  $\mu\text{L}$  Rnase-free water. Examine 1  $\mu\text{L}$  on 1% agarose gel (*see Note 13*).

3. For two color WMISH, prepare a Fluorescein-labeled probe for the second gene to be examined. Follow the steps described above except use 10X fluorescein RNA labeling mix instead of DIG.

### 3.3. WMISH Day 1: Probe Hybridization

1. For each basket of embryos to be hybridized, fill 12 successive wells of a 24-well plate with 2 mL of the following solutions: 1 well with 75% methanol in PBT, 1 well with 50% methanol in PBT, 1 well with 25% methanol in PBT, 2 wells with PBT, 1 well with PK at final concentration (*see Note 5*), 1 well with PBT, 1 well with PGF for postfixation, 2 wells with PBT, 1 well with 1:1 PBT/hybridization buffer, and 1 well with hybridization buffer.
2. Rehydrate the embryos by taking the basket through the wells with methanol in PBT (5 min in each). Rinse and then wash the embryos in PBT.
3. Put the basket into the PK well and incubate for empirically determined time (*see Note 5*).
4. Remove the basket from Proteinase K, quickly rinse in PBT and put into PGF to stop PK reaction. Postfix for 20 min then rinse and wash with PBT.
5. To prepare the embryos for hybridization, do a rinse in the PBT/hybridization buffer. Let the embryos settle before proceeding.
6. Rinse with 1 mL hybridization buffer. Again let the embryos settle before the next step.
7. Remove the basket from the final well of the 24 well plate and place into a Bijou tube with 1 mL of hybridization buffer. Cap the vial and place at 65°C to prehybridize for 1 h.
8. To the Bijou add an additional 1 mL of hybridization buffer (prewarmed to 65°C) containing 1  $\mu\text{L}$  DIG-labeled riboprobe. Immediately place at 70°C and hybridize overnight.
9. For two-color WMISH, add 1  $\mu\text{L}$  of fluorescein labeled riboprobe to the above buffer and carry out overnight hybridization with both probes simultaneously.

### 3.4. WMISH Day 2: Antibody Reaction

1. Following overnight hybridization, remove probe solution. For this, and subsequent washing steps, use a Pasteur pipet placed down between the basket and the side of the Bijou to aspirate out the buffer.
2. Rinse twice with 2 mL of hybridization buffer (prewarmed to 65°C).
3. Wash twice for 30 min each time at 55°C with 2 mL of hybridization buffer (prewarmed to 55°C).
4. Wash once for 10 min at 55°C with a 1:1 mix of hybridization buffer and TBST (prewarmed to 55°C).
5. For each basket of embryos, fill five successive wells of a 24-well plate with 2 mL of the following solutions: 3 wells with TBST, 1 well with blocking buffer A, 1 well with blocking buffer B.

6. Remove the basket from the Bijou (use forceps) and put it through the first 2 wells with TBST to rinse the embryos twice. Then place the basket in the third well with TBST to wash the embryos for 15 min.
7. Move the basket to blocking buffer A and incubate 1 h with gentle rocking.
8. Move the basket to blocking buffer B and incubate for another hour, again with gentle rocking.
9. Make a 1/2000 dilution of AP coupled anti-DIG antibody by diluting 1  $\mu$ L into 2 mL of blocking buffer B (prechilled on ice) in a Bijou vial. Transfer the basket to the Bijou, cap and incubate at 4°C overnight with gentle rocking.

### 3.5. WMISH Day 3: Detection

1. Following the overnight antibody reaction, remove the basket and transfer it to an appropriate setup for large volume washes (*see Note 14*).
2. Wash three times for 1 h each time with 100 mL TBST with gentle rocking.
3. Carefully remove embryos from the basket and transfer them to an organ culture dish using a plastic transfer pipet (cut to enlarge the opening for older embryos). Use the transfer pipet to remove any TBST that was carried over, being careful not to suck up the embryos.
4. Rinse the embryos in the plate very briefly with water and add approx 0.5 mL of undiluted BM Purple AP substrate to the plate. Incubate at room temperature (*see Note 15*).
5. Alternatively, if a lighter color is required first in a two color WMISH (*see Note 16*) incubate in BCIP diluted to 250  $\mu$ g/mL in 0.1 M Tris, pH 9.5, 0.05 M MgCl<sub>2</sub>, 0.1 M NaCl, 0.1% Tween-20.
6. Terminate the staining reaction when sufficient color has accumulated by carefully removing the AP substrate solution and adding 1 mL of PBT. Rinse, remove, and add new PBT for a total of two 5 min washes. Embryos at this point can either be prepared for embedding and sectioning, or stored at 4°C in PBT. If doing sectioning or a two-color WMISH, embryos should be photographed (*see Note 17*) prior to proceeding with the next steps.

### 3.6. Additional Steps for Two-Color WMISH

1. If it is necessary to eliminate the AP activity of the first antibody (*see Note 18*), for each basket set up 13 wells with 2 mL of the following solutions: 2 wells with AP inactivation buffer, 3 wells with PBT, 1 well with PF, 3 wells with PBT, 3 wells with TBST, 1 well with blocking buffer B. If it is not necessary to eliminate AP activity, set up 3 wells of TBST only and proceed to **step 3.6.6**.
2. Transfer the embryos back into a basket and place it into the first well with AP inactivation buffer. Incubate for 15 min then transfer to the second well for an additional 15 min incubation.
3. Rinse the embryos once then wash twice by taking the basket through the PBT wells.
4. Fix the embryos again for 20 min in PF.
5. Following fixation, rinse once and wash twice in PBT.
6. Rinse once and wash twice in TBST.
7. Place the basket in blocking buffer B, and incubate 1 h with gentle rocking.
8. Transfer the basket to a Bijou with 2 mL of a 1/2000 dilution of AP coupled antifluorescein antibody in blocking buffer B (prechilled on ice). Cap and incubate at 4°C overnight with gentle rocking.
9. Following the antibody reaction, proceed exactly as described in **Subheading 3.5**. Stain with the substrate not used in the first round.

### 3.7. Embedding and Sectioning

1. A few hours prior to infiltrating embryos prepare a resin bed in each BEEM capsule to be used (one per embryo). Mix 0.5 mL JB-4 A + C with 20  $\mu$ L JB-4 solution B and pipet into a capsule (*see Note 19*). Tightly cap and leave upright and undisturbed to allow to polymerize properly.
2. Set up 7 wells of a 24-well plate with 2 mL of the following solutions: 1 well with PBS, 1 well with 25% methanol/water, 1 well with 50% methanol/water, 1 well with 75% methanol/water, 3 wells with JB-4 A + C. Keep plate on ice.
3. Return embryos to baskets and dehydrate by taking the basket through the methanol series. Leave the basket in each well for 2 min.
4. To infiltrate, take the basket through the three wells of JB-4 A + C. Leave the basket in each well for 2–10 min depending on the size of the embryos (*see Note 20*).
5. Following the third change of JB-4 A + C, transfer embryos individually one to each prepared BEEM capsule using a plastic transfer pipet (cut to enlarge the opening for older embryos). Try to carry over only a minimal volume of JB-4 A + C. Orient the embryo in the capsule with a tungsten needle or forceps (*see Note 21 and Fig. 2*).
6. Make up 1 mL of JB-4 embedding solution and quickly add to fill the capsule to the top. Cap tightly and leave upright. Allow to polymerize undisturbed overnight.
7. Using a razor blade, cut a line up the side of the capsule and pop out the block. With the razor blade, cut away the area on either side of the embryo, leaving a small disk approx 5 mm thick with the embryo in the middle (*see Fig. 2A*). For cross sectioning the embryo, continue trimming the block as shown in **Fig. 2B** (also *see 14*). The block also can be trimmed to accommodate a sagittal or frontal sectioning strategy.
8. Make sure the pyramid shaped block is as small as possible (*see Note 22*) and that the base is completely flat. Put a drop of superglue onto the top of a mounting stud and press the base of the block to it. Cure at 50°C in a vacuum oven at least 2 h before proceeding.
9. Pipet 50  $\mu$ L water drops onto a silanated glass slide (*see Note 23*). Mount the stud with glued block into an appropriate holder on a microtome (*see Note 24*). Cut and transfer sections (10  $\mu$ m) one at a time to the slide. Pick up a section from the knife with forceps and quickly submerge into a drop to prevent curling (*see Note 25*). Allow drop to evaporate.
10. Briefly counter stain (2–5 min) with nuclear fast red and mount a cover slip using Gel/Mount.

### 4. Notes

1. To maintain an RNase-free environment, make solutions using DEPC-treated water. Reserve separate bottles of chemicals for RNA solutions (never insert anything in these bottles).
2. The utmost care should be taken with dissection tools, especially with fine forceps like Dumont INOX #5 Biologie. Be careful never to touch the tips of these forceps to anything but the embryos, as they are easily bent or dulled.
3. Baskets are tubes which have had their conical bottoms removed and a nylon mesh affixed. Embryos placed in a basket are supported by the mesh. To make a basket, take a 2-mL polypropylene tube and cleanly cut off the bottom with a razor blade. Put a small piece of aluminum foil on a hot plate. Cut a small square of mesh (any 100–200  $\mu$ m nylon mesh will do). Adjust the temperature of the hot plate so that nylon mesh melts but polypropylene does not. Put the mesh on the aluminum foil. Press the bottom of the cut tube to it until the mesh melts and is fused onto the bottom rim of the tube, then remove. The foil will detach as soon as the tube is cool. Ten to fifteen embryos may be placed in each basket depending on size. If they are grouped at the outset according to which probe (or antibody) they will receive, they can be kept in the same basket from the dissection steps to the detection steps.

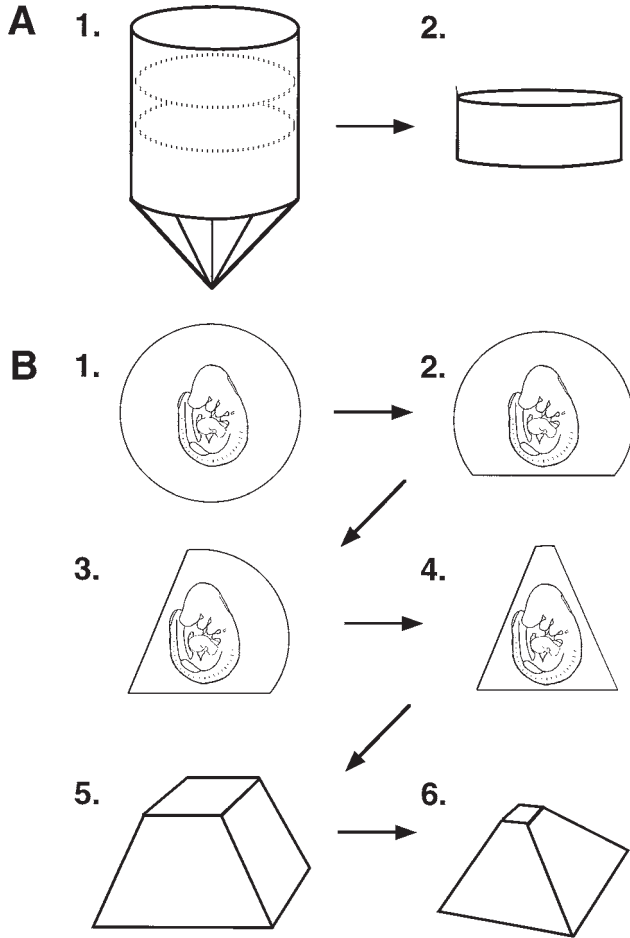

Fig. 2. Preparing and trimming blocks for sectioning plastic embedded embryos. The BEEM capsule is shown in A.1. The embryo should be in the region between the dotted circles. This region is cut out using a razor blade and is shown in A. 2. and B. 1. This disk subsequently is trimmed as shown in B.2., B.3. and B.4. A three-dimensional view of the block, as trimmed up to the point shown in B.4., is shown in B.5. Final trimming results in a pyramid-shaped block as shown in B.6. This is then superglued to a mounting stud.

4. Use sterile disposable plasticware whenever possible. Sterile transfer pipets are especially good for picking up embryos and depositing them in baskets. Bijou tubes are the perfect size to hold baskets when a sealed chamber is required. Baskets fit easily in the wells of 24-well plates along with the 2 mL liquid volumes that are used for all steps. Solution changes are done easily by moving the basket from well to well of a 24-well plate.
5. Correct PK treatment of embryos is critical for a successful WMISH. If the concentration of PK is too low or the incubation time too short, the reagents cannot penetrate and the result will be a weak or undetectable signal. Conversely, too high of a concentration or too long of an incubation will result in high background and perhaps even damage to the embryos. Therefore, each batch of PK must be tested to find the optimal concentration and incubation time for differently staged embryos. As a guide, we suggest making up a 100  $\mu\text{g}/\text{mL}$  PK stock and test dilutions of 5, 10, and 20  $\mu\text{g}/\text{mL}$ . Treat test embryos

(use several at each stage) for 5, 10, or 15 min with each of these concentrations. Carry out the WMISH procedure using a control riboprobe, such as one for a well-studied embryonically expressed gene. Once the optimal PK concentration is determined, a large batch can be made and stored in 1.5 mL aliquots at  $-20^{\circ}\text{C}$ . Post-PK fixation with paraformaldehyde and glutaraldehyde stops PK, so get embryos into fix quickly.

6. The BBR stock suspension is very difficult to work with. It may be necessary to enlarge the opening of a transfer pipet and use that to aliquot the suspension. Alternatively, it may be poured.
7. Other AP substrates are available. Below is a list of ones we have tried and the results we have obtained.
  - a. NBT/BCIP: Same basic components as BM Purple, but different ratios can give a more blue/black color.
  - b. INT/BCIP: Supposed to give a brick red color. Did not work in our hands; extensive orange background.
  - c. Magenta Phos, with and without tetrazolium red: Shows little or no background, but takes very long to fully develop and is not very intense. The color is too similar to BM Purple for them to be used together in a two-color WMISH. It may be possible to use it with some NBT/BCIP formulations.
  - d. Fast Red: Although there was extensive orange background, the region specifically probed for was considerably more intense. With some optimization, this one has promise!
  - e. Vector Red: Did not work in our hands; extensive orange background.
  - f. Any of the above with levamisole: Should reduce endogenous AP activity, but we have found little or no effect when used with the above substrates.
8. It is beyond the scope of this chapter to provide the reader a detailed description of dissection techniques for early mouse embryos. The reader is directed to other sources including ones in this volume ([4](#), [12](#), [13](#)). However, it should be stressed that a good dissection is paramount to the overall quality of the WMISH. This is best accomplished with practice and the use of good tools that are reserved only for embryo dissection. Keep in mind the following points when dissecting embryos for a WMISH experiment. For E 6.5–7.5 embryos, remove the ectoplacental region and Reichert's membrane. Puncture the amnion with either a fine tungsten needle or the fine forceps. This step is required to prevent the trapping of WMISH reagents in the amniotic cavity. For E 7.5–8.5 embryos, remove as much of the extra-embryonic membranes (yolk sac and amnion) as possible. The fine forceps can be used like scissors to trim away the membranes from the embryo: hold the yolk sac with one forceps, while using the other to pinch the membrane close to the embryo; release, and repeat the pinch farther along the membrane until it separates fully from the embryo. Embryos at E 9.5 and E 10.5 will need to have the brain and neural tube punctured in a few places also, to prevent trapping of reagents; again use forceps or a needle.
9. A convenient way to keep solutions within plates cold is to place the plate on the back surface of a metal block (e.g., one from a Thermolyne Dri-bath incubator) which is embedded in ice in a bucket.
10. Fixation time requirements differ for embryos at different stages. We routinely fix 1 h for 7.5 dpc embryos, 1.5 h for 8.5 dpc embryos, 2 h for 9.5 dpc embryos; on ice.
11. Dehydrated embryos are stored in the baskets in Bijou tubes. Puncture the basket cap with a syringe needle, otherwise the air pressure may prevent the MeOH from entering the basket through the mesh bottom. Store the Bijou tubes securely in an upright position. Be careful where you label the basket. The ink from Sharpie pens is methanol soluble and will stain the embryos blue/black!
12. The riboprobe is synthesized using as template, a plasmid (e.g., Bluescript) in which a cDNA insert is flanked by T3, T7, or SP6 RNA polymerase promoter sites. When prepar-

ing plasmid DNA, it is essential to eliminate all RNase treatment steps. Using an appropriate restriction enzyme, the plasmid is linearized at least 750 bp distal to the promoter of the polymerase to be used for in vitro transcription. For an antisense probe (to detect gene activity) transcribe with the polymerase whose promoter is at the 3' end of the cDNA. Make a sense probe to use as a control. Too much DNA in the in vitro transcription may cause a problem later in the hybridization. Therefore, it is important to determine the concentration of plasmid DNA and add the correct amount into the labeling reaction.

13. The in vitro reaction should yield at least 10  $\mu\text{g}$  of RNA for every 1  $\mu\text{g}$  of input template. Initially, it is a good idea to determine the concentration of an aliquot by measuring the optical density (remember to subtract the DNA template contribution) as well as looking at it on an agarose gel. For subsequent reactions, it may be sufficient to estimate the concentration just by looking at an aliquot on a gel. Run the gel at fairly high voltage for only a short time. Otherwise, the RNA will diffuse too much to get a good idea of its condition and amount. It should be readily visible and will probably appear as a smear. An average size of approximately 500 b is optimal.
14. Postantibody washes are done with very large volume exchanges of buffer. This can be done in a small basin, such as the lid of a pipet tip rack. The baskets can be suspended over the basin using a rack made out of styrofoam into which appropriately sized holes have been punched. The holes should be just big enough so that the baskets are held tightly. Push the baskets into the holes so that the bottoms are below the liquid level in the basin.
15. The speed of the BM Purple coloring reaction can be increased by incubating at 37°C, but watch closely to avoid background. Also, keep coloring reaction out of direct light.
16. For most two-color WMISH experiments the gene that is expressed at a lower level should be detected first, using BM Purple. It does not seem to matter whether the probe is DIG labeled or fluorescein labeled. For detecting the more strongly expressed gene in the second round we use BCIP. The greenish-blue BCIP precipitate provides a good contrast to the purple (*see Fig. 1*), but it takes longer to develop and gives a weaker signal than BM purple. Unless it is inactivated, the AP coupled to the antibody used in the first round will react with the AP substrate used in the second round. This additional color is not noticeable if the substrate used in the first reaction produces a darker color. Therefore, if the expression of the two genes under study does not overlap, detect the weaker gene first using BM purple and then detect the stronger gene using BCIP. If the expression of the two genes does overlap, use BCIP first. After photography, carry out the second detection using BM purple.
17. When photographing embryos following WMISH, it is helpful to make a bed of agarose in a plate and carve a trough with forceps. Embryos can be easily positioned within the trough for photography. Keep in mind that different sources of light will highlight different features. We have found that the best way to capture the color is to use an illuminator (e.g., Fostec model EKE-I) with a 2 inch by 2 inch fiber-optic panel. Much of the morphology of the embryo is lost with this lighting, however. For the best morphology, a microscope base with mirror reflected light, or dark field works well, although, color may be difficult to detect. A way to see some of the morphology, as well as some color, is to place a white background under the specimen and position flexible fiber-optic gooseneck lamps so that light hits the specimen directly from the sides.
18. In some cases it may be desirable to inactivate the AP from the first round. We provide a method for acid glycine treatment. An alternative is to incubate embryos in TBST for 30 min at 65°C. Whereas glycine seems a bit more efficient than heat treatment, it may lead also to a decrease in the intensity of the second color.

19. The BEEM capsules are prefilled halfway up so that the embryo will be embedded in the cylindrical area of the block well away from the conical bottom. Otherwise, it is difficult subsequently to trim the block correctly.
20. Be sure to do these infiltration step for the minimum amount of time. The color precipitate is soluble in the JB4 solution and will be lost with time.
21. E 9.5 embryos, and E 8.5 embryos that are curled, will naturally lie on their sides as shown schematically in **Fig. 2**. This position is fine; just make sure the embryo is in the middle away from the sides of the capsule.
22. The smaller the block, the smaller the section and the smaller the likelihood that the section will cause problems when transferred to the slide. If the base is not flat, it may not glue well to the mounting stud.
23. Silanated slides are used for two reasons: the water drops bead up and the sections stick well to the surface after the water drops evaporate. Two rows of four to five drops can be set up per slide.
24. We use a rocking arm microtome set up to accommodate triangular glass knives. Glass knives are inexpensive, disposable, and easy to make (**14**). They work very well with softer plastics such as JB-4.
25. Hold the section under the surface of the drop of water for a few seconds, then let go. The section may continue to stick to the forceps; if so wait a few seconds and the section should float away. This part of the technique requires practice and patience. If the block is small enough, 2–3 sections can be put into each drop.

## Acknowledgments

The authors would like to thank the following colleagues for invaluable advice during the development of this protocol: David Ish-Horowicz, Lidia Kos, Vlado Knezevic, Mike Levin, Susan Mackem, Kathleen Mahon, and Malcolm Moos.

## References

1. Lowe, L. A., Supp, D. M., Sampath, K., Yokoyama, T., Wright, C. V., Potter, S. S., Overbeek, P., and Kuehn, M. R. (1996) Conserved left-right asymmetry of nodal expression and alterations in murine situs inversus. *Nature* **381**, 158–161.
2. Hemmati-Brivanlou, A., Frank, D., Bolce, M. E., Brown, B. D., Sive, H. L., and Harland, R. M. (1990) Localization of specific mRNAs in *Xenopus* embryos by whole-mount *in situ* hybridization. *Development* **110**, 325–330.
3. Conlon, R. A. and Herrmann, B. G. (1993) Detection of messenger RNA by *in situ* hybridization to postimplantation embryo whole mounts, in *Methods in Enzymology, vol. 225, Guide to Techniques in Mouse Development* (Wassarman, P. M. and DePamphilis, M. L., eds.), Academic, San Diego, CA, pp. 373–383.
4. Hogan, B., Beddington, R., Costantini, F., and Lacy, E. (1994) *Manipulating the Mouse Embryo. A Laboratory Manual*, 2nd ed., Cold Spring Harbor Laboratory, Plainview, NY.
5. Jowett, T. and Lettice, L. (1994) Whole-mount *in situ* hybridizations on zebrafish embryos using a mixture of digoxigenin- and fluorescein-labelled probes. *Trends Genet.* **10**, 73–74.
6. Henrique, D., Adam, J., Myat, A., Chitnis, A., Lewis, J., and Ish-Horowicz, D. (1995) Expression of a Delta homologue in prospective neurons in the chick. *Nature* **375**, 787–790.
7. Nieto, M. A., Patel, K., and Wilkinson, D. G. (1996) *In situ* hybridization analysis of chick embryos in whole mount and tissue sections. *Methods Cell Biol.* **51**, 219–235.
8. Conlon, R. A. (1997) Whole mount *in situ* hybridization to embryos and embryonic tissues, in *Methods in Molecular Biology, vol. 63, Recombinant Protein Protocols: Detection and Isolation* (Tuan, R. S., ed.), Humana Press, Totowa, NJ, pp. 257–262.



9. Hsu, C. W. and Tuan, R. S. (1997) Whole-mount *in situ* hybridization for developing chick embryos using digoxigenin-labeled RNA probes, in *Methods in Molecular Biology*, vol. 63, *Recombinant Protein Protocols: Detection and Isolation* (Tuan, R. S., ed.), Humana Press, Totowa, NJ, pp. 263–270.
10. Stern, C. D. (1998) Detection of multiple gene products simultaneously by *in situ* hybridization and immunohistochemistry in whole mounts of avian embryos. *Curr. Top. Dev. Biol.* **36**, 223–243.
11. Stachel, S. E., Grunwald, D. J., and Myers, P. Z. (1993) Lithium perturbation and gooseoid expression identify a dorsal specification pathway in the pregastrula zebrafish. *Development* **117**, 1261–1274.
12. Cockroft, D. L. (1990) Dissection and culture of postimplantation embryos, in *Postimplantation Mammalian Embryos—A Practical Approach*, (Copp, A. J. and Cockroft, D. L., eds.), IRL, Oxford, UK, pp. 15–39.
13. Sturm, K. and Tam, P. P. L. (1993) Isolation and culture of whole postimplantation embryos and germ layer derivatives, in *Methods in Enzymology*, vol. 225, *Guide to Techniques in Mouse Development* (Wassarman, P. M. and DePamphilis, M. L., eds.), Academic, San Diego, CA, pp. 164–190.
14. Martins-Green, M. M. (1990) Transmission electron microscopy and immunolabelling for light and electron microscopy, in *Postimplantation Mammalian Embryos—A Practical Approach*, (Copp, A. J. and Cockroft, D. L., eds.), IRL, Oxford, UK, pp. 127–154.
15. Burgess, R., Cserjesi, P., Ligon, K. L., and Olson, E. N. (1995) Paraxis: a basic helix-loop-helix protein expressed in paraxial mesoderm and developing somites. *Dev. Biol.* **168**, 296–306.
16. Herrmann, B. G. and Kispert, A. (1994) The T genes in embryogenesis. *Trends Genet.* **10**, 280–286.

## Multicolor Whole-Mount *In Situ* Hybridization

Giselbert Hauptmann and Thomas Gerster

### 1. Introduction

*In situ* hybridization is a procedure that allows the detection of the site(s) of transcription of a given gene at a cellular level within an entire organism. Since its introduction into developmental biology (1), this procedure has become an indispensable tool to investigate gene expression; initial protocols employed tritiated probes. These procedures required very long exposure times and allowed the detection of transcripts only on tissue sections. The method was drastically improved by the use of nonradioactive digoxigenin-labeled probes. This allowed the detection of gene transcription also in whole-mounted *Drosophila* embryos (2). This enhanced technique allowed to obtain results within a few days instead of weeks. The *Drosophila* protocol was quickly adapted to embryos of vertebrate model organisms that are widely used in developmental biology like *Xenopus* (3), zebrafish (4) and mice (5).

The use of whole-mounts is very helpful to provide a three-dimensional overview of an expression pattern and makes it less likely that small expression domains are overlooked. During the investigation of the expression of a given gene one often wants to relate the position of its expression domains to those of well-characterized marker genes. If suitable antibodies exist, this can be done by a combination of *in situ* hybridization with immunostaining. However, such antibodies are often not available, or the antigen is irreversibly denatured during the preceding *in situ* hybridization procedure. As a substitute for the use of antibodies, we have, therefore, combined the use of digoxigenin-substituted probes together with fluorescein-labeled RNA probes. We then individually detect the position of either probe using different color substrates (6). In this procedure, both probes are first hybridized simultaneously to an embryo or a piece of tissue. The two probes are then detected consecutively. The sample is first incubated and stained with an alkaline phosphatase-conjugated antibody specific for one of the haptens. To specifically detect the second probe by another antibody (which is also conjugated to alkaline phosphatase), it is necessary to strip the first antibody from the sample. If this is not done, then the still bound first antibody conjugate would produce a color precipitate also with the second substrate combination. Therefore, the first antibody is removed by a short incubation at low pH, which does not harm the overall integrity of the sample. Recently, the availability of biotin as a third label for

RNA probes led us to test whether we could expand our two-color *in situ* hybridization protocol to the use of a third color. In fact, we found that this works nicely in *Drosophila* embryos (7). However, we had no success with the use of biotinylated probes in zebrafish embryos. This appears to be due to a high level of endogenous biotin. Nevertheless, the procedure described here is not strictly limited to the detection of the activity of three genes by hybridization of three different RNA probes. The use of different color substrates discussed in **ref. 7** makes it possible to detect the expression of two genes at the *in situ* hybridization level using digoxigenin and fluorescein probes and combine this with immunohistochemistry using an antibody specific for the product of a third gene which is visualized by a secondary antibody conjugated to alkaline phosphatase.

## 2. Materials

1. Buffers: PBS: 8 g/L NaCl, 0.2 g/L KCl, 16 mM Na<sub>2</sub>HPO<sub>4</sub>, 4 mM NaH<sub>2</sub>PO<sub>4</sub>; final pH should be 7.3. Buffer can be prepared from a 10X stock.  
PBSTw: PBS containing 0.1% Tween-20 (Boehringer Mannheim, Mannheim, Germany).  
20X SSC: 3 M NaCl, 300 mM trisodium citrate. 2X SSCTw and 0.2X SSCTw contain the corresponding SSC strength together with 0.1% Tween-20.
2. Fixative: 4 g paraformaldehyde (BDH Laboratory Supplies, London, UK) are suspended in 100 mL PBS and stirred in a fume hood at about 60°C until everything is dissolved (about 1 h). The solution is cooled, 4 µL 2 N NaOH are added, mixed again, and the fixative is dispensed into aliquots and stored at -20°C. **Caution:** All solutions containing formaldehyde should be handled in fume hoods wearing gloves. Formaldehyde waste should be inactivated in concentrated aqueous NaHSO<sub>3</sub> solution.
3. Rehydration solutions: Mixtures of 75%, 50%, 25% (v/v), respectively, of methanol in PBSTw.
4. Embryo permeabilization: Proteinase K (Boehringer Mannheim) is dissolved at 20 mg/mL in TE (10 mM Tris-HCl pH 8.0, 1 mM EDTA) and stored at -20°C in 10 µL aliquots. Aliquots are not refrozen. Glycine is dissolved at 100 mg/mL in double-distilled H<sub>2</sub>O and stored in aliquots at -20°C. Used aliquots can be refrozen. Proteinase K and glycine are diluted in PBSTw just prior to use.
5. Reagents for RNA probe synthesis: NTP mix: ATP, CTP, GTP 15.4 mM each, UTP 10.0 mM. This mix can be made up from commercially available 100 mM stocks (e.g., from Boehringer Mannheim). Aliquots are stored at -20°C.  
Digoxigenin-11-UTP, fluorescein-12-UTP and biotin-16-UTP are purchased as 10 mM solutions from Boehringer Mannheim.  
5X transcription buffer (Promega, Madison, WI): 200 mM Tris-HCl pH 7.9, 30 mM MgCl<sub>2</sub>, 10 mM spermidine, 50 mM NaCl.  
Source of enzymes: RNasin (Promega); T7 RNA polymerase, T3 RNA polymerase or SP6 RNA polymerase are from Boehringer Mannheim, Promega, or Fermentas; RNase-free DNaseI is from Promega.
6. Materials for probe purification: TNE: 100 mM NaCl, 20 mM Tris-HCl pH 7.5, 10 mM EDTA. NucTrap<sup>®</sup> push columns are obtained from Stratagene, La Jolla, CA.
7. Hb4 Hybridization buffer: 50% formamide, 5X SSC, 50 µg/mL heparin sodium salt (Fluka), 0.1% Tween-20, 5 mg/mL torula RNA (Sigma, St. Louis, MO), pH 6.7 @ 25°C. The buffer is stored at -20°. Heparin can be stored frozen as a 50 mg/mL stock in double-distilled H<sub>2</sub>O. The formamide has to be of analytical or molecular biology grade.

8. Serum and antibodies: Sheep serum (Sigma) for blocking of embryos is heat inactivated at 56°C for 30 min and stored in aliquots at -20°C. The alkaline-phosphatase-conjugated polyclonal F<sub>ab</sub> fragments (Boehringer Mannheim) directed against digoxigenin, fluorescein or biotin have to be preabsorbed with unhybridized embryos in order to reduce background. The stages used for preabsorption should include about the same stages than the ones that will be used for *in situ* hybridization. For preabsorption zebrafish embryos are fixed overnight in 4% paraformaldehyde at 4°C without dechorionization. Embryos are washed four times for 5 min in PBSTw and stored in methanol at -20°C. 1 mL of embryos of the appropriate stages are rehydrated by rinsing three times for 5 min in PBSTw. The embryos are homogenized with a pestle in a 2-mL Eppendorf tube and the volume is adjusted to about 1.0 mL PBSTw. 10 µL of the appropriate antibody is added and is preabsorbed by shaking at least overnight at 4°C. Embryonic debris is spun down and the supernatant passed through a sterile filter (Millex-GV 0.22 µm, Millipore, Bedford, MA). The embryonic debris is washed with PBSTw and this supernatant is sterile filtered as well. The combined filtrates are filled up with PBSTw to 20 mL yielding a final antibody dilution of 1:2000. An antibody preabsorbed with zebrafish embryos works also well for the staining of *Drosophila* embryos. If one chooses *Drosophila* embryos for preabsorption then they are fixed and stored just like those used for *in situ* hybridization and they can be used analogously to the procedure described above for zebrafish embryos. The antibody conjugates are stable for at least half a year at 4°C if bacterial contamination is avoided.
9. Staining solutions: In this protocol, we present the use of the following substrates: Fast Blue B/NAMP, Fast Red TR, NBT/BCIP. The use of additional substrates is discussed in **ref. 7**. In general, all staining buffers should be prepared fresh since MgCl<sub>2</sub> will precipitate as Mg(OH)<sub>2</sub> at alkaline pH. Levamisol for the staining solutions can be stored at -20°C as a 1 M stock (made up in H<sub>2</sub>O) and should always be handled with gloves.

For the Fast Blue staining stock solutions of 50 mg/mL Fast Blue B (Sigma; dimethylformamide) and 50 mg/mL naphthol-AS-MX-phosphate (NAMP) (Sigma; in dimethylsulfoxide) are prepared. These stocks are stored at -20°C. The staining solution is prepared just prior to use. It contains 100 mM Tris pH 8.2, 100 mM NaCl, 50 mM MgCl<sub>2</sub>, 0.1% Tween-20, 1 mg/mL Fast Blue B, 0.5 mg/mL NAMP.

For the Fast Red stain, we use either of two different formulations of the substrates. We either use the corresponding tablet set from Sigma in which a buffer and a substrate tablet are dissolved consecutively in 1 mL H<sub>2</sub>O yielding final concentrations of 1 mg/mL Fast Red TR and 0.4 mg/mL NAMP. Alternatively, we frequently use also the "Red" tablets from Boehringer Mannheim's Multicolor Detection Set. In this case, however, we deviate in two points from the procedure recommended by the manufacturer. The staining buffer (SB8.2) consists of 100 mM Tris pH 8.2 (instead of pH 9.5), 100 mM NaCl, 50 mM MgCl<sub>2</sub>, 0.1% Tween-20.

Furthermore, we dissolve one tablet in 4 mL of SB8.2 instead of 10 mL, resulting in final concentrations of 250 µg/mL Fast Red TR and 500 µg/mL naphthol-phosphate, respectively.

The two stock solution for the NBT/BCIP color substrates contain 75 mg/mL nitro-blue-tetrazolium chloride (NBT, Boehringer Mannheim) (in 70% dimethylformamide/H<sub>2</sub>O) or 50 mg/mL 5-bromo-4-chloro-3-indolyl-phosphate (BCIP, Boehringer Mannheim) (in dimethylformamide), respectively. The stock solutions are stored at -20°. Just prior to use 4.5 µL NBT and 3.5 µL BCIP are added per 1 mL of staining buffer (100 mM Tris-HCl pH 9.5, 100 mM NaCl, 50 mM MgCl<sub>2</sub>, 0.1% Tween-20, 1 mM levamisol). This yields final concentrations of 337.5 µg/mL or 337.5 µg/mL, respectively.

### 3. Methods

1. Fixation and storage of embryos: The following procedure is used in our laboratory for zebrafish embryos. It should be readily adaptable to any other vertebrate embryos: To avoid that the fixed embryos will have curved tails, it is necessary to remove prior to fixation the chorions from embryos older than 20 h (20 somites) by the use of watchmaker forceps or by a short treatment with pronase (Sigma). Younger embryos can be fixed in their chorions as it is much easier this way to remove the chorion without damaging the embryo. The embryos are fixed at 4°C in small Petri dishes over night (or longer) in 4% paraformaldehyde. The fixed embryos are washed four times for about 5 min with PBSTw (see **Note 1**). One hundred percent methanol is then added and replaced after 5 min with fresh methanol. The embryos should be chilled to -20°C for at least 30 min for permeabilization (see **Note 2**). *Drosophila* embryos are collected according to the procedure by Tautz and Pfeifle (2). In brief, embryos are collected in a nylon mesh vial and rinsed with 0.7% NaCl, 0.03% Triton X-100. They are then dechorionated in 3% Clorox for 3 min and rinsed again. The embryos are fixed on a rotator for 20 min in a two-phase mixture of heptane: 10% formaldehyde/PBS (1:1). The aqueous phase is removed and the embryos devitellinized in heptane:methanol (1:1). After 2–3 rinses in methanol the embryos can be stored in methanol at -20°C.
2. Proteinase digestion and postfixation: To enhance the accessibility of the probe to its target RNA the embryos have to be gently digested with a limited amount of proteinase. The methanol treated embryos are rehydrated at room temperature by incubation of about 5 min each in 75%, 50%, and 25% methanol in PBSTw. The embryos are then washed twice for 5 min with PBSTw.

Zebrafish embryos are digested with proteinase K (10 µg/mL) for 1 to 20 min depending on their stage (1 cell to 50% epiboly: 1 min; 60% epiboly to 10 somites: 2–3 min; 10–20 somites: 3–4 min; 24–32 h: 5–6 min; 40–50 h: 10–20 min).

Rehydrated *Drosophila* embryos are prefixed for 10 min in 4% paraformaldehyde in PBS and washed four times 5 min in PBSTw. They are then digested with proteinase K (50 µg/mL) for 3 min at room temperature. The digestion time and the protease concentration may, however, need to be optimized depending on the circumstances.

The proteinase K digestion of all embryos is stopped by two short rinses in 2 mg/mL glycine. Embryos are refixed at room temperature in 4% paraformaldehyde for 20 min. After four washes for 5 min in PBSTw, the embryos are taken up in Hb4. Large batches of embryos can be processed up to this stage and while some of them can be used directly for prehybridization, the rest can be stored, e.g., in 2 mL Eppendorf tubes at -20°C for at least several months.

3. Preparation of RNA probes: The template plasmid should be of reasonable purity (e.g., suitable for sequencing). The template is first linearized with the appropriate restriction enzyme. The DNA is then phenol extracted and precipitated with ethanol. Care should be taken to work under RNase-free conditions. The in vitro transcription reaction is set up as follows: 1 µg linearized template is taken up in the appropriate amount of DEPC-treated H<sub>2</sub>O to give a final reaction volume of 20 µL. To the DNA are then added: 2 µL 100 mM DTT, 1.3 µL NTP mix, 0.7 µL digoxigenin-11-UTP or fluorescein-12-UTP or biotin-16-UTP. The components are mixed and briefly centrifuged before the addition of 4 µL 5X transcription buffer, 20 U RNasin and 20–40 U of the appropriate RNA polymerase that will produce an antisense probe transcript. After mixing and a brief centrifugation the reaction is incubated for 2–3 h at 37°C (see **Note 3**).

After the incubation 2 U RNase-free DNase are added (care should be taken to mix the reaction well). The template is digested for 15–30 min at 37°C. Then 45 µL DEPC-treated

H<sub>2</sub>O is added and the mixture is purified over a NucTrap<sup>®</sup> push column as follows. The push column is hydrated by pushing through 70  $\mu$ L TNE. Then the probe mixture is loaded on the column and pushed through, followed by a wash of another 70  $\mu$ L TNE (*see Note 4*). This usually yields a volume of purified probe of about 110  $\mu$ L. The eluate is precipitated with 55  $\mu$ L 7.8 M NH<sub>4</sub>Ac and 0.5 mL ethanol for 30 min at room temperature. The probe is spun down in a microcentrifuge and the pellet is briefly washed with 80% ethanol and air dried. Then it is redissolved in 25  $\mu$ L DEPC-treated H<sub>2</sub>O. A 1  $\mu$ L aliquot may be checked by gel electrophoresis. The probe is stored at  $-20^{\circ}\text{C}$  after the addition of 75  $\mu$ L Hb4 (*see Note 5*).

4. Hybridization: The hybridization steps are performed in a water bath. If possible, there should be the possibility to shake the samples in order to ensure equal contacts between all embryos and the probe(s). The hybridization temperature should be at least  $55^{\circ}\text{C}$  (*see Note 6*). The permeabilized embryos are transferred into 2 mL microcentrifuge tubes with a round bottom (Eppendorf) and prehybridized with 350  $\mu$ L Hb4 for at least 1 h. Towards the end of prehybridization the probe(s) (*see Note 7*) are diluted to the appropriate concentrations in 100  $\mu$ L Hb4 and denatured at  $80^{\circ}\text{C}$  for 5–10 min, chilled on ice/ethanol, spun down and kept briefly on ice/ethanol until use. The prehybridization solution is then replaced with the probe mix and the samples are hybridized overnight.
5. Removal of excess probe: Aspirate the probe and save it (usually it can be reused two or three times). Wash embryos twice for 30 min (or four times for 15 min) in 50% formamide/2X SSCTw at the hybridization temperature. Then wash once for 15 min in 2X SSCTw and twice for 30 min (or four times for 15 min) in 0.2X SSCTw (*see Note 8*). The embryos are then blocked at room temperature for 1–8 h with PBSTw containing 5% heat inactivated sheep serum.
6. Antibody incubation: The hybridized embryos are then incubated with the corresponding preabsorbed alkaline phosphatase-conjugated F<sub>ab</sub> fragment at a 1:2000 dilution in PBSTw (*see Note 9*). The antibody incubation is carried out on a rocking platform for a few hours at room temperature or over night at  $4^{\circ}\text{C}$ . After the incubation the antibodies are aspirated and saved. They can be reused several times and their performance often improves as the signal-to-noise ratio is increased because of this repeated preabsorption of the antibodies to the hybridized embryos. The embryos are transferred from the 2 mL tubes to small Petri dishes. If many samples are processed at the same time, it is helpful to put the embryos into 6 well plates. This allows to keep a better overview over all samples and reduces the risk that the content of the small dishes is spilled accidentally. The embryos are washed six times for at least 20 min with PBSTw (one of the washes can also be overnight at  $4^{\circ}\text{C}$ ).
7. Detection: The choice of color substrates depends strongly on individual requirements as discussed extensively in **ref. 7**. In the following, we propose as an example (**Fig. 1A**), the use of one of many different possibilities (*see Note 10*). The embryos are equilibrated twice with the staining buffer for Fast Blue/NAMP (without substrates). The complete staining solution is then added to the embryos (*see Note 11*). As many substrates are sensitive to light the stainings should be kept in the dark for as much time as possible. The staining can be carried out in principle for up to 24 h. It should, however, be closely monitored in order to avoid the accumulation of background staining. The accumulation of excessive background can sometimes be reduced by exchanging the staining solution after a certain time and addition of new stainings solution containing freshly diluted substrates. Once the desired staining intensity is reached, the staining is stopped by several washes with PBSTw. The embryos can be stored for a few days at  $4^{\circ}\text{C}$  until they are processed further.

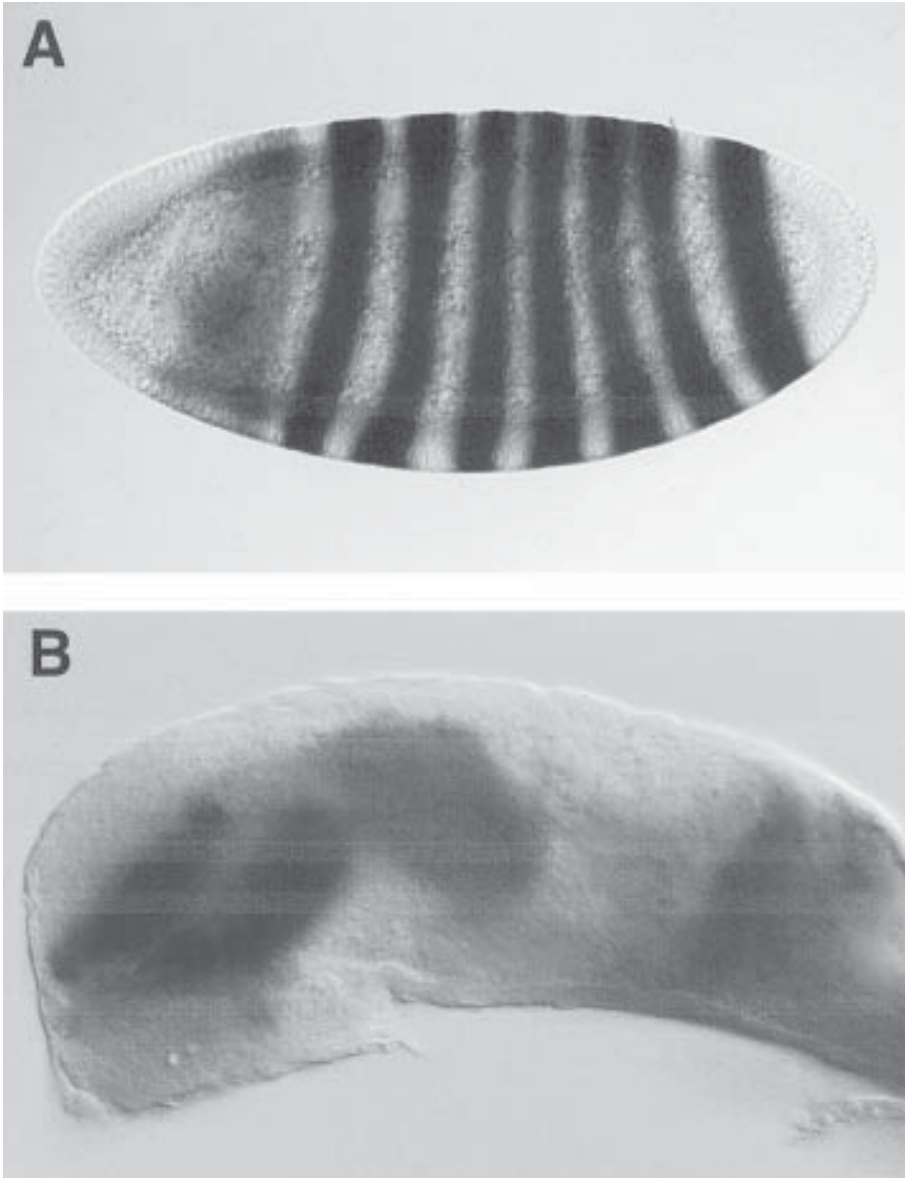

Fig. 1. (See color plate 6 appearing after p. 262.) (A) Blastoderm stage *Drosophila* embryo stained first in blue for expression of *sloppy-paired* (9) (fluorescein probe detected with Fast Blue B/NAMP), then in red for expression of *empty spiracles* (10) (biotin probe detected with Fast Red TR) and finally in purple for *fushi tarazu* (11) transcripts (digoxigenin probe detected with NBT/BCIP). (B) Whole-mount (yolk and eyes removed) of the head of a 27-hpf zebrafish embryo stained by a combination of *in situ* hybridization and immunostaining. Expression of *pax-6* (12,13) in the forebrain was detected first in red (fluorescein probe detected with Fast Red TR). Expression of *dlx-2* (14) which overlaps in the anterior diencephalon and in the telencephalon with *pax-6* expression was then detected in purple (digoxigenin probe detected by NBT/BCIP staining). Finally, expression of *engrailed* genes at the midbrain/hindbrain boundary (15) was detected in blue by immunostaining with the monoclonal antibody 4D9 (16) (the bound antibody was detected with Fast Blue B/NAMP).

8. Removal of first antibody: In order to allow the separate detection of a second or third hybridized probe in a different color by the corresponding alkaline-phosphatase coupled conjugates, one has to prevent any interference from the first antibody. Therefore, the first antibody must be removed prior to the next staining (*see Note 12*). For this purpose, the samples are incubated for 10 min at low pH in 100 mM glycine-HCl pH 2.2, 0.1% Tween-20 at room temperature followed by neutralization with four short PBSTw washes.
9. Detection of second and third antibodies: The embryos are now ready for detection of the second probe. For this, they are incubated with the next preabsorbed alkaline phosphatase conjugated F<sub>ab</sub> fragment as described above under **Subheading 3., step 6**. After the antibody incubation the embryos are washed six times with PBSTw to remove unbound antibody and are then equilibrated twice with the appropriate incubation buffer for the next color substrate (e.g., Fast Red). During the equilibration step the substrate tablet(s) is dissolved. The tablet(s) often does not dissolve completely and the solution has therefore to be cleared by centrifugation or by filtration. After staining with the second substrate as described in **Subheading 3., step 7** the embryos are washed again several times in PBSTw. In the case that one wants to study the transcript distribution of a third gene, the second antibody is stripped by incubation in 100 mM glycine-HCl pH 2.2, 0.1% Tween-20 and the embryos are subjected to a third round of antibody incubation using the preabsorbed alkaline phosphatase-coupled antibody that has not been used yet. This is followed by PBSTw washes and detection with a third substrate combination (e.g., BCIP/NBT) giving again another color (*see Note 13*).
10. Storage of embryos: The embryos are usually stored in glycerol at 4°C (*see Note 14*).

#### 4. Notes

1. If possible, all washing and incubation steps are performed on a rocking platform to ensure even contact with the surrounding solvents for all embryos.
2. The embryos can be stored at this stage for several months. To prevent evaporation, the embryos should be stored in airtight vials.
3. It is important that the reaction mixture is set up at room temperature and in the indicated order. Otherwise, the spermidine present in the transcription buffer may precipitate the template. The incubation is at 37°C. Some people claim that SP6 RNA polymerase works somewhat better at 40°C. For unknown reasons, we generally tend to obtain higher yields of RNA when using T7 RNA polymerase than when using T3 RNA polymerase.
4. If synthesizing biotinylated probes the TNE used in the gel filtration step should be supplemented with 0.1% Tween-20.
5. To obtain a good probe it is very important to quench any background in the hybridization that may be caused by nonincorporated hapten-carrying nucleotides. To ensure an optimal probe purification, we use two consecutive steps that are each supposed to separate free nucleotides from DNA. Although DNA probes can also be used for *in situ* hybridization we use exclusively RNA probes since we had more consistent results with them. But even by using RNA probes, we have observed considerable variations in the quality of probes. In our experience, dot blots to determine the degree of incorporation of labeled nucleotides are not very reliable predictors for the quality of a probe. We, therefore, test the quality of probes directly in pilot *in situ* hybridization experiments, usually by starting with 1 μL (of a total of 100) of the probe. If this yields a high background during a short staining time, then the probe should be diluted. If the signal intensity is too low, the amount of probe should be increased or a new probe should be synthesized. It has frequently been suggested that probes have to be hydrolyzed to lengths of 200–500 nucleotides to ensure



good penetration into the embryo. However, we have found that probe hydrolysis drastically reduces the sensitivity of the probes and therefore we rather advise to use probes of the maximal possible length.

6. In general, we perform hybridizations at 55°C for zebrafish and at 65°C for *Drosophila* probes. Higher temperatures reduce unspecific background, but may be deleterious for the physical integrity of the specimens. We do not recommend to go higher than 70°C.
7. Depending on the experiment one can use only a single probe (labeled with digoxigenin) or combine this with a fluorescein and/or a biotinylated probe. When using fluorescein-labeled probes one should bear in mind that they are sensitive to light. Therefore, one should attempt to minimize the exposure to light by covering the samples during all subsequent incubations. Similarly, these probes should be stored in the dark.
8. In the case that a probe gives excessive levels of background, it may help to treat the embryos after the hybridization with RNases to remove all the residual probe RNA that is not engaged in double strands. For this purpose, embryos are washed once in 50% formamide/2X SSCTw for 20 min at 60°C, washed twice for 15 min at 60°C in 2X SSCTw and equilibrated with PBSTw for 5–10 min at 37°C. They are then digested for 30 min at 37°C with 20 µg/mL RNase A-100 U/mL RNase T<sub>1</sub> in PBSTw. The embryos are rinsed for 15 min at 37° in 2X SSCTw and washed once in 50% formamide/2X SSCTw for 1 h at 60°C, once for 15 min in 2X SSCTw and twice in 0.2X SSCTw for 15 min at 60°C.
9. The order in which the antibodies are used depends on the circumstances of the experiment. In zebrafish, we find that fluorescein probes tend to give weaker signals than digoxigenin-substituted probes and the detection sensitivity appears to slightly decrease with each round of detection. Therefore, one will tend to use the anti-fluorescein antibody first to detect the more abundant of the transcripts. Biotin cannot be used as a label in zebrafish whole-mounts. This is probably owing to the presence of considerable levels of endogenous biotin thus creating a high background of unspecific staining. In *Drosophila*, we observed about similar efficiencies for digoxigenin-, biotin-, and fluorescein-substituted probes.
10. We tend to use Fast Red in the first or second staining cycle for two reasons:
  - a. Its sensitivity of detection is one order of magnitude below that of NBT/BCIP.
  - b. This reduced sensitivity would be further compromised when combined with the slightly lowered sensitivity of probes that are analyzed only in the final round of detection.

Because NBT/BCIP is the substrate with the highest sensitivity we tend to use it last. However, if the analyzed genes are expressed at high enough levels the order of different substrate combinations can easily be reversed (*see ref. 6*).

11. To reduce the required amounts of expensive substrates the embryos can be stained in dishes smaller than a regular 3 cm Petri dish. However, it is important that the embryos are always well covered and that the optical properties of the container allow to easily determine the progress of staining under a stereomicroscope.
12. We had initially experimented with inactivating the first antibody (i.e., the associated alkaline phosphatase) by heat treatment, as has also been suggested by others (*8*). However, this procedure is less well suited than the removal of the entire antibody conjugate by a wash at low pH. We have observed that incubation at 65°C for 20 min or at 80°C for 10 min causes fading of the Fast Red stain. This results in a weaker and more diffuse signal. On the other hand, the purple precipitate of the NBT/BCIP stain darkens during heating in an uncontrolled fashion and may lead to increased background staining.
13. Instead of using three different RNA probes for *in situ* hybridization, one can also use the different substrates to combine *in situ* hybridizations using two differently labeled probes

together with immunohistochemistry, employing an antibody directed against the product of a third gene (see **Fig. 1B**). This requires that the antigen recognized by the antibody is not irreversibly denatured during the preceding *in situ* hybridizations. It is important that the *in situ* hybridizations are carried out prior to the immunostaining because the sheep serum used for the blocking contains high amounts of RNases. These would destroy the target transcripts for the *in situ* hybridizations. For the incubation of such an antibody, it is important to avoid buffers containing DMSO, despite the fact that this is frequently included in such buffers. If DMSO is used, this can lead to a blurring of at least the Fast Red and possibly also of other stains.

14. For inspection in the microscope we mount embryos in glycerol. They should not be mounted in nonaqueous media because the Fast Red stain is soluble in alcohol. Therefore, mounting in, e.g., Canada Balsam will destroy the staining!

## Acknowledgments

The authors would like to thank Drs. U. Walldorf and W. J. Gehring for DNA plasmids, Dr. G. Halder for *Drosophila* embryos and C. Bornmann for technical assistance. This work was supported by the Schweizerischer Nationalfonds and the Cantons Basel-Stadt and Basel-Land.

## References

1. Hafen, E., Levine, M., Garber, R. L., and Gehring, W. J. (1983) An improved *in situ* hybridization method for the detection of cellular RNAs in *Drosophila* tissue sections and its application for localizing transcripts of the homeotic *Antennapedia* gene complex. *EMBO J.* **2**, 617–623.
2. Tautz, D. and Pfeifle, C. (1989) A non-radioactive *in situ* hybridization method for the localization of specific RNAs in *Drosophila* embryos reveals translational control of the segmentation gene *hunchback*. *Chromosoma* **98**, 81–85.
3. Hemmati-Brivanlou, A., Frank, D., Bolce, M. E., Brown, B. D., Sive, H. L., and Harland, R. M. (1990) Localization of specific mRNAs in *Xenopus* embryos by whole-mount *in situ* hybridization. *Development* **110**, 325–330.
4. Schulte-Merker, S., Ho, R. K., Herrmann, B. G., and Nüsslein-Volhard, C. (1992) The protein product of the zebrafish homologue of the mouse T-gene is expressed in nuclei of the germ ring and the notochord of the early embryo. *Development* **116**, 1021–1032.
5. Rosen, B. and Beddington, R. S. P. (1993) Whole-mount *in situ* hybridization in the mouse embryo: gene expression in three dimensions. *Trends Genet* **9**, 162–167.
6. Hauptmann, G. and Gerster, T. (1994) Two color whole-mount *in situ* hybridization to vertebrate and *Drosophila* embryos. *Trends Genet* **10**, 266.
7. Hauptmann, G. and Gerster, T. (1996) Multicolor whole-mount *in situ* hybridization to *Drosophila* embryos. *Dev. Genes Evol.* **206**, 292–295.
8. Jowett, T. and Lettice, L. (1994) Whole-mount *in situ* hybridizations on zebrafish embryos using a mixture of digoxigenin- and fluorescein-labelled probes. *Trends Genet* **10**, 73–74.
9. Grossniklaus, U., Pearson, R. K., and Gehring, W. J. (1992) The *Drosophila sloppy paired* locus encodes two proteins involved in segmentation that show homology to mammalian transcription factors. *Genes Dev.* **6**, 1030–1051.
10. Walldorf, U. and Gehring, W. J. (1992) *Empty spiracles*, a gap gene containing a homeobox involved in *Drosophila* head development. *Embo J.* **11**, 2247–2259.
11. Hafen, E., Kuroiwa, A., and Gehring, W. J. (1984) Spatial distribution of transcripts from the segmentation gene *fushi tarazu* during *Drosophila* embryonic development. *Cell* **37**, 833–841.

12. Puschel, A. W., Gruss, P., and Westerfield, M. (1992) Sequence and expression pattern of *pax-6* are highly conserved between zebrafish and mice. *Development* **114**, 643–651.
13. Krauss, S., Johansen, T., Korzh, V., Moens, U., Ericson, J. U., and Fjose, A. (1991) Zebrafish *pax[zf-a]*: a paired box-containing gene expressed in the neural tube. *EMBO J.* **10**, 3609–3619.
14. Akimenko, M.-A., Ekker, M., Wegner, J., Lin, W., and Westerfield, M. (1994) Combinatorial expression of three zebrafish genes related to *distal-less*: Part of a homeobox gene code for the head. *J. Neurosci.* **14**, 3475–3486.
15. Ekker, M., Wegner, J., Akimenko, M. A., and Westerfield, M. (1992) Coordinate Embryonic Expression of 3 Zebrafish engrailed Genes. *Development* **116**, 1001–1010.
16. Patel, N. H., Martin-Blanco, E., Coleman, K. G., Poole, S. J., Ellis, M. C., Kornberg, T. B., and Goodman, C. S. (1989) Expression of *engrailed* proteins in arthropods, annelids and chordates. *Cell* **58**, 955–968.

## Methods for Double Detection of Gene Expression

### *Combined In Situ Hybridization and Immunocytochemistry or Histochemistry*

Ronald A. Conlon

#### 1. Introduction

The distribution of two different molecules can be analyzed within the same embryo using the procedures described below. The protocol for combined whole mount *in situ* hybridization and immunocytochemistry allows for simultaneous detection of messenger ribonucleic acid (mRNA) and protein. The protocol for combined whole mount *in situ* hybridization and  $\beta$ -galactosidase staining allows for simultaneous detection of mRNA and transgene-directed  $\beta$ -galactosidase expression. Simultaneous detection allows for the most direct comparison of expression patterns. These procedures are derived from protocols used in *Drosophila* (1) and mice (2,3).

#### 2. Materials

The required materials include those for whole mount *in situ* hybridization, plus the following reagents.

##### 2.1. Combined Protein and RNA Detection

1. High-salt wash (500 mM NaCl, 10 mM Pipes pH 6.8, 1 mM EDTA, 0.1% Tween 20, autoclaved).
2. TBST (137 mM NaCl, 25 mM Tris-HCl pH 7.6, 3 mM KCl, 0.1% Tween 20, autoclaved).
3. Primary antibody against the protein of interest.
4. An appropriate secondary antibody conjugated to horse radish peroxidase.
5. Antidigoxigenin antibody, alkaline phosphatase-conjugated (Boehringer Mannheim, Mannheim, Germany). Store at 4°C.
6. Blocking Reagent for nucleic acid hybridization (Boehringer Mannheim).
7. DAB (30 mg/mL 3, 3'-diaminobenzidine tetrahydrochloride in 10 mM Tris pH 7.6 stored at -20°C in the dark in single-use aliquots). Handle with extreme caution: DAB is carcinogenic.
8. BCIP (50 mg/mL 5-bromo-4-chloro-3-indolyl phosphate, toluidine salt in 100% N,N-dimethyl-formamide, stored at -20°C in the dark).

9. NBT (75 mg/mL nitroblue tetrazolium salt in 70% N,N-dimethylformamide, stored at  $-20^{\circ}\text{C}$  in the dark).
10. NTMT (100 mM NaCl, 100 mM Tris-HCl pH 9.5, 50 mM  $\text{MgCl}_2$ , 0.1% Tween 20).
11. PBTE (PBS containing 0.1% Tween 20 and 1 mM EDTA, autoclaved).
12. 50% glycerol/50% PBTE.
13. 80% glycerol/20% PBTE.
14. Sodium azide.

## 2.2. Combined $\beta$ -Galactosidase and RNA Detection

1. 100 mM EGTA pH 7.3 treated with 0.1% diethylpyrocarbonate and autoclaved.
2. 1 M  $\text{MgCl}_2$  treated with 0.1% diethylpyrocarbonate and autoclaved.
3. Fixative G, prepared fresh (0.2% glutaraldehyde, 2 mM  $\text{MgCl}_2$ , 6 mM EGTA pH 7.3 in PBS).
4. Wash G (PBT containing 2 mM  $\text{MgCl}_2$ , treated with 0.1% v/v diethylpyrocarbonate and autoclaved).
5. X-gal (25 mg/mL 5-bromo-4-chloro-3-indolyl  $\beta$ -D-galactopyranoside in N,N-dimethylformamide stored at  $-20^{\circ}\text{C}$ ).
6. Potassium ferricyanide ( $\text{K}_3\text{Fe}(\text{CN})_6$ ).
7. Potassium ferrocyanide ( $\text{K}_4\text{Fe}(\text{CN})_6 \cdot 3\text{H}_2\text{O}$ ).

## 3. Methods

### 3.1. Combined Protein and RNA Detection

Follow the protocol of your choice for whole mount *in situ* hybridization until the point at which the antibody to digoxigenin is to be added.

#### 3.1.2. Day 1

1. Prepare a 1% w/v solution of Blocking Reagent (Boehringer Mannheim) in TBST. The reagent must be stirred and heated for some time to make a milky solution. Once in solution, cool to  $4^{\circ}\text{C}$ .
2. Rinse the embryos twice with high salt wash, then heat in high salt wash at  $68^{\circ}\text{C}$  for 20 min.
3. Incubate for at least 1 h at room temperature in TBST containing 1% blocking reagent.
4. Incubate the embryos with the antibodies overnight at  $4^{\circ}\text{C}$ . The antidigoxigenin antibody should be diluted to 1/5000, and the primary antibody against the protein of interest should be diluted to its working concentration.

#### 3.1.3. Day 2

5. Rinse briefly three times with TBST, then wash five or six times, 1 h each, at room temperature in the same buffer.
6. Incubate for at least 1 h at room temperature in TBST containing 1% blocking reagent.
7. Incubate with the secondary antibody overnight at  $4^{\circ}\text{C}$ .

#### 3.1.4. Day 3

1. Rinse three times with TBST, then wash five or six times, 1 h each, at room temperature in the same buffer.
2. Incubate for 20 min in the dark with TBST containing 0.3 mg/mL DAB.
3. In the dark, develop the peroxidase reaction by adding hydrogen peroxide to 0.03%. The reaction typically generates signal for the first 10 or 15 min, and then background staining begins to become evident. Stop the reaction by rinsing with TBST (*see Note 4.1.*).
4. Wash twice for 20 min each at room temperature with NTMT.

5. Incubate with the alkaline phosphatase color reagents (4.5  $\mu\text{L}/\text{mL}$  NBT and 3.5  $\mu\text{L}/\text{mL}$  BCIP in NTMT). For most messages the color reaction needs to continue overnight at room temperature. Do not agitate the embryos during the overnight color reaction. Protect from light.
6. Stop the color reaction with three rinses with PBTE. Clear the embryos by passing the embryos into 1:1 glycerol/PBTE for 1 h, then into 4:1 glycerol/PBTE with 0.02% sodium azide. The peroxidase reaction product fades with exposure to light. Store at 4°C in the dark (*see Note 4.2.*).

### 3.2. Combined $\beta$ -Galactosidase and RNA Detection

The procedure for  $\beta$ -galactosidase staining decreases the sensitivity of the *in situ* hybridization procedure somewhat, so this combined procedure works best for prevalent target mRNAs (*see Note 4.3.*).

#### 3.2.1. Embryo Preparation, $\beta$ -Galactosidase Staining and Storage

1. Dissect gestational day 6 to 10 embryos free from extraembryonic tissues in cold PBS. A small puncture hole must be made in the anterior neural tube of day 9 and 10 embryos.
2. Fix in 10 mL of fresh cold Fixative G for 10 min on ice.
3. Rinse three times with Wash G. Wash with Wash G for 60 min at 4°C.
4. Transfer to a 2-mL plastic screw-cap tube. Incubate in freshly made staining solution (1 mg/mL X-gal, 2 mg/mL potassium ferrocyanide, 1.6 mg/mL potassium ferricyanide in Wash G) at 37°C until desired staining intensity is achieved. The incubation period can vary from minutes to hours depending on the level of expression of  $\beta$ -galactosidase. Use the minimum incubation period possible.
5. Rinse twice with PBT. Fix for 2 h at 4°C in fresh fixative (4% paraformaldehyde in PBS).
6. Rinse three times with cold PBT. Change directly into 100% methanol, invert the tube several times to mix. Store at -20°C, or proceed to **step 7**.
7. Treat with a 5:1 mixture of 100% methanol and 30% hydrogen peroxide for 2–3 h at room temperature. Rinse three times in methanol. Store at -20°C.
8. The detection of RNA by *in situ* hybridization may be resumed by rehydrating the embryos through a methanol series.

## 4. Notes

1. The peroxidase reaction products may be intensified by addition of metal salts to the reaction. If this is desired, make a 0.3% w/v stock solution of  $\text{NiCl}_2$  or  $\text{CoCl}_2$ . Add to the DAB staining solution for a final concentration of 0.03%, filter, and use immediately.
2. The accumulated background from two combined procedures may obscure signal somewhat. Better visualization may be possible with a stronger clearing agent, for example 1:2 benzyl alcohol/benzyl benzoate (BABB). In glass or polypropylene tubes, dehydrate the embryos quickly through an alcohol series to 100% ethanol. Transfer to 1:1 100% ethanol/BABB until the embryos sink, then into BABB. BABB dissolves polystyrene so the embryos must be observed in glass dishes. BABB also slowly dissolves the colored reaction products of alkaline phosphatase and  $\beta$ -galactosidase, so the embryos cannot be kept in this clearing agent for very long. Reverse the solvent series to return the embryos to an aqueous storage solution.
3. The combined procedures give their best results when the probed expression patterns are largely nonoverlapping, since it is difficult to distinguish double-labeled cells.

**References**

1. Cubas, P., de Celis, J.-F., Campuzano, S., and Modolell, J. (1991) Proneural clusters of achaete-scute expression and the generation of sensory organs in the *Drosophila* imaginal wing disc. *Genes Dev.* **5**, 996–1008.
2. Davis, C. A., Holmyard, D. P., Millen, K. J., and Joyner, A. L. (1991) Examining pattern formation in mouse, chicken and frog embryos with an *En*-specific antiserum. *Development* **111**, 287–298.
3. Conlon, R. A. and Rossant, J. (1992) Exogenous retinoic acid rapidly induces anterior ectopic expression of murine *Hox-2* genes in vivo. *Development* **116**, 357–368.

## Visualization of the Expression of Green Fluorescent Protein (GFP)-Linked Proteins

Joseph C. Ayoob, Jean M. Sanger, and Joseph W. Sanger

### 1. Introduction

One of the most remarkable and unexpected advances in cell biology in the 1990s has been the introduction of expression plasmids containing a wide variety of cDNAs ligated to the cDNA of the protein responsible for the bioluminescence of the jellyfish, *Aequoria victoria* (1,2). The original expression plasmid for this jellyfish protein, green fluorescent protein (GFP) yielded a low level of fluorescence. However, through mutagenesis, enhanced GFPs have been produced that are about 35 times brighter than the wildtype GFPs (3,4). There are now blue and yellow fluorescent proteins and other colors may soon be available. The size of green fluorescent protein, about 28 kD (5,6), creates a large fluorescent tag in comparison to the 500 Dalton fluorescent dyes that have been coupled to purified proteins; nevertheless, GFP does not seem to interfere with most interactions of its linked protein. There are cases, however, where the placement of the large GFP probe has interfered with the nearby domains of proteins. For example, coupling GFP to the N-terminal region of alpha-actinin, near the actin-binding domain resulted in a GFP probe that could not bind actin, whereas GFP linked to the C-terminus of alpha-actinin resulted in a probe that readily bound actin filaments (7). An alternate approach to eliminating interference by GFP is to introduce a linker of several amino acids between the GFP probe and the protein (8). The expression of GFP-linked proteins has been particularly advantageous for following proteins whose low abundance or solubility properties make them unsuitable for microinjection into living cells. The cDNAs for a number of abundant cytoskeletal proteins have also been coupled to GFPs because transfection can be easier than microinjection and cell lines can be created expressing these GFP-cytoskeletal proteins. The expression of GFP plasmids encoding different proteins has permitted the dynamic changes of the proteins to be studied in living cells during events such as cell division (9), cell locomotion (10), and myofibrillogenesis (7).

This chapter outlines the steps involved in the transfection of cultured cells with expression plasmids coding for GFP. We will use as an example of this process, the transfection of nonmuscle cells with a plasmid encoding for alpha-actinin ligated to GFP. Alpha-actinin is an actin-binding protein that crosslinks actin filaments, and is



concentrated in focal adhesions, dense bodies of stress fibers and lamellipodia of cells (**II**). The same procedures would be followed for other plasmids encoding GFPs coupled to any other host protein.

## 2. Materials

1. Culture medium:
  - a. PtK2 medium: 10% Fetal Bovine Serum (FBS, Life Technologies Inc., Gaithersburg, MD), 1% L-Glutamine (200 mM, Life Technologies Inc.), in Minimum Essential Medium with Earle's Salts and without L-Glutamine (MEM, Life Technologies Inc.). Filter medium using a sterile filtration system (0.22  $\mu$ m membrane, e.g., Stericup™, Millipore, Bedford, MA). Store in the refrigerator.
  - b. Serum-free medium: Opti-MEM® (Life Technologies Inc.).
2. Trypsin-EDTA (0.25%, Life Technologies Inc.).
3. Cells: *Potorous tridactylis* (rat kangaroo) kidney cell line (PtK2, ATCC, Rockville, MD).
4. Culture dishes:
  - a. 35 mm microwell dishes, uncoated with 1.5 mm glass bottom (MatTek, Ashland, MA)
  - b. 22 × 22 × 1.5 mm coverslip (Fisher Scientific, Pittsburgh, PA) placed into a 35 mm Petri dish (Fisher).
5. Liposomal transfection reagent: LipofectAMINE™ (Life Technologies Inc.).
6. Plasmids. Expression plasmids encoding GFP are available from a number of companies. We have used the plasmid encoding on an enhanced GFP (CLONTECH, Palo Alto, CA). Standard molecular biology techniques are used to place the cDNA for GFP on either the N- or C-terminus of the selected protein.
7. Low Salt Solution: 0.1 M KCl, 0.001 M MgCl<sub>2</sub>, 0.006 M K<sub>2</sub>HPO<sub>4</sub>, 0.004 M KH<sub>2</sub>PO<sub>4</sub>, pH 7.0. Add the following stock solutions to 3 L of distilled water: 190 mL 2 M KCl, 3.8 mL 1 M MgCl<sub>2</sub>, 23 mL 1 M K<sub>2</sub>HPO<sub>4</sub>, 15 mL 1 M KH<sub>2</sub>PO<sub>4</sub>. Adjust the pH to 7.0 and add additional distilled water to a total volume of 3.8 L.
8. Paraformaldehyde fixative: 3% paraformaldehyde in the low-salt solution. Dissolve 1.8 g NaCl in 150 mL of distilled water. Add 6 g of paraformaldehyde (e.g., "Baker" grade, J. T. Baker, Phillipsburg, NJ) to salt solution. Add three drops of 1 M NaOH from a Pasteur pipet. Heat to 60°C while stirring. After solution cools, add 1.6 mL of 1 M K<sub>2</sub>HPO<sub>4</sub> and 0.4 mL of 1 M KH<sub>2</sub>PO<sub>4</sub>. Adjust pH to 7.4. Slowly and with stirring add 0.2 mL of 1 M MgCl<sub>2</sub> and 0.2 mL of 100 mM CaCl<sub>2</sub>. Bring volume to 200 mL with distilled water. Aliquot and store at -20°C for 1 mo.
9. Permeabilization solution: 0.1% Igepal (Sigma, St. Louis, MO) in low salt solution.
10. Blocking solution: 50 mM NH<sub>4</sub>Cl in low-salt solution.

## 3. Methods

1. Cell culture and preparation for transfection: The day before transfection, subculture a confluent population of PtK2 cells onto either glass bottom dishes or coverslips (*see* **Notes 1** and **2**). To subculture, add 2 mL of trypsin to a 35-mm dish of cells and incubate in a 37°C CO<sub>2</sub> incubator for 15 min. After 15 min, transfer the medium and detached cells to a 14-mL centrifuge tube. Rinse the dish with an additional 2 mL of PtK2 medium to remove any loosely adherent cells and add this to the tube. Spin 5 min at setting 5 in a table top centrifuge. Decant the supernatant and resuspend the pellet in 6–8 mL of PtK2 medium. Distribute 1 mL of the suspension of cells to each of 6–8 culture dishes, and bring the total volume in each dish to 2 mL and incubate overnight. This will yield 6–8 glass bottom dishes of approximately 50% confluency the next day. Cells cultured on coverslips can be split in a similar ratio.

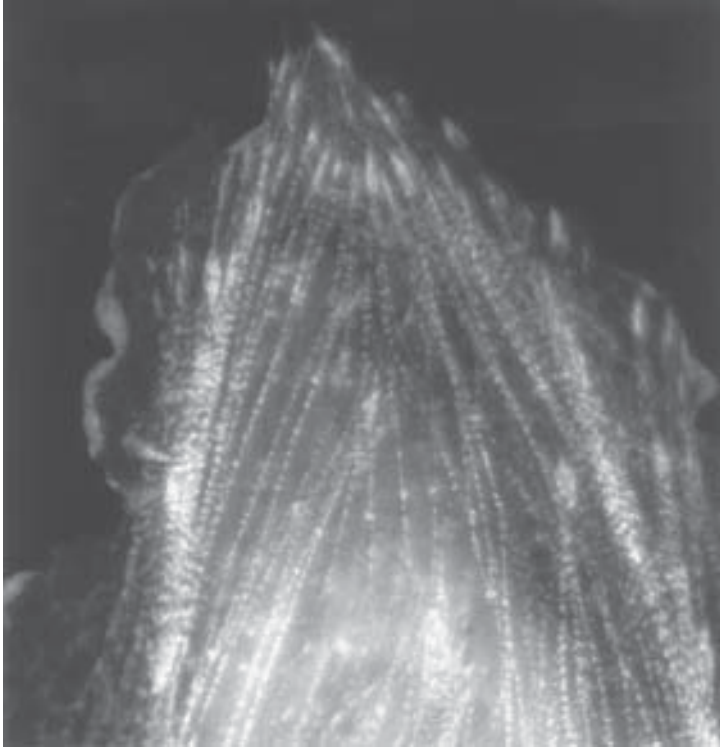

Fig. 1. PtK2 cell transfected with an enhanced GFP plasmid containing the cDNA encoding alpha-actinin. Note the localization of alpha-actinin-GFP in the lamellipodium on the left of the cell, the attachment plaques and the dense bodies of the stress fibers.

2. Transfection of cells with a DNA probe using LipofectAMINE: Add 100  $\mu$ L of Opti-MEM to two separate sterile tubes. Add 10  $\mu$ L of LipofectAMINE to tube one and add 2  $\mu$ g of DNA to tube two (*see* **Notes 3–5**). Mix tubes one and two together, swirl immediately and incubate at room temperature for 30–45 min. Add 800  $\mu$ L of serum-free medium to the DNA-LipofectAMINE mixture. Remove PtK2 medium from cells and add 2 mL Opti-MEM. Repeat (*see* **Note 6**). Remove Opti-MEM and add 1 mL DNA-LipofectAMINE mixture to the cells. Incubate 5–7 h in 37°C CO<sub>2</sub> incubator. After the initial incubation period, add 1 mL of PtK2 culture medium to the cells and incubate overnight. The next morning, remove the transfection mixture from the dish, and add 2 mL PtK2 medium.
3. Preparation of cells for live imaging: Expression of the GFP fusion protein in cells grown on glass bottom dishes can be followed over the course of several days (**Fig. 1**). A transfected dish can be kept on the stage of an inverted microscope with the addition of heat and CO<sub>2</sub>. A heat curtain (ASI 400 Air Stream Incubator; NevTek, Burnsville, VA) can be used to maintain a temperature of 37°C on the stage of the microscope. To provide the cells with a 5% CO<sub>2</sub> environment place, first make a small hole in the side of the bottom of a 100-mm Petri dish by inserting a heated 22 gage needle through the plastic. Fit a CO<sub>2</sub> regulator with an adaptor that can be connected to rubber tubing which will end in a fitting for a 22 gage needle that will deliver the gas into the inside the Petri dish (*see* **Note 7**). Invert the Petri dish over the dish of transfected cells and perfuse through

CO<sub>2</sub> from a tank of 5% CO<sub>2</sub>/balance air. A weight should be placed on the dish to hold it in place. An annular microscopic insert works well to hold down the dish and does not interfere with imaging. If the glass coverslips have been marked with a diamond-tipped scribe in a series of loops or a grid, the transfected cells can be returned to the incubator after an image is recorded and then the cells relocated for imaging at subsequent time points (*see Note 8*).

4. Imaging of transfected cells: GFP expression can be seen in less than 24 h after the start of transfection (**Fig. 1**). In some instances, expression can be seen as early as 5 h. The transfected cells can be identified with epi-fluorescence optics and filters optimized for the species of GFP used (Chroma, Technology Corp., Brattleboro, VT; Omega Optical, Brattleboro, VT). It is best to use the minimum level of exciting light to avoid bleaching and damage to transfected cells. Images can be acquired with intensified video cameras or cooled CCD cameras keeping the exposures as brief as possible. Image-processing software allows time-lapse recording to be automated and images saved to disk. Changes in the intensity of the GFP signal can be measured over time and correlated with changes in structure.
5. Fixing cells and antibody staining: The transfected cells can be fixed and permeabilized so that other cellular proteins can be identified with immunofluorescence. The GFP-alpha-actinin (or other localized GFP labeled proteins) in the stress fibers, lamellipodia or dense bodies are not lost during these processes. Fix the cells by incubating them in 2 mL of the paraformaldehyde solution for 15 min at room temperature. Rinse several times with the low salt solution. Permeabilize the cells with 2 mL of the permeabilization solution for 5 min at room temperature. Rinse again with the low-salt solution. Add 2 mL of the 50 mM NH<sub>4</sub>Cl solution for 5 min at room temperature to block any unreacted aldehyde groups of the fixative. Rinse cells again with the low-salt solution. The cells are now ready to be stained with antibodies or phalloidin using standard techniques.

#### 4. Notes

1. Conduct all cell culture work in a sterile environment, i.e., a tissue culture hood. Rinse hands and swab medium containers and tubes with 70% ethanol to reduce the chance of contamination of the culture. Care should be taken to be as sterile as possible, not only in the feeding and subculturing processes, but also in the preparation of the medium and other solutions that are to be used with live cells. Coverslips can be sterilized by exposure to ultraviolet (UV) light overnight in the hood.
2. The glass bottom dishes are useful for high-magnification viewing of the GFP signal in live cells over several hours or days. Coverslips are more convenient if cells are to be fixed and stained with an antibody. They can be mounted on a slide with a mounting agent (e.g., Mowiol, Boehringer Mannheim, Indianapolis IN).
3. A UV Spectrophotometer can be used to quantify the amount of DNA in a solution. An optical density (O.D.) of 1 at a wavelength of 260 nm equals 0.05 µg/µL.
4. The amounts of LipofectAMINE and DNA added as well as the time of incubation of the mixture with the cells can be changed to try to optimize efficiency. The above amounts and times work very well and typically yield transfection rates around 30–50%.
5. The purity of the DNA is also important for good transfection efficiency. The 260/280 nm absorbance ratio of DNA to protein should be 1.7 or above. Qiagen plasmid Maxi kits (Qiagen, Valencia, CA) yield good-quality DNA for use in transfections. An endotoxin-free plasmid maxi-kit can be used to prepare DNA virtually free of lipopolysaccharides, which have been shown to reduce transfection efficiency (**12**).
6. The presence of serum reduces the efficiency of transfection. When rinsing the cells with the serum-free medium let the Opti-MEM stand in the dish for a minute or so. Rinsing the

cells twice in this manner is usually sufficient for the removal of most of the serum containing medium. The 5–7 h of transfection without medium and in the presence of LipofectAMINE can be harmful to the cells. To avoid or to lessen this affect, some serum can be added to the dishes during transfection or the time of transfection can be shortened.

7. Plastic wrap can be placed over the stage with a hole for the objective lens to make a tighter seal to keep the CO<sub>2</sub> under the Petri dish. Humidity can be provided by two methods. Small containers (e.g., a cap of a tube) filled with water can be placed under the dish to provide humidity for the cells. In addition, the CO<sub>2</sub> can be bubbled through distilled water before it reaches the needle. A tank of 5% CO<sub>2</sub>/air accepts a regulator with a CGA-590 nozzle.
8. Sterilize the diamond-tipped pen before scoring the dishes. Expose the open dish to UV light for at least an hour after making the marks to sterilize the dish. A suggested pattern of marks is three rows of loops, each with a different number of loops.

### Acknowledgment

This work is supported in parts by grants from NSF (DCB 19041 to J. M. S.), NIH (HL-48954 to J. W. S. and J. M. S.), USDA (to J. W. S. and J. M. S.) and the MDA (to J. W. S.).

### References

1. Prasher, D. C., Eckenrode, V. K., Ward, W. W., Prendergast, F. G., and Cormier, M. J. (1992) Primary structure of the *Aequorea victoria* green-fluorescent protein. *Gene* **111**, 229–233.
2. Chalfie, M., Tu, Y., Euskirchen, G., Ward, W. W., and Prasher, D. C. (1994) Green Fluorescent Protein as a marker for gene expression. *Science* **263**, 802–805.
3. Heim, R., Prasher, D. C., and Tsien, R. Y. (1994) Wavelength mutations and posttranslational autoxidation of green fluorescent protein. *Proc. Natl. Acad. Sci. USA* **91**, 12,501–12,504.
4. Heim, R., Cubitt, A. B., and Tsien, R. Y. (1995) Improved green fluorescence. *Nature* **373**, 663–664.
5. Yang, F., Moss, L. G., and Phillips, G. N. (1996) The molecular structure of Green Fluorescent Protein. *Nature Biotechnol.* **14**, 1246–1251.
6. Ormo, M., Cubitt, A. B., Kallio, K., Gross, L. A., Tsien, R. Y., and Remington, S. J. (1996) Crystal structure of the *Aequorea victoria* green fluorescent protein. *Science* **273**, 1392–1395.
7. Dabiri, G. A., Turnacioglu, K. K., Sanger, J. M., and Sanger, J. W. (1997) Myofibrillogenesis visualized in living embryonic cardiomyocytes. *Proc. Natl. Acad. Sci. USA* **94**, 9493–9498.
8. Doyle, T. and Botstein, D. (1996) Movement of yeast cortical actin cytoskeleton in vivo. *Proc. Natl. Acad. Sci. USA* **93**, 3886–3891.
9. Moores, S. L., Sabry, J. H., and Spudich, J. A. (1996) Myosin dynamics in live *Dictyostelium* cells. *Proc. Natl. Acad. Sci. USA* **93**, 443–446.
10. Gerisch, G., Albrecht, R., Heizer, C., Hodgkinson, S., and Maniak, M. (1995) Chemoattractant-controlled accumulation of coronin at the leading edge of *Dictyostelium* cells monitored. *Curr. Biol.* **5**, 1280–1285.
11. Lazarides, E. and Burridge, K. (1975) Alpha-actinin: immunofluorescent localization of a muscle structural protein in non-muscle cells. *Cell* **6**, 289–298.
12. Weber, M., Moller, K., Welzeck, M., and Schorr, J. (1995) Effects of lipopolysaccharide on transfection efficiency in eukaryotic cells. *BioTechniques* **19**, 930–940.

## Monoclonal Antibodies in the Analysis of Embryonic Development

Vahe Bedian

### 1. Introduction

Determination and differentiation of tissues during embryogenesis of multicellular organisms relies on differential utilization of genetic information in different cell types at different stages of development, resulting in unique patterns of gene expression that impart the necessary morphological, biochemical, and functional characteristics to different cell lineages. One important approach to the analysis of embryonic development has therefore focused on the identification of tissue and stage specific gene products, both at the level of gene expression and of cellular protein products. Monoclonal antibodies have been successfully used in the identification, analysis, purification, and cDNA cloning of developmentally regulated antigens in many organisms, including insect, amphibian, avian, and mammalian species (1–10).

Two general strategies are available in the immunological analysis of developmental systems: a. searching for novel tissue and stage specific antigens by immunization with whole tissue or cell extracts and screening against different embryonic tissues and stages and b. raising monoclonal antibodies to developmentally significant proteins identified through biochemical analysis, or protein products of specific genes identified by mutational analysis and cloning. Both approaches have certain advantages and limitations. Immunizing with complex cellular extracts or subcellular fractions has the potential for discovering novel antigens, but tissue-specific markers are usually minor cellular constituents and may not elicit a strong immune response. In this circumstance, the probability of a response to a minor specific constituent can be enhanced by utilizing immunosuppression against a related tissue or cell type that does not express the specific marker antigen (11–13). Immunization with complex antigens also presents the complication that hybridomas need to be screened against tissue sections, a relatively time consuming albeit very informative procedure. Using a purified and/or expressed protein usually has the advantage of making abundant material of specific interest available, but may suffer from the limitations of bacterial expression systems, which do not produce protein with native conformation, and problems with membrane proteins which may be difficult to express and purify. Designing peptides from sequence information allows targeting even more specific regions of interest, but the

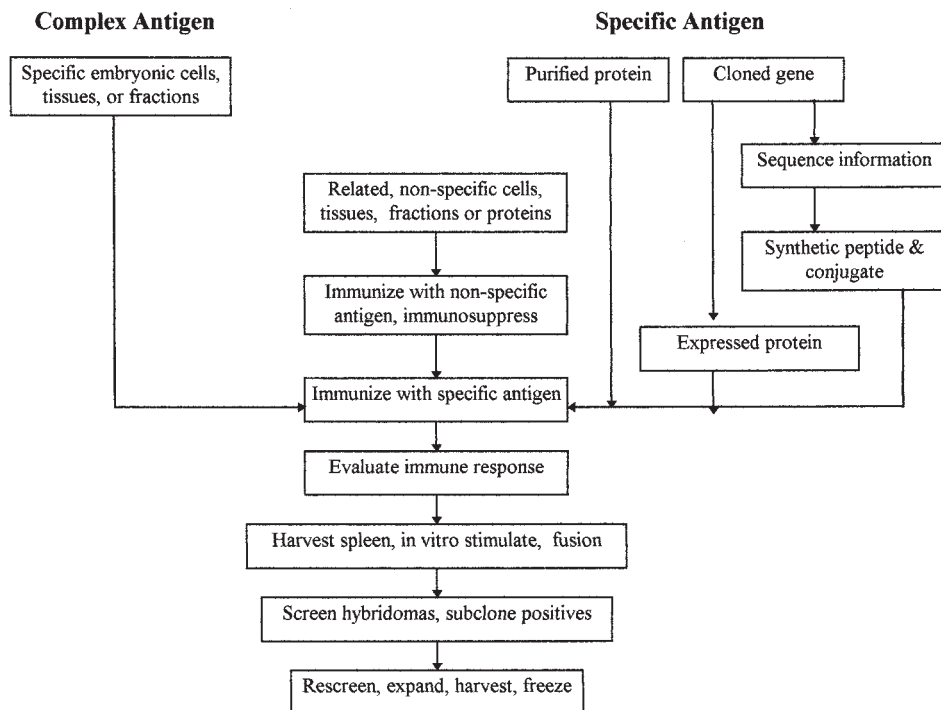

Fig. 1. Major steps in producing immunological reagents with desired reactivity and specificity.

chosen peptide may not be accessible to antibodies in the context of the full protein. Furthermore, the peptide sequence needs to be chosen with care to ensure that a. it is antigenic, b. it has specificity for the protein of interest and will not cross-react with other cellular components, and c. it is not conserved in the host animal (mouse) and will be immunogenic when injected. The problems of low antigenicity and immunogenicity can sometimes be rectified by synthesizing a peptide that is the juxtaposition of the peptide of interest and a helper T-cell epitope (14). In vitro stimulation of lymphocytes with antigen, preferably after at least one in vivo immunization has been done, also helps overcome problems of low immune response, and can conserve antigen usage when availability is a concern (15). The specific approach taken must therefore be tailored to each situation, and it is often necessary to attempt several approaches to produce immunological reagents with the desired reactivity and specificity. The high efficiency fusion procedure described below (16) uses azaserine selection and optimized, fusion tested reagents, and has been successfully used to produce monoclonal antibodies to rare and difficult antigens. The flowchart in Fig. 1 outlines the major steps in these approaches.

## 2. Materials

1. Immunization and immunosuppression: antigens are prepared in sterile calcium–magnesium-free phosphate buffered saline (8.0 g NaCl, 0.2 g KCl, 1.15 g Na<sub>2</sub>HPO<sub>4</sub>, 0.2 g KH<sub>2</sub>PO<sub>4</sub> per liter, pH 7.4). Six-week-old Balb/c mice (Jackson Laboratories, Bar Harbor, ME) or other strains of mice (see Note 4), if desired, are used for immunizations. Cyclophosphamide

(Sigma, St. Louis, MO) is prepared in sterile PBS at a concentration of 0.1 mg/mL. Adjuvants that are useful for immunizations include Titermax (Sigma), RiBi, (RiBi Biochem, Hamilton, MT) complete Freund's (CFA), and incomplete Freund's (IFA) adjuvant (Sigma). Adjuvant peptide (N-acetyl muramyl-L-alanyl-D-isoglutamine; Sigma) is used for *in vitro* stimulation of lymphocytes with antigen.

2. Myeloma and hybridoma culture: Sp2/0Ag14 mouse myelomas (available from ATCC) are used as the fusion partner. The following media are needed: HY medium (90% high-glucose DMEM, 10% NCTC135, both available from Sigma); Myeloma medium for Sp2 culture [HY supplemented with 10% fetal bovine serum (FBS) and 2 mM L-glutamine (Gibco, Grand Island, NY)]; Fusion medium composed of HY supplemented with 20% FBS (*see Note 1*), 5% Origen hybridoma cloning factor (Fisher Scientific Co., Pittsburgh, PA), 4 mM L-glutamine, 0.15 mg/mL oxalacetate, 0.05 mg/mL pyruvate, 0.2 U/mL insulin, 13.6 µg/mL hypoxanthine, 1.0 µg/mL azaserine (*see Note 2*), 100 U/mL penicillin, 100 µg/mL streptomycin. All these reagents are available from Sigma. Oxalacetate/pyruvate/insulin (OPI), hypoxanthine/azaserine (HA), and penicillin/streptomycin (P/S) are available as premixed stocks. Hybridoma culture/cloning medium is the same as fusion medium above but without azaserine or P/S.
3. Fusion: Erythrocyte lysis solution is 0.17 M NH<sub>4</sub>Cl, pH 7.5, and fusion-tested polyethylene glycol solution is 45% PEG, 1500–3000 Da range, 5% DMSO, 50% HY. We have obtained good results with Sigma PEG (P7181), although lots can vary (*see Note 3*).
4. ELISA screening: Antigen binding buffer is 50 mM sodium carbonate bicarbonate buffer, pH 9.5, composed of 2.93 g NaHCO<sub>3</sub> and 1.59 g Na<sub>2</sub>CO<sub>3</sub> per liter. Other buffers, such as 50 mM sodium borate buffer pH 8.5 or PBS can also be used if binding in bicarbonate buffer is not efficient. ELISA plates are Nunc Maxisorb or Becton–Dickinson Probind plates (Fisher). It is worth trying both plates during assay development and selecting the one that shows stronger binding of specific antigen. Blocking solution can be 0.2–2% BSA or ovalbumin in PBS, or 0.1–2.0% instant milk. Wash buffer is PBST (PBS with 0.1% Tween 20). Affinity purified, HRP and FITC conjugated goat antimouse IgG secondary antibodies are BMB (Indianapolis, IN). Substrate is freshly prepared from ABTS tablets (BMB). Make fresh formaldehyde by dissolving 0.4 g paraformaldehyde in 1 mL of 1 M NaOH at 60°C, neutralize with 1 M HCl, then add 0.5 mL 10X PBS and bring volume to 10 mL. This solution should be kept tightly capped at 4°C and used within a few days.
5. Immunofluorescence screen: Subbing solution is composed of 0.8% gelatin and 0.5% chromium potassium sulfate. Subbed slides are made by rinsing microscope slides in ethanol, allowing them to dry, then dipping in subbing solution and drying in a dust-free environment. Mounting medium is made of 7.5 mL glycerol, 12 mL 0.2 M Tris pH 8.5, 6 mL water, saturated with polyvinyl alcohol (Sigma) by overnight stirring. DABCO (diazabicyclo [2,2,2] octane, Sigma) is added to 33 mg/mL to prevent fading.

### 3. Methods

1. Immunizations: antigen dosage depends on its nature, availability and degree of conservation. Typically, 200 µg of complex cellular antigens, 30–100 µg of purified proteins, and 10–30 µg of conjugated peptide (usually KLH conjugate; the dose refers to peptide content not including the carrier) are used per immunization, and 2–4 mice are immunized per antigen (*see Note 4*). Emulsify the antigen with adjuvant in a total volume of ~200 µL per animal. Titermax is an excellent adjuvant for most antigens, but RiBi or CFA can be used if the response with Titermax is weak. If a nonspecific counterpart of the antigen is available and immunosuppression against it will be attempted, inject the nonspecific antigen with cyclophosphamide (100 mg/kg of weight) intraperitoneally (*i.p.*), followed by *i.p.*

administration of cyclophosphamide 1–2 d after antigen injection. Start immunization with specific antigen on day 7, alternating i.p. with subcutaneous (s.q.) routes. Usually, incomplete Freund's adjuvant is used for these boosts. Allow 2–3 wk between the first and second immunizations with specific antigen to produce a secondary response with class switching and affinity maturation. Additional boosts can be administered 1–2 wk apart. Perform tail bleeds 4–5 d after each immunization by making a small incision in a tail vein and collecting 20–50  $\mu\text{L}$  of blood. Serum from these bleeds is used to determine antibody titers. Three days prior to the fusion, inject around one-half dose of antigen without adjuvant into the tail vein, and another half dose i.p. to provide vigorous stimulation of antigen positive B cells.

2. Sp2 myeloma cells should have undergone 8-azaguanine selection and/or been tested for sensitivity to azaserine within approx 12 mo. Grow Sp2 cells in log phase in myeloma medium in a density range of  $1\text{--}5 \times 10^5$  cells/mL. Feed Sp2 cells with fresh medium the day before the fusion, since mitotic cells are the best fusion partners. Check that viability is  $>95\%$ .
3. Spleen harvest and in vitro stimulation. After administration of appropriate anesthetic, sacrifice the mouse, collect as much blood as possible by cardiac puncture, and dissect the spleen. Homogenize the spleen using a sterile "Collector" stainless steel sieve homogenizer (Bellco, Vineland, NJ) with a 60 mesh screen, and centrifuge the cells at 300g for 15 min. Resuspend the pellet in 5 mL ice cold erythrocyte lysis buffer, and incubate on ice for 8 min. Add 10 mL of HY and repeat centrifugation. Resuspend the pellet in HY (no serum) and count. Typical yield from the spleen of a well-immunized animal is  $1\text{--}2 \times 10^8$  lymphocytes with  $>98\%$  viability. If in vitro stimulation with antigen is planned, suspend the cells in hybridoma culture/cloning medium at  $10^7$  cells/mL density, add sterile antigen and adjuvant peptide to final concentrations of 1  $\mu\text{g}/\text{mL}$  and 20  $\mu\text{g}/\text{mL}$ , respectively, and incubate in a humidified 8%  $\text{CO}_2$  incubator for 3–4 d. During this culture period you should observe an increasing number of blasts (large, activated B cells), although overall viability of the culture will drop to 30–60%.
4. Fusion: for every  $10^8$  freshly harvested or in vitro stimulated lymphocytes, prepare  $6 \times 10^7$  Sp2 cells from log phase cultures. Centrifuge the Sp2 cells at 200g for 10 min and mix pelleted cells with lymphocytes in serum free HY in a 50-mL tube. Fill the tube with HY and centrifuge at 300g for 15 min. Suspend the pellet in a minimal volume of residual medium, and keep the tube at 37°C. Add 1 mL of PEG solution prewarmed to 37°C over 30 s with mixing. In the next 15 s, fill a 10-mL pipet with 12 mL serum-free HY. Over the next 45 s, deliver 3 mL of this medium to the fusion mix with gentle swirling, followed by the remaining 9 mL over the next 45 s. Fill the tube with medium and allow the cell suspension to rest at RT for 8 min. Pellet cells at 200g for 10 min, gently resuspend the pellet in residual medium by tapping, add 20 mL of fusion medium, transfer the suspended cells to a bottle, and add the remaining necessary amount of fusion medium (use 200 mL per  $10^8$  lymphocytes). Pour the cell suspension into a sterile trough and distribute 0.13 mL per well into 96 well plates using a multichannel pipettor. Incubate at 37°C and 8%  $\text{CO}_2$ . On days 5–6, examine randomly selected rows or columns of wells microscopically to determine the average number of hybridomas per well. Feed wells with 0.1 mL of hybridoma culture/cloning medium on day 7. Start harvesting supernatants from yellow wells around day 10.
5. Screening: Serum from test bleeds is used for developing the screening assay and for evaluating the immune response. Purified protein or peptide antigens can be conveniently tested by ELISA. Dispense 0.1 mL antigen at 1–10  $\mu\text{g}/\text{mL}$  in bicarbonate binding buffer into ELISA plate wells and incubate for several hours at RT, or overnight at 4°C (see **Note 5**).



Plates with antigen can be sealed and frozen for later use. Remove antigen and fill well with blocking solution (*see Note 6*). Incubate for 30 min at RT. Rinse wells with PBST, and dispense 90  $\mu\text{L}$  of serial dilutions (e.g., 1/300, 900, 2700, 8100, 24300, 72900) of immune serum into wells. Include nonimmune serum or no primary antibody as a negative control. Incubate for 45 min at RT. Wash three times 10 min each with PBST. Incubate 30 min at RT with an a manufacturer recommended dilution of secondary antibody (usually 0.1–1.0  $\mu\text{g}/\text{mL}$  in blocking solution), or determine optimal dilution by trying different concentrations and determining signal and background levels (*see Note 7*). Repeat wash steps. Prepare fresh solution of substrate and add 200  $\mu\text{L}$  per well. Allow reaction to develop and monitor absorbance using a multiplate reader with a 405 nm filter. Continue substrate reaction until negative control is just above substrate absorbance, and positive control has OD<sub>405</sub> of 1.0–2.0. The titer of serum is the dilution that gives half maximal signal. Titers of 20,000 to 50,000 are indicative of a good immune response, but positive hybridomas can be isolated from mice with lower titer. The same assay is used for screening hybridoma supernatants, with the immune serum acting as positive control. For cell surface antigens that cannot be purified easily, a cellular version of the ELISA can be used. If cells are adherent, culture them in microtiter plate wells. Centrifuge nonadherent cells ( $10^5$  cells/well) onto poly-L-lysine (10  $\mu\text{g}/\text{mL}$  in PBS, 30 min at RT) coated plates at 400g for 10 min. Fix with 4% formaldehyde freshly prepared from paraformaldehyde. Proceed with blocking and incubation steps as above. When it is necessary to screen against tissues, fix embryos in 4% formaldehyde, equilibrate with 10–20% sucrose, embed in OCT compound, freeze quickly, and cut 10  $\mu\text{m}$  sections in a cryomicrotome. Optimal temperature for frozen sections needs to be determined for each tissue, but is typically between  $-12$  and  $-25^\circ\text{C}$ . Transfer sections to subbed slides and store sections in a desiccated chamber at  $-80^\circ\text{C}$  overnight to improve attachment to the slide. The next day, warm up sections while in desiccator box, rehydrate 10 min in PBS at RT, and incubate with primary and secondary antibodies as above in a humid chamber. To make processing of large numbers of samples feasible, apply sections to subbed slides in a regular array and dry between sections to allow application of different primary supernatants on the same slide without mixing (*see Notes 8 and 9*). Wash 3X 10 min each with PBST. Incubate with a FITC conjugated secondary (*see Note 10*) antibody at 1/500–1/2000 dilution in blocker, repeat washes, and mount slides with a #1 cover slip and mounting medium. Examine slides immediately under an epifluorescence microscope to determine binding and specific tissue localization of antibodies.

6. Subcloning hybridomas by limiting dilution: Resuspend positive wells in 1 mL of hybridoma culture/cloning medium, and transferred to a tube. Confirm cell density (typically,  $2 \times 10^5$  cell/mL) and adjust if necessary. Perform three 1/10 dilutions to get a suspension at 200 cells/mL. Dilute 1.2 mL into 12 mL to get 20 cells/mL density. Distribute 0.12 mL of this suspension into half of a 96-well plate (2 cells per well). Add 6 mL of medium to remaining cells and distribute in the other half plate (1 cell per well). Microscopically score number of clones in all wells on days 4–6, feed with 0.1 mL of medium on day 7, and harvest and retest supernatants starting around day 10. Positive wells that were visually scored as single clones are considered monoclonal, but can be recloned by the same method for assurance. Expand positive monoclonal hybridomas to 20 mL of healthy culture, freeze several vials containing  $2 \times 10^6$  cells each, and continue expanding culture to desired volume and high cell density for optimal monoclonal antibody production. Test supernatants on other immune assays, such as Western blots, immunohistochemistry, immunoprecipitation, etc.

#### 4. Notes

1. Fetal bovine serum used for fusions should be tested for cloning efficiency of the parental myeloma. This test correlates well with number of hybridomas generated in a fusion. Obtain serum samples from reliable suppliers and test cloning efficiency of Sp2 cells in 5 and 10% serum containing medium. Do not use Origen cloning factor so as not to mask the growth characteristics of the serum. Use a dilution scheme similar to the one described in **Subheading 3.** for subcloning hybridomas, and count number of clones in wells between days 3–5.
2. Selection with azaserine is preferable to the older HAT selection because HA is less toxic than HAT, and does not encourage mycoplasma contamination associated with HAT. The yield of hybridomas is significantly higher with HA selection. Number of hybridomas produced from a fusion increases with the antigenicity of the material used. Typical expected yields under the conditions presented here, per  $10^8$  lymphocytes will range between 1000 hybridomas for a weak immunogen (e.g., conserved small peptide), to 10,000 hybridomas for strong immunogens (e.g., complex cellular mixtures from invertebrates).
3. PEG lots can differ in their fusion efficiency and toxicity, and should be tested to select a good lot. Sigma's PEG (cat. no. P7181) has generally yielded good results, but we have found other manufacturers and lots of PEG, such as Kodak 1450, to give high yields as well. However, many other sources of PEG have given significantly worse results. Compare PEG samples by performing test fusions with equal numbers of splenocytes from the same spleen, and count the number of hybridomas generated.
4. It is usually desirable to produce antibodies in Balb/c mice, because the Sp2 myeloma cells were derived from this strain and hybridomas can easily be grown as ascites in the host strain. However, MHC restriction of immune response sometimes makes Balb/c mice a weak responder. In this case, immunize two animals from several strains with different MHC backgrounds, evaluate the immune response, and choose the best responding strain.
5. In the case of peptide antigens, it is desirable to have a peptide that has been biotinylated at one of the termini. This conjugate can be used with streptavidin-coated plates to provide a high-affinity link to the solid phase. This method also presents the peptide antigen to the test antibody in an optimal, unhindered configuration.
6. Degree of blocking can be varied depending on the situation. Generally, milk and serum are considered to be strong blockers, because BSA and ovalbumin are considered medium blockers, and Tween 20 in the wash buffer can act as a weak blocker. Strong blockers produce lower background, and may require higher concentrations of secondary antibody for signal development. The danger of using a strong blocker is that sometimes the blocking reagent will compete with the noncovalent attachment of antigen to the plastic surface and dislodge it, resulting in false negatives. This is particularly true when the antigen is a small peptide. When using free peptides for ELISA screening, it is possible to perform the assay without a separate blocking step, relying on the serum in test supernatants, and Tween 20 in the wash buffer to provide adequate blocking. In this situation, higher dilutions of secondary antibody should be used to achieve acceptable signal to background ratios.
7. Typical absorbances in an optimized ELISA: The 0.05 for unreacted substrate, 0.1 for no primary antibody control (reflecting non-specific binding of secondary antibody), 0.15 for nonimmune serum control, and 1.5 for immune serum positive control. The dilution of serum can be at one half maximal signal point (providing the highest sensitivity to changes in assay optimization), or a factor of 2 more concentrated (providing a higher signal strength).

8. When working with tissue sections on slides, it is very important to make sure that the tissues do not dry out after the rehydration step. Accumulation of salts during the drying of thin PBS films will weaken antibody-antigen interactions and cause autofluorescence of the tissue.
9. For screening large numbers of supernatants on tissue sections or cultured cells, we have used a device that helps prevent mixing of reagents between different areas on the slide. This device consists of a solid plastic plate (5" × 5" × 1/2" thick) with four bolts threaded through it, that can accommodate two standard 1" × 3" microscope slides. Pieces of silicon rubber gasket with holes punched at distances matching multichannel pipet spacing are used on top of the slides to isolate each area containing tissue samples. If frosted slides are used, two rows of six holes can be made in the usable area of the slide. A second plastic plate with holes that match the rubber gasket openings is put on top of the assembly, and washers and wing nuts are used to clamp the assembly together and produce a watertight seal. Tissue sections must be placed in the areas defined by the openings in the gaskets. This device is needed only during the primary antibody incubation. Subsequent washes and secondary antibody incubation can be done on the whole slide.
10. FITC conjugated antibodies can produce strongly fluorescent aggregates that can interfere with the staining pattern. To avoid this problem pellet aggregates by centrifugation in a microfuge, or filter the solution through a 0.2- $\mu$ m filter just prior to use.

## References

1. Kolodkin, A. L., Matthes, D. J., O'Conner, T. P., Patel, N. H., Admon, A., Bentley, D., and Goodman, C. S. (1992) Fasciclin IV: sequence, expression and function during growth cone guidance in the grasshopper embryo. *Neuron* **9**, 831–845.
2. Bastiani, M. J., Harrelson, A. L., Snow, P. M., and Goodman, C. S. (1987) Expression of fasciclin I and II glycoproteins on subsets of axon pathways during neuronal development in the grasshopper. *Cell* **48**, 745–755.
3. Bedian, V., Oliver, C. E., McCoon, P., and Kaufman, S. A. (1986) A cell surface differentiation antigen of *Drosophila*. *Dev. Biol.* **115**, 105–118.
4. Bedian, V. and Jungklaus, C. E. (1987) Expression of the differentiation antigen F7D6 in tumorous tissues of *Drosophila*. *Dev. Genet.* **8**, 165–177.
5. Zipurski, S. L., Venkatesh, T. R., and Benzer, S. (1985) From monoclonal antibody to gene for a neuron-specific glycoprotein in *Drosophila*. *Proc. Natl. Acad. Sci. USA* **82**, 1855–1859.
6. Zipurski, S. L., Venkatesh, T. R., Teplow, D. B., and Benzer, S. (1985) Neuronal development in the *Drosophila* retina: monoclonal antibodies as molecular probes. *Cell* **36**, 15–26.
7. Nudelman, E., Hakomori, S., Knowles, B. B., Solter, D., Nowinski, R. C., Tam, M. R., and Young, W. W., Jr. (1980) Monoclonal antibody directed to the stage specific embryonic antigen (SSEA-1) reacts with branched glycolipid similar in structure to Ii antigen. *Biochem. Biophys. Res. Comm.* **97**, 443–451.
8. Aoyama, H., Asamoto, K., Nojyo, Y., and Kinutani, M. (1992) Monoclonal antibodies specific to quail embryo tissues: their epitopes in the developing quail embryo and their application to identification of quail cells in quail-chick chimeras. *J. Histochem. Cytochem.* **40**, 1769–1777.
9. Franke, W. W., Stehr, S., Stumpp, S., Kuhn, C., Heid, H., Rackwitz, H. R., Schnolzer, M., Baumann, R., Holzhausen, H. J., and Moll, R. (1996) Specific immunohistochemical detection of cardiac/fetal alpha-actin in human cardiomyocytes and regenerating skeletal muscle cells. *Differentiation* **60**, 245–250.

10. Wilcox, M., Browder, D. L., and Smith, R. J. (1981) A position-specific cell surface antigen in the *Drosophila* wing imaginal disc. *Cell* **25**, 159–164.
11. Ou, S. K., McDonald, C., and Patterson, P. H. (1991) Comparison of two techniques for targeting the production of monoclonal antibodies against particular antigens. *J. Immunol. Methods* **145**, 111–118.
12. Williams, C. V., Stechmann, C. L., and McLoon, S. C. (1992) Subtractive immunization techniques for the production of monoclonal antibodies to rare antigens. *BioTechniques* **12**, 842–847.
13. O'Doherty, U., Swiggart, W. J., Inaba, K., Yamaguchi, Y., Kopeloff, I., Bhardwaj, N., and Steinman, R. M. (1993) Tolerizing mice to human leukocytes: a step toward the production of monoclonal antibodies specific for human dendritic cells, in *Dendritic Cells in Fundamental and Clinical Immunology* (Kamperdijk et al., eds.), Plenum, NY, pp. 165–172.
14. Dalum, I., Jensen, M. R., Hindersson, P., Elsner, H. I., and Mouritsen, S. (1996) Breaking of B cell tolerance towards a highly conserved self protein. *J. Immunol.* **157**, 4796–4804.
15. Boss, B. D. (1984) An improved in vitro immunization procedure for the production of monoclonal antibodies against neural and other antigens. *Brain Res.* **291**, 193–196.
16. Lane, R. D., Crissman, R. S., and Ginn, S. (1986) High efficiency fusion procedure for production of monoclonal antibodies against weak immunogens, in *Methods in Enzymology*, vol. 121 (Langone, J. J. and Vunakis, H. V., eds.), pp. 183–192.

## Mesoderm Induction in *Xenopus*

### *Oocyte Expression System and Animal Cap Assay*

Jie Yao and Daniel S. Kessler

#### 1. Introduction

Vertebrate mesoderm forms a diversity of tissues, including notochord, somitic muscle, pronephros, mesenchyme, and blood. In the amphibian *Xenopus laevis*, mesoderm arises in the equatorial region (marginal zone) of the blastula embryo in response to inducing signals produced by vegetal pole cells (1). This model of *Xenopus* mesoderm induction is derived from tissue recombination experiments in which vegetal pole tissue (prospective endoderm) was cocultured with animal pole tissue (prospective ectoderm) and resulted in the conversion of animal pole tissue into mesoderm (2). Therefore, vegetal pole cells of the cleavage embryo secrete factors that can redirect animal pole cells from ectodermal fates to mesodermal fates. These studies identified the source of mesoderm-inducing signals (vegetal pole) and established the animal pole explant as a responsive tissue useful for identifying mesoderm-inducing factors (3–5).

*Xenopus* mesoderm induction is perhaps the most thoroughly examined example of vertebrate induction and a number of secreted factors have been identified that are capable of inducing mesodermal differentiation when applied to animal pole explants. The majority of the identified inducing factors belong to the transforming growth factor-beta (TGF $\beta$ ) family, including activin, nodal, Vg1, and bone morphogenetic proteins (BMPs), or the fibroblast growth factor family (FGFs) (1,6). The mesoderm inducers differ in the type of differentiated mesoderm produced: activin, nodal, and Vg1 induce dorsal mesoderm, including notochord and muscle; BMPs induce blood, a ventral mesodermal tissue; and FGFs induce dorsolateral mesoderm, including muscle and mesenchyme.

Based on the experiments of Nieuwkoop (2), the mesoderm induction assay we describe consists of two components: an animal pole explant capable of responding to inducers and a source of mesoderm-inducing factors. Animal pole explants, isolated from the “top” of blastula stage embryos (stages 8–9) (7), form ciliated epidermis when cultured in a simple saline solution, but are competent to form differentiated mesoderm when cultured in the presence of mesoderm-inducing factors. Sources of mesoderm-inducing factors are diverse and include crude tissue extracts, partially purified

biochemical fractions, and pure or recombinant proteins. Typically, animal pole explants are cultured in soluble preparations of protein or protein expression is directed within explant tissue by microinjection of *in vitro* transcribed mRNA encoding candidate inducers. Here we describe the use of *Xenopus* oocytes for the rapid production of highly active soluble preparations of mesoderm-inducing proteins (8,9). These methods provide a powerful bioassay for identifying proteins that induce mesodermal fates.

## 2. Materials (see Note 1)

1. MS222: 3-aminobenzoic acid ethyl ester (Sigma, St. Louis, MO).
2. Sutures: Cuticular 4-0 silk (683G, Ethicon, Bridgewater, NJ).
3. 1X OR2<sup>-</sup>: 82 mM NaCl, 2.5 mM KCl, 1 mM Na<sub>2</sub>HPO<sub>4</sub>, and 5 mM HEPES, pH 7.8. Prepare as 10X stock, autoclave, and store at room temperature (RT) for the preparation of 1X OR2<sup>-</sup>, 1X OR2<sup>+</sup>, and 1X OR2<sup>+</sup>/bovine serum albumin (BSA).
4. 1X OR2<sup>+</sup>: 1X OR2<sup>-</sup> supplemented with 1 mM CaCl<sub>2</sub> and 1 mM MgCl<sub>2</sub>. Filter sterilize and store at RT.
5. 1X OR2<sup>+</sup>/BSA: 1X OR2<sup>+</sup> supplemented with 0.5 mg/mL BSA (Fraction V, Sigma). Filter sterilize and store at RT.
6. Collagenase stock: 200 μL 1.0% BSA (Fraction V, Sigma), 200 μL 1% Soybean Trypsin Inhibitor (Type II-S, Sigma), and 400 μL 10% Collagenase (Type IA, Sigma). The individual components of the stock solution are prepared in 1X OR2<sup>-</sup>. Prepare 800 μL aliquots and store at -20°C.
7. Collagenase digestion solution: Combine 1200 μL of 1X OR2<sup>-</sup> and 800 μL of collagenase stock solution (a single aliquot). Final concentration of collagenase is 2% and 2 mL of the digestion solution is sufficient to defolliculate 1000 oocytes.
8. 0.1 M KH<sub>2</sub>PO<sub>4</sub>, pH 6.5: Prepare as a 1 M stock, autoclave or filter sterilize, and store at RT.
9. 50X Gentamicin (10 mg/mL, Gibco-BRL, Gaithersburg, MD): To prevent bacterial growth, supplement oocyte and embryo culture media at 0.2 mg/mL.
10. Human chorionic gonadotropin (Sigma): Resuspend in sterile water at a final concentration of 1000 U/mL. Stable for 2 wk stored at 4°C.
11. 1X MMR: 100 mM NaCl, 2 mM KCl, 1 mM MgSO<sub>4</sub>(7H<sub>2</sub>O), 5 mM HEPES Acid, 0.1 mM EDTA, and 2 mM CaCl<sub>2</sub>(2H<sub>2</sub>O), pH 7.8. Prepare as a 10X stock, autoclave or filter sterilize, and store at RT.
12. Dejelly solution: 3.5% L-Cysteine-HCl (Sigma), pH 7.9 (use NaOH pellets to adjust pH). The cysteine will come out of solution if exposed to air for 1–2 d so store in 100 mL bottles filled to the very top and cap tightly.
13. Hair knife: Eyebrow hair (slightly curved and tapered) is attached to a wooden-handled dissecting needle with melted wax or crazy glue (see Note 2).
14. Forceps: Dumont number 5 (Fine Science Tools, Foster City, CA).

## 3. Methods

1. Oocyte isolation: Immerse adult female in deionized water (see Note 1) supplemented with MS222 (2 mg/L) for 15 min and test for complete anesthetization by toe-pinch. Continue immersion until no response is detected and transfer frog to an ice-filled tray (an additional anesthetic for amphibians). Using a sterile scalpel, make a 1 cm incision through the skin and body wall muscle of the ventral–lateral abdomen. Gently withdraw a portion of the ovary (1–2 cm in length) through the incision, excise with fine scissors and place in a 100-cm Petri dish containing 1X OR2<sup>-</sup> (Fig. 1). Withdraw additional ovary pieces until 5–10 have been collected (sufficient to prepare 1000s of oocytes), return the ovarian tissue present at the incision to the abdominal cavity, and close the incision with single

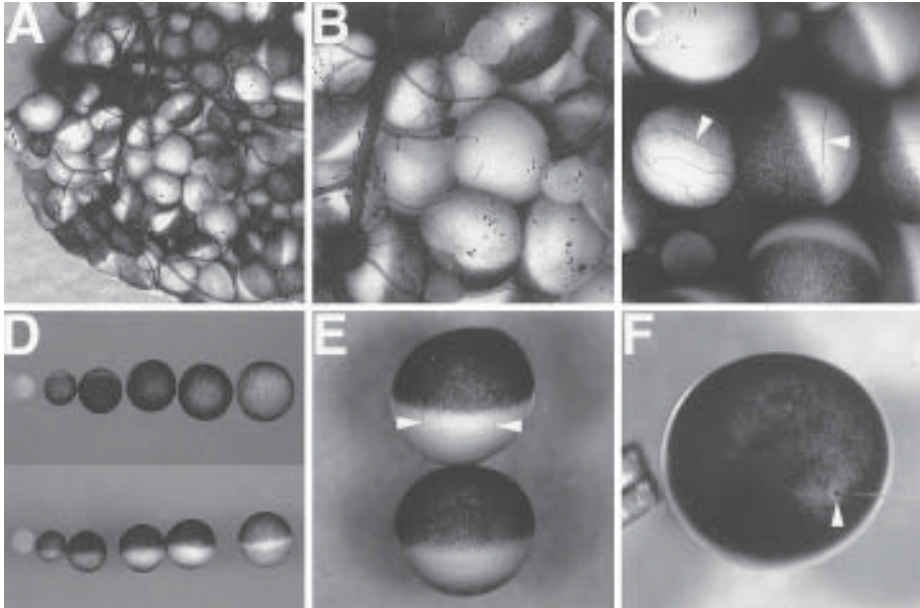

Fig. 1. Isolation and defolliculation of *Xenopus* oocytes. (A) Ovary fragment with oocytes contained within ovary membranes. (B) Higher magnification of (A) showing large blood vessels within ovary membranes. (C) Oocytes still attached to ovary membranes with capillaries of the follicle cell layer indicated (arrowheads). (D) Stage I–VI oocytes (left to right) viewed from the animal pole (top panel) and lateral aspect (bottom panel). The youngest oocytes (stage I) are unpigmented and pigmentation is present in stages II–VI. Only the largest oocytes (stages V–VI) are used for protein expression. (E) Individual oocytes before (top) and after (bottom) defolliculation. Note the presence of fine capillaries (arrowheads) before defolliculation, and their absence afterwards. (F) Withdrawal of the micropipet (right) following microinjection of a stage VI oocyte results in only a small wound (arrowhead) and no cytoplasmic leakage. Blunted forceps (left) are used to orient the oocyte for microinjection.

sutures in the muscle wall and skin using 4–0 silk. Allow the frog to recover in shallow water and return to isolation tank for 1 d of observation.

- Oocyte defolliculation: In the 100-mm Petri dish containing 1X OR2–, use forceps to tear ovary pieces into smaller fragments containing <50 oocytes each. This permits a more uniform digestion of the follicle cell layer. Transfer the ovary fragments into a 100-mL beaker and rinse 5X with 100 mL of 1X OR2– to remove blood, ovary membranes, and some of the smaller oocytes. Be sure to allow the larger ovary fragments to settle to the bottom before pouring off the medium. Prepare 4 mL of collagenase digestion solution (two aliquots of thawed collagenase stock solution plus 2.4 mL of 1X OR2–) and combine with ovary fragments in a 60-mm Petri dish (*see Note 3*). Incubate at RT on a horizontal shaker (50 rpm) for 1–2 h. Due to variability in the activity of collagenase lots, it is necessary to follow the digestion closely to determine the appropriate end point. After 30 min examine the oocytes under a stereo dissection microscope every 15 min. At first, individual oocytes enclosed in follicle cells will be released from the ovary fragment, and with continued digestion the follicle cells are removed from each oocyte. The fine capillaries present in the follicle cell layer are lost in fully defolliculated oocytes (**Fig. 1**). Once a majority of the oocytes are free of follicle cells, transfer to a 100-mL beaker

and rinse 5X with 100 mL of 1X OR2+. Replace 1X OR2+ medium with 0.1 M  $\text{KH}_2\text{PO}_4$  (pH 6.5) and incubate at RT for 10 min. Rinse oocytes once with 1X OR2+/BSA, transfer to a large glass crystallizing dish (150 mm diameter  $\times$  75 mm tall) containing 150 mL 1X OR2+/BSA supplemented with gentamicin (0.2 mg/mL), cover dish with plastic wrap and incubate at 19°C overnight. This overnight incubation permits healthy oocytes to recover from digestion whereas damaged oocytes will die. Damaged oocytes are wrinkled, flaccid (do not recover shape following a gentle touch with forceps), or have pigmentation that is swirled or speckled, and should be discarded.

3. Oocyte injection and culture: Select healthy large oocytes (stage V–VI, uniform pigmentation, resilient to the touch) and transfer to a 60-mm Petri dish containing 1X OR2+ (**Fig. 1**). For microinjection, we use a nitrogen gas driven system (PLI-100, Medical Systems, Greenvale, NY) and an Oxford micromanipulator (Micro Instruments, Oxford, UK). Glass capillaries (1.0 mm OD–0.58 mm ID, Sutter Instruments, Novato, CA) are pulled on a horizontal needle puller (P-87, Sutter Instruments) and the tip ground at a 20° angle (EG-40, Narishige, Tokyo, Japan). The final outer diameter of the needle is approx 5  $\mu\text{m}$ . Capped, in vitro transcribed RNA is prepared using the Message Machine kit (Ambion Inc., Austin, TX) and is resuspended in RNase-free water for injection. To avoid clogging of the needle it is important to spin the RNA at maximum speed in a microfuge (1 min) to pellet any particulates in the RNA. Inject each oocyte with a maximum of 50 ng of RNA in a maximum volume of 50 nL. Injection is performed on the stage of a stereo dissection microscope and approx 20 oocytes are loaded onto a siliconized glass slide in a large drop of 1X OR2+ using a large bore plastic Pasteur pipet. Use blunted Dumont forceps to maneuver and steady the oocytes for injection (**Fig. 1**). Following injection, oocytes are returned to a 60-mm Petri dish containing 1X OR2+/BSA and are allowed to recover for 1 h at 19°C. Damaged oocytes showing cytoplasmic leakage or non-uniform pigmentation are discarded.

To obtain high concentration conditioned supernatant, oocytes are transferred to a 96-well U-bottom cell culture dish. Fill each well with 100  $\mu\text{L}$  1X OR2+/BSA supplemented with gentamicin and transfer 10 oocytes per well being careful to minimize the addition of medium. To provide a negative control sample, set up wells containing uninjected oocytes. Incubate 2–4 d at 19°C and examine daily to monitor oocyte health. Excluding wells in which oocytes have lysed or leaked extensively, collect and combine conditioned supernatants and store at 4°C or –20°C depending on the sensitivity of the activity to freeze-thaw. We routinely inject 100–200 oocytes per RNA sample and collect at least 1 mL of conditioned and control supernatants.

4. Oocyte supernatant analysis: The production of secreted factors by oocytes can be analyzed by standard Western blotting if antibodies are available. Typically, 5  $\mu\text{L}$  of supernatant provides a strong signal for efficiently secreted factors. In addition, cellular expression can be examined by collecting oocytes after removal of supernatant, washing once in 1X OR2+, and preparing whole cell lysates for Western blot analysis. Alternatively, metabolic labeling of secreted factors can be used to detect secreted factors. For this approach, oocytes are cultured in 1X OR2+ (no BSA) supplemented with  $^{35}\text{S}$ -methionine (0.25 mCi/mL), supernatants are resolved by sodium dodecyl sulfate-polyacrylamide gel electrophoresis (SDS-PAGE), and labeled proteins are detected by autoradiography or fluorography. BSA is omitted from the medium because it is nonenzymatically linked to  $^{35}\text{S}$ -methionine, resulting in labeled BSA that may obscure the detection of expressed protein.
5. Fertilization of *Xenopus* eggs: Egg fertilization is performed in vitro using surgically removed testes. To isolate the testes, a male frog is lethally injected (upper hind-leg, subcutaneous) with MS222 (0.2 g in 0.5 mL water) and after 10 min use a toe-pinch to ensure complete anesthetization. With a sterile scalpel, make an incision across the lower abdomen through both the skin and body wall muscle. The testes are almost white, covered



with capillaries, and are attached to the base of the fat bodies, which are yellowish, multilobed, bilaterally positioned structures. Pull the fat body out of the body cavity to reveal the testes and then cut away from the fat body and connective tissue. Rinse and store the testes in a 60-mm Petri dish containing 1X MMR at 4°C. The sperm contained within the testes are viable for approx 1 wk.

Egg-laying by females is stimulated by subcutaneous injection of the upper hind-leg with human chorionic gonadotropin (0.75 mL at 1000 U/mL). If kept at RT after injection, egg-laying commences in 10 h and is accompanied by swelling and reddening of the cloaca. Eggs are collected in an empty crystallizing dish (80 mm diameter × 40 mm tall) by holding the hind limbs against the body and gently applying manual pressure to the abdomen. This procedure triggers a reflex that results in the release of hundreds of eggs and can be carried out once an hour for several hours without harming the frog. With a clean razor blade cut a small piece of testes (approx 2 mm), place in 0.5 mL deionized water in a 1.5-mL microtube, macerate with a pipet tip or microtube pestle, and pipet mixture directly onto eggs in dish. Following a 5-min RT incubation to allow sperm binding, flood the dish with 0.1X MMR (see **Note 1**). By approx 20 min postfertilization (pf), eggs will reorient in relation to gravity, resulting in an upward positioning of the pigmented animal pole which is less dense than the vegetal pole. First cleavage occurs 90 min pf and is followed by further cleavages every 30 min until the midblastula stage (see **Note 4**). The jelly coat can be removed at any time after egg reorientation by replacing the medium with dejelly solution (3.5% cysteine-HCl) and incubating at RT for 5–10 min with occasional gentle swirling. The dejelly solution is removed by rinsing 5X with 0.1X MMR. If the eggs clump together after rinsing, place in dejelly solution for an additional 5 min and rinse again in 0.1X MMR. Eggs that fail to reorient or cleave, or display an abnormal cleavage pattern should be discarded.

6. Preparation of animal pole explants: The approximate stage of a blastula embryo can be identified by viewing the animal pole from above and counting the number of blastomeres on a diameter. At stage 7 (early blastula, 7 h pf) approx 10 blastomeres are present, at stage 8 (midblastula, 8 h pf) approx 20 blastomeres, and at stage 9 (late blastula, 9 h pf) there are too many blastomeres to count easily (>50) (7). Explants are routinely prepared from mid- to late blastula stages (>20 blastomeres) (**Fig. 2**) (see **Notes 4** and **5**).

Transfer embryos into a 1% agarose-coated 60-mm Petri dish containing 0.5X MMR (see **Note 6**). Using forceps to orient the embryo, force the closed tips of one forceps through the vitelline membrane and into the vegetal pole. Tear open the vitelline membrane and vegetal pole by allowing the forceps tips to open. With the other forceps, grasp the transparent vitelline membrane at the animal pole and pull away from embryo. Use both forceps to open the vegetal pole until the inner surface of the animal pole is exposed (smaller, pigmented cells) and then use a hair knife (see **Note 2**) to cut away tissue surrounding the animal pole (**Fig. 2**). The surrounding tissue should be cut away soon after opening the embryo because the embryo will start to close up within minutes. Inexperienced individuals should open only 2–3 embryos before cutting away tissue whereas those with more experience routinely open 8–10 at a time. The animal pole explant is approx 400 μm × 400 μm (10 × 10 cells if prepared at stage 8) and should contain no unpigmented cells when viewed from the outer surface. Within 15 min the explant will begin healing and in 1 h forms a ball of tissue with cells from the exterior of the embryo covering the entire exposed surface of the explant (**Fig. 2**).

7. Culture of animal pole explants: To assess the mesoderm-inducing activity of an oocyte supernatant, or other source of inducer, explants are transferred into medium containing the inducer using a p200 pipetman with a wide bore tip (cut a standard tip 1 cm from end). Care must be taken to ensure that explants are not exposed to the liquid-air interface since

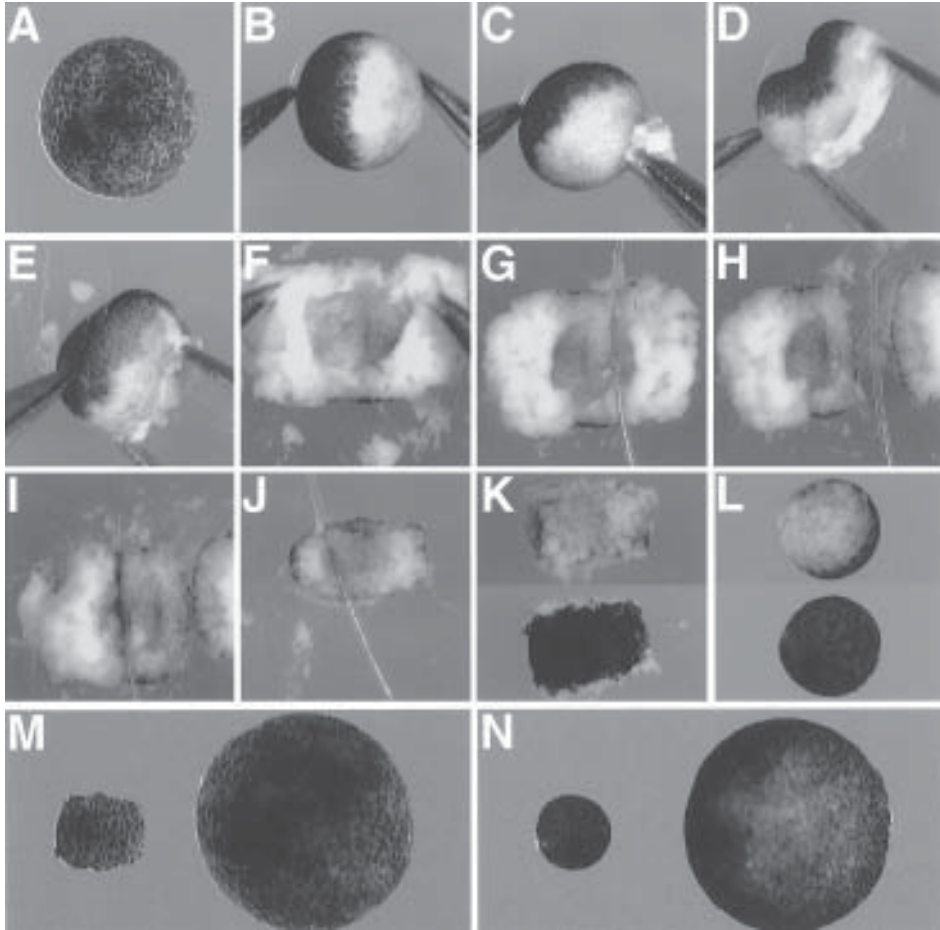

Fig. 2. Preparation of animal pole explant. (A) Animal view of a blastula embryo (stage 8) from which the explant is prepared. Note that approx 20 blastomeres are present along a diameter across the animal pole. (B) Use forceps to reorient the embryo. (C) Push forceps through vitelline membrane and into vegetal pole. (D) Open forceps tips to tear open the vitelline membrane and vegetal pole. (E) Pull transparent vitelline membrane away from embryo using other forceps (left). (F) Use both forceps to pull and cut open embryo to expose the inner surface of the animal pole. (G–J) Cut away tissue surrounding animal pole using a hair knife. If prepared from a stage 8 embryo, the final explant is approx 10 cells  $\times$  10 cells. (K) The inner (top) and outer (bottom) surface of the explant immediately after preparation. (L) Following 30 min of incubation, the explant has formed a ball of tissue with a decreasing amount of exposed inner tissue (top) and increasing coverage of the explant with outer tissue (bottom). (M) A comparison of an explant (left) to an intact embryo (right) immediately after explant preparation. (N) A comparison of an explant (left) to an intact embryo (right) 1 h after explant preparation.

the surface tension will lyse the explants. To avoid lysis, draw a “cushion” of medium into the pipet tip both before and after drawing explants into tip, and quickly move tip into the medium of the recipient well without drawing air into tip. Gently expel explants and dislodge any explants sticking to the inner surface of tip by gently drawing medium back into tip. It is important to transfer explants into the inducer solution before healing because

only the inner surface cells can respond to inducer. Distribute explants in the well so that explants do not come into contact which would lead to fusion of explants.

To conserve the oocyte supernatants, explants are cultured in 1% agarose-coated wells of a 48-well culture dish (see **Note 6**) containing a minimum of 200  $\mu\text{L}$  of solution. If the source of inducer is abundant or very high specific activity, it is easier to culture explants in 0.5 mL in a well of a 24-well culture dish. Oocyte supernatants are diluted at least 1:1 in 0.5X MMR and often display activity even when diluted 1:1000 or more (**9**). To determine the activity of a given supernatant we routinely prepare dilutions between 1:3 and 1:1000 with three- or fivefold increments. Prepare a minimum of 6–8 explants for each well and include a control well in which explants are cultured in uninjected oocyte supernatant at a dilution equal to the highest dose used for other supernatants. To determine the stage of the explants, culture at least 10 intact embryos from the same fertilization in 0.1X MMR at the same temperature as explants. If the response of explants is to be examined at different stages of development, prepare 6–8 explants for each time point. For culture of explants overnight, add 2–3 volumes of 0.5X MMR supplemented with gentamicin following 4 h of culture in inducer (see **Note 4**).

8. Assessment of mesoderm induction: The response of animal pole tissue to inducers can be assessed in several ways including morphological, histological, and molecular analyses. The morphological response to mesoderm induction is first observed during neurula stages and is maximal at tailbud stages. Uninduced explants remain spherical and dorsal mesodermal cell types undergo extensive cell movements, resulting in elongation of the explant. Strong dorsal inducers such as activin, Vg1, and nodal induce extreme elongation, resulting in a long cylindrical shape (**Fig. 3**) (**5,9**). FGFs induce less vigorous cell movements with explants forming an oblong shape, and the ventral mesoderm induced by BMPs does not undergo substantial cell movements. Histological analysis is used to examine the formation of differentiated mesoderm in tailbud stage explants. Standard methods are used for fixation, embedding in paraplast, and preparation of 10  $\mu\text{m}$  sections, which are developed with standard stains such as hematoxylin and eosin (H&E) (**10**). To provide a positive control for the presence and staining character of mesodermal tissues, stage-matched sections of intact embryos (same fertilization as explants) should be prepared. The presence of differentiated mesoderm can also be detected using a variety of tissue-specific antibodies, which function in both whole-mount and section immunocytochemistry protocols (**11,12**).

A number of methods are available for the detection of mesoderm-specific gene expression that are routinely used to assess mesoderm induction in explants. These methods are particularly important in examining the early response to induction because the initial gene expression changes occur at the gastrula stage, long before detectable tissue differentiation. For example, the pan-mesodermal marker brachyury is widely used as a gastrula-stage response to mesoderm induction (**13**). Given that approx 1  $\mu\text{g}$  of total RNA can be recovered from a single animal pole explant, a group of 6–8 explants yields sufficient RNA for standard analyses including northern blotting and RNase protection. However, when it is necessary to assess the expression of multiple markers, RNA yield may become limiting for these approaches. Therefore, reverse transcription-polymerase chain reaction (RT-PCR) has become widely used because of the requirement for minimal starting material and the great sensitivity of detection (**14**). A typical RT of 2–3  $\mu\text{g}$  of total RNA will yield enough cDNA template to assay the expression of more than 10 markers. Finally, whole-mount or section *in situ* hybridization can be used to detect the gene expression response to mesoderm induction (**15**). For all of these methods, it is important to examine gene expression in control explants (treated with uninjected oocyte supernatant) and in intact embryos which serve as negative and positive controls, respectively.

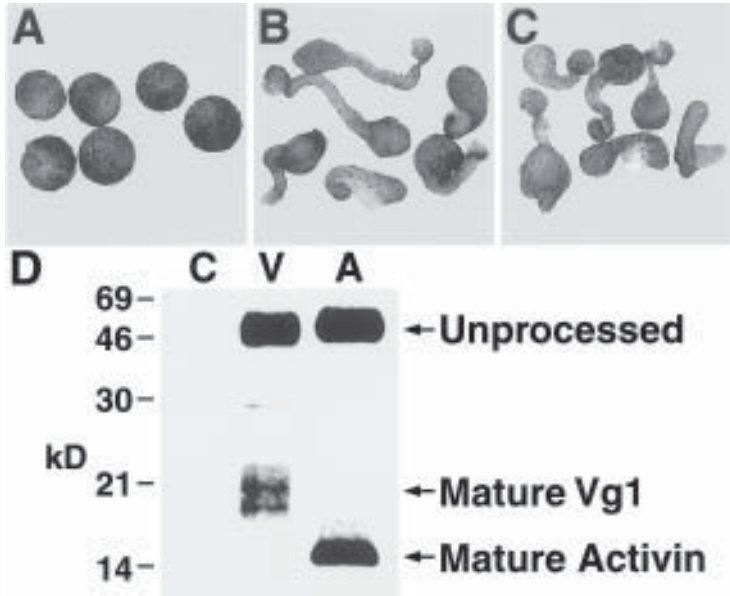

Fig. 3. Mesoderm induction by conditioned supernatants of injected oocytes. Animal pole explants were prepared at the blastula stage (stage 8) and cultured in oocyte supernatants until the tailbud stage (stage 22). (A) Explants cultured in uninjected oocyte supernatant remained spherical, whereas supernatants conditioned with Vg1 (B) or activin (C) induced a dramatic elongation of the explant, a morphogenic response indicative of dorsal mesoderm formation. In these experiments, the dilutions used were 1:3 for the control supernatant, 1:10 for the Vg1 supernatant, and 1:100 for the activin supernatant. (D) Oocytes were metabolically labeled with  $^{35}\text{S}$ -methionine (0.25 mCi/mL), 10  $\mu\text{L}$  of conditioned supernatant was resolved by 15% SDS-PAGE, and labeled protein was detected by autoradiography. Mature Vg1 (lane V) was expressed as a pair of distinctly glycosylated products of approx 18 kDa and mature activin (lane A) was a 14-kDa unglycosylated product. In addition, for both Vg1 and activin this high-level expression results in secretion of unprocessed precursor as well (approx 46 kDa). No products were detected in the uninjected oocyte supernatant (lane C), but longer exposure revealed a series of endogenous secreted proteins, none of which was synthesized at the high levels observed for injected Vg1 and activin.

#### 4. Notes

1. Water quality is perhaps the most critical factor in successfully working with amphibian embryos and explants. At a minimum, deionized water should be used in preparing all solutions and, if available, reverse osmosis purified water is preferable. Adults should be maintained in deionized water supplemented with sea salts because tap water in many parts of the country can be lethal to *Xenopus*.
2. It may be necessary to sample the eyebrow hairs of both colleagues and family to obtain a useful hair knife. The hair must not be too curly or thick, nor can it be too thin or soft. The ideal hair has approx  $30^\circ$  bend (base to tip), tapers to the end, and has some stiffness. It has been suggested that nose hairs make the best hair knives, but none will confirm it (G. Thomsen, personal communication). A recently introduced high-tech alternative to the traditional hair knife is the Gastromaster (Xenotek, 800-260-5656, [www.gastromaster.com](http://www.gastromaster.com)), a microsurgical instrument that uses a platinum wire tip to cut embryonic

tissues. This is not as gentle or precise as a hair knife, but the Gastromaster permits much more rapid preparation of explants, which may be essential for large-scale experiments.

3. Collagenase activity is inhibited by calcium and magnesium so it is crucial that oocytes are not exposed to medium containing calcium and magnesium until follicle cell digestion is complete. At that point, the use of medium supplemented with calcium and magnesium will inhibit the residual collagenase and prevent overdigestion.
4. *Xenopus* embryos and explants thrive when cultured at 16–24°C. Within this range, increasing or decreasing the temperature will effect the rate of development without effecting survival. At higher temperatures (22–24°C), development proceeds at approximately twice the rate observed at the low temperature (16°C), and therefore, temperature can be used to control the timing of development. Temperature fluctuations can be detrimental to normal development and can make it difficult to predict the rate of development, so for intensive use, it is best to culture embryos in incubators.
5. Animal pole explants are competent to respond to mesoderm inducers from the early blastula stage until the early gastrula stage (stage 10.5) (16). To accurately assess the mesoderm-inducing activity of a given factor, explants must be prepared and transferred into inducer solution at least 1 h before the end of competence and before healing of the explants has occurred.
6. The thickness of the agarose coating in dissection dishes and in culture wells differs in an important way. For the 60 mm Petri dish used for explant preparation, the bed of 1% agarose should be at least 0.5 cm thick since it must provide a resilient surface on which cutting pressure can be applied. In addition, the presence of agarose prevents sticking of explants to the plastic surface of the dish. In the wells of the culture dishes a thin, flat coating of agarose is achieved by adding molten agarose to the well and immediately removing as much as possible. By keeping the depth of the agarose coating to a minimum, a meniscus does not form, thus avoiding the presence of a central low point into which explants would collect and fuse. Any contact between healing explants will result in fusion of the combined explants which can interfere with an accurate assessment of mesoderm induction at the morphological level. Contact between explants is avoided by using a thin agarose coating and by keeping the explants well distributed and separated in the well. If explants have started to fuse, a hair knife can be used to gently cut the explants apart.

## Acknowledgment

This work was supported in part by grants from the NIH (HD35159), the American Digestive Health Foundation, and the Pew Scholars Program in the Biomedical Sciences.

## References

1. Kessler, D. S. and Melton, D. A. (1994) Vertebrate embryonic induction: mesodermal and neural patterning. *Science* **266**, 596–604.
2. Nieuwkoop, P. D. (1969) The formation of mesoderm in urodelean amphibians. I. Induction by the endoderm. *Roux Arch. EntwMech. Org.* **162**, 341–373.
3. Geithe, H. P., Asashima, M., Asahi, K. I., Born, J., Tiedemann, H., and Tiedemann, H. (1981) A vegetalizing inducing factor. Isolation and chemical properties. *Biochim. Biophys. Acta* **676**, 350–356.
4. Born, J., Geithe, H. P., and Tiedemann, H. (1972) Isolation of a vegetalizing factor. *Hoppe-Seylers Z. Physiol. Chem.* **353**, 1075–1084.
5. Symes, K. and Smith, J. C. (1987) Gastrulation movements provide an early marker of mesoderm induction in *Xenopus laevis*. *Development* **101**, 339–349.

6. Heasman, J. (1997) Patterning the *Xenopus* blastula. *Development* **124**, 4179–4191.
7. Nieuwkoop, P. D. and Faber, J. (1967) Normal Table of *Xenopus laevis* (Daudin), 2nd ed., North Holland Publishing, Amsterdam, The Netherlands.
8. Gurdon, J. B., Lane, C. D., Woodland, H. R., and Marbaix, G. (1971) Use of frog eggs and oocytes for the study of messenger RNA and its translation in living cells. *Nature* **233**, 177–182.
9. Kessler, D. S. and Melton, D. A. (1995) Induction of dorsal mesoderm by soluble, mature Vg1 protein. *Development* **121**, 2155–2164.
10. Kelly, G. M., Eib, D. W., and Moon, R. T. (1991) Histological preparation of *Xenopus laevis* oocytes and embryos, in *Methods in Cell Biology*, Vol. 36 (Kay, B. K. and Peng, H. B., eds.), Academic, San Diego, CA, pp. 389–417.
11. Hemmati-Brivanlou, A. and Harland, R. M. (1989) Expression of an *engrailed*-related protein is induced in the anterior neural ectoderm of early *Xenopus* embryos. *Development* **106**, 611–617.
12. Bolce, M. E., Hemmati-Brivanlou, A., Kushner, P. D., and Harland, R. M. (1992) Ventral ectoderm of *Xenopus* forms neural tissue, including hindbrain, in response to activin. *Development* **115**, 681–688.
13. Smith, J. C., Price, B. M. J., Green, J. B. A., Weigel, D., and Herrmann, B. G. (1991) Expression of a *Xenopus* homolog of *Brachyury* (*T*) in an immediate-early response to mesoderm induction. *Cell* **67**, 79–87.
14. Wilson, P. A. and Melton, D. A. (1994) Mesodermal patterning by an inducer gradient depends on secondary cell-cell communication. *Curr. Biol.* **4**, 676–686.
15. Harland, R. M. (1991) *In situ* hybridization: an improved whole mount method for *Xenopus* embryos, in *Methods in Cell Biology*, Vol. 36 (Kay, B. K. and Peng, H. B., eds.), Academic, San Diego, CA, pp. 675–685.
16. Jones, E. A. and Woodland, H. R. (1987) The development of animal cap cells in *Xenopus*: a measure of the start of animal cap competence to form mesoderm. *Development* **101**, 557–563.

## Amphibian Organizer Activity

Christof Niehrs

### 1. Introduction

The amphibian *organizer* corresponding to the upper dorsal *blastopore lip* of the early *gastrula*, is one of the classical systems in which embryonic patterning has been studied (1). Its two major inducing activities are *neural induction* and *dorsalization* of ventral *mesoderm* differentiation. Organizer activity is revealed either by transplantation of the upper dorsal blastopore lip into the ventral side of a host gastrula or by inserting the tissue into the gastrula blastocoel (Einsteck method). This results in the formation of an induced structure which, depending on the embryonic stage of the upper blastopore lip, is a head, trunk, or a tail. While the Einsteck is much easier to perform than the organizer transplant, the position of the implant can be less well controlled, which needs to be considered when interpreting the results (2). However, the Einsteck can be also carried out with heterologous material, cell pellets, and injected animal caps (3,4) and is more versatile than the organizer transplant.

The hallmark of organizer activity is that host cells are recruited and “organized” into the induced structures, whereas donor cells mostly contribute to the dorsal mesodermal tissues (notochord, muscle) within the induced tissue. To distinguish between donor and host cells, donor cells are typically labeled with a *lineage tracer*. The mechanism of action of inducers expressed in the organizer involves inhibition of *BMP*- and *Wnt* signaling (1,5,6). In this chapter, the organizer transplant and the *Einsteck* method will be described. For further details on staging and morphological details of *Xenopus* embryogenesis, the normal table should be consulted (7).

### 2. Materials

1. Two or more hair knives are prepared by pulling out eyebrow hairs and selecting the thinnest and least curved ones. Baby hair is said to work very well as are fine thorns of certain cacti. The hairs are inserted into the end of a syringe needle, whose tip has been removed by drilling it off with a pair of pliers. The hair is fixed in place with molten wax or glue. Excess wax can be removed by blotting it into a Kleenex placed on a hot surface.
2. Two Dumont no. 5 watchmaker forceps (Fine Science Tools, Foster City, CA).
3. 5 cm Petri dishes, bacteriology grade.
4. 5 cm Petri dishes filled with a bed of 5 mL 1% agarose in 0.1X modified Barth’s saline (MBS). Hemispherical holes of the size to hold an embryo are made with the heated tip of a Pasteur pipet which is flamed to a small ball.

From: *Methods in Molecular Biology*, Vol. 137: *Developmental Biology Protocols*, Vol. III  
Edited by: R. S. Tuan and C. W. Lo © Humana Press Inc., Totowa, NJ

5. 5 cm Petri dishes filled with dark plasticine (colored clay from toy shops). Small hemispherical depressions are made with a Pasteur pipet that was flamed to a small ball to fit embryos. Make several indentations and of different size, the diameter of embryos may vary.
6. Modified Barth's saline (1X MBS): 88 mM NaCl, 1.0 mM KCl, 0.41 mM CaCl<sub>2</sub>, 0.33 mM Ca(NO<sub>3</sub>)<sub>2</sub>, 0.82 mM MgSO<sub>4</sub>, 2.4 mM NaHCO<sub>3</sub>, 10 mM HEPES, pH 7.4. A 10X MBS solution can be kept at 4°C for several months. Use 20 mg/L oxytetracycline, Pen-Strep, or similar antibiotics are added to working solutions.
7. MEMFA fixative: 2 mM EGTA, 1 mM MgSO<sub>4</sub>, 0.1 M MOPS, pH 7.4, 3.7% formaldehyde. A 10X salt solution without formaldehyde can be stored at -20°C, but the final fixative should be made up fresh.
8. Tetramethylrhodamine-dextrane-amine (RDA) 10,000 MW (Molecular Probes, Eugene, OR, D-1817) for lineage labeling. A stock solution of 10 mg/mL in water is stored at -20°. The quality of the dye varies with batches and some can be toxic following injection; this should be tested before. If the batch is toxic it can be cleaned as follows. Add to 100 µL 50 mg/mL RDA in water 50 µL Qiaex (Qiagen, Chatsworth, CA) glass beads (for DNA purification) and 200 µL ethanol, mix. Add 1 mL ethanol and heat 5' 50°C, spin beads briefly, discard supernatant. Wash beads with 1 mL chloroform, spin, discard supernatant. Wash 2X 1 mL ethanol, dry beads. Because the yield is approx 30%, add 30 µL water, heat 5' 50°C, spin beads briefly, collect supernatant containing purified RDA. The exact yield can be determined photometrically.
9. Ethanol, 2-propanol, paraplast, 2-propanol/paraplast (1:1) embedding molds, if histology is desired.

### 3. Methods

#### 3.1. Organizer Transplant

1. Following in vitro fertilization, *Xenopus* early gastrulae (stage 10–10.5 [7]) are obtained after about 10 h at room temperature and 15 h at 15°C. It is therefore advisable to fertilize embryos in the afternoon before the day of transplantation, to dejelly and keep them at 15°C. Embryos are cultivated in 0.1X MBS. Try to make a series of different stages of embryos to have gastrulae over a few hours. This can be done either by multiple small fertilizations or by putting batches of embryos at 15° at 1 h interval. If donor and host contributions are to be distinguished, donors may be labeled by microinjecting every blastomere of 4-cell embryos into the equatorial region with 5 nL 10 mg/mL RDA. Light exposure of RDA-containing embryos should be minimized to avoid bleaching of the dye.
2. Two gastrulae are transferred into plasticine-lined Petri dishes containing 1X MBS. Using two watchmaker forceps the vitelline envelope is removed without damaging the embryo (see **Notes 1** and **3**).
3. To excise the upper dorsal blastopore lip place the donor embryo on its animal side and flatten it by gently touching with a hair knife. The crescent shaped pigment aggregation indicates the dorsal lip. Cut out a piece of the upper lip with hair knives (as in **Fig. 1**). Do not saw or press while cutting, the cleanest cuts are obtained with a tugging movement. Remember the animal and vegetal sides of the explant.
4. Prepare a host by removing an approximately equal piece from the opposite, ventral side. Place the host into a plasticine depression with the wound facing up. Carefully, insert the dorsal lip into the wound, observing the correct animal–vegetal orientation. Place a small piece of broken cover glass on top as weight to facilitate healing. Transfer the transplanted embryos after about 30 min into the depression of an agarose lined dish containing 0.1X MBS by sucking them into a mouth pipet or by using a cutoff blue tip. Avoid any air bubbles or air contact with embryos or explants, as this will destroy them (see **Note 2**).



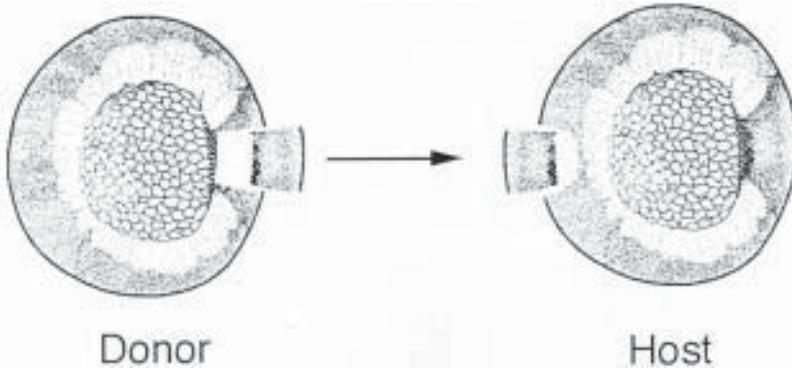

Fig. 1. Stage 10 gastrulae shown in vegetal view, dorsal side facing to the right up. The transplantation of the upper dorsal blastopore lip is schematically shown.

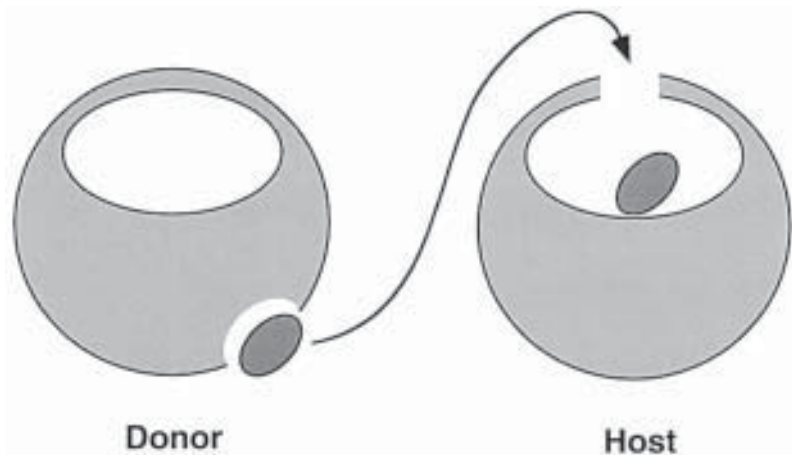

Fig. 2. Schematic drawing of the Einsteck method. The transplantation of an organizer piece into the blastocoel of a host gastrula is shown.

- Two days after the operation, an induction should be clearly seen which is frequently of trunk-type under these conditions. To obtain head inductions (**Fig. 2**) very early blastopore lips have to be used (**Fig. 3**) (stage 10) (*see Notes 4 and 5*).

### 3.2. Einsteck Method

- Follow **Subheading 3.1., steps 1–3**.
- The host embryo is placed into a depression with the animal pole facing up. A small slit is made into the animal pole with a hair knife. The transplant is inserted through the slit into the blastocoel. After 30 min transplanted embryos are transferred into 0.1X MBS.
- After 2 d, an induction should be seen, which is often located ventral of the head, close to the heart, where the blastocoel ends up.

### 3.3. Histological Analysis

- For fixation of injected RDA an aldehyde containing fixative should be used. Transfer embryos into a flat bottom vial (e.g., 1 mL screw cap glass vial), remove most of the Barth

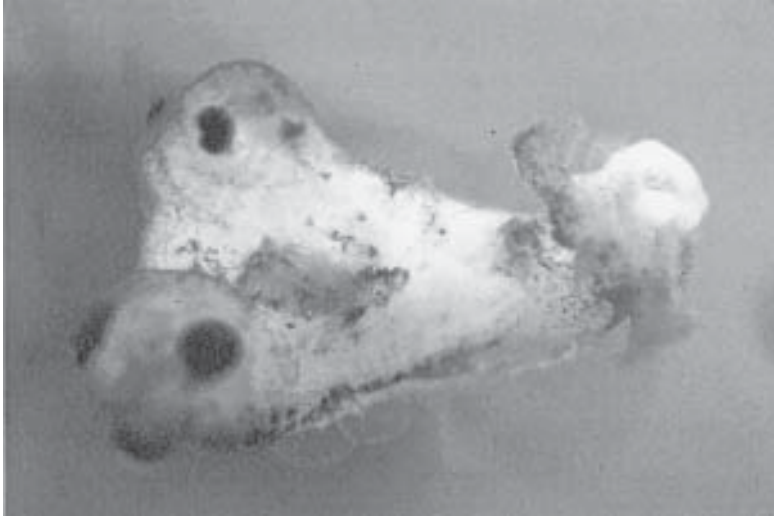

Fig. 3. Secondary axis induced following transplantation of the dorsal blastopore lip to the ventral side of a host embryo (courtesy of E. M. De Robertis). The embryo shows a complete secondary head with eyes and cement gland.

solution. Embryos are fixed in MEMFA at room temperature for at least 2 h or longer with agitation. Longer fixation will not affect them.

2. Embryos are dehydrated by 1 h or longer incubations each in 50% and 70%, ethanol and finally 2X 100% 2-propanol.
3. Pour embryos into embedding molds. Add molten 2-propanol/paraplast slurry (60–65°C). Incubate 1 h or longer in oven at 60–65°C. Replace with 100% paraplast at 60–65°C and incubate over night.
4. Transverse sectioning is advised to allow easy identification of secondary induced axes. Orient embryos for embedding, e.g., using a steel or glass needle, which is frequently heated with a Bunsen burner to avoid paraplast solidifying on the tool. To orient embryos with their head or tail down cool the plastic mold bottom by touching a cold surface. The solidifying paraplast on the bottom aids in stabilizing the embryos. Once the surface is solidified place the mold into a tray with cold water. Cut about 10  $\mu\text{m}$  sections on a microtome. Dewax in 100% Xylene and embed in Canadabalsam or similar mounting media.

#### 4. Notes

1. Removal of the vitelline envelope may be difficult at first try as it is hard to see. It is important to have fine forceps with precisely fitting tips. The membrane is grasped with the right forcep and pulled open with the left one. Slight puncturing of the animal cap may help and is not harmful.
2. Problems in embryo healing may be owing to too different size or shape of donor tissue and receiving wound in organizer transplants.
3. Gastrulae should not be kept for too long in 1X Barth as they tend to exogastrulate.
4. Small pieces of foreign tissue fragments as well as cell and protein pellets can also be inserted into the gastrula blastocoel to test their inductive effect.
5. Different clutches of embryos may not respond equally well and different frogs may therefore be tested.

## References

1. Lemaire, P. and Kodjabachian, L. (1996) The vertebrate organizer: structure and molecules. *Trends Genet.* **12**, 525–531.
2. Slack, J. M. and Isaacs, H. V. (1994) The Einsteck-method: position and structure of projections formed by implants of a ventral character. *Dev. Biol.* **161**, 313–317.
3. Ruiz i Altaba, A. and Melton, D. A. (1989) Interaction between peptide growth factors and homeobox genes in the establishment of antero-posterior polarity in frog embryos. *Nature* **341**, 33–38.
4. Cho, K. W., Morita, E. A., Wright, C. V., and De, R. E. (1991) Overexpression of a homeodomain protein confers axis-forming activity to uncommitted *Xenopus* embryonic cells. *Cell* **65**, 55–64.
5. Moon, R. T., Brown, J. D., Yang-Snyder, J. A., and Miller, J. R. (1997) Structurally related receptors and antagonists compete for secreted wnt ligands. *Cell* **88**, 725–728.
6. Glinka, A., Wu, W., Onichtchouk, D., Blumenstock, C., and Niehrs, C. (1997) Head induction by simultaneous repression of Bmp and wnt signalling in *Xenopus*. *Nature* **389**, 517–519.
7. Nieuwkoop, P. D. and Faber, J. (1967) *Normal Table of *Xenopus laevis**. North Holland, Amsterdam, The Netherlands.

## Improved Techniques for Avian Embryo Culture, Somite Cell Culture, and Microsurgery

David S. Packard, Jr., Christopher Cox, and Thomas J. Poole

For more than a century, avian embryos have been used in the study of development. Yet, as research techniques improve, there is increased need for animal models that exhibit excellent development *in vitro* and are easily accessible for observations, manipulations, and cell culturing. Herein, we describe improved techniques (1) for culturing avian embryos on a transparent substratum, (2) for microsurgery and transplantation of avian embryo tissues, and (3) for the *in vitro* cultivation of avian somite cells.

### 1. Protocol 1: Culturing Avian Embryos

#### 1.1. Introduction

The technique of culturing avian embryos on semisolid nutritive substrata was first introduced by Waddington (1). He mixed an extract from minced avian embryos with blood plasma from an adult bird. The plasma soon clotted to form a fairly firm clot. Duck or chicken embryos were successfully cultured on these clots. Spratt (2) first suggested the use of agar as a substratum. He combined the agar with a diluted egg extract to provide an opaque, nutritive substratum. Britt and Herrmann (3) showed that increasing the concentration of the egg extract in the agar substratum and increasing the size of the blastoderm explanted with the embryo led to more rapid rates of protein synthesis. Klein, McConnell, and Riquier (4) found that incubating such cultures in high oxygen atmospheres led to improved development. Packard and Jacobson (5) mixed the agar with chicken egg yolk-albumen supernatant, at a ratio of one part 6% agar to three parts egg supernatant, to produce a relatively transparent substratum, which greatly improved visualization of the cultured embryo. Furthermore, rather than using a salt solution for the liquid medium that surrounds the embryo as it rests on the agar-containing substratum, Packard and Jacobson substituted fresh yolk-albumen supernatant and obtained excellent development in an atmosphere of 95% oxygen and 5% carbon dioxide. Here, we provide a detailed description of this technique along with a further modification designed to provide excellent development on a thin, more transparent substratum of agar, undiluted albumen, and glucose (6,7). To select the avian embryo

culture technique most suitable for your research, we recommend reading the discussions of Selleck (8) and Darnell and Schoenwolf (9).

Advantages:

- Excellent development of embryos placed in culture at the intermediate primitive streak (stage 3; Hamburger and Hamilton [10]) to somite stages for at least 24 h.
- Excellent visualization of the embryo for experimental manipulations.
- Permits frequent observation of the embryo.
- Extensive surgical interventions are facilitated (i.e., no wound gaping) by the absence of the vitelline membrane and the concomitant reduction in mechanical tension within the embryo because of the absence of an expanding blastoderm.
- Experimental materials may be readily added to the fluid medium or injected into the embryo's functioning vascular system.
- Cultured embryos are readily available for histological or immunochemical procedures.
- Relatively inexpensive.

Limitations:

- Limited development when starting with embryos younger than Hamburger–Hamilton stage 3.
- Not suitable for studies requiring more than 40–48 h of development.
- CNS abnormalities may occur, possibly related to the reduced expansion of the embryo's blastoderm.
- The precise chemical composition of both the substratum and the liquid medium are unknown.

## 1.2. Materials

1. Purified agar (e.g., Sigma A 5306).
2. Glucose.
3. Howard's saline (11): 7.2 g NaCl, 0.17 g CaCl<sub>2</sub>, 0.37 g KCl, 1 L distilled water. Autoclave or filter the solution for sterility.
4. Liquid albumen from five chicken eggs.
5. 125-mL sterile Erlenmeyer flask.
6. 125-mL sterile Erlenmeyer flask, graduated (mL ± 5%).
7. Sterile wide-mouth 500-mL Erlenmeyer flask (2), stopper no. 10.
8. Sterile glass Petri dish bottoms, 60 mm.
9. Sterile small glass finger bowls about 12 cm in diameter (or autoclavable plastic containers of similar dimensions).
10. Thermometer, 0–100°C.
11. Histological slide warming table or suitable substitute.
12. Cheesecloth (such as cheesecloth wipes from Thomas Scientific, Swedesboro, NJ) cut into 15 cm squares and autoclaved.
13. 35 × 10-mm disposable, clear, polystyrene tissue-culture dishes.
14. Super fine, stainless steel forceps with straight points (e.g., Dumont style L5, Fine Science Tools): *see Subheading 1.4., Note 1.*
15. Wide-mouth pipets: Use 5 mL plastic, disposable transfer pipets (e.g., Falcon polyethylene). Widen the openings to approximately 5 mm diameter by removing the tips with sterile scissors. Alternatively, such pipets can be made from 8-mm OD glass tubing with 1-mm wall thickness, pipet mouth is approx 5 mm in diameter, overall length about 15 cm, use rubber or Neoprene bulbs.
16. Sterile, disposable Pasteur pipets.
17. Sterile, round bottom 50-mL centrifuge tubes (glass, polypropylene, or polystyrene).

18. 95% O<sub>2</sub>, 5% CO<sub>2</sub> (medical gas).
19. Glass dessicator jar with specimen plate (e.g., Corning Pyrex, flange inside diameter = 250 mm).
20. Two stage oxygen pressure regulator with a shut-off valve following the second stage.
21. Tubing, Tygon, laboratory grade, 1/4 in. bore, 3/8 OD.
22. Rubber or Neoprene stopper.
23. Glass or rigid plastic tubing, 8-mm OD, 1-mm wall.
24. Stopcock grease.
25. Incubator, 0–50°C.
26. Glass Petri dish, 100 mm × 15 mm.
27. Hot plate, Bunsen burner, or autoclave.
28. Water bath, controlled temperature, 50°C.
29. Parafilm M sealing film, American National Can, Greenwich, CT.
30. Aluminum foil, e.g., Reynolds Standard Gauge.

### 1.3. Methods

1. Preparing agar culture dishes: Preheat a small temperature-controlled water bath to 50°C. Place 20 to 50 35 mm plastic culture dishes on a 37°C histological slide warming table. Place a piece of sterile cheese cloth (or a wide mesh sterile gauze pad) over the mouth of a 500-mL Erlenmeyer flask and push the center of the cloth down into the flask about 1 cm to provide a pouch-like depression to hold the albumen. Fix the cloth in this position with tape. Crack open an unincubated fertile chicken egg and then slowly and carefully pour as much albumen as possible into the cloth while retaining the yolk within the shell. The liquid albumen will be strained into the flask. Repeat this procedure with four or more eggs. Put 75 mL of liquid albumen obtained by this method into a graduated 100-mL Erlenmeyer flask, cover the opening of the flask with Parafilm, and place the flask into the 50°C water bath.

Add 1.5 g of agar and 0.4 g of glucose to 50 mL of Howard's saline (*II*) in a 100 mL flask. Cover the opening of the flask with aluminum foil. The agar may be melted by gently boiling the mixture on a hot plate or over a bunsen burner. Whereas this method is faster, one must be careful not to overheat the solution and char the agar-glucose. An easier method of melting the agar is to autoclave the flask containing the mixture for 30 min with the autoclave set for liquids. After removing the hot flask from the autoclave, push a thermometer through the foil covering of the flask and into the melted agar solution to monitor its temperature. Let the agar solution cool to 60°C (*see Subheading 1.4., Note 2*). Pour a sufficient volume of the agar solution into the graduated flask containing the liquid albumen to bring the volume in the second flask to 100 mL (it is not necessary to be more accurate than this in measuring the total volume of the mixture and it would be difficult to do so while keeping the temperatures of the solutions suitable for successful mixing). Gently swirl the flask to mix the solutions without creating air bubbles.

Before the agar-albumen solution solidifies, it must be poured into culture dishes that have been warmed on a histological slide warming table. The objective of this procedure is to produce a thin, clear substratum in the culture dishes to facilitate optimal visualization of embryos during experimental procedures. Take a culture dish from the slide warming table and remove its cover. Pour a small amount of solution into the dish (about 1 mL or less with experience), and rapidly slide the culture dish back and forth on the benchtop to spread the agar-albumen in a thin layer on the bottom of the dish. Rotate the dish while sliding it to cover the entire bottom. Replace the cover and put the dish on a flat horizontal surface to cool (repeat the procedure with the next culture dish). The dishes may be stored for several weeks at 4°C in closed containers lined with moist paper towels to prevent dehydration of the agar medium (*see Subheading 1.4., Note 3*).

2. Preparing the yolk-albumen liquid culture medium: Empty the contents of two unincubated chicken eggs into a wide-mouth 500-mL flask, cover the mouth of the flask with Parafilm, and shake the flask vigorously for about 10 s. Pour the contents of the flask into two 50-mL centrifuge tubes and centrifuge them in a refrigerated (4°C) centrifuge at 14,900g for 30 min. Remove the tubes and use a Pasteur pipet to remove the thin layer of lipid-rich material from the surface of the yolk-albumen supernatant in each tube. Pour the supernatant from each tube into a 250-mL flask and cover the flask mouth with Parafilm. Because both heat and time in storage can greatly reduce the ability of yolk-albumen supernatant to support embryonic development, keep the supernatant at 4°C for no more than 6 h. The supernatant contains sufficient pH buffering capacity to obviate the need for additional buffers (3).
3. Providing an incubation atmosphere of O<sub>2</sub> and CO<sub>2</sub>: Embryos developing on an agar-based substratum, as described here, require high levels of oxygen for optimal development. This phenomenon is probably related to the fact that the blastoderm, and thus the area vasculosa, does not continue to expand. As a result, the embryo increases in mass as its area for gas exchange remains approximately unchanged. Apparently, an atmosphere with high levels of oxygen at least partially compensates for the relatively small area vasculosa. We recommend a gas mixture of 95% oxygen and 5% carbon dioxide (*see Note 4*).

Fill the space below the specimen plate of a large glass dessicator jar with water. Bore two holes in a rubber or Neoprene stopper that will fit into the opening in the dessicator cover. These holes should be of appropriate diameter to allow two pieces of glass or rigid plastic tubing to pass through with a tight fit. One tube should carry gas from a shut-off valve mounted on the second stage of a two-stage gas pressure regulator through the stopper and into the water at the bottom of the dessicator jar. In this way, gas entering the jar will be humidified by bubbling through the warm water. A second piece of tubing should begin near the underside of the stopper and exit the jar to provide a gas vent. Although a very low rate of flow will be used for the oxygen mixture, one should vent the gas in a safe manner. Thus prepared, the dessicator jar should be placed into a 37.5°C incubator. Each culture dish should be placed, without its cover, into a glass 100-mm Petri dish. To avoid drying, a piece of wet paper towel should be placed in the bottom of the glass dish and its cover put in place. Up to three 35-mm agar culture plates will fit in each glass 100-mm dish. The glass dish may now be placed in the dessicator jar and a gas flow of approx 15 mL/min established.

4. Culturing chicken embryos on the agar-albumen medium: Remove from storage a few of the prepared culture dishes with agar-albumen substratum, fill them with freshly prepared yolk-albumen supernatant and allow them to warm to room temperature. Open fertile chicken eggs after appropriate incubation time by first wiping the shell with 70% ethanol, and then either cracking the shell or removing the blunt end of the shell with fine scissors. Carefully, pour the contents of the shell into a finger bowl containing a volume of sterile Howard's saline sufficient to cover the yolk. With one hand, grip the yolk near its equator using fine watchmaker's forceps. With the other hand, gently cut through the vitelline membrane with fine scissors just beyond the peripheral border of the blastoderm. Continue this cut completely around the blastoderm. Remove the forcep from the yolk mass and use it to gently grasp the cut edge of the disk of vitelline membrane to which the embryo and the blastoderm are attached, and to peel the disk from the underlying yolk mass. While keeping the isolated vitelline membrane/blastoderm below the surface of the saline, set the scissors down, pick up a glass Petri dish bottom, submerge it in the saline, and carefully place the blastoderm into the dish bottom. Remove the dish from the bowl along with a small volume of salt solution. Dry the undersurface of the Petri dish with a tissue, place the dish under a stereo microscope, (*see Note 5*) and using two fine forceps,

turn the vitelline membrane so that the ventral side of the blastoderm (the side to which yolk is attached) is facing up and spread the membrane out flat. Use one forcep to hold the edge of the vitelline membrane, and probe the edge of the blastoderm with the other forcep until it begins to loosen from the vitelline membrane. Gently peel the blastoderm from the underlying vitelline membrane. Some investigators recommend trimming the blastoderm to reduce its diameter and thus make the embryo easier to handle. As shown by Britt and Herrmann (3), we have found that such trimming impairs development. Use a wide-mouth pipet to remove the embryo and its blastoderm from the dish and place them in a second glass Petri dish bottom filled with sterile saline. Hold the edge of the blastoderm with a forcep and gently pull it through the saline to remove some of the adherent yolk. Then spread the blastoderm flat, as before, and use a Pasteur pipet to gently wash the loose yolk from the blastoderm with a gentle stream of salt solution. Remove the embryo from the dish with a wide-mouth pipet or a spoon and place the embryo into a previously prepared agar-albumen culture dish filled with yolk-albumen supernatant. Be careful to introduce as little saline as possible into the egg supernatant. Excessive dilution of the supernatant can impair development and even lead to precipitation of proteins, thus rendering the mixture opaque. Spread the embryo and blastoderm out with the dorsal surface up and gently remove the supernatant medium with a Pasteur pipet until the embryo flattens out on the substratum. Leave just enough supernatant so that under low-power magnification, you can see a little of it flow when the dish is tipped. Too little supernatant will result in a dead, dried embryo, and too much supernatant will cause poor development and the formation of ectodermal vesicles. Incubate the culture dish in a humidified atmosphere of 95% O<sub>2</sub> and 5% CO<sub>2</sub> at 37.5°C as described earlier. Excellent development of somite stage embryos may be attained with this culture method (Fig. 1).

If one wishes the embryos to develop for longer than 20–24 h, it is possible to extend the culture period to approx 40 h by refreshing the yolk–albumen supernatant medium (see Note 6). After about 20–24 h in culture, remove the culture dish containing the embryo and carefully add 10 drops of fresh yolk-albumen supernatant with a disposable Pasteur pipet. Let the drops fall gently onto the blastoderm about half-way between its peripheral edge and the embryo. This procedure will avoid loosening the blastoderm from the substratum. Potentially, fatal bleeding may occur if the blastoderm is detached from the substratum. Return the dish to the incubator and after about 20–30 min, draw off the excess supernatant with another Pasteur pipet, and reincubate the embryo (see Note 7).

#### 1.4. Notes

1. The tips must be even more sharp than as received from the supplier so that one can grasp small bits of tissue. The points must also be rather narrow, long, and tapered to reduce capillary forces when placed near the delicate embryonic tissues. Be sure to sharpen the forceps with the tips gently held in contact (wrap a piece of tape around the forceps to hold them in the closed position). This procedure will help ensure that in the closed position the sharpened tips will be in register and in close contact. Consult craft tool catalogs for coarse, medium, and fine sharpening stones.
2. It is important to maintain the recommended temperatures when mixing the liquid albumen with the melted agar. If the agar is too hot, proteins in the albumen will be denatured (cooked!). If either solution is too cool, the agar will clump, leading to incomplete mixing.
3. For those who might wish to experiment further with various substrata, we have tried the following variations, none of which proved as successful as the method described here: a. harder and softer agar-albumen mixtures, b. gelatin-albumen, c. collagen-albumen, d. collagen gel (polymerized with ammonium hydroxide fumes), e. a layer of dried liquid albumen, and even f. empty culture dishes with no added substratum.



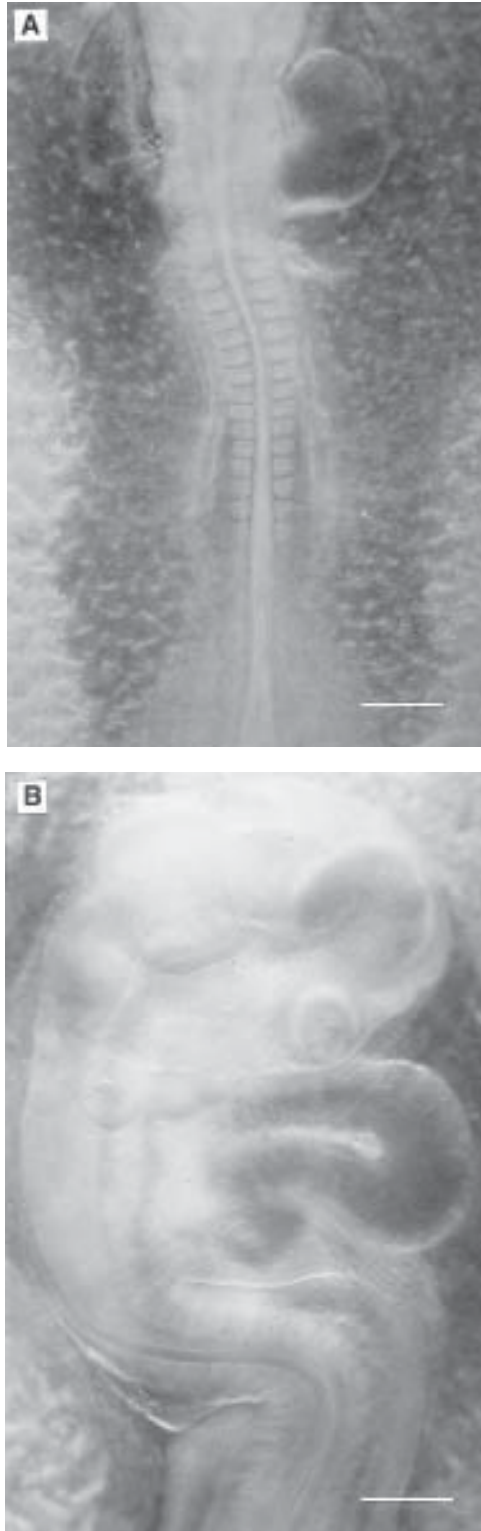

Fig. 1. (See color plates 7 and 8 appearing after p. 262.)

4. With regard to the atmosphere recommended here for culturing explanted embryos, we have compared the performance of gas containing 95% O<sub>2</sub> and 5% CO<sub>2</sub> with mixtures containing 100% O<sub>2</sub>, 95% O<sub>2</sub> and 5% N<sub>2</sub>, 95% O<sub>2</sub> and 5% air, and 100% air. As judged by the increase in the stage of development and the number of somite pairs, the gas mixture containing 95% O<sub>2</sub> and 5% CO<sub>2</sub> was clearly superior to the others.
5. The thin, transparent agar-albumen substratum utilized in this technique permits excellent visualization of the cultured embryo during experimental manipulation and photomicrography. One could, for example, place the culture plate on a black background (such as a piece of unexposed and developed color positive film) and epi-illuminate the embryo from above. An even more effective technique is to simulate dark-field lighting by passing a beam of light from a bright dissecting lamp (a fiber-optic illuminator with an infrared filter is ideal) through the embryo from below. Use a mirror to illuminate the embryo without shining the beam of light directly into the objective lens of the stereo microscope. A base from a stereo microscope that contains an adjustable mirror works well. To ensure free movement of the base relative to the microscope, it must not be attached to the microscope. Adjust the tilt of the mirror and rotate the base somewhat while viewing the embryo through the microscope. Continue adjusting until the illuminated embryo is seen with a dark background.
6. Wolff and Simon (12) kept embryos in culture for more than 48 h by culturing them and their blastoderms on a convex substratum and grafting strips of extraembryonic blastoderm from another embryo around the edge of the cultured blastoderm. After healing, the enlarged blastoderm is said to form a larger vascular system that can support older embryos.
7. It is likely that this embryo culture technique will also work well with many reptilian embryos. Packard (13) successfully cultured early primitive streak to somite stage embryos of the snapping turtle, *Chelydra serpentina*, on a substratum consisting of agar and chicken yolk-albumen supernatant. The liquid medium in which the turtle embryos were cultured consisted of fresh chicken egg yolk-albumen supernatant, rather than turtle egg supernatant. This use of chicken egg supernatant preserved more of the rare turtle eggs for experimentation. We found it necessary to add antibiotics to the chicken yolk-albumen supernatant, and the incubation temperature was lowered to 30°C.

## 2. Protocol 2: Microsurgery and Transplantation of Avian Embryo Tissues

### 2.1. Introduction—Transplantation of Segmental Plate Mesoderm between Avian Embryos Cultured on an Agar Substratum

Although the techniques described in this section were developed for the transplantation of segmental plate mesoderm between avian embryos, they are readily adaptable to other tissues and embryo culture methods. For example, Packard (14) used a similar microsurgical approach for the transplantation of epiblast between avian embryos in

---

Fig. 1. (opposite page) Photomicrographs of a chicken embryo cultured on the agar-albumen substratum described in this chapter. (A) Embryo with 18 pairs of somites shown at the time it was explanted. The cranial end of the embryo is toward the top of the figure. The developing hindbrain and spinal cord can be seen along the embryo's axis flanked by paired somites. The heart was beating and blood circulation was observed in the embryonic and extraembryonic vasculature. (B) Photomicrograph of the same embryo as shown in (A) following 20 h of culture on the agar-albumen substratum. Note the extensive development of the somites, neural tube, and the heart. The axis of the rapidly lengthening embryo has buckled caudal to the heart, probably because of the inability of the blastoderm to expand when cultured on the agar-albumen substratum. Scale bar = 0.5 mm.

New culture. Williams and Ordahl (15) have described a method for the transplantation of segmental plate mesoderm into embryos developing in ovo.

## 2.2. Materials

1. Howard's saline, sterile: *see Subheading 1.2., step 3.*
2. Tyrode's solution, sterile: Divide 1 L of distilled water into two nearly equal portions. Add 8.0 g NaCl, 1.0 g NaHCO<sub>3</sub>, 0.2 g KCl, 0.05 g NaH<sub>2</sub>PO<sub>4</sub>·H<sub>2</sub>O, to one portion and 0.47 g MgCl<sub>2</sub>·6 H<sub>2</sub>O, 1.0 g glucose, and 0.2 g CaCl<sub>2</sub> to the other portion. Autoclave both solutions separately, cool, and mix.
3. Calcium- and magnesium-free Tyrode's solution, sterile: add all constituents of Tyrodes solution, EXCEPT CaCl<sub>2</sub> and MgCl<sub>2</sub>·H<sub>2</sub>O, to 1 L of distilled water and autoclave.
4. Trypsin solution: add 0.5 g of trypsin (bovine or porcine pancreas) and 0.1 g ethylenediaminetetraacetic acid (EDTA) to 100 mL of CMF-Tyrode's solution (see above).
5. Tungsten wire (Imperial Gauge 33, AWG 30, 0.254 mm diameter).
6. Pin vises or needle holders, steel with adjustable chuck (similar devices are used to hold inoculating loops).
7. Agar-albumen culture dishes: *see Subheading 1.3.* for preparation and conditions of incubation.
8. Fresh yolk-albumen supernatant: **Subheading 1.3., step 2.**
9. Sterile wide-mouth pipets: **Subheading 1.2., step 15.**
10. Glass Petri dish bottoms.
11. Forceps, superfine (sharpened): *see Subheading 4., Note 1.*
12. Sterile, disposable Pasteur pipets with rubber bulbs. One milliliter plastic, disposable transfer pipets are also suitable.
13. Phosphate-buffered saline; 56 mL 0.5 M Na<sub>2</sub>HPO<sub>4</sub>, 16 mL 0.5 M NaH<sub>2</sub>PO<sub>4</sub>, 29.4 g NaCl in 3.5 L deionized water.

## 2.3. Methods

1. Preparation of tungsten wire needles: Tungsten wire needles are widely used for the microdissection of embryonic tissues. Sharpened tungsten wire yields a very fine, strong, and stiff tip that is easy to guide and cuts precisely. The wire can be sharpened electrolytically by applying a low voltage and repeatedly immersing the tip into either a saturated aqueous solution of sodium nitrite or a 10 N aqueous solution of sodium hydroxide. The use of these solutions is hazardous, therefore proper safety precautions should be taken, including use of protective clothing, gloves, safety glasses, and a fume hood. Cut the tungsten wire into pieces about 2 cm in length (you will need at least five or six needles, so cut a piece of wire for each needle). Insert each piece of wire into a metal needle holder or pin vise with an adjustable chuck. Alternatively, the wire may be inserted into a 21- or 22-gage hypodermic needle that has been attached with epoxy glue to a wooden dowel of appropriate diameter (the wire need not be glued into the needle, because the natural curl of the wire will hold it in place) or the wire can be glued into a Pasteur pipet (8). Attach one side of the output terminal of a 12 Vac power supply to the wire (we use an alligator clip) and the other side to a conductive electrode that is placed in the solution to be used. This electrode will tend to be etched away with time. We have found that an electrode composed of several strands of 3-0 surgical steel monofilament suture is quite stable. The solution used for sharpening can be stored and used conveniently in a small (4-6 mL) sample vial with a screw top. After taking adequate safety precautions, place the electrode into the solution, apply the electrical voltage, and briefly immerse the tip of the wire into the solution. If a long, thin tip (best suited for very fine cuts) is desired, immerse about

2.5 mm of the wire. A shorter, more robust tip (useful for moving grafts or closing ectodermal flaps without cutting them) may be created by immersing only about 1 mm of the wire. Continue to briefly immerse the wire and periodically check the tip with a stereo microscope. When the desired tip is achieved, rinse the needle thoroughly with distilled water. Resharpenering the tip of a used and damaged needle will usually require only a few immersions. While these sharp needles are useful for many microsurgical procedures, some investigators may wish to consider fashioning tungsten wire microscapels (16).

2. Suggestions for using wire needles: Keep the sharpened tungsten wire needles stored vertically in a needle holder. One can drill holes of the appropriate diameter and number in a piece of wood or plastic or one can adapt an existing item from the laboratory, such as a test-tube rack. The goal is to store the needles so that they are readily available during microsurgery while also protecting their tips from any contact with other objects. The sharpened tips are extremely delicate and they will be damaged by any contact with objects harder than embryos.

To make a straight cut in the embryo, orient the embryo so that the cut can be made in an approximately horizontal (right or left) direction as seen by the microsurgeon in the stereo microscope (see **Subheading 2.4., Note 1**). Place the tip of the needle on the desired location for the beginning of the cut and gently push the tip through the tissues to be cut. Gently raise the tip of the needle just enough to bring the tip up through the tissues. The motion resembles the beginning of a movement that would eventually bring the needle into a horizontal position, parallel with the surface of the substratum. A very small amount of tissue will be cut. Extend the cut in the desired direction by repeating the procedure. Better control is achieved with numerous smaller cuts, rather than with fewer, larger cuts. At some point, the tip of the needle will become covered with tissue fragments or yolk. When this happens, simply insert the tip into the agar-albumen substratum beyond the edge of the blastoderm. Drag the tip backward through the substratum and the excess material will be pulled from the tip. Be certain that the tip does not penetrate the substratum as it will be destroyed by contact with the bottom of the culture dish. Needle tips may also be cleaned by immersion in a sonication bath (15).

3. Preparing the embryos for culture and microsurgery: Before you begin, remove several of the previously prepared agar-albumen culture dishes (see **Subheading 1.3.**) from storage, fill them with fresh yolk-albumen supernatant (also described above), and allow them to come to room temperature. At the desired stage of development, remove the embryo from the yolk, as described in the preceding section, and separate it from the vitelline membrane. Next, use a wide-mouth pipet to place the embryo in a glass Petri dish bottom containing calcium- and magnesium-free (CMF) Tyrode's solution (17). Use the sharpened forceps to gently pull the embryo through the solution to remove the loose yolk particles. Spread the blastoderm out with the endodermal surface up and use a Pasteur pipet to carefully wash away any remaining loose yolk with a gentle stream of CMF Tyrode's solution. Remove only the larger, loose clumps of yolk, because they are more likely to disperse later and obscure your view of the embryo, or significantly increase the length of subsequent enzyme treatment. Draw the embryo up with another wide-mouth pipet and place it in a second dish containing CMF Tyrode's solution and repeat the washing procedure. Then place the embryo in about 5 mL of CMF Tyrode's solution containing 0.5–1.0% trypsin and 0.1% EDTA. Spread the blastoderm flat at this time as it will make it easier to spread again later onto the agar-albumen substratum. The embryo should remain in this solution for approx 5 min (see **Subheading 2.4., Notes 2 and 3**). Finally, carefully withdraw the embryo from the trypsin-containing solution with a wide-mouth pipet, wash it in a culture dish filled with phosphate-buffered saline, and expel it into one of the agar-albumen culture dishes filled with fresh yolk-albumen supernatant. Using a

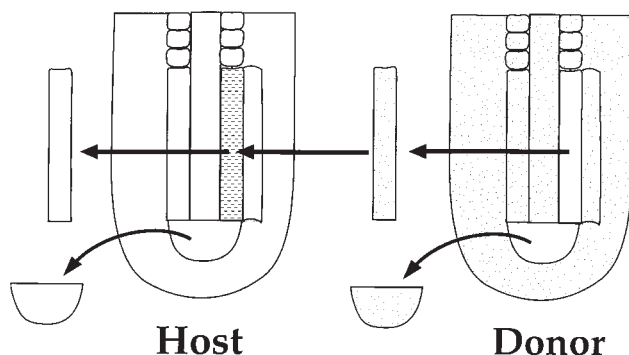

Fig. 2. Diagram illustrating the removal of a segmental plate from a donor embryo and how it can be inserted into a host embryo in the place of the host's original segmental plate. Following treatment with trypsin, the ectoderm covering the segmental plate was cut on three sides and pulled laterally as a flap. The segmental plate was then circumscribed with cuts and gently removed from the underlying endoderm. The particular experiment illustrated here required that the formation of additional segmental plate mesoderm be stopped at the time of the transplantation. Accordingly, Hensen's node and the surrounding tissues were removed from the caudal end of each embryo and discarded (adapted from Packard et al., 1993 [18]).

forcep, gently pull the embryo back and forth a few times through the yolk-albumen supernatant to wash away any trypsin solution remaining on its surface. Spread the blastoderm onto the substratum and carefully draw off the excess supernatant with a Pasteur pipet. The embryo is now ready for microsurgery and incubation.

4. Removal of the segmental plate mesoderm: The thin agar-albumen substratum used in the embryo culture technique recommended here is particularly suited for visualization and for microsurgery (see **Subheading 1.4., Note 5**). Choose which segmental plate you wish to remove. Rotate the embryo so that the cranial end points away from you if you are right handed, or toward you if you are left handed, so that you will not have to reach across the neural tube to make the first cut. On the side of the embryo from which the segmental plate is to be removed, make a cut through the ectoderm that is at right angles to the embryonic axis. This cut should pass from a point immediately lateral to the caudal border of the last formed somite to the lateral border of the neural tube (**Fig. 2**). Make a similar cut through the ectoderm at the level of the cranial edge of Hensen's node. Now rotate the embryo so that its cranial end is closest to your dominant hand. Make a cut that passes through the ectoderm and along the lateral edge of the neural tube, from the cranial cut to the caudal cut. These cuts will create a three-sided flap of ectoderm that can now be gently loosened from the underlying mesoderm by careful sweeping motions of the tip of the tungsten needle (**Fig. 2**). Fold the flap laterally to expose the mesoderm of the segmental plate. Again, rotate the culture dish so that the embryo is oriented as for the first cut. With the tip of the needle, carefully cut through the extracellular matrix (a very thin, clear layer) remaining between the last formed somite and the cranial end of the segmental plate that is to be removed. Be careful not to tear the underlying endoderm although very small holes may heal quickly. Make a second, similar, cut through the mesoderm at the caudal end of the segmental plate (see **Subheading 2.4., Note 4**). The final cuts should be parallel to the embryonic axis along the lateral edge of the segmental plate and between the segmental plate and the neural tube. These latter two cuts should pass through the mesoderm and extracellular matrix only and avoid damaging the endoderm. These cuts

have circumscribed the segmental plate and one can now gently loosen its cranial end from the endoderm with the tip of the needle. Continue loosening the segmental plate from the endoderm with minute sweeping motions of the needle tip. This task will be easier if the loose end of the segmental plate is periodically lifted dorsally and caudally with the side of the needle to create additional work space. Once the segmental plate has been completely detached from the endoderm, nudge it laterally onto the dorsal surface of the ectoderm.

5. Transplantation of the isolated segmental plate: The method used to carry a tissue graft from the donor embryo to the host is dependent on the size of the graft. Large explants, such as those described by Packard (19), can be safely moved by using a method similar to that described in the previous section for moving blastoderms from one dish to another. Carefully, introduce additional fresh yolk-albumen supernatant to the culture dish and remove the graft or explant with a wide-mouth pipet. Smaller grafts, such as excised segmental plates, can be transported with mouth-operated micropipets (15). Alternatively, one can move small grafts with sharpened forceps. If the tips of the forceps are dipped into the shallow layer of yolk-albumen supernatant in the culture dish, and they are gradually brought toward each other until they nearly touch, capillary forces will cause some of the supernatant to run up between the two tines of the forceps. This same phenomenon can be exploited to carry grafts of embryonic tissue. After isolating a segmental plate as described above, clean the forceps and place the tips very close to the cranial end of the segmental plate. Gradually squeeze the forceps to bring the tips closer together until liquid supernatant is seen to run up between the tines. If the tips were placed correctly, the segmental plate will be swept up in the flow of supernatant and carried up and between the tines. Now remove the forceps from the culture dish and be certain that the tips do not move with respect to each other. Immediately touch the tips of the forceps into the supernatant in the host embryo's culture dish and allow them to separate. The supernatant will flow from the forceps into the supernatant of the second culture dish carrying the segmental plate with it. If the graft should adhere to the forceps, be sure the forceps are clean and then try prewetting them by drawing supernatant between the tines and discharging it just before picking up the graft. Once the segmental plate has been placed with the host embryo, move it into the graft site with tungsten needles. Adjust the graft's orientation with respect to the host as desired (see **Subheading 2.4., Note 5**). Push the flap of ectoderm that originally covered the host's segmental plate over the graft (the flap will have contracted somewhat, but healing is rapid and usually the ectoderm will cover the region of the surgery within 2 h). The host embryo is now ready for incubation.

## 2.4. Notes

1. For maximum control of the needle during microsurgery, rest the hand holding the needle and the forearm on a smooth, flat object (we use an inverted dissecting instrument tray) the upper surface of which is about the same height above the bench top as the embryo. Next, brace this hand with your other hand before bringing the needle tip into the field of view of the stereo microscope. By working the needle from this firmly braced position, much finer control of the needle tip is possible.
2. There are alternatives to the use of trypsin prior to microsurgery. Some surgical procedures, such as grafting fragments of epiblast, may not require pretreatment. In other cases, only mild reduction in the adhesion between germ layers may be required and so washing the embryo several times with calcium- and magnesium-free Tyrode's saline might be sufficient. The addition of 0.1% EDTA will make the solution even more effective. When enzyme treatment was unavoidable, other investigators have used, besides trypsin,

enzymes such as pancreatin (15) and collagenase (20). Because the use of enzymes to prepare embryos for microsurgery may introduce unanticipated variables into the experimental design, their use should be minimized or even avoided when possible.

3. Because variables such as the size of the blastoderm or the amount of yolk present will affect the precise time of incubation in trypsin solution, it is useful to develop a visual endpoint for trypsin treatment. For the segmental plate transplantation experiments, we found that when the embryo's neural tube appeared wrinkled or open and/or the segmental plates were observed to flare slightly, laterally away from the neural tube, the embryo was transferred immediately into the supernatant in the culture dish. If trypsinization occurs too rapidly, one can slow the reaction by lowering the temperature or reducing the concentration of trypsin. Conversely, one can increase the trypsinization rate by incubating the embryo and the trypsin solution at a higher temperature or by increasing the concentration of the enzyme.
4. Identification of the caudal end of the segmental plate is somewhat arbitrary because it gradually blends with the primitive streak. Yet, a consistent definition is required to ensure reproducible results. For example, Packard (18,19) defined the caudal border of the segmental plate as being at the axial level of the cranial border of the chorda bulb (the widest and most caudal portion of the notochord located immediately cranial to the node).
5. The original orientation of the excised segmental plate can be determined since the lateral border of the plate will be convex and the cranial end will be narrower than the caudal end. If desired, further regression movements that would lead to the formation of new segmental plate in the embryo can be inhibited by removing the region containing Hensen's node (18). When grafting tissues other than the segmental plate, cut the graft so that its shape records its original orientation. For example, one might consistently cut the right, cranial corner from rectangular grafts. Grafts may also be marked with carbon particles by inserting a moist needle tip into powdered carbon and then pushing the carbon-covered tip into the graft. When the tip is removed, a few carbon particles will remain embedded in the graft. Also, note how the grafts warp following removal from the donor. Epiblast grafts, for example, tend to be convex dorsally (14).

### 3. Protocol 3: In Vitro Cultivation of Avian Somite Cells

#### 3.1. Introduction—A Simplified Method for Culturing Avian Somite Cells

Described below is a method for culturing dissociated avian somite cells. The method is adaptable to other cell types, and it is suitable for assaying changes in the phenotype of individual cells. The technique has been used to look at endothelial cell induction from somite mesoderm by various growth factors. Others have used somite explants in a similar way to identify signals for myocyte differentiation (21). Dissociated cells make quantitation possible by counting individual cells.

#### 3.2. Materials

1. 35-mm culture dishes (e.g., Corning 25000, Corning Glassworks, Corning, NY).
2. Gelatin (e.g., Sigma G 2500, Sigma Chemical Co., St. Louis, MO).
3. Pronase (e.g., Boehringer Mannheim 165 921, Roche Diagnostics Corp., Indianapolis, IN).
4. Minimal Essential Media Eagle (MEM; e.g., Sigma M 0643).
5. Bufferall 100X (e.g., Sigma B8405).
6. Fetal bovine serum (FBS; e.g., Sigma F-2442).
7. Culture slides, 4 well (e.g., Nunc 177380, Nalgene Nunc, Rochester, NY).
8. Tissue-culture plates, 24 well (e.g., Falcon 3047, Falcon, Los Angeles, CA).
9. Howard's saline; *see Subheading 1.2., step 3.*
10. Phosphate-buffered saline (PBS); *see Subheading 6.13.*

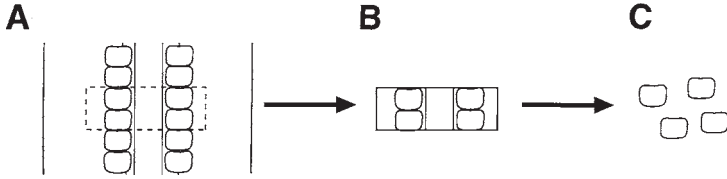

Fig. 3. (A) Diagram of a portion of a somite-stage avian embryo. Dashed lines indicate the position of the cuts recommended for the isolation of embryonic tissue samples. (B) Diagram of a typical somite-containing tissue sample prior to digestion with pronase. (C) Somites isolated following pronase digestion.

11. Trypsin/EDTA solution: 0.5 g porcine trypsin and 0.2 g EDTA in 1 L of normal saline (also available from Irvine Scientific, cat. no. 9346).
12. 500-mL 0.2- $\mu$ m nylon membrane filter units (e.g., Corning no. 430773).
13. MEM, alpha modification (e.g., Sigma M 4526).
14. Formalin (37% formaldehyde).
15. Tungsten wire needles: *see Subheading 2.3*.
16. Wide-mouth pipets: *see Subheading 1.2*.
17. Forceps, superfine, sharpened: *see Subheading 2.2*.
18. Microcentrifuge tubes (e.g., VWR 2017-698) (VWR Scientific, West Chester, PA).
19. Micropipet, 50  $\mu$ L (e.g., VWR 53432-783).

### 3.3. Method

Open fertile chicken or Japanese quail eggs that have been incubated for the desired time into a finger bowl containing Howard's saline (II). Remove the embryo and place it in a 35-mm culture dish filled with Howard's saline. Store the dish on ice until you are ready to remove the tissue sample from the embryo. It is important to reduce the amount of unwanted tissue in order to hasten the subsequent pronase digestion step. Accordingly, use a tungsten wire needle to make two cuts through the embryo perpendicular to the anterior-posterior axis with one cut passing cranial to the most cranial somites to be isolated, and the other passing caudally to the most caudal somites to be isolated (Fig. 3). Make two more cuts parallel to the embryonic axis medial to the area opaca creating a small rectangular piece of tissue containing the desired somites plus the adjacent neural tube and other tissues (Fig. 3). Store the embryonic tissue samples thus created in MEM on ice until ready for the pronase digestion step.

Incubate the tissue samples with 0.5% pronase in Howard's saline at room temperature (22). The time required for pronase treatment will vary according to the size and the number of tissue samples. In our hands, a typical digestion time is 5 min for a small fragment (Fig. 3) and up to 1 h for a whole embryo. One can monitor the progress of the digestion using a stereo microscope. Place the embryonic tissue samples in the pronase solution with their dorsal sides up, and watch for the corners of the ectoderm to peel away from the mesoderm. This phenomenon indicates that the digestion is sufficiently complete, and the embryonic tissue samples should be removed from the pronase solution. Rinse them in a 35-mm dish containing Howard's saline, and then place them into another 35-mm dish containing MEM at room temperature for further dissection. Remove the ectoderm and endoderm from each tissue sample by holding it with a tungsten needle and peeling the ectoderm and endoderm from the mesoderm with



superfine forceps (*see Subheading 3.4., Note 1*). Next, use tungsten needles to remove the neural tube from the somites and the lateral mesoderm. Finally, remove the somites one at a time from the more lateral mesoderm by holding the tissue stationary with one needle while using the other to sever the attachment between the somite and the lateral plate mesoderm.

Transfer the isolated somites to a 1.5-mL microcentrifuge tube using a mouth micropipet and keep the tube on ice until all of the somites have been isolated. Pellet the somites by spinning for 5 min at 1000g in a clinical centrifuge. Next, carefully decant the supernatant, and resuspend the pellet in 100–200  $\mu$ L of trypsin/EDTA solution. Incubate this suspension for 1 min at 37°C to dissociate the somites (*see Subheading 3.4., Note 2*). Centrifuge the cell suspension at 1000g for 5 min. Decant the supernatant carefully to avoid disturbing the pellet. To inactivate the trypsin, gently resuspend the pellet in 200  $\mu$ L of alpha MEM with 7.5% heat inactivated FBS and centrifuge for 5 min at 1000g. Repeat this inactivation step two times to ensure that all of the trypsin has been inactivated.

Resuspend the pellet in alpha MEM with or without FBS, as desired. Plate the cells onto glass culture slides or plastic tissue culture dishes (*see Subheading 3.4., Note 3*). The cells can be incubated in an air incubator when the culture medium is buffered with Bufferall. Following the desired culture period, add an equal volume of PBS. Remove the same volume of liquid as added and replace with PBS. Repeat several times until the color of the solution changes from red to clear. For fixation, repeat the changes described above with the desired fixative. Fix for 1 h at room temperature in formalin.

### 3.4. Notes

1. The ectoderm and endoderm should peel readily from the mesoderm. If any resistance is found, repeat the pronase treatment to ensure complete separation of the tissues.
2. Resuspension of the somite cells should be done very gently in order to avoid lysing them. The time required for trypsin to dissociate the somites can vary depending on the batch of trypsin and the length of the previous pronase treatment. If the tissue samples easily fall apart following the pronase treatment, the subsequent trypsin incubation should be 1 min or less.
3. Preparation of gelatin coated glass culture slides or tissue culture plates: Prepare a solution of 0.3% (w/v) gelatin in PBS, filter sterilize it using a 0.2- $\mu$ m filter unit, and then store it at 4°C. Coat the wells of the culture slide thoroughly. When using 4-well glass culture slides or 24-well culture plates, 500  $\mu$ L of gelatin is sufficient. Leave culture slides or plates containing the gelatin solution at room temperature for 3 h before plating the dissociated somite cells. Wash the wells several times with alpha MEM prior to plating the cells. For subsequent analyses, we have found it sufficient to plate the somite cells at a concentration that corresponds to 10 somites for each well.

### Acknowledgment

The use of an agar-albumen substratum was suggested to us by Dr. Syamala Murti Sternick. The authors wish to thank Dr. Louis DeGennaro, Scott Berkowitz, John Kushneir, and Marianne Miles for many helpful discussions and Marisa Marron and Sandy L. B. McGillis for their expert technical assistance. The diagrammatic illustrations were prepared by Kit Heffner, M.S., C.M.I.

## References

1. Waddington, C. H. (1932) Experiments on the development of chick and duck embryos, cultivated *in vitro*. *Phil. Trans. Royal Soc.* **B221**, 179–230.
2. Spratt, N. T., Jr. (1947a) Development *in vitro* of the early chick blastoderm explanted on yolk and albumen extract saline-agar substrata. *J. Exp. Zool.* **106**, 345–365.
3. Britt, L. G. and Herrmann, H. (1959) Protein accumulation in early chick embryos grown under different conditions of explantation. *J. Embryol. Exp. Morphol.* **7**, 66–72.
4. Klein, N. W., McConnel, E., and Riquier, D. J. (1964) Enhanced growth and survival of explanted chick embryos cultured under high levels of oxygen. *Dev. Biol.* **10**, 17–44.
5. Packard, D. S., Jr. and Jacobson, A. G. (1976) The influence of axial structures on chick somite formation. *Dev. Biol.* **53**, 36–48.
6. Spratt, N. T., Jr. (1947b) A simple method for explanting and cultivating early chick embryos *in vitro*. *Science* **106**, 452.
7. DeHaan, R. L. (1967) Avian embryo culture, in *Methods in Developmental Biology* (Wilt, F. H. and Wessells, N. K., eds.), Crowell, New York, pp. 401–412.
8. Selleck, M. A. J. (1996) Culture and microsurgical manipulation of the early avian embryo, in *Methods in Cell Biology*, vol. 51, Academic, New York, pp. 1–21.
9. Darnell, D. K. and Schoenwolf, G. C. (1997) Modern techniques for cell labeling in avian and murine embryos, in *Molecular and Cellular Methods in Developmental Toxicology* (Daston, G. P., ed.), CRC, Boca Raton, FL, pp. 231–272.
10. Hamburger, V. and Hamilton, H. L. (1951) A series of normal stages in the development of the chick embryo. *J. Morphol.* **88**, 49–92.
11. Howard, E. (1953) Some effects of sodium chloride concentration on the development of early chick blastoderms in culture. *J. Cell. Comp. Physiol.* **41**, 237.
12. Wolff, E. and Simon, D. (1955) L'explantation et la parabiose *in vitro* de blastodermes incubés d'embryons de Poulet. L'organisation de la circulation extra-embryonnaire. *C. R. Acad. Sci. Paris* **241**, 1994–1996.
13. Packard, D. S., Jr. (1980) Somite formation in cultured embryos of the snapping turtle, *Chelydra serpentina*. *J. Embryol. Exp. Morphol.* **59**, 113–130.
14. Packard, D. S., Jr. (1986) The epiblast origin of avian somite cells, in *Somites in Developing Embryos* (Bellairs, R., Ede, D. A., and Lash, J. W., eds.), Plenum, New York, pp. 37–45.
15. Williams, B. A. and Ordahl, C. P. (1996) Manipulation of the avian segmental plate *in vivo*. *Methods Cell Biol.* **51**, 81–92.
16. Conrad, G. W., Bee, J. A., Roche, S. N., and Teillet, M.-A. (1993) Fabrication of microscalpels by electrolysis of tungsten wire in a meniscus. *J. Neurosci. Methods* **50**, 123–127.
17. Tyrode, M. V. (1910) The mode of action of some purgative salts. *Arch. Int. Pharmacodynamie Ther.* **20**, 205–223.
18. Packard, D. S., Jr., Zheng, R.-Z., and Turner, D. C. (1993) Somite pattern regulation in the avian segmental plate mesoderm. *Development* **117**, 779–791.
19. Packard, D. S., Jr. (1980) Somitogenesis in cultured embryos of the japanese quail, *Coturnix coturnix japonica*. *Am. J. Anat.* **158**, 83–91.
20. Pettway, Z., Guillory, G., and Bronner-Fraser, M. (1990) Absence of neural crest cells from the region surrounding implanted notochords *in situ*. *Dev. Biol.* **142**, 335–345.
21. Stern, H. M., Lin-Jones, L., and Hauschka, S. D. (1997) Synergistic interactions between bFGF and a TGF- $\beta$  family member may mediate myogenic signaling from the neural tube. *Development* **124**, 3511–3523.
22. Poole, T. J. and Coffin, J. D. (1989) Vasculogenesis and angiogenesis: two distinct morphogenetic mechanisms establish embryonic pattern. *J. Exp. Zool.* **251**, 224–231.

## Neural Crest Cell Outgrowth Cultures and the Analysis of Cell Migration

Donald F. Newgreen and Mark Murphy

### 1. Introduction

The neural crest gives rise to many differentiated cell types including craniofacial connective tissue, peripheral neurons, Schwann cells, various endocrine organs, and pigment cells and it has been extensively studied as a model of cell commitment and lineage diversification (1). However, one of its major features is its suitability as a model for studying morphogenesis (2). It is an excellent example of epithelium-to-mesenchyme transition and cell migration, because in the neural crest these events a. are strictly timetabled and routed, b. are of large scale, c. are easy to focus on because they occur when the rest of the body-plan has stabilized, d. are relatively accessible to manipulation, and e. can be replicated with high fidelity in cell culture.

The culture of neural crest cells was initiated by Cohen (3) to study cell differentiation. The technique was first used to study morphogenesis by Maxwell (4). Further studies (5–8) showed that the *in vitro* system could give morphogenetic information on the roles of cell recognition, adhesion, signaling, and second messenger molecules in programmed cell death (9), the conversion of premigratory to migratory cells (10) and the control of cell migration (2,11,12). We detail here how to set up neural crest morphogenesis assays; the general strategy is outlined in Fig. 1.

### 2. Materials

1. Fine scissors and watchmaker's forceps are used to harvest embryos. Dissections are done in bacteriological plastic 3 and 10 cm Petri dishes. Mounted tungsten needles are used for microdissection. Pasteur or plastic pipets are used to transfer tissues. Dissections require a binocular dissecting microscope preferably with fiber-optic lights. Cultures are incubated in a humidified 37–38°C incubator; note that this requires a 5–10% CO<sub>2</sub> atmosphere for rodent cells, but avian cells tolerate air. An inverted phase contrast microscope is used to monitor cultures.
2. Type, size and material of culture dishes vary with the experiment. We routinely use 3 cm bacteriological “nonadhesive” plastic low-sided dishes (Sarstedt, Newton, NC) for avian cell culture and 24-well TC plates (Linbro, Horsham, PA) for mouse cells.
3. Standard medium (e.g., Eagle's Basal Medium [EBM], Dulbecco's Modified Eagle's Medium [DMEM], Ham's F12, M199, RPMI, Liebovitz L15) is used for dissection and

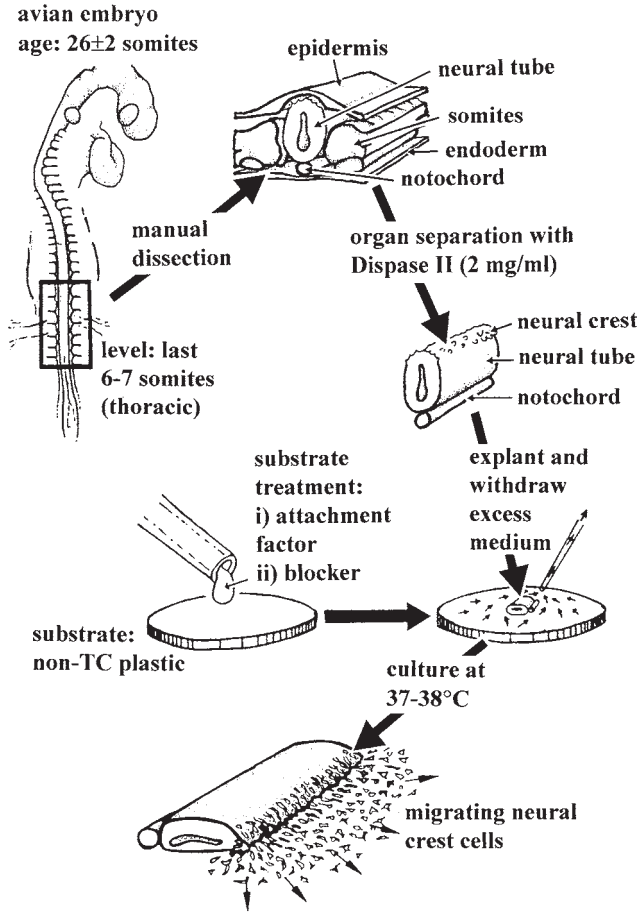

Fig. 1. General scheme of tissue selection and enzyme assisted isolation of the neural tube. The tube then is explanted onto a substrate coated with attachment molecules, where it produces neural crest cells in a spatiotemporally normal way, which migrate over the substrate.

culture (we have used CSL, Parkville, Victoria, Australia; Trace, Noble Park, Victoria, Australia; Gibco-BRL, Gaithersburg, MD; and ICN Biomedical, Costa Mesa, CA). This is buffered for air (10–20 mM HEPES) for dissection medium. Avian cells can be cultured in the same medium in an air atmosphere, but for rodents cells the culture medium needs a bicarbonate buffer adjusted for 5–10% CO<sub>2</sub> atmosphere. Fetal calf serum (FCS; from e.g., CSL, Trace, Gibco-BRL, ICN) at 1–10% is the most common medium supplement, but horse serum is also used. Sera are usually heat inactivated (56°C, 30 min). Store sera at or below –20°C. Commercial-defined media (e.g., Monomed from CSL) and even completely unsupplemented media are also used especially when assaying growth factors. A simple defined supplement is N1 (13): BSA 100 µg/mL; insulin 5 µg/mL; transferrin 5 µg/mL; progesterone 6.3 ng/mL; putrescine 16 µg/mL; selenium 5.2 ng/mL (all Sigma, St. Louis, MO). Store 1000X N1 stocks for up to 1 yr at at –80°C in single-use aliquots. Made up N1 medium keeps for 2–3 wk at 4°C. Antimicrobials like pen/strep can be included at standard concentrations, but are usually not necessary in short-term cultures. For avian cells, we usually use 3% FCS in DMEM or F12; for the more fastidious mouse cells, we use 10% FCS plus Monomed in EBM.

4. Dispase II (Roche Diagnostics, Indianapolis, IN) is used for enzymatic dissection. Store as a 50× stock at 100 mg/mL (approx 120 U/mL) in dissecting medium at −20°C for more than 1 yr; this withstands repeated freeze/thaw cycles.
5. Substrate attachment molecules include plasma fibronectin, vitronectin, laminin-1, collagen I and IV (suppliers: Sigma; Roche Diagnostics; Gibco-BRL; etc.). Store for 6–12 mo at 1 mg/mL in PBS at −80°C in single use aliquots.
6. BSA and ovalbumin (Sigma) are the most commonly used substrate blocking molecules, but other proteins can be used (e.g., hemoglobin). Stock/working concentration is 10 mg/mL in PBS. BSA should be heated for 5 min at 75°C; store at −20°C for over 1 yr.

### 3. Methods

#### 3.1. Avian Embryos

##### 3.1.1. Embryo Harvest

1. Chick (*Gallus gallus*) or quail (*Coturnix coturnix japonica*) eggs are obtained from commercial suppliers. Eggs are incubated at 38°C for 1.5–2.7 d in a forced draft humidified incubator (see **Table 1**).
2. Wipe the egg with 70% ethanol and allow to rest long axis horizontal for several minutes to bring the embryo to the top. With the tip of fine scissors puncture a small hole in the blunt (air sac) end of the shell and a second hole in the top; this drops the yolk.
3. Using scissors cut a 2-cm (chick) or 1-cm (quail) diameter window in the uppermost part of the shell. Sitting on top of the yolk, the blastoderm and embryo can be clearly seen by the blood distribution in embryos older than about 2 d incubation. Younger than this, the center of the blastoderm can be seen (usually) as a keyhole-shaped reflective area over a whitish patch in the yolk. A small white dot on the yolk means the egg is infertile.
4. Grasp the edge of the blastoderm with forceps and cut entirely around the perimeter with scissors. Lift the blastoderm into a 10-cm Petri dish of dissecting medium. Collect all embryos in this dish; they can be stored for hours at room temperature or on ice. The blastoderms are then transferred by forceps through several dishes of dissecting medium to clean them.
5. Dishes with blastoderms are placed on a black background under a dissecting microscope and illuminated from the side. The embryos are staged using Hamburger and Hamilton (HH) stages (**14**) and somite counts (**Fig. 2A**). Use only embryos of age-appropriate stage and normal morphology.

##### 3.1.2. Microdissection

1. Tungsten needles are used in a scissor action (**Figs. 1** and **2B**) to cut out a rectangle of tissue containing the desired level of neural tube (see **Table 1**). For migration assays, we recommend using the thoracic segment level to the last seven somites from embryos of  $26 \pm 2$  somites age (HH15; about 2.5 d incubation in both chicken and quail). It is useful, especially for cranial levels, to initially isolate a slightly longer segment than is desired and trim it down later.
2. Excised pieces (**Fig. 2C**) are transferred via “nonadhesive” Pasteur pipet to a dish containing medium plus 2 mg/mL Dispase II. Pieces can be pooled in Dispase on ice with minimal enzyme activity. Tissue separation occurs by 10–30 min at room temperature, or by 5–10 min at 37°C (**Fig. 2D**). The timing with Dispase is not critical, unlike, e.g., trypsin.
3. Final separation of the neural tube (**Fig. 2E**) is achieved by gentle manipulation. Pin down unwanted tissue with one needle and nudge the rest away with the other needle: the tissue will separate on anatomical borders. For cranial and cervical tissues, remove endoderm,

**Table 1**  
**Characteristics of Avian Neural Tube/Crest Cultures**

Axial level	Optimal age <sup>a</sup>	Optimal level <sup>b</sup>	Uses	Comments
Mesencephalon	7–10 som (approx I1.5)	Mes	Migration	Epidermis impossible to totally remove. NT coherent. NC outgrowth rapid, large but not predictably R-C or D-V patterned.
Rhombomere 1,2,3	9–10 som (approx I1.6)	Single rhombos	Migration apoptosis	Rhomb. boundaries more obvious after Dispase; otherwise as above.
Rhombomere 4,5,6 Vagal (som 1–7)	10–12 som (approx I1.6) 11–14 som (approx I1.7)	Single rhombos Vagal	Migration apoptosis Migration	As above. Epidermis difficult to totally remove at youngest stage. NT less coherent, may spread as epithelium. NC outgrowth rapid, large and predictably R-C and D-V patterned.
Cervical (som. 5–19)	18–22 som (approx I2)	–4 to –12	Migration	NT less coherent, may spread as epithelium. NC outgrowth rapid, small and predictably R-C and D-V patterned.
Thoracic (som. 20–26)	24–28 som (approx I2.5)	–1 to –7	Migration	NT coherent. NC outgrowth rapid, massive and predictably R-C and D-V patterned.
Thoracic (som. 20–26)	18–20 som (approx I2)	+2 to +6	EMT	NT less coherent, spreads as epithelium. NC outgrowth delayed but R-C and D-V patterned.
Lumbosacral (som. 28–40)	30–34 som (approx I2.7)	+2 to –3	Migration	Sclerotome cell contamination. NT coherent. NC outgrowth rapid, massive and predictably R-C and D-V patterned.

D-V = dorso-ventral; EMT = epithelium-mesenchyme transition; NC = neural crest; NT = neural tube; R-C = rostro-caudal.

<sup>a</sup>Age in somite pairs (som) and incubation days (I).

<sup>b</sup>Level as named level; or relative to last somite where –1 is last somite, –2 is second-last somite, etc.; and + is “estimated somite widths” caudal to last somite.

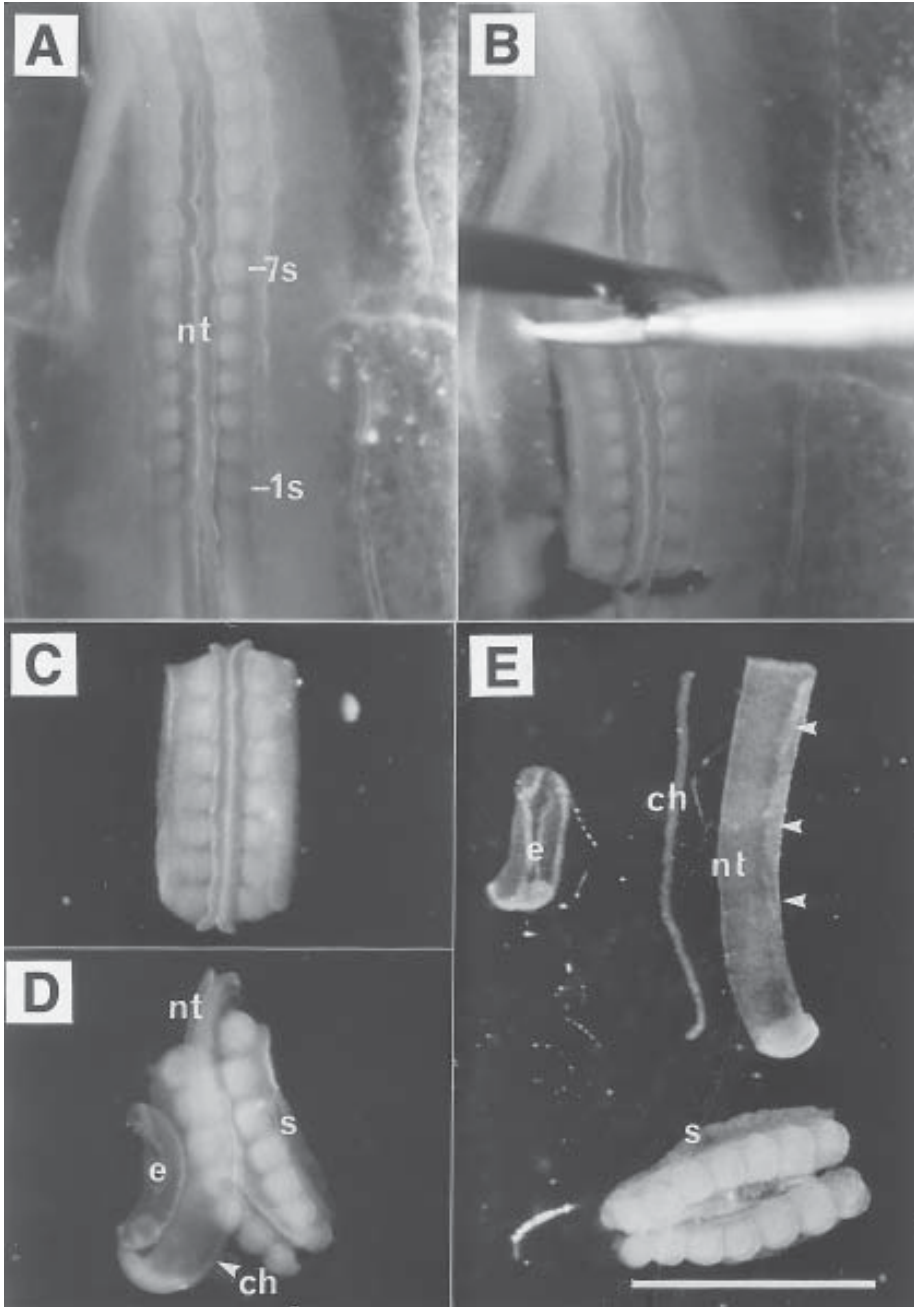

Fig. 2. Microdissection to isolate the thoracic neural tube. (A) The trunk level from the last somite ( $-1$  s) to seventh last somite ( $-7$  s), with the neural tube (nt), is identified. (B) This region is excised using tungsten needles in a scissor action. (C) The result is a tissue rectangle. (D) After exposure to Dispase, the rectangle partly separates into epidermis (e), notochord (ch), somites (s), and neural tube (nt). The somites are attached ventrally to the endoderm (not visible). Note the elongation of the neural tube and the contraction of the epidermis. (E) Dissection is completed with needles. Note the neural crest (arrowhead) visible along the dorsal surface of the neural tube. Scale = 1 mm.

somites then epidermis. For thoracic and lumbosacral tissue, reverse the order. To remove the notochord, pin one needle between the ventral neural tube and notochord about half way along the tube; try to exploit a preexisting gap to avoid nicking the tube. Then hook the notochord away; it will “unzip” toward both ends of the tube. Dorso-ventral polarity is identifiable because the neural tube usually bends slightly with the dorsal side convex, and neural crest cells can often be recognized as a more refractile fringe (**Fig. 2E**). Alternatively, the notochord can be left in place, where it acts as a ventral marker: note however that if explants are placed close together, the notochord can interfere with neural crest cell migration from another explant (**2**).

4. Neural tubes are transferred through several changes of medium to wash out the Dispase, which is *not* inactivated by serum protease inhibitors. The medium should contain at least some protein, e.g., 0.1% BSA, 1–10% serum, to prevent the neural tubes from sticking to the dish. They can be stored in this medium for several hours, but are best placed in culture medium and explanted within 30 min because they may open along the dorsal seam to produce a scroll-like shape with less predictable crest cell outgrowth.

## 3.2. Rodent Embryos

### 3.2.1. Embryo Harvest

1. Embryos are taken from any strain of mouse (e.g., CBA and C57/B16) at embryonic day (E) 9, where E0 is the day of vaginal plug detection. Rat embryos of E11 are treated similarly. This age provides thoracic-level neural explants.
2. Kill the mice by cervical dislocation, swab with alcohol, and with fine scissors, open the peritoneal cavity.
3. Using forceps, lift one end of the uterine horns and using fine scissors trim the connective tissue, fat and blood vessels to free the uterus from the body wall. Remove both uteri from the animal at the cervix (the point at which the two horns connect with the body wall) and place them into a 10-cm Petri dish in dissecting medium.
4. Place one uterus into a clean 10-cm Petri dish of dissecting medium. Under a dissecting microscope, grip the region of the uterus between individual decidua with fine curved forceps. Holding this firmly against the bottom of the dish, gently tease the uterine tissue with other forceps until the embryo “pops out.” There are usually 2–4 embryos per uterine horn in mice (3–6 in rats) but this varies between individuals and also between strains.
5. Transfer the embryos to a fresh dish using a wide-mouthed “nonadhesive” Pasteur pipet. Each embryo is stripped of membranes with fine forceps then staged according to Theiler (**15**) for the mouse and Christie (**16**) for the rat. Only those embryos which are equivalent to mouse E9–E9.5 (15–29 somites; stages T14/15) or rat E10.75–12 (15–28 somites; stages C20/21) are used.

### 3.2.2. Microdissection

1. Transect the embryos at the level of the last somite using needles, under a dissecting microscope. The second transection is made 8–10 somites rostral to this. Trim off tissue ventral and lateral to the neural tube as for avian embryos. Dissect in small batches to avoid storage for extended (>30 min) periods.
2. Transfer the trunk segments via pipet to Dispase and incubate at a low temperature (10–15°C) for 15 min, and then at 37°C for 6 min. Do not hold rodent (cf., avian) tissue for long periods and never on ice.
3. Transfer the segments to a Petri dish containing dissecting medium, 1% fetal calf serum (FCS), 0.1% DNase I (Roche Diagnostics). Remove the somites and surrounding tissue,



including notochord, as previously described for Aves. The more nicks in the tube, the poorer the outcome. Transfer to mouse cell culture medium and explant without delay.

### 3.2.3. Preparation of Substrates

1. Substrates are molecules that permit cell migration, which are adsorbed to the culture dishes (**Fig. 1**). The most frequently used substrate is human plasma fibronectin. This is applied at 10–50  $\mu\text{g}/\text{mL}$  in phosphate-buffered saline (PBS) or other protein-free medium for at least 30 min. Other substrate molecules can be used such as laminin-1 (approx 20–50  $\mu\text{g}/\text{mL}$ ) and vitronectin (approx 5  $\mu\text{g}/\text{mL}$ ). The concentrations are a guide only; run a dilution series to find the dilution giving reliable neural crest cell outgrowth. Usually, the entire dish does not need to be coated: a standing drop of 100  $\mu\text{L}$  coats a circle of about 8 mm diameter. The area covered by the drop should be outlined in indelible marker on the underside of the dish.
2. The substrate solution is washed off, rinsed with PBS and replaced by blocking solution (e.g., 10 mg/mL bovine serum albumin [BSA]) for a similar time; this prevents later adsorption of unwanted molecules.

### 3.2.4. Preparation of Specialized Substrates

1. Variations in cell migration between explants can be reduced by assessing migration along a defined “corridor.” Score parallel lines in a coated dish using two scalpel blades clamped together (Swann-Morton #10 blades cut a corridor 400  $\mu\text{m}$  wide [Swann-Morton, Sheffield, UK]). Place the neural tube overlapping the lines; the neural crest cell population arising between the lines remain in this corridor.
2. Multiple molecular substrates can be made by adding two molecules in solution together. Alternatively, two solutions can be applied one after another; do not add blocker after the first because this will exclude the second from adsorbing.
3. Alternating stripes of two substrate molecules (A and B) can also be made (**8**), these are most useful when a cellular response is suspected to involve a substrate choice, or when the response to one substrate molecule is conditional on the presence of a second molecule. In the simplest form of the stripes assay, the substrate is adsorbed with molecule A, blocked, then washed. Then, a plastic pipet tip is lightly wiped over the substrate in a series of parallel lines; we make 15–20 lines across a cm of substrate. This clears the coating from 20 to 100  $\mu\text{m}$  wide stripes of substrate which is then available to adsorb a second substrate molecule, B, followed by a blocker. Assuming that the first blocker prevents binding by B, and B does not bind to A, this gives a series of stripes A/B/A/B/A/B, etc. By omitting the first blocker, or by using molecules that bind to previously adsorbed molecules, a stripe series: A+B/B/A+B/B/A+B/B/, etc., is obtained. Mark the bottom of the dish to indicate the orientation of the lines. The stripes produced by this simple technique are neither uniformly wide nor uniformly spaced, and nor are they exactly parallel, but the pattern is sufficient to answer most questions of substrate choice. A microtemplate system has been designed to overcome these problems (**17**). The stripes can be detected later by appropriate antibodies.

### 3.2.5. Explantation

1. Neural tubes are transferred using a pipet to a culture dish so that a defined amount of medium is present, e.g., for avian explants we transfer all neural tubes together in 100- $\mu\text{L}$  culture medium to 3-cm diameter dish containing 900  $\mu\text{L}$  medium.
2. The explants are then pushed into the area of adsorbed substrate; in the case of striped substrates the neural tubes are placed perpendicular to the stripes. Several explants can be

placed in the same dish; we place up to eight neural tubes on an 8-mm diameter area of substrate.

3. The final volume required is critical; an optimal amount allows neural tubes to settle and attach rapidly (<15 min). Too little medium volume and the explants dry out; too much and the explants float which delays attachment variably, which makes comparisons of cell outgrowth dynamics difficult. The medium is slowly withdrawn with a calibrated pipet to strand the avian explants, yet keep them moist. Minor repositioning of the explants must be done quickly because substantial numbers of neural crest cells may stick to the substrate at the original site. We leave 500  $\mu\text{L}$  in a 3-cm dish. The precise volume varies for different dishes and must be established by trial and error.
4. For avian cells in 3-cm fibronectin dishes, after 2 h at 37–38°C in a humidified incubator, exuberant neural crest cell emigration has commenced; at this stage bring the culture medium volume up to at least 700  $\mu\text{L}$  to ensure that the explants do not dry out.
5. Mouse neural tubes are explanted into fibronectin-coated Linbro wells with 170  $\mu\text{L}$  of culture medium. The volume is made up to 500  $\mu\text{L}$  after 24 h; avoid any disturbance to these cultures before this time.

### 3.2.6. Analysis

1. Morphogenesis assay results are obtained quickly; between 0.5 and 24 h in culture.
2. Analysis of the dynamics of cell movement are made by time-lapse phase contrast video. Note that the cells respond poorly to light so use a low-light intensity camera. Answers to simple questions like “how fast do the cells move” not only depends on controllable variables like the time interval over which displacement is measured, the substrate, and the time in vitro, but also on cell density, which is difficult to control precisely. The outcome of cell movement at the population level can also be usefully analyzed but requires similar analytical care: even neural tube explants of identical age and axial level, prepared in identical ways, cultured in the same dish and made to occupy defined “corridors” of identical width can show major differences in extent of neural crest cell distribution which are traceable to tube-to-tube variation in the number of neural crest cells generated.
3. To fix cultures for, e.g., antibody labeling, gently pipet 4% freshly made up paraformaldehyde in PBS into one side of the culture dish whereas simultaneously withdrawing culture medium from the other side. Fix for 15 min then wash with PBS 3 times and quench with 0.1 *M* glycine in PBS for 15 min. If necessary, permeabilize cells with 0.1% Triton X-100 in PBS for 10 min followed by 4–6 brief washes in PBS plus 10 mg/mL BSA. Alternatively, fix by replacing the medium with methanol at –20°C.
4. Antibodies are applied in PBS plus BSA. It is economical to use approx 20  $\mu\text{L}$  standing drops, but for this cultures must be on bacteriological plastic, Triton must be completely washed off and the area around the explant(s) must be dried with a tissue to prevent the drop from spreading and drying. Small volume incubations must be done in a humid box. Both immunofluorescence and chromogen methods work well.
5. Plastic dishes have unsatisfactory optical qualities; instead, mount a glass coverslip on top of the culture grown on plastic and view through this (to accommodate microscope objectives it will be necessary to cut the side off the dish with scissors). Mounting medium is PBS or glycerol with 25–100 mg/mL DABCO (Sigma) to retard FITC fluorescence fading, or commercial antifade mountants (Bio-Rad, Richmond, CA; Molecular Probes, Eugene, OR; Vector, Burlingame, CA; etc.); only PBS is suitable for simultaneous phase observation.

#### 4. Notes

1. Dissecting needles are made from 0.25 or 0.5-mm diameter tungsten wire (e.g., Goodfellow, Cambridge, UK); we prefer the thicker wire except for dissection of individual rhombomeres. Needles are electrolytically sharpened in 1 *N* NaOH using a copper counterelectrode. A convenient power source is a 10-V microscope power supply. Needles can be resharpened in a few seconds. The needles are mounted in hollow handles (e.g., Dick, Esslingen, Germany) accommodating a maximum length of wire, which can be fed out as the wire shortens with repeated sharpening. Always have extra needles ready if the pair in use become damaged. Alternatively, 27 or 30 gage needles can be used, with 1–2 mL syringe barrels as handles.
2. Various problems with culture vessels include: cluster wells often are inaccessibly deep; neural explants are not as healthy in large dishes/volumes; visibility is impaired by the meniscus in small wells; nonbiological cell adhesion to tissue culture (TC) plastic can obscure specific adhesion-based responses.
3. Quail explants give slightly more robust neural crest cell cultures than do chickens. Rat explants seem more robust than mouse.
4. Unincubated avian eggs can be stored at temperatures of 6–16°C for up to 2 wk. Once started, incubation can be interrupted for at least 12 h by cooling.
5. Over 1.5–2.7 d incubation, chick and quail embryos are almost identical in chronology and morphology. Rats and mice are similar morphologically but differ chronologically. For staging by somite counts, note that after about 10–12 somites age, the most rostral 1–2 somites cannot be distinguished. In birds, the omphalo-mesenteric arteries (visible after about 2 d incubation) are level with somite 20/21 so do not bother to count the somites rostral to this. In rodents, the posterior border of the forelimb bud marks the level of somite 12.
6. The thoracic level produces the most abundant neural crest cell outgrowth uncontaminated by other cells and should be used unless particular axial levels (e.g., cranial, vagal, etc.) are required. The pros and cons of various axial levels are detailed in **Table 1**.
7. All tissue transfers must be done with a pipet; lifting the tissue through the surface tension layer can destroy the explants. The tips of glass pipets should be fire-polished. Tissues in protein-free medium adhere to glass and plastic with fabulous rapidity and tenacity therefore *all* pipets must be treated to prevent this. Filling pipets briefly with a protein solution (e.g., BSA, serum, egg albumin) will suffice, it is not necessary to siliconize. The same holds true for the plastic dishes (even “nonadherent” bacteriological grade ones). Failure to do this will lead to regrets!
8. We recommend Dispase II (neutral protease; Roche Diagnostics) at 2 mg/mL (2.4 U/mL) because it is cheap, effective, and gentle. Dispase requires calcium (do not use with EDTA) and can be used even in the presence of serum. Dispase used in this way isolates embryonic organs by digesting the extracellular matrix between them but leaves cell–cell adhesions within the organs functionally active. Dispase followed by calcium reduction gives a cell suspension. Other enzymes can be used, but note that collagenase preparations are active because of contaminating proteases; pure collagenase is expensive and useless for neural tube isolation. Concentrations of crude collagenase must be determined empirically. Trypsin at 0.1% can be used, but can lead to less robust explants. All these enzymes must be used in calcium-containing medium.
9. Isolation of Dispase-treated tissues can be performed rapidly by repeated trituration, but we do not recommend it because some loosely adherent neural crest cells detach from the neural tube. Loss of these cells may contribute to the variable number of crest cells produced by explants of identical stage and axial level.

10. We recommend bacteriological dishes for culture because with tissue culture-grade dishes, even blockers like BSA will not completely suppress cell adhesion.
11. Stock solutions of substrate molecules should be thawed on ice; this is particularly critical for laminin-1 which can form an insoluble gel. Check activity of frozen stock in standard migration bioassay every couple of months.
12. The efficacy of blocker proteins should be tested if not already known; for example, we found that BSA blocks unwanted adsorption of fibronectin but is much less effective against laminin (**18**).
13. The neural tube explant sometimes spreads as a sheet of epithelial cells, as well as giving rise to a mesenchymal neural crest cell outgrowth. Epithelial outgrowth is greatest from the ends, particularly the developmentally youngest and less coherent caudal end (*see Fig. 2*) especially with trypsin isolation. To minimize this, after washing free of protease, trim off and discard about a somite's width from each end of the neural tube before explantation.
14. Neural tube cells can adhere and spread on fibronectin immediately after Dispase treatment, but on laminin-1, vitronectin and collagen a 1–2 h recovery at 37°C is required before full adhesive ability is regained.

## References

1. Le Douarin, N. M. (1982) *The Neural Crest*, Cambridge University Press, Cambridge, UK.
2. Newgreen, D. F. (1992) Establishment of the form of the peripheral nervous system, in *Development, Regeneration and Plasticity of the Autonomic Nervous System* (Hendry, I. A. and Hill, C. E., eds.), Harwood Academic, Switzerland, pp. 1–94.
3. Cohen, A. M. and Konigsberg, I. R. (1975) A clonal approach to the problem of neural crest determination. *Dev. Biol.* **46**, 262–280.
4. Maxwell, G. D. (1976) Substrate dependence of cell migration from explanted neural tubes in vitro. *Cell Tissue Res.* **172**, 325–330.
5. Newgreen, D. F., Ritterman, M., and Peters, E. A. (1979) Morphology and behaviour of neural crest cells of chick embryos in vitro. *Cell Tissue Res.* **203**, 115–140.
6. Newgreen, D. F. and Thiery, J. P. (1980) Fibronectin in early avian embryos: Synthesis and distribution along the migration pathways of neural crest cells. *Cell Tissue Res.* **211**, 269–291.
7. Newgreen, D. F. and Gibbins, I. L. (1982) Factors controlling the time of onset of the migration of neural crest cells in the fowl embryo. *Cell Tissue Res.* **224**, 145–160.
8. Newgreen, D. (1984) Spreading of explants of embryonic chick mesenchymes and epithelia on fibronectin and laminin. *Cell Tissue Res.* **236**, 265–277.
9. Graham, A., Francis-West, P., Brickell, P., and Lumsden, A. (1994) The signalling molecule BMP-4 mediates apoptosis in the rhombencephalic neural crest. *Nature* **372**, 684–686.
10. Newgreen, D. F. and Minichiello, J. (1995). Control of epitheliomesenchymal transformation. I. Events in the onset of neural crest cell migration are separable and inducible by protein kinase inhibitors. *Dev. Biol.* **170**, 91–101.
11. Wang, H. U. and Anderson, D. J. (1997) Eph family transmembrane ligands can mediate repulsive guidance of trunk neural crest migration and motor axon outgrowth. *Cell* **18**, 383–396.
12. Kerr, R. S. E. and Newgreen, D. F. (1997) Isolation and characterization of chondroitin sulfate proteoglycans from embryonic quail that influence neural crest cell behavior. *Dev. Biol.* **192**, 108–124.
13. Bottenstein, J. E., Skaper, S. D., Varon, S. S., and Sato, G. H. (1980) Selective survival of neurons from chick embryo sensory ganglionic dissociates utilizing serum free supplemented medium. *Exp. Cell Res.* **125**, 183–190.

14. Hamburger, V. and Hamilton, H. L. (1951) A series of normal stages in the development of the chick embryo. *J. Morphol.* **188**, 49–92.
15. Theiler, K. (1989) *The House Mouse. Atlas of Embryonic Development*. Springer-Verlag, New York.
16. Christie, G. A. (1964) Developmental stages in somite and post-somite rat embryos, based on external appearance, and including some features of the macroscopic development of the oral cavity. *J. Morphol.* **114**, 263–286.
17. Vielmetter, J., Stolze, B., Bonhoeffer, F., and Stuermer, C. A. O. (1990) In vitro assay to test differential substrate affinities of growing axons and migratory cells. *Exp. Brain Res.* **81**, 283–287.

## The Chimeric Human/Mouse Model of Angiogenesis

Eric Petitclerc, Tami von Schalscha, and Peter C. Brooks

### 1. Introduction

#### 1.1. Angiogenesis and Vascular Development

Angiogenesis, the formation of new blood vessels from preexisting vessels, is an essential component of many normal biological processes such as embryonic development, wound healing, and endometrial maturation in premenopausal women (1–3). This process is similar to, but not identical with vasculogenesis, which is associated with the development of blood vessels from precursor cells termed angioblasts (4,5). Under normal physiological conditions the complex cellular events controlling vascular development are tightly regulated. However, when the molecular and biochemical mechanisms controlling angiogenesis are disrupted, uncontrolled neovascularization can contribute to a number of pathologies. In fact, several clinically important human diseases are characterized by abnormal vascular development including solid tumor growth, rheumatoid arthritis, diabetic retinopathy, and psoriasis (1–3,6–8). Thus, the pathological consequences of abnormal neovascularization impacts a large segment of the population and clearly demonstrates the need for an in depth understanding of the molecular mediators involved in the regulation of angiogenesis. To this end, an expanding body of work has identified a wide variety of molecules as potential targets for antiangiogenic strategies including a complex network of cytokines, cell adhesion receptors, proteolytic enzymes, and extracellular matrix components (9–11). Interestingly, many of these important discoveries were first identified by the use of in vitro and in vivo angiogenesis models.

#### 1.2. Angiogenesis Models

A major difficulty in gaining a complete understanding of angiogenesis and vascular development arises from the complexity and wide array of molecules that contribute to new blood vessel growth. Because angiogenesis is not a static event, but rather a continuum of interconnected cellular processes, in vitro models such as endothelial cell proliferation, migration, and invasion may provide only limited information (12–14). Furthermore, in vitro models such as endothelial tube formation and aortic ring models also provides only limited information because angiogenesis does not occur in isolation, but rather occurs in a complex extracellular microenvironment (15–17). Thus,

there is great need for reliable and reproducible *in vivo* models. To this end, a number of models have been developed that allow researchers the ability to study angiogenesis in the context of a true physiological microenvironment. Some of the more commonly used animal models include the rat, mouse, and rabbit corneal pocket assays (18–20), the murine retinal neovascularization model (8), the primate iris model (21), and the chick embryo chorioallantoic membrane (CAM) assay (22,23). Whereas these models provide researchers with the ability to study blood vessel development *in vivo*, they provide no information on human angiogenesis. Therefore, a model that allows the study of human blood vessel development in the microenvironment of human tissue would be of great use. In this chapter, we will describe a method to study human tumor-induced angiogenesis within full thickness human skin.

### 1.3. The Chimeric Human/Mouse Model of Angiogenesis

The previously described chimeric human/mouse model has been used to study a variety of biological processes such as tumor growth, metastasis, and wound healing (24–26). In this method, full thickness human neonatal foreskin is transplanted on the backs of immunosuppressed SCID mice (Fig. 1). The human skin graft contains preexisting human blood vessels, which can connect with the murine vascular system, providing a source of human blood vessels. Human tumor angiogenesis can be induced within this tissue by injecting a single cell suspension of tumor cells (27). Angiogenesis can be assessed by microvascular density counts in conjunction with immunological staining using antibodies specifically directed to human vessels (27). This unique model system combines the benefits of using immunosuppressed animals with the flexibility of inducing human angiogenesis by a wide variety of tumor types or purified cytokines. Thus, whereas this model requires technical experimental manipulations, it has the major advantage of providing an assay to evaluate human blood vessel development within a true human tissue.

## 2. Materials

1. 6-to-8-wk-old female SCID mice (20–30 g).
2. Human neonatal foreskins (newborn to 2 mo).
3. Ketamine HCl (Ketaset 100 mg/mL).
4. Metofane (methoxyflurane) (Mallinckrodt Veterinary, Mundelein, IL).
5. Ethanol.
6. Sterile water.
7. Dulbecco's Modified Eagles Medium (DMEM) (Irvine Scientific, Santa Ana, CA).
8. Fetal bovine serum (FBS).
9. Alcohol swab preps.
10. Sterile gauze (4 in. × 4 in.).
11. Needles (25 and 30 gage).
12. Sterile Petri dishes (100 mm and 35 mm).
13. Syringes (10 cc and 50 cc).
14. Transparent dressing.
15. Adhesive strips (Band-Aids<sup>®</sup>) (Johnson & Johnson, New Brunswick, NJ).
16. Sterile gloves.
17. Electric shaver.
18. Forceps.
19. Hemostats.

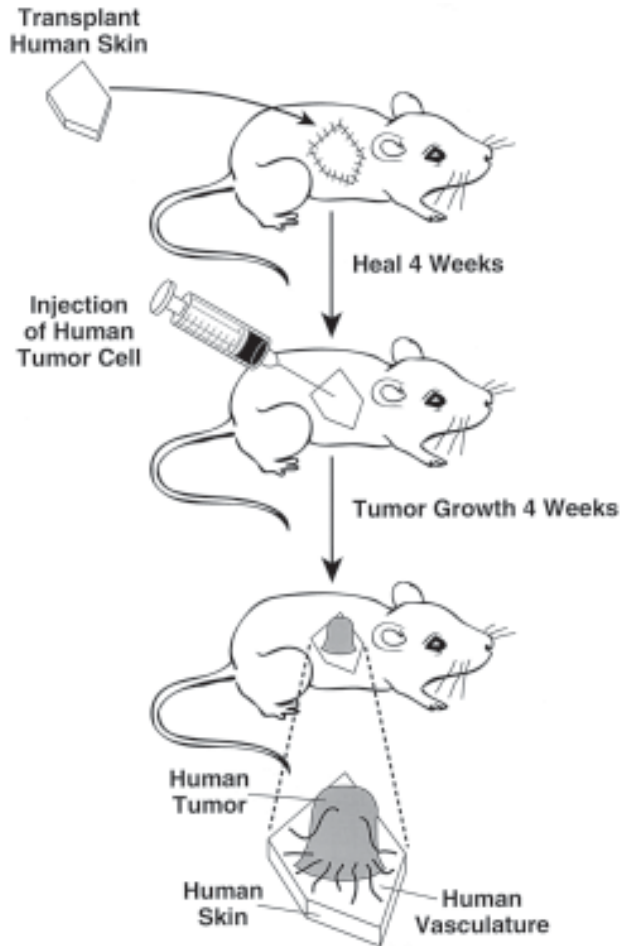

Fig. 1. The chimeric human/mouse model of angiogenesis. Human neonatal foreskin is transplanted on the backs of SCID mice (6-to-8-wk old). The human skin graft is allowed to heal for 2 to 4 wk. Angiogenesis can then be induced by injecting a single cell suspension of human tumor cells intradermally within the human skin. The tumor cells begin to form palpable tumors within 2 to 4 wk depending on the tumor cell type. These tumors induce the growth of human blood vessels into the tumor mass. The tumor and surrounding human skin can be resected and snap frozen for cryosections.

20. Scissors.
21. Sutures (5-0 silk black braided 18 in.).
22. Laminar flow sterile hood.
23. Calipers.
24. Cryomolds.
25. OCT embedding compound.
26. Anti-CD-31 human specific antibody.
27. Goat Antimouse FITC or rhodamine conjugated IgG.
28. Fluorescent mounting medium.
29. Glass tissue slides and cover slips.
30. Penicillin-streptomycin solution.



### 3. Methods

#### 3.1. Preparation of Human Foreskin Tissues

The human neonatal foreskins can be obtained from the Cooperative Human Tissue Network (CHTN) in association with Case Western University and stored for transport in DMEM supplemented with 1% penicillin-streptomycin. Upon arrival, the foreskin tissues are aseptically prepared for surgical transplantation by trimming free the underlying fat pad and connective tissues. The trimmed human foreskin tissue is then carefully cut in an oval shape (approximately 5 mm × 10 mm) making sure that no rough edges are present. Special care must be taken to avoid damaging the foreskins by excess pinching with the forceps. Once cut to the appropriate size, they can be stored at 4°C for up to 1 wk in DMEM containing 10% FBS and 1% penicillin-streptomycin.

#### 3.2. Preparation of Animals for Surgery

Before beginning any animal procedure, be sure to become acquainted with and follow all NIH guidelines and individual institutional guidelines for the humane care and use of laboratory animals. Consultations with your institution's veterinarian and vivaria staff is strongly recommended. Because the animals used in this protocol are immunosuppressed mice (SCIDs), care must be taken to prevent contact with potential infectious agents. At all times, sterile gloves, face masks, hair covers, and clean lab coats should be worn. In addition, all surgical instruments should be sterilized by autoclaving and sanitized with 70% ethanol between individual mice. The mice should be prepared for surgery one at a time by swabbing the belly with 70% ethanol followed by an ip injection with ketamine (100 mg/mL) diluted 1:10 in sterile water (200 to 300 cc per mouse). Following the ketamine injection, if the mouse becomes hyperactive, do not use it for surgical transplantation. Three to five min after ketamine injection when the mouse demonstrates decreased activity, gently place the head of the mouse in a 50-mL syringe containing gauze prewetted with Metofane located in the bottom of the syringe. Hold the head of the mouse in the opening for 30 to 60 s to achieve a light to moderate level of anesthesia. Frequently monitor the animal's condition and repeat as necessary to maintain this level of anesthesia.

#### 3.3. Surgical Procedure for the Human Skin Graft

While working quickly and carefully, swab the dorsal side of the mouse with 70% ethanol, being careful not to soak the mouse because this could lead to a rapid drop in body temperature. Carefully shave the entire dorsal side of the mouse from the front legs to the rear legs to provide a hair-free area with which to work. Remove any excess hair and clean the area with 70% ethanol. Place the mouse on a sterile pad and again assess the level of anesthesia. Repeat the Metofane procedure as necessary to maintain a moderate level of anesthesia. Using sterile forceps, grasp and lift the skin within the center of the prepared area and quickly snip the skin, being careful to avoid any muscle tissue. Carefully cut and remove an oval section approximately 5 mm × 10 mm. Any bleeding is usually minimal and can be stopped by gentle pressure with a sterile gauze. For the best results, select a section of previously prepared human tissue that is slightly smaller than the resected area. Place the oval-shaped foreskin tissue inside the resected area on the back of the mouse (**Fig. 1**). Care should be taken to avoid drying out the resected area. Keep the area moist with DMEM medium used for storage of the human tissue.

Using sterile hemostats, grab the needle of the suture at a 90° angle. Thread the suture 2 to 3 mm from the edge of the tissue, from top to bottom through mouse skin then from bottom to top through the human skin following the curve of the needle. To make the knot, twist the silk suture two times around the hemostat, then grab the loose end and pull the suture through to form the knot. Repeat the operation and cut the silk ends 1 to 2 mm from the knot. Eight stitches placed evenly around the graft tissue is usually sufficient. Additional stitches may be necessary for uneven shaped tissues.

Once the tissue is properly sutured, a sterile dressing is applied to the surgical wound. To apply the dressing, take a 2 cm × 8 cm piece of transparent dressing and wrap it around the midsection of the mouse. Care should be taken not to hinder the animal's breathing or the mobility of its legs. Next place a Band-Aid around the dressing for extra support. Wrap a final layer of transparent dressing around the animal and place it back in the cage. The mice should be carefully monitored after 24 h and periodically thereafter to insure that the dressing is not impeding the breathing or movement of the mice. One week later, cut the dressing on the ventral side if the animal has not already chewed through it, but do not remove it. The dressing will fall off as the wound heals in approximately 2 to 3 wk.

### **3.4. Tumor-Induced Angiogenesis**

Approximately 3 wk following surgery, the human skin grafts are inspected for proper healing and integrity. The human tissue should be pale without traces of black or necrotic tissue. Angiogenesis can be induced within the human skin by an intradermal injection (50 µL per mouse) of a single cell suspension of tumor cells resuspended in sterile phosphate-buffered saline (PBS) using a 30-gage needle (**Fig. 1**). The number of tumor cells injected depends on the growth characteristic of the particular tumor type used and is determined experimentally. Following the tumor cell injections, the mice are monitored daily for the development of a palpable solid tumor mass.

### **3.5. Administration of Angiogenesis Antagonist**

Once palpable tumors are detected (usually 1 to 2 wk depending on tumor type), measure the length and width of the tumor with calipers and determine the tumor volume using the following formula  $V = (L \times W^2)/2$  where  $V$  = the volume,  $L$  = the length, and  $W$  = the width. Group animals with similar tumor volumes to assess the effects of systemically or intraperitoneally administered antagonist. The amount of antagonist delivered and the duration of the treatment depends on the nature of the antagonist to be tested and should be determined experimentally. Intravenous injections can be performed by diluting the antagonist to be tested in sterile saline (0.9%) and injected via the tail vein in a total volume of 50 µL per injection per mouse. For ip injections, antagonist can be diluted similarly and a total of 100 µL per injection per mouse can be used. Tumor growth can be monitored by caliper measurements on a daily or weekly basis to assess the effects of the angiogenesis antagonists on tumor growth.

### **3.6. Preparation of Tumor Tissue for Analysis**

At the end of the treatment protocol, a final tumor measurement should be made and the animals euthanized. Carefully resect the solid tumor and the surrounding human skin from the mouse. Place the resected tissue in a 35-mm Petri dish and wash the

tissue 3 times with 1 mL of sterile PBS. Place the trimmed and washed tumor tissue in the plastic cryomold (20 mm × 25 mm × 5 mm) and cover the tissue with OCT embedding compound. Allow the tissue to sit undisturbed for 5 to 10 min to allow the OCT to equilibrate with the tissue. Snap freeze the embedded tumor tissue in liquid nitrogen by carefully holding the cryomold containing the tissue in contact with the liquid nitrogen allowing the tissue to freeze from the bottom up (usually 30 to 45 s). The frozen blocks of tumor tissue can be stored at  $-80^{\circ}\text{C}$  until used. Frozen tissue blocks are next cut with the use of a cryostat. Sections of tissue between 3–6  $\mu\text{m}$  are optimal for use and are mounted on microscope slides. The tissue sections are next fixed by immersing the slides for 30 s in 100% acetone. The slides containing the tissue sections can now be stored for up to 3 wk at  $-80^{\circ}\text{C}$ .

### **3.7. Indirect Immunofluorescent Staining of Tumor Tissue**

Tumor-associated angiogenesis involving human blood vessels can be quantified by counting the number of tumor-associated human blood vessels per high powered ( $\times 200$ ) microscopic field. To begin, fixed tissue sections are rehydrated with PBS (100 to 500  $\mu\text{L}$  per slide) for 10 min. The nonspecific binding sites within the tissue are blocked by incubation with 2.5% bovine serum albumin (BSA) in PBS (100 to 500  $\mu\text{L}$  per slide) for 1 to 2 h at room temperature. Next, the tissues are stained with a human specific monoclonal antibody (Mab) directed to CD-31, a well-known marker of blood vessels (27). Tissues are incubated for 1 to 2 h at room temperature with anti-CD-31 Mab at a concentration of 5 to 10  $\mu\text{g}/\text{mL}$  diluted in 1.0% BSA in PBS. The tissues are next washed five times with PBS for 5 min each, followed by incubation (1 to 2 h at room temperature) with goat antimouse fluorescein isothiocyanate (FITC) or Rhodamine-labeled secondary antibody diluted 1:400 in 1.0% BSA in PBS. For the best results, it may be necessary to experimentally titer the antibody concentrations. The slides are next washed five times with PBS for 5 min each and a drop of fluorescent mounting medium containing antifade reagent is placed on the tissue and covered with a glass cover slip. The edges of the slide are sealed with clear nail polish to prevent the slide from drying out.

### **3.8. Quantification of Human Tumor-Associated Angiogenesis**

Angiogenesis can be quantified by determining the number of human (CD-31 positive) tumor-associated blood vessels in high power ( $\times 200$ ) microscopic fields. Using a compound microscope fitted with epifluorescence and an ocular eyepiece fitted with a grid, the human blood vessels can be counted. The blood vessel counts should be concentrated in the periphery of the tumor near the tumor-host interface (Fig. 2). This is the area thought to contain the majority of the actively proliferating angiogenic blood vessels (28). Using a  $\times 10$  ocular eyepiece fitted with a grid, and a  $\times 20$  objective, select an area with a high vessel density. Count the number of human-specific CD-31 positive vessels within the gridded microscopic field ( $\times 200$ ). From this position, change the microscopic field in four separate directions (left, right, up, and down) from the starting point and count the number of human vessels in each as before (Fig. 2). Repeat this procedure four to five times for each individual tumor for a total of 16 to 20 microscopic fields. Representative photographs can also be taken to document the analysis.

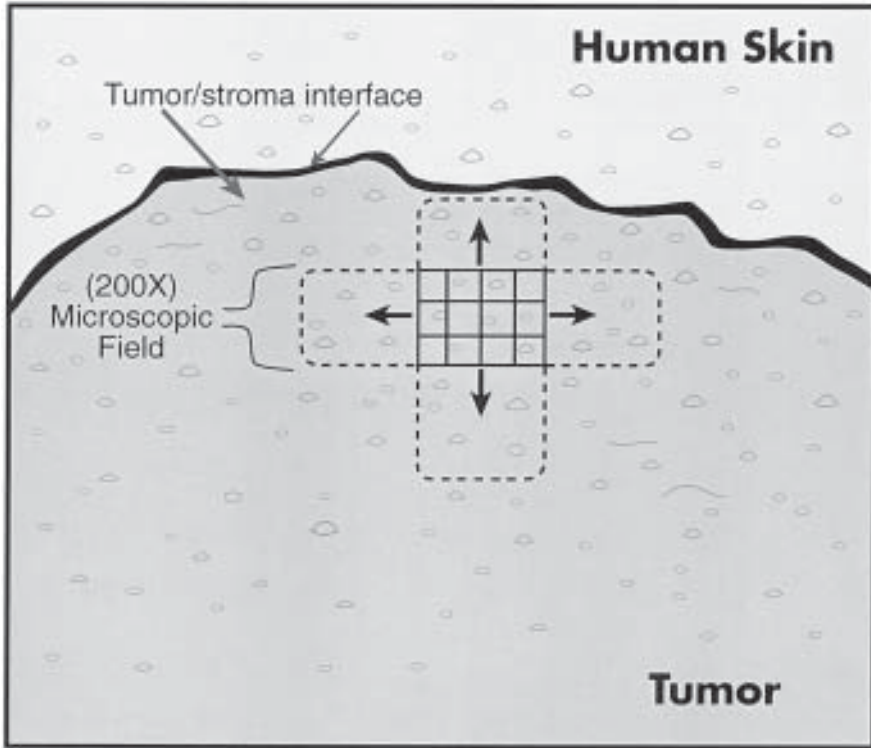

Fig. 2. Quantification of human blood vessels. Frozen sections of human tumor can be stained with monoclonal antibodies specifically directed to human blood vessels (anti-CD-31 Mab). An initial ( $\times 200$ ) microscopic field (solid grid box) is chosen in the periphery of the tumor near the tumor host interface with a high vessel density. The number of CD-31 positive human blood vessels can be determined in the initial field followed by moving the field (dashed grid boxes) in four separate direction, left, right, up, and down and vessel counts made in each field. A total of 16 to 20 fields should be counted per tumor sample.

Angiogenesis can be reported as the number of human blood vessels per  $\times 200$  microscopic field.

#### 4. Notes

1. Neonatal human foreskins should be obtained from newborns up to 2 mo. Older human donor skin may result in poor grafting properties.
2. To increase the efficiency of the grafting procedure, perform the surgery as soon as possible after receiving the donor skin.
3. Murine blood vessels from the host tissue will invade the human skin. To minimize the number of murine vessels within the human skin, use the animals for experiments as soon as possible after the grafts have healed (2.5–4 wk after surgery).
4. To limit the number of murine vessels entering the tumor, inject the tumor cells as close to the center of the human donor tissue as possible in a small volume (50  $\mu$ L or less). In addition, use a rapidly proliferating tumor that grows well in the human skin and end the experiment soon after a small palpable tumor is evident. This will help prevent the tumor from growing into the murine skin.

## Acknowledgment

P. C. Brooks was supported in part by grants from the NCI (1R29CA74132-01) and the Stop Cancer Foundation of Los Angeles. E. Petitclerc was supported in part by postdoctoral fellowships from the Medical Research Council of Canada and The Fonds de la Recherche en santé du Québec.

## References

1. Folkman, J. (1995) Clinical applications of research on angiogenesis. *N. Engl. J. Med.* **333**, 1757–1763.
2. Blood, C. H. and Zetter, B. R. (1990) Tumor interactions with the vasculature: angiogenesis and tumor metastasis. *Biochem. Biophys. Acta.* **1032**, 89–118.
3. Folkman, J. and Ingber, D. (1992) Inhibition of angiogenesis. *Semin. Cancer Biol.* **3**, 89–96.
4. O'Reilly, M. S., Holmgren, L., Shing, Y., Chen, C., Rosenthal, R. A., Moses, M., et al. (1994) Angiostatin: a novel angiogenesis inhibitor that mediates the suppression of metastases by a lewis lung carcinoma. *Cell* **79**, 315–328.
5. Poole, T. J. and Coffin, J. D. (1989) Vasculogenesis and angiogenesis: two distinct morphogenetic mechanisms establish embryonic vascular pattern. *J. Exp. Zool.* **251**, 224–231.
6. Drake, C. J., Cheresch, D. A., and Little, C. D. (1995) An antagonist of integrin avb3 prevents maturation of blood vessels during embryonic neovascularization. *J. Cell Sci.* **108**, 2655–2661.
7. Gastl, G., Hermann, T., Steurer, M., Zmija, J., Gunsilius, E., Unger, C., and Kraft, A. (1997) Angiogenesis as a target for tumor treatment. *Oncology* **54**, 177–184.
8. Friedlander, M., Theesfeld, C. L., Sugita, M., Fruttiger, M., Thomas, M. A., Chang, T., and Cheresch, D. A. (1996) Involvement of integrins  $\alpha v \beta 3$  and  $\alpha v \beta 5$  in ocular neovascular disease. *Proc. Natl. Acad. Sci. USA* **93**, 9764–9769.
9. Brooks, P. C. (1996) Cell adhesion molecules in angiogenesis. *Cancer Met. Rev.* **15**, 187–194.
10. Auerbach, W. and Auerbach, R. (1994) Angiogenesis inhibition: a review. *Pharmac. Ther.* **63**, 265–311.
11. Sunderkotter, C., Steinbrink, K., Goebeler, M., Bhardwaj, R., and Sorg, C. (1994) Macrophages and angiogenesis. *J. Leuk. Biol.* **55**, 410–422.
12. Takano, S., Gately, S., Neville, M. E., Herblin, W. F., Gross, J. L., Engelhard, H., et al. (1994) Suramin, an anticancer and angiosuppressive agent, inhibits endothelial cell binding of basic fibroblast growth factor, migration, proliferation, and induction of urokinase-type plasminogen activator. *Cancer Res.* **54**, 2654–2660.
13. Gupta, S. K. and Singh, J. P. (1994) Inhibition of endothelial cell proliferation by platelet factor-4 involves a unique action on S phase progression. *J. Cell Biol.* **127**, 1121–1127.
14. Trochon, V., Mabilat, C., Bertrand, P., Legrand, Y., S.-M., F., Soria, C., et al. (1996) Evidence of involvement of CD44 in endothelial cell proliferation, migration and angiogenesis in vitro. *Int. J. Cancer* **66**, 664–668.
15. Grant, D. S., Tashiro, K.-I., Segui-Real, B., Yamada, Y., Martin, G. R., and Kleinman, H. K. (1989) Two different laminin domains mediate the differentiation of human endothelial cells into capillary-like structures in vitro. *Cell* **58**, 933–943.
16. Nicosia, R. F., Lin, Y. J., Hazelton, D., and Qian, X. (1997) Endogenous regulation of angiogenesis in the rat aortic model. *Am. J. Pathol.* **151**, 1379–1386.
17. Roskelley, C. D., Srebrow, A., and Bissel, M. J. (1995) A hierarchy of ECM-mediated signaling regulates tissue-specific gene expression. *Curr. Opin. Cell Biol.* **7**, 736–747.
18. Sholley, M. M., Ferguson, G. P., Seibel, H. R., Montour, J. L., and Wilson, J. D. (1994) Mechanisms of neovascularization. *Lab. Invest.* **51**, 624–634.

19. Friedlander, M., Brooks, P. C., Shaffer, R. W., Kincaid, C. M., Varner, J. A., and Cheresch, D. A. (1995) Definition of two angiogenic pathways by distinct av integrins. *Science* **270**, 1500–1502.
20. Chen, C., Parangi, S., Tolentino, M. J., and Folkman, J. (1995) A strategy to discover circulating angiogenesis inhibitors generated by human tumors. *Cancer Res.* **55**, 4230–4233.
21. Miller, J. W., Adamis, A. P., Shima, D. T., D'Amore, P. A., Moulton, R. S., O'Reilly, M. S., et al. (1994) Vascular endothelial growth factor/vascular permeability factor is temporally and spatially correlated with ocular angiogenesis in a primate model. *Am. J. Pathol.* **145**, 574–584.
22. Brooks, P. C., Clark, R. A. F., and Cheresch, D. A. (1994) Requirement of vascular integrin  $\alpha v \beta 3$  for angiogenesis. *Science* **264**, 569–571.
23. Nguyen, M., Shing, Y., and Folkman, J. (1994) Quantitation of angiogenesis and antiangiogenesis in the chick embryo chorioallantoic membrane. *Microvasc. Res.* **47**, 31–40.
24. Christofidou-Solomidou, V., Bridges, M., Murphy, G. F., Albelda, S. M., and DeLisser, H. M. (1997) Expression and function of endothelial cell av integrin receptors in wound-induced human angiogenesis in human skin/SCID mice chimeras. *Am. J. Pathol.* **151**, 975–983.
25. Christofidou-Solomidou, M., Murphy, G. F., and Albelda, S. M. (1996) Induction of E-selectin-dependent leukocyte recruitment by mast cell degranulation in human skin grafts transplanted on SCID mice. *Am. J. Pathol.* **148**, 177–188.
26. Juhasz, I., Albelda, S. M., Elder, D. E., Murphy, G. F., Adachi, K., Herlyn, D., et al. (1993) Growth and invasion of human melanoma in human skin grafted on immunodeficient mice. *Am. J. Pathol.* **143**, 528–537.
27. Brooks, P. C., Stromblad, S., Klemke, R., Visscher, D., Sarkar, F. H., and Cheresch, D. A. (1995) Antiintegrin  $\alpha v \beta 3$  blocks human breast tumor growth and angiogenesis in human skin. *J. Clin. Invest.* **96**, 1815–1822.
28. Pluda, J. M. (1997) Tumor-associated angiogenesis: mechanisms, clinical implications, and therapeutic strategies. *Semin. Oncol.* **24**, 203–218.

## Analysis of Embryonic Vascular Morphogenesis

Thomas N. Sato and Sona Bartunkova

### 1. Introduction

The circulatory system is the first organ system to develop in the embryo. It is an essential system for the normal development of other organs and the whole embryonic body. During the last several years, we have begun to understand the specific molecules that regulate the differentiation of cells that comprise the circulatory system as well as the subsequent morphogenic events (*1,2*). In this chapter, protocols to study expression of genes and proteins that have been shown to be critical for vascular morphogenesis will be described in detail (*1–6*). The list of genes and proteins includes endothelial cell receptor tyrosine kinases and their ligands, extracellular matrix, and smooth muscle markers. Protocols to examine overall patterns of blood vessel network in developing embryos will be also provided. All of the protocols are developed for the use with mouse embryos.

### 2. Materials

#### 2.1. Riboprobes for In Situ Hybridization

1. Endothelial receptor tyrosine kinases (EC-RTKs)
  - Mouse TIE1 (available from T. N. Sato; island1005@aol.com).
  - Mouse TIE2 (available from T. N. Sato; island1005@aol.com).
  - Mouse FLK1 (VEGF-R2) (available from T. N. Sato; island1005@aol.com).
  - Mouse FLT1 (VEGF-R1) (available from T. N. Sato; island1005@aol.com).
  - Mouse FLT4 (VEGF-R3) (available from T. N. Sato; island1005@aol.com).
2. Ligands for EC-RTKs
  - VEGF-A (available from T. N. Sato; island1005@aol.com).
  - Angiopoietin-1 (request from G. D. Yancopoulos; gdy@regpha.com).
  - Angiopoietin-2 (request from G. D. Yancopoulos; gdy@regpha.com).
3. Smooth muscle marker
  - SM22 $\alpha$  (available from T. N. Sato; island1005@aol.com).

#### 2.2. Antibodies for Immunohistochemistry

- Mouse TIE1 (request from T. Suda, Kumamoto University, Kumamoto, Japan; fax: 81-96-373-5332).
- Mouse TIE2 (request from T. Suda, Kumamoto University, Kumamoto, Japan; fax: 81-96-373-5332).

From: *Methods in Molecular Biology, Vol. 137: Developmental Biology Protocols, Vol. III*  
Edited by: R. S. Tuan and C. W. Lo © Humana Press Inc., Totowa, NJ

Mouse FLK1 (VEGF-R2) (request from Andre Schuh, University of Toronto, Canada; fax: 416-978-8765).

Mouse fibronectin (Gibco-BRL, Gaithersburg, MD, cat. no. 12123—014).

Mouse laminin (Becton Dickinson, Rutherford, NJ, cat. no. 40023).

Mouse collagen type IV (Biosdesign, cat. no. T40263).

Mouse PECAM-1 (CD31) (Pharming, San Diego, CA, cat. no. 01951D).

### 2.3. Useful Transgenic Mouse Models

TIE1/*LacZ* (request from K. Alitalo, alitalo@helsinki.fi).

TIE2/*LacZ* (available from Jackson Lab, Bar Harbor, ME, IMR stock #JR2856).

FLK1/*LacZ* (available from Jackson Lab, IMR stock #JR2593).

SM22 $\alpha$ /*LacZ* (request from E. Olson, University of Texas, Southwestern Medical Center at Dallas, TX; fax: 214-648-1196).

Angiopoietin-1/*LacZ* (request from G. D. Yancopoulos; gdy@regpha.com).

Angiopoietin-2/*LacZ* (request from G. D. Yancopoulos; gdy@regpha.com).

### 2.4. Reagents

#### 2.4.1. In Situ Hybridization

1. <sup>35</sup>S-CTP (70 Ci/mL, NEN, Dupont, Boston, MA, cat. no. NEG-064C).
2. NICK column (Pharmacia, Uppsala, Sweden, cat. no. 17-0855-02).
3. Proteinase K (stored at 20 mg/mL in 0.5-mL aliquot in DEPC treated dH<sub>2</sub>O at -20°C).
4. 5X TE: 50 mM Tris-HCl, pH 8.0, 5 mM EDTA.
5. TEA/acetic anhydride: 0.625 mL acetic anhydride in 250 mL 0.1 M TEA, pH 8.0 immediately before use.
6. Hybridization mix: 50% formamide, 0.3 M NaCl, 20 mM Tris-HCl, pH 8.0, 5 mM EDTA, 10 mM Na-pyrophosphate, pH 8.0, 1X Denhardt's, 10% dextran sulfate, 0.5 mg/mL yeast RNA (stored as 0.9 mL/tube at -80°C).

#### 2.4.2. Immunohistochemistry

1. Trypsin (Sigma, St. Louis, MO, cat. no. T7168).
2. 1X automation buffer (Biomedica Corp., Foster City, CA, cat. no. M30).
3. Vector VIP peroxidase substrate kit (Vector, Burlingame, CA, cat. no. SK-4600).
4. Biotinylated rabbit antirat IgG, mouse serum absorbed (Vector, cat. no. BA-4001).
5. Biotinylated goat antirabbit IgG (Vector, cat. no. BA-1000).
6. Vectastain *Elite* ABC-peroxidase kit (Vector, cat. no. PK-6100).
7. HRP-coupled goat antirat IgG, mouse serum absorbed (Kirkegaard & Perry Laboratories, Gaithersburg, MD, cat. no. 05-16-12).
8. PBSMT: 3% instant skim milk powder, 0.1% Triton X-100, in phosphate-buffered saline (PBS). Make fresh solution each time.
9. PBT: 0.2% Bovine serum albumin (BSA), 0.1% Triton X-100 in PBS. Make fresh solution each time.

#### 2.4.3. LacZ staining

- |                                   |         |
|-----------------------------------|---------|
| 1. 0.1 M PIPES buffer, pH 6.9     | For 1 L |
| PIPES (M.W. = 324.3)              | 32.43 g |
| MgCl <sub>2</sub> (M.W. = 203.31) | 0.41 g  |
| EGTA (M.W. = 380.4)               | 0.76 g  |
| pH with 10 N NaOH to 6.9          |         |



2. 2% Paraformaldehyde in PIPES buffer
  - 1 mL 20% paraformaldehyde.
  - 100 mL 0.1 M PIPES buffer.
  - Heat to 55°C with stirring and add NaOH until clear.
  - Cool at room temperature and filter the solution.
  - The pH should be neutral (check by pH paper).
3.  $\beta$ -Galactosidase staining solution: 100 mL
 

1X PBS (Ca <sup>2+</sup> , Mg <sup>2+</sup> free from Gibco-BRL, Gaithersburg, MD)	100 mL
Potassium ferricyanide (M.W. = 329.26)	0.16 g
Potassium ferrocyanide (M.W. = 422.41)	0.21 g
MgCl <sub>2</sub>	0.04 g (or 200 $\mu$ L of 1 M)
Mix well and then add,	
10% NP-40 (from Boehringer Mannheim)	20 $\mu$ L
Sodium deoxycholate	0.01 g

  - Filter and store at room temperature in dark (light-free) container.
  - Just before use, add 1 mL of 2% X-gal into 19 mL of the above solution (i.e., final 0.1% X-gal concentration). 2% X-Gal: 2 gram 4-chloro-5-bromo-3-indolyl  $\beta$ -D-galactoside dissolved in 100 mL dimethylformimide (stored at -20°C in the aluminum foil-wrapped glass bottle).

### 3. Methods

#### 3.1. In Situ Hybridization with Embryonic Sections

This section describes the *in situ* hybridization histochemical method to detect the expression of mRNA encoding proteins that are critical for endothelial cell or smooth-muscle cell differentiation and/or vascular morphogenesis.

##### 3.1.1. Linearization of a Plasmid DNA

The template DNA can be prepared by plasmid prep kit (e.g., Qiagen kit, Chatsworth, CA).

Assemble the following:

- 20  $\mu$ L plasmid DNA (= 20  $\mu$ g)
- 10  $\mu$ L 10X buffer
- 10  $\mu$ L 1 mg/mL BSA
- 55  $\mu$ L dH<sub>2</sub>O
- 5  $\mu$ L restriction enzyme

Total vol 100  $\mu$ L

Incubate at 37°C for 1.5 h.

Then, check 1  $\mu$  on minigel for the completion of the digest.

Extract twice with phenol/chloroform/IAA, saturated with TE pH 8.0.

Extract once with chloroform/IAA.

Add 10  $\mu$ L 3 M NaOAc, pH 5.5 and 300  $\mu$ L absolute EtOH and precipitate DNA on dry ice for 15 min.

Microfuge at 4°C for 15 min and pour off EtOH and add cold 70% EtOH gently and respin for 2 min at 4°C.

Pour off EtOH and respin 5 s and remove EtOH completely using a micropipet tip.

Dry the DNA pellet in the SpeedVac for 2 min.

Dissolve the pellet into 10  $\mu$ L DEPC-treated dH<sub>2</sub>O. Warm up to 37°C for 30 min to completely dissolve.

Take 1  $\mu\text{L}$  and mix with 499  $\mu\text{L}$   $\text{dH}_2\text{O}$  (i.e., 1:500 dilution) and measure the  $\text{OD}_{260/280}$ . Adjust the concentration to 1  $\mu\text{g}/\mu\text{L}$  with DEPC-treated  $\text{dH}_2\text{O}$ . Store the DNA at  $-20^\circ\text{C}$ .

### 3.1.2. Riboprobe Synthesis and Purification

Transcription reaction:

Assemble in the following order:

- 4.75  $\mu\text{L}$  DEPC-treated  $\text{dH}_2\text{O}$
- 5  $\mu\text{L}$  5X buffer
- 1  $\mu\text{L}$  linearized template DNA (= 1  $\mu\text{g}$ )
- 1.25  $\mu\text{L}$  10 mM ATP
- 1.25  $\mu\text{L}$  10 mM UTP
- 1.25  $\mu\text{L}$  10 mM GTP
- 2.5  $\mu\text{L}$  100 mM DTT
- 1  $\mu\text{L}$  RNAsin (40  $\mu\text{g}/\mu\text{L}$ , Promega, Madison, WI, cat. no. N2111).
- 5  $\mu\text{L}$   $^{35}\text{S}$ -CTP (70 mCi/mL, NEN, Dupont, Boston, MA, cat. no. NEG-064C).
- 2  $\mu\text{L}$  RNA polymerase (e.g., T3, T7, SP6 pol, 10–20 U/ $\mu\text{L}$ )

Total vol is 25  $\mu\text{L}$ .

Incubate at  $37^\circ\text{C}$  for 2 h.

Take 1  $\mu\text{L}$  and dilute with 99  $\mu\text{L}$   $\text{dH}_2\text{O}$  (i.e., 1:100 dilution) and calculate the incorporation of  $^{35}\text{S}$ -CTP and the amount of the synthesis by TCA precipitation. \*Usually the incorporation is about 60% or more. If it is less than 50%, something is wrong with either the template DNA or the transcription reaction.

\*Calculation of the amount of riboprobe synthesized: (The amount of RNA) in gram =  $58.3 \times 10^{-12} \times 5 \times 330 \times 4 \times \text{incorporation}$  (e.g., 0.6 for 60% incorporation). We usually obtain 200–300 ng riboprobe per foregoing reaction.

Termination reaction:

Add 1  $\mu\text{L}$  RNase-free DNase (2  $\mu\text{g}/\mu\text{L}$ , Ambion Inc., Austin, TX, cat. no. 2222) to the rest of the transcription reaction mix.

Incubate at  $37^\circ\text{C}$  for 15 min and then add the following:

Alkaline hydrolysis:

- 60  $\mu\text{L}$  TES (10 mM EDTA, Tris-HCl pH 7.5, 0.2% SDS).
- 1.67  $\mu\text{L}$  5 M NaCl.
- 1  $\mu\text{L}$  1 M DTT.

Mix well and leave on ice at least 30 min. Also make 2 N NaOH from 10 N NaOH stock (stored at  $4^\circ\text{C}$ ) and precool on ice. Make sure the sample is ice cold before adding NaOH. Otherwise, the RNA will be hydrolyzed too much.

Add precooled 10  $\mu\text{L}$  of ice-cold 2 N NaOH and mix well and briefly spin at  $4^\circ\text{C}$  and incubate the tube on ice for 45 min.

Neutralization:

Add 20  $\mu\text{L}$  2 M HEPES, mix vortex, and spin briefly at room temperature.

Purification of the RNA probe:

Add 100  $\mu\text{L}$  TE saturated phenol/chloroform/IAA (25:24:1) and vortex well.

Spin at room temperature for 5 min and carefully transfer the upper phase to an empty microfuge tube.

Prepare the “Nickcolumn” (Pharmacia-Upjohn, Kalamazoo, MI) as follows: Wash the column first by pouring-in-and-out with the freshly prepared equilibration buffer (10 mM EDTA, 10 mM Tris-HCl pH 7.5, 10 mM dithiothreitol [DTT]). Then, equilibrate the column by washing with 3 mL of the equilibration buffer.

\*Preparation of the equilibration buffer (20 mL):

19.2 mL DEPC-treated dH<sub>2</sub>O.

0.2 mL Tris-HCl, pH 7.5.

0.4 mL DEPC-treated 0.5 M EDTA.

0.2 mL 1 M DTT.

Load the extracted probe (100  $\mu$ L) to the preequilibrated Nick column.

Wash the column with 400  $\mu$ L equilibration buffer and elute the probe in the next 400  $\mu$ L equilibration buffer. Collect this second 400  $\mu$ L.

To this eluate (400  $\mu$ L), add 40  $\mu$ L DEPC-treated 3 M NaOAc, pH 5.5 and 2  $\mu$ L 10 mg/mL tRNA and 1000  $\mu$ L absolute EtOH. Mix well and precipitate RNA at  $-20^{\circ}\text{C}$  overnight or longer (the probe can be stored in this condition at  $-20^{\circ}\text{C}$  until use).

Spin at  $4^{\circ}\text{C}$  for 15 min and wash the RNA ppt with 1000  $\mu$ L cold 70% EtOH by spinning at  $4^{\circ}\text{C}$  for 2 min.

Pipet out as much as the spn and respin briefly and remove the residual EtOH completely by pipeting.

Dry the pellet completely in the SpeedVac for 2 min (do not dry too much because it becomes difficult to completely dissolve).

Dissolve the pellet into 20  $\mu$ L TE and save 1  $\mu$ L for the quantitation.

\*Dilute this 1  $\mu$ L with 99  $\mu$ L dH<sub>2</sub>O (i.e., 1:100) and count the radioactivity of the 1  $\mu$ L of the diluted sample.

Use the probe immediately after dissolved in TE for hybridization.

Pretreatment of the paraffin-embedded sections (*see* **Notes 1** and **2**):

- |   |  |
|---|--|
| 1. Xylene   | 10 min 2X                                    |
| 2. 100% EtOH  | 5 min 2X                                     |
| 3. 95%, 85%, 70%, 50%, 30% EtOH,<br>saline, PBS             | 30 s (5 min for 70% EtOH,<br>saline and PBS) |
| 4. 4% Paraformaldehyde                                      | 20 min                                       |
| 5. PBS  | 5 min 2X                                     |
| 6. 20 $\mu$ g/mL protease K in 5X TE                        | 7.5 min                                      |
| 7. PBS  | 5 min  |
| 8. Reuse #4<br>(4% paraformaldehyde in PBS)                 | 5 min  |
| 9. H <sub>2</sub> O   | Dip  |
| 10. TEA/acetic anhydride                                    | 10 min                                       |
| 11. PBS   | 5 min  |
| 12. Saline  | 5 min  |
| 13. Follow <b>step 3</b> in reverse order<br>(30%–95%–100%) | 30 s (70% 5 min)                             |
| 14. Air-dry for about 2 h                                   |  |

Hybridization:

15. Mix probe at 0.2 ng/ $\mu$ L/kb in 100 mM DTT and heat it at  $85^{\circ}\text{C}$  for 5 min. Then mix with H.X. by the ratio of 1 to 9 (e.g., 90  $\mu$ L probe in TE + 10  $\mu$ L 1 M DTT is heated and mixed with 900  $\mu$ L H.X.)
16. Hybridize (use 50–70  $\mu$ L per slide) at  $55^{\circ}\text{C}$  overnight in 5X SSC/50% formamide.

Posthybridization wash: Prewarm all the buffers.

- |                      |                               |
|----------------------|-------------------------------|
| 17. 5X SSC/10 mM DTT | Remove coverslip              |
| 18. 5X SSC/10 mM DTT | 20 min                        |
| 19. 5X SSC/10 mM DTT | $55^{\circ}\text{C}$ , 30 min |

- |   |                          |
|---|--------------------------|
| 20. 50% formamide/<br>2X standard saline citrate (SSC)/<br>100 mM DTT | 65°C, 25 min             |
| 21. 1X TE/0.5 M NaCl  | Room temperature, 10 min |
| 22. 1X TE/0.5 M NaCl  | 37°C 10 min 3X           |
| 23. 20 µg/mL RNase in foregoing buffer                                | 37°C, 30 min             |
| 24. 1X TE/0.5 M NaCl  | 37°C, 15 min             |
| 25. 50% formamide/<br>2X SSC/100 mM DTT                               | 65°C, 25 min             |
| 26. 2X SSC  | 65°C, 15 min             |
| 27. 0.1X SSC  | 65°C, 15 min             |
| 28. 30%, 60%, 80%, 95% EtOH/<br>30 mM ammonium acetate                | 30 s/each                |
| 29. 100% EtOH   | 30 s                     |
| 30. Air dry.  |                          |
| 31. Dried slides are ready for emulsion coating and exposure:         |                          |

Preparation of the darkroom:

Set the water both to 42°C. Make sure that the level of water reaches to the upper level to the emulsion.

Make sure that all the glasswares used for emulsion preparation are very clean, in particular, free of traces of old emulsion.

Prepare “the slide cover box” by using a hard paper box cover wrapped with aluminum foil to cover drying slides loosely.

Preparation of the emulsion (*see Note 3*):

Add 10 mL of 300 mM ammonium acetate to the coplin jar.

Turn off all lights (including the safelights) and transfer about 10 mL of solid emulsion to a small 10-mL beaker and transfer all to the coplin jar, which contains ammonium acetate solution.

Cover the jar with a glass lid and let emulsion melt for 20–30 min.

Stir the emulsion very gently with a clean slide.

Slowly dip two test glass slides into the emulsion and let them set in the vertical position (use a test tube rack to hold the slides).

Bring these test slides outside of the dark room to check the level of emulsion solution and make sure that the emulsion is mixed well (i.e., emulsion should coat the glass slide uniformly).

Dipping slides:

Place your slides in order before going into the dark room.

Dip each slide into the emulsion slowly and at a constant speed (count the number to make sure of constant speed) to obtain a uniform monolayer of emulsion coating.

Dry the dipped slides in vertical position leaned against the test tube rack and cover the entire thing with “the slide cover box” as prepared above.

Dry for 2–3 h at RT in the box in the dark room.

Do not unplug the water bath, which may generate the electrical spark.

Preparation of the black boxes:

Clean up the small black slide boxes (free of dust) (Fisher Scientific, Pittsburgh, PA, cat. no. 22-167-403).

Wrap a fair amount of desiccant with kimwipes and put it between the blank slides to hold it in the box.

Close the slide box until ready for emulsion-coated slides.

Prepare one sheet of plastic wrap and one sheet of aluminum foil for each slide box and set aside.

Exposure of the slides:

After 2–3 h drying, put about five slides in each black slide box in the dark room.

Close all the boxes completely and wrap with plastic wrap first and then with foil.

Turn on the safelight and check the box, then turn on the room light.

Clean up the emulsion jar and the room.

Put the slide boxes in the desiccator with enough desiccants in the cold room for exposure.

The required exposure time for each probe:

TIE1, TIE2, VEGF-A: Three to four weeks

Angiopoietin-1, angiopoietin-2: Two to three weeks

FLK1, FLT1, FLT4, SM22 $\alpha$ : Two weeks

Developing slides:

Take out the slide boxes from the desiccator and warm up to room temperature for at least 30 min.

Set Kodak D-19 and Rapid Fix solution on ice and monitor the temperature until it reaches 14°C.

Once it reaches 14°C, develop the slides immediately in the dark room as follows.

Dip slide for 3.5 min in Kodak D-19 solution, then briefly in H<sub>2</sub>O twice and fix for 5 min in Rapid Fix in complete darkness (no safelight!).

Turn on the room light.

Rinse the slides in the running tap water for 20 min or longer.

Counterstain sections with hematoxyline and eosin or other histological staining methods.

## **3.2. Immunohistochemical Staining of Mouse Embryos**

This section describes the immunohistochemical method used to detect expression of proteins that are critical for endothelial cell differentiation and vascular morphogenesis in both paraffin sections and whole mount embryos.

### **3.2.1. Staining Procedure for Paraffin Sections with Monoclonal Antibody to PECAM-1 (CD31)**

1. Bake slides in 56°C oven for 1 h.
2. Wash in xylene for 10 min.
3. Wash in 100% ethanol for 10 min.
4. Wash in 70% ethanol for 10 min.
5. Air dry and outline sections with PAP PEN (Labscientific Inc., Livingston, NJ, cat. no. Pen513).
6. Rehydrate in PBS for 5 min.
7. Treat with 0.1 % trypsin in PBS for 30 min at 37°C.
8. Wash in running tap water for 10 min.
9. Wash in 70% ethanol for 5 min.
10. Wash in 0.3% H<sub>2</sub>O<sub>2</sub> in methanol for 30 min.
11. Wash in 70% ethanol for 5 min.
12. Wash in 1X automation buffer for 5 min
13. Incubate with the blocking buffer (1X PBS, 5% BSA, 2% rabbit serum) for 30 min.
14. Blot excess serum from sections.
15. Incubate with rat anti-mouse CD31 monoclonal antibody (1:50 dilution in blocking buffer of the 0.5 mg/mL stock) for 2 h at room temperature in the humidified box.
16. Wash in 1X automation buffer for 5 min.

17. Incubate with biotinylated rabbit antirat IgG (1:100 dilution in blocking buffer of the 0.5 mg/mL stock) for 30 min.
18. Wash in 1X automation buffer for 5 min twice.
19. Incubate with ABC reagent for 30 min (prepare 30 min before use).
20. Wash in 1X automation buffer for 5 min.
21. Incubate with peroxidase substrate solution (Vector VIP Kit) for 2–15 min.
22. Wash in tap water for 5 min.
23. Dehydrate through series of ethanol (50% ethanol for 15 s, 70% ethanol for 15 s, 95% ethanol for 15 s twice, 100% ethanol for 15 s and then for 30 s), and finally clear in xylene for 5 min three times.
24. Mount with permount.

### 3.2.2. Staining Procedure with Paraffin Sections with Antibodies to Laminin, Fibronectin, Collagen Type IV

1. Bake slides in 56°C oven for 1 h.
2. Wash in xylene for 10 min.
3. Wash in 100% ethanol for 10 min.
4. Wash in 70% ethanol for 10 min.
5. Air dry and outline sections with PAP PEN (Jersey Lab & Glove, cat. no. Pen513).
6. Rehydrate in PBS for 5 min.
7. Treat with 0.1% trypsin in PBS for 30 min at 37°C.
8. Wash in running tap water for 10 min.
9. Wash in 70% ethanol for 5 min.
10. Wash in 0.3% H<sub>2</sub>O<sub>2</sub> in methanol for 30 min.
11. Wash in 70% ethanol for 5 min.
12. Wash in 1X automation buffer for 5 min.
13. Incubate with the blocking buffer (1X PBS, 5% BSA, 2% rabbit serum) for 30 min.
14. Blot excess serum from sections.
15. Incubate with rabbit anti-laminin IgG (1:50 dilution), fibronectin (1:50 dilution), or collagen type IV (1:50 dilution) for two hours at room temperature in the humidified box. All the antibody stocks are 1 mg/mL concentration.
16. Wash in 1X automation buffer for 5 min.
17. Incubate with biotinylated goat antirabbit IgG (1:100 dilution of the 1.0 mg/mL stock) for 30 min.
18. Wash in 1X automation buffer for 5 min twice.
19. Incubate with ABC reagent for 30 min (prepare 30 min before use).
20. Wash in 1X automation buffer for 5 min.
21. Incubate with peroxidase substrate solution (Vector VIP Kit) for 2–15 min.
22. Wash in tap water for 5 min.
23. Dehydrate through series of ethanol (50% ethanol for 15 s, 70% ethanol for 15 s, 95% ethanol for 15 s twice, 100% ethanol for 15 s and then for 30 s), and finally clear in xylene for 5 min three times.
24. Mount with permount.

### 3.2.3. Whole Mount Staining (PECAM-1)

1. Collect embryos in ice-cold PBS, dissect away extraembryonic membranes. If the embryos are older than E9.0, introduce a sharp incision along the dorsal midline of the hindbrain using a pulled injection needle.
2. Rinse the embryos in ice-cold PBS for 10 min and fix in 4% paraformaldehyde/PBS overnight at 4°C.

3. Rinse the embryos in PBS at RT (5 min  $\times$  3).
4. Dehydrate embryos through 25% MeOH, 50% MeOH, 75% MeOH, 100% MeOH (15 min/each) at RT. Do twice of 100% MeOH.
5. Incubate embryos in 5% H<sub>2</sub>O<sub>2</sub> in MeOH for 4–5 h at RT to bleach the embryos and block endogenous peroxidase. Stop bleaching by rinsing embryos with 100% MeOH twice. At this point, the embryos can be stored in MeOH at –20°C for at least a few weeks.
6. Rehydrate the embryos through 75% MeOH, 50% MeOH, 25% MeOH, PBS (15 min/each) at RT. Do twice of PBS.
7. Incubate the embryos in PBSMT (1 h  $\times$  2) at RT.
8. Incubate the embryos in diluted primary antibody (10  $\mu$ g/mL final concentration) in PBSMT at 4°C overnight. Use only the minimum volume (0.2 mL).
9. Wash in PBSMT (1 h  $\times$  5) at 4°C. Use 1 mL for each wash.
10. Incubate the embryos with the diluted secondary antibody in PBSMT at 4°C overnight. For HRP-coupled goat antirat IgG (mouse absorbed) (Kirkegaard and Perry), use 1/100 dilution.
11. Repeat **step 9**, adding a final 20 min wash in PBT at room temperature.
12. Make up the developing solution while the embryos are in the final wash with PBT as follows: Dissolve 10 mg tablet of DAB (Sigma) in 10 mL of PBT by gently shaking in the 15-mL centrifuge tube on the orbital shaker by laying down the tube. After the DAB is dissolved, add 0.17 g NiCl<sub>2</sub> and let it dissolve by gently shaking on the orbital shaker. Mix 3 parts of this concentrated solution with 7 parts of PBT (i.e., final concentration is 0.3 mg/mL DAB, 0.5% NiCl<sub>2</sub> in PBT).
13. Incubate the embryos in this developing solution for 20 min at room temperature.
14. Add H<sub>2</sub>O<sub>2</sub> to 0.03% final concentration (i.e., 1  $\mu$ l of 30% H<sub>2</sub>O<sub>2</sub> for 1 mL of developing solution) and immediately mix gently. It takes about 10 min to get color developed.
15. Rinse the embryos in PBT (5 min  $\times$  2) and then PBS (5 min  $\times$  2) at RT. Fix the embryos in 2% paraformaldehyde/0.1% glutaraldehyde/PBS at 4°C overnight.
16. Rinse the embryos in PBS (5 min  $\times$  3) at RT. In order to take the whole embryo picture, equilibrate the embryos in 50% glycerol at RT for 1 h and then in 70% glycerol for 1 h. The pictures can be taken in 70% glycerol.
17. After the pictures come out satisfactory, the embryos were rinsed in PBS several times to remove glycerol and then dehydrated through methanol series for paraffin-embedding.

### 3.3. LacZ Staining of Transgenic Mice

This section describes the *LacZ* staining method of the useful transgenic mouse lines in which *LacZ* is expressed as a histochemical indicator of expression of genes that are critical for endothelial cell or smooth muscle cell differentiation and/or vascular morphogenesis.

#### 3.3.1. Whole Mount (Earlier than E13.5)

1. Dissection and washing embryos in cold PBS (Ca, Mg-free from Gibco-BRL).
2. Fix the embryos in cold 2% paraformaldehyde in 0.1 M PIPES buffer, pH 6.9 for 15 min.
3. Rinse embryos in PBS for 5 min three times (30 min each for E12.5).
4. Staining in  $\beta$ -galactosidase staining solution at 30°C (do not use 37°C because it gives nonspecific staining in certain embryonic structures) for 30 min to overnight
5. Postfix in cold 2% paraformaldehyde, 0.1% glutaraldehyde in PBS, pH 7.0 overnight at 4°C for poststaining paraffin-sectioning.
6. Rinse in PBS for 5 min  $\times$  3.
7. For whole-mount photography, equilibrate the embryo in 50% glycerol/PBS for 30 min and then in 70% glycerol/PBS for 30 min.

8. Dehydrate the embryos for paraffin sectioning as follows:

PBS	10 min 3X
Saline	10 min 2X
70% Alcohol	10 min 2X
85% Alcohol	10 min
95% Alcohol	10 min
100% Alcohol	10 min 2X
Xylene	10 min 3X
Paraffin	30 min 3X

Cool in the mold and section at 6  $\mu$

### 3.3.2. Sections (E13.5 or Older and Adult Organs)

1. Perfuse embryos or postnatal mice with PBS (10–15 mL for an adult mouse).
2. Perfuse with 2% paraformaldehyde/PIPES buffer (30 mL for an adult mouse).
3. Perfuse with PBS (30 mL for an adult mouse).
4. Each organ is dissected and rinsed with PBS for 10 min.
5. Equilibrate the organs with 18% sucrose/PBS at 4°C overnight.
6. Mount the sucrose equilibrated organs in OCT (Tissue-Tek [Curtiss Laboratories, Bensalem, PA]).
7. Prepare 10–90  $\mu$ m cryosections on the slides.
8. Postfix the sections on the slide in 2% paraformaldehyde/0.1 M PIPES buffer at room temperature for 5 min.
9. Rinse with PBS (5 min 2X).
10. Stain in the X-gal staining solution overnight at 30°C.
11. Rinse in PBS for 10 min twice.
12. Counterstain with neutral red, dehydrate through series of ethanol (50% ethanol for 15 s, 70% ethanol for 15 s, 95% ethanol for 15 s twice, 100% ethanol for 15 s, and then for 30 s), and finally clear in xylene for 5 min three times.
13. Mount the slides with Permount.

## 4. Notes

1. Cryosections for the *in situ* hybridization are pretreated as follows: Sections on the slides are air-dried for 30 min and continue onto **step 4** (i.e., 4% paraformaldehyde fixation).
2. Cryosections for the PECAM immunohistochemical staining are pretreated as follows: Sections on the slides are air-dried for 30 min and outlined with PAP PEN. The slides are then washed in 1X automation buffer for 5 min and continue onto **step 9** (i.e., washing with 70% ethanol for 5 min).
3. For preparation of the emulsion for *in situ* hybridization, one can also use a slide-coating device (Electron Microscopy Sciences, cat. no. 70520) instead of coplin jar. For a slide-coating device, use 8.5 mL of H<sub>2</sub>O and 8 mL of emulsion. This should be enough for coating approx 25 slides.

## Acknowledgment

Authors would like to thank other present and past members of Sato Laboratories who have contributed to developing the foregoing protocols, especially Ying Qing, Thorsten Schlaeger, and Xiang-Qing Li.



**References**

1. Hanahan, D. (1997) Signaling vascular morphogenesis and maintenance. *Science* **277**, 48–50.
2. Risau, W. (1997) Mechanisms of angiogenesis. *Nature* **386**, 671–674.
3. Sato, T. N., Qin, Y., Kozak, C. A., and Audus, K. L. (1993) *tie-1* and *tie-2* define another class of putative receptor tyrosine kinase genes expressed in early embryonic vascular system. *Proc. Natl. Acad. Sci. USA* **90**, 9355–9358.
4. Sato, T. N., Tozawa, Y., Deutsch, U., Wolburg-Buchholz, K., Fujiwara, Y., Gendron-Maguire, M., et al. (1995) Distinct roles of the receptor tyrosine kinases Tie-1 and Tie-2 in blood vessel formation. *Nature* **376**, 70–74.
5. Schlaeger, T. M., Qin, Y., Fujiwara, Y., Magram, J., and Sato, T. N. (1995) Vascular endothelial cell lineage-specific promoter in transgenic mice. *Development* **121**, 1089–1098.
6. Schlaeger, T. M., Bartunkova, S., Lawitts, J. A., Teichmann, G., Risau, W., Deutch, U., and Sato, T. N. (1997) Uniform vascular-endothelial-cell-specific gene expression in both embryonic and adult transgenic mice. *Proc. Natl. Acad. Sci. USA* **94**, 3058–3063.

## Epithelial–Mesenchymal Interactions

Brian K. Hall

### 1. Introduction

Cell–cell and tissue–tissue interactions initiate and regulate genomic expression in the initiation and maintenance of cell differentiation and tissue morphogenesis for virtually every vertebrate organ system. They operate as the major signaling system between microenvironment, extracellular milieu, cells, and tissues. Signaling can be *direct*, requiring establishment of intimate cell-to-cell contact between signaling and responding cells, or *indirect*, involving either release and recognition of signal molecules, or an interaction between responding cells and extracellular matrices of signaling cells.

In all metazoans, cells are organized either into (1) sheets of connected, polarized cells (epithelia) that typically rest on an extracellular basement membrane, which they synthesize and deposit from their basal surfaces, or (2) as loose meshworks of cells (mesenchyme) that are connected only by the extracellular matrix they secrete.

Cell-to-cell signaling typically occurs between epithelial and mesenchymal cells. Such signaling, which is normally referred to as an *epithelial–mesenchymal interaction*, may be one way (epithelial → mesenchymal; mesenchymal → epithelial) or bidirectional (epithelial ↔ mesenchymal) and is hierarchical, one signal leading to another in an epigenetic cascade (1–3). Epithelial–mesenchymal interactions are normally identified by separating mesenchyme from epithelium and maintaining each component either in isolation (to detect whether differentiation is initiated) or in recombination (to detect whether differentiation that fails in isolated tissues, occurs in recombined tissues). The term for the latter experimental approach is *tissue recombination*. A component—e.g., limb bud mesenchyme—may be recombined with epithelium from: a limb bud from the same or a different-aged embryos; from another organ system of the same embryos or from a different embryo; from an embryo carrying a gene mutation (4,5); from an embryo that has been treated with a drug (6); or even from another species or class of vertebrates (5,7,8). We speak of such recombinations as *homospecific* (same species), *homotypic* (same tissue or organ) and *homochronic* (same age), or *heterospecific*, *heterotypic*, and *heterochronic* (different species, organ, or age; see Fig. 1). Such interactions allow us to assess normal development and even to assess the etiology of cancers and tumors (9,10).

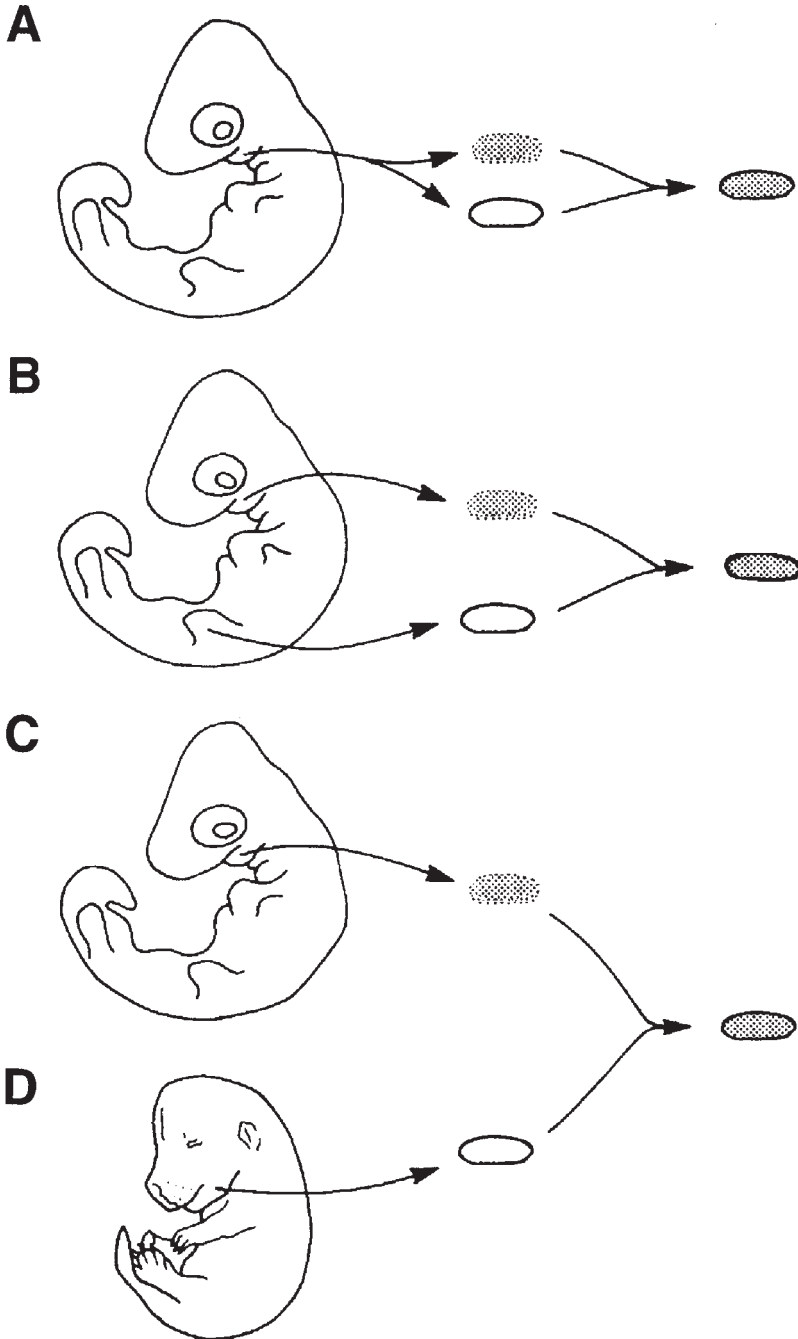

Fig. 1. Examples of types of tissue recombinations of epithelia (black) and mesenchyme (stippled) from mandibular arches and limb buds of chick (A–C) and mouse (D) embryos. (A) A homospecific, homotypic, and homochronic tissue recombination of mandibular epithelium and mesenchyme. (B) A homospecific, homochronic, but heterotypic, recombination of mandibular mesenchyme with limb bud epithelium. (C and D) A heterospecific, heterochronic, homotypic recombination of mandibular mesenchyme from the chick with mandibular epithelium from the mouse. Modified from *ref. 19*.

The proximate cellular basis of an interaction (whether it is direct or indirect) can be investigated by a combination of approaches including: direct apposition of the epithelium and mesenchyme in recombination to allow cell-to-cell contact; indirect association on either side of a diffusible filter or membrane to allow diffusion-mediated interaction (*11*); association of mesenchyme with the acellular epithelial basement membrane or basement membrane products deposited onto a filter to allow matrix-mediated interactions (*12*); or culture of mesenchyme in medium conditioned by preculture with epithelium or epithelial cell products. These approaches are detailed in the procedures in this chapter.

## 2. Materials

1. Dissecting instruments
  - a. A minimum of two pairs of fine (no. 5) watchmaker forceps, iris scissors, and needles (tungsten, glass, or sharpened hypodermic).
  - b. An alcohol lamp or Bunsen burner to flame instruments.
  - c. A supply of sterile Petri dishes sized appropriate for the embryos or tissues to be dissected.
  - d. A metal rack on which to store sterile instruments and cotton wool to cover the rack.
  - e. A research-quality dissecting microscope with at least  $\times 10$  eyepieces ( $\times 15$  for dissection of very small tissues) and a fiber-optic light source to provide maximal illumination with minimal generation of heat.
2. Solutions to separate tissues
  - a. Enzymatic separation:
    - 0.85% saline solution—8.5 g NaCl dissolved in 1 L distilled water at room temperature.
    - $\text{Ca}^{++}$  and  $\text{Mg}^{++}$ -free Tyrode's solution—8.0 g NaCl; 0.2 g KCl; 0.05 g  $\text{NaH}_2\text{PO}_4\cdot\text{H}_2\text{O}$ ; 1.0 g glucose; 1 g  $\text{NaHCO}_3$ , 0.02 g phenol red in 1 L of distilled water at room temperature. Keep refrigerated once made.
    - Enzyme solution—3.0% solution (w:w) of trypsin and pancreatin: 0.257 g beef pancreas trypsin and 0.043 g pig pancreas pancreatin (both from BDH chemicals) in 10 mL  $\text{Ca}^{++}$  and  $\text{Mg}^{++}$ -free Tyrode's solution. Mix immediately before use.
  - b. Chelating agent: 0.1–0.3% EDTA (ethylenediaminetetraacetic acid) in  $\text{Ca}^{++}$  and  $\text{Mg}^{++}$ -free Tyrode's solution (0.1–0.3 g EDTA/L) dissolved at room temperature.
  - c. Serum-supplemented saline or culture medium: We typically use a 50:50 mixture of horse serum and culture medium.
3. Millipore filter substrates: Sheets of black Millipore filter (Millipore, Bedford, MA) (0.45- $\mu\text{m}$  porosity, 125–150  $\mu\text{m}$  thickness) are cut into 1-cm squares and sterilized in a sterile Petri dish with 70% ethanol. Two or three rinses with sterile distilled water is sufficient to remove the ethanol.

## 3. Methods

1. Dissection of embryonic organs or tissues: Dissection under sterile conditions is critical. Tissues, instruments, media, and the surrounding environment must all be sterile. Instruments are sterilized either in an autoclave (following the instructions for the particular instrument), or in 70–80% ethanol and the ethanol allowed to evaporate.

We perform sterile dissections in a room equipped with ultraviolet lights, which are kept on whenever the room is unoccupied, but switched off before entering the room (*see warning, Note 1*). We use a metal rack to support instruments under a wad of ethanol-soaked cotton wool when instruments are not in use. An alcohol lamp or Bunsen

burner can be used to “flame” instruments after use. Flaming involves passing the tip of the instrument rapidly through the flame.

Procedures for dissecting tissues will vary from organ to organ, species to species, and from researcher to researcher. Practice is required. Some prefer to dissect using scalpel and forceps; others prefer dissecting needles of tungsten wire or fashioned from glass rods. Needles from hypodermic syringes make excellent dissecting tools; they come in a range of sizes and can be sharpened and/or shaped on a stone. Individuals should determine the instruments that work best in their hands and then maintain them for their exclusive use. The particular tissues might be best dissected on a solid glass substrate, such as a glass Petri dish. Plastic Petri dishes also serve well. Tissues that need to be supported can be dissected on a bed of agar or on paraffin or plasticine (**Note 2**).

The medium in which the dissection is performed will also vary with the tissue and how the tissue is to be maintained (**Note 3**). A saline appropriate to the species is sufficient for short-term dissections. Dissections that will take longer, or tissues that are to be cultured, are best performed in the same medium in which they will be cultured.

Dissections should be performed as speedily as practicable using definite, sharp cuts that will do minimal damage to the tissues surrounding the cut. Wherever possible, surrounding tissues should be left intact during the dissection to provide a tissue that can be held in place with forceps while the tissue of interest is being dissected (**Note 4**).

Depending on the length of time required for dissection, properties of the tissues, and/or time required for subsequent procedures, it may be necessary to perform dissections in a cold room or in a Petri dish supported on a bed of ice. In any event, time to dissect should be kept as short as is consistent with obtaining intact tissues.

2. Separating epithelium from mesenchyme: Methods of separation will depend on whether the basement membrane of the epithelium is to be retained intact. Two procedures are described below: 1) enzymatic separation in which the basement membrane is destroyed, and 2) separation using a chelating agent in which the basal lamina is left intact on the surface of the mesenchyme (*see* **Note 5**).
  - a. Enzymatic separation: Enzymatic-based techniques to separate epithelium from mesenchyme work by destroying the basement membrane, allowing the epithelium to be physically separated from the associated core of mesenchyme. A mixture of trypsin and pancreatin (typically 3%) in a saline solution, or in a  $\text{Ca}^{2+}$  and  $\text{Mg}^{2+}$ -free saline solution, works best.  $\text{Ca}^{2+}$  and  $\text{Mg}^{2+}$  are required for cell cohesion. A  $\text{Ca}^{2+}$  and  $\text{Mg}^{2+}$ -free saline solution, therefore, speeds enzymatic separation. Timing of separation must be carefully monitored and differs from organ to organ, age to age, and species to species. Too long in the enzyme solution and the tissues will dissociate into a single-cell suspension. This is undesirable. Too little time in the enzyme solution and the components either cannot be separated, or can only be separated with difficulty. This is a nuisance. Separation at room temperature is too slow. Separation at  $37^{\circ}\text{C}$  is too rapid, but may be unavoidable for tissues whose metabolism is very sensitive to temperature changes. In our experience,  $4^{\circ}\text{C}$  is the optimal temperature, and 45–50 min is the optimal time for embryonic chick limb buds or mandibular arches. Tissues from embryonic mice typically require an additional 30 min. Agitation is not required. At the end of the time, tissues are placed into saline or culture medium containing excess protein (as horse serum) to slow enzymatic digestion and allow epithelial and mesenchymal components to be separated.
  - b. Chelating agents: Separating with a chelating agent breaks the type IV collagen links between the basal lamina and the epithelium so that when dissected, the intact basal lamina remains on the mesenchyme (*see* **Fig. 2**). Consequently, this approach is used

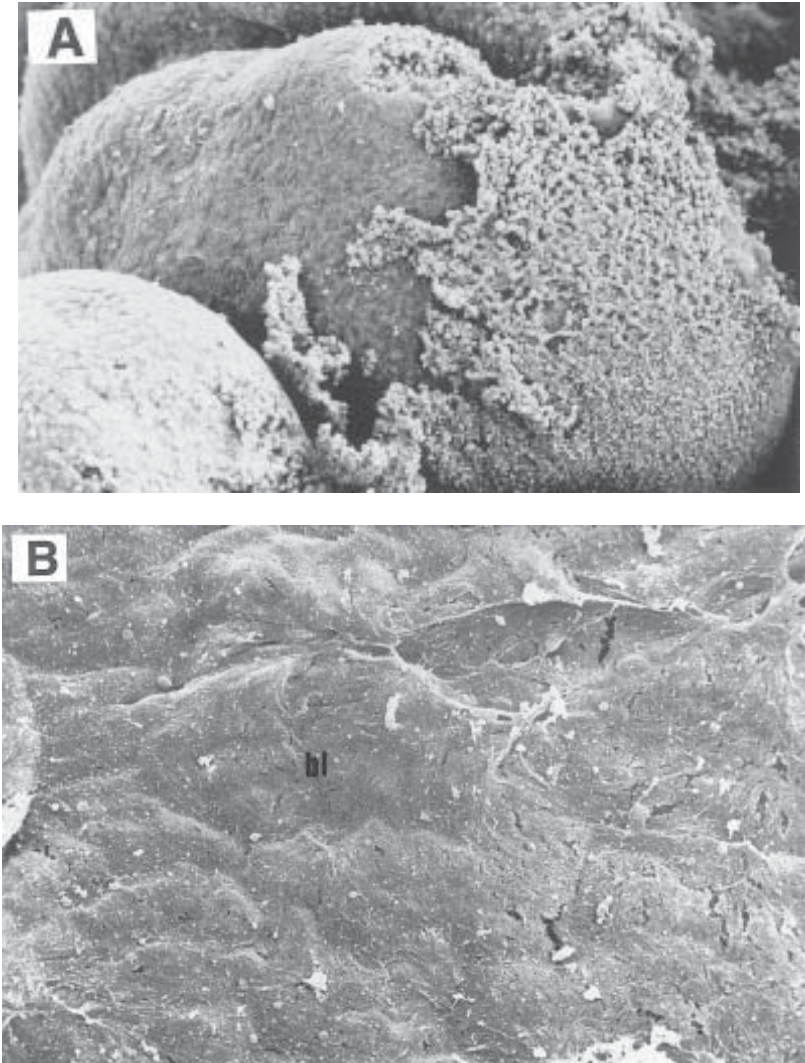

Fig. 2. (A) A scanning electron micrograph of the mandibular arch from an embryonic chick after 1 h exposure to 0.5% EDTA at 4°C and partial removal of the epithelium from the left-hand portion of the mandible to expose the underlying basal lamina.  $\times 186$ . (B) A scanning electron micrograph of mesenchyme from the eye of an embryonic chick after EDTA-treatment to illustrate the intact basal lamina (bl) after removal of the epithelial cells.  $\times 1300$  (see **ref. 17** for details).

when it is hypothesized that a matrix-mediated interaction is involved (13–15). We have found 0.5% EDTA for 1 h at 4°C to be ideal for separating avian and murine mandibular and limb buds to retain the basal lamina on the mesenchyme (Note 6). At the end of the time, tissues are placed into saline or culture medium containing divalent cations to slow digestion and allow epithelial and mesenchymal components to be separated.

In either **step a** or **b**, if tissues or organs are left for the requisite time at 4°C, it should be possible to separate epithelial and mesenchymal components using fine dissecting instruments (Note 7). Epithelium and mesenchyme are then placed into sepa-

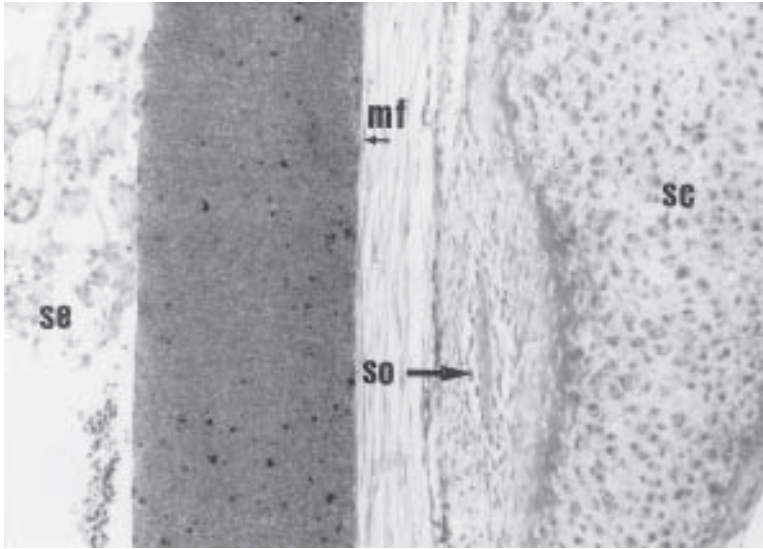

Fig. 3. Recombination of scleral epithelium (se) and scleral mesenchyme across a 150- $\mu$ m thick Millipore filter (mf). A bony scleral ossicle (SO) has formed in response to a diffusible signal from the epithelium. Scleral cartilage (SC) also differentiates.  $\times 220$ .

rate dishes (35-mm diameter plastic, presterilized Petri dishes are ideal) in serum- or cation-supplemented saline or culture medium.

Some tissues are treated as above (i.e., exposed to enzyme solution or chelating agent), but not separated into epithelial and mesenchymal components. These tissues form the intact, enzyme-treated positive controls.

3. Tissue recombination: At this stage, epithelial and mesenchymal components can be maintained apart or recombined, either directly or indirectly (**Note 8**).
  - a. Separate tissues: Epithelial sheets or mesenchyme are placed separately onto individual squares of black Millipore filters. Mesenchyme can be pipeted onto the filters or transferred gently using watchmaker's forceps. Epithelial sheets are best transferred using a wide-bore pipet in a minimal amount of fluid. Because they tend to float free, epithelial sheets can be gently attached to the filters by pushing the corners of the epithelial sheet into the surface of the filter.
  - b. Direct recombination: Place the epithelial sheet onto the Millipore substrate as before. Place the mesenchyme (either from the same or from a different organ, age, embryo, species) onto the epithelial sheet to which it will readily adhere (**Note 9**). No further manipulation is required.
  - c. Indirect recombination: In this version of tissue recombination, a barrier is placed between the two tissues. Place the epithelium on the material to be used as the barrier. This may be a Millipore filter (filters of varying porosity and thickness, are available; see **Fig. 3**), a Nuclepore filter (with much smaller and more regular pore sizes), or a dialysis membrane to exclude molecules of particular sizes (**Note 10**). Because the epithelium must be inverted, it will be necessary to lightly coat the epithelium with a solution of 1–5% agar to maintain the epithelium on the barrier.

Invert the barrier filter with attached epithelium and place the mesenchyme on the underside of the barrier, directly across from the epithelium (see **Fig. 4**). Seal the mesenchyme in place with agar.

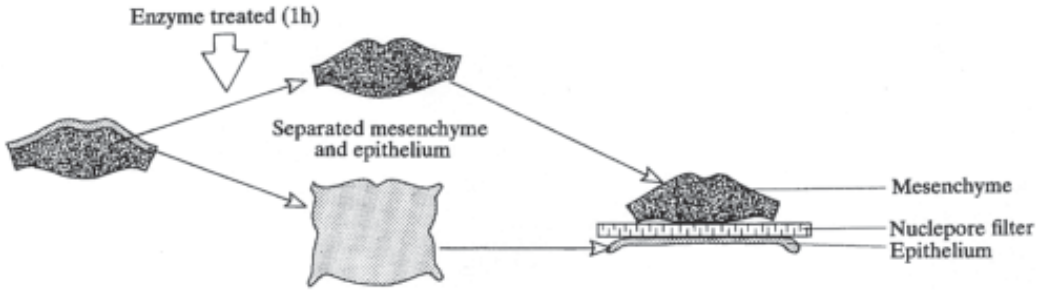

Fig. 4. A diagram to illustrate separation of the mandibular arch into epithelial and mesenchymal components and tissue recombination across a Nuclepore filter. Modified from **ref. 20**.

4. Subsequent treatment: Isolated epithelia or mesenchyme, or tissue recombinations, can be maintained in organ culture following the procedures outlined in Chapter 45 (Vol. I) and in the chapters in Sections V and VI of this volume; grafted to the chorioallantoic membranes of host chick embryos (16); or grafted *in vivo*, either under the kidney capsule, or into the anterior chamber of the eye (7).

#### 4. Notes

1. *Warning:* Exposure to ultraviolet light can cause damage to eyesight. It is imperative that UV lights *always* be switched off before entering the sterile room. Surfaces can be surface-sterilized by swabbing with ethanol if dissection is going to take an inordinately long time.
2. Wide, low-rimmed dishes provide maximal access to the tissues.
3. Tissues should never be dissected dry. Embryonic tissues dry out extremely rapidly.
4. At all costs, avoid holding the tissue of interest with forceps during the dissection as this will cause tissue damage. Place the forceps around the tissue or grip adhering tissue that can be discarded subsequently.
5. In either case, it is important to run tissues in parallel through the procedure used to separate mesenchyme from epithelium, but to leave these tissues intact. They provide the positive control for the technique used to separate the tissues into epithelial and mesenchymal components. Such intact, but treated, tissues should behave as intact, untreated tissues. Should the intact, but treated, tissues fail to form the structures of interest, then the procedure used to separate the tissues may have been too harsh or prolonged. Inclusion of such a positive control in every experiment is critical, no matter whether separation procedures in previous experiments have been adequate.
6. The best test that the basal lamina has been retained on the mesenchyme is to prepare some specimens of mesenchyme for transmission or scanning electron microscopic analysis, or to use whole mount visualization of an antibody against a basal lamina component such as laminin, fibronectin, or type IV collagen.
7. This is a critical step. If the epithelial and mesenchymal components do not separate with ease, tissues should be returned to the enzymatic or chelating solution at 4°C for 5–10 min and rechecked. Under ideal conditions, the epithelium should separate as a coherent sheet and the mesenchyme as a coherent and single aggregation. Gentle aspiration several times in a wide-bore pipet will aid separation.
8. In our experience, tissues are placed on black Millipore tissues at this stage. Tissues are typically transparent; the nontoxic black substrate provides a ready background against which to visualize tissues subsequently maintained in culture.



9. If the mesenchyme does not adhere to the epithelium, there may be too much liquid on the surface of the filter substrate. Lift the filter with the adhering epithelium from the liquid and drain off excess liquid. The mesenchyme should then adhere.
10. We (17) have used Nuclepore filters (Nuclepore Co., Pleasanton, CA) ranging from 0.03–0.8  $\mu\text{m}$  porosity and 5- or 10- $\mu\text{m}$  thickness. Filters with a porosity of 0.1–0.8  $\mu\text{m}$  permit cell process to pass through. Filters with a porosity of 0.03  $\mu\text{m}$  do not (18). We (17) have also used dialysis membranes (Spectrum Medical Industries Inc., Los Angeles, CA) with molecular weight cutoffs of 2000–2500, 6000–8000, and 12,000–14,000 Dalton.

## Acknowledgment

The author would like to thank Sharon Brunt and past graduate students and post-doctoral fellows whose technical expertise and research acumen played such important roles in developing our approach to epithelial–mesenchymal interactions, a technique that was introduced into the laboratory by Mary Tyler twenty years ago. Ongoing work is supported by NSERC of Canada (grant A5056) and by the Killam Trust of Dalhousie University.

## References

1. Chandebois, R. and Faber, J. (1983) *Automation in Animal Development: A New Theory Derived from the Concept of Cell Sociology*. S. Karger AG, Basel.
2. Nieuwkoop, P. D., Johnen, A. G., and Albers, B. (1985) *The Epigenetic Nature of Early Chordate Development*. Cambridge University Press, Cambridge.
3. Hall, B. K. (1983) Epigenetic control in development and evolution, in *Development and Evolution* (Goodwin, B. C., Holder, N. J., and Wylie, C. C., eds.), Cambridge University Press, Cambridge, pp. 353–379.
4. Goetinck, P. F. and Abbott, U. K. (1964) Studies on limb morphogenesis. 1. Experiments with the polydactylous mutant, Talpid<sup>2</sup>. *J. Exp. Zool.* **155**, 161–170.
5. Sawyer, R. H., Abbott, U. K., and Trelford, J. D. (1972) Inductive interactions between human dermis and chick chorionic epithelium. *Science* **175**, 527–529.
6. Bradamante, Z. and Hall, B. K. (1980) The role of epithelial collagen and proteoglycan in the initiation of osteogenesis by avian neural crest cells. *Anat. Rec.* **197**, 305–315.
7. Sawyer, R. H. and Fallon, J. F., eds. (1983) *Epithelial-Mesenchymal Interactions in Development*. Praeger, New York.
8. Hall, B. K. (1980) Tissue interactions and the initiation of osteogenesis and chondrogenesis in the neural crest-derived mandibular skeleton of the embryonic mouse as seen in isolated, murine tissues and in recombination of murine and avian tissues. *J. Embryol. Exp. Morphol.* **58**, 251–264.
9. Cunha, G. R., Hayashi, N., and Wong, Y. C. (1992) Regulation of differentiation and growth of normal adult and neoplastic epithelia by inductive mesenchyme. *Cancer Surveys* **11**, 73–90.
10. Hodges, G. M. and Rowlatt, C., eds. (1994) *Developmental Biology and Cancer*. CRC, Boca Raton, FL.
11. Dunlop, L.-L. L. and Hall, B. K. (1995) Relationships between cellular condensation, preosteoblast formation and epithelial-mesenchymal interactions in initiation of osteogenesis. *Int. J. Dev. Biol.* **39**, 357–371.
12. Hall, B. K. and Van Exan, R. J. (1982) Induction of bone by epithelial cell products. *J. Embryol. Exp. Morphol.* **69**, 37–46.
13. Hall, B. K. (1983) Tissue interactions and chondrogenesis, in *Cartilage, Volume 2, Development, Differentiation and Growth* (Hall, B. K., ed.), Academic, New York, pp. 187–222.

14. Hall, B. K., Van Exan, R. J., and Brunt, S. L. (1983) Retention of epithelial basal lamina allows isolated mandibular mesenchyme to form bone. *J. Craniofac. Genet. Dev. Biol.* **3**, 253–267.
15. Hall, B. K. (1984) Matrices control the differentiation of cartilage and bone, in *Matrices and Cell Differentiation* (Kemp, R. B. and Hinchliffe, J. R., eds.), Alan R. Liss, New York, pp. 147–169.
16. Hall, B. K. (1978) Grafting of organs and tissues to the chorioallantoic membrane of the embryonic chick. *Tissue Cult. Assoc. Man.* **4**, 881–884.
17. Pinto, C. B. and Hall, B. K. (1991) Toward an understanding of the epithelial requirement for osteogenesis in scleral mesenchyme of the embryonic chick. *J. Exp. Zool.* **259**, 92–108.
18. Saxén, L. (1980) Mechanisms of morphogenetic tissue interactions: the message of transfilter experiments, in *Differentiation and Neoplasia* (McKinnell, R. G., Di Berardino, M. A., Blumenfeld, M., and Bergam, R. D., eds.), Springer-Verlag, Berlin, pp. 147–154.
19. Hall, B. K. (1983) Embryogenesis: cell–tissue interactions, in *Skeletal Research: An Experimental Approach*, vol. 2 (Kunin, A. S. and Simmons, D. J., eds.), Academic, New York, pp. 53–87.
20. Van Exan, R. J. and Hall, B. K. (1984) Epithelial induction of osteogenesis in embryonic chick mandibular mesenchyme studied by transfilter tissue recombinations. *J. Embryol. Exp. Morphol.* **79**, 225–242.

## Methods for Manipulating the Chick Limb Bud to Study Gene Expression, Tissue Interactions, and Patterning\*

Maria A. Ros, B. Kay Simandl, Allen W. Clark, and John F. Fallon

### 1. Introduction

From the beginnings of experimental embryology (1) through the present day, the developing chick limb has proven a fruitful system to study. The results of these studies have demonstrated the ability of the limb bud to self-differentiate (2), the role of cellular and tissue interactions during limb budding and differentiation (reviewed in [3]), and recently, the relationship of particular gene expressions to pattern formation and differentiation (reviewed in [4]). The ability to manipulate the developing chick limb bud, with survival even through hatching, has permitted the insight that three interdependent organizing centers control cascades of gene expressions that permit limb development (reviewed in [5]). Here we describe several common methods of manipulating the chick limb bud. These techniques, above all, require patience. It is our experience that most investigators can master these procedures; the more sensitive the investigator is to the needs of the embryo, the greater his/her success.

The fertile chicken egg is the starting material for these procedures. There is a great deal known about the chicken egg; much of this has been summarized in (6) and (7). Similarly, there is extensive literature on the chick embryo dating back to Aristotle's accurate accounts in *History of Animals* (8). There are a number of summaries that are useful, including *Lillie's Embryology of the Chick* (9), *The Avian Embryo* (10), and *The Atlas of Chick Development* (11). These sources complement each other and investigators will find each to be valuable.

There are two staging systems for chick embryos. The first, by Eyal-Giladi and Kochav (12), describes the stages of development in the oviduct and immediately after laying and are designated I-XIV. The standard series of stages after egg laying are those of Hamburger and Hamilton designated 1-46 (referred to in this chapter as HH) (13). These have been reproduced in (9), (11), and the original paper as referenced in (14). To do the work in this chapter, reproducible staging of chick embryos is required. When misstaging occurs it will be impossible to repeat a given experiment. Misstaging need not occur because the HH series gives integrated system by system criteria that are easy to follow.

\*This chapter is dedicated to Mary T. Gasseling and Amata Hornbruch in recognition of their contributions to experimental studies of limb development.

From: *Methods in Molecular Biology, Vol. 137: Developmental Biology Protocols, Vol. III*  
Edited by: R. S. Tuan and C. W. Lo © Humana Press Inc., Totowa, NJ

## 2. Materials

### 2.1. Fertile Chicken Eggs

Experimentation with chick embryos requires freshly laid, fertile eggs. It is not difficult to find a convenient source of hen eggs; however, sometimes the strain of chicken that is readily available is not optimal for experimental manipulation. For example, pigmented eggs are not suitable for experiments requiring the study of relatively late embryos because the pigmentation of the feathers may obscure or interfere with the visibility of the skeleton after staining. For this reason, white flocks should be chosen when possible; the White Leghorn varieties are favored when available because of their generalized use. Investigators should also be aware that some strains of White Leghorn chicken embryos survive microsurgery better than other strains.

1. Laboratories normally estimate their needs and order eggs once a week. Eggs not incubated on arrival should be stored at 15°C. At this temperature, embryonic development is arrested; the fertile eggs are viable for at least 1 wk. As a general rule, unused eggs should be discarded after 1 wk of storage.
2. Storing the eggs at 15°C is required to obtain uniformity of embryonic development during the first stages following incubation. If the eggs are stored at room temperature (usually about 22°C) when incubated, embryo viability and developmental synchrony decline.

### 2.2. Forced Draft Incubator

Eggs should be incubated in a forced-draft incubator at 38–39°C and 95% relative humidity, which is easily obtained when a reservoir of water is maintained inside the incubator. Forced air insures a uniform temperature throughout the incubator, which is required for consistent development of the embryos. The eggs should be rotated during the incubation period. Many incubators rotate the eggs automatically; for manual rotation, twice daily is sufficient. Rotation improves development and prevents the developing embryo from adhering to the shell membrane.

### 2.3. Dental or Hand-Held Drill for Windowing the Egg

The optimal time for windowing eggs (**Fig. 1A–F** and **Fig. 2A,B**) for experimental manipulations of the limb bud is during the third day of incubation. Because the embryo develops in contact with the shell membrane before windowing, it is necessary to create a space that separates the embryo from this membrane.

1. Transfer the eggs from the incubator to holders, e.g., plastic rings, Syracuse dishes with a nest of cotton (*see Fig. 1A*), or clay-made nests that stabilize them in a horizontal position.
2. Swab the eggs lightly with 70% ethanol and allow to air dry.
3. Candle the egg to locate the embryo and mark its position on the shell surface (*see Fig. 1B*). The embryo is clearly visible by candling after 48 h of incubation and infertile eggs can be discarded at this point. Younger embryos are often difficult to see by candling, and in this case, the middle of the yolk should be marked on the shell. While you are candling the eggs, it is important to be sure the embryo rotates as the egg is rotated and is not stuck to the shell membrane. If this occurs, turn the egg 180° and let it sit for a few minutes and candle again.
4. With a dental drill or a small hand tool, make a hole in the pointed end of the egg using a #6 carbide burr (available from dental supply companies) (*see Fig. 1C*).

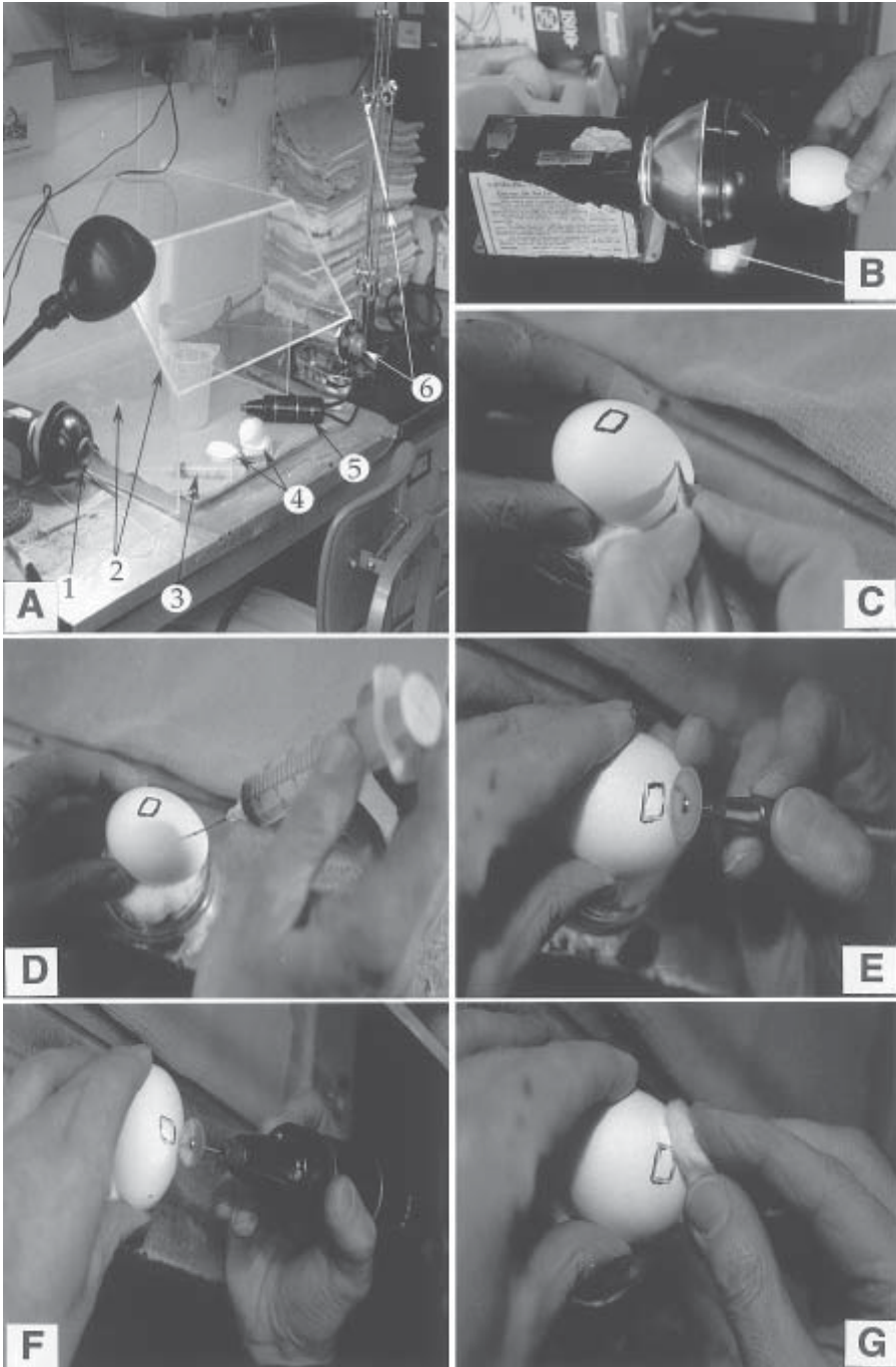

Fig. 1. Procedure for windowing eggs. (A) Layout of egg opening area: (1) egg candler, (2) Plexiglas hood, (3) syringe with 18 gage needle, (4) Syracuse dishes to hold eggs, (5) hand-held drill, and (6) dental drill. (B) Candling eggs to locate embryo position. (C) Drilling hole in pointed end of egg. (D) Withdrawing albumen. (E) Cutting window in shell using dental drill. (F) Alternative, cutting window using hand-held drill. (G) Cleaning away shell dust with cotton dampened with 70% ethanol.

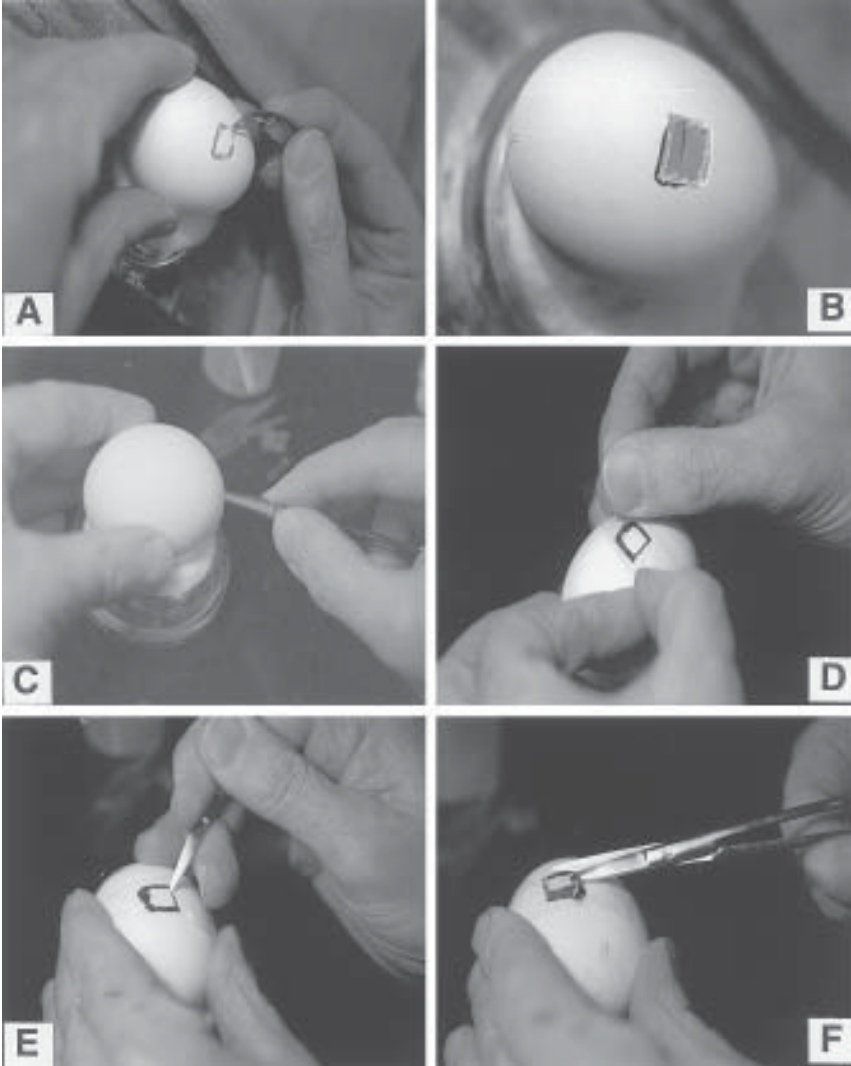

Fig. 2. Procedure for windowing eggs, continued. (A) Remove shell with forceps leaving shell membrane. (B) Remove shell membrane with forceps; embryo will be visible. (C) Alternative, cutting window without drill. Make hole in blunt end of egg using pointed end of sharp/sharp scissors. (D) Place cellophane tape over shell to be removed. (E) Pick a hole through the tape and egg shell large enough to insert a scissors blade. (F) Cut shell along marking to create window; embryo will be visible.

5. To create an air space inside the egg to separate the embryo from the shell membrane, insert an 18-gage needle through the hole into the albumen and, with an attached syringe, remove about 1 to 2 mL of albumen (see Fig. 1D). Avoid removing yolk as this will cause the embryo to die. The hole normally closes because the albumen dries out, but if necessary, it can be sealed with a small amount of molten paraffin.
6. An alternative for dropping the embryo from the shell membrane is to open a hole in the blunt end of the shell as shown in Fig. 2C; this causes the air pocket in the blunt end to collapse, creating an air space above the embryo (see Note 1).

7. Next, cut a window approx 1 cm × 1 cm in the shell encircling the marked location of the embryo using an abrasive wheel attached to the dental or hand-held drill (diamond dust or carborundum wheels are available at dental supply companies or hardware stores). The wheel should cut only the shell and leave the shell membrane intact (*see Fig. 1E,F*). During windowing, shell dust is produced. If the shell membrane is penetrated, shell dust is propelled into the egg. This may interfere with subsequent procedures and introduce bacteria and spores into the egg. When many eggs are to be opened, even if performed in a Plexiglas™ hood to contain the shell dust (**Fig. 1A**), a surgical face mask should be worn to prevent breathing shell dust.
8. After cutting the window, wipe the surface of the egg, including the grooves cut in the shell, with a cotton swab very lightly moistened with 70 % ethanol to clean the egg of shell dust; too much alcohol will kill the embryo (**Fig. 1G**).
9. Remove the sawed square of shell carefully with fine forceps and observe through the shell membrane that the embryo has dropped and is not stuck to the shell membrane (*see Fig. 2A,B*). If the embryo is stuck, a drop of phosphate-buffered saline (PBS) can be put on the shell membrane, a small hole made and the embryo will drop.
10. Carefully tear the shell membrane away. Care should be taken that all of the shell membrane is removed; if a small piece contacts the egg contents, it may act as a wick and moisture will be lost resulting in death of the embryo.
11. Cover the window with cellophane tape and return the egg to the incubator. Scotch brand Transparent tape (3M 600) or Magic Transparent tape (3M810) is recommended.
12. After windowing, maintain the egg in a horizontal position using the egg holder (*see Notes 1 and 2* for windowing eggs of younger or older embryos.)

#### 2.4. Windowing Eggs Without a Drill

Eggs may be windowed manually if a drill is not available (**Fig. 2C–F**). This requires only a pair of small sharp/sharp scissors.

1. After candling, use the closed pointed end of the scissors (*see Fig. 2C*) to bore a hole in the blunt end of the egg shell. This causes collapse of the air space and drops the embryo away from the shell membrane.
2. Place a piece of cellophane tape (*see Fig. 2D*) over the area of the shell to be opened.
3. Using the pointed end of the scissors, pick a hole (*see Fig. 2E*) through the tape and the shell large enough to insert a scissors blade. The tape prevents pieces of shell from dropping into the egg.
4. Cut the shell (*see Fig. 2F*) along the marking to create a window; the embryo will be visible.
5. Close the window with cellophane tape.

#### 2.5. Microsurgical Instruments

There are many types of instruments; some of them, such as fine forceps, insect pins, iridectomy scissors, and so on, may be purchased (Fine Science Tools, Inc., Foster City, CA). Specialized instruments can be made by the investigator to perform the desired manipulation (*see Notes 3 and 4*). An excellent source for instruction on manufacture of custom instruments is found in (*15*).

#### 2.6. Tungsten Needles (**Fig. 3**)

Tungsten needles are very popular and have replaced the traditional glass needles. They are easy to prepare and can be repeatedly sharpened. Short lengths (5–7 cm) of

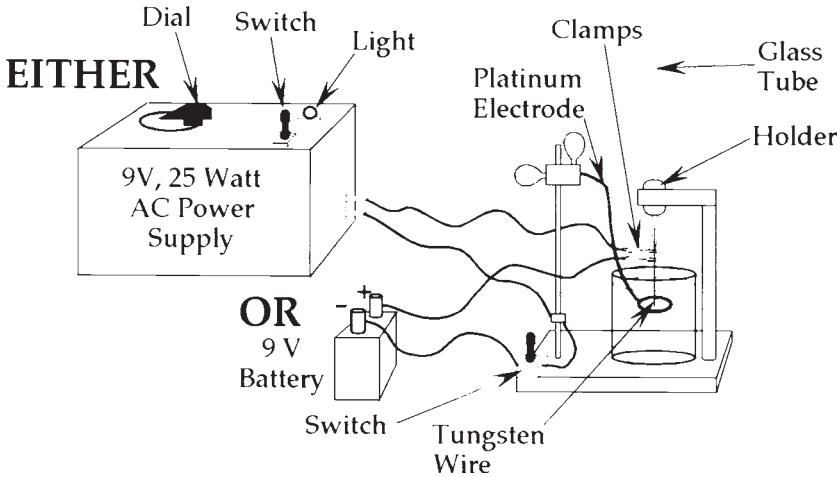

Fig. 3. Electrically powered tungsten needle sharpener. (1) Place a small beaker of 2% KOH under the platinum electrode. (2) Center the platinum electrode with respect to the beaker and lower until the circular ring is 1–2 cm beneath the surface. (3) Slide the tungsten needle through the holder and lower it until the needle point is centered and even with or slightly below the level of the circular ring of the platinum electrode. (4) Place the clamp on the tungsten wire above the surface of the KOH solution. [If you use a battery, have the clamp connected to the positive (+) pole.] (5) Turn on the switch of either the AC power supply or the battery. (6) Turn the dial of the AC power supply to a reading equivalent to about 7 V and sharpen to the desired point by raising and lowering the needle. (7) When finished, turn the power supply dial to “0” and turn the switch to off, then remove the needle.

tungsten wire (Goodfellow Metals, Berwin, PA, #W 005310, diameter 0.125 mm, or larger) are attached to either wooden holders with a strong glue such as Super Glue™ or glass tubing, which is melted around the wire in a flame. To perform precise manipulations, the attachment of the wire to the holder needs to be firm. The free end of the tungsten wire has to be sharpened either manually or electrolytically (*see* **Notes 3** and **4** and **Fig. 3**).

### 2.7. Agar Staining Needles

Nile Blue sulfate is very useful when applied locally by means of agar staining needles. Agar needles impregnated with this dye are used like brushes to stain the tissue by gently touching the desired location.

1. To manufacture a staining needle, place the tapered end of a disposable Pasteur pipet over a flame and pull out the glass to about 0.5 mm diameter, let cool and break off in the middle of the newly created taper.
2. Using the flame, form the new end of the pipet into a blunt ball-shaped end about 1 mm in diameter.
3. Make a solution of 2% agar, heat until the agar is dissolved, and then add 1% (W/V) Nile Blue sulfate.
4. Allow the solution to cool slightly and then dip the formed tip of the pipet in this solution. Dip the tip repeatedly into the agar allowing the agar to cool before adding the next coat. The tip of the pipet will be colored blue by the adhering gel.





Fig. 4. (See color plate 9 appearing after p. 262.) Photograph of a living stage 17 chick embryo viewed through a window cut in the egg shell. Blue food coloring was injected into the yolk prior to photographing. Note how the somites, otic vesicle, neural tube, and emerging wing bud stand out.

5. Sterilize the pipets under UV light and store covered to protect from dust while not in use.
6. Immediately before use, moisten the staining needle in phosphate-buffered saline (PBS) so the dye is released and the needle does not stick to the embryo.
7. Staining needles can be a source of contamination if not discarded on a regular schedule after use.

### **2.8. Buffers, Stains, Fixatives, and Other Solutions**

1. PBS, pH 7.4 composition per liter: 8 g NaCl, 0.2 g KCl, 1.44 g  $\text{Na}_2\text{HPO}_4$ , 0.24 g  $\text{KH}_2\text{PO}_4$ .
2. Food coloring and vital dyes to aid in visualizing the embryo (see **Fig. 4**).

- a. The early stages of the chick embryo are difficult to see. One useful way to enhance embryo visibility is to inject food coloring into the yolk directly beneath the embryo. This has no effect on subsequent development. The effectiveness of this approach is shown in **Fig. 4**. To do this, drill a hole in the blunt end of the egg after windowing the egg. Load a tuberculin syringe fitted with a 1.5 in., 21-gage needle with food coloring. This may be diluted with PBS or used full strength. Insert the needle in the hole while viewing the embryo with a dissecting microscope. Push the needle through the yolk so that the tip of the needle is visible beneath the embryo, then deliver a very small amount of food coloring through the needle. Monitor the embryo so that only the smallest volume of dye necessary to increase visibility is used. Visualizing the embryo in this way is especially helpful when an investigator is learning a procedure. After the procedure is learned, food coloring may not be necessary and vital dyes may be used. Vital stains like neutral red chloride or Nile Blue sulfate work well (*see steps b and c*, below). Very low doses administered to the embryo do not interfere with embryonic development; higher concentrations are toxic. Several microliters of neutral red pipeted on top of the embryo causes the embryo to rapidly acquire a reddish color that facilitates visualization.
- b. Neutral red stock solution, 1/1000 neutral red chloride (Sigma, St. Louis, MO, #N7005) (W/V) in saline, 137 mM NaCl, 2.8 mM KCl.
- c. Nile Blue sulfate stock solution, 1:200 (W/V) in saline, 137 mM NaCl, 2.8 mM KCl. One source of this vital dye is Sigma Chemicals #N5632.
3. Horse serum, Gibco-BRL (Gaithersburg, MD) #26050-070.
4. Trypsin, Gibco-BRL #15090-046.
5. Collagenase Type 1, Worthington Biochemical Corp. (Freehold, NJ) #F2M23A4; 0.4% in Saline G.
6. Saline G, 140 mM NaCl, 5.4 mM KCl, 1.1 KH<sub>2</sub>PO<sub>4</sub>, 1.1 mM Na<sub>2</sub>HPO<sub>4</sub>, 0.1% glucose, 0.5% phenol red.
7. Eagle's MEM, Gibco-BRL #11090-081.
8. Penicillin-streptomycin, Gibco-BRL #15145-046, 500 U mL<sup>-1</sup>; 500 µg mL<sup>-1</sup>.
9. Fixative for cartilage staining, 10% (V/V) aqueous formalin, 10 mL of commercial formaldehyde (37–40%) in 90 mL distilled water.
10. Fixative for light microscopy, 95% ethanol, 40% formaldehyde, and glacial acetic acid in a ratio of 17:2:1. This gives excellent fixation for routine paraffin sections.
11. Victoria blue B Stain for cartilage.
  - a. Fix in 10% formalin overnight. Use glass scintillation vials; use vial caps with polyethylene cone-shaped liner (Kimble #FS74525-22400 [Kimble/Kontes, Vineland, NJ]); foil-lined caps will be destroyed by the acid alcohol used in this procedure.
  - b. Rinse in 3% hydrochloric acid in 70% ethanol (V/V) (this solution is referred to as "acid alcohol") 2–3 times over the course of a day.
  - c. Stain overnight in Victoria blue B, 1/100 (W/V) in 1% hydrochloric acid in 70% ethanol.
  - d. Destain in acid alcohol, repeated changes, until skin loses blue color.
  - e. Rinse in 70% ethanol, 2 times, 1 h each.
  - f. Dehydrate in 95% ethanol, 2–3 times, 1 h each.
  - g. Begin to clear in a mixture of 95% ethanol/methyl salicylate, 2/1 (V/V). When tissue equilibrates, change to 95% ethanol/methyl salicylate, 1/2 (V/V). Equilibration is indicated by sinking of the embryo. We find placing the vials on a low-speed shaker speeds this process. At this point, embryos can be stored in this solution or transferred to 100% methyl salicylate. *See Note 5* for an alternative method for staining cartilage.

### 3. Methods

The chick embryo is a widely used model in developmental biology. The accessibility for manipulation while developing in the egg is one of its main advantages. We acknowledge that there are many ways of performing a particular manipulation, but the steps we describe here have proved successful in our hands.

All manipulations should be carried out with sterile instruments, materials, and solutions. Autoclaving instruments is preferred, but if an autoclave is not available soaking in 70% ethanol prior to use is adequate. Solutions may be sterilized by membrane filtration (0.22- $\mu\text{m}$  pore size). The addition of an antibiotic is recommended following manipulations and subsequent observations of the embryo (*see Note 6*).

#### 3.1. Experimental Analysis of the Apical Ectodermal Ridge

The apical ectodermal ridge (AER) is the pseudostratified columnar epithelium rimming the growing tip of the chick limb bud. Using the dissecting microscope, the AER can be observed easily as an ectodermal thickening at the limb bud apex. John W. Saunders, Jr. first discovered its importance by showing that determination of skeletal elements in the limb bud was arrested after AER removal and that the level of truncation correlated with the stage at which the AER was removed (wing [16,17]; leg [18]). It is important to note that removal of the AER is easily performed between stages 19 to 21. At earlier stages, the AER is not morphologically defined (19) and the preridge region is very wide (according to fgf-8 expression [20]). Furthermore, the AER will still form after the apical epithelium is removed as late as midstage 18 (*see, e.g., [18]*). After stage 22, the position of the AER becomes ventrally located so that it is less accessible.

##### 3.1.1. Removal of the AER

1. Open the eggs as described in **Subheading 2.3.** and stage them according to Hamburger-Hamilton.
2. With fine forceps, remove the vitelline membrane; this is facilitated by picking a small hole in the membrane and adding 1–2 drops of PBS to float the membrane free of the embryo. Using fine forceps, open the amniotic sac to expose the limb bud; this is best accomplished by tearing open the amnion at the sero-amniotic raphe and opening only the amount needed to accomplish the procedure. You can see the raphe as an opaque line bisecting the embryo. An opening made this way will heal more easily than simply tearing through the amnion near the limb bud. If embryos are dying after a procedure, one of the first things we examine is whether or not there is too large a tear in the amnion as this in itself will cause the death of the embryo.
3. Lightly stain the distal tip of the bud by gently touching it with a Nile Blue staining needle (*see Subheading 2.8.2.*) moistened with PBS. Staining makes the AER very easy to see because the AER cells concentrate the blue color.
4. To perform the microsurgery effectively, view the limb bud at  $\times 25$ – $40$  with a dissecting microscope. With a very sharp tungsten needle, make a cut in the dorsal limb bud ectoderm following the *junction* between the AER and the dorsal ectoderm from the anterior to posterior body wall; do not cut into the mesoderm. After the cut is made along the length of the AER, introduce the tip of the tungsten needle into this cut and carefully push the AER off the mesoderm so that the dorsal aspect of the AER becomes separated and you see the underside of the ventral ectoderm. An L-shaped needle may facilitate this part of the procedure. The apical ridge will be floating in the amniotic fluid attached only by the ventral ectoderm.

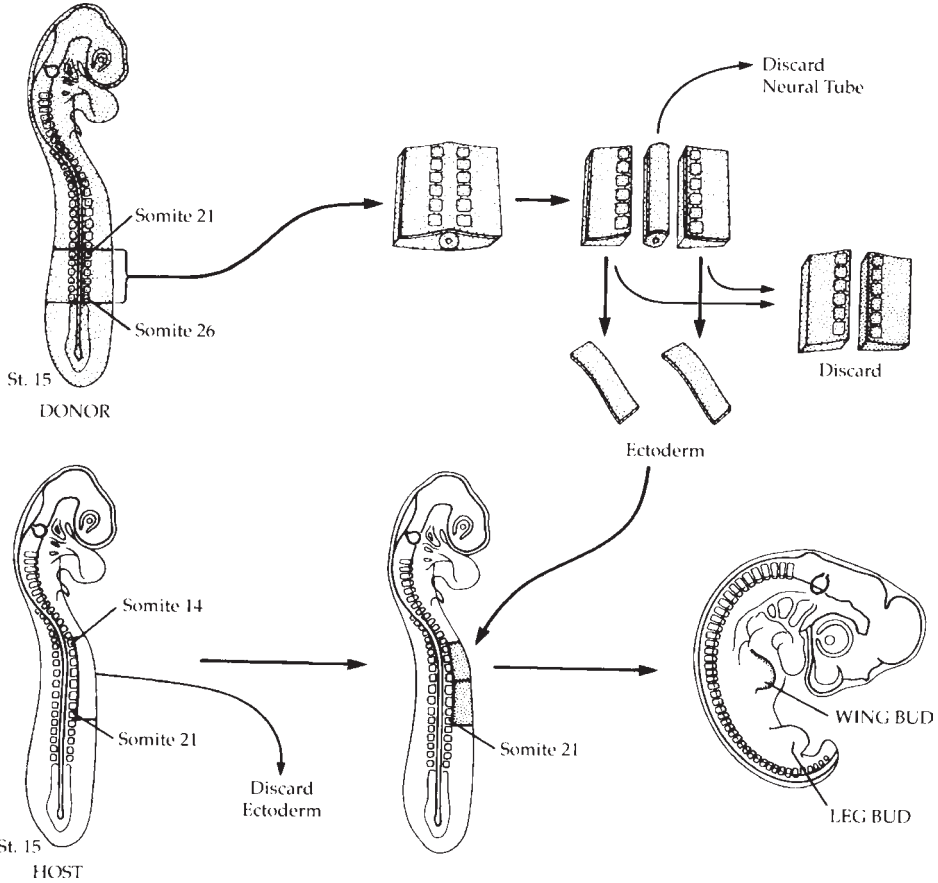

Fig. 5. Procedure for grafting flank ectoderm to the limb field to assay for AER induction.

5. Proceed to cut the surface of the exposed ventral ectoderm, parallel to the base of the AER. After this step, the AER lies loose, attached only anteriorly and posteriorly. Cut the anterior and posterior attachments and the entire apical ridge will detach. Remove the AER from the egg and discard.
6. Seal the window with cellophane tape and return the egg to the incubator.
7. Allow the embryos to develop until time for analysis. Note that partial AER removal and even as little as a somite length, can be very useful for specific experiments (21).

### 3.1.2. Induction of AERs in Competent Ectoderm (Figs. 5 and 6)

The ectoderm covering the distal rim of the bud develops into the AER under the influence of the mesoderm. The nature of this induction is unknown, but FGF-10 has been proposed as the AER inducer (22). It is presently thought that the positioning of the AER at the distal rim of the bud is determined by the presence of a boundary between dorsal and ventral ectodermal compartments expressing and not expressing *Radical Fringe*, respectively (23,24). Limb mesoderm retains AER-inducing capabilities up to at least stage 20 (25) and when a competent ectoderm is grafted over it, a new AER is induced. Flank ectoderm (26) and ventral limb ectoderm (23) will develop an AER when grafted onto the denuded dorsal surface of a limb field or early limb bud.

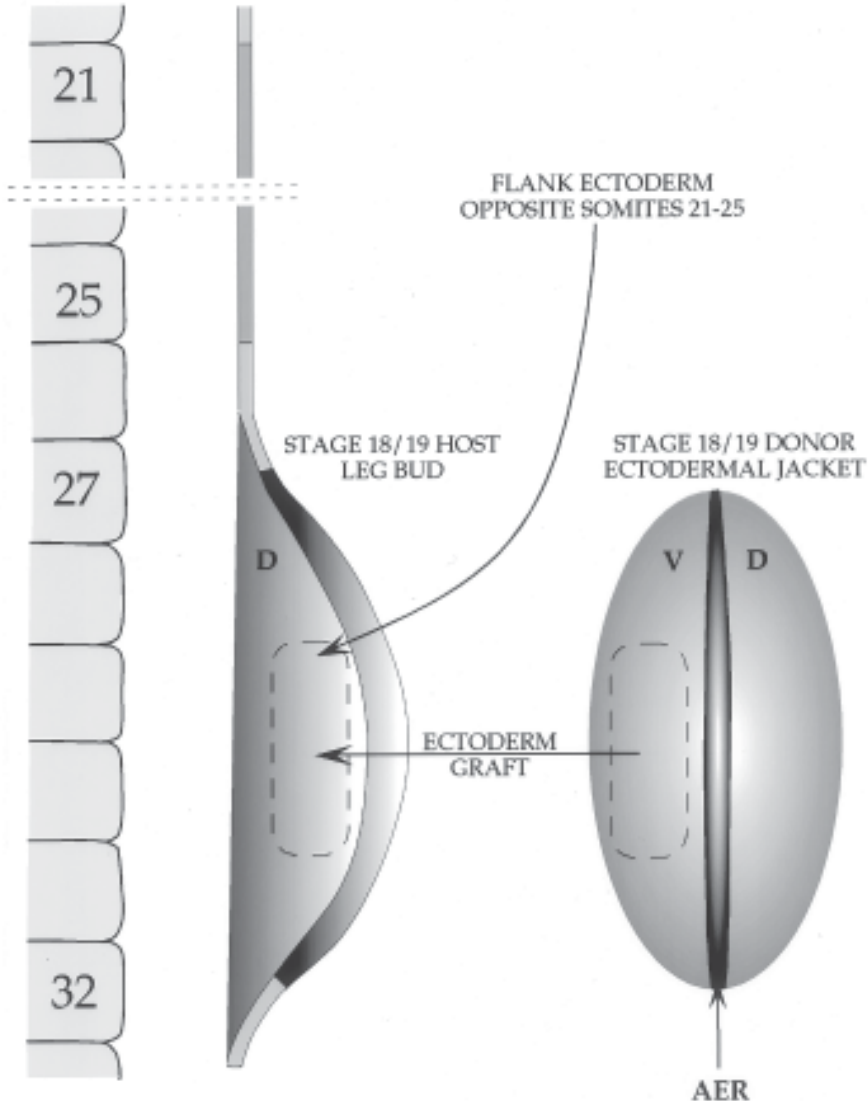

Fig. 6. Procedure for grafting ectoderm to the dorsal surface of the leg bud to assay for AER forming ability. D = dorsal limb bud; V = ventral limb bud.

1. To perform this manipulation, begin by opening and staging the eggs as previously described above (*see Subheading 2.3.*). Remove staged embryos (*see Figs. 5 and 6*) and place into ice-cold PBS. Dissect the regions to be used for donor ectoderm, i.e., limb buds or flank region.
2. Transfer the dissected regions to 0.5% trypsin in ice-cold PBS until the ectoderm becomes loose over the mesoderm (time may vary from 20 min–1 h). Transfer the tissue pieces to ice-cold PBS + 10% horse serum and dissect the ectoderm free. The horse serum stops further trypsin digestion of the tissues.
3. In the case of the limb bud, carefully trim the ventral ectoderm free of AER cells (the AER can be stained lightly with Nile Blue or neutral red to facilitate the visualization of these cells).

4. Select and expose the limb regions of stage 15 embryos (**Fig. 5**) or 18–19 (**Fig. 6**) to be used as hosts. Prepare a graft bed with a sharpened tungsten needle by peeling off the ectoderm covering the limb field or dorsal limb bud ectoderm. Very light staining of the ectoderm with a Nile Blue staining needle improves visibility of the ectoderm and facilitates its removal without injuring the subjacent mesoderm.
5. Transfer the donor ectoderm and carefully push it over the prepared graft bed until the ectoderm is smooth and remains in place. Seal the window with cellophane tape and return the egg to the incubator.

### 3.2. Experimental Analysis of the Zone of Polarizing Activity

The zone of polarizing activity (ZPA) discovered by Saunders and Gasseling (27) is a region of mesodermal cells located at the postaxial border of the limb bud. This region controls patterning of the anterior posterior axis; when a piece of ZPA is grafted to the limb bud anterior border of a host embryo, it causes a mirror-image duplication of the host limb. Recently, it has been demonstrated that ZPA action is mediated by sonic hedgehog (shh) production (28,29), and consequently, this manipulation is frequently used to analyze the shh pathway. The ability to induce a mirror-image duplication in a host limb bud is called polarizing activity. Any tissue in the embryo that synthesizes shh will show polarizing activity in the limb bud assay, e.g., Hensen's node, floor plate of the neural tube, feather buds, and the postaxial border of the reptilian or mammalian limb buds.

The test for polarizing activity is performed in the anterior border of the limb bud. When this mesoderm is exposed to shh in conjunction with the AER, it becomes respecified and produces a mirror-image duplication of the wing. There are several ways of grafting the tissue to be analyzed. Classically, the tissue was introduced into a notch or slit made into the anterior distal limb bud mesoderm (27). A modification of grafting the ZPA tissue to a position under the AER ("subridge assay") devised by Gasseling (see [3]) and perfected by Tickle (30) has proved to be a more sensitive assay (see **Fig. 7**). We will describe both methods below.

#### 3.2.1. Original ZPA Assay

1. Select an appropriately staged embryo to be a donor of ZPA tissue. There are maps showing the localization of the ZPA at each stage of development (28,31).
2. Remove the embryo from the egg, place it in a tissue culture dish containing ice-cold PBS and remove the extraembryonic membranes. With a needle or fine forceps dissect the ZPA as in **Fig. 7**.
3. To remove the ectoderm transfer the dissected ZPA regions to 0.5% trypsin in PBS at room temperature. Monitor digestion under a dissecting microscope; the ectoderm will loosen from the mesoderm in approx 5 min.
4. Transfer the ZPA pieces to a tissue culture dish containing ice-cold PBS + 10% horse serum and dissect the ectoderm from the mesoderm. When the ZPA mesodermal pieces are freed of ectoderm, cut them in several fragments of about 50–100 cubic  $\mu\text{m}$ . If necessary, pieces may be stored on ice for about two hours.
5. Window, stage and expose the limb bud of host embryos; optimal duplications are seen in stage 20 hosts. To perform the original ZPA graft of Saunders and Gasseling (27), cut a slit in the distal preaxial border of the bud as shown at 1 in **Fig. 7**.

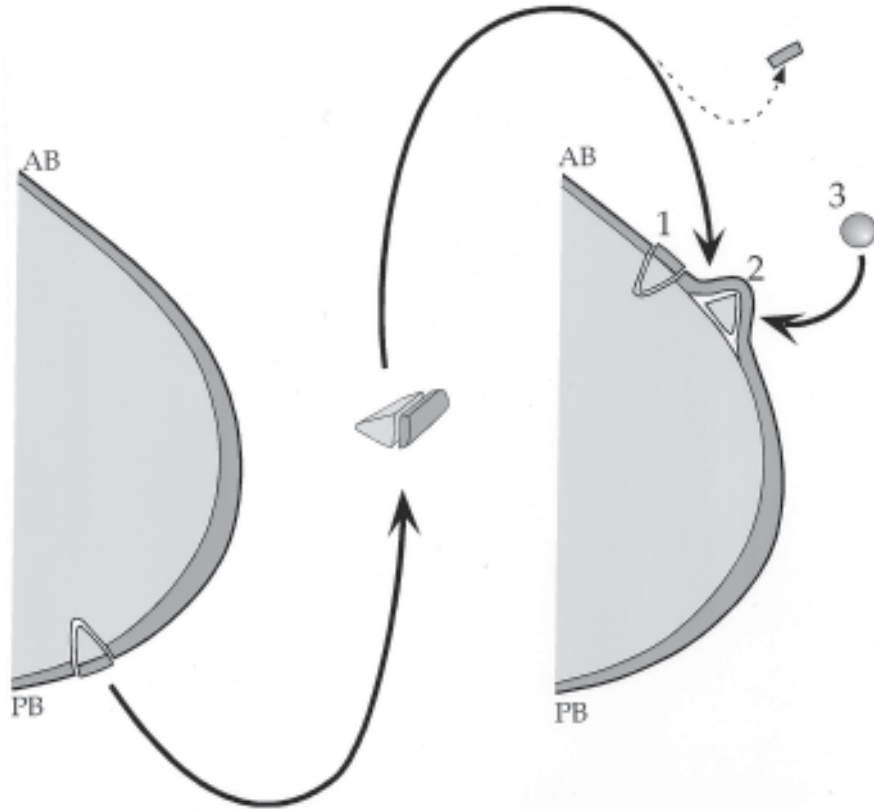

Fig. 7. Procedures for polarizing activity assay (1,2) and bead grafting (3). AB, anterior border of preaxial region of the limb bud; PB, posterior border of postaxial region of the limb bud.

6. Pipet the graft of ZPA next to the slit and push the tissue into the slit with fine forceps or a blunt tungsten needle. The original assay was done with or without donor ectoderm in place and there was no detectable difference in the result.
7. Seal the window with cellophane tape and return the egg to the incubator until time for analysis.

### 3.2.2. Subridge ZPA Assay

1. Obtain ZPA pieces as in **Subheading 3.2.1.**
2. Lightly stain the apical ridge of a Hamburger-Hamilton stage 20 host by touching it gently with a PBS moistened Nile Blue staining needle.
3. With a sharpened tungsten needle loosen a portion of the AER at the anterior border of the bud large enough to receive the graft as described for ridge removal. The loosened AER can be stretched to form a loop (see **Fig. 7, #2**) to hold the graft tissue.
4. When the graft site is prepared, use a Pasteur pipet to transfer the donor graft tissue to the host embryo and place it on the dorsal surface of the limb bud.
5. With a blunt tungsten needle, carefully push the ZPA fragment close to the loop of loosened AER and position the graft between the loosened ridge and the subjacent mesoderm. The graft will be held in place by the natural tension of the AER.
6. Seal the window with cellophane tape and return the egg to the incubator until time for analysis.

### 3.3. Recombinant Limbs

Once the AER forms, subsequent growth depends on the interaction between the AER and the underlying mesoderm. Recombinations between different types of ectoderm and mesoderm have proved useful to determine the interactions taking place between the two components. For example, ectoderm and mesoderm interchanges between wing and leg demonstrated that the mesoderm is responsible for the type of limb formed, i.e., wing or leg, and that the limb bud ectoderm directs dorsal ventral patterning. Recombinations between mesoderm and ectoderm of different developmental stages allowed the conclusion that the AER's influence is permissive. This technique, pioneered by Edgar Zwilling (32), is delightfully simple and has great potential. We describe two basic techniques.

#### 3.3.1. Recombinant Limbs with Intact Mesoderm (Fig. 8)

These experiments are usually performed at about stage 20, although earlier or later stages may be used. Sometimes the desired recombinant limbs use ectodermal jackets that are not the same shape or size as the mesodermal component. In this case, trim the mesoderm at the anterior border and do not remove the ZPA. When performing experiments using wing mesoderm always use leg jackets and vice versa. The reason for this is that even a small amount of mesoderm left in the jacket will differentiate in the recombinant, leading to possible spurious interpretations. Using leg jackets with wing mesoderm will allow detection of the smallest amount of contaminating mesoderm from the jacket donor which will appear as a toe or toes.

1. For the ectodermal component (jacket) of intact mesoderm recombinant limbs, collect limb buds from specific stage embryos in ice-cold PBS. Transfer the limb buds to 0.5% trypsin in ice-cold PBS for 1 h or until ready to combine with the mesodermal component of the recombinant.
2. Separately, for the mesodermal component, collect limb buds from specific stage embryos in ice-cold PBS. Transfer these limb buds to 0.5% trypsin in ice-cold PBS. Length of trypsinization is stage-dependent; allow the limb buds to digest for 1 h or until the ectoderm is easily detached from the mesoderm.
3. Keep careful track of stages and axes of the buds so that you do not change relationships you wish to maintain (e.g., if you want to maintain the dorsal ventral axes of ectoderm and mesoderm components). This can be accomplished by carbon marking of the ectoderm and/or mesoderm. To do this, dip a PBS-moistened tungsten needle into a dish of Norite A activated charcoal; granules of the charcoal will stick to the needle. Then gently touch the tissue to be marked with the charcoal-laden needle. Granules will then stick to the tissue.
4. Transfer one ectoderm donor and one mesoderm donor to a small tissue-culture dish containing ice-cold PBS + 10% horse serum.
5. Peel off the ectoderm and recombine the tissues as desired. Allow the ectoderm and mesoderm to heal together at room temperature for 15 min to 1 h before grafting to a host embryo. Discard the unused ectoderm and mesoderm.

These recombinant limbs can be grafted to different locations in host embryos such as the dorsal surface of the limb bud or the somites. We think that grafting to the somites of stage 20–24 host embryos at the flank level is best because the graft environment is free of limb influences.

6. For somite grafting, using a tungsten needle, make a superficial incision the length of two to three somites. At each end extend the incision medially so that a flap of the somitic



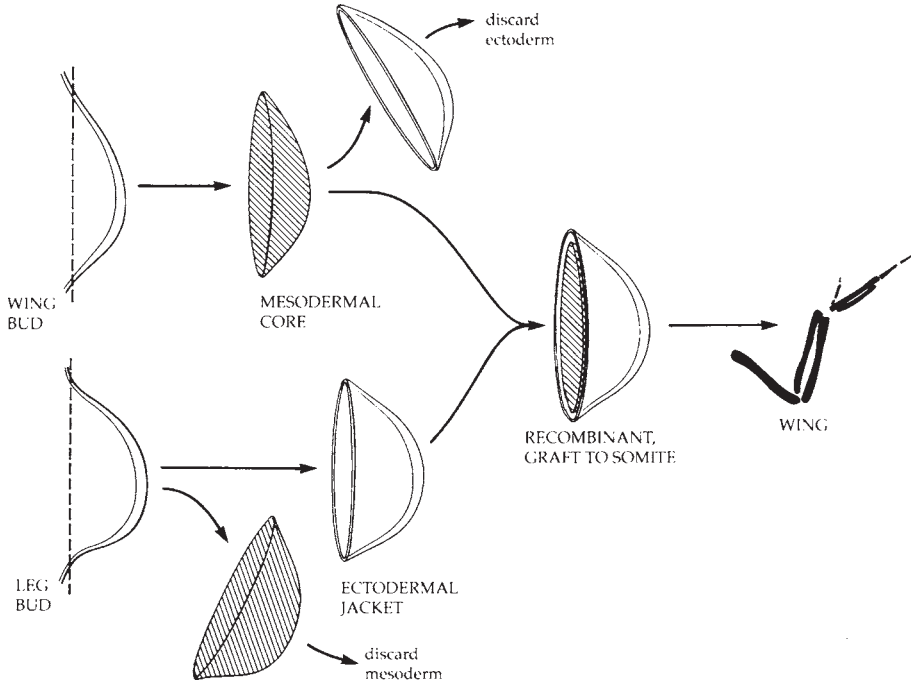

Fig. 8. Procedure for recombinant limb technique using whole wing mesoderm placed in a leg bud ectodermal jacket.

tissue is formed; lift this flap to expose the graft bed. Some bleeding helps with the attachment of the graft; however, profuse bleeding will likely cause death of the host.

7. With a Pasteur pipet transfer the recombinant to the host graft bed.
8. With fine forceps, place the base of the recombinant limb over the graft bed and hold it in place with the forceps for a short time to allow attachment of the recombinant. The somite flap will abut the graft and help it to adhere.
9. Usually the graft will become attached to the graft bed, but it may be necessary to use a platinum pin. Platinum pins are small fragments of platinum wire (Goodfellow #PT005114, 0.025 mm) about 0.5 mm long that can be bent into right angles and used to hold grafted tissues in place.
10. Seal the window with cellophane tape and return the egg to the incubator until time for analysis.

### 3.3.2. Recombinant Limbs with Dissociated Mesoderm (Fig. 9)

These recombinant limbs require the dissociation and reaggregation of the mesoderm, and consequently, the relationship between mesodermal cells is changed and the extracellular matrix is disrupted. This technique also was originally devised by Zwilling (32) and has proven useful in analyzing factors controlling gene expression (33). The recombinant limbs develop into limb-like structures; the skeletal elements formed depend on the mesodermal composition. The recombinants allow insight into the role played by each of the organizing centers of the bud as the ZPA may or may not be introduced into the recombinant.

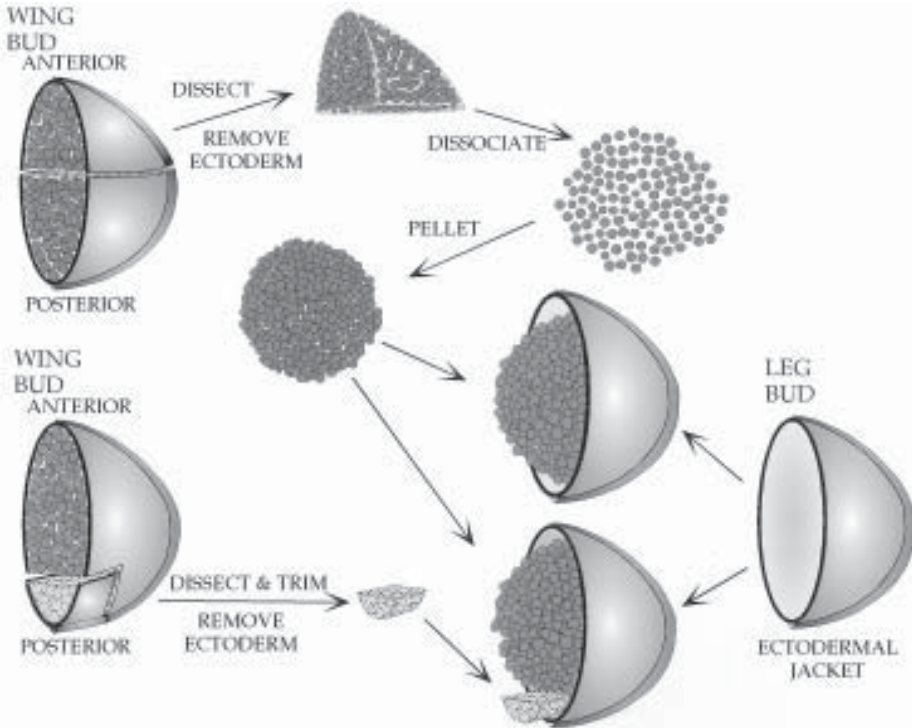

Fig. 9. Procedure for recombinant limb technique using dissociated anterior (preaxial) wing bud mesoderm, pelleted, and stuffed into a leg bud ectodermal jacket either with or without added undissociated ZPA.

This procedure is very powerful as it permits analysis of the morphogenetic potential of selected limb mesoderm under ridge influence. For example, recombinant limbs can be made from only anterior or posterior mesoderm (34). The developmental potential of the interdigital mesoderm normally fated to die, has also been analyzed in this way (35).

1. To prepare the mesodermal component of the recombinant limb, collect limb buds from the embryo in ice-cold PBS in a tissue-culture dish. Dissect anterior or posterior pieces from the limbs as in Fig. 9.
2. To remove the ectoderm from the mesodermal pieces, digest the fragments in 0.5% trypsin in PBS for 9 min at 37°C.
3. Transfer the fragments to ice-cold PBS + 10% horse serum and peel off the ectoderm.
4. Wash the mesodermal fragments in ice-cold PBS for 10 min. A certain amount of trial and error is required to properly size mesodermal pieces for optimal dissociation conditions. Fragments that are too large fail to dissociate completely; fragments that are too small become sticky, stringy, and unusable.
5. To dissociate the cells, transfer the mesodermal fragments to 100  $\mu$ L 0.4% collagenase in Saline G in a 1.5-mL microfuge tube at room temperature and digest for 10 min.
6. Remove collagenase by washing several times with Saline G + 10% horse serum at room temperature.
7. Add 1 mL of Saline G + 10% horse serum and triturate several times (8–10 times does not harm the cells) with an automatic pipeter set at 0.5 mL.

8. To form a pellet, centrifuge the tube at 500g for 7–10 min at room temperature.
9. To facilitate recovery of the pellet, incubate the tube containing the pellet for a half hour at 37°C. This stabilizes the pellet so that you can detach it from the bottom of the tube with fine forceps.
10. Pour the fluid with the pellet into a small tissue-culture dish filled with ice-cold Saline G + 10% horse serum on ice.
11. To prepare the ectodermal component of the recombinant limb, collect limb buds from stage 22 embryos to be used as ectoderm donors. Ectodermal jackets of stage 22 limb buds are ideal as they are sac shaped and big enough to hold a large amount of pelleted mesodermal cells.
12. Digest the dissected limb buds in 0.5% trypsin in ice-cold PBS until the mesodermal pellet is ready (about 2 h). Note that ectodermal jacket preparation must be done in parallel with preparing the mesodermal pellet so that both are ready at the same time.
13. Transfer trypsin-digested limb buds to ice-cold PBS + 10% horse serum. Peel off one limb bud ectodermal jacket and transfer it to the dish with the mesodermal pellet.
14. Take a fragment of the pellet and stuff it into the ectoderm; continue stuffing pellet fragments until the ectodermal jacket is full.
15. Allow the recombinant limbs to heal together for 15 min to 1 h at room temperature prior to grafting to a host embryo somites as described above in **Subheading 3.3.1**.
16. Seal the window with cellophane tape and return the egg to the incubator until time for analysis.

### 3.4. Bead Implantation (Fig. 7)

Retinoic acid was the first molecule applied to the limb bud in carrier beads ([36] and see **Note 7**). This has proven to be a generally useful procedure to slowly release exogenously supplied molecules into developing limb buds from a point source positioned at the investigator's discretion (e.g., [29]). The effects of a variety of growth factors can be analyzed by this method.

#### 3.4.1. *Shh* and Other Growth Factor-Loaded Beads

There are a variety of beads that can be used to slowly release proteins; bead choice is primarily determined by the reactive groups on the protein to be released. Among the most commonly used are heparin acrylic (Sigma #H5263 [Sigma Chemical Co., St. Louis, MO]) because many growth factors have a heparin binding site, and the beads are white, easily handled, and can be tracked after grafting (see **Note 8**).

1. To prepare the beads, place a small quantity of beads into a 35- or 60-mm tissue-culture dish containing PBS. Wash them several times with PBS.
2. Using a dissecting microscope, select beads approx 100–150  $\mu\text{m}$  diameter for use.
3. Carefully remove the PBS with a pipet and soak the beads in the desired concentration of growth factor for 1 h at room temperature. Control beads are prepared without the added growth factor. In order to prevent desiccation during bead loading, it is important to keep the soaking solution in a humid atmosphere. This can be accomplished by pipeting a thin ring of PBS into the perimeter of the dish used for soaking the beads.
4. After loading the beads with the growth factor, flood the beads with several mL of PBS and the beads are ready for use.
5. To graft the beads to a position under the AER, loosen the AER at the anterior border of the limb bud as for making ZPA grafts described in **Subheading 3.2.2**.

6. Using fine forceps or a pipet, transfer one growth factor-loaded or control bead to the host embryo and push it under the loosened AER in the same way as for ZPA grafts (see Fig. 7, #3). The bead will be held in place by the tension of the stretched AER.
7. Seal the window with cellophane tape and return the egg to the incubator until time of analysis.

### 3.4.2. Grafting Beads to the Mesoderm

1. To graft the bead into the limb bud mesoderm make a clean incision through the ectoderm with a sharp tungsten needle in the region where you want to place the bead.
2. Transfer one bead to the host embryo and place it on top of the ectodermal incision.
3. Push the bead so it is introduced into the mesoderm or under the ectoderm as the experiment requires.
4. Seal the window with cellophane tape and return the egg to the incubator until time of analysis.

## 4. Notes

1. Windowing eggs for very young embryos. If the experimental manipulations are to be performed on embryos during the first or second day of incubation, do not remove albumen, as this procedure may cause malformations (37). In this case, create an air space between the embryo and the shell membrane by drilling a hole in the middle of the blunt end of the egg. Carefully tip the egg and separate the embryo from the shell membrane by collapsing the air chamber (Fig. 2C). Proceed as above to open the window in the shell and visualize the embryo. After the experimental procedure on the embryo, add PBS to nearly fill the space in the egg. Seal the window with waterproof electrical tape. Rotate the eggs and incubate on a holder with the window side down. This method prevents malformations and embryo death (method of Fisher and Schoenwolf [37], see also Fernandez-Teran et al. [38]).
2. Windowing eggs for late embryos. If a procedure is to be carried out later than 4 d of development, it is best to open the eggs around the time the embryo is to be manipulated. For this procedure, keep the eggs vertical with the blunt end upward during incubation and all subsequent steps. Swab the eggs lightly with 70% ethanol and allow to air dry. Candle the eggs to locate the air sac at this time of development. Using a drill, open a window in the blunt end of the egg over the air chamber. Remove the shell and underlying shell membrane; note that the internal air sac shell membrane should still cover the embryo. With fine forceps remove this membrane being careful not to damage the vasculature of the chorioallantoic membrane. To facilitate this, add several drops of PBS on top of the membrane, then make a small hole in this membrane where there are no vessels. The PBS will pass under the shell membrane through the hole and the separation between the shell membrane and the chorioallantoic membrane will occur allowing access to the embryo after the shell membrane is removed. Seal the window with cellophane tape.
3. Electrolytic sharpening of tungsten needles. The free end of the tungsten wire is used as one electrode of the electrolytic process. The other electrode is an inert metal; platinum is best, but stainless steel also can be used successfully. An appropriate electrolytic solution is 2% KOH. An electric current (9 V) can be obtained with either an AC power supply or a battery to sharpen the wire. If a battery is used, the tungsten wire should be the positive electrode; the other wire should be the negative electrode. To obtain a nice taper, manually raise and lower the needle repeatedly. Periodically observe the tungsten wire tip under a dissecting microscope and stop when the desired sharpening has been obtained. Follow the procedure in the caption for Fig. 3.

4. Manual sharpening of tungsten needles. If the means for electrolytic needle sharpening is not available, use the following alternative. Melt sodium nitrite in a vessel with a Bunsen burner flame. Introduce the free end of the tungsten wire into the melted sodium nitrite and sharpen by raising up and down as in **Subheading 4.3**. To monitor the process, periodically observe the end of the wire under the dissecting microscope and stop when the required sharpening has been achieved. Protective eyewear is essential for this procedure.
5. Alternative method for staining skeletal cartilage. Skeletal cartilage may also be stained with alcian green or alcian blue after overnight fixation in 5% (W/V) aqueous trichloroacetic acid according to the method of Summerbell (17). We have found this is especially useful for staining the very earliest cartilage condensations.
6. Addition of PBS and use of antibiotic after manipulations. After microsurgical procedures, carefully add several drops of PBS on top of the embryo to replace moisture lost during manipulations. Addition of an antibiotic (penicillin-streptomycin) after surgical manipulations helps to prevent growth of bacteria introduced during manipulations. When observing the embryo any time after manipulations, it is beneficial to add 1–2 drops of the antibiotic (*see Subheading 3.*).
7. Method for applying retinoic acid to carrier beads. AG1-X2 ion-exchange resin beads (Bio-Rad, Hercules, CA, #AG1X2) are used to load and apply retinoic acid. Usually all-*trans*-retinoic acid dissolved in dimethyl sulfoxide (DMSO) is loaded onto beads (Sigma #R2625) at concentrations from “physiological” (0.01 mg/mL) to “pharmacological” (1 mg/mL). The stock solution can be aliquoted and kept frozen in the dark. Select beads according to size (approx 100–150  $\mu\text{m}$  beads are used). Soak the beads in 100  $\mu\text{L}$  retinoic acid solution for 20 min at room temperature (protect from light to prevent retinoic acid breakdown by photolysis). For a given volume, use a consistent number of beads. Wash three times in 100- $\mu\text{L}$  drops of Eagle’s minimum essential medium (MEM) and hold in 100  $\mu\text{L}$  at 37°C for at least 20 min prior to use. Graft for growth factor carrier beads as discussed in **Subheading 3.4.1**.
8. Alternative types of beads for protein loading. Affi-Gel Blue beads (Bio-Rad, #153-7301) work well as carrier beads and are easy to see because of their blue color. Affi-Gel heparin beads (Bio-Rad, #153-6173) can also be used; however, these beads are colorless and more difficult to manipulate and track after grafting. To keep track of the bead after placing in the embryo, put a few granules of Norite A activated charcoal on the bead before grafting.
9. Functional analysis of the AER after its manipulation (**Fig. 10**). The effect of AER manipulation, e.g., dissociation or various AER culture conditions, may be analyzed in a recombinant limb as follows.

Remove the AER from embryos as indicated in **Subheading 3.1.** above, collect and carry out the desired manipulation, e.g., dissociate the AER (39) or grow it in culture (40).

In order to place the AER back in position and test its functional capabilities, wrap a piece of back ectoderm around normal stage 20 limb bud mesoderm together with the manipulated AER cells (*see Fig. 10*). The first step is to remove the ectodermal jacket from the mesoderm. To do this, collect limb buds of stage 19–20 embryos in ice-cold PBS. Transfer the limb buds to 0.5% trypsin in ice-cold PBS and allow them to digest for 1 h or more until the ectoderm is easily detached from the mesoderm.

To collect the back ectoderm, dissect pieces of the back trunk (the portion covering the neural tube and the somites) of stage 22 HH embryos in ice-cold PBS. Transfer the trunk pieces to 0.5% trypsin in ice-cold PBS and allow them to digest for approx 1 h or until the back ectoderm is easily removed as a single sheet.

Transfer one digested limb bud and one digested trunk piece and the experimentally manipulated AER to a tissue-culture dish containing ice-cold PBS + 10% horse serum.

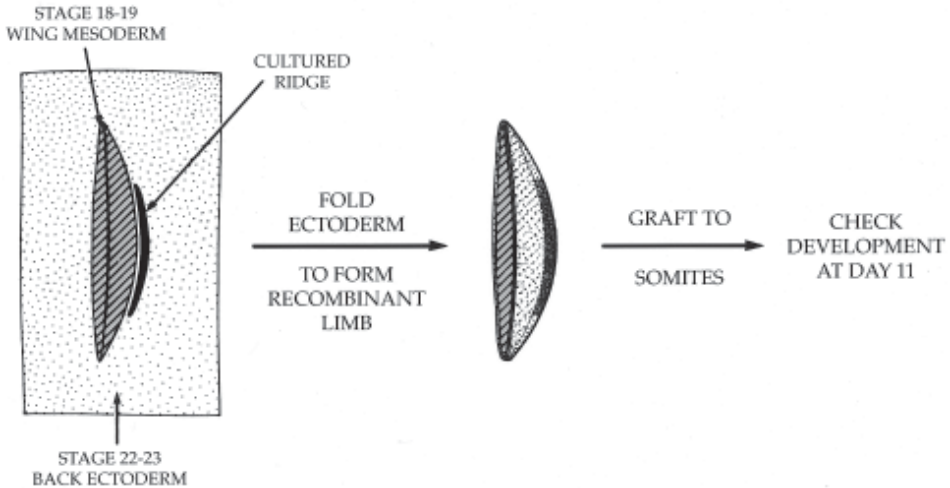

Fig. 10. Procedure for recombining limb technique to assay for AER function after experimental manipulation of the AER.

Peel off the ectoderm from the limb bud and recombine the tissues as shown in **Fig. 10**. Allow the recombined limb to heal together at room temperature for at least 30 min before grafting. Graft the recombined limb onto the somites as previously described (see **Subheading 3.3.1.**).

## Acknowledgments

This work was supported in part by NIH grant #HD32551 and a Vilas Associate Award from the University of Wisconsin Graduate School to John F. Fallon and grant PM95-0088 to Maria A. Ros.

We thank Lucy Taylor for making some of the original drawings. We appreciate the comments of Nicholas Caruccio, Randall Dahn, Matthew Harris, and Kay Rashka who read various versions of this work. We thank Diana Meyers for help with the typing and for reading the manuscript.

## References

1. Peebles, F. (1911) On the interchange of the limbs of the chick by transplantation. *Biol. Bull.* 2014–2018.
2. Hamburger, V. (1938) Morphogenetic and axial self-differentiation of transplanted limb primordia of 2-day chick embryos. *J. Exp. Zool.* **77**, 379–399.
3. Saunders, J. W., Jr. (1977) The experimental analysis of chick limb bud development, in *Vertebrate Limb and Somite Morphogenesis*. Cambridge University Press, Cambridge, UK, pp. 1–24.
4. Tickle, C. and Eichele, G. (1994) Vertebrate limb development. *Annu. Rev. Cell Biol.* **10**, 121–152.
5. Johnson, R. L. and Tabin, C. J. (1997) Molecular models for vertebrate limb development. *Cell* **90**, 979–990.
6. Romanoff, A. L. and Romanoff, A. J. (1949) *The Avian Egg*. Wiley, New York.
7. Bellairs, R. (1964) Biological aspects of the yolk of the hen's egg, in *Advances in Morphogenesis*. Academic, New York, pp. 217–272.

8. Barnes, J. (1984) History of animals, in *The Complete Works of Aristotle*. Princeton University Press, Princeton, NJ, pp. 880–884.
9. Hamilton, H. L. (1952) *Lillie's Development of the Chick*. 3rd ed. Holt, Rinehart and Winston, New York.
10. Romanoff, A. L. (1960) *The Avian Embryo, Structural and Functional Development*. Macmillan, New York.
11. Bellairs, R. and Osmond, M. (1998) *The Atlas of Chick Development*. Academic, San Diego, CA.
12. Eyal-Giladi, H. and Kochav, S. (1976) From cleavage to primitive streak formation: a complementary normal table and a new look at the stages of the development of the chick. I. General Morphology. *Dev. Biol.* **49**, 321–337.
13. Hamburger, V. and Hamilton, H. L. (1951) A series of normal stages in the development of the chick embryo. *J. Morphol.* **88**, 49–92.
14. Hamburger, V. and Hamilton, H. L. (1992) A series of normal stages in the development of the chick embryo. *Dev. Dyn.* **195**, 231–272.
15. Hamburger, V. (1960) *A Manual of Experimental Embryology*. Revised Edition, University of Chicago Press, Chicago, IL.
16. Saunders, J. W. J. (1948) The proximo-distal sequence of origin of the parts of the chick wing and the role of the ectoderm. *J. Exp. Zool.* **108**, 363–404.
17. Summerbell, D. (1974) A quantitative analysis of the excision of the AER from the chick limb bud. *J. Embryol. Exp. Morphol.* **32**, 651–660.
18. Rowe, D. A. and Fallon, J. F. (1982) The proximodistal determination of skeletal parts in the developing chick leg. *J. Embryol. Exp. Morphol.* **68**, 1–7.
19. Todt, W. L. and Fallon, J. F. (1984) Development of the apical ectodermal ridge in the chick wing bud. *J. Embryol. Exp. Morphol.* **80**, 21–41.
20. Michaud, J. L., Lapointe, F., and Le Douarin, N. M. (1997) The dorsoventral polarity of the presumptive limb is determined by signals produced by the somites and by the lateral somatopleure. *Development* **124**, 1453–1463.
21. Rowe, D. A. and Fallon, J. F. (1981) The effect of removing posterior apical ectodermal ridge of the chick wing and leg bud on pattern formation. *J. Embryol. Exp. Morphol.* **65(Suppl.)**, 309–325.
22. Ohuchi, H., Nakagawa, T., Yamamoto, A., Araga, A., Ohata, T., Ishimaru, Y., et al. (1997) The mesenchymal factor, FGF10, initiates and maintains the outgrowth of the chick limb bud through interaction with FGF8, an apical ectodermal factor. *Development* **124**, 2235–2244.
23. Laufer, E., Dahn, R., Orozco, O. E., Yeo, C.-Y., Pisenti, J., Henrique, D., et al. (1997) Expression of Radical fringe in limb-bud ectoderm regulates apical ectodermal ridge formation. *Nature* **386**, 366–373.
24. Rodriguez-Estaban, C., Schwabe, J. W. R., De La Pena, J., Foy, B., Eshelman, B., and Izpisua-Belmonte, J. C. (1997) Radical Fringe positions the apical ectodermal ridge at the dorsal ventral boundary of the vertebrate limb. *Nature* **386**, 360–366.
25. Carrington, J. L. and Fallon, J. F. (1984) The stages of flank ectoderm capable of responding to ridge induction in the chick embryo. *J. Embryol. Exp. Morphol.* **84**, 19–34.
26. Carrington, J. L. and Fallon, J. F. (1986) Experimental manipulation leading to induction of dorsal ectodermal ridges on normal limb buds results in a phenocopy of the *Eudiplopodia* chick mutant. *Dev. Biol.* **116**, 130–137.
27. Saunders, J. W. J. and Gasseling, M. T. (1968) Ectodermal-mesenchymal interactions in the origin of limb symmetry, in *Epithelial-Mesenchymal Interactions*. Williams and Wilkins, Baltimore, MD, pp. 78–97.

28. Riddle, R. D., Johnson, R. L., Laufer, E., and Tabin, C. (1993) Sonic hedgehog mediates the polarizing activity of the ZPA. *Cell* **75**, 1401–1416.
29. Lopez-Martinez, A., Chang, D. T., Chiang, C., Porter, J. A., Ros, M. A., Simandl, B. K., et al. (1995) Limb-patterning activity and restricted posterior localization of the amino-terminal product of Sonic hedgehog cleavage. *Curr. Biol.* **5**, 791–796.
30. Tickle, C., Lee, J., and Eichele, G. (1985) A quantitative analysis of the effect of all-*trans*-retinoic acid on the pattern of chick wing development. *Dev. Biol.* **109**, 82–95.
31. Honig, L. S. and Summerbell, D. (1985) Maps of strength of positional signalling activity in the developing chick wing bud. *J. Embryol. Exp. Morphol.* **87**, 163–174.
32. Zwillling, E. (1964) Development of fragmented and dissociated limb bud mesoderm. *Dev. Biol.* **9**, 20–37.
33. Ros, M. A., Lyons, G. E., Mackem, S., and Fallon, J. F. (1994) Recombinant limbs as a model to study homeobox gene regulation during limb development. *Dev. Biol.* **166**, 59–72.
34. Crosby, G. M. and Fallon, J. F. (1975) Inhibitory effect on limb morphogenesis by cells of the polarizing zone coaggregated with pre- or postaxial wing bud mesoderm. *Dev. Biol.* **46**, 28–39.
35. Ros, M. A., Piedra, M. E., Fallon, J. F., and Hurle, J. M. (1997) Morphogenetic potential of the chick leg interdigital mesoderm when diverted from the cell death program. *Dev. Dyn.* **208**, 406–419.
36. Eichele, G., Tickle, C., and Alberts, B. M. (1984) Microcontrolled release of biologically active compounds in chick embryos: beads of 200-micron diameter for the local release of retinoids. *Anal. Biochem.* **142**, 542–555.
37. Fisher, M. and Schoenwolf, G. C. (1983) The use of early chick embryos in experimental embryology and teratology: improvements in standard procedures. *Teratology* **27**, 65–72.
38. Fernandez-Teran, M., Piedra, M. E., Simandl, B. K., Fallon, J. F., and Ros, M. A. (1997) Limb initiation and development is normal in the absence of the mesonephros. *Dev. Biol.* **189**, 246–255.
39. Errick, J. E. and Saunders, J. W., Jr. (1976) Limb outgrowth in the chick embryo induced by dissociated and reaggregated cells of the apical ectodermal ridge. *Dev. Biol.* **50**, 26–34.
40. Boutin, E. L. and Fallon, J. F. (1992) Insulin improves survival but does not maintain function of cultured chick wing bud apical ectodermal ridge. *Anat. Record* **233**, 467–477.



## Palate Development

### *In Vitro Procedures*

**M. Michele Pisano and Robert M. Greene**

#### **1. Introduction**

The mammalian secondary palate provides an excellent experimental paradigm with which to investigate regulation of the sequential expression and interaction of molecular signals during embryogenesis. The secondary palate arises as bilateral extensions of the oral aspect of the maxillary processes of the first arch. In mammalian embryos, these palatal extensions make contact, fuse with one another and give rise to the secondary palate (roof of the oral cavity) (1,2). The palatal processes, consisting of mesenchymal cells embedded in a loosely organized extracellular matrix and enclosed within a stratified epithelium, initially grow vertically on either side of the tongue. The processes subsequently undergo a series of morphogenetic movements that result in their reorientation above the tongue, thereby bringing the medial edge epithelium (MEE), on the apical surface of each process, into contact forming a midline epithelial seam. Cells of the MEE undergo a precise sequence of molecular changes that culminate in removal of the midline epithelial seam. These changes include cessation of DNA synthesis, increased synthesis of cell-surface glycoconjugates, increased synthesis of lysosomal enzymes, cell death of the peridermal (surface) cell layer, and transdifferentiation of the subjacent MEE from an epithelial to a mesenchymal phenotype. Fusion of the palatal processes, followed by peridermal cell death and transdifferentiation of the MEE and migration into the underlying mesenchyme results in formation of the definitive secondary palate (3,4).

The developing secondary palate has proven to be a valuable model system for gaining insight into molecular aspects of growth and tissue differentiation, as well as into mechanisms of reproductive toxicity. A fascinating observation is that virtually all aspects of palatal tissue differentiation that occur *in vivo* can be mimicked *in vitro*. This suggests that factors regulating palatal tissue growth and differentiation are locally derived. Accordingly, a number of *in vitro* techniques have been developed that recapitulate the *in vivo* growth and differentiation of embryonic palatal tissue. These techniques include monolayer culture of embryonic palate mesenchymal (MEPM) cells, embryonic palate suspension culture, and embryonic palate organ culture on various

substrata. Specific methodological approaches and considerations enabling utilization of these approaches are presented in this chapter.

## 2. Materials

### 2.1. Murine Embryonic Palate Mesenchymal Cell Culture (see Notes 4.1 and 4.2)

1. Solutions and media
  - a. CMF-PBS: Calcium- and magnesium-free phosphate-buffered saline (pH 7.2); Composition per liter: 0.2 g KCl, 0.2 g KH<sub>2</sub>PO<sub>4</sub>, 8.0 g NaCl, 2.16 g Na<sub>2</sub>HPO<sub>4</sub> · 7H<sub>2</sub>O. Filter to sterilize through a 0.20- $\mu$ m cellulose acetate filter and store at 4°C.
  - b. Trypsin/EDTA: Gibco-BRL (Life Technologies, Gaithersburg, MD; #25300-047). Supplied as sterile solution. Prepare 2 mL aliquots in sterile polypropylene tubes and store at -20°C. Avoid repeated freeze/thaw.
  - c. Complete culture medium: Opti-MEM™ (Gibco-BRL, #31985-070) containing 5% fetal bovine serum, 2-mM glutamine (Gibco-BRL, #25030-016), 150 U penicillin/150  $\mu$ g/mL streptomycin/0.37  $\mu$ g/mL amphotericin B (Gibco-BRL, #15240-062), 55  $\mu$ M mercaptoethanol (Gibco-BRL, #21985-023); (pH 7.2). Composition per 500 mL: 462 mL Opti-MEM™, 25 mL fetal bovine serum, 5 mL glutamine, 7.5 mL antibiotic/antimycotic solution, 0.5 mL mercaptoethanol solution. Add components, adjust pH to 7.2, and filter sterilize through a 0.2- $\mu$ m low-protein binding cellulose acetate filter. The complete medium is stable for 1 wk when stored at 4°C in the dark.
2. Sterile dissecting instruments: Dissecting instruments are available from various suppliers of surgical instruments. The following catalog numbers from Roboz Surgical Instrument Co. (Rockville, MD) is provided for illustrative purposes.
  - Microdissecting scissors (#RS-5980).
  - Operating scissors (#RS-6814).
  - Dressing forceps (#RS-8106).
  - Two microforceps (#RS-5045).
  - A #3 scalpel handle (#RS-9843) with #11 scalpel blade.
  - Spring vannas scissors (#RS-5610).
3. Miscellaneous materials
  - Microspatula (VWR Scientific; Bridgeport, NJ, #57949-000).
  - Two sterile rubber stoppers (55 mm diameter).
  - Sterile glass screw cap culture tube (12 × 100 mm).
  - Sterile, disposable 50 mL conical polypropylene tube.
  - Sterile, disposable 100 mm Petri dishes.
  - Sterile glass Pasteur pipets.
  - Sterile, disposable 35 mm or 60 mm tissue culture dishes.
  - Hemocytometer (Hausser Scientific Improved Neubauer Phase Hemocytometer—0.1 mm deep [Fisher Scientific, St. Louis, MO]).
  - CO<sub>2</sub> gas tank.

### 2.2. Murine Embryonic Palate Suspension Culture (see Notes 4.1 and 4.3)

1. Solutions and media
  - a. CMF-PBS: Calcium- and magnesium-free PBS (pH 7.2); composition per liter: 0.2 g KCl, 0.2 g KH<sub>2</sub>PO<sub>4</sub>, 8.0 g NaCl, 2.16 g Na<sub>2</sub>HPO<sub>4</sub> · 7H<sub>2</sub>O. Filter sterilized through a 0.20- $\mu$ m cellulose acetate filter and store at 4°C.
  - b. Complete suspension culture medium: DME/F12 (Sigma Chemical Co., St. Louis, MO, #D-8900) containing 2 mM glutamine (Gibco-BRL, #25030-016), 150 U penicillin/150  $\mu$ g/mL streptomycin/0.37  $\mu$ g/mL amphotericin B (Gibco-BRL, #15240-062); (pH 7.2).

Composition per 500 mL: 487.5 mL DME/F12, 5 mL glutamine, 7.5 mL antibiotic/antimycotic solution. Prepare DME/F12 according to package directions, add components, adjust pH to 7.2, and filter sterilized 0.2- $\mu$ m low-protein binding cellulose acetate filter. The complete suspension culture medium is stable for 1 wk when stored at 4°C in the dark.

2. Sterile dissecting instruments: See list of dissecting instruments itemized in **Subheading 2.1**.
3. Miscellaneous materials
  - Microspatula (VWR Scientific; Bridgeport, NJ, #57949-000).
  - Sterile rubber stopper (55 mm diameter).
  - Sterile, disposable 50 mL conical polypropylene tube.
  - Sterile, disposable 100 mm Petri dishes.
  - Sterile glass Pasteur pipets.
  - Sterile polypropylene vials with caps (VWR Scientific), #16465–262).
  - Aliquot mixer/rocker plate.
  - Mixed gas tank: 50% O<sub>2</sub>, 5% CO<sub>2</sub>, 45% N<sub>2</sub>.

### **2.3. Murine Embryonic Palate Organ Culture on Collagen Gels (see Notes 4.1 and 4.4)**

1. Solutions and media
  - a. CMF-PBS: Calcium- and magnesium-free PBS (pH 7.2); Composition per liter: 0.2 g KCl, 0.2 g KH<sub>2</sub>PO<sub>4</sub>, 8.0 g NaCl, 2.16 g Na<sub>2</sub>HPO<sub>4</sub> · 7H<sub>2</sub>O. Filter sterilized through a 0.20- $\mu$ m cellulose acetate filter and store at 4°C.
  - b. Vitrogen 100 Collagen: (Collagen Corp., Palo Alto, CA). Supplied as a sterile, ready to use solution. Prepare small aliquots in sterile polypropylene tubes and store at 4°C.
  - c. DME/F12 Medium (10 $\times$ ): (Sigma, #D-8900). Prepare a 10 $\times$  *stock* by dissolving powdered medium in approx 80 mL deionized water. Add 1.2 g sodium bicarbonate. Adjust volume to 100 mL with deionized water, filter sterilize through a 0.20- $\mu$ m cellulose acetate filter and store at 4°C.
  - d. Sodium pyruvate: (Gibco-BRL, #890-1840). Prepare a 100-mM stock solution (11 mg/mL) in deionized water and filter sterilize through a 0.20- $\mu$ m cellulose acetate filter. Prepare small aliquots in sterile polypropylene tubes and store at –20°C.
  - e. Glutamine: (Gibco-BRL, #25030-016). Supplied as a 200-mM sterile solution.
  - f. Antibiotic/antimycotic solution: (Gibco-BRL, #15240-062). Supplied as a sterile solution containing 10,000 U penicillin, 10,000  $\mu$ g/mL streptomycin, and 25  $\mu$ g/mL amphotericin B.
  - g. Complete organ culture medium (1 $\times$ ): DME/F12 containing 2 mM glutamine, 1 mM pyruvate, 100 U penicillin/100  $\mu$ g/mL streptomycin/0.25  $\mu$ g/mL B; (pH 7.2). Composition per 100 mL: 96.5 mL DME/F12 (1 $\times$ ), 1 mL glutamine, 1 mL pyruvate, 1.5 mL antibiotic/antimycotic solution. Prepare 10 $\times$  stock of DME/F12 as described in step g, *dilute* to 1 $\times$  with deionized water, adjust pH to 7.2, and filter sterilize through a 0.2- $\mu$ m low-protein binding cellulose acetate filter. Complete organ culture medium (1 $\times$ ) is stable for 1 wk when stored at 4°C in the dark.
  - h. Complete organ culture medium (10 $\times$ ) for preparation of collagen gels: DME/F12 containing 20 mM glutamine, 10 mM pyruvate, 1000 U penicillin/1000  $\mu$ g/mL streptomycin/2.5  $\mu$ g/mL amphotericin B; (pH 7.2). Composition per 100 mL: 65 mL DME/F12 (10 $\times$ ), 10 mL glutamine, 10 mL pyruvate, 15 mL antibiotic/antimycotic solution. Prepare 10 $\times$  stock of DME/F12 as described immediately above, add components, adjust pH to 7.2, and filter sterilize through a 0.2  $\mu$ m low-protein binding cellulose acetate filter. Complete organ culture medium (10 $\times$ ) is stable for 1 wk when stored at 4°C in the dark.

2. Sterile dissecting instruments: See list of dissecting instruments itemized in **Subheading 2.1**.
3. Miscellaneous materials
  - Microspatula (VWR Scientific, Bridgeport, NJ, #57949-000).
  - Sterile rubber stopper (55 mm diameter).
  - Sterile, disposable 50 mL conical polypropylene tube.
  - Sterile, disposable 100 mm Petri dishes.
  - Sterile glass Pasteur pipets.
  - Sterile, disposable 35 mm tissue culture dishes or 24-well multiwell culture plates.
  - 0.1 *N* NaOH.
  - Sterile Q-tip cotton swabs.
  - Sterile toothpicks.
  - CO<sub>2</sub> gas tank.

### 3. Methods

#### 3.1. Murine Embryonic Palate Mesenchymal Cell Culture (see Notes 4.1 and 4.2)

1. Collection of murine embryos: Embryos are harvested from pregnant mice of appropriate gestational age as follows. Euthanize the pregnant mouse, sterilize the abdominal area with 70% ethanol and exteriorize the gravid uterus through an incision in the lower abdomen. Remove the intact uterus and place in a 100-mm Petri dish containing sterile CMF-PBS on ice. Using small scissors with the points angled upward, cut through the uterine musculature along its entire length exposing the embryo/placental units. With the two watchmakers forceps, tear the extraembryonic membranes and expose the embryos. Release individual embryos from their umbilical cord and remove them to a separate Petri dish of sterile CMF-PBS on ice.
2. Dissection of murine embryonic palatal tissue: Secondary palatal shelves are dissected from the harvested embryos with the aid of a dissecting stereo microscope containing overhead illumination of a sterile rubber stopper on the stage. Using a watchmaker forceps, place an individual embryo on the sterile rubber stopper and adjust the magnification and illumination. With a #11 scalpel blade, cut through the neck to separate the head of the embryo from the body. Remove the body to sterile, cold CMF-PBS, for possible utilization in other protocols. Make a second horizontal incision above the maxilla, but below the level of the eyes, and remove/discard the developing cranial tissue. Lay the remaining piece of tissue down such that the maxillary side is toward the rubber stopper and the mandible is facing upward. With the scalpel, remove/discard the posterior third of the head. Using the spring vannas scissors with points angled upward, make a cut through the angle of the mouth on both sides of the developing oral cavity and remove/discard the mandible and tongue. With the aid of the scalpel, trim away all remaining maxillary, nasal, and neural tissue, as well as the primary palate, leaving only the intact secondary palatal shelves. As each palatal tissue sample is dissected and collected, transfer it, using the microspatula, to a sterile 50-mL conical polypropylene tube containing a large volume of CMF-PBS, on ice.
3. Enzymatic dissociation of embryonic palatal tissue: Continue to dissect and pool secondary palatal tissue from all of the embryos as just described. When complete, allow the palates to settle to the bottom of the tube and, using a glass Pasteur pipet, aspirate off most of the buffer. Gently transfer the palates to a *fresh*, sterile rubber stopper and finely mince the tissue with a #11 scalpel blade. Transfer the minced tissue to a sterile glass screw cap culture tube containing 2 mL of CMF-PBS. Add an equal volume (2 mL) of trypsin/EDTA solution. Incubate in a 37°C water bath for 10 min, with gentle shaking, to dissociate cells. Terminate the digest with an equal volume (4 mL) of cold, complete medium and disperse

any remaining clumps by repetitive pipeting with a Pasteur pipet. Pellet the cells by centrifugation at 75g for 15 min at 4°C. After centrifugation of the sample, remove and discard the supernatant and gently resuspend the cell pellet in a *known* volume of cold, complete medium. Maintain cell suspension on ice until plating.

4. Determination of cell number and preparation of cells for plating: Count an aliquot of the cell suspension using a hemocytometer and calculate total cell number. Dilute cells, as necessary, with an appropriate volume of complete medium to adjust the final cell density of the cell suspension to  $2.0 \times 10^5$  cells/mL of medium. Plate 1.0 mL into 35 mm tissue culture dishes (2.6 mL into 60 mm tissue culture dishes) in order to achieve a final plating density of  $2.5 \times 10^4$  cells/cm<sup>2</sup>.
5. Maintenance of cell cultures: Incubate cell cultures at 37°C in a humidified atmosphere of 5% CO<sub>2</sub>/95% air. Change the medium the day after establishing the cultures and every 2 days thereafter.

### **3.2. Murine Embryonic Palate Suspension Culture** (see Notes 4.1 and 4.3)

1. Collection of murine embryos: Embryos are harvested from pregnant mice as detailed in **Subheading 2.1.**
2. Dissection of murine embryonic palatal tissue: Secondary palatal shelves for suspension culture are dissected from the harvested embryos as described in **Subheading 2.1.**, and pooled in a 50-mL polypropylene tube containing sterile CMF-PBS, on ice.
3. Preparation of the suspension cultures: Prior to initiating individual cultures, add 1.5 mL of complete suspension culture medium to each culture vial. Gently “gas” the medium in each vial with a sterile Pasteur pipet, quickly cap, and place the culture vials on a rocker plate in a 37°C incubator and allow the temperature and gas content of the medium to equilibrate for 30 min *prior to* adding tissue. Depending on the intended experimental design, transfer single or multiple palates to each vial using the microspatula (*see Notes*). Quickly recap and return vials to the incubator.
4. Maintenance of suspension cultures: Incubate suspension cultures at 37°C with gentle rocking. Change the medium daily. Flush vials with gas mixture at each medium change.

### **3.3. Murine Embryonic Palate Organ Culture on Collagen Gels** (see Notes 4.1 and 4.4)

1. Preparation of collagen substrate gels: For 10 mL of collagen substrate solution, combine 5.5 mL Vitrogen 100™ collagen (Collagen Corp., Palo Alto, CA), 1.0 mL sterile 0.1 N NaOH, 1.0 mL sterile 10X complete organ culture medium and 2.5 mL sterile deionized water. Pipet gel solution into 35-mm culture dishes (approx 2 mL) or individual wells of a 24-well multiwell culture plate (approx 1.5 mL). Incubate dishes/plates in a 37°C oven for a minimum of 60 min in order for the collagen substrate gels to harden.
2. Collection of murine embryos: Embryos are harvested from pregnant mice as detailed in **Subheading 2.1.**
3. Dissection of murine embryonic palatal tissue: Secondary palatal shelves for organ culture are dissected from the harvested embryos as described in **Subheading 2.1.**, and pooled in a 50-mL polypropylene tube containing sterile CMF-PBS on ice.
4. Establishment of organ cultures: Place a 100 µL drop of 1× complete organ culture medium on the surface of each collagen gel. Using a sterile microspatula, gently place an individual palatal shelf on the drop of medium allowing the tissue to float onto the medium. Carefully remove excess medium with a Pasteur pipet or by wicking away the fluid with a sterile cotton swab, allowing the palatal shelves to settle directly onto the collagen gel. Place the organ cultures in a 37°C incubator with a humidified atmosphere of 5% CO<sub>2</sub>/95% air for 3 h in order to facilitate adhesion of the palatal shelves to the collagen gels. Remove

cultures from the incubator and gently add 1 mL of 1× complete organ culture medium being careful not to dislodge the palatal shelves from the gel.

5. Maintenance of organ cultures: Incubate embryonic palate organ cultures at 37°C in a humidified atmosphere of 5% CO<sub>2</sub>/95% air. Change the medium daily.
6. Termination of organ cultures: Aspirate most of the medium from the cultures, carefully lift palates from the collagen gel with a sterile toothpick, and process as directed by the intended experimental design.

## 4. Notes

### 4.1. General Notes

1. As with any cell/tissue culture methodology, all steps in the above protocols should be performed under sterile conditions in a laminar flow hood or equivalent unit.
2. Opti-MEM™, DME/F12, glutamine, pyruvate, and antibiotic/antimycotic solutions are light-sensitive and should not be stored in a glass-door refrigerator unless the bottles are foil wrapped.
3. Glutamine, pyruvate, trypsin/EDTA, and the antibiotic/antimycotic solution can be purchased from various suppliers of cell/tissue culture products in both liquid or lyophilized forms. Opti-MEM™ is available from Gibco-BRL in liquid and powder forms. Lyophilized versions of media and media components are significantly more economical.
4. In order to expedite routine preparation of medium for the above protocols, aliquots containing a mixture of medium “additives” (heat-inactivated serum, glutamine, pyruvate, and antibiotic/antimycotic) can be prepared in volumes necessary to make 100, 250, or 500 mL of complete medium and stored at –20°C. Avoid repeated freeze/thaw.
5. Dissection of embryonic palatal tissue on a sterile rubber stopper with overhead illumination of the sample (in lieu of tissue in a culture dish of buffer illuminated from below) provides greater ease of visualization and handling of the tissue.
6. All changes of medium should be conducted with medium prewarmed to 37°C.

### 4.2. Murine Embryonic Palate Mesenchymal Cell Culture

1. The culture conditions detailed in **Subheading 2.1.** facilitate the growth of embryonic palate mesenchymal cells, but not that of palate epithelial cells.
2. Fetal bovine serum differs in its “biological activity” depending on the supplier and/or lot. Therefore, in order to achieve the greatest cell viability and cell growth kinetics, it is best to test serum from various suppliers/lots. This can be accomplished by establishing growth curves for embryonic palate mesenchymal cells grown under the foregoing-detailed conditions using media prepared with different sources and lots of serum. When planning to employ this culture protocol for a discrete set of studies over the long-term, sera should be purchased in bulk from the same lot and stored in usable aliquots at –20°C. Little decline has been detected in the “quality” of serum stored under these conditions for up to one year.
3. Serum should be heat inactivated prior to use to deactivate endogenous proteases. It can be purchased as such, or can be heat inactivated prior to use by incubating in a shaking water bath at 55°C for 30 min.
4. Caution regarding mercaptoethanol: The mercaptoethanol used in the preparation of the complete culture medium is *not* concentrated mercaptoethanol, but rather a special diluted, tissue culture grade solution, available from Gibco-BRL.
5. During the trypsin digestion and cell dissociation, large clumps of tissue can be dissociated mechanically by *gentle* repetitive pipeting with a sterile Pasteur pipet. Avoid harsh pipeting, which generally results in the rupturing of cells and the release of DNA/RNA. The presence of excess ruptured cells is generally evident by a viscous nucleic acid mate-

rial which tends to entrap tissue fragments and cells and ultimately results in decreased cell yields.

6. The volume of complete culture medium used to resuspend the cell pellet must be determined empirically, as this will vary depending on the number of embryonic palatal shelves that were pooled for digestion.
7. Use of the hemocytometer:
  - Count the number of cells in the center grid and four corner grids of the hemocytometer, and determine the *average cell number/grid*. The sample of cell suspension should be sufficiently dilute to yield a readily and reproducibly countable number of cells per grid.
  - Multiply the average cell number/grid by 10,000 to obtain the *number of cells/mL*.
  - Multiply the number of cells/mL by the number of milliliters of complete medium in which the cells are suspended, to obtain the *total number of cells*.
8. Plating density should also be established empirically depending on the experimental design and intended use of the cell cultures. Cultures intended for examination of cell-growth kinetics should be established at lower densities in order to examine lag and early log phases of growth.

#### **4.3. Murine Embryonic Palate Suspension Culture**

1. Palatal shelf *pairs* from an individual embryo can be dissected and maintained in a single microfuge tube with CMF-PBS on ice until initiating the suspension cultures. Individual shelves from each pair can then be placed into separate vials and maintained as a “matched pair” for control and experimental purposes.
2. For RNA and protein analyses via northern and western blotting, it may be necessary to pool palatal shelves from an entire litter for each treatment (one palatal shelf from each embryo placed into a vial containing *control* medium and the other palatal shelf from each embryo placed into a vial containing *treatment* medium).

#### **4.4. Murine Embryonic Palate Organ Culture on Collagen Gels**

1. Palatal shelf *pairs* from an individual embryo can be dissected and maintained in a single microfuge tube with CMF-PBS on ice until initiating the organ cultures. Individual shelves from each pair can then be placed into separate vials and maintained as a “matched pair” for control and experimental purposes.
2. For RNA and protein analyses via Northern and Western blotting, it may be necessary to pool palatal shelves from an entire litter for each treatment (one palatal shelf from each embryo placed into a vial containing control medium and the other palatal shelf from each embryo placed into a vial containing *treatment* medium).
3. Vitrogen 100 collagen is light sensitive. In order to maintain sterility and minimize exposure to light and temperature fluctuations, prepare small aliquots in sterile polypropylene tubes and store at 4°C.
4. For best results in preparing the collagen gel substrates, keep all solutions, including the Vitrogen 100 collagen, on ice while preparing the gels.
5. Prepare collagen substrate gels in a 37°C incubator *without* CO<sub>2</sub>.
6. Vitrogen 100 collagen varies slightly from lot to lot. Adjust concentration of collagen solution to 17 mg of collagen per 10 mL of gel solution.
7. Collagen substrate gels can be prepared a day ahead and maintained in a 37°C tissue culture incubator.
8. Collagen substrate gels are extremely fragile and light sensitive. Minimize excessive handling and exposure to light.

9. Depending on the intended experimental design, several palatal shelves can be cultured on the same collagen gel
10. Palatal shelves that do not attach to the collagen gels, or those that detach during media changes are discarded from the experiment.

### Acknowledgments

This work is supported in part by NIH grants DE12363 and DE12115 to M.M.P. and NIH grants DE05550 and DE12858 to R.M.G.

### References

1. Moore, K. L. and Persaud, T. V. N. (1993) *The Developing Human Fifth Edition: Clinically Oriented Embryology*, W. B. Saunders, Philadelphia, PA.
2. Greene, R. M. and Weston, W. M. (1994) Craniofacial embryology, in *Mastery of Plastic and Reconstructive Surgery* (Cohen, M., ed.), Little, Brown, Boston, MA, pp. 459–470.
3. Greene, R. M., Linask, K. K., Pisano, M. M., Weston, W. M., and Lloyd, M. R. (1991) Transmembrane and intracellular signal transduction during palatal ontogeny. *J. Craniofac. Genet. Dev. Biol.* **11**, 262–276.
4. Greene, R. M., Weston, W., Nugent, P., Potchinsky, M., and Pisano, M. (1998) Signal transduction pathways as targets for induced embryotoxicity, in *Handbook of Developmental Neurotoxicology* (Slikker, W. and Chang, L., eds.), Academic, San Diego, CA, pp. 119–139.



## In Vitro Fertilization

Susan Heyner and Michael J. Tucker

### 1. Overview

Almost 20 years ago, the first successful in vitro fertilization (IVF) and embryo transfer (ET) was described by Steptoe and Edwards (1). This engendered a great deal of excitement and in hindsight, we can say that it marked the movement of reproductive medicine for the treatment of infertility from the operating room into the laboratory. The first successful IVF pregnancy was achieved in a woman with blocked fallopian tubes, and consequently, IVF-ET was viewed initially as a treatment for tubal obstruction. Within a short time, these techniques were adopted for the treatment of infertility of unknown origin, for severe male factor infertility, endometriosis, and immunological infertility. More recently, these boundaries have been enlarged to include treatment of women with premature ovarian failure and postmenopausal patients using donated oocytes. In addition, azoospermic men have been successfully treated, and in conjunction with preimplantation diagnosis, IVF has been applied to couples in which a severe genetic defect may be eliminated by screening embryos before transfer to the uterus.

The endocrine management of the patient is crucially important to a successful outcome. It is beyond the scope of this chapter to describe this aspect, and the reader is referred to a recent review (2). In this chapter, we will provide a theoretical background, as well as practical guidelines for laboratory management of human IVF-ET. Gamete-intrafallopian transfer (GIFT) was widely practiced until the introduction of successful intracytoplasmic sperm injection (ICSI) protocols. The drawback to the GIFT procedure, which was used primarily for unexplained infertility and mild male factor patients, is that because the gametes are transferred to the reproductive tract, there is no feedback for fertilization, whereas ICSI provides this information. Consequently, we do not discuss GIFT.

The major procedures carried out in the IVF laboratory consist of the following: oocyte retrieval (pickup) and assessment of maturity, preparation and evaluation of semen, micromanipulation of oocytes, culture of oocytes plus sperm “insemination,” cumulus and corona cell removal and evaluation of fertilization, culture of zygotes, evaluation and transfer of cleavage stage embryos, and cryopreservation of human zygotes and/or embryos. In addition, the laboratory personnel bear the responsibility

for quality control procedures for every aspect of the laboratory. It is clearly beyond the scope of this chapter to compile a handbook of IVF procedures. Therefore, we discuss theoretical considerations for each major procedure, provide practical guidelines, and refer the reader to other published procedures or reviews. The procedures that follow are only one approach to methods used in the IVF laboratory. There are many successful programs that use protocols that differ to some degree from those described later see (3,4). In the Appendix, we indicate some of the media that may be used for IVF, and some of the major sources for materials.

## 2. Oocyte Retrieval

The maturational status of the oocyte at the time of retrieval is acknowledged to be a predictor of success in achieving high-quality cleavage stage embryos. Oocyte quality frequently is a reflection of the ovarian stimulation protocol, and it is therefore important to record oocyte quality at the time of retrieval. Oocytes are classified as a. mature, metaphase II, possessing a first polar body and no germinal vesicle b. immature, metaphase I with no polar body or germinal vesicle, and immature prophase I, with germinal vesicle, c. postmature exhibiting darkened cytoplasm and clumped coronal cells, and d. degenerating or atretic oocytes possessing very dark and clumped ooplasm. The evaluation of oocyte maturity has been discussed in detail by Veeck (5,6) who has provided valuable photographic examples, as well as a description of the lab procedures she has used. Immature oocytes may be *in vitro* matured (IVM) for 12–48 h using modified culture conditions (7), but extremely low fertilization rates are obtained with conventional IVF; intracytoplasmic sperm injection (ICSI) has been reported to be more successful (8), though the competence of such immature eggs even after successful IVM and ICSI remains poor.

### 2.1. Introduction

Women undergoing ART procedures are treated with hormonal regimes that induce supernumerary follicles in each ovary. Cumulus-oocyte complexes (COC's) are retrieved from fluids that are flushed from follicles visualized by a clinician by means of ultrasound. The laboratory personnel pick up the COC's from the aspirated fluids and after appropriate washing procedures, place each in an individual drop of culture medium prior to adding an aliquot of the partner's spermatozoa. At the time of oocyte retrieval, the clinician(s) will provide the laboratory with fluids that have been aspirated from the follicles. It is critical that pH and temperature be maintained while the fluids are examined for the presence of an oocyte, and while the oocyte(s) is evaluated for maturational status or micromanipulated. This procedure is used for patients who have been unable to conceive after one year of unprotected intercourse, and for whom all other conventional methods of fertility enhancement, e.g., artificial insemination, have failed.

### 2.2. Materials

1. Pasteur pipets 9" (VWR Scientific, West Chester, PA, #14673-043).
2. Manual pipeters.
3. 100 mm Petri dishes (Falcon, Los Angeles, CA, #1029).
4. Tuberculin syringes (Air-Tite Products Co., Virginia Beach, VA, #TS1) equipped with 23 gage needle (B-D 309623).

5. Slide warmer covered with a sterile drape.
6. Dissecting microscope in sterile hood.
7. Heated (37°C) tube warmer block.
8. Prepared organ culture (Falcon cat. #3037; optional, see later) and Nalge Nunc 60 mm dish (Nalge Nunc International, Rochester, NY, #150326) with droplets of medium under mineral oil, or Nalge Nunc 4-well dishes (Nalge Nunc #9383-L20) with droplets under oil. Dishes in incubator (*see* Appendix for dish preparation).
9. Instrument wash and follicle flush (*see* Appendix for media).
10. Disposable gloves (Safeskin HypoClean Powder-Free Latex exam gloves, Fisher Scientific, Pittsburgh, PA, #113901B).

Inverted microscope equipped with Hoffman differential optics/Nomarski interference contrast optics.

**Note:** The laboratory requires subdued lighting, and the room temperature between 75–80°F. All equipment checks are carried out first thing in the morning and the results recorded. Laboratory personnel are in surgical attire, wearing scrubs, mask, head cover and shoe covers. Before the procedure, hands are washed thoroughly. Make sure that patient name and number are taped to the outer and inner doors of the appropriate incubator, and that all dishes have patient name and number; patients can be color coded.

### 2.3. Methods

1. Aseptic working conditions—wipe all areas down with 70% ethanol. Place sterile drape over slide warmer where instruments will be placed.
2. Give prewarmed instrument wash and follicle flush fluid to nurse. Have additional follicle fluid warming in incubator in case it is needed.
3. 100 mm Petri dishes should be in the hood.
4. Place 1 mL tuberculin syringe and Pasteur pipet and holder on the sterile barrier-covered warming tray.
5. Nurse will deliver aspirate in 15-mL tubes (Falcon #2099) to heating block in laboratory window. Tubes should not remain in block for more than 3 min.
6. Empty each follicular aspirate into a large Petri dish. Examine each under the dissecting microscope using a syringe equipped with a 23-gage needle, or Pasteur pipet to draw cumulus clumps/cells to the edge of the liquid for closer examination as necessary.
7. When an oocyte is found, record on patient form, quickly assess for maturity and transfer the oocyte to the culture dish taken from the incubator. After all the oocytes have been retrieved, thoroughly rinse with insemination media. It is most important to remove any red blood cells. As needed, dissect away up to 90% of the cumulus before placing one oocyte per microdrop in each Nalge Nunc well or droplet of medium.

**Note:** Dissection may be performed in the organ culture dish if preferred.

8. Grade the oocytes (under the high power scope) according to visible characteristics. These include appearance, amount of cumulus, the tightness of the corona layer and the appearance of the cytoplasm, where this is possible.
9. If an oocyte appears to be immature, it may be cultured for 24 h or more prior to attempting fertilization by means of ICSI.
10. Mature oocytes have sperm added 2–6 h postretrieval.

**Note:** The time from placing an aspirate in a Petri dish for examination to placing the oocyte in the culture dish should not exceed 5 min, and should preferably be less.

## 2.4. Criteria for Oocyte Maturity

1. Examine the cumulus cells: are they fluffy, intermediate or sparse?
2. Are the corona cells well radiated, or tight?
3. Is the oocyte cytoplasm (when it is possible to visualize) clear or granular, light or dark?
4. Without excessive handling, evaluate the oocyte as immature, mature, or postmature, based on appearance of cumulus and corona cells as well as the oocyte cytoplasm.

**Note:** the physician is informed immediately if the oocytes appear to be of poor quality.

## 3. Semen Collection and Analysis

### 3.1. Introduction

Accurate semen analysis (SA) is a crucially important component of the assisted reproductive technologies (ART) laboratory. IVF patients have at least one complete semen analysis carried out before oocyte retrieval. This allows the IVF team to plan for special sperm washing procedures should the sample be abnormal. The semen analysis provides objective information on the qualitative and quantitative aspects of sperm movement, and an objective measure of the sperm numbers.

Any comprehensive infertility investigation undertaken for a couple unable to establish a pregnancy after one year of normal, unprotected intercourse should begin with a complete SA. The most accurate evaluation of seminal fluid is made by considering the results of two or more SA's over a reasonable period of time (e.g., several weeks). A semen analysis is always indicated when the fertility of the male is in question. Because the current thinking in the field of infertility is to consider the male and female as a reproductive unit rather than as individuals, it is important to examine semen even if the wife/partner has obvious, treatable fertility problems. This is done in order to allow the clinician to optimize the fertility potential of both partners. The male partner will have provided a semen sample that had a thorough evaluation performed by the andrology component some weeks prior to oocyte retrieval. In the case of a questionable initial sample, the semen analysis should be repeated at least once. On the day of the IVF procedure, where possible, obtain the sperm sample first, to obviate unnecessary oocyte collection if sperm cannot be obtained. Media used for semen processing vary from laboratory to laboratory. Commonly used media include Ham's F-10, human tubal fluid (HTF), and Gamete 100; a list of media and suppliers is provided in the Appendix. All media contain a protein source, commonly 0.3% bovine serum albumin (BSA) or human serum albumin (HSA). Methods for carrying out a semen analysis have been described elsewhere in detail (9,10).

### 3.2. Note

The following guidelines must be followed to ensure accuracy of semen analysis results.

1. The male partner is instructed to refrain from sexual activity (i.e., ejaculation) for at least 48 h prior to submitting semen to the lab for analysis. A period of sexual abstinence helps to ensure that sperm count, motility, and viability are maximized in the analyzed specimen.
2. The only acceptable method of specimen collection for an SA is masturbation. Specimens collected following coitus interruptus (i.e., withdrawal) should not be analyzed because this method does not provide a reliable, representative sample. The specimen may become contaminated and/or there may be loss of the first portion of the ejaculate, which contains the highest concentration of spermatozoa.

### 3.3. Method for Collection

1. The patient must masturbate into a sterile, plastic specimen container. Rubber stoppers or condoms are not acceptable because they may interfere with the viability of the spermatozoa. Use of a seminal collection device (nonspermatotoxic condom) may be used if absolutely necessary, but is not favored for optimal recovery of viable sperm. Containers of the following specifications are provided for by this lab for this purpose: Falcon 4.5 oz. disposable polypropylene, screw-cap container (Fisher Scientific, #0553851). Patients collecting the specimen at home and who are unable to obtain the proper container from the lab in advance, must purchase a sterile, plastic container from their local pharmacy.
2. The patient/sperm donor must be instructed to collect the entire specimen, not just a portion of it.
3. Commercial lubricating gels must not be used as an aid in masturbation because they have been found to be detrimental to sperm quality. If some type of lubricant is absolutely necessary a special medium will be provided that is not harmful to the sample. This medium, formulated in the laboratory, consists of: 50% (v/v) glycerol in modified HTF; mineral oil may also be used.
4. All patients and donors must collect the specimen on the clinic/hospital premises in private rooms provided for this purpose. The patient is provided with a specimen cup and directed to the collection room. After collection, he hands the container to a nurse in the IVF suite, who will sign to acknowledge receipt as well as verify the patient identification. The nurse will then deliver the specimen to the IVF laboratory. This rule is made to ensure that the sample is as fresh as possible when analyzed. For some men, there may be psychological factors that preclude specimen collection away from home. In these few cases, advice is given to deliver the specimen to the lab as soon as possible after collection. If this situation occurs during cold weather the specimen must be carried in an insulated container during transit in order to avoid temperature extremes (semen should not fall below 20°C or rise above 40°C during the interval between ejaculation and analysis). Patients should be warned against storing semen in a home refrigerator prior to delivery.
5. Semen must be placed at room temperature immediately after collection and stored there until analyzed. Specimen containers must be labeled with the patient's full name, date and time of collection, spillage or not, initials of person receiving the sample, name of physician requesting analysis, and number of days abstinence. The technician must record both the time that the sample was received in the lab and time of analysis on the results form.
6. Semen must be allowed to liquefy at room temperature for approx 30 min. Before complete liquefaction, the sample cannot be pipeted, well mixed, or properly analyzed. For accurate and reliable results, semen should be evaluated within one hour after collection.
7. Following liquefaction, semen is transferred to a sterile, plastic 15 mL conical tube using a Pasteur pipet. Aliquots are removed for analysis after measuring total volume and mixing gently.

### 3.4. Materials and Method for Analysis

#### 3.4.1. Materials

1. Screw-top, polypropylene 4.5 oz sterile specimen container (Falcon #4010).
2. Sterile Pasteur pipets, 5 3/4 in or 9 in (Fisher Scientific, #13-678-20A or C).
3. Disposable gloves (Safeskin HypoClean Powder-Free Latex exam gloves; Fisher Scientific, #113901B).
4. 15 mL sterile, graduated conical test tubes (Falcon #2099).
5. Gilson Pipetman (p20, p200, p1000) (Rainin Instrument Corp.).
6. Sterile micropipet tips (Scientific Accessory, #05110, 1-100  $\mu$ L, #05116, (100-1000  $\mu$ L).
7. Phase-contrast microscope with 10 $\times$ , 40 $\times$ , and 100 $\times$  objectives.

8. Eight-key laboratory counter (Clay Adams, Parsippany, NJ).
9. Slide warmer (37°C).
10. Makler counting chamber (Zygotek Systems, Springfield, MA).
11. Swim-up medium (SWM; *see* Appendix).

### 3.4.2. Method

1. Wear gloves for protection, and observe biohazard regulations. **Note:** Centrifuge tubes must be capped when spun in centrifuge.
2. Semen is collected in a sterile specimen cup and is allowed to liquefy for approx 30 min before processing begins.
3. Pour into 15-mL conical centrifuge tube labeled with patient name and I.D. number, and note volume on patient form. If volume is more than 3 mL, divide into two tubes.
4. Place 5  $\mu$ L of semen on a Makler chamber (Pharmakopius International Inc., Research Triangle Park, NC) and place glass cover on top of drop. Examine under a magnification of 100 $\times$ . The weight of the coverslip spreads the sample for optimum viewing. The freshly made wet preparation is left to stabilize for approx 1 min. Assessment of motility is made as close to 37°C as possible. Count three strips of 10 grids and take average. This will be sperm count  $\times 10^6$ . Evaluate the percentage of motility (count 100 sperm) and progression (how well sperm is traveling forward). (1 = worst, 4 = best).
5. Add (sterilely) 2 $\times$  specimen volume of SWM to the 15-mL conical centrifuge tube. Mix well with pipet.
6. Centrifuge at about 400g for 5 min.
7. Remove supernate with sterilized glass Pasteur pipet and add 1–2 mL SWM. Mix again.
8. Centrifuge again for 5 min at 400g.
9. Filter sperm through one of the commercially available sperm gradients (*see* Appendix).
10. Repeat motility, progression and concentration analysis.
11. To determine volume needed from swim-up for adding to oocyte.

### 3.4.3. Calculations

1. Final concentration of sperm  $\times$  % motile = number of motile sperm.
2. Assume  $X \times 10^6$  total motile sperm (per mL), e.g., if you need 100,000 total. Therefore, volume needed =  $(X \times 10^6)/100,000$
3. Preincubate sperm for 1 h before insemination. Add sperm to oocytes (50,000/oocyte/mL with a normal sample, 250,000/oocyte/mL with poor sample) approx 2–6 h after retrieval. In a 50- $\mu$ L microdrop, add 5000–10,000 sperm to achieve approx 100,000–200,000/mL concentration. Remove 1 dish at a time from incubator, place under dissecting microscope. Remove lid, add appropriate volume of washed sperm with pipetman and sterile tip, injecting sperm into the drop containing the oocyte. Maximum volume of sperm added is 15  $\mu$ L. Replace lid and return dish to incubator. Use a new pipet tip for each addition of sperm. Oil overlay is used to control changes in pH and humidity. Cap remaining sperm and leave at room temperature overnight for reinsemination purposes next day. The lower temperature will delay capacitation and sperm cell aging.

For very low sperm counts:

1. Use a smaller volume (100–200  $\mu$ L) for swim-up. Alternatively, wash 3 $\times$  and then place the resuspended pellet under oil to allow sedimentation; remove motile sperm from the overlay. If there are very few sperm, use the dish lid and pick up sperm with a 15  $\mu$ m bore micropipet for use in ICSI.

In case of debris or gelatinous material in semen:

1. Let clear particulate settle to bottom of tube.
2. Take off supernatant for washing and analysis.
3. Use special wash (*see* Appendix).

For viscous samples:

1. Add 256 IU chymotrypsin (Sigma CHY-55) to 5 mL medium. Wash three times. Mix the sample several times with a sterile Pasteur pipet. *Note:* For some patients, *donor sperm* are required. *Complete documentation* of donor sperm is required. This includes the source (internal or external), donor number, and verification that the donor selection is in accord with the guidelines recommended by the American Society for Reproductive Medicine. The sample is thawed at 37°C and the total count, percent motility and forwards progression are recorded.

#### 3.4.4. Note

1. To achieve the most accurate semen analysis results, samples must be analyzed within 1 h after collection.
2. Thorough mixing of the specimen, to achieve a uniform distribution of spermatozoa is very important. Avoid vigorous mixing of the sample, as this could damage the cells.
3. Motility and viability are the most time-dependent parameters in the semen analysis; these must always be evaluated first, because they progressively deteriorate the longer the sperm remain in the seminal plasma.
4. When assessing motility on the wet mount, it is essential to focus through the entire depth of a given field so as to include nonmotile sperm that have settled down into a different plane. However, use of the Makler chamber (Pharmakopius) should provide a monolayer of cells if the sperm concentration/volume used is not too high.
5. Unusual amounts of debris may result in an inaccurate sperm count. This should be noted on the report.

## 4. Corona Removal and Evaluation of Fertilization

### 4.1. Introduction

Oocytes are observed for evidence of fertilization between 15 and 20 h post-insemination. This step is extremely important, as only normally fertilized (two pronuclear stage) zygotes are cultured for transfer to the uterus, or cryopreserved for future cycles. Oocytes possessing more than two pronuclei may be used for quality control procedures, or discarded. Oocytes without a pronucleus should be left in the dish with motile sperm and observed for the next 48 h.

Fertilization checks are carried out the morning after oocyte retrieval; between 12 and 20 h postaddition of sperm. By this time, the cumulus mass has dispersed and is usually plated down in the dish, forming a monolayer, on which the oocyte surrounded by corona cells, sits. It is necessary to remove the corona cells so that the presence of two pronuclei, indicative of normal fertilization, may be visualized. The most common method used to remove these cells consists of drawing the oocyte into, and expelling from, a finely hand-drawn Pasteur pipet. It is important that the diameter of the pipet be approximately the same size as the oocyte; if it is smaller, excessive compression may result in zona rupture.

## 4.2. Materials

1. Finely heat-drawn micropipets.
2. Drummond manual pipeter (Drummond, Broomall, PA).
3. Inverted microscope, equipped with Hoffman modulation optics/Nomarski.
4. Culture dishes containing growth medium (GM; *see* Appendix).
5. Sterile Pasteur pipets (VWR #14673-043).

## 4.3. Method

1. Dislodge the oocyte with a Pasteur pipet, or with a fine needle.
2. The coronal cells are mechanically removed by aspirating the egg through a hand-pulled micropipet which is sized by breaking the tip with a watchmakers forceps or simply broken to a diameter of approx 150  $\mu\text{m}$ . Cleaning of the oocyte should not take more than 60 s; if so, the oocyte must be provided with an oil overlay to protect against pH and humidity changes. Before corona removal, if using watchmaker's forceps to size the pipets, dip the forceps into ethanol, and allow to air dry in the hood before use.
3. Following removal of the corona cells, the oocyte is observed (under the inverted microscope, on a heated stage, at a magnification of approx 200 $\times$ ) for the presence of pronuclei and polar bodies, and the oocytes that have been fertilized normally (presence of two pronuclei) are transferred to individual wells of four-well Nalge Nunc dishes containing growth media or 60 mm dishes containing droplets under oil. The dish(es) is then incubated at 37°C in a humid atmosphere of 5% CO<sub>2</sub> in air until the time of embryo transfer (ET).
4. If two pronuclei are not observed, the oocyte(s) may need to have additional sperm added, if there are no, or very few motile gametes in the dish. With normospermic samples, it is not usually necessary to add more sperm. Additional sperm may be either the original sperm swim-up, a washed fresh sample, or cryopreserved sperm. The original sample may be used if there is a sufficient sample, showing approx 70% of the original motility, and if the sample is within 24 h of processing. If the original sample is not suitable, a fresh sample may be used, or a previously cryopreserved back up sample. After analyzing motility and progression, recalculate needed volume if necessary. Reinsemination should not be considered when oocytes are more than 25 h postretrieval. In general, reinsemination is not productive, and rescue ICSI is now favored (**11**).
5. The number of pronuclei, polar bodies, presence of motile sperm in the dish and any remarkable features are recorded for each oocyte. Any polypronuclear oocytes are cryopreserved for subsequent use in quality control procedures, discarded, or donated for research, according to patient consent.
6. The following day (day 2), the status of each zygote is determined using the following criteria: number of blastomeres, quality of cytoplasm, and amount of blebbing. Photographic records are maintained. Similar observations are made on the day of transfer, day 3. Any oocytes that failed to fertilize are discarded; any embryos not transferred are either cryopreserved on day 3 or allowed to develop in culture for a further 2 d. At that time, blastocysts are cryopreserved and degenerate embryos are discarded and the chart so marked. Day 5 transfers are becoming more common, allowing the embryos to "select themselves" by development to the blastocyst stage. This allows the number of embryos to be transferred to be reduced, minimizing multiple implantations (**12**).

## 4.4. Note

Always use separate instruments for each patient. Speed is important in order to reduce the exposure of the oocytes to changes in pH and temperature. Therefore, all the equipment needed should be ready beforehand, with the stage warmer of the micro-



scope turned on in advance. All dishes should be labeled with patient name, number and whether the dish is IM or GM. The laboratory personnel should fill in the patient information sheet and take it to the IVF nurse's station as soon as evaluation of fertilization/development has been completed. The nurse then informs the attending physician. This report is verified at the afternoon IVF team meeting. Any abnormal results, for example, contamination are to be reported *immediately* to the attending physician and to the laboratory supervisor and director. Corrective action is then taken after these individuals have discussed appropriate measures.

## 5. Embryo Transfer

### 5.1. Introduction

The last step performed by the laboratory is to load the embryos for transfer into a catheter, so that the clinician may introduce them into the uterus under the supervision and guidance of the embryologists.

### 5.2. Materials

1. Catheter and cannula to be used for transfer (*see* Appendix).
2. Two 1 cc tuberculin syringes (Air-Tite, Virginia Beach, VA, TS1), one with needle attached and one without needle.
3. Two 35 mm plastic culture dishes (Nalge Nunc 150318).
4. Embryo transfer media (ETM; *see* Appendix).
5. Sterile gloves (Safeskin HypoClean Powder-Free Supra Latex Surgical Gloves).
6. Micropipet.
7. Nikon/Olympus IX70 inverted microscope equipped for Hoffman modulation/Nomarski optics and photography.

### 5.3. Method

1. Approximately 72 h after retrieval, embryos are transferred.
2. Before the transfer, examine all embryos for developmental stage, note cell number and examine any late-fertilized oocytes for developmental stage. Late fertilized embryos may be transferred along with the cleaved ones. All embryos are graded, photographed and all observations recorded.
3. Place sterile barrier on warming tray.
4. Remove ETM from incubator and pour approx 0.5 mL into bottom of 35 mm dish.
5. Rinse catheter 2× with warm media immediately before loading.
6. Draw ETM into a tuberculin syringe that has had the 0.2 level marked with a wax pencil without attached needle, attach to rinsed catheter, push through into discard dish. Repeat. Draw up approx 1 cm of air. Leave catheter full of media. Do not touch end of catheter or cannula with nonsterile hands.
7. Take first embryo from incubator. Pour a small amount of ETM in lid of a 35-mm dish. Transfer first embryo to the ETM using a micropipet. Be sure to visualize embryo at all times using a microscope.
8. Continue to collect embryos one at a time until all are in the ETM.
9. With tuberculin syringe plus needle, or a fire-polished glass pipet gently "push" each embryo to the bottom of the liquid as close to each other as possible.
10. Put on sterile gloves and pick up sterile catheter/cannula.
11. Holding the end of the catheter so that opening is toward embryos, draw up on the plunger of the attached syringe so that the embryos are picked up in as little media as possible (10–20  $\mu$ L).

12. Once the physician has introduced the catheter into the uterus, the embryologist will push the plunger to the end of the syringe in a slow, steady manner.
13. After approx 10 s, the physician will remove the catheter and cannula, gently rotating it carefully, to ascertain that the catheter was not kinked in the cervix. In cases of difficult ET, ultrasound guidance with a transabdominal probe may be used to guarantee the entrance of the catheter into the uterine cavity.
14. Take the catheter/cannula to the lab and examine it to ensure that all embryos have been transferred. Flush remaining media (detach syringe, draw up air, and reattach) into lid while looking in microscope. Look through any cells using the TB syringe and needle. If any embryos are found, inform physician and using a fresh catheter/cannula, repeat transfer procedure.

#### **5.4. Note**

The number of embryos to be transferred is a joint decision between lab and clinical personnel. The embryologist provides the judgment of the embryo quality, whereas the physician assesses the patient age, history, and personal inclination.

### **6. Embryo Quality**

#### **6.1. Grades Used to Assess Embryo Quality**

*Grade 1:* Embryo showing expected number of cells for time after insemination, individual blastomeres intact and symmetrical, with <10% fragmentation.

*Grade 2:* Embryo showing one of the following: slow development, asymmetrical blastomeres, extracellular debris or slight (10–25%) fragmentation.

*Grade 3:* Embryo having one or more degenerate blastomeres, but with at least half the cells intact (25–50% fragmentation).

*Grade 4:* Embryo with at least one blastomere intact. Degenerate Embryo is totally fragmented/nonviable.

**Note:** Embryos are evaluated at 24 and 48 h, respectively, following confirmation of fertilization. Intermediate grades, particularly 1.5–2.5, are also used to differentiate quality. **Figure 1** provides some examples of the foregoing.

### **7. Embryo Cryopreservation (Zygote to Six-Cell Embryo)**

#### **7.1. Introduction**

Embryo cryopreservation is a recognized adjunct to assisted reproduction, with the implantation rate of thawed embryos approaching that of fresh embryos. The underlying basis of cryopreservation is the control of molecular movement within the cell. Cells are pretreated with cryoprotectants to replace the intracellular water, thus minimizing damage from ice crystals. Most common embryo cryopreservation protocols currently use 1,2-propanediol (PrOH, a penetrating cryoprotectant, and sucrose, which is nonpenetrating. These are used in a slow-freeze/rapid-thaw manner. Survival of one-cell and early cleavage stage embryos is generally in excess of 70%. A number of clinics advocate freezing at the one-cell stage, which obviates the need to select embryos on the basis of quality; on the other hand, freezing embryos on the second or third day allows the selection of high-grade embryos, and has been shown to lead to higher pregnancy rates (**13**). The criteria determining the stage are based on the number of two-pronuclear zygotes obtained, consultation with the clinician and consideration of the patient's wishes; each case is individualized.

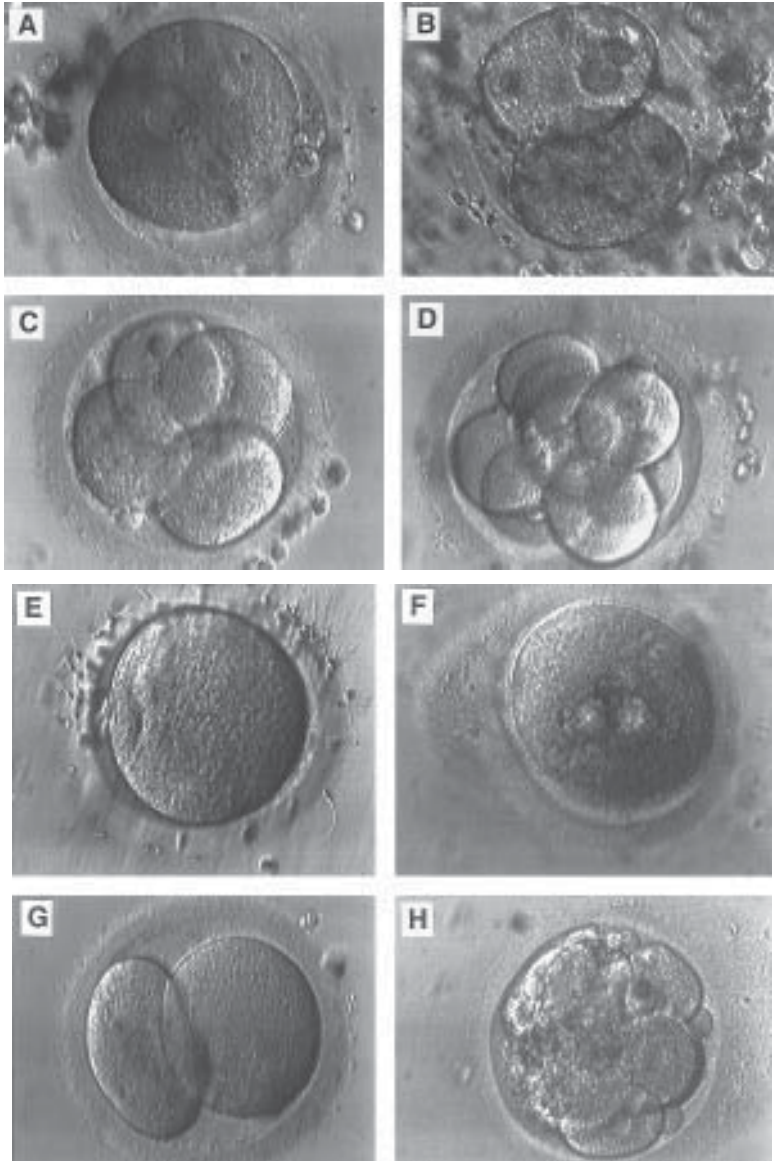

Fig. 1. (A) Normally fertilized oocyte showing two pronuclei. (B) Two-cell stage embryo with some adherent cumulus cells. (C) Grade 1 four-cell stage embryo. (D) Grade 1 eight-cell stage embryo. (E) Unfertilized oocyte showing sperm adhering to the zona pellucida. (F) Triploid oocyte with three pronuclei. (G) Unequal cleavage in a two-cell stage embryo. (H) Heavily fragmented day 3 embryo.

Following treatment of the embryos with cryoprotectant solutions, the temperature is lowered in a systematic manner in a controlled rate freezer, until it reaches between  $-38$  to  $-80^{\circ}\text{C}$ . The embryos can then be transferred to storage in liquid nitrogen. Cryopreservation has an important clinical application in IVF procedures, since it allows a patient to preserve supernumerary embryos for transfer in a subsequent cycle.

## 7.2. Materials

1. Propanediol (Sigma #P1009).
2. Sucrose (Sigma #S1888).
3. Earle's medium (*see* Appendix).
4. Serum (maternal or selected donor, heat inactivated at 56 for 30 min).
5. Light mineral oil (Sigma #P6755).
6. 5 mL pipets (Falcon 7543).
7. Sterile filter (Nalge Nunc, cat. #150-0020).
8. Diamond-tipped scribe (Curtin Matheson [Fisher Scientific], #22-268-912).
9. Inverted microscope.
10. Binocular microscope.
11. Culture dish (Nalge Nunc #150326).
12. Freezing ampules (Corning #25708).
13. Pasteur pipet(s) (VWR #14673-043).
14. Laboratory timer.

## 7.3. Method

**Note:** All manipulations are carried out at room temperature; therefore warming plates and microscope stage warmers should be off or cool.

1. Make up freezing solutions:
  - a. 15% serum in Earle's medium (10 mL).
  - b. PrOH (1.5 M)—add 1.4 mL of PrOH to 8.76 mL of (I). Note: use a 5-mL pipet and expel several times as PrOH is very viscous.
  - c. PrOH (1.5 M) with sucrose (0.1 M)—dissolve in 0.171 g of sucrose in 5 mL of b.
2. Filter sterilize solutions b. and c. and gas (5% CO<sub>2</sub> in air).
3. Label ampules with patient name, I.D., and date, using the diamond scribe. Clean ampules with alcohol and label with cold-proof ink; flame the ampule to set the ink.
4. Set up a Nalge Nunc culture dish for each group of embryos to be cryopreserved; use light mineral oil at room temperature as the overlay.
5. Divide the dish into two sections, one for PrOH and one for PrOH/sucrose. Use two droplets of each solution, and keep the dish gassed at room temperature (**Fig. 2**).
6. Regas PrOH/sucrose if necessary.
7. Select embryos to be frozen.
8. Move selected embryos to PrOH droplets and set the timer for 10 min.
9. Observe embryos in PrOH droplet for contraction and reexpansion.
10. Using the diamond scribe, score the glass ampules, and break off the top; flame-smooth the broken edge.
11. Fill the ampules to just below the neck with PrOH/sucrose (approx 0.5 mL).
12. Move embryos to PrOH/sucrose droplets
13. Observe embryos for contraction and reexpansion.
14. Transfer embryos to the ampules (1/ampule), using a sized heat-pulled micropipet; observe the embryo entering the ampule.
15. Heat seal the ampules; first heat the length of the neck, gently turn the ampule with the top 3–4 mm in a very hot flame until nearly melted. Do not wait too long or the tip will become too thin. Check the seal, and if necessary, reseal. Time spent in PrOH + sucrose should be less than 5 min.
16. Place the ampules in the controlled rate freezer and start the program.
17. Seed the ampules at  $-5.5^{\circ}$  to  $-7^{\circ}\text{C}$  by touching the ampule with forceps cooled in liquid nitrogen.

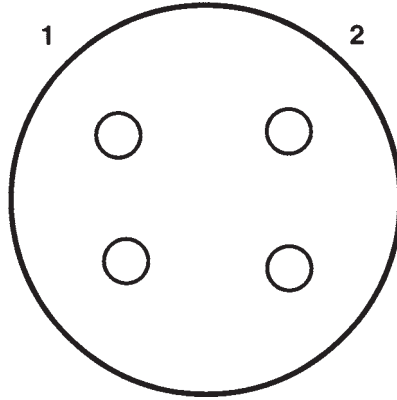

Fig. 2. Arrangement of droplets under oil for cryopreservation. **1.** Droplets containing PrOH. **2.** Droplets containing PrOH/sucrose

18. When seeding has occurred (*see* color change owing to crystal formation), plunge ampules into liquid nitrogen, and subsequently move to liquid nitrogen storage tank.
19. Complete all documentation for the embryos; patient name, I.D., embryo freezing sheet, and index card.

### 7.3.1. Using the Controlled Rate Freezer

**Note:** Ensure that the freezing machine is ready to go; nitrogen vapor freezers require liquid nitrogen, whereas methanol bath freezers need to be warmed up before they can be cooled down for the freezing procedure. Each machine should be programmed for the purpose, following the manufacturer's directions.

### 7.3.2. Program for Controlled Rate Freezer

All freezing machines should be checked for the reliability of their temperature readings, especially for seeding and plunging, by means of an independent thermocouple.

*Ramp 1.*  $-20^{\circ}\text{C}$  per minute down to  $-6.5^{\circ}\text{C}$ .

*Ramp 2.* Hold for 15 min (seeding point).

*Ramp 3.*  $-0.3^{\circ}\text{C}$  per minute down to at least  $-36^{\circ}\text{C}$ .

*Ramp 4.* Hold for up to 30 min (plunging temperature).

## 8. Thawing the Embryos

### 8.1. Materials and Methods

1. Earle's medium (*see* Appendix).
2. Sucrose (Sigma #S1888).
3. Propanediol (Sigma #P1009).
4. Water bath at  $31^{\circ}\text{C}$ .
5. Diamond-tipped scribe (Curtin Matheson [Fisher Scientific], #22-268-912).
6. Inverted microscope.
7. Binocular microscope.
8. Large culture dish (Falcon #1029) with droplets under oil.
9. Ampules containing cryopreserved embryos.

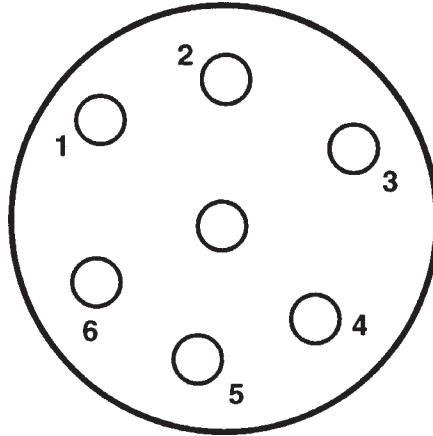

Fig. 3. Arrangement of droplets under oil for embryo thawing. Droplets 1–6 contain dilutions of PrOH as shown.

10. Sterile Pasteur pipet(s) (VWR #14673-043).
11. Acrodiscs (Fisher Scientific, #09-730-182).
12. Thawing solutions and methods:
  - a. 15% serum in Earle's medium ( $2 \times 10$  mL)
  - b. Sucrose (0.2 M) dissolve 0.68 g of sucrose in 10 mL of 1.
  - c. Sucrose (0.2 M) add 0.6 mL of Pr(OH)<sub>2</sub> to 4.4 mL of solution 2.
  - d. Sterile filter solutions 2 and 3 and then gas.
  - e. Remove warming plate from microscope stage, or ensure that they are cool.
  - f. Make dilutions of PrOH in sucrose (0.2 M). Use small culture tubes as follows:

	Sucrose/PrOH	Sucrose
1.00 M PrOH	0.4 mL	0.2 mL
0.75 M PrOH	0.3 mL	0.3 mL
0.50 M PrOH	0.2 mL	0.4 mL
0.25 M PrOH	0.1 mL	0.5 mL

- g. Regas tubes if necessary
- h. Set up a large culture dish with droplets under oil as follows (*see Fig. 3*):

#PrOH	Sucrose
1. 1.50 M	0.2 M
2. 1.00 M	0.2 M
3. 0.75 M	0.2 M
4. 0.50 M	0.2 M
5. 0.25 M	0.2 M
6. —	0.2 M

- i. Keep this dish gassed at room temperature.
- j. Have pipet and scribe to hand, place dish on microscope stage, focused on center droplet.
- k. Heat water bath to 31°C.
  1. Thaw one ampule at a time. Remove one ampule at a time from the Dewar (wear protective goggles, gloves, etc.); hold ampule still in the waterbath until no more ice crystals are visible.

- m. Mark the ampule low on the neck with the diamond scribe, and break it open. Save the neck portion (just in case), and flame the open end of the ampule.
- n. Use a regular pipet to remove the contents of the ampule and place in the center droplet. Pipet up and down fairly vigorously (in case the embryo is stuck to the wall of the ampule), but do not empty the ampule completely. If the embryo is not recovered immediately, wash the ampule out using media from the central droplet.
- o. Immediately the embryo is found, move it to the second 1.5 M PrOH/sucrose droplet, then using a clean pipet, move it to the 1.0 M PrOH/sucrose droplet.
- p. If subsequent embryos are to be thawed, replace the contents of the center droplet with fresh 1.5 M PrOH/sucrose.
- q. Embryos are moved through decreasing dilutions of PrOH while the concentration of sucrose remains constant at 0.2 M. Embryos remain in each dilution for 8 min.
- r. While the embryo is still in the PrOH solution, make up a small Nalge Nunc dish with droplets of 15% serum in Earle's (solution 1). Keep this dish gassed at room temperature.
- s. Leave the embryo in the last droplet (0.2 M sucrose) for 2 min. After this time, the droplet is diluted with approximately the same volume of solution 1. The embryo remains in this diluted sucrose solution for 1 min.
- t. Move the embryo to the dish containing only medium. Wash it by passing through at least five droplets of medium using a clean pipet for each movement. Discard the first wash drop to prevent it running into others.
- u. Place the dish with the washed embryo in the incubator.

## 9. Micromanipulation

### 9.1. Introduction

In vitro fertilization has proven to be of outstanding use in cases of male infertility. In cases where the sperm count is very low, or motility is impaired, IVF has been used in conjunction with micromanipulation. The object of micromanipulation is to enable the sperm to enter the oocyte. Intracytoplasmic sperm injection (ICSI) has proven to be much more efficient in obtaining high rates of normal fertilization than earlier approaches, such as subzonal insertion of a small number of sperm, or partial zona dissection (14–16). Another widely used micromanipulation procedure is assisted hatching. Assisted hatching is a technique designed to assist the embryo “escape” from the surrounding zona pellucida (17). In many laboratories, this technique is indicated when the patient is  $\geq 38$ -years-old and/or has elevated FSH values on day three; there are  $\leq 5$  blastomeres 68–74 h postinsemination; the zona is  $\geq 15 \mu$ ;  $> 20\%$  perivitelline space filled with fragments, or the patient has had two failed embryo transfers. Embryo biopsy is a procedure in which 1–2 blastomeres are withdrawn from an (usually) 8-cell stage embryo, and analyzed for a genetic defect known to be carried by one or both parents, using the polymerase chain reaction (PCR) or fluorescent *in situ* hybridization techniques.

We provide an outline of the procedures used in our laboratory as a guide. However, it must be emphasized that these techniques are mastered only after extensive “hands on” practice. It is helpful to attend one of the many courses on micromanipulation that are offered. Similarly, the equipment described below is that which we use; other laboratories have excellent results using other equipment.

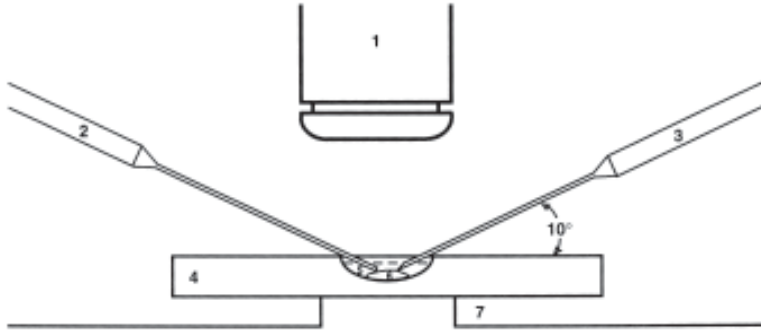

Fig. 4. Arrangement of the workstation for ICSI. 1. Microscope condenser. 2. Holding pipet (on left-hand side). 3. Injection pipet (on right-hand side). 4. Glass depression slide. 5. Culture media. 6. Oil overlay.

## 9.2. Materials

### 9.2.1. The Workstation

The micromanipulation workstation is set up so that the holding pipet is placed in a tool holder and held in a hydraulic joystick-controlled micromanipulator (model MO-188; Narishige Co. Ltd., Tokyo, Japan) on the operator's left. The tool holder for the holding pipet is attached to a "mushroom" (Research Instruments, Medical, Inc., Vero Beach, FL, by a length of intramedic tubing (PE 90, Clay Adams #7420). The system is air filled. The other pipet (for ICSI, assisted hatching or embryo biopsy) is also placed in a tool holder and held in a hydraulic joystick-controlled micromanipulator (model MO-188) with the coarse movement controlled by an electronic joystick [model MM-188 (Narishige)] on the operator's right. The tool holder for this pipet is attached either to another "mushroom" or to a filter-isolated mouth pipet by a length of PE 90 intramedic tubing; this system is also air filled. The inverted microscope is a Nikon Diaphot equipped with Hoffman Modulation contrast optics (20 $\times$ , 40 $\times$ ) and phase objectives (4 $\times$ , 10 $\times$ , 20 $\times$ ). Another excellent model is the Olympus IX-70 with infinity-corrected optics. **Figure 4** provides a diagram representation of the workstation.

### 9.2.2. Making Glass Tools

All glass tools are either bought commercially (*see* Appendix for suppliers) or are fashioned from glass capillary tubes (R-6 glass, custom glass tubing: Drummond Scientific, Broomall, PA). The tubes are 150-mm long, with an outside diameter of 1 mm and an inside diameter of 0.65 mm.

### 9.2.3. Holding Pipets

The holding pipets utilized for all the micromanipulation procedures are made in the same way.

1. The middle portion of a length of capillary tubing is heated using a gas microburner. As the glass begins to liquify the tubing is removed from the flame and the ends of the tube are pulled in opposite directions to draw out a fine glass thread.
2. Using a deFonbrune-type microforge (Technical Products International, St. Louis, MO) equipped with an ocular micrometer, a spot along the glass thread where the outside diam-



eter is approx 100  $\mu\text{m}$  and the inside diameter greater than 50  $\mu\text{m}$  is located. Pipets that do not have such a spot are discarded. Using the microforge, usable pipets are broken at this spot of 100  $\mu\text{m}$  OD and 50  $\mu\text{m}$  ID.

3. This cut end is heat-polished to smooth it and to shrink the hole at the end of the pipet to 20–25  $\mu\text{m}$ .
4. The pipets are placed in holders and kept at the micromanipulation workstation. These pipets can be made well in advance of their use (up to a week) as long as they are stored under sterile conditions.

#### 9.2.4. Injection Pipets

1. Injection pipets are made from the capillary tubing using a Sutter pipet puller (model P-97) (Sutter Instrument Co., Novato, CA). This model can be programmed to hold 10 sets of pulling instructions. The capillary tube is positioned in the puller so that two pipets of equal length are obtained from each capillary tube. These pipets will have a very sharp point, however the lumen will not be patent.
2. The microforge is used to break the injection pipet at a point where the inside diameter is approx 5  $\mu\text{m}$ . The outside diameter will be 6–7  $\mu\text{m}$ . The beveler (model EG-4, Narishige Co.) is used to bevel the point (45° bevel). It takes about 30–60 s for this first beveling operation. The grinding surface is wet initially with pure water prior to use. This should only be repeated every 3–5 min if necessary. The pipet is then plunged into 25% hydrofluoric acid, and the plunger of the syringe is depressed forcing air out of the tip of the pipet. This procedure is repeated with pure water to wash the tip clean.
3. The pipet is moved to a sterile area and allowed to dry for at least 2 h. These pipets may be made the day of use, or can be used up to 2–3 wk if stored sterile. The pipet is moved to a sterile area and allowed to dry for at least 2 h. These pipets are made the day of use.

#### 9.2.5. Sperm Sampling and Examination

Sperm preparation in the early days of ICSI involved washing and centrifugation through Percoll gradients. However, concerns with potential contamination with Percoll have led most laboratories to use other reagents to separate sperm cells from debris. These are marketed under different commercial names, and suppliers are listed in the Appendix. Extremely poor semen samples are centrifuged into pellets and resuspended in small volumes for sedimentation.

#### 9.2.6. Preparation of the Oocytes

Cumulus cells of the aspirated oocytes are removed by a brief incubation in HEPES-buffered media containing up to 80 IU/mL hyaluronidase (Hyase, Scandinavian IVF Science, Vero Beach, FL). The process is monitored under the stereoscope because removing the cells by pipetting gently through a hand-drawn glass pipet. The maturation stage is assessed and recorded, based on the presence or absence of the first polar body and germinal vesicle. Following removal of the cumulus cells, oocytes are placed in a microdrop of IM under oil and returned to the incubator for at least 1 h.

#### 9.2.7. Materials for Intracytoplasmic Sperm Injection (ICSI)

1. Falcon Petri dish (#1006, 50  $\times$  9 mm).
2. Mineral oil prepared for IVF (*see* Appendix).
3. Insemination and growth medium.

4. Holding pipet.
5. Injection pipet.
6. Acid Tyrode's (Sigma "embryo tested").
7. 10% PVP (ICSI-100; Scandinavian IVF).
8. Depression well slides (Fisher Scientific, #12560A).

The ICSI procedure is carried out on the warmed stage of an inverted microscope.

### 9.3. Method

1. Straight microtools are placed on the inverted microscope at the workstation (e.g., Olympus IX 70 with Nomarski interference contrast optics) with the holding pipet on the left side and the injecting pipet on the right-hand side.
2. A small drop (<5  $\mu\text{L}$ ) of prepared sperm suspension and a droplet of PVP are placed side by side under oil and the motile sperm are allowed to swim out into the PVP for use.
3. Oocytes are then added in a separate droplet away from the sperm/PVP droplets.
4. Using the end of the needle, a single sperm is picked up and moved to a clean area of the PVP.
5. Using the end of the needle, the sperm tail is crushed to immobilize it. This destabilizes the membrane, aiding in the decondensation of the sperm head following placement within the oocyte cytoplasm.
6. The sperm is then picked up by the injection needle, tail first, and raised from the oil.
7. The holding pipet is lowered into the droplet containing the oocytes. An oocyte is held securely to the pipet by means of mechanical suction so that the polar body is in the 10–12 or 8–6 clock position. This will allow the operator of the injection pipet to place the sperm as close as possible to the prospective oocyte pronucleus, but without disruption of the oocyte chromatin. The microneedle is lowered into the drop. The point of the needle should be touching the zona pellucida with the sperm head at the tip.
8. The oolemma must be penetrated, and the microneedle pushed firmly and deeply into the cytoplasm. A small amount of ooplasm is drawn into the injection pipet and then expelled gently with the spermatozoon.
9. It is essential to ascertain that the oolemma is ruptured before expelling the sperm together with the aspirated cytoplasm. The injection microneedle can then be used to remove the oocyte from the holding pipet and guide it away from residual oocytes requiring micro-manipulation.

**Note:** The injection procedure should rarely take more than 1 min per oocyte, consequently 3–4 oocytes can be injected in each batch, after which, the media can be replaced, to receive more gametes for injection. Control for the holding and injection micropipets may be achieved by means of air-filled control units (Research Instruments) or by means of filter-isolated mouth pipets.

10. Oocytes are transferred to GM in microdrops under oil, and observed for fertilization and cleavage. **Figure 5** is a diagram representation of this procedure.

## 10. Assisted Hatching

### 10.1. Introduction

Assisted hatching can be carried out at virtually any time before ET, however, many labs recommend 3 h prior to transfer.

### 10.2. Materials

1. 60-mm Petri dish (Falcon #1007).
2. Oil prepared for IVF (see Appendix).

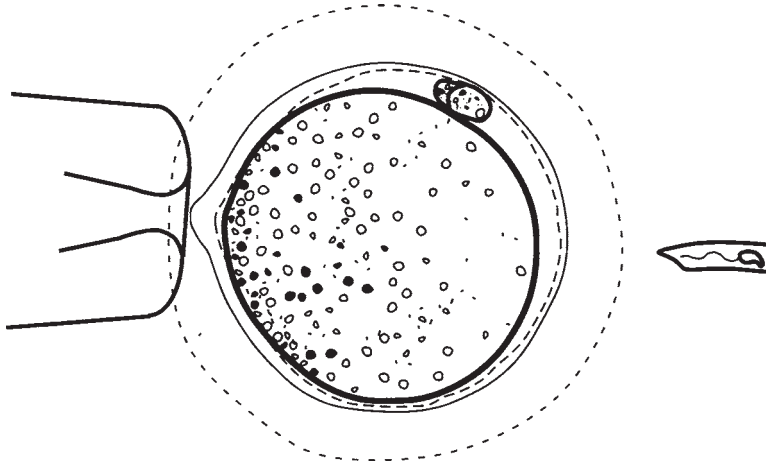

Fig. 5. Diagrammatic representation of the ICSI procedure.

3. Growth medium (*see* Appendix).
4. Holding pipet.
5. Hatching pipet.
6. Acid Tyrode's (Sigma "embryo tested").

### 10.3. Method

The holding pipet is purchased or made as described above. The pipet containing the acid Tyrode's is manufactured by pulling the blank on the Sutter pipet puller. The tip of the pipet is cut on the microforge so that the inside diameter is approx 10–12  $\mu\text{m}$ . Acid Tyrode's (pH 2.4–2.5) is loaded into the pipet after it is placed into the tool holder. The workstation is set up as described above with the hatching pipet in the micromanipulator on the operator's right. Hatching is carried out on a depression glass well slide. One at a time, the embryo is held in place with the holding pipet, and the hatching pipet brought into close proximity, using the drive warp. The acid Tyrode's containing pipet can be located anywhere from the 1 o'clock to the 5 o'clock position of the embryo. The acid Tyrode's is slowly released onto the zona. The process is carefully observed so that the embryo is not flooded with the acid Tyrode's. The flow of acid Tyrode's is slowed when a significant indentation is visible in the zona. Care is taken so that the moment this becomes a hole, the embryo is moved away from the hatching pipet and placed in a new area of the drop. When all are hatched, the embryos are rinsed 6 $\times$  in fresh drops of culture medium under oil until transfer to the patient.

## 11. Appendix

### 11.1. Preparation of Media and Dishes

Media used in the IVF lab include the follicle and instrument wash media (based on phosphate buffered salt solutions) and media for gametes and embryos. The most commonly used follicle and instrument wash medium is Dulbecco's phosphate buffered saline, which is available commercially. Media used to culture human gametes and embryos have been adopted from studies in other species, most commonly, the mouse.

A number of commonly used media are available commercially, and it is a matter of individual choice which is used. Commercially prepared media have been quality tested, but should always be tested again in the lab before use, and the pH and osmolarity confirmed. Earlier culture methods involved the use of organ culture dishes or test tubes, with a volume of 1–2 mL of media. However, most embryologists now culture human gametes and embryos in microdrops, with a mineral oil overlay. The oil prevents evaporation, and helps to stabilize pH and temperature.

### **11.2. Insemination Media (IM): Sperm Wash Media (SWM), Growth Media (GM), and Embryo Transfer Medium (ETM)**

The above are all based on a salt solution containing an energy source, protein and a bicarbonate buffer. Depending on the medium used, 10% protein supplement is added, usually human serum albumin (HSA); some media are supplied complete with the protein supplement. The media are placed in separate flasks, and labeled with the patient's name, I.D. number, and date of expiration. Preparation of culture dishes is carried out in laminar flow hoods, using sterile technique, the day before the procedure to allow for gas equilibration and prewarming. Suitable media for IVF and gamete preparative procedures may be obtained from the companies listed below.

### **11.3. Other Reagents: Instrument and Follicle Wash, Mineral Oil, Acid Tyrodes, Sperm Wash, and PVP**

These media and reagents are all available commercially, saving valuable preparation time in the IVF laboratory.

### **11.4. Preparation of Culture Dishes**

Studies in a number of animal species, but principally in the mouse, have shown that mammalian oocytes may be fertilized in vitro and successfully cultured up to the stage of implantation. For optimal culture conditions, it is important to minimize evaporation losses and changes in pH and temperature, and therefore, an oil overlay is desirable. Further, because it is known that there are autocrine growth factor circuits, culture in microdrops is believed to enhance development.

1. Depending on the expected number of follicles, label culture dishes with patient name and number.
2. When prepared, place dishes in incubator until needed (do not keep longer than 36 h). Organ culture dishes may be used to hold the cumulus oocyte complex during the retrieval.

### **11.5. Organ Culture Dishes**

Organ culture dishes (Falcon cat. #3037) have the central well rinsed with IM, and then 1 mL of IM placed in it. The 2-mL IM are placed in the moat. Dish is then labeled with patient number, name, and date.

### **11.6. Microdrop Cultures**

Nalge Nunc 60-mm dish (Nalge Nunc #150326) or Nalge Nunc 4-well dishes (Nalge Nunc #9383-L20) have 50  $\mu$ L droplets of IM or GM placed on the dish bottom or in

each well. The drops of media are then covered with equilibrated oil, and the dishes returned to the incubator containing 5% CO<sub>2</sub> in humidified air for equilibration before use.

### 11.7. Quality Control

Quality control is of utmost importance in the ART laboratory. Instrument checks should be carried out on a routine basis, and daily checks of incubators, warming plates, refrigerators, freezers, and microscopes are mandatory. Media and all disposables are assayed for potential toxicity by a human sperm motility assay or a mouse embryo assay. The human sperm assay has the advantage of using human gametes, but has been reported to be rather variable. The two-cell mouse assay is relatively simple to perform and is fairly reproducible. Some laboratories use the one-cell mouse assay, which involves culture of zygotes in media containing protein for 24 h, followed by culture in protein-free media for 72 h.

During the past few years, the College of American Pathologists (CAP) sent media for testing to ART laboratories round the country as a means of assessing quality control and comparing laboratories. The results, whether using the sperm assay, or one of the two mouse embryo assays, were quite variable. One must conclude that at the present time, there is no “gold standard” test for media/disposables toxicity. However, in our hands, the human sperm and the two-cell mouse assay were congruent when testing the media sent by CAP.

## 12. Human Sperm Motility Assay

### 12.1. Materials

1. Semen sample from a normal donor.
2. Disposable latex gloves (Safeskin HypoClean Powder-Free Latex exam gloves; Fisher Scientific #113901B).
3. 15 mL sterile, graduated conical test tubes (Fisher Scientific, #0553851).
4. Sterile tubes with snap caps (Thomas Scientific, Swedesboro, NJ, cat. #9219-F22).
5. Gilson Pipetman (p20, p200; Rainin Instrument Corp.).
6. Micropipet tips (Scientific Accessory, #05110).
7. Centrifuge.
8. Makler counting chamber (Zygotek Industries, Springfield, MA).
9. Phase contrast microscope with 10×, 40×, and 100× objectives (Olympus Model BH-2).
10. Eight-key laboratory counter (Clay Adams).
11. Media to be tested, and media that have already been tested (control).

Media that have been in contact with plastic disposables are tested as a measure of the toxicity of the disposables

### 12.2. Method

1. Specimen(s) from normal semen donors are placed in a conical test tube and washed once by gentle centrifugation (400g) using pretested media, and allowed to swim up, following the usual lab procedures. Percent motility and progression are recorded.
2. Sperm are diluted to a concentration of  $3 \times 10^5$ /mL, and 300  $\mu$ L aliquots placed in sterile tubes with snap caps in the loose position.
3. At 24 and 48 h intervals, the medium is gently agitated and a 12- $\mu$ L sample withdrawn. Motility and progression are assessed by placing a drop on a microscope slide, covered with a coverslip and motility and progression assessed.

### 12.3. Interpretation of Results

The test is satisfactory if there is at least 50% of the original motility at 24 h. **Note:** Media may be tested with or without protein supplement; media without protein supplement provides a more stringent test of the media. Lots that have been tested should be so marked with green tape a label indicating the date of the test. Lots that are yet to be tested should be marked with a red tape. Lots that fail the bioassay should be discarded.

## 13. Mouse Two-Cell Embryo Assay

### 13.1. Materials

1. Female mice (approx 4–6 wk of age); singly caged males of proven fertility.
2. Pregnant mare serum gonadotropin (PMSG, Sigma).
3. Human chorionic gonadotropin (hCG, Sigma).
4. Tuberculin syringe, 25 and 30 gage needles.
5. Surgical instruments: coarse and fine scissors, coarse and fine forceps.
6. Watchmakers forceps.
7. 70% ethanol.
8. 100-mm Petri dishes (Falcon cat. #1001).
9. Dissecting microscope.
10. Nalge Nunc four-well plates (Nalge Nunc #9383-L20).
11. Equilibrated mineral oil (Sigma “embryo tested”).
12. Fine drawn pipet for embryo transfer.

### 13.2. Method

1. Mice are housed in an animal facility with dark and light cycles regulated so that there are either 12 light and 12 dark, or 14 light and 10 dark.
2. Female mice are injected i.p. with 5 I.U. PMSG, between 1 and 4 p.m.
3. Forty eight hours later, the females are injected i.p. with 5 I.U. human chorionic gonadotropin (hCG, Sigma) in the middle of the light period, and each is placed with a singly caged male. Mating is ascertained the following morning, by the presence of a copulation plug.
4. Approximately 45 h post-hCG, mated females are sacrificed by cervical dislocation, the abdomen opened, and the oviducts removed.
5. The oviducts are placed in a small drop of medium in a Petri dish and embryos flushed from the fimbriated end of the oviduct, using a syringe equipped with a 30-gage needle and watchmakers forceps.
6. Embryos are washed three times to remove any debris, and set up in groups of 10–12 per 50 mL microdrop, under oil (*see* 3.06).
7. Development of the embryos is assessed at 24 h intervals, and the number of blastocysts formed after 72 h culture is recorded.

### 13.3. Interpretation of Results

The test is satisfactory if there is 80% blastocyst formation at 72 h. **Note:** Cryopreserved mouse embryos are obtainable commercially for those laboratories lacking animal facilities.

### 13.4. Quality Control for Cryopreservation Procedures

Mouse embryos or the human sperm assay are used to test solutions, techniques and equipment. Mouse embryos at the eight-cell stage or polypronuclear human zygotes

are used for checking survival after freezing and thawing. Charts are reviewed to ensure that 50% survival of two pronuclear stage human zygotes is being maintained. Detailed procedures for mouse embryo cryopreservation and thawing are described in Chapter 9 in Vol. I of this series by Richa.

Following thawing, the embryos are placed in culture (50  $\mu$ L drops under oil) and observed following 48 h. The test is acceptable if there is at least 75% blastocyst formation.

#### **14. Some Commercial Sources for Media, Tools, and Reagents Used in the ART Laboratory**

1. Fertility Technologies, Inc., 313 Speen Street, Natick, MA 01760; 800 368-8324; diagnostics, media, equipment, and disposables.
2. Gibco-BRL, Grand Island, NY; 800 828-6686; media and balanced salt solutions.
3. Humagen Fertility Diagnostics, Inc., 2400 Hunter's Way, Charlottesville VA 22911; 800 937-3210; kits for semen analysis, slides, and tools.
4. Marlow, Inc., 15 Forest Parkway, Shelton CT 06484; 203 929-6321 (Wallace Catheters).
5. Irvine Scientific, 2511 Daimler Street, Santa Ana, CA 92705; 800 577-6097; diagnostics, media, and disposables.
6. Scandinavian IVF Science USA Inc. 821 Dahlia Lane, P.O. Box 3158, Vero Beach FL 32963 561 231-3304; media, reagents, and tools.
7. Sigma Chemical Co., P.O. Box 14508, St. Louis, MO 63178; 800-325-5052; media and reagents.

#### **Acknowledgments**

The authors would like to express their deep thanks for the collegiality of the many embryologists they have worked with in the ART laboratory.

#### **References**

1. Steptoe, P. C. and Edwards, R. G. (1978) Birth after the reimplantation of a human embryo. *Lancet* **II**, 366.
2. Edwards, R. G. (1996) The history of assisted human conception with especial reference to endocrinology. *Exp. Clin. Endocrinol. Diabetes* **104**, 183–204.
3. Keel, B. A. and Webster, B. W., eds. (1990) Organization of the in vitro fertilization/embryo transfer laboratory, in *CRC Handbook of the Laboratory Diagnosis and Treatment of Infertility*, CRC Press, Boca Raton, FL.
4. Trounson, A. and Gardner, D. K., eds. (1993) *Handbook of In Vitro Fertilization*, CRC Press, Boca Raton, FL.
5. Veeck, L. L. (1986) *Atlas of the Human Oocyte and Early Conceptus*, Williams and Wilkins, Baltimore, MD.
6. Veeck, L. L. (1991) *Atlas of the Human Oocyte and Early Conceptus, Volume 2*, Williams and Wilkins, Baltimore, MD.
7. Janssenwillen, C., Nagy, Z. P., and Van Steirtegehem, A. C. (1995) Maturation of human cumulus-free germinal-vesicle-stage oocytes to metaphase II by co-culture with monolayer Vero cells. *Hum. Reprod.* **10**, 375–378.
8. Nagy, Z. P., Janssenwillen, C., Liu, J., Loccufier, A., Devroey, P., and Van Steirtegehem, A. (1996) Pregnancy and birth after intracytoplasmic sperm injection of in vitro matured germinal-vesicle stage oocytes: case report. *Fertil. Steril.* **65**, 1047–1050.
9. *WHO Laboratory Manual for the Examination of Human Semen and Sperm-Cervical Mucus Interactions, Third edition*, Cambridge University Press, Cambridge, UK, 1992.

10. Mortimer, D. (1994) *Practical Laboratory Andrology*. Oxford University Press, New York.
11. Morton, P. C., Yoder, C. S., Tucker, M. J., Wright, G., Brockman, W. D. W., and Hort, H. I. (1997) Reinsemination by intracytoplasmic sperm injection of 1-day-old oocytes after complete conventional fertilization failure. *Fertil. Steril.* **68**, 488–491.
12. Elsner, C. W., Tucker, M. J., Sweitzer, C. L., Brockman, W. D. W., Morton, P. C., Wright, G., and Toledo, A. A. (1997) Multiple pregnancy rate and embryo number transferred during in vitro fertilization. *Am. J. Obstet. Gynecol.* **177**, 350–356.
13. Tucker, M. J., Morton, P. C., Sweitzer, C. L., and Wright, G. (1995) Cryopreservation of human embryos and oocytes. *Curr. Opinion Ob. Gyn.* **7**, 188–192.
14. Tucker, M. J., Wiker, S. R., Wright, G., Morton, P. C., and Toledo, A. A. (1993) Treatment of male infertility and idiopathic failure to fertilize in vitro with under zona insemination and direct egg injection. *Am. J. Obstet. Gynecol.* **169**, 324–330.
15. Tucker, M. J., Wright, G., Morton, P. C., Mayer, M. P., Ingargiola, P. E., and Jones, A. E. (1995) Practical evolution and application of direct intracytoplasmic sperm injection for male factor and idiopathic fertilization failure infertilities. *Fertil. Steril.* **63**, 820–827.
16. Tucker, M. J., Morton, P. C., Wright, G., Ingargiola, P. E., Jones, A. E., and Sweitzer, C. L. (1995) Factors affecting success with intracytoplasmic sperm injection. *Reprod. Fertil. Dev.* **7**, 229–236.
17. Cohen, J., Alikani, M., Reing, A. M., Ferrara, T. A., Trowbridge, J., and Tucker, M. (1992). Selective assisted hatching of human embryos. *Ann. Acad. Med. Singapore* **21**, 565–570.



## Trophoblast Differentiation

### *An In Vitro Model for Trophoblast Giant Cell Development*

**Thomas J. Peters, Belinda M. Chapman, and Michael J. Soares**

#### 1. Introduction

Trophoblast cells are situated between maternal and embryonic compartments and effectively permit the embryo to develop within the female reproductive tract. These cells develop along a multilineage differentiation pathway and their growth and differentiation are pivotal to the establishment and maintenance of pregnancy (1–4).

In the mouse and rat, there are at least four recognizable differentiated cell phenotypes: trophoblast giant cells, spongiotrophoblast cells, glycogen cells, and syncytial trophoblast cells. The cell types are arranged into two distinct regions within the chorioallantoic placenta: the junctional zone and the labyrinth zone. The junctional zone is proximal to maternal tissues and has a prominent endocrine role, whereas the labyrinth zone is adjacent to fetal tissues and has significant endocrine and transport roles.

Trophoblast giant cells are one of the first differentiated cells to arise in the developing embryo (1–4). Morphologically, they are striking in their large size and are easily recognized within the developing placenta. Trophoblast giant cells form via a process referred to as endoreduplication, continued DNA replication without concomitant cell division, and are situated at the maternal-fetal interface within the junctional and labyrinth zones of the chorioallantoic placenta. This trophoblast cell population is characterized by its endocrine and invasive phenotypes (4,5). Spongiotrophoblast cells represent another endocrine cell population of the chorioallantoic placenta and share a developmental linkage with glycogen cells, which are typified by their accumulation of glycogen (4,6). Syncytial cells have a significant role in fetal-maternal exchange and arise by cell fusion (6).

Progress in studying the control of differentiation in a number of different cell types has been directly related to the development of in vitro culture models. Investigations concerning the trophoblast giant cell lineage have benefitted from the generation of a transplantable rat choriocarcinoma by Dr. Shinichi Teshima and his colleagues at the National Cancer Institute, Tokyo, Japan (7). The tumor was experimentally induced by removal of the fetus and exposure of placental primordia to the extrauterine environment and was found to be transplantable. Female rats bearing the transplanted choriocarcinoma

show extensive mammary gland development that likely relates to the production of a lactogenic hormone (7). Trophoblast giant cells are present within the tumors and are responsible for the expression of at least one member of the placental prolactin (PRL) family, placental lactogen-I (PL-I, 7-9). Dr. Teshima generously shared the transplantable tumor with Dr. Michel Vandeputte of the University of Leuven, Belgium, and subsequently Dr. Vandeputte kindly shared the transplantable tumor with our laboratory. Dr. Vandeputte's laboratory and our laboratory independently established cell lines from the choriocarcinoma, referred to as *RCHO* and *Rcho-1*, respectively (10,11). The cells are aneuploid and bear immunological similarity to cells of the placental primordia referred to as the ectoplacental cone, but not trophoblast of the blastocyst (9-12). Although most characteristics of the *RCHO* and *Rcho-1* cells are similar, there do appear to be some differences, especially regarding the expression patterns of members of the placental PRL family (11,13). Most of the remaining discussion relates to our experiences with the *Rcho-1* trophoblast cell line.

*Rcho-1* trophoblast cells represent a stem cell population capable of differentiation along the trophoblast giant cell lineage (11). The cells can be manipulated to proliferate or differentiate depending upon culture conditions. Proliferation of *Rcho-1* trophoblast cells depends on factors present in fetal sera that have not been completely characterized (14). Differentiation is induced by growing the cells to confluence and removing mitogenic stimuli and can recapitulate the stage-like progression of trophoblast giant cells developing *in situ* (15). *Rcho-1* trophoblast cells induced to differentiate endoreduplicate (14,15) and exhibit an endocrine phenotype that includes the expression of members of the placental PRL family (PL-I; PL-II, PRL-like protein-A, PLP-A; PLP-C, PLP-Cv, PLP-D, decidual/trophoblast PRL-related protein, d/tPRP; 11,14,16-19) and enzymes involved in steroidogenesis (cytochrome *P450* side-chain cleavage, *P450scc*; cytochrome *P450* 17 $\alpha$  hydroxylase, *P450c17*; 20,21). Collectively, these endocrine features of developing *Rcho-1* trophoblast cells closely resemble the characteristics of junctional zone trophoblast giant cells of the chorioallantoic placenta with the exception that PL-I fails to turn off *in vitro* unlike its normal behavior *in vivo* (15,22). This latter feature may reflect a deficit in *Rcho-1* trophoblast cells or alternatively, an indication that termination of PL-I expression is controlled by factors arising in cell types other than the trophoblast giant cells. *In vitro* differentiation of *Rcho-1* trophoblast cells is also associated with the acquisition of an invasive phenotype, including the expression of gelatinase B and  $\alpha$ 1 integrin (5).

*Rcho-1* trophoblast cells have been utilized in both *in vitro* and *in vivo* experimentation. *In vitro* experimentation has included the use of *Rcho-1* trophoblast cells for investigating: 1) the trophoblast giant cell-specific phenotype (11,14-21,23-25); 2) signaling pathways controlling trophoblast giant cell development (14,26-37); and 3) transcriptional regulation of various genes expressed in trophoblast giant cells (16,17,20,21,33-38). An overview of the *Rcho-1* trophoblast cell phenotype is presented in **Table 1**. The physiological consequences of elevated PL production and ectopic trophoblast transplantation have been investigated through *in vivo* transplantation of the *Rcho-1* trophoblast cells to several different tissue sites (8,9,39-45).

*Rcho-1* and *RCHO* trophoblast cells are remarkable in their ability to enter and progress through the trophoblast giant cell differentiation pathway. These cells have proven to be a valuable resource for studying the biology of trophoblast cells.

**Table 1**  
**Rcho-1 Trophoblast Cell Phenotype**

Genes	Stage of <i>Rcho-1</i> cell differentiation		Ref. no.
	Proliferative	Differentiated	
Endocrine			
PRL family <sup>a</sup>	–	+	(11,14,16–19)
<i>P450sc</i>	–	+	(21)
<i>P450c17</i>	–	+	(20)
Cell adhesion/invasion			
$\alpha$ 5, $\beta$ 5 integrin	+	+	(5)
$\alpha$ 1 integrin	–	+	(5)
<i>Gelatinase B</i>	–	+	(5)
<i>Connexin 31</i>	–	+	(29)
Receptor tyrosine kinases (ligands)			
<i>EGFR, ErbB2</i>	+	+	(31)
( <i>HB-EGF, TGF<math>\alpha</math></i> )	+	+	(31)
<i>Sky/Tyro3/Dtk</i>	–	+	Unpublished data <sup>b</sup>
( <i>Gas6</i> )	+	+	Unpublished data <sup>b</sup>
<i>FGFR-1</i>	–	+	Unpublished data <sup>b</sup>
Intracellular kinases			
<i>Src, Yes, Lyn</i>	–	+	(30)
<i>Lim kinase-1</i>	±	+	Unpublished data <sup>b</sup>
<i>cdc-2</i>	+	–	(5)
Transcription factors			
<i>c-fos, c-jun, junB</i>	±	±	(33,34)
<i>GATA-2, GATA-3</i>	±	±	(36)
<i>HES-1, HES-2, Pem, Mash-2</i>	+	+	(25,35)
<i>Hxt, TLE/groucho</i>	–	+	(25,35)
<i>Id-1, Id-2</i>	+	–	(35)

<sup>a</sup>PRL family includes *PL-I, PL-II, PL-Iv, PLP-A, PLP-C, PLP-Cv, PLP-D, d/tPRP*.

<sup>b</sup>Unpublished data from T. J. Peters, B. M. Chapman, and M. J. Soares.

## 2. Materials

### 1. Culture media

a. Standard growth medium: NCTC-135 culture medium (Sigma Chemical Co., St. Louis, MO) containing 50  $\mu$ M 2-mercaptoethanol (Bio-Rad, Richmond, CA), 1 mM sodium pyruvate (Sigma), 100  $\mu$ g/mL penicillin (Sigma), 100 U/mL streptomycin (Sigma), and 20% heat-inactivated fetal bovine serum (FBS, Sigma). The addition of HEPES (Sigma) at a final concentration of 10–20 mM is optional.

b. Standard differentiation medium: NCTC-135 culture medium (Sigma) containing 50  $\mu$ M 2-mercaptoethanol (Bio-Rad), 1 mM sodium pyruvate (Sigma), 100  $\mu$ g/mL penicillin (Sigma), 100 U/mL streptomycin (Sigma), and 1–10% heat-inactivated horse serum (JRH Biosciences, Lenexa, KS). The addition of HEPES (Sigma) at a final concentration of 10–20 mM is optional.

2. Cell dissociation medium: A trypsin-EDTA solution containing 0.25% trypsin and 0.02% EDTA in Hank's balanced salt solution (Sigma) supplemented with 10 mM HEPES (Sigma) is used to dissociate the cells.

3. Cell freezing and storage medium: Standard growth medium containing 10% dimethyl sulfoxide (Sigma).
4. The StrataCooler® Cryopreservation Module is available from Statagene (La Jolla, CA).
5. Polyclonal antibodies to various members of the rat PRL family and to rat *P450* side-chain cleavage enzyme are available from Chemicon International (Temecula, CA).
6. Extracellular matrix-coated BioCoat® MATRIGEL Invasion Chambers can be obtained from Collaborative Biomedical Products (Bedford, MA).
7. Diff-Quick stain for cells is available from Allegiance Scientific Products (McGaw Park, IL).
8. Lipofectamine reagent and Opti-MEM culture medium can be obtained from Gibco-BRL (Gaithersburg, MD).
9. Geneticin (Sigma) is prepared as a 40× stock solution (10 mg/mL) in Hank's balanced salt solution (Sigma) and stored at 4°C.

### 3. Methods

1. *Rcho-1* trophoblast cells are routinely maintained in 75-cm<sup>2</sup> flasks at subconfluent conditions in standard growth medium in an atmosphere of 5% CO<sub>2</sub>/95% air at 37°C in a humidified incubator (see **Notes 1** and **2**). Initially, the *Rcho-1* trophoblast cells are plated at 1–2 × 10<sup>6</sup> cells per flask and fed at 2-d intervals.
2. Routine passaging of *Rcho-1* trophoblast cells utilizes brief exposure (30–60 s) to a trypsin-EDTA solution followed by vigorous agitation of the culture flask (see **Note 3**). Following dissociation of the cells from the culture plate, culture medium containing serum is added to inhibit the actions of trypsin. After collection by centrifugation, the cells are resuspended with fresh standard growth medium and replated at a splitting ratio of 1:3. Under normal growth conditions, the cells are usually passaged at 2–3-d intervals.
3. Limiting dilution strategies can be used to clone *Rcho-1* trophoblast cells (**11,17**). Cells are plated into 96-well plates at concentrations estimated at a half cell per well. The number of cells per well should be verified. Under standard growth conditions (presence of FBS), colonies of cells can be observed within a week of culture in approx 40–50 wells of a 96-well plate. Colony outgrowths are then harvested and expanded.
4. *Rcho-1* trophoblast cells can be stored frozen in liquid nitrogen. We normally freeze aliquots of cells containing 1–2 × 10<sup>6</sup> cells/mL in standard growth medium containing 10% dimethyl sulfoxide. Aliquots are placed in the StrataCooler® Cryopreservation Module, transferred to a –80°C freezer for at least 24 h, and then stored indefinitely in liquid nitrogen. Frozen aliquots can be rapidly thawed at 37°C, washed once in standard growth medium, and reseeded into culture plates.
5. Trophoblast giant cell differentiation is induced by growing the *Rcho-1* trophoblast cells to a high density in standard growth medium and then replacing the medium with standard differentiation medium (see **Fig. 1** and **Notes 4** and **5**). High cell density and the absence of growth stimulation (removal of FBS) facilitate trophoblast giant cell formation.
6. Differentiation can be assessed by monitoring endoreduplication (**11,14**) the expression of members of the PRL gene family (**14**), the biosynthesis of steroid hormones (**20,21**), or acquisition of an invasive phenotype (**5,29**).
  - a. Endoreduplication can be assessed by monitoring cellular DNA content (**15,46**) or indirectly by determination of nuclear size (**11**).
  - b. Expression of members of the PRL gene family can be monitored by Northern blotting, Western blotting, *in situ* hybridization, or immunocytochemistry (**11,15–17**).
  - c. Steroidogenic capacity of the cells can be evaluated by measuring levels of progesterone and/or androstenedione in conditioned medium by radioimmunoassay (**20,21**). Alternatively, the expression of the key enzymes involved in progesterone and

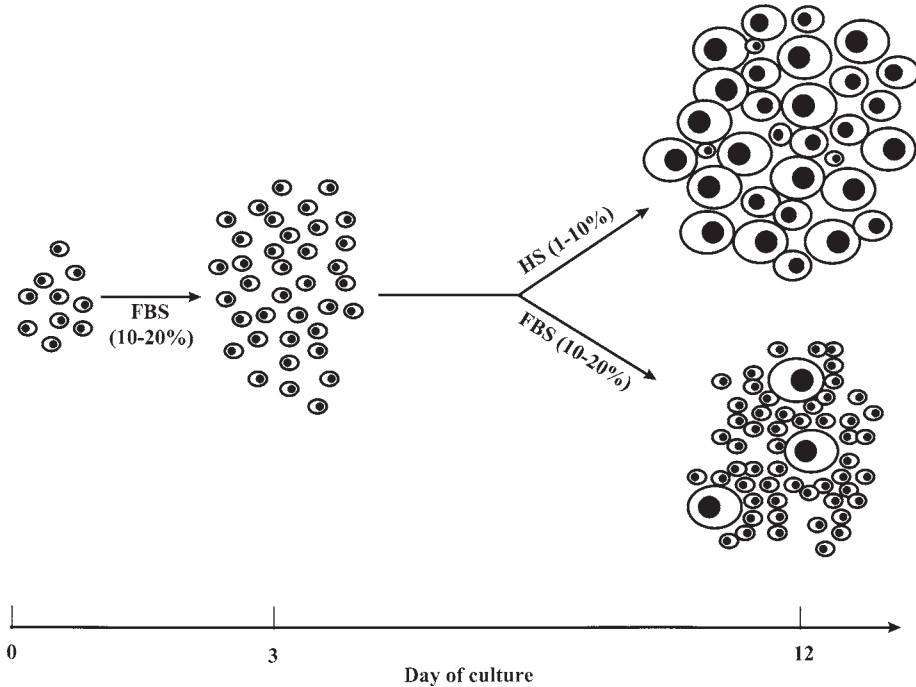

Fig. 1. Schematic representation of the in vitro manipulation of *Rcho-1* trophoblast cells. The cells are routinely grown in FBS-containing medium. As the cells become more densely distributed, they are shifted to horse serum (HS) containing medium. Continued maintenance of the cells in FBS containing culture medium results in the generation of a mixed population of stem and differentiated cells. Shifting the *Rcho-1* trophoblast cells to HS results in an enrichment of trophoblast giant cells. Modified from **ref. 4**.

androstenedione biosynthesis (*P450scc*; *P450c17*) can be determined by molecular hybridization and immunological strategies (20,21).

- d. The invasive phenotype can be assessed by determining the expression of gelatinase B and/or  $\alpha 1$  integrin (5), through the analysis of gelatinase B activity in conditioned medium by substrate gel electrophoresis (zymography; 5,47), and/or by following the directional movement of cells through an extracellular matrix (5,29). Briefly, the latter analysis is performed with the aid of extracellular matrix-coated BioCoat MATRIGEL Invasion Chambers. *Rcho-1* trophoblast cells are seeded at  $5 \times 10^4$  per 3 mL in standard growth medium. Cells are then incubated at  $37^\circ\text{C}$  for various durations. Chambers can be removed, the matrix and cells on the upper surface of the chambers scraped, and the membrane fixed and stained with Diff-Quick. Chamber membranes are then excised and placed on slides, overlaid in immersion oil, and cells that invaded and attached to the under surface of the chamber are counted.
7. DNA can be transferred into *Rcho-1* trophoblast cells using liposome-mediated procedures (17,21,34,35). Initially, cells are plated at a concentration of  $2 \times 10^4$ /well of a six-well plate and allowed to stabilize in standard growth medium for 60 h. The cells are then incubated with a DNA/lipofectamine mixture (lipofectamine reagent, 10  $\mu\text{L}$ ; DNA construct, 2  $\mu\text{g}$ ; Opti-MEM culture medium, 200  $\mu\text{L}$ ) at  $37^\circ\text{C}$  for 7 h. Following the transfection the DNA/lipofectamine mixture is removed and the medium is changed to either standard growth medium or standard differentiation medium. Stable DNA transfected cell

lines can be generated via the introduction of DNA constructs with selectable cassettes such as those encoding for neomycin resistance. Effective selection for neomycin resistance generally requires exposure to geneticin at a concentration of 250  $\mu\text{g}/\text{mL}$  for 2–3 wk. Differentiated *Rcho-1* trophoblast cells can also be transfected using similar procedures.

8. *Rcho-1* trophoblast cells can be maintained in vivo (see **Note 6**). The cells can be readily transplanted beneath the kidney capsule (**9**). *Rcho-1* trophoblast cells ( $1\text{--}5 \times 10^6$ ) grown in vitro are harvested as described and transferred beneath the kidney capsule of 4-wk-old female rats (we have used Lewis and Holtzman strains) in a volume of 25–50  $\mu\text{L}$  using a 27-gage needle and 1-mL syringe. The cells grow rapidly and need to be harvested within 2 wk, preferably 10–12 d. Harvested transplants can also be minced and transferred beneath the kidney capsule of additional recipient animals.

#### 4. Notes

1. We routinely use NCTC-135 culture medium for growth and general maintenance of the *Rcho-1* trophoblast cell line. Other culture media formulations are potentially suitable. We have previously used RPMI-1640 as a base medium, but it does not adequately maintain the pH at higher cell densities. The cells grow more vigorously in RPMI-1640 culture medium but at the cost of poor pH regulation. The addition of HEPES (10–20 mM) to the culture medium improves the pH control. The cells grow much better under conditions of high humidity. Cellular proliferation is dependent upon the presence of some unidentified factors present in FBS. Please note that lots of FBS should be screened. We have had difficulty in maintaining appropriate behavior of the *Rcho-1* trophoblast cells with some lots of FBS.
2. Maintenance of the cells at an appropriate density that is compatible with growth is critical for expansion of the *Rcho-1* cells. Please note that the cells never achieve a true confluent culture nor do they form a “homogeneous” monolayer. Clusters or patches of small cells surrounding islands of larger more adherent cells (including giant cells) are typically observed in the cultures (see **Fig. 2**). If the *Rcho-1* cells are not passaged at appropriate intervals, then problems arise, which are generally associated with lifting of the cells from the culture surface and/or an arrest of cell proliferation.
3. The *Rcho-1* trophoblast cell line contains a mixture of stem and differentiated cells (see **Fig. 2**). This feature of the *Rcho-1* trophoblast cell line makes the line valuable for studying the process of trophoblast cell differentiation; however, it is a nuisance for routine cell-culture maintenance. Manipulating various aspects of the culture procedure can influence the cellular composition of the cell line. Cell composition can influence growth rates and features of differentiation. Stem cells can be enriched by growing the cells at low densities and passaging following brief trypsinization. Maintaining the cells at higher densities or any type of significant stress (humidity, pH,  $\text{CO}_2$  deprivation, and so on) can lead to differentiation (giant cell formation) or cell death, both of which result in an irreversible termination of the culture. Harvesting the *Rcho-1* trophoblast cells following brief treatment with trypsin-EDTA results in isolation of a population of cells enriched in stem cells. This procedure also results in the enrichment of differentiated cells (trophoblast giant cells) that are more adherent and not removed by brief exposure to the trypsin-EDTA solution. Harvesting the differentiated cells generally requires more vigorous dissociation methods such as scraping with a rubber policeman. The use of scraping without enzyme-chelator treatment is also an effective method for harvesting cells; however, it is not normally an acceptable in vitro method for passaging in that it results in the generation of large clumps that do not readily grow when seeded into new flasks. Thus, the method of passaging can affect the cellular composition of the cell line. Consistency in cell culture

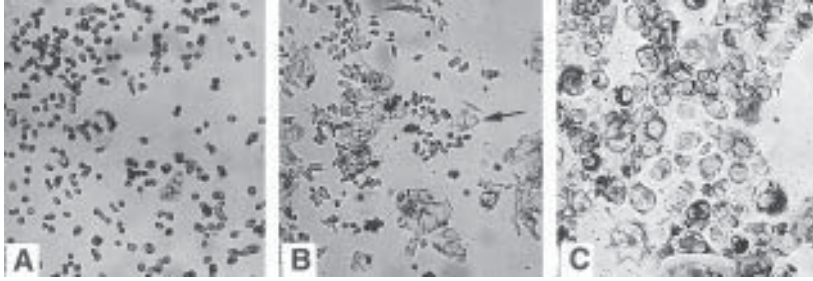

Fig. 2. Morphology of *Rcho-1* trophoblast cells at different stages of the differentiation continuum. (A) growth phase, containing predominantly stem cells; (B) transitional stage, containing a mixture of stem cells and giant cells, please note that the arrow is pointed at an early stage trophoblast giant cell; (C) differentiation phase, containing predominantly giant cells. All cells were photographed under phase contrast microscopy.

practices is extremely important in working with the *Rcho-1* trophoblast cell line. Variations in culture densities, passaging methods, and splitting ratios significantly influence the phenotype of the cell line.

4. The nutritive needs of differentiating cells appear to be less than the needs of proliferating cells; however, differentiating *Rcho-1* trophoblast cells minimally require some factors present in horse serum and cannot tolerate the absence of serum for more than 24–48 h. Differentiation will occur in the presence of FBS; however, under these conditions the cultures are comprised of a greater proportion of stem cells, and thus the cultures are more heterogeneous (Fig. 1). Differentiation in horse serum enriches for the trophoblast giant cell population (Fig. 2C). In the presence of horse serum, proliferation of the stem cell population is greatly arrested. Within a few days following replacement with horse serum some cells detach from the culture plate surface, whereas others increase in size. A large percentage of the detached cells are viable and will readhere to the culture plate surface by reexposure to FBS containing culture medium. Under some circumstances, the adherent horse serum-growth arrested stem cell population can be revived by reintroduction of FBS. Development of serum-free culture conditions facilitating either proliferation or differentiation of the *Rcho-1* trophoblast cells will be valuable for future studies on the control of trophoblast cell differentiation. Please note that the quality of both FBS and horse serum can affect *Rcho-1* trophoblast cell differentiation. We have had difficulty in promoting and maintaining differentiated trophoblast cells with some lots of serum. Thus, individual lots of FBS and horse serum should be prescreened.
5. Differentiation of the *Rcho-1* trophoblast cells appears to be restricted to the trophoblast giant cell phenotype. *Rcho-1* trophoblast cells are excellent models for investigating the trophoblast giant cell lineage, but *not* other lineages of differentiated trophoblast cells (e.g., spongiotrophoblast, syncytial trophoblast, or glycogen cells). *Rcho-1* trophoblast cells display dramatic morphologic (see Fig. 2) and functional changes as they differentiate (11,14,15,21). Trophoblast giant cell differentiation is a continuum and will proceed over at least a 2–3 wk period in culture. The ontogeny of gene expression of trophoblast giant cells developing *in situ* is largely recapitulated under conditions promoting differentiation of *Rcho-1* trophoblast cells maintained *in vitro*.
6. *In vivo* transplantation of the *Rcho-1* trophoblast cells has been effectively used to elevate circulating levels of lactogenic hormones. The predominant lactogen expressed by the transplants is PL-I (9). A good check for a successful transplant is a lactogenic response in

the host animal's mammary glands or a luteotrophic response in the host animal's ovaries. Please note that the *Rcho-1* trophoblast cells are potentially capable of expressing other peptide hormones and also steroid hormones (4), thus the physiological consequences of trophoblast cell transplantation may be complex. *Rcho-1* and/or *RCHO* trophoblast cells have also been successfully transplanted to the cerebral ventricles, lungs, testes, and uteri of rats (7,40,44).

7. Cancer cells, such as those represented by the *Rcho-1* trophoblast cells, are caricatures of normal development and represent potentially important models for dissecting molecular mechanisms controlling differentiation (48). The key is in identifying and appreciating which regulatory pathways are characteristic of normal development and which are associated with the transformed phenotype. Thus, it is imperative to perform complementary experimentation using primary cultures of trophoblast cells and in vivo models.

## Acknowledgments

The authors would like to thank Teresa N. Faria, Gary P. Hamlin, Christopher B. Cohick, Kyle E. Orwig, and Guoli Dai for their participation in the development of procedures associated with the use of the *Rcho-1* trophoblast cell line. This work was supported by grants from the NICHD (HD 20676, HD 33994), the W. S. Sutton Award, and the Kansas Health Foundation.

## References

1. Gardner, R. L. and Beddington, R. S. P. (1988) Multi-lineage "stem" cells in the mammalian embryo. *J. Cell Sci.* **10(Suppl.)**, 11–27.
2. Soares, M. J., Faria, T. N., Hamlin, G. P., Lu, X.-J., and Deb, S. (1993) Trophoblast cell differentiation: expression of the placental prolactin family, in *Trophoblast Cells: Pathways for Maternal-Embryonic Communication* (Soares, M. J., Handwerger, S., and Talamantes, F., eds.), Springer-Verlag, New York, pp. 43–65.
3. Rossant, J. (1995) Development of the extraembryonic lineages. *Sem. Dev.* **6**, 237–247.
4. Soares, M. J., Chapman, B. M., Rasmussen, C. A., Dai, G., Kamei, T., and Orwig, K. E. (1996) Differentiation of trophoblast endocrine cells. *Placenta* **17**, 277–289.
5. Peters, T. J., Albieri, A., Bevilaqua, E., Chapman, B. M., Crane, L. H., Hamlin, G. P., et al. (1999) Differentiation-dependent expression of gelatinase B/matrix metalloproteinase-9 in trophoblast cells. *Cell Tiss. Res.* **295**, 287–296.
6. Soares, M. J., Chapman, B. M., Kamei, T., and Yamamoto, T. (1995) Control of trophoblast cell differentiation: lessons from the genetics of early pregnancy loss and trophoblast neoplasia. *Dev. Growth Differ.* **37**, 355–364.
7. Teshima, S., Shimosato, Y., Koide, T., Kuroki, M., Kikuchi, Y., and Aizawa, M. (1983) Transplantable choriocarcinoma of rats induced by fetectomy and its biological activities. *Gann* **74**, 205–212.
8. Verstuyf, A., Sobis, H., and Vandeputte, M. (1989) Morphological and immunological characteristics of a rat choriocarcinoma. *Int. J. Cancer* **44**, 879–884.
9. Faria, T. N., Deb, S., Kwok, S. C. M., Vandeputte, M., Talamantes, F., and Soares, M. J. (1990) Transplantable rat choriocarcinoma cells express placental lactogen: identification of placental lactogen-I immunoreactive protein and messenger ribonucleic acid. *Endocrinology* **127**, 3131–3137.
10. Verstuyf, A., Sobis, H., Goebels, J., Fonteyn, E., Cassiman, J. J., and Vandeputte, M. (1990) Establishment and characterization of a continuous in vitro line from a rat choriocarcinoma. *Int. J. Cancer* **45**, 752–756.



11. Faria, T. N. and Soares, M. J. (1991) Trophoblast cell differentiation: establishment, characterization, and modulation of a rat trophoblast cell line expressing members of the placental prolactin family. *Endocrinology* **129**, 2895–2906.
12. Verstuyf, A., Fonteyn, E., Sobis, H., and Vandeputte, M. (1992) A rat cytotrophoblast antigen defined by a monoclonal antibody. *Am. J. Reprod. Immunol.* **28**, 6–11.
13. Duckworth, M. L., Robertson, M. C., Schroedter, I. C., Szpirer, C., and Friesen, H. G. (1993) Molecular genetics and biology of the rat placental prolactin family, in *Trophoblast Cells: Pathways for Maternal-Embryonic Communication* (Soares, M. J., Handwerker, S., and Talamantes, F., eds.), Springer-Verlag, New York, pp. 169–190.
14. Hamlin, G. P. and Soares, M. J. (1995) Regulation of DNA synthesis in proliferating and differentiating trophoblast cells: involvement of transferrin, transforming growth factor- $\beta$ , and tyrosine kinases. *Endocrinology* **136**, 322–331.
15. Hamlin, G. P., Lu, X.-J., Roby, K. F., and Soares, M. J. (1994) Recapitulation of the pathway for trophoblast giant cell differentiation in vitro: stage-specific expression of members of the prolactin gene family. *Endocrinology* **134**, 2390–2396.
16. Dai, G., Liu, B., Szpirer, C., Levan, G., Kwok, S. C. M., and Soares, M. J. (1996) Prolactin-like protein-C variant: complementary DNA, unique six exon gene structure, and trophoblast cell-specific expression. *Endocrinology* **137**, 5009–5019.
17. Orwig, K. E., Dai, G., Rasmussen, C. A., and Soares, M. J. (1997) Decidual/trophoblast prolactin-related protein: characterization of gene structure and cell-specific expression. *Endocrinology* **138**, 2491–2500.
18. Iwatsuki, K., Shinozaki, M., Hattori, N., Hirasawa, K., Itagaki, S., Shiota, K., and Ogawa, T. (1996) Molecular cloning and characterization of a new member of the rat placental prolactin (PRL) family, PRL-like protein D (PLP-D). *Endocrinology* **137**, 3849–3855.
19. Rasmussen, C. A., Orwig, K. E., Vellucci, S., and Soares, M. J. (1997) Dual expression of prolactin-related protein in decidua and trophoblast tissues during pregnancy in rats. *Biol. Reprod.* **56**, 647–654.
20. Yamamoto, T., Chapman, B. M., Johnson, D. C., Givens, C. R., Mellon, S. H., and Soares, M. J. (1996) Cytochrome P450 17 $\alpha$ -hydroxylase gene expression in differentiating rat trophoblast cells. *J. Endocrinol.* **150**, 161–168.
21. Yamamoto, T., Roby, K. F., Kwok, S. C. M., and Soares, M. J. (1994) Transcriptional activation of cytochrome P450 side chain cleavage enzyme expression during trophoblast cell differentiation. *J. Biol. Chem.* **269**, 6517–6523.
22. Faria, T. N., Deb, S., Kwok, S. C. M., Talamantes, F., and Soares, M. J. (1990) Ontogeny of placental lactogen-I and placental lactogen-II expression in the developing rat placenta. *Dev. Biol.* **141**, 279–291.
23. Dai, G., Imagawa, W., Liu, B., Szpirer, C., Levan, G., Kwok, S. C. M., and Soares, M. J. (1996) Rcho-1 trophoblast cell placental lactogens: complementary deoxyribonucleic acids, heterologous expression, and biological activities. *Endocrinology* **137**, 5020–5027.
24. Shirai, T., Itonori, S., Soares, M. J., Shiota, K., and Ogawa, T. (1996) Changes in ganglioside composition of the rat choriocarcinoma cell line, Rcho-1. *Glycoconjugate J.* **13**, 415–442.
25. Nakayama, H., Liu, Y., Stifani, S., and Cross, J. C. (1997) Developmental restriction of Mash-2 expression in trophoblast correlates with potential activation of the Notch-1 pathway. *Dev. Genet.* **21**, 21–30.
26. Roby, K. F., Hamlin, G. P., Soares, M. J., and Hunt, J. S. (1994) Differential responses of phenotypically distinct rat trophoblast cell lines to MHC class I antigen-inducing cytokines. *Placenta* **15**, 577–590.
27. Balzarini, J., Verstuyf, A., Hatse, S., Goebels, J., Sobis, H., Vandeputte, M., and De Clercq, E. (1995) The human immunodeficiency virus (HIV) inhibitor 9-(2-phosphonyl-

- methoxyethyl) adenine (PMEA) is a strong inducer of differentiation of several tumor cell lines. *Int. J. Cancer* **61**, 130–137.
28. Yamaguchi, M., Kawai, M., Kishi, K., and Miyake, A. (1995) Regulation of rat placental lactogen (rPL)-II secretion: cAMP inhibits rPL-II secretion in vitro. *Eur. J. Endocrinol.* **133**, 342–346.
  29. Grummer, R., Hellmann, P., Traub, O., Soares, M. J., and Winterhager, E. (1996) Regulation of connexin 31 gene expression upon retinoic acid treatment in rat choriocarcinoma cells. *Exp. Cell Res.* **227**, 23–32.
  30. Kamei, T., Hamlin, G. P., Chapman, B. M., Burkhardt, A. L., Bolen, J. B., and Soares, M. J. (1997) Signaling pathways controlling trophoblast cell differentiation: Src family protein tyrosine kinases. *Biol. Reprod.* **57**, 1302–1311.
  31. Peters, T. J., Das, S. K., Dey, S. K., and Soares, M. J. (1997) Trophoblast giant cell endocrine differentiation via autocrine/paracrine mechanisms involving the epidermal growth factor receptor signaling pathway. 79th Ann. Meet. Endocrine Soc., Minneapolis, MN.
  32. Yamamoto, T., Chapman, B. M., and Soares, M. J. (1997) Protein kinase C-dependent and independent mechanisms controlling rat trophoblast cell DNA synthesis and differentiation. *J. Reprod. Fertil.* **111**, 15–20.
  33. Shida, M., Ng, Y. K., and Linzer, D. I. H. (1993) Transcriptional regulation of the placental lactogen genes in mouse trophoblast giant cells, in *Trophoblast Cells: Pathways for Maternal-Embryonic Communication* (Soares, M. J., Handwerker, S., and Talamantes, F., eds.), Springer-Verlag, New York, pp. 243–252.
  34. Shida, M., Ng, Y. K., Soares, M. J., and Linzer, D. I. H. (1993) Trophoblast-specific transcription from the mouse placental lactogen I gene promoter. *Mol. Endocrinol.* **7**, 181–188.
  35. Cross, J. C., Flannery, M. L., Blanar, M. A., Steingrimsson, E., Jenkins, N. A., Copeland, N. G., et al. (1995) Hxt encodes a basic helix-loop-helix transcription factor that regulates trophoblast cell development. *Development* **121**, 2513–2523.
  36. Ng, Y. K., Engel, J. D., and Linzer, D. I. H. (1994) GATA factor activity is required for the trophoblast-specific transcriptional regulation of the mouse placental lactogen I gene. *Development* **120**, 3257–3266.
  37. Yamamoto, T., Chapman, B. M., Clemens, J., Richards, J. S., and Soares, M. J. (1995) Analysis of cytochrome P450 side-chain cleavage gene promoter activation during trophoblast cell differentiation. *Mol. Cell. Endocrinol.* **113**, 183–194.
  38. Vuille, J.-C., Cattini, P. A., Bock, M. E., Verstuyf, A., Schroedter, I. C., Duckworth, M. L., and Friesen, H. G. (1993) Rat prolactin-like protein A partial gene and promoter structure: promoter activity in placental and pituitary cells. *Mol. Cell. Endocrinol.* **96**, 91–98.
  39. Arbogast, L. A., Soares, M. J., Robertson, M. C., and Voogt, J. L. (1993) A trophoblast-specific factor increases tyrosine hydroxylase activity in fetal hypothalamic cell cultures. *Endocrinology* **133**, 111–120.
  40. Arbogast, L. A., Soares, M. J., Tomogane, H., and Voogt, J. L. (1992) A trophoblast-specific factor(s) suppress circulating prolactin levels and increases tyrosine hydroxylase activity in tuberoinfundibular dopaminergic neurons. *Endocrinology* **131**, 105–113.
  41. Tomogane, H., Arbogast, L. A., Soares, M. J., Robertson, M. C., and Voogt, J. L. (1993) A factor(s) from a rat trophoblast cell line inhibits prolactin secretion in vitro and in vivo. *Biol. Reprod.* **48**, 325–332.
  42. Tomogane, H., Mistry, A. M., and Voogt, J. L. (1991) Late pregnancy and rat choriocarcinoma cells inhibit nocturnal prolactin surges and serotonin-induced prolactin release. *Endocrinology* **130**, 23–28.

43. Mathiasen, J. R., Tomogane, H., and Voogt, J. L. (1992) Serotonin-induced decrease in hypothalamic tyrosine hydroxylase activity and corresponding increase in prolactin release are abolished at midpregnancy and by transplants of rat choriocarcinoma cells. *Endocrinology* **131**, 2527–2532.
44. Sobis, H., Waer, M., and Vandeputte, M. (1996) Normal and malignant trophoblasts do not recruit granulated metrial gland cells. *Tumour Biol.* **17**, 13–19.
45. Flietstra, R. J. and Voogt, J. L. (1997) Lactogenic hormones of the placenta and pituitary inhibit suckling-induced prolactin (PRL) release but not the ante-partum PRL surge. *Proc. Soc. Exp. Biol. Med.* **214**, 258–264.
46. Rossant, J. and Tamura-Lis, W. (1981) Effect of culture conditions on diploid to giant-cell transformation in postimplantation mouse trophoblast. *J. Embryol. Exp. Morphol.* **62**, 217–227.
47. Hibbs, M. S., Hasty, K. A., Seyer, J. M., Kang, A. H., and Mainardi, C. L. (1985) Biochemical and immunological characterization of the secreted forms of human neutrophil gelatinase. *J. Biol. Chem.* **260**, 2493–2500.
48. Pierce, G. B. (1985) Carcinoma is to embryology as mutation is to genetics. *Am. Zool.* **25**, 707–712.

## Bone Marrow-Derived Mesenchymal Progenitor Cells

Brian Johnstone and Jung Yoo

### 1. Introduction

Primary monolayer cultures of marrow stromal cells, as they are referred to in the hemopoietic field, contain monocytes, macrophages, and endothelial cells (1,2). In addition, they contain precursor cells that can differentiate into multiple mesenchymal cell types (3–5). In vitro, the highly proliferative adherent fibroblast-like cells of marrow form colonies, which Friedenstein termed colony-forming units-fibroblast (CFU-f) (3). These cells are cultured as stromal support cells for hematopoietic cell differentiation, but the use of these cells for the investigation of mesenchymal tissue cell differentiation has become common. In recent years, there has been interest in using these cells for regeneration/repair of mesenchymal tissues (6,7).

It is clear that mesenchymal progenitor cells can be isolated from all mesenchymal tissues, but those of bone marrow are of particular interest because of the relative ease of harvest of both animal and human bone marrow. However, techniques for the purification of mesenchymal progenitor cells from the population of adherent marrow cells are not yet available, nor are methods for separating progenitor cells of different differentiation potentials. Thus, it is as yet unproven that there exist true mesenchymal stem cells within marrow, capable of both self-renewal and differentiation into all mesenchymal tissue types. This chapter outlines the protocol for the culture of mesenchymal progenitor cells from human bone marrow. The method outlined is based on that of Haynesworth et al. (8). Culture of these cells from the marrow of other species is referred to in the Notes section.

### 2. Materials

1. For harvest: Sterile heparin (100 U/1 mL of saline).
2. For fractionation of cells: Dulbecco's modified Eagles medium (DMEM)-low glucose, containing 10% fetal bovine serum (FBS). Percoll gradient: A 70% Percoll (Sigma, St. Louis, MO) gradient is made in a 50-mL centrifuge tube by mixing 22.05 mL of Percoll with 2.45 mL 1.5 M NaCl and 10.5 mL Tyrodes solution. The gradient is formed by centrifuging this solution at 20,000g for 15 min. The formed gradient can be stored at 4°C.
3. For cell counting: Acetic acid (3%).

### 3. Methods

1. Harvest of marrow from the iliac crest of human subjects (*see Note 1*): Introduce a sterile large-bore needle (greater than 14 gage) into either the anterior or posterior iliac spine after betadine preparation of the skin. Attach a 10-mL syringe containing 1 mL of heparinized saline to the needle. Aspirate 5 to 10 mL of marrow into the syringe and mix the aspirate with the heparinized saline by shaking. The syringe containing marrow is transported to the laboratory (*see Note 2*).
2. Fractionation of marrow on Percoll gradient (*see Note 3*): Express marrow from syringe into a 50-mL sterile centrifuge tube and add 25 mL of DMEM-Ig with 10% FBS. Centrifuge tube at 600g for 5 min. Take off supernatant and discard, leaving approx 5 mL above pellet to avoid aspirating the pellet of cells. Resuspend the cell pellet in the remaining solution by repeat pipeting and slowly layer it on top of the preformed Percoll gradient. Centrifuge the Percoll gradient tube containing the sample at 460g for 15 min. Approximately the upper third to half of the resulting fractionated mixture has a pink hue, the red blood cells will accumulate at the bottom of the tube, and there will be an opaque region in between. Aspirate the top 14 mL of the upper fraction, add it to 35 mL of medium and centrifuge at 600g for 5 min. After centrifugation, remove and discard supernatant. Resuspend cell pellet in 7 mL of medium. Remove an aliquot (20  $\mu$ L) and mix with 20  $\mu$ L of 4% acetic acid (*see Note 4*). Immediately count the nucleated cells with hemocytometer.
3. Plating of cells: Plate cells at  $20 \times 10^6$  per 100-mm dish in DMEM with 10% of a selected lot of FBS (*see Notes 5 and 6*) and culture in standard conditions (37°C, 5% CO<sub>2</sub>).
4. Cell culture: The first medium change is done after 4 d of culture. At this time, very few adherent cells will be seen on microscopic inspection (*see Note 7*). These few cells appear fibroblastic and form colonies within 7–10 d. The colonies will cover approx 80% of the dish after 14–18 d.
5. At this point, cells can be harvested and used for differentiation assays. The cells can be further expanded by passage and it has been shown that the progenitor cells with the ability for osteochondral differentiation are still present in the expanded population (*see Note 8*).

### 4. Notes

1. Other cancellous bone sites rich in red marrow can be used for marrow harvest. The iliac crest harvest is a routine out-patient procedure but it can also be done at the time of surgery, such as at the time of iliac crest harvest for spine fusion. For other species, the type of harvest can depend on whether there is a need for survival surgery for the animal donor. Marrow can be successfully harvested from the tibia or iliac crest of anesthetized rabbits with a minor incision and exposure of the chosen bone. The iliac crest is harvested in the same manner described for human iliac crest samples, except that prior exposure of the bone is necessary for appropriate positioning of the needle. For smaller species, such as rats and mice, sacrifice of the animal is required in order to harvest whole bones (generally, femur and tibia are used), and marrow is flushed out after dissection of the ends of the bone.
2. Human marrow can be left in the syringe overnight at 4°C without loss of cell yield.
3. Marrow can be plated out directly without prior gradient separation. However, this can affect the colony forming ability of the preparation. For other species, marrow is not routinely fractionated prior to plating. Other researchers have used Ficoll-Paque density gradients (Pharmacia Biotech, Inc., Uppsala, Sweden) to separate the mononuclear fraction (*9,10*).
4. Acetic acid will lyse the red blood cells to allow easier counting of the nucleated cells.
5. The selection of an appropriate lot of FBS is important for the growth of marrow-derived, culture plate adherent cells (*11*). Lennon et al. also suggest that the expansion of the

progenitor cell subpopulation is also affected by the serum lot used, and recommend that some type of differentiation assay be included in the serum screen.

6. Some researchers interested in the osteogenic differentiation of human marrow progenitor cells add dexamethasone and ascorbate to their primary cultures (**10,12,13**).
7. There is a wide range of estimates of the number of colony-forming cells per  $10^6$  nucleated cells (**13**). This may be related to the varied culture conditions used, including the batch of serum, as discussed in **Note 5**. Leaving the cells longer than 4 d before the first medium change does not add significantly to the yield of adherent cells.
8. Cells of other species have been shown to lose differentiation potential with expansion (**14**). Further purification of progenitor cells has been attempted by negative immunoselection to remove contaminating monocytes, lymphocytes, and endothelial cells (**10**). Alternatively, purification of progenitor cells has been reported with cell sorting of fresh marrow with an as-yet uncharacterized antigen found on progenitor cells (**15**).

## References

1. Fei, R.-G., Penn, P. E., and Wolf, N. S. (1990) A method to establish pure fibroblast and endothelial cell colony cultures from murine bone marrow. *Exp. Hematol.* **18**, 953–957.
2. Penn, P. E., Jiang, D. Z., Fei, R. G., Sitnicka, E., and Wolf, N. S. (1993) Dissecting the hematopoietic microenvironment. IX. Further characterization of murine bone marrow stromal cells. *Blood* **81**, 1205–1213.
3. Friedenstein, A. J. (1976) Precursor cells of mechanocytes. *Int. Rev. Cytol.* **47**, 327–355.
4. Owen, M. (1988) Marrow stromal stem cells. *J. Cell Sci.* **10(Suppl.)**, 63–76.
5. Caplan, A. I. (1991) Mesenchymal stem cells. *J. Orthop. Res.* **9**, 641–650.
6. Wakitani, S., Goto, T., Pineda, S., Young, R., Mansour, J., Caplan, A., and Goldberg, V. (1994) Mesenchymal cell-based repair of large, full-thickness defects of articular cartilage. *J. Bone Jt. Surg.* **76A**, 579–592.
7. Grande, D. A., Southerland, B. S., and Manji, R. (1995) Repair of articular defects using mesenchymal stem cells. *Tissue Eng.* 345–352.
8. Haynesworth, S. E., Goshima, J., Goldberg, V. M., and Caplan, A. I. (1992) Characterization of cells with osteogenic potential from human marrow. *Bone* **13**, 81–88.
9. Kim, C.-H., Cheng, S.-L., and Kim, G.-S. (1997) Lack of autocrine effects of IL-6 on human bone marrow stromal osteoprogenitor cells. *Endocrin. Res.* **23**, 181–190.
10. Rickard, D. J., Kassem, M., Hefferan, T. E., Sarkar, G., Spelsberg, T. C., and Riggs, B. L. (1996) Isolation and characterization of osteoblast precursor cells from human bone marrow. *J. Bone Min. Res.* **11**, 312–324.
11. Lennon, D. P., Haynesworth, S. E., Bruder, S. P., Jaiswal, N., and Caplan, A. I. (1996) Human and animal mesenchymal progenitor cells from bone marrow: identification of serum for optimal selection and proliferation. *In Vitro Cell. Dev. Biol.* **32**, 602–611.
12. Beresford, J. N., Joyner, C. J., Devlin, C., and Triffitt, J. T. (1994) The effects of dexamethasone and 1,25-dihydroxyvitamin D<sub>3</sub> on osteogenic differentiation of human marrow stromal cells in vitro. *Arch. Oral Biol.* **39**, 941–947.
13. Majors, A. K., Boehm, C. A., Nitto, H., Midura, R. J., and Muschler, G. F. (1997) Characterization of human bone marrow stromal cells with respect to osteoblastic differentiation. *J. Orthop. Res.* **15**, 546–557.
14. Goshima, J., Goldberg, V. M., and Caplan, A. I. (1991) The osteogenic potential of culture-expanded rat marrow mesenchymal cells assayed in vivo in calcium phosphate ceramic. *Clin. Orthop.* **262**, 298–311.
15. Simmons, P. J. and Torok-Storb, B. (1991) Identification of stromal cell precursors in human bone marrow by a novel monoclonal antibody, STRO-1. *Blood* **78**, 55–62.

## Identification, Characterization, and Differentiation of Human Prostate Cells

Parmender P. Mehta, Carlos Perez-Stable,  
Bernard A. Roos, and Mehrdad Nadji

### 1. Introduction

The prostate is organized as a classical exocrine gland and is composed of a complex array of ductal-acinar structures embedded in stroma. The ducts and acini are lined by the secretory and nonsecretory epithelial cells, whereas stroma comprises of smooth muscle cells, fibroblasts, and blood vessels. The major secretory cells in the prostate are the luminal epithelial cells, which face the lumen of ducts and acini and supply approx 30% of the seminal fluid components. The nonsecretory epithelial cells, called basal epithelial cells, lie below the luminal epithelial cells and rest on the basement membrane, which separates the prostatic epithelium from the surrounding stroma (1,2). The luminal epithelial cells are highly differentiated cells that express prostate-specific antigen (PSA; ref. 3–7), cytokeratins 8 and 18 (8,9), and the nuclear androgen receptor (AR; ref. 2 and 10). In contrast to luminal epithelial cells, basal epithelial cells do not express PSA and AR but express cytokeratins 5 and 14 (8,9), P-cadherin (11), Bcl2 (12), and *c-met* (13,14). The function of basal epithelial cells during prostate morphogenesis is unknown, although a putative stem cell role has been suggested (15). Although prostatic epithelium is formed of two major compartments comprising basal and luminal cells, it also contains a minor component of cells of unknown function with distinct neuroendocrine characteristics, which can be distinguished from surrounding epithelial cells as they express neuroendocrine markers, such as chromogranin A and neurone-specific enolase (16,17). The smooth muscle cells, fibroblasts, and the endothelial cells in the blood vessels of prostate stroma can be distinguished from one another, and from epithelial cells, as each cell type expresses a different set of biochemical markers (Table 1).

Prostate morphogenesis and differentiation of epithelial cells are governed by reciprocal stromal-epithelial interactions, even though differentiation of prostate pertains to the organization of the epithelial, and not stromal, cells within the gland (2,10). Because both prostatic epithelium and stroma are composed of distinct and separate cell populations, where each population may play a unique role, the proliferation and differentiation of epithelial cells of the human prostate are poorly understood (2,10,15).

**Table 1**  
**Expression of Markers by Cell Type**

Cell type	Markers
Epithelial <sup>a</sup>	
Basal	BCL-2; Met; CK 5, 14; P-Cd
Luminal	AR; PSA; CK 8,18
Neuroendocrine	CgA; NSE
Stromal <sup>b</sup>	
Smooth muscle	$\alpha$ -SM actin; desmin; AR
Fibroblasts	vimentin
Endothelial	Factor VIII

<sup>a</sup>AR = androgen receptor; CK = cytokeratin; CgA = chromogranin A; NSE = neuronal-specific enolase; P-Cd = P-cadherin; PSA = prostate-specific antigen; SM = smooth muscle.

<sup>b</sup>Expression of cytokeratins 5 and 14, P-cadherin and Bcl-2, and lack of expression of AR and PSA, is a unique feature of basal cells. On the other hand, luminal cells express PSA, cytokeratins 8 and 18, and AR, but not cytokeratins 5 and 14, P-cadherin, and Bcl-2. Neuroendocrine cells express neurosecretory molecules such as chromogranin A, serotonin, and neuronal-specific enolase. Smooth muscle cells express desmin and  $\alpha$ -smooth muscle actin, fibroblasts, vimentin. Prostate epithelial cells do not express these proteins. Factor VIII, also called von Willebrandt Factor, is a 220-kD protein secreted by the endothelial cells and a reliable marker for identifying endothelial cells (24).

Prostate epithelial cells are notorious with regard to expression of PSA and AR because the expression of these markers has been found to be dependent on the cell strain, passage number, and culture conditions (19,25). Interestingly, the expression of these markers in cell culture can be induced by treatment with dihydrotestosterone (an androgen) and 1,25 dihydroxyvitamin D<sub>3</sub> (reviewed in ref. 26). Because PrEGM may also allow the growth of both basal and luminal epithelial cells, it is likely that these cultures will consist of a mixture of these cell types (for example, see Fig. 1). For additional reading, the reader is referred to excellent reviews by Webber et al. (21–23) and Peehl (19).

Although the primordial cell type that gives rise to basal, luminal, and neuroendocrine epithelial cells during normal and abnormal prostate morphogenesis and differentiation has not yet been identified, the expression of PSA has been unequivocally accepted as a marker of differentiation for both normal and malignant epithelial cells of the prostate (3–7,18,19). However, the most aggressive forms of prostate cancer are composed of highly undifferentiated cells, which express little or no PSA (7,18). Therefore, biochemical markers that can distinguish different types of prostate cells are important for a better understanding of prostate morphogenesis, differentiation, and the etiology of prostate cancer. In this chapter we describe cell culture protocols for growing epithelial cells from normal and malignant prostate tissues and for studying various biochemical markers that distinguish between cell types by immunocytochemical and molecular methods.



## 2. Materials

### 2.1. Cell Culture

1. Prostate epithelial cell growth medium (PrEGM): This is a serum-free medium formulated to grow basal and luminal epithelial cells derived from normal and malignant human prostate tissues (**19**). This medium is purchased from Clonetics (San Diego, CA), either as the complete formulation with a shelf life of 1 mo at + 4°C or as a basal medium plus frozen supplements with a shelf life of 6 mo at + 4°C and -70°C, respectively.
2. 10X phosphate-buffered saline (PBS): Dissolve 80 g NaCl, 2 g of KCl, 14.4 g of Na<sub>2</sub>HPO<sub>4</sub>, and 2.4 g of KH<sub>2</sub>PO<sub>4</sub> in 800 mL of distilled water. Adjust the pH to 7.2 and volume to 1 L with distilled water. Sterilize by autoclaving, aliquot in 100-mL lots, and store at + 4°C. Dilute 10X with autoclaved distilled water before use. 10X PBS is 0.1 M Na<sub>2</sub>PO<sub>4</sub>, 1.3 M NaCl, and 30 mM KH<sub>2</sub>PO<sub>4</sub>.
3. Trypsin-EDTA: 0.25% trypsin (w/v) and 0.01% EDTA as the disodium salt (w/v), pH 7.4. Purchase trypsin (Crystalline, Type III) and EDTA from Sigma Chemical Co. (St. Louis, MO). Stock solution of trypsin is prepared at 2.5 mg/mL in 10X PBS. Filter, sterilize, and store at -20°C in 2-mL aliquots. Prepare stock solution of EDTA at 0.1 µg/mL in distilled water. Filter, sterilize, and store in 2-mL aliquots at + 4°C. To prepare 20 mL of working trypsin-EDTA solution, add 2 mL of each of the stock solutions (trypsin and EDTA) to 16 mL of autoclaved distilled water, mix, and use. It is important to use crystalline trypsin for dissociation of primary cultures of prostate epithelial cells to optimize cell viability.
4. Hank's Balanced Salt Solution (HBSS): Purchase from Gibco-BRL (Gaithersburg, MD).
5. Dispase (Grade 1): Purchase from Roche Diagnostics (Indianapolis, IN). It is a neutral protease, and the working solution is prepared in HBSS at 5 U/mL, sterile-filtered, and stored at -20°C in 5-mL aliquots. If a precipitate forms upon thawing, centrifuge and use the supernatant (which remains active) for dissociating prostate tissues.

### 2.2. Immunocytochemistry and Immunohistochemistry

1. Buffers and stock solutions:
  - a. 1 M Na<sub>2</sub>PO<sub>4</sub> buffer; pH 7. Prepare 1 M stock solutions of Na<sub>2</sub>HPO<sub>4</sub> and NaH<sub>2</sub>PO<sub>4</sub> by dissolving 142 g and 120 g, respectively, in 1 L of distilled water. Mix 57.7 mL of 1 M stock solution of Na<sub>2</sub>HPO<sub>4</sub> and 42.3 mL of 1 M stock solution of NaH<sub>2</sub>PO<sub>4</sub> to obtain 100 mL of 1 M Na<sub>2</sub>PO<sub>4</sub> buffer at pH 7. Aliquot after autoclaving in 100-mL lots in capped bottles. Store at room temperature.
  - b. 10X PBS: Prepare as described in **Subheading 2., step 2** above.
  - c. 5X Multipurpose solution (MPS): Add 20 mL of normal goat serum, or serum from the animal in which your secondary antibody has been raised, to 29 mL of autoclaved distilled water. Add 1 mL of 10% sodium azide solution and 50 mL of 10X PBS. Store at + 4°C (*see Note 1*). Sodium azide is poisonous. Avoid inhalation of powder and use caution when handling the liquid. Normal sera from goat, rabbit, and donkey can be purchased either from Vector Laboratories (Burlingame, CA) or from Jackson Immuno Research Laboratories, Inc. (West Grove, PA).
  - d. 20% Triton X-100 and 20% Tween-20 solutions: In a 100-mL beaker, add 20 mL of Triton X-100 or Tween-20, 10 mL of 10X PBS, and 70 mL of distilled water. Stir for 2 h in a magnetic stirrer. Aliquot in 15-mL plastic tubes and store at room temperature protected from light. Working solutions for immunocytochemical analyses are prepared more conveniently and accurately from 20% stock solutions of detergents than from full-strength (100%) solutions.

- e. Blocking solution (BS): In a beaker, add 20 mL of 5X MPS, 1 mL of 20% Triton X-100 solution (0.2% final concentration), and 79 mL distilled water. Mix well. Aliquot in 15-mL plastic tubes and store at + 4°C (see **Notes 1** and **2**).
  - f. Immunostaining solution (IMS): Add 20 mL of 5X MPS, 78 mL distilled water, and 2 mL of 20% Tween-20 solution (0.4% final concentration). Mix well. Aliquot in 15-mL plastic tubes and store at + 4°C. Tween-20 is less denaturing than Triton X-100 (see **Notes 1** and **2**).
2. Antibodies: The following antibodies have been successfully used by us to detect the indicated protein in human samples:
- a. Monoclonal anti-Cytokeratin 18, clone CY-90 (Sigma).
  - b. Monoclonal anti-Cytokeratin 8, clone M20 (Sigma).
  - c. Monoclonal anti-Cytokeratin 5, clone 903 (Enzo Biochemicals, New York, NY).
  - d. Monoclonal anti-Cytokeratin 14, clone NCL-LL002 (Novocastra Laboratories, Ltd; Newcastle upon Tyne, UK; US Distributor, Vector Laboratories).
  - e. Monoclonal antivimentin, clone V9 (Sigma).
  - f. Monoclonal antismooth muscle actin, clone 1A4 (Sigma).
  - g. Two antidesmin antibodies: A rabbit polyclonal (Sigma); and a mouse monoclonal, clone D33 (Dako, Carpinteria, CA).
  - h. Two anti-PSA antibodies: A rabbit polyclonal and a mouse monoclonal, clone ER-PR8 (Dako).
  - i. Two antichromagranin antibodies: A rabbit polyclonal and a mouse monoclonal, clone DAK-A3 (Dako).
  - j. Two antineurone-specific enolase antibodies: A rabbit polyclonal and a mouse monoclonal, clone BBS/NC/VI-H14 (Dako).
  - k. Fluorochrome- or enzyme-linked secondary antibodies raised in various species obtained from Jackson Immuno Research Laboratories, Inc.
  - l. Vectastain ABC Kits. The enzyme detection systems based upon the activity of horseradish peroxidase are available from Vector Laboratories and supplied in various kit forms. A wide variety of substrate kits are provided as separate items with seven different peroxidase substrates. Instructions to use various reagents in the kits are provided by the manufacturer, and reagents in the kits are stable for several months when stored at + 4°C.
3. Fixatives:
- a. 2% paraformaldehyde in 0.1 M Na<sub>2</sub>PO<sub>4</sub> buffer. Heat 47 mL of distilled water in a beaker to approx 65°C and, in a fume hood, add 10 g paraformaldehyde and 20 µL of 10 M NaOH. Stir until the solution clears. Cool and filter through Whatmann 3 MM paper. This is 20% stock solution, which can be stored up to 1 mo at + 4°C without significant alterations in its fixing properties. To prepare 10 mL of 2% working fixative, add 1 mL stock solution of paraformaldehyde to 8 mL of water followed by 1 mL of 1 M Na<sub>2</sub>PO<sub>4</sub> buffer (pH 7.0). Because of the large buffering capacity of 0.1 M NaPO<sub>4</sub> buffer and thus the better control of pH (see **Note 3**), this fixative preserves the morphology of cells better than that prepared in PBS, because of the better control of pH (see **Note 3**).
  - b. Histochoice: Purchase from Amresco Inc. (Solon, OH). This noncross-linking fixative is designed as a substitute for paraformaldehyde or formalin and we have used this successfully with most antibodies because the epitopes of the antigens recognized by various antibodies are not destroyed even when cells are kept in this fixative for 3 d (see **Note 3**).

### **2.3. Reverse Transcription Polymerase Chain Reaction (RT-PCR)**

Purchase Perkin-Elmer Amp tubes and RT-PCR kit components from Perkin-Elmer (Foster City, CA). We have also used deoxyribonucleotides (dNTPs), random hexamers (Roche Diagnostics), Rnasin (an inhibitor of RNase), and murine leukemia virus (MuLV) reverse transcriptase from Promega (Madison, WI), purchased separately, with these kits.

### **2.4. RNase Protection Assay (RPA)**

1. Diethylpolycarbonate (DEPC)-treated distilled water. Purchase DEPC from Sigma Chemical Co. Add 2 mL of DEPC to 2 L of distilled water, mix vigorously, let stand at room temperature overnight, aliquot in 500-mL lots, and autoclave for 20 min in liquid cycle. Store at room temperature.
2. Trizol reagent: It is used for extracting total RNA from tissues and cells. Purchase from Gibco-BRL.
3. Hybridization buffer: Prepare 5X hybridization buffer with the following composition: 200 mM PIPES, pH 6.4, 2 M NaCl, 5 mM EDTA. Prepare 10 mL of 1X hybridization buffer by mixing 8 mL of ultrapure formamide (Sigma) and 2 mL of 5X hybridization buffer. Aliquot in 1-mL lots and store at  $-20^{\circ}\text{C}$ .
4. RNase cocktail: Purchase from Ambion (Austin, TX). It is a DNase-free mixture of two ribonucleases, RNase A (500 U/mL), and RNase T<sub>1</sub> (20,000 U/mL).
5. RNA suspension buffer: 80% ultrapure (deionized) formamide, 0.1% Bromophenol Blue, and 0.1% Xylene cyanol (Sigma).

## **3. Methods**

### **3.1. Procurement of Prostate Tissue**

All steps pertaining to cell culture should be carried out under sterile conditions. Adult human prostate tissues should be procured from autopsies, cystectomies, and radical prostatectomies. Because epithelial cells established from normal, benign, and malignant human prostates cannot be distinguished from one another morphologically (19,20), it is recommended that a pathologist familiar with the histology of the prostate be available for tissue acquisition and its subsequent analysis prior to establishment of cultures.

Collect prostate specimens and place them immediately in 50-mL tubes containing 20 mL HBSS. Prostate tissues can be kept in HBSS for 4–16 h at  $+4^{\circ}\text{C}$  without significant loss in viability.

### **3.2. Establishment of Primary Cultures**

1. Maintaining sterile precautions, transfer prostate tissue specimens from 50-mL tubes to 10-cm Petri dishes, mince tissues to approx 1 mm<sup>3</sup> with forceps and scissors, transfer to 15-mL tubes containing 5 mL of HBSS at room temperature, and centrifuge at 500g for 5 min.
2. Discard supernatant, add 5 mL of HBSS, and repeat **step 1** twice.
3. Transfer tissue pieces to 50-mL Erlenmeyer's flask. Add 25 mL (for 25–30, 1-mm<sup>3</sup> tissue pieces) of HBSS containing Dispase (5 U/mL), cover flask loosely with sterile aluminum foil, and rock gently for 12–18 h at  $37^{\circ}\text{C}$  in a 95% air/5% CO<sub>2</sub> humidified incubator.
4. With a wide-mouthed pipet, transfer the contents of flask to 15-mL tubes (approx five 1-mm<sup>3</sup> tissue pieces per tube). Add 10 mL of HBSS to flask, swirl, and transfer the remaining fragments to 15-mL tubes. Centrifuge 3 min at 500g and discard supernatant.

5. Resuspend pellet, which may have cell clumps of different sizes, in 5 mL of HBSS and pipet vigorously to disperse larger clumps. Centrifuge once as in **step 4**.
6. Resuspend pellet from each 15-mL tube in 10 mL PrEGM. Count cells in hemocytometer to determine roughly the total number of cells obtained, and transfer cell suspension, together with cell clumps, to 2–4 75 cm<sup>2</sup> flasks (approx 10<sup>6</sup> cells per flask in 15 mL of PrEGM). Incubate at 37°C in a 95% air/5% CO<sub>2</sub> humidified incubator.
7. After clumps or individual epithelial cells have attached to the culture surface, which usually takes 3–4 d, carefully aspirate half of the spent PrEGM, add 15 mL of fresh PrEGM, and incubate flasks until they become semiconfluent.
8. Aspirate and add 20 mL of fresh PrEGM. After 24 h, remove PrEGM, trypsinize, remove aliquot for counting, and split cells into two parts, one for frozen storage, one for continuing culture. For freezing, the cells are suspended in freezing medium (20% PrEGM, 70% fetal bovine serum, and 10% cell culture grade DMSO) at a density of 10<sup>6</sup> cells per mL. For culture, the remaining cells are plated in 75-cm<sup>2</sup> flasks, at  $2 \times 10^5$  cells per flask in 15 mL of fresh PrEGM (*see Note 4*).

### 3.3. Characterization of Primary Cell Cultures

An ideal method to obtain a pure population of epithelial cells is cloning. However, it is not suitable for the primary cultures of human prostate epithelial cells because cells from isolated clones will senesce before a sufficient number is generated for further studies. Although PrEGM has been nutritionally optimized to allow the selective growth of human prostate epithelial cells, the identity and purity of primary cultures established must be checked by looking for the presence of other stromal cell types such as fibroblasts, smooth muscle, and endothelial cells (*see Fig. 1*). Moreover, the epithelial origin of such cells must be verified. Smooth muscle cells in cultures can be identified by the presence of desmin and  $\alpha$ -smooth muscle actin, both of which are not expressed by normal and malignant prostate epithelial cells (*19,21–23*). Similarly, the presence of endothelial cells and fibroblasts can be assessed by studying, respectively, the expression of factor VIII and vimentin (*19,21–24*). **Table 1** summarizes various biochemical markers that have been used to identify and characterize different cell types in prostate in vivo and in vitro, and **Fig. 1** shows the morphology of epithelial cells derived from normal and malignant prostates. We describe below immunocytochemical and cell-molecular biological methods to study the expression of various markers in basal and luminal prostate epithelial cells.

#### 3.3.1. Immunocytochemical Detection of Markers in Cultured Cells

1. Place sterilized, clean glass cover slips in six-well clusters.
2. Trypsinize freshly confluent cells and seed on cover slips in 2 mL of PrEGM at a density of  $3 \times 10^4$  cells per well. Although prostate epithelial cells can attach to glass cover slips, their adherence is increased when cover slips are coated with poly L-lysine or poly D-ornithine at 10  $\mu$ g/mL in PBS for 4–16 h. Purchase stock solutions of poly L-lysine or poly D-ornithine from Sigma Chemical Co. and use as per manufacturer's instructions.
3. Grow cells to the same density (cells per cm<sup>2</sup> of the surface area) used for biochemical experiments, for example, as used for the RPA analysis. It is also important to keep the ratio of cell number per cm<sup>2</sup> to volume of the medium constant because the expression of some markers is influenced by the culture conditions (*see footnote to Table 1*).

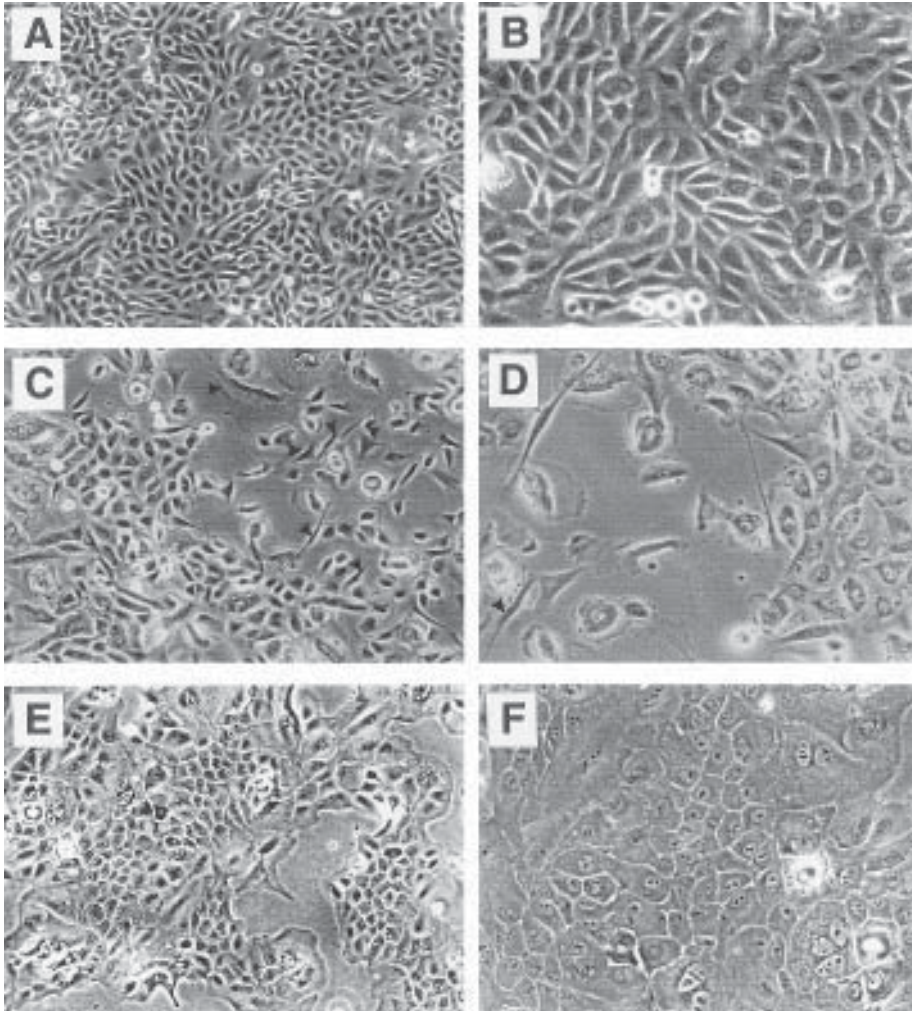

Fig. 1. Morphology of human prostate epithelial cells in primary culture. **A–D**, Normal; **E,F**, Malignant. **A,B**, Pure cultures, **C,D**, Cultures contaminated with the fibroblasts (arrows) and smooth muscle cells (arrowheads). Note that cells established from both normal prostate and prostate tumors appear epithelial. Magnification:  $\times 150$  (**A**, **C**, and **E**) and  $\times 300$  (**B**, **D**, and **F**).

4. Once confluent, cells should receive fresh medium daily. Do not let cells remain confluent for more than a day without fresh medium changes.
5. Remove PrEGM gently and rinse twice with warm PBS. If cells appear to be less adherent to glass cover slips, add PBS carefully from the sides to avoid their dislodging.
6. Fix cells in 1 mL of 2% paraformaldehyde, prepared as described above (**Subheading 2.2., step 3a**), for 5–15 min (*see also Note 3*).
7. Remove fixative and rinse cells twice with 1 mL of PBS at room temperature, 5–10 min each on a rocking platform, to remove excess of fixative. A trace amount of paraformaldehyde can interfere with the binding of antibody to the antigen in subsequent steps.
8. Permeabilize and block cells for 30 min in MPS containing 0.2% Triton X-100 at room temperature (*see Notes 1 and 2*).

9. Remove permeabilization and blocking solution and incubate 60 min at room temperature with the primary antibody diluted appropriately in MPS containing 0.4% Tween-20 (*see Note 5 and also Notes 1 and 2*).
10. Remove the antibody and store in the refrigerator at +4°C. The diluted antibody solution can be used at least twice without the loss of sensitivity (*see Note 6*).
11. Wash cells three times (10–15 min each) with PBS containing 0.25% Tween-20 on a rocking platform.
12. Incubate 60 min with the secondary antibody diluted appropriately in MPS containing 0.4% Tween-20. Use fluorochrome- and/or horseradish peroxidase-conjugated goat antimouse or antirabbit secondary antibodies (*see Notes 1 and 5*).
13. Remove the secondary antibody and wash cells three times (10–15 min each) with PBS containing 0.25% Tween-20 on a rocking platform.
14. Wash cover slips once with water to remove salts, which upon drying, interfere with the microscopic analysis.
15. Mount cover slips on glass slides with cell side facing down using commercially available aqueous mounting media containing antifade (*see Note 7*). Dry slides, protected from light, overnight at room temperature, and apply nail polish at the edges of the cover slips before storing them at +4°C. Alternatively, develop color using DAB as a substrate for horseradish peroxidase (available in kit form from Vector Laboratories). Wash slides, dehydrate, and mount them in DPX as described above.

### **3.4. Detection of Immunocytochemical Markers in Formaldehyde-Fixed Archival Tissue Sections**

As alluded to earlier, prostate differentiation pertains to organization, and arrangement, of epithelial cells within the ducts and acini of the prostate, which forms the prognostic basis for distinguishing prostate tumors of different histological grades from normal prostate (18). Morphogenesis and differentiation of rat and mouse prostate have been studied extensively because organs at different stages of development can be procured easily (2,10). Because morphogenesis of human prostate differs significantly from rodent prostates in embryological origin, adult anatomy, and etiology of the disease (2), and procurement of both normal and cancerous prostate tissues is difficult, it is more convenient and customary to study various markers of differentiation in archival paraffin sections obtained from the surgical pathology archives. The tissues obtained from various surgical archives are usually fixed in 10% formalin-saline solution for 10–16 h and processed through paraffin wax. However, if the arrangement of obtaining fresh surgical prostate specimen has been made with the resident surgeon, such tissues, ideally, should be fixed in 2% paraformaldehyde in as lifelike a manner as soon as possible so that the effects of autolysis on morphology and arrangement of cells within tissues are minimized. The duration of fixation will depend upon the size of the tissues. Once the tissues are fixed, prepare paraffin blocks and cut sections according to standard procedures (27–32).

1. Use 3- to 4- $\mu$ M thin paraffin sections on albuminized glass slides and circle them with a nonadhesive PAP pen, which permits concentration of the reagents on the sections and reduces the cost of the primary and secondary antibodies.
2. Place slides for 12–18 h in a 56°C oven, although considerably less time may be required to melt the paraffin.

3. Deparaffinize in two dishes of xylene for 3 min each and rehydrate the sections in decreasing grades of ethanol, twice for 2 min each of two sets of dishes containing 100, 95, 90, 85, and 70% ethanol.
4. Place slides in a 1:4 solution of 3% hydrogen peroxide in methanol (made fresh) for 30 min to block endogenous peroxide (*see Note 8*) and rinse in running tap water for 30 min.
5. After washing slides for 5 min in PBS, dry excess PBS with absorbent paper without drying the sections within the circle.
6. Block sections for 30 min with MPS containing 0.2% Triton X-100 in a humidity chamber. Discard excess blocking solution by shaking slides gently, and dry excess of MPS as described in **step 5**.
7. Add drops of appropriately diluted primary antibody in MPS containing 0.4% Tween-20 to sections so that the solution is contained within the circles. Incubate 60 min at room temperature. Appropriate dilutions of the primary antiserum should be determined by checkerboard studies as described in **Note 5**.
8. Flush slides with PBS using a squeeze bottle while holding them at an angle (avoid direct flushing of the tissue sections) and wash in three changes of PBS, each 10 min.
9. Add drops of biotinylated secondary antibody to cover the circled sections and incubate for 30 min at room temperature. The proper dilution of the secondary antibody should be determined by checkerboard studies as described in **Note 5**.
10. Repeat **step 8**, dry slides, place them in the humidity chamber, add drops of avidin-biotin peroxidase complex (Vector Laboratories) according to the manufacturer's instructions.
11. Incubate 30 min, flush slides with PBS, wash in three changes of PBS for 10 min each. Dry and place slides on a staining rack.
12. Add drops of chromogenic substrate (diaminobenzidine, DAB; Vector Laboratories) prepared according to the manufacturer's instructions and incubate for 3–8 min or until the desired color is achieved.
13. Flush slides with tap water and wash in running tap water for 5 min.
14. Counterstain with hematoxylin (*see Note 9*), wash slides in running tap water for 5 min and dehydrate sections with increasing grades of ethanol, twice for 2 min in each of the 70, 85, 90%, and absolute alcohol.
15. Clear slides with xylene twice, each time for 2 min. Place cover slips on sections using an appropriate mounting medium.

An example of typical immunostaining for PSA and connexin43, a protein localized at cell–cell contact areas, is shown in **Fig. 2**.

### **3.5. Detection of Epithelial Markers by Reverse Transcription (RT)-PCR Assay**

Because of the limited availability and small size of normal and pathogenetic prostate tissues, RT-PCR is the most sensitive and the best method to characterize gene expression. PSA is expressed by the majority of luminal epithelial cells established from normal prostate glands, and its expression often continues in cells derived from malignant prostate tissues although the expression becomes heterogenous (**4,5,18**). We describe below an RT-PCR based assay to analyze the expression of PSA, cytokeratin 5, and cytokeratin 8. Similar techniques can be used to study the expression of other markers.

1. Primers: The sequences of the forward and reverse primers for PSA, cytokeratins 8 and 18, and human  $\beta_2$ -microglobulin are as follows:

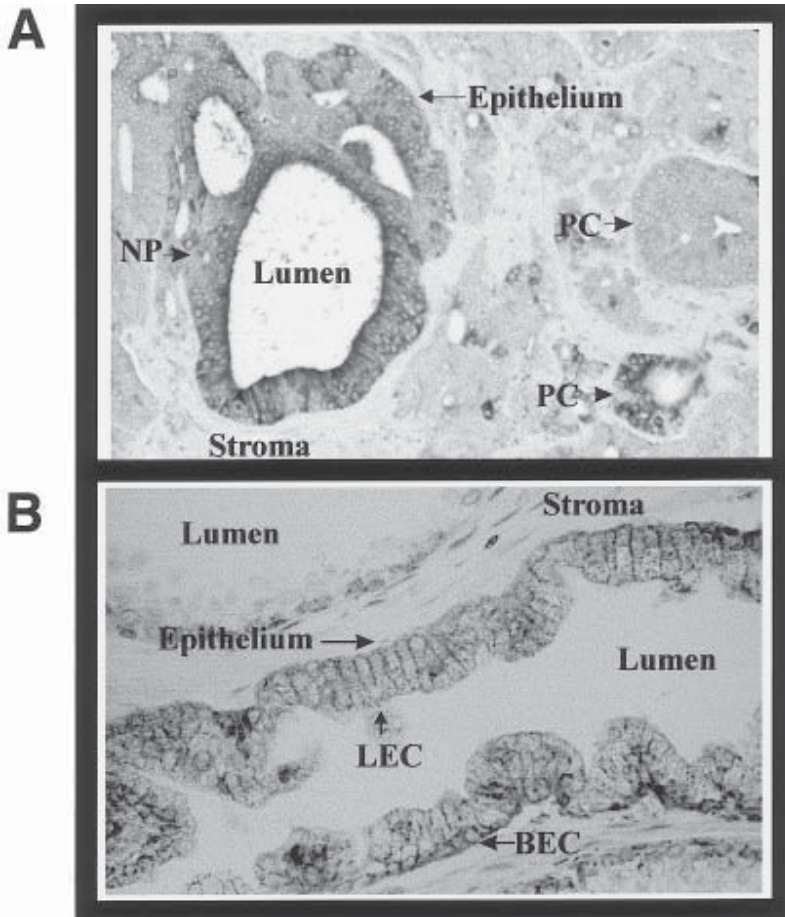

Fig. 2. (See color plate 10 appearing after p. 262.) Detection of prostate-specific antigen (PSA) and a membrane protein (connexin43) in archival paraffin sections of human prostate tumors. Immunostaining for (A) PSA and (B) connexin43. Note that immunostaining (intense brown color) is confined to epithelium. As expected, immunostaining in (A) is observed throughout the cytoplasm of all cells, whereas in (B) it is confined to the areas of cell-cell contact. The nuclei, which are counterstained with hematoxylin, appear blue. Sections were immunostained according to the method mentioned in the text. NP = normal part of the tumor. PC = malignant part of the tumor. LEC = luminal epithelial cells. BEC = basal epithelial cells.

- a. PSA: Forward: 5'-ACTGCATCAGGAACAAAAGCGTGA-3'; Reverse: 5'-CGCACA CACGTCATTGGAAATAAC-3'. The size of the amplified fragment is 361 bp (33).
- b. Cytokeratin 5: Forward: 5'-GTGGAGCTGGAGGCCAAGGTTGATGCA-3'; Reverse: 5'-GCCACTGCTTGCCTGAAGCCAGAGC-3'. The size of the amplified fragment is 700 bp (34).
- c. Cytokeratin 8 (49-248): Forward (19 mer): 5'-ATCAACTTCCTCAGGCAGC-3'; Reverse (24 mer): 5'-TCATACTTGATCTGGTACATGCTC-3'. The size of the amplified fragment is 200 bp (35). Human  $\beta_2$ -microglobulin (internal control oligonucleotide primers): Forward: 5'-ACCCCACTGAAAAAGATGA-3'; Reverse: 5'-ATC TTCAAACCTCCATGATG-3'. The size of the amplified fragment is 120 bp (36).



2. Isolate total RNA using Trizol reagent from prostate tissues and cells and treat it with RNase-free DNase (Ambion), which we highly recommend, to remove possible DNA contamination (*see Note 10*). In an RNase-free Eppendorf test tube, mix 20  $\mu\text{g}$  of total RNA, 10  $\mu\text{L}$  of 10X DNase buffer (supplied with the Perkin-Elmer kit), and bring volume to 100  $\mu\text{L}$  with DEPC-treated distilled water. Tap tubes gently, add 5  $\mu\text{L}$  (10 U) of DNase, and incubate at 37°C for 30 min followed by incubation for 5 min at 75°C to inactivate the DNase.
3. Extract samples with equal volume of phenol/chloroform, precipitate RNA from the aqueous layer with two volumes of ethanol, and resuspend in 21  $\mu\text{L}$  DEPC-treated distilled water (*see Notes 10 and 11*).
4. Adjust the concentration of the precipitated RNA to 0.5  $\mu\text{g}/\mu\text{L}$  with DEPC-treated distilled water, aliquot in 3- $\mu\text{L}$  lots into several RNAs-free Eppendorf tubes (0.5 mL), and store at -80°C. Once the tubes are thawed, they should be used or discarded. Do not reuse RNA for RT-PCR once the tubes have been thawed.
5. Reverse transcription (RT). Using Perkin-Elmer Gene Amp tubes and RT-PCR kit components, prepare RT master mix containing the following components:
  - a.  $\text{MgCl}_2$ , 5 mM.
  - b. PCR buffer II.
  - c. dATP, dCTP, dGTP, dTTP, 1 mM.
  - d. RNasin, 1 U.
  - e. MuLV RT, 2.5 U.
  - f. Random hexamers, 2.5 mM.
  - g. DNase-treated RNA (add last), 0.5  $\mu\text{g}$ .
6. Adjust the total volume of each sample to 10  $\mu\text{L}$  with DEPC-treated distilled water. We highly recommend using a negative control, which is RT master mix with RT, but without RNA. Cover with mineral oil and incubate at 42°C for 1 h in a thermocycler.
7. PCR. Prepare PCR master mix in PCR buffer II containing the following reagents:
  - a.  $\text{MgCl}_2$ , 2 mM.
  - b. AmpliTaq polymerase, 1.25 U.
  - c. Primers (forward and reverse), 250 ng each per reaction.

Add 40  $\mu\text{L}$  of PCR master mix to RT tubes prepared above (**step 5**) and amplify using the following conditions: 2 min 94°C, 1 cycle; 1 min 55°C (annealing), 2 min 72°C (extension), 1 min 94°C (denaturing), 35 cycles, followed by extension for 7 min 72°C, 1 cycle.
8. Run 5–10  $\mu\text{L}$  of the final reaction mixture in 2% agarose minigel. Alternatively, PCR products can be labeled with the addition of  $^{32}\text{P}$ -dCTP (1  $\mu\text{Ci}$ ) and analyzed on (polyacrylamide) gels for more sensitive detection.

An example of typical PSA PCR product is shown in **Fig. 3** (top box).

### 3.6. RNase Protection Assay (RPA)

#### 3.6.1. Plasmids

Plasmid pPSA-Bluescript-KS contains a cDNA fragment covering sequences 183-544 of human PSA cDNA, amplified using PSA primers mentioned above, and cloned into pBluescript-KS (Promega). Plasmid phAR-HE0.7/BS contains a cDNA fragment covering sequences 1849-2562 of human androgen receptor cDNA (37). The construction of these plasmids has been described (38), and they can be obtained from Dr. Carlos Perez-Stable. For internal control, we use plasmid pTRIPLESRIPT-GAPDH or pTRI

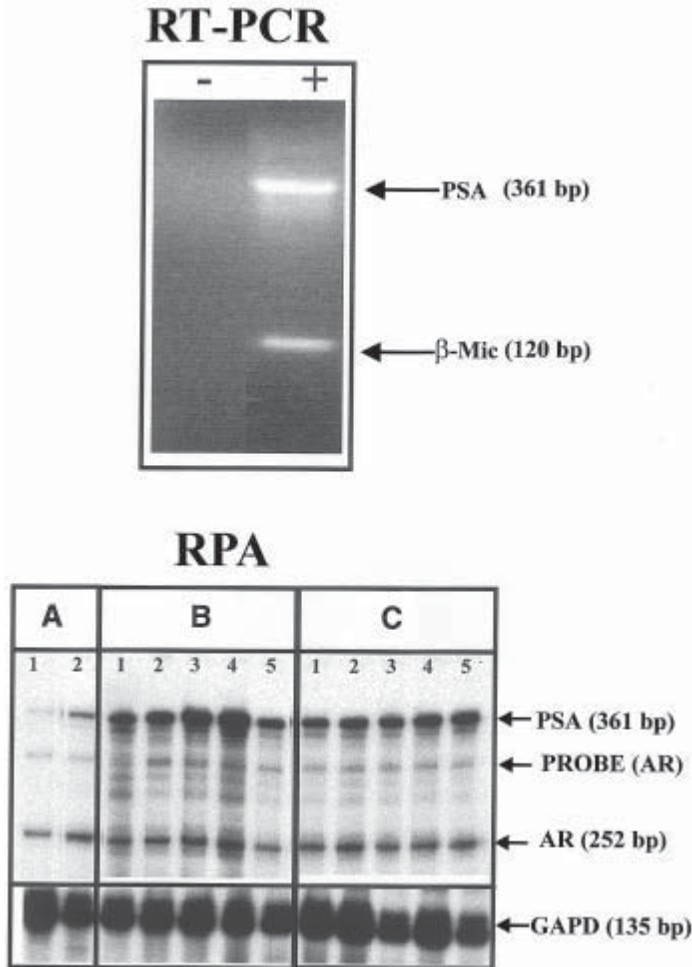

Fig. 3. Simultaneous detection of target mRNAs by RT-PCR and RPA. **Top box.** RT-PCR of human prostate-specific antigen (PSA) and  $\beta_2$ -microglobulin ( $\beta$ -Mic) using the primers mentioned in the text. - = Without RNA; + = With RNA. **Bottom box.** The levels of prostate-specific antigen (PSA)-, androgen receptor (AR)-, and glyceraldehyde-3-phosphate dehydrogenase (GAPDH)-specific mRNAs were measured simultaneously by RPA of 10  $\mu$ g of total RNA (isolated from various clones derived from a human prostate cancer cell line, LNCaP) according to the method mentioned in the text. (A) RPA from clones that express low levels of PSA (lanes 1 and 2); (B,C). RPA from clones in which connexin genes were introduced by retrovirally mediated gene transfer. Note that connexin-expressing clones show a much higher level of PSA-specific mRNA, whereas the levels of AR- and GAPDH-specific mRNAs do not change significantly. Each lane represents protected fragments from one independently isolated clone. Arrows indicate the position of the protected fragments. Probe = undigested androgen receptor probe (*see ref. 38*).

cyclophilin containing cDNA sequences of human glyceraldehyde-3-phosphate dehydrogenase and cyclophilin genes, respectively. These plasmids are purchased in undigested or ready-to-use form (Ambion).

### 3.6.2. Preparation of RNA Probes

1. Digest 25  $\mu\text{g}$  each of pPSA-Bluescript-KS, phAR-HE0.7/BS, and pTRIPLESCRIPT-GAPDH with *Bam*H1, *Stu*1, and *Sty*-1, respectively, or use pTRI-cyclophilin and pTRIPLESCRIPT-GAPDH in ready-to-use form. Purify the digested plasmids using standard recombinant DNA protocols (*see Note 11*) and resuspend in DEPC-treated distilled water at 0.75  $\mu\text{g}/\mu\text{L}$ . Store in convenient aliquots at  $-20^{\circ}\text{C}$ .
2. Prepare RNA probes for RPA using a standard reaction of 15  $\mu\text{L}$  as follows: In an autoclaved Eppendorf tube, mix the reagents in the following order:
  - a. 3 mL 5X transcription buffer (Ambion).
  - b. 1.5  $\mu\text{L}$  0.1 M DTT.
  - c. 2.2  $\mu\text{L}$  rNTP (rATP, rCTP, rGTP, 3.3 mM each).
  - d. 2.2  $\mu\text{L}$  UTP (0.1 mM).
  - e. 0.75  $\mu\text{L}$  RNasin.
  - f. 0.75  $\mu\text{g}$  pPSA-Bluescript-KS, phAR-HE0.7/BS, pTRIPLESCRIPT-GAPDH or pTRI cyclophilin (prepared as described above).
  - g. 3  $\mu\text{L}$   $^{32}\text{P}$ -UTP (3000 Ci/mmol).
  - h. 0.75  $\mu\text{L}$  T 7 RNA polymerase.
3. Incubate at room temperature for 1 h and check percentage incorporation of the radioactive label as described in **ref. 47**. It should be between 40–50% (*see Note 12*).
4. Add 2–8 U of RNase-free DNase (Ambion), incubate at  $37^{\circ}\text{C}$  15 min, add 10 mL RNA suspension buffer, denature 3 min at  $80^{\circ}\text{C}$ , and carefully load on 4% polyacrylamide/50% urea gel (0.8-mm thick sequencing gel from Gibco-BRL). Place shield between you and the gel while loading samples.
5. Run gel at 350 V until Bromophenol Blue has migrated approx two-thirds of the length of the gel. Carefully separate the plates, wrap gel with Saran Wrap, place in a cassette (place paper towels in cassette to prevent contamination).
6. In a dark room, cut a piece of X-ray film smaller than gel. Place film on gel with tape (to prevent movement) and mark film/gel with a Sharpie pen. Expose for 1 min and develop film.
7. Behind a shield, align gel over the film and cut out appropriate band with a razor blade and forceps.
8. Elute probe from gel slice in 1 mL of elution buffer (0.5 M NaCl; 0.1% SDS; 10 mM EDTA) in an autoclaved Eppendorf tube at  $37^{\circ}\text{C}$  for 1–2 h or at room temperature overnight (*see Note 10*).
9. Centrifuge tubes 1 min, remove supernatant with pipet, precipitate with 2 vol of ethanol (add 10  $\mu\text{g}$  yeast tRNA as a carrier), resuspend in 60  $\mu\text{L}$  RNase-free distilled water, and count 1  $\mu\text{L}$  in scintillation fluid. The total counts should range between  $1\text{--}5 \times 10^7$  cpm.

### 3.6.3. Hybridization

1. Extract total RNA using Trizol reagent (Gibco-BRL) in RNase-free environment (*see Note 10*) following the manufacturer's instructions, and determine the concentration of RNA in a spectrophotometer.
2. Dry 5–10  $\mu\text{g}$  RNA, together with the amount of probe needed, in a speed vacuum. Use  $2 \times 10^5$  cpm of probe per reaction for target mRNA to be detected, and  $1 \times 10^5$  cpm/reaction for internal control (GAPDH or cyclophilin).
3. Resuspend probe in hybridization buffer (80% formamide; 20% 5X hybridization buffer). Add 20  $\mu\text{L}$  per dried RNA sample, heat at  $65^{\circ}\text{C}$  for 10 min to resuspend, heat at  $95^{\circ}\text{C}$  for 3 min to denature, and hybridize at  $37^{\circ}\text{C}$  for 16 h in a water bath.

4. Add 200  $\mu\text{L}$  RNase digestion buffer (10 mM Tris-HCl, pH 7.5; 0.3 M NaCl; 5 mM EDTA) containing 1/200 dilution of RNase cocktail (Ambion), and incubate at 37°C for 30 min. Stop reaction with 16  $\mu\text{L}$  10% SDS and 2  $\mu\text{L}$  proteinase K (10 mg/mL) at 37°C for 15 min.
5. Precipitate RNA samples with ethanol using 10  $\mu\text{g}$  yeast tRNA as a carrier (*see Note 11*).
6. Resuspend in 7  $\mu\text{L}$  RNA suspension buffer (80% formamide, 1 mM EDTA, 0.1% bromophenol blue, and 0.1% xylene cyanol), heat at 65°C for 10 min to denature, and load on 5% polyacrylamide/50% urea gel with denatured labeled markers.
7. Expose gels to X-ray film.

A typical example of RPA, to detect simultaneously the expression of 3 mRNA species, is shown in **Fig. 3** (bottom box).

#### 4. Notes

1. Serum in MPS solution: Nonspecific background staining is usually observed in cells and tissue sections at sites other than where the specific antigen-antibody binding should have occurred if such sites are not blocked appropriately. Usually it is less intense than the specific binding, and in tissue sections the most common site is on highly charged collagen and connective tissues (**31,32**). These sites are blocked by the use of a combination of nonimmune serum and optimally diluted antibodies. The nonimmune serum should be from the same animal species that produced fluorochrome- or enzyme-linked secondary antibody and should be used at concentrations between 1–5%. Moreover, detergents such as Triton X-100 or Tween-20, at a concentration ranging from 0.1–0.5%, are included to facilitate the accessibility of antibody molecules to antigens because fixation alone is not sufficient to make cell membranes permeable to large immunoglobulin molecules (**39**). This step is essential when the antigens are localized intracellularly. If the antigen to be detected is a membrane protein, replace the above detergents with 0.1% saponin, which is unlikely to extract membrane proteins. If the background still persists, include a basic peptide, such as poly L-lysine (Mr 3000–6000 D) at a concentration of 0.01% (w/v) in MPS. A high level of background autofluorescence is observed when fluorochrome-conjugated secondary antibodies are used to observe cells or tissue sections fixed with paraformaldehyde. This autofluorescence can be blocked by incubating cells or tissue sections by including 1% sodium or potassium borohydrate, 50–100 mM ammonium chloride, 100 mM ethanolamine, or 0.1 M glycine in MPS.
2. Choice of detergents: Although a description of defining characteristics, amphiphilicity, surface activity, and micellization of detergents is beyond the scope of this chapter, they are used in immunocytochemical analysis for the permeabilization of cell membranes to allow antibody accessibility, for solubilization of antigens and aggregated antibody molecules, and for washing immune complexes to reduce backgrounds. In general, nonionic and amphoteric detergents are less denaturing to protein antigens and antibody molecules. Of the two detergents mentioned in this chapter, we have found that compared to Triton X-100, Tween-20, when used at a final concentration of 0.4%, eliminates nonspecific background without weakening the binding of antibody to the antigen or that of primary antibody to secondary antibody. However, we have found that Triton X-100 permeabilizes cell membranes better than Tween-20. *See (39,40)* for additional reading.
3. Choice of fixatives and duration of fixation: There is an extensive literature on the use of fixatives in immunohistochemistry and immunocytochemistry (**27–32,39**). In choosing a fixation protocol, two criteria are of prime importance: 1) it must keep the antigen in such a form that it can be recognized efficiently by the antibody and 2) it must maintain the cellular architecture and morphology of the tissues to enhance visual quality. Although

crosslinking fixatives, such as paraformaldehyde, may mask or change some epitopes by creating a network of linked antigens, the cellular architecture and tissue morphology are excellently maintained. On the other hand, noncrosslinking fixative, such as Histochoice (although in some cases it may not maintain the cellular architecture and tissue histology as well as paraformaldehyde) has been found to be excellent, because unlike paraformaldehyde, overfixation of tissues or cells with Histochoice does not result in the loss of immunostaining with all the antibodies that we have tried.

4. Maintenance and freezing of primary cultures of human prostate epithelial cells: Human prostate epithelial cells whether derived from normal or malignant prostate tissues have a limited life-span and, when passaged weekly, cannot be maintained in a proliferative state for more than 2 mo. It is, therefore, prudent to freeze between 12–20 ampules of each cell strain within two passages after the primary cultures have been established. Storage of prostate epithelial cells in liquid nitrogen is recommended. Long-term storage of prostate epithelial cells in deep freezers with temperatures ranging from  $-130^{\circ}\text{C}$  to  $-80^{\circ}\text{C}$  is not satisfactory because it results in the loss of cell viability at the time of thawing or recovering cells. Although highly expensive, human prostate epithelial cells can also be purchased from Clonetics, a company that has specialized in growing a variety of fibroblastic and epithelial cells established from human tissues.
5. Concentration and choice of primary and secondary antibodies: The concentration of primary antibodies to be used for immunocytochemical detection will be determined by their specificity as well as affinity and avidity to the antigens to be detected. Whereas commercial suppliers provide information about the specificity of both primary and secondary antibodies, appropriate dilution or concentration of primary antibody will depend upon its affinity and avidity toward an antigen, information not generally provided (41,42). The antibodies, both monoclonal and polyclonal, mentioned above work optimally when used at 0.5 to 1  $\mu\text{g}/\text{mL}$  in IMS containing 0.4% Tween-20. Moreover, nonspecific and high-background immunostaining can be avoided by using secondary antibodies with a minimal cross-reactivity to human proteins, which although more expensive, can be purchased from Jackson Immuno Research Laboratories, Inc. However, in the event of nonspecific or high-background immunostaining, we recommend that the optimal concentration/dilution of both primary and secondary antibodies be determined by the checkerboard analysis as shown in **Table 2**. The dilutions of primary and secondary antibodies in the example shown in **Table 2** are chosen based upon our experience. The checkerboard analysis could be extended, however, to any range of dilutions. For fluorochrome-conjugated secondary antibodies the dilutions typically range from 1:100 to 1:1000, and for enzyme-linked secondary antibodies the range is 1:1000 to 1:10,000. The numbers in the columns and rows in **Table 2** refer to numbered slides of tissue sections or cells. For instance, in the example shown in **Table 2**, if slide number 28 shows the best reaction and the least background, the working dilutions for the primary antibody and secondary antibody should be 1:800 and 1:1600, respectively. For additional details, the reader is referred to (27–31).
6. Stability and reuse of primary antibodies: Antibodies are resistant to a broad range of mildly denaturing conditions. Whereas most undiluted antibodies are stable for years when stored at  $-20^{\circ}\text{C}$ , working and used dilute solutions of antibodies can be stored conveniently at  $+4^{\circ}\text{C}$  where they are stable for at least 6 mo provided contamination of these solutions with bacteria and fungi is avoided. Contamination can be avoided by the addition of sodium azide to a final concentration of 0.02% in working solutions. Moreover, a working solution of primary antibodies can be used at least twice without significant loss of the quality of immunostaining. We have found that the used working solutions of pri-

**Table 2**  
**Optimization of Primary and Secondary Antibody Concentration**

Secondary	Primary					
	1:100	1:200	1:400	1:800	1:1600	1:2400
1:100	1	2	3	4	5	6
1:200	7	8	9	10	11	12
1:400	13	14	15	16	17	18
1:800	19	20	21	22	23	24
1:1600	25	26	27	28	29	30

mary antibodies, when stored appropriately, give the least nonspecific background without compromising the results. Because fluorochrome- or enzyme-linked secondary antibodies have now become relatively cheap, we do not recommend the storage and reuse of secondary antibody solutions. Although sodium azide has been shown to inhibit the activity of horseradish peroxidase, we have found that its addition to solutions containing primary antibodies does not interfere with the development of color provided it is not included in the IMS containing secondary antibodies and the cells or sections are washed thoroughly before color development.

7. An inexpensive antifade mounting medium: We have used several mounting media containing antifade reagents, which are added to prevent bleaching of fluorescence during observation. Examples of these mounting media are: Fluoromount-G (Electron Microscopy Sciences, Ft. Washington, PA), Vectashield (Vector Laboratories), SlowFade antifade kit (Molecular Probes, Eugene, OR). Because these mounting media are expensive and yet allow considerable bleaching of fluorescence during observation, we provide here a formulation of mounting medium which we have found to be 20–40 times cheaper, and better, than commercially available mounting media. This mounting medium should be prepared as follows:
  - a. Add 10 g of polyvinyl alcohol (powder; MW approx 100,000) to 80 mL 1X PBS.
  - b. Heat to 70°C with stirring and add n-propyl gallate to 1%. Stir to dissolve. Do not heat.
  - c. Let cool to room temperature and add 30 mL of glycerol. Stir to mix thoroughly.
  - d. Adjust pH to approx 7.5 using 1 M Na<sub>2</sub>HPO<sub>4</sub>. Use pH paper and not pH meter.
  - e. Add 400 drops of SlowFade (Molecular Probes). Stir and mix.
  - f. Aliquot in 1-mL lots and store at –20°C.
  - g. To use, thaw an aliquot by heating to 70°C in a water bath and use at room temperature.
  - h. With prolonged storage, the color of the solution changes to black. Do not worry.
8. Blocking of endogenous peroxidase: Before using horseradish peroxidase-labeled secondary antibody, it is necessary first to inhibit or block any endogenous peroxidase present in the tissue sections because the substrate-chromogen reaction used to visualize peroxidase cannot distinguish between the extrinsic peroxidase label and the endogenous tissue peroxidase. We have described the most popular way of achieving irreversible blocking of endogenous peroxidase, although there are several ways to achieve it.
9. Counterstaining. The counterstaining and mounting technique used will be determined by which enzyme label and visualization techniques are used. With DAB the colored end products are alcohol fast; therefore, alcoholic stains may be used followed by dehydration, clearing in xylene, and mounting in DPX. Stain the sections in Mayer's hematoxylin for 30 s, wash off with running water for 15 min, dehydrate in graded series of alcohol, clear in xylene, and mount in DPX.

10. A number of precautions should be taken to ensure that the glassware, solutions, and reagents used in working with RNA are free from RNase contamination (43,44).
11. Purification, phenol/chloroform extraction, and ethanol precipitation of nucleic acids are excellently explained in (43,45,46).
12. Percentage incorporation should be determined by trichloroacetic acid precipitation assay (43,47).

## Acknowledgments

This work was supported in part by VA Merit Review awards (to Parmender P. Mehta and Bernard A. Roos), a Department of Defense grant (DAMD 17-98-1-8525 to Bernard A. Roos), and an NIH grant (CA73769 to Parmender P. Mehta). Support from the Sylvester Comprehensive Cancer Center, University of Miami School of Medicine, and the Miami VAMC Geriatric Research, Education, and Clinical Center is gratefully acknowledged.

## References

1. McNeal, J. E. (1988) Normal histology of the prostate. *Am. J. Surg. Pathol.* **12**, 619–633.
2. Cunha, G. R., Donjacour, A. A., Cooke, P. S., Mee, S., Bigsby, R. M., Higgins, S. J., and Sugimura, Y. (1987) The endocrinology and developmental biology of the prostate. *Endocr. Rev.* **8**, 338–362.
3. Papsidero, L. D., Kuriyama, M., Wang, M. L., Horoszewicz, J. S., Leong, S. S., Valenzuela, L., et al. (1981) Prostate antigen: a marker for human prostate epithelial cells. *J. Natl. Cancer Inst.* **66**, 37–42.
4. Nadji, M., Tabei, Z., Castro, A., and Morales, A. R. (1979) Immunohistochemical demonstration of prostatic origin of malignant neoplasm. *Lancet* **1**, 671–672.
5. Nadji, M., Tabei, S. Z., Castro, A., Chu, T. M., and Morales, A. R. (1980) Prostatic origin of tumors. An immunohistochemical study. *Am. J. Clin. Pathol.* **73**, 735–739.
6. Nadji, M. and Morales, A. R. (1984) Immunohistologic markers for prostate cancer. *Ann. NY Acad. Sci.* **420**, 134–139.
7. Nadji, M., Tabei, S. Z., Castro, A., Chu, T. M., Murphy, G. P., Wang, M. C., and Morales, A. R. (1981) Prostate-specific antigen: an immunohistologic marker for prostatic neoplasms. *Cancer* **48**, 1229–1232.
8. Sherwood, E. R., Berg, L. A., Mitchell, N. J., McNeal, J. E., Kozlowski, J. M., and Lee, C. (1990) Differential cytokeratin expression in normal, hyperplastic and malignant epithelial cells from human prostate. *J. Urol.* **143**, 167–171.
9. Nagle, R. B., Ahmann, F. R., McDaniel, K. M., Paquin, M. L., Clark, V. A., and Celniker, A. (1987) Cytokeratin characterization of human prostatic carcinoma and its derived cell lines. *Cancer Res.* **47**, 281–286.
10. Cunha, G. R., Alarid, E. T., Turner, T., Donjacour, A. A., Boutin, E. E., and Foster, B. A. (1992) Normal and abnormal development of the male urogenital tract. Role of androgens, mesenchymal-epithelial interactions, and growth factors. *J. Androl.* **13**, 465–475.
11. Jarrard, D. F., Paul, R., van Bokhoven, A., Nguyen, S. H., Bova, G. S., Whellock, M. J., et al. (1997) P-cadherin is a basal cell-specific epithelial marker that is not expressed in prostate cancer. *Clin. Cancer Res.* **3**, 2121–2128.
12. McDonnell, T. J., Troncoso, P., Brisbay, S. M., Logothetis, C., Chung, L. W. K., Hsieh, J.-T., et al. (1992) Expression of the protooncogene *bcl-2* in the prostate and its association with emergence of androgen-independent prostate cancer. *Cancer Res.* **52**, 6940–6944.
13. Pisters, L. L., Troncoso, P., Zhou, H. E., Li, W., von Eschenbach, A. C., and Chung, L. W. K. (1995) C-Met proto-oncogene expression in benign and malignant human prostate tissues. *J. Urol.* **154**, 293–298.

14. Humphrey, P. A., Zhu, X., Zarnegar, R., Swanson, P. E., Ratliff, T. L., Vollmer, R. T., and Day, M. L. (1995) Hepatocyte growth factor and its receptor (C-Met) in prostatic carcinoma. *Am. J. Pathol.* **147**, 386–396.
15. Bonkhoff, H. and Remberger, K. (1996) Differentiation pathways and histogenetic aspects of normal and abnormal prostatic growth: a stem cell model. *Prostate* **28**, 98–106.
16. Di Sant Agnese, P. A. (1992) Neuroendocrine differentiation in human prostate carcinoma. *Hum. Pathol.* **23**, 287–296.
17. Gkonos, P. J., Krongrad, A., and Roos, B. A. (1995) Neuroendocrine peptides in the prostate. *Urol. Res.* **23**, 81–87.
18. Isaacs, W. B., Bova, G. S., Morton, R. A., Bussemakers, M. J. G., and Ewing, C. M. (1994) Molecular biology of prostate cancer. *Semin. Oncol.* **21**, 514–521.
19. Peehl, D. M. (1992) Culture of human prostatic epithelial cells, in *Culture of Epithelial Cells* (Freshney, R. I., ed.), ch. 7, Wiley-Liss, New York, pp. 159–180.
20. Mehta, P. P., Lokeshwar, B. L., Schiller, P. C., Bendix, M. V., Ostenson, R. C., Howard, G. A., and Roos, B. A. (1996) Gap-junctional communication in normal and neoplastic prostate epithelial cells and its regulation by cAMP. *Mol. Carcinog.* **15**, 18–32.
21. Webber, M. M., Bello, D., and Quader, S. (1996) Immortalized and tumorigenic adult human prostate epithelial cell lines: characteristics and applications. Part 1. Cell markers and immortalized nontumorigenic cell lines. *Prostate* **29**, 386–394.
22. Webber, M. M., Bello, D., and Quader, S. (1997) Immortalized and tumorigenic adult human prostatic epithelial cell lines: characteristics and applications. Part 2. Tumorigenic cell lines. *Prostate* **30**, 58–64.
23. Webber, M. M., Bello, D., and Quader, S. (1997) Immortalized and tumorigenic adult human prostatic epithelial cell lines: characteristics and application. Part 3. Oncogenes, suppressor genes, and applications. *Prostate* **30**, 136–142.
24. Fajardo, L. F. (1989) Special report: the complexity of endothelial cells. *Am. J. Clin. Pathol.* **92**, 241–250.
25. Fong, C.-J., Sherwood, E. R., Sutkowski, D. M., Abu-Jawdeh, G. M., Yokoo, H., Bauer, K. D., et al. (1991) Reconstituted basement membrane promotes morphological and functional differentiation of primary human prostatic epithelial cells. *Prostate* **19**, 221–235.
26. Webber, M. M., Bello, D., Kleinman, H. K., Waringer, D. D., Williams, D. E., and Rhim, J. S. (1996) Prostate specific antigen and androgen receptor induction and characterization of an immortalized adult human prostatic epithelial cell line. *Carcinogenesis* **17**, 1641–1646.
27. Nadji, M. and Morales, A. R. (1983) Immunoperoxidase: Part 1. The technique and its pitfalls. *Lab. Med.* **14**, 767–771.
28. Nadji, M. and Morales, A. R. (1984) Immunoperoxidase: Part 2. Practical applications. *Lab. Med.* **15**, 33–37.
29. Nadji, M. (1986) Immunoperoxidase techniques. I. Facts and artifacts. *Am. J. Dermatopathol.* **8**, 32–36.
30. Nadji, M. and Ganjei, P. (1990) Immunocytochemistry in diagnostic cytology: a 12 year perspective. *Am. J. Clin. Pathol.* **94**, 470–475.
31. Nadji, M. and Morales, A. R. (1998) Immunohistochemical techniques, in *Principles and Practice of Surgical Pathology and Cytopathology* (Silverberg, E. G., ed.), vol. 1, ch. 5, Churchill Livingstone, New York, pp. 63–75.
32. Jones, E. L. and Gregory, J. (1989) Immunoperoxidase techniques, in *Antibodies* (Catty, D., ed.), vol. 2, ch. 5, Oxford University, New York, pp. 155–177.
33. Lundwall, A. and Lilja, H. (1987) Molecular cloning of human prostate specific antigen cDNA. *FEBS Lett.* **214**, 317–322.



34. Fan, H., Oro, A. E., Scott, M. P., and Khavari, P. A. (1997) Induction of basal cell carcinoma features in transgenic human skin expressing Sonic Hedgehog. *Nature Med.* **3**, 788–792.
35. Leube, R. E., Bosch, F. X., Romano, V., Zimbelmann, R., Hofler, H., and Franke, W. W. (1986) Cytokeratin expression in simple epithelia. III. Detection of mRNAs encoding human cytokeratins nos. 8 and 18 in normal and tumor cells by hybridization with cDNA sequences in vitro and in situ. *Differentiation* **33**, 69–85.
36. Noonan, K. E., Beck, C., Holzmayer, T. A., Chin, J. E., Wunder, J. S., Andrulis, I. L., et al. (1990) Quantitative analysis of *MDR1* (multidrug resistance) gene expression in human tumors by polymerase chain reaction. *Proc. Natl. Acad. Sci. USA* **87**, 7160–7164.
37. Tille, W. D., Marcelli, M., Wilson, J. D., and McPhaul, M. J. (1989) Characterization and expression of cDNA encoding the human androgen receptor. *Proc. Natl. Acad. Sci. USA* **86**, 327–331.
38. Mehta, P. P., Perez-Stable, C., Nadji, M., Asotra, K., and Roos, B. A. (1999) Suppression of human prostate cancer cell growth by forced expression of connexin genes. *Dev. Genet.* **24**, 91–110.
39. Harlow, E. and Lane, D. (1988) *Antibodies. A Laboratory Manual*. Cold Spring Harbor Laboratory, Cold Spring Harbor, New York.
40. Neugebauer, J. M. (1990) Detergents: an overview, in *Methods in Enzymology* (Deutscher, M. P., ed.) vol. 182, ch. 18, Academic, New York, pp. 239–253.
41. Catty, D. (1988) Properties of antibodies and antigens, in *Antibodies* (Catty, D., ed.), vol. 1, ch. 1, Oxford University, New York, pp. 7–18.
42. Catty, D. and Raykundalia, C. (1988) Production and quality control of polyclonal antibodies, in *Antibodies* (Catty, D., ed.), vol. 1, ch. 2, Oxford University, New York, pp. 19–79.
43. Sambrook, J., Fritsch, E. F., and Maniatis, T. (1989) *Molecular Cloning. A Laboratory Manual*. Cold Spring Harbor Laboratory, Cold Spring Harbor, New York.
44. Blumberg, D. D. (1987) Creating a ribonuclease-free environment, in *Methods in Enzymology* (Berger, S. L. and Kimmel, A. R., eds.), vol. 152, ch. 2, Academic, New York, pp. 21–24.
45. Wallace, D. M. (1987) Precipitation of nucleic acids, in *Methods in Enzymology* (Berger, S. L. and Kimmel, A. R., eds.), vol. 152, ch. 5, Academic, New York, pp. 41–48.
46. Wallace, D. M. (1987) Large- and small-scale phenol extractions, in *Methods in Enzymology* (Berger, S. L. and Kimmel, A. R., eds.), vol. 152, ch. 4, Academic, New York, pp. 33–41.
47. Berger, S. L. (1987) Quantifying <sup>32</sup>P-labeled and unlabeled nucleic acids, in *Methods in Enzymology* (Berger, S. L. and Kimmel, A. R., eds.), vol. 152, ch. 6, Academic, New York, pp. 49–55.

## Preparation of Chick Striated Muscle Cultures

Camille DiLullo, Jacquelyn Gerhart, and Mindy George-Weinstein

### 1. Introduction

The maturation of striated muscle in primary cultures closely parallels the formation of striated muscle in vivo. Primary cultures thus serve as model systems for the study and manipulation of various aspects of muscle development including the regulation of gene expression, myofibril assembly, myocyte fusion, and myotube contraction. The following protocols provide instructions for the preparation of skeletal muscle cultures from either day 10 embryonic pectoralis muscle or day 2 somites and segmental plate mesoderm. Both methods will yield well-striated, multinucleated, contracting myotubes (**Fig. 1**) (1–4). Also included is a protocol for the preparation of cardiac cultures from day 7 embryonic heart. This method will yield well-striated, contracting cardiomyocytes (**Fig. 1**) (5,6).

### 2. Materials

A list of materials common to all three protocols is provided, followed by subsections, which list specific materials required for the individual protocols.

*Alcohol:* 200 proof anhydrous ethanol (Electron Microscopy Sciences, Fort Washington, PA).

*Eggs:* Fertilized White Leghorn chicken eggs. One source for these eggs is Truslow Farms, Chesterton, MD.

*Glassware:* Pasteur pipets are available from Fisher Scientific (Pittsburgh, PA) and other vendors.

*Plasticware:* 35 mm, 60 mm, and 100 mm Falcon tissue culture dishes and Petri dishes, sterile 15 mL and 50 mL polypropylene, conical centrifuge tubes with screw caps, Eppendorf tubes with snap caps and sterile, disposable, plastic pipets are available from Fisher Scientific.

#### 2.1. Cultures from Day 10 Embryonic Chicken Pectoralis Muscle

*Aclar:* Aclar squares are prepared from aclar #33c (5.0 mm gage), a plastic sold by Allied Signal, Pottsville, PA. The easiest way to purchase this plastic is on a roll. The roll is usually supplied as 16 in. wide and is sold by the pound. One pound provides a sheet that is approx 4.5 m long. A cutting fee is charged for purchasing a quantity under 100 lb.

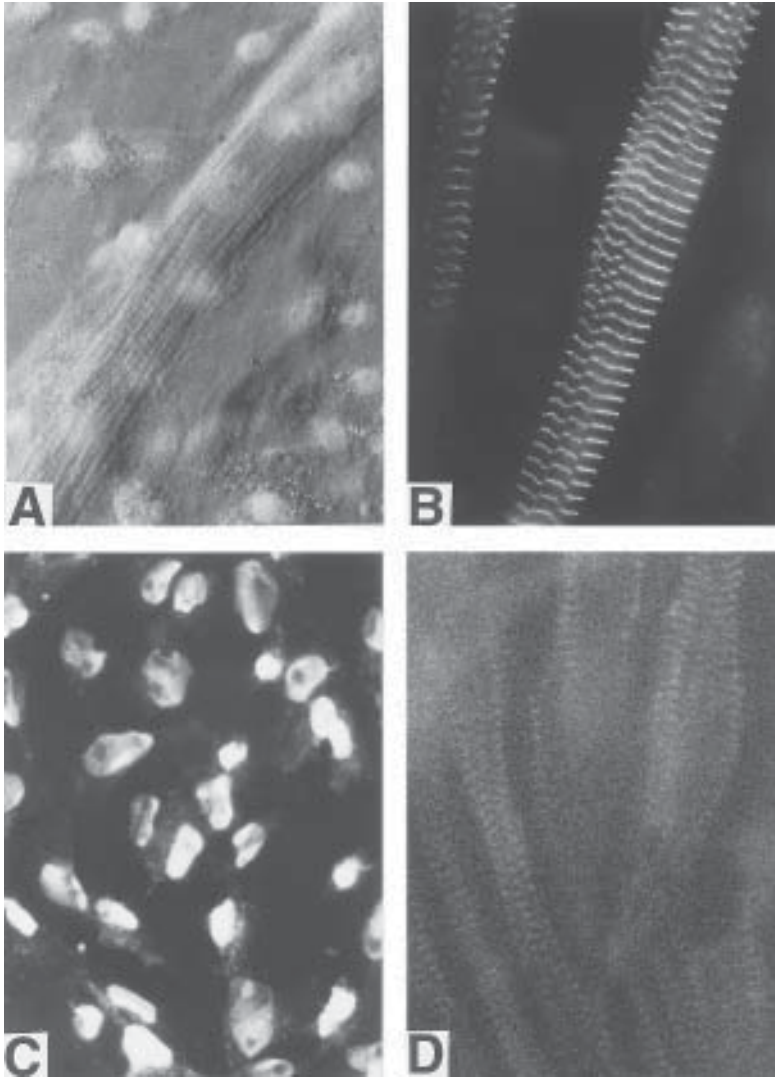

Fig. 1. An example of muscle prepared by each of the primary muscle culture protocols is illustrated in the following micrographs. Pectoralis muscle, segmental plate, and cardiac muscle cultures were immunofluorescently labeled with antibodies to  $\alpha$ -actinin, MyoD, or titin, respectively. Multinucleated myotubes from embryonic pectoralis muscle cultures are shown in phase contrast (A) and with a sarcomeric distribution of  $\alpha$ -actinin along striated myofibrils (B). Differentiating segmental plate cells contain MyoD in the nucleus (C). Striated cardiomyocytes from embryonic heart show titin with a sarcomeric localization (D).

*Buffers:* 1 $\times$  Hanks' balanced salt solution (HBSS) (cat. #24020-067) and calcium-magnesium-free HBSS (cat. #14170-039) are available from Life Technologies, Gaithersburg, MD.

*Filters:* The syringe filter holder (cat. #09-753-10A) and 5 cc syringes (cat. #1482335) are available from Fisher Scientific. The lens paper was purchased from Thomas Scientific, Swedesboro, NJ.

*Instruments:* Dumont #5 Bio Inox forceps (cat. #11255-20), Dumont #55 Bio Inox forceps (cat. #11252-20), fine scissors (cat. #14061-10), knives (handle/ cat. #26015-11, insert blades/cat. #26007-01), and the bead sterilizer (cat. #18000-45) are available from Fine Science Tools, Foster City, CA. The hemocytometer and the cell counter are available from Thomas Scientific.

*Medium:* One medium formulation is used throughout this entire protocol. It consists of minimal essential medium (MEM) with Earle's salts and L-glutamine (cat. #11095-031) supplemented with an additional 1% L-glutamine (200 mM), 10% horse serum, 10% embryo extract, 1% penicillin-streptomycin (5000 U/mL penicillin and 5000 µg/mL streptomycin, cat. #25030-016) and 1% fungizone (250 µg/mL amphotericin B and 205 µg/mL sodium desoxycholate, cat. #15295-017). Embryo extract should be prepared from day 11 chicken embryos (**Note 1**). However, embryo extract can be purchased from Life Technologies, the source of all the other medium components.

*Substrate:* The collagen used in this protocol was made directly from rat tails (**Note 2**). It is commercially available from several sources, including Sigma Chemical Co., St. Louis, MO, or Life Technologies.

*Trypsin:* 2.5% trypsin—10× solution (cat. #15090-012—Life Technologies).

## **2.2. Cultures from Chick Embryo Somites and Segmental Plate Mesoderm**

*Buffers:* Phosphate-buffered saline (PBS): Prepare a stock solution containing 50 g NaCl, 1.25 g KCl, 0.71 g Na<sub>2</sub>HPO<sub>4</sub>, and 1.25 g KH<sub>2</sub>PO<sub>4</sub> in 400 mL deionized water. Adjust pH to 7.2 with 1 N NaOH, then increase volume to 500 mL. Before use, add 8 mL of PBS stock solution to 100-mL deionized water to yield a 1× working solution. Autoclave to sterilize.

*Medium:* *DES cell culture medium:* Reconstitute Dulbecco's modified Eagle medium containing high glucose and L-glutamine (#12100-046) as directed on the package and add 3.7 g NaHCO<sub>3</sub>. Adjust pH to 7.4 with 1 N NaOH or 1 N HCl. To 84 mL Dulbecco's modified Eagle medium, add 5-mL fetal bovine serum, 5-mL horse serum, 5-mL chick embryo extract (**Note 3**) and 1 mL of a solution containing 10,000 U penicillin G sodium and 10,000 U streptomycin sulfate. All components are obtained from Life Technologies, Gaithersburg, MD. *DMEM/F12 cell culture medium:* Add 10,000 U penicillin and 10,000 U streptomycin per mL of DMEM/F12 medium (Life Technologies).

*Instruments:* Dumont forceps (cat. #25729-081), fine scissors (cat. #14063-11) and knives (cat. #10055-12) are available from Fine Science Tools, Foster City, CA. Knives should be sharpened before each use by rubbing them against crocus cloth. Crocus cloth may be obtained from any hardware store. The hemocytometer and the cell counter are available from Thomas Scientific (Swedesboro, NJ).

*Micropipets:* Drummond Scientific precision micropipet (Broomall, PA) (**Note 4**).

*Substrates:* *Gelatin:* A 0.1% solution of gelatin (300 bloom #G-2500, Sigma Chemical Co.) is prepared by adding the gelatin slowly to boiling deionized water while stirring. To coat tissue culture dishes with gelatin, add 1 mL of gelatin solution to each 35 mm dish. Place dishes at 4°C overnight. Remove solution and air dry under a laminar flow hood. *Fibronectin:* Add 10 µg of human serum fibronectin (Life Technologies) per mL of PBS. Add 1 mL of this fibronectin solution to each gelatin-coated dish. Incubate at 37°C overnight. Remove solution and air dry. Replace lids and store a

minimum of 3 d before use. If necessary, the coated dishes can be used after 24 h; however, the initial inoculum of cells in 15  $\mu$ L of medium tends to spread out to a greater extent and evaporate faster than if the dishes were coated at least 3 d before use.

*Trypsin:* 0.25% trypsin, 1 mM EDTA (1 $\times$ , cat. #25200-056, Life Technologies).

### 2.3. Cardiac Cultures from Day 10 Embryonic Chicken Heart

*Buffers:* 1 $\times$  Hank's balanced salt solution (cat. #24020-067) and calcium–magnesium-free Hank's balanced salt solution (cat. #14170-039) are from Life Technologies, Gaithersburg, MD.

*Coverslips:* 22 mm  $\times$  22 mm glass cover slips are available from Fisher Scientific, Pittsburgh, PA.

*Instruments:* Dumont #5 Bio Inox forceps (cat. #11255-20) and Dumont #55 Bio Inox forceps (cat. #11252-20) are available from Fine Science Tools, Foster City, CA.

*Medium:* This protocol requires both plating medium and growth medium. Every component is available from Life Technologies.

Plating medium is minimal essential medium (MEM) with Earle's salts without glutamine (cat. #11090-65), 5% fetal calf serum (**Note 5**), 1% penicillin-streptomycin (5000 U/mL penicillin and 5000  $\mu$ g/mL streptomycin, cat. #25030-016) and 1% L-glutamine (200 mM).

Growth medium is the same as plating medium except that no L-glutamine is added to the solution. The lack of L-glutamine promotes the proliferation of myocytes over fibroblasts (**6**). Growth medium is MEM with Earle's salts without glutamine, 5% fetal calf serum and 1% penicillin-streptomycin (5000 U/mL penicillin and 5000  $\mu$ g/mL streptomycin, cat. #25030-016).

*Trypsin:* 2.5% trypsin—10 $\times$  solution (cat. #15090-012—Life Technologies).

## 3. Methods

### 3.1. Cultures from Day 10 Embryonic Chicken Pectoralis Muscle

1. It is best to have everything prepared in advance of starting so that there will be minimal delay in plating cells once they have been removed from the embryo.
  - Prepare dishes with a clear (**Notes 6 and 7**) coated with collagen (**Note 8**). This should be done at least one day in advance.
  - Prepare media (**Note 9**).
  - Sterilize instruments (**Note 10**).
  - Sterilize day 10 embryonic White Leghorn chicken eggs (staged according to Hamburger–Hamilton [7]) by dousing them with 70% EtOH and letting them air dry (approx 10 min).
2. Crack an egg on the edge of a sterile 100-mm Petri dish. Empty the embryo and the contents into the dish. Quickly decapitate the embryo with a scissors (**Note 11**) and remove the extraembryonic membranes. Transfer the body to another sterile 100 mm Petri dish that contains 5–6 mL of HBSS. Repeat this for all the eggs that you intend to use. The number of eggs is dependent upon the number of plates that you want and the cell density per plate. One embryo will typically yield 6–10 million skeletal muscle cells.
3. Looking through a dissecting microscope at a relatively low power (approx 6 $\times$ ), lay the embryo on its back so that its ventral side is up. Pick up the skin over the breast with a fine forceps (Dumont #5) and use a scissors to cut away the skin exposing the pectoral muscle.

The connective tissue layer that covers the pectoral muscle often comes off with the skin. If it does not, remove the connective tissue layer with a fine forceps.

4. The pectoral muscle must now be removed from the sternum with a forceps. Remove as much of the muscle as possible. To improve visualization and maneuverability in this area, the clavicle can be clipped near the point at which it inserts into the sternum. Transfer the muscle into a sterile 60-mm Petri dish that contains HBSS.
5. The muscle must now be cleaned of as much nonmuscle tissue as possible. While working under the dissecting microscope, although at a higher magnification (approx 12 $\times$ ), separate the muscle from blood vessels, connective tissue and any remaining cartilage. The easiest way to do this is to anchor the tissue to the dish with a forceps in one hand (**Note 12**). A fine forceps (Dumont Biology #55) in the other hand can be used to pull the muscle fibers away from the larger piece of tissue. Transfer small pieces of muscle to a dry 35-mm Petri dish (**Note 13**). The medium transferred on the forceps with the muscle should be sufficient to keep the muscle fibers from drying out.
6. Mince the muscle pieces in the medium that is in the dish from the transfer. The trypsin will be added directly to these cells so the amount of medium should be kept to a minimum. Mince the muscle using two small sharp knives. Place the knives in the muscle, blade edges down with the points of the blades facing each other. Start with the back edge of each blade touching and pull the knives away from each other by sliding the blades apart. Catch the muscle in between the blades. Repeat this until the muscle tissue has been reduced to very small cubes (<1–2 mm).
7. Add trypsin to calcium–magnesium-free HBSS (CMF) (make a 1:10 dilution of the 10 $\times$  stock) for a 0.25% final trypsin solution. Add 2 mL of the trypsin solution to the minced muscle pieces and incubate at 37°C for 20–30 min.
8. After trypsinization, transfer the muscle pieces to a sterile 15 mL centrifuge tube with a sterile Pasteur pipet and add 2–3 mL of serum containing medium or a few mL of serum to stop the trypsin reaction. Centrifuge the cells at 200g for 5–10 min. Check to make sure the cells have been pelleted and then discard the supernatant. If the cells have not pelleted, centrifuge again at a slightly higher g force or for a longer period. Be careful not to be too aggressive or the cells will be damaged.
9. Add 5–10 mL of medium to the cells and disperse them with a sterile 9" Pasteur pipet. The amount of medium you add will depend on the number of embryos that you started with. For one to two embryos start with 5 mL. The cells can always be diluted further. Pipet the cells gently until all the visible particles have been dispersed. The small bore of the end of the pipet facilitates dissociation of the cells (**Note 14**).
10. Filter the cells through lens paper in a stainless steel filter (**Note 15**) attached to a sterile 10-mL disposable syringe. If the cells have been dispersed properly, gravity should be sufficient to move the cell suspension from the syringe to the tube. If the cells do not pass through the filter by gravity alone, use very gentle pressure on the syringe plunger.
11. Use a hemocytometer to count the cells. Dilute the sterile stock suspension 1:10 or 1:20 in HBSS. Keep in mind that anything that goes into the tube of stock cells must be sterile. Fill both chambers of the hemocytometer with the diluted cell suspension. If there are too many cells to obtain an accurate count, then dilute the cells further and count again. There should be 100–200 cells per chamber. Count the cells using a cell counter (**Note 16**) and calculate the number of cells per mL following the instructions provided with the hemocytometer. Do not forget to take into account the dilution factor if you dilute your cells to count them. Finally, multiply the number of cells/mL by the total number of mL you have in the stock suspension to calculate the total number of cells.

12. Prepare the cell suspension for plating from the stock cell solution. Determine the number of dishes that you need and the cell density per plate that you would like. This will vary by application. For example, if you want 10 dishes and a cell density of  $5 \times 10^5$  cells/dish, then you need  $5 \times 10^5$  cells  $\times 10 = 50 \times 10^5$  ( $5 \times 10^6$ ) total cells. Determine the total number of mL you will need for plating the cells. (If you use 1.5 mL of media per dish and you plan to plate 10 dishes then you will need a final volume of 15 mL to plate the cells.) Calculate the amount of stock solution that will provide you with the total number of cells you need. Add this to enough medium to give you the appropriate final volume for plating and mix well. (If you need  $5 \times 10^6$  cells for plating in 15 mL of medium and you have a stock suspension of  $9 \times 10^6$  cells in 5 mL, then take approx 2.8 mL of stock suspension and add it to 12.2 mL of medium.) Plate the cells in tissue culture dishes prepared with collagen-coated aclar (**Note 17**).
13. Maintain cells in a 37°C incubator with 5% CO<sub>2</sub> in air. Feed cells every day or every other day. Within 5–8 d you should have healthy, well-striated, contracting myotubes.

### 3.2. Cultures from Chick Embryo Somite and Segmental Plates

1. Incubate fertilized eggs for approx 48 h at 37°C (**Note 18**). We usually begin with 48 eggs for each cell culture preparation. This number of embryos yields an average of 30 cultures of somite or segmental plate cells.
2. Rest eggs on their side for several minutes. The yolk with the embryo will float to the upper side of the egg. Bring the egg into a laminar flow hood. Keeping the egg on its side, crack the egg gently, separate the halves and allow the contents to empty into a 100-mm tissue culture dish without breaking the yolk (**Note 19**). If the embryo is not lying in the center of the yolk, gently glide the edge (not the tips) of the scissors over yolk, rolling it so as to move the embryo into its center.
3. Gently glide the edge of the scissors over the surface of the embryo to remove excess albumin.
4. Pierce both sides of the yolk. Its contents will leak out thereby flattening the yolk. The embryo should remain in the center of the broken yolk.
5. Cut a square around the embryo and its vitelline membrane. Insert closed scissors under this square and gently elevate the embryo onto the scissors and off of the yolk.
6. Transfer the embryo on the scissors to a 100-mm tissue culture dish (**Note 20**) containing PBS. Gently shake the embryo off of the scissors. If the PBS becomes cloudy from excess yolk, transfer embryos to another 100-mm dish containing PBS. Transfer embryos by placing forceps under the embryos and lifting them out of the PBS.
7. Place the dish under a dissecting microscope. Stage the embryos according to the method of Hamburger–Hamilton (7). They should have developed to stages 13–14 and contain approx 22 pairs of somites.
8. Embryos can be dissected either ventral or dorsal side up. Flatten the vitelline membrane. Make an incision between the lateral border of the somites and segmental plate, and the intermediate mesoderm (**Fig. 2**). This is done by placing one knife at this border to steady the tissue and positioning the other knife against the first knife. The second knife then slices along the lateral border. Reposition the knives at progressively caudal regions until the desired number of somites and the segmental plate have been detached at their lateral border. Repeat this dissection on the opposite side of the embryo. The somites and segmental plates that are still attached to the neural tube and notochord are separated from the remainder of the embryo by making an incision at the rostral most pair of somites that are to be cultured and between the caudal portion of the segmental plate and the tail bud (**Fig. 2**).
9. Make an incision between the most caudal pair of somites and rostral portion of the segmental plate (**Fig. 2**).

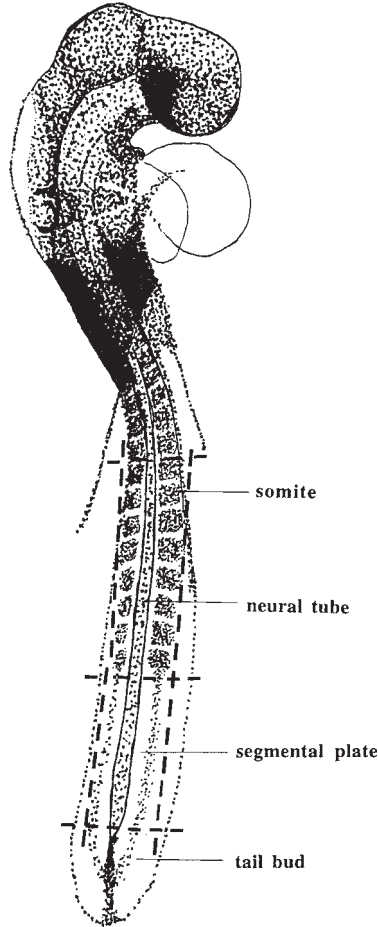

Fig. 2. Dissection of the stage 14 chick embryo. Incisions (hatched lines) are made at the lateral border of the somites and segmental plate on both sides of the embryo. Pieces containing the somites and segmental plates still attached to the neural tube are isolated from the embryo by making incisions between the eighth and ninth most caudal pairs of somites; the most caudal somites and the rostral end of the segmental plate and the segmental plate and tail bud.

10. Transfer pieces containing somites or segmental plates still attached to the neural tube, notochord, and epithelia into a 35-mm tissue culture dish containing 1 mL of trypsin solution using a 9-in. glass pipet. Wet the inside of the pipet first with PBS in order to prevent the tissues from sticking to the glass. Incubate tissues in trypsin for 10–30 s until the neural tube begins to swell and notochord becomes curved. To prevent over-trypsinization, add no more than five pieces of tissue to the trypsin solution at a time.
11. Using a micropipet attached to a mouth pipeting aspirator device, remove tissues containing somites or segmental plates from the trypsin solution and place in separate 35-mm tissue culture dishes containing 2 mL of DES medium. Keep the amount of trypsin that is transferred with the tissues to a minimum.
12. Draw the pieces of tissue up into the micropipet and then expel them back into the medium. Be careful not to produce bubbles. The diameter of the pipet should be smaller than the size of the tissue so that the epithelia will be peeled away from the dorsal and ventral



surfaces. The epithelia will appear as a translucent sheet of cells. With repeated pipeting, the somites and segmental plates will become detached from the neural tube and notochord. Somites often will come off of the neural tube in groups, like beads on a string. The segmental plate detaches in smaller pieces and has the appearance of a relatively compact mesenchyme. The process of repeated pipeting also will result in the somites and segmental plates breaking up into small groups of cells as well as single cells.

13. The neural tube, notochord, and epithelia are not dissociated by this limited trypsinization. They should be removed from the dish with the micropipet. The neural tube will appear as a translucent tube. The notochord, a thin, dark, ribbon-like structure, either will remain attached to the neural tube or become separated from it. The medium in the dish will now contain single somite or segmental plate cells, small groups of cells and larger pieces of these tissues.
14. Repeat steps 8–11 until all somites and segmental plates have been isolated.
15. Transfer the larger pieces of somite and segmental plate tissues into a 15-mL conical centrifuge tube containing 2-mL trypsin solution. Incubate in a 37°C water bath for 10 min or until all pieces have been dissociated.
16. Remove the remaining medium containing cells and small cell aggregates from the dish and place in a separate conical centrifuge tube. Do not add trypsin.
17. Centrifuge both tubes for 10 min at 200g. Carefully withdraw the medium and resuspend each cell pellet in 100  $\mu$ L of DES medium. Combine contents of both tubes into one.
18. Remove 5  $\mu$ L of cell suspension, add it to 45  $\mu$ L of PBS and count the cells in a hemocytometer.
19. Adjust the volume of the cell suspension by adding DES medium to yield a cell density of  $2 \times 10^4$  per 15  $\mu$ L of medium. Add 15  $\mu$ L of cell suspension to the center of a 35-mm tissue culture dish coated with gelatin and fibronectin (**Note 21**). Place cells in a 37°C incubator containing 5% CO<sub>2</sub> in air.
20. Observe cultures under a phase contrast microscope after 90 min. In most cases, cells will have attached loosely to the dish by this time. They will have a mostly rounded morphology. To check for attachment, very gently move the dish from side to side. If the cell mass remains in place, the cells are sufficiently attached to allow for the addition of more medium. If cells have not attached, return cultures to the incubator and check them again after 30 min (**Note 22**).
21. Flood the culture dishes with 1–2 mL of DMEM/F12 medium. This is done by placing the pipet tip against the inside of the lip of the dish and slowly adding the medium so that it gently diffuses across the dish and onto the cells (**Note 23**).
22. Return the cultures to the incubator. The following day the dishes may be rocked to spread the medium evenly over the surface of the dish.
23. Culturing somite and segmental plates in DMEM/F12 medium results in approximately 70% of the cells differentiating into skeletal muscle and 95% expressing the skeletal muscle specific transcription factor MyoD (**Fig. 1**) within 24 h after plating (**4**). Although a few chondroblasts emerge in these cultures, the dominant pathway is myogenesis. In contrast, when somites and segmental plates are cultured in medium containing sera and embryo extract, far fewer cells differentiate and detachment and cell death begin to occur 72 h after plating (**3**). Thus, growth of these cells in serum free medium is superior to enriched media in that the cultures are nearly homogeneous for skeletal muscle and cell viability is maintained.

### 3.3. Cardiac Cultures from Day 10 Embryonic Chicken Heart

1. Preparation is important so it is best to have everything ready in advance of starting so that there will be minimal delay in plating cells once they have been removed from the embryo.

**Note:** Cardiac cells will rapidly adhere to glass. Use plastic as much as possible in order to avoid losing cells.

- Prepare dishes with sterile glass cover slips (**Notes 24 and 25**). This should be done at least one day in advance.
  - Prepare media (**Note 26**).
  - Sterilize instruments (**Note 10**).
  - Sterilize day 7 embryonic White Leghorn chicken eggs (staged according to Hamburger–Hamilton [7]) by dousing them with 70% EtOH and letting them air dry (approx 10 min).
2. Crack an egg on the edge of a sterile 100-mm Petri dish. Empty the embryo and the contents into the dish. Quickly decapitate the embryo with a scissors (**Note 11**) and remove the extraembryonic membranes. Transfer the body to another sterile 100-mm Petri dish that contains 5–6 mL of HBSS. Repeat this for all the eggs that you intend to use. The number of eggs is dependent upon the number of plates that you want and the cell density per plate. One heart will typically yield 1–2 million cardiac cells.
  3. Looking through a dissecting microscope at a relatively low power (approx 6 $\times$ ), lay the embryo on its back so that its ventral side is up. Place a fine scissors under the sternum at the midline and cut up to the level of the clavicles. Retract the skin, pectoral muscle, and sternum with a fine forceps (Dumont #5) to expose the heart. Cut through the clavicles on either side of the sternum.
  4. At this point, the heart should be fairly well exposed. Grasp the major vessels with a fine forceps (Dumont Biology #55) and remove the heart. Place the heart in a 60-mm Petri dish with HBSS.
  5. Using the dissecting microscope, remove the major vessels from the heart but do not remove the atria. Lay the heart on its side, anchor it down with a pair of forceps, and pull the vessels away from it. The valves lying just beneath the vessels also will be pulled away. If they are not, remove these as well.
  6. Again, using the stereo microscope, remove the pericardium from the heart. This should peel off as a sheet; however, it tears easily and will probably come off as many small sheetlike pieces. Expel as much blood from the heart chambers as possible.
  7. Transfer the cleaned heart to a dry 60-mm Petri dish and mince (**Note 27**). Add 1 mL of calcium–magnesium Hank’s balanced salt solution (CMF) to the dish. Collect minced cardiac tissue with a Pasteur pipet that has been rinsed with CMF (to prevent cardiac cells from sticking to the sides of the pipet—**Note 28**). Put the cardiac tissue into a 15-mL polypropylene tube. Add 8.8 mL of CMF and 0.2 mL of 2.5% trypsin to the tube (final solution has 0.05% trypsin). Gently rock the tube back and forth 20 times and incubate at 37°C for 10 min. Sit the tube in the incubator upright so that the cells can settle to the bottom.
  8. Remove the supernatant with a Pasteur pipet. Do not spin the cells. Add another 9.8 mL of CMF and 0.2 mL of trypsin. Incubate at 37°C for 15 min, gently shaking the tube every 5 min to make sure that all the cells are exposed to the trypsin. If the cell pellet is large, the second incubation can be extended to 20 min.
  9. Collect the suspended cells with a sterile plastic pipet and add cells to a 50-mL conical centrifuge tube that contains 10 mL of plating medium. Add 1–2 mL of plating medium to the 15-mL tube and gently pipet up and down to capture any remaining cardiac cells. Add this suspension to the 50 mL tube. Centrifuge for 5 min at 200g.
  10. Discard the supernatant and add fresh plating medium. Gently pipet the suspension using a drawn out glass Pasteur pipet (**Note 14**) until the cells are completely dispersed. Make sure the pipet has been thoroughly wetted before contact with the cardiac cells.

The mechanical action must be very gentle because the cells are fragile and harsh dispersion will destroy them.

11. Plate the cells into 35-mm tissue culture dishes containing sterile glass cover slips (**Note 17**). When plating, put the cells into the center of the coverslip and allow the surface tension to keep the medium on the glass and not spill over onto the rest of the dish. The next day, when the cells have attached to the glass, the plating medium can be removed and the cardiac growth medium added.
12. Cells should be maintained in a 37°C incubator with 5% CO<sub>2</sub> in air. Feed cells every other day with cardiac growth medium.

#### 4. Notes

1. Embryo extract should be prepared from day 11 chicken embryos. Use 90–120 eggs for a single batch. Sterilize eggs by dousing them with 70% EtOH and let air dry under sterile conditions. Sterilize forceps and a 1-L glass bottle. Break each egg and empty the contents into a sterile 100-mm Petri dish. Isolate the embryos, decapitate and place them into another sterile 100-mm Petri dish that contains sterile HBSS. You can put approx 15–20 embryos in each dish with HBSS. Do not let the embryos overflow the dish. Take a 50- or 60-cc sterile plastic syringe (without a needle) and place over the mouth of the sterile 1 L bottle. Carefully place the embryos one by one into the syringe making sure they do not touch the sides of the syringe or anything that has been handled. When the syringe is about three quarters full, put in the plunger and push the embryos through the end of the syringe into the bottle. Continue this until all the embryos have gone through the syringe. Note the volume that the embryos take up in the bottle and add an equal volume of sterile HBSS. Close the bottle and mix the contents well. Let the mixture sit at room temperature for 1 h, shaking the bottle periodically. At the end of the hour, make sure the contents are well mixed and pour the mixture into sterile 50 mL polypropylene centrifuge tubes. Do not fill beyond the 40 mL mark in order to leave room for expansion of the contents upon freezing. Quick freeze the tubes by immersing in an acetone/dry ice bath and then store at –70°C. The extract is generally good for at least one year. Embryo extract must be centrifuged before use. After centrifugation, the debris should be compacted at the bottom of the tube. The supernatant can then be decanted into a separate sterile container for use in the medium formulations.
2. To make rat tail collagen, collect between 8–12 rat tails. The tails will be good for 1–2 yr if they are kept at –20°C. If the tails have been frozen, they must be rehydrated by bringing them to room temperature and submerging them in sterile HBSS for 30 min to 1 h. Put the tails into 70% alcohol in sterile dishes for 1 h. Subsequently, put the tails into fresh sterile BSS. Sterilize a small bone cutter and some sturdy forceps. Under sterile conditions, clip through the skin and cartilage approx 3 cm from the small end of the tail and pull this piece away from the rest of the tail. You will be left with a small, free piece of tail in which you will see shiny, white collagen fibers sticking out at each end as well as some free fibers at the end of the large piece of tail. Remove as many of the free collagen fibers from the large piece of tail as possible with a sterile forceps and put them into sterile BSS in a sterile 100-mm Petri dish. Remove the remaining collagen from the small piece of tail and put those fibers into the same 100-mm Petri dish. Repeat this until all collagen has been removed from every tail. The collagen fibers must then be cleaned to remove any remaining pieces of cartilage, blood vessels, etc. Do this under a dissecting microscope and put the clean collagen fibers into 1% acetic acid in a sterile flask and maintain at 4°C, stirring until all the collagen is dissolved. This usually takes 1–2 d. One tail to approx 60 mL of 1% acetic acid is a good rule of thumb. The solution can always be diluted later if it is

too viscous. Finally, spin the solution to remove any undissolved collagen pieces or any other debris.

3. Chick embryo extract is prepared as described (**Note 1**) except that an equal volume of sterile PBS is added to the embryos after they have been passed through the syringe. After the solution has stood at room temperature for 1 h, it is centrifuged at 20,000 rpm for 60 min at 4°C. The supernatant is placed in 15-mL centrifuge tubes and stored at -70°C.
4. Using a diamond tip pen, score the middle of a 50 µL Drummond Scientific precision micropipet. Wrap the pipet in a paper towel and snap it in half. Heat the tip in a flame and gently pull the tip with forceps to elongate and narrow the diameter. Remove from the flame and immediately press a razor blade into the glass. Break off the tip and place it back into the flame to smooth the end. The diameter should be approx 0.5 mm. Place the micropipet into the end of the aspirator tube provided with the Drummond micropipets. Attach tubing to the end of the aspirator tube and a mouth piece to the free end of the tubing.
5. Each lot of fetal calf serum will differentially affect the growth potential of the cardiac cultures. If the cultures do not grow well, try a new lot of fetal calf serum. Alternatively, several lots of fetal calf serum can be tried initially and the lot that best promotes cardiac growth should be set aside to use for cardiac medium.
6. To prepare the squares, cut a piece of aclar from the roll. Wash aclar strip with detergent (SigmaClean laboratory glassware cleaning concentrate, Sigma Chemical Co.) to remove any residual grease from the manufacturing process. Be careful with what you use to scrub the aclar. Even mildly abrasive devices like scrub pads can scratch the aclar and make it difficult to see through it later if your end goal is microscopic examination of the cells. Rinse thoroughly and cut the aclar into squares (approx 22 × 22 mm). Put these into a glass container with concentrated nitric acid and shake for 30 min. **Caution:** Do not shake too fast or the nitric acid will spill out of the container. Carefully pour off the nitric acid and wash the aclar pieces with doubly distilled deionized water three times for approx 10 min each or until all the nitric acid has been washed away. Submerge the aclar pieces in 95% EtOH and shake for 15 min. Use sterile forceps to submerge any pieces adhering to the container walls. Change the alcohol and shake for another 15 min. Stir the aclar pieces around periodically to make sure that the pieces do not stick to each other. Air dry the pieces under a sterile hood. Remove them one by one from the alcohol with sterile forceps and lay flat on sterile towels until dry. Store them in a sterile container. These will last indefinitely as long as they remain sterile.
7. Preparation of collagen-coated aclar dishes. Place a small drop of collagen (one drop from a Pasteur pipet) into the bottom of a 35-mm tissue culture dish. Place a sterile aclar square on top of the collagen (this will hold the square in place). Put 4–5 drops of collagen on top of the aclar and spread around. Let it dry overnight. The collagen is toxic to the cells if it is still wet when the cells are plated. It is easy to spread the collagen with a Pasteur pipet that has been configured into a hockey stick. Over the flame from a Bunsen burner, seal the end of a 9" Pasteur pipet. Hold the thin end of the pipet in the flame about 30 mm from the end. Within a few minutes the glass will begin to bend. Let it bend until you have about a 70–90° angle. Collagen can be purchased from a number of companies, but it is expensive and does not usually work as well as collagen made in smaller quantities in the lab (**Note 2**).
8. Cultures are generally more successful if the collagen is made in the laboratory (*see Note 2*).
9. Medium should be prepared before you begin dissecting the muscle. The medium formulation includes embryo extract that is not commercially produced and must be made in advance (*see Note 1*).
10. A bead sterilizer works very well to sterilize the instruments but they can also be sterilized with EtOH in a sterile container for at least 20 min. The advantage of using the bead

sterilizer is that the hot beads will sterilize accidentally contaminated instruments in approx 20 s as opposed to 20 min by reesterilization with EtOH.

11. A good sturdy scissors should be used for this purpose. More delicate scissors can be reserved for fine dissection.
12. This forceps should not be too fine because pressing against the dish will destroy the tip. An old Dumont Biology #5 works well.
13. Keep in mind that when mincing in a plastic container the knives often cut loose slivers of plastic that can get mixed in with the muscle tissue.
14. To obtain an even finer bore on the Pasteur pipet tip, hold the tip of the small end of a sterile 9" Pasteur pipet over a Bunsen burner flame until the edges of the opening begin to narrow. Be careful that you do not hold it over the flame so long that the opening closes completely.
15. The filter is two pieces of lens paper that are cut to fit the filter holder. The lens paper is inserted into the filter holder and covered with an O-ring. Take care to ensure that the entire filter is completely covered. The filter holder cover is screwed into place and the whole filter is sterilized in an autoclave.
16. A cell counter is not necessary to obtain the cell counts; however, it does make counting easier.
17. Place the dishes under an ultraviolet (UV) light in a sterile hood for 5–10 min before the cells are plated into them. The plastic lid must be off of the dishes when under the UV light. Make sure that the lid is turned upside down and placed so that the inside is facing up to the UV light.
18. The length of incubation will vary depending on the incubator and the desired stage of development. Somites and segmental plates can be cultured from younger embryos (3). When cultured in medium containing sera and embryo extract, fewer cells differentiate from stage 10 embryos than stages 13–14 embryos (3). Although the rate of differentiation of younger mesoderm cells (stages 8–10) cultured in serum-free medium has not been determined, greater than 80% of premesoderm cells from stages 3–4 epiblast chick embryos form skeletal muscle *in vitro* (4,8).
19. All plasticware, instruments and solutions must be sterile. Instruments are sterilized by placing them in a beaker containing 70% ethanol.
20. Do not use Petri dishes. When dissections are made in Petri dishes, a toxic substance is released that kills cells when the knife cuts the plastic.
21. It is important that the cells are plated in the center of the dish so that they can be viewed from above with high magnification lenses after performing immunofluorescent localizations or *in situ* hybridizations. Adding  $2 \times 10^4$  cells in 15  $\mu$ L of medium results in a plating efficiency of 90%. By the following morning, the cells have flattened and the cultures consist of a nearly confluent monolayer. This method of plating cells in a small volume in the center of a dish is an adaptation of the micromass culture method for limb bud cells (9). Plating cells as a small spot in a larger dish produces many more cultures than would have been possible if cells were plated at the same density over the entire surface of the dish.
22. It is critical that the dishes are flooded within 90 min because the initial plating medium evaporates quickly, becomes concentrated, and kills the cells.
23. It is not necessary to cover the entire surface of the dish at the time of flooding. It is only important that the pool of medium reaches the cells and mixes with the original drop of plating medium. Do not shake the dish to spread the medium as this may detach the cells.
24. Make sure the cover slips are free from grease. Wash them two times for 10–15 min in a beaker with 70% EtOH and one time with 95% EtOH. Air dry on sterile towels under a UV hood. When thoroughly dry, store in sterile Petri dishes for future use.

25. Preparation of dishes with sterile glass cover slips: Place a small drop of collagen (one drop from a Pasteur pipet) into the bottom of a 35-mm tissue culture dish. Place a sterile glass cover slip on top of the collagen (this will hold the square in place). Let it dry overnight.
26. Medium should be prepared before you begin dissecting the muscle.
27. Make sure to keep the heart cells in plastic because they stick very readily to glass and are easy to lose.
28. Sterile disposable plastic pipets can also be used to transfer the cardiac cells.

## Acknowledgments

The authors thank Thor W. Nilsen for critical reading of the manuscript and Patrisia Mattioli for the preparation of photomicrographs.

## References

1. Lin, Z., Lu, M.-H., Schultheiss, T., Choi, J., Holtzer, H., DiLullo, C., et al. (1994) Sequential appearance of muscle-specific proteins in myoblasts as a function of time after cell division: evidence for a conserved myoblast differentiation program in skeletal muscle. *Cell Motility Cytol.* **29**, 1–19.
2. Holtzer, H., Schultheiss, T., DiLullo, C., Choi, J., Costa, M., Lu, M.-H., and Holtzer, S. (1990) Autonomous expression of the differentiation programs of cells in the cardiac and skeletal myogenic lineages. *Ann. NY Acad. Sci.* **599**, 158–169.
3. George-Weinstein, M., Gerhart, J., Foti, G., and Lash, J. W. (1994) Maturation of myogenic and chondrogenic cells in the presomitic mesoderm of the chick embryo. *Exp. Cell Res.* **211**, 263–274.
4. George-Weinstein, M., Gerhart, J., Blitz, J., Simak, E., and Knudsen, K. (1997) N-cadherin promotes the commitment and differentiation of skeletal muscle precursor cells. *Dev. Biol.* **185**, 14–24.
5. Lu, M.-H., DiLullo, C., Schultheiss, T., Holtzer, S., Murray, J. M., Choi, J., et al. (1992) The vinculin/sarcomeric- $\alpha$ -actinin/ $\alpha$ -actin nexus in cultured cardiac myocytes. *J. Cell Biol.* **117**, 1007–1022.
6. Dlugosz, A. A., Antin, P. B., Nachmias, V. T., and Holtzer, H. (1984) The relationship between stress fiber-like structures and nascent myofibrils in cultured cardiac myocytes. *J. Cell Biol.* **99**, 2268–2278.
7. Hamburger, V. and Hamilton, H. L. (1951) A series of normal stages in development of the chick embryo. *J. Morphol.* **88**, 49–92.
8. George-Weinstein, M., Gerhart, J., Reed, R., Flynn, J., Callihan, B., Mattiacci, M., et al. (1996) Skeletal myogenesis: The preferred pathway of chick embryo epiblast cells in vitro. *Dev. Biol.* **173**, 279–291.
9. Ahrens, P. B., Solursh, M., and Reiter, R. S. (1977) Stage related capacity for limb chondrogenesis in cell culture. *Dev. Biol.* **60**, 69–82.

## Study of Skeletal Myogenesis in Cultures of Unsegmented Paraxial Mesoderm

Anne-Gaelle Borycki and Charles P. Emerson, Jr.

### 1. Introduction

Recent developments in the field of skeletal myogenesis have identified signaling tissues that control the determination and the differentiation of muscle cells in unsegmented paraxial mesoderm of vertebrate embryos (1–3). Unsegmented mesoderm, called presomitic mesoderm in mouse embryos and segmental plate in avian embryos, requires signals from the notochord, the dorsal neural tube, and the surface ectoderm to positively initiate muscle formation (4–10), whereas signals from the lateral plate and the ventral neural tube negatively control muscle formation (10–12). Together, these positive and negative signals define and specify a localized group of cells within the presomitic mesoderm that differentiate into muscle. Although many of these studies were performed using *in vivo* microsurgeries (10–15), tissue-culture experiments have provided a useful minimal system to investigate the functions of signals involved in myogenesis during development (4–9,16). Identification of the specific signaling molecules controlling muscle formation is in progress, and for many of these studies, involve culture of unsegmented mesoderm in the presence of embryonic inducing tissues; or in the presence of conditioned medium of cells stably transfected with candidate signal gene (16); or in the presence of purified molecules (17); or following infection with retroviral vector expressing specific signal molecules (18).

This chapter presents three protocols for unsegmented mesoderm explant tissue cultures to study skeletal myogenesis: 1) culture on agarose substrates; 2) culture on gelatin substrates; and 3) culture on platform inserts. All three methods are applicable for both avian and mouse embryos, and represent variations of methods currently described in the literature. The choice of the culture method depends on the techniques available for assay and analysis of the response of explants, the treatments applied to the explants (addition of purified proteins, addition of antisense oligonucleotides, addition of conditioned medium, coculture with cell lines), and the type of culture (cells spreading in a monolayer or compact tissue explants). Agarose-coated explant culture methods preserve the architecture of the explant, and therefore cell–cell interactions and extracellular matrix interactions. This method is suitable for culture studies using conditioned or factor-supplemented media, and for analysis of gene expression by whole-mount *in situ*

hybridization or by immunohistochemistry, as well as by RT-PCR techniques (4,5). Platform insert explant culture methods also preserve the architecture of the explants and are suitable for culture studies using antisense oligonucleotides, conditioned or factor-supplemented media, and for analysis of gene expression by whole-mount *in situ* hybridization or immunohistochemistry, as well as RT-PCR techniques. Gelatin culture methods promote cell spreading, which may, in some cases, offer different technical advantages. These cultures are suitable for treatment with conditioned or factor-supplemented media, antisense oligonucleotides, and coculture with cell lines (7,16). Techniques for analysis of gene expression in monolayer cultures include immunohistochemistry and RT-PCR.

## 2. Materials

1. Culture media
  - a. Medium for agarose culture: Dulbecco's modified Eagle medium (DMEM-Gibco-BRL, Gaithersburg, MD) with L-glutamine and glucose (4.5 g/L) containing 15% fetal calf serum (FCS-Gibco-BRL), and 1% penicillin/streptomycin/fungizon (Gibco-BRL). Store at 4°C.
  - b. Medium for gelatin culture: DMEM/F-12 (1:1) with 15 mM HEPES buffer and L-glutamine (Gibco-BRL) containing 15% FCS, 2 ng/mL bFGF (Sigma, St. Louis, MO) and 1% penicillin/streptomycin/fungizon (Gibco-BRL). Store at 4°C.
  - c. Medium for platform insert culture: Leibovitz's L-15 with L-glutamine (Gibco-BRL) with 15% FCS (Gibco-BRL), and 1% penicillin/streptomycin/fungizon (Gibco-BRL). Store at 4°C.
2. Buffer and solutions
  - a. PBS: Phosphate-buffered saline, pH 7.5. Prepare and autoclave solution A containing 160 g/L NaCl, 8 g/L KCl, 3 g/L  $\text{KH}_2\text{PO}_4$ , and 3.12 g/L  $\text{Na}_2\text{HPO}_4$ . Prepare and autoclave solution B containing 15 g/L  $\text{MgSO}_4$  and 1.6 g/L  $\text{CaCl}_2$ . For 1 L of PBS, add 50 mL of solution A, 10 mL of solution B, and 1.1 g of glucose to distilled water. Adjust the pH to 7.2 with 1 N NaOH, and sterilize through 0.22  $\mu\text{m}$  filter. Store at room temperature.
  - b. 1X dispase II solution: Dissolve the sterile 10X Dispase II solution (Boehringer Mannheim, Mannheim, Germany) in PBS, aliquot and store at -20°C. Thaw on ice before use, and do not refreeze aliquot.
  - c. Gelatin solution: 0.001% Gelatin solution (from porcine skin, Sigma) in distilled water, autoclaved. Store at room temperature.
  - d. Agarose solution: 1% Agarose (Gibco-BRL, ref. 15510) solution in distilled water, autoclaved. Store at 4°C.
  - e. Sylgard solution: Solution of Sylgard 184 is prepared by mixing Sylgard 184 Curing Agent (1 part) to Sylgard 184 silicone elastomer (10 parts) (Dow Corning, Midland, MI, ref. ET052545). Prepare fresh.
  - f. 4% Paraformaldehyde solution: Add 2 g of paraformaldehyde (J. T. Baker, Phillipsburg, NJ, ref. S898) to 40 mL of PBS. Add approx 1 mL of 1 N NaOH to adjust to pH 7.0. Stir and heat at 60°C until completely dissolved. Adjust volume to 50 mL with PBS. Prepare fresh.
3. Plasticware
  - a. 24-Well plates
  - b. 48-Well gelatin-coated plates: Under the hood, pour 0.2–0.5 mL of gelatin solution in each well. Let sit for 3–4 h, before removing excess solution. Let dry under the hood overnight. Wrap into Saran Wrap and store at room temperature.



- c. 6-Well agarose-coated plates: Bring agarose into solution, and let cool at 50°C. In a sterile tube, mix 1 volume of agarose solution to 1 volume of DMEM medium. Pour 3 mL of this solution into 6-well plates. Let solidify. Prepare plates immediately before use.
  - d. Cell-culture platform insert, 8.0 µm pore size, for a 24-well plate (Falcon, Los Angeles, CA).
  - e. Sylgard-coated dishes (35 mm × 10 mm, Nalge Nunc, Wiesbaden, Biebrich, Germany): coat lids and dishes with a solution of Sylgard 184 silicone elastomer freshly prepared (see **Subheading 2.**). Let solidify (24 h). Maximum mechanical strength is obtained after 7 d.
4. Other materials
    - a. Filter rings: Cut rings into filter paper (#1, Whatman Inc., Clifton, NJ) of approx 35-mm diameter and 10-mm diameter for the hole.
    - b. Electrolytically sharpened tungsten (diameter: 0.25 mm, Goodfellow, Cambridge, Cambridge, UK) knives.
    - c. Gel saver II pipet tips (1–200 µL capacity), USA Scientific (Ocala, FL).

### 3. Methods

#### 3.1. Embryo Harvest

For studies of quail or chicken embryos, incubate eggs from 42–48 h in order to recover embryos from stage 11 to stage 13. Open the top of the egg with forceps, remove excess of albumin, and pour yolk into a Petri dish (embryo facing up). Lay a filter ring on the yolk, with the embryo in the window of the ring, and cut 1 cm off the perimeter of ring with scissors to fix the extraembryonic membrane to the filter. Lift the filter with the attached embryo gently and place in a Petri dish in PBS to rinse adherent yolk. For studies of mouse embryos, harvest embryos at day 9.5 postcoitus by performing a cesarean incision and extracting the uterus from the abdomen of the mouse. Transfer the uterus into PBS in a Petri dish and extract embryos with forceps, with special care to preserve the tail of embryos.

#### 3.2. Dissections

To dissect segmental plate (sp) from avian embryos (**Fig. 1A**), transfer the embryo attached to a filter, dorsal side up, onto a Sylgard dish into a drop of PBS (**Fig. 1A-a**). With a tungsten knife, remove the extraembryonic membrane over the tail region (**Fig. 1A-b**). Dissect out the SP by performing small cuts to separate the neural tube and then the lateral plate (**Fig. 1A-c,d,e**), followed by transverse cuts in the posterior end and the anterior end to release the tissue from the segmental plate (**Fig. 1A-f**). Collect the SP explant with a 20-µL pipet and a gel saver tip (**Fig. 1A-g**).

To dissect presomitic mesoderm (PSM) from mouse embryos (**Fig. 1B**), transfer the embryo onto a Sylgard dish in PBS (**Fig. 1B-a**). Cut off the tail of the embryo including the PSM and the first 3–4 somites (**Fig. 1B-b**). Position the tail in the dish, dorsal side up, anchoring it by the somite region with a tungsten knife (**Fig. 1B-c**). Dissect the PSM by performing small posterior to anterior cuts along the neural tube (**Fig. 1B-c**). Perform a transverse cut at the level of the boundary between the PSM and the first somite (**Fig. 1B-d**), and lay the tissue on the side with the internal “neural tube” side facing up (**Fig. 1B-e**). The PSM appears now on the outside part of the tissue, and a thin white line marks the boundary with the lateral plate. Cut along this line to separate the lateral plate from the PSM (**Fig. 1B-f**). Collect the PSM explant with a 20-µL pipet and a gel saver tip (**Fig. 1B-g**).

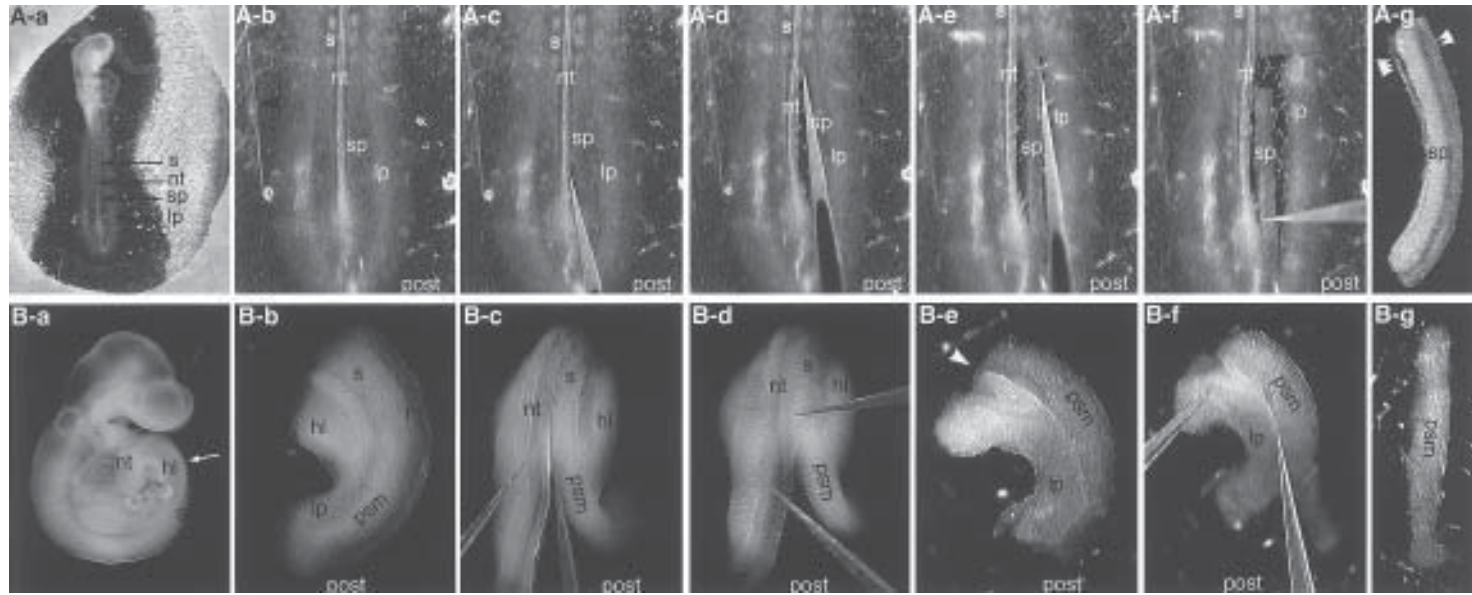

Fig. 1. Procedure for unsegmented mesoderm dissection from quail and mouse embryos. **(A)** Segmental plate dissection from quail embryo. **a.** Stage 12 quail embryo attached to a filter ring is placed onto a Sylgard dish into PBS. **b.** Extra-embryonic membrane is removed over the segmental plate region (black arrow head). **c.** and **d.** Using a tungsten knife, SP is separated from neural tube by performing small posterior to anterior cuts. **e.** Using a tungsten knife, SP is separated from lateral plate by performing small posterior to anterior cuts. **f.** Segmental plate is released by transverse cuts in the posterior, then the anterior end. **g.** Segmental plate explant as seen after dissection. The double arrowhead points to the surface ectoderm. The triple arrowhead points to the endoderm. **(B)** Presomitic mesoderm dissection from mouse embryo. **a.** 9.5-d-old mouse embryo is placed onto a Sylgard dish into PBS. The tail is cut at the level of the hind limb with the tungsten knife (white arrow). **b.** Side view of the tail after separation from the mouse embryo. **c.** Holding the tail with a tungsten knife, dorsal side up, the PSM is separated from the neural tube by performing small posterior to anterior cuts. **d.** The PSM is isolated by performing a transverse cut at the posterior border of the first somite. **e.** The tissue comprising PSM and lateral plate lays on the side, “neural tube” side up. The border between lateral plate and presomitic mesoderm is seen as a thin white line (white arrowhead). **f.** Holding the explant on the lateral plate side with a tungsten knife, the PSM is separated from the lateral plate by performing small cuts along the border between PSM and lateral plate. **g.** Presomitic mesoderm as seen after dissection (*see Note 5*). s: somite; nt: neural tube; sp: segmental plate; psm: presomitic mesoderm; lp: lateral plate; hl: hind limb; post: posterior.

To remove surface ectoderm (*see Note 1*), incubate the quail embryo or the mouse tail in a 1X dispase solution for 45 s or 1 min, respectively. Stop the digestion by rinsing with PBS, before gently peeling off the surface ectoderm over the unsegmented mesoderm with a tungsten knife.

### 3.3. Culture

1. Culture on agarose-coated plate: transfer unsegmented mesoderm tissue onto the surface of the agarose-coated well. Several explants can be cultured in the same well. Cover explants with 0.5 mL of DMEM medium. Incubate for up to 24 h at 37°C in a humidified CO<sub>2</sub> tissue culture incubator.
2. Culture on gelatin-coated plate: transfer with pipet explants on the surface of gelatin-coated well containing 0.5 mL of DMEM/F-12 medium (*see Note 2*). Culture one explant per well for up to 3 d at 37°C in a humidified CO<sub>2</sub> incubator.
3. Culture on platform insert: transfer with pipet explant on the membrane of the culture insert. Several explants can be cultured in the same insert. Position the insert into the well of a 24-well plate. Add 0.3 mL of Leibovitz medium into the well. The membrane of the culture insert should be just immersed by the medium to place the tissue near the air interface. Culture for up to 48 h at 37°C in a humidified incubator without CO<sub>2</sub>.

### 3.4. Analysis (*see Note 3*)

After culture, cells can be fixed in a 4% paraformaldehyde solution for 30 min at 4°C, in the case of gelatin-coated cultures. For platform insert cultures and agarose-coated cultures, explants can be collected with a pipet, transferred into 2-mL eppendorf tubes, and fixed for 1 h at room temperature in 4% paraformaldehyde (*see Note 4*). Gene expression in explants can then be analyzed either by whole-mount *in situ* hybridization (*see Chapters 28 and 30*) (**Fig. 2A**) or whole-mount immunohistochemistry, for unsegmented mesoderm cultured on platform insert and on agarose-coated plates, or by immunohistochemistry (*see Chapters 29 and 31*) (**Fig. 2B**) for unsegmented mesoderm cultured on gelatin-coated plates.

Alternatively, RNA can be prepared from explants or cells, followed by analysis of gene expression by semiquantitative RT-PCR (*see Chapter 26*), for all types of explant cultures.

## 4. Notes

1. Dispase II is a gentle, neutral protease from a bacterial source, claimed by the provider as preserving cell membrane integrity. Its activity can be modulated by further dilution of the stock 1X solution (2.4 U/mL). Working concentrations range from 0.6 to 2.4 U/mL. Alternatively, a solution 4:1 of 0.2% pancreatin in PBS and 0.1% trypsin can be used for tissue digestion (**8**). In this case, incubate tissues or embryos on ice for 4–5 min and stop digestion by adding culture medium.
2. For gelatin-substrate cultures with either mouse or avian unsegmented mesoderm, it is possible to transversally cut in half the explant before transferring into culture. This provides twice as many explants for culture. We have not seen differences in the ability to induce myogenesis between the posterior half and the anterior half of the explant after 3 d in culture in presence of inducing-tissues (axial tissues or surface ectoderm).
3. Early myogenic determination can be detected by monitoring *myoD* and *myf5* expression, in avian and mouse embryos, respectively. Although cDNA probes and PCR primers are available for mouse and avian systems, only antimouse MyoD antibody is available com-

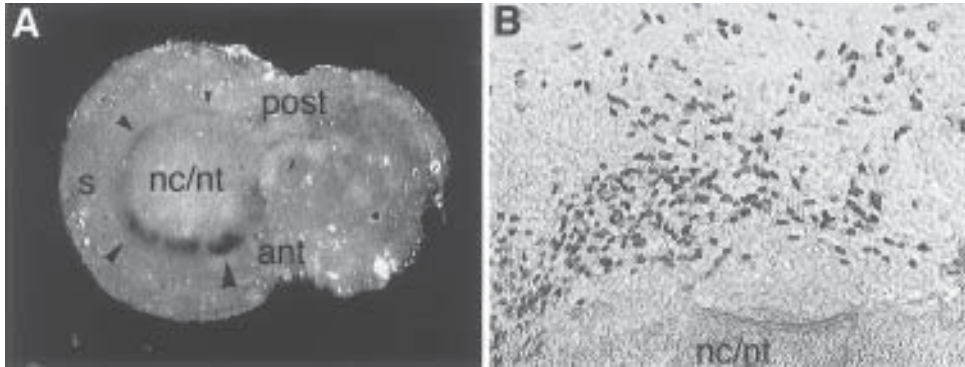

Fig. 2. (A) *myoD* activation in segmental plate explant cultured in presence of surface ectoderm and axial tissues. Segmental plate explants, with overlying surface ectoderm and notochord/neural tube, from a stage 12 quail embryos were cultured for 16 h on agarose-coated plates. Explants were fixed in 4% paraformaldehyde and analyzed by *in situ* hybridization using a DIG-labeled RNA probe for quail *myoD*. Arrowheads indicate increasing expression of *myoD* from the posterior to anterior region of the explant. ant: anterior; post: posterior; nc/nt: notochord/neural tube; s: somite. Note that, in these explants, the architecture of the tissues and the spatial and temporal timing of gene expression are conserved. (B) MyoD activation in presomitic mesoderm explant cultured in presence of surface ectoderm and axial tissues. Presomitic mesoderm explants, with overlying surface ectoderm and notochord/neural tube, from 9.5-d-old mouse embryos were cultured for 3 d on gelatin-coated plates. Explants were fixed in 4% paraformaldehyde and analyzed by immunohistochemistry using an antimouse MyoD (5.8A) antibody. nc/nt: notochord/neural tube. Note that, in these explants, somitic cells spread out as a monolayer from the explant.

mercially and reliable (Clone 5.8A, Vector Laboratories, Burlingame, CA). In contrast, numerous antibodies raised against contractile muscle proteins and cDNA probes are available in both systems to study muscle differentiation. In the case of mouse embryos, transgenic mice carrying a *lacZ* reporter gene under the control of muscle specific promoter (*myoD*, MLC, and so on) allow simple detection of muscle cells through *lacZ* staining of the explants.

4. Because of the thickness of the tissues, fixation is performed for 1 h at room temperature to ensure complete fixation.
5. In mouse embryos, the surface ectoderm and the endoderm are thinner epithelia as compared to those of quail embryos, and therefore are barely visible after dissection.

## Acknowledgments

The authors wish to thank Brian Brunk, and also Jonathan Cooke, Giulio Cossu, Steven Hauschka, Howard Holtzer, and Frank Stockdale for technical discussions and advice. This work was supported by a grant to Charles P. Emerson, Jr. from the NIH.

## References

1. Lassar, A. B. and Munsterberg, A. E. (1996) The role of positive and negative signals in somite patterning. *Curr. Opin. Neurobiol.* **6**, 57–63.
2. Christ, B. and Ordahl, C. P. (1995) Early stages of chick somite development. *Anat. Embryol.* **191**, 381–396.

3. Cossu, G., Tajbakhsh, S., and Buckingham, M. (1996) How is myogenesis initiated in the embryo? *Trends Genet.* **12**, 218–223.
4. Buffinger, N. and Stockdale, F. E. (1994) Myogenic specification in somites: induction by axial structures. *Development* **120**, 1443–1452.
5. Buffinger, N. and Stockdale, F. E. (1995) Myogenic specification of somites is mediated by diffusible factors. *Dev. Biol.* **169**, 96–108.
6. Munsterberg, A. E. and Lassar, A. B. (1995) Combinatorial signals from the neural tube, floor plate and notochord induce myogenic bHLH gene expression in the somite. *Development* **121**, 651–660.
7. Stern, H. M. and Hauschka, S. D. (1995) Neural tube and notochord promote in vitro myogenesis in single somite explants. *Dev. Biol.* **167**, 87–103.
8. Cossu, G., Kelly, R., Tajbakhsh, S., Di Donna, S., Vivarelli, E., and Buckingham, M. (1996) Activation of different myogenic pathways: myf-5 is induced by the neural tube and MyoD by the dorsal ectoderm in mouse paraxial mesoderm. *Development* **122**, 429–437.
9. Fan, C. M. and Tessier-Lavigne, M. (1994) Patterning of mammalian somites by surface ectoderm and notochord: evidence for sclerotome induction by a hedgehog homolog. *Cell* **79**, 1175–1186.
10. Pownall, M. E., Strunk, K. E., and Emerson, C. P., Jr. (1996) Notochord signals control the transcriptional cascade of myogenic bHLH genes in somites of quail embryos. *Development* **122**, 1475–1488.
11. Pourquie, O., Coltey, M., Breant, C., and Le Douarin, N. M. (1995) Control of somite patterning by signals from the lateral plate. *Proc. Natl. Acad. Sci. USA* **92**, 3219–3223.
12. Pourquie, O., Coltey, M., Teillet, M. A., Ordahl, C., and Le Douarin, N. M. (1993) Control of dorsoventral patterning of somitic derivatives by notochord and floor plate. *Proc. Natl. Acad. Sci. USA* **90**, 5242–5246.
13. Brand-Saberi, B., Ebensperger, C., Wilting, J., Balling, R., and Christ, B. (1993) The ventralizing effect of the notochord on somite differentiation in chick embryos. *Anat. Embryol.* **188**, 239–245.
14. Bober, E., Brand-Saberi, B., Ebensperger, C., Wilting, J., Balling, R., Paterson, B. M., et al. (1994) Initial steps of myogenesis in somites are independent of influence from axial structures. *Development* **120**, 3073–3082.
15. Goulding, M., Lumsden, A., and Paquette, A. J. (1994) Regulation of Pax-3 expression in the dermomyotome and its role in muscle development. *Development* **120**, 957–971.
16. Stern, H. M., Brown, A. M. C., and Hauschka, S. D. (1995) Myogenesis in paraxial mesoderm: preferential induction by dorsal neural tube and by cells expressing Wnt-1. *Development* **121**, 3675–3686.
17. Munsterberg, A. E., Kitajewski, J., Bumcrot, D. A., McMahon, A. P., and Lassar, A. B. (1995) Combinatorial signaling by sonic hedgehog and wnt family members induces myogenic bHLH gene expression in the somite. *Genes Dev.* **9**, 2911–2922.
18. Maroto, M., Reshef, R., Munsterberg, A. E., Koester, S., Goulding, M., and Lassar, A. B. (1997) Ectopic pax-3 activates myoD and myf-5 expression in embryonic mesoderm and neural tissue. *Cell* **89**, 139–148.

## Embryonic Limb Mesenchyme Micromass Culture as an In Vitro Model for Chondrogenesis and Cartilage Maturation

Anthony M. DeLise, Emanuela Stringa,  
Wendy A. Woodward, Maria Alice Mello, and Rocky S. Tuan

### 1. Introduction

In vitro techniques for the study of chondrogenic differentiation of embryonic limb mesenchymal cells have been available for some time. Early methods require high-density confluent monolayer cell cultures (1,2). The micromass culture method developed by Ahrens et al. (3) represented a convenient system for the observations and analysis of the differentiative processes and phenomena analogous to those exhibited by the limb cartilage anlagen *in situ*. In these cultures, limb mesenchymal cells first undergo condensation giving rise to aggregates that later become cartilage nodules (3,4), thereby mimicking the differentiative phenomena occurring during embryonic limb development in vivo, i.e., mesenchymal condensation preceding cartilage differentiation (5–9). The micromass limb mesenchymal culture system has gained great popularity for the analysis of the regulatory steps and differentiative processes that result in the condensation of the mesenchyme and the formation and maturation of the cartilage anlagen.

This chapter outlines the protocols developed for culturing limb bud mesenchymal cells from mouse and chick embryos used in the authors' laboratory. In addition, techniques and protocols for histochemical and immunohistochemical detection of chondrocyte markers at all stages of differentiation and maturation are also described.

### 2. Materials and Methods

#### 2.1. Mouse Embryonic Limb Mesenchyme Cultures

##### 2.1.1. Materials

1. Mouse embryos: Use gestational day 11.5 to 12.5 embryos (*see Note 3.1.1.*).
2. 10X Glucose: Composition per 250 mL, 2.5 g tissue culture grade glucose q.s. to 250 mL with ddH<sub>2</sub>O, filter sterilize, and store at 4°C.
3. 10X Calcium–magnesium-free saline (CMFS): Composition per 250 mL, 0.925 g KCl, 0.075 g KH<sub>2</sub>PO<sub>4</sub>, 20.0 g NaCl, 0.568 g NaHCO<sub>3</sub>, 0.315 g NaH<sub>2</sub>PO<sub>4</sub> · H<sub>2</sub>O q.s. to 250 mL with ddH<sub>2</sub>O, filter sterilize, and store at 4°C.

From: *Methods in Molecular Biology*, Vol. 137: *Developmental Biology Protocols*, Vol. III  
Edited by: R. S. Tuan and C. W. Lo © Humana Press Inc., Totowa, NJ

4. 200X Penicillin/streptomycin: Dissolve 2.89 g of penicillin (1730 U/mg, Sigma Chemical Co., St. Louis, MO) and 5.0 g of streptomycin (761 U/mg, Sigma) in 500 mL of water, pH to 7.3 and filter sterilize. Aliquot and store at  $-20^{\circ}\text{C}$ .
5. 1X Saline–glucose solution (CMFSG): Composition per 250 mL, 25 mL of 10X glucose, 25 mL of 10X CMFS, 1.25 mL of 200X penicillin/streptomycin, q.s. to 250 mL with ddH<sub>2</sub>O, filter sterilize, and store at  $4^{\circ}\text{C}$ .
6. Culture medium: Composition per 250 mL, 25 mL fetal bovine serum (Atlanta Biologicals, Atlanta, GA), 1.25 mL 200X penicillin/streptomycin, q.s. to 250 mL with 1X Dulbecco's Modified Eagle's Medium (DMEM; Gibco-BRL, Gaithersburg, MD). Store the prepared culture medium at  $4^{\circ}\text{C}$ .
7. Digestion solution: 0.002% EDTA (Fisher Scientific, Pittsburgh, PA) and 0.01% trypsin type II from porcine pancreas (Sigma) in CMFSG.
8. 20  $\mu\text{m}$  mesh Nitex filter (Tetko, Lancaster, NY).
9. Microdissection forceps and scissors.
10. Stereomicroscope.
11. Hemacytometer.

### 2.1.2. Methods

1. Harvesting of the embryos: Sacrifice the mouse by cervical dislocation, remove the embryos from the uterus by Caesarean section.
2. Rinse embryos in CMFSG at room temperature.
3. With the aid of a stereomicroscope, dissect the limbs (both fore- and hindlimbs) using microdissection forceps and scissors.
4. Collect the limbs in a 50-mL conical tube with 4 mL CMFSG.
5. Cell dissociation: Add the digestion solution and pipet up and down using a 10-mL pipet for about 20–30 times, until the limbs are totally disintegrated (*see Note 3.1.2.*).
6. Stop the enzymatic digestion with an equal volume of culture medium.
7. Pass the mixture of dissociated limbs through the Nitex filter to eliminate fibrous materials and tissue debris.
8. Take a 10- $\mu\text{L}$  aliquot and determine cell number by hemacytometer counting and collect the rest of the cells by centrifugation at 230g for 10 min.
9. Resuspend the cell pellet in enough culture medium to reach the cell concentration desired (from 10 to  $20 \times 10^6$  cells/mL).
10. Plate cells as 10  $\mu\text{L}$  micromass drop in a 24-mm tissue culture well and incubate at 5% CO<sub>2</sub>,  $37^{\circ}\text{C}$  in a humidified tissue culture incubator for 1.5 or 2 h to allow cell attachment (*see Notes 3.1.3., 3.1.4., and 3.1.5.*).
11. Feed the micromass with 1 mL of culture medium (*see Note 3.1.6.*).
12. Change medium after 24 h.
13. After another 24 h, change medium with medium containing 25  $\mu\text{g}/\text{mL}$  ascorbic acid (*see Note 3.1.7.*).
14. Change medium every other day.

## 2.2. Chicken Embryonic Limb Mesenchyme Cultures

### 2.2.1. Materials

1. 10X Glucose: *see Subheading 2.1.1.*
2. 10X Calcium–magnesium-free saline (CMFS): *see Subheading 2.1.1.*
3. 10X Ham's F-12 Culture Media (Gibco-BRL), prepare as per manufacturer's instructions, store at  $4^{\circ}\text{C}$ .
4. 200X Penicillin/streptomycin: *see Subheading 2.1.1.*

5. 1X Saline–glucose solution (CMFSG): *see Subheading 2.1.1.*
6. Enzymatic digestion solution: 4.0-mL chicken serum (Sigma), 40 mg trypsin (Sigma) in 10 mL CMFSG, 40 mg collagenase (Worthington Biochemical, Lakewood, NJ) in 10 mL CMFSG, q.s. to 40 mL with CMFSG. Filter sterilize.
7. Chick embryo extract: Either from a commercial source, e.g., Gibco-BRL, or as described in Tuan and Scott (10).
8. 10% Calf serum [5-mL calf serum (Gibco-BRL/Hyclone, Logan, UT), q.s. to 50 mL with CMFSG].
9. Culture medium: Composition per 250 mL, 25-mL fetal bovine serum (Atlanta Biologicals), 1.25 mL 200X penicillin/streptomycin, 500  $\mu$ L chick embryo extract, q.s. to 250 mL with 1X Ham's F-12 culture media. Prepare 1X Ham's F-12 by adding 25 mL of 10X Ham's F-12 to a beaker and q.s. to 250 mL with ddH<sub>2</sub>O. Adjust the pH of the solution to 7.1 to 7.2 with HCl and then filter sterilize into a sterile bottle (filtering the solution will raise the pH 0.2–0.3). Remove 26.75 mL of the solution and replace it with the fetal bovine serum, penicillin/streptomycin, and chick embryo extract. Only prepare enough culture medium to feed the cells for 3 d and store the prepared culture medium at 4°C.
10. Microdissection forceps and scissors.
11. Stereomicroscope.

### 2.2.2. Methods

1. Embryo incubation and limb bud harvesting:
  - a. Incubate fertilized eggs at 99.5°C in a humidified egg incubator for 4 d (96 h). Working in a tissue culture hood (*see Note 3.2.1.*), crack open the egg and drop the contents into a large sterile plastic Petri dish. Using a pair of sterile blunt forceps, remove the embryo (*see Note 3.2.2.*) from the underlying yolk and place the embryo in a sterile plastic Petri dish containing prewarmed (37°C) CMFSG. Repeat for the remaining eggs.
  - b. With the aid of a stereomicroscope, dissect the limb buds from the embryos using a pair of fine forceps and scissors. Snip each limb bud longitudinally (*see Note 3.2.3.*) and with a sterile glass Pasteur pipet, transfer the limb buds to another sterile plastic Petri dish containing prewarmed (37°C) CMFSG. Keep this dish covered. Repeat the above steps until all eggs have been processed.
2. Limb bud digestion:
  - a. Using a sterile Pasteur pipet, transfer the limb buds into a 125-mL plastic Nalgene™ Erlenmeyer flask with a screw top lid (Nalge Nunc, Rochester, NY). Remove as much of the excess CMFSG as possible. Add the enzymatic digestion solution to the limb buds (*see Note 3.2.4.*) and close the flask tightly with the screw top lid. Place the flask in a 37°C water bath and incubate for 1 h (*see Note 3.2.5.*) with gentle shaking (*see Note 3.2.6.*). At the conclusion of the 1 h digestion, neutralize the enzymatic digestion by adding an equal volume (40 mL) of 10% calf serum in CMFSG to the Erlenmeyer flask containing the limb buds and enzymatic digestion solution. Swirl gently to mix. Do not discard the remaining 10 mL of 10% calf serum.
3. Separation of limb bud mesenchymal cells:
  - a. After the digestive enzymatic action has been neutralized, separate the enzyme/calf serum solution containing the limb bud cells into 4 × 20 mL aliquots in 50-mL conical centrifuge tubes (Falcon, Los Angeles, CA). Vortex each tube for three brief shocks. This will break up any remaining whole limb buds.
  - b. Place a cell strainer (Falcon) over a new 50-mL conical tube and filter the enzyme/calf serum solution containing the limb bud cells through the cell strainer. This will remove any undigested limb buds and clumps, leaving behind a suspension of single cells.



Aliquot the filtered cell suspension into 4X 20 mL aliquots in 50-mL conical centrifuge tubes. Centrifuge at 230g for 10 min to pellet the cells.

- c. After centrifugation, aspirate the supernatant from each tube using a glass Pasteur pipet. The white layer on the bottom contains the limb bud cells. Add approx 200  $\mu$ L (see **Note 3.2.7.**) of 10% calf serum to each tube using a 1000  $\mu$ L Pipetman<sup>®</sup> pipet (or equivalent) (Rainin Instrument Co., Inc., Woburn, MA) and gently resuspend the cells by pipetting up and down two to three times (see **Note 3.2.8.**). Combine all of the cell suspensions from the four tubes in a 15-mL conical centrifuge tube. Flick or tap the tube gently to mix. At this point, determine the total cell suspension volume by drawing the total volume up into the pipet tip (see **Note 3.2.9.**).
4. Cell counting and plating:
- a. To determine the cell concentration, make a 1:50 dilution of the cell suspension. Place 480  $\mu$ L of 10% calf serum in a 15-mL conical centrifuge tube. Add to this 10  $\mu$ L of Trypan blue and 10  $\mu$ L of the cell suspension. Vortex briefly to mix. Load 10  $\mu$ L of this dilution onto a hemacytometer. Count the number of cells present in five large grids (each grid is 1 mm  $\times$  1 mm). Do not count nonviable blue cells. Take the average of the five grids and use this number to calculate the cell concentration of your cell suspension as follows: average number of cells/grid  $\times$  50 (dilution factor)  $\times$   $10^4$  = cells/mL. Adjust the cell concentration to  $20 \times 10^6$  cells/mL by adding the appropriate volume of 10% calf serum to the cell suspension.  
 For example, if the cell count average is 50, and the total cell suspension volume is 940  $\mu$ L, then
 
$$50 \text{ cells} \times 50 \times 10^4 = 25 \times 10^6 \text{ cells/mL}$$

$$25 \times 10^6 \text{ cells/mL} \times 0.93 \text{ mL} = 23.25 \times 10^6 \text{ cells}$$

$$23.25 \times 10^6 \text{ cells} \div 20 \times 10^6 \text{ cells/mL} = 1.1625 \text{ mL}$$

$$1.1625 \text{ mL} - 0.93 \text{ mL} = 0.2325 \text{ mL 10\% calf serum to add to give a cell concentration of } 20 \times 10^6 \text{ cells/mL}$$
  - b. Plate the cells ( $20 \times 10^6$  cells/mL) in 10  $\mu$ L drops (see **Note 3.2.10.**) in the center of each well of a Corning<sup>™</sup> 24-well tissue culture plate (see **Note 3.2.11.**). Place the tissue culture plates in a humidified incubator at 37°C, 5% CO<sub>2</sub> for 1.5–2 h to allow the cells to attach to the tissue culture plates. After the 1.5–2 h incubation, feed the cells by adding 1 mL of culture medium/well (see **Note 3.2.12.**). Culture medium should be replaced daily.
  - c. Culture day 1 is the day after plating. Cellular condensations are visible on culture day 2 and refractile cartilage nodules are evident on day 3 (**Fig. 1A–C**). Keeping cells in culture longer than 5 d requires a change in culture conditions (see **Subheading 2.3.**).

## 2.3. Long Term Culture of Chick Embryonic Limb Mesenchymal Cells

### 2.3.1. Materials

1. 10X Glucose: see **Subheading 2.1.1.**
2. 10X Calcium–magnesium-free saline (CMFS): see **Subheading 2.1.1.**
3. 1X Saline–glucose solution (CMFSG): see **Subheading 2.1.1.**
4. 200X Penicillin/streptomycin: (see **Subheading 2.1.1.**).
5. Enzymatic digestion solution: see **Subheading 2.2.1.**
6. 10% Calf serum: see **Subheading 2.2.1.**
7. Dulbecco's modified Eagle's medium and Ham's F-12 medium (DMEM/F12) (Gibco-BRL).
8. Culture medium: Consists of a 1:1 mixture of DMEM/F12, containing 1.1 mM CaCl<sub>2</sub>, 2X penicillin/streptomycin, 1% glucose, and 10% fetal bovine serum (Hyclone). Only prepare enough culture medium to feed the cells for 2 d and store the prepared culture medium at 4°C.

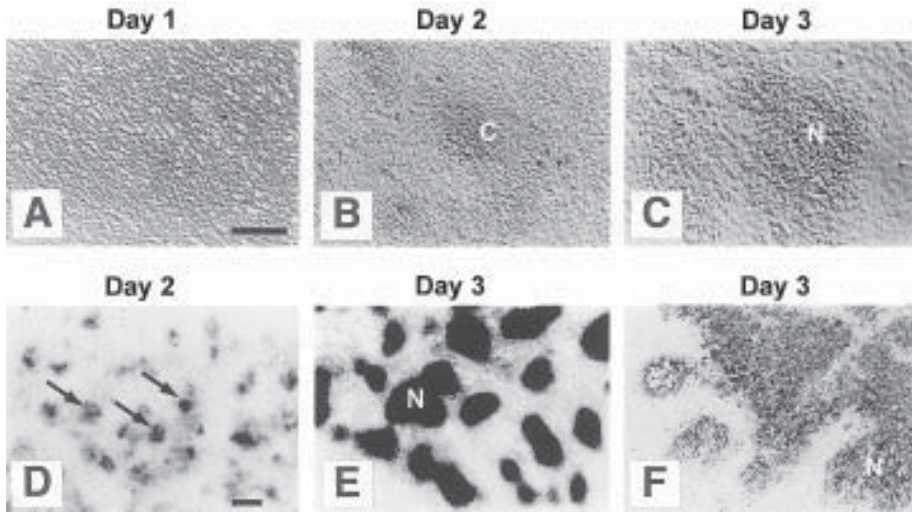

Fig. 1. Morphology and characterization of chicken limb mesenchymal cells maintained in high density micromass cultures. (A–C) Morphology of cells viewed by Hoffman Modulation Contrast<sup>®</sup> optics (Modulation Optics, Inc., Greenvale, NY). Note the appearance of cellular aggregates (i.e., condensations) by culture day 2 (B), and the formation of cartilaginous nodules with refractile extracellular matrix by day 3 (C). (D) Detection of condensing chondroprogenitor cells in day 2 cultures using PNA staining. Binding of HRP-conjugated PNA is detected histochemically, revealing aggregates of condensing cells (arrows). (E) Staining of cartilage nodules on day 3 using Alcian blue stain. Nodules stain intensely with the cationic dye. (F) Immunohistochemical detection of collagen type II in cartilaginous nodules in day 3 cultures. Collagen type II is found localized to nodules in areas corresponding to Alcian blue staining. C, condensing cellular aggregates; N, nodule. Bars = 100  $\mu$ m.

9.  $\beta$ -Glycerophosphate (Sigma).
10. Glutamine (Sigma).
11. Ascorbate (Sigma).
12. Microdissection forceps and scissors.
13. Stereomicroscope.

### 2.3.2. Methods

1. Embryo incubation and limb bud harvesting: *see Subheading 2.2.2.*
2. Limb bud digestion: *see Subheading 2.2.2.*
3. Separation of limb bud mesenchymal cells: *see Subheading 2.2.2.*
4. Cell counting and plating: *see Subheading 2.2.2.*, and below.
  - a. Plate the cells ( $25\text{--}30 \times 10^6$  cells/mL) in 10  $\mu$ L drops in the center of each well of a Corning<sup>™</sup> 24-well tissue culture plate (Corning Glassworks, Corning, NY). Place the tissue culture plates in a humidified incubator at 37°C, 5% CO<sub>2</sub> for 1.5 to 2 h to allow the cells to attach to the tissue culture plates. After the 1.5–2 h incubation, feed the cells by adding 1 mL of culture medium/well. Culture medium should be replaced daily.
  - b. Culture day 1 is the day after plating. From culture day 2 on, the culture medium is supplemented with 2.5 mM  $\beta$ -glycerophosphate, 0.3 mg/mL glutamine, and 25 mg/mL ascorbate (II).
  - c. Cultures can be maintained for up to 28 d and representative samples fixed and evaluated on designated days, e.g., 7, 14, 21, and 28 d in culture (*see Note 3.3.1.*).

## 2.4. Detection of Mesenchymal Cell Condensation Using Peanut Agglutinin Staining

The plant lectin, peanut (*Arachis hypogaea*) agglutinin (PNA), binds to cell surface oligosaccharides, specifically Gal-1,3-GalNAc. PNA binding activity is considered a marker for cells with chondrogenic potential (12–16) (see **Note 3.4.1.**).

### 2.4.1. Materials

1. Phosphate-buffered saline (PBS), pH 7.4: Composition per liter, 8 g NaCl, 0.2 g KCl, 1.15 g Na<sub>2</sub>HPO<sub>4</sub>, and 0.2 g KH<sub>2</sub>PO<sub>4</sub>.
2. 4% Paraformaldehyde in PBS: Composition per 200 mL, dissolve 8 g of solid paraformaldehyde (flakes or pellets) in 150 mL of heated ddH<sub>2</sub>O (not boiling) and add 40–50  $\mu$ L of 10 N NaOH and let dissolve. Add 20 mL of 10X PBS (composition per liter, 80 g NaCl, 2.0 g KCl, 11.5 g Na<sub>2</sub>HPO<sub>4</sub>, and 2.0 g KH<sub>2</sub>PO<sub>4</sub>) and q.s. to 200 mL with ddH<sub>2</sub>O. Let cool to room temperature and pH to 7.4. Store at 4°C for up to 1 mo.
3. Peroxidase blocking solution: One part 30% hydrogen peroxide:9 parts methanol.
4. 100  $\mu$ g/mL Peroxidase conjugated PNA (Sigma) in PBS (see **Note 3.4.2.**).
5. AEC colorimetric substrate for peroxidase (Zymed, San Francisco, CA).

### 2.4.2. Methods

1. Remove culture medium.
2. Rinse 2X with PBS.
3. Fix cells with 4% paraformaldehyde for 10 min.
4. Wash with PBS 2X, 2 min.
5. Block endogenous peroxidases with peroxidase blocking solution for 10 min.
6. Rinse with PBS 2X, 2 min.
7. Add peroxide conjugated PNA solution for 30 min to 1 h.
8. Rinse with PBS 3X, 2 min.
9. Incubate 5 min with 3-amino-9-ethylcarbazole (AEC) colorimetric substrate.
10. Rinse with water.
11. Observe by means of either bright field or Hoffman modulation contrast optics (Modulation Optics, Inc., Greenvale, NY) and photograph in color (**Fig. 1D**).

## 2.5. Detection of Cartilage Differentiation

### 2.5.1. Materials

1. Alcian blue staining:
  - a. PBS: see **Subheading 2.4.1.**
  - b. Alcian blue stain (Sigma): 1.0% Alcian blue in 0.1 N HCl, pH 1.0. Dissolve 10 g of Alcian blue stain in 1 L of 0.1 N HCl, pH 1.0. Stir overnight and filter through a coffee filter before using. Stain can be reused (see **Note 3.5.1.**).
  - c. Kahle's fixative: composition per 450 mL, 130 mL absolute ethanol, 4.5 mL formaldehyde, 17.5 mL glacial acetic acid, 298 mL ddH<sub>2</sub>O.
2. Sulfate incorporation:
  - a. [<sup>35</sup>S] Sulfate (NEN/DuPont, Boston, MA).
  - b. [<sup>3</sup>H] Leucine (NEN/DuPont).
  - c. PBS: see **Subheading 2.4.1.**
  - d. Brass cylindrical cork-boring device.
  - e. Bunsen burner.
  - f. Glass rod.
  - g. Scintillation counter.

3. Immunohistochemistry:
  - a. PBS: *see Subheading 2.4.1.*
  - b. 70% Ethanol.
  - c. Enzymes: hyaluronidase (300 U/mL, Sigma) in PBS, chondroitinase (1.5 U/mL, Sigma) in PBS.
  - d. Peroxidase blocking solution: *see Subheading 2.4.1.*
  - e. Appropriate primary antibodies.
  - f. Humidified chamber: this can be made by placing wet paper towels in the bottom of a plastic storage box sealable with a lid.
  - g. Histostain-SP™ kit (Zymed Laboratories) and substrate chromogen: 1 drop each of Zymed reagents 3A, 3B, and 3C per mL of ddH<sub>2</sub>O.
  - h. Mouse IgG (Sigma) (*see Note 3.5.2.*).

### 2.5.2. Methods

1. Alcian blue staining:
  - a. Rinse cultures in PBS.
  - b. Fix cultures in Kahle's fixative: 10 min.
  - c. Rinse cultures in PBS.
  - d. Cover cultures with Alcian blue dye: 6 h—overnight.
  - e. Rinse cultures with water.
  - f. Allow cultures to air dry.
  - g. View and count nodules (**Fig. 1E**; *see Note 3.5.3.*).
2. Sulfate incorporation:
  - a. One day prior to fixing cultures, feed cultures with Ham's F-12 medium plus 1  $\mu\text{Ci/mL}$  [<sup>3</sup>H] leucine and 2.5  $\mu\text{Ci/mL}$  [<sup>35</sup>S] sulfate (*see Notes 3.5.4. and 3.5.5.*).
  - b. Twenty-four hours after dosing cultures with isotopes, remove the medium by aspiration. (**Note:** For the purposes of radioactivity safety and usage report, assume 99% incorporation of isotope into the cultures when disposing of the discarded medium.)
  - c. Rinse cultures in PBS.
  - d. Fix cultures in Kahle's fixative: 10 min.
  - e. Rinse cultures in PBS.
  - f. Allow cultures to air dry.
  - g. In a hood, place the tissue culture dish upside-down on a piece of bench paper. Heat a brass cylindrical cork boring device for several minutes in a Bunsen burner, and carefully use it to melt through the tissue culture dish around the culture approaching from the bottom side of the dish (*see Note 3.5.6.*).
  - h. Using forceps, drop the culture disk into a labeled scintillation vial.
    - i. When all of the cultures have been removed and placed in 7-mL scintillation vials, fill the vials with 4-mL scintillation fluid, and count the samples using a liquid scintillation counter equipped with a dual isotope counting program.
    - j. Dividing the <sup>35</sup>S dpm by the <sup>3</sup>H dpm yields the incorporation of sulfate, which has been normalized with respect to overall protein synthesis.
  - k. Culture disks and the plates from which they were removed should be disposed of in appropriate radioactive waste bins.
3. Immunohistochemistry:
  - a. Rinse cultures in PBS.
  - b. Fix cultures in 4% paraformaldehyde for 5 min.
  - c. Rinse culture in PBS.

- d. If storing cultures, cover in 70% ethanol and keep at 4°C. Before proceeding to next step, rehydrate cultures in PBS for 10 min.
- e. At this point, cultures can be treated with enzymes or other procedures to enhance the accessibility of antigens for the antibodies (*see Note 3.5.7.*).
- f. Incubate in peroxidase blocking solution for 10 min.
- g. Rinse in PBS 3X, 2 min.
- h. Incubate with primary antibody (enough to cover cells approx 150  $\mu$ L/10  $\mu$ L spot culture) for 90 min at 37°C in humidified chamber (*see Note 3.5.8.*).
- i. Rinse in PBS 3X, 2 min.
- j. Incubate with secondary antibody (three drops of solution 1B from Histostain-SP™ kit [Zymed]) for 20 min at room temperature.
- k. Rinse in PBS 3X, 2 min.
- l. Incubate with streptavidin conjugated horseradish peroxidase (one drop reagent 2 from Histostain-SP™ kit) for 5 min at room temperature.
- m. Rinse in PBS 3X, 2 min.
- n. Incubate with substrate chromogen (enough to cover cultures) at room temperature until a distinct red color is seen (**Fig. 1F**).
- o. Rinse in ddH<sub>2</sub>O 3X, 2 min.

## 2.6. Detection of Cartilage Maturation

### 2.6.1. Materials

1. Mineralization
  - a. Alizarin red
    - i. 4% Paraformaldehyde in PBS (*see Subheading 2.4.1.*) or Histochoice™ (Amresco, Solon, OH).
    - ii. PBS: *see Subheading 2.4.1.*
    - iii. Alizarin red S (Sigma, St. Louis, MO), pH 6.4: Mix 1.0 g of Alizarin red S to 90 mL of water and add dilute NH<sub>4</sub>OH (28% ammonia diluted 100× with water) until the pH is 6.4 (approx 10 mL) (*I7*).
    - iv. Differentiating solution: Mix 0.5 mL of concentrated HCl with 500 mL of 95% EtOH.
  - b. <sup>45</sup>Ca incorporation
    - i. 4% Paraformaldehyde in PBS: *see Subheading 2.4.1.*
    - ii. PBS: *see Subheading 2.4.1.*
    - iii. [<sup>45</sup>Ca] Calcium chloride (NEN/DuPont, Boston, MA).
    - iv. 2% Sodium dodecyl sulfate (SDS).
    - v. Scintillation counter.
  - c. Ca atomic absorption
    - i. Lyophilizer.
    - ii. Ashing furnace.
    - iii. 0.3 N HCl (Tracer Analysis Grade, Fisher Scientific).
    - iv. Atomic absorption apparatus (e.g., Model 11E, Thermo Jarrell Ash Corp., Franklin, MA).
2. Alkaline phosphatase activity
  - a. PBS: *see Subheading 2.4.1.*
  - b. 0.05% Triton X-100 (Fisher Scientific) in Tris-HCl, pH 7.5.
  - c. Spectrophotometric alkaline phosphatase enzyme assay kit (ALP10, Sigma).
  - d. Micro BCA assay kit (Pierce Chemicals, Rockford, IL).
  - e. Homogenizer.
  - f. Sonicator.
  - g. Spectrophotometer.

3. Collagen type X expression (*see Note 3.6.1.*)
  - a. Immunohistochemistry
    - i. PBS: *see Subheading 2.4.1.*
    - ii. Histochoice™ (Amresco).
    - iii. 0.1 *N* acetic acid.
    - iv. Hyaluronidase 300 U/mL (Calbiochem, La Jolla, CA; **18**) in PBS.
    - v. Rabbit derived antibodies directed against chicken collagen type X (Source: Dr. Maurizio Pacifici, University of Pennsylvania, Philadelphia).
    - vi. Histostain-SP™ Kit (Zymed).
  - b. Immunoblot
    - i.  $\epsilon$ -Amino-n-caproic acid (ACA, Sigma): 50X Stock, 328 mg/mL in H<sub>2</sub>O.
    - ii. Phenylmethylsulfonyl fluoride (PMSF, Sigma): 200X stock, 34.8 mg/mL in 100% EtOH.
    - iii. Benzamidine hydrochloride (BA-HCl, Sigma): 100X stock, 78.0 mg/mL in H<sub>2</sub>O.
    - iv. PBS: *see Subheading 2.4.1.*
    - v. 2% Sodium dodecyl sulfate (SDS, Gibco-BRL) in PBS.
    - vi. 10% Trichloroacetic acid (Fisher).
    - vii. Micro BCA assay Kit (Pierce Chemical).
    - viii. Pepsin (0.2 mg/mL in 0.5 *N* acetic acid, Sigma).
    - ix. Reducing sample buffer: 10 mM Tris-HCl, pH 8, 1 mM EDTA, 1% SDS, 10% Glycerol, 0.01% Bromophenol Blue, and 5%  $\beta$ -mercaptoethanol (Sigma).
    - x. Polyacrylamide gel (Bio-Rad, Richmond, CA).
    - xi. Electrophoresis apparatus.
    - xii. Electrotransfer apparatus.
    - xiii. Nitrocellulose (0.2  $\mu$ m pore size, Schleicher & Schuell, Keene, NH).
    - xiv. 0.05% Tween 20 (Sigma) in Tris (Fisher)-buffered saline (TTBS).
    - xv. Dry milk.
    - xvi. Bovine serum albumin (BSA, Sigma).
    - xvii. Primary Antibody: Chick type X collagen antibody.
    - xviii. Secondary Antibody: Alkaline phosphatase-conjugated goat anti-rabbit IgG (Sigma).
    - xix. Nitroblue tetrazolium and 5-bromo-4-chloro-3-indolyl phosphate p-toluidine salt (BCIP/NBT, Sigma).
4. Apoptosis
  - a. Terminal deoxynucleotidyl transferase-mediated dUTP nick end labeling (TUNEL) (**19**).
    - i. 4% Paraformaldehyde in PBS (*see Subheading 2.4.1.*) or Histochoice™ (Amresco).
    - ii. *In situ* Cell Death Detection Kit, POD (Roche Diagnostics, Indianapolis, IN).
  - b. Gel electrophoresis of DNA.
    - i. DNA extraction solutions: *see Methods and Materials in (20).*
    - ii.  $\alpha$ [<sup>32</sup>P]-dideoxy ATP (Amersham, Arlington Heights, IL).
    - iii. 2% Agarose gel.
    - iv. Electrophoresis apparatus.
    - v. Ethidium bromide (0.5  $\mu$ g/mL, Sigma).
    - vi. Gel dryer.
    - vii. X-ray film.

### 2.6.2. Methods

1. Mineralization
  - a. Alizarin red S.
    - i. Sample embedding and sectioning.

- The cultures have been previously fixed with 4% paraformaldehyde for 20 min at room temperature or Histochoice™ (Amresco) for 45 min at room temperature.
  - Rinse cultures with distilled water 2X, 5 min.
  - Carefully scrape the cultures off of the tissue culture dish using a thin spatula and transfer to a small plastic vial, e.g., scintillation vial.
  - Dehydrate the cultures in increasing steps of 70, 95, and 100% EtOH for 1 h, 1 h, and overnight, respectively, at room temperature.
  - Change cultures to fresh 100% EtOH for 1 h at room temperature.
  - Change cultures to amyl acetate for 30 min at room temperature.
  - Change cultures to amyl acetate for 30 min at 55°C.
  - Change cultures to amyl acetate:paraffin for 1 h at 55°C.
  - Change to amyl acetate:paraffin four more times.
  - Embed cultures in paraffin. Prior to embedding, prepare paper labels identifying each sample and record the orientation it will be embedded. Fill an embedding mold with paraffin and transfer the culture into the molding block using a prewarmed spatula. Orient the culture, insert the label, and allow to cool overnight.
  - Using a microtome, cut 0.8  $\mu\text{m}$  sections of the cultures.
- ii. Staining (18)
- Sections are deparaffinized by immersion in Histo-Clear™ (National Diagnostics, Atlanta, GA) for 3 min followed by rehydration in a descending series of EtOH (i.e., 100, 95, and 70% EtOH).
  - Stain sections with Alizarin red S for 2 min.
  - Wash sections in water for 5–10 s.
  - Differentiate sections in differentiation solution for 15 s.
  - Dehydrate in two changes of 100% EtOH, 5 s each.
  - Clear in Xylene for 5 s.
  - Mount sections and visualize under light microscopy.
- b.  $^{45}\text{Ca}$  incorporation
- i. One day prior to fixing cultures, feed cultures with culture medium plus 1  $\mu\text{Ci/mL}$   $^{45}\text{Ca}$  (see Notes 3.6.2. and 3.6.3.).
  - ii. Twenty-four hours after dosing cultures with isotopes, remove the medium by aspiration. (Note: For the purposes of radioactivity safety and report, assume 99% incorporation of isotope into the cultures when disposing of the discarded medium.)
  - iii. Rinse cultures in PBS.
  - iv. Fix cultures in 4% paraformaldehyde for 5 min.
  - v. Rinse cultures in deionized water.
  - vi. Allow cultures to air dry.
  - vii. Lyse the cells for 24 h in 2% SDS.
  - viii. Remove the lysate from each culture and place in separate scintillation vials.
  - ix. Add 4 mL of scintillation fluid to each vial and count the samples using a liquid scintillation counter.
  - x. The amount of incorporated  $^{45}\text{Ca}$  is reported as counts  $\text{min}^{-1} \mu\text{g}^{-1}$  (see Note 3.6.4.).
  - xi. Culture plates and radioactive liquid waste should be disposed of in appropriate radioactive waste bins.
- c. Ca atomic absorption
- i. Aspirate culture medium and rinse cultures with PBS.
  - ii. Scrape cultures off of the tissue culture plates using a rubber spatula and transfer to microcentrifuge tubes. Rinse plate and spatula with ddH<sub>2</sub>O and add rinse to the tube.

- iii. Dessicate the samples by lyophilization.
  - iv. Place samples in porcelain crucibles and ash for 2 h at 650°C in ashing furnace.
  - v. Dilute samples in 500  $\mu\text{L}$  of 0.3 *N* HCl.
  - vi. Analyze Ca concentration of samples by atomic absorption.
2. Alkaline phosphatase activity
    - a. Aspirate culture medium and rinse cultures with PBS.
    - b. Homogenize and extract cells with 0.05% Triton X-100 in Tris-HCl (10 up and down strokes) at 4°C.
    - c. Sonicate homogenate for 30 s for further extraction.
    - d. Centrifuge at 16,000*g* for 5 min at 4°C.
    - e. Add 10  $\mu\text{L}$  of extract to ALP-10 Alkaline Phosphatase Assay Kit per manufacturer's instructions and read  $A_{405}$  at 1 min intervals for 5 min.
    - f. Alkaline phosphatase activity is determined by the amount of p-nitrophenyl released from the substrate p-nitrophenyl phosphate (based on  $A_{405}$ )  $\text{min}^{-1}$   $\text{mg}$  of protein $^{-1}$  (as determined by micro BCA assay).
  3. Collagen type X expression
    - a. Immunohistochemistry
      - i. Sample embedding and sectioning *see* **Subheading 2.6.2**.
      - ii. Sections are deparaffinized by immersion in Histo-Clear™ for 3 min followed by rehydration in a descending series of EtOH (i.e., 100, 95, and 70% EtOH).
      - iii. Sections are swelled overnight in 0.1 *N* acetic acid (*see* **Note 3.6.5**).
      - iv. Rinse in PBS 2X.
      - v. Enzymatically digest sections with 300 U/mL of hyaluronidase for 40 min at 37°C (*see* **Note 3.6.6**). For this and all following solutions, use enough to cover the entire tissue section.
      - vi. Rinse sections in PBS 3X, 2 min.
      - vii. Block endogenous peroxidases with peroxidase blocking solution for 10 min.
      - viii. Rinse sections with PBS 3X, 2 min.
      - ix. Block the sections with nonimmune serum for 10 min.
        - x. Blot to remove nonimmune serum and do not rinse.
      - xi. Incubate the sections with the chick collagen type X primary antibody at a 1:200 dilution in PBS for 30–60 min at room temperature.
      - xii. Rinse sections in PBS 3X, 2 min.
      - xiii. Incubate the sections with the biotinylated secondary antibody (supplied in Zymed kit) for 10 min at room temperature.
      - xiv. Rinse sections in PBS 3X, 2 min.
      - xv. Incubate the sections with the enzyme conjugate (streptavidin-peroxidase conjugate, provided in the Zymed kit) for 10 min at room temperature.
      - xvi. Rinse sections in PBS 3X, 2 min.
      - xvii. Detect antigen by incubation with the substrate-chromagen mixture (supplied in Zymed kit) for 5–10 min (*see* **Note 3.6.7**).
    - b. Immunoblot
      - i. Extract and homogenize cultures in 2% SDS in PBS containing protease inhibitors (1 *mM* PMSF, 50 *mM* ACA, and 5 *mM* BA-HCl) for 2 h at 4°C.
      - ii. Precipitate proteins with 10% trichloroacetic acid.
      - iii. Centrifuge samples at 16,000*g* for 10 min in a table top microcentrifuge.
      - iv. Resuspend the pellet in 2% SDS in PBS.
      - v. Determine protein concentration using the micro BCA assay.
      - vi. Aliquot 40  $\mu\text{g}$  of protein into a 1.5-mL microcentrifuge tube and digest overnight at 4°C with pepsin (0.2 *mg*/mL in 0.5 *N* acetic acid) (*see* **Note 3.6.8**).



- vii. Ethanol precipitate proteins and resuspend in 15  $\mu$ L of reducing sample buffer containing 1X proteinase inhibitors (ACA, PMSF, and BA-HCl).
  - viii. Boil samples for 2 min and load onto a 4–15% polyacrylamide gel and run at 100 V for 1 h (*see Note 3.6.9.*).
  - ix. Electrotransfer to nitrocellulose (0.2  $\mu$ m pore size) 4°C overnight at 10 V.
  - x. Block blots overnight at 4°C with 5% dry milk in TTBS.
  - xi. Incubate blots with a 1:1000 dilution of the primary collagen type X antibody in TTBS with 1% BSA for 3 h at room temperature.
  - xii. Rinse blots in PBS 3X, 5 min.
  - xiii. Incubate blots with a 1:2500 dilution of the secondary alkaline phosphatase conjugated goat anti-rabbit IgG antibody in TTBS for 1 h at room temperature.
  - xiv. Rinse blots in PBS 3X, 5 min.
  - xv. Detect immunoreactive proteins by incubation with BCIP/NBT (*see Notes 3.6.10.* and **3.6.11.**).
4. Apoptosis
- a. Terminal deoxynucleotidyl transferase-mediated dUTP nick end labeling (TUNEL) (*17*).
    - i. Embedding and sectioning: *see Subheading 2.6.2.*
    - ii. Immunofluorescent detection (TUNEL assay) (*see Note 3.6.12.*)
      - Sections are deparaffinized by immersion in Histo-Clear™ for 3 min followed by rehydration in a descending series of EtOH (i.e., 100, 95, and 70% EtOH).
      - Rinse sections in PBS.
      - Incubate sections with terminal transferase and fluorescein-conjugated dUTP to label the 3' end of fragmented nuclear DNA.
      - Rinse cultures in PBS.
      - Visualize the fluorescein label by epifluorescence microscopy.
    - iii. Immunohistochemical detection (*in situ* cell death detection kit, POD) (*see Note 3.6.12.*)
      - Follow the procedure described above for Immunofluorescent Detection up to and including **step ii, bullet item 4.**
      - Incubate sections with the antifluorescein-POD antibody for 30 min at 37°C.
      - Wash sections in PBS.
      - Incubate sections with the POD substrate for 5–20 min at room temperature until red stain is seen.
      - Rinse cultures in water and examine under light microscopy.
  - b. Gel electrophoresis of DNA
    - i. DNA is extracted from cultures as described by Ray et al. (*20*) and labeled with  $\alpha$ [32P] dideoxy ATP as described by Tilly and Hsueh (*21*).
    - ii. Separate DNA by electrophoresis on a 2% agarose gel.
    - iii. Stain the gel with 10 mg/mL ethidium bromide to visualize the size markers and vacuum dry the gel overnight without the use of heat.
    - iv. Expose the dried gel to X-ray film for 4 h at –70°C.
    - v. Develop X-ray film (*see Note 3.6.13.*).

### 3. Notes

#### 3.1. Mouse Embryonic Limb Mesenchyme Culture

1. This culture system is not suited for studying cells from limb buds derived from older embryos (i.e., more than gestational day 13.5): in fact, it is very difficult to dissociate cells from limbs with formed cartilage with this method.
2. Place the pipet tip close to the bottom of the tube to generate some gentle shearing. Do not pipet up and down more times than necessary to dissociate the limb buds, as the viability of the cell will begin to decrease.

3. The pH of the medium is crucial and has to be in the range from 7 to 7.5 to allow optimal adhesion of the cells to the well. More basic or acidic medium result in poor cell adhesion and cell death.
4. Do not disturb in any way after the cells are plated, since adhesion at this stage is very weak.
5. If cells were plated in 35 mm dishes, add several drops of culture medium on the side of the dish to prevent evaporation of the cell drop.
6. Add medium very slowly in order to not disturb the attached cells.
7. Do not add ascorbic acid before 48 h after plating: the presence of ascorbate earlier disturbs the adhesive process and results in increased cell death.

### **3.2. Chicken Embryonic Limb Mesenchyme Culture**

1. Remove 10–15 eggs from the incubator at a time and lay them on their sides in a clean cardboard egg carton to allow the embryo to float to the top. Pour 70% EtOH over the eggs and place them into the tissue culture hood.
2. Embryos should be at Hamburger–Hamilton stage 23–24 (22). Limb buds at this stage have not yet initiated overt chondrogenesis and should appear round in shape. Limb buds from embryos earlier or later than this stage will not undergo the sequential steps of condensation, differentiation, and overt chondrogenesis *in vitro*, described in the model system developed by Ahrens et al. (3).
3. Because of the significant amount of extracellular matrix in the limb bud, it is important to snip the limb buds longitudinally to enable the digestive enzymes to reach the limb bud core. This promotes a more complete limb bud digestion and subsequently a higher yield of limb bud cells.
4. Prepare the enzymatic digestion solution after all of the limb buds have been dissected from the embryos. For 80–100 limb buds (the expected yield of limb buds from 30 eggs), prepare 40 mL of enzymatic digestion solution.
5. Do not allow the digestion to proceed longer than 1 h even if the limb buds look whole. Excessive digestion will compromise the integrity of the cells and they will die.
6. Periodically during the 1 h incubation, remove the flask from the water bath and gently swirl the contents. This will also help to facilitate a more complete digestion.
7. For 30 eggs, 200  $\mu$ L of 10% calf serum added to each tube plus the residual 10% calf serum remaining in each tube will total approx 1 mL and will be approximately the proper plating concentration. Adjustments to cell concentration may be made later.
8. Do not use a small-bore pipet because this may shear the cells.
9. It is important to know the exact total volume of the cell suspension so that the cell concentration can be accurately calculated and any adjustments can be made accordingly.
10. Avoid irregularly shaped droplets and air bubbles in the droplets.
11. Corning™ brand tissue culture plasticware appears to work the best for optimal adhesion of limb bud mesenchyme plated in high-density micromass culture. Corning™ 6- and 12-well tissue culture plates as well as 35-mm plastic Petri dishes can also be used, however, when using the larger well plates or the Petri dishes, a 20- $\mu$ L drop of 10% calf serum or culture medium should be placed on the edge of the well to prevent the micromass droplet from drying.
12. When feeding the cells, let the culture medium run down the sides of the wells so as not to disturb the cells. The cell attachments are very tenuous at this point and if the medium is introduced too quickly, the cells will wash off the plate and eventually die. When feeding cells plated in 6- and 12-well plates use 4 and 2 mL of culture medium/well, respectively.

### **3.3. Long-Term Chicken Embryonic Limb Mesenchyme**

1. The long term culture of embryonic limb mesenchyme represents a unique system to study the complete life history of chondrocytes, covering differentiation, proliferation, apoptosis, hypertrophy, and mineralization (23). Chondrocyte maturation in this system has been shown to be influenced by bioactive agents, including thyroxine and transforming growth factor- $\beta$ 1 (24).

### **3.4. Detection of Mesenchymal Cell Condensation Using Peanut Agglutinin Staining**

1. PNA staining may be performed on both avian and mammalian cells.
2. If 100  $\mu$ g/mL peroxidase conjugated PNA gives too high background, reduce to 50  $\mu$ g/mL.

### **3.5. Detection of Cartilage Differentiation**

1. It is important that the pH of the cationic Alcian blue dye is 1.0 to maintain the negative charge of the glycosaminoglycans for binding of the cationic dye (25).
2. Mouse IgG is used as a negative control. In addition, several cultures should be processed through the procedure in the absence of primary antibody to assess the level of nonspecific background from the secondary antibody.
3. Nodule counting can be done using a Zeiss SR stereoscope at 12X magnification. Be consistent in setting the criterion for a single nodule. In the case of "coalesced" nodules, estimate the total number of nodules by relying on the distinct shape and average size of nodules in the immediate surrounding area. Note that nodules will be of different size in different parts of the culture, i.e., larger in the center and smaller in the periphery, as to be expected from the distribution of cells in a hemispherical cell drop. Alternatively, or in addition, the amount of cartilage can be estimated by measuring the amount of extractable dye. Punch out the circular disk containing the culture from the plastic tissue culture plate, and extract in 6 M guanidine-HCl (4 cultures/mL) for 8 h at room temperature. Dye concentration can be estimated spectrophotometrically as  $A_{650}$ .
4. To ensure uniform specific activity, isotopes should be added to untreated 1X medium, and then aliquoted and supplemented with any treatment called for in the experiment.
5. Isotopes should be added to sterile medium in a vertical flow tissue culture hood. Gloves, lab coat, and protective eye wear should be worn, and the hood should be monitored with a Geiger counter before and after use.
6. The culture will frequently remain in the end of the boring device and can be removed by passing a glass rod through the hollow boring device and pushing on the disk (the culture is now on the opposite side of the disk, and will not be damaged by the glass rod).
7. Immunostaining of extracellular matrix components in the chondrifying cultures may be enhanced by selective enzymatic digestion. Incubate cells in reaction buffer for 10 min to equilibrate specimen prior to enzymatic treatment. For collagen antibodies, digest cultures with hyaluronidase, 300 U/mL, in PBS for 40 min at 37°C. For aggrecan antibodies, digest cultures with chondroitinase, 1.5 U/mL, in PBS for 40 min at 37°C.
8. Using a PAP pen (Research Products International Corp., Mt. Prospect, IL) to make a hydrophobic circle around the culture may be necessary to keep the antibody solution covering the culture.

### **3.6. Detection of Cartilage Maturation**

1. Generally, because large nodules formed over the entire culture by day 7 and significantly reduced resolution of whole mount observation, cultures maintained for 7 d or more were examined exclusively after sectioning.

2. Isotopes should be added to untreated 1X medium, and then aliquoted and supplemented with any treatment called for in the experiment.
3. Isotopes should be added to sterile medium in a vertical flow tissue culture hood. Gloves, lab coat, and protective eye wear should be worn, and the hood should be monitored with a Geiger counter before and after use.
4. All  $^{45}\text{Ca}$  counts  $\text{min}^{-1}$  were calculated by subtracting the background values from cell-free substrata that were incubated under identical conditions. The total protein of each sample was determined using the micro BCA assay (Pierce Chemicals, as per manufacturer's instructions).
5. Incubation with 0.1 N acetic acid causes the cultures to swell exposing the collagen fibrils.
6. Enzymatic digestion with hyaluronidase degrades proteoglycans and further enhances accessibility of the antibodies.
7. Duration of incubation with the substrate-chromogen mixture will vary. Leave the mixture on the samples until a strong red signal is observed.
8. Pepsin digestion removes the N-terminal and C-terminal propeptides from procollagen  $\alpha$  chain molecules and converts them to mature collagen molecules to permit a more accurate assessment of the amount of collagen present.
9. Run the gel until the dye front just comes off the gel. This will ensure good separation of the proteins.
10. Detection of the immunoreactive proteins may take 5–15 min. Monitor the blot as it develops, then stop developing when strong bands are visible and prior to intense background staining.
11. As a positive control, protein extract from an embryonic day 19 chick growth plate can be used. An irrelevant mouse IgG as the primary antibody can be used as a negative control.
12. For this assay, follow the manufacturers protocol except for the proteinase K digestion step. This step is excluded when samples are fixed with Histochoice™, a noncrosslinking fixative.
13. As a negative control,  $\alpha$ [ $^{32}\text{P}$ ] ddATP labeled DNA from the caudal region of chick embryonic sternum may be used, since chondrocytes from this region are not hypertrophic (26). As a positive control, a DNA sample treated with 500  $\mu\text{g}/\text{mL}$  of micrococcal nuclease (Sigma) at 37°C for 10 min may be used to show internucleosomal DNA degradation (27).

## Acknowledgments

This work was supported in part by NIH grants (ES07005, DE11327, AR44501, and DE12864). Maria Alice Mello was supported by a fellowship from CAPES, Brazil; Anthony M. DeLise was supported by NIH training grant T32-ES07282.

## References

1. Umansky, R. (1966) The effect of cell population density on the developmental fate of reaggregating mouse limb bud mesenchyme. *Dev. Biol.* **13**, 31–56.
2. Caplan, A. (1970) Effects of the nicotinamide-sensitive teratogen 3-acetylpyridine on chick limb cells in culture. *Exp. Cell Res.* **62**, 341–355.
3. Ahrens, P. B., Solorsh, M., and Reiter, R. S. (1977) Stage-related capacity for limb chondrogenesis in cell culture. *Dev. Biol.* **60**, 69–82.
4. Solorsh, M., Ahrens, P., and Reiter, R. (1978) A tissue culture analysis of the steps in limb chondrogenesis. *In Vitro* **14**, 41–61.
5. Kosher, R., Savage, M., and Chan, S. (1979) In vitro studies on the morphogenesis and differentiation of the mesoderm subjacent to the apical ectodermal ridge of the embryonic chick limb bud. *J. Embryol. Exp. Morphol.* **50**, 75–97.

6. Newman, S., Pautou, M. P., and Kierney, M. (1981) The distal boundary of morphogenic primordia in chimeric avian limb buds and its relation to an accessible population of cartilage progenitor cells. *Dev. Biol.* **84**, 440–448.
7. San Antonio, J. D. and Tuan, R. S. (1986) Chondrogenesis of limb bud mesenchyme *in vitro*: stimulation by cations. *Dev. Biol.* **115**, 313–324.
8. Jiang, H., Soprano, D. R., Li, S. W., Soprano, K. J., Penner, J. D., Gyda, M., III, and Kochhar, D. M. (1995) Modulation of limb bud chondrogenesis by retinoic acid and retinoic acid receptors. *Int. J. Dev. Biol.* **39(4)**, 617–627.
9. Thorogood, P. V. and Hinchcliffe, J. R. (1975) An analysis of the condensation process during chondrogenesis in the embryonic chick hind limb. *J. Embryol. Exp. Morphol.* **33**, 581–606.
10. Tuan, R. S., Scott, W. A., and Cohn, Z. A. (1978) Calcium-binding protein of the chick chorioallantoic membrane. II. Vitamin K-dependent expression. *J. Cell Biol.* **77**, 752–761.
11. Boskey, A. L., Stiner, D., Doty, S. B., Binderman, I., and Leboy, P. (1991) Studies of mineralization in tissue culture: optimal conditions for cartilage calcification. *J. Bone Min. Res.* **16**, 11–36.
12. Aulthouse, A. A. and Solursh, M. (1987) The detection of a precartilag, blastema specific marker. *Dev. Biol.* **84**, 440–448.
13. Milaire, J. (1991) Lectin binding sites in developing mouse limb buds. *Anat. Embryol.* **184**, 479–488.
14. Zimmermann, B. and Thies, M. (1984) Alterations of lectin binding during chondrogenesis of mouse limb bud. *Histochemistry* **81**, 353–361.
15. Stringa, E. and Tuan, R. S. (1996) Chondrogenic cell subpopulation of chick embryonic calvarium: isolation by peanut agglutinin affinity chromatography and *in vitro* characterization. *Anat. Embryol.* **223**, 1–11.
16. Stringa, E., Love, J. M., McBride, S. C., Suyama, E., and Tuan, R. S. (1997) *In vitro* characterization of chondrogenic cells isolated from chick embryonic muscle using peanut agglutinin affinity chromatography. *Exp. Cell Res.* **232(2)**, 287–294.
17. Kiernan, J. A. (1990) *Histological and Histochemical Methods: Theory and Practice*, 2nd ed. Pergamon Press, New York.
18. Jacenko, O. and Tuan, R. S. (1986) Calcium deficiency induces expression of cartilage-like phenotype in chicken embryo calvaria. *Dev. Biol.* **115**, 215–232.
19. Gavrieli, Y., Sherman, Y., and Ben-Sasson, S. A., (1992) Identification of programmed cell death *in situ* via specific labeling of nuclear DNA fragmentation. *J. Cell Biol.* **119(3)**, 493–501.
20. Ray, S., Ponnathpur, V., Huang, Y., Tang, C., Mahoney, M. E., Ibrado, A. M., et al. (1994) 1- $\beta$ -D-Arabinofuranosylcytosine-, mitoxantrone-, and paclitaxel-induced apoptosis in HL-60 cells: improved method for detection of internucleosomal DNA fragmentation. *Cancer Chemother. Pharmacol.* **34**, 365–371.
21. Tilly, J. and Hsueh, A. J. W. (1993) Microscale autoradiographic method for the qualitative and quantitative analysis of apoptotic DNA fragmentation. *J. Cell Phys.* **154**, 519–526.
22. Hamburger, V. and Hamilton, H. L. (1951) A series of normal stages in the development of the chick embryo. *J. Morphol.* **88**, 49–92.
23. Lev, R. and Spicer, S. S. (1964) Specific staining of sulfate groups with Alcian blue at low pH. *J. Histochem.* **12**, 309.
24. Mello, M. A. and Tuan, R. S. (1999) High density micromass cultures of embryonic limb bud mesenchymal cells: an *in vitro* model of endochondral skeletal development. *In Vitro Cell Dev. Biol.* **35**, 262–269.

25. Mello, M. A. and Tuan, R. S. (1998) Cartilage maturation *in vitro* is influenced by TGF- $\beta$ 1 and T3. *Trans. Ortho. Res. Soc.* **44**, 495.
26. Reginato, A. M., Tuan, R. S., Ono, T., Jimenez, S. A., and Jacenko, O. (1993) Effects of calcium deficiency on chondrocyte hypertrophy and type X collagen expression in chick embryonic sternum. *Dev. Dyn.* **189**, 284–295.
27. Arends, M. J., Morris, R. G., and Wyllie, A. H. (1990) Apoptosis: the role of the endonuclease. *Am. J. Pathol.* **136**, 593–608.

## Electroporation-Mediated DNA Transfection of Embryonic Chick Limb Mesenchymal Cells

Anthony M. DeLise and Rocky S. Tuan

### 1. Introduction

Electroporation has been frequently adopted as a means to transfect primary cells or cell lines that demonstrate resistance to other commonly used methods of transfection, e.g., DEAE-dextran or calcium phosphate precipitation or liposome-mediated transfection. Electroporation is a method of transfection utilizing an electric field to introduce foreign materials into cells. This method of transfection has been demonstrated to be effective on both prokaryotic (1–4) and eukaryotic cells (5–8) and is capable of introducing DNA, large macromolecules (e.g., antibodies), proteins, dyes, metabolic precursors (e.g.,  $^{32}\text{P}$ -ATP), and nonpermeant drugs and metabolites into cells with high efficiency (4,8–13).

The exact mechanism for molecular uptake during electroporation is not known. However, the current hypothesis is that temporary aqueous “pores” form in the cell membrane as the result of a strong electric field pulse. The electric field not only causes the formation of “pores” in the cell membrane, it also provides an electrostatic driving force for the transport of large molecules into the cell otherwise incapable of entering by simple diffusion.

In order for electroporation to be effective, the voltage and capacitance ( $\mu\text{F}$ ) used must exceed the breakdown potential of the cell membrane thereby initiating the formation of electropores. In addition, there are many other parameters to consider for optimizing transfection efficiency including the electroporation medium, amount of DNA (or other molecule), cell density, cell number, sample volume, electroporation cuvet gap width, and pre- and/or postincubation periods (14). Consequently, electroporation conditions must be empirically determined for each cell type. Most commonly, electroporation is used for transfection of both adherent and suspension cell cultures. However, more contemporary protocols have adapted electroporation for transfection of cells *in situ* (7,15–17). This chapter will describe a method for electroporation transfection of plasmid DNA into embryonic chick limb mesenchymal cells for *in vitro* study of cellular condensation and chondrogenesis using the micromass culture procedure described by Ahrens et al. (18). This procedure employs a high density ( $20 \times 10^6$  cells/mL) spot culture (10  $\mu\text{L}$ ) to recapitulate initial events of the *in vivo* chondrogenic

pathway. Therefore, it is necessary to transfect these cells prior to plating in order to attain a high transfection efficiency. Also, methods to determine transfection efficiency and cell viability will also be described.

## 2. Materials

### 2.1. Electroporation

1. Embryonic chick limb bud cells (*see* Chapter 33).
2. Electroporation apparatus (e.g., Electroporator II, Invitrogen, San Diego, CA).
3. Electroporation cuvetts (0.4 cm gap width; Invitrogen).
4. Power supply (up to 400 V).
5. Plasmid DNA.

### 2.2. MTT Cell Viability Assay

1. Culture medium: *see* **Materials** in Chapter 33.
2. MTT [3-(4,5-dimethylthiazol-2-yl)-2,5-diphenyltetrazolium bromide] (Molecular Probes, Eugene, OR).
3. Phosphate-buffered saline (PBS), pH 7.4: composition per liter, 8 g NaCl, 0.2 g KCl, 1.15 g Na<sub>2</sub>HPO<sub>4</sub>, and 0.2 g KH<sub>2</sub>PO<sub>4</sub> q.s. to 1 L with ddH<sub>2</sub>O, autoclave, store at room temperature.
4. 0.2- $\mu$ m Syringe filter (Nalge Nunc, Rochester, NY).
5. 10-mL Plastic syringe (Becton Dickinson, Franklin Lakes, NJ).
6. Acid-isopropanol (0.04 N HCl in isopropanol).
7. 96-well microtiter plate (Falcon, Franklin Lakes, NJ).
8. ELISA plate reader.

### 2.3. Transfection Efficiency

1. 20 mg/mL X-Gal or Red-Gal (Research Organics, Cleveland, OH) (40X stock). Both X-Gal and Red-Gal are prepared in dimethylsulfoxide (DMSO) and stored frozen at -20°C, protected from light.
2. 0.5 M potassium ferricyanide (100X) prepared in PBS and stored at room temperature protected from light.
3. 0.5 M potassium ferrocyanide (100X) prepared in PBS and stored at room temperature protected from light.
4. 1 M MgCl<sub>2</sub> (500X) prepared in PBS and stored at room temperature protected from light.
5. 20% Sodium dodecyl sulfate (SDS) prepared in water and stored at room temperature.
6. IGEPAL CA-630 (Sigma, St. Louis, MO).
7. PBS, pH 7.4: composition per liter, 8 g NaCl, 0.2 g KCl, 1.15 g Na<sub>2</sub>HPO<sub>4</sub>, and 0.2 g KH<sub>2</sub>PO<sub>4</sub> q.s. to 1 L with ddH<sub>2</sub>O, autoclave, store at room temperature.
8. 4% Paraformaldehyde in PBS: Composition per 200 mL, dissolve 8 g of solid paraformaldehyde (flakes or pellets) in 150 mL of heated ddH<sub>2</sub>O (not boiling) and add 40–50  $\mu$ L of 10 N NaOH. Let dissolve. Add 20 mL of 10 $\times$  PBS (composition per liter, 80 g NaCl, 2.0 g KCl, 11.5 g Na<sub>2</sub>HPO<sub>4</sub>, and 2.0 g KH<sub>2</sub>PO<sub>4</sub>) and q.s. to 200 mL with ddH<sub>2</sub>O. Let cool to room temperature and pH to 7.4. Store at 4°C for up to 1 mo.
9. 150  $\times$  25 mm Tissue culture dish with 20 mm grid (Falcon).

## 3. Methods

### 3.1. Electroporation

1. Obtain embryonic chick limb mesenchymal cells as described in Chapter 33 of this book with the following changes.



2. After harvesting, digesting, and separating the limb bud mesenchymal cells, adjust the cell concentration to  $40 \times 10^6$  cells/mL with 10% calf serum in calcium–magnesium-free saline with glucose (*see Note 4.1.1*).
3. Place 400  $\mu$ L of the cell suspension into a 0.4-cm gap width electroporation cuvet.
4. Add to the cuvet 10  $\mu$ g of the desired plasmid DNA and 10  $\mu$ g of the reporter plasmid DNA (*see Note 4.1.2*).
5. Very gently mix the contents of the cuvet by pipetting up and down two or three times using a 1000  $\mu$ L micropipet (e.g., Pipetman, Gilson Inc., Middleton, WI). Do not use pipet with a smaller bore tip because it may shear the cells.
6. Cap the electroporation cuvet and place the cuvet on ice for 10 min.
7. Place the cuvet in the electroporator and electroporate the cells on the following settings: 380 V, 250  $\mu$ F, and  $\infty \Omega$  (*see Note 4.1.3*).
8. Place the cuvet on ice for 10 min.
9. Using a 1000- $\mu$ L pipet, remove the white debris that is floating on the top of the cell suspension inside each cuvet. This debris consists of dead cells and DNA.
10. Very gently mix the contents of the cuvet by pipetting up and down two or three times using a 1000- $\mu$ L pipet. Do not use a small bore pipet because it may shear the cells.
11. Plate the cells in 10  $\mu$ L drops (*see Note 4.1.4*) in the center of each well of a Corning™ 24-well tissue culture plate (*see Note 4.1.5*) (Corning Glassworks, Corning, NY). Place the tissue culture plates in a humidified incubator at 37°C, 5% CO<sub>2</sub> for 1.5–2 h to allow the cells to attach to the tissue culture plates. After the 1.5–2 h incubation, feed the cells by adding 1 mL of culture medium/well (*see Note 4.1.6*). Culture medium should be replaced daily.
12. Culture day 1 is the day after plating. Cellular condensations are visible on culture day 2. Keeping cells in culture longer than 5 d requires a change in culture conditions.

### 3.2. MTT Cell Viability Assay (19,20)

1. An MTT cell viability assay can be performed on day 1 or older cultures (*see Note 4.2.1*).
2. Prepare a 5 mg/mL MTT stock in PBS just prior to use. Filter this solution through a 0.2- $\mu$ m syringe filter to sterilize and to remove a small amount of insoluble residue present in some batches of MTT.
3. Aspirate the culture medium from all wells of an assay and replace with fresh culture medium.
4. Add 10  $\mu$ L of the filtered 5 mg/mL MTT stock solution per 100  $\mu$ L of culture medium to each well of an assay (i.e., 100  $\mu$ L of 5 mg/mL MTT stock per 1 mL of culture medium).
5. Incubate the cultures in a humidified incubator at 37°C, 5% CO<sub>2</sub> for 4 h.
6. Remove the cultures from the incubator. Deep purple crystal precipitates should be visible in the cultures (*see Note 4.2.2*).
7. Aspirate the culture medium containing the MTT solution from all the wells.
8. Add 200  $\mu$ L of room temperature acid-isopropanol to each well (*see Note 4.2.3*).
9. After several minutes at room temperature, to ensure that all the dark purple crystals have dissolved, transfer the acid-isopropanol from each well to a 96-well microtiter plate and read the absorbance at 560 nm on an ELISA plate reader.
10. Read plates immediately after the deep purple crystals (*see Note 4.2.4*) are dissolved.

### 3.3. Transfection Efficiency

1. Electroporate embryonic chick limb mesenchymal cells with 10  $\mu$ g of a  $\beta$ -galactosidase expression plasmid using the electroporation procedure described (*see Subheading 3.1.*).

2. After the post-electroporation incubation on ice, dilute the cells to  $5 \times 10^5$  cells/mL with culture medium (i.e., add the entire contents of the electroporation cuvet to 31.6 mL of culture medium).
3. Gently swirl the cells to mix.
4. Plate the entire 32 mL cell suspension in a 150-mm tissue culture dish with a 20-mm grid.
5. Incubate the cells in a humidified incubator at 37°C, 5% CO<sub>2</sub> overnight (18–20 h).
6. Aspirate the culture medium from the cells and rinse with PBS 2X.
7. Fix the cells with 4% paraformaldehyde for 20 min at room temperature.
8. Rinse the cells with PBS 2X, 5 min.
9. Add enough X-Gal or Red-Gal solution (composition: to 12 mL of PBS, add 125 μL of 100X potassium ferricyanide, 125 μL 100X potassium ferrocyanide, 25 μL of 500X MgCl<sub>2</sub>, 6.5 μL of 20% SDS, 2.5 μL of IGEPAL CA-630, and 313 μL of either 40X X-Gal or Red-Gal in DMSO; *see* **Note 4.3.1.**) to cover the entire bottom of the plate.
10. Cover the plate with aluminum foil to protect it from light and incubate overnight at 37°C.
11. Aspirate the X-Gal or Red-Gal solution from the cells and rinse with PBS 2X, 3 min.
12. Under a microscope, count the number of blue (X-Gal) or red (Red-Gal) stained cells, as well as the number of unstained cells, in each of 10 grid squares (20 mm × 20 mm) on the bottom of the plate. The ratio of stained to unstained cells will be the transfection efficiency.

## 4. Notes

### 4.1. Electroporation

1. Electroporation is a physical method of transfection that renders the plasma membrane of the cells permeable. Many of the cells are unable to recover from this physical insult and subsequently die. The optimal electrical pulse is one that is high enough to permeabilize the plasma membrane to yield sufficiently high level of transfection efficiency, while causing no more than 50% cell death. Therefore, since the optimal cell plating density for the micromass culture is  $20 \times 10^6$  cells/mL, doubling the cell concentration prior to electroporation will yield a concentration of approx  $20 \times 10^6$  cells/mL after electroporation when one accounts for the amount of cell death because of electroporation.
2. When performing transfections it is sometimes desirable to cotransfect a reporter construct to visualize the transfected cells and also to calculate the transfection efficiency. It is important to keep the total amount of DNA constant. Therefore, an empty plasmid vector (e.g., pBluescript) or sonicated salmon sperm DNA can be used with the control cells.
3. These settings have been shown to cause 35–45% cell death and yield a 25–35% transfection efficiency in viable cells when using Hamburger–Hamilton stage 23–24 chick embryonic limb buds. It should be noted that electroporation parameters will need to be determined for each cell type used.
4. Avoid irregularly shaped droplets and air bubbles in the droplets.
5. Corning brand tissue culture plasticware appears to work the best for optimal adhesion of limb bud mesenchyme plated in high-density micromass culture. Corning 6- and 12-well tissue culture plates as well as 35-mm plastic Petri dishes can also be used; however, when using the larger well plates or the Petri dishes, a 20-μL drop of 10% calf serum or culture medium should be placed on the edge of the well to prevent the micromass droplet from drying.
6. When feeding the cells, let the culture medium run down the sides of the wells so as not to disturb the cells. The cell attachments are very tenuous at this point and if the medium is introduced too quickly, the cells will wash off the plate and eventually die. When feeding cells plated in 6- and 12-well plates use 4 and 2 mL of culture medium/well, respectively.

## 4.2. MTT Cell Viability Assay

1. If one desires to determine the number of viable cells remaining after electroporation, it is best to perform the MTT cell viability assay on culture day 1 before the cells have a chance to begin proliferating.
2. MTT is a tetrazolium salt that is a substrate for many mitochondrial enzymes. Therefore, viable cells have the ability to transform the soluble tetrazolium salt into an insoluble MTT formazan. This insoluble formazan forms a deep purple-colored precipitate inside the cells.
3. When adding the acid-isopropanol to the wells, add it slowly down the side of the well to prevent the cells from detaching from the tissue culture plate.
4. To determine the number of viable cells remaining after electroporation transfection, the average relative absorbance is compared to a standard curve generated from nonelectroporated cells at known concentrations.

## 4.3. Transfection Efficiency

1. One problem we have noticed in X-Gal/Red-Gal staining is the accumulation of crystals in the tissue culture dish after the overnight incubation using higher concentrations of X-Gal or Red-Gal (e.g., 40 mg/mL). These crystals interfere with visualizing the cells under the microscope. Reducing the concentration of X-Gal/Red-Gal to 20 mg/mL prevents crystal formation without compromising staining intensity (*see ref. 21*).

## Acknowledgments

This work was supported in part by the NIH under grants (ES07005, DE11327, AR44501, and DE12864). The work of Anthony M. DeLise was supported by an NIH training grant T32-ES07282.

## References

1. Rachek, L. I., Tucker, A. M., Winkler, H. H., and Wood, D. O. (1998) Transformation of *Rickettsia prowazekii* to rifampin resistance [published erratum appears in *J. Bacteriol.* 1998 Aug;180(15):4015]. *J. Bacteriol.* **180(8)**, 2118–2124.
2. Brown, J. S., Aufauvre-Brown, A., and Holden, D. W. (1998) Insertional mutagenesis of *Aspergillus fumigatus*. *Mol. Gen. Genet.* **259(3)**, 327–335.
3. McCormac, A. C., Elliott, M. C., and Chen, D. F. (1998) A simple method for the production of highly competent cells of *Agrobacterium* for transformation via electroporation. *Mol. Biotechnol.* **9(2)**, 155–159.
4. Loimaranta, V., Tenovuo, J., Koivisto, L., and Karp, M. (1998) Generation of bioluminescent *Streptococcus* mutants and its usage in rapid analysis of the efficacy of antimicrobial compounds. *Antimicrob. Agents Chemother.* **42(8)**, 1906–1910.
5. Ohyama, H., McBride, J., and Wong, D. T. (1998) Optimized conditions for gene transfection into the human eosinophilic cell line EoL-1 by electroporation. *J. Immunol. Methods* **215(1–2)**, 105–111.
6. Harrison, R. L., Byrne, B. J., and Tung, L. (1998) Electroporation-mediated gene transfer in cardiac tissue. *FEBS Lett.* **435(1)**, 1–5.
7. Brownell, H. L., Lydon, N. B., Schaefer, E., Roberts, T. M., and Raptis, L. (1998) Inhibition of epidermal growth factor-mediated ERK1/2 activation by in situ electroporation of nonpermeant [(alkylamino)methyl]acrylophenone derivatives. *DNA Cell Biol.* **17(3)**, 265–274.

8. Zhang, W. W., Charest, H., and Matlashewski, G. (1995) The expression of biologically active human p53 in *Leishmania* cells: a novel eukaryotic system to produce recombinant proteins. *Nucleic Acids Res.* **23(20)**, 4073–4080.
9. Scott, D. A., Docampo, R., and Benchimol, M. (1998) Analysis of the uptake of the fluorescent marker 2',7'-bis-(2-carboxyethyl)-5-(and-6)-carboxyfluorescein (BCECF) by hydrogenosomes in *Trichomonas vaginalis*. *Eur. J. Cell Biol.* **76(2)**, 139–145.
10. Regnier, V., Le Doan, T., and Preat, V. (1998) Parameters controlling topical delivery of oligonucleotides by electroporation. *J. Drug Target.* **5(4)**, 275–289.
11. Boitano, S., Dirksen, E. R., and Evans, W. H. (1998) Sequence-specific antibodies to connexins block intercellular calcium signaling through gap junctions. *Cell Calcium.* **23(1)**, 1–9.
12. de Vries, J. and Wackernagel, W. (1998) Detection of nptII (kanamycin resistance) genes in genomes of transgenic plants by marker-rescue transformation. *Mol. Gen. Genet.* **257(6)**, 606–613.
13. To, K. Y., Cheng, M. C., Chen, L. F., and Chen, S. C. (1996) Introduction and expression of foreign DNA in isolated spinach chloroplasts by electroporation. *Plant J.* **10(4)**, 737–743.
14. Chang, D. C. (1997) Experimental strategies in efficient transfection of mammalian cells. Electroporation. *Methods Mol. Biol.* **62**, 307–318.
15. Sakamoto, K., Nakamura, H., Takagi, M., Takeda, S., and Katsube, K. (1998) Ectopic expression of lunatic Fringe leads to downregulation of Serrate-1 in the developing chick neural tube; analysis using in ovo electroporation transfection technique. *FEBS Lett.* **426(3)**, 337–341.
16. Suzuki, T., Shin, B. C., Fujikura, K., Matsuzaki, T., and Takata, K. (1998) Direct gene transfer into rat liver cells by in vivo electroporation. *FEBS Lett.* **425(3)**, 436–440.
17. Ochiai, H., Park, H. M., Nakamura, A., Sasaki, R., Okumura, J. I., and Muramatsu, T. (1998) Synthesis of human erythropoietin in vivo in the oviduct of laying hens by localized in vivo gene transfer using electroporation. *Poult. Sci.* **77(2)**, 299–302.
18. Ahrens, P. B., Solursh, M., and Reiter, R. S. (1977) Stage-related capacity for limb chondrogenesis in cell culture. *Dev. Biol.* **60(1)**, 69–82.
19. Gerlier, D. and Thomasset, N. (1986) Use of MTT colorimetric assay to measure cell activation. *J. Immunol. Methods* **94(1–2)**, 57–63.
20. Mosmann, T. (1983) Rapid colorimetric assay for cellular growth and survival: application to proliferation and cytotoxicity assays. *J. Immunol. Methods* **65(1–2)**, 55–63.
21. Sullivan, R. and Lo, C. W. (1997) Histochemical and fluorochrome-based detection of beta-galactosidase. *Methods Mol. Biol.* **63**, 229–246.

## Murine C3H10T1/2 Multipotential Cells as an In Vitro Model of Mesenchymal Chondrogenesis

Andrew R. Haas and Rocky S. Tuan

### 1. Introduction

Bone, muscle, fat, and cartilage are differentiated adult tissues derived from embryonic mesoderm. Under the control of specific molecular and cellular signals, mesenchymal stem cells differentiate into one of these mature tissues. The involvement of the master genes *myoD*, *myogenin*, and *myf-5* in muscle differentiation is well understood and represents a model for the regulation of mesodermal differentiation (1). At the present, the understanding of similar master signals involved in osteoblast, adipocyte, and chondroblast differentiation remains incomplete.

The embryonic chick limb bud has been widely used as a model system to study chondrogenic differentiation both in vivo (2) and in vitro using the high-density micromass culturing technique (3,4). Limb bud mesenchymal cells maintained as micromass cultures recapitulate the in vivo condensation event required for chondrogenic differentiation. Identification of a nontransformed, undifferentiated multipotential cell type as a chondrogenic model system would be ideal as it would eliminate repetitive, time-consuming isolations of primary cells from chick embryonic limb buds. Our laboratory has recently described the ability of the mouse mesenchymal stem cell line C3H10T1/2 to undergo chondrogenic differentiation when maintained as high-density micromass cultures in the presence of the chondro- and osteoinductive growth factor, recombinant human bone morphogenetic protein-2 (rhBMP-2). Histologically, cells in these cultures assume a round morphology and elaborate an extracellular matrix (ECM) that stains intensely with Alcian blue, indicating the presence of negatively charged glycosaminoglycans characteristic of cartilage extracellular matrix (5). The ECM contains both collagen type II and cartilage proteoglycan link protein, characteristic of cartilage (5). In addition, BMP-2-treated micromass cultures show enhanced labeling with [<sup>35</sup>S]sulfate consistent with elevated proteoglycan synthesis. Thus, the C3H10T1/2 cell line serves as an useful model system to study the molecular and cellular events involved in chondrogenic differentiation. This chapter details the setup of chondrogenic micromass cultures of C3H10T1/2 cells and various methods of demonstrating chondrogenic differentiation.

## 2. Materials

1. Phosphate-buffered saline (PBS), pH 7.4, composition per liter, 8 g NaCl, 0.2 g KCl, 1.15 g Na<sub>2</sub>HPO<sub>4</sub>, and 0.2 g KH<sub>2</sub>PO<sub>4</sub>.
2. C3H10T1/2 cells, clone 8, obtained from the American Type Culture Collection (ATCC-catalog CCL 226).
3. Tissue culture flasks (e.g., Corning [Glassworks, Corning, New York], Nunc [Wiesbaden-Biebrich, Germany]).
  - a. 75-cm<sup>2</sup>/150-cm<sup>2</sup> tissue culture flasks.
  - b. 24-well tissue culture plate.
  - c. 4-/8-well tissue culture chamberslides.
4. Fetal bovine serum (e.g., Hyclone, Logan, UT).
5. Culture media (e.g., Gibco [Gaithersburg, MD], Fisher Scientific [Pittsburgh, PA]).
  - a. Dulbecco's Modified Eagle Medium (DMEM).
  - b. Ham's F12 medium.
6. Trypsin-EDTA (0.05% trypsin/1.0 mM EDTA): Prepare 20X stock solution trypsin in 1X PBS (0.1 g in 10 mL PBS), put 1 mL aliquots into 1.5-mL Eppendorf tubes and freeze at -20°C. Prepare 20X (20 mM) stock solution EDTA from a 0.5-M stock solution (a 1:25 dilution—see **Note 1**), dilute trypsin and EDTA to 1X in PBS, sterile filter, and maintain at 4°C until ready to use.
7. Recombinant human BMP-2 (rhBMP-2): generous gift of Genetics Institute, Inc. (Cambridge, MA). Each stock solution obtained from the company varies in concentration. From the stated concentration provided by the supplier, dilute the rhBMP-2 to a concentration of 20 ng/μL in Ham's F12/10% FBS medium. Aliquot dilutions into small volumes (usually 125 μL—enough for one 24-well plate) to limit the number of freeze/thaw cycles. Freeze aliquots at -80°C.
8. Kahle's fixative: For 450 mL, combine 299 mL distilled water, 130 mL 100% EtOH, 17.5 mL glacial acetic acid, and 4.35 mL 37% formaldehyde, store at 4°C.
9. 1% Alcian blue 8-GX (Sigma, St. Louis, MO): dissolve 1.0 g Alcian blue into 100 mL 0.1 N HCl, stir overnight, filter with Whatman #1 filter paper (Whatman, Clifton, NJ), and store at room temperature.
10. Permeabilization solution: HEPES-Triton: 20 mM HEPES, pH 7.2, 300 mM sucrose, 50 mM NaCl, 3 mM MgCl<sub>2</sub>, 0.5% Triton X-100 (Fisher).
11. Anticollagen type II monoclonal antibody (CIICI), ascites fluid (**6**): Obtained from the Developmental Studies Hybridoma Bank (Johns Hopkins University School of Medicine and the University of Iowa, NICHD contract NO1-HD-6-2915), used at a 1:50 dilution for immunofluorescence.
12. Antilink protein monoclonal antibody (8A4; 7): a generous gift of Dr. B. Caterson (University of Wales—Cardiff, UK), 1:50 dilution for immunofluorescence.
13. Histochoice MB fixative (Amresco Inc., Solon, OH).
14. Normal goat serum (Sigma): Diluted to 10% in 1X PBS.
15. Goat antimouse fluorescein isothiocyanate-conjugated secondary IgG antibody (Cappel [Organon-Teknika, Durham, NC]): used at a 1:80 dilution.
16. Coverslip mounting agent: Fluoromount G (Southern Biotechnology Associates, Birmingham, AL).
17. Cell scraper (e.g., Fisher).
18. Cryoembedding medium: Tissue-Tek OCT Compound (Sakura Finetek USA, Torrance, CA).
19. Sodium [<sup>35</sup>S]sulfate/[<sup>3</sup>H]leucine: Obtained from NEN DuPont (Boston, MA).
20. 15-mm cork borer.
21. Liquid scintillation fluid.
22. Liquid scintillation counter.

### 3. Methods

#### 3.1. Tissue Culture

1. Maintain C3H10T1/2 cells in DMEM/10% FBS in 75-cm<sup>2</sup>/150-cm<sup>2</sup> tissue culture flasks (depending on the scale of the desired experiment—*see Note 2*). Change medium in culture flasks every 3 d until cells become fully confluent and are ready for micromass culturing (*see Note 3*).
2. Trypsinize cells by first suctioning all medium from the flasks, rinse the bottom of the flask two times with prewarmed 37°C PBS (to remove excess FBS which contains trypsin inhibitors), and suction each rinse (*see Note 4*).
3. Add 2 mL trypsin-EDTA to 75-cm<sup>2</sup> flask, and 4 mL to 150-cm<sup>2</sup> flask. Rock flask to ensure that the bottom of the flask is fully coated with trypsin-EDTA. Place the flask into the 37°C incubator for 5 min.
4. Remove the flask from the incubator, and gently tap the flask against the heel of one hand to help dislodge the cells (if a slurry of dislodged cells is not observed, either tap the flask a little harder or put the flask back into the incubator for several more min).
5. Once cells are dislodged, add 2–3 mL of Ham's F12 medium/10% FBS, and use the pipet-aid to rinse the bottom of the flask several times to dislodge all remaining cells and to break cells apart. Place the cells into a 15-mL conical centrifuge tube, remove a sample to count on a standardized hemacytometer, and centrifuge the remaining cells at 900 rpm for 7 min.
6. Resuspend the pellet to a density of 10<sup>7</sup> cells/mL in Ham's F12 medium/10% FBS based on the cell count obtained.
7. Using a 20- $\mu$ L pipet, carefully place a 10- $\mu$ L drop of cells into the center of each well of a 24-well plate (stop every 8 wells to resuspend the cells in the 15-mL centrifuge tube to prevent them from settling—*see Note 4*). Place the 24-well plate in the 37°C incubator for 1–1.5 h to allow the cells to adhere (*see Note 6*).
8. Remove the plate from the incubator and add 1.0-mL Ham's F12 medium with or without 100 ng/mL rhBMP-2. Place the 24-well plate back into the incubator for the desired time period. Change medium every 3 d, including fresh rhBMP-2 supplementation (*see Note 7*).

#### 3.2. Alcian Blue Staining

Steps involved in Alcian blue staining may be performed in a nonsterile environment.

1. Remove the cultures from the incubator and rinse each well of the 24-well plate 2X with 0.5–1.0 mL of 4°C PBS.
2. After removing the last rinse, add 0.5–1.0 mL of 4°C Kahle's fixative (enough to cover the culture sufficiently) and fix the cultures at room temperature for 10 min. Suction Kahle's fixative from wells and rinse cultures 2X with PBS or distilled water (once cells have been fixed, rinses can be performed with distilled water).
3. After removing last rinse, add 0.5–1.0 mL of 1% Alcian blue stain 8-GX to each well and allow cultures to stain at room temperature overnight (*see Note 8*).
4. The next day, rinse cultures 2–3X with distilled water, maintain a layer of water on cultures, and observe/photograph the staining (*see Note 9* and **Fig. 1**).

#### 3.3. Immunofluorescent Staining of BMP-2-Treated C3H10T1/2 Micromass Cultures

Cultures are incubated for the desired time period (e.g., days 1, 5, 9, 13) to assay for chondrogenic differentiation based on cartilage-specific markers collagen type II, and link protein of the large cartilage proteoglycan complex. Early cultures (day 1) can be

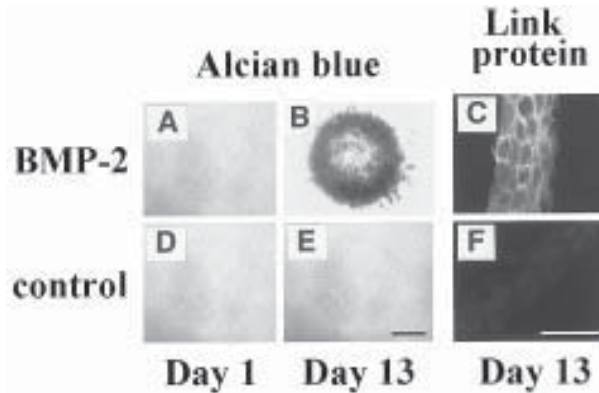

Fig. 1. Chondrogenic differentiation of C3H10T1/2 micromass cultures. (A,B,D,E) Alcian blue staining of control and BMP-2-treated micromass cultures. BMP-2-treated micromass cultures exhibit significant positive staining at day 13 (B) compared to day 1 (A). This staining indicates the presence of a negatively charged ECM, characteristic of cartilage-sulfated proteoglycans. Control cultures show only low level, background staining at both day 1 (D) and day 13 (E) (Bar = 2 mm). (C,F) Immunofluorescent staining of day 13 control and BMP-2-treated micromass cultures for link protein of the large cartilage proteoglycan. Day 13 BMP-2-treated micromass cultures (C) exhibit positive staining in a distinct extracellular pattern characteristic of cartilage ECM. Control cultures (F) do not stain for link protein. (Bar = 50  $\mu$ m).

done in 4-well chamberslides for ease of processing and staining. However, because of the thickness and extensive extracellular matrix present in older cultures (e.g., days 5, 9, 13), these cultures should be sectioned to effectively stain and visualize signal.

1. In either case, cultures are initially rinsed 3X with 4°C PBS, then fixed with Histochoice MB for 25 min at 4°C. After fixation, cultures are rinsed 3X for 2 min with 4°C PBS (see **Note 10**).
2. At this point, older cultures are stained for 5 min with eosin (in order to visualize cultures during embedding and sectioning) and are carefully scraped from the 24-well plate with a cell scraper. Using two pair of forceps, very gently remove the micromass culture from the end of the cell scraper and orient it into the embedding medium to obtain cross sections. Freeze the blocks at -80°C.
3. Cryosection embedded cultures at 8  $\mu$ m thickness, place 4–5 sections on each charged slide, and dehydrate sections in a dessicator under vacuum overnight. Remove the slides from the desiccator, select the slides to be stained, and place the remainder of the slides in a slidebox in a sealable plastic bag at -80°C. Using a wax pen, create wells around each section and rehydrate the sections 3X with PBS for 10 min each.
4. At this point, cryo-sections and early whole mount cultures follow the same steps. Permeabilize cultures with HEPES-Triton at 4°C for 45 min.
5. Block the cultures/sections with room temperature PBS/10% HEPES-Triton/10% normal goat serum for 45 min at 37°C (see **Note 11**). After cultures/sections have been blocked, add the monoclonal antibody CIICI or 8A4 (diluted as in materials section in PBS/10% HEPES-Triton/10% normal goat serum) as a drop contained within the circle formed with the wax pen, and incubate at 37°C for 2.5 h.
6. Rinse the culture/sections 3X for 5 min with room temperature PBS at 37°C. Following the final rinse, add the goat anti-mouse secondary antibody (diluted as in materials section in PBS) and incubate at 37°C for 1 h.



7. Rinse cultures/sections 3X for 5 min with PBS at 37°C. Mount coverslips, seal the edges with fingernail polish to prevent evaporation, and view slides under an ultraviolet (UV) microscope to detect immunofluorescent staining (**Fig. 1**).

### 3.4. Metabolic Sulfate Labeling

BMP-2-treated or control micromass cultures can be metabolically labeled with sodium [<sup>35</sup>S]sulfate, which becomes incorporated into newly synthesized, highly sulfated proteoglycans characteristic of cartilage extracellular matrix.

1. Set up micromass cultures as described above. Twenty-four hours prior to the desired termination time point, cultures are labeled with [<sup>35</sup>S]sulfate and [<sup>3</sup>H]leucine (to standardize for total protein synthesis).
2. Under sterile conditions and with the appropriate radioactive precautions, prepare a stock solution of Ham's F12 medium containing 5.0 μCi/mL sodium [<sup>35</sup>S]sulfate and 1.0 μCi/mL [<sup>3</sup>H]leucine (*see Note 12*). Remove regular medium, add Ham's F12 medium containing sodium [<sup>35</sup>S]sulfate and [<sup>3</sup>H]leucine, label plates radioactive, and place plates into 37°C incubator for 24 h.
3. After the 24-h labeling period, cultures are ready to be harvested. Under nonsterile conditions with appropriate radioactive precautions, suction all radioactive medium into a dedicated radioactive trap or into a collecting container with a pipet-aid. Rinse cultures, fix with Kahle's fixative, and rinse again as detailed in Alcian blue staining section (remember all rinses are to be considered radioactive and therefore the volume used for rinses and fixation should be kept to a minimum to prevent a disposal problem).
4. After the final rinse, cultures must be counted by liquid scintillation counting to determine the level of incorporation. We have found that the best way to remove cultures from the 24-well plate is to punch out a disc containing the micromass culture from the plate. Heat a 5–7 cm cork borer with a bunsen burner and when red hot, gently, on an angle, punch through about 80% of the bottom of the 24-well plate (turned upside down) leaving a small attachment point for the disc.
5. Punch the disc with a pair of forceps to snap off the remaining attachment. In this manner, about 3–4 wells can be punched before the borer needs to be reheated. Using the forceps, place the disc into a scintillation tube, add scintillation fluid, and count the tubes on the <sup>35</sup>S and <sup>3</sup>H channels.

### 4. Notes

1. Prepare 0.5 M EDTA stock solution by placing 186.1 g Na<sub>2</sub>EDTA-2H<sub>2</sub>O in 700-mL distilled water. Adjust pH to 8.0 with 10 M NaOH with vigorous stirring to dissolve EDTA. Bring volume to 1.0 L with distilled water.
2. Low passage C3H10T1/2 cells work best for chondrogenic experiments. Therefore, it is very important to keep track of the passage number of the 75-cm<sup>2</sup>/150-cm<sup>2</sup> tissue culture flasks and to note the passage number of each micromass experiment. C3H10T1/2 cells tend to lose chondrogenic capacity as they approach the twentieth passage. To this end, it is critical to grow a large batch of early passage cells obtained from the ATCC and freeze them in liquid nitrogen to ensure a large stock of low-passage C3H10T1/2 cells.
3. When growing large batches of cells in 75-cm<sup>2</sup>/150-cm<sup>2</sup> tissue culture flasks, cells should not be kept at a fully confluent state for more than 24 h. We have noted that an extended period of contact inhibition among cells decreases their response to BMP-2 and cells exhibit significantly less chondrogenic capacity. Therefore, cells must be observed closely to ensure that they are not confluent for an extended time.

4. When trypsinizing cells from the 75-cm<sup>2</sup>/150-cm<sup>2</sup> tissue culture flasks, it is critical to rinse the flasks first with prewarmed 37°C 1X PBS. Otherwise, residual FBS will inactivate the trypsin-EDTA and prevent dissociation of the cells.
5. We have observed that micromass cultures undergo optimal chondrogenic differentiation when plated onto 24-well plates, compared to other types of multiwell culture plates.
6. Once the micromass cultures are placed into the incubator, do not allow the cells to attach for longer than 1.5 h or the surface of micromass will dry and the culture will die.
7. Working dilutions of the rhBMP-2 stock solution should be made under sterile conditions and on ice to minimize inactivation and/or degradation of the rhBMP-2. Place all dilutions into sterile 500- $\mu$ L Eppendorf tubes and freeze at -80°C as soon as aliquots are prepared. Dilute only half of the stock solution at one time, unless experiments would allow the use of the diluted BMP-2 in a 2-mo time period. Repeated freeze-thaw cycles of diluted aliquots should be avoided (no more than one cycle ideally).
8. Filtration of fresh Alcian blue stain can be very tedious and time consuming. An alternative to filtration is to prepare a large bottle of Alcian blue and allow all the sediment to settle. When the stain is needed, carefully withdraw it from the top to avoid disrupting the sediment. Stain can be reused 1–2 times before discarding.
9. Color photography of Alcian blue stain can be performed, but black and white photographs using a yellow filter provides for the best contrast in these cultures.
10. Fixation of micromass cultures with Histochoice MB (Amresco) provides for the best staining of collagen type II and link protein. This fixative does not crosslink extracellular matrix and avoids the need to perform an enzymatic digestion step in staining for collagen type II and link protein.
11. When placing slides into 37°C incubator for blocking and primary and secondary antibody incubations, make sure there is sufficient fluid on each section/culture and that the slide is in a humidified chamber. If the sections/cultures become dry at any time during these incubations, undesirable nonspecific staining will occur.
12. When metabolically labeling micromass cultures with sodium [<sup>35</sup>S]sulfate, it is very important to use a radioactive decay table for <sup>35</sup>S to calculate the amount needed to compensate for the relatively rapid decay.

## Acknowledgments

The authors thank Dr. A. E. Denker for the development of the micromass culture technique for C3H10T1/2 cells. This work was supported in part by the NIH under grants (ES 07005, DE 11327, AR 44501, DE 12864).

## References

1. Emerson, C. P. (1993) Embryonic signals for skeletal myogenesis: arriving at the beginning. *Curr. Opin. Cell Biol.* **5**, 1057–1064.
2. Ede, D. A. (1983) Cellular condensations and chondrogenesis, in *Cartilage: Development, Differentiation, and Growth* (Hall, B. K., ed.), Academic, New York, vol. 2, pp. 143–185.
3. Ahrens, P. B., Solorsh, M., and Reiters, R. (1977) Stage-related capacity for limb chondrogenesis in cell culture. *Dev. Biol.* **60**, 69–82.
4. San Antonio, J. D. and Tuan, R. S. (1986) Chondrogenesis of limb bud mesenchyme in vitro: stimulation by cations. *Dev. Biol.* **115**, 313–324.
5. Denker, A. E., Haas, A. R., Nicoll, S. B., and Tuan, R. S. (1999) Chondrogenic differentiation of murine C3H10T1/2 multipotential mesenchymal cells: I. Stimulation by bone morphogenetic protein-2 in high-density micromass cultures. *Differentiation* **64**, 67–76.

6. Caterson, B., Christner, J. E., Baker, J. R., and Couchman, J. R. (1985) Production and characterization of monoclonal antibodies directed against connective tissue proteoglycans. *Fed. Proc. Fed. Am. Soc. Exp. Biol.* **44**, 386–393.
7. Holmdahl, R., Rubin, K., Klareskog, L., Larsson, E., and Wigzell, H. (1986) Characterization of the antibody response in mice with type II collagen-induced arthritis using monoclonal anti-type II collagen antibodies. *Arthr. Rheum.* **29**, 400–410.

## Skeletogenesis

### *In Vitro Analysis of Bone Cell Differentiation*

**Adesola Majolagbe and Pamela Gehron Robey**

#### 1. Introduction

A common goal of cell biologists is the establishment of in vitro model systems that faithfully recapitulate a particular biological process that occurs in vivo. Currently, numerous methodologies exist for in vitro analysis of osteoblastic cells, however, many of these methods depend on the use of fetal tissue, osteosarcoma, or immortalized cell lines. Although all of these model systems have generated a great deal of knowledge on the phenotypic character of osteoblastic cells as they undergo the maturational process that ultimately leads to the formation of a mineralized matrix, a great deal of variability has been noted in the literature from one culture method to another. This variability can arise from differences in the animal species and the developmental age of the starting material used for the establishment of such cultures, the amount of soft tissue associated with the starting material, and alterations in patterns of phenotypic expression owing to tumorigenic or immortalization processes (1).

The method that is described in this chapter was developed in order to minimize some of the potential differences in the starting material used to generate osteoblastic cultures (2). The method employs the use of bacterial collagenase to pretreat fragments of bone to remove all soft tissue components. Whereas it is recognized that the soft tissue associated with bone surfaces such as periosteum and marrow contain osteogenic progenitor cells, they are present in variable amounts depending on the developmental age and site from which the bone is harvested. These progenitors can contribute significantly to maturational heterogeneity or expression of other phenotypes. Specific methods for establishment of such osteogenic progenitors free of other cell types (hematopoietic, endothelial) have been reported, and are described elsewhere in this volume (mesenchymal stem cells). Rather, this method focuses on cultures established from cells that are protected from the collagenase pretreatment because they are surrounded by mineralized matrix (osteocytic cells), that are subsequently able to migrate from bone fragments and begin to proliferate. The resulting cells display characteristics of preosteoblasts by virtue of alkaline phosphatase activity, formation of cAMP after treatment with parathyroid hormone (PTH), and with time in culture, they become

mature osteoblasts that form mineralized nodules in vitro. This method can be applied to fetal and postnatal material from all animal species, including human, and has been used extensively to characterize the biosynthesis of bone matrix proteins, expression of these proteins as a function of differentiation, and other parameters of the osteoblastic lineage (3–6).

## 2. Materials

1. Storage medium: Any nutrient medium that contains 10% fetal bovine serum (FBS).
2. Enzyme medium:
  - 225 mL of DMEM with 4.0 g glucose/L  
(Biofluids, Inc., Rockville, MD, list no. 104).
  - 225 mL Ham's F-12K without calcium chloride  
(Biofluids, Inc., list no. 161)
  - 5 mL glutamine (200 mM)  
(Biofluids, Inc., list no. 300)
  - 5 mL pen-strep (10,000 U/mL)  
(Biofluids, Inc., list no. 303)
  - 1.25 mL of L-ascorbic acid sodium salt (10 mg/mL)  
(Sigma Chemical Co., St. Louis, MO, catalog no. A-7631)
  - 3.9 mL of calcium stock (116 mM)  
(Biofluids, Inc., list no. 342)
  - Filter through a 0.22- $\mu$ m 500-mL filter unit.
3. Collagenase P: From *Clostridium histolyticum* (Boehringer Mannheim, Mannheim, Germany (cat no. 1213873)
  - 250 U of collagenase/mL
  - Filter through a 0.22- $\mu$ m 150-mL filter unit.
4. Growth medium: 225 mL of DMEM without calcium chloride and with 4.0 g glucose/L  
(Biofluids, Inc., list no. 160)
  - 225 mL of Ham's F-12K without calcium chloride  
(Biofluids, Inc., list no. 161)
  - 5 mL glutamine 200 mM  
(Biofluids, Inc., list no. 300)
  - 5 mL pen-strep (10,000 U/mL)  
(Biofluids, Inc., list no. 303)
  - 1.25 mL of L-ascorbic acid sodium salt (10 mg/mL)  
(Sigma, cat. no. A-7631).
  - 50 mL FBS
  - Filter through a 0.22- $\mu$ m 500-mL filter unit.
5. Complete medium: 225 mL of DMEM with 4.0 g glucose/L  
(Biofluids, Inc., list no. 104)
  - 225 mL of Ham's F-12K without calcium chloride  
(Biofluids, Inc., list no. 161)
  - 5 mL glutamine (200 mM)  
(Biofluids, Inc., list no. 300)
  - 5 mL pen-strep (10,000 U/mL)  
(Biofluids, Inc., list no. 303)
  - 1.25 mL of L-ascorbic acid sodium salt (10 mg/mL)  
(Sigma, cat. no. A-7631)
  - 3.9 mL of calcium stock (116 mM)  
(Biofluids, Inc., list no. 342)

50 mL FBS

Filter through a 0.22- $\mu$ m 500-mL filter unit

6. Serum free medium:

240 mL of DMEM with 4.0 g glucose/L

(Biofluids, Inc., list no. 104)

240 mL of Ham's F-12K without calcium chloride

(Biofluids, Inc., list no. 161)

5 mL glutamine (200 mM)

(Biofluids, Inc., list no. 300)

5 mL pen-strep (10,000 U/mL)

(Biofluids, Inc., list no. 303)

1.25 mL of L-ascorbic acid sodium salt (10 mg/mL)

(Sigma, cat. no. A-7631)

3.9 mL of calcium stock (116 mM)

(Biofluids, Inc., list no. 342)

Filter through a 0.22- $\mu$ m filter unit

then add 2.5 mL of ITS<sup>+</sup> (N.B. ITS PLUS!)

(Collaborative Research, New Bedford, MA, cat. no. 40352)

7. Mineralization medium:

225 mL of DMEM with 4.0 g glucose/L

(Biofluids, Inc., list no. 104)

225 mL of Ham's F-12K without calcium chloride

(Biofluids, Inc., list no. 161)

5 mL glutamine (200 mM)

(Biofluids, Inc., list no. 300)

5 mL pen-strep (10,000 U/mL)

(Biofluids, Inc., list no. 303)

1.25 mL of L-ascorbic acid sodium salt (10 mg/mL)

(Sigma, cat. no. A-7631)

3.9 mL of calcium stock (116 mM)

(Biofluids, Inc., list no. 342)

50 mL FBS

5 mL of  $\beta$ -glycerol phosphate (500 mM)

(Sigma, cat. no. G-6251)

Filter through a 0.22- $\mu$ m 500-mL filter unit

then add 2.5 mL of ITS (N.B! not ITS PLUS)

(Collaborative Research, cat. no. 40350)

8. Freezing medium:

44 mL  $\alpha$ MEM

50 mL FBS

5 mL dimethylsulfoxide

(Sigma, cat. no. D-2650)

1 mL pen-strep (10,000 U/mL)

(Biofluids, Inc., list no. 303)

### 3. Methods

1. *Normal human trabecular bone harvest*: under sterile conditions, remove trabecular bone from the bone specimen (patella, tibia, distal femoral epiphysis, or femoral head) using a sterile No. 2 bone curet. Place scooped bone fragments into sterile Pearce Reacti-vials (Pearce Butler Co., Rockford, IL) (3-mL size) filled with 1.5 mL of enzyme media. The scooped bone chips must be kept moist throughout the procedure (*see Note 1*).

2. *Mincing/washing*: mince the bone chips in each vial using small sharp surgical scissors. After allowing the fragments to settle briefly, aspirate the supernatant fluid. Wash the bone fragments with enzyme medium to remove fat and bone marrow several times by adding fresh enzyme medium, allowing the fragments to settle before aspiration. Continue mincing until the fragments have a fine, sandy texture. Transfer the fragments into a sterile 50-mL conical tube containing enzyme medium (about 30 mL), and further wash the fragments by vortexing (10 times, 2 min each) to remove tissue debris. This action will further release soft tissue from the bone fragments. This is to be repeated until the enzyme medium becomes clear when looking through the tube (*see Note 2*).
3. *Pretreatment of bone fragments with collagenase* (*see Note 3*): estimate the volume of bone fragments (not more than 5 mL settled bed volume per tube), then add 50 mL of collagenase P enzyme media (1.2 mg collagenase P in 50-mL conical tube). The bone fragments are digested for 2 h on a rotator in an incubator at 37°C, or until the cellular material on the bone surface disappears (**Fig. 1A**).
4. *Plating of collagenase pretreated bone fragments*: after digestion, the fragments are washed to stop the collagenase activity by allowing to fragments to settle to the bottom of the tube and drawing off the supernatant fraction (four times, 2 min each with 30 mL of enzyme medium without the enzyme). Bone fragments are then placed into a sterile Petri dish treated for tissue culture growth (Falcon, Los Angeles, CA). One No. 5 curet filled with collagenase pretreated fragments is used to seed a 150-mm plate or one No. 2 curet for a 100-mm dish containing the growth medium. Swirl the plates around for few seconds to spread the bone chips evenly onto the Petri dish. The growth medium is replaced three times a week. The bone fragments attach to the dishes and cells should emerge after two weeks of bone preparation (**Fig. 1B**). Four to six weeks are required for the cells to reach confluence depending on the age of the donor (*see Notes 4–6*).
5. *Passaging*: when primary cultures become approx 70–80% confluent (**Fig. 1C**), they should be washed twice with Hank's balanced salt solution (2 min each) before adding trypsin. Five mL of freshly thawed trypsin-EDTA at 40°C should be added per 150-mm dish and the dish incubated at 37°C for approx 10 min when the majority of the cells have detached from the fragments and the dish. The cells are broken up into a single-cell suspension by drawing the trypsin up and down in a pipet several times. The cell suspension is then removed, leaving the fragments behind (or for further treatment with trypsin to remove more cells) and placed in a sterile 50-mL tube. Trypsin is inactivated by adding FBS to a final concentration of 10%. The suspension is allowed to sit for 5 min to allow any fragments that are transferred inadvertently to settle to the bottom. The supernatant fraction is carefully removed to avoid drawing up the settled fragments and the number of the cells in the suspension are counted. For proliferation studies, cells are plated at a density of 10,000 cells/cm<sup>2</sup>, in either 24- or 48-well plates (Costar, Cambridge, MA) in serum-free or serum reduced (1–2% FBS) medium.
6. *Storage of first passage cells*: If cells are not to be used immediately, the suspension is centrifuged for 5–10 min at 100g to pellet the cells. The cells are resuspended in freezing medium by pipeting up and down approximately eight times. The cells are then counted by either a hemocytometer or automated methods (Coulter counter) and the volume adjusted with freezing medium to between 1–5 × 10<sup>6</sup> cells/mL. One mL of cell suspension is placed in a cryotube, which is placed into a specially designed freezing container (Nalge Nunc, Rochester, NY, cat. no. 5100-0001) with 2-propanol at room temperature. The freezing container is then transferred to a –80 freezer for 24 h, at which time the cryotubes are transferred to a liquid nitrogen container for storage. Viability of cells is maintained for at least 1 yr.

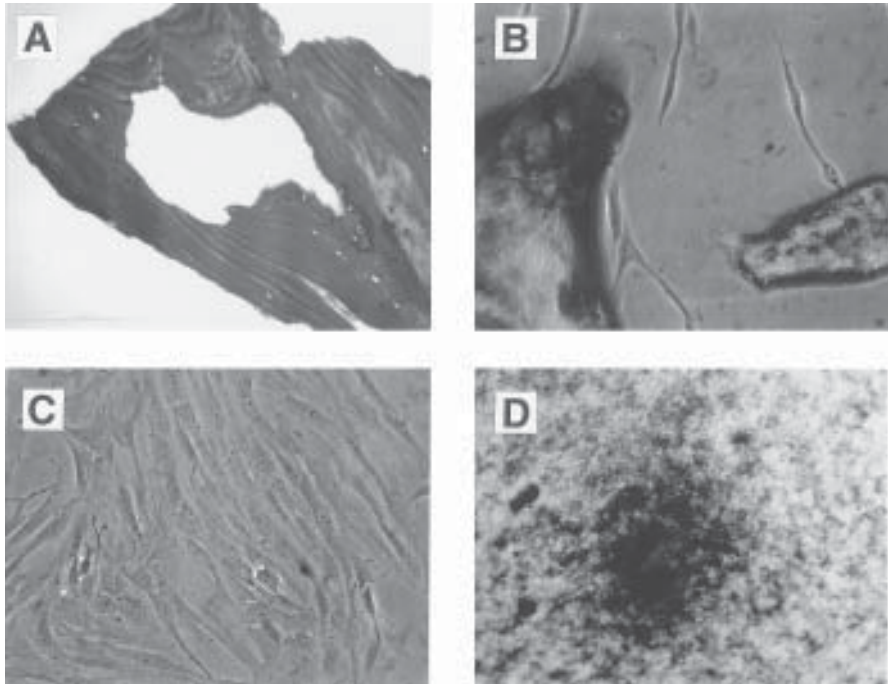

Fig. 1. Preparation of normal human trabecular bone cells for studies of osteoblastic maturation in vitro. (A) Small fragments of trabecular bone are minced until they reach the consistency of sand and treated with bacterial collagenase to remove all of the soft tissues associated with the mineralized matrix. (B) When the pretreated fragments are placed in low-calcium growth medium, cells begin to emerge from the fragments after approx 2 wk, depending on the age of the donor. (C) With continued incubation in low calcium growth medium, the cells form a monolayer of ellipsoid cells. (D) When switched to mineralization medium, the cells begin to multilayer and form bone nodules as indicated by von Kossa staining.

**Table 1**  
**Expression of Bone Matrix Proteins as a Function of Maturational Stage**

Osteoprogenitor	Preosteoblast	Osteoblast	Mature osteoblast	Osteocyte
± Alkaline Phosphatase	Alkaline Phosphatase	Decorin	Osteopontin	Fibronectin
Versican	Collagens I and III	Thrombospondin	Bone Sialoprotein	Biglycan
Heparan Sulfate PGs	Decorin	Fibronectin	Collagen type I	Osteocalcin
Collagen I and III	Thrombospondin	Osteonectin		
		Biglycan		

7. *Osteoblastic differentiation*: For in vitro analysis, cells are plated at 40,000 cells per cm<sup>2</sup> in mineralization medium and fed three times a week. Cells proliferate, multilayer, and form bone-like nodules as has been described previously in this and other systems (Fig. 1D). The pattern of bone matrix protein expression by these cells in vitro (7–9) mimics what has been described by *in situ* analysis of bone formation (10) (Table 1). The osteoblastic



nature of the cells has also been confirmed by demonstration of bone formation using an *in vivo* assay (Majolagbe and Gehron Robey, unpublished data).

#### 4. Notes

1. The bone specimen should be placed in a sterile container with nutrient medium containing 10% FBS and stored at 4°C until processed. Furthermore, the bone sample should be used within 48 h of surgery to ensure viability.
2. Proper mincing and washing is critical for the removal of soft tissue and cellular debris from the bone fragments. This step is also necessary to optimize cell growth. Removal of soft tissue is more efficient and better cellular outgrowth is obtained from small, sand-like fragments than from larger fragments.
3. Many commercial preparations of collagenase have high levels of clostripain activity, which is toxic to many cell types. Preparations with a high collagenase:clostripain activity should be selected if collagenase P is not used.
4. Using the medium formulations described above, the CO<sub>2</sub> level in the incubator should be set at 8% to maintain the appropriate pH. DMEM is not as well buffered as most medium formulations and consequently an alkaline pH is noted when only 5% CO<sub>2</sub> is used. This considerably delays cellular outgrowth and proliferation.
5. It is well known that different manufacturers have different processes by which plastic is treated to render it suitable for cell attachment. It has been noted that cellular outgrowth is more rapid on Falcon plates (Falcon, Los Angeles, CA) than on other brands. However, upon passage, there are no obvious differences between one brand and another.
6. The use of flasks for establishment of primary cultures is not recommended. Cellular outgrowth is dependent on the fragments remaining attached to the bottom of the dish. Upending flasks during feeding causes the fragments to become detached. Moving and feeding plates should be performed carefully to minimize disruption of the fragments from the bottom of the plate.

#### References

1. Gehron Robey, P. (1992) Cell-mediated calcification *in vitro*, in *Calcification in Biological Systems* (Bonucci, E., ed.), CRC, Boca Raton, FL, pp. 107–127.
2. Gehron Robey, P. and Termine, J. D. (1985) Human bone cells *in vitro*. *Calcif. Tissue Int.* **37**, 453–460.
3. Fedarko, N. S., Termine, J. D., and Gehron Robey, P. (1990) High-performance liquid chromatographic separation of hyaluronan and four proteoglycans produced by human bone cell cultures. *Anal. Biochem.* **188**, 398–407.
4. Fedarko, N. S., Termine, J. D., Young, M. F., and Gehron Robey, P. (1990) Temporal regulation of hyaluronan and proteoglycan metabolism by human bone cells *in vitro*. *J. Biol. Chem.* **265**, 12,200–12,209.
5. Fedarko, N. S., Bianco, P., Vetter, U., and Gehron Robey, P. (1990) Human bone cell enzyme expression and cellular heterogeneity: correlation of alkaline phosphatase enzyme activity with cell cycle. *J. Cell Physiol.* **144**, 115–121.
6. Fedarko, N. S., Vetter, U. K., Weinstein, S., and Gehron Robey, P. (1992) Age-related changes in hyaluronan, proteoglycan, collagen, and osteonectin synthesis by human bone cells. *J. Cell Physiol.* **151**, 215–227.
7. Gehron Robey, P. and Grzesik, W. J. (1995) The biochemistry of bone-forming cells: cell-matrix interactions, in *Biological Mechanisms of Tooth Eruption, Resorption and Replacement by Implants* (Davidovitch, Z., ed.), EBSCO Media, Birmingham, AL, pp. 167–172.

8. Lian, J. B. and Stein, G. S. (1995) Development of the osteoblast phenotype: molecular mechanisms mediating osteoblast growth and differentiation. *Iowa Orthop. J.* **15**, 118–140.
9. Kasai, R., Bianco, P., Gehron Robey, P., and Kahn, A. J. (1994) Production and characterization of an antibody against the human bone GLA protein (BGP/osteocalcin) propeptide and its use in immunocytochemistry of bone cells. *Bone Miner.* **25**, 167–182.
10. Gehron Robey, P., Bianco, P., and Termine, J. D. (1992) The cell biology and molecular biochemistry of bone formation, in *Disorders of Mineral Metabolism* (Favus, M. J. and Coe, F. L., eds.), Raven, New York, pp. 241–263.

## Studying Early Hematopoiesis Using Avian Blastoderm Cultures

Carol A. Eisenberg

### 1. Introduction

The process of hematopoiesis occurs very early during embryogenesis, with the appearance of red blood cells within the yolk sac (1,2). It is at the gastrula stage when hematopoietic stem cells arise from newly formed mesoderm (3,4). Only mesoderm cells found within the extraembryonic area opaca (AO) and not the embryo proper (area pellucida; AP), will demonstrate red blood cell phenotypes (5,6). These cells, which are part of the extraembryonic circulatory system, will enter the embryo during later stages of development to form the primitive and definitive hematopoietic lineages (2). The stimulus for red blood cell formation from AO mesoderm appears to be AO endoderm (2,6). Interestingly, AP mesoderm is also capable of producing red blood cells when cocultured with AO endoderm (5). However, the mechanism(s) by which specification of hematopoietic cells occurs are poorly understood. In this report is described a culture model system that facilitates the study of the early events that occur during hematopoiesis.

In blastoderm suspension cultures, cells dissociated from early avian blastodiscs (7) are allowed to aggregate and evolve into cultures resembling embryoid bodies from teratocarcinomas. Within the first 5 d of culture, these aggregates produce red blood cells (Fig. 1), thus replicating many early embryonic events (8–11). These cultures can be comprised of either cells from the AP or from both the AP and AO. Those composed of AP mesoderm, which does not normally give rise to blood cells *in situ*, will possess red blood cells if taken from early gastrulating embryos. However, if the blastoderm suspension cultures are made from later staged embryos, hematopoiesis will not occur. Yet, these cultures can display hematopoietic cells if stem cell factor (SCF) is added (9). Hence, these blastoderm suspension cultures provide a method by which to identify factor(s) responsible for directing early mesoderm cells toward the hematopoietic lineage.

### 2. Materials (see Notes 1 and 2)

1. DPBS: Dulbecco's phosphate-buffered saline (DPBS), pH 7.4, containing 0.20 g  $\text{KH}_2\text{PO}_4$ , 0.20 g KCl, 8.00 g NaCl, and 1.15 g  $\text{Na}_2\text{HPO}_4$  per liter: Once dissolved, adjust the pH with either 1 N HCl or 1 N NaOH. Immediately sterilize this buffer by filtration through a

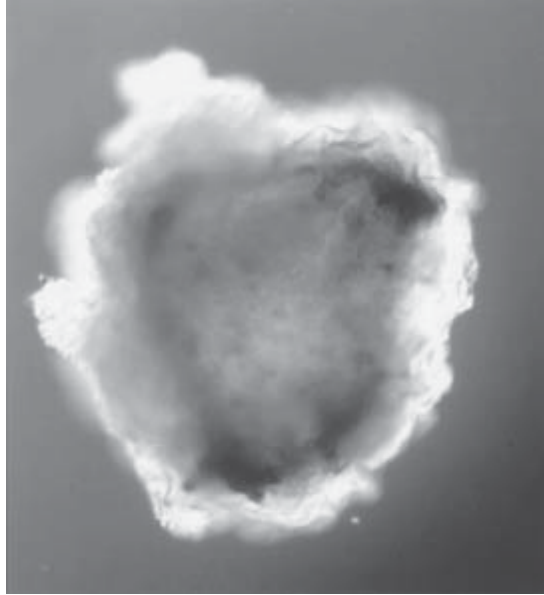

Fig. 1. (See color plate 11 appearing after p. 262.) Red blood cell formation within chicken blastoderm aggregates. Aggregate culture was visualized using differential interference contrast optics. As shown, Hamburger and Hamilton (HH; 12) stage 4 aggregate gave rise to hemoglobin-positive cells. Large blood islands were visible by their red color. Aggregates derived from later stage embryos (HH stage 5) embryos will not contain red blood cells (9).

0.22- $\mu\text{m}$  cellulose acetate membrane and store at 4°C in the dark until ready for use. Discard if solution becomes cloudy or forms a visible precipitate.

2. 1X Trypsin-EDTA, pH 7.4: Rehydrate trypsin-EDTA 10X powder (Gibco-BRL, Gaithersburg, MD) in 20 mL sterile water. Immediately dilute into 980 mL sterile DPBS to obtain a final concentration of 0.5 g trypsin and 0.2 g EDTA-4Na per liter. Aliquot into sterile, polypropylene tubes and store at -20°C for up to 6 mo.
3. Medium: Dulbecco's modified Eagle's medium (DME) with 4.5 g/L glucose and L-glutamine, without NaHCO<sub>3</sub> (Gibco). Dissolve powder into 700 mL water and add 3.7 g NaHCO<sub>3</sub>. Adjust pH to 7.4 with 1 N NaOH and add additional water to bring the final volume to 790 mL. Sterilize by filtration through a 0.22- $\mu\text{m}$  cellulose acetate membrane and then add 200 mL fetal bovine serum (FBS; see Note 3) and 10 mL of 100X penicillin-streptomycin (Gibco-BRL) to yield final concentrations of 100 U for each antibiotic. Store medium at 4°C in the dark for up to one month.
4. Trypan blue: Dissolve 0.85 g NaCl and 0.4 g trypan blue into 100 mL water. Immediately filter through a 0.22- $\mu\text{m}$  cellulose acetate membrane and store at 4°C until ready for use. Discard if any visible precipitate forms.

### 3. Methods

1. Isolation of blastoderm: crack open the egg and gently pour contents into a sterile, bacteriological grade 100  $\times$  20 mm Petri dish. The white disk-shaped embryo will be found on top of the yolk. Carefully remove the thick egg albumin that covers the embryo with sterilized, curved, blunt-ended, serrated forceps. Harvest the embryo from the yolk by laying a paper ring over the blastoderm and cutting the adhered vitelline membrane around

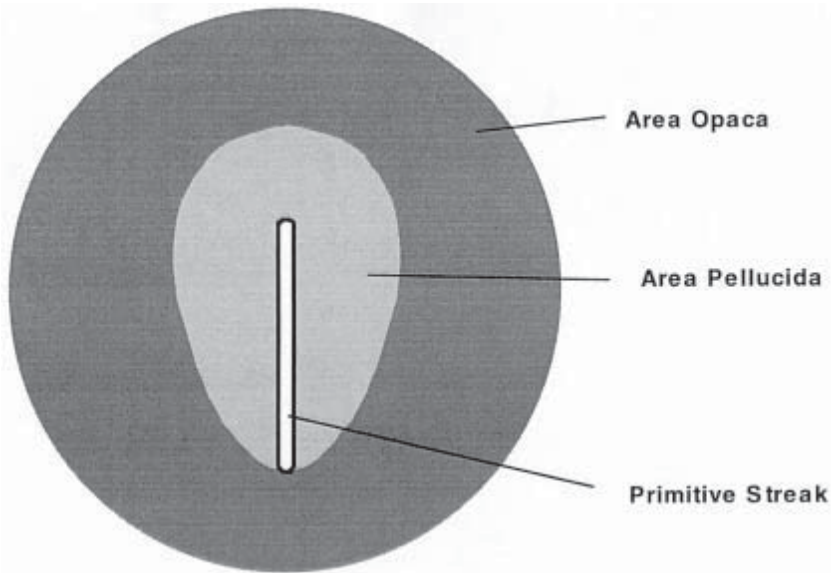

Fig. 2. Schematic diagram depicting a HH stage 4 avian embryo.

the ring with sterile, curved scissors. These rings, cut from sheets of Whatman 3MM paper (Whatman, Clifton, NJ), have inner and outer dimensions of 9 mm and 13 mm, respectively. These rings should be sterilized either by gamma irradiation or by overnight exposure to UV light.

2. Separation of embryonic from extraembryonic tissue: place paper ring with embryo on an inverted lid from a sterile, 35-mm Petri dish. The embryo should be oriented so that the ventral side is facing up. Carefully remove any adhering yolk by gently pipeting with sterile, DPBS. Keep the cleaned blastoderm in DPBS to maintain cell viability. With the aid of a dissecting microscope, cut the area pellucida away from the area opaca using fine glass needles (**Fig. 2**). These needles are made from 5 3/4 in.-Pasteur pipets, which have been pulled under flame and sterilized by overnight exposure to UV light. Transfer tissue to a sterile, 1.5-mL microfuge tube containing 1 mL DPBS. Keep the tissue on wet ice until all the blastoderms are harvested.
3. Preparation of cell suspension: pellet tissue fragments by centrifugation at 250g for 10 min and resuspend in 1X trypsin-EDTA (0.5 mL per 10 fragments). After a 10 min incubation at 37°C, gently dissociate the fragments by repeated pipeting until no cell clumps are visible under the microscope. Immediately stop the trypsinization by adding an equal volume of medium and pellet the cells by centrifugation at 250g for 10 min. Resuspend the pellet in fresh medium and determine the viable cell number by trypan blue exclusion.
4. Production of aggregates: prepare a cell suspension of 1.25 to 2.5 × 10<sup>6</sup> cells/mL in fresh medium. Distribute this cell suspension in 20 µL drops on an inverted lid from a sterile, bacterial-grade 100 × 20 mm Petri dish. Place the lid back on the Petri dish, which contains 2 mL DPBS. To maintain uniform growth and size of aggregates, care should be taken not to have the 20 µL drops merge with one another. Following 48 h of incubation at 37°C with 5% CO<sub>2</sub>, transfer aggregates to new bacterial-grade Petri dishes containing 15 mL fresh medium. Aggregates can be cultured for an additional 5 d before any loss of cell viability.

#### 4. Notes

1. All solutions should be made with high-purity, endotoxin-free deionized water. Cell-culture grade water, obtained from commercial sources, can also be used in all preparations.
2. Unless stated otherwise, all solutions should be stored in sterile, autoclaved glass bottles.
3. The number and development of red blood cells is dependent upon the quality of the FBS. Good batches can yield hemoglobin-positive cells by the third day in culture. Therefore, it is imperative that several lots of FBS be tested to ensure optimal aggregate cell maturation.

#### Acknowledgments

This work was supported by NIH Grant RO1 HL55923.

#### References

1. Orkin, S. H. (1996) Development of the hematopoietic system. *Curr. Opin. Genet. Dev.* **6**, 597–602.
2. Zon, L. I. (1995) Developmental biology of hematopoiesis. *Blood* **86**, 2876–2891.
3. Dzierzak, E. and Medvinsky, A. (1995) Mouse embryonic hematopoiesis. *Trends Genet.* **11**, 359–366.
4. Rich, I. N. (1992) The developmental biology of hemopoiesis: effect of growth factors on the colony formation of embryonic cells. *Exp. Hematol.* **20**, 368–370.
5. Kessel, J. and Fabian, B. C. (1986) The pluripotency of the extraembryonic mesodermal cells of the early chick blastoderm: effects of the AP and AOV environments. *Dev. Biol.* **116**, 319–327.
6. Wilt, F. H. (1967) The control of embryonic hemoglobin synthesis. *Adv. Morphol.* **6**, 89–125.
7. Eyal-Giladi, H. and Kochav, S. (1976) From cleavage to primitive streak formation: a complementary normal table and a new look at the first stages of the development of the chick. I. General morphology. *Dev. Biol.* **49**, 321–337.
8. Dardick, I., Stterfield, G., and Wainwright, L. K. (1976) Cellular composition of erythropoietic cell populations and aggregate cell cultures derived from early chick blastodiscs. *Tissue Cell* **8**, 277–292.
9. Eisenberg, C. A. and Markwald, R. R. (1997) Mixed cultures of avian blastoderm cells and the quail mesoderm cell line QCE-6 provide evidence for the pluripotentiality of early mesoderm. *Dev. Biol.* **191**, 167–181.
10. Mitrani, E. and Eyal, G. H. (1982) Cells from early chick embryos in culture. *Differentiation* **21**, 56–61.
11. Sanders, E. J. and Zalik, S. E. (1976) Aggregation of cells of early chick blastoderms. *Differentiation* **6**, 1–11.
12. Hamburger, V. and Hamilton, H. L. (1951) A series of normal stages in the development of the chick embryo. *J. Morphol.* **88**, 49–92.

## Isolation and Culture of Mouse Germ Cells

Maria P. De Miguel and Peter J. Donovan

### 1. Introduction

The isolation and culture of germ cells has allowed both the analysis of gene expression in these cells as well as studies of their behavior and growth requirements. Some of the factors found to be important for the *in vitro* culture of germ cells have subsequently been found to be physiologically relevant to germ cell growth and development *in vivo*. For example, leukemia inhibitory factor (LIF) was identified as a potent germ cell survival factor and mitogen in culture (1). Subsequently, targeted disruption of the signaling component of the LIF receptor, *gp130*, demonstrated the importance of this signaling pathway for germ cell development in the embryo (2). Cultures of primordial germ cells (PGCs) have also been used as a model system in which to study cell migration and invasiveness (3). More recently, the ability of PGCs to give rise to pluripotent stem cells, similar to embryonic stem (ES) cells, has been revealed in culture (4,5). The development of these cells from human PGCs represents an important advance in the study of human embryology (6). Similarly, recent developments in spermatogonial transplantation (7,8) have opened up new and exciting avenues for the study of this important lineage. The ability of isolated spermatogonia to repopulate the testis tubule and give rise to mature sperm provides a rigorous transplantation system in which to test many hypotheses about spermatogonial growth and differentiation. In effect, it provides for those working on spermatogonial stem cells the same experimental system that has been available for many years for those working on hemopoietic stem cells. This experimental paradigm has accelerated efforts to develop a culture system for spermatogonia similar to that used to such good effect for the analysis of hematopoiesis. This chapter outlines the protocols developed for culture of mouse PGCs and spermatogonia, but which are applicable to the culture of the same cells from a variety of different species including birds and humans.

### 2. Materials

#### 2.1. Buffers and Solutions

1. PBS: Phosphate-buffered saline, without  $\text{Ca}^{2+}$  and  $\text{Mg}^{2+}$ , pH 7.0 (Gibco-BRL, Gaithersburg, MD).
2. HBSS: Hank's balanced salt solution, without  $\text{Ca}^{2+}$  and  $\text{Mg}^{2+}$  (Sigma Chemical Co., St. Louis, MO).

From: *Methods in Molecular Biology, Vol. 137: Developmental Biology Protocols, Vol. III*  
Edited by: R. S. Tuan and C. W. Lo © Humana Press Inc., Totowa, NJ

3. Collagenase solution: 1 mg/mL (Sigma) in HBSS.
4. Trypsin/EDTA for PGCs and gonocytes (undifferentiated spermatogonia): HBSS containing 0.05% trypsin and 0.53 mM EDTA.
5. Trypsin/EDTA for differentiating spermatogonia: HBSS containing 0.25% trypsin and 1 M EDTA.
6. Trypsin inhibitor solution: 0.5 mg/mL soybean trypsin inhibitor (Sigma) and 6.5 mg/mL bovine serum albumin (Sigma) in DMEM/F-12 (Dulbecco's modified Eagle's medium and Nutrient mixture F-12 [Ham] 1:1).
7. Borate buffer 0.2 M pH 8.5: Dissolve 12.4 g boric acid and 4 g NaOH in 900 mL dH<sub>2</sub>O. Add approx 40 mL HCl 0.1 N to reach pH 8.5, and make up to 1 L.
8. Fast Red/naphthol phosphate solution: Make up a 1 mg/mL solution of Fast Red TR salt (Sigma, stored at -20°C) in dH<sub>2</sub>O. Add 40 µL/mL Naphthol AS-MX phosphate (Sigma, stored at 4°C). Both reagents must be very fresh. Use immediately.

## 2.2. Culture Media

1. Basic culture medium for PGCs: DMEM high glucose, supplemented with 15% fetal calf serum (HyClone, Logan, UT), 2 mM glutamine (Gibco-BRL), 5 U/mL penicillin-streptomycin (Gibco-BRL), and 1 mM Na<sup>+</sup> pyruvate (Sigma).
2. Basic culture medium for gonocytes and spermatogonia: (supplemented DMEM/F-12): DMEM and Nutrient mixture F-12 (HAM) 1:1, supplemented with 2 mM glutamine, 15 mM HEPES buffer, 1 mM Na<sup>+</sup> pyruvate, 5 U/mL penicillin-streptomycin, 5 µg/mL insulin and transferrin (Sigma), 200 ng/mL retinol acetate (Sigma), 0.1% BSA (Sigma), and growth factors.
3. Matrigel membrane: Matrigel (Becton Dickinson, Rutherford, NJ) diluted in DMEM/F-12 to 1.4 mg/mL.
4. Growth factors for PGC culture: mSCF (Genzyme, Boston, MA) 10 ng/mL, mLIF (Gibco-BRL) 1000 U/mL, hbFGF (Gibco-BRL) 1 ng/mL.
5. Growth factors for culture of gonocytes (undifferentiated spermatogonia): Forskolin (Sigma) 100 µM, mLIF (Gibco-BRL) 1000 U/mL, mOSM (Sigma) 10 ng/mL.
6. Growth factors for culture of differentiating spermatogonia: Forskolin (Sigma) 100 µM, mSCF (Genzyme) 10 ng/mL, mEGF (Gibco/BRL) 10 ng/mL.

## 2.3. Fixatives

1. 2.5% Formaldehyde in PBS: 6.7 mL of 37% formaldehyde in 100 mL PBS.
2. 4% Paraformaldehyde: 4 g Paraformaldehyde in 100 mL PBS. To dissolve the paraformaldehyde, preheat the PBS at 90°C, and add NaOH until the solution turns completely clear. Let it cool down before use. Make fresh every time.
3. Acid:ethanol: 2 mL acetic acid and 38 mL ethanol precooled at -20°C.

## 3. Methods

### 3.1. PGCs Isolation and Culture

1. Embryo dissection
  - a. 8.5 d post coitum (dpc): Separate each embryo and deciduum cutting the uterus between them, very near to each embryo in order to allow the deciduum to protrude. Put them in a Petri dish with ice-cold PBS. Prick the decidua with a pair of fine (Dumont #5) forceps and the embryo should pop out. Flatten out the embryo and remove the posterior third, including the caudal end of the primitive streak and allantois. The PGCs are localized at the junction of the primitive streak and allantois in the hindgut diverticulum.



- b. 10.5 dpc: Separate each embryo as for 8.5 dpc embryos. Dissect the embryo free of the placenta and amnion and cut it in half, just below the fore limbs. Keep the caudal half of the embryo. The genital ridges lie at about the level of the developing hind limbs. Cut down both sides of the ventral body wall with forceps, following the line of the spine and peel away the ventral body wall. Be careful not to pull out the developing gut because at this age the gonads can be torn out along with it. Separate the gonads, mesonephros, and part of the aorta with forceps, and place them in a tube with PBS on ice. For older embryos, *see Note 1*.
2. Enzymatic digestion and homogenization: Incubate the gonads in the trypsin/EDTA solution for 10 min at 37°C. Remove the trypsin/EDTA solution gently, being careful not to aspirate the gonads. Add 250  $\mu$ L of PGC medium and pipet slowly with a micropipet tip (200  $\mu$ L) until a single-cell suspension is obtained (about 50 strokes).
3. Culture: PGCs are routinely cultured on confluent monolayers of STO cells at 37°C in an atmosphere of 95% air and 5% CO<sub>2</sub>. To prepare feeder layers, coat the plates with 0.1% gelatin for 1 h. Aspirate the gelatin and wash the wells once in PBS. Trypsinize subconfluent plates of STO cells (growing in DMEM plus 10% FCS) to produce a single-cell suspension. Plate them at a density of  $10 \times 10^4$  cells/cm<sup>2</sup>. Allow the STO cells to settle down and attach and the next morning irradiate them (5000 rads) to induce cell cycle arrest. After irradiation, immediately remove the culture medium and refeed the STO cells with PGC medium plus growth factors (*see Subheading 2.*). Plate PGCs on top of the STO feeder layer. We aim to plate approx 100–200 PGCs per well of a 24-well plate, or 50 PGCs per well of a 96-well plate. This is the equivalent of three 8.5 dpc embryos worth of PGCs per well of a 24-well plate, or 75 PGCs/cm<sup>2</sup>. For larger or smaller wells scale the amount of cells plated up or down accordingly. Change the medium every day by gentle aspiration of two-thirds of medium and refeeding with fresh medium.

### **3.2. Spermatogonia Isolation and Culture (Sertoli Cell-Gonocyte Cocultures)**

1. Animal sacrifice: For isolating undifferentiated spermatogonia, sacrifice 1-to-3-d old male mice. Disinfect the bodies by washing them in 70% ethanol. Open the body cavity with forceps and remove the undescended testes by pulling on the epididymis. Put the isolated testes in a Petri dish with HBSS on ice. Decapsulate the testes under cold light such as a fiber optic light source. Complete decapsulation of the testes is important. If decapsulation is incomplete, the resultant cell suspension will contain an increased number of endothelial cell and hematopoietic progenitor cell contaminants. After 7 d of culture these contaminants will dominate the culture.
2. Enzymatic digestion and homogenization: Put the decapsulated testes in a 50-mL plastic tube with the collagenase solution (in a volume of 10 mL) and incubate at 37°C for 15 min, with manual agitation every 5 min (*see Note 2*). Monitor tubule disruption under a phase-contrast microscope (*see Note 3*). Place the tube on ice for 10 min to let the tubule fragments settle by gravity, and then remove the supernatant containing the interstitial cells. Wash the pellet in HBSS, mixing with a 25-mL plastic pipet. Put the tube again on ice for 10 min, aspirate the HBSS to remove the peritubular myoid cells and add 4 mL trypsin/EDTA solution. Incubate at 37°C for 2 min, and then mix with a pipet. Spin at 175g at room temperature (RT) for 5 min, remove the trypsin/EDTA solution out and add the trypsin-inhibitor solution. Resuspend and spin again at RT for 5 min at 175g. Remove the solution and add 1 mL of complete medium (*see Subheading 2.*). To isolate differentiated spermatogonia, *see Note 4*.

3. Culture: Count the viable cells (*see Note 5*) and plate them at a density of  $0.25 \times 10^6$  cells/cm<sup>2</sup> (containing about  $6 \times 10^3$  spermatogonia), which is half a million cells per well in a 24-well plate, in Matrigel-coated plates (*see Note 6*) with culture medium supplemented with growth factors (*see Subheading 2.*). Culture at 37°C in an atmosphere of 95% air and 5% CO<sub>2</sub>. Change the medium every other day by gentle aspiration of two-thirds of medium and refeeding with fresh medium. *See Note 7* for spermatogonial culture on STO feeders.

### 3.3. Monitoring Cell Survival

1. The total cell number in cultures of Sertoli cells and spermatogonia can be determined using a colorimetric assay. Fix the cultures in 2.5% formaldehyde in PBS for 15 min. Wash the plates in 10 mM borate buffer (pH 8.5) for 10 min. Incubate with 0.1% methylene blue in 0.1 M borate buffer (pH 8.5) for 10 min at 24°C. Wash four times in 0.1 M borate buffer and then incubate in 0.1 M HCl at 37°C for 1 h. Specific cell-incorporated methylene blue can be determined by reading the absorbance at 595 nm. Uptake of methylene blue is linearly correlated with the number of viable cells (*9*).
2. Identification of germ cells
  - a. PGC identification: PGCs are routinely identified in culture by alkaline phosphatase histochemistry: Wash the cultures in PBS without Ca<sup>2+</sup> and Mg<sup>2+</sup> (prewarmed at 37°C) and then fix the cultures in 4% paraformaldehyde in PBS for 30 min at RT. Wash the cultures three times in PBS, once in distilled water, and then incubate them in Fast Red/naphthol phosphate solution for 30 min. After staining, wash them again in distilled water; PGCs will be stained red. We recommend counting the cells within a few days of staining, otherwise the cell morphology deteriorates. PGCs can also be identified in culture using monoclonal antibodies such as anti-SSEA-1 (*see ref. 3*). The anti-SSEA-1 monoclonal antibody can be obtained from the Developmental Studies Hybridoma Bank (<http://www.uiowa.edu/~dshbwww/info.html>).
  - b. Identification of spermatogonia: When performing cocultures of Sertoli cells and spermatogonia, the latter can be distinguished from Sertoli cells by morphological criteria. Spermatogonia are usually positioned on top of the Sertoli cell monolayer (sometimes at the same focal plane) but never beneath the Sertoli cells, where contaminating peritubular myoid cells are localized. Spermatogonia are relatively large in size, rounded, or elongated in shape, and have a light nucleus containing one to several dark prominent nucleoli. In addition to these morphological criteria, any of the epitopes common to all germ cell types, i.e., GCNA (*10*), or vasa antigen (*11*) can be used for identification of germ cells, using standard immunocytochemical techniques.

### 3.4. Cell Proliferation

Analysis of cell proliferation can be carried out in all types of cultures by BrdU incubation and anti-BrdU immunocytochemical detection using a cell proliferation kit (Amersham, Arlington Heights, IL), following the manufacturer's instructions. In brief, incubate the cultures with BrdU at 1:1000 dilution in culture medium for 1 h at 37°C. Wash the cultures several times in PBS and then fix them in acid:ethanol for 10 min. Timing is important, because longer fixation will destroy alkaline phosphatase activity. Rehydrate the cultures in PBS and add the anti-BrdU antibody, for 1 h at RT. Then wash in PBS, incubate with the second antibody (peroxidase antimouse IgG) for 30 min, and develop with DAB. Proliferative rates can be obtained by counting labeled vs unlabeled cells. BrdU-labeled PGCs can be identified by double staining for BrdU and alkaline phosphatase. BrdU-labeled spermatogonia can be identified using antibodies to vasa.

#### 4. Notes

1. Dissection of older embryos (11.5 to 13.5 dpc) is carried out in basically the same way as the 10.5 dpc embryos, with the expected increase in embryo size associated with a higher yield of PGCs. The number of PGCs per embryo is approx  $1 \times 10^3$  PGCs/embryo at 10.5 dpc,  $5 \times 10^3$  PGCs/embryo at 11.5 dpc,  $10 \times 10^3$  PGCs/embryo at 12.5 dpc, and  $35 \times 10^3$  PGCs/embryo at 13.5 dpc. There may be some strain variation. We routinely use F1 hybrid strains (e.g., B6C3F1 or B6D2F1) because they have relatively large litter sizes. We do not routinely isolate PGCs from 9.5 dpc embryos because at this stage the developing genital ridges and mesonephros are difficult to isolate. Any possible advantage that might be gained from the greater cell numbers with respect to 8.5 dpc embryos is far outweighed by the difficulty and, therefore, the increased time of dissection.
2. Differences between species: In the case of rat testes, use 1 mg/mL hyaluronidase together with the collagenase solution, and incubate the decapsulated testes in this solution for 30 min at 37°C (for more details, *see ref. 12*).
3. Monitoring tubule disruption during enzymatic digestion: Under a phase-contrast microscope observe the cell suspension after each enzymatic step: after collagenase digestion, tubules should be partially disrupted, devoid of interstitial cells, in such a way that the peritubular myoid cells appear protruding to the outside of the tubules. After the wash in HBSS, tubules must also be lacking peritubular myoid cells, so the isolated cells are mostly Sertoli cells and germ cells.
4. In the case of Sertoli cell-differentiated spermatogonia coculture, sacrifice mice 6-to-8-d old (for prepuberal, up to 20-d old, *see ref. 13*). Take out the testes and decapsulate them in the same way as for newborns. Enzymatic digestion is similar, except that two rounds of collagenase digestion should be performed.
5. Trypan blue exclusion method: to monitor the viability of the cell suspension, mix 10  $\mu$ L cell suspension, 90  $\mu$ L culture medium, and 100  $\mu$ L trypan blue (Sigma), and place this mixture in a hemocytometer. Count exclusively the cells that are viable, that is, which have not acquired the dye.
6. When making Matrigel membrane (Becton Dickinson) all the materials, pipets, and plates should be kept on ice to avoid gelling. Matrigel thickness influences the proliferation/differentiation state of spermatogonia in culture. To maintain spermatogonial proliferation, make a very thin layer of Matrigel (<50  $\mu$ m) by placing the diluted Matrigel in the culture well and aspirating it right away. This causes Sertoli cells to form a monolayer on which spermatogonia will proliferate. To induce spermatogonial differentiation, make a thick Matrigel layer (approx 1.5 mm), adding 200  $\mu$ L undiluted Matrigel/cm<sup>2</sup>. This “thick gel method” allows Sertoli cells to reorganize in cords in which spermatogonia will differentiate into spermatocytes (*14*). To get the Matrigel membrane to gel, place plates at 37°C for 30 min and then wash once with DMEM/F-12.
7. Spermatogonia can also be cultured on STO cell monolayers, in a similar way to PGCs; in this case 10% FBS should be added to the culture medium (for more details, *see ref. 15*).

#### References

1. Dolci, S., Williams, D. E., Ernt, M. K., Resnick, J. L., Brannan, C. I., Lock, L. F., et al. (1991) Requirements for mast cell growth factor for primordial germ cell survival in culture. *Nature* **352**, 809–811.
2. Yoshida, K., Taga Y. K., Saito, M., Suematsu, S., Kumanogoh, A., Tanaka, T., et al. (1996) Targeted disruption of gp130, a common signal transducer for the interleukin 6 family of cytokines, leads to myocardial and hematological disorders. *Proc. Natl. Acad. Sci. USA* **93**, 407–411.

3. Donovan, P. J., Stott, D., Cairns, L. A., Heasman, J., and Wylie, C. C. (1986) Migratory and postmigratory primordial germ cells behave differently in culture. *Cell* **44**, 831–838.
4. Resnick, J. L., Bixler, L. S., Cheng, L., and Donovan, P. J. (1992) Long-term proliferation of primordial germ cells in culture. *Nature* **359**, 550–551.
5. Matsui, Y., Zsebo, K., and Hogan, B. L. (1992) Derivation of pluripotential embryonic stem cells from murine primordial germ cells in culture. *Cell* **70**, 841–847.
6. Shambloott, M. J., Axelman, J., Wang, S., Bugg, E. M., Littlefield, J. W., Donovan, P. J., et al. (1998) Derivation of pluripotential stem cells from cultured primordial germ cells. *Proc. Natl. Acad. Sci. USA* **95**, 13,726–13,731.
7. Brinster, R. L. and Zimmermann, J. W. (1994) Spermatogenesis following male germ-cell transplantation. *Proc. Natl. Acad. Sci. USA* **91**, 11,298–11,302.
8. Jiang, F. X. and Short, R. V. (1995) Male germ cell transplantation in rats: apparent synchronization of spermatogenesis between host and donor seminiferous epithelia. *Int. J. Androl.* **18**, 326–330.
9. Goldman, R. and Bar-Shavit, Z. (1979) Dual effect of normal and stimulated macrophages and their conditioned media on target cell proliferation. *J. Natl. Cancer Inst.* **63**, 1004–1016.
10. Enders, G. C. and May, J. J. (1994) Developmentally regulated expression of a mouse germ cell nuclear antigen examined from embryonic day 11 to adult in male and female mice. *Dev. Biol.* **163**, 331–340.
11. Abe, K. and Noce, T. (1997) A DEAD-family protein gene, *Ddx4*, encoding a murine homolog of *Drosophila vasa* maps to the distal end of mouse chromosome 13. *Mammal. Gen.* **8**, 622–623.
12. Van Dissel-Emiliani, F. M. F., de Rooij, D. G., and Meistrich, M. L. (1989) Isolation of rat gonocytes by velocity sedimentation at unit gravity. *J. Reprod. Fertil.* **86**, 759–766.
13. Bellve, A. R., Cavicchia, J. C., Millette, C. F., O'Brien, D. A., Bhatnagar, Y. M., and Dym, M. (1977) Spermatogenic cells of the prepuberal mouse. *J. Cell Biol.* **74**, 68–85.
14. Hadley, M. A., Byers, S. W., Suarez-Quian, C. A., Kleinman, H. K., and Dym, M. (1985) Extracellular matrix regulates Sertoli cell differentiation, testicular cord formation, and germ cell development *in vitro*. *J. Cell Biol.* **101**, 1511–1522.
15. Nagano, M., Avarbock, M. R., Leonida, E. F., Brinster, C. L. J., and Brinster, R. L. (1998) Culture of mouse spermatogonial stem cells. *Tissue Cell* **30**, 389–397.

## Cadherin-Mediated Cell–Cell Interactions

Karen A. Knudsen and Alejandro Peralta Soler

### 1. Introduction to Cadherins and Catenins

Cadherins constitute a family of transmembrane glycoproteins (**Table 1**) that mediate cell–cell adhesion by their ability to self-associate (**1–4**). For example, E-cadherin binds only to E-cadherin and not to N-cadherin. The homotypic interaction of cadherins is important for the sorting of cells during morphogenesis and for maintaining the normal structure and function of tissues (**5–8**). Cadherins are highly conserved across species and consist of three domains—i.e., an extracellular domain, transmembrane domain, and intracellular domain. The extracellular domain has multiple calcium-binding regions, which are required for cadherin function. The so-called classical cadherins have five extracellular subdomains (EC1–EC5) with the EC1 domain containing the sequences responsible for self-association and cell–cell adhesion. The intracellular domain is highly conserved across the cadherin family and associates with several proteins collectively termed catenins (**9,10**). The catenins mediate linkage of the cadherins to the actin cytoskeleton, a mechanism essential for optimal cadherin activity (**11**).

Beta-catenin, or alternatively  $\gamma$ -catenin (more commonly known as plakoglobin) binds directly to the intracellular carboxy terminal region of the cadherin (**11–13**). In addition to associating with classical cadherins, plakoglobin binds to desmosomal cadherins (**11,14**). Alpha-catenin interacts with the cadherin indirectly by binding to  $\beta$ -catenin or plakoglobin (**11**). It also binds to actin (**15**) and  $\alpha$ -actinin (**16,17**), thereby linking the cadherin to the actin cytoskeleton (**11**). Other proteins associate with the cadherin/catenin complex, including p120<sup>ctn</sup> (a substrate for src), which binds directly to the cytoplasmic domain of cadherins, but does not compete with  $\beta$ -catenin or plakoglobin (**18–21**). In addition, receptor tyrosine kinases, such as the EGF receptor (**22**), and tyrosine phosphatases, such as PTP $\mu$  (**23**) associate with the cadherin/catenin complex. Receptor tyrosine kinases, tyrosine phosphatases, and p120<sup>ctn</sup> appear to regulate the activity of the cadherin, perhaps by modifying the clustering of cadherin/catenin complexes within the plane of the membrane, or by controlling their linkage to the actin cytoskeleton.

Beta-catenin appears to hold a key position in the coordination of morphogenesis and cellular processes such as proliferation and differentiation (**24–27**). Together with

**Table 1**  
**Classical Cadherins and Other Selected Members of the Cadherin Family**

Cadherin	cDNA cloned	Tissue distribution
E-Cadherin (uvomorulin, LCAM)	Human, mouse, chicken, <i>Xenopus, Drosophila</i>	Epithelia, skin, osteoclasts, liver, pancreas, kidney, gonads, placenta brain, sensory neurons
N-Cadherin (ACAM)	Human, mouse, bovine, chicken, <i>Xenopus</i> Zebrafish	Brain, notochord, neural tube, somites, skeletal muscle, myocardium, endothelium, mesothelium, ovary, testes, fibroblasts, chondrocytes, inner ear, eye, kidney, pancreas
P-Cadherin	Human, mouse, bovine	Placenta (mouse), skin, breast (myoepithelial cells), prostate (basal cells)
R-Cadherin (cadherin-4)	Human, mouse, chicken, <i>Xenopus</i>	Eye (retina, pigmented epithelium), brain, skeletal muscle, pancreas, gastrointestinal tract
VE-Cadherin (cadherin-5)	Human, mouse, rat	Vascular endothelium Endothelial macrophages
K-Cadherin (cadherin-6)	Human, mouse	Brain, cerebellum, kidney, gastric mucosa, lung, pancreas
Cadherin-7	Chicken	
Cadherin-8	Human, mouse, rat	Brain
Cadherin-9	Rat	Brain
Cadherin-10	Chicken, rat	Brain
OB-Cadherin (cadherin-11)	Human, mouse	Osteoblasts, somites, skeletal muscle, fibroblasts
Cadherin-12	Human	
T-Cadherin <sup>a</sup> (H-cadherin, cadherin-13)	Human, chicken	Nerve, neural crest cells, retina, heart, aorta somite, skeletal muscle, kidney
Cadherin-14	Human	
M-Cadherin (cadherin-15)	Human, mouse	Developing skeletal muscle, satellite cells, cerebellum
PB-Cadherin	Rat	Pituitary, brain
B-Cadherin	Chicken	Brain, eye, ear, liver, intestine, bladder, kidney, heart, skeletal muscle, skin
EP-Cadherin (C-cadherin)	<i>Xenopus</i>	Oocytes, unfertilized and fertilized egg, blastula, gastrula, muscle, epidermis
F-Cadherin	<i>Xenopus</i>	
XB-Cadherin	<i>Xenopus</i>	Blastula, cement gland, epithelia
Li-Cadherin <sup>a</sup>	Rat	Liver, intestine
Ksp-Cadherin <sup>a</sup>	Rabbit	Kidney
HPT-1 Cadherin <sup>a,b</sup>	Human	Gastrointestinal tract

<sup>a</sup>No interaction with catenins.

<sup>b</sup>Involved in intestinal peptide transport.

p120<sup>ctn</sup> and plakoglobin,  $\beta$ -catenin belongs to the Armadillo (arm) family of proteins (28). Armadillo is the product of the *armadillo* segment polarity gene, essential for normal development of the *Drosophila* embryo (29). Vertebrate  $\beta$ -catenin and *Drosophila* Armadillo are integral parts of the Wnt and Wingless signaling pathways, respectively (26). In vertebrates, secreted Wnt(s) binds to a 7-pass transmembrane receptor, Frizzled(s), causing hyperphosphorylation and activation of Disheveled, which in turn inactivates the serine/threonine kinase, glycogen synthase kinase (GSK)3 $\beta$  (30–32). In the absence of Wnt, GSK3 $\beta$ , acting together with *adenomatous polyposis coli* (APC) protein, an oncogene found mutated in colon cancer, induces phosphorylation of  $\beta$ -catenin and targets it for degradation by the ubiquitin/proteasome pathway (33–36). Conversely, in the presence of Wnt, GSK3 $\beta$  is inactivated resulting in increased cytoplasmic levels of  $\beta$ -catenin and its interaction with members of the HMG family of transcription factors, such as LEF-1 (37,38) and Tcf-3 (39). The  $\beta$ -catenin/transcription factor complex moves to the nucleus where it activates transcription of genes such as *Samois* (40). In short,  $\beta$ -catenin actively participates in multiple cellular processes including cell–cell adhesion, signaling, growth control, and regulation of transcription.

Alpha-catenin ( $\alpha$ (E) and  $\alpha$ (N)) links the cadherin /catenin complex to the actin cytoskeleton (11). It shares homology with the cytoskeleton associated protein vinculin, and like vinculin, interacts directly with both actin and  $\alpha$ -actinin. Loss of function of  $\alpha$ (E)-catenin in mice disrupts the trophoblast epithelium and blocks development at the blastocyst stage (41). Tumor cells missing  $\alpha$ -catenin, (e.g., human PC9 lung carcinoma cells) exhibit reduced cell–cell adhesion and cannot form an epithelium (42). Forced expression of  $\alpha$ -catenin in these cells increased cell–cell adhesion and junctional complexes, decreased cell growth, and restored the cells' ability to form a polarized epithelium (43). The absence of  $\alpha$ -catenin in human tumors correlates with increased tumor aggressiveness (44,45) suggesting a tumor suppressor role for  $\alpha$ -catenin.

Together, cadherins, catenins,  $\alpha$ -actinin, vinculin, and actin, as well as additional proteins, make up a structure called the cell–cell adherens junction (9,46–49). Adherens junctions, along with desmosomes and tight junctions, are prominent in epithelia and are critical to the function of the normal epithelium. E-cadherin-mediated adhesion is essential for normal epithelial cell polarization and the formation of desmosomes, gap junctions, and tight junctions (43,50). Adherens junctions also are found in nonepithelial cells and are probably present in all cells with a functional cadherin adhesion system. N-cadherin is expressed in the intercalated disks between cardiomyocytes (46,51). The N-cadherin-catenin complex mediates the interaction of cardiomyocytes and has a critical role in the electrical coupling and coordinate contraction of myocardial cells by promoting gap formation and organization of the myofibrils (51–53).

In addition to promoting specific cell–cell adhesion and organizing the actin cytoskeleton, cadherin/catenin complexes appear to signal intracellular events that alter cell growth and differentiation (54,55). Both antiproliferative, prodifferentiation, and antiapoptotic signals have been attributed to cadherin-mediated adhesion (54–57). Signals arising from cadherin-mediated adhesion clearly can be modulated or even blocked by signaling from other factors such as cell–matrix adhesion, growth factors, and cytokines (54).

## 2. Methods for the Study of Cadherins and Catenins

### 2.1. Detection of Cadherins and Catenins

The first members of the cadherin family to be discovered were E(epithelial)-cadherin and N(nerve)-cadherin, named after the tissues where they were found prominently expressed. Cadherins originally bore several nomenclatures, including uvomorulin (mouse E-cadherin), cellCAM120/80 (human E-cadherin), LCAM (chicken E-cadherin) and ACAM (chicken N-cadherin). Initially cadherins were identified through the generation and use of specific antibodies, particularly those that inhibited the calcium-dependent aggregation of cells (58). Antibodies are used widely for immunofluorescence light microscopy to localize cadherins in cells, for immunoblot analysis to determine protein levels, and for immunoprecipitation and affinity chromatography to isolate and purify cadherins and their associated proteins. Many additional members of the cadherin family were discovered subsequently by other methods, such as screening cDNA libraries under low-stringency conditions, or employing RT-PCR using primers selected from regions of high-sequence homology among cadherins (59). It is highly likely that not all cadherin family members have been discovered yet. The catenins were discovered because they coimmunoprecipitated with the cadherins (60). It was found early that the same catenins associated with different cadherins (61) and that their presence is required for optimal cadherin-mediated cell adhesion (62).

#### 2.1.1. Immunofluorescence and Immunohistochemistry

Although, microscopic observation cannot provide direct evidence of the activity of cadherin-mediated cell–cell adhesion, a qualitative assessment of the presence of cadherin-mediated adhesion can be made in cultured cells and in tissues by light microscopic observation. Cultured epithelial cells with a fully functional E-cadherin/catenin adhesion system form a cobblestone pattern with cells tightly adherent to one another by long stretches of contact between their plasma membranes (16,63). On the other hand, fibroblasts and muscle cells expressing the N-cadherin/catenin complex, contact one another through many finger-like projections (16). The expression of cadherins and catenins can be determined using specific antibodies from commercial sources (Table 2) or as gifts from individual laboratories. In most cases, the antibodies can be used for immunofluorescence light microscopy, immunohistochemistry on frozen tissue sections, and Western immunoblot analysis. A more limited number of available antibodies recognize their antigens in formalin-fixed, paraffin-embedded tissue sections (Table 2).

*Immunofluorescence light microscopy* (IF) is very useful for studying the expression and distribution of cadherins and catenins in cultured cells (see also **Subheading 5.**). Cadherins are usually found at the cell surface and are prominent at regions of cell–cell contact. When catenins are bound to cadherins, they also appear at the cell surface, in areas of cell–cell contact. In fact, the presence of  $\beta$ -catenin at cell–cell contact sites can indicate the presence of a cadherin even if its identity is unknown (53). Catenins also can be found in the cytoplasm and sometimes in the nucleus, particularly if APC is nonfunctional or the cells are responding to Wnt-mediated signaling (64).

For IF, cells can be cultured on glass cover slips, glass or plastic chambered slides, or plastic culture dishes. In general, best results are obtained with cells cultured on



glass cover slips. Plastics can give background fluorescence. Certain cells may require that fibronectin (40  $\mu\text{g}/\text{mL}$ ) be applied to the glass to promote cell–matrix attachment. If fibronectin is allowed to dry on the cover slip, it should be dissolved in water to prevent salt deposition.

The best fixation method has to be determined empirically for each antigen and antibody. In general, ice cold methanol is excellent for retaining the antigenic determinants of cadherins and catenins at the plasma membrane (54), although a fixative such as Histochoice (Amresco, Solon, OH) can also be used (16). Methanol both fixes and permeabilizes cells, which is necessary for antibody access to the intracellular catenins. If paraformaldehyde is used as a fixative, the cells should be permeabilized with a detergent either before or after fixation. Detergent applied to cells before fixing them can lead to the loss of cadherin and catenins not bound to the actin cytoskeleton. This may be desirable in some cases because the staining may reflect only optimally functional or detergent-insoluble cadherin.

Catenins can be seen in the cytoplasm and associated with the plasma membrane, and  $\beta$ -catenin can be present in the nucleus. Methanol fixation, which is excellent for preserving cadherin and catenin staining at the membrane is not the fixative of choice for detecting nuclear proteins. Rather, a fixation with paraformaldehyde followed by detergent permeabilization is required. In most cases, fixed cells can be stored in PBS with 0.02% azide, at 4°C, for weeks prior to staining.

Standard IF methods are used. Nonspecific binding of first and/or second antibodies is prevented by incubating the cells with a blocking agent, such as a buffer containing nonimmune serum from the same species as the secondary antibody (e.g., 10% normal goat serum in PBS). Primary and secondary antibodies should be diluted in the blocking buffer. The primary antibody is then applied to the cells for 1–2 h at room temperature or overnight at 4°C in a humid chamber. The best antibody concentration should be determined empirically. As a general rule, a starting concentration of primary antibody for IF is 10 times that used for immunoblot analysis, unless otherwise specified. Excess primary antibody can be difficult to wash from the cells or sections, or can exhibit nonspecific binding, so its concentration, like that of the secondary antibody, should be the lowest necessary for detecting the specific antigen.

After thoroughly washing away the primary antibody, a commercially available secondary fluorescence-tagged, species-specific antibody is applied (e.g., CY3-conjugated goat antimouse IgG). The vendor will recommend an effective working concentration, but this should be confirmed empirically. Both primary and secondary antibodies should be diluted into the blocking buffer to reduce nonspecific binding. In addition, centrifugation of the antibodies prior to their use is recommended to avoid micro-precipitates that can form a “starry night” background.

When staining cells with a single primary antibody, a CY3-conjugated secondary antibody is recommended because CY3 bleaches less quickly than fluorescein and provides a strong signal that can be easily photographed. Double labeling can be performed with two primary antibodies of different species (e.g., mouse anti-N-cadherin and rabbit anti- $\beta$ -catenin), or different antibody isotypes, followed by species- or isotype-specific secondary antibodies conjugated to different fluorochromes, such as rhodamine (or CY3) and fluorescein (56). Secondary antibodies should be thoroughly washed away. If the cells were grown on a cover slip, it is mounted with mounting

**Table 2**  
**Commercially Available Antibodies to Cadherins and Catenins**

Protein	Vendor	Ab name	Pab	Mab	IF	WB	IP	IHC	FP	Species	Comments	
E-Cadherin	Transduction Labs	C37020		M	+	+		+		H, D, R		
		C20820		M	+	+		<sup>a</sup>		H, D, R, M	Crosses weakly to P-cad	
	Zymed	HECD-1		M	+	+			<sup>a</sup>	+	H	
		SHE78-7		M		+				+	H	
		ECCD-1		R						+	M	
		ECCD-2		R	+	+	+				M	
	Sigma	Santa Cruz Biotechnology	DECMA-1		R	+	+		+	+	H, B, D, M	
			SC-1500	G		+	+				H, M, R	Blocking peptide available
Chemicon	MAB1996		M	+			+		H, Rab			
N-Cadherin	Zymed	NCD2		R	+	+	+		+	Ch, X		
	Sigma	FA5		M	+			+	+	Ch		
		GC4		M	+	+		+	+	+	Ch, H, Rab, R	
		7.2.3		M	+	+		+			Ch	
	Santa Cruz	SC-1502	G		+	+				H, M, R	Reacts with R-cad	
P-Cadherin	Zymed	PCD-1		R	+	+			+	M (weak to R)		
		NCC-CAD-299		M	+	+	+	+	+	H		
	Transduction Labs	C24120		M	+	+	+	<sup>a</sup>		H, M		
	Santa Cruz	SC-1501	G		+	+				H, M, R	Blocking peptide available	
VE-Cadherin	Transduction Labs	C26120		M	+	+				H		
	Chemicon	MAB1989		M	+	+	+	+		H		
R-Cadherin	Transduction Labs	C38020		M		+				R		
M-Cadherin	Santa Cruz	SC-69	Rab		+	+				H, M, R	Blocking peptide available	
K-Cadherin	Transduction Labs	C42720		M	+	+				H, M, R		
	Santa Cruz	SC-1530	G		+	+				H, M, R	Blocking peptide available	
Pan-Cadherin	Sigma	C3678	Rab		+	+		<sup>a</sup>		Many species	Made to Ch N-cad	
		CH-19		M	+			<sup>a</sup>		Many species	Made to Ch N-cad	
	Santa Cruz	SC-1499	G							H, M, R	Made to H P-cad	

$\alpha$ -Catenin	Zymed	$\alpha$ -Catenin	Rab		+	+		H, M, X	Antigen-affinity purified	
	Zymed	$\alpha$ -cat-7A4	M	+	+	+	<sup>a</sup>	H, M, R, Ch, X	To C-terminus	
$\alpha$ (N)	Sigma	C2081	G		+	+	<sup>a</sup>	H, M, R	Blocking peptide available	
$\alpha$ (E)	Santa Cruz	SC-1498	G		+	+		H, M, R	Blocking peptide available	
		SC-1495			+	+	<sup>a</sup>	H, M, R		
$\beta$ -Catenin	Zymed	CAT-5H10	Rab	M	+	+	+	<sup>a</sup>	H, M, R, Ch	
		C2206		M	+	+			H, R, M, D, Ch	To C-terminus
	Sigma	15B8	M	+	+	+		H, R, M, D, Ch		
	Santa Cruz	6F9	M	+	+	+		H, D, B, Ch		
Plakoglobin	American Research Products	SC-1496	G			+	+	<sup>a</sup>	H, M, R	Blocking peptide available
		PG5.1		M	+	+			H, R, M, B, Ch	
		PG-11E4		M	+	+	+		H, M, R	
		15F11		M	+	+		+	H, D, B	
		SC-1497		G			+	+	<sup>a</sup>	H, M, R
Z01	Chemicon	MAB1520	Rab	R	+	+		+	M, R, B, P, D	
	Zymed	Z01		R	+	+		<sup>a</sup>	H, M, R, GP, D	
	DSHB <sup>b</sup>	R26.4C		R		+			R, M, D, P	
P120 <sup>CAS</sup>	Transduction Labs	P17920	M	M	+	+	+		H, M, R, D, Ch	Recognizes multiple isoforms
	Upstate Biotechnology	2B12		M		+	+		H, M, R, D, Ch	

<sup>a</sup>Immunohistochemistry is possible on paraffin sections with antigen recovery.

<sup>b</sup>Developmental Studies Hybridoma Bank.

Key: H = human, M = mouse, R = rat, Ch = chicken, B = bovine, X = *Xenopus*, D = dog, P = pig, GP = guinea pig, G = Goat, IF = immunofluorescence, WB = Western blot, IP = immunoprecipitating, IHC = immunohistochemistry, IHC\* = paraffin sections with antigen recovery, FP = function perturbing.

medium on a glass slide, cell-side down. If the cells were grown on a regular slide, in welled or chambered slide, or in a culture dish, a cover slip is mounted on top of the stained cells.

Inclusion of an antibleaching agent (e.g., 0.4% n-propyl gallate or 0.12% p-phenylene diamine) in the mounting medium is recommended when using FITC-labeled second antibodies. However, p-phenylene diamine can give a background in the wavelength used for CY3 or rhodamine and should be omitted when using these fluorescent probes. Some commercial mounting media contain Hoeschst or DAPI stain for simultaneous nuclear labeling that can help in visualizing cells. A conventional or confocal fluorescence microscope equipped with the appropriate set of filters is necessary for visualizing the fluorescent stains. Because the fluorescence signal fades with light activation, the cells should be examined as briefly as possible before being photographed using high-speed Polaroid or 35 mm film. The slides can be sealed with nail polish and stored in the refrigerator in the dark for some weeks, but for the best results photography should be done as soon as possible, preferably on the same day as the staining was performed.

*Immunohistochemistry* can be used to examine the expression and distribution of cadherins and catenins in tissues, both normal and diseased (65) (see also **Subheading 5**). Cadherins and catenins are important morphoregulators during embryogenesis. They also have been used as tumor markers. The presence of a particular cadherin(s) has been used to identify the cellular origin of a tumor (66,67). Reduction, loss, or aberrant cellular distribution of cadherins and catenins have been shown to correlate with increased tumor aggressiveness (68,69) and poor patient prognosis (70,71).

When using mouse monoclonal antibodies to analyze cadherins and catenins in rat or mouse tissues, background staining can arise owing to the antimouse IgG second antibody recognizing endogenous immunoglobulins. In rat tissues this can be reduced by using a second antibody that has been absorbed to remove antirat IgG antibodies. In mouse tissues, background can be reduced by removing (e.g., tissue perfusion) or blocking endogenous IgG, using commercially available systems (e.g., HistoMouse™ SP Kit, Zymed, South San Francisco, CA).

Cadherin and catenin antibodies that recognize their antigens in cells fixed and stained as described above for immunofluorescence light microscopy also will recognize the antigens in frozen tissue sections (72). However, only a limited number of cadherin and catenin antibodies can be used for immunohistochemistry of formalin-fixed, paraffin-embedded tissues (see **Table 2**). Formalin-fixed and routinely processed tissues provide good histological detail for morphological analysis. However, in studying the expression and distribution of cadherins and catenins in routinely processed human tissues, variables in fixation (time prior to fixation, fixation time and temperature, sample size, etc.) may result in false negative or inconsistent immunohistochemical staining. Therefore, methods for the retrieval of antigenic determinants may be necessary for the detection of cadherins and catenins in human tissues. Although the mechanisms by which antigen retrieval methods work are not fully understood, heat-induced methods have been used successfully to unmask antigenic determinants in human and mouse tissues. The methods include microwave, steam, pressure cooking, and autoclave heating. Ideal temperature, time of heating, buffer composition, pH, molarity, and ion concentration should be considered for each antigen (73). Heat-induced

antigen retrieval methods have been used successfully to detect cadherins and catenins in routinely processed paraffin-embedded tissues. The most consistent of these methods include heat-induced epitope unmasking using a citrate buffer and steam in a vegetable steamer (66,67,74), a pressure cooker (Peralta Soler, unpublished observations), or microwave (65). In contrast, enzyme-based methods are not recommended for detection of cadherins and catenins in paraffin-embedded tissue sections, because of high background and the high frequency of false positive or negative stainings.

Immunohistochemistry of cadherins and catenins in cytology specimens is particularly difficult. We and others have used cytopspin preparations for the detection of N-cadherin in pleural fluid (75,76) from patients with pleural mesothelioma, a type of tumor known to express N-cadherin, with limited success, owing to high background and inconsistent results. As an alternative, cytology specimens, can be centrifuged, fixed as a tissue, and embedded in paraffin, as a “cell block,” a method commonly used for diagnostic evaluation of cells. We found that this procedure produces more reliable stainings of cadherins and catenins, when used with antigen retrieval protocols described above (66).

*Controls*, both positive and negative, are critical and should be included in every IF and immunohistochemistry protocol. A negative control with no primary antibody is important to detect nonspecific staining by the secondary antibody. When available, absorption of the primary antibody with the antigen can help in determining the specificity of the primary antibody. In addition, the use of different primary antibodies directed against different epitopes on the protein of interest will add confidence in the staining. The use of tissues or cells known to express the antigen are recommended as positive controls. A similar expression to that observed in the positive control adds evidence of the specificity of the reaction. However, tissues or cells chosen as positive controls usually have abundant antigen that can be easily detected even when using antibodies at a low concentration or low-affinity antibodies. Therefore, a negative reaction in the tissues or cells of interest cannot rule out the presence of low levels of the antigen, or antigens altered by mutation or fixation procedures. For example, a normal columnar epithelium can be used as a positive control when studying the expression of E-cadherin in tumors. However, because E-cadherin expression is so high and the protein characteristically distributed in normal adult epithelial cells, it can be easily detected, even with low-affinity antibodies or in tissues subjected to long fixation. In contrast, tumors or other cells or tissues may have limited E-cadherin expression, a diffuse cytoplasmic E-cadherin distribution, or a E-cadherin that is more labile to fixation. Another example is the use of heart tissue as a positive control when studying the expression of N-cadherin in tumors. In the adult myocardium, N-cadherin is easily detectable when using antigen retrieval methods; it is located in the highly stable junctions of the intercalated discs, even in samples obtained from human autopsies that have been subjected to unpredictable fixation protocols (Peralta Soler and Knudsen unpublished observations). In contrast, the detection of N-cadherin may be more difficult in formalin-fixed, paraffin embedded tumors expressing N-cadherin, such as pleural mesotheliomas (66) and some ovarian carcinomas (67), although frozen sections have clearly shown N-cadherin expression in these tumors (72). Therefore, in some cases, the same antibody used in the normal positive control may be inadequate for the detection of the antigen in the samples of interest, and produce false negative results.

### 2.1.2. Electron Microscopy and Immunoelectron Microscopy

Cadherins and catenins, along with the actin cytoskeleton and its associated proteins such as  $\alpha$ -actinin and vinculin (77), are the major components of the cell–cell adherens junction (AJ). The AJ is a specialized region of the membrane where the plasma membrane of adjacent cells lies in close contact. By electron microscopy the cell–cell AJ is seen as a region of close cell–cell apposition with parallel plasma membranes and intracellular densities into which actin filaments insert. Although AJs are most prominent in epithelia and the myocardium, recognizable AJs are also found between other cell types, such as fibroblasts. Morphometric analysis of electron micrographs can be used to quantify the extent of junctions between cells. In this way, function perturbing antibodies to cadherins have been shown to decrease cell–cell junctions between sarcoma cells (78), lens cells (79), and cardiomyocytes (51).

The detection of cadherins and catenins at the ultrastructural level is useful for the study of subcellular distribution and the interaction of the cadherin/catenin complex with cell structures, such as membrane junctions. Double immunoelectron microscopy (IEM) using two or more primary antibodies from different species and colloidal gold probes of different size can provide evidence of interactions between cadherins and catenins themselves, colocalization, or differential subcellular distribution (80). Two basic methods can be used for IEM of cadherins and catenins: preembedding IEM and postembedding IEM.

*Preembedding IEM:* This method is used mostly for detecting extracellular antigenic sites (80), although permeabilization of membranes can be applied for detecting intracytoplasmic epitopes (81–84). The cells or tissues are fixed with a fixative known to preserve the antigenic sites as for immunohistochemistry. For example 4% paraformaldehyde for 2 h at 4°C (84) or periodate-lysine paraformaldehyde (85), for 30 min at room temperature (Peralta Soler, unpublished observations). The fixatives should be of EM purity. The buffers recommended are those used for conventional EM (e.g., 0.1 M sodium phosphate or sodium cacodylate buffers at pH 7.4; see ref. 86 for a review of EM methods). After fixation, the cells or tissues are washed extensively in the same buffer. Permeabilization of the membranes can be obtained with 0.05%–0.1% saponin or Triton X-100, taking special consideration to time, temperature and concentration of the detergent (see [87,88] for fixation and permeabilization protocols for IEM). For tissues, cryostat sections of 15  $\mu$ m in thickness can be obtained for improving the access of the primary antibodies and electron-dense probes to the sites of interest. Cells grown on culture inserts (e.g., Falcon polycarbonate filters) can be fixed and permeabilized *in situ*. Subsequently, the cell-containing-filter can be cut in small pieces and incubated with the antibodies and electron-dense probes. Cells grown in dishes can be gently scraped and centrifuged. A loose cell pellet can be used for incubations with the antibodies and the probes. The cells or tissue slices are then incubated with the primary antibody. After extensive washings, the antibody can be detected using electron-dense markers, such as horseradish peroxidase (87), or colloidal gold probes tagged with secondary antibodies or protein A or G (88). Colloidal gold probes are more commonly used today, because they can be quantified, and are easy to distinguish from cellular structures (88). Colloidal gold probes can be manufactured and labeled in the lab (80,88), or obtained from commercial sources. The choice of source, colloidal gold

size, and working concentrations of the complexes are very important considerations for a successful IEM study. Small colloidal gold probes (nanogold) have the advantage of easy penetration through permeabilized plasma membranes. However, the small colloidal gold requires silver intensification for detection, it may cluster spontaneously producing a false clustered distribution of the antigen, and excess unbound gold is more difficult to remove than larger colloidal gold (88). Large colloidal gold probes (20–40 nm in diameter) have the advantage of easy identification for quantitative studies. However, they penetrate cell membranes with difficulty and are less sensitive for the detection of antigens. After extensive washings, the cells or tissues are fixed in glutaraldehyde, and processed for routine transmission electron microscopy (86) or for freeze fracture techniques (89).

*Postembedding IEM:* This method, particularly useful for detecting subcellular distribution of intracytoplasmic antigens, requires the embedding of the samples and ultrathin sectioning prior to the application of the IEM protocol. Postembedding IEM is technically difficult and requires highly trained personnel. Samples are embedded in media for ultrathin cryosectioning or in hydrophilic resins, such as LRWhite or Lowicryl (88). When using hydrophilic resins, fixation protocols are similar to those described for preembedding IEM, prior to incubation with the primary antibody. In general, osmium tetroxide is not used, because it produces severe alterations of antigenic sites. Thus, a disadvantage of postembedding IEM methods is the relatively poor preservation of some cellular structures, particularly lipid-rich membranes. After fixation, the samples are dehydrated and embedded in the resin. Each type of resin requires specific polymerization protocols. For example, LRWhite resins are polymerized in gelatin capsules at 50°C, whereas Lowicryl resins are polymerized with ultraviolet (UV) light in a freezer (88). Ultrathin sections, usually mounted on nickel grids, are incubated with the primary antibodies and subsequently with the electron-dense probes. Similar considerations as those described above apply to the choice of the electron-dense probes (88). However, colloidal gold of larger size than those used in preembedding IEM can be applied, since ultrathin sections of cells or tissues are exposed to the secondary antibody-labeled gold. Postembedding IEM methods have been used for the subcellular localization of cadherins and catenins (83,90,91).

## 2.2. Western Immunoblot Analysis

The first step in Western immunoblot analysis is protein extraction. Cadherins are transmembrane proteins and therefore have to be extracted from cells or tissues with detergent, using either a nonionic detergent such as NP40 (0.5–1%), or an ionic detergent such as SDS (e.g., Laemmli sample buffer) (16,92,93). Cadherin that is insoluble in NP40 or Triton X-100 (Sigma Chemical Co., St. Louis, MO) but can be solubilized with 2% SDS is considered to reflect cadherin tightly anchored to the actin cytoskeleton. In some systems, useful information can be gathered by examining both NP40/Triton-soluble and -insoluble cadherin pools. Catenins bound to cadherins are extracted with detergent in the same manner as the cadherins. However, noncadherin-bound catenins (i.e., cytoplasmic) can be released by rupturing the cells in the absence of detergent. This can be accomplished by vigorously homogenizing the cells in a hypotonic buffer until the cells are broken apart (16). It should be noted that the salt concentration can affect both specific and nonspecific protein–protein interactions.

Proteolysis of cadherins and catenins is not of great concern if cells or tissues are extracted quickly with hot 2% SDS or Laemmli sample buffer. However, when extracting cells or tissue with nonionic detergents, protease inhibitors and EDTA should be included. Although calcium protects cadherins from proteolytic attack, its presence may enhance  $\beta$ -catenin degradation. Therefore, at a minimum, inclusion of EDTA (1–2 mM) and PMSF (2 mM) in the extraction buffer are needed to prevent degradation of cadherins and catenins.

Cadherins have molecular weights in the range from 115 to 145 kD, whereas the catenins have molecular weights in the range of 80–120 kD. Therefore, an 8–9% acrylamide gel will serve well for resolving these proteins. Standard SDS-PAGE protocols are used, including addition of a fresh reducing agent to the cell or tissue extract. When comparing cadherin or catenin levels, equal protein amounts should be applied to the lanes of the gel. Following electrophoresis, the proteins are transferred to nitrocellulose, or an alternative membrane, using standard conditions for immunoblot analysis. The use of commercially available prestained molecular weight standards can help in assessing the completeness of protein transfer.

To begin the immunoblotting procedure, the protein-bearing nitrocellulose (or alternative membrane) is “blocked” with BSA (3%) or milk solid proteins to prevent non-specific binding of primary and secondary antibodies. One hour at room temperature is sufficient for blocking; however, the nitrocellulose also can be stored in blocking buffer at 4°C for much longer periods particularly if azide (0.02%) is added to prevent bacterial growth. The antigen-specific first antibody is diluted into blocking buffer and allowed to react (shaking) with the membrane-bound proteins for 1–3 h at room temperature. Overnight incubation is not recommended as it can increase background staining. The vendor (or investigator in the case of a gift antibody) will recommend a concentration at which to use the antibody, but this also should be determined empirically. After thoroughly washing away nonbound first antibody, enzyme conjugated, species and isotype specific second antibody (e.g., alkaline phosphatase goat antimouse IgG) diluted in the blocking buffer is added for 45–60 min at room temperature. Subsequently, nonbound second antibody is thoroughly washed away and the appropriate detection reagent(s) for ECL or dye detection is added.

In general, standard methods for immunoblotting are used. However, one consideration to keep in mind is that both primary and secondary antibodies may exhibit some nonspecific background staining. This often can be minimized by reducing the concentration of first and/or second antibody until only the antigen is detected. A “no first antibody” control always should be included to reveal any nonspecific binding of the second antibody. In addition, if a polyclonal antibody generated to synthetic peptide is used and the peptide is available, it should be used as a competitive inhibitor to ensure antibody specificity.

### **3. Analysis of the Cadherin/Catenin Complex and Functional Assay of Cadherin-Mediated Cell–Cell Adhesion**

#### **3.1. Immunoprecipitation**

The catenins were discovered because they associated with the cadherins during cadherin immunoprecipitation (IP). Initially, immunoprecipitates from metabolically radiolabeled cells were analyzed (61). The number of immunoprecipitated bands



detected after polyacrylamide gel electrophoresis and autoradiography can vary with the cell type, the methods used to extract the cells, the conditions of the immunoprecipitation, and the stringency with which the immunoprecipitate is washed. A band with molecular weight corresponding to  $\beta$ -catenin (95 kDa) is always observed unless the cells are missing  $\beta$ -catenin, but the presence and level of bands corresponding to  $\gamma$ -catenin (83 kDa) and  $\alpha$ -catenin (102 kDa) is more variable. As well, additional bands can be observed. These may represent novel proteins or can be cadherin/catenin breakdown products. As specific antibodies to cadherins and catenins have become available, immunoprecipitates are now analyzed frequently by immunoblotting (i.e., IP/blot) (16,92).

The first step of the IP or IP/blot is extraction of the protein from tissue or cells (see **Subheading 2.2.** on immunoblotting). If the goal is to identify proteins that associate with cadherins (or catenins), it is important to extract the protein to be immunoprecipitated under conditions that will not disrupt protein–protein interactions within the complex. Because detergent is required to extract cadherins, protein–protein interactions involving hydrophobic interactions will be broken and proteins bound to the complex through such interactions lost. The concentration of salt in the extraction buffer can affect protein interactions. In addition, the state of the cells—confluent, subconfluent, recently fed or serum starved—may affect the composition of the complex. Therefore, it is important to establish the precise experimental conditions for extracting and maintaining the protein complex of interest.

There are several considerations to keep in mind when performing immunoprecipitations. Perhaps the most important element is the antibody. For best results, the antibody should be the most specific, highest affinity antibody available. If a polyclonal antibody is used, it ideally should be affinity purified using the antigen. To immunoprecipitate the majority of the antigen, the antibody should be in slight excess over antigen. It will likely be necessary to estimate how much antigen is in the cell or tissue extract by knowing the total protein concentration and guessing what percent of the total protein represents the antigen. Antibody and extract are mixed 1–2 h at 4°C in the presence of protease inhibitors. Antibody/antigen interactions are high affinity and go to completion in about 40 min, so excessive incubation is not recommended as it only encourages protease attack on the proteins of interest. After the antibody/antigen complex has formed, it has to be “captured.” Protein A or protein G Sepharose (or a mix of A/G), or species-specific antibodies conjugated to Sepharose or Agarose are commonly used and should be added in an amount needed to capture all the antibody. The specification sheet from the vendor will give the theoretical antibody binding capacity of the resin. Because the resin will capture both free and antigen-bound antibody and both will be eluted for immunoblot analysis, vast excess antibody over antigen may cause problems for subsequent immunoblotting, particularly if antibodies from the same species are used for both immunoprecipitation and immunoblotting. In addition, excess antibody may hinder loading enough total protein to detect the antigen.

Controls are important for immunoprecipitations and IP/blots because proteins, including primary and secondary antibodies, can stick nonspecifically to resins and proteins bound to them. To reduce proteins that bind nonspecifically to the resin, the extract can first be exposed to the resin in the absence of the immunoprecipitating antibody (93). Negative controls for immunoprecipitation should include no-first anti-

body and a nonrelevant or nonimmune antibody. When feasible, it is advisable to include as a positive control an antibody that is known to precipitate an identifiable antigen known to be present in the extract. After the antibody/antigen complex has been captured, it has to be washed thoroughly to remove nonspecifically bound proteins before being eluted for analysis. The washing step should be given some careful consideration. Low-stringency conditions (e.g., less than 150 mM salt and 0.5% NP40) may be desired to retain proteins weakly bound to the immunoprecipitated protein but carries the risk that nonspecifically bound proteins may not be washed away. High-stringency washing conditions (e.g., 150 mM or higher salt, 1% NP40 or Triton X-100, 0.5% sodium deoxycholate, and 0.1% SDS) will wash away nonspecifically bound proteins but may also release proteins that bind with low affinity to the immunoprecipitated protein.

The washed immunoprecipitate can be eluted efficiently with hot Laemmli sample buffer (1–2X), collected and stored in the freezer, or resolved immediately by SDS-PAGE. In the case of metabolically radiolabeled cells, the gel is dried and exposed to X-ray film for the time necessary to detect bands. For immunoblotting, the proteins are transblotted electrophoretically to nitrocellulose (or an alternative membrane) and blotted with antibodies to detect both the immunoprecipitated antigen and the coimmunoprecipitating protein(s). Immunoblotting with the same antibody used for the immunoprecipitation will confirm that the immunoprecipitation was successful. (Note that this approach, i.e., IP/blot, where the same antibody is used for both IP and blot analysis can be used to detect low-abundance proteins not detected by straight immunoblot analysis.) For IP/blots it is important to remember that the immunoprecipitate contains IgG that, when reduced, will migrate as heavy (approx 50 kDa) and light (approx 25 kDa) chains. These may be detected by the second antibody. To reduce this problem, when possible use different species antibodies for the IP and blot and a highly species-specific second antibody. Another way to reduce the problem is to covalently conjugate the immunoprecipitating antibody to Sepharose (16). If the proteins of interest migrate at the same molecular weights as the heavy or light chain, it may be possible to run a nonreduced gel in which case the IgG will travel at 150 kDa.

Although antibodies to the major cadherins and catenins are commercially available, antibodies to less well-characterized cadherins are either not available or available only as gifts. For studying these cadherins, or for studying transcription of any cadherin or catenin, Northern blot or RT-PCR analysis of mRNA prepared from cells or tissue can be employed (94,95). In addition, *in situ* hybridization can be performed to examine mRNA levels, as has been accomplished for a number of cadherins (95–97).

### 3.2. Cell Aggregation Assays

A quantitative assessment of cadherin-mediated adhesion can be determined by aggregating cells in suspension in the presence and absence of calcium (98) (see also **Subheading 5. Specific Protocols**). To place cells in suspension, EDTA or trypsin/EDTA are used most commonly. However, in the absence of calcium the cadherins are susceptible to proteolysis by the trypsin. To protect the cadherin, calcium (1–2.5 mM) can be added to the cells 5–15 min prior to exposing them to trypsin. This renders the cadherin more resistant to degradation, presumably owing to calcium-dependent conformational changes. This feature, plus the requirement of calcium for cell–cell adhe-

sion, are hallmark characteristics of cadherins, and together they are used to demonstrate the presence of a functional cadherin adhesion system (**99–101**). When treated with trypsin/EDTA (TE), cells with a cadherin system would be expected to exhibit reduced or no cell–cell adhesion in either the absence or presence of calcium, at least in a short-term assay (i.e., <60 min). Eventually, the cells will replace the cadherin on their surface. In contrast, cells treated with trypsin in the presence of calcium (TC) would be expected to exhibit strong cell–cell adhesion, but only in the presence of calcium, not in its absence.

When assessing cell–cell adhesion using an aggregation assay, the goal is to measure how well the cells form aggregates in a given period of time. The methods used to achieve this goal are as diverse as the individuals who perform them. However, some basic conditions should be met. First, it is necessary to start with a single-cell population, or as close to one as possible. Although some cell types can be harvested and dispersed into single cells with EDTA alone or with trypsin/Ca<sup>++</sup>, others may require trypsin/EDTA treatment to achieve a single-cell population. Of course, this treatment will remove cadherin from the cell surface, but the cells will replace the cadherin on their surface. This may occur during the aggregation assay. Alternatively, a recovery period may be necessary.

Several variables are important for the aggregation assay. Both the time of mixing and cell concentration will affect the number of cell contacts made and will influence the extent of aggregation. In addition, the vigorousness of the mixing will affect the extent of aggregation and the aggregate size, as will any pipeting done at the end of the mixing. Of course, the presence of calcium will affect aggregation. If the cells possess a calcium-independent adhesion system, such as NCAM, they will aggregate to a certain degree even in the absence of calcium (**102**). However, if a functional cadherin system is present the cells will aggregate to a much larger extent in the presence of calcium (**103**). Thus, the assay should be conducted in both the presence and absence of calcium. The temperature should be 37°C, and glucose should be provided in longer duration assays (e.g., >60 min) because cadherin-mediated adhesion has been shown to be temperature sensitive and energy dependent (**98,104**).

The extent of aggregation can be quantified by determining the loss of single cells, using a particle counter such as a Coulter counter, or by counting single and aggregated cells using a light microscope. Although use of a Coulter counter may be less subjective, microscopic observation has the advantage that the cells' healthiness and viability can be confirmed. In the case of microscopic scoring, the person scoring the assay should be blinded to the experimental design if possible, and/or two persons should score the assay. In addition, the definition of an aggregate, e.g., a cluster containing three or more cells, should be established ahead of time.

Less quantitative assays can give a researcher a quick look at the functional activity of a cadherin adhesion system in cells. For example, cells in a buffer (or medium) with/without calcium can be centrifuged to the bottom of a test tube to force cell–cell contact and then incubated for some length of time (e.g., 1–2 h). Alternatively, the cells can be forced into contact by suspending them in hanging drops of medium (**54**). After being held in close contact, the cells are resuspended by pipeting and examined microscopically for the presence and size of aggregates. The cells can be photographed to record the results if counting is difficult. It may be possible to quantify the assay by

scoring, for example, the number and/or size of aggregates, comparing treatment groups. Because the vigor and amount of pipeting can affect the aggregate number and size, this manipulation must be done consistently between treatment groups.

## **4. Functional Manipulation of Cadherins and Catenins**

### **4.1. Calcium Depletion and Antibody Perturbation**

Because cadherins are transmembrane proteins and the extracellular domains promote cell–cell adhesion, it is possible to perturb cadherin function by adding extracellular antagonists. One potent, but not necessarily specific, way to block cadherin function *in vitro* is to reduce the extracellular calcium level in the medium (e.g., <0.2 mM). This has striking effects on cell–cell adhesion and cellular processes dependent on cadherin-mediated adhesion in cells such as skeletal myoblasts (98), epithelial cells (105), and keratinocytes (63,106). For some cells, the reduction in calcium may also perturb cell-matrix adhesion and very likely will perturb other cell functions.

As a more specific strategy, antibodies that block the function of the cadherin can be added *in vivo* or *in vitro*. A few such antibodies are commercially available (see **Table 2**). For example, rat NCD-2 (Zymed) and mouse GC4 (Sigma) monoclonal antibodies block the function of chicken N-cadherin, whereas HECD-1 (Zymed) and ECCD-1 (Zymed) block the function of human and mouse E-cadherin, respectively.

### **4.2. Growth Factor Effects on Cadherin Function**

Cadherin function can be altered by growth factors. Addition of epidermal growth factor (EGF) to receptor-positive cells can disrupt cadherin-mediated cell–cell adhesion (107). In addition, hepatocyte growth factor, also known as scatter factor (HGF/SF) reduces cell–cell adhesion and causes the scattering of receptor-positive cells (108). Both HGF/SF and its tyrosine kinase receptor, cMet, have been implicated in the migration of skeletal myoblasts into the growing limb bud (109–111). The mechanism of the effect of these growth factors is thought to involve receptor-induced tyrosine phosphorylation of  $\beta$ -catenin with concomitant loss of  $\alpha$ -catenin from the complex and reduced linkage to the cytoskeleton (20,22). V-src kinase activity also increases  $\beta$ -catenin phosphorylation and decreases cadherin-mediated activity (112–115). Because linkage of the cadherin/catenin complex to the actin cytoskeleton is necessary for optimal cadherin-mediated adhesion, alterations in tyrosine phosphorylation represents one way in which the activity of cadherins can be regulated. Although EGF and HGF/SF decrease cell–cell adhesion, other growth factors or cytokines appear to increase cadherin activity. For example, FGF increased N-cadherin-mediated neurite outgrowth (116) and Wnt-1 has been shown to increase cadherin-mediated cell adhesion (117,118).

### **4.3. In Vitro Manipulation of Cadherins and Catenins**

The activity of cadherins can be inhibited by exogenous expression of a dominant negative cadherin (119). This is a truncated cadherin whose extracellular domain is deleted or mutated such that it can no longer self-associate, and therefore cannot promote cell–cell adhesion. The transmembrane and intracellular domains are wildtype and therefore the truncated cadherin binds catenins (54). It is thought that the dominant negative cadherin inhibits the activity of endogenous cadherin(s) by competing for catenins. The truncated dominant negative cadherin has been expressed in both cells

in vitro and tissue in vivo and has been shown to perturb cadherin function as well as other cellular processes, such as migration and apoptosis (57,120).

Catenins are intracellular proteins and therefore cannot be perturbed easily by function perturbing antibodies. However, the level of  $\beta$ -catenin can be manipulated in several ways. Exposure of cells or tissue to Wnt(s) increases the cytoplasmic level of  $\beta$ -catenin in cells with the appropriate receptor, which in turn alters transcription and cellular processes in a number of systems (25,27,39,118,121,122). This approach to manipulating  $\beta$ -catenin is not easy, however, since Wnts, while secreted into the extracellular environment, bind to cells and/or extracellular matrix and act locally. No active recombinant Wnt(s) is available; therefore, the Wnt RNA or cDNA has to be used to achieve Wnt expression. As an easier but less specific approach, there are reports that  $\text{LiCl}_3$  inhibits GSK3 $\beta$  and therefore may act like a Wnt (123).

Truncated versions of  $\beta$ -catenin missing critical serine/threonine phosphorylation sites in the amino terminus are not readily degraded by the ubiquitin/proteasome pathway. Thus, transfecting cells with such a truncated  $\beta$ -catenin cDNAs can lead to increased  $\beta$ -catenin expression (36). In fact, some melanoma and colon cancers have this more stable, truncated  $\beta$ -catenin and thus have higher than normal levels of  $\beta$ -catenin. In addition, colon tumors with mutated APC (adenomatous polyposis coli), which is involved in regulating  $\beta$ -catenin levels, have high levels of cytoplasmic and nuclear  $\beta$ -catenin (124). In contrast to increasing  $\beta$ -catenin levels, deleting  $\beta$ -catenin from cells is problematic since most cells also express plakoglobin which can substitute for  $\beta$ -catenin in the cadherin/catenin complex, although it is not known if the two proteins are completely functionally equivalent.

The level of cadherin and catenin expression can be increased by forced expression of exogenous cDNAs under the influence of a strong constitutive or inducible promoter, or it can be decreased using an antisense approach. This can have significant effects. Overexpression of cadherin in *Xenopus* embryos blocks signaling through  $\beta$ -catenin, presumably by sequestering  $\beta$ -catenin at the plasma membrane and preventing it from entering the nucleus (24). On the other hand, in oral squamous carcinoma cells that exhibit a fibroblast-like morphology and inappropriately express N-cadherin, antisense constructs decreased the endogenous N-cadherin expression, allowing reexpression of E-cadherin and P-cadherin and restoring the cells to an epithelial phenotype (125).

#### **4.4. In Vivo Genetic Manipulation of Cadherins and Catenins**

Cadherins and catenins can be manipulated in vivo by genetic means. Knockout mutations have been generated in mice for E-, P-, and N-cadherin (126). Mice lacking E- or N-cadherin die as embryos, whereas the P-cadherin-null mouse is viable. The E-cadherin-null mouse embryo undergoes initial compaction because of the presence of maternal E-cadherin but subsequently fails to form a blastocyst or trophoderm, or to implant (127,128). N-cadherin-null embryos form neural tubes and somites but die by embryonic day 10, perhaps because their disorganized myocardium (53). In contrast, the P-cadherin-null mouse is viable and fertile, but exhibits precocious mammary gland development (129). Targeted disruption of cadherin function has been achieved in mice through the use of a dominant negative cadherin mutant under the control of a specific promoter. Expression of a mutant dominant negative N-cadherin

under control of a promoter that only functions only in postmitotic enterocytes disrupted cell–cell and cell–matrix contacts, increased enterocyte migration, caused a loss of the polarized phenotype, and produced precocious apoptosis (57).

Catenins also have been disrupted in mice.  $\beta$ -catenin-null embryos compact, form blastocysts, and implant but fail to gastrulate (130). The plakoglobin mouse dies midgestation exhibiting desmosomal defects in the myocardium and heart rupture (131). Mouse embryos homozygous for a loss-of-function mutation in the gene encoding  $\alpha$ -E-catenin display a disrupted trophoblast epithelium and blockage in development at the blastocyst stage (41).

The phenotypes of the above mutations, particularly that of the N-cadherin-null mouse, perhaps are milder than what might have been predicted. It is likely that this results from overlapping function and compensation among the cadherins and catenins.

## 5. Specific Protocols—Immunofluorescence Light Microscopy (IF) on Cultured Cells

### 5.1. Introduction to Specific Protocols

Immunofluorescence light microscopy (IF) utilizing specific antibodies is a powerful tool for assessing the expression and cellular localization of cadherins, catenin, and proteins associated with the cadherin/catenin complex, such as  $\alpha$ -actinin, vinculin, and other cytoskeletal proteins.

### 5.2. Materials for IF

1. Buffers.
  - a. PBS, phosphate-buffered saline, pH 7.4: Composition per liter, 8 g NaCl, 0.2 g KCl, 1.15 g  $\text{Na}_2\text{HPO}_4$ , and 0.2 g  $\text{KH}_2\text{PO}_4$ . Purchase as a preweighed packet for 1 L (Gibco-BRL, Grand Island, NY)
  - b. 10% Goat serum/PBS: 10 mL Normal goat serum (Sigma); 90 mL PBS.
2. 2% Paraformaldehyde in PBS: 2.5 mL 16% paraformaldehyde stock solution (Electron Microscopy Sciences, Ft. Washington, PA, which, after opening, can be stored at 4°C for up to 1 wk) added to 17.5 mL PBS.
3. Triton X-100 (0.5%): 0.5 mL Triton X-100 (Sigma) added to 95.5 mL PBS. Mix well.
4. 0.15 M glycine in PBS: 15 mL 1 M glycine (Sigma) stock (7.507 g/100 mL PBS) added to 85 mL PBS. Store at  $-20^\circ\text{C}$ .
5. Eight-chambered slides (or chambered cover slips) (Fisher Scientific, Pittsburgh, PA).
6. 18-Well hydrophobic resin coated slides (manufactured by Erie Scientific; available through Fisher Scientific).
7. Cover slips (11  $\times$  22-#1) (Thomas Scientific, Swedesboro, NJ).
8. Antigen-specific first antibodies (*see Table 2*).
9. Fluorescence conjugated second antibodies (Jackson ImmunoResearch Laboratories, Inc. West Grove, PA).
10. 100-mm Petri dishes, glass and plastic (Fisher Scientific).
11. Whatman filter paper (Fisher Scientific).
12. Coplin jars for slides (Fisher Scientific).
13. Cover slip staining jars (Thomas Scientific).
14. Self-closing forceps for handling cover slips (Fisher Scientific).
15. Mounting medium: 1.2 g Elvanol (Air Products and Chemicals Inc., Allentown, PA); 2.4 mL 95% glycerol (Sigma); 3.0-mL distilled water; 6.0 mL Tris HCl, 0.1 M, pH 8.5.

Place 3 g glycerol in a 50-mL tube. Add 1.2 g Elvanol and stir well with a glass rod (avoid getting Elvanol on the sides of the tube). Add 3 mL water, stir well, and let sit at room temperature for 4 h to overnight. Add 5 mL Tris buffer, place the tube in a 50°C water bath, and stir the mixture for 10 min to dissolve the Elvanol. Quickly and thoroughly stir in remaining 1 mL Tris buffer with 15 mg p-phenylene diamine (free base, Sigma) dissolved in it. Work quickly, as the p-phenylene diamine oxidizes and turns a dark color which interferes with fluorescence. Centrifuge the mixture at 1000g for 15 min to remove particles. Aliquot into eppendorf tubes and store at –70°C. Omit the p-phenylene diamine for rhodamine or CY-3, as it can interfere with the signal.

### 5.3. Methods for IF (see Notes 1–3 and Subheading 5.4.)

1. Culture of cells on matrix suitable for IF: Cells can be cultured in a variety of configurations on either glass or plastic. In general, glass yields less background fluorescence compared with plastic, but some cells attach better to plastic. For high resolution, cells should be grown on glass cover slips placed in cell culture dishes, e.g., 11 × 22-1 cover slip in the well of a 6-well culture dish. For best results, the cover slips should be washed in a soap solution (0.1% NP40 in PBS) for 30 min, rinsed thoroughly with distilled water, sterilized by autoclaving or soaking in 70% ethanol, and placed into culture dishes using sterile forceps. Alternatively, cells can be cultured on sterile chambered (e.g., 8-chamber) glass or plastic slides, or in 35-mm plastic culture dishes. If antibodies are in short supply, cells can be grown on slides coated with a hydrophobic resin and having multiple hydrophilic wells, e.g., slides with 18 wells of 5-mm diameter. These slides are sterilized by placing 1–4 slides in glass Petri dishes containing two half moons of filter paper (to which sterile water is later added for humidity), and autoclaving. Addition of matrix protein such as gelatin, collagen, fibronectin, or laminin may be necessary for firm cell attachment but should be avoided when possible as this can generate nonspecific background staining. In general, at least 48 h is required for the cells to attach firmly to their substratum and not be lost during the fixation and many washings involved in IF. Cells can be fixed at various densities but care has to be taken with high-density cultures as the cells can dislodge from the matrix as a sheet and be lost during staining.
2. Fixation of cells: The best fixation method has to be established for each antigen and antibody. However, in general fixing cells in ice-cold methanol is excellent for staining cadherins and catenins. This is done by removing the medium from the cells, rinsing them quickly with PBS, and placing them in –20°C methanol at –20°C for 10 min. Subsequently, the cells are drained of methanol, washed once with PBS and kept at 4°C in PBS containing 0.02% sodium azide to prevent bacterial growth until stained. Although methanol fixation is fine for cadherins and catenins located at the plasma membrane, it is not the method of choice for viewing nuclear proteins. For staining nuclear proteins, the cells should be fixed in paraformaldehyde and permeabilized with Triton X-100. To do this, the cells are washed 1–2 times with PBS and fixed in 2% paraformaldehyde/PBS for 10–30 min at room temperature. Subsequently, the cells are washed once with PBS, and twice for 10 min each with 0.15 M glycine/PBS. The cells are then washed once with PBS, and twice for 5–10 min with 0.5% Triton X-100 in PBS. Finally, the cells are washed 3–4 times with PBS to remove the detergent and stored in PBS with 0.02% azide in the refrigerator.
3. Blocking nonspecific antibody binding sites: To reduce nonspecific binding of first and second antibodies, the fixed cells are incubated with 10% goat serum in PBS for 60 min at room temperature. The goat serum/PBS solution should be centrifuged to remove particles, aliquoted and stored at –20°C.

4. Reacting cells with the antigen-specific antibody: After removing the goat serum/PBS, place the first antibody on the cells. The antibody can be in several forms, such as conditioned supernate from a hybridoma, ascites fluid, or purified IgG or IgM. It should be diluted into goat serum/PBS. The appropriate antibody concentration (or dilution) may have to be determined empirically. If the antibody is a gift, the donor may suggest an effective concentration, or if it has been purchased, the vendor will suggest a concentration. Generally, 1–2 h at room temperature provides adequate time for the antibody to bind the antigen. If the total volume of antibody solution on the cells is low, the reaction should be done in a humidified environment. The first antibody can be applied overnight at 4°C if care is taken to prevent evaporation of the antibody containing solution.
5. Washing away antibody not bound to antigen: Antibody not specifically bound to the antigen has to be removed. This is done by removing the antibody solution, and washing the cells three times, 5 min each, first once with 10% goat serum/PBS and then twice with PBS.
6. Detecting the antigen bound antibody: A second antibody that will specifically recognize the first antibody is used to detect the antigen-antibody complex on the cells. The antibody should recognize the appropriate animal species, e.g., mouse or rabbit, and the appropriate antibody isoform, e.g., IgG or IgM. When doing double labeling the secondary antibodies should be absorbed so they are highly species and isotype specific. Second antibodies are conjugated to fluorescent moieties such as fluorescein (FITC), rhodamine, or CY-3 and can be purchased from numerous vendors who will recommend an appropriate antibody dilution for IF. The antibody is diluted into 10% goat serum/PBS and applied to the cells for 45 min at room temperature, in the dark. To avoid background staining, this time should not be increased beyond 60 min.
7. Removing nonbound second antibody: Secondary antibody not bound to the antigen/antibody complex is removed by washing the cells three times, 3 min each, with PBS, and once quickly with distilled water just prior to mounting.
8. Mounting the cells: For cells grown on cover slips, the cover slips are mounted on glass slides, cells-side down. For cells grown on plastic dishes, chambered slides, or slides with multiple wells, glass cover slips are mounted on top of the cells. A commercial mounting medium, or one prepared in the laboratory, is used. Some mounting media contain additives that will retard bleaching of the fluorescence, particularly that of FITC. However, the additives can give a background when using rhodamine or CY3.
9. Viewing the cells: An epifluorescence microscope (e.g., Nikon, Zeiss) equipped with the appropriate objectives and sets of filters specific for FITC, rhodamine, CY-3, and/or Texas red is needed for visualizing the cells. Results are recorded with a high-speed film (e.g., Kodak TMAX 400; Polaroid type 57, ASA 3000).
10. Controls: Eliminate the first antibody or use nonimmune antibody to confirm that the second antibody is not binding to the cells in a nonspecific fashion. If it is, try diluting it more, or switch vendors. Eliminate the second antibody to confirm that the cells themselves do not fluoresce. Include an antibody known to bind a specific protein as a positive control.

#### 5.4. Notes

1. First and second antibodies should be centrifuged (e.g., high speed in a microfuge) to eliminate particles that can give background staining. If small dots of background staining persist, it may be helpful to filter the antibody solution through a 0.22- $\mu$ m filter.
2. To prevent evaporation of small amounts of antibody-containing solutions, place the coverslips, slides, or plates in a humidified chamber. A Petri dish lined with filter paper dampened with distilled water will suffice.



3. Coplin jars for slides and staining jars or cover slips are useful for the washing steps but require too much antibody for the first and second antibody steps. The antibodies can be puddled on the cells, using as little volume as is necessary to cover the cells.

## **6. Immunohistochemistry of Cadherins and Catenins in Routinely Processed, Paraffin-Embedded Tissue Sections**

### **6.1. Introduction**

Alterations of cadherins and catenins constitute important steps in mechanisms of development and disease. The study of the expression and distribution of cadherins and catenins can provide important information for both developmental biologists and pathologists concerned with the diagnostic and prognostic assessment of tumor and nontumor pathologies. Thus, detection of cadherins and catenins by immunohistochemistry in routinely processed tissues adds a valuable tool.

### **6.2. Materials and Methods (see Subheading 6.3., Notes 1–4)**

1. Sections, 5  $\mu\text{m}$  in thickness, are placed onto Superfrost Plus slides (Fisher Scientific), deparaffinized in xylene and progressively hydrated in a xylene-ethanol series ending in PBS (Sigma).
2. Steam-based antigen retrieval is performed in a vegetable steamer (Black and Decker, Shelton, CT, model HS 900).
3. Plastic Coplin jars (Fisher) containing citrate buffer, pH 6.0, also called antigen retrieval solution (Dako Corp., Carpinteria, CA) are placed in the steamer (up to six jars can be placed in the steamer at one time). The steamer, containing distilled water in the lower compartment, is heated for 20 min.
4. The sections are then transferred from PBS to the plastic Coplin jars containing prewarm citrate buffer, and heated for another 20 min in the steamer.
5. The Coplin jars are removed from the steamer and cooled at room temperature for 20 min.
6. Carefully drying in between the sections with a filter paper, but maintaining the sections wet, circles are made with a PAP Pen (Electron Microscopy Sciences). This saves reagents and allows the simultaneous detection of several antigens in serial sections placed on the same slide.
7. Sections are exposed to 3%  $\text{H}_2\text{O}_2$  (Sigma) in 50% methanol for 10 min at room temperature in a humid chamber.
8. Sections are washed by immersion in a Coplin jar with PBS, 2X 10 min each.
9. Sections are then incubated with 10% normal goat serum (Sigma) in PBS, for 45 min.
10. Excess serum is removed and the primary antibody is added to the sections (*see Table 2* for a listing of current available anticadherin and antcatenin antibodies and their applications). Sections are incubated overnight at 4°C in a humid chamber. Negative controls include the replacement of primary antibody with 10% normal goat serum, or incubation of the primary antibodies with blocking peptides when available. Positive controls include the use of tissues known to express the cadherin under study.
11. The sections are washed in PBS, 3X 5 min each.
12. Sections are incubated with a biotinylated species-specific secondary antibody (Vector Labs, Burlingame, CA) diluted in PBS following the manufacturer's instructions, for 45 min, in a humid chamber, at room temperature.
13. Sections are washed in PBS, 3X 5 min each.
14. Sections are incubated with avidin-biotin complex (Vector Labs), prepared according to the manufacturer's instructions, for 45 min in a humid chamber at room temperature.

15. PBS washes, 3X 5 min each.
16. Sections are exposed to 3,3'-diaminobenzidine (DAB peroxidase substrate), freshly prepared from tablets (Fast DAB tablet set, Sigma) following manufacturer's instructions.
17. Color development reaction (golden brown) is monitored under the light microscope and it usually occurs between 2 and 8 min.
18. Reaction is stopped by placing the slides in Coplin jars containing distilled water.
19. Sections are counterstained with Harris hematoxylin (Baxter) for 10–20 s, washed with tap water, dehydrated with a ethanol-xylene series, and coverslipped with Histomount (Fisher).

### 6.3. Notes

1. This protocol describes a manual procedure. When using multiple primary antibodies of different species, a run of no more of 30 slides is recommended to avoid mistakes. Automated immunohistochemistry systems are available (e.g., Ventana Medical Systems, Tucson, AZ). They are used in pathology and research laboratories, where a large number of samples is stained daily.
2. Drying between tissue sections on slides containing more than one section is done prior to encircling the sections with a PAP Pen, using a piece of folded filter paper. It should be done quickly and carefully, to avoid drying of the sections, which will produce background or false positive reactions.
3. Negative controls are used to evaluate nonspecific binding of secondary antibodies and avidin-biotin complex. Blocking peptides should be used when polyclonal antibodies directed against short peptides are applied. Blocking peptides are less commonly used for monoclonal antibodies, which are usually made to longer peptide sequences or entire proteins.

As positive controls, use routinely processed, paraffin-embedded heart tissue for N-cadherin, colon epithelia for E-cadherin and skin for P-cadherin run together with the tissues of interest, and any of these tissues for catenins. When evaluating tumor tissues, the intensity of the reactions and cellular distribution of the cadherin/catenins must be evaluated very carefully. Although immunohistochemistry is not a quantitative method, the data can be expressed as a table, indicating percentage of positive and negative cells and subcellular distribution of the antigen (cytoplasm or plasma membrane). This is particularly useful in the assessment of tumors, where decreased expression, abnormal subcellular distribution, or the expression of an aberrant cadherin may be indicative of invasive behavior of the tumor cells (69,74,125).

4. When using human surgical specimens, the researcher should be aware of some artifacts that can be found in paraffin sections of archival tissues. Because the time prior to fixation, fixation time, and processing of surgical specimens can vary greatly, antigens can be destroyed, producing false negative reactions, or their antigenicity can be enhanced, producing false positive artifacts (for a review, see ref. 132).

## 7. Aggregation Assays

### 7.1. Introduction

Cadherin activity can be determined by aggregating cells in suspension in the presence of calcium. The following represent two simple, low-cost assays that do not require sophisticated equipment. Assay #1 is quantitative, whereas assay #2 is more qualitative.

## 7.2. Aggregation Assay #1: Materials

1. Buffers and solutions:
  - a. PBS (Sigma).
  - b. Hanks' balanced salt solution without calcium chloride, magnesium sulfate, phenol red, and bicarbonate (Sigma).
  - c. 100 mM CaCl<sub>2</sub> stock. 1.47 g CaCl<sub>2</sub> dihydrate (Sigma) dissolved in 100-mL distilled water.
  - d. 100 mM EGTA stock. 4.68 g ethylene glycol-bis(β-aminoethyl ether)-N,N,N',N'-tetraacetic acid, tetrasodium salt (Sigma) dissolved in 100 mL PBS, pH adjusted to 7.4.
  - e. 100 mM EDTA stock. 3.8 g ethylenediaminetetraacetic acid, tetrasodium salt (Sigma) dissolved in 100 mL PBS, pH adjusted to 7.4.
  - f. HHBSS. 10 mM HEPES (N-2-hydroxyethyl-piperazine-N'-2-ethanesulfonic acid) (Sigma) in HBSS. 0.238 g HEPES dissolved in 100-mL HBSS, adjusted to pH 7.4 if necessary.
2. Soybean trypsin inhibitor (SBTI, Type I-S, Sigma).
3. 5 mL Fernback flasks (Thomas Scientific), coated with Sigmacote (Sigma) to prevent cells from attaching to the flask.
4. Hanging drop slides, two concavities (Fisher Scientific).
5. Hemacytometer (Fisher Scientific).
6. Hand tally counters (2) (Fisher Scientific).
7. Cover slips (22 mm squares, #1) (Fisher Scientific).
8. Adams Nutator Single Speed Orbital Mixer (Fisher Scientific).

## 7.3. Method for Aggregation Assay #1 (see Subheading 7.4., Notes 1–6)

1. Harvesting cells for the assay: To perform an aggregation assay, it is necessary to prepare a suspension of single cells. Monolayer cultures of subconfluent cells should be used because, depending on the cell type, it may be difficult to disperse cells from overly confluent cultures. If cells are harvested in the common fashion using a 0.25% trypsin-EDTA solution (Sigma), the cadherin will be degraded and lost from the cell surface because cadherins are sensitive to proteolysis when calcium is absent. In this case, a recovery period of at least 60 min at 37°C may be needed prior to initiating the aggregation assay. To protect the cadherin, calcium (1–2.5 mM) should be present when the cells are washed free of serum and harvested with trypsin. The least amount of trypsin (Sigma, e.g., 0.01–0.1%, and the shortest incubation period necessary to produce single cells in suspension should be employed. These conditions should be determined empirically. It may be possible to harvest some cell types without trypsin, by using 1 mM EDTA in PBS at 37°C. Shaking the cells during the harvest may promote their release from the dish. Detached cells are collected, pipeted into a single-cell suspension, and trypsin activity inhibited by adding soybean trypsin inhibitor (Type I-S, Sigma) to the same final concentration as the trypsin. The cells are then washed twice in Hanks' balanced salt solution (HBSS) without calcium chloride, magnesium sulfate, phenol red, and bicarbonate (Sigma), but containing 10 mM Hepes (Sigma) (HHBSS).
2. Preparing cells for the assay: Once the cells have been harvested and pipeted into a single-cell suspension, the concentration can be adjusted for the aggregation assay. For this assay the concentration should be adjusted to  $2.5\text{--}4.5 \times 10^5$  cells per mL HHBSS and 1 mL added to a 5-mL Fernback flask. These flasks sit nicely in the disposable styrofoam holder for 50-mL centrifuge tubes.
3. Starting the aggregation assay: Set aside some cells aside for determining the percentage of aggregation at the start of the assay (i.e., time zero). The assay is started by adding to a final concentration 1 mM EGTA or 1 mM Ca<sup>++</sup> to replicate flasks. The flasks are secured

in a holder, taped on a Nutator shaker, and placed at 37°C for up to 120 min. The optimal time of mixing has to be determined empirically. Some cells are sensitive to 1 mM EGTA and may die during the assay. If this is the case reduce the EGTA concentration to 0.1 mM, or eliminate it altogether.

4. Stopping the assay: Remove the cells from 37°C, gently pipet them 2–3 times to suspend them well, and for scoring fill the wells of hanging drop slides with the cells. Place a cover slip on top of the cells, avoiding bubbles; this will improve the optics and eliminate cell movement during scoring. Score the assay immediately as the viability of the cells may decrease. It may be possible to fix the cells with glutaraldehyde for later scoring.
5. Scoring the assay: View the cells using an inverted phase contrast microscope equipped with a grid in the eyepiece. Using two counters, count both single cells and cells in aggregates of three or more. The percentage of aggregation is determined by the formula:  $\frac{\text{The number of aggregated cells} + \text{total number of cells (singles + aggregates)}}{\text{total number of cells (singles + aggregates)}} \times 100$ . Count at least 500 cells per well from least three representative fields.

#### 7.4. Notes

1. For scoring aggregation microscopically it is important that the aggregates not be allowed to get too large, or it will be difficult to accurately count the number of cells in an aggregate. The size of the aggregates can be controlled by varying the cell concentration and the time of mixing, i.e., the higher the cell concentration and the longer the time of mixing, the larger the aggregates will be.
2. It is important to be consistent in the number of times the cells are pipeted before being loaded into the hanging drop slides because the shear force during pipeting can disperse the aggregates.
3. Optimally, the person scoring the assay should be blinded to the experimental design.
4. For statistical analysis, perform 4–6 replicates for each experimental group. Expect variability.
5. Be sure to score the percentage of aggregation at time zero. Ideally, this should be less than 10%.
6. If available, a particle counter, such as a Coulter counter, can be used to score aggregation. The extent of aggregation is determined by the ratio of the total particle number at the end of mixing to the particle number at time zero, which in the case of single cells is equal to the number of cells placed in the flask.

#### 7.5. Aggregation Assay #2: Materials

1. Medium, preferably with and without calcium.
2. Petri dishes (Fisher Scientific)

#### 7.6. Method for Aggregation Assay #2 (see Subheading 7.7., Notes 1 and 2)

1. Harvest cells in the same manner as for passaging them, or as described above. Suspend the cells in medium, with and without 1–2 mM calcium if possible, and with and without serum.
2. Adjust the cell concentration to  $1.5\text{--}2.5 \times 10^5$  cells/mL.
3. Place 20  $\mu$ L drops of suspended cells on the lid of a Petri dish.
4. Place 5-mL sterile water or PBS in the Petri dish bottom to provide humidity and reduce evaporation of the media. Place the lid on the bottom with the cells suspended from the lid.
5. Place the cells in a 5% CO<sub>2</sub> incubator at 37°C for up to 24 h.
6. For examination, remove and invert the lid and view the cells using an inverted phase contrast microscope. To maintain sterility, or to induce the cells to reestablish cell matrix adhesion, transfer the cells by pipet to a flask or culture dish containing medium.

7. Pipet the aggregates to assess the strength of cell–cell adhesion. Use Trypan blue staining to determine cell viability.
8. Record the results by photographing the cells.

### 7.7. Notes

1. This assay is a more visual, qualitative assay and is not readily quantifiable. This assay is useful, for example, for evaluating functional activity of a cadherin exogenously expressed in a cadherin-negative cell line (i.e., mouse L fibroblasts). However, it may be possible to quantify the assay by counting the number of aggregates present after triturating the cells.
2. It may not be feasible to perform this assay in the absence of calcium (or the absence of serum) when incubation times exceed 1 h because complete medium may be required to maintain cell viability.

### References

1. Kemler, R., Ozawa, M., and Ringwald, M. (1989) Calcium-dependent cell adhesion molecules. *Curr. Opin. Cell. Biol.* **1**, 892–897.
2. Takeichi, M. (1990) Cadherins: a molecular family important in selective cell-cell adhesion. *Annu. Rev. Biochem.* **59**, 237–252.
3. Magee, A. I. and Buxton, R. S. (1991) Transmembrane molecular assemblies regulated by the greater cadherin family. *Curr. Opin. Cell. Biol.* **3**, 854–861.
4. Grunwald, G. B. (1993) The structural and functional analysis of cadherin calcium-dependent cell adhesion molecules. *Curr. Opin. Cell. Biol.* **5**, 797–805.
5. Takeichi, M. (1988) The cadherins: cell-cell adhesion molecules controlling animal morphogenesis. *Development* **102**, 639–655.
6. Ranscht, B. (1994) Cadherins and catenins: interactions and functions in embryonic development. *Curr. Opin. Cell. Biol.* **6**, 740–746.
7. Gumbiner, B. M. (1996) Cell adhesion: the molecular basis of tissue architecture and morphogenesis. *Cell* **84**, 345–357.
8. Huber, O., Bierkamp, C., and Kemler, R. (1996) Cadherins and catenins in development. *Curr. Opin. Cell. Biol.* **8**, 685–691.
9. Tsukita, S., Tsukita, S., Nagafuchi, A., and Yonemura, S. (1992) Molecular linkage between cadherins and actin filaments in cell-cell adherens junctions. *Curr. Opin. Cell. Biol.* **4**, 834–839.
10. Aberle, H., Schwartz, H., and Kemler, R. (1996) Cadherin-catenin complex: protein interactions and their implications for cadherin function. *J. Cell. Biochem.* **61**, 514–523.
11. Wheelock, M. J., Knudsen, K. A., and Johnson, K. R. (1996) Membrane-cytoskeleton interactions with cadherin cell adhesion proteins: roles of catenins as linker proteins. *Curr. Topics Memb.* **43**, 169–185.
12. Kemler, R. (1993) From cadherins to catenins: cytoplasmic protein interactions and regulation of cell adhesion. *Trends Genet.* **9**, 317–321.
13. Aberle, H., Butz, S., Stappert, J., Weissing, H., Kemler, R., and Hoschuetzky, R. (1994) Assembly of the cadherin-catenin complex in vitro with recombinant proteins. *J. Cell Sci.* **107**, 3655–3663.
14. Wahl, J. K., Sacco, P. A., McGranahan, T. M., Sauppé, L., Wheelock, M. J., and Johnson, K. R. (1996) Plakoglobin domains that define its association with the desmosomal cadherins and the classical cadherins: identification of unique and shared domains. *J. Cell Sci.* **109**, 1043–1054.
15. Rimm, D. L., Koslov, E. R., Kebriaei, P., Cianci, C. D., and Morrow, J. S. (1995) a(E)-catenin is an actin-binding and -bundling protein mediating the attachment of F-actin to the membrane adhesion complex. *Proc. Natl. Acad. Sci. USA* **92**, 8813–8817.

16. Knudsen, K. A., Peralta Soler, A., Johnson, K. R., and Wheelock M. J. (1995) Interaction of  $\alpha$ -actinin with the cadherin/catenin cell-cell adhesion complex via  $\alpha$ -catenin. *J. Cell Biol.* **130**, 67–77.
17. Nieset, J. E., Redfield, A. R., Jin, F., Knudsen, K. A., Johnson K. R., and Wheelock, M. J. (1997) Characterization of the interactions of  $\alpha$ -catenin with a-actinin and  $\beta$ -catenin/plakoglobin. *J. Cell Sci.* **110**, 1013–1022.
18. Reynolds, A. B., Daniel, J., McCrea, P. D., Wheelock, M. J., Wu, J., and Zhang, Z. (1994) Identification of a new catenin: the tyrosine kinase substrate p120<sup>cas</sup> associates with E-cadherin complexes. *Mol. Cell. Biol.* **14**, 8333–8342.
19. Daniel, J. M. and Reynolds, A. B. (1995) The tyrosine kinase substrate p120<sup>cas</sup> binds directly to E-cadherin but not to the adenomatous polyposis coli protein or  $\alpha$ -catenin. *Mol. Cell. Biol.* **15**, 4819–4824.
20. Shibamoto, S., Hayakawa, M., Takeuchi, K., Hori, T., Oku, N., Miyazawa, K., et al. (1994) Tyrosine phosphorylation of  $\beta$ -catenin and plakoglobin enhanced by hepatocyte growth factor and epidermal growth factor in human carcinoma cells. *Cell Adhes. Commun.* **1**, 295–305.
21. Staddon, J. M., Smales, C., Schulze, C., Esch, F. S., and Rubin, L. L. (1995) p120, a p120-related protein (p100), and the cadherin/catenin complex. *J. Cell Biol.* **130**, 369–381.
22. Hoschuetzky, H., Aberle, H., and Kemler, R. (1994) b-Catenin mediates the interaction of the cadherin-catenin complex with epidermal growth factor receptor. *J. Cell Biol.* **127**, 1375–1380.
23. Brady-Kalnay, S. M., Rimm, D. L., and Tonks, N. K. (1995) Receptor protein tyrosine phosphatase PTPF associates with cadherins and catenins *in vivo*. *J. Cell Biol.* **130**, 977–986.
24. Heasman, J., Crawford, A., Goldstone, K., Garner-Hamrick, P., Gumbiner, B., McCrea, P., et al. (1994) Overexpression of cadherins and underexpression of beta-catenin inhibit dorsal mesoderm induction in early *Xenopus* embryos. *Cell* **79**, 791–803.
25. Gumbiner, B. M. (1995) Signal transduction of beta-catenin. *Curr. Opin. Cell. Biol.* **7**, 634–640.
26. Peifer, M. (1995) Cell adhesion and signal transduction: the Armadillo connection. *Trends Cell. Biol.* **5**, 224–229.
27. Miller, J. R. and Moon, R. T. (1996) Signal transduction through beta-catenin and specification of cell fate during embryogenesis. *Genes Dev.* **10**, 2527–2539.
28. Peifer, M., McCrea, P. D., Green, K. J., Wieschaus, E., and Gumbiner, B. (1992) The vertebrate adhesive junction proteins  $\beta$ -catenin and plakoglobin and the *Drosophila* segment polarity gene *armadillo* form a multigene family with similar properties. *J. Cell Biol.* **118**, 681–691.
29. Peifer, M., Pai, L.-M., and Casey, M. (1994) Phosphorylation of the *Drosophila* adherens junction protein Armadillo: roles for Wingless signal and Zeste-White 3 kinase. *Dev. Biol.* **166**, 543–556.
30. Krasnow, R. E., Wong, L. L., and Adler, P. N. (1995) *disheveled* is a component of the frizzled signaling pathway in *Drosophila*. *Development* **121**, 4095–4102.
31. Bhanot, P., Brink, M., Samos, C. H., Hsieh, J.-C., Wang, Y., Macke, J. P., et al. (1996) A new member of the frizzled family from *Drosophila* functions as a Wingless receptor. *Nature* **383**, 225–230.
32. Yang-Snyder, J., Miller, J. R., Brown, J. D., Lai, C.-J., and Moon, R. T. (1996) A *frizzled* homolog functions in a vertebrate *Wnt* signaling pathway. *Curr. Biol.* **6**, 1302–1306.
33. Rubinfeld, B., Souza, B., Albert, I., Muller, O., Chamberlain, S. H., Masiarz, F. R., et al. (1993) Association of the APC gene product with  $\beta$ -catenin. *Science* **262**, 1731–1733.
34. Su, L.-K., Vogelstein, B., and Kinzler, K. W. (1993) Association of the APC tumor suppressor protein with catenins. *Science* **262**, 1734–1737.

35. Rubinfeld, B., Albert, I., Porfiri, E., Fiol, C., Munemitsu, S., and Polakis, P. (1996) Binding of GSK3 $\beta$  to the APC- $\beta$ -catenin complex and regulation of complex assembly. *Science* **272**, 1023–1026.
36. Munemitsu, S., Albert, I., Souza, B., Rubinfeld, B., and Polakis, P. (1995) Regulation of intracellular  $\beta$ -catenin levels by the adenomatous polyposis coli (APC) tumor-suppressor protein. *Proc. Natl. Acad. Sci. USA* **92**, 3046–3050.
37. Behrens, J., von Kries, J. P., Kuhl, M., Bruhn, L., Wedlich, D., Grosschedl, R., and Birchmeier, W. (1996) Functional interaction of  $\beta$  catenin with the transcription factor LEF-1. *Nature* **382**, 638–642.
38. Huber, O., Korn, R., McLaughlin, J., Ohsugi, M., Herrmann, B. G., and Kemler, R. (1996) Nuclear localization of  $\beta$ -catenin by interaction with transcription factor LEF-1. *Mech. Dev.* **59**, 3–10.
39. Molenaar, M., van de Wetering, M., Oosterwegel, M. M., Peterson-Maduro, J., Godsave, S., Korinek, V., et al. (1996) XTcf-3 transcription factor mediates  $\beta$ -catenin-induced axis formation in xenopus embryos. *Cell* **86**, 391–399.
40. Brannon, M., Gomperts, M., Sumoy, L., Moon, R. T., and Kimelman, D. (1997) A  $\beta$ -catenin/XTcf-3 complex binds to the Samois promoter to regulate dorsal axis specification in *Xenopus*. *Genes Dev.* **11**, 2359–2370.
41. Torres, M., Stoykova, A., Huber, O., Chowdhury, K., Bonaldo, P., Mansouri, A., et al. (1997) An  $\alpha$ -E-catenin gene trap mutation defines its function in preimplantation development. *Proc. Natl. Acad. Sci. USA* **94**, 901–906.
42. Shimoyama, Y., Nagafuchi, A., Fujita, S., Gotoh, M., Takeichi, M., Tsukita, S., and Hirohashi, S. (1992) Cadherin dysfunction in a human cancer cell line: possible involvement of loss of  $\alpha$ -catenin expression in reduced cell-cell adhesiveness. *Cancer Res.* **52**, 5770–5774.
43. Watabe, M., Nagafuchi, A., Tsukita, S., and Takeichi, M. (1994) Induction of polarized cell-cell association and retardation of growth by activation of the E-cadherin-catenin adhesion system in a dispersed carcinoma line. *J. Cell Biol.* **127**, 247–256.
44. Shimazui, T., Schalken, J. A., Giroldi, L. A., Jansen, C. F. J., Akaza, H., Koiso, K., et al. (1996) Prognostic value of cadherin-associated molecules ( $\alpha$ ,  $\beta$ , and  $\gamma$ -catenins and p120<sup>cas</sup>) in bladder tumors. *Cancer Res.* **56**, 4154–4158.
45. Kadowaki, T., Shiozaki, H., Inoue, M., Tamura, S., Oka, H., Doki, Y., et al. (1994) E-cadherin and  $\alpha$ -catenin expression in human esophageal cancer. *Cancer Res.* **54**, 291–296.
46. Volk, T. and Geiger, B. (1984) A 135-kDa membrane protein of intercellular adherens junctions. *EMBO J.* **3**, 2249–2260.
47. Geiger, B., Ginsberg, D., Salomon, D., and Volberg, T. (1990) The molecular basis for the assembly and modulation of adherens-type junctions. *Cell Diff. Dev.* **32**, 343–354.
48. Tsukita, S., Itoh, M., Nagafuchi, A., Yonemura, S., and Tsukita, S. (1993) Sub-membranous junctional plaque proteins include potential tumor suppressor molecules. *J. Cell. Biol.* **123**, 1049–1053.
49. Lewis, J. E., Jensen, P. J., Johnson, K. R., and Wheelock, M. J. (1994) E-cadherin mediates adherens junction organization through protein kinase C. *J. Cell Sci.* **107**, 3615–3621.
50. Birchmeier, W. and Behrens, J. (1994) Cadherin expression in carcinomas: role in the formation of cell junctions and the prevention of invasiveness. *Biochim. Biophys. Acta.* **1198**, 11–26.
51. Peralta Soler, A. and Knudsen, K. A. (1994) N-cadherin involvement in cardiac myocyte interaction and myofibrillogenesis. *Dev. Biol.* **162**, 9–17.
52. Goncharova, E. J., Kam, Z., and Geiger, B. (1992) The involvement of adherens junction components in myofibrillogenesis in cultured cardiac myocytes. *Development* **114**, 173–183.

53. Radice, G. L., Raburn, H., Matusnami, H., Knudsen, K. A., Takeichi, M., and Hynes, R. O. (1997) Developmental defects in mouse embryos lacking N-cadherin. *Dev. Biol.* **181**, 64–78.
54. Redfield, A., Nieman, M. T., and Knudsen, K. A. (1997) Cadherins promote skeletal muscle differentiation in three-dimensional cultures. *J. Cell Biol.* **138**, 1323–1331.
55. Larue, L., Antos, C., Butz, S., Huber, O., Delmas, V., Dominis, M., and Kemler, R. (1996) A role for cadherins in tissue formation. *Development* **122**, 3185–3194.
56. George-Weinstein, M., Gerhart, J., Blitz, J., Simak, E., and Knudsen, K. A. (1997) N-cadherin promotes skeletal myogenesis. *Dev. Biol.* **185**, 14–24.
57. Hermiston, M. L. and Gordon, J. I. (1995) In vivo analysis of cadherin function in the mouse intestinal epithelium: essential roles in adhesion, maintenance of differentiation and regulation of programmed cell death. *J. Cell Biol.* **129**, 489–506.
58. Hatta, K. and Takeichi, M. (1986) Expression of N-cadherin adhesion molecules associated with early morphogenetic events in chick development. *Nature* **320**, 447–449.
59. Suzuki, S., Sano, K., and Tanihara, H. (1991) Diversity of the cadherin family: evidence for eight new cadherins in nervous tissue. *Cell Reg.* **2**, 261–270.
60. Ozawa, M., Buribault, H., and Kemler, R. (1989) The cytoplasmic domain of the cell adhesion molecule uvomorulin associates with three independent proteins structurally related in different species. *EMBO J.* **8**, 1711–1717.
61. Wheelock, M. J. and Knudsen, K. A. (1991) N-cadherin-associated proteins in chicken muscle. *Differentiation* **46**, 35–42.
62. Nagafuchi, A. and Takeichi, M. (1988) Cell binding function of E-cadherin is regulated by the cytoplasmic domain. *EMBO J.* **7**, 3679–3684.
63. Wheelock, M. J. and Jensen, P. J. (1992) Regulation of keratinocyte intercellular junction organization and epidermal morphogenesis by E-Cadherin. *J. Cell Biol.* **117**, 415–425.
64. Rubinfeld, B., Robbins, P., El-Gamil, M., Albert, I., Porfiri, Em., and Polakis, P. (1997) Stabilization of  $\beta$ -catenin by genetic defects in melanoma cell lines. *Science* **275**, 1790–1792.
65. Packer, A. I., Elwell, V. A., Parnass, J. D., Knudsen, K. A., and Wolgemuth, D. J. (1997) N-cadherin protein distribution in normal embryos and in embryos carrying mutations in the homeobox gene *Hoxa-4*. *Int. J. Dev. Biol.* **41**, 459–468.
66. Han, A. C., Peralta Soler, A., Knudsen, K. A., Wheelock, M. J., Johnson, K. R., and Salazar, H. (1997) Differential expression of N-cadherin in pleural mesotheliomas and E-cadherin in lung adenocarcinomas in formalin-fixed, paraffin-embedded tissues. *Hum. Pathol.* **28**, 641–645.
67. Peralta Soler, A., Knudsen, K. A., Tecson-Miguel, A., McBrearty, F. X., Han, A. C., and Salazar, H. (1997) Expression of E-cadherin and N-cadherin in surface epithelial-stromal tumors of the ovary distinguishes mucinous from serous and endometrioid tumors. *Hum. Pathol.* **28**, 734–739.
68. Behrens, J., Mareel, M., Van Roy, F., and Birchmeier, W. (1989) Dissecting tumor cell invasion: Epithelial cells acquire invasive properties after the loss of uvomorulin-mediated cell-cell adhesion. *J. Cell Biol.* **108**, 2435–2447.
69. Takeichi, M. (1993) Cadherins in cancer: Implications for invasion and metastasis. *Curr. Opin. Cell Biol.* **5**, 806–811.
70. Bringuier, P. P., Umbas, G. M., Schaafsma, H. E., Karthaus, H. F. M., Debruyne, F. M. J., and Schalken, F. M. J. (1993) Decreased E-cadherin immunoreactivity correlates with poor survival in patients with bladder tumors. *Cancer Res.* **53**, 3241–3245.
71. Sitonen, S. M., Kononen, J. T., Helin, H. J., Rantala, I. S., and Holli, K. A., and Isola, J. J. (1996) Reduced E-cadherin expression is associated with invasiveness and unfavorable prognosis in breast cancer. *Am. J. Clin. Pathol.* **105**, 394–402.



72. Peralta Soler, A., Knudsen, K. A., Jaurand, M.-C., Johnson, K. R., Wheelock, M. J., Klein-Szanto, A. J. P., and Salazar, H. (1995) The differential expression of N-cadherin and E-cadherin distinguishes pleural mesotheliomas from lung adenocarcinomas. *Hum. Pathol.* **26**, 1363–1369.
73. Shi, S.-R., Cote, R. J., and Taylor, C. R. (1997) Antigen retrieval immunohistochemistry: Past, present, and future. *J. Histochem. Cytochem.* **45**, 327–343.
74. Peralta Soler, A., Harner, G. D., Knudsen, K. A., McBrearty, F. X., Grujic, E., Salazar, H., et al. (1997) The expression of P-cadherin identifies PSA-negative cells in epithelial tissues of male sexual accessory organs and in prostatic carcinomas: implications for prostate cancer biology. *Am. J. Pathol.* **151**, 471–478.
75. Jeffers, M. (1996) E-cadherin in mesothelioma. *Hum. Pathol.* **27**, 1245 (letter to editor).
76. Peralta Soler, A., Knudsen, K., and Salazar, H. (1996) E-cadherin in mesothelioma. *Hum. Pathol.* **27**, 1246 (reply to letter to editor).
77. Drenckhahn, D. and Franz, H. (1986) Identification of actin-,  $\alpha$ -actinin-, and vinculin-containing plaques at the lateral membrane of epithelial cells. *J. Cell Biol.* **102**, 1843–1852.
78. Matsuzaki, F., Mege, R.-M., Jaffe, S. H., Friedlander, J. D., Gallin, W. J., Goldberg, J. I., et al. (1990) cDNAs of cell adhesion molecules of different specificity induce changes in cell shape and border formation in cultured S180 cells. *Proc. Natl. Acad. Sci. USA* **110**, 1239–1252.
79. Volk, T. and Geiger, B. (1986) A-CAM: a 135-kD receptor of intercellular adherens junctions. II. antibody-mediated modulation of junction formation. *J. Cell Biol.* **103**, 1451–1464.
80. Peralta Soler, A. and Knudsen, K. A. (1991) Colocalization of N-CAM and N-cadherin in avian skeletal myoblasts. *Dev. Biol.* **148**, 389–392.
81. Bornemann, A. and Schmalbruch, H. (1994) Immunocytochemistry of M-cadherin in mature and regenerating rat muscle. *Anat. Record* **239**, 119–125.
82. Kartenbeck, J., Schmelz, M., Franke, W. W., and Geiger, B. (1991) Endocytosis of junctional cadherins in bovine kidney epithelial (MDBK) cells cultured in low Ca<sup>2+</sup> ion medium. *J. Cell Biol.* **113**, 881–892.
83. Rajasekaran, A. K., Hojo, M., Huima, T., and Rodriguez-Boulan, E. (1996) Catenins and zonula occludens-1 form a complex during early stages in the assembly of tight junctions. *J. Cell Biol.* **132**, 451–463.
84. Uchida, N., Honjo, Y., Johnson, K. R., Wheelock, M. J., and Takeichi, M. (1996) The catenin/cadherin adhesion system is localized in synaptic junctions bordering transmitter release zones. *J. Cell Biol.* **135**, 767–779.
85. McLean, I. W. and Nakane, P. F. (1974) Periodate-lysine paraformaldehyde fixative: a new fixative for immunoelectron microscopy. *J. Histochem. Cytochem.* **22**, 1077–1083.
86. Hayat, M. A. (1989) *Principles and Techniques of Electron Microscopy* (Hayat, M. A., ed.), CRC, Boca Raton, FL.
87. Polak, J. M. and Varndell, I. M. (1984) *Immunolabelling for Electron Microscopy* (Polak, J. M. and Varndell, I. M., eds.), Elsevier, New York.
88. Hayat, M. A. (1989) *Colloidal Gold. Principles, Methods, and Applications* (Hayat, M. A., ed.), Academic, New York.
89. Fujimoto, K., Nagafuchi, A., Tsukita, S., Kuraoka, A., Ohokuma, A., and Shibata, Y. (1997) Dynamics of connexins, E-cadherin and a-catenin on cell membranes during gap junction formation. *J. Cell Sci.* **110**, 311–322.
90. Volk, T. and Geiger, B. (1986) A-CAM: a 135-kD receptor of intercellular adherens junctions. I. Immunoelectron microscopic localization and biochemical studies. *J. Cell Biol.* **103**, 1441–1450.

91. Cifuentes-Diaz, C., Nicolet, M., Goudou, D., Rieger, F., and Mege, R. M. (1994) N-cadherin expression in developing, adult and denervated chicken neuromuscular system: accumulations at both the neuromuscular junction and the node of Ranvier. *Development* **120**, 1–11.
92. Knudsen, K. A. and Wheelock, M. J. (1992) Plakoglobin, or an 83 kD homolog distinct from  $\beta$ -catenin, interacts with E-cadherin and N-cadherin. *J. Cell Biol.* **118**, 671–679.
93. Johnson, K. R., Lewis, J. E., Li, D., Wahl, J., Peralta Soler, A., Knudsen, K. A., and Wheelock, M. J. (1993) P- and E-cadherin are in separate complexes in cells expressing both cadherins. *Exp. Cell Res.* **207**, 252–260.
94. Chen, B., Blaschuk, O. W., and Hales, B. F. (1991) Cadherin mRNAs during rat embryo development *in vivo* and *in vitro*. *Teratology* **44**, 581–590.
95. Kimura, Y., Matsunami, H., Inoue, T., Shimamura, K., Uchida, N., Ueno, T., et al. (1995) Cadherin-11 expressed in association with mesenchymal morphogenesis in the head, somite, and limb bud of early mouse embryos. *Dev. Biol.* **169**, 347–358.
96. Hoffman, I. and Balling, R. (1995) Cloning and expression analysis of a novel mesodermally expressed cadherin. *Dev. Biol.* **169**, 337–346.
97. Arndt, K. and Redies, C. (1996) Restricted expression of R-cadherin by brain nuclei and neural circuits of the developing chicken brain. *J. Comp. Neurol.* **373**, 373–399.
98. Knudsen, K. A. and Horwitz, A. F. (1977) Tandem events in myoblast fusion. *Dev. Biol.* **58**, 328–338.
99. Takeichi, M. (1977) Functional correlation between cell adhesive properties and some cell surface proteins. *J. Cell Biol.* **75**, 464–474.
100. Grunwald, G. B., Geller, R. L., and Lilien, J. (1980) Enzymatic dissection of embryonic cell adhesive mechanisms. *J. Cell Biol.* **85**, 766–776.
101. Brackenbury, R., Thiery, J.-P., Rutishauser, U., and Edelman, G. M. (1977) Adhesion among neural cells of the chick embryo. An immunological assay for molecules involved in cell-cell binding. *J. Biol. Chem.* **252**, 6835–6840.
102. Knudsen, K. A., McElwee, S. A., and Myers, L. (1990) A role for the neural cell adhesion molecule, NCAM, in myoblast interaction during myogenesis. *Dev. Biol.* **138**, 159–168.
103. Knudsen, K. A. (1985) The calcium-dependent myoblast adhesion that precedes cell fusion is mediated by glycoproteins. *J. Cell Biol.* **10**, 891–897.
104. Knudsen, K. A. and Horwitz, A. F. (1978) Differential inhibition of myoblast fusion. *Dev. Biol.* **66**, 294–307.
105. Gumbiner, B., Stevenson, B., and Grimaldi, A. (1988) The role of the cell adhesion molecule uvomorulin in the formation and maintenance of the epithelial junctional complex. *J. Cell Biol.* **107**, 1575–1587.
106. O'Keefe, E. J., Briggaman, R. A., and Herman, B. (1987) Calcium-induced assembly of adherens junctions in keratinocytes. *J. Cell Biol.* **105**, 807–817.
107. Watabe, M., Matsumoto, K., Nakamura, T., and Takeichi, M. (1993) Effect of hepatocyte growth factor on cadherin-mediated cell-cell adhesion. *Cell Struct. Funct.* **18**, 117–124.
108. Rosen, E. M., Nigam, S. K., and Goldberg, I. D. (1994) Scatter factor and the *c-Met* Receptor: a paradigm for mesenchymal/epithelial interaction. *J. Cell Biol.* **127**, 1783–1787.
109. Bladt, F., Riethmacher, D., Isenmann, S., Aguzzi, A., and Birchmeier, C. (1995) Essential role for the *c met* receptor in the migration of myogenic precursor cells into the limb bud. *Nature* **376**, 768–771.
110. Myokai, F., Washio, N., Asahara, Y., Yamaai, T., Tanda, N., Ishikawa, T., et al. (1995) Expression of the hepatocyte growth factor gene during chick limb development. *Dev. Dyn.* **202**, 80–90.
111. Takayama, H., LaRochelle, W. J., Anver, M., Bockman, D. E., and Merlino, G. (1996) Scatter factor/hepatocyte growth factor as a regulator of skeletal muscle and neural crest development. *Proc. Natl. Acad. Sci. USA* **93**, 5866–5871.

112. Volberg, T., Zick, Y., Dror, H., Subanay, J., Gilon, C., Levitzki, A., and Geiger, B. (1992) The effect of tyrosine-specific protein phosphorylation in the assembly of adherens-type junctions. *EMBO J.* **11**, 1733–1742.
113. Matsuyoshi, N., Hamaguchi, M., Taniguchi, S., Nagafuchi, A., Tsukita, S., and Takeichi, M. (1992) Cadherin-mediated cell-cell adhesion is perturbed by *v-src* tyrosine phosphorylation in metastatic fibroblasts. *J. Cell Biol.* **118**, 703–714.
114. Behrens, J., Vakaet, L., Friis, R., Winterhager, E., Van Roy, F., Mareel, M. M., and Birchmeier, W. (1993) Loss of epithelial differentiation and gain of invasiveness correlates with tyrosine phosphorylation of the E-cadherin/ $\beta$ -catenin complex in cells transformed with a temperature-sensitive *v-SRC* gene. *J. Cell Biol.* **120**, 757–766.
115. Takeda, H., Nagafuchi, A., Yonemura, S., Tsukita, S., Behrens, J., Birchmeier, W., and Tsukita, S. (1995) *V-src* kinase shifts the cadherin-based cell adhesion from the strong to the weak state and  $\beta$ -catenin is not required for the shift. *J. Cell Biol.* **131**, 1839–1847.
116. Williams, E. J., Furness, J., Walsh, F. S., and Doherty, P. (1994) Activation of the FGF receptor underlies neurite outgrowth stimulated by L1, N-CAM, and N-Cadherin. *Neuron* **13**, 583–594.
117. Bradley, R. S., Cowin, P., and Brown, A. M. C. (1993) Expression of Wnt-1 in PC12 cells results in modulation of plakoglobin and E-cadherin and increased cellular adhesion. *J. Cell Biol.* **123**, 1857–1865.
118. Hinck, L., Nelson, J. J., and Papkoff, J. (1994) Wnt-1 modulates cell-cell adhesion in mammalian cells by stabilizing  $\beta$ -catenin binding to the cell adhesion protein cadherin. *J. Cell Biol.* **124**, 729–741.
119. Fujimori, T. and Takeichi, M. (1992) Disruption of epithelial cell-cell adhesion by exogenous expression of a mutated nonfunctional N-cadherin. *Mol. Biol. Cell* **4**, 37–47.
120. Kintner, C. (1992) Regulation of embryonic cell adhesion by the cadherin cytoplasmic domain. *Cell* **69**, 225–236.
121. Funayama, N., Fagotto, F., McCrea, P., and Gumbiner, B. M. (1995) Embryonic axis induction by the armadillo repeat domain of beta-catenin: evidence for intracellular signaling. *J. Cell Biol.* **128**, 959–968.
122. Papkoff, J., Rubinfeld, B., Schryver, B., and Polakis, P. (1996) Wnt-1 regulates free pools of catenins and stabilizes APC-catenin complexes. *Mol. Cell Biol.* **16**, 2128–2134.
123. Stambolic, V., Ruel, L., and Woodgett, J. R. (1996) Lithium inhibits glycogen synthase kinase-3 activity and mimics Wingless signalling in intact cells. *Curr. Biol.* **6**, 1664–1668.
124. Inomata, M., Ochiai, A., Akimoto, S., Kitano, S., and Hirohashi, S. (1996) Alteration of  $\beta$ -catenin expression in colonic epithelial cells of familial adenomatous polyposis patients. *Cancer Res.* **56**, 2213–2217.
125. Islam, S., Carey, T. E., Wolf, G. T., Wheelock, M. J., and Johnson, K. R. (1996) Expression of N-cadherin by human squamous carcinoma cells induces a scattered fibroblastic phenotype with disrupted cell-cell adhesion. *J. Cell. Biol.* **135**, 1643–1654.
126. Hynes, R. O. (1996) Targeted mutations in cell adhesion genes: what have we learned from them? *Dev. Biol.* **180**, 402–412.
127. Riethmacher, D., Brinkmann, V., and Birchmeier, C. (1995) A targeted mutation in the mouse E-cadherin gene results in defective preimplantation development. *Proc. Natl. Acad. Sci. USA* **92**, 855–859.
128. Larue, L., Ohsugi, M., Hirchenhain, J., and Kemler, R. (1994) E-cadherin null mutant embryos fail to form a trophectoderm epithelium. *Proc. Natl. Acad. Sci. USA* **91**, 8263–8267.
129. Radice, G. L., Ferreira-Cornwell, M. C., Robinson, S. D., Rayburn, H., Chodosh, L. A., Takeichi, M., and Hynes, R. O. (1997) Precocious mammary gland development in P-cadherin-deficient mice. *J. Cell Biol.* **139**, 1025–1032.

130. Haegel, H., Larue, L., Ohsugi, M., Federov, L., Herrenknecht, K., and Kemler, R. (1995) Lack of  $\beta$ -catenin affects mouse development at gastrulation. *Development* **121**, 3529–3537.
131. Ruiz, P., Brinkmann, V., Birchmeier, C., Gunthert, U., Franke, W. W., and Birchmeier, B. (1996) Target mutation of plakoglobin in mice reveals essential functions of desmosomes in the embryonic hearts. *J. Cell Biol.* **135**, 215–225.
132. Taylor, C. R. and Cote, R. G. (1994) *Immunomicroscopy: A Diagnostic Tool for the Surgical Pathologist*. W. B. Saunders, Philadelphia, PA.

## Analysis of Hyaluronan Using Biotinylated Hyaluronan-Binding Proteins

Charles B. Underhill and Lurong Zhang

### 1. Introduction

In this chapter, we describe the preparation and use of b-PG, a biotinylated complex that specifically binds hyaluronan (1,2). The b-PG is derived from cartilage and consists of a trypsin fragment of the proteoglycan core protein and one of the link proteins. Because of its ability to bind to hyaluronan with high affinity and specificity, the b-PG agent has proved to be useful in the histochemical localization of hyaluronan and its quantitative analysis by an enzyme linked assay (1,2).

The b-PG reagent described here has evolved from several earlier versions. The first use of fluorescently tagged cartilage proteins for histochemistry of hyaluronan was described by Knudson and Toole (3). Shortly after, Ripellino et al. described the use of a biotinylated reagent that was isolated from cartilage by ultracentrifugation (4). The present protocol consists of a modification of one originally described by the late Dr. A. Tengblad that involves the use of affinity chromatography (5). It should be acknowledged that the procedure describe here draws heavily from the excellent work of Dr. Tengblad.

While b-PG is a very useful reagent, its preparation is a major undertaking. The synthesis of HA-Sepharose and the purification of b-PG is both expensive and time consuming. Once the HA-Sepharose has been prepared, the isolation of b-PG takes about 2 wk. In general, we prepare several batches of the b-PG at one time, until we have exhausted our supply of cartilage extract. On the positive side, the HA-Sepharose can be reused many times, and the preparations of b-PG can be stored under the appropriate conditions for a number of years without loss of activity.

In the following sections we will describe:

1. The preparation of HA-Sepharose;
2. The isolation of b-PG;
3. The use of b-PG in histochemistry; and
4. The quantitative analysis of hyaluronan using b-PG in an enzyme linked assay.

## 2. Materials

### 2.1. Preparation of HA-Sepharose

1. The NH<sub>2</sub>-derivatized matrix, EAH Sepharose 4B is purchased from Pharmacia Biotech (Uppsala, Sweden). In general, we use 100 mL (two batches) of the matrix for each preparation. Alternatively, the derivatized matrix can be prepared according to the methods described by Cambiaso et al. (6).
2. Highly purified hyaluronan of approx  $7 \times 10^5$  molecular weight is obtained from Lifecore Biomedical (Chaska, MN).
3. Testicular hyaluronidase (type VI-S), 1-ethyl-3-(3-dimethylamino-propyl)carbodiimide and the other incidental reagents are obtained from Sigma Chemical Co. (St. Louis, MO).

### 2.2. Isolation of b-PG

1. Bovine nasal cartilage is purchased from Pel-Freez (Rogers, AR).
2. For processing of the cartilage, we use a Surform pocket plane (Stanley Tools) that is available in most hardware stores and cheese cloth that can be obtained at most grocery stores. In addition, large size dialysis tubing (3.3-cm Spectrapor membrane tubing) was used. In place of a Surform plane, a meat grinder may also be used.
3. Trypsin (type III) and soybean trypsin inhibitor (Type I-S) are both obtained from Sigma.
4. The biotinylating reagent Sulfo-NHS-LC-Biotin (EZ-Link) is obtained from Pierce (Rockford, IL).
5. Because the procedure requires large amounts of 4 M guanidine HCl, 0.5 M Na acetate pH 5.8, it is worthwhile to purify crude preparations of this reagent. To do this, 1528 g of practical grade guanidine HCl (Sigma) and 272 g of Na acetate-3 H<sub>2</sub>O is dissolved in water, the pH is adjusted to 5.8 and the volume to 4 L. A tablespoon full of decolorizing carbon (Norit, Baker, NJ) is added to the solution which is stirred for 1 h. The solution is then passed through a Whatman filter on Buchner funnel and stored for use.

### 2.3. Histochemistry for Hyaluronan

1. The normal histochemical reagents consist of a clearing agent (Americlear), ethyl alcohol, and 30% H<sub>2</sub>O<sub>2</sub>.
2. A 10X stock solution of calcium–magnesium-free phosphate-buffered saline (PBS-A) is prepared from the following: 80 g NaCl, 2.0 g KH<sub>2</sub>PO<sub>4</sub>, 2.0 g KCl, and 11.5 g Na<sub>2</sub>HPO<sub>4</sub> dissolved in 1 L of water. After diluting 1 to 10, the pH should be 7.3.
3. The reagent buffer consists of 90% PBS-A, 10% calf serum which should be passed through a 0.45 μm filter prior to use. This may be frozen in 10-mL aliquots.
4. Streptavidin-horse radish peroxidase can be purchased from Kirkegaard and Perry (Gaithersburg, MD).
5. The 3-amino-9-ethylcarbazole, dimethyl formamide (or dimethyl sulfoxide) and Mayer's hematoxylin solution are purchased from Sigma.
6. Crystal/mount to preserve the chromogen is purchased from Biomedica (Foster City, CA).

### 2.4. Enzyme Linked Assay for Hyaluronan

1. Hyaluronan was purchased from Lifecore Biomedical.
2. Bovine serum albumin, 2,2'azinobis (3-ethylbenzthiazoline sulfonic acid), 1-ethyl-3-(3-dimethylamino-propyl)carbodiimide and NaN<sub>3</sub> are purchased from Sigma.

### 3. Methods

#### 3.1. Preparation of HA-Sepharose

The b-PG is isolated by affinity chromatography on a matrix of hyaluronan coupled to Sepharose (HA-Sepharose). The preparation of the HA-Sepharose involves two steps. In the first step, hyaluronan is converted to an appropriate size so it can penetrate the gel, and in the second step it is coupled to an  $\text{NH}_2$ -derivatized gel using a carbodiimide cross-linking agent. While the preparation of this gel is expensive, it can be reused many times.

1. To convert hyaluronan to the appropriate size, 1 g of the hyaluronan is dissolved in 500 mL of 0.15 M NaCl, 0.15 M Na acetate pH 5.0 and then incubated with 4000 U of testicular hyaluronidase (type VI-S, Sigma) for 3 h at room temperature. The digestion is stopped by placing the sample in a boiling water bath for 20 min and then the sample is centrifuged (10,000g, 15 min) to remove any precipitate. Four volumes of ethyl alcohol are added to the solution, which is cooled to  $-20^\circ\text{C}$  for 1 h and then centrifuged (10,000g, 15 min) and the pellet of digested hyaluronan is collected. The precipitate is washed once in 75% alcohol to remove the acetate buffer.
2. For the coupling reaction, the digested hyaluronan (approx 1 g) is redissolved in a small volume of distilled water, mixed with 100 mL of the EAH Sepharose 4B and brought to a final volume of 250 mL. The suspension is placed on a shaking table (to avoid shearing the beads with a magnetic stirrer), the pH is adjusted to 4.7 and 2 g of the coupling agent 1-ethyl-3-(3-dimethylamino-propyl) carbodiimide is added to the mixture. Thereafter, the pH is continuously adjusted to 4.7 until the reaction has been completed (approx 3 h).
3. The mixture is allowed to sit over night, and then 10 mL of acetic acid is added to the suspension for a period of 6 h to block residual coupling agent. The gel is then transferred to a Buchner funnel and washed sequentially with 1 L each of: (a) 1 M NaCl, (b) 0.05 M formic acid, and (c) distilled water. The preparation is finally washed with 0.5 M Na acetate pH 5.7 plus a small amount of Na azide and is stored in this buffer at  $4^\circ\text{C}$  (see **Note 1**). The gel is stable for years.

#### 3.2. Isolation of b-PG

The preparation of b-PG involves a number of steps. First, the extract is treated with trypsin to reduce its size. Second, the biotin-coupling reaction is carried out on the crude preparation so that endogenous hyaluronan protects the binding site. And finally, affinity chromatography is carried out taking advantage of the fact that the binding of aggrecan to hyaluronan is reversed by 4 M guanidine HCl.

1. The bovine nasal cartilage is thawed out and stripped of associated membranes with a pair of pliers, and then shredded with a Surform pocket plane. This step may take 1 d.
2. The shredded cartilage is weighed and mixed with 10 mL of 4 M guanidine HCl, 0.5 M Na acetate pH 5.8 for each gram of cartilage. The mixture is placed in a large beaker and placed on a shaking table at  $4^\circ\text{C}$  overnight (the solution is generally too thick to use a stirring bar).
3. To remove the solid material, pour the extract through several layers of prewashed cheese cloth. The fluid is then centrifuged (10,000g, 45 min,  $4^\circ\text{C}$ ) and the supernatant is passed through a filter paper (Whatman no. 1, Whatman, Clifton, NJ) on a Buchner funnel.
4. The extract is then placed in large dialysis tubes (3.3 cm) and dialyzed against running tap water (leave plenty of room for the swelling of the dialysis bag because of osmosis).

Dialyze first against running tap water overnight and then against several changes of distilled water (it is necessary to remove the last traces of guanidine HCl that interfere with the biotin reaction).

5. The dialyzed extract is then lyophilized for long-term storage. For this, the extract is poured into ice cube trays, frozen, and then placed in a lyophilization bottle. This step may take several days (*see Note 2*).
6. Approximately 3 g of the lyophilized extract is mixed with 100 mL of 0.1 M HEPES, 0.1 M Na acetate pH 7.3, and is stirred overnight at 4°C to dissolve. The resulting mixture will be opaque and lumpy. In some cases, it may be desirable to further dialyze this sample against the above buffer to make sure that all of the guanidine has been removed.
7. Add 1.6 mg of purified trypsin to the mixture and then incubate at 37°C with occasional stirring. As the digestion progresses, the extract becomes less viscous. After 2 h, the digestion is stopped by adding 2 mg of soybean trypsin inhibitor and the pH is adjusted to 8.0.
8. Assay the protein content of the extract using a coomassie blue staining reagent (it should be between 5–10 mg/mL). Using the total amount of protein as a basis, add 1/10 the weight of sulfo-NHS-LC biotin to the sample. Allow the coupling reaction to proceed for 1–2 h at room temperature.
9. Dialyze the extract against three changes of 500 mL each of 4 M guanidine HCl, 0.5 M Na acetate, pH 5.8. The guanidine solutions can be reused several times for the first two changes, however, the final concentration of the extract should be close to 4 M guanidine HCl, 0.5 M Na acetate, pH 5.8.
10. Using a Buchner funnel, wash 100 mL of the HA-Sepharose with 4 M guanidine HCl, 0.5 M Na acetate, pH 5.8. and then transfer this gel to a beaker containing the extract. The mixture is poured into a large dialysis bag (leaving room for expansion) and placed in a beaker with nine volumes of distilled water. For the first 4 h, it is important to resuspend the beads that have settled out by inverting the bag upside down every 30 min. The beaker is then shaken overnight on a rotary table in the cold room.
11. Degas the mixture in a vacuum and pour into a column of the appropriate size. The gel is then washed with 200 mL of 1 M NaCl followed by a 400-mL linear gradient of from 1 to 3 M NaCl. At this point, the column is connected to a fraction collector (2.5 mL fractions) and the specifically bound proteins are eluted with 4 M guanidine HCl, 0.5 M Na acetate, pH 5.8. Each fraction is monitored for protein and those containing most of the protein are pooled and dialyzed against 0.15 M NaCl (*see Note 3*).
12. The concentration is adjusted to 200 µg/mL and then mixed with an equal volume of glycerol (100 µg/mL final concentration). Between 1 and 3 mg of the b-PG is generally obtained. This can be stored at –20°C, and is stable for a number of years (*see Note 4*).

### 3.3. Histochemistry of Hyaluronan with b-PG

The b-PG reagent is excellent for the histochemical localization of hyaluronan in tissue sections.

1. While fixation in formaldehyde by itself results in adequate preservation, Lin et al. has found that acid formalin in 70% alcohol provides superior retention of hyaluronan (7). The use of cetylpyridinium chloride to help retain the hyaluronan is not advised.
2. The fixed tissue can then be processed and sectioned by a variety of techniques. These include direct cryostat sectioning, as well as paraffin and polyester wax embedding (8). Because hyaluronan has a very stable structure, preservation of its structural integrity is generally not a problem.



3. The sections are rehydrated, by two 5 min incubations in the following solutions. Clearing agent (Americlear); 100% ethyl alcohol; 95% alcohol, 75% alcohol, and then water. The sections are then incubated for 5 min in 10% H<sub>2</sub>O<sub>2</sub> to inactivate endogenous peroxidases. The sections are then rinsed in two washes of water and finally in PBS-A.
4. The slides are placed on a moist sponge in a covered baking pan and overlaid with a solution of 8–10 µg/mL of b-PG dissolved in 10% calf serum, 90% PBS-A (make sure the sections do not dry out). After 1 h the slides are washed for 5 min in PBS-A.
5. The sections are incubated for 15 min with a 1–500 dilution of streptavidin coupled to horse radish peroxidase in 10% calf serum, 90% PBS-A. Following the incubation, the slides are washed for 5 min in PBS-A.
6. The sections are then incubated with a substrate for horse radish peroxidase. We use 3-amino-9-ethylcarbazole that is particularly sensitive and gives rise to an intense red precipitate (9). This should be prepared immediately before use in the following manner:
  - a. Dissolve 2 mg of 3-amino-9-ethylcarbazole in 0.5 mL of dimethyl formamide (or dimethyl sulfoxide).
  - b. Mix with 9.5 mL of 0.05 M Na acetate, pH 5.0.
  - c. Pass solution through a 0.45-µm filter. The solution should be clear at this point.
  - d. Add 10 µL of 30% H<sub>2</sub>O<sub>2</sub> (1 µL per mL).
  - e. Apply substrate to the slides. The reaction product has an intense red color. The incubation time can vary from less than 5 min to more than 30 min depending upon the section. Monitor the progress of the reaction by observing the slide under low magnification.
  - f. Stop the reaction by washing section in PBS-A (or distilled water for hematoxylin staining).
7. If counter staining is desired, then the section can be dipped in Mayer's hematoxylin for 4 min, and then washed sequentially in distilled water, PBS-A and finally distilled water.
8. For permanent preservation of the stain, the sections can be coated with Crystal/mount (Biomedica) before attaching a cover slip.
9. To control for nonspecific staining, two different procedure may be used. First, the b-PG may be mixed with 0.1 mg/mL hyaluronan prior to application to the section. Alternatively, the sections may be pretreated with hyaluronidase. In our hands, the nonspecific staining is minimal (*see Note 5*).

### 3.4. An Enzyme-Linked Assay for Hyaluronan

This assay is based upon the ability of a sample of hyaluronan to bind to b-PG in solution and prevent it from binding to hyaluronan that is attached to a plastic substrate (2). In our hands, the assay is sensitive to concentrations of hyaluronan between 50 ng/mL and 1 µg/mL.

1. The first step of this protocol is to coat plates with hyaluronan. It is important to note that pure hyaluronan by itself does not attach to plastic surfaces or nitrocellulose (however, crude preparations of hyaluronan, which are often associated with protein, will stick via the protein). Our approach is to couple hyaluronan to bovine serum albumin (HA-BSA) that adheres tightly to the plastic. For this, 100 mg of hyaluronan is dissolved in 500 mL of 0.2 M NaCl and the pH is adjusted to 4.7. To this is added 100 mg of bovine serum albumin followed by 20 mg of 1-ethyl-3(3-dimethylaminopropyl) carbodiimide. The pH is maintained at 4.7 for 1 h and then the solution is dialyzed extensively against PBS-A. The HA-BSA is aliquoted into 96 well plates (100 µL/well) and incubated for 30 min. The wells of the plate are then washed with PBS-A and then blocked with 10% calf serum, 90% CMF-PBS.

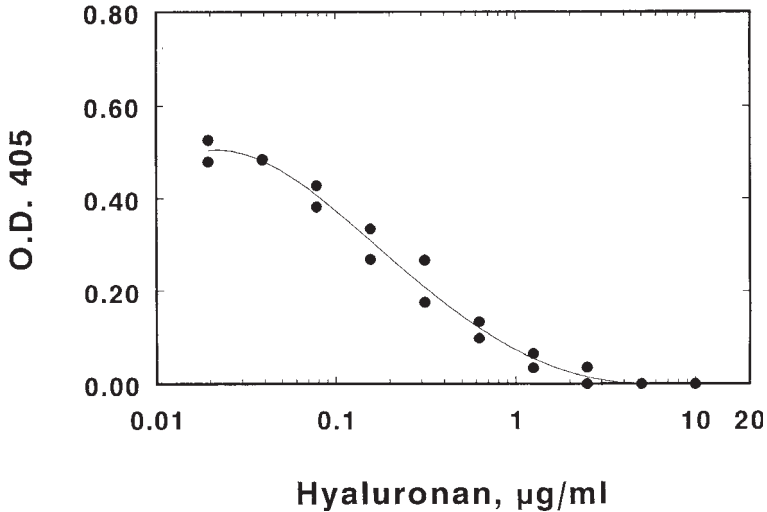

Fig. 1. Example of a standard curve for hyaluronan using the b-PG enzyme-linked assay. Varying amounts of standard hyaluronan were mixed with a set amount of b-PG and the mixtures were added to wells of a microtiter plate that had been precoated with HA-BSA. The amount of b-PG bound to the plate was then determined by the addition of peroxidase-labeled streptavidin, followed by a substrate for peroxidase.

2. In the next step, hyaluronan is released from the samples by digesting them overnight with trypsin or pronase (0.5 mg/mL, 37°C), which is then inactivated by heating to 100°C for 20 min. These samples, as well as a standard containing a known amount of hyaluronan, are serially diluted with PBS-A (100 µL per dilution).
3. An equal volume of 1 or 4 µg/mL b-PG in 10% calf serum, 90% PBS-A is added to each dilution and mixed for 1 h. Duplicate 50 µL aliquots of each dilution are then added to the wells of the 96-well plates that had been precoated with HA-BSA as described earlier. After shaking for 1 h, the plates are thoroughly washed with water and then incubated for 20 min with 100 µL/well of peroxidase labeled streptavidin diluted 1–500 in 10% calf serum, 90% PBS-A.
4. The plates are again washed with water and then to each well is added 100 µL of a peroxidase substrate consisting of 0.03% H<sub>2</sub>O<sub>2</sub>, 0.5 mg/mL 2,2' azinobis (3-ethylbenzthiazoline sulfonic acid) in 0.1 M Na citrate pH 4.2. After 30 min, the reaction is terminated by the addition of 25 µL/well of 2 mM NaN<sub>3</sub>. The OD<sub>405</sub> is determined using an ELISA reader.
5. When the OD<sub>405</sub> of the standard is then plotted on semi-log paper, the curve is linear over the range from 50 ng/mL to 1 µg/mL of hyaluronan (*see Fig. 1*). Reading from test samples should be restricted to this central linear region. Control experiments showed that 10 µg/mL of chondroitin sulfate and heparin had little or no effect on the binding of b-PG to the plate.

#### 4. Notes

1. The use of a Buchner funnel greatly facilitates the processing of the Sepharose. To transfer the gel from the funnel to a beaker, first allows the buffer to flow into the gel, release the vacuum, then rim the wall of the funnel with a spatula to separate the gel from the edge. Reapply the vacuum until the gel shrinks on top of the filter paper. The funnel is inverted and gel can be held as the filter paper is removed.

2. In some cases, we omit this lyophilization step, which saves a considerable amount of time. In this case, the appropriate amount of solid Hepes and Na acetate is added directly to the dialyzed extract.
3. To collect the b-PG in a minimal amount of buffer, it is important to keep a sharp interface with the guanidine buffer eluting the gel. To accomplish this, allow the 3 M NaCl to run into the top of the gel and then apply the 4 M guanidine to the top of the gel by inverting a 10-mL pipet so that the large opening is on the bottom.
4. Freeze thawing of the b-PG preparation in the absence of glycerol leads to a significant loss of binding activity.
5. Several factors influence the staining of hyaluronan with b-PG. First, the b-PG will only stain hyaluronan that is available to it. For this reason, the hyaluronan in cartilage does not stain because it is already complexed with proteins. Second, the hyaluronan may be lost from the section. When the synovial cavity is stained histochemically, no staining is observed because the hyaluronan is lost from the section.

### Acknowledgment

This work was supported by the USAMRMC under grant number DAMD17-94-J-4173.

### References

1. Green, S. J., Tarone, G., and Underhill, C. B. (1988) Distribution of hyaluronate and hyaluronate receptors in the adult lung. *J. Cell Sci.* **89**, 145–156.
2. Underhill, C. B., Nguyen, H. A., Shizari, M., and Culty, M. (1993) CD44 positive macrophages take up hyaluronan during lung development. *Dev. Biol.* **155**, 324–336.
3. Knudson, C. B. and Toole, B. P. (1985) Fluorescent morphological probe for hyaluronate. *J. Cell Biol.* **100**, 1753–1758.
4. Ripellino, J. A., Klinger, M. M., Margolis, R. U., and Morgolis, R. K. (1985) The hyaluronic acid binding region as a specific probe for the localization of hyaluronic acid in tissue sections. *J. Histochem. Cytochem.* **33**, 1060–1066.
5. Tengblad, A. (1979) Affinity chromatography on immobilized hyaluronate and its application to the isolation of hyaluronate binding proteins from cartilage. *Biochim. Biophys. Acta* **578**, 281–289.
6. Cambiaso, C. L., Goffinet, A., Vaerman, J.-P., and Heremans, J. F. (1975) Glutaraldehyde-activated aminoethyl-derivative of Sepharose as a new versatile immunoadsorbent. *Immunochemistry* **12**, 273–278.
7. Lin, W., Shuster, S., Maibach, H. I., and Stern, R. (1997) Patterns of hyaluronan staining are modified by fixation techniques. *J. Histochem. Cytochem.* **45**, 1157–1163.
8. Kusakabe, M., Sakakura, T., Nishizuka, Y., Sano, M., and Matsukage, A. (1984) A polyester wax embedding and sectioning technique for immunohistochemistry. *Stain Technol.* **59**, 127–132.
9. Graham, R. C., Lundholm, U., and Karnovsky, M. J. (1965) Cytochemical demonstration of peroxidase activity with 3-amino-9-ethyl carbazole. *J. Histochem. Cytochem.* **13**, 150–158.

## Microinjection of Fluorescently Labeled $\alpha$ -Actinin into Living Cells

Jean M. Sanger, Barbara A. Danowski, and Joseph W. Sanger

### 1. Introduction

The introduction of microinjection of trace amounts of a fluorescently labeled protein (**1,2**) into cultured cells leads to its incorporation into the cell's pool of endogenous protein. Provided the microinjected protein has retained the properties of the native protein, it will become incorporated into the same structures as the endogenous protein and will serve, therefore, as a marker of the native protein's distribution in the cell. This allows the changes in a protein's localization to be followed in live cells in response to normal functions such as movement (**3**) or division (**4**) or formation of structures like stress fibers or myofibrils (**5–9**). Responses of the protein to inhibitors of cell function (**11,12**), or to interactions of the injected cell with other cells such as bacteria, can also be analyzed within a single live cell (**13**).

$\alpha$ -Actinin is a component of the actin cytoskeleton in nonmuscle and muscle cells. It is localized most prominently in focal contacts and in the dense bodies of stress fibers of nonmuscle cells and in the Z-bands of muscle cells (**14–17**). Microinjection of trace amounts of fluorescently labeled  $\alpha$ -actinin into cultured cells provides a view of these structures as they undergo dynamic rearrangements in response to changes in cell activity (**10**). This chapter outlines the steps involved in preparing (**18**) and labeling  $\alpha$ -actinin with a fluorescent dye (**2,19,20**), and discusses the requirements for microinjection of the labeled protein into cells and observation of the live microinjected cells. The same principles would apply to labeling and microinjection of other proteins.

### 2. Materials

1. Container that will hold 8–10 L of distilled water. Keep in cold room (4°C). Replenish as needed.
2. Homogenizing solution is distilled water plus 0.5 mM PMSF. Normally, we make a 0.5-M solution of PMSF in DMSO (or methanol), and then add 1 mL per liter of solution, for 0.5 mM final concentration. Two liters of cold distilled H<sub>2</sub>O with 2 mL 0.5 M PMSF (0.261 g/3 mL methanol) added just before use.
3. Buffers:
  - a. Buffer A: 1 L 2 mM Tris base, 1 mM EGTA, titrated with NaOH to pH 9.0.
  - b. Stock 4X Buffer B: 4 L of a 4X stock solution of Buffer B. (8 to 9 liters of 1X Buffer B will be used for one preparation.)

From: *Methods in Molecular Biology*, Vol. 137: *Developmental Biology Protocols*, Vol. III  
Edited by: R. S. Tuan and C. W. Lo © Humana Press Inc., Totowa, NJ

Formula for 4X Buffer B:

80 mM Tris base	9.69 g/L = 38.76 g/4 L
80 mM NaCl	4.68 g/L = 18.72 g/4 L
0.4 mM EDTA	0.15 g/L = 0.62 g/4 L
0.002% NaAzide*	32 mL/4 L

Adjust the pH to 7.6 with glacial acetic acid. Keep at 4°C. Store at 4°C (in your cold room).

\*Stock solution of NaAzide is 10% (10 g plus distilled water to make 100 mL solution).

- c. 1X Buffer B. Dilute 1 L of 4X Buffer B with 3 L of cold water. Adjust pH to 7.6 again with glacial acetic acid. Add 600 mg DTT to 4 L Buffer B just before use.
4. Frozen chicken gizzards (Pel-Freeze Biologicals, Rogers, AR).
5. Iodoacetamidotetramethyl rhodamine (IATR, Molecular Probes, Eugene, OR).
6. Sephadex preppacked G-25 column (PD-10 columns; code no. 17-0851-01; Pharmacia, Piscataway, NJ).
7. Standard salt solution: 2.7 mM KCl, 138 mM NaCl, 1.1 mM KH<sub>2</sub>PO<sub>4</sub>, 8.1 mM Na<sub>2</sub>HPO<sub>4</sub>, 0.5 mM MgCl<sub>2</sub>, 1.0 mM CaCl<sub>2</sub>, pH 7.2.
8. Thin-wall borosilicate glass capillaries with an inner filament (World Precision Instruments, Inc., Sarasota, FL, or Clark Electromedical Instruments, Reading, UK). Choose the outer diameter of the capillaries to fit the needle holder of the microinjector—either 1.0 or 1.5 mm.
9. Upright or horizontal micropipet puller (Sutter Instrument Co., Novato, CA).
10. Micromanipulator and microinjection apparatus.
11. Oxyrase (Oxyrase Inc., Mansfield, OH).

### 3. Methods

#### 3.1. Purification of $\alpha$ -Actinin

1. Turn on Sorvall RC-5 centrifuge (Sorvall, Newtown, CT) to 4°C and spin GSA rotor for 10 min at 10,000g to cool. Start warm water bath (37°C) to warm the 1 L solution of Buffer A.
2. Weigh out 100–150 g chicken gizzard, partially thaw at room temperature for 10–15 min, and place on ice in cold room (*see Note 1*). Add 2 mL PMSF to the 2 L of cold dH<sub>2</sub>O (homogenizing solution).
3. Trim fat from gizzards. Leave them in cold room (4°C) for about 1 h before use. Put half the gizzards in a Waring blender with 500-mL homogenizing solution (1X Buffer B). Pulse the blender blades 4X for 10 s each, with 10-s intervals between pulses. Put gizzard mixture into three Sorvall bottles, and repeat the blending with the remaining gizzards and 500 mL homogenizing solution.
4. Spin bottles in the Sorvall centrifuge at 4°C for 15 min at 10,000g. Discard the supernatant and resuspend the pellets with a spatula in a small amount of homogenizing solution.
5. Repeat **step 3**, pulsing half the resuspended pellets at a time in 500-mL homogenizing solution using only one 10-s pulse.
6. Centrifuge at 4°C for 15 min at 10,000g. Discard the supernatant and resuspend the pellets in 1 L Buffer A, 37°C. Readjust pH to 9 using 1 M NaOH (*see Note 2*), and add 1 mL 0.5 M PMSF to the mixture. Allow centrifuge to warm to room temperature.
7. Stir resuspended mixture gently in 37°C water bath, using a large, football-shaped stir bar allowing it to reach 37°C, and then stir for 30 min more, keeping the temperature at 37°C.
8. Centrifuge the suspension at 10,000g for 15 min at room T. Collect the supernatant by filtering it through cheese cloth placed over a 1-L graduated cylinder. Liquid should be clear to partly cloudy yellowish-brown. Measure volume and transfer to 2 L beaker.

9. Titrate to pH 7–7.2 with 0.5 M glacial acetic acid. Add 1 M  $\text{MgCl}_2$ , to give a final concentration of 10 mM. Stir at room temperature for 15 min. Mixture will go from clear to cloudy.
10. Centrifuge for 10 min at 10,000g at room temperature. Collect supernatant, measure volume, and bring temperature down with ice bath to  $< 8^\circ\text{C}$ . This will take approx 1 h.
11. Slowly, over 10–15 min, add 14.9 g solid  $(\text{NH}_4)_2\text{SO}_4$ , per 100 mL supernatant, stirring gently in the cold for 30 min.
12. Centrifuge for 25 min at 10,000g,  $4^\circ\text{C}$ . Collect supernatant and add 5.6 g of  $(\text{NH}_4)_2\text{SO}_4$  per 100 mL supernatant. Stir gently in the cold for 30 min.
13. Centrifuge for 20 min at 12,000 rpm,  $4^\circ\text{C}$ . Discard supernatant and dissolve the pellets in Buffer B using 2–3 mL per cup. Combine the pellets, rinse the cups using not more than 20–30 mL total volume, and dialyze against 4 L Buffer B overnight in the coldroom.
14. Remove solution from dialysis bag and centrifuge in the small rotor (SS34) at 17,000g for 20–25 min at  $4^\circ\text{C}$ . Collect supernatant with transfer pipet and place into a 50 or 100 mL beaker. The conductance of the sample should be lower than the conductance of the buffer in the DE-52 column. If it is not, add cold distilled water to lower the conductance of the sample. Typically, for a sample of 35 mL, 10–17 mL of water is added (i.e., the sample volume is increased approx 30–50% with distilled water. If you cannot measure the conductance of the sample, dilute your preparation one to one with cold distilled water.)
15. Remove 50  $\mu\text{L}$  for a gel sample. Load the protein onto a DE-52 column ( $2.5 \times 45$  cm) that has been equilibrated overnight with Buffer B. Wash with 1–3 column volumes (200–300 mL) of Buffer B, and elute the proteins with a linear gradient of 0–370 mM NaCl, collecting 3 mL fractions.
16. Using OD measurements at 280 nm, take gel samples of protein fractions eluted. The last major peak should contain  $\alpha$ -actinin running at 95 kD.
17. Pool the  $\alpha$ -actinin fractions and determine protein concentration with a OD reading at 280 nm (see **Note 3**). Add  $(\text{NH}_4)_2\text{SO}_4$  at 26 g/100 mL stirring for 30 min in the cold.
18. Centrifuge at 17,000g for 20 min at  $4^\circ\text{C}$ . Discard supernatant and dissolve pellet in a minimum volume of Buffer B in preparation for loading on Sepharose Cl-6B column ( $2.5$  cm  $\times$  90 cm) (see **Note 4**).
19. Centrifuge the dissolved protein to clarify it at 12,000g for 20 min,  $4^\circ\text{C}$ .
20. Load the protein onto a Cl-6B column that has been preequilibrated with 4 L Buffer B. Elute with Buffer B and pool the fractions from the major peak.
21. Add  $(\text{NH}_4)_2\text{SO}_4$  at 26 g/100 mL in the same manner as before, and centrifuge at 17,000g for 20–25 min,  $4^\circ\text{C}$ .
22. Dissolve the pellet in 8 mL of 1 mM  $\text{KHCO}_3$ , place in dialysis bag and dialyze overnight against 4 L 1 mM  $\text{KHCO}_3$ . Measure the protein concentration as in **step 17**. The protein is now ready for labeling.

### 3.2. Labeling of $\alpha$ -Actinin with IATR (Iodoacetamidotetramethyl Rhodamine)

1. To label 10 mg of  $\alpha$ -actinin (at a concentration of at least 10 mg/mL), dissolve 0.5 mg of dye (IATR) in a volume of 200 mM Na-borate buffer equal to the volume of  $\text{KHCO}_3$  solution containing 10 mg  $\alpha$ -actinin. Fifty micrograms  $\mu\text{g}$  of dye per mg of protein is used.
2. Stir the dye at room temperature for 30–60 min and then remove undissolved dye by spinning in a clinical desktop centrifuge for 3 min.
3. Add the Na-borate buffer/dye solution to the  $\alpha$ -actinin in a 50-mL beaker. Cover with foil and stir in pan of ice for 3–4 h in the cold.

4. Add 50 mM of  $\beta$ -mercaptoethanol (20  $\mu$ L per 6.5 mL protein/dye mixture) to protein/dye mixture to stop the reaction.
5. Spin at 12,000g for 15 min in a glass test tube to clarify.
6. Equilibrate a disposable Pharmacia G-25 syringe column (Pharmacia & Upjohn, Kalamazoo, MI) (10-mL volume) with 25 mL 1 mM  $\text{KHCO}_3$ .
7. Load the labeled protein on the column, and allow it to enter the beaded layer. (One should not load more than 2.5 mL of protein solution in an individual column. If there is a larger volume of labeled protein, use a second equilibrated column.)
8. When the entire protein sample is in the column, elute with 1 mM  $\text{KHCO}_3$  collecting the pink-colored fraction (*see Note 5*). Dialyze against 1 mM  $\text{KHCO}_3$ , pH 7 and adjust concentration to 0.5–1.0 mg/mL for microinjection.

### 3.3. Permeabilized Cell Assay for IATR Labeled $\alpha$ -Actinin

1. Culture on glass coverslips (preferably cells from a cell line like PtK2 (7,10,17) that has a lot of stress fibers).
2. Remove the culture medium and place the cells in 0.02% Nonidet P-40 detergent in standard salt for 1–5 min at room T.
3. Wash 5X in cold standard salt for total of 10 min.
4. Remove standard salt and add 30–35  $\mu$ L IATR- $\alpha$ -actinin to a coverslip and place in dark humidity chamber in the cold for 30 min.
5. Wash 3X with cold standard salt.
6. Add 30–35  $\mu$ L fluorescein or bodipy phalloidin to coverslips and place in dark humidity chamber in the cold for 15 min.
7. Wash 3X with standard salt.
8. Fix with paraformaldehyde for 15 min.
9. Wash 3X with standard salt.
10. Mount in mounting medium and observe cells with epifluorescence and a 60 or 100X objective. The phalloidin-positive stress fibers should show a beaded distribution of IATR- $\alpha$ -actinin (20,21).

### 3.4. Microinjection and Observation of Cells

1. Filter a small amount (50–100  $\mu$ L) IATR- $\alpha$ -actinin through a 0.2- $\mu$ m syringe filter to remove any particles.
2. Pull a microneedle with a tip about 0.5  $\mu$ m in diameter and load the labeled protein into the needle by touching the blunt end of the needle to a drop of the protein or immersing the blunt end into a small tube of the protein (*see Note 6*).
3. Microinject cells on an inverted microscope with phase-contrast objective of 20 or 40X and a long working distance condenser (*see Note 7*). The cells can be grown directly on the plastic surface of a 35 mm culture dish or on a coverslip that is placed in the dish, or cemented over an opening drilled into the bottom of the dish (MatTek Corp., Ashland, MA) (*see Note 8*).
4. The injected cells can be observed immediately or returned for a time to the  $\text{CO}_2$  incubator. For observation of the IATR- $\alpha$ -actinin signal in live cells, a 60 or 100X high numerical aperture objective lens is required and epifluorescence imaging with a rhodamine filter cube. Phase-contrast or DIC imaging of the same field will provide a reference image of the cell, the nucleus and other organelles. The coverglass-bottom MatTek dishes are ideal for observing cells with an inverted microscope. Culture medium can be removed and added easily to the cells on the microscope stage. The cells should be maintained at 36°C with a heated stage or heat curtain (ASI 400 Air Stream Incubator, NevTek, Burnsville,

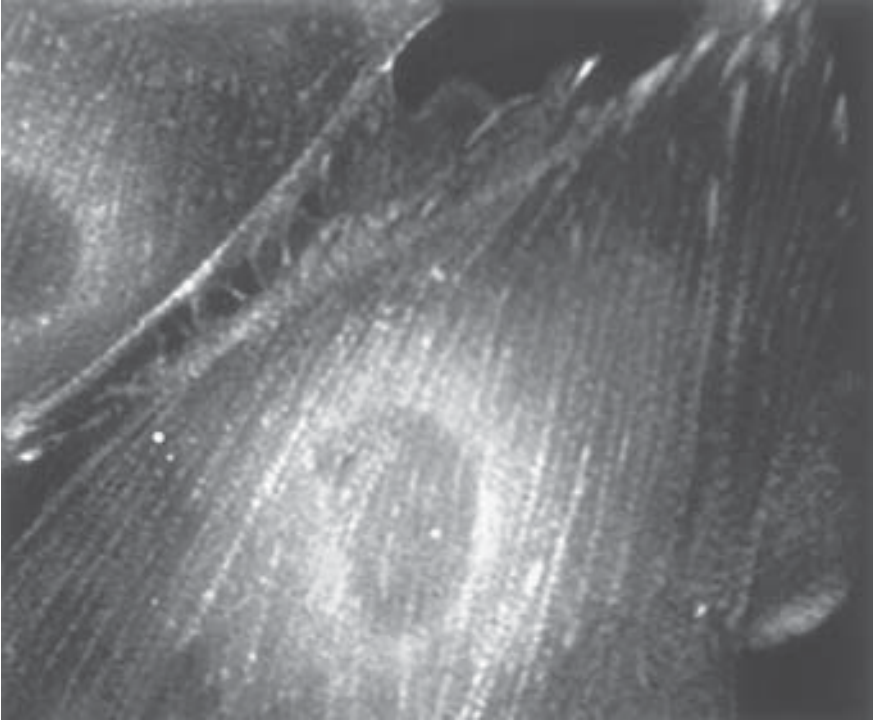

Fig. 1. PtK2 cell was microinjected with IATR- $\alpha$ -actinin. Note the periodic distribution of the labeled protein along the stress fibers. The ends of the stress fibers are marked by concentrations of  $\alpha$ -actinin, i.e., attachment plaques.

VA). The cells should be either in a HEPES-buffered culture medium or in an atmosphere of 5% CO<sub>2</sub>. The latter can be achieved with a small homemade chamber formed by inverting the bottom of a 100-mm culture dish over the smaller MatTek culture dish, inserting a syringe needle in the side of the 100-mm dish through a small hole made with a heated needle, and flowing CO<sub>2</sub> through tubing connecting the syringe needle to a tank of 5% CO<sub>2</sub>. A small weight is used to hold the 100-mm dish down firmly, on the microscope stage, and humidity is provided with a reservoir of distilled water placed on the stage under the 100-mm chamber. For long periods of observation, the culture medium is replaced with fresh medium every 6–12 h. In order to minimize photooxidative damage to the cells during long-term viewing, 10- $\mu$ L per mL of Oxyrase can be added to the medium (22).

The rhodamine signal from the injected cells is just visible to the eye, and an intensified video camera such as SIT (Dage MTI, Michigan City, IN) or a cooled CCD camera (Hamamatsu, Bridgewater, NJ; Princeton Instruments, Trenton, NJ; or Photometrics, Tuscon, AZ) is needed to acquire images. **Figure 1** illustrates a SIT image of two PtK2 cells microinjected with fluorescently labeled  $\alpha$ -actinin localized in attachment plaques and ruffles, and in a banded pattern, along stress fibers. A 32-frame average (1 s) of the fluorescent signal was acquired and sharpened with Metamorph image processing software (Universal Imaging, Inc., West Chester, PA). **Figure 2** shows a cardiomyocyte isolated from a 5-d chick embryo. Microinjected  $\alpha$ -actinin was incorporated into the Z-bands of the myofibrils in the center of the cell and in the Z-bodies of the shorter nascent and premyofibrils nearer the cell periphery (*see Note 9*). A 32-frame average of the SIT image



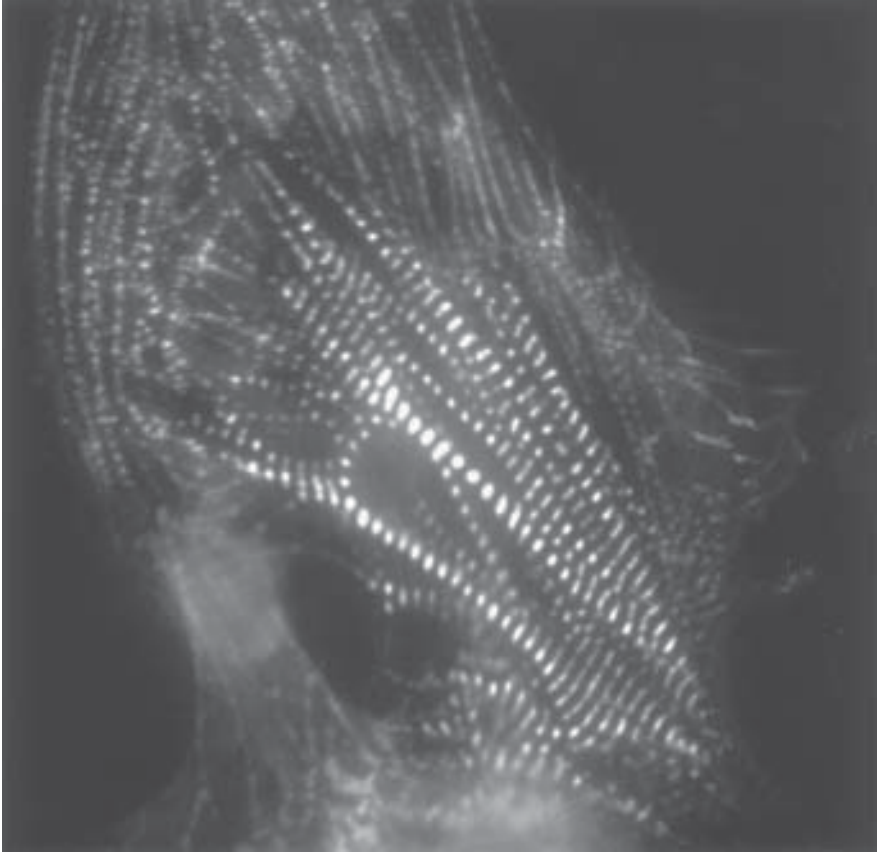

Fig. 2. Embryonic cardiomyocyte was microinjected with IATR- $\alpha$ -actinin. The central mature myofibrils exhibit concentrations of the labeled protein in the Z-bands, boundaries of sarcomeres. The spacings between these adjacent Z-bands are about 2  $\mu$ m. Premyofibrils with their shorter  $\alpha$ -actinin rich Z-bodies (boundaries of the minisarcomeres) are detected at the spreading edges of this cell. The premyofibrils will grow and fuse to form mature myofibrils (26).

was acquired and enhanced with Metamorph image processing software (Universal Imaging, Inc., West Chester, PA).

#### 4. Notes

1. All steps except 7–10 should be carried out in the cold.
2. The pH of the resuspended mixture will be about pH 7.0.
3.  $[\alpha\text{-Actinin mg/mL}] = \text{OD } 280/1.1$
4. For the best resolution on Sepharose sizing columns, the volume loaded should not be greater than 4% of the column volume. Our column volume is approx 530 mL, so the volume of the protein solution to be greater than approx 10 mL.
5. The protein is in the faint pink layer that comes off first and is separated by clear effluent and a dark band of free dye.
6. The filament in the glass needle promotes capillary flow of a small amount of fluid into the end of the tip. Some labeled proteins like vinculin and talin stick to glass. Therefore, for such proteins, the unpulled glass capillaries should be dipped into a silicon solution

like Sigmacote (Sigma Chemical, St. Louis, MO) and placed upright on filter paper to drain and dry before pulling. In this case, the labeled protein is introduced into the tip of the capillary by back loading from a syringe with a long needle or fine tubing (MicroFil™, World Precision Instruments, Sarasota, FL) that fits into the glass capillary.

7. Micromanipulators are commercially available from several sources and can be mechanical (Leica, Rockleigh, NY), hydraulic (Narishige, Greenvale, NY) or motorized (Eppendorf, Hamburg, Germany). Injection can be via a homemade pressure injection system (23) or commercial system (Narishige; Eppendorf).
8. Most cultures of cells can remain on the stage of the injection microscope for up to 60 min at room temperature in the usual culture medium.
9. It can be advantageous to inject muscle cells in medium that contains an inhibitor of muscle contraction (20 mM 2,3-butanedione monoxime, Sigma Chemical Co.), or of calcium ion influx (1 mM verapamil, Sigma Chemical Co.) prior to microinjection (24). This approach is particularly valuable for the microinjection of adult heart muscle cells (25). After microinjection, the dishes are rinsed with control medium to remove the inhibitor.

## Acknowledgments

This work is supported in part by grants from the NSF (DCB 19041 to Jean M. Sanger), NIH (HL-48954 to Joseph W. Sanger), USDA (to Joseph W. Sanger and Jean M. Sanger) and the MDA (to Joseph W. Sanger).

## References

1. Kreis, T. E. and Birchmeir, W. (1982) Microinjection of fluorescently labeled proteins into living cells with emphasis on cytoskeletal proteins. *Int. Rev. Cytol.* **75**, 209–228.
2. Feramisco, J. R. (1979) Microinjection of fluorescently labeled alpha-actinin into living fibroblasts. *Proc. Natl. Acad. Sci. USA* **76**, 3967–3971.
3. Taylor, D. L., Amato, P. A., Luby-Phelps, K., and McNeil, P. (1984) Fluorescent analog cytochemistry. *Trends Biochem. Sci.* **9**, 88–91.
4. Salmon, E. D., Leslie, R. J., Saxton, W. M., Karow, M. L., and McIntosh, J. R. (1984) Spindle dynamics in sea urchin embryos: analysis using a fluorescent labeled tubulin and measurements of fluorescence redistribution after laser photobleaching. *J. Cell Biol.* **99**, 2165–2174.
5. Danowski, B. A. (1998) Microtubule dynamics in serum-starved and serum-stimulated Swiss 3T3 mouse fibroblasts: implications for the relationship between serum-induced contractility and microtubules. *Cell Motil. Cytoskel.* **40**, 1–12.
6. Mittal, B., Sanger, J. M., and Sanger, J. W. (1987) Visualization of myosin in living cells. *J. Cell Biol.* **105**, 1753–1760.
7. Sanger, J. M., Mittal, B., Dome, J. S., and Sanger, J. W. (1989) Analysis of cell division using fluorescently labeled actin and myosin in living PtK2 cells. *Cell Motil. Cytoskel.* **14**, 201–219.
8. Wang, Y.-L. (1984) Reorganization of actin filament bundles in living fibroblasts. *J. Cell Biol.* **99**, 1478–1485.
9. Sanger, J. M., Mittal, B., Pochapin, M. B., and Sanger, J. W. (1986) Myofibrillogenesis in living cells microinjected with fluorescently labeled alpha-actinin. *J. Cell Biol.* **102**, 2053–2066.
10. Sanger, J. M., Pochapin, M. B., Mittal, B., and Sanger, J. W. (1987) Stress fiber and cleavage furrow formation in living cells microinjected with fluorescently labeled alpha-actinin. *Cell Motil. Cytoskel.* **7**, 209–220.

11. Sanger, J. M., Dabiri, G., Mittal, B., Kowalski, M. A., Haddad, J. G., and Sanger, J. W. (1990) Disruption of microfilament organization in living non-muscle cells by microinjection of Vitamin-D binding protein or DNase I. *Proc. Natl. Acad. Sci. USA* **87**, 5474–5478.
12. Dabiri, G., Sanger, J. M., Portnoy, D., and Southwick, F. (1990) *Listeria monocytogenes* moves rapidly through the host cell cytoplasm by inducing directional actin assembly. *Proc. Natl. Acad. Sci. USA* **87**, 6068–6072.
13. Pavalko, F. M. and BurrIDGE, K. (1991) Disruption of the actin cytoskeleton after microinjection of proteolytic fragments of alpha-actinin. *J. Cell Biol.* **114**, 481–491.
14. Masaki, T., Endo, M., and Ebashi, S. (1968) Localization of 6S component of alpha-actinin at Z-Bands. *J. Biochem. (Tokyo, Japan)* **62**, 630–632.
15. Lazarides, E. and BurrIDGE, K. (1975) Alpha-actinin: immunofluorescent localization of a muscle structural protein in non-muscle cells. *Cell* **6**, 289–298.
16. Sanger, J. W., Sanger, J. M., and Jockusch, B. M. (1983) Differences in the stress fibers between fibroblasts and epithelial cells. *J. Cell Biol.* **96**, 961–969.
17. Turnacioglu, K. K., Sanger, J. W., and Sanger, J. M. (1998) Sites of monomeric actin incorporation in living PtK2 and REF-52 cells. *Cell Motil. Cytoskel.* **40**, 59–70.
18. Feramisco, J. R. and BurrIDGE, K. (1980) A rapid purification of alpha-actinin, filamin and a 130,000 dalton protein from smooth muscle. *J. Biol. Chem.* **255**, 1194–1199.
19. McKenna, N., Meigs, J. B., and Wang, Y.-L. (1985) Exchangeability of alpha-actinin in living cardiac fibroblasts and muscle cells. *J. Cell Biol.* **103**, 2163–2171.
20. Sanger, J. W., Mittal, B., and Sanger, J. M. (1984) Interaction of fluorescently labeled contractile proteins with the cytoskeleton in cell models. *J. Cell Biol.* **99**, 918–928.
21. Sanger, J. M., Dome, J. S., Mittal, B., Somlyo, A. V., and Sanger, J. W. (1989) Dynamics of the endoplasmic reticulum in living non-muscle and muscle cells. *Cell Motil. Cytoskel.* **13**, 301–319.
22. Waterman-Storer, C., Sanger, J. W., and Sanger, J. M. (1993) Dynamics of organelles in the mitotic spindle of living cells: membrane microtubule interactions. *Cell Motil. Cytoskel.* **26**, 19–39.
23. Sanger, J. M., Pochapin, M. B., and Sanger, J. W. (1985) Midbody sealing after cytokinesis in embryos of the sea urchin *Arbacia punctulata*. *Cell Tissue Res.* **240**, 287–292.
24. Bartoli, M. and Claycomb, W. C. (1997) Transfer of macromolecules into living adult cardiomyocytes by microinjection. *Mol. Cell. Biochem.* **172**, 103–109.
25. LoRusso, S. M., Imanaka-Yoshida, K., Shuman, H., Sanger, J. M., and Sanger, J. W. (1992) Incorporation of fluorescently labeled contractile proteins into freshly isolated living adult cardiac myocytes. *Cell Motil. Cytoskel.* **21**, 111–122.
26. Rhee, D., Sanger, J. M., and Sanger, J. W. (1994) The premyofibril: evidence for its role in myofibrillogenesis. *Cell Motil. Cytol.* **28**, 1–24.

## Pax3 and Vertebrate Development

Jonathan A. Epstein

### 1. Introduction

Pax3, a transcription factor expressed in the developing embryo, is a critical factor for the proper formation of the mammalian nervous, cardiovascular, and muscular systems. In the mouse, spontaneous mutations in *Pax3* resulting in complete loss of function have provided important models for the study of neural tube defects, congenital cardiac diseases affecting the outflow tract of the heart, and for the elucidation of the genetic pathways regulating myogenesis. In humans, haploinsufficiency of *PAX3* results in deafness, pigmentation defects, and other neural crest-related abnormalities as well as variable-limb myopathy. An impressive array of genetic and molecular analyses have been employed in order to understand the function of Pax3, and these will be the focus of this review.

The *Pax* genes in mammals consist of nine related genes each encoding a characteristic DNA binding domain termed the paired domain (reviewed in [1,2]). This structural motif has been conserved during evolution and remarkably similar genes are found in *Drosophila* (3,4) and *Caenorhabditis elegans* (5,6). X-ray crystallography and molecular data suggest that the paired DNA binding domain is composed of two subunits that each resemble another ancient structural motif, the homeodomain (7–9). The function of *Pax* genes has also been conserved across species, best exemplified by the surprising finding that Pax6 regulates development of the compound eye of the fruitfly as well as the mammalian ocular system (10–12). Other *Pax* genes have been found to be critical for skeletal, kidney, thyroid, B-cell, and pancreas development (reviewed [2]). The understanding of molecular pathways regulated by *Pax* genes, therefore, has broad implications.

### 2. The Splotch Mouse

In 1954, Auerbach described a spontaneous mutation in the mouse that caused coat color abnormalities characterized by a white belly spot explaining the label “Splotch” (13). Intercrosses of *Splotch* mice result in 25% of the offspring expiring prior to day 14 of gestation (E14), whereas another 25% appear normal (no belly spot), and 50% are viable, but display the characteristic pigmentation abnormality. Hence, *Splotch* behaves as a semidominant mutation with subtle abnormalities present in the heterozygotes

**Table 1**  
**Effects of *Pax3* Mutations in Humans and Mice**

	Syndrome or strain	Heterozygous phenotype	Homozygous phenotype
Human	Waardenburg syndrome	Deafness	Embryonic lethal?
		Dystopia canthorum	Anencephaly?
		Pigmentary defects	Deafness
		Limb muscle hypoplasia	Severe pigmentary defects Severe limb contractures
Mouse	<i>Spotch</i>	Pigmentary defects (white belly spot)	Neural tube defects Abnormal dorsal root ganglia, peripheral nervous system Cardiac outflow tract defects Absent limb musculature

In humans, Waardenburg syndrome types 1 and 3 are caused by mutations in *PAX3* and are autosomal dominant. Only rare homozygous patients have been described (23,62). In the mouse, mutations or deletions of *Pax3* have been found in all alleles of *Spotch*. Heterozygous deficient mice are viable with a characteristic white belly spot.

(pigmentation defects) and more severe abnormalities (leading to embryonic lethality) in the homozygotes (Table 1).

In-depth analysis of the homozygous embryos reveals multiple defects including a failure of the neural tube to close in the lumbo-sacral region, sometimes associated with exencephaly. The dorsal root ganglia are absent or severely reduced in size. The limb musculature is absent, and the outflow tract of the heart is abnormally formed (Fig. 1). These characteristics are identical among several alleles of *Spotch* that arose independently either spontaneously or as the result of mutagenesis. One allele, *Spotch-delayed*, displays less severe abnormalities and the affected embryos survive until shortly after birth.

A series of reports within the past ten years have identified the molecular cause of the *Spotch* phenotype. In all cases, mutations in the *Pax3* gene have been identified including a large deletion (*Spotch<sup>4H</sup>*), an intragenic deletion (*Spotch<sup>2H</sup>*), a splice acceptor site mutation (*Spotch*), and a missense mutation (*Spotch-delayed*) (14–16). All of these except *Spotch-delayed* are expected to result in complete loss of function of *Pax3*. *Spotch-delayed* results from a Gly to Arg mutation in the 9th position of the paired-type DNA binding domain. This mutation would be expected to impair DNA binding by the paired domain, but probably does not result in complete loss of function because residual binding activity might be retained, and a second DNA binding domain encoded by *Pax3*, the homeodomain, remains intact. This is consistent with the more subtle phenotype of this allele.

### 3. Waardenburg Syndrome

In humans, mutations in *PAX3* have been identified as the cause of Waardenburg syndrome (17,18) consisting of variable degrees of facial dysmorphology, myopathy, deafness, and pigmentary abnormalities as described by the Dutch ophthalmologist Petrus Waardenburg in 1951 (19) (Table 1). Waardenburg's patients all had dystopia

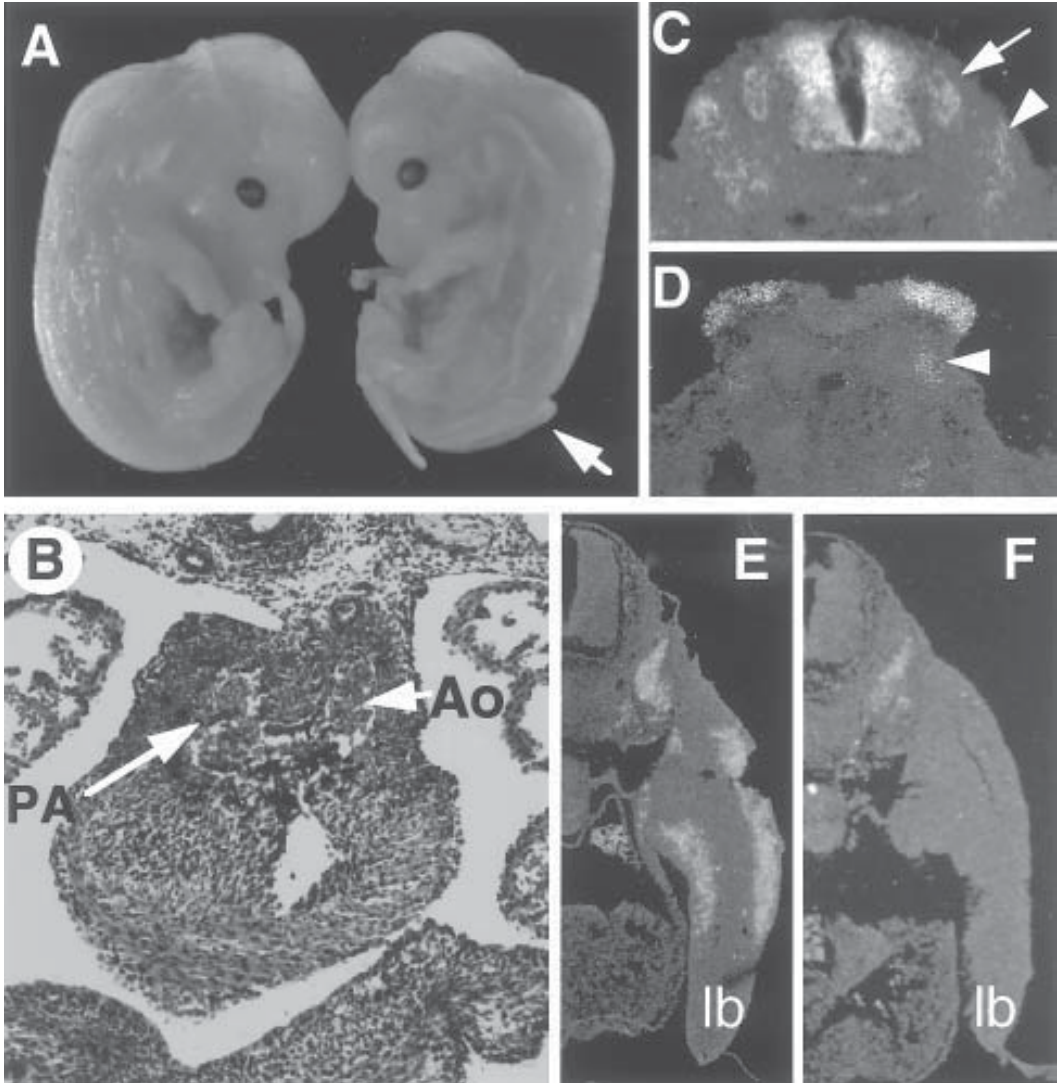

Fig. 1. (See color plate 12 appearing after p. 262.) The *Splotch* mouse. (A) E11.5 wild type (left) and homozygous *Splotch* (right) embryos are shown. Note the patent neural tube of the *Splotch* mouse in the lumbosacral region (arrow). (B) Transverse section through an E13.5 homozygous *Splotch* embryo heart reveals persistent truncus arteriosus. The right ventricle exits into a single vessel which has been only partially septated into the aorta (Ao) and the pulmonary artery (PA). Blood is seen within the great vessels. (C,D) *In situ* hybridization of transverse sections at the hindlimb level of E11.5 wild type (C) and homozygous *Splotch* (D) embryos reveals *Pax3* expression in the dorsal neural tube, the dorsal root ganglia (arrow, C) and the dermamyotome (arrowhead). The nonfunctional transcripts in *Splotch* are stable and can be detected by this method. Note in *Splotch* the splayed open and patent neural tube, the absence of dorsal root ganglia and the abnormally shaped somites which remain spherical in the caudal region unlike the elongated structure seen in the wild type. (E, F) *In situ* hybridization of transverse sections of E11.5 wild-type (E) and *Splotch* (F) embryos at the forelimb level shows a complete absence of *MyoD* expression in the limb (lb) of *Splotch* embryos. *In situs* were performed as detailed in Chapter 27 of this volume.

canthorum, a lateral displacement of the eyes, which is the distinguishing feature of type 1 Waardenburg syndrome. Patients with a similar constellation of findings, but without dystopia canthorum, are diagnosed with type 2 Waardenburg syndrome (reviewed in [20]). Interestingly, this disorder is not caused by *PAX3* mutations, but rather by mutations in another transcription factor gene *MITF*, the human homolog of the mouse *microphthalmia* gene (21,22). When limb muscle hypoplasia accompanies the other features of type 1 Waardenburg syndrome the disorder is classified as type 3, or Klein-Waardenburg syndrome. These patients harbor *PAX3* mutations and may represent particularly severe alleles.

Waardenburg syndrome is the most common cause of congenital sensorineural deafness and accounts for 2–3% of all congenital hearing disorders. The requirement for *PAX3* for normal sound perception is not understood, but is thought to be related to the role of neural-crest derivatives including melanocytes in the inner ear. The pigmentation defects, including a characteristic white forelock and differently colored eyes (heterochromia irides), are examples of other neural crest-related features. Waardenburg syndrome is inherited as an autosomal dominant trait, and few cases of homozygosity have been described. This is perhaps surprising given the high frequency of intermarriages within deaf communities, and may suggest that homozygosity can be embryonic lethal as it is in the mouse. In fact, the only human homozygote in which the specific *PAX3* mutation has been defined was because of a missense mutation that may not have resulted in complete loss of function (23). Unlike homozygous *Spotch* embryos, this baby did not have a neural tube defect, though there is a small, but definite increased risk of neural tube defects associated with Waardenburg syndrome in general (24,25).

More than 50 different *PAX3* mutations have been identified in patients with Waardenburg syndrome including missense, nonsense, frameshift, splicing, and deletion mutations (reviewed in [20]). Dystopia canthorum is an important diagnostic criteria because there is a tight correlation between the degree of dystopia and the likelihood of *PAX3* mutation as the cause of the disorder (26). Importantly, there is not a correlation between the severity of the phenotype and the particular *PAX3* mutation, and the penetrance is variable within a given family (27). This suggests modifying genes and loci that affect the clinical presentation. Mouse genetics and the availability of a mouse model in which to study *Pax3* mutations may provide a system for identifying such modifier genes (28).

#### 4. Pax3 and Nervous System Development

The pattern of *Pax3* mRNA expression in the developing mouse embryo was first described by Goulding et al. in 1991 (16), and has been confirmed and extended by others. To date, however, no immunohistochemical studies have been presented to confirm the *Pax3* protein expression profile in the developing mouse embryo. *Pax3* mRNA transcripts were not reported to be present in the adult mouse, and were first detected at about day 8.5 of gestation. Transcripts are first evident in the dorsal neural tube, the region from which neural crest cells emerge. *Pax3* is also expressed in the developing hindbrain, mesencephalon, and prosencephalon where it invariably remains confined to the ventricular zone of the developing central nervous system, a region of high mitotic activity. As maturing neurons exit the ventricular zone and migrate through the intermediate zone, *Pax3* expression is lost. By E17, transcripts are no longer detect-

able, though they reappear between E18.5 and postnatal day 5 in the peripheral nervous system (29).

Pax3 is critical for the development of the peripheral nervous system (29). It is expressed in midgestation dorsal root and sympathetic ganglia and is evident in neural-crest cells migrating from rhombomeres 2 and 4. In *Splotch* embryos, the dorsal root ganglia are small or absent. By crossing *Splotch* to a transgenic mouse in which  $\beta$ -galactosidase is expressed from a *Hoxa-7* promoter, Tremblay et al. discovered several other abnormalities of nervous development in homozygous mutant *Splotch* embryos (30). The trigeminal (Vth cranial nerve), superior (IX), and jugular (X) ganglia are poorly formed and the frontal, ophthalmic and spinal accessory nerves are reduced or absent. *Pax3* is also expressed in developing and regenerating Schwann cells where it may play a role in maintaining the undifferentiated or nonmyelinated axonal phenotype and may directly repress expression of myelin basic protein by binding to the proximal promoter of this gene. In Schwann cells, Pax3 may directly or indirectly activate expression of glial fibrillary acidic protein (GFAP), nerve growth factor receptor (NGFR), L1, and neural-cell adhesion molecule (N-CAM). These observations in the peripheral nervous system parallel those in the central nervous system where Pax3 is expressed in astrocytic (nonmyelinating), but not in oligodendrocytic (myelinating) neurons.

## 5. Pax3 and Cardiovascular Development

Although human patients with Waardenburg syndrome who inherit one mutant allele of *PAX3* only rarely have associated congenital heart disease (31), the homozygous *Splotch* mouse in which both *Pax3* alleles are nonfunctional provides an important model for cardiac outflow tract disorders. Homozygous *Splotch* embryos display persistent truncus arteriosus, in which the single great vessel, the truncus arteriosus, emerging from the embryonic heart fails to divide into the proximal aorta and the pulmonary artery. A less-severe variant of this disorder, double outlet right ventricle, is sometimes observed (32). In this case, the truncus arteriosus is septated, but both great vessels are seen to emerge from the right ventricle and a ventricular septal defect is invariably present allowing for outlet of blood from the left ventricle. *Splotch* embryos also have abnormal myocardial development that may be a secondary defect because of the abnormal hemodynamics associated with structural heart disease. The compact layer of the embryonic heart is abnormally thin and there is defective excitation-contraction coupling owing to a decreased inward calcium current (33). The myocardial defect is thought to be secondary because *Pax3* is not known to be expressed in myocardial cells, though one report suggests that rare transcripts may be detected in embryonic myocardium by reverse transcription and polymerase chain reaction (33). In addition, the occasional homozygous *Splotch* embryo without structural heart disease had normal excitation-contraction coupling.

Failure of outflow tract septation in *Splotch* is almost certainly because of a defect of cardiac neural crest cell migration or function, because identical defects have been produced in the chick by ablation of neural crest cells prior to migration to the developing heart field (34). These ablation studies have localized the origin of the cardiac neural crest to the cranial region between the mid-otic placode and the caudal boundary of the third somite. These neural crest cells normally contribute to the outflow tract and



also populate the great vessels where they differentiate into smooth muscle. They also populate the developing thymus, thyroid, and parathyroid glands, and abnormalities in these organs have also been described in homozygous *Spotch* mice.

This spectrum of defects is of particular interest to pediatric cardiologists and to human geneticists because it is strikingly reminiscent of patients with DiGeorge syndrome, in which outflow tract defects including persistent truncus arteriosus and double-outlet right ventricle accompany developmental anomalies of the thymus and parathyroid glands as well as neural crest-related facial dysmorphology (reviewed in [35]). Similar anomalies are seen after vitamin A deficiency or retinoic acid treatment. Many patients with DiGeorge syndrome have deletions that involve a region of chromosome 22q11, and it is now clear that some patients with isolated congenital heart disease involving the outflow tract, but without the other associated findings of DiGeorge syndrome also have similar chromosomal deletions. The responsible gene or genes on chromosome 22 have not been identified, though several interesting candidates have been proposed (36). This region of chromosome 22 is syntenic with a region on mouse chromosome 16 (37). Because mouse *Pax3* is located on chromosome 1, and human *PAX3* has been mapped to chromosome 2q35, *PAX3* is clearly not the “DiGeorge gene.” Nevertheless, the phenotypic similarities are such that it is reasonable to postulate that *PAX3* is involved in the same developmental and molecular cascades that have gone awry in DiGeorge patients.

The mechanism by which cardiac neural crest cells orchestrate conotruncal septation is unknown. It is unlikely that neural crest derivatives play a major structural role in the outflow tract septum because quail-chick chimera studies and lineage analysis suggests that a relatively small population of neural crest cells actually populate the septal region (38). These cells migrate only as far as the outflow tract and have not been detected within the atrioventricular endocardial cushion region. Nevertheless, a series of septation events take place that divide the primitive heart tube into the mature four chambered vertebrate heart with distinct systemic and pulmonary circulations. Epithelial-mesenchymal transformation events take place at both the atrioventricular and outflow tract levels that produce the atrioventricular (mitral and tricuspid) and outflow (aortic and pulmonary) valves, respectively. Yet only outflow tract septation is affected in neural crest ablated chicks, in *Spotch* mice, and in DiGeorge patients.

Although no supporting experimental evidence exists, it seems likely that cardiac neural crest cells exert a morphogenic effect via a series of inductive interactions with other cell types within the outflow tract region, perhaps by way of secreted growth factors, expression of growth factor receptors, or by direct cell-to-cell contact. It is hoped that further studies involving the *Spotch* mouse and discovery of pathways regulated by *Pax3* may help to elucidate this process. Progress concerning the role of *Pax3* during skeletal muscle development may provide some clues.

## 6. Pax3 and Skeletal Muscle Development

*Pax3* plays a crucial role in the development of the musculature. *Pax3* is expressed early during formation of the bilaterally symmetric somites, which form as spherical condensations of the mesodermal tissue that flanks the neural tube (16). Expression becomes restricted to the dorsal-lateral portion of the dermamyotome that includes the myogenic precursors that will migrate away from the somite to form the musculature

of the abdominal wall and limbs. Axial muscles including the paraspinal and intercostal muscles arise more medially within the somite. Homozygous *Spotch* embryos have no limb muscles and patients with Waardenburg syndrome display variable limb muscle hypoplasia. By whole mount *in situ* hybridization, *Pax3* expressing cells can be seen to migrate towards the developing wing in the chick (39,40) or towards the limb buds in the mouse (41). Subsequently, *Pax3* expressing cells populate the regions destined to become the dorsal and ventral muscle masses of the limb, and *Pax3* expression abates just prior to activation of the myogenic bHLH transcription factors in these domains.

In *Spotch* embryos, diI labeling studies have shown that myogenic precursors do not migrate to the limb buds, but these precursors are able to differentiate into muscle, at least under some conditions (42). This failure of migration is associated with the absence of expression of the cell surface tyrosine kinase receptor c-Met, and *Pax3* is capable of directly activating the expression of *c-met* in some cell types (43). *Pax3* can bind to the proximal *c-met* promoter via paired domain recognition of a binding site that is highly homologous to the optimal *Pax3* paired domain binding site determined *in vitro* (44) and transactivation of the *c-met* promoter is abrogated by a mutation in the paired domain found in a family with Waardenburg syndrome (43). In *Spotch* embryos, cells that would normally have expressed *Pax3* can be detected because the mutant transcript is stable and, although nonfunctional, can be visualized by *in situ* hybridization techniques. These cells would normally express *c-met*, but this expression is absent in *Spotch*. The ligand for c-Met, hepatocyte growth factor (also known as scatter factor), is expressed at high levels in the embryonic limb bud and causes delamination of c-Met expressing myoblasts from the somite (45,46). Inactivation of the *c-met* gene by homologous recombination in the mouse results in embryos without limb musculature (47). Hence, *c-met* appears to be a direct transcriptional target of *Pax3* and is involved in a molecular pathway required for limb myoblast migration.

A series of recent studies have suggested that the role of *Pax3* in muscle development may be more complicated than simply regulating migration of a subset of myogenic precursors. In culture, *Pax3* overexpression in cells capable of undergoing myogenic differentiation results in impaired expression of terminal differentiation markers (48), whereas overexpression in some chick-derived primary cultures seems to promote *MyoD* and *myosin* expression (49). In addition, Margaret Buckingham's group in Paris provided the fascinating observation that a mouse embryo lacking both *Myf5* and *Pax3* had almost no muscular development whatsoever below the head region (hypaxial or epaxial), despite the fact that *Myf5* deficiency alone is normally compensated (at least in part) by *MyoD* (50).

Expression analysis and gene targeting studies in the mouse have succeeded in establishing a functional hierarchy for the four myogenic bHLH factors (*MyoD*, *Myf5*, *myogenin*, and *MRF4*) (reviewed in [51]). *Myf5* and *MyoD* function as determination factors early in myogenic differentiation and are partially redundant. *Myogenin* and *MRF4* act as downstream differentiation factors. *Myf5* transcripts appear first in the mouse somite, at about E8.5. (The roles of *Myf5* and *MyoD* appear to be reversed in the chick.) It now appears that the *Myf5* expressing cells, located medially in the mouse somite, represent a distinct population of cells from those located more laterally that will express *MyoD* about 2 d later. *Myf5* expressing cells will go on to express *MyoD*, and vice versa, such that by birth each factor is able to largely compensate for the other.

This model is supported strongly by the recent demonstration of delayed limb muscle development in *MyoD* deficient mice compared to wild type (52). Limb muscles develop normally in *Myf5*-deficient mice. Conversely, axial (intercostal) muscle development is delayed specifically in *Myf5* deficient embryos. In either case, and in embryos lacking both *Myf5* and *MyoD*, *Pax3* expressing myoblasts apparently migrate normally.

The fact that axial muscles do not develop in *Splotch* embryos lacking *Myf5* (50) suggests a specific requirement for *Pax3* in order for the *MyoD* lineage to rescue axial muscle development. Aside from the absence of limb musculature in *Splotch*, *MyoD* expression is apparently normal. In this regard, it is important to point out that *Pax3* expression is not confined to limb muscle precursors; *Pax3* expression is easily detected in the somite long after limb myoblasts have migrated. These results suggest that there are at least two pathways for *MyoD* activation, one requiring *Myf5* and the other requiring *Pax3*. These pathways may be partially redundant. Further analysis of the *MyoD* promoter and enhancer regions may identify specific sequences required for mediating these activation pathways.

The ultimate fate of limb muscle progenitors in *Splotch* embryos is unknown. It is possible that, like *Myf5* deficient myoblasts (53), they transdifferentiate into other cell types such as skin, bone, or cartilage. This could be examined by knocking *lacZ* into the *Pax3* locus thus providing a lineage marker for these cells. It is also possible that *Pax3* deficient myoblasts undergo apoptosis. A role for *Pax3* or related molecules in preventing apoptosis has been suggested (54,55), and we have preliminary results that support this hypothesis. A *Pax* binding site in the *p53* promoter has been reported (56), and some *Pax* gene products are capable of repressing *p53* expression, though this activity was not reported for *Pax3*. The possibility that *Pax3* might act as a survival factor for undifferentiated or undetermined myoblasts could explain the lack of axial muscles in *Myf5/Pax3* deficient embryos. Because *MyoD* normally is activated significantly later than *Myf5*, those myoblast precursors fated to express *MyoD* might require *Pax3* for survival prior to *MyoD* activation. In the absence of *Pax3*, those cells would be predicted to undergo apoptosis, *MyoD* could not be activated, and muscle development could not be rescued. (In *Splotch* embryos with intact *Myf5*, the alternate postulated pathway for *MyoD* activation, that requiring *Myf5*, would account for *MyoD* expression and axial muscle development.) Experiments are underway to test this model. It is intriguing to wonder if *Pax3* might act as a survival factor in other settings as well, such as in muscle satellite cells, in dorsal root ganglia neurons (which are absent or reduced in *Splotch*), or in the CNS. Other *Pax* genes could also subserve similar functions in B cells, thymus, kidney, ocular, pancreas, or skeletal development.

## 7. Pax3 and Rhabdomyosarcoma

The important role of *Pax3* in muscle development is emphasized by the discovery of a chromosomal translocation involving *PAX3* that causes a tumor of muscle in humans (57–59). In many patients with alveolar rhabdomyosarcoma a t(2;13) translocation results in the expression of a fusion protein (PAX3/FKHR) containing the DNA binding domains of PAX3 fused in frame to the transactivation domain of a forkhead family member. The resulting gene product is a more potent transcriptional activator than PAX3 itself and is able to transform myoblast and fibroblast cell lines

in culture. Amazingly, a second translocation involving *PAX7*, a close relative of *PAX3*, has also been discovered in patients with alveolar rhabdomyosarcoma and this translocation results in the precisely homologous region of *PAX7* fused to the same forkhead transactivation domain (60). In addition, rhabdomyosarcomas that are not caused by either of these translocations may in some cases express either *PAX3*, *PAX7*, or both.

The mechanism by which *PAX3/FKHR* is oncogenic is unclear. One report suggested that *Pax* genes are able to transform NIH/3T3 cells (61), but in our hands this is at best a rare event. The enhanced transcriptional activation potential of *PAX3/FKHR* or ectopic expression (e.g., lack of downregulation during myogenic differentiation) may account for tumor progression. It is also possible that the fusion protein has altered target gene specificity such that pathways not normally regulated by *PAX3* in muscle are ectopically activated or repressed. *PAX3/FKHR* is capable of activating expression of the gene encoding the platelet-derived growth factor alpha receptor (*PDGF $\alpha$ R*) in a dose-dependent manner, whereas *PAX3* is unable to activate expression of this gene (63). This activation is dependent upon an intact homeodomain of *PAX3/FKHR* that binds to a palindromic ATTA binding site in the *PDGF $\alpha$ R* promoter. Because muscle cells normally express *PDGF*, the ectopic activation of *PDGF $\alpha$ R* may establish an autocrine growth factor loop that could lead to uncontrolled cellular proliferation.

In addition, *PAX3/FKHR* is able to activate expression of *c-MET*, and tumor tissue from patients harboring the translocation reveals a correlation between *PAX3/FKHR* and *c-MET* expression (F. Barr, personal communication). These tissues also express the ligand for *c-Met*, hepatocyte growth factor, again suggesting the possibility of an autocrine loop. The documented role of *c-met* in cell migration suggests that this pathway may also contribute to tumor invasion or metastasis formation. It is interesting to note that treatment of rhabdomyosarcoma cells expressing *PAX3/FKHR* with antisense oligonucleotides that inhibit expression of the fusion protein results in apoptosis (54).

## 8. Conclusion

*Pax3* is a nuclear transcription factor expressed during midgestation that plays critical roles in the proper formation of the central and peripheral nervous systems, morphogenesis of the outflow tract region of the heart, and the muscular system. Many defects in affected human patients with *PAX3* mutations resulting in Waardenburg syndrome, and in affected *Plotch* mice, can be attributed to defects of neural crest migration or function and to defects in muscular development. *PAX3* is also implicated in a tumor of muscle affecting humans.

In many cases, *Pax3* is expressed in rapidly proliferating cells and is downregulated prior to terminal differentiation. The precise role that *Pax3* plays in terminal differentiation of neuronal or myoblast cells is unknown. Few target genes regulated by *Pax3* are known, but one is the *c-met* receptor that is responsible, at least in part, for orchestrating the migration of limb muscle progenitors requiring *Pax3*. Further analysis of *Pax3* function offers significant prospects for elucidating the molecular causes of neural tube defects, congenital heart disease, and myogenic differentiation pathways.

## References

1. Walther, C., Guenet, J. L., Simon, D., Deutsch, U., Jostes, B., Goulding, M. D., et al. (1991) Pax: a murine multigene family of paired box-containing genes. *Genomics* **11**, 424–434.
2. Dahl, E., Koseki, H., and Balling, R. (1997) Pax genes and organogenesis. *Bioessays* **19**, 755–765.
3. Bopp, D., Jamet, E., Baumgartner, S., Burri, M., and Noll, M. (1989) Isolation of two tissue-specific *Drosophila* paired box genes, Pox meso and Pox neuro. *EMBO J.* **8**(11), 3447–3457.
4. Quiring, R., Walldorf, U., Kloter, U., and Gehring, W. J. (1994) Homology of the eyeless gene of *Drosophila* to the Small eye gene in mice and aniridia in humans. *Science* **265**, 785–788.
5. Chisholm, A. D. and Horvitz, H. R. (1995) Patterning of the *Caenorhabditis elegans* head region by the Pax-6 family member vab-3. *Nature* **377**, 52–55.
6. Zhang, Y. and Emmons, S. W. (1995) Specification of sense-organ identity by a *Caenorhabditis elegans* Pax-6 homologue. *Nature* **377**, 55–59.
7. Czerny, T., Schaffner, G., and Busslinger, M. (1993) DNA sequence recognition by Pax proteins: bipartite structure of the paired domain and its binding site. *Genes Dev.* **7**, 2048–2061.
8. Epstein, J. A., Glaser, T., Cai, J., Jepeal, L., Walton, D. S., and Maas, R. L. (1994) Two independent and interactive DNA binding subdomains of the PAX6 paired domain are regulated by alternative splicing. *Genes Dev.* **8**, 2022–2034.
9. Xu, W., Rould, M. A., Jun, S., Desplan, C., and Pabo, C. O. (1995) Crystal structure of a paired domain-DNA complex at 2.5 Å resolution reveals structural basis for Pax developmental mutations. *Cell* **80**, 639–650.
10. Halder, G., Callaerts, P., and Gehring, W. J. (1995) Induction of ectopic eyes by targeted expression of the eyeless gene in *Drosophila*. *Science* **267**, 1788–1792.
11. Glaser, T., Walton, D. S., and Maas, R. L. (1992) Genomic structure, evolutionary conservation and aniridia mutations in the human PAX6 gene. *Nat. Genet.* **2**, 232–239.
12. Ton, C. C. T., et al. (1991) Positional cloning and characterization of a paired box- and homeobox-containing gene from the aniridia region. *Cell* **67**, 1059–1074.
13. Auerbach, R. (1954) Analysis of the developmental effects of a lethal mutation in the house mouse. *J. Exper. Zool.* **127**, 305–329.
14. Epstein, D. J., Vekemans, M., and Gros, P. (1991) Splotch (Sp2H), a mutation affecting development of the mouse neural tube, shows a deletion within the paired homeodomain of Pax-3. *Cell* **67**, 767–774.
15. Epstein, D. J., Vogan, K. J., Trasler, D. G., and Gros, P. (1993) A mutation within intron 3 of the Pax-3 gene produces aberrantly spliced mRNA transcripts in the splotch (Sp) mouse mutant. *Proc. Natl. Acad. Sci. USA* **90**, 532–536.
16. Goulding, M. D., Chalepakis, G., Deutsch, U., Erselius, J. R., and Gruss, P. (1991) Pax-3, a novel murine DNA binding protein expressed during early neurogenesis. *EMBO J.* **10**, 1135–1147.
17. Baldwin, C. T., Hoth, C. F., Amos, J. A., da Silva, E. O., and Milunsky, A. (1992) An exonic mutation in the HuP2 paired domain gene causes Waardenburg's syndrome. *Nature* **355**, 637–638.
18. Tassabehji, M., Read, A. P., Newton, V. E., Harris, R., Balling, R., Gruss, P., and Strachan, T. (1992) Waardenburg's syndrome patients have mutations in the human homologue of the Pax-3 paired box gene. *Nature* **355**, 635–636.
19. Waardenburg, P. J. (1951) A new syndrome combining developmental anomalies of the eyelids, eyebrows and nose root with pigmentary defects of the iris and head hair and with congenital deafness. *Am. J. Hum. Genet.* **3**, 195–253.
20. Read, A. P. and Newton, V. E. (1997) Waardenburg syndrome. *J. Med. Genet.* **34**, 656–665.
21. Hodgkinson, C. A., Moore, K. J., Nakayama, A., Steingrimsson, E., Copeland, N. G., Jenkins, N. A., and Arnheiter, H. (1993) Mutations at the mouse microphthalmia locus are associated with defects in a gene encoding a novel basic-helix-loop-helix-zipper protein. *Cell* **74**(2), 395–404.

22. Tassabehji, M., Newton, V., and Read, A. (1994) Waardenburg syndrome type 2 caused by mutations in the human microphthalmia (MITF) gene. *Nat. Genet.* **8**, 251–255.
23. Zlotogora, J., Lerer, I., Bar-David, S., Ergaz, Z., and Abeliovich, D. (1995) Homozygosity for Waardenburg syndrome. *Am. J. Hum. Genet.* **56**, 1173–1178.
24. Pantke, O. A. and Cohen, M. M. (1971) The Waardenburg syndrome. *Birth Defects* **7**, 147–152.
25. da-Silva, E. O. (1991) Waardenburg I syndrome: a clinical and genetic study of two large Brazilian kindreds, and literature review. *Am. J. Med. Genet.* **40**, 65–74.
26. Farrer, L. A., et al. (1994) Locus heterogeneity for Waardenburg syndrome is predictive of clinical subtypes. *Am. J. Hum. Genet.* **55**, 728–737.
27. Pandya, A., et al. (1996) Phenotypic variation in Waardenburg syndrome: mutational heterogeneity, modifier genes or polygenic background? *Hum. Mol. Genet.* **5**, 497–502.
28. Asher, J. H. J., Harrison, R. W., Morell, R., Carey, M. L., and Friedman, T. B. (1996) Effects of Pax3 modifier genes on craniofacial morphology, pigmentation, and viability: a murine model of Waardenburg syndrome variation. *Genomics* **34**, 285–298.
29. Kioussi, C., Gross, M. K., and Gruss, P. (1995) Pax3: a paired domain gene as a regulator in PNS myelination. *Neuron* **15**, 553–562.
30. Tremblay, P., Kessel, M., and Gruss, P. (1995) A transgenic neuroanatomical marker identifies cranial neural crest deficiencies associated with the Pax3 mutant Splotch. *Dev. Biol.* **171**, 317–329.
31. Mathieu, M., Bourges, E., Caron, F., and Piussan, C. (1990) Waardenburg's syndrome and severe cyanotic cardiopathy. *Arch. Fr. Pediatr.* **47(9)**, 657–659.
32. Franz, T. (1989) Persistent truncus arteriosus in the Splotch mutant mouse. *Anat. Embryol.* **180(5)**, 457–64.
33. Conway, S. J., Godt, R. E., Hatcher, C. J., Leatherbury, L., Zolotouchnikov, V. V., Brotto, M. A. P., et al. (1997) Neural crest is involved in development of abnormal myocardial function. *J. Mol. Cell. Cardiol.* **29**, 2675–2685.
34. Kirby, M. L., Gale, T. F., and Stewart, D. E. (1983) Neural crest cells contribute to aorticopulmonary septation. *Science* **220**, 1059–1061.
35. Driscoll, D. A. (1994) Genetic basis of DiGeorge and velocardio-facial syndromes. *Curr. Opin. Pediatr.* **6**, 702–706.
36. Gong, W., Emanuel, B. S., Collins, J., Kim, D. H., Wang, Z., Chen, F., et al. (1996) A transcription map of the DiGeorge and velocardio-facial syndrome minimal critical region on 22q11. *Hum. Mol. Genet.* **5**, 789–800.
37. Galili, N., et al. (1997) A region of mouse chromosome 16 is syntenic to the DiGeorge, velocardiofacial syndrome minimal critical region. *Genome Res.* **7**, 17–26.
38. Noden, D., Poelmann, R., and Gittenberger-de Groot, A. (1995) Cell origins and tissue boundaries during outflow tract development. *Trends Cardiovasc. Med.* **5**, 69–75.
39. Goulding, M., Lumsden, A., and Paquette, A. J. (1994) Regulation of Pax-3 expression in the dermomyotome and its role in muscle development. *Development* **120**, 957–971.
40. Williams, B. A. and Ordahl, C. P. (1994) Pax-3 expression in segmental mesoderm marks early stages in myogenic cell specification. *Development* **120**, 785–796.
41. Bober, E., Franz, T., Arnold, H., Gruss, P., and Tremblay, P. (1994) Pax-3 is required for the development of limb muscles: a possible role for the migration of dermomyotomal muscle progenitor cells. *Development* **120**, 603–612.
42. Daston, G., Lamar, E., Olivier, M., and Goulding, M. (1996) Pax-3 is necessary for migration but not differentiation of limb muscle precursors in the mouse. *Development* **122(3)**, 1017–1027.
43. Epstein, J. A., Shapiro, D. N., Cheng, J., Lam, P. Y., and Maas, R. L. (1996) Pax3 modulates expression of the c-Met receptor during limb muscle development. *Proc. Natl. Acad. Sci. USA* **93(9)**, 4213–4218.
44. Chalepakis, G. and Gruss, P. (1995) Identification of DNA recognition sequences for the Pax3 paired domain. *Gene* **162**, 267–270.

45. Heymann, S., Koudrova, M., Arnold, H., Koster, M., and Braun, T. (1996) Regulation and function of SF/HGF during migration of limb muscle precursor cells in chicken. *Develop. Biol.* **180**(2), 566–578.
46. Brand-Saber, B., Muller, T. S., Wilting, J., Christ, B., and Birchmeier, C. (1996) Scatter factor/hepatocyte growth factor (SF/HGF) induces emigration of myogenic cells at interlimb level in vivo. *Develop. Biol.* **179**(1), 303–308.
47. Bladt, F., Riethmacher, D., Isenmann, S., Aguzzi, A., and Birchmeier, C. (1995) Essential role for the c-met receptor in migration of myogenic precursor cells into the limb bud. *Nature* **376**, 768–771.
48. Epstein, J. A., Lam, P., Jepeal, L., Maas, R. L., and Shapiro, D. N. (1995) Pax3 inhibits myogenic differentiation of cultured myoblast cells. *J. Biol. Chem.* **270**, 11,719–11,722.
49. Maroto, M., Reshef, R., Munsterberg, A. E., Koester, S., Goulding, M., and Lassar, A. (1997) Ectopic Pax-3 activates myoD and myf-5 expression in embryonic mesoderm and neural tissue. *Cell* **89**, 139–148.
50. Tajbakhsh, S., Rocancourt, D., Cossu, G., and Buckingham, M. (1997) Redefining the genetic hierarchies controlling skeletal myogenesis: Pax-3 and myf-5 act upstream of myoD. *Cell* **89**, 127–138.
51. Rudnicki, M. A. and Jaenisch, R. (1995) The MyoD family of transcription factors and skeletal myogenesis. *BioEssays* **17**, 203–209.
52. Kablar, B., Krastel, K., Ying, C., Asakura, A., Tapscott, S. J., and Rudnicki, M. A. (1997) MyoD and Myf-5 differentially regulate the development of limb versus trunk skeletal muscle. *Development* **124**, 4729–4738.
53. Tajbakhsh, S., Rocancourt, D., and Buckingham, M. (1996) Muscle progenitor cells failing to respond to positional cues adopt non-myogenic fates in myf-5 null mice. *Nature* **384**(6606), 266–270.
54. Bernasconi, M., Remppis, A., Fredericks, W., Rauscher, F., and Schafer, B. (1996) Induction of apoptosis in rhabdomyosarcoma cells through down-regulation of PAX proteins. *Proc. Natl. Acad. Sci. USA* **93**, 13,164–13,169.
55. Phelan, S. A., Ito, M., and Loeken, M. R. (1997) Neural tube defects in embryos of diabetic mice: role of the Pax-3 gene and apoptosis. *Diabetes* **46**, 1189–1197.
56. Stuart, E. T., Haffner, R., Oren, M., and Gruss, P. (1995) Loss of p53 function through PAX-mediated transcriptional repression. *EMBO J.* **14**(22), 5638–5645.
57. Barr, F. G., Galili, N., Holick, J., Biegel, J. A., Rovera, G., and Emanuel, B. S. (1993) Rearrangement of the PAX3 paired box gene in the paediatric solid tumour alveolar rhabdomyosarcoma. *Nature Genet.* **3**, 113–117.
58. Galili, N., Davis, R. J., Fredericks, W. J., Mukhopadhyay, S., Rauscher, F. J., III, Emanuel, B. S., et al. (1993) Fusion of a fork head domain gene to PAX3 in the solid tumor alveolar rhabdomyosarcoma. *Nat. Genet.* **5**, 230–235.
59. Shapiro, D. N., Sublett, J. E., Li, B., Downing, J. R., and Naeve, C. W. (1993) Fusion of PAX3 to a member of the forkhead family of transcription factors in human alveolar rhabdomyosarcoma. *Cancer Res.* **53**, 5108–5112.
60. Davis, R. J., D'Cruz, C. M., Lovell, M. A., Biegel, J. A., and Barr, F. G. (1994) Fusion of PAX7 to FKHR by the variant t(1;13)(p36;q14) translocation in alveolar rhabdomyosarcoma. *Cancer Res.* **54**(11), 2869–2872.
61. Maulbecker, C. C. and Gruss, P. (1993) The oncogenic potential of Pax genes. *EMBO J.* **12**(6), 2361–2367.
62. Ayme, S. and Philip, N. (1995) Possible homozygous Waardenburg syndrome in a fetus with exencephaly. *Am. J. Med. Genet.* **59**, 263–265.
63. Epstein, J. A., Song, B., Lakkis, M., and Wang, C. (1998) Tumour-specific PAX3-FRHR transcription factor, but not PAX3, activates the platelet-derived growth factor alpha receptor. *Mol. Cell. Biol.* **18**, 4118–4130.

## Genetic-Engineered Models of Skeletal Diseases I

### *Collagen Type X*

Olena Jacenko

#### 1. Introduction

Formation of the vertebrate skeleton is an intricately orchestrated, multistep process. Mechanisms underlying skeletogenesis need to account for the global specification of skeletal pattern, commitment of cells to skeletal and hematopoietic lineages, local control of skeletal shape and growth, as well as function and homeostasis of the skeletal tissue. The complexity of these processes is reflected by the large number of diseases with skeletal manifestations. Specifically, osteochondrodysplasias, defined as developmental disorders affecting cartilage and/or bone, comprise a diverse group of more than 150 characterized forms of skeletal abnormalities (*1*). Whereas the intricacies of the processes underlying skeletogenesis are still not fully understood, the recent identification of the genetic basis for a number of heritable skeletal disorders is yielding significant insights (*2–4*). To a large extent, these successes are because of the convergence of information gained from murine transgenesis, and from murine and human genetics.

Our ability to manipulate genes through transgenesis is often yielding exciting and unexpected consequences, and is providing insights into vertebrate development under normal and pathologic states. This chapter will focus on providing a sample protocol one may follow to establish and functionally characterize a skeletal extracellular matrix gene mutation through murine transgenesis. Specific emphasis will be on the use of dominant interference as a strategy for disruption of gene function of a multimeric molecule at the protein level. For this purpose, the collagen X transgenic (Tg) mouse model will be discussed as an example. Although many issues regarding the function of collagen X are still being resolved, this murine model has helped identify a collagen X mutation in a human chondrodysplasia. Furthermore, the collagen X Tg mice are providing information regarding the molecular basis of the disease phenotype as well as collagen X function during skeletogenesis. Last, this animal model is supporting a previously unforeseen link between endochondral skeletogenesis and hematopoiesis.



## 2. Materials and Methods

### 2.1. SUMMARY—Generation of a Transgenic Mouse Model for a Skeletal Disease

#### 2.1.1. Strategy Selection and Construct Preparation

1. Identification of molecule of interest.
2. Analysis of gene/protein structure and expression.
3. Formation of hypothesis regarding function.
4. Selection of strategy for in vivo functional studies:
  - a. Disruption of gene function at protein level:
    - i. Dominant interference (for multimeric or multidomain molecules).
    - ii. Misexpression (for creating imbalance in molecule's concentration).
  - b. Gene inactivation: (through gene targeting and homologous recombination; gene "knock-out").
  - c. Conditional gene inactivation; gene substitution (gene "knock-in").
5. Design of transgene constructs
6. Confirmation of transgene constructs:
  - a. Restriction map.
  - b. Sequence.
  - c. In vitro transcription.
  - d. Cell-free translation.
7. Preparation of transgene construct for introduction into mice.

#### 2.1.2. Transgenesis Involving Pronuclear Microinjections

1. Pronuclear microinjections of transgene.
2. Identification of  $F_0$  mice.
3. Germ-line transmission of transgene to  $F_1$  mice.
4. Confirmation of independent transgene insertion sites in several lines.
5. Expansion of 2–3 lines per transgene construct.
6. Characterization of transgene expression.
7. Segregation of genotype with phenotype in independent lines.

#### 2.1.3. Transgenesis Involving Gene Inactivation

1. Establishment of embryonic stem (ES) cell cultures and electroporation of transgene.
2. Positive-negative selection and expansion of ES clones with homologous recombination.
3. Coculture of ES clone with morulae or injection into blastocysts, followed by intrauterine implantation into foster mother.
4. Identification of chimeras or  $F_0$  mice.
5. Germ-line transmission of transgene to  $F_1$  mice and expansion of lines.
6. Confirmation of loss of gene expression on mRNA and protein level.
7. Segregation of genotype with phenotype.

#### 2.1.4. Analysis of Transgenic Mice

1. Assessment of phenotype.
  - a. Visual observations.
  - b. Gross observations upon dissection.
  - c. Histological analysis at macroscopic and microscopic level.
  - d. Colocalization of transgene product (or lack of protein) with observed defect.

- e. Functional assays.
- f. Characterization of mechanism of transgene action.
2. Correlation with human disorder.
3. Identification of molecular and biochemical basis for disease phenotype.

## **2.2. Experimental Rationale:**

### ***The Reverse Genetics Approach to Address Skeletal Development***

Approaches involving reverse genetics (e.g., from gene to phenotype) as well as forward genetics (e.g., from phenotype to gene) have become feasible in mice. Together, these tools are permitting a molecular analysis of both known and previously unknown genes. With advances in transgenic and gene targeting technologies (5) (also, see Chapters 40–45 in Vol. II of this series), reverse genetics has been used extensively to study skeletal gene function during development. To undertake this approach, one needs to have some information regarding the biology of the process of interest, as well as the association of a particular matrix gene with this specific process. Likewise, some information regarding gene and protein structure and processing is required to design appropriate transgene constructs. Last, ideally one would be able to speculate on the phenotypic consequences (at least temporospatially) that may result from mutations in the gene of choice.

For example, since its discovery in 1982, collagen X has been associated with endochondral ossification (EO), a mechanism of skeletogenesis where hypertrophic cartilage is replaced with bone and marrow (reviewed in [6]). This association is primarily owing to the restricted and predominant pattern of collagen X expression to a subset of cartilage cells, the hypertrophic chondrocytes. Concomitant with and subsequent to chondrocyte hypertrophy, the morphogenetic events of EO initiate in this cartilage matrix. Specifically, the cartilage matrix changes from being avascular and non-calcifiable to one that is penetrable by blood vessels and capable of calcification. Vascular invasion imports osteoclasts and chondroclasts for the degradation of the hypertrophic cartilage matrix, and stem cells for differentiation and deposition of bone, marrow stroma, and blood cells. Thus, trabecular bone forms on top of remaining hypertrophic cartilage spicules, whereas the marrow stroma establishes the appropriate conditions for subsequent hematopoiesis.

The transient expression of collagen X occurs at the onset of chondrocyte hypertrophy, and this protein represents the major biosynthetic product of these cells. The spatiotemporal restriction of collagen X to skeletal elements undergoing EO thus predicts that collagen X may participate in the EO-associated events, namely mineralization, vascular invasion, matrix stabilization during the cartilage-to-bone/marrow transition, or contribution toward establishment of the marrow microenvironment (6). To test this possibility, the reverse genetics approach was undertaken in mice where collagen X function was disrupted both by a dominant interference mutation (7), and by gene inactivation (8,9).

## **2.3. Construct Design and Rationale for Dominant Interference**

Three general strategies (summarized in [5,10]) could be used when probing gene function through transgenesis in mice: 1) disruption of gene function at the protein level through dominant interference or overexpression; 2) gene inactivation through

gene targeting and homologous recombination; and 3) a combination of both (e.g., conditional gene inactivation or gene substitution). The choice of strategy depends in large part on the characteristics of the molecule of interest, as well as on the availability of the corresponding DNA.

Dominant interference may be the strategy of choice when one is dealing either with a multimeric molecule such as a collagen, with a protein with multiple functional domains or subunits (e.g., gene-regulatory proteins), or with an enzyme whose activity may be limited by substrate availability. During dominant interference, a partially functional molecule, representing an inhibitory variant of the endogenous molecule of interest, interferes with the endogenous molecule's function by competing for interactions at the protein level. The resultant phenotype is considered dominant, because even at low levels the inhibitor can have an effect (usually disruptive) on the normal function of the endogenous molecule.

For collagen X, dominant interference through pronuclear microinjection was the best approach for several reasons. First, at the time the mouse collagen X gene had not yet been cloned; however, the chicken, bovine, and human genes were characterized (6). The lack of a mouse embryonic stem cell strain-specific genomic DNA prohibited use of gene targeting in embryonic stem (ES) cells, for which the latter is a prerequisite (5). Second, the dominant interference approach has previously proved successful for studying collagen function. Specifically, dominant interference mutations in collagens were demonstrated to cause severe manifestations of disorders such as osteogenesis imperfecta, Ehlers Danlos syndrome, epidermolysis bullosa, Alport's syndrome, and certain chondrodysplasias, in both humans and in mice (summarized in [2,4,11,12]). These disease examples served as a basis for the design of collagen X transgene constructs.

The collagen X molecules are composed of three identical  $\alpha 1(X)$  chains, encoded by a condensed *COL10A1* gene (Fig. 1A). Exon 3 encodes the majority of the monomer (reviewed in [6]). Three monomers associate and fold into homotrimeric molecules that are secreted into the matrix. The  $\alpha 1(X)$  homotrimers consist of three distinct protein domains, which include a central triple helical domain (COL1) that is flanked by a

---

Fig. 1. (*opposite page*) Schematic representation of the collagen X gene, message, and protein, with potential disease mechanisms underlying mutations in Tg mice and in humans with SMCD indicated. (A) The collagen X gene (top) contains three exons, which are represented by boxes and numbered starting from the 5' end of the gene. Dotted lines indicate correspondence between exons and mRNA (middle), and between mRNA and translation product, an  $\alpha 1(X)$  chain (bottom). The globular regions of collagen X are marked NC1 and NC2, and the triple-helical region labeled COL1. Constructs encoding partially functional  $\alpha 1(X)$  chains with 21 or 293 amino acid deletions in the COL1 domain were generated for expression in Tg mice, and are postulated to act predominantly through a dominant interference mechanism. A clustering of mutations found in patients with SMCD is in the NC1 domain, and the disease likely results predominantly through haploinsufficiency. (B) Alizarin red S stained whole skeletons of day-21 transgene-negative (left), and transgene-positive, perinatal-lethal mutants (center and right). Note thoracolumbar kyphosis and accentuated neck lordosis in mutants. (C and D) X-rays of the arm (C) and femur (D) from a 5-yr-old patient with SMCD. Note flaring of bones at the metaphyses. (Figure is modified from O. Jacenko and D. Chan [1998], *J. Cells Mater.* **8**, 123–134.)

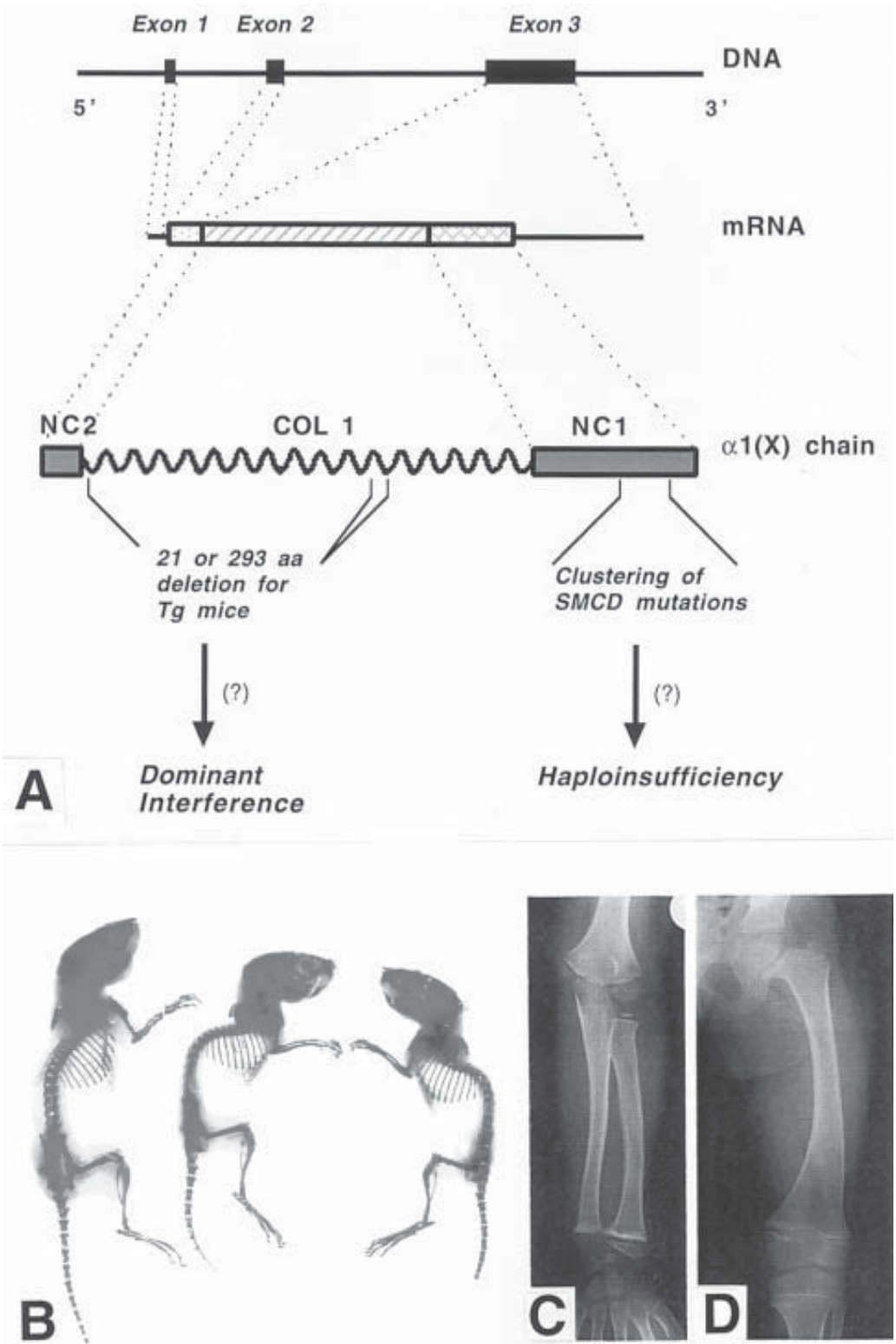

Fig. 1

small nonhelical globular NC2 domain at the amino terminus, and by a larger highly conserved nonhelical carboxyl-terminal NC1 domain. The NC1 domain of collagen X shares sequence similarities with the C-terminal propeptide domain of fibrillar collagens, which is involved in intracellular  $\alpha$ -chain selection, followed by association of the three  $\alpha$ -chains and subsequent trimerization/triple helix formation (13). By analogy, the  $\alpha 1(X)$  NC1 domain is anticipated to play a similar role in collagen X assembly. We have taken advantage of this in the design of the transgene constructs (7,14). By deleting portions of the gene encoding the central, triple-helical domain of collagen X, we generated partially functional alpha chains with intact NC1 and NC2 domains (Fig. 2B). We predicted that these truncated Tg products would be able to compete with endogenous collagen X chains at the NC2 domain; however, because of the central deletions, these hybrid trimers would not be able to fold into stable trimeric collagens. As a consequence, these hybrid molecules would either be degraded through a protein suicide mechanism, or would persist as abnormal molecules that would further disrupt endogenous collagen X supramolecular assembly (Fig. 2B).

It should also be noted that we selected to use chicken collagen X DNA for two reasons. First, mouse collagen X had not yet been cloned. Second, we needed a way to differentiate the transgene product from the endogenous. Because the available chicken collagen X cDNA and protein sequences showed a high degree of identity at the carboxyl domains with those from other species (15), this implied that intraspecies molecular interaction would likely occur. Furthermore, we had available several monoclonal antibodies against chick collagen X that were already shown not to cross-react with mouse collagen X, and polyclonal antimouse collagen X antibodies.

One of the more common issues that researchers encounter in analysis of transgenic mice is the inability to differentiate the transgene product from the endogenous. This can be circumvented as described for the collagen X mice by using DNA with high identity from a different species, or by adding to the transgene a tag that could be recognized by a specific antibody. Alternatively, PCR primers could be designed to differentiate between the endogenous and transgene messages by RT-PCR, or probes generated that would identify different size messages by northern blot. These issues should be considered at the initial planning stages and tested prior to generation of the transgene constructs; the inability to observe transgene expression in resultant mice may impair subsequent analyses.

#### **2.4. Testing of Transgene Constructs**

The success of generating useful transgenic mouse models depends greatly on the care taken for the design and preparation of the transgene constructs. It is thus advised that the transgene constructs, as well as subcomponents of the constructs, be tested prior to microinjection. In vitro, this may involve testing at several levels, including assaying for promoter specificity by in vitro transcription studies, transgene expression by cell-free translation, as well as confirmation of the entire construct by restriction mapping and sequencing.

When selecting transgenesis through pronuclear injection, a hybrid promoter/reporter construct must be designed (5). As discussed above, the "reporter" in this case would be a transgene that when expressed, would encode a mutant variant of the molecule of interest. Expression of the transgene would be dependent on the activity and specificity

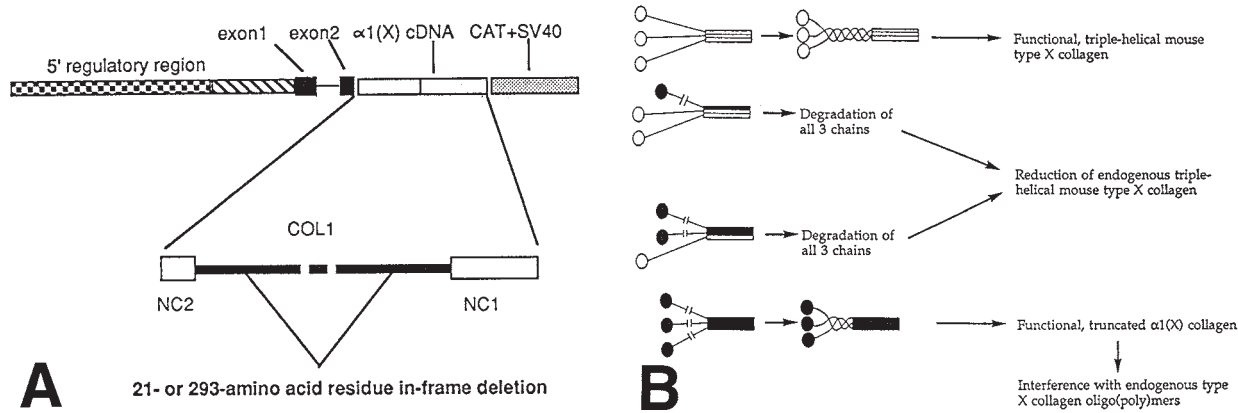

Fig. 2. Design of transgene constructs for dominant interference of collagen X. **(A)** Four collagen X transgene constructs were generated for pronuclear microinjection. The chicken  $\alpha 1(X)$  cDNA containing a central in-frame deletion of either 21 or 293 codons, was inserted between the 5' portion of the chicken  $\alpha 1(X)$  gene, and CAT (bacterial chloramphenicol acetyl transferase). The 5' region contains repressor elements located within 4700 bp (cross-hatched and lines bars) or within 1600 bp (lined bars) of the transcription start site, as well as exon 1, intron 1, and exon 2 up to the translation start codon. The CAT portion contains SV40 splice signals and a polyadenylation site. Expression of these constructs yields truncated  $\alpha 1(X)$  polypeptides with 21 or 293 amino acid deletions in the triple-helical domain (COL1), but with intact NC1 and NC2 nontriple-helical domains. **(B)** Schematic representation of dominant interference. A hypothetical mechanism is shown by which truncated chick  $\alpha 1(X)$  chains (shaded molecules) may interfere with the formation of triple-helical mouse  $\alpha 1(X)$  homotrimers (clear molecules), or with their oligo(poly)mer structure in the matrix. The inability of the hybrid molecules to form stable heterotrimers may lead to a degradation of the hybrid chains through a protein suicide mechanism, causing a reduction in the functional levels of the endogenous gene. Likewise, secretion of truncated homotrimers may interfere with endogenous collagen X function. Alternatively, the persistence of either the heterotrimers or of homotrimers may also result in a gain-of-function phenotype. (Figure is modified from **Fig. 1** in O. Jacenko, P. LuValle, B. R. Olsen (1993), *Nature* **365**, 56–61.)

of the selected promoter. These promoters may be constitutive, inducible, cell-specific, viral, or that of a housekeeping gene. Typically, for dominant interference one would expect the transgene to be coexpressed with the endogenous molecule of interest. Thus, for the collagen X mice, we selected the 5' region of the chick collagen X gene, which has been tested previously *in vitro*. Specifically, it was shown through transient transfection experiments that this region contained promoter and silencer elements, which are active in both mammalian and embryonic chicken cells (7,16,17). In general, however, *in vitro* transcription results do not always mimic *in vivo* conditions. For this reason, to assure greater success obtaining appropriate transgene expression, it would be optimal to use a promoter whose activity was already confirmed *in vivo* (e.g., through generation and analysis of a Tg mouse with promoter/reporter transgene construct). For our purpose, we included different lengths of the chicken collagen X promoter that were tested by *in vitro* transcription studies to increase the likelihood of obtaining tissue-specific expression (Fig. 2A).

Likewise, the transgene should be tested to ensure a proper DNA reading frame which, upon expression, would yield a translation product of expected size. This can be accomplished by cloning the transgene into a vector containing an *Sp6* or *T7* promoter, and using a commercially available kit for *in vitro* transcription. Subsequent cell-free translation would generate polypeptides that could be analyzed by SDS-PAGE. Currently, kits are available that provide a TNT-coupled transcription and translation system that could be carried out in a single reaction (Promega, Madison, WI). Such assays are relatively quick and straight forward, and may readily identify reading frame alterations in the construct that would impair expression of a proper transgene product. Alternatively, once mice are generated, it is typically far more labor-intensive and time-consuming, not to mention expensive, to identify the cause for lack of transgene expression. It is thus recommended to invest the time in confirming the various components of the transgene construct at the initial phases of the experiment prior to generating mice.

For dominant interference of collagen X, the aforementioned approach involving *in vitro* transcription coupled to cell-free translation was further used to confirm the dominant interference mechanism of transgene action. Specifically, by coexpressing a wild-type cDNA with the transgene, we were able to distinguish different size peptides corresponding to full-length and truncated collagen X alpha chains (7). Furthermore, under conditions favoring chain association, we were able to confirm interactions at the carboxyl domain between truncated chick, and full-length mouse collagen X (Fig. 3; O. Jacenko, et al., manuscript in preparation). Thus, through this approach, we were confident that at least *in vitro*, our constructs encoded a transgene product that would be able to compete for association with full-length endogenous collagen X chains. It is possible that this approach may be useful for confirming other dominant interference constructs where intermolecular interactions are expected.

Once the promoter and transgene are tested, they are cloned into an appropriate vector. If the transgene is a fragment of genomic DNA or is a cDNA, it would require splice signals and a polyadenylation site, which are often provided by *SV40* sequences. Once the construct is assembled, it needs to be confirmed by restriction mapping; often it is also of value to confirm the sequence, especially at splice regions, by direct sequencing. Last, once a transgene construct is prepared, extensive care needs to be

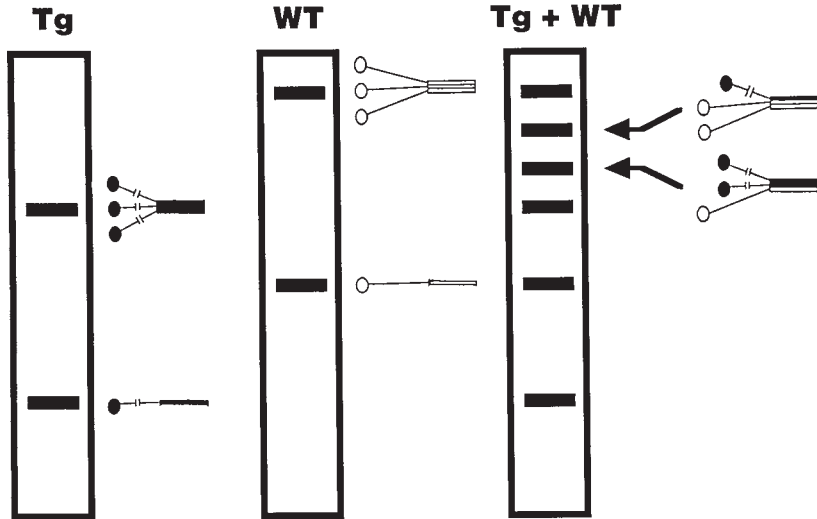

Fig. 3. Schematic representation of coexpression of truncated chick collagen X transgene product with full-length mouse molecules in a cell-free translation system. Cell-free translation and the *in vitro* formation of homotrimers and heterotrimers of the truncated chick transgene and full-length mouse collagen X can be visualized by SDS-PAGE. The first panel depicts an SDS-PAGE lane with cell-free translation products of the transgene (Tg) under conditions favoring associations; formation of both monomers and homotrimers is seen. Likewise, translation of wild type (WT; second panel), full-length mouse collagen X molecules under similar conditions reveals both monomeric and homotrimeric proteins. Cotranslation of transgene and wild-type (Tg + WT; third panel) collagen X constructs identifies two additional bands; the higher molecular weight product migrating below the mouse homotrimers comprises the heterotrimer of (wild type)<sub>2</sub>(transgene) chains; the faster migrating band below corresponds to (wild type)(transgene)<sub>2</sub> chains. Similar analyses to these have confirmed that at least *in vitro* the heterotypic and homotypic associations at the carboxyl domain occur between the transgene–transgene, and transgene–wild-type collagen X polypeptides. This supports dominant interference as a mechanism for transgene action, but does not exclude the possibility that persistence of these abnormal molecules in growth plates may also contribute to the phenotype.

taken for its purification prior to injection. Specifically, the plasmid containing the transgene construct is purified twice by cesium chloride gradient centrifugation (18). The transgene construct is then isolated by restriction enzyme digestion, minimizing inclusion of vector sequences; this is to avoid possible vector contribution to the murine phenotype. The inserts are then purified by gel electrophoresis and electroelution, and concentrated using ion-exchange column chromatography (e.g., Schleicher and Schuell, Keene, NH; Elutip-d Kit), followed by ethanol precipitation. Inserts are then resuspended in Tris-EDTA (TE) buffer, checked by gel electrophoresis to confirm lack of contaminants (e.g., vector sequences), and quantitated.

### 2.5. Generation of Transgenic Mice by Pronuclear Injection and Establishment of Transgenic Lines

The generation of Tg mice by pronuclear microinjection has been described in detail elsewhere (5, also *see* Chapter 44 in this volume by Garofalo and Horton and Part V:



Transgenesis: *Production and Gene Knockout* in Vol. II of this series). Briefly, the morning following natural matings of inbred mice, fertilized mouse eggs at the one-cell stage are flushed from the oviduct and cultured for 1–2 h until pronuclei become visible. A solution containing the linearized transgene construct is then microinjected via a glass micropipet into the male pronucleus of a fertilized egg that is restrained. Injected eggs are then surgically transferred into the oviduct of a pseudopregnant surrogate mother, who has been previously mated with a vasectomized male. Resultant pups ( $f_0$ ) are then analyzed for transgene presence by genomic Southern blot, dot blot, and/or PCR, using tail DNA obtained from biopsies. For these analyses, it is important to obtain tail DNA with an  $OD_{260/280}$  ratio greater than 1.6/1.7. For this purpose, we use a modified protocol of Laird et al. (19), followed by phenol/chloroform extraction (*see Subheading 3.*).

### 3. SUMMARY—Genomic Tail DNA Isolation, Purification, and Analysis by Southern Blot

#### Day 1:

1. Incubate microcentrifuge tubes containing lysis mix (100 mM Tris-HCl pH 8.5, 5 mM EDTA, 0.2% SDS, 200 mM NaCl, 100  $\mu$ g proteinase K per mL) and approx 2 cm clipped tail at 56°C overnight in a rotating tube rack or other means of continuous agitation. (This step is important to accomplish efficient lysis. Failure to mix well will result in poor restriction digestion.)

#### Day 2:

2. Remove microcentrifuge tubes containing lysed tail tissue and vortex rigorously to break apart undigested aggregates.
3. If digest is incomplete, add 1–3  $\mu$ L proteinase K per sample and digest for 1 h at 56°C.
4. Vortex tubes until all aggregates are dispersed.
5. Centrifuge at 9000–10,000g at 4°C, 10–15 min.
6. Transfer supernatant into tubes containing 700  $\mu$ L ice-cold isopropanol. Avoiding carry over from pellet.
7. Shake each tube vigorously by inversion until DNA forms a stringy precipitate.
8. Spool DNA using a sterile pipet tip and pipetor; dab off excess alcohol on lid of Eppendorf tube and transfer to 200  $\mu$ L of deionized water (DI) or TE.
9. If isolations look clean (e.g., if DNA precipitate is colorless and appears viscous upon resuspension), resuspend DNA either at 37°C overnight, or at 56°C for 1 h. If DNA appears slightly colored and very viscous, proceed with phenol/chloroform treatment.
10. For phenol/chloroform, bring tail DNA volume to 200  $\mu$ L with either DI or TE.
11. Proceed with phenol/chloroform extraction as detailed in Maniatis et al. (18). After first extraction, remove the top phase. Add equal volume DI to interphase and bottom phase, and repeat extraction. If interphase is still extensive, repeat phenol/chloroform extraction for the third time, and collect only the upper phase.
12. Following ethanol precipitation, transfer DNA with a sterile pipet tip to clean tube containing 100  $\mu$ L DI or TE.
13. Let DNA resuspend overnight at 37°C; prior to OD, place at 56°C for up to 1 h to thoroughly mix via pipeting.

#### Day 3:

14. Measure  $OD_{260}$ ,  $OD_{280}$ , and calculate DNA concentration and  $OD_{260}/OD_{280}$  ratios (should be above 1.7).
15. Immediately aliquot 8  $\mu$ g DNA for restriction digest.

16. Choose your digest so that only one enzyme is used. Cut DNA over a minimum period of 6 h, with 2-to-3 additions of enzyme. Include both BSA, RNase, and, if needed, spermidine in the digest mix.
17. Run DNA on ultrapure agarose gel at maximum 60 V (we run gels at 20 V overnight).

Day 4:

18. Denature (1.5 M NaCl, 0.5 N NaOH; 20 min) and neutralize (1 M Tris-HCl pH 7.5, 1.5 M NaCl; 30 min  $\times$  2) gel; rinse in 20X SSC.
19. Set up DNA transfer onto Hybond N+ nylon filter (general approach summarized in Maniatis et al. [18]).

Day 5:

20. Rinse filter in 5X SSC and UV cross-link DNA to filter (via Spectrolinker, transilluminator, or baking in oven).
21. Prehybridize for 2 h at 45°C with formamide (50% formamide, 20% 20X SSC, 80 g Dextran sulfate per liter, 0.2% 0.5M EDTA, 10% SDS, 10% 100X Denhardt's, 25 mg salmon sperm DNA), using agitation (e.g., Hybaid oven or shaking water bath).
22. Hybridize overnight using a random prime-labeled  $^{32}\text{P}$  probe (Boehringer Mannheim, Mannheim, Germany) at 45°C with formamide. (We random-prime label 3.3 ng purified linearized approx 2 Kb probe per lane containing 8  $\mu\text{g}$  genomic DNA; probe specific activity is in the range of  $10^7$  or  $10^8$  cpm per  $\mu\text{L}$ .)

Day 6:

23. Stringency washes (0.1% SDS, 0.1X SSC; first set of washes at room temperature, 5 min  $\times$  3; second set at 55°C, 20 min  $\times$  3) and film exposure.

Typically, approx 10–20% of the  $f_0$  pups carry the transgene, and are referred to as founders. Each founder represents the result of an independent transgene microinjection and integration event. Transgene integration usually occurs at the one-cell stage, therefore, the germ cells and all somatic cells of the founder will contain the transgene. However, if integration occurs at a later point, not all cells may contain the foreign DNA; the founder is then a mosaic for the transgene. All founders thus need to be bred with wild-type mice to identify germ-line transmission of the transgene, and to establish unique families of mice, or transgenic lines. For this purpose,  $f_1$  hemizygotes (e.g., mice carrying the transgene on one of two chromosomal alleles) are interbred with other hemizygotes from the same line (e.g., originating from the same founder) to generate homozygous mice for the transgene. Homozygotes are identified by the intensity of transgene hybridization signals on genomic Southern blots when compared to those of hemizygotes (**Fig. 4**). Furthermore, they are confirmed as homozygotes by backcrossing to wild-type mice; such matings should yield 100% hemizygous offspring.

Genotyping of offspring from  $f_0$  and  $f_1$  by Southern blot is essential not only for identifying homozygotes, but for confirming independent transgene insertion sites (summarized in [5]). Transgene integration is random, therefore the DNA may insert anywhere in the genome. By doing so, it may disrupt endogenous gene function, leading to a phenotype. Approximately 10% of the random integration events result in insertional mutagenesis, which most commonly manifests as a recessive phenotype. Alternatively, a spontaneous mutation may arise coincidentally in the transgenic strain and result in a phenotype. *The basic requirement in the analysis of transgenic mice is therefore to establish the involvement of the transgene in any aberrant phenotype.*

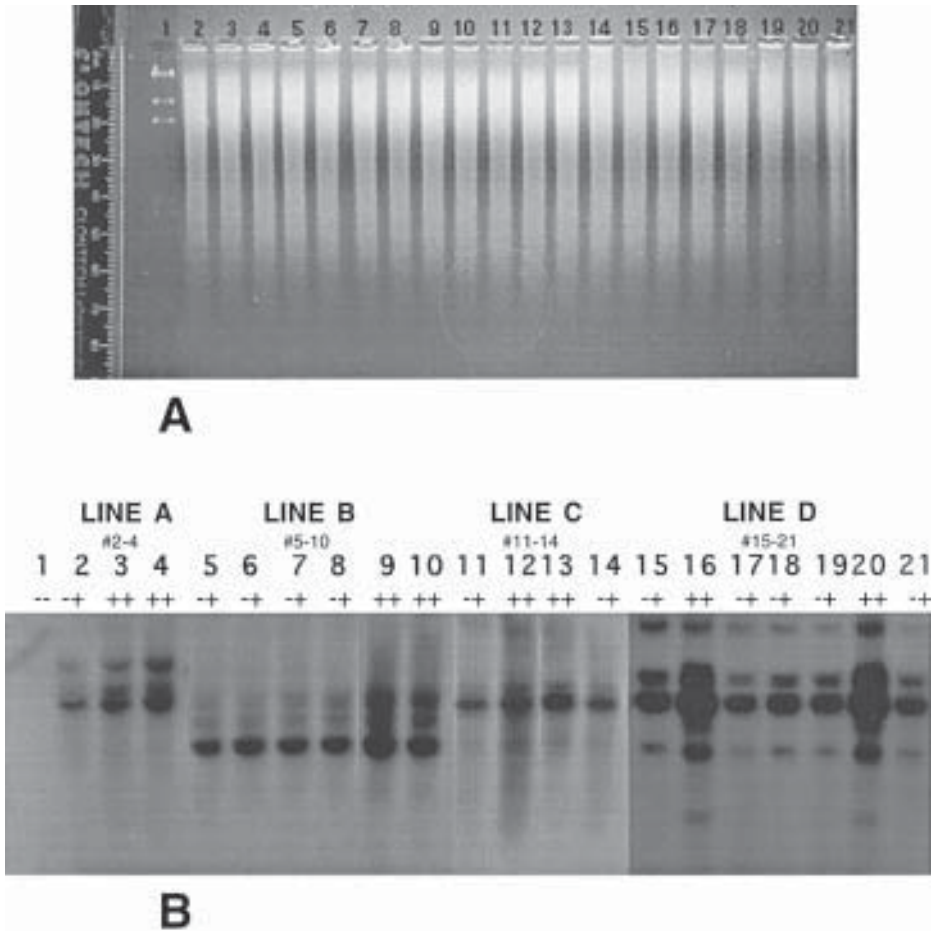

Fig. 4. Genotyping of mice and confirmation of independent transgene insertion sites in 4 Tg mouse lines by genomic Southern blot analysis. **(A)** Agarose gel showing 8  $\mu$ g per lane of mouse genomic DNA isolated from tail biopsies according to the protocol in **Subheading 2.5**. DNA was purified, quantitated, digested with Sac I for 6 h, and electrophoresed through an 0.8% agarose gel. Lane 1 = molecular weight standard. **(B)** Detection of transgenes by Southern blot hybridization in four independent Tg lines carrying the same transgene construct (Line A = lanes 2–4; Line B = lanes 5–10; Line C = lanes 11–14; Line D = lanes 15–21). Genomic DNA from agarose gel shown in **(A)** was blotted onto nylon, and hybridized with a  $^{32}$ P-labeled chicken  $\alpha$ 1(X) probe specific for the transgene. Even though the same transgene is present in each line, hybridization patterns are distinct. These patterns result from head-to-tail concatenation and rearrangements of internal transgene sequences, differences in transgene copy number, as well as independent 5' and 3' transgene insertion sites. Furthermore, based on hybridization intensities within each line, hemizygous (–+) and homozygous (++) mice can be identified.

To determine whether the phenotype results from insertional mutagenesis, a spontaneous mutation, or from transgene expression, mice from several transgenic lines carrying the same transgene need to be compared based on genotype, phenotype, and transgene expression. To rule out insertional mutagenesis, a minimum of two lines

(representing at least two independent microinjection events and transgene insertion sites) must show the same phenotype, and express the transgene message/product in a similar temporal pattern. Southern blot analysis of genomic DNA obtained from tail biopsies from mice in these lines should reveal different insertion sites, evidenced by differences in migrations of specific DNA fragments following digestion with the same restriction enzyme (**Fig. 4A,B**). Southern analysis will also reveal transgene dosage, as well as head-to-tail arrangements (7). It is important to realize that transgene expression does not necessarily correspond to transgene copy number, but is influenced by the insertion site microenvironment. Furthermore, transgene deletions and rearrangements can occur over a number of generations, and thus may influence transgene expression and the resultant phenotype. These points further underline the importance of initially analyzing mice from several transgenic lines, and then maintaining two to three of these lines for characterization. If more than one transgenic line is not available, or if the phenotype appears to result from insertional mutagenesis, characterization of the transgene insertion site becomes necessary. This is accomplished by first cloning the genomic DNA flanking both sides of the inserted transgene, and later using these clones to isolate the intact gene (5).

For the collagen X transgenic mice, 4 transgene constructs were microinjected, and 21 founders were identified out of 68 pups (7). Of these founders, 15 were able to establish transgenic lines representing all constructs, and have yielded similar skeleto-hematopoietic phenotypes. Southern blot confirmed an independent transgene insertion site in each line (e.g., **Fig. 4**; also, *see Fig. 2 in [7]*). These data led to the conclusion that the observed phenotype in these lines had to result from the presence of the collagen X transgene, and not from disruption of an endogenous gene through random transgene integration.

### **3.1. Segregation of Genotype with Phenotype**

The first requirement in the analysis of transgenic mice is to demonstrate that the transgene and the newly identified murine phenotype are genetically inseparable. As aforementioned, this is first accomplished by standard genetic crosses and genomic DNA analysis to identify genotypically positive pups, and to monitor transgene cosegregation with the observed phenotype. Second, transgene expression in the expected temporospatial pattern needs to be confirmed in all lines. This may be accomplished at the mRNA level by northern blot, *in situ* hybridization, or RT-PCR, and/or at the protein level by immunohistochemistry, Western immunoblotting, or immunoprecipitation. As mentioned in **Subheading 2.3.**, it is thus important to be able to differentiate between the transgene product and the endogenous protein of interest. For dominant interference in particular, it is important to demonstrate coexpression of these proteins, as well as an interaction.

For collagen X mice, transgene coexpression with endogenous collagen X was demonstrated first by immunohistochemistry using species-specific collagen X antibodies (7). Both the truncated chick and the full-length mouse molecules were colocalized to hypertrophic cartilage, as expected. Furthermore, these data were confirmed on the message level by both northern blot, and RT-PCR. For the latter, a similar expression pattern was observed for the transgene product and mouse collagen X at 4 different developmental stages, in 14 different tissues and organs (M. Campbell, C. Gress,

A. Franklin, and O. Jacenko; manuscript in preparation). These data further rule out contribution of inappropriate transgene expression to the observed murine phenotype.

### 3.2. Assessment of Phenotype

A number of approaches could be undertaken in analyzing the murine transgenic phenotype. Because most of these approaches depend on the specific defect, only general methods will be summarized. Overall there are 4 basic categories of phenotypes that could ensue: 1) lethal; or nonlethal and 2) visibly apparent; 3) apparent only by histologically or biochemically approaches; 4) not apparent by any means.

The first and most obvious phenotypic assessment is by visual inspection. Daily observations of all mice, starting at the  $f_0$  stage, will alert the researcher for gross morphologic and behavioral changes. Attention should be on litter size compared to that of wild-type controls both on the day of birth as well as at weaning; *in utero* and perinatal lethality; weight, number, and size of pups upon weaning; sex and genotype ratios after wild-type  $\times f_0$ , and  $f_1$  hemizygote matings; alertness; mobility; obvious skeletal malformations, or disproportionate growth. For this reason, it is recommended that at least initially, the mouse litters be inspected daily by the researchers (rather than solely by the animal facility caretakers) from date of birth to postweaning and genotyping. Furthermore, the pups should be compared to chronologically equivalent wild-type controls for growth and/or behavioral changes throughout their lives.

Following visual assessment, subsequent analyses would involve dissection of animals at specific time-points, a visual inspection of organs, and histological analysis. For histological assessment, it is recommended that tissue sections are first viewed after conventional hematoxylin/eosin (H&E) staining for general morphology. For this purpose, tissues should be freshly dissected, fixed for 3 d in either Bouin's or 4% paraformaldehyde in phosphate-buffered saline (PBS), decalcified if needed, dehydrated in an ascending ethanol series, embedded in paraffin, and sectioned at approx 6–8- $\mu$ m thickness. Following H&E analysis, specific dyes may be selected for assessment of certain tissue properties. For example, in viewing cartilage, certain dyes may be used that specifically react with the high density of negative charges from the carboxyl and sulfate groups of chondroitin and keratan sulfate glycosaminoglycans that comprise aggrecan. Specifically, Alcian blue at pH 1 stains the sulfate groups of GAGs characteristically found in cartilage; likewise, toluidine blue stains cartilage metachromatically because of its avidity for the negatively charged GAGs. For osteoarthritic changes, safranin O is typically used to monitor loss of articular cartilage proteoglycans. For mineralized tissues, Alizarin red S or Von Kossa stains are good choices. For blood analysis (e.g., bone marrow sections or peripheral blood smears), Giemsa or Romanovsky stains are ideal because they differentiate various degrees of cell avidities for eosin, methylene blue, and azure dyes, and thus distinguish different blood cell types and lineages. If skeletal, mineralization, and/or cartilage defects are anticipated, mice may also be viewed macroscopically by X-rays as well as by whole skeleton staining with Alizarin red S and/or Alcian blue (e.g., **Fig. 1B**). For details on specific histological protocols, the text by Humason (20) is highly recommended.

In addition to conventional histology, it is essential to demonstrate transgene expression, and to colocalize it with the observed morphological defects. Several approaches are mentioned above for this purpose. For immunohistochemical localiza-

tion of the transgene product, it is often preferred to use cryosections for the sake of antigen preservation, although the morphology of the tissue typically suffers. Likewise, immunohistochemistry may identify whether the pattern of expression of other molecules is altered as a consequence of transgene expression.

Thus, a phenotypic abnormality can be identified in transgenic mice at either the macroscopic and/or microscopic level. This phenotype is further confirmed to result as a consequence of transgene expression by demonstrating a similar phenotype in several lines with independent transgene insertion sites. Furthermore, the transgene product is expected to exhibit a temporospatial expression pattern that is coincident with the histological, biochemical, or behavioral defect. Once these links are established, functional assays may be designed to address the role of the molecule in question (e.g., protein–protein interactions, biomechanical studies, and so on), as well as to confirm the mechanism of transgene action through which the pathogenic phenotype arises. These approaches would depend entirely on specific situations (e.g., see below for the collagen X Tg mice). Once the aberrant murine phenotype is characterized, it may serve as a basis for screening human disorders with comparable phenotypes that may ensue from mutations in the molecule of interest.

Difficulties arise if a lethal phenotype occurs in mice, or if no apparent defect could be identified. To address such issues, new transgenesis techniques are being developed that enable the researcher to delete or substitute genes in specific tissues and at specific developmental stages of a mouse's life (for review *see* [10]). For example, if embryonic lethality occurs, the resultant mice may not be analyzed appropriately. Through the generation of “inducible knock-outs,” this problem may be circumvented; a conditional expression of a mutation, or a deletion of a gene in mice after this gene has performed any possible function during embryonic development, would allow the animals to be born alive, and for the mutation to be manifested at a predetermined time-point (10,21,22). Likewise, in transgenic or knock-out mice with no apparent phenotype, “knock-in” technology, involving the replacement of the gene in question by another gene, may establish whether the two genes can compensate for one another's function (10,23,24). Alternative studies may involve interbreeding of the transgenic or knock-out mice with other transgenic mouse models to rule out compensation (e.g., generation of compound homozygotes as in the case with paralogous HOX genes (25,26).

For the collagen X Tg mice, transgene expression in hypertrophic cartilage yielded a variable, skeleto-hematopoietic phenotype in 14 Tg mouse lines, each with an independent transgene insertion site (7,14). Specifically, approx 20–25% of the transgene-positive mice exhibited perinatal-lethality; this phenotype was manifested as thoracolumbar kyphosis and wasting approx week 3 after birth. The remaining 75–80% of the transgene-positive mice exhibited variable dwarfism; with age, these mice were susceptible to skeletal deformities, nonhealing skin ulcers, and aggressive lymphosarcomas. The latter suggested impaired immune function.

The skeletal defects were first confirmed by X-ray and by whole skeleton staining with Alizarin red S (7,14) (also *see* Fig. 1B). Subsequent histology revealed specific defects in the metaphyseal zones of tissues arising through EO (6,7). In particular, histomorphometry of perinatal-lethal and dwarfed Tg mice revealed growth plate compressions in hypertrophic cartilage zones and reduced trabecular bone. Electron microscopy detected a disruption of the hypertrophic chondrocyte pericellular matrix

network (likely composed of collagen X), as well as a decompartmentalization of the chondro-osseous junction. This was manifest microscopically by proteoglycan aggregates masking collagen fibrils in proliferative growth plate zones (O. Jacenko, et al., manuscript in preparation).

The predominant murine phenotype of dwarfism with metaphyseal involvement helped identify two human autosomal dominant disorders, Schmid metaphyseal chondrodysplasia (SMCD), and spondylometa-physal dysplasia (SMD), resulting from mutations in the carboxyl domain of collagen X (for review *see* [6,27,28]) (Fig. 1C,D). Through use of the *in vitro* transcription coupled to cell-free translation technology detailed above, it was proposed that collagen X haploinsufficiency (e.g., a 50% reduction in collagen X) may be the likely mechanism underlying the human pathology in SMCD; this condition would result from the inability of mutant chains to form associations at the carboxyl domain, which are prerequisite for subsequent chain trimerization (Figs. 1A and 2B). Likewise, dominant interference mutations in the triple-helical collagen X domain were proposed to yield more severe phenotypes, possible involving altered hematopoiesis, as seen in the Tg mice (Figs. 1A and 2B).

Specifically, the 20% of mice with perinatal-lethality had the most severe histological defects including greatest growth plate compressions, the least amount of bony trabeculae, and a depletion of the hematopoietic compartment in the marrow. The latter was evidenced as a predominance of mature erythrocytes, and a reduction of leukocytes, which is characteristic of marrow aplasia. Gross observation of organs upon dissection, followed by histology, immunohistochemistry, and flow cytometry revealed changes in all lymphatic organs. These included a dramatic thymic reduction with a paucity of immature T lymphocytes; spleens were also small, discolored, displayed altered architecture, and a decrease in B cells. A comparable phenotype was seen in ~10.5% of homozygous mice with null alleles for collagen X<sup>8</sup> (C. Gress and O. Jacenko; manuscript in preparation). These intriguing hematopoietic abnormalities led us to propose that cartilage substitution by bone and marrow may establish the marrow stromal microenvironment prerequisite for blood cell differentiation. These data underline the intricate and previously unforeseen relationship between endochondral skeletogenesis and hematopoiesis.

### 3.3. Examples of Application

To date, transgenesis has yielded invaluable information regarding all phases of skeletal development. Murine models have both confirmed, as well as helped identify mutations in molecules underlying a number of skeletal dysostoses and dysplasias in humans (reviewed in [3,4,12,29–32]). A few examples include the involvement of *Hox* and *Pax* genes in the global specification of skeletal pattern; TGF $\beta$  superfamily members in specification of skeletal shape; transcription factors including *SOX9*, *Cbfa1*, *PU.1*, *c-src*, and *c-fos* in the commitment of cells to the chondrogenic, osteogenic, or hematopoietic (osteoclastic) lineages; proliferation-controlling factors including fibroblast and insulin-like growth factors that control local skeletal growth and shape; extracellular matrix molecules including collagens (types I, II, IX, X, XI), proteoglycans (glypican, sulfate transporter defect), glycoproteins (matrix Gla protein, osteocalcin, COMP) that contribute towards the structure and function of skeletal tissue; and molecules involved in calcium homeostasis (PTH/PTHrP receptor, calcitriol receptor, cal-

cium-sensing receptors-CaSr) that control skeletal homeostasis. For most of the listed molecules, transgenic murine models as well as corresponding human diseases have been identified and characterized. In some cases, the murine models have contributed towards the identification of the corresponding human disease, and are serving as models for the development of therapies.

Along with the many successes there are a few uncertainties. Specifically, it is becoming apparent that murine models do not always mimic the human phenotypes. Furthermore, in several cases murine phenotypes were shown to be strain-specific, implying the existence of modifying genes that may effect the penetrance of the disease phenotype; incidentally, this phenomenon is also observed in human disorders (33). Last, it is not often possible to identify a specific function of the molecule of interest through transgenesis; rather, this approach reveals the phenotypic consequences resulting from the molecule's disruption, and provides a means for characterizing the molecular mechanisms underlying the disease phenotype. These issues are well exemplified by the collagen X Tg mice.

Based on the dominant interference collagen X Tg murine model as well as on the human mutations resulting in SMCD and SMD, one would predict a moderate-to-severe phenotype if collagen X were inactivated. However, Rosati et al. (8) reported no gross phenotypic changes in their collagen X null (KO) mice. These animals were on the 129/SvEv  $\times$  C57BL/6J (B6) background, and were subsequently bred with B6 wild-type mice for establishment of lines. This finding suggests that only the presence of an abnormal collagen X (e.g., resulting in a gain-of-function phenotype), can modify bone growth in mice. Furthermore, this scenario is at odds with the proposed mechanism of haploinsufficiency for the human SMCD mutations; likewise, it implies that the dominant interference collagen X mutations in Tg mice may result primarily in a gain-of-function phenotype.

In contrast, chondro-osseous defects were observed in a second set of collagen X null mice, generated by Kwan et al. (9). In addition to generating 129/SvJ  $\times$  B6 hybrids, the null mutation was bred into the 129/SvJ strain. Interestingly, more pronounced phenotypic changes were observed in the 129/SvJ strain, and mimicked certain trends reported for the Tg mice and SMCD patients. However, unlike human patients with SMCD, mice heterozygous for the null allele appeared to be phenotypically normal despite being haploinsufficient. Whereas these studies have reconciled some differences in the mouse phenotypes, an overall milder phenotype than in the SMCD patients is still unresolved, and questions the proposed mechanism of haploinsufficiency for SMCD patients.

Last and foremost amidst the unresolved phenotypic differences are the hematopoietic changes described in the collagen X Tg mice, which have not been originally reported in either the KO mice, or in SMCD patients. As aforementioned, we have recently observed a variable skeleto-hematopoietic phenotype in a subset of the collagen X null mice described by Rosati et al. (8) that mirrored the defects seen in the Tg mice with perinatal lethality (C. Gress and O. Jacenko; submitted manuscript). Ongoing characterization of the murine phenotypes should establish whether all mice with defective collagen X have altered hematopoiesis, if this is strain-specific, an effect of a modifier gene, or a direct result of collagen X disruption. In conjunction, unraveling the mechanisms underlying the murine and human disease phenotypes should provide insights into other disorders with skeleto-hematopoietic changes.



#### 4. Notes

1. Transgene constructs should be designed so that the transgene product or its expression pattern could be distinguished from that of the endogenous molecule.
2. Each component of the transgene constructs (e.g., promoter and “reporter” DNA) should be tested extensively *in vitro* prior to generation of Tg mice.
3. Independent transgene insertion sites should be demonstrated in several Tg mouse lines by Southern blot analysis, and 2–3 of these lines (with similar phenotypes) should be maintained for subsequent analysis.
4. A correlation needs to be established between transgene presence (based on transgene segregation, expression, and localization) and the disease phenotype.
5. Phenotypic penetrance may vary in different mouse strains. Furthermore, phenotypic variations may ensue from an outbred background, or from the presence of strain-specific modifier genes. If a variable phenotype, or phenotypic discrepancies between outbred mouse strains is observed, inbreeding into pure genetic backgrounds may help resolve these issues.
6. Different transgenesis strategies may yield distinct phenotypes; it may be useful to compare the outcomes from several approaches (e.g., dominant interference vs knock-out).
7. The function of the molecule in question may not be readily apparent through transgenic approaches (e.g., see above regarding distinct outcomes from different transgenesis strategies). Typically, Tg murine models reveal the consequences of the disruption of the molecule’s function, which often yields a disease phenotype.
8. The correlation between murine disease models and human disorders may not be precise. This may be of particular relevance towards the generation of murine osteochondrodysplasia models where the molecule in question is localized to skeletal tissue. For such studies the weight-bearing and load differences in quadrupeds vs bipeds should be taken into account.

#### Acknowledgments

The author greatly appreciates the comments and critical review of the manuscript by Dr. James San Antonio from Thomas Jefferson University. This work has been supported by NIH:NIAMS #AR43362.

#### References

1. Spranger, J. (1992) International classification of osteochondrodysplasias. *Eur. J. Ped.* **151**, 407–415.
2. Jacenko, O. and Olsen, B. R. (1995) Transgenic mouse models in studies of skeletal disorders. *J. Rheumatol.* **22**, 49–41.
3. Mundlos, S. and Olsen, B. R. (1997) Heritable diseases of the skeleton. Part I: Molecular insights into skeletal development-transcription factors and signaling pathways. *FASEB J.* **11**, 125–132.
4. Mundlos, S. and Olsen, B. R. (1997) Heritable diseases of the skeleton. Part II: Molecular insights into skeletal development-matrix components and their homeostasis. *FASEB J.* **11**, 227–233.
5. Jacenko, O. (1997) Strategies in generating transgenic mammals. *Meth. Molec. Biol.* **62**, 399–424.
6. Chan, D. and Jacenko, O. (1998) Phenotypic and biochemical consequences of collagen X mutations in mice and humans. *Matrix Biol.* **17**, 169–184.
7. Jacenko, O., LuValle, P., and Olsen, B. R. (1993) Spondylometaphyseal dysplasia in mice carrying a dominant negative mutation in a matrix protein specific for cartilage-to-bone transition. *Nature* **365**, 56–61.

8. Rosati, R., Horan, G. S., Pintero, G. J., Garofalo, S., Keene, D. R., Horton, W. A., et al. (1994) Normal long bone growth and development in type X collagen null mice. *Nature Gen.* **8**, 129–135.
9. Kwan, K. M., Pang, M. K., Zhou, S., Cowen, S. K., Kong, R. Y., Pfordte, T., et al. (1997) Abnormal compartmentalization of cartilage matrix components in mice lacking collagen X: implications for function. *J. Cell Biol.* **136**, 459–471.
10. Ezzell, C. (1996) Research in focus. Murine mania: researchers devise a host of new techniques for making knock-out mice. *J. NIH Res.* **8**, 33–36.
11. Olsen, B. R. (1995) New insights into the function of collagens from genetic analysis. *Cur. Opin. Cell Biol.* **7**, 720–727.
12. Horton, W. A. (1996) Molecular genetic basis of the human chondrodysplasias. *Growth Growth Disord.* **25**, 683–697.
13. Doege, K. J. and Fessler, J. H. (1986) Folding of the carboxyl domain and assembly of procollagen. *J. Biol. Chem.* **261**, 8924–8935.
14. Jacenko, O., LuValle, P., Solum, K., and Olsen, B. R. (1993) A dominant negative mutation in the  $\alpha 1(X)$  collagen gene produces spondylometaphyseal defects in mice, in *Progress in Clinical and Biological Research: Limb Development and Regeneration*, vol. 383B. Wiley-Liss, New York, pp. 427–436.
15. Apte, S. S. and Olsen, B. R. (1993) Characterization of the mouse type X collagen gene. *Matrix* **13**, 165–179.
16. LuValle, P. A., Iwamoto, M., Fanning, P., Pacifici, M., and Olsen, B. R. (1993) Multiple negative elements in a gene that codes for an extracellular matrix protein, collagen X, restrict expression to hypertrophic chondrocytes. *J. Cell Biol.* **121**, 1173–1179.
17. LuValle, P., Jacenko, O., Iwamoto, M., Pacifici, M., and Olsen, B. R. (1993) From cartilage to bone- the role of collagenous proteins, in *Molecular Basis of Morphogenesis* (Bernfield, M., ed.), Wiley/Liss, New York, pp. 189–205.
18. Maniatis, T., Fritsch, E. F., and Sambrook, J., eds. (1982) *Molecular Cloning: A Laboratory Manual*. Cold Spring Harbor Laboratory Press, Cold Spring Harbor, NY.
19. Laird, P. W., Zijderveld, A., Linders, K., Rudnicki, M. A., Jaenisch, R., and Berns, A. (1991) Simplified mammalian DNA isolation procedure. *Nucl. Acids Res.* **19**, 4293.
20. Humason, G. L. (1967) *Animal Tissue Techniques*. W. H. Freeman, San Francisco, CA.
21. Sauer, B. (1998) Inducible gene targeting in mice using the cre/lox system. *Methods* **14**, 381–392.
22. Kuhn, R., Schwenk, F., Aguet, M., and Rajewsky, K. (1995) Inducible gene targeting in mice. *Science* **269**, 1427–1429.
23. Cheng, J. D., Ryseck, R. P., Attar, R. M., Dambach, D., and Bravo, R. (1998) Functional redundancy of the nuclear factor kappa B inhibitors I Kappa B alpha and I Kappa B beta. *J. Exp. Med.* **188**, 1055–1062.
24. Wang, Y., Schnegelsberg, P., Dausman, J., and Jaenisch, R. (1996) Functional redundancy of the muscle-specific transcription factors Myf5 and myogenin. *Nature* **379**, 823–825.
25. Condeelis, B. G. and Capecchi, M. R. (1994) Mice with targeted disruptions in the paralogous genes *hoxa-3* and *hoxd-4* reveal synergistic interactions. *Nature* **370**, 304–306.
26. Davis, A. P., Witte, D. P., Hsieh-Li, H. M., Potter, S. S., and Capecchi, M. R. (1995) Absence of radius and ulna in mice lacking *hoxa-11* and *hoxd-11*. *Nature* **375**, 791–795.
27. Jacenko, O., Olsen, B. R., and Warman, M. L. (1994) Of mice and men: heritable skeletal disorders. *Am. J. Hum. Genet.* **54**, 163–168.
28. Ikegawa, S., Nishimura, G., Nagai, T., Hasegawa, T., Ohashi, H., and Nakamura, Y. (1998) Mutation in the type X collagen gene (COL10A1) causes spondylometaphyseal dysplasia. *Am. J. Hum. Genet.* **63**, 1659–1662.

29. Komori, T., Yagi, H., Nomura, S., Yamaguchi, A., Sasaki, K., Deguchi, K., et al. (1997) Targeted disruption of *Cbfa1* results in a complete lack of bone formation owing to maturational arrest of osteoblasts. *Cell* **89**, 755–764.
30. Li, M., Squire, J. A., and Weksberg, R. (1998) Overgrowth syndromes and genomic imprinting: from mouse to man. *Clin. Genet.* **53**, 165–170.
31. Root, A. W. (1996) Recent advances in genetic disorders of calcium homeostasis. *Adv. Pediatr.* **43**, 77–125.
32. Brown, E. M. and Pollak, M. (1998) The extracellular calcium sensing receptor: its role in health and disease. *Ann. Rev. Med.* **49**, 15–29.
33. Erickson, R. P. (1996) Mouse models of human genetic disease: which mouse is more like a man? *BioEssays* **18**, 993–998.

## Genetic-Engineered Models of Skeletal Diseases II

### *Targeting Mutations into Transgenic Mice Chondrocytes*

**Silvio Garofalo and William A. Horton**

#### **1. Introduction**

The manipulation of mice genome is a powerful technique to analyze biological processes that cannot be studied in tissue culture (*1*). The understanding of many developmental processes is today improving because of such techniques. This is also changing the way human genetic diseases are studied. It is now possible to reproduce in laboratory mice the same genetic defects identified in human diseases and, taking species differences into account, to mimic the pathological events that lead to the specific diseases. This allows a developmental, biochemical, and genetic study of human disorders that, for ethical, clinical, or practical reasons, was impossible before. Indeed, the study of genetic diseases of the skeleton has received a great benefit from the generation and the analysis of genetically engineered mutants. However, the availability of such mutants is still limited and considerable effort is required to genetically dissect the pathways that can alter skeletal development. Although such pathways may be very well conserved in *Drosophila* or Zebrafish, the formation of bone and cartilage is a function acquired later in evolution that cannot be extrapolated from invertebrates and lower vertebrates. These organisms are not the ideal organisms to model human diseases of the skeleton. Therefore, the laboratory mouse is very rapidly becoming the experimental animal of choice to generate mutant animals that carry defects at different checkpoints of cartilage and bone formation (also *see* Chapters 43 by Jacenko and 45 by Liu, Snead, and Maxson in this volume).

We have developed and used a simple experimental approach that, using transgenic animals, may help to delineate the role of specific genes in the formation of the cartilaginous template of the skeleton. The approach allows the generation of cartilage-specific gain-of-function mice by use of the chondrocyte specific *cis*-elements of the mouse  $\alpha 1(\text{II})$  procollagen gene (*Col2a1*).

Although *Col2a1* is expressed in several nonskeletal tissues (*2*), the highest levels of expression are reached in chondrocytes, where its transcripts represent the most abundant mRNA. The genetic dissection and isolation of the *cis*-elements that confer tissue-specific expression showed that a very short sequence of intron 1, which is highly

conserved in several species, is essential for tissue specificity (3,4). Genetic engineering of the *Col2a1* promoter and intron 1 allowed us to develop a chondrocyte-specific expression vector to be used for gene targeting in transgenic mice chondrocytes (5).

With this tool in our hands and the goal to mimic the phenotype of human skeletal diseases in the mouse, we have generated experimental organisms carrying such defects, by insertion in transgenic mice genome of engineered cDNAs carrying specific mutations that have been identified in human chondrodysplasias, like hypochondrogenesis, achondroplasia, and thanatophoric dysplasia. The expression of such mutations was restricted to chondrocytes by the promoter and regulatory elements of *Col2a1* (Fig. 1). This allowed study of the developmental consequences of such mutations in an entire model organism. In prospective, such mice, if proved to be good models of human skeletal diseases, may represent the starting point for testing novel treatments, including genetic therapies that may benefit human health.

## 2. Materials

1. The chondrocyte-specific expression plasmid SP- $\beta$ geo-BpA can be obtained from the authors. The sequence and restriction map are indicated in Fig. 2.
2. SeaPlaque GTG low-melting Agarose (FMC BioProducts, Rockland, ME, cat. no. 50112)
3. TAE buffer (40X): 1.6 M Tris base, 0.8 M Na acetate 3H<sub>2</sub>O, 40 mM EDTA-Na 2H<sub>2</sub>O
4. Buffer A (DNA loading and washing buffer): 0.3 M NaCl, 10 mM Tris-HCl pH 7.4, 0.1 mM EDTA
5. Buffer B (DNA elution buffer): 1 M NaCl, 10 mM Tris-HCl pH 7.4, 0.1 mM EDTA, 1% caffeine
6. Microinjection buffer: 5 mM NaCl, 5 mM Tris-HCl pH 7.4, 0.1 mM EDTA
7. Gibco-BRL NACS PREPAC™ Cartridge (Life Technologies, Bethesda, MD, cat. no. 1526NP)
8. Floating Millipore filter VMWP 01300 (pore size 0.05  $\mu$ m) (Millipore, Bedford, MA)
9. Strains of mice: B6D2F1 and CD1 (vasectomized male mice to plug pseudopregnant CD1 females)
10. Stereomicroscope with understage and fiber optic illuminators
11. Microinjection station: Inverted microscope with 40X and 10X objectives and contrast condenser, right- and left-hand manipulators with pipet holders and isolation table
12. 50 cm<sup>3</sup> Glass syringe connected with Tygon tubing to the right manipulator
13. Micrometer syringe connected with a Tygon tubing to the left manipulator and filled with Fluorinert Electronic Liquid FC77 (3M Company, St. Paul, MN, cat. no. FC77)
14. Mechanical pipet puller and microforge
15. 37°C incubator with 5% CO<sub>2</sub>
16. M2 (Sigma, St. Louis, MO, M7167) and M16 embryo tested media (Sigma M7292)
17. Hyaluronidase type IV-S from bovine testis (Sigma F3884): 10 mg/mL in M2. Filter sterilize and store in aliquot at -20°C. Dilute to 300  $\mu$ g/mL in M2 medium
18. Mineral oil embryo tested (Sigma M8410)
19. Animal balance
20. Microsurgery tools (dissection scissors, watchmaker's forceps Dumont #5, hemostatic clip (serafine) 4 cm or smaller, blunt forceps, wound clips with applicator)
21. Aspirator tube assembly (Sigma A-5177)
22. Hard glass capillary 1.5-mm external diameter for transfer pipet (BDH Laboratory Supplies, Dorset, UK)

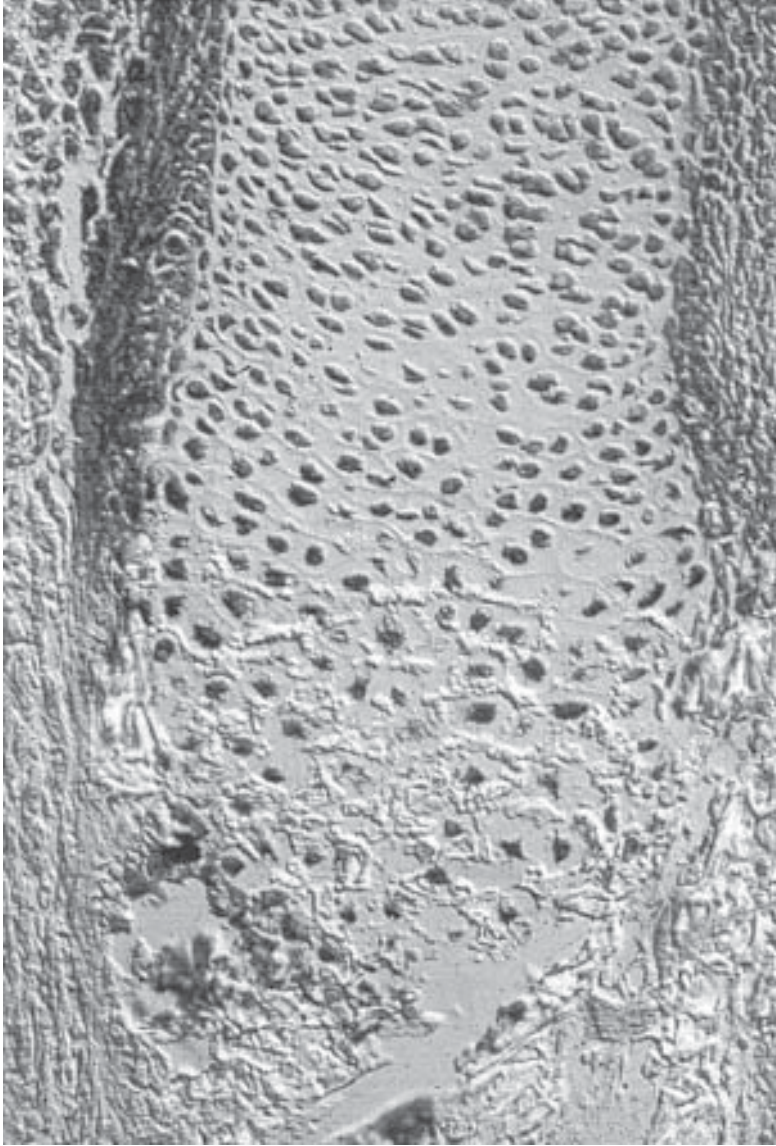

Fig. 1. Microscopy of tibial growth plate from transgenic mouse coinjected with the reporter transgene, SP- $\beta$ geo-BpA, and a transgene carrying a Gly574Ser mutation of *COL2A1* found in an infant with hypochondrogenesis.  $\beta$ -galactosidase activity is restricted to chondrocytes. The normal columnar architecture of the growth plate with its zones of proliferative and hypertrophic chondrocytes is disturbed by the mutation.

23. Glass tubing for injection pipet with internal glass filament (Clark Electromedical Instruments (Pangbourne, Reading, UK) cat. no. GC100TF-15 or World Precision Instruments (Sarasota, FL) cat. no. TW100F-4) and
24. Glass capillary for making holding pipet (FHC Inc., Bowdoinham, ME, cat. no. 27-30-1)
25. Glass depression slides (Fisher, Pittsburgh, PA) and plastic tissue culture dishes (Corning Glassworks, Corning, NY)

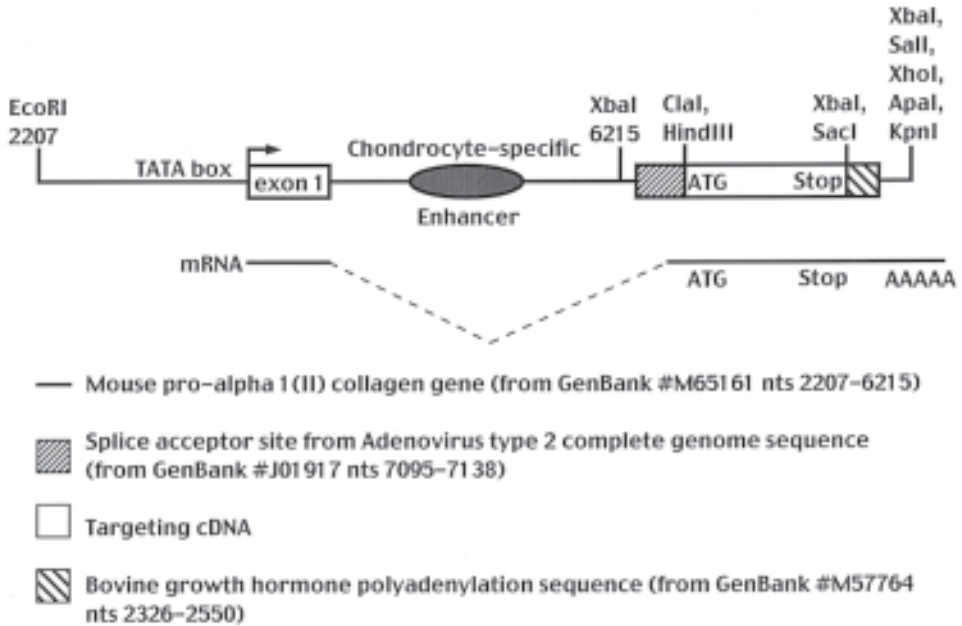

Fig. 2. Structure of mouse *Col2a1* expression vector used to target chondrocytes.

26. Diamond pencil
27. Avertin anesthetic: Mix 10 g of 2,2,2-tribromoethyl alcohol (Aldrich, Milwaukee, WI, T4,840-2) with 10 mL of tert-amyl alcohol (Aldrich 24,048-6). Dilute 2.5% and store wrapped in foil at 4°C. Inject with doses ranging from 0.014 to 0.018 mL/g body weight.
28. 1% adrenalin
29. Pregnant mare's serum (PMS—Sigma G4527) is resuspended at 50 IU/mL in sterile 0.9% NaCl and then divided in 1-mL aliquots. Can be stored for 1 mo at –20°C. A dose of 0.1 mL (5 IU) is injected into each animal, 72 h before the collection of fertilized eggs.
30. Human chorionic gonadotropin (hCG, Sigma C8554) is resuspended at 500 IU/mL in sterile water and then divided in 100- $\mu$ L aliquots, lyophilized, and stored, protected from light, at –20°C. To induce superovulation, a 100  $\mu$ L aliquot is resuspended in 1 mL of sterile 0.9% NaCl to give a final concentration of 50 IU/mL; 0.1 mL is injected intraperitoneally per each animal the afternoon before the collection of fertilized eggs.
31. Mouse ear punch (Fisher 01 337B)
32. Tail digestion buffer: 50 mM Tris HCl pH 8.0, 100 mM EDTA, 100 mM NaCl, 1% SDS.
33. Proteinase K 10 mg/mL dissolved in H<sub>2</sub>O and stored at –20°C in small aliquots. (0.35 mg/tail)
34. Saturated phenol, chloroform, and isoamyl alcohol (Amresco, Solon, OH)
35. DNA precipitation buffer: 30% PEG 6000, 1.8 M NaCl
36. TE buffer: 10 mM Tris-HCl pH 7.5, 0.1 mM EDTA
37. Perkin-Elmer Cetus (Norwalk, CT) DNA thermal cycler
38. SeaKem agarose (FMC Bioproducts, cat. no. 50074)
39. Denaturing solution: 1.5 M NaCl, 0.5 M NaOH
40. Alkali transfer buffer: 1.5 M NaCl, 0.25 M NaOH
41. Hybond-N + nylon blotting membrane (Amersham, Arlington Heights, IL)

### 3. Methods

1. Chondrocyte-specific expression vectors: The regulatory *cis*-elements of *Col2a1* are suitable for chondrocyte-specific gene targeting. Although a tissue-specific enhancer is located in intron 1 (3) and cartilage-specific gene expression can be achieved with this very short sequence and a minimal heterologous promoter (5), for chondrocyte-specific gene targeting we have always used constructs containing a modified *Col2a1* promoter and intron 1 sequence.

We have generated mice with a longer (−3000) and shorter (−687 and −309) promoters. There was no difference in tissue-specific expression of β-galactosidase reporter gene in transgenic mice with these promoters (5). The genomic DNA sequence of this regulatory elements can be found in Genbank (accession no. M65161). In **Fig. 2** a schematic representation of the expression vector with the restriction sites convenient for cloning is shown.

To allow translation to start from the Kozak sequence of the targeted gene, we modified the *Col2a1* translation starting sequence from ATG to CTG. The expression cassette contained the 5' flanking sequence, TATA box, the *Col2a1* transcription starting site, the modified exon 1, the splicing donor site and a large part of intron 1 from the *EcoRI* site at position 2207 to the *XbaI* site at 6215 of the deposited mouse *Col2a1* genomic sequence (M65161).

Because exon 2 of *Col2a1* was alternatively spliced out by a complicated mechanism not yet understood, we replaced the 3' sequence of intron 1 and the exon 2 splicing acceptor site with a much stronger splice acceptor sequence derived from a 43 bp long fragment (from 7095 to 7138) of adenovirus type 2 genome (Genbank accession # J01917). A 12 bp long polypyrimidine stretch (5' TCCCTTTTTTTT 3'), that is believed to increase the strength of splice acceptor sites, was inserted before the adenoviral sequence.

Constructs with these changes were tested in transgenic mice and showed excellent chondrocyte-specific expression of the reporter gene, demonstrating that replacing the ATG sequence and introducing an artificial splicing acceptor site before the reporter gene do not interfere with tissue-specific expression (5).

Finally, at the 3' end of the targeted gene, soon after the translation stop codon, we inserted a polyadenylation site derived from the bovine growth hormone gene. This site has worked well with many cDNAs that we have targeted to chondrocytes, including the reporter gene originally used to test its function.

2. Preparation of microinjected DNA: Digest 10–20 μg of transgene DNA construct with the appropriate restriction enzyme to release transgene DNA from vector sequence and separate the digested fragments in a 0.8% SeaPlaque low melting agarose in TAE buffer. Use bacteriophage lambda *HindIII* digested DNA as molecular weight marker. Preheat buffers A and B. Cut the appropriate band out the gel, melt agarose in 500 μL buffer A at 65–70°C for 10 min. Prewash a BRL NAC prepacked column (hooked up to a 1-mL insulin syringe) with 1 mL of preheated buffer A three times. Load melted DNA band onto NAC column twice. Wash column with 10 mL of preheated buffer A. Elute in three steps (very slowly) with 200 μL, 200 μL, and 50 μL of preheated buffer B. Precipitate by filling tube with 95% ethanol, place in −20°C overnight (or 0.5 h at −80°C), then spin at cold room. Resuspend DNA in 50 μL (100 μL if necessary) of autoclaved, embryo-tested H<sub>2</sub>O and measure concentration by running 5 μL of purified DNA against several dilutions of *HindIII* digested phage lambda DNA and visually comparing the intensity of the ethidium bromide stained bands. Dialyze DNA against 30 mL autoclaved and embryo-tested H<sub>2</sub>O on a floating Millipore filter VMWP 01300 (pore size 0.05 μm) shiny side up, for 30 min. Dilute DNA to 1–2 ng/μL concentration with microinjection buffer. Spin DNA for 15 min, aliquot into 50 μL aliquots. Spin aliquots 15 min before use in microinjection.



3. Generation of transgenic mice: PMS (0.1 mL = 5 IU) is injected into B6D2F1 female, 72 h before the collection of fertilized eggs and is followed by 0.1 mL of hCG intraperitoneally the afternoon before the collection of fertilized eggs. Superovulated females are mated with stud mice the night before egg collection.

Microinjection involves the following steps:

- a. Dissection of oviducts: Sacrifice plugged donor females and expose completely the abdomen organs. Uterus and attached ovary should be clearly visible. The oviduct is between uterus and ovary. With a fine scissor, cut first between ovary and oviduct, then between uterus and oviduct. Transfer the oviduct in M2 medium. Dissect oviduct from the other side.
- b. Recovery of fertilized eggs: Under a dissecting microscope recognize a single swollen region, termed ampulla, that contains the cumulus mass. It consists in numerous fertilized eggs that are visible through the walls of ampulla and are surrounded by cumulus cells. Tearing the ampulla, let the cumulus mass escape. With a transfer pipet, transfer eggs in a second M2 dish.
- c. Removal of cumulus cells: Mix cumulus mass with 50  $\mu$ L of hyaluronidase for a few minutes, pipeting eggs up and down until the eggs are completely separated. Wash eggs twice in M16 and maintain in a microdrop culture in a CO<sub>2</sub> incubator until they are required for microinjection.
- d. DNA injection into pronuclei to produce transgenic embryos: Remove injectable eggs from microdrop, rinse in M2, and put them into the injection chamber grouped together. Using a 4X objective, one egg is drawn onto the tip of the holding pipet and moved at the center of the field. Switch to the  $\times 40$  objective and focus to locate the egg pronuclei. The larger (the male pronucleus) is targeted. Focusing on the pronucleus, bring the loaded microinjection pipet tip up to the zona pellucida and adjust the fine vertical micromanipulator control to bring the tip into the same focal plane as the pronucleus. Introduce the tip of the microinjection needle into the pronucleus by penetrating the egg membrane and the zona pellucida. When the pipet is in the nucleus, squeeze the injection syringe with the left hand. Successful injection is indicated by the swelling of the pronucleus. Withdraw pipet in a single rapid movement when nucleus has reached about twice its normal volume. Move to the next egg of the batch. When they are finished, return those that have survived to M16 microdrop culture at 37°C in 5% CO<sub>2</sub> incubator after two washes in M16.
- e. Oviduct transfer of manipulated embryos: Surviving eggs can be returned into the oviduct of pseudopregnant recipient female the same day of injection or after overnight culture when they are at two cell stage. The recipient female, which has been plugged by vasectomized males the night before, is anesthetized and placed in a petri dish. A small transverse incision (<1 cm) is made at the level of the last rib, about 1 cm from the spinal cord. The ovary should be visible with its white fat pad. The smallest possible cut should be made through the body wall to pull out the fat pad, the ovary, oviduct, and uterus. Hold the reproductive tract in position over the back of the mouse by a serafine and move the mouse to the stage of a surgical microscope with a fiberoptic light source. Identify the opening of the oviduct or infundibulum, which is the target of the transfer procedure. It is usually located within a cavity behind a transparent membrane called the bursa. Ripping the bursa to the extent that the opening is readily accessible with minimal bleeding. Use adrenalin if excessive bleeding occurs. The eggs are prepared to transfer in an oviduct-transfer pipet. Such pipet should have an internal diameter of around 150  $\mu$ m and flame-polished tip. The pipet is first filled with oil, then with a small bubble of air, followed by M2 medium, and another air bubble. The

eggs come next in a stacked order with a minimal volume of medium and are followed by a third air bubble and M2. Push the tip of the transfer pipet toward the top of the infundibulum and enter into the ampulla. Expel the content of the pipet and monitor the delivery of the eggs by the presence of air bubbles. Withdraw the oviduct transfer pipet, remove the serafine, grip the fat pad and the reproductive tract in the body wall, and then clip the skin together with an autoclip. Let mouse recover. Delivery should occur in 18–20 d.

4. Detection of transgenic mice

- a. DNA isolation from mouse tails: At weaning age (about 2–3 wk), cut a 1–3-mm piece of mouse tail and place in 1.5-mL Eppendorf tube. Label this tube with a number identical to ear tag applied to the mouse. Separate males and females in different cages. Add 350  $\mu$ L of tail digestion buffer with 35  $\mu$ L proteinase K. Incubate overnight at 55°C; vortex during incubation if possible. Spin 1 min in microfuge and remove supernatant to a fresh tube. Extract supernatant with equal volume of saturated phenol. Extract with equal volume phenol:chloroform:isoamyl alcohol (25:24:1). Extract with equal volume chloroform:isoamyl alcohol (24:1). Add 0.4 volumes (about 154  $\mu$ L) of DNA precipitation solution. Mix well and incubate on ice 2 h or 4°C overnight. Spin for 6 min in microfuge at room temperature. Decant immediately. (Pellet will be very hard to see.) Wash by adding 1 mL 70% ethanol at room temperature. Invert tube several times to completely mix contents. Spin 2 min at room temperature. Decant immediately. The pellet will be clearly visible. Wash once again at room temperature by adding 1 mL 70% ethanol down the side of tube opposite the pellet (be careful not to disturb pellet) and then decant. Air dry for approx 30 min and resuspend in 100  $\mu$ L TE buffer. Measure OD at 260 nm of 5  $\mu$ L diluted in 500  $\mu$ L TE to get concentration.
- b. PCR detection of transgenic mice: This is a very convenient and fast technique, however, contamination among samples is a very common problem. To minimize such a problem during cutting of the tails, maximum attention should be given to avoid blood contamination. Changing or washing the blade after each sample will reduce this problem. It is very important to change pipet tips for each DNA sample during the procedure of DNA extraction.

The primers to be used in PCR reaction need to be very carefully selected. The 5' forward primer is at the end of the tissue-specific elements in intron 1, close to the *Xba*I site, before the adenoviral splice acceptor site. It can be used independently from the targeted cDNA. We have used the following primer (designated *Col2-Xba*I) with excellent results: 5' GGAGAGGGTCCAGCCCGAGCTAC 3'.

The 3' reverse primer is specific for the targeted cDNA and therefore will change with the different targeting constructs. It should ideally amplify a 300 bp long fragment and therefore should map such distance from the 5' end of the cDNA.

For several primer sets, the following PCR conditions work very well: melting 95°C  $\times$  45 s, annealing 60°C  $\times$  1 min, extension 72°C  $\times$  2 min, for 30 cycles with a terminal extension of 7 min. If there are nonspecific bands, it is convenient to increase annealing temperature 1°C per experiment, until ideal conditions are reached for clean detection of transgenic mice.

For positive control we use 1–2 pg of plasmid construct DNA. Run this positive control reaction at a separate time than analysis of mouse tail genomic DNA to minimize possible contamination and to establish ideal annealing conditions. Mixing 1  $\mu$ g of mouse genomic DNA with positive control plasmid can help to mimic the conditions of genomic PCR and to identify condition of reduced PCR background. Always run a negative control without any DNA in the sample to detect contamination of your reagents or materials.

- c. Genomic Southern blot: This is an alternative technique to PCR to identify transgenic mice and it is very convenient to confirm PCR results when they are dubious. We routinely use genomic DNA Southern blot for screening of  $F_0$  mice and to establish the transgene copy number or their genomic stability. There is no alternative to Southern blot when it is necessary to distinguish mice homozygous from mice heterozygous for the transgene insertion. Digest 5–10  $\mu\text{g}$  of tail genomic DNA with five times excess of appropriate restriction enzyme. Separate DNA on 0.8% SeaKem agarose gel in TAE buffer at 20 V for 16 h, with *HindIII* digested lambda DNA as a molecular weight marker. We run up to 38 samples per gel in two rows of 20 wells. After photography, the gel is rinsed in distilled  $\text{H}_2\text{O}$  and placed in 0.25 M HCl for 30 min. After a second wash in  $\text{H}_2\text{O}$ , the gel is placed in denaturation buffer for 30 min. Blot off excess liquid from the gel and equilibrate for 10–15 min in alkali transfer buffer. Set up capillary blot. After 16 h in transfer, label the wells and remove nylon filter from the gel. Rinse in 2X SSC for 10 min, dry between Whatman 3MM paper (Whatman, Clifton, NJ), and use for hybridization. Hybond N+ does not require UV crosslinking when alkali transfer is used.

## Acknowledgments

The authors are grateful to Guang Zhou, Chad Smith, Jeremy Cooke, Mirta Machado, Phil Soriano, and Benoit de Crombrughe for help and advice. Silvio Garofalo is the recipient of an Arthritis Foundation Investigator Award. This work was funded by research grants from the Shriners Hospitals for Children (#8520) and Telethon Foundation ONLUS (#925).

## References

1. Hogan, B., Beddington, R., Costantini, F., and Lacy, E. (1994) *Manipulating the Mouse Embryo: A Laboratory Manual*. 2nd ed. Cold Spring Harbor Laboratory Press, Cold Spring Harbor, NY.
2. Cheah, K. S., Lau, E. T., Au, P. K., and Tam, P. P. (1991) Expression of the mouse alpha 1(II) collagen gene is not restricted to cartilage during development. *Development* **111**(4), 945–953.
3. Horton, W., Miyashita, T., Kohno, K., Hassell, J. R., and Yamada, Y. (1987) Identification of a phenotype-specific enhancer in the first intron of the rat collagen II gene. *Proc. Natl. Acad. Sci. USA* **84**, 8864–8868.
4. Mukhopadhyay, K., Lefebvre, V., Zhou, G., Garofalo, S., Kimura, J. H., and de Crombrughe, B. (1995) Use of a new rat chondrosarcoma cell line to delineate a 119-base pair chondrocyte-specific enhancer element and to define active promoter segments in the mouse pro- $\alpha$ 1(II) collagen gene. *J. Biol. Chem.* **270**(46), 27,711–27,719.
5. Zhou, G., Garofalo, S., Mukhopadhyay, K., Lefebvre, V., Smith, C., Eberspaecher, H., and de Crombrughe, B. (1995) A 182 bp fragment of the mouse pro- $\alpha$ 1(II) collagen gene is sufficient to direct chondrocyte-specific expression in transgenic mice. *J. Cell Sci.* **108**, 3677–3684.

## Transgenic Mouse Models of Craniofacial Disorders

Yi-Hsin Liu, Malcolm L. Snead, and Robert E. Maxson, Jr.

### 1. Introduction

Disorders affecting craniofacial development represent a large fraction of birth defects (**1**). The advent of transgenic and gene knockout technology has led to the identification of a variety of genes that have roles in craniofacial development. These technologies, together with the tools of human genetics, are being used to recreate specific human genetic defects in the mouse, providing an understanding of the pathophysiology of craniofacial disorders and laying the foundation for improvements in therapies.

Our laboratory has focused on a transgenic model of craniosynostosis, the premature fusion of calvarial bones with consequent abnormalities of skull shape (**2,3**). A feature in over 100 genetic syndromes, craniosynostosis occurs in about 1 in 3000 live births. We showed previously that an activating mutation (P148H) in the homeodomain protein *Msx2* is associated with Boston-type craniosynostosis, a highly penetrant, autosomal dominant disease characterized in a single large kindred (**4**). Activating mutations in *FGF receptors 1–3* can also lead to syndromes with craniosynostosis (**5,6**) as can loss of function mutations in the basic HLH protein *M-twist* (**7,8**).

We have used both the CMV (cytomegalovirus) and *Msx2* promoters to overexpress the mutant and wild-type forms of *Msx2* in transgenic mice (*see refs. 9 and 9a*). The calvarial bones of such mice grow at an increased rate and prematurely invade the sutural space, consistent with the early stages of craniosynostosis. These mice thus provide a model of at least some features of Boston-type craniosynostosis. Here we contribute a general protocol for producing a transgenic mouse model of a human craniofacial disease using our experience with modeling Boston-type craniosynostosis to illustrate its use.

### 2. Materials

1. 10% bovine serum albumin (BSA): 1 g BSA dissolve in 10 mL of deionized H<sub>2</sub>O.
2. 2 mg/mL glycine in phosphate-buffered saline-Tween 20 (PBT): 40 mg in 20 mL PBT.
3. 0.2% glutaraldehyde/4% paraformaldehyde in phosphate-buffered saline (PBS), freshly prepared: 200  $\mu$ L of 25% glutaraldehyde in 24 mL of 4% paraformaldehyde in PBS.

4. Hybridization buffer: 50% formamide, 0.75 M NaCl, 1X PE, 100 µg/mL tRNA, 0.05% heparin, 0.1% BSA, 1% sodium dodecyl sulfate (SDS).

	To make 10 mL	Final conc.
Formamide	5.0 mL	50%
5 M NaCl	1.5 mL	0.75 M NaCl
10X PE	1.0 mL	1X PE
10 mg/mL tRNA	0.1 mL	100 µg/mL
5% heparin	0.1 mL	0.05%
10% BSA	0.1 mL	0.1%
20% SDS	0.5 mL	1.0%

5. 5% heparin: 50 mg in 1 mL of deionized H<sub>2</sub>O.  
 6. 10X PE: for 100 mL, 100 mM PIPES, 3.24 g, pH 6.8, 10 mM EDTA, 10 mL of 0.1 M EDTA.  
 7. 4% paraformaldehyde in PBS: 800 mg/20 mL PBS.  
 8. 0.2% glutaraldehyde/4% paraformaldehyde: 80 µL 25% glutaraldehyde in 10 mL in 4% paraformaldehyde in PBS.  
 9. 10X PBS: for 100 mL, 8 g NaCl, 0.2 g KCl, 1.15 g Na<sub>2</sub>HPO<sub>4</sub>, 0.2 g KH<sub>2</sub>PO<sub>4</sub>.  
 10. PBT: 500 mL PBS + 500 µL Tween-20.  
 11. RNase Buffer: 0.5 M NaCl, 10 mM PIPES, pH 7.2, 0.1% Tween-20, pH 7.2.

	100 mL	50 mL
5 M NaCl	10 mL	5 mL
PIPES	0.324 g	0.162 g
Tween-20	100 µL	50 µL

12. Wash 1: 300 mM NaCl, 1X PE, 1% SDS.

	100 mL	50 mL
3 M NaCl	10 mL	5.0 mL
10X PE	10 mL	5.0 mL
20% SDS	5 mL	2.5 mL
Deionized H <sub>2</sub> O	75 mL	37.5 mL

13. Wash 1.5: 0.05 M NaCl, 1X PE, 0.1% SDS.

	100 mL	50 mL
5 M NaCl	1.0 mL	0.50 mL
10X PE	10.0 mL	5.00 mL
20% SDS	0.5 mL	250.00 µL
Deionized H <sub>2</sub> O	88.5 mL	44.25 mL

14. Wash 2: 50% formamide, 300 mM NaCl, 1X PE, 1% SDS.

	100 mL	50 mL
Formamide	50 mL	25.0 mL
3 M NaCl	10 mL	5.0 mL
10X PE	10 mL	5.0 mL
20% SDS	5 mL	2.5 mL
Deionized H <sub>2</sub> O	25 mL	12.5 mL

15. Wash 3: 50% formamide, 150 mM NaCl, 1X PE, 0.1% SDS.

	100 mL	50 mL
Formamide	50.0 mL	25.00 mL
10X PE	10.0 mL	5.00 mL
3 M NaCl	5.0 mL	2.50 mL
20% SDS	0.5 mL	0.25 mL
Deionized H <sub>2</sub> O	34.5 mL	17.25 mL

16. Wash 4: 500 mM NaCl, 1X PE, 0.1% Tween-20.

	100 mL	50 mL
5 M NaCl	0 mL	5 mL
10X PE	10 mL	5 mL
Tween-20	100 µL	50 µL
Deionized H <sub>2</sub> O	80 mL	40 mL

Color reagents: 33 µL NBT (stock conc. 10 µg/µL)/mL, 3.3 µL BCIP (stock conc. 50 µg/µL)/mL in 2 mM levamisole in NTMT, mix.

For	NBT	BCIP
1 mL	33 µL	3.3 µL
5 mL	165 µL	17.5 µL

Tablet weighing 25 mg contains 10 mg of NBT. Divide the tablet into small pieces and weigh the amount of each piece. Take a small piece of NBT and dissolve in appropriate amount of deionized water, e.g.,

1 mg dissolve in	40 µL	2 mg in	80 µL
3 mg	in 120 µL	4 mg in	160 µL
5 mg	in 200 µL	6 mg in	240 µL
7 mg	in 280 µL	8 mg in	320 µL
9 mg	in 360 µL		

Store at 40°C.

50 mg/mL BCIP (5-bromo-4-chloro-3-indolyl phosphate, toluidine salt) in 100 dimethyl-formamide = 50 µg/µL.

Inactivated embryo powder: 6 mg of powder in 1 mL of TBST to 70°C for 30 min.

17. Inactivated goat serum: heat to 70°C for 30 min.  
 18. CMFET: for 100 mL, 0.8 g NaCl, 0.02 g KCl, 0.115 g Na<sub>2</sub>HPO<sub>4</sub>, 0.02 g EDTA, 0.1% Tween-20.  
 19. NTM: 100 mM NaCl, 100 mM Tris-HCl, pH 9.5, 50 mM MgCl<sub>2</sub>, freshly prepared.  
 20. NTMT: Same as NTM with 0.1% Tween-20.  
 21. 10X TBS: 8 g NaCl, 0.2 g KCl, 3 g Tris-HCl, pH 7.6, in 100 mL.  
 22. TBST: 1X TBS with 0.1% Tween-20.

### 3. Method

#### 3.1. Preliminary Considerations

##### 3.1.1. Nature of Genetic Defect

The nature of the human genetic defect informs the approach to modeling the disorder. If the defect is caused by a recessive loss of function mutation or a dominant haploinsufficiency, then the modeling of the disorder will require inactivating or

**Table 1**  
**Promoters That Can Target Gene Expression to Craniofacial Structures**

Gene	Expression profile in craniofacial region	Reference(s)
<i>Msx2</i>	Head ectomesenchyme, branchial arches, neural crest, tongue, tooth buds, cartilages, cranial ganglia	(9)
<i>pro-<math>\alpha</math>1(I)collagen</i>	Osteoblast, calvaria	(20,21)
<i>pro<math>\alpha</math>2(I)collagen</i>	Branchial arches, meninges, tongue, osteoblasts of mandibular bone, chondrocytes of Meckel's cartilage	(22–24)
<i>Timp-1</i>	Mandible-Meckel's cartilage, maxilla, calvaria	(25)
CMV	Neural crest, branchial arches, meninges, tongue, tooth primordia, head ectomesenchyme	(27–29)
<i>Cx43</i>	Neural crest, branchial arches, meninges, head mesenchyme, mandible, maxilla	(26)
<i>Msx1</i>	Maxilla, mandible, meninges, and the bones of the skull, first and second branchial arches	(30,31)

attenuating the function of the gene in question. If the defect is caused by a dominant gain of function mutation, then a transgenic approach may provide a suitable model. Subsumed in the gain of function mechanism are dominant activating mutations, which enhance the function of the gene product, as well as dominant negative mutations, which inactivate the protein in question and also abrogate the activity of the wild-type protein. Both mechanisms can be modeled by transgenic approaches. In the case of the dominant activating mutation, it may not be necessary to express the mutant form of the protein; simple overexpression of the wild-type gene may be sufficient to produce a phenotype. In the case of a dominant negative mechanism, expression of the mutant protein would be necessary to produce the phenotype.

Molecular data on the effect of the mutation on gene function can be helpful here. For example, in the case of Boston craniosynostosis, we knew that the mutation enhanced the affinity of the protein for DNA; thus the mutation was likely to be dominant/activating (10).

### 3.1.2. Design of Transgene

Assuming that a transgenic approach is likely to provide a model of the disorder in question, the next step is to design a suitable vector for the expression of the gene. A key element of the expression vector is the promoter. A few promoters that direct expression to craniofacial tissues have been characterized in sufficient detail to be useful. **Table 1** describes these promoters and their expression patterns.

In general, the use of a promoter that mimics the expression of the endogenous gene is ideal. This allows for the maximum precision in the modeling of the disorder. However, a more general promoter can also be informative. As has been clearly demonstrated from work in *Drosophila* and vertebrates, the ectopic expression of a gene can show whether the gene has a dominant effect on cell fate or morphogenetic processes. This information may prove helpful in the analysis of the pathophysiological mechanism. For example, in Boston craniosynostosis, we used the CMV promoter to gener-

ally overexpress *Msx2* (9) and the *Msx2* promoter to overexpress *Msx2* at the sites of its normal expression (9a). We showed that in general, CMV-driven overexpression resulted in a craniosynostosis-like phenotype as well as ectopic cranial bone. Specific overexpression under the control of *Msx2* caused only the craniosynostosis-like condition. These data suggested that *Msx2* is sufficient to induce cells to an osteogenic fate and thus provided a hypothesis as to how a dominant active mutation in *Msx2* could lead to craniosynostosis.

The use of the *Msx2* promoter was made possible by first mapping the promoter in transgenic mice. This entailed fusing the promoter with a *lacZ* reporter and using such constructs to produce transgenic mice. Although this can be labor intensive and expensive, it is a necessary first step in identifying a promoter that can be used to overexpress a putative disease gene.

### 3.2. Production and Evaluation of Mice

We use standard methods (10a) for the injection of the transgene (see Chapters 43 and 44 in this volume and Part V: Transgenesis Production and Gene Knockout in Vol. II in this series), the implantation of injected eggs into pseudopregnant females, and the genotyping of resulting pups.

#### 3.2.1. Choice of Stable vs Transient Transgenics

Transgenic mice are typically made as stable lines, which entails breeding founder mice and evaluating the phenotype in the F<sub>1</sub> or F<sub>2</sub> generation. Alternatively, F<sub>0</sub>s may be analyzed directly. Such a “transient” transgenic approach offers the advantage of relatively quick results. A disadvantage is that the transgenic line is not maintained; therefore further analysis of any phenotype will require more injections.

#### 3.2.2. Evaluation of Phenotypes

After the transgene status of founder animals has been demonstrated and a breeding strategy established, the next major issue facing an investigator is to identify any phenotypic change in transgenic animals compared with their nontransgenic counterparts. We outline several approaches, macroscopic and microscopic, that we have found useful in pursuit of a complete characterization of the transgenic phenotype. Detailed protocols are given in **Subheading 3.2.3.**

##### 3.2.2.1. LETHALITY

The first issue is whether overexpression of the transgene is lethal. This problem is most acute when the transgene is generally overexpressed throughout development. Lethality may be embryonic or postnatal. Demonstrating embryonic lethality entails first genotyping progeny of a transgenic mating. The absence of transgenic mice after screening a significant number of pups strongly suggests embryonic lethality. There may also be a correlation between transgene dosage and lethality: homozygosity for the transgene may be a lethal condition, whereas heterozygosity is not. If lethality is encountered, sometimes simply screening a sufficiently large number of transgenics will identify viable animals. Presumably such animals are viable because they express the transgene at lower levels. Another approach is to try a different mouse strain. Outbred and hybrid strains often reduce the severity of a transgenic phenotype. If lethality continues to be a problem, using a different promoter, preferably moving to one with a



more focal expression pattern, may result in a less profound defect and increased viability of transgenic animals.

#### 3.2.2.2. GROSS ANALYSIS OF CRANIOFACIAL PHENOTYPES

As a first step in the evaluation of morphological phenotypes, we generally carry out alizarin red S and Alcian blue stains of whole skulls (**11**). Nontransgenic littermates are used as controls. This technique can be easily used in conjunction with animal necropsy to identify changes in the whole animal. For example, we knew that *Msx2* was expressed in abundant amounts in a wide variety of tissues outside the skull. Consequently, overexpressing the *Msx2* protein under the control of either the *CMV* promoter or the *Msx* promoter might alter the developmental fate of noncalvarial tissues in transgenic animals. To identify such changes, we undertook complete necropsies on animals from each transgenic line from several selected stages of development. These necropsy studies of visceral organs could be easily combined with other approaches, such as preserving the bodies for alizarin red staining of the skeleton. In this manner, alterations in the visceral organs or the skeletal body plan could be identified and an approach developed to explore the role of the expression of the transgene in the development of the affected tissue.

#### 3.2.2.3. MICROSCOPIC ANALYSIS

More detailed analysis of phenotypes entails histological methods. We generally use standard paraformaldehyde fixation followed by paraffin embedding (described in detail in **Subheading 3.2.3.4.**). It is sometimes useful to embed in plastic (historesin), which provides excellent tissue preservation and also enables *lacZ* to be visualized under dark field with great sensitivity (**12**). Standard H and E stain usually serves well. Bright-field or phase-contrast microscopy are generally adequate for visualization of craniofacial structures, although differential interference contrast (DIC) optics provide exceptionally good views of developing calvarial bone and the osteoblastic cells that compose the osteogenic front (unpublished observations).

#### 3.2.2.4. WHOLE MOUNT IMMUNOHISTOCHEMISTRY AND *IN SITU* HYBRIDIZATION

It is often important to know the sites and levels of expression of the transgene. Hence the detection of the messenger RNA or the protein (or both) encoded by the transgene may be useful. In addition, if the transgene is likely to alter cell fate, then an analysis of molecular markers is likely to provide critical information on embryonic territories and the differentiation status of cells composing an affected structure. For these purposes—transgene expression and molecular marker analysis—both whole mount immunohistochemistry and *in situ* hybridization are extremely useful (**4,13–15**).

#### 3.2.2.5. CELL PROLIFERATION ANALYSIS

BrdU incorporation can be used to assess the proliferation status of tissues of transgenic mice. Embryos *in utero* can be labeled by injection of BrdU into pregnant female mice; postnatal animals can be labeled by direct intraperitoneal injection of BrdU. The quantity of BrdU and the labeling time must be tailored to the tissue of interest. We provide a protocol below that works well for craniofacial tissues (*see* **ref. 16**; **Subheading 3.2.3.4.**).

### 3.2.2.6. CELL MIGRATION ANALYSIS

Some craniofacial tissues, particularly cranial neural crest, are highly migratory. Therefore it may be of interest to assess the influence of a transgene on the migratory properties of a craniofacial cell population. The vital dye, DiI, has been used extensively to document migratory patterns of craniofacial neural crest (e.g., see **ref. 17**). DiI is injected directly into individual cells in embryos *ex vivo* or in organ culture. The location of the dye is then monitored in frozen sections by epifluorescence or confocal microscopy. A recent innovation in the visualization of DiI makes use of polyethylene glycol as an embedding medium, which preserves the location of DiI and provides single cell resolution (**18**).

### 3.2.3. Specific Protocols

In this section we present, in detail, specific protocols that we view as key in the analysis of craniofacial phenotypes.

#### 3.2.3.1. IMMUNOCHEMISTRY ON MOUSE CALVARIA (MODIFIED FROM **REFS. 4, 13–15**)

1. Fix the specimen at the appropriate developmental stage in freshly prepared 4% paraformaldehyde (see **Note 1**). Process the tissue for embedding in paraffin and sectioning.
2. Wash the specimen in a volume that is approx 3–4X the volume of the specimen. Perform three washes in PBT for 10 min each.
3. To ablate endogenous peroxidase activity, treat the specimen with 3% H<sub>2</sub>O<sub>2</sub> in PBS for 10 min at room temperature (RT).
4. Wash the specimen in three changes of PBT for 10 min each.
5. Block nonspecific sites for primary antibody binding within the specimen by washing the specimen with 10 g% BSA or appropriate preimmune serum in PBS 30 min at RT.
6. Remove the blocking solution and replace with the primary antibody at the appropriate dilution in PBS. Incubate overnight at 14°C (see **Notes 2 and 3**).
7. Wash the specimen 2X with PBT across the specimen to remove excess antibody. Then wash the specimen 3X more by covering the specimen with PBT for 3 min each (see **Note 4**).
8. Apply 1–2 drops of biotinylated antibody specific to the animal species in which the primary antibody was raised for 10 min at RT in PBT (see **Notes 5–7**).
9. Wash the specimen 2X with PBT for a few minutes to remove excess antibody. Then wash the specimen 3X more for 30 min each.
10. Apply 1–2 drops of streptavidin-peroxidase conjugate for 15 min at RT in PBT.
11. Wash the specimen 2X with PBT across the specimen to remove excess reagent. Then wash the specimen 3X more by covering the specimen with PBT for 3 min each.
12. Apply appropriate substrate-chromogen mixture for 5–10 min at RT, frequently checking for signal development.
13. Stop the reaction by washing with PBT several times to remove the substrate.

#### 3.2.3.2. CALVARIAL ANALYSIS BY WHOLE MOUNT STAINING

1. Harvest embryonic tissues at the appropriate stage of development. In order to visualize the fetal skeletal elements (cartilage will stain blue and bone red), fix and stain the tissue in 80 mL of 95% ethyl alcohol, 20 mL glacial acetic acid containing 10 mg% of Alcian blue. Stain the tissues for 12–48 h (see **Notes 8–11**).
2. Remove specimen and rinse in solution containing 80 mL of 95% ethyl alcohol and 20 mL glacial acetic acid. Add enough fluid to adequately cover the specimen. Destain the specimen in 95% ETOH for 30–60 min.

3. Remove the destain solution and replace it with 70% ETOH for 30–60 min or until the specimen sinks. Add enough fluid to adequately cover the specimen.
4. Repeat step 3 using instead 30% ETOH for 30–60 min or until the specimen sinks. Add enough fluid to adequately cover the specimen.
5. Repeat step 3 using instead distilled or deionized for 30–60 min or until the specimen sinks. Add enough fluid to adequately cover the specimen. The solution should be fairly clear at this point (*see Note 12*).
6. Remove the fluid from the last step and replace it with 1% KOH solution. Add 10–12 drops of Alizarin Red S solution (stock solution is 2 g% in deionized water). Stain the specimen for 12–24 h.
7. Remove the last solution and destain in 1% KOH solution. Replace the 1% KOH until the solution remains clear, and no more dye is leached from the specimen. Add enough fluid to adequately cover the specimen.
8. Transfer the specimen to a new vial and cover the specimen with a solution of KOH and glycerin, made from equal parts of 1% KOH and glycerin. After 6 h change the solution to one made from one part 1% KOH and three parts glycerin. After 6 h change to 100% glycerin (*see Notes 13 and 14*).

### 3.2.3.3. WHOLE MOUNT *IN SITU* FOR MOUSE CALVARIA STAINING (MODIFIED FROM REFS. 4, 13, 14)

1. In order to preserve target sequences, the exclusion of RNase activity is essential to the success of this procedure. Use glassware baked at 200°C for 2 h and DEPC-treated water for all procedures. Perform all dissections at reduced ambient temperature.
2. Fix the specimen from the desired developmental stage in 4–5X the tissue volume using freshly prepared ice-cold 4% paraformaldehyde in standard PBS (*see Notes 15–18*).
3. Wash 5X at 5°C with 5X the tissue volume of PBT (*see Note 19*).
4. To bleach the specimens use a 5:1 mixture of PBT with 30% H<sub>2</sub>O<sub>2</sub> for 2–3 h at 4°C, followed by three washes in PBT 5 min each (*see Note 20*).
5. Digest the tissue to permit probe penetration using 10 µg/mL proteinase-K in PBT for 30 min at RT with gentle rocking of the specimen. Use 4–5X the volume of the tissue (*see Note 21*).
6. Wash 2X with freshly prepared 2 mg/mL glycine in PBT 5 min each. Use 4–5X the volume of the tissue.
7. Wash three times with PBT for 10 min each at RT. Fix the specimens with freshly prepared 0.2% glutaraldehyde (EM grade)/4% paraformaldehyde in PBS at RT for 20 min with gentle rocking. Wash the specimens with three changes of PBT. Use 4–5X the volume of the tissue for each of these steps.
8. Wash the specimen 2X with hybridization buffer (HB). Use 4–5X the volume of the tissue.
9. Prehybridize for at least 1 h at 65°C with gentle rocking. Use 4–5X the volume of the tissue (*see Note 22*).
10. Replace HB and add probe to a final concentration 1 µg/mL HB. Hybridize overnight at 65°C with rotation (*see Note 23*).
11. Wash the specimen 3X with Wash 1 for 30 min at 65°C with gentle rocking. Use 4–5X the volume of the tissue.
12. Wash the specimen 2X with Wash 1.5 for 30 min at 50°C with gentle rocking. Use 4–5X the volume of the tissue.
13. Wash the specimen 1X with RNase buffer. Treat the specimen with 100 µg/mL RNase A and 100 µg/mL RNase T1 in RNase buffer for 60 min at 37°C with gentle rocking. Wash 1X with RNase buffer (*see Note 24*).

14. Wash the specimen with Wash 2 for 30 min at 50°C with gentle rocking. Use 4–5X the volume of the tissue.
15. Wash the specimen with Wash 3 for 30 min at 50°C (45°C for AT-rich probes) with rocking. At the same time, inactivate the sheep serum by heating to 70°C for 30 min and also inactivate the embryo powder by heating 6 mg in 1 mL TBST at 70°C for 30 min.
16. Wash the specimen 2X in Wash 4, then place the specimens in TBST at 70°C for 20 min.
17. Rock the specimens in TBST containing 2 mM levamisole (0.5 mg/mL freshly added) and 10% heat-inactivated sheep serum for 2–3 h at RT.

At the same time, preabsorb the antibody as follow: To prepare 10 mL of solution, use 1 mL of inactivated embryo powder (ice-cold) + 25  $\mu$ L inactivated sheep serum + 5  $\mu$ L antidigoxigenin antibody-alkaline phosphatase (AP). Shake this mixture gently at 4°C for 1 h then spin at 4°C for 10 min. Recover the supernatant and dilute to 10 mL with 1% (v/v) sheep serum in TBST containing 2 mM levamisole.

18. Incubate the specimens with the preabsorbed antibody (4X the volume of specimens) overnight at 4°C with gentle rocking.
19. Wash the specimen 3X with TBST containing freshly prepared 2 mM levamisole for 5 min each. Continue to wash the specimen an additional 5–6X for 60 min each at RT in TBST containing freshly prepared 2 mM levamisole.
20. Wash 2X for 5 min each with freshly prepared NTMT containing freshly prepared 2 mM levamisole for 20 min at RT with gentle rocking. Use 4–5X the volume of the specimen.
21. Initiate the color reaction by adding the chromogen and then move to a low light or dark area. Protect the specimen from direct light. For the chromogen, we use 330  $\mu$ g NTB, 165  $\mu$ g BCIP in 1 mL NTMT containing freshly prepared 2 mM levamisole. Gently rock the glass tube for the first 5 min, then stand the containers until sufficient color has developed to allow detection.
22. When the color development is sufficient to produce a photographic record, stop the color reaction with three washes for 5 min each using TBST 10 (*see Note 25*).
23. Clear the tissues by placing the specimens into a solution of 1:1 glycerol:CMFET for 1 h and then into a solution 4:1 glycerol:CMFET for 1 h with gentle rocking. The specimens can be stored at 4°C (*see Note 26*).

### 3.2.3.4. BRDU LABELING OF CALVARIAL TISSUES (MODIFIED FROM REF. 16)

1. Mice are injected intraperitoneally with 100  $\mu$ g/g of body weight, 2 h prior to be sacrificed.
2. Heads are fixed and decalcified in 4% paraformaldehyde + 10% EDTA overnight to 2 d depending on the age of the animal. For animals younger than 2 d, overnight fixation and decalcification is sufficient.
3. Bisect the head at the coronal sutures.
4. Dehydration through graded alcohol and paraffin embedment.
5. Section.
6. Deparaffinize sections through xylene and hydrate sections in descending grades of alcohols.
7. Soak sections in 1X PBS, 2X, 5 min each.
8. Quench endogenous peroxidase activity by soaking sections in 3% hydrogen peroxide in methanol for 10 min.
9. Wash in 1X PBS, 3X, 3 min each.
10. Incubate sections with 100  $\mu$ g/mL proteinase K in 50 mM Tris-HCl, 5 mM EDTA (pH 8.0) for 20 min at 37°C (*see Note 27*).
11. Depurinate DNA in 2 N HCl (freshly made) for 45 min at RT.

12. Neutralized sections in 0.1 M sodium borate (pH 8.5) for 10 min.
13. Wash sections 3X with 1X PBT (1X PBS, 0.1% Tween-20) for 3 min each.
14. Apply 2–3 drops of blocking solution A (Zymed HistoMouse Immunostaining kit) (Zymed Laboratories, South San Francisco, CA). Incubate for 30 min.
15. Wash 3X with 1X PBT for 3 min each.
16. Apply 2–3 drops of blocking solution B. Incubate for 10 min.
17. Wash 3X with 1X PBT for 3 min each.
18. Apply mouse monoclonal anti-BrdU antibody (B2531; Sigma, St. Louis, MO) at 1:250 dilution in PBS. Incubate overnight at RT in a wet chamber.
19. Wash sections 3X with 1X PBT for 3 min each.
20. Apply 2–3 drops of biotinylated secondary antibody, incubate 20 min.
21. Wash sections 3X with 1X PBT for 3 min each.
22. Apply 2–3 drops of streptavidin-HRP conjugate and incubate for 10 min.
23. Wash sections 3X with 1X PBT for 3 min each.
24. Incubate sections with AEC substrate. Monitor the extend of the red stain to prevent overstaining.
25. Stop by washing sections with 1X PBS.
26. Counterstain sections with hematoxylin.

### 3.2.3.5. ALKALINE PHOSPHATASE HISTOCHEMICAL STAINING (MODIFIED FROM REF. 19)

1. Deparaffinize.
2. Wash sections 3X in 1X TBST for 3 min each.
3. Incubate sections in 1X NMTT (100 mM NaCl, 50 mM MgCl<sub>2</sub>, 100 mM Tris-HCl, pH 9.5, 0.1% Tween-20) 3 min, three changes.
4. Apply NBT-BCIP (0.34 mg/mL nitroblue tetrazolium salt, 0.175 mg/mL 5-bromo-4-chloro-3-indolyl-phosphate) staining solution in 1X NMT.
5. Incubate until purple color appears.
6. Stop reaction by washing sections with 1X PBS.
7. Counter stain sections with nuclear fast red.

## 4. Notes

1. We use washed, sterile glass scintillation vials for these steps and a rocking table with a cadence of approx 10 rpm. More violent rocking tends to harm the specimen by causing physical distortion of the tissues.
2. Dilution of the primary antibody is difficult to estimate, but we prefer the least amount of primary antibody that provides signals in positive control specimens. Low concentration of primary antibodies tend to prevent trapping that contributes to high background.
3. We have also found that preabsorbing the primary antibody with mouse embryo powder reduces background but also results in the need to increase the amount of primary antibody, because there is a net concentration reduction of the primary antibody following absorption. Make embryo powder by euthanizing an embryo at a developmental stage that does *not* express the target protein in question. Freeze the embryos in liquid nitrogen, place in a pestle under liquid nitrogen and mortar the tissues until they are a fine powder. Divide the powder into small aliquots in precooled 1.5-mL tubes and store at –80°C for future use.
4. If the background remains unacceptable, you may consider two principal adjustments. First, consider reducing the concentration of the primary antibody. If modification of the primary antibody fails to reduce nonspecific staining, then increase the number of washes but not their volume. These additional washes tend to repartition the primary antibody into the solution of lower antibody concentration (e.g., the wash buffer).

5. This step is unique for your tissues. Longer incubations may be used with lower amounts of biotinylated antibody. Because this is a concentration-dependent reaction, keeping the volume of PBT low is useful. If you are problem solving high backgrounds or other problems, be sure to use the same amount of PBT each time so as not to alter the final relative concentration of reagents.
6. Another consideration is that longer incubation times are usually required for penetration of reagents to deeper structures. To improve tissue penetration, we have found that removing the dermis is very beneficial, because the skin prevents penetration of reagents just as it does in living animals. However, great care must be exercised in removing the dermis to ensure that anatomic relationships are not distorted.
7. The remaining steps are essentially the same as for detection of antibody complexes on tissue sections.
8. With proper planning and management, it is possible to obtain corroborative data in the form of whole mount *in situ* hybridization, whole mount immunostaining, histologic sections and/or *in situ* hybridization performed on tissue sections using variations of this protocol. Thus, it would be possible to document a skeletal malformation at the whole embryo level, at the tissue section level, and also include assays for either mRNA and/or protein molecules in selected target tissues using but a few specimens.
9. If the specimens are also to be used for the preparation of histologic sections, then fix the specimens using freshly prepared 4% paraformaldehyde for a time suitable to their volume and developmental age before starting step 1.
10. If the specimens are also to be used in whole mount *in situ* hybridization analysis or *in situ* hybridization to tissue sections, then steps to ensure the absence of RNase activity in all glassware and reagents used in these steps must be taken. The steps required for RNA detection are extremely tedious and time consuming. Unless the phenotype is so variable as to require inclusion of all specimens in order to obtain adequate sampling, it would be more expeditious to include less numbers of specimens in this type of analysis.
11. We generally use glass scintillation vials to hold each specimen. They are cheap, transparent, and can be obtained with screw-top lids that seal well. If you are anticipating including whole mount procedures, then be sure to rinse each bottle well with 2- $\mu$ m filtered deionized autoclaved water (RNase-free if you are planning *in situ* hybridization) in order to remove lint and dust deposited during manufacturing. These particles cling to the specimen tenaciously (if you forget this step once, you will never forget it a second time) and makes photographic documentation impossible. It is a real disappointment to have gone through so many arduous steps to have the final record for publication marred.
12. If the specimen is delicate or if preservation of fine structure is required, refix the specimen in freshly made 4% paraformaldehyde or in 10% buffered formalin for 6–18 h. However, additional fixation will slow the clearing of the specimen.
13. A small crystal of thymol may be added to prevent biological growth.
14. After a photographic record is made of the cleared specimen, it may be embedded in paraffin for the production of histologic sections.
15. Use rocking and a warm water bath (approx 40°C) to facilitate the paraformaldehyde to go into solution.
16. Embryonic specimens prior to 15 d of gestation (E15) are readily permeable across their cutaneous barrier; after E15, stripping the epidermis is useful.
17. In these procedures, the times and volumes are related to the physical characteristics of the specimens. Larger, older specimens require larger volumes, more frequent changes of solutions, and longer periods to achieve optimal results. The specific conditions may be slightly altered to achieve an optimal result for your specimen.

18. We favor using washed, deionized-water-rinsed, oven-baked (to remove RNase), liquid scintillation glass vials for our specimens. The specimen will become very sticky during these steps. To avoid debris sticking to and ruining the specimen, be sure to carefully wash all vessels used in preparing solutions. Use 2- $\mu$ m filtered, deionized-, sterile water as a final rinse for all vessels. All solutions should be filtered through a 2- $\mu$ m filter to remove fine particulates. These extraordinary precautions, coupled with the need to avoid RNase contamination, make these steps extremely time consuming.
19. The specimens can be stored at this point by dehydrating them through a graded methanol series. Transfer the specimens to 50% v/v methanol, and thence through 75%, 85%, 95% methanol and store in 100% methanol. Late gestation age calvaria require approx 20–30 min in each solution. Embryonic stage embryos, E9 through E15 (plug is day 0) require about 15–20 min in each solution (*see Note 20*).
20. For methanol dehydrated specimens use a 5:1 mixture of 100% methanol with 30% H<sub>2</sub>O<sub>2</sub> for 5–6 h at RT, followed by several washes in 100% methanol. Then three washes in PBT for 5 min each before proceeding to next step.
21. It is important to use a gentle rocking action that results in the specimen moving in the solution but not bouncing against the vessel. The specimen will become more easily damaged after proteinase treatment and appropriate care must be exercised.
22. Longer prehybridization steps are perfectly acceptable, including overnight.
23. This procedure requires large amounts of asymmetric dioxygenin-labeled cRNA probe to be generated, and this is costly. We use enough HB to just cover the specimen, ensuring we are working at a likely concentration that represents an excess of labeled probe and also enough fluid to prevent drying out of the specimen and the absorption of the probe to tissues in a nonspecific manner. Reannealing times are proportional to concentration, time, and temperature and are influenced by sodium concentration, acceptable base mismatch, etc., just as they are during hybridization to target sequences in tissue sections or on membranes. In whole mounts, however, the possibility to generate noise is much greater, so we prefer to use a lower concentration of probe and hybridize for longer periods of time.
24. This step generates large amounts of RNase. We prefer to do this step in someone else's lab but most of our colleagues are on to us by now, so we just use a room different from the one in which we synthesize the cRNA probes and prepare the specimens.
25. To intensify the signal, you may dehydrate the specimens through a series of graded washes of methanol using TBST and ending at 100% methanol (*see step 3*, substitute TBST for the PBT used in step 3) then rehydrate the specimen through graded methanol, stop at TBST. Use about 4–5X the volume of the tissue.
26. Obtain a photographic record of the specimens often. We have found that a good dissecting microscope with a through-the-lens metering system works well. We use one 100-W fiber optic sources to transilluminate the specimen and several 100-W fiber optic sources to obliquely light the specimen. The oblique light facilitates obtaining depth of field that helps establish the anatomic relationships as well as allowing maximum visualization of the hybridization signal in tissues in the specimen.
27. The concentration of proteinase K used is critical to the success of this procedure. The amount of proteinase K used should be empirically tested depends on the tissue.

## Acknowledgment

This work was supported by grants from NIH-NIDCR to Y.-H. L., M. L. S., and R. E. M.

## References

1. Gorlin, R. J., Cohen, M. M., and Levin, L. S. (1990) *Syndromes of the Head and Neck*. 3rd ed. Oxford University Press, New York, pp. 672–673.
2. Cohen, M. M., Jr. (1986) *Craniosynostosis: Diagnosis, Evaluation and Management*. Raven, New York.
3. Cohen, M. M., Jr. (1988) Craniosynostosis update 1987. *Am. J. Med. Genet.* **4(Suppl.)**, 99–148.
4. Jabs, E. W., Muller, U., Li, X., Ma, L., Luo, W., Haworth, I., Klisak, I., Sparkes, R., Warman, M., Mulliken, J. B., Snead, M. L., and Maxson, R. (1993) A mutation in the homeodomain of the human MSX2 gene in a family affected with autosomal dominant craniosynostosis. *Cell* **75**, 443–450.
5. Gorlin, R. J. (1997) Fibroblast growth factors, their receptors and receptor disorders. *J. Craniomaxillofac. Surg.* **25**, 69–79.
6. Wilkie, A. O. (1997) Craniosynostosis: genes and mechanisms. *Hum. Mol. Genet.* **6**, 1647–1656.
7. el Ghouzzi, V. L. M. M., Perrin-Schmitt, F., Lajeunie, E., Benit, P., Renier, D., Bourgeois, P., Bolcato-Bellemin, A. L., Munnich, A., and Bonaventure, J. (1997) Mutations of the TWIST gene in the Saethre-Chotzen syndrome. *Nat. Genet.* **15**, 42–46.
8. Howard, T. D., Paznekas, W. A., Green, E. D., Chiang, L. C., Ma, N., Ortiz de Luna, R. I., Garcia Delgado, C., Gonzalez-Ramos, M., Kline, A. D., and Jabs, E. W. (1997) Mutations in TWIST, a basic helix-loop-helix transcription factor, in Saethre-Chotzen syndrome. *Nat. Genet.* **15**, 36–41.
9. Liu, Y.-H., Kundu, R., Wu, L., Luo, W., Ignelzi, M. A., Jr., and Maxson, R. E. (1995) Premature suture closure and ectopic cranial bone in mice expressing Msx2 transgenes in the developing skull. *Proc. Natl. Acad. Sci. USA* **92**, 6137–6141.
- 9a. Liu, Y.-H., Tang, Z., Kundu, R. K., Wu, L., Luo, W., Zhu, D., Sangiorgi, F., Snead, M. L., and Maxson, R. E. (1999) Msx2 gene dosage influences the number of proliferative osteogenic cells in growth centers of the developing murine skull: a possible mechanism for MSX2-mediated craniosynostosis in humans. *Dev. Biol.* **205**, 260–274.
10. Ma, L., Golden, S., and Maxson, R. (1996) The molecular basis of Boston type craniosynostosis: The Pro148->His mutation in the N-terminal arm of the MSX2 homeodomain stabilizes DNA binding without altering nucleotide sequence preferences. *Hum. Mol. Genet.*, in press.
11. Humason, G. L. (1997) *Animal Tissue Techniques*. W. H. Freeman, pp. 195–197.
12. Lazik, A., Liu, Y., Bringas, P., Sangiorgi, F., and Maxson, R. (1996) A sensitive method for analyzing beta-galactosidase reporter gene expression in tissue sections of mouse embryos. *Trends Genet.* **12**, 445–447.
13. Conlon, R. A. and Rossant, J. (1992) Exogenous retinoic acid rapidly induces anterior ectopic expression of murine Hox-2 genes in vivo. *Development* **116**, 357–368.
14. Snead, M. L., Paine, M. L., Chen, L. S., Yoshida, B., Luo, W., Zhou, D., Lei, Y. P., Liu, Y. H., and Maxson, R. E. (1996) The murine amelo-genin promoter: developmentally regulated expression in transgenic animals. *Connect. Tissue Res.* **35**, 41–47.
15. Harlow, E. and Lane, D. (1988) *Antibodies. A Laboratory Manual*. Cold Spring Harbor Laboratory, Cold Spring Harbor, NY.
16. Silverstrini, R., Daidone, M. G., and Costa, A. (1995) Determination of the cell proliferation fraction in human tumors, in *Cell Growth and Apoptosis: A Practical Approach*. IRL, Oxford, 59–77.
17. Saldivar, J. R., Sechrist, J. W., Krull, C. E., Ruffins, S., and Bronner-Fraser, M. (1997) Dorsal hindbrain ablation results in rerouting of neural crest migration and changes in gene expression, but normal hyoid development. *Development* **124**, 2729–2739.



18. Lazik, A., Liu, Y.-H., Sangiorgi, F., and Maxson, R. (1997) A method for preparing DiI-labeled tissue that allows single-cell resolution with conventional epifluorescence microscopy. *Trends Genet.* **13**, 376.
19. Zernik, J., Twarog, K., and Upholt, W. B. (1990) Regulation of alkaline phosphatase and alpha2(I) procollagen synthesis during early intramembranous bone formation in the rat mandible. *Differentiation* **44**, 207–215.
20. Rossert, J., Eberspaecher, H., and de Crombrughe, B. (1995) Separate cis-acting DNA elements of the mouse pro-alpha 1(I) collagen promoter direct expression of reporter genes to different type I collagen-producing cells in transgenic mice. *J. Cell. Biol.* **129**, 1421–1432.
21. Rossert, J. A., Chen, S. S., Eberspaecher, H., Smith, C. N., and de Crombrughe, B. (1996) Identification of a minimal sequence of the mouse pro-alpha 1(I) collagen promoter that confers high-level osteoblast expression in transgenic mice and that binds a protein selectively present in osteoblasts. *Proc. Natl. Acad. Sci. USA* **93**, 1027–1031.
22. D'Souza, R. N., Niederreither, K., and de Crombrughe, B. (1993) Osteoblast-specific expression of the alpha 2(I) collagen promoter in transgenic mice: Correlation with the distribution of TGF-beta 1. *J. Bone Miner. Res.* **8**, 1127–1136.
23. Bou-Gharios, G., Garrett, L. A., Rossert, J., Niederreither, K., Eberspaecher, H., Smith, C., Black, C., and de Crombrughe, B. (1996) A potent far-upstream enhancer in the mouse pro alpha 2(I) collagen gene regulates expression of reporter genes in transgenic mice. *J. Cell. Biol.* **134**, 1333–1344.
24. Niederrither, K., D'Souza, R. N., and de Crombrughe, B. (1992) Minimal DNA sequences that control the cell lineage-specific expression of the pro alpha 2(I) collagen promoter in transgenic mice. *J. Cell. Biol.* **119**, 1361–1370.
25. Flenniken, A. M. and Williams, B. R. G. (1990) Developmental expression of the endogenous TIMP gene and a TIMP-lacZ fusion gene in transgenic mice. *Genes Dev.* **4**, 1094–1106.
26. Lo, C. W., Cohen, M. F., Huang, G. Y., Lazatin, B. O., Patel, N., Sullivan, R., Pauken, C., and Park, S. M. (1997) Cx43 gap junction gene expression and gap junctional communication in mouse neural crest cells. *Dev. Genet.* **20**, 119–132.
27. Kothary, R., Barton, S. C., Franz, T., Norris, M. L., Hettle, S., and Surani, M. A. (1991) Unusual cell specific expression of a major human cytomegalovirus immediate early gene promoter-lacZ hybrid gene in transgenic mouse embryos. *Mech. Dev.* **35**, 25–31.
28. Baskar, J. F., Smith, P. P., Nilaver, G., Jupp, R. A., Hoffmann, S., Peffer, N. J., Tenney, D. J., Colberg-Poley, A. M., Ghazal, P., and Nelson, J. A. (1996) The enhancer domain of the human cytomegalovirus major immediate-early promoter determines cell type-specific expression in transgenic mice. *J. Virol.* **70**, 3207–3214.
29. Koedood, M., Fichtel, A., Meier, P., and Mitchell, P. J. (1995) Human cytomegalovirus (HCMV) immediate-early enhancer/promoter specificity during embryogenesis defines target tissues of congenital HCMV infection. *J. Virol.* **69**, 2194–2207.
30. Takahashi, T., Guron, C., Shetty, S., Matsui, H., and Raghov, R. (1997) A minimal murine Msx-1 gene promoter. Organization of its cis-regulatory motifs and their role in transcriptional activation in cells in culture and in transgenic mice. *J. Biol. Chem.* **272**, 22,667–22,678.
31. MacKenzie, A., Purdie, L., Davidson, D., Collinson, M., and Hill, R. E. (1997) Two enhancer domains control early aspects of the complex expression pattern of Msx1. *Mech. Dev.* **62**, 29–40.