

S E R I E S   T E C H N O L O G I E S   N r 5



# Compressed earth blocks

production equipment



Centre for  
the Development of Industry  
ACP - EU



CRATerre-EAG  
BASIN-EAS

# **Compressed earth blocks**

**production equipment**

Since it was founded in 1977, the Centre for the Development of Industry (CDI) has acquired extensive technical and commercial know-how in the creation, development and rehabilitation of small and medium-sized industries in the ACP countries (Africa, Caribbean and Pacific), particularly through the establishment of lasting partnerships with companies in the European Union.

In publishing this collection of "Practical Guides", the CDI is meeting a clearly expressed need by ACP promoters and companies in the EU wishing to lay the foundations for industrial co-operation. The purpose of these guides is to enable them to adapt to the technical, commercial, financial, administrative and legal environment of the different countries. Designed to ease their task by providing detailed information - in simple practical terms - on a specific aspect or field of their activities, these guides are intended above all to be effective tools which managers can use on a day-to-day basis.

To prepare the guides, the CDI calls upon the services of consultants, researchers and businessmen - in both the ACP countries and the European Union - with extensive experience in the field concerned, in the practical problems actually encountered by entrepreneurs and in the solutions to be applied. Whenever circumstances allow, the CDI cooperates with partners (consultancy bureau, research body, specialised institution, etc.) to ensure that the guides are as widely circulated as possible.

Authors : Hugo Houben, Vincent Rigassi, Philippe Garnier

Contributors : Patrice Doat, Thierry Joffroy, Alexandre Douline, Hubert Guillaud

Assistance : Marie-France Ruault, David Rodriguez, Régine Rivière, Titane Galer

Translation: Claire Norton

Photographs : © CRATerre-EAG except these supplied by the manufacturers

Drawings : © CRATerre-EAG

© 1996 CDI and CRATerre-EAG, Brussels - 2<sup>d</sup> edition

This volume of CDI Guides is published jointly by the CDI and CRATerre-EAG.

May not be sold by persons or organisations other than the CDI and its official distributors. Price: 20 ecus

Reproduction authorised with indication of the source, except for commercial purposes.

ISBN : 2-906901-13-X



# CONTENTS

---

## 1. INTRODUCTION

Why this guide? .....	7
When and how to use the guide ? .....	8
How is the guide set out? .....	8

## 2. THE COMPRESSED EARTH BLOCK

Presentation .....	9
Diversity of product .....	11
Position in relation to other materials .....	12
Technical performance .....	14
General specifications .....	16
Conditions of use .....	18
Current norms .....	22
Examples of compressed earth block buildings .....	24

## 3. THE TECHNOLOGY OF PRODUCTION

Production cycle .....	32
The raw material: soil .....	34
Stabilization .....	36
Production equipment .....	38
Pulverizers .....	44
Screens .....	47
Mixers .....	49
Presses .....	52

## 4. EQUIPMENT SELECTION

General selection criteria .....	65
Selection criteria for presses .....	68

## 5. INVENTORY OF EQUIPMENT

Inventory of pulverizers .....	72
Inventory of mixers .....	78
Inventory of presses .....	86
Index of equipment .....	110

## CONTENTS

<b>6. DIRECTORY OF MANUFACTURERS AND DISTRIBUTORS</b> .....	114
<b>7. BRICKWORKS</b>	
Types of brickworks and capital investments .....	125
Semi-mechanized brickworks .....	128
Fully mechanized brickworks .....	130
Manufacturing and organization parameters: a quality approach .....	132
<b>8. THE FEASIBILITY STUDY</b>	
The six phases of a project .....	135
The feasibility study .....	135
Financial and economic evaluation .....	136
Production cost .....	136
Unit cost price .....	137
Break-even point .....	138
The degree of sensitivity of the unit cost price .....	139
The degree of sensitivity of the brickworks .....	140
<b>SERVICES OFFERED</b>	
Centre for the Development of Industry - CDI	
A tool for the development of industrial enterprises in ACP countries .....	143
International Centre for Earth Construction - CRA Terre-EAG .....	147
Building Advisory Service and Information Network - BASIN .....	149
<b>BIBLIOGRAPHY</b> .....	151

## ACKNOWLEDGEMENTS

CRATerre-EAG wishes to thank:

- The Centre national d'essais et de recherche des travaux publics (CNERTP), Benin
- The Ecole inter-états d'ingénieurs de l'équipement rural (EIER), Burkina Faso
- The Laboratoire du bâtiment des travaux publics (LBTP), Côte d'Ivoire
- The Ecole nationale des travaux publics de l'Etat (ENTPE), France
- The Department of Rural Housing and Cottage Industries, Ghana
- The Malawi Housing Corporation, Malawi
- The Centre for Earth Construction Technology (CECTech), Nigeria
- The Department of Geological Survey and Mines, Uganda
- The Building Research Establishment, United Kingdom
- The Centre expérimental de recherches et d'études pour l'équipement (CEREEQ), Senegal
- Dr D.J.T. Webb, engineer, United Kingdom
- Kiran Mukerji, consultant architect, Germany
- Pierre-Eric Verney, architect, France

for their invaluable help and collaboration.

CDI  
Centre for the Development of Industry  
(ACP-EU Lomé Convention)  
52 avenue Herrmann Debroux  
B-1160 Brussels - Belgium  
Phone +32 2 679 18 11  
Fax +32 2 675 26 03  
Telex 61427 cdi b

CRATerre-EAG  
International Centre  
for Earth Construction  
B.P. 53  
F-38092 Villefontaine Cedex - France  
Phone +33 74 95 43 91  
Fax +33 74 95 64 21

This is the second edition of the guide entitled «Compressed earth blocks: selection of production equipment». It has been revised, corrected and updated by experts from CRATerre-EAG (The International Centre for Earth Construction - School of Architecture of Grenoble) in collaboration with the international scientific committee RILEM TC 153 - CIB W 90 «Compressed earth block technology», on the basis of information provided by the various establishments which are the subject of the present guide.

Despite their best efforts, in close collaboration with equipment manufacturers, for the updating and checking of these data, the CDI and CRATerre-EAG cannot be held responsible for any inaccuracies or omissions of the data in question. The fact that an establishment appears in this document does not imply any obligation on its parts to supply any of the services described in the corresponding description. The CDI and CRATerre pass on the information contained in the present document in good faith. They can accept no responsibility for any errors or omissions, or their consequences.

# 1. INTRODUCTION

---

## WHY THIS GUIDE?

Raw earth has been used for the construction of buildings since the most ancient times, and the traditional housing that exists in many parts of our planet bears witness to this fact. Abandoned and forgotten with the advent of industrial building materials, particularly concrete and steel, it is today the subject of renewed interest in developing countries as well as in industrialized countries.

Often criticized for its sensitivity to water and its lack of durability, this building material has in its present form many advantages for the construction of durable, comfortable and low-cost housing. If logic and modern methods are applied to its use, it can be all of the following:

- efficient and durable;
- available locally and cheaply;
- economical in energy and in foreign currency;
- an encouragement for the development of building trade skills;
- job-creating;
- capital gains generating;
- a dynamic force for the building sector;
- ideal for small and medium scale industries.

Today, earth building production techniques range from the most rudimentary, manual and craft-based to the most sophisticated, mechanized and industrial. At the top of this range, which has been the subject of unprecedented scientific research, the production of earth building materials is no longer in any way inferior to that of other current building materials, even the most elaborate. In the case of the compressed earth block, this trend towards industrialization emerged approximately 25 years ago. Earth technology is therefore no longer a matter of strictly craft-based practices without development potential. The evolution from craft to industrial is possible, and is taking place, but it is clear that this trend needs to be justified with regard to the parameters of particular situations: global development policy, socio-economic and cultural aspects, economic and technological interdependence. It is therefore particularly important to select equipment in the light of these parameters and criteria in order to ensure the best possible match of production machinery to a given context.

The object of the present guide is to meet a growing demand for information from ACP countries regarding this technology. The guide is principally intended to enable entrepreneurs, national decision-makers, industrial groups and professional bodies to make a short-list in full knowledge of the facts, and using a soundly structured approach. The guide makes no claim to replace manufacturers' technical and marketing documentation. Users are strongly urged to contact the manufacturers they short-list before proceeding with their final choice of production equipment.



## INTRODUCTION

### **WHEN AND HOW TO USE THE GUIDE?**

For this guide to be an effective support for an investment in compressed earth block production technology, it should be consulted during the design phase of your project, at the start of each new phase as it unfolds and before making any decision or commitment. It should also be consulted in case of doubt.

As a general rule, it should be consulted to:

- carry out the feasibility study;
- establish the specifications to be included in a call for tenders;
- establish one or more comparative tables;
- draw up a short-list;
- be sufficiently well informed to negotiate/discuss with suppliers;
- write the technical part of an order or contract;
- know how to demand technical assistance and/or training.

This guide, which refers specifically to production equipment, can be used along with other publications such as "The basics of compressed earth blocks", "Compressed earth blocks" (video), "Compressed earth blocks: manual of production", "Compressed earth blocks: manual of design and construction", etc. (see bibliography).

### **HOW IS THE GUIDE SET OUT?**

The way in which the guide is set out is intended to be practical and simple. It deals with the specifics of compressed earth block production as a whole and then progresses logically through the stages of equipment selection, purchase and production. The equipment is presented as a series of uniform technical sheets describing the main technical features and allowing easy comparison. A short-list of suitable pieces of equipment can thus be compiled using a list of predetermined criteria.

The units of measurement used in this guide conform as far as possible to ISO recommendations. In particular, the unit of pressure used is the MPa. Note: 1 MPa = 1 MN/m<sup>2</sup> = 10 bars.

In order to avoid too frequent repetition of the term "compressed earth block", the abbreviation "CEB" is sometimes used.

# 2. THE COMPRESSED EARTH BLOCK

## PRESENTATION

### THE MAIN TECHNIQUES FOR BUILDING WITH EARTH

Amongst traditional raw earth building practices, a vast number of construction techniques can be listed, with an infinite range of variants expressing their cultural and geographical origins. There are twelve main, well-known methods using earth as a building material. Amongst these, six are commonly used and constitute the major technical types:

- the compressed earth block;
- adobe or moulded brick;
- cob or piled and shaped earth;
- rammed earth or earth tamped into formworks;
- wattle and daub or earth used as fill-in within a wooden framework;
- straw clay using a formwork to fill in between posts.

### THE COMPRESSED EARTH BLOCK

The earth is compressed, in block form, in a mould. Formerly, the earth was compressed in the mould by means of a small pestle, or by tamping energetically with a very heavy lid on the mould. Nowadays, presses are used, and there exists a wide range of these.

The compressed earth block may be stabilized. In this case the product is called a "Stabilized compressed earth block". Stabilization of the earth consists in modifying the properties of the earth-water-air system in order to obtain permanent properties compatible with a particular application.

Compressed earth blocks are stabilized by adding a stabilizer to the earth. In most cases the stabilizer is a conventional binder such as cement or lime. The percentage by weight of these binders varies from 3 to 19%, with a mean of 6 to 8%.

### The advantages of the compressed earth block

The compressed earth block technique has several advantages which deserve mention:

- The production of the material, using mechanical presses varying in design and operation, marks a real improvement over traditional methods of producing earth blocks, whether adobe or hand-compacted, particularly in the consistency of quality of the products obtained. This quality furthers the social acceptance of a renewal of building with earth.
- Compressed earth block production is generally linked to the setting up of quality control procedures which can meet requirements for building products' standards, or even norms, notably for use in urban contexts.
- In contexts where the building tradition already relies heavily on the use of small masonry elements (fired bricks, stone, sand-cement blocks), the compressed earth block is very easily assimilated and forms an additional technological resource serving the socio-economic development of the building sector.
- Policy-makers, investors and entrepreneurs find the flexibility of mode of production of the compressed earth block, whether in the rural or the urban context, small-scale or industrial, a convincing argument.

## THE COMPRESSED EARTH BLOCK

- Architects and the inhabitants of buildings erected using this material are drawn to the architectural quality of well-designed and well-executed compressed earth block buildings.

### **Some constraints**

The quality of compressed earth blocks depends on good soil selection and preparation and on the correct choice of production material. Architectural use of the material must take account of specific design and application guidelines which must be applied by both architects and builders. This means that professional skills must be ensured by suitable training. From an economic point of view, a technical-economic study enables the feasibility of the technology to be determined in each application context.

## THE COMPRESSED EARTH BLOCK

### DIVERSITY OF PRODUCT

There are four types of blocks.

#### **Solid blocks**

Most solid blocks are prismatic in shape (parallelepipeds, cubes, multiple hexagons, etc.). They have a very wide range of uses.

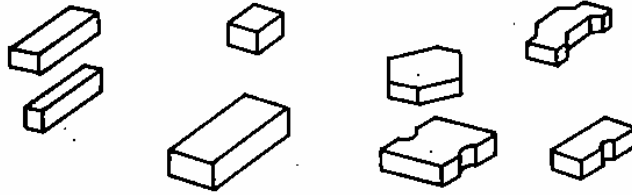

#### **Hollowed blocks**

These blocks usually have 5 to 10% of the material removed, but this can reach 30% with sophisticated procedures. The recesses improve the adhesion of the mortar, and make the blocks lighter. Certain blocks enable ring-beams (lost formwork) to be built.

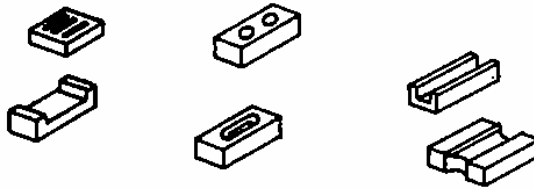

#### **Alveolate blocks**

These have the advantage of being light, but they require fairly sophisticated moulds and higher compression pressures. Their production is delicate. They are particularly suited to reinforced masonry (in earthquake areas).

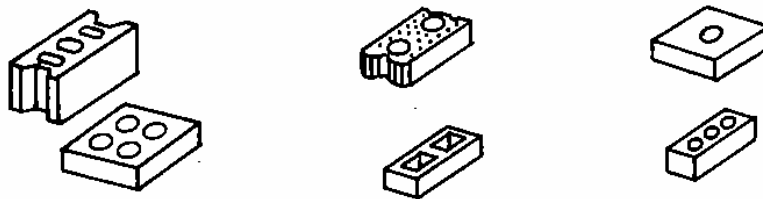

#### **Interlocking blocks**

These blocks can, in principle, be assembled without the use of mortar, but they require fairly sophisticated moulds and generally high compression pressures. Their production is fairly laborious. They are often used for non-loadbearing structures.

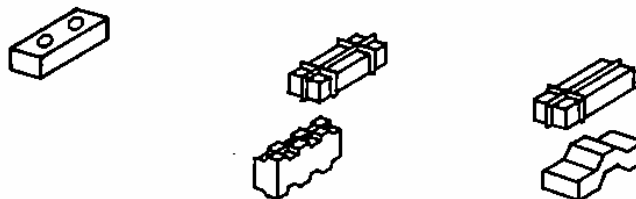

## THE COMPRESSED EARTH BLOCK

### POSITION IN RELATION TO OTHER MATERIALS

A simplistic approach to the definition of the position of the compressed earth block in relation to other building materials is necessarily a false approach (e.g. just comparing compressive strength or production costs only). The question is a complex one.

When comparing materials it is important to do so for all stages of their existence, and for all the processes they undergo during that existence; the comparison should be made in the light of all aspects of the material's uses.

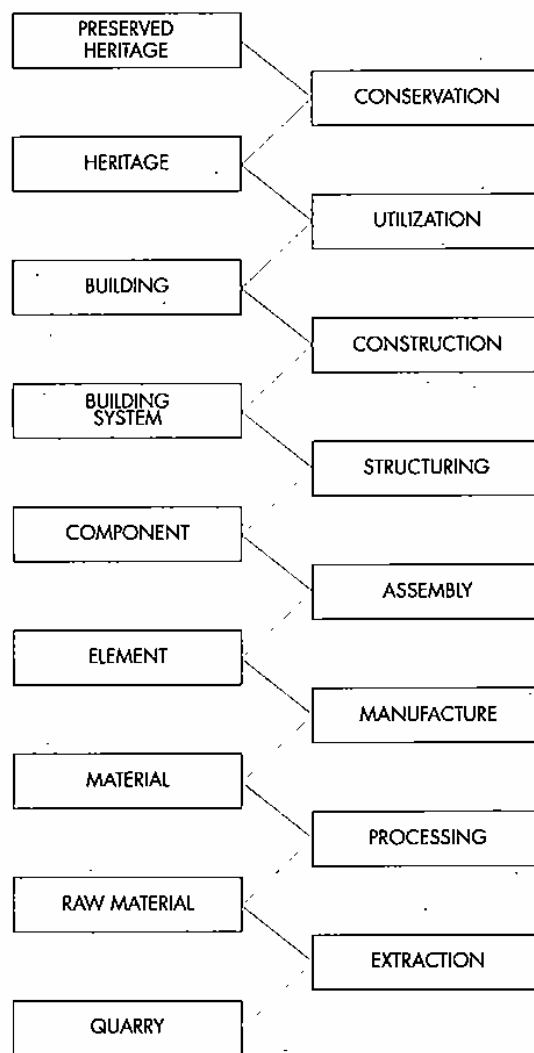

## THE COMPRESSED EARTH BLOCK

The main aspects of use are as follows:

- technical aspects: mechanical, static, hydrous, physical, qualitative and other characteristics;
- economic aspects: unit production cost, volume production cost, production cost by technical unit (e.g. cost per unit of compressive strength), economic break-even point, capital required, etc;
- health aspects: emission of harmful gases or other chemical compounds, radiation, likelihood of harbouring disease-carrying insects, etc;
- psychological aspects: nature of the material, surface texture, colour, shape, luminosity, etc;
- ecological aspects: deforestation, quarrying into hills, water consumption, energy consumption, generation of pollution, production of waste, etc;
- social aspects: use of labour for manufacture and transport, cultural and social acceptability, etc;
- institutional aspects: legislation, insurance, development policy, norms and standards, etc.

Clearly, only a well-planned feasibility study can produce this type of analysis, which carries great weight in the final choice.

However, a simple comparison of some of the important characteristics of the stabilized compressed earth block with those of other conventional construction materials of the artisanal sector is given in the table below:

<b>COMPARISON OF CHARACTERISTICS</b>						
CHARACTERISTICS	SYMBOL	UNIT		STABILIZED COMPRESSED EARTH BLOCKS	FIRE CLAY BRICKS	CONCRETE BLOCKS
28 DAY WET COMPRESSIVE STRENGTH	Rc 28 wet	MPa	A	1	0.5	0.7
			B	4	6	5
REVERSIBLE MOISTURE EXPANSION		% linear	A	0.2	0.02	0.05
			B	0.02	0	0.02
APPARENT BULK DENSITY	$\rho$	kg/m <sup>3</sup>	A	1,700	1,400	1,700
			B	2,200	2,400	2,200
COEFFICIENT OF THERMAL CONDUCTIVITY	$\lambda$	W/m °C	A	0.81	0.7	1.0
			B	1.04	1.3	1.7
DURABILITY UNDER SEVERE NATURAL EXPOSURE				LOW TO VERY GOOD	LOW TO EXCELLENT	LOW TO VERY GOOD
ENERGY INCORPORATED IN THE BUILDING COMPONENT				LOW	VERY HIGH	HIGH
CEMENT INCORPORATED IN THE BUILDING COMPONENT		% [weight]	A	8	0	14
			B	5	0	12

A: normal conditions of production

B: optimum conditions of production

Note: the extreme figures obtained in laboratories for these various materials are not shown here.

## THE COMPRESSED EARTH BLOCK

### TECHNICAL PERFORMANCE

The technical performance of compressed earth blocks observed under real production conditions varies widely. Nevertheless, four major types of block may be defined on the basis of analysis of this performance. There is no direct relationship between these four types of block and their conditions of production.

The following conditions can however be linked:

- type 1 : unstabilized compressed earth block;
- type 2 : stabilized compressed earth block produced in adequate conditions;
- type 3 : stabilized compressed earth block produced with care, using machinery which performs well and a quality control system;
- type 4 : stabilized compressed earth block produced in certain exceptional industrial conditions.

TECHNICAL PERFORMANCE OF COMPRESSED EARTH BLOCKS						
MECHANICAL CHARACTERISTICS	SYMBOL	UNIT	COMPRESSED EARTH BLOCK TYPE			
			TYPE 1	TYPE 2	TYPE 3	TYPE 4
28 DAY DRY COMPRESSIVE STRENGTH (+ 40 % AFTER 1 YEAR, + 50 % AFTER 2 YEARS)	Rc 28 dry	MPa	= 2	2 4	> 4	> 12
28 DAY WET COMPRESSIVE STRENGTH	Rc 28 wet	MPa	0.1 0.5	> 1	> 2	> 6
28 DAY DRY TENSILE STRENGTH	Rt 28 dry	MPa	0.5 1	0.2 0.4	1 2	> 2
28 DAY DRY BENDING TEST	Rb 28 dry	MPa	0.5 1			
28 DAY DRY SHEAR TEST	Rs 28 dry	MPa	= 0.5			
POISSON'S RATIO	$\mu$				0.15 0.35	
YOUNG'S MODULUS	E	MPa			700 7,000	
APPARENT BULK DENSITY	$\rho$	kg/m <sup>3</sup>	1,700 2,200	1,700 2,200	1,700 2,200	> 2,200
UNIFORMITY OF DIMENSIONS			GOOD	GOOD	EXCELLENT	EXCELLENT

## THE COMPRESSED EARTH BLOCK

TECHNICAL PERFORMANCE OF COMPRESSED EARTH BLOCKS						
HYDROUS CHARACTERISTICS	SYMBOL	UNIT	COMPRESSED EARTH BLOCK TYPE			
			TYPE 1	TYPE 2	TYPE 3	TYPE 4
SWELL		mm/m				
POTENTIAL SHRINKAGE		mm/m				
SHRINKAGE DUE TO DRYING		mm/m	0.2 1		0.2 1	
PERMEABILITY		mm/m			1.10 E-5	
WATER ABSORPTION THROUGH THE SURFACE TO BE COATED		% (weight)				
TOTAL ABSORPTION		kg/m <sup>3</sup>			10 20	0 7.5
SENSITIVITY TO FROST			HIGH	MEDIUM	LOW	NO
SENSITIVITY TO EFFLORESCENCE			NO	LOW	LOW	VERY LOW
DURABILITY UPON EXPOSURE TO WEATHER			VERY LOW	LOW	GOOD	EXCELLENT

TECHNICAL PERFORMANCE OF COMPRESSED EARTH BLOCKS						
PHYSICAL CHARACTERISTICS	SYMBOL	UNIT	COMPRESSED EARTH BLOC TYPE			
			TYPE 1	TYPE 2	TYPE 3	TYPE 4
SPECIFIC HEAT	C	kJ/kg	= 0.85		0.65 0.85	
COEFFICIENT OF CONDUCTIVITY	$\lambda$	W/m °C	0.81 0.93	0.81 0.93	0.81 0.93	0.93 1.04
DAMPING COEFFICIENT (40 cm wall)	m	%	5 10	5 10	5 10	5 10
LAG TIME COEFFICIENT (40 cm wall)	d	h	10 12	10 12	10 12	10 12
COEFFICIENT OF ACOUSTIC ATTENUATION (40 cm wall to 500 Hz)		dB	50	50	50	50
COEFFICIENT OF ACOUSTIC ATTENUATION (20 cm wall to 500 Hz)		dB	40	40	40	40
FIRE RESISTANCE			GOOD	GOOD	GOOD	GOOD

**Note:** the absence of a value indicates that the information is unavailable, because this parameter is very sensitive to the type of clay used.



## **GENERAL SPECIFICATIONS**

Compressed earth blocks have traditionally not exceeded the following maximum dimensions:

- length : 40 cm (exceptionally 50)
- width : 20 cm (exceptionally 30)
- height : 10 cm (exceptionally 20)

The solid blocks most commonly used today have the following nominal moulding dimensions:

- length : 29.50 cm
- width : 14.00 cm
- height : 9.00 cm

These blocks are used here as a reference for the general specification.

### **Nominal dimensions**

- Length : 29.50 cm
- Width : 14.00 cm
- Height : 9.00 cm

### **Tolerance on dimensions**

- Length : + 1, -3 mm
- Width : + 1, -2 mm
- Height : + 2, -1 mm

### **Surface flatness**

- Sides: any deviation should not exceed 1 mm.
- Compression surfaces: any deviation should not exceed 3 mm.

### **Edge straightness**

- Any deviation should not exceed 2 mm.
- Some roughness of the edges is tolerated, as long as it is due to turning out and not due to faulty manipulation.

### **Roughness of external sides**

- External faces of the block which are to be rendered or faces which will not be visible within the masonry should preferably have a rough finish.
- External faces of the block which are not to be rendered should have a smooth finish.

### **Pitting, holes, punctures, scratches**

- For rough finish faces, these should not exceed 15% of the surface.
- For smooth finish faces, these should not exceed 1% of the surface.

### **Density**

- Dry:
  - minimum: 1,700 kg/m<sup>3</sup> or 6.319 kg/block;
  - recommended: 2,000 kg/m<sup>3</sup> or 7.434 kg/block.

## THE COMPRESSED EARTH BLOCK

- recommended: 2,000 kg/m<sup>3</sup> or 7.434 kg/block.  
— Freshly moulded:  
minimum: 1,870 kg/m<sup>3</sup> or 6.950 kg/block;  
recommended: 2,200 kg/m<sup>3</sup> or 8.177 kg/block.

### **Obliqueness of surfaces**

- The external faces, shape and size tolerances must be respected.
- The internal faces of voids must be oblique and should have no sharp edges.

### **Lamination, cleavages**

There are not tolerated on any surface.

### **Gaps, fissures, crazing, cracks**

- Micro-fissures:  
may be tolerated on all surfaces.
- Macro-fissures:  
are tolerated only on non-exposed surfaces;  
their width and depth may not exceed 1 mm;  
their length must not exceed 10 mm, and their total quantity must not exceed, on average, one gap per 10 cm of edge, that is to say 21 mm.

### **Chipped corners**

The width and depth of chipped corners must not exceed 10 mm.

### **Dry compressive strength**

For single or two-storey buildings, downward forces are about 0.1 to 0.2 MPa. There is therefore no point in employing materials capable of resisting a compression of 10 MPa or more. Nevertheless, a compression strength of 0.1 MPa is insufficient, because there are additional stresses or loads other than this single aspect of the performance of a solid compressed earth block and of a building constructed with this material. A fairly large safety factor is therefore accepted at present in most situations in which this type of material is employed. A compressive strength of 2.0 to 2.4 MPa thus offers a wide safety margin which is now specified in most of the proposed standards and in the recommendations currently in force.

In calculating a value of dry compressive strength generally considered satisfactory for solid compressed earth blocks, the following parameters are taken into account for single- or two-storey buildings:

- variations in the quality of production and of workmanship;
- accidental increase in overloads;
- the nature of the material, the strength of the mortar, the slenderness ratio of the wall and the way in which loads are placed on it;
- the ratio of dry to wet compressive strength.

The mean dry compressive strength of solid compressed earth blocks after curing for 28 days should be greater than 2.4 MPa, with no value less than 2.0 MPa. It should also be noted that a dry compressive strength of 1.5 MPa is sufficient for the block to withstand transport by wheelbarrow or lorry.

## THE COMPRESSED EARTH BLOCK

### **Wet compressive strength**

The mean wet compressive strength of solid compressed earth blocks after curing for 28 days (24 days + 4 days or 27 days + 1 day) should be greater than 1.2 MPa, with no value less than 1.0 MPa. The ratio of mean dry to mean wet compressive strength, both after 28 days, should be less than or equal to 2.

### **CONDITIONS OF USE**

The conditions of use of compressed earth blocks depend essentially on the following parameters (provided that they are used in accordance with accepted practice):

- climatic conditions;
- type of building;
- purpose of the building;
- design of the building (building and protection systems);
- technical performance of the compressed earth blocks.

The complexity of the interrelationships between these parameters prevents the compilation of a set of universally applicable technical specifications for the construction of buildings using compressed earth blocks. However, the preparation of this kind of document is recommended for each large project.

### **BUILDING DESIGN**

Architectural and design considerations will dictate the conditions of use of one or other type of CEB. A design which is suited to a given context (climate, skills, etc.) should enable optimum use to be made of compressed earth blocks, i.e. good quality results even with materials with technical performances regarded as low. Nevertheless, although architectural choices are undoubtedly the best "stabilizer", it can prove indispensable to also use other protection systems.

#### **Protection by treatment of the building**

Architectural design and building application: roof overhangs, verandahs, footings, etc.

#### **Protection by treatment of surfaces**

Use of coatings: thick plaster, cladding, paint, etc.

#### **Protection by treatment of the material**

Stabilization by additives in bulk material, by impregnation, or by thin film coatings.

A good design should take account of all the parameters of the context and respond to each in a specific manner.

## THE COMPRESSED EARTH BLOCK

### **TYPE OF BUILDINGS**

Buildings can essentially be divided into two types.

#### **Single-storey buildings**

Minimum load stresses, low aerodynamic effects, low surface area exposed to bad weather.

#### **Multi-storey buildings**

High load stresses, aerodynamic effects due to high exposure to wind, large surface area exposed to bad weather.

### **PURPOSE OF THE BUILDING**

Three types of use can essentially be defined.

#### **Individual use**

If the building is damaged, only one building, one family and one owner are involved. The damage, from the point of view of society in general, is limited and can be remedied on an individual basis.

#### **Collective use**

Collective buildings and large projects involving individual buildings are included under this heading. If a design error leads to substantial damage the effect will be multiplied over a large number of buildings. Choices must thus be much more securely founded than in the first case.

#### **Public use**

This might involve small or large buildings belonging to local regional or national authorities. In all cases utilization is intensive and the psychological influence as an example is very important. Every possible precaution must therefore be taken to ensure that the buildings (schools, health centres, administrative offices, etc.) remain in the best possible condition over time.

## THE COMPRESSED EARTH BLOCK

### CLIMATIC CONDITIONS

The ACP countries are located in regions characterized by three main types of climate.

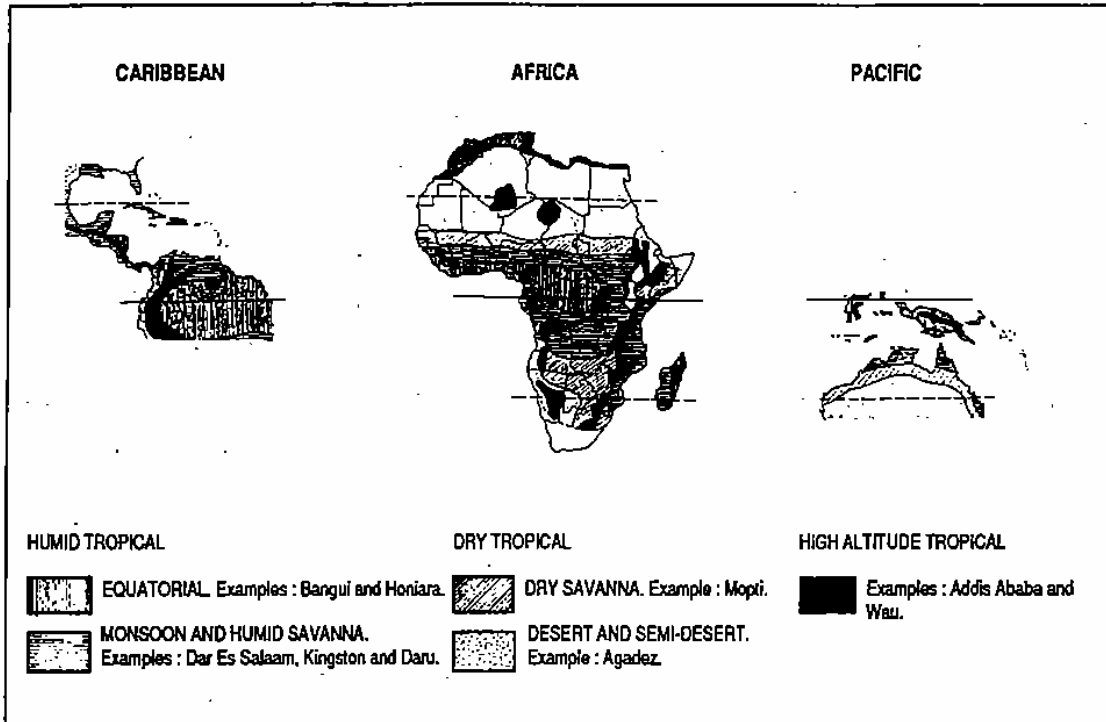

## THE COMPRESSED EARTH BLOCK

The minimum-standard block recommended for a given application is shown in the following table. The general indication of the recommended type of block is not absolute, and must be considered in the light of local conditions. It is important to note that where a precise indication (e.g. type 2) is shown for a given parameter, it refers to the general external walls of the building. There is nothing to prevent the use of other types of blocks in particular parts of the building (e.g. type 1 blocks for interior walls and type 3 blocks for the substructure).

<b>CONDITIONS OF USE OF COMPRESSED EARTH BLOCKS</b>					
DESIGN AND BUILDING PROTECTION SYSTEMS	TYPE OF BUILDING	PURPOSE OF THE BUILDING	CLIMATIC CONDITIONS		
			TROPICAL HUMID	TROPICAL DRY	TROPICAL ALTITUDE
			BLOCK TYPE	BLOCK TYPE	BLOCK TYPE
GOOD DESIGN WITH NO PARTICULAR RISK (OF EROSION, LOADS, ETC.)	SINGLE-STOREY	INDIVIDUAL	2	1	1
		COLLECTIVE	3	1	1
		PUBLIC	3	2	2
	MULTI-STOREY	INDIVIDUAL	3	1	2
		COLLECTIVE	3	2	2
		PUBLIC	3	3	3
GOOD DESIGN WITH RISK OF EROSION TO THE WALLS (RAIN, WIND, IMPACT, ETC.)	SINGLE-STOREY	INDIVIDUAL	1	1	1
		COLLECTIVE	2	1	2
		PUBLIC	2	1	2
	MULTI-STOREY	INDIVIDUAL	3	1	2
		COLLECTIVE	3	2	2
		PUBLIC	3	3	3
GOOD DESIGN WITH SIGNIFICANT LOADS AND POSSIBLE RISK OF EROSION	SINGLE-STOREY	INDIVIDUAL	3	2	2
		COLLECTIVE	3	2	3
		PUBLIC	3	3	3
	MULTI-STOREY	INDIVIDUAL	3	2	3
		COLLECTIVE	3	3	3
		PUBLIC	3	3	3

For further details, see "Technical Performance" and "Current Norms".

## **CURRENT NORMS**

### **NORMATIVE DOCUMENTS**

Generally speaking, a normative document is a document containing regulations, guidelines or characteristics for certain activities or their results.

#### **Form**

Normative documents can take several forms:

- standard;
- technical specification;
- code of practice;
- regulation;
- recommendation;
- requirement;
- specifications.

#### **Nature**

The obligation to comply with normative documents varies according to their nature which may be:

- professional: accepted by consensus within the profession;
- legal: having been formally sanctioned by the law;
- proposed: having been through the acceptance procedure of a legal committee, but awaiting formal legal sanction.

#### **Subject**

Normative documents can have the following subjects:

- terminology;
- product;
- manufacture;
- utilization;
- tests.

With regard to compressed earth blocks, the oldest normative documents for ACP countries date back to the fifties. More recently, and especially since the end of the eighties, much effort has been spent on this aspect and many countries now have normative documents.

THE COMPRESSED EARTH BLOCK

COUNTRY ACP-EU	SUBJECT				
	TERMINOLOGY	PRODUCT	MANUFACTURE	UTILIZATION	TESTS
CAMEROON	DRAFT STANDARDS	DRAFT STANDARDS	DRAFT RECOMMENDATIONS	DRAFT RECOMMENDATIONS	DRAFT STANDARDS
CHAD		PROFESSIONAL RECOMMENDATIONS	PROFESSIONAL RECOMMENDATIONS	PROFESSIONAL RECOMMENDATIONS	
CÔTE D'IVOIRE		DRAFT STANDARDS	PROFESSIONAL RECOMMENDATIONS	PROFESSIONAL RECOMMENDATIONS	DRAFT STANDARDS
ETHIOPIA					CODES OF PRACTICE
FRANCE			PROFESSIONAL RECOMMENDATIONS	PROFESSIONAL RECOMMENDATIONS	
GHANA		DRAFT STANDARDS	DRAFT STANDARDS		
KENYA		LEGAL NORMS		LEGAL NORMS	LEGAL NORMS
MADAGASCAR			PROFESSIONAL SPECIFICATIONS	PROFESSIONAL SPECIFICATIONS	PROFESSIONAL SPECIFICATIONS
MAUI		PROFESSIONAL REQUIREMENT	PROFESSIONAL RECOMMENDATIONS		
NIGERIA					PROFESSIONAL RECOMMENDATIONS
TOGO	LEGAL NORMS	LEGAL NORMS	PROFESSIONAL RECOMMENDATIONS	PROFESSIONAL RECOMMENDATIONS	LEGAL NORMS
ZIMBABWE				LEGAL NORMS	



THE COMPRESSED EARTH BLOCK

**EXAMPLES OF COMPRESSED EARTH BLOCK BUILDINGS**

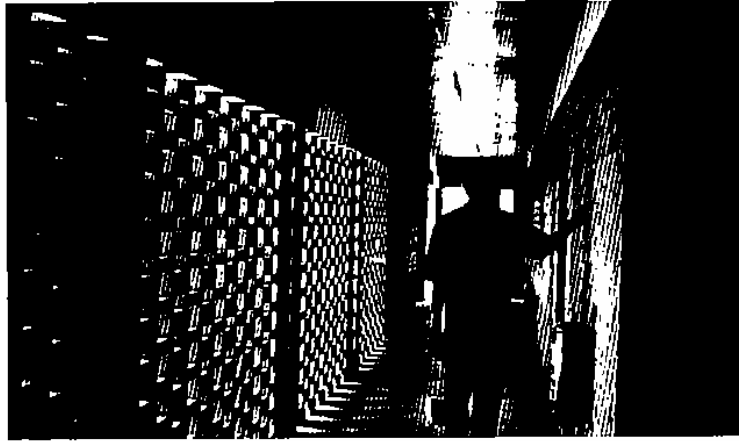

*1. Training centre, Burkina Faso.*

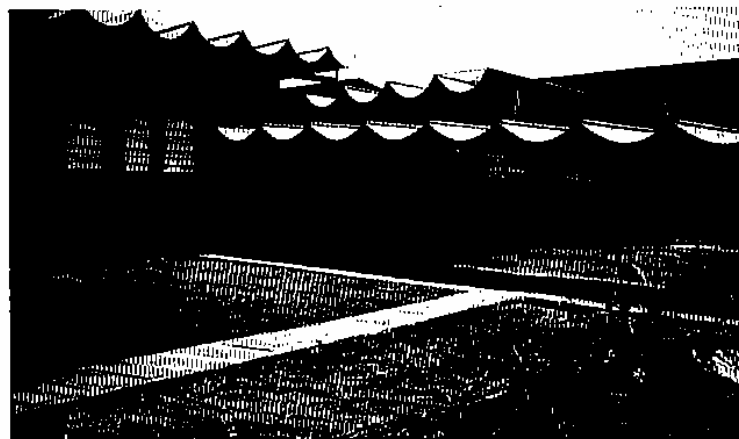

*2. Crèche, Abidjan, Côte d'Ivoire.*



*3. Private home, Jos, Nigeria.*

THE COMPRESSED EARTH BLOCK

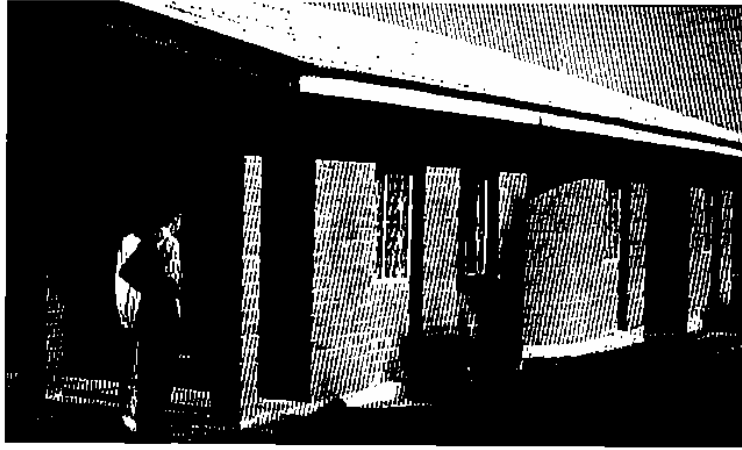

4. Private home, Jos, Nigeria.



5. Tourism building, Côte d'Ivoire.



6. Individual house, Douala, Cameroon.

THE COMPRESSED EARTH BLOCK



*7. External gallery of house, Douala, Cameroon.*



*8. Multi-storey rented housing, Cavani, Mayotte.*



*9. Rented villa, Mayotte, of local inspiration. Built by SIM.*

THE COMPRESSED EARTH BLOCK



10. *Mayotte airport.*



11. *Rented housing estate, Mayotte.*



12. *Social centre, Oura-Sagui, Senegal.*

THE COMPRESSED EARTH BLOCK

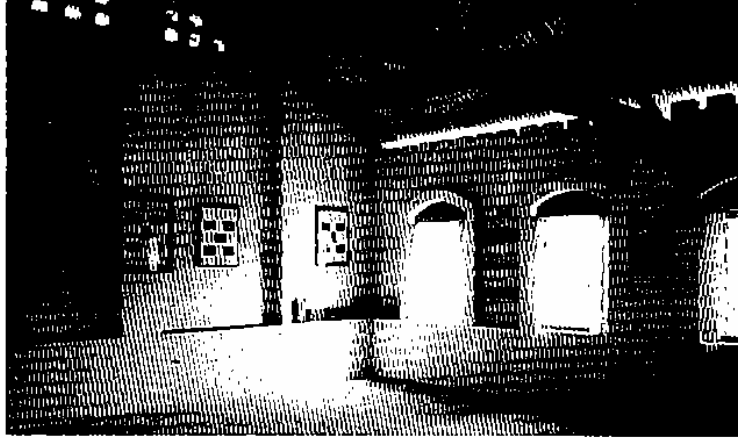

13. School, Kinshasa, Zaire.

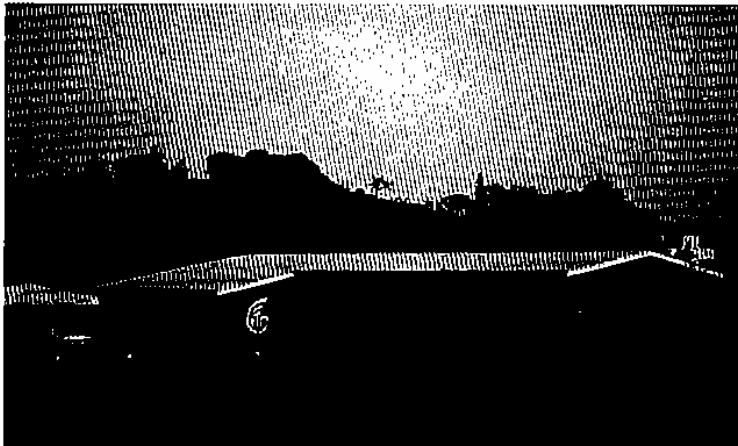

14. Centre for French teaching and documentation, Jos, Nigeria.



15. Tourist office, Mayotte.

THE COMPRESSED EARTH BLOCK

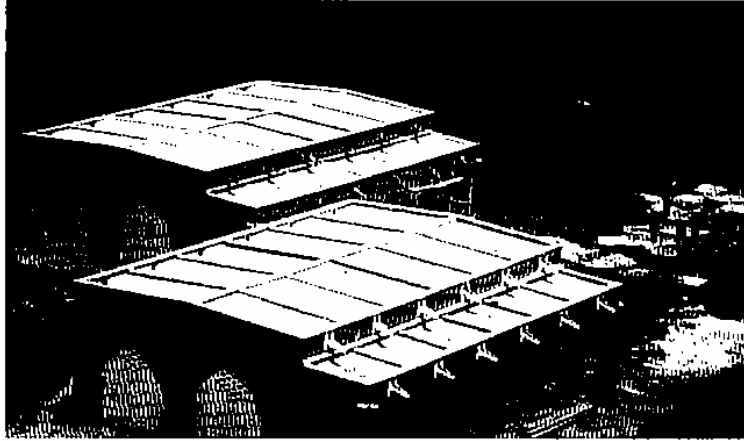

16. Schools, Jenaale, Somalia.



17. Earth housing estate "Domaine de la terre", L'Isle d'Abeau, France.

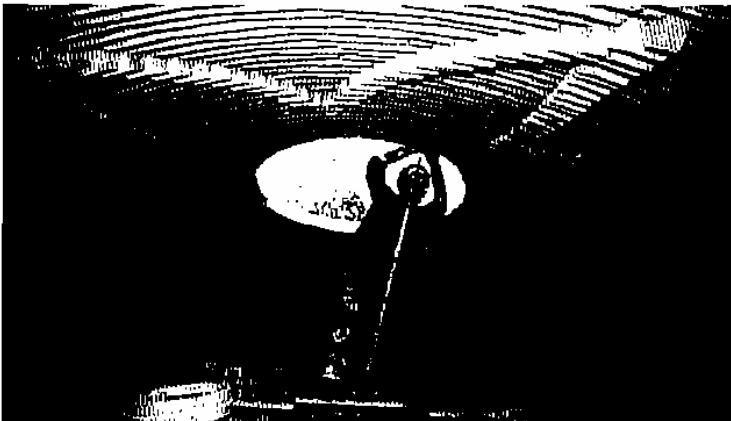

18. Villa, Corsica, France.

THE COMPRESSED EARTH BLOCK



19. Interior of the "24-hour house", Grenoble, France.



20. Earth housing estate "Domaine de la terre", L'Isle d'Abeau, France.



21. Extension of the abbey of Thoronet, France.





# 3. THE TECHNOLOGY OF PRODUCTION

## PRODUCTION CYCLE

Here we describe the production of cement or lime-stabilized compressed earth blocks on the craft scale, using presses of all kinds with the exception of industrialized production units.

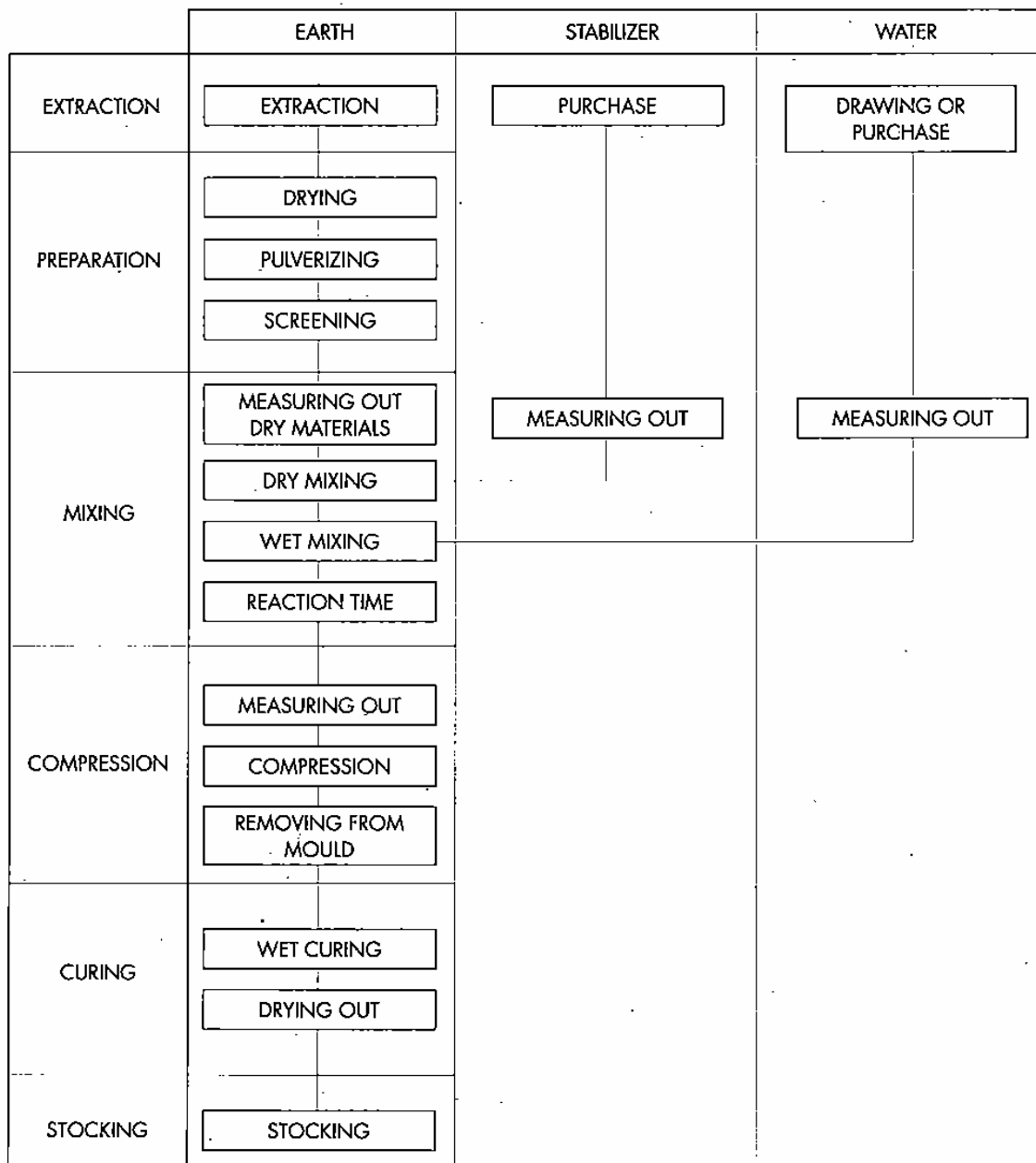

## THE TECHNOLOGY OF PRODUCTION

- EXTRACTION from the quarry or pit.
- DRYING by spreading in thin layers or passing through a hot-air cyclone.
- PULVERIZING to break up lumps of clay.
- SCREENING to eliminate undesirable elements after general preparation.
- MEASURING OUT the dry soil by weight or by volume with a view to mixing it with water and/or with stabilizer.
- DRY MIXING to maximize the effectiveness of a stabilizer in powder form.
- WET MIXING to add water by spraying after adequate dry mixing, or directly in the form of a liquid stabilizer.
- REACTION during variable hold-back time depending on the nature of the stabilizer; very short for cement, longer for lime.
- MEASURING OUT the amount of mixed material for optimum block density.
- COMPRESSION of the mixed material.
- REMOVING the block from the mould.
- WET CURING, the length of time depending on the climate and the nature of the stabilizer.
- DRYING OUT which should enable the quality required to be achieved.
- STOCKING of the products ready for use.

## **THE RAW MATERIAL: SOIL**

### **GENERAL OBSERVATIONS**

At the surface of the solid part of the planet's crust (land), soil forms a layer of loose material, varying in thickness, which supports living creatures and their structures and plant life. Soil is formed from bed-rock as a result of very long processes of weathering and the very complex manner in which particles migrate. These result in an infinite number of types of soil, with infinite variations in characteristics. Topsoil or agricultural soil, which contains a high proportion of organic matter, forms a layer above the bed-rock, which may be more or less weathered. It cannot be used for the production of compressed earth blocks. When the upper layers of earth are made up of loose material and contain little organic matter, they can be used for the manufacture of CEBs.

### **COMPOSITION**

Soils are made up of varying proportions of four types of material: gravels, sands, silts and clays. Each of these behaves in a characteristic way and, for example, when exposed to variations in humidity, some will change in volume, others will not.

The first two of these types of material are stable, the other two unstable. This notion of stability, i.e. the ability to withstand alternate humidity and dryness without its properties changing, is of fundamental importance in a building material.

### **EXPLOITATION**

Usable layers or deposits of soil are rarely found at the surface of the ground (except in arid areas), because here soils contain too much organic matter. The depth of this organic topsoil rarely exceeds a few tens of centimetres. Usable soil below this organic topsoil is rarely found at great depths, where there are too many stones, or even solid rock. The thickness of the usable layer of soil varies greatly, from a few centimetres to several metres.

### **PRELIMINARY INVESTIGATION**

Existing data should preferably be gathered before starting work on site. These might include maps or descriptions emanating from geological, pedological, topographical or agronomic surveys or from roadworks. It is often very useful to question the people living in the area as they may be able to supply conclusive information, particularly if earth is being used for building in the locality, suggesting that there are deposits being exploited. Very often soil suitable for building is covered by a layer of topsoil; one must therefore avoid precipitate and unchecked sampling and remember that the topsoil, which is unsuitable for building purposes, is often the local farmers' only means of subsistence.

### **SOIL MECHANICS**

As we have already seen, soil is made up of inert materials (gravels and sands) and active materials (silts and clays). The former act like a skeleton and the latter like a binding agent, similar to a cement. The structure of a soil is thus comparable to that of concrete with a different binding agent. The proportion in which each type of material is present will determine the behaviour and properties of different soils.

## THE TECHNOLOGY OF PRODUCTION

The following curve gives an approximate indication of the types of soil which are recommended for the manufacture of compressed earth blocks. As can be seen, the proportions of each type of material can vary considerably depending on the qualities of each, which differ quite widely, particularly for clays. Knowing the proportions of each, as shown on a particle size distribution curve, is an important indicator but is rarely enough for soil selection purposes.

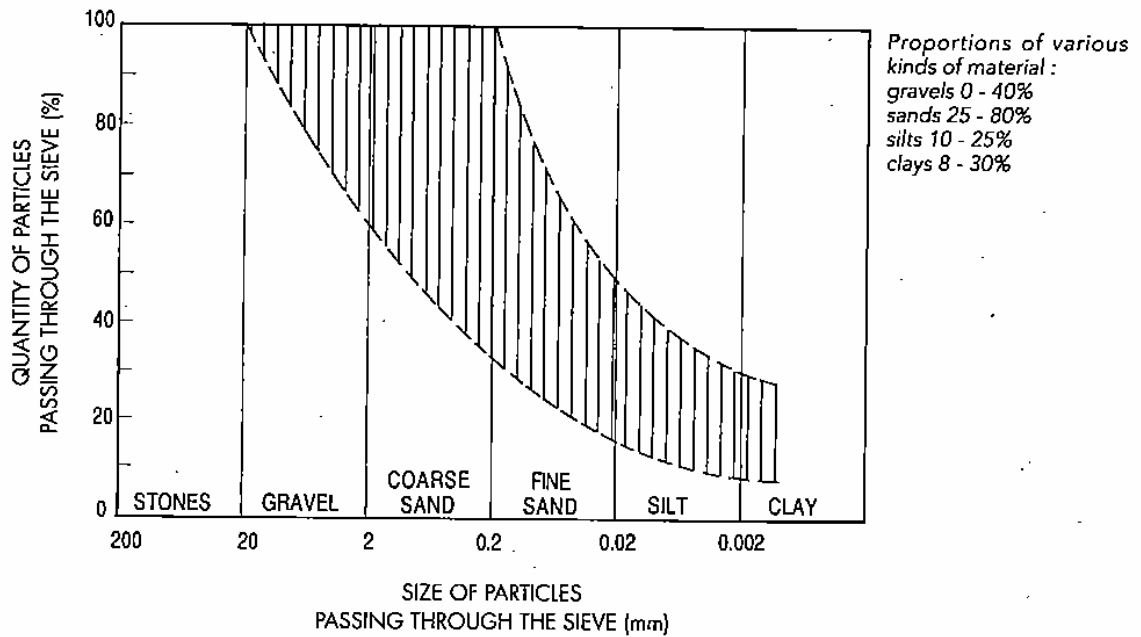

It is generally accepted that many soils which fall outside the recommended areas can still give acceptable results in practice. On the other hand, soils which do conform will in most cases give good results. The shaded areas are guidelines for the user and not specifications to be rigidly applied. In particular, it should be mentioned that in certain cases soils containing up to 70% clay have given totally satisfactory results.

## **STABILIZATION**

### **GENERAL CONSIDERATIONS**

#### **Definition**

A soil is stabilized to lend it properties which are irreversible in the face of physical constraints. A great many factors must be taken into account, among them the design of the building, the quality of the materials used, economic aspects of the project and issues of durability. For stabilization to be successful, the process used must be compatible with these various imperatives.

#### **Processes**

Two processes can be used to stabilize compressed earth blocks.

- Physical stabilization: the properties of a soil can be modified by treating its texture using a controlled mix of the various particle fractions.
- Chemical stabilization: other materials or chemical products are added to the soil and modify its properties.

#### **When to stabilize**

There is a tendency at present to stabilize systematically, but stabilization is not obligatory. One can manage very well without and build with earth successfully without stabilizing. Stabilization can entail a significant additional cost of between 30% and 50% of the cost price of the material.

- Do not stabilize material which is not going to be exposed to water: protected walls, rendered walls, internal walls which have been designed well, following the logic of earth as a building material.
- Do stabilize when the material is going to be exposed, because of poor design which fails to take account of the fundamental principles of building with earth, or location constraints such as a damp site or walls exposed to driving rain.

#### **Stabilizers**

There are more than a hundred products in use today for the stabilization of soil for building. These stabilizers can be used both in the body of the walls and in their outer skin (in renders, for example). The two main stabilizers are cement and lime.

### **CEMENT STABILIZATION**

#### **General observations**

Cement is probably one of the best stabilizers for CEBs. Adding cement before compression improves the characteristics of the material, and particularly its resistance to water, thanks to the irreversible nature of the bonds it creates between the largest particles. Cement mainly affects sands and gravels, as it does in concrete or in a sand-cement mortar. This means that it is not necessary, and indeed may be harmful, to use soils which have too high a clay content (> 30%). Its use does not require too much water given the humid compression state of CEBs.

## THE TECHNOLOGY OF PRODUCTION

### **Efficiency and how much to use**

In general, at least 5 to 6% cement will be needed to obtain satisfactory results. Compressive strength is highly dependent on the amount used. With low proportions (2 to 3%) certain soils perform less well than when left unstabilized. 8% cement usually is considered as an economically acceptable upper limit.

### **Efficiency parameters**

Soil: the best results are obtained with sandy soils. The presence of iron oxides has been observed to allow stabilization to occur efficiently with little cement, as a result of pozzolanic reactions or hardening effects. This applies specifically to lateritic soils.

Organic matter: the presence of organic matter presents a risk.

Water: water containing salts must in all cases be avoided.

Sulphates: these are very harmful.

## **LIME STABILIZATION**

### **General observations**

Non-hydraulic lime (quicklime or slaked lime) is commonly used as a stabilizer for clayey soils. Lime will above all form bonds with the clays present, and hardly at all with the sands. It should be considered only if cement stabilization is impossible. Hydraulic limes resemble cement.

### **Efficiency and how much to use**

Adding 2 to 3% lime immediately provokes a lowering of the plasticity of the soil and fragments lumps. For ordinary stabilization purposes, the amounts generally used range from 6 to 12%. It should be noted that in the case of lime, there is an optimum quantity to be used for each type of soil.

### **Efficiency parameters**

Soil: the best results are obtained with clayey soils (30 to 40% and even 70%).

Organic matter: this slightly reduces the stabilizing effects, but lime can be capable of neutralizing some of the organic matter present.

Sulphates: these are harmful and to be avoided.

## **PRODUCTION EQUIPMENT**

### **GENERAL CRITERIA**

The following list enumerates the essential points to which the manufacturer should be able to reply when consulted. Certain criteria are more elaborate than others, because they are particularly sensitive or generally insufficiently taken into account.

#### **Manufacturer's references**

The market for production equipment is constantly evolving and it is not therefore unusual to find a manufacturer's or a retailer's address changing fairly frequently. Address details do not therefore always allow one to evaluate a manufacturer's past. As far as possible, arrange to visit the manufacturer. The manufacturer's reference details (name, address, telephone, telex, machine name, serial number, etc.) and the exact name of the machine should be engraved on a metallic plate riveted onto the machine.

#### **Identification of the manufacturer**

It is important to know what type of manufacturer one is dealing with. The manufacturer should therefore be asked to specify the following points:

- the company's history;
- statutes;
- business capital;
- professional qualification certificate;
- number of employees in each department;
- manufacturer's own technical capacities;
- associates;
- subcontractors;
- sales staff;
- distributors.

#### **References**

It is important to be aware of the stage of development of the proposed machine and to make enquiries amongst those clients who already use it. The manufacturer should therefore be asked to specify the following points:

- number of machines produced;
- number sold;
- number in operation;
- number on order or with confirmed options to buy;
- clients' references.

It is useful to find out if the manufacturer keeps up links with clients, because client feedback enables machine design to be continually improved in the light of practical experience of its use.

#### **Denomination of the machine**

One sometimes finds machines on the market that are very similar but differ in designation either within the range of one manufacturer's products or from one manufacturer to another. In the first instance, the different denominations correspond to the same machine, but at different periods of manufacture. In the second case, they are more or less accurate copies (as regards

## THE TECHNOLOGY OF PRODUCTION

quality of materials, tolerances of dimensions, reliability, etc.) of a machine that was or is commercially successful or even, in some cases, of a machine that has been a total failure. They could also be being manufactured under licence. A distinction should therefore be made between a machine's:

- exact denomination;
- common denomination;
- commercial denomination.

### **Historical development of the machine**

If the manufacturer cites a patent, one should not confuse "patent" with "patent pending". A patent is not necessarily a guarantee of quality. Manufacturers frequently apply for patents for processes that are already in the public domain, and such applications are not always rejected by the patent-awarding bodies. One runs the risk of paying for the right to exploit a meaningless patent.

### **Presentation of the machine**

One must obtain from the supplier a brief description of the machines, if applicable, and of how they operate. Photos taken from every angle are necessary, on the one hand to ensure that the machine really exists, and on the other to complement the salesman's presentation of the machine.

### **Degree of integration**

In the case of mobile and fixed production units, which have integrated devices for the preparation of the earth and/or the evacuation of the products, one should verify if the production unit provides for simultaneous or alternate (only one action at a time) operation and whether the capacities of the various component devices (sieve, conveyor belt, mixer, hopper, etc.) are correctly matched to follow the basic rules of production (supplying, correct proportioning, mixing time, etc.).

### **Degree of automation**

Certain machines can automatically carry out all or part of the production process. In general, it is the filling, compression and turning out cycles which are automated. It is useful to be able to unhitch the automation management system in order to be able to carry out running checks and make adjustments. Preferably, the automation management system should enable one to adjust the rate of production. The reliability of mechanical or electronic control systems should be checked. The automation management system should preferably be protected by a sealed box. In regions prone to sand-storms or very high rates of relative humidity, the use of simple electric circuits should be avoided. One should bear in mind that sophisticated control systems demand specific maintenance and repair skills, or may need to be replaced entirely if they fail. Complete automation from feeding in the raw materials to palletization and removal of the product is feasible, but requires very high investment and will demand maintenance standards which are unusual in the profession.

### **Options**

One should request descriptions of the available options, their performance, cost and the compatibility of these various options in relation to one another and in relation to the existing equipment.



## THE TECHNOLOGY OF PRODUCTION

### **Mobility**

Machines can be fitted with wheels and moved by hand or loaded onto an independent chassis which is pulled by a vehicle capable of pulling the weight. The independent chassis therefore implies that the machine can be transported from one site to another, but cannot be moved instantly from one end of the site to another. Large diameter wheels fitted with pneumatic tyres are more efficient for road transport than small non-pneumatic wheels, which are adequate for movement within the production area.

### **Working dimensions**

This criterion greatly affects the organization of the production area.

### **Transportation dimensions**

This criterion greatly affects the cost of transportation of the machine.

### **Net weight**

A particularly heavy machine will not be able to be moved, even a few metres, without recourse to a suitable lifting mechanism.

### **Packaged weight**

This criterion greatly influences the cost of transportation of the machine.

### **Working conditions**

Particular attention must be paid to these, especially to manufacturing and handling operations which should not require too arduous manual labour, nor particularly tiring positions. Installing a structure to protect the equipment and workers from the elements (sun, rain, wind, etc.) can also be considered.

### **Number of workers needed around the machine**

This figure must be the result of experience acquired in the field and not just a theoretical value based on the degree of the automation of the machine. One should distinguish between the personnel needed to operate and maintain the machine, and those responsible for handling raw materials and finished products. The level of qualification must be determined for all the personnel.

### **Security devices**

Special attention must be given to ergonomic utilization, to the passive safety of the workers and to the immediate surroundings as well as to the safety mechanisms of the machine itself (thermal fuses, security pins, circuit-breakers, etc.). The machine must without fail be equipped with an emergency stop switch which is readily accessible. Sensitive mechanical parts (motors, electronic modules, etc.) should be adequately protected from the risk of jolts, such as blows with a shovel, from water and from dust.

## THE TECHNOLOGY OF PRODUCTION

### **Price**

Beware speculation. Certain machines are sold at several times their price - up to ten times as much, depending upon the retailer. Some cost more than others which perform just as well, and some cost the same but perform much worse. It is vital to amortize the purchase price in the production budget. The manufacturer must be asked to detail every item and not rely on formulae such as "inclusive" etc., so that tenders may be compared fairly.

In order to reduce legal argument, the International Chamber of Commerce has adopted the INCOTERMS system, (a contraction of INternational COMmercial TERMS). The objective of these is to define a series of rules specifying the interpretation of the main terms used in international sales contracts. These number thirteen and give a standardized definition of the rights and obligations of the parties as soon as they use these acronyms or abbreviations. They qualify a sales price and specify the reciprocal obligations of the buyer and the seller with regard to despatch, transport, customs and delivery, etc.

Some common INCOTERMS:

- The EXW price should include the unit cost excluding tax as well as the quantities and cost of packaging. Together, these represent an ex-works price, i.e. as the goods leave the factory.
- The FOB price should include transport expenses from the factory to the embarkation quay, transit and customs expenses, and loading expenses. Costs incurred specifically in evaluating the implementation of the project may be included in this "Free on Board" price.
- The CIF price means that the loading, freight and insurance are paid for by the seller up to the port of destination or the agreed site. It stands for "Cost, Insurance, Freight".

FOB or CIF prices can sometimes be artificially raised to compensate for discounts given on EXW prices. These increases are often found under headings such as packaging, containerization, transport to the departure point, etc.

### **Expenses**

Banking charges (such as letters of credit, exchange or transfer commissions) and charges incurred by intermediaries must be taken into account. It should be stated whether responsibility for these lies with the seller or the buyer. A letter of credit accepted by the seller, who then has to submit an invoice, will cost approximately 5% of the CIF price. In addition, a letter of credit taken out by the buyer will cost him approximately 5 to 7%. Letters of credit for "sensitive" countries can cost up to 14%. Any intermediaries used to transfer a letter of credit from the buyer to the seller will ask for a minimum of 10 to 12%. They will also require a commission of at least 15%. All this can increase the CIF price by 25 to 30%.

### **Sales or rental conditions**

One should check the validity of contracts indexed to the quantity of products produced or involving the payment of royalties for the right to exploit a (possibly meaningless) patent.

### **Delivery deadlines**

The contract must provide for a penalty clause if delivery deadlines are not met.

## THE TECHNOLOGY OF PRODUCTION

### **Conformity certificates**

Certificates stating the conformity of the equipment to the norms applicable in the country where the machine will be operating must be requested.

### **Operating manual**

This must be delivered with the machine and fully explain its operation, adjustments required for production and general maintenance procedures. It does not replace the technical manual intended for major maintenance and machine repairs.

### **Installation contract**

Fixed production units must be installed on the production site, by competent technicians who will also be responsible for making the adjustments necessary for effective production. Some manufacturers suggest installation plans for the production lay-out which suit the features of the machine (feeding, emptying and product storage). In addition, the installation technicians should be able to demonstrate methods of earth selection, choice of stabilizer, mixing methods, block production and curing.

### **After-sales service contract**

The after-sales service contract must clearly stipulate the period within which service will be provided.

### **Guarantee**

As far as the guarantee is concerned, its scope, duration (generally one year) and application should be specified. Checking it with regard to parts (defective steel, motors, etc. ), labour (poor assembly, failed welds, etc.) and design is recommended. Parts which have been replaced or reconditioned should have a minimum guarantee.

### **Maintenance**

Particular attention must be paid to this criterion. One must request a maintenance schedule (what procedures and how frequently) and a sufficiently detailed technical manual. This must contain all the diagrams (hydraulic, electric, electronic, etc.) needed to give a good understanding of the working of the machine in order to diagnose the cause of breakdowns, and a list of spare parts with their exact origins and references.

### **Training contract**

Training may relate to the operation of the machine, the maintenance and repair of the machine, the production technique or even building with earth as a whole. The objectives of this training, as well as the type of personnel expected to receive it, must be clearly defined.

### **Feasibility study**

Some manufacturers offer to carry out feasibility studies for their potential clients on compressed earth blocks production or even building construction using these materials. It is preferable to commission such studies from competent and objective professionals rather than from manufacturers.

## THE TECHNOLOGY OF PRODUCTION

### **Suitability of equipment**

Equipment specifically for the production of compressed earth blocks has only recently become available. But one should be aware that a range of equipment used in the ceramic industries, in public works and in agriculture may be suitable for use with compressed earth blocks. These items should however be analyzed carefully in the light of the technical criteria detailed below. The similarities and the differences which exist between the production of compressed earth blocks and their original function should also be kept in mind, so that any necessary modifications can be made. It should be noted, for example, that the stresses placed on machines used in the ceramics industry are often much less than those encountered in the production of CEBs.

## **PULVERIZERS**

### **KEY ISSUES**

The mix of mineral constituents, of water and of stabilizer, must be homogenous. From this point of view, a much better quality mix will be achieved with small diameter particles (< 5 mm) than with coarse particles (lumps, nodules, pebbles). If the soil is full of lumps or coarse nodules during compression, these elements will invariably form weak spots within the block.

### **TPOLOGY**

Pulverizers can be sub-divided into two families.

#### **Crushers**

These enable conglomerate particles (bonded by clay) to be broken down, but leave homogenous particles (stones, gravel) intact. They do not modify the particle size distribution of the soil.

#### **Jaw crushers**

This type of pulverizer comes with one or two motorized or manual jaws, fitted with a simple reciprocating motion mechanism. The double jaw motorized systems may be able to fragment stones, in which case they are regarded as grinders, but are heavy and expensive. Manual systems are best suited to fine, dry soils.

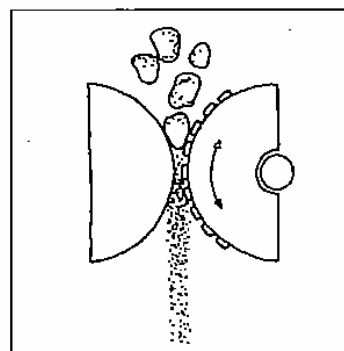

#### **Squirrel cage crushers**

These are motorized and consist of one or two "squirrel cages" with metal bars, turning at high speed in opposite directions close to one another. This type of pulverizer is better suited to fine soils, but may also work with moist soil.

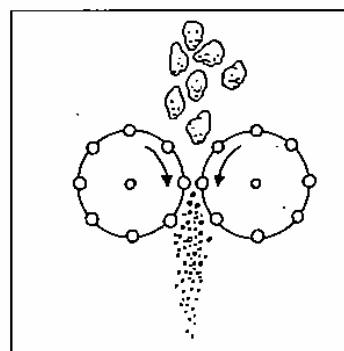

## THE TECHNOLOGY OF PRODUCTION

### **Grinders**

These will break down both conglomerate particles and homogenous particles and will therefore modify the grain size distribution of the soil to varying degrees, depending as much on the type of soil as on the equipment.

### **Propeller grinders**

These are motorized and similar to compost shredding machines. If the soil contains too much gravel, the propellers will rapidly wear. They are best suited to dry soils. The propellers may be placed either vertically or horizontally.

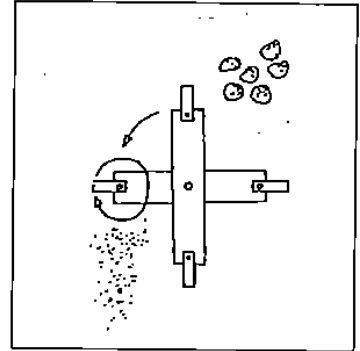

### **Cutter or hammer grinders**

These are motorized and consist of steel blades swinging around an axis which in turn rotates around a main central axis. The thickness of the blades can vary from 1 to 5 or 10 cm, and the thicker type of blade may be a solid mass of metal weighing several kilos. This is the main difference between cutter grinders and hammer grinders. They are suitable for gravelly and dry soils. The extent of grinding will depend on the power and speed of the motor.

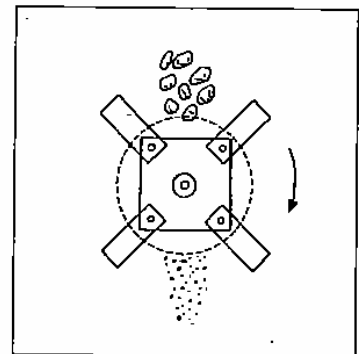

## **TECHNICAL CRITERIA**

### **Texture and grain size distribution of the soil**

Pulverizers should enable one to obtain a soil within which at least 50% of the conglomerate particles (held together by clay) are less than 5 mm in diameter. As we have already seen, pulverizers may or may not modify the grain size distribution of the soil. Choosing between the various types will of course depend on the type of soil to be processed, the budgets available, outputs and organization methods (e.g. the particle diameters can be reduced by crushing and/or screening). Certain pulverizers can also be fitted with a sieving system which enables the coarser elements to be removed and in some cases recycled.

### **Moisture content of the soil**

For stabilized compressed earth blocks, it is better to use dry soil, since the mixing of mineral components and stabilizer must without fail be carried out in dry conditions to ensure good ho-

## THE TECHNOLOGY OF PRODUCTION

mogeneity. However, certain climatic conditions can necessitate the use of wet soil which has been thoroughly loosened by pulverization, which also helps to dry out before mixing.

Motorized squirrel cage crushers can be used to process wet soil, provided it has a fine texture. Cutter or propeller grinders fitted with powerful motors can also be used with wet soil but this runs the risk of jamming the machine as a result of the build-up of a crust of earth which the humidity has made sticky. Fast-spinning blades will minimize this problem, but nevertheless the cutters or propellers will wear rapidly as they rub against the crust of soil building up within the drum.

### **Feeding and delivery**

The height of the feed hopper should not be too great, to make loading easier. It can also be useful if the pulverized soil is delivered at such a height as to allow direct feeding of a wheelbarrow or a conveyor belt. For safety reasons, the feeding device of the pulverizer should be fitted with a system to prevent backing up and dust build-up. It should also be equipped with a sifting grill to avoid too many coarse elements passing through into the pulverizing system. The delivery device of the pulverizer should be fitted with a safety system to prevent stones being projected large distances, and also a dust protection system.

### **Power**

Pulverization is an operation which requires a great deal of power. It is therefore important that the machines should be equipped with very powerful motors and this is all the more the case is they are to be intensively used.

### **Transmission**

Pulverization is not a smooth continuous operation like mixing. The operation is very jerky, and subjects the soil being pulverized to large acceleration forces. As the motor is turning continuously, it is important that a very flexible transmission system be fitted. Belt drive is preferable, or, failing that, the motor should be equipped with a very efficient system of protection.

### **Wear and tear and maintenance**

Any parts which are in contact with the soil, including the drum, should be made out of special abrasion resistant steels; so should the moving parts which should also be very easily replaceable given their rapid wear and tear. Depending on the precise way the machine is used, these parts will only be able to withstand a few hours' operation if they are unsuited to the nature of the soil. In this case, parts manufactured from special alloys of exceptional hardness, but with a core which remains relatively flexible to avoid brittleness, will be needed. The fixing system should be designed in such a way that it will not be affected by abrasion at all. The design should allow for the elements in contact with the soil to be able to withstand very violent blows without damage. All the bearings, motors and other sensitive parts should be well-protected from dust. Pulverizers, whatever their type, should be designed so that if necessary the interior space (drum) can be cleaned easily, as this can become coated with a crust of wet, compacted soil.

### **Mobility**

Pulverizers should preferably be easy to move around the production area in order to be able to adapt to the volume of earth, raw or prepared.

## SCREENS

### KEY ISSUES

Screening is indispensable either when the earth has texture defects (too many large particles or too much organic content) or when the pulverization is imperfect. The most appropriate particle size depends upon the construction technique intended and the specific nature of the construction project.

### TPOLOGY

The most frequently used screening system is manual and consists of a metallic mesh fixed to a rigid frame of wood or metal. This frame is either fixed at an angle by rigid legs, or suspended almost horizontally from a superstructure. Loading is often manual, but a mechanical loader can also be used. This kind of screen is easy to make, and there are no specialized manufacturers. Most of the screens available on the market are part of soil preparation systems or production units or factories, which explains the difficulty in finding this kind of equipment. Here we consider screens which are available on the open market, most of which are not necessarily specific to the production of compressed earth blocks, but rather are derived from public works applications, for which it is often necessary to grade material into several particle sizes, an operation which is rarely of any use in the production of compressed earth blocks.

#### Rotating screens

These consist of a metal or wire netting cylinder, rotated by hand or by motor, and are simple to make. Soil can be screened successively through screens of different sizes. The resulting fractions can then be mixed back together in the required proportions.

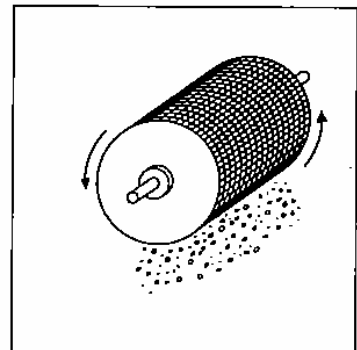

#### Vibrating screens

These are motorized and consist of a single vibrating screen or a combination of several screens, usually fitted one above the other. Successive sifting is possible to divide the soil into several fractions prior to mixing in the proportions needed. Vibrating screens are generally intended for large production units. These machines are generally complex, heavy and consume a lot of energy.

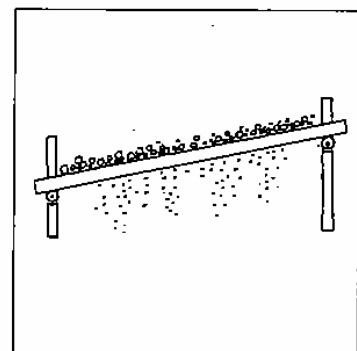



## THE TECHNOLOGY OF PRODUCTION

### **TECHNICAL CRITERIA**

#### **Soil particle size distribution**

For compressed earth block production, the fraction of the soil of less than 15 or 20 mm in diameter, and sometimes even less than 5 mm, is used, depending on the technical specifications of the press, which determine those of the finished products. 5 mm for presses which are sensitive to compression and for hollow blocks with relatively thin sides (30 to 50 mm); 15 to 20 mm for presses less sensitive to compression (hypercompression) and intended for the manufacture of solid blocks. For any given soil, the most efficient systems are those which reject the minimum amount on screening.

#### **Moisture content of the soil**

The systems which perform best enable soil to be sifted in a dry, moist, or even wet state.

#### **Filling and exit points**

Their design should allow for easy filling and emptying out into a wheelbarrow or conveyor belt.

#### **Wear and tear and maintenance**

All the bearings, motors and other sensitive items should be perfectly protected from dust. Metal screens have the advantage of being robust, but are generally more expensive and difficult to replace than wire netting screens. Replacing the screen grid itself must be easy. Their design should allow for easy filling and emptying out into a wheelbarrow or conveyor belt.

#### **Mobility**

Wheels can be a useful feature in non-integrated units, as they make the screen easier to move or transport so as to adapt to the volume of untreated and/or prepared earth.

## MIXERS

### KEY ISSUES

The mixing process is particularly important for the final quality of the product. A homogeneous mixture is absolutely necessary. Mixing should first of all be done in the dry state. The mixed soil must then be wetted evenly, and so water should be added as a fine spray, as a mist, or as high-pressure steam, according to the construction technique and the level of sophistication employed.

### TPOLOGY

#### Horizontal shaft mixers

These are motorized and consist of a number of blades mounted on a horizontal rotating shaft which turns within a horizontal cylindrical drum, often quite small in size.

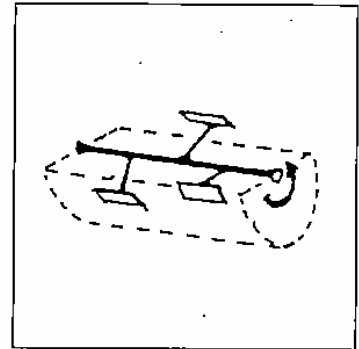

#### Planetary mixers

These are motorized and consist of blades fixed to a vertical rotating shaft which turns inside a drum. The blade movement is more or less complex depending on the level of sophistication of the mechanisms. There are even models where it is the drum which rotates.

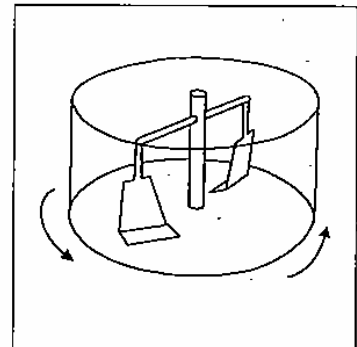

#### Linear mixers

These are motorized and made up of a series of blades forming a discontinuous or continuous helical screw, which turns inside a horizontal or vertical drum. The most sophisticated horizontal systems have a double drum fitted with two shafts. These models are no longer commercially available but can still be found second-hand.

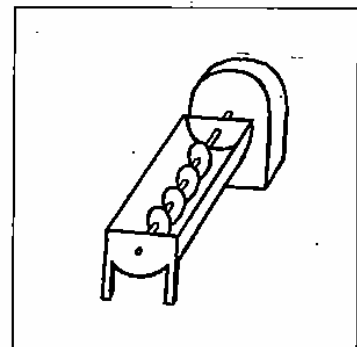

## THE TECHNOLOGY OF PRODUCTION

### **Note**

There are other types of mixers, but they are not specific to the production of compressed earth blocks and are to be found in the ceramics, public works and agricultural industries. One example is the linear mixers intended for fired bricks, which may be suitable. Other examples are concrete mixers, planetary concrete mixers and finally rotivators. As a general rule, none of these mixers is recommended for CEBs, either because their mixing time is too short, or because the mix is not homogenous. These machines are not intended for a material such as soil, which becomes sticky when exposed to water and forms lumps or aggregates which are impossible to compress. A mixer of this type may, however, prove to be usable, but only provided that it meets the technical criteria specific to the compressed earth block which are set out below.

### **TECHNICAL CRITERIA**

#### **Quality and mixing time**

Mixers used to prepare soil intended for the production of compressed earth blocks must be capable of mixing it for a duration of 2.5 to 4 minutes, if an optimum result is to be obtained. The systems used should on no account produce soil stuck together in the form of lumps. The moving parts inside the mixers' drums should be designed so that the soil can in no circumstances impede their operation.

#### **Wetting**

If the mixer is fitted with a watering system, this will allow water to be added in the form of a fine spray.

#### **Power and capacity**

The power taken up by the mixing of soil is significantly greater than that used to mix concrete. The usable capacities of vertical axis mixers claimed by the manufacturers are often given for mixing concrete and should be considerably reduced for soil. It should be noted that the quoted capacity gives the volume of the drum. The volume of soil which can be mixed is in the order of 50% of the volume of the drum. The wave of soil lifted by the mixer blades as they rotate is higher than that of concrete, so the mixer walls need to be significantly (approximately 20%) higher too.

#### **Feeding and delivery**

Access for feeding should be easy (a fixed ramp, platform or conveyor belt). Emptying out should be able to be done directly either into a wheelbarrow, or into the feeding hopper of the press, or onto a conveyor belt.

#### **Safety**

Mixers should be fitted with a protective grill and possibly with an automatic cut-off system which operates if the grill is opened. The emptying system should preferably be fitted with a safety device, making it impossible, for example, for someone to put their hand into the mixer.

## THE TECHNOLOGY OF PRODUCTION

### **Wear and tear and maintenance**

Mixers should be extremely resistant to wear and tear by abrasion, particularly when used with lateritic soils. This applies equally well to the drum as to the blades or other mixing devices such as disks. The shape of the blades should be examined to ensure that they penetrate well into the mix causing as little abrasion as possible, but moving it along as much as possible. Earth is highly abrasive, particularly when lateritic. It is useful if the blades are easily replaceable and readily available as spare parts.

### **Mobility**

In certain cases, wheels can be useful to avoid having to move too much soil around.

## **PRESSES**

### **KEY ISSUES**

For the production of compressed earth blocks, the action of the presses consists in pressing the particles closer together. This densification is obtained by applying compaction forces, static or dynamic, which may seem simple, but which nevertheless depend upon several essential variables in order to work efficiently.

### **TPOLOGY**

#### **Manual presses**

Only compressing and turning out operations are carried out by the machines which are operated by hand.

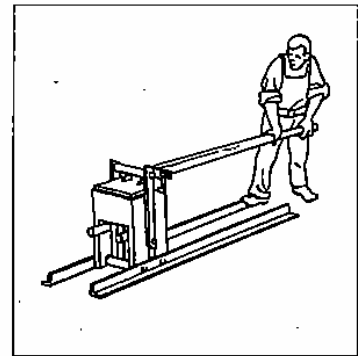

#### **Motorized presses**

Only compressing and turning out operations are carried out by the machines which are motorized.

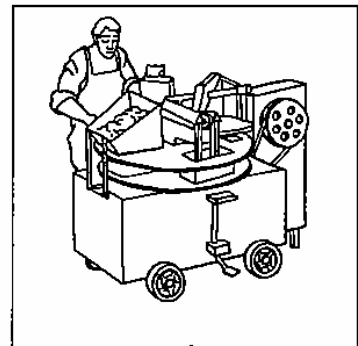

#### **Mobile production units**

These production units are easily transportable. Not only the compressing and turning out operations but also the preparation the material and/or the evacuation of the finished products are motorized or even automated.

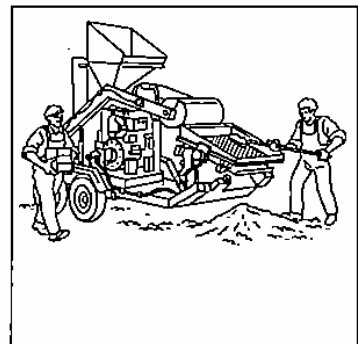

## THE TECHNOLOGY OF PRODUCTION

### **Fixed production units**

These production units are particularly difficult to transport. Not only the compressing and turning out operations but also preparation of the material and/or the evacuation of the finished products are motorized or even automated.

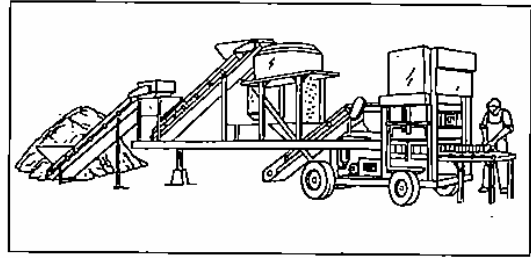

### **TECHNICAL CRITERIA**

#### **Product descriptions**

Certain machines can produce a complete range of components (blocks, large and small paving tiles, roofing tiles, etc.). For each of these products, one must request:

- its denomination;
- its geometrical description;
- plans;
- photos.

Manufacturers often provide reports of experimental tests or technical opinions concerning the products manufactured by their machines. Great care should be taken to check the validity of these documents.

#### **Block dimensions**

Compressed earth blocks have traditionally not exceeded the following maximum dimensions:

- length : 40 cm (exceptionally 50 cm);
- width : 20 cm (exceptionally 30 cm);
- height : 10 cm (exceptionally 20 cm).

There is a wide range of other block dimensions derived from the concrete and fired brick industries.

For historic reasons, the usual most commonly used block has the nominal dimensions of 29.5 x 14.0 x 9.0 (l x w x h). Two of these dimensions depend on those of the mould and are therefore invariable (except if the mould is worn). The third, often the height, depends on a setting and on the mechanical play of the power transmission systems. It is often the subject of minute variations related to the delicate balance between the raw material and the equipment. It is recommended that the vertical direction in which the block will be laid should be apparent from its dimensions or shape, and this should generally and preferably be the direction of compression during production. This is particularly true for load-bearing walls.

The modularity of the block should take account of the different bonding patterns needed when working with traditional mortar joints (1 to 1.5 cm thick), with adhesion using adhesive-mortar-adhesive (a few mm thick), with self-adhesion and with dry stacking (no joint thickness), or indeed with vertical or horizontal interlocking (no joint thickness). For a soil with a given moisture content, presses never produce blocks with perfectly consistent dimensions and/or dry mass. This is due to the irregularity of filling of the mould and to variations in the operation of the machine (e.g. the warming up of the hydraulic oil, etc.).

## THE TECHNOLOGY OF PRODUCTION

For blocks intended to be assembled using traditional mortar joints, a variation in the height of the blocks of less than 1 mm is very good, between 1 and 3 mm is good and acceptable, and of more than 3 mm is poor. For blocks intended to be assembled using adhesive-mortar joints, a variation in the height of the blocks of less than 2 mm should be achieved. For blocks intended to be assembled dry with no joint thickness, self-adhering or stacked, vertically or horizontally interlocking, the variation in the height of the blocks should theoretically be 0 mm.

A simple mechanically transmitted static compressive force limits one to approximately 415 cm<sup>2</sup> (and on no account should this exceed 600 cm<sup>2</sup>) of surface area of compression, or 8 to 10 cm in height for ordinary systems. In the case of simultaneous, equal double compression, the height is limited at best to 20 cm. This height limitation also applies to dynamic compression by vibration or impact, but here the surface area of compression may be much greater, although restricted to approximately 1,000 cm<sup>2</sup>. Dimensions which are too great make it difficult to handle the blocks because of their excessive size.

Multi-purpose machines also enable reduced height products to be manufactured by adjusting the depth of the mould and the travel of the piston. This is particularly useful for producing, for example, blocks 5 to 6 cm high for decorative bonding patterns or for building vaults and domes, or indeed for making paving stones.

### **Dimensions of other products**

For the other finished products, one must request:

- complete dimensions (l x w x h);
- tolerances;
- void ratio (% of frogs and hollows);
- typical dry mass;
- geometrical description;
- diagrams;
- photos.

### **Surface effects**

Certain methods of compressing and removing the block leave the exposed faces of the products very smooth, while others leave them rough. Depending on the intended use of the products, it may be an advantage to choose one option or the other. Surface roughness on the faces of blocks which are to have a mortar or render applied helps the mortar or render to adhere. Smooth surfaces are preferable for masonry which will remain exposed.

### **Hollows**

It is useful to be able to produce blocks with all kinds of hollows (frogs, partial or through perforations, etc.). Hollows can increase the coefficient of thermal insulation, reduce the weight of the block, allow spaces for reinforcement or wires to be introduced, etc. The volume of such hollows is generally limited to approximately 30% (percentage of voids) of the total volume of the product, in the case of the best-performing machines. The particle size distribution of the soil should be suited to the thickness of the sides in order to avoid mechanical weaknesses and to ensure that the appearance of the product remains good. The sides will generally have a minimum width of 3 cm.

## THE TECHNOLOGY OF PRODUCTION

### **Energy source**

The operation of presses can call for a human energy source (manual presses) or a mechanical one (presses with electrical or thermal motors).

- Manual presses: the force generated by one or more workers depends mainly on their weight, but also on their endurance and on the care with which they do their work. It is not uncommon to find significant differences in the quality of products (appearance, strength, etc.) over a period of several hours' work. For manual single-lever presses being operated by only one operator, the lever should in general measure at least 2m long in order to generate sufficient pressure.
- Motorized presses: motorization avoids the human fatigue factor of manual presses, and the forces generated may be greater, with more compact transmission systems. As far as is reasonably possible, it is preferable to have motors of more than adequate size, adapted for use in tropical conditions, and protected against dust and sand-storms if necessary. They should be taken from a range which is locally available, including all spare parts, maintenance servicing and repairing. Mechanical accessibility must be ensured in case the motor needs to be taken apart. For internal combustion thermal motors, air-cooling has the advantage of avoiding problems of freezing and of the radiator getting clogged up in dusty environments.

In the case of both moveable and fixed production units, using the same energy sources for the various sub-tasks creates interdependence in the event of a breakdown, is very complex and sometimes results in poor accessibility for repairs.

### **Energy transmission**

Energy can be transmitted to the various mechanisms and to the soil by levers, pivots, connecting rods, ball-and-socket joints, pistons, jacks, etc. Two main groups of energy transmission systems can be identified: mechanical and hydraulic.

- Mechanical systems: these machines are generally simple and fairly heavy, unless they are made of special alloys. If special alloys are used, it might not always be easy to repair the machine.
- Hydraulic systems: these machines are more complex and more sensitive to the environment, particularly to air containing a lot of dust or sand. Externally mounted hydraulic pumps are not particularly vulnerable to external dust since they are deliberately sealed units. They do however remain more sensitive to dust particles carried by the hydraulic fluid. Immersed pumps are an ideal solution from many points of view (cooling by the oil itself, less risk of deterioration due to dust particles, lower cost, longer life span, etc.), but can only be worked by an electric motor. As far as pollution by dust of the hydraulic oil is concerned, care must be taken to ensure that the reservoir is equipped with a pressurized aspirator with an air filter.

The heating up of hydraulic fluid results from the product of Output x Pressure. The heating up of hydraulic oil cannot be blamed solely on the compression but is a function of the system as a whole. As heating up is inevitable, the machinery must be of a generous size in proportion to the output (distributors, valves, flexible pipes, etc.) in order to reduce constant load loss. This affects the cost of the machine.



## THE TECHNOLOGY OF PRODUCTION

The fact that many of the parts fitted on hydraulic systems were intended originally for operating temperatures in the order of 70 to 80°C maximum means that measures must be taken to cool the hydraulic oil and/or use larger reservoirs; or to use parts and hydraulic oil capable of withstanding temperatures of up to 120°C; or finally to reduce the pressure of the fluid or simplify the hydraulic system. The occurrence of overheating in hydraulic oil is more of a risk in Sahelian and tropical environments. The correct operating of a hydraulic system in high temperatures always entails an additional cost compared with a basic machine. On the other hand, low temperatures (approaching 5°C in the morning in the Sahara and the Sahel for example) can equally cause serious operating problems.

The service pressure of the hydraulic fluid should be as low as possible, whilst remaining compatible with the desired compression pressure in order not to overstrain the pipes and to avoid overheating. To work at a low hydraulic pressure, the active surface area of the valve will have to be considerably increased. This increases its volume, and as a result the output of the pump for the same production rate. The reservoir capacity is in general designed as a security measure against overheating and to protect the pumps. Thus in the event of the sudden rupture of a flexible pipe for example, the operator must have the time to stop the machine before the hydraulic pump(s) run dry, as this causes them to deteriorate rapidly.

The "Output x Pressure" compromise also determines the power of the motor driving the pumps. The machines should preferably be fitted with a thermometer and a manometer to check the hydraulic fluid. Maintenance costs often become considerably greater than anticipated and supplies of spare parts sometimes creates enormous problems in remote regions. For this reason, making sensitive parts (flexible pipes, joints, etc.) uniform is highly desirable, to say the least. Flexible pipes must be made of a material which is resistant to ultra-violet rays and should remain flexible and water-tight in hot, dry climates.

### **Hydraulic fluid consumption**

There is no consumption of hydraulic fluid, unless something damages the circuits. Correctly and continuously filtered, oil which has not been subjected to overheating can stay in service for several years. This remains, however, an exceptional situation. Obtaining hydraulic fluid is often difficult and expensive. This is all the more critical when special oils are used. The fluid change devices must be carefully designed in order to prevent the introduction of dust or sand particles, for example during maintenance.

### **Energy consumption**

Energy consumption must be taken into account, particularly in terms of fuel supply and frequent electricity cuts. Where continuous production is imperative, it is often preferable to opt for a multiple energy source (e.g. electrical motors linked both to the mains supply and to an emergency back-up generator.)

### **Compression**

Compression may be static, dynamic by vibration, dynamic by impact, or mixed, which combines some of the other types of compression.

## THE TECHNOLOGY OF PRODUCTION

Up till now, static compression has been the most widely used, sometimes linked to a dynamic effect e.g. the effect of a hinged lid. Dynamic compression can to some extent liberate one from the fairly limited sizes of the products made using static compression. On the other hand, for dynamic compression, compression time is fairly long and the moulds are placed under great strain. They therefore have to be reinforced with and/or made from special steels. As the body of the moulding is subjected to considerable stress introduced by vibration, it has to be very specially designed. Dynamic compression by vibration almost always implies motorization.

### **Available force**

This is the force potentially available to compress the soil, a force which can be used as required: applied to a small or a large surface for example. This parameter does not therefore express the performance of a press, but allows it to be situated within a certain range.

### **Compression pressure**

The potential of the press can be better appreciated by considering its compression pressure. This is the pressure which is theoretically applied to the soil and it expresses the link between the usable force and the surface area to which it is applied (to one or more blocks).

The classification generally adopted is as follows:

— very low pressure	:	1 to 2 MPa
— low pressure	:	2 to 4 MPa
— medium pressure	:	4 to 6 MPa
— high pressure	:	6 to 10 MPa
— hyperpressure	:	10 to 20 MPa
— megapressure	:	20 to 40 MPa and over.

### **Available pressure at the end of compression**

This is the pressure which is actually applied to the soil at the end of the compression. This parameter is particularly difficult to measure in the case of mechanical energy transmission systems and in the case of dynamic compression. It is the pressure at the end of compression value which is generally specified in production works requirements. If a value for pressure at the end of compression is provided by the manufacturer, how this was measured should be checked. Pressure at the end of compression is measured after allowing for all the losses of pressure due to the effects of operation, friction and inertia.

In the case of machines using mechanical transmission of energy, it is significantly lower than the compression pressure. Thus, for a small, lever-operated manual press, the pressure at the end of compression is for example between 1.5 to 2 MPa, in optimum conditions, whereas the literature quotes 4.5 MPa which corresponds generally rather to the compression pressure (the pressure theoretically applied to the soil).

In the case of machines using hydraulic transmission of energy, the pressure at the end of compression is virtually the same ( $\approx - 5\%$ ) as the compression pressure. On the other hand, the pressure at the end of compression diminishes if the hydraulic fluid overheats or if there is much loss of load in a very complicated hydraulic circuit.

In the case of dynamic or mixed compression, the notion of compression at the end of compression is not appropriate and a measuring procedure has in fact yet to be developed to enable values to be obtained equivalent to the value obtained by direct measuring in the case of static compression.

## THE TECHNOLOGY OF PRODUCTION

It should be noted that the use of mixed compression (continuous, simple, static compression with dynamic impact compression) e.g. by using a hinged lid is very efficient and enables the drawbacks of using relatively low compression to be overcome.

Mechanical strength and the behaviour of the block when exposed to water are almost directly proportional to the pressure at the end of compression, up to a certain point, which is often situated between 4 and 10 MPa, and then becomes asymptotic or may even fall. Too high a pressure at the end of compression (often in excess of 10 MPa) can sometimes be harmful, especially if it is rapidly achieved, if the soil is fine, or if the optimum moisture content has not been respected. This then introduces effects of lamination, cracking and swelling after the removal of the block. This is particularly the case for hollow or alveolate blocks with thin sides. It is therefore useful if the press allows the pressure at the end of compression to be adjusted to suit the properties of the material.

The regularity of the appearance of the product depends not only on the pressure at the end of compression, but more particularly on the choice of soil and its condition (how finely it has been pulverized, the homogeneity of the moisture content) at the moment at which it is used.

### **Dynamic effect coefficient**

For static compression presses, there is a dynamic effect due to the inertia of the machine which means that compression performance in production will exceed that measured in the laboratory. Thus for a manual lever-operated press, a dynamic effect coefficient in the order of 1.2 is applied, and this increases the pressure at the end of compression measured in the laboratory, step by step, depending on the displacement of the compression mechanism.

### **Compression mode**

The frictional forces which occur along the sides of the mould and within the soil reduce the pressure at the end of compression. This causes variations in the dry density, and therefore in the mechanical characteristics of the blocks, depending on their height (compression gradient). For a pressure at the end of compression of less than 6 MPa, this effect is negligible if the height of the blocks is less than 7 cm, low if it lies between 7 and 12 cm, medium if it lies between 12 and 15 cm and significant if the height exceeds 15 cm. For simple static compression, the height of good quality blocks should generally be restricted to a maximum of approximately 10 cm.

Double compression which applies pressure to both sides at the same time can theoretically enable blocks of approximately 20 cm high to be produced. The least compressed fraction of the soil is found in the middle, which is the least vulnerable part. To be really efficient, the pressure applied should be the same on both sides of the block, should be simultaneously applied and should at no point be reduced. Double compression therefore enables high blocks to be produced using relatively weak energy transmission systems; to achieve the same height using single compression would require very large systems of energy transmission applying great force.

With single dynamic compression, one can to some extent achieve the same heights without recourse to double compression.

### **Direction of compression**

The direction in which the press applies pressure on the CEB is of no importance in itself. Compression can be applied vertically or horizontally.

## THE TECHNOLOGY OF PRODUCTION

However, it is recommended that blocks are laid in walls in such a way that the direction of the loads applied to the blocks corresponds to the direction of compression. Otherwise, the compressive strength of the blocks can sometimes be reduced by 20%. This does not preclude their being used in this way, provided that the compressive strength measured this way round meets the requirements of the building. Blocks used this way round, i.e. perpendicularly to the direction of compression, must be very homogenous and display no significant difference in dry density on one side compared with the other (too great a compression gradient).

### **Compression ratio**

In theory the compression ratio expresses the relationship between the volume of loose earth introduced into the mould and the volume of the soil after compression.

In general, the length and width of the earth remain constant, and only the height is variable. The volume of the mould should be designed in such a way that it can preferably contain exactly the volume of earth required for the manufacture of the block.

In practice the compression ratio is therefore defined by the relationship between the depth of the mould before compression and the depth after compression. For blocks approximately 10 cm in height, the compression ratio should preferably be at least 1.65, and ideally nearer to 2, this figure rarely being attained. The value of the compression ratio can be distorted by too great a depth of mould, which means that the mould is never entirely filled.

Manual precompaction (which has a significant effect on output) or mechanical precompaction thanks to a hinged lid, a precompression roller or a filling mixer, can resolve the disadvantage of insufficient or mediocre compression.

The compression ratio should preferably be adjustable, by modifying the depth of the mould and/or the travel of the piston, so as to perfectly match the soil used and its optimum moisture content. For mechanical energy transmission machines, this sometimes poses some problems. In the case of hydraulic energy transmission machines, adjustments are generally easy. In the case of a dynamic compression effect, the compression ratio may vary. The possibility of making this adjustment is essential for a press intended for multiple use and suited for the manufacture of a range of products.

Loose earth placed in the mould has a dry density which varies between 1,000 and 1,400 kg/m<sup>3</sup>. Compressed, it should have a dry density of at least 1,700 kg/m<sup>3</sup> and can reach 2,300 kg/m<sup>3</sup>, depending on the soil used and on the compression applied.

### **Compression speed**

Production imperatives can impose high speeds. The minimum compression time limit, however, is of the order of 1 to 2 sec. for 10 cm blocks, if the risk of lamination is to be avoided. If compression is carried out too quickly, it must be interrupted after precompression in order to let the compressed air escape. This precompression, which enables the soil to be rapidly placed in the mould, is carried out at a relatively low pressure. The final compression is then carried out at a much lower speed. The compression speed is all the more critical the higher the compression pressure and the lower the operating play between the piston and the mould, which makes it difficult for the air squeezed out of the earth to escape.

## THE TECHNOLOGY OF PRODUCTION

### **Vibration frequency**

In the case of presses using mixed compression, dynamic compression by vibration and static compression, the vibration frequency of the vibrating table is in the order of 50 to 80 Hz and should be adjustable.

### **Vibration amplitude**

In the case of presses using mixed compression, dynamic compression by vibration and static compression, the vibration amplitude of the vibrating table is a few millimetres and should be adjustable.

### **Vibration duration**

In the case of presses using mixed compression, dynamic compression by vibration and static compression, the vibration duration of the vibrating table is in the order of a few tenths of a second, depending mainly on the grain size distribution of the soil. The vibration duration should be adjustable.

### **Tamping frequency**

In the case of presses using dynamic compression by impact, the tamping frequency is in the order of 180 blows per minute.

### **Tamping travel**

In the case of presses using dynamic compression by impact, the tamping travel is in the order of 40 mm.

### **Tamping duration**

In the case of presses using dynamic compression by impact, the tamping duration is in the order of 10 to 15 seconds and should be adjustable up to 30 seconds.

### **Ways of filling the mould**

There are two ways of filling: measuring the soil by volume, which is the more widely used and the easier, and measuring by mass, which is the more accurate, but the more difficult to carry out.

Filling can be carried out manually or automatically with a fixed hopper or by transfer from a drawer mould, or indeed through other mechanisms such as a mixer.

For rotating moulds or drawer moulds which pass only once under a fixed hopper, there is a problem of even filling, that is of one side of the mould being filled higher than the other. During compression, the upper face of the block is in danger of being imperfectly parallel with the lower face and the compression mechanism can be irremediably bent out of shape.

The problem of even and constant filling is even more acute when several moulds are being filled simultaneously, particularly if the way they are placed in relation to the exit point of the hopper is not very carefully calculated (as with several front moulds). The problem of even filling of moulds can be resolved in various ways, such as direct distribution of the soil into the moulds from a mixer (the rotation movement of the blades being the opposite to the rotation

## THE TECHNOLOGY OF PRODUCTION

of the mould, which ensures even distribution), an intermediate measuring out drawer between the hopper and the mould, or manual topping-up in between the hopper distribution point and the point of compression.

To be efficient, hopper filling systems should not be too sensitive to how much soil is contained in the hopper, how loose it is or its moisture content. These specific problems can be resolved in several ways: vibrating the hopper, checking that there is enough soil in it, etc.

If the hopper is loaded from too great a height, a mechanized means of supply will have to be used.

### **Compression mechanism**

There are several types of mould: fixed moulds, rotating moulds (rotating tables) with or without bases, translation moulds (with slide-valves), and free-standing moulds.

There are also several ways in which the compression piston may move: vertically upwards, vertically downwards or horizontally.

In all cases, the piston guidance mechanism should ensure that the piston is perfectly aligned throughout its travel. The two compression faces (the face of the piston(s), the face of the lid, and the base) must remain perfectly parallel one to the other during the entire movement. At the end of the compression, there should never be any jamming of the mechanism, such as is generally provoked by insufficient operating play.

The sides of the moulds must be very thick and reinforced to avoid becoming bent or buckled over time. The sides of the moulds should generally be made of steel plate, of a minimum thickness of 1.5 cm. Steels resistant to corrosion should preferably be used. It is even recommended to use higher mechanical strength steels which do not require any special thermal treatment.

Synthetic coatings such as Teflon applied to the surfaces of moulds or compression pistons are ineffective. Generally speaking, any problems of sticking during the first few days of production will be rapidly resolved by the polishing action of the soil, which is highly abrasive. Replacing worn parts with spares made of special steel such as stainless steel is very effective, but rather expensive.

One should be able to take apart sub-structures of complex and expensive moulds in order to replace worn parts. If the vertical corners of the blocks are rounded or chamfered to make them easier to remove from the mould, this should be to as small an extent as possible (e.g.  $r = 2$  mm) in order to avoid problems of applying mortar. One should check if the compression mechanism will enable elements to create hollows to be installed. The play between the compression mechanism and the mould should be such that the air can escape easily during compression.

### **Monitoring devices at the end of the compression cycle**

These can be calibrated on the displacement carried out, which is generally the case for presses using mechanical transmission of energy, or on the pressure at the end of compression, which is sometimes the case for presses using hydraulic transmission of energy.

Thus a pressostat shunt connected to the compression circuit will be subject to the same pressure as the block, and at the same time. An adjustable pressostat is therefore able to trigger the end of compression when the pressure has reached the required level. Adjustments should

## THE TECHNOLOGY OF PRODUCTION

be able to be carried out very simply with an instant readout obtainable, and without halting production.

A manometer allows one to obtain a direct reading of the pressure which is attained at the end of compression. Adjusting this final pressure, which should be easy to do, has a significant effect on the dry density of the block. Thus for certain critical soils, a variation of 5% in the dry density of the block can result in a fall of 30 to 50% in its crushing strength (this is an extreme case).

In practice, in order to avoid sudden jamming of the compression mechanism or excessive variations in the dimensions of the products, some mechanical presses are fitted with compensating devices (springs, valves, regulators, torque limiters, etc.) which means that one cannot always classify machines simply into the categories of constant displacement or constant pressure at the end of actual compression.

In the event of jamming, the machines should preferably not need the mould to be taken apart in order to remove the block being produced, or manual removal of the block from within the mould. It is preferable for the cycle to continue in any case and for the defective block to be rejected by the operator.

Ideally, from the point of view of building quality control into the production machinery, the presses should be fitted with a device which ensures a constant pressure at the end of compression, in parallel with a system which enables a given height of blocks to be ensured and which remains within the tolerances imposed.

### **Number of moulds per table**

The greater the number of moulds on a table, the more difficult it will be to change the modular dimensions of the block or the product. In certain cases, it is possible to produce different products in one single operation.

### **Turning out mechanisms**

There are three ways in which the turning out piston may move: in the direction of compression, in the opposite direction, or perpendicular to the direction of compression.

In all cases, the turning out and removal device should not damage, deform or exert undue force on the product, which remains vulnerable to the effects of shearing and blows. Any defects caused are often difficult to see with the naked eye at first.

Certain devices prevent a new production cycle from starting up until the blocks have been removed, which avoids destroying the following blocks or causing a machine malfunction. In the case of turning out devices which work by horizontal movement, a layout which allows a few blocks to be automatically stocked is needed. In all cases, an automatic prestocking surface for a few blocks is very useful. The turning out mechanism should be checked to see if it allows for the installation of devices for making hollows.

### **Length of the filling, compression and turning out cycle**

Simple manual presses have a mechanical cycle of 30 to 60 seconds, and those which perform best have cycles as low as approximately 15 seconds. Clearly, this cycle depends to a large extent on human factors which will have a determining influence on output.

## THE TECHNOLOGY OF PRODUCTION

For motorized presses which need a human input, it is difficult to go below 15 seconds for the complete sequence of filling, compression (minimum 1 or 2 seconds) and turning out.

Automatic production units can at best carry out this same cycle in 3 to 4 seconds. In theory, a 15 sec. cycle, for example, is the equivalent of approximately 2,000 cycles of filling, compression and turning out per 8-hour working day. The more complex the compression action is made (two-stroke compression, dynamic compression), the longer the cycle. To increase output, presses are fitted with devices enabling several blocks to be produced per cycle.

### **Output**

Output is normally expressed in CEBs/unit of time. In order to take account of different sizes of blocks (these are not the same for all presses), it is preferable to express output in m<sup>3</sup> of products manufactured in 8 hours (1 day).

The theoretical output of the machines corresponds to the product of the theoretical number of cycles of filling, compression and turning out per unit of time and of the number of blocks produced per cycle. The theoretical output of automatic presses or presses requiring only slight human input is easy to check and is in general fairly objective. For manually controlled motorized presses, the theoretical output is often more subjective. If these operations are manually executed, the time of execution, a totally empirical estimate, and the theoretical output put forward by certain manufacturers is often highly exaggerated. These manufacturers in fact frequently cite outputs based on the best performance ever registered by the machine, but which can clearly never be replicated in a normal production context. In reality, most of the time, theoretical output bears no relation to actual output on site.

Practical output corresponds to the theoretical output less estimated down-time, which is mainly due to break-downs or routine maintenance of the machine. Actual output on site is different again. This is dependent on a number of factors which are totally independent of the machine, such as production organization, supply management, etc. Actual output is very often equivalent to less than half the commercial claims for theoretical output.





## 4. EQUIPMENT SELECTION

---

Before a piece of equipment is bought, it has to be selected from the large range available on the market.

Selecting a specific machine will be determined by knowing:

- the needs of the project;
- the use the machine is to be put to;
- the conditions of utilization;
- a great number of other factors.

### GENERAL SELECTION CRITERIA

Amongst the selection criteria most commonly encountered are the following, listed in alphabetical order. It should be noted that technical criteria will also weigh heavily in the selection process.

#### **Accessibility**

The product which results from the production process should be economically accessible to the users. If this is not the case, various solutions can be considered, such as help in kind, subsidized production, etc.

#### **Appropriation**

One objective is often that the one-off technology transfer should benefit the development of the population concerned. It should be easily transmissible to this population and technically capable of being appropriated. This means that it must above all be culturally and socially acceptable.

#### **Competitiveness**

The operation, although viable, may not necessarily be competitive with other sectors. This lack of competitiveness often results from a market distorted by subsidies.

#### **Complexity**

Certain machines require very highly qualified staff for their organization, operation and maintenance. If there are no such staff, or if it is impossible to train any, this necessarily eliminates a certain number of machines. Complexity equally implies dependency on spare parts supply sources.

#### **Conditions of purchase**

Conditions of payment, discounts, etc. Delivery times cover not only the availability of the machines, but also the time needed to transport it, complete customs formalities and deliver it to its final destination.

## EQUIPMENT SELECTION

### **Cost**

Budget restrictions considerably restrict equipment choice. Not only must the cost of the machine be taken into account, but also the cost of all the attendant factors: transport, customs, spare parts, peripheral equipment, etc.

### **Economizing foreign currency**

Over and above the economic aspects directly linked to the project, one may be seeking to economize foreign currency at the macro-economic level.

### **Energy transmission**

The implications of choosing between mechanical and hydraulic transmission systems are fundamental, as they have a determining influence on the progress of the project, notably with regard to the following points: maintenance, spare parts, availability of hydraulic fluid, complexity of repairs, etc.

### **Financial viability**

It is not always necessary nor desirable to set up operations which are viable at micro-economic level. On the other hand, if such viability is being sought, this will influence the choice of machines in a very precise way.

### **Flexibility**

Not all machines have the flexibility necessary to manufacture a range of products other than simple variants of the parallelepiped block (paving stones, tiles, etc.)

### **Interchangeability**

It may be useful to acquire machines bearing in mind other machines which are already in operation in the same project, in the region, or in the country.

### **Job creation**

Certain machines are designed specifically to reduce human input to a minimum. It is sometimes on the contrary desirable to create as many jobs as possible around the operation of the machine, and this from both the economic and the social point of view.

### **Longevity**

An estimate of longevity should be based on a large number of factors, such as robustness, wear and tear, the quality of the materials used, maintenance frequency, etc.

### **Mobility**

The weight, size and means of moving the machines often defines their suitability to the size or to the basic character of the project.

## EQUIPMENT SELECTION

### **Origin**

For this criterion, the question must be correctly worded. The condition "to buy a machine manufactured in country X" will not eliminate the same machines as the condition "to buy a machine in country X"; nor will "to buy a machine in the currency of country X".

### **Output**

The quantity of bricks required over a defined period is a very important factor in choosing machines. Combined with other data, the influence of output on the choice may be variable: it is sometimes preferable to acquire several machines with an individual output which is lower than that of another machine, but with a collective output which is equivalent or higher. It is important to base decisions on figures for practical output and not on those for theoretical output.

### **Partnership**

Certain installations imply a partnership which is imposed by the manufacturer or the retailer. Such a partnership is not always desirable, but in certain cases can be completely logical.

### **Potential to evolve**

Rather than install at the outset a complex machine, it may be preferable to start out with a simple installation, but one which has a good potential to evolve, leading ultimately to complete industrialization.

### **Power supply**

Choosing between manual and motorized machines will be a critical factor. The type of motorization sought may also dictate the choice in the light of the cost and availability of the power supply required for the operation of the machine.

### **Reliability**

Consideration of overall reliability should take a large number of factors into account, such as the system used by various mechanisms, the degree of sophistication of automatic features, sensitivity of the components to the environment, etc.

### **Reliability of the manufacturer**

Not only the manufacturers' references, but also those of users who are their clients, may have a bearing on the choice. After-sales service should be ensured long term.

### **Safety**

The safety of users should be a decisive factor in the final choice.

### **Training**

Training which is provided under the responsibility of the manufacturer can be a very powerful argument for purchasing particular machines.

## EQUIPMENT SELECTION

### **Training impact**

In certain cases the organization, operation and maintenance requirements of the machines, if they are set at an appropriate level, can help to qualify the users and thus to prepare them to get through important stages of the intended overall development plan.

## **SELECTION CRITERIA FOR PRESSES**

Amongst the selection criteria most commonly encountered are the following, listed in alphabetical order. It should be noted that the other technical criteria will also weigh heavily in the selection process.

### **Category of block**

Not all machines have the characteristics necessary to manufacture the category or categories of block required. The list of categories of block may usefully be consulted.

### **Compression mechanism**

The quality of the machines, but also the quality of the products, are highly dependent on the compression mechanism.

### **Compression ratio**

This ratio can play an essential part in the quality of the product and will therefore determine the choice between two machines which are otherwise identical.

### **Pressure**

This criterion is logically linked to that referring to the category of block. It is imperative to distinguish between pressure during compression and pressure at the end of compression.

### **Type of block**

Not all machines have the characteristics necessary to manufacture the type of blocks required to meet the performance sought. The table of types of block may usefully be consulted.

The following considerations may determine conditions for the utilization of manual presses (this list is not intended to be exhaustive or restrictive):

- if a large amount of labour has to be employed;
- if capital resources are limited;
- if the projects are located in very remote regions;
- if working space is very restricted;
- if atmospheric conditions are not too harsh;
- if the project is a small one;
- if the quality of the blocks is not of vital importance;
- if the buildings are being constructed on a self-help basis;
- etc.

## EQUIPMENT SELECTION

The following considerations may determine conditions for the utilization of motorized presses (this list is not intended to be exhaustive or restrictive):

- if there are ample financial resources;
- if there is an imperative need for high outputs;
- if the blocks must be of higher quality;
- if the power-supply is available regularly and in sufficient quantities;
- if maintenance poses no problem;
- if labour is very expensive or scarce;
- if high quality training is planned;
- etc.

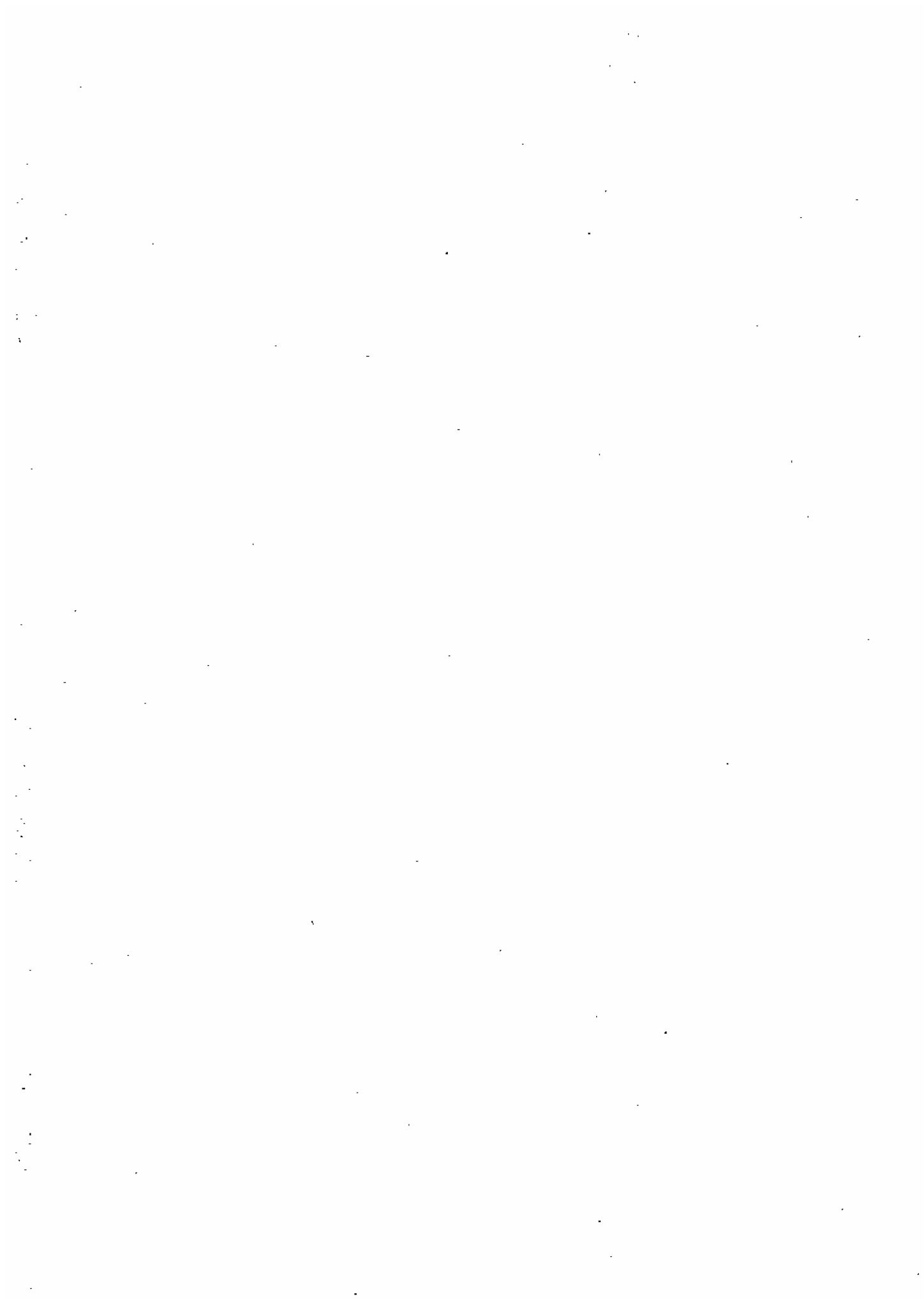

## 5. INVENTORY OF EQUIPMENT

Here we present pulverizers, mixers and presses which originate in EU countries or in those of the ACP zone. Each piece of equipment is presented in the form of a checklist summarizing its main technical characteristics, together with a descriptive paragraph and a photograph of the machine.

It is strongly recommended that the manufacturers be asked to reconfirm this data.

The data quoted in these sheets is entirely the responsibility of the manufacturer.

RANGE OF PRICES (in ecus)			
CATEGORY	*	**	***
A	150 - 200	200 - 250	250 - 300
B	350 - 450	450 - 600	600 - 700
C	1,000 - 1,350	1,350 - 1,650	1,650 - 2,000
D	2,350 - 2,900	2,900 - 3,450	3,450 - 4,000
E	4,100 - 4,600	4,600 - 5,100	5,100 - 5,600
F	6,000 - 7,350	7,350 - 8,650	8,650 - 10,000
G	14,000 - 17,350	17,350 - 20,650	20,650 - 24,000
H	28,000 - 30,750	30,750 - 33,500	33,500 - 36,300
I	73,500 - 82,000	82,000 - 90,500	90,500 - 99,000
J	129,000 - 206,000	206,000 - 283,000	283,000 - 360,000

*Ecu 1 = BEF 37.74 (Belgian Franc) = FRF 6.31 (French Franc) = DEM 1.83 (Deutchemark) = USD 1.27 (\$) = GBP 0.83 (£) (on 20 December 1995).*



## INVENTORY OF EQUIPMENT

### **INVENTORY OF PULVERIZERS**

Characteristics should be interpreted in the following way:

#### **Working dimensions**

These are the maximum working dimensions of the machine excluding operators. If a lever is used, its travel is taken into account in these measurements.

#### **Transport dimensions**

This corresponds to the dimensions during transport of the piece of equipment, either packaged or towed as appropriate.

#### **Packaged weight**

This is the gross weight of the machine with its shipping packaging.

#### **Energy source**

The energy source is either human, electric or thermal (petrol or diesel motor).

#### **Power**

Depending on the type of motor, this is given in kW or hp.

#### **Energy consumption**

Depending on the type of motor, this is given in kWh or l/hour.

#### **Pulverizing**

This consists in grinding or crushing, depending on the family of pulverizer concerned.

#### **Pulverizing mechanism**

Jaws, squirrel cages, screws, cutters, hammers or others as appropriate.

#### **Theoretical output**

This is provided by the manufacturer in m<sup>3</sup>/h of finished product. Theoretical output bears no relation to actual output in the field.

#### **Daily theoretical output**

This is provided by the manufacturer in m<sup>3</sup> or is obtained by multiplying the hourly theoretical output by 8 hours.

#### **Factory price (EXW)**

This is provided by the manufacturer, see also "Price" in the section on "General criteria". All prices (valid at 01/01/94) have been converted into ecus. This is identified by a letter and by one or more asterisks which relate to a range of prices which can be looked up in the table entitled "Range of Prices".

## INVENTORY OF EQUIPMENT

### **ALTECH - France BROYEUR PROJECTEUR**



www.altech.fr

Category: pulverizer  
Working dimensions (l x w x h): 1.50 x 1.10 x 1.20 m  
Transportation dimensions (l x w x h): 1.60 x 1.20 x 1.30 m  
Packaged weight: 240 kg  
Energy source: electric motor / petrol engine  
Power: 3 kW / 8 hp  
Energy consumption: 3.0 kWh / 3.0 l/hour  
Pulverizing: grinding  
Pulverizing mechanism: hammers  
Theoretical output: 8 m<sup>3</sup>/hour  
Daily theoretical output: 64 m<sup>3</sup>  
Factory price (EXW): D\* (electric) / D\*\* (petrol)

As simple to move around as a wheelbarrow, this is suitable for all kinds of building site. It can be used for gravel and slightly damp soils. A single machine can feed 4 GEO 50 presses.

### **ALTECH - France BROYEUR TAMISEUR**

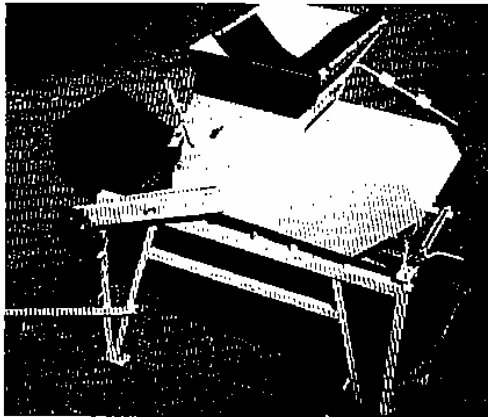

Category: pulverizer  
Working dimensions (l x w x h): 2.00 x 1.10 x 1.80 m  
Transportation dimensions (l x w x h): 1.40 x 1.10 x 1.70 m  
Packaged weight: 320 kg  
Energy source: electric motor / petrol / diesel engine  
Power: 3 kW / 8 hp / 10 hp  
Energy consumption: 3 kWh / 3.0 l/hour / 2.5 l/hour  
Pulverizing: grinding  
Pulverizing mechanism: hammers  
Theoretical output: 8 m<sup>3</sup>/hour  
Daily theoretical output: 64 m<sup>3</sup>  
Factory price (EXW): D\*\*\*

In addition to the features described for the ejecting grinder, this is also fitted with a vibrating sieve. Together, these enable it to process soils containing more gravel and to calibrate the soil selected more accurately. A single motor drives both functions and the machine can still be moved around by one man. It can work independently as a grinder or as a sieve.

## INVENTORY OF EQUIPMENT

### APPRO-TECHNO - Belgium BROYEUR DE TERRE TERSTARAM

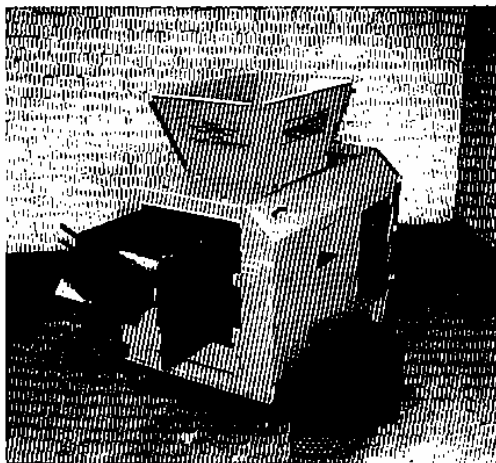

Category: pulverizer / screen  
Working dimensions (l x w x h): 1.60 x 0.95 x 1.38 m  
Transportation dimensions (l x w x h): 1.70 x 1.05 x 1.53 m  
Packaged weight: 750 / 820 kg  
Energy source: electric motor / diesel engine  
Power: 22 kW / 19 hp  
Energy consumption: 22 kWh / 3.0 - 3.5 l/hour  
Pulverizing: grinding  
Pulverizing mechanism: hammers  
Theoretical output: 9 m<sup>3</sup>/hour  
Daily theoretical output: 70 m<sup>3</sup>  
Factory price (EXW): E\* (electric) / F\* (diesel)

This machine can reduce the following raw materials, dry or wet, to a maximum diameter of 5 mm: stony laterite, moraines, tuffs, pozzolanas, clayey rock. Its power gives an output capable of feeding several motorized stabilized block production lines. It consists of 24 special steel hammers 10 mm thick. The inside of the grinding drum is lined with manganese steel plates which are resistant to wear and easy to replace. The perforated grill which acts as a sieve can be easily removed. Its wheels make it easy to move so that the grinder faces away from the wind; the operators and the motor may thus be kept out of the dust cloud which will depend on how moist the raw material is.

### APPRO-TECHNO - Belgium DÉSAGRÉGATEUR TERSTARAM



Category: pulverizer  
Working dimensions (l x w x h): 1.30 x 1.00 x 1.55 m  
Transportation dimensions (l x w x h): 1.40 x 1.10 x 1.70 m  
Packaged weight: 580 / 598 kg  
Energy source: electric motor / diesel engine  
Power: 2.2 kW / 5 hp  
Energy consumption: 2.2 kWh / 0.9 l/hour  
Pulverizing: crushing  
Pulverizing mechanism: squirrel cage  
Theoretical output: 9 m<sup>3</sup>/hour  
Daily theoretical output: 70 m<sup>3</sup>  
Factory price (EXW): D\* (electric) / D\*\*\* (diesel)

This machine was specially designed to prepare soil of a grain size suitable for the production of compressed earth blocks and burnt clay bricks and tiles. This pulverizer is of the squirrel cage type, consisting of two cage rotors made of 4 easily removable square high carbon steel rods. The rotors are parallel and counter-rotate. The machine is equipped with two wheels for easy transportation and daily cleaning operations. A wheelbarrow can be placed under the machine so that the crushed soil falls straight into it.

## INVENTORY OF EQUIPMENT

### BOLYN CONSTRUCTIONS CO LTD - Nigeria SOIL SIEVE/DISINTEGRATOR



Category: pulverizer / screen  
Working dimensions (l x w x h): 1.20 x 0.65 x 0.65 m  
Transportation dimensions (l x w x h): 0.80 x 0.75 x 0.75 m  
Packaged weight: 100 kg  
Energy source: human  
Power: not applicable  
Energy consumption: not applicable  
Pulverizing: crushing  
Pulverizing mechanism: jaw crushers  
Theoretical output: 0.6 m<sup>3</sup>/hour  
Daily theoretical output: 5 m<sup>3</sup>  
Factory price (EXW): B\*

The soil sieve/disintegrator is capable of grinding laterite soil. The handle is moved forwards and backwards, rotating the moving semi-circular head close to the metal face of the disintegrator to grind the soil. The broken down soil falls through a 6 mm sieve fitted on the lower side of the disintegrator and can be collected in any container. The machine can be dismantled for easy transportation. It can be efficiently used or operated by 2 men, one filling and the other swinging the handle. It is strong and maintenance free, although requiring regular oiling of the moving part with used engine oil to reduce the wear and tear associated with metal rubbing metal.

### CERATEC - Belgium CERADES H2 E/D

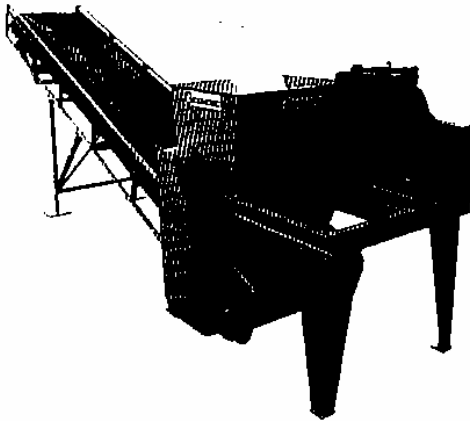

Category: pulverizer  
Working dimensions (l x w x h): 1.30 x 1.10 x 1.40 m  
Transportation dimensions (l x w x h): 1.51 x 1.29 x 0.95 m  
Packaged weight: 586 / 699 kg  
Energy source: electric motor / diesel engine  
Power: 1.1 kW / 5 hp  
Energy consumption: 4 kWh / 0.9 V/hour  
Pulverizing: crushing  
Pulverizing mechanism: squirrel cage  
Theoretical output: 9 m<sup>3</sup>/hour  
Daily theoretical output: 70 m<sup>3</sup>  
Factory price (EXW): D\*\* (electric) / E\*\* (diesel)

The CERADES H2 is a soil crusher essentially composed of two squirrel cage type rotors turning in opposite directions at high speed and reducing lumps of soil into small particles by impact on the rotor bars. It not only crushes, but also mixes and homogenizes raw materials with a Mohs hardness rating of 1 to 3 and a humidity of 0 to 20%. It is used only for preparing relatively dry soils and is not recommended for either moist clays or plastic soils. Driven by diesel engine or electric motor, it can be supplied with or without an integrated conveyor belt (model H2T) for removing material and using the same energy source.

## INVENTORY OF EQUIPMENT

### CITADOB INTERNATIONAL S.A. - Belgium STATION DE CONCASSAGE/CRIBLAGE

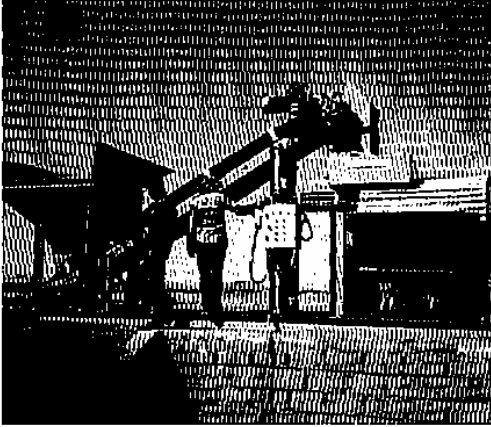

Category: pulverizer / screen  
Working dimensions (l x w x h): 6.50 x 3.10 x 3.50 m  
Transportation dimensions (l x w x h): not communicated  
Packaged weight: 1.500 kg  
Energy source: electric motor  
Power: 9 kW  
Energy consumption: 9 kWh  
Pulverizing: grinding  
Pulverizing mechanism: hammers  
Theoretical output: 8 - 10 m<sup>3</sup>/hour  
Daily theoretical output: 56 - 70 m<sup>3</sup>  
Factory price (EXW): G\*\*\*

This crushing/screening unit consists in a conveyor belt, a hammer grinder and a rotating sieve.

---

### OSKAM V/F - Netherlands KNUSTER



Category: pulverizer  
Working dimensions (l x w x h): 1.57 x 0.52 x 1.19 m  
Transportation dimensions (l x w x h): 1.18 x 0.52 x 0.82 m  
Packaged weight: 150 kg  
Energy source: electric motor / diesel  
Power: 5.5 kW / 7 hp  
Energy consumption: 5.5 kWh / not communicated  
Pulverizing: grinding  
Pulverizing mechanism: horizontal propeller  
Theoretical output: 3 m<sup>3</sup>/hour  
Daily theoretical output: 15 - 20 m<sup>3</sup>  
Factory price (EXW): D\*

This pulverizer was originally designed in 1992, with the aim of producing an easily transportable machine. It consumes little energy in comparison to its relatively high output.

## INVENTORY OF EQUIPMENT

### PARRY / ITW - United Kingdom PENDULUM CLAY CRUSHER

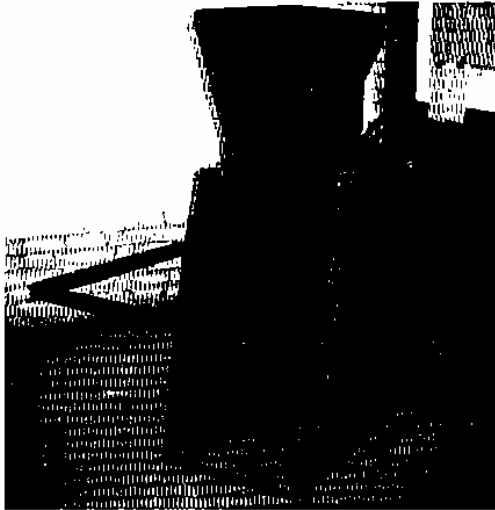

Category: pulverizer  
Working dimensions (l x w x h): 1.57 x 0.83 x 1.67 m  
Transportation dimensions (l x w x h): 1.54 x 0.88 x 1.21 m  
Packaged weight: 372 kg  
Energy source: human  
Power: not applicable  
Energy consumption: not applicable  
Pulverizing: crushing  
Pulverizing mechanism: jaw crusher (hardened steel semi-rotating head)  
Theoretical output: 0.6 m<sup>3</sup>/hour  
Daily theoretical output: 5 m<sup>3</sup>  
Factory price (EXW): D\*

The ITW Pendulum clay crusher meets the needs of small production units such as brickworks. It is a machine which is derived from the field of fired products and which can also be used for the production of CEBs. It grinds, crushes and screens dry clay concretions (schist, laterite or friable rock) producing a fine powder. The resulting clay will be free of any concretion and ready to be moulded into high quality blocks and other clay-based products. The clay is crushed between a flat static plate and a semi-circular hardened steel head which works on the principle of a pendulum, storing energy to make the machine operable using only light manual power.

### ETRA STRUCTURE - France TETRAMAC

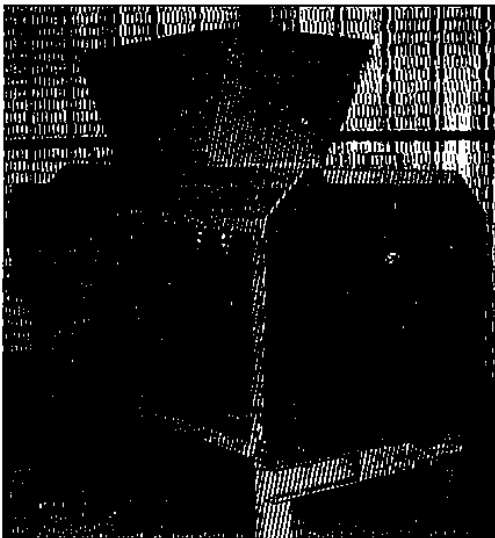

Category: pulverizer / screen  
Working dimensions (l x w x h): 1.60 x 0.95 x 1.38 m  
Transportation dimensions (l x w x h): 1.70 x 1.05 x 1.53 m  
Packaged weight: 750 / 820 kg  
Energy source: electric motor / diesel engine  
Power: 22 kW / 19 hp  
Energy consumption: 22 kWh / 3.0 - 3.5 l/hour  
Pulverizing: grinding  
Pulverizing mechanism: hammers  
Theoretical output: 9 m<sup>3</sup>/hour  
Daily theoretical output: 70 m<sup>3</sup>  
Factory price (EXW): E\* (electric) / F\* (diesel)

This grinder has been designed to reduce any type of soil to a particle size of less than 5 mm in diameter. Its power enables it to feed several production lines. All parts which wear out are easily replaceable and its wheels enable it to be moved around without difficulty.

## INVENTORY OF EQUIPMENT

### **INVENTORY OF MIXERS**

Characteristics should be interpreted in the following way.

#### **Working dimensions**

These are the maximum working dimensions of the machine excluding operators. If a lever is used, its travel is taken into account in these measurements.

#### **Transport dimensions**

This corresponds to the dimensions during transport of the piece of equipment, either packaged or towed as appropriate.

#### **Packaged weight**

This is the gross weight of the machine with its shipping packaging.

#### **Energy source**

The energy source is either human, electric or thermal (petrol or diesel motor).

#### **Power**

Depending on the type of motor, this is given in kW or hp.

#### **Energy consumption**

Depending on the type of motor, this is given in kWh or l/hour.

#### **Mixing**

This consists in planetary mixing or using a horizontal shaft.

#### **Mixing mechanism**

This is a succinct description of the system (e.g. vertical axis with blades, etc.)

#### **Drum capacity**

This is the maximum capacity of the drum.

#### **Operational capacity**

This corresponds to the volume of earth that can be placed in the drum. In excess of this capacity, mixing no longer takes place in a regular way. This figure is provided by the manufacturer.

#### **Theoretical output**

This is provided by the manufacturer in m<sup>3</sup>/h of finished product or calculated on the basis of one mix every 4 minutes. Theoretical output bears no relation to actual output in the field.

#### **Daily theoretical output**

This is provided by the manufacturer in m<sup>3</sup> or is obtained by multiplying the hourly theoretical output by 8 hours.

#### **Factory price (EXW)**

This is provided by the manufacturer, see also "Price" in the section on "General criteria". All prices (valid at 01/01/94) have been converted into ecus. This is identified by a letter and by one or more asterisks which relate to a range of prices which can be looked up in the table entitled "Range of prices".

## INVENTORY OF EQUIPMENT

### ALTECH - France MALAXEUR 250 L

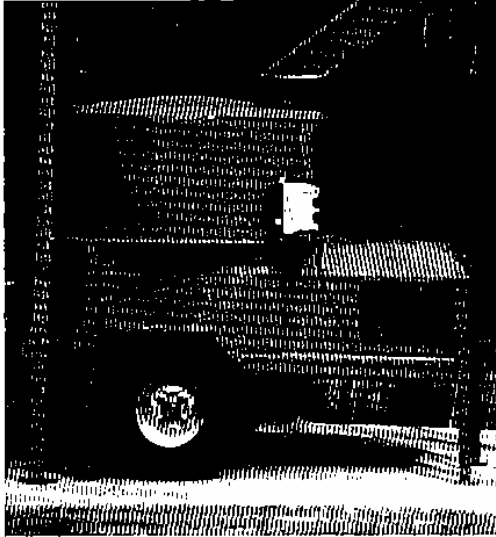

Category: mixer  
Working dimensions (l x w x h): 1.50 x 1.15 x 1.15 m  
Transportation dimensions (l x w x h): 1.60 x 1.25 x 1.25 m  
Packaged weight: 300 kg  
Energy source: electric motor / petrol engine  
Power: 7.5 hp / 8.5 hp  
Energy consumption: 5 kWh / not communicated  
Mixing: planetary  
Mixing mechanism: vertical shaft equipped with blades  
Drum capacity: 250 l  
Operational capacity: 120 l  
Daily theoretical output: 25 m<sup>3</sup>  
Factory price (EXW): E\* (electric) / E\*\* (petrol)

Specially developed for the preparation of stabilized soil, this machine can process more than 3 m<sup>3</sup> of mix per hour. Simple and fast, it can feed two GEO 50 presses and thus produce more than 3,000 blocks. All parts which wear out are easily replaceable and it is extremely simple to maintain. Mounted on wheels, it can be moved around by one man. The mixer is fitted with a safety lid with grid.

### ALTECH - France MALAXEUR 320 L



Category: mixer  
Working dimensions (l x w x h): 1.70 x 1.45 x 1.40 m  
Transportation dimensions (l x w x h): 1.80 x 1.55 x 1.50 m  
Packaged weight: 420 kg  
Energy source: electric motor / petrol / diesel engine  
Power: 8.5 hp / 10 hp / 10 hp  
Energy consumption: 6 kWh / not communicated  
Mixing: planetary  
Mixing mechanism: vertical shaft equipped with blades  
Drum capacity: 320 l  
Operational capacity: 160 - 200 l  
Daily theoretical output: 40 m<sup>3</sup>  
Factory price (EXW): F\*

Similar to the 250 litre mixer, this machine can process 5 m<sup>3</sup> per hour. Simple and fast, it can feed two GEO 50 presses and thus produce more than 5,000 blocks. All parts which wear out are easily replaceable and it is extremely simple to maintain. Mounted on wheels, it can be moved around by one man, but it is also supplied as a fixed unit. The mixer is fitted with a safety lid with grid.



## INVENTORY OF EQUIPMENT

### APPRO-TECHNO - Belgium TERSTAMIX

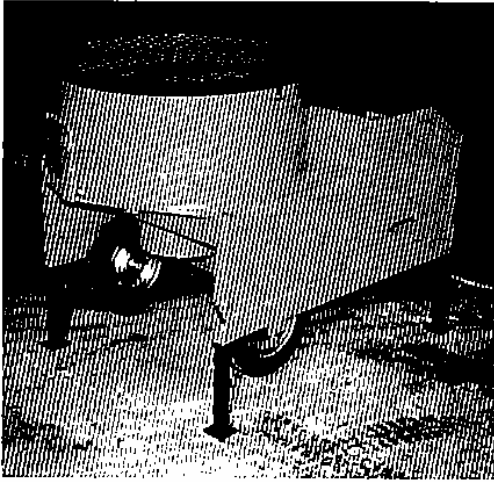

Category: mixer  
Working dimensions (l x w x h): 1.40 x 1.10 x 1.20 m  
Transportation dimensions (l x w x h): 1.70 x 1.10 x 1.15 m  
Packaged weight: 578 / 600 kg  
Energy source: electric motor / diesel engine  
Power: 7.5 hp / 9 hp  
Energy consumption: 5.5 kWh / 1.7 l/hour  
Mixing: planetary  
Mixing mechanism: non turning antiwear steel drum and 2-blade rotary mill  
Drum capacity: 250 l  
Operational capacity: 180 l  
Daily theoretical output: 24 m<sup>3</sup>  
Factory price (EXW): E<sup>4</sup> (electric) / E<sup>4</sup> (diesel)

This mixer makes it possible to obtain an homogeneous mixture of cement and soil. Thanks to this homogeneous mixing, the percentage of cement can be reduced to 4 or 5%. The shape of the blades prevents the formation of soil lumps. Since the mixing is the most delicate and most laborious operation, setting up a mixing machine in a production line is very much appreciated. It is easy to move around thanks to its wheels. When in its high position, a wheelbarrow can be wheeled under the emptying hatch.

### ATIKA MASCHINENFABRIK - Germany TZ 200/125

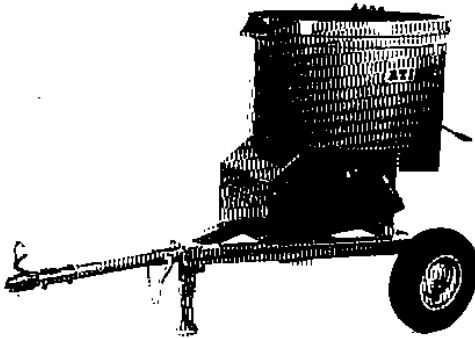

Category: mixer  
Working dimensions (l x w x h): 1.40 x 1.10 x 1.20 m  
Transportation dimensions (l x w x h): 1.55 x 1.25 x 1.35 m  
Packaged weight: 300 kg  
Energy source: electric motor  
Power: 2 kW  
Energy consumption: 2 kWh  
Mixing: planetary  
Mixing mechanism: rotating drum and 3-blade rotary mill  
Drum capacity: 200 l  
Operational capacity: 125 l  
Daily theoretical output: 15 m<sup>3</sup>  
Factory price (EXW): C<sup>3</sup>

The ATIKA TZ 200/125 forced mixer is not only ideal for concrete and mortar, but also for earth. High efficiency and fast mixing are the main features of the mixing mechanism which includes 3 offset, ideally located mixing paddles. A sliding hatch underneath the drum allows the mix to be quickly and directly unloaded. The drum protection cover and the grid ensure maximum safety by allowing the machinery to work in a closed chamber.

## INVENTORY OF EQUIPMENT

### CERATEC - Belgium CERAMIX 250 LC/LF

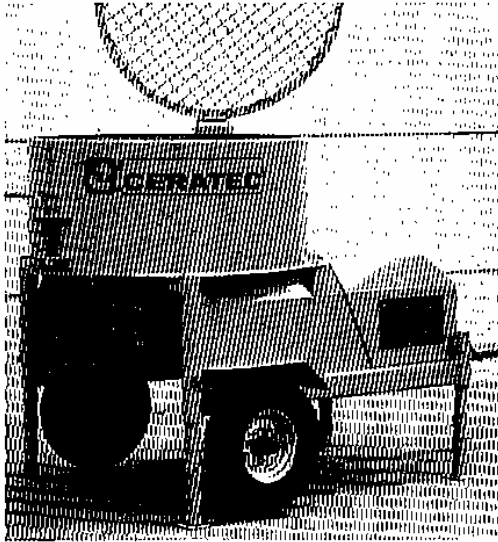

Category: mixer  
Working dimensions (l x w x h): 1.55 x 1.10 x 1.20 m  
Transportation dimensions (l x w x h): 1.60 x 1.15 x 1.30 m  
Packaged weight: 300 kg  
Energy source: electric motor / petrol / diesel engine  
Power: 3.5 kW / 7.5 hp / 7.5 hp  
Energy consumption: 3.5 kWh / 1.3 l/hour / 0.9 l/hour  
Mixing: planetary  
Mixing mechanism: blades fixed on a rotary vertical shaft  
Drum capacity: 250 l  
Operational capacity: 180 l  
Daily theoretical output: 21.6 m<sup>3</sup>  
Factory price (EXW): E\*\*

These mixers achieve extremely homogenous results whatever materials are present, and in little time compared to so-called rolling processes. The interior volume of a circular, vertical shaft drum is fitted throughout with scraping and mixing blades carefully positioned around a vertical shaft. The drum's gridded, removable safety cover enables the materials put in during the operation of the machine to be calibrated and protects the operator. The mix is removed through an opening hatch located at the bottom of the drum and under which a wheelbarrow can be wheeled.

### CITADOB INTERNATIONAL S.A. - Belgium STATION DE MALAXAGE



Category: mixer  
Working dimensions (l x w x h): 8.00 x 1.00 x 1.90 m  
Transportation dimensions (l x w x h): 5.00 x 1.00 x 1.90 m  
Packaged weight: 600 kg  
Energy source: electric motor  
Power: 6.25 kW  
Energy consumption: 6.25 kWh  
Mixing: horizontal shaft  
Mixing mechanism: non turning drum, 4 small blades rotating around the horizontal shaft  
Drum capacity: 120 l  
Operational capacity: 100 l  
Daily theoretical output: 17 m<sup>3</sup>  
Factory price (EXW): G\*

This is a mixing unit fitted with a horizontal shaft, a hopper and 2 loading and unloading conveyor belts, specially designed for producing compressed earth blocks.

## INVENTORY OF EQUIPMENT

### EDWARD BENTON & CO. LTD - United Kingdom CRETEANGLE TEC 225

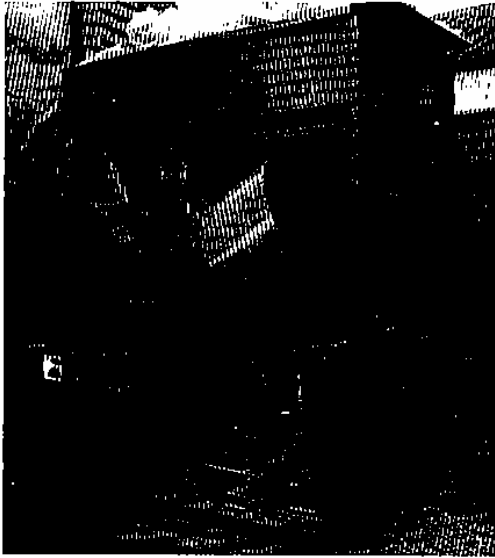

Category: mixer  
Working dimensions (l x w x h): 2.13 x 1.42 x 1.38 m  
Transportation dimensions (l x w x h): 2.21 x 1.50 x 1.40 m  
Packaged weight: 1 250 kg  
Energy source: electric motor  
Power: 10 hp  
Energy consumption: 7.5 kWh  
Mixing: planetary  
Mixing mechanism: gear unit driving mixing pan  
Drum capacity: 225 l  
Operational capacity: 112 l  
Daily theoretical output: 13.5 m<sup>3</sup>  
Factory price (EXW): G\*\*

This mixer is a factory production model with a fast and efficient mixing action achieved by the pan being driven and the aggregates turning the revolving star blade. Three fixed paddle blades divert the flow of the material into a defined path giving a forced mixing action, and the side scraper blade prevents the material building up on the side of the pan, and also diverts the mix back into the flow of material.

### ESA-SED - France CMD 250 LC/LF

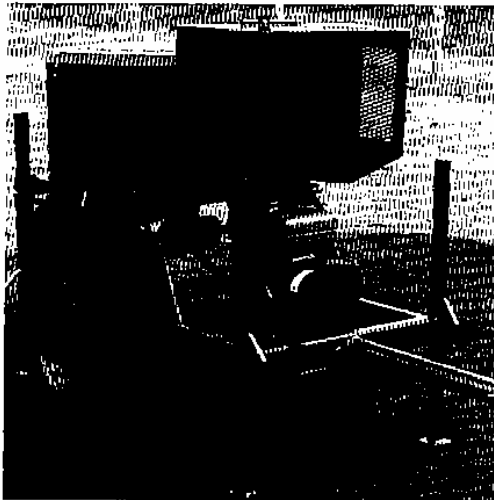

Category: mixer  
Working dimensions (l x w x h): 1.50 x 1.20 x 1.15 m  
Transportation dimensions (l x w x h): 2.25 x 1.15 x 1.15 m  
Packaged weight: 260 kg  
Energy source: electric motor / petrol engine  
Power: 7.5 hp / 8.5 hp  
Energy consumption: 5.5 kWh / not communicated  
Mixing: planetary  
Mixing mechanism: vertical shaft equipped with blades  
Drum capacity: 250 l  
Operational capacity: 160 l  
Daily theoretical output: 19.2 m<sup>3</sup>  
Factory price (EXW): E\* (electric) / D\*\*\* (petrol)

This mixer achieves extremely homogenous results whatever materials are present, and in 5 to 10 times less time compared to so-called rolling processes (such as cement-mixers). It enables continuous operation, as a result of the fact that the drum does not tilt - the loading aperture is permanently open at the top and the unloading aperture permanently open at the bottom. This design enables samples to be taken during mixing and additional material to be added if necessary. The careful location and orientation of the blades allow the product to be removed in record time, even in the case of adhesive mixes.

## INVENTORY OF EQUIPMENT

### ESA-SED - France CMD 320 LC

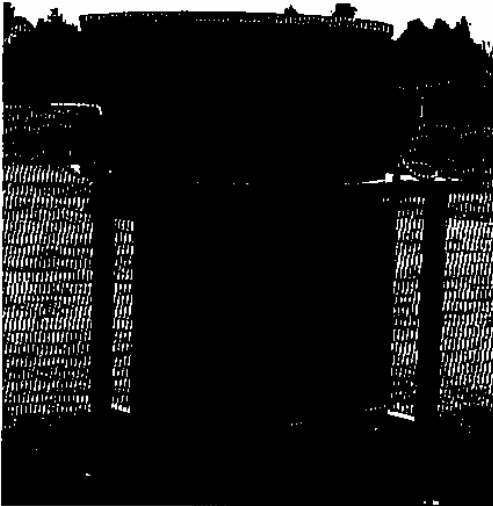

Category: mixer  
Working dimensions (l x w x h): 1.40 x 1.25 x 1.75 m  
Transportation dimensions (l x w x h): 1.40 x 1.25 x 1.70 m  
Packaged weight: 380 kg  
Energy source: electric motor  
Power: 10 hp  
Energy consumption: 7.5 kWh  
Mixing: planetary  
Mixing mechanism: vertical shaft equipped with blades  
Drum capacity: 320 l  
Operational capacity: 240 l  
Daily theoretical output: 28.8 m<sup>3</sup>  
Factory price (EXW): E\*\*\*

Like the CMD 250 LC/LF, the CMD 320 LC achieves extremely homogenous mixes whatever materials are present. It enables continuous operation, as a result of the fact that the drum does not tilt - the loading aperture is permanently open at the top and the unloading aperture permanently open at the bottom. This design enables samples to be taken during mixing and additional material to be added if necessary. The careful location and orientation of the blades allow the product to be removed in record time, even in the case of adhesive mixes..

---

### ESA-SED - France CMD 500 LC

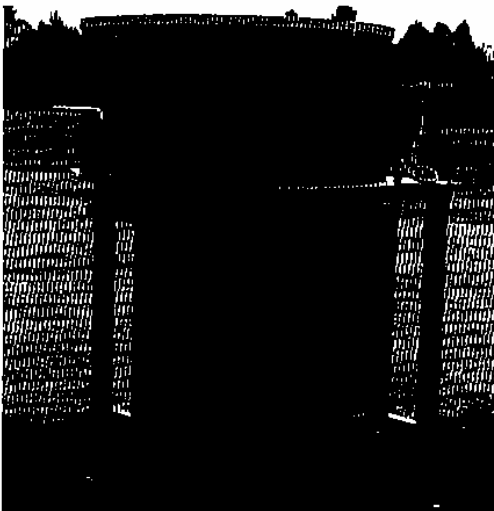

Category: mixer  
Working dimensions (l x w x h): 1.50 x 1.30 x 1.75 m  
Transportation dimensions (l x w x h): 1.50 x 1.30 x 1.70 m  
Packaged weight: 420 kg  
Energy source: electric motor  
Power: 12 hp  
Energy consumption: 8.8 kWh  
Mixing: planetary  
Mixing mechanism: vertical shaft equipped with blades  
Drum capacity: 500 l  
Operational capacity: 375 l  
Daily theoretical output: 45 m<sup>3</sup>  
Factory price (EXW): F\*

Like the CMD 250 LC/LF and the CMD 320 LC, the CMD 500 LC mixer achieves extremely homogenous mixes whatever materials are present. It enables continuous operation, as a result of the fact that the drum does not tilt - the loading aperture is permanently open at the top and the unloading aperture permanently open at the bottom. This design enables samples to be taken during mixing and additional material to be added if necessary. The careful location and orientation of the blades allow the product to be removed in record time, even in the case of adhesive mixes.

## INVENTORY OF EQUIPMENT

### OSKAM V/F - Netherlands T75

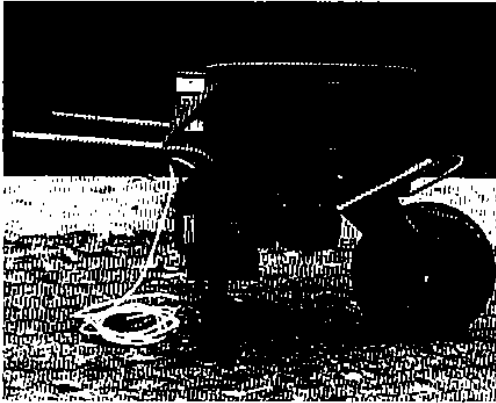

Category: mixer  
Working dimensions (l x w x h): 0.70 x 0.54 x 0.30 m  
Transportation dimensions (l x w x h): 0.70 x 0.54 x 0.30 m  
Packaged weight: 90 kg  
Energy source: electric motor  
Power: 1 hp  
Energy consumption: 1.1 kWh  
Mixing: planetary  
Mixing mechanism: screw gear directly driven by motor  
Drum capacity: 70 l  
Operational capacity: 50 l  
Daily theoretical output: 5 m<sup>3</sup>  
Factory price (EXW): C\*

Small and effective forced cement mixer, perfect for mixing small amounts of mortar or lime. Easy to move due to its compact size (approximately the size of a wheelbarrow).

---

### OSKAM V/F - Netherlands T 300 / 310

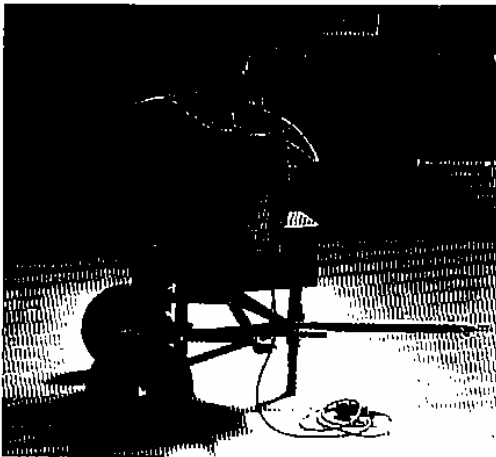

Category: mixer  
Working dimensions (l x w x h): 1.43 x 1.00 x 1.10 m  
Transportation dimensions (l x w x h): 1.43 x 1.00 x 1.10 m  
Packaged weight: 310 kg  
Energy source: electric motor  
Power: 3 hp  
Energy consumption: 4 kWh  
Mixing: planetary  
Mixing mechanism: screw gear directly driven by motor  
Drum capacity: 300 l  
Operational capacity: 170 l  
Daily theoretical output: 20 m<sup>3</sup>  
Factory price (EXW): C\*\*\* / D\*\*\* (with options).

This mixer was originally designed by the late Vang Svendsgaard from Denmark, who had over 20 years' experience in this field. A electronic weighing and water-spraying system can be added to the basic unit.

## INVENTORY OF EQUIPMENT

### OSKAM V/F - Netherlands T 500

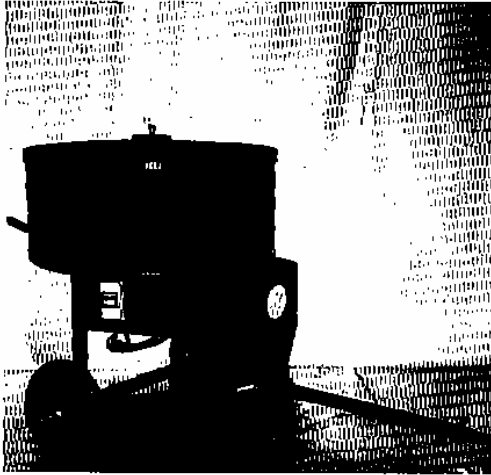

Category: mixer  
Working dimensions (l x w x h): 1.43 x 1.40 x 1.20 m  
Transportation dimensions (l x w x h): 1.43 x 1.40 x 1.20 m  
Packaged weight: 500 kg  
Energy source: electric motor  
Power: 7.5 hp  
Energy consumption: 5.5 kWh  
Mixing: planetary  
Mixing mechanism: screw gear directly driven by motor  
Drum capacity: 500 l  
Operational capacity: 300 l  
Daily theoretical output: 40 m<sup>3</sup>  
Factory price (EXW): D\*\*

Originally designed to mix light and heavy concrete, this machine produces highly homogeneous mixtures from any component. Mixing can be done dry or wet in more or less three minutes. The machine is been designed so that the product can be taken out or components can be added during the mixing operation. Cleaning and maintenance of unit is simple since the mixing unit can be raised and adjusted in height, thus facilitating cleaning of mixing bowl bottom.

---

### TETRA STRUCTURE - France TETRAMIX

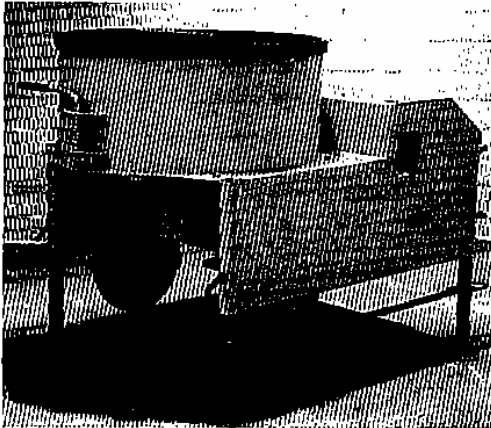

Category: mixer  
Working dimensions (l x w x h): 1.40 x 1.10 x 1.20 m  
Transportation dimensions (l x w x h): 1.70 x 1.10 x 1.15 m  
Packaged weight: 578 / 600 kg  
Energy source: electric motor / diesel engine  
Power: 7.5 hp / 9 hp  
Energy consumption: 5.5 kWh / 1.7 l/hour  
Mixing: planetary  
Mixing mechanism: non turning antiwear steel tank and a 2-blade rotary mill  
Drum capacity: 250 l  
Operational capacity: 180 l  
Daily theoretical output: 24 m<sup>3</sup>  
Factory price (EXW): E\* (electric) / E\*\*\* (diesel)

This mixer is specially designed for soil-based mixes. It allows good homogeneity of mixes to be rapidly achieved. It is easy to move around the production area thanks to its wheels.

## INVENTORY OF EQUIPMENT

### **INVENTORY OF PRESSES**

Characteristics should be interpreted in the following way.

#### **Working dimensions**

These are the maximum working dimensions of the machine excluding operators. If a lever is used, its travel is taken into account in these measurements.

#### **Transport dimensions**

This corresponds to the dimensions during transport of the piece of equipment, either packaged or towed as appropriate.

#### **Packaged weight**

This is the gross weight of the machine with its shipping packaging.

#### **Energy source**

The energy source is either human, electric or thermal (petrol or diesel motor).

#### **Energy consumption**

Depending on the type of motor, this is given in kWh or l/hour.

#### **Compression**

This is either static or dynamic or both. For more details, refer to the section on "Technical criteria".

#### **Available force**

See "Technical criteria", data expressed in kN (10 kN = 1T) provided by the manufacturer.

#### **Compression pressure**

See "Technical criteria".

#### **Compression mode**

Simple or double.

#### **Compression ratio**

See "Technical criteria".

#### **Compression mechanism**

Description of the system; for more details see "Technical criteria".

#### **Number of moulds per table**

See "Technical criteria".

## INVENTORY OF EQUIPMENT

### **Number of blocks per cycle**

This may differ from the number of moulds per table, in the case of turning tables. It is always lower or equal to the number of moulds per table.

### **Theoretical output**

This is provided by the manufacturer in m<sup>3</sup>/h of finished product. Theoretical output bears no relation to actual output in the field.

### **Daily theoretical output**

This is provided by the manufacturer in m<sup>3</sup> of blocks produced or is obtained by multiplying the hourly theoretical output by 8 hours.

### **Categories of blocks**

These are the blocks obtained using currently available moulds (see "Diversity of products").

- 1 : solid block
  - 2 : hollowed block
  - 3 : alveolate block
  - 4 : interlocking block
- Other products: moulds to be ordered.

### **Dimensions of blocks**

That is to say those which are obtained with the moulds delivered with the machine or the most common. If other moulds are currently available the note "(other sizes available)" is included next to the size of the reference blocks quoted.

### **Factory price (EXW)**

This is provided by the manufacturer, see also "Price" in the section on "General criteria". All prices (valid at 01/01/94) have been converted into ecus. This is identified by a letter and by one or more asterisks which relate to a range of prices which can be looked up in the table entitled "Range of prices".



## INVENTORY OF EQUIPMENT

### MANUAL PRESSES

ALTECH - France

#### GEO 50

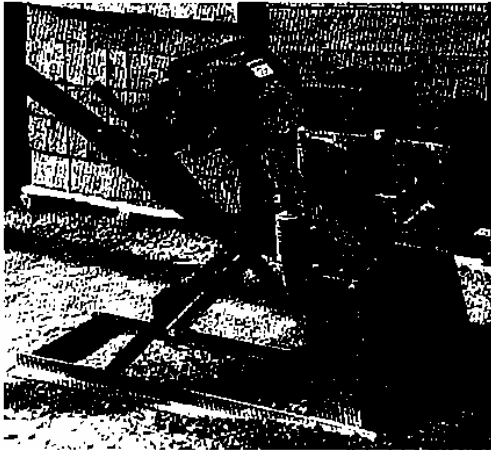

Category: manual press  
Production dimensions (l x w x h): 2.50 x 0.35 x 2.50 m  
Transportation dimensions (l x w x h): 1.20 x 0.60 x 0.60 m  
Packaged weight: 200 kg  
Energy source: human  
Energy consumption: not applicable  
Compression: static  
Available force: 150 kN  
Compression pressure: 3.5 MPa  
Available pressure at the end of compression: 2.5 - 3.5 MPa  
Compression mode: double  
Compression ratio: 1.75  
Compression mechanism: 2 vertical stroke pistons and suspended mechanism  
Number of moulds / table: 1  
Number of blocks / cycle: 1 (or 2 small sized)  
Theoretical output: 300 blocks/hour  
Daily theoretical output: 8.9 m<sup>3</sup>  
Categories of blocks: 1, 2  
Dimensions of blocks: 29.5 x 14.0 x 9.0 cm (other sizes available)  
Factory price (EXW): C\*\*

This is a genuine simultaneous action (upper and lower sides of the mould), double compression press. Compression and turning out of the block take place on the same side. The press is fitted with an adjustable measuring-out device and with an intermediate stacking table which facilitate the mould-filling and turning out operations. Several sizes of moulds are available. Easy to handle and to transport (180 kg), it does not need to be fixed to the ground.

APPRO-TECHNO - Belgium

#### TERSTARAM

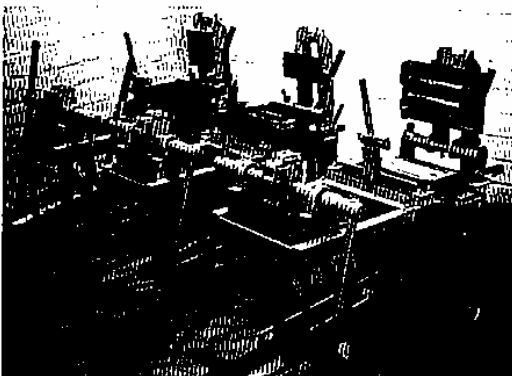

Category: manual press  
Production dimensions (l x w x h): 1.35 x 0.70 x 0.90 m  
Transportation dimensions (l x w x h): 1.50 x 0.55 x 1.02 m  
Packaged weight: 520 kg  
Energy source: human  
Energy consumption: not applicable  
Compression: static and dynamic  
Available force: 150 kN  
Compression pressure: 3.6 MPa + impact  
Available pressure at the end of compression: 1.0 MPa  
Compression mode: simple  
Compression ratio: 1.42 (+ hinged lid)  
Compression mechanism: vertical stroke piston and hinged lid  
Number of moulds / table: 1  
Number of blocks / cycle: 1 (or 2 small sized)  
Theoretical output: 190 blocks/hour  
Daily theoretical output: 5.7 m<sup>3</sup>  
Categories of blocks: 1, 2, other products  
Dimensions of blocks: 29.5 x 14.0 x 9.0 cm (other sizes available)  
Factory price (EXW): C\*\*

Ideal for the production of stabilized and fired bricks, tiles, floor tiles and salt bricks for livestock, the Terstaram can be used with moulds to meet customers required dimensions to a maximum of 29.5 x 29.5 cm and a maximum height of 10 cm. Changing the mould takes 15 minutes. Its design, robustness and standardization make it particularly suitable for tropical countries where its ease of maintenance is an added advantage.

## INVENTORY OF EQUIPMENT

### AUSBILDUNGSVERBUND METALL GmbH - Germany AVM CINVA RAM BLOCK PRESS



Category: manual press  
Production dimensions (l x w x h): 4.00 x 0.25 x 2.50 m  
Transportation dimensions (l x w x h): not communicated  
Packaged weight: 100 kg  
Energy source: human  
Energy consumption: not applicable  
Compression: static  
Available force: 90 kN  
Compression pressure: 2.0 MPa  
Available pressure at the end of compression: not communicated  
Compression mode: simple  
Compression ratio: not communicated  
Compression mechanism: vertical stroke piston  
Number of moulds / table: 1  
Number of blocks / cycle: 1  
Theoretical output: 60 blocks/hour  
Daily theoretical output: 2.2 m<sup>3</sup>  
Categories of blocks: 2  
Dimensions of blocks: 30.0 x 15.0 x 10.0 cm  
Factory price (EXW): B\*\*\*

The Metalwork Training Centre (Ausbildungsverbund Metall) in Rüsselsheim was asked by GATE to produce the CINVA Ram type soil block press for overseas projects. The model shown is an interlocking one but a hand operated press for solid blocks is also produced by this centre. These are probably the first CINVA Ram type presses to be built in Germany, and some modifications were made to satisfy official German DIN standards.

### B.B. BROTHERS TECHNOLOGICAL CO. - Nigeria B.B. PRESS

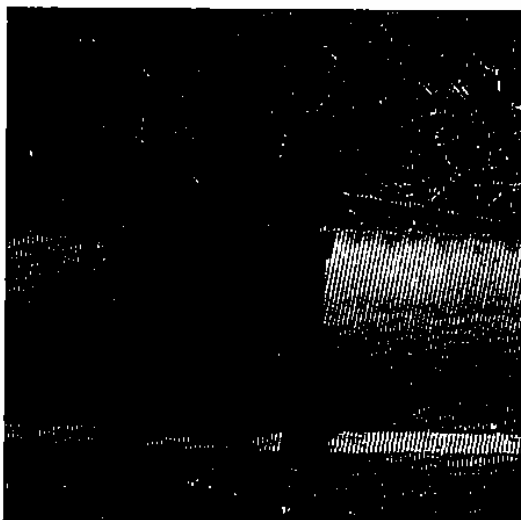

Category: manual press  
Production dimensions (l x w x h): 3.00 x 0.30 x 1.80 m  
Transportation dimensions (l x w x h): 0.60 x 0.40 x 0.80 m  
Packaged weight: 50 kg  
Energy source: human  
Energy consumption: not applicable  
Compression: static  
Available force: not communicated  
Compression pressure: not communicated  
Available pressure at the end of compression: not communicated  
Compression mode: simple  
Compression ratio: 1.50  
Compression mechanism: vertical stroke piston  
Number of moulds / table: 1  
Number of blocks / cycle: 1  
Theoretical output: 90 blocks/hour  
Daily theoretical output: 2.8 m<sup>3</sup>  
Categories of blocks: 1  
Dimensions of blocks: 29.5 x 14.0 x 9.5 cm  
Factory price (EXW): A\*

This is a CINVA Ram type press produced by B.B. Brothers Technological Co. since 1991..

## INVENTORY OF EQUIPMENT

### BOLYN CONSTRUCTIONS CO. LTD - Nigeria V.S. CINVA RAM

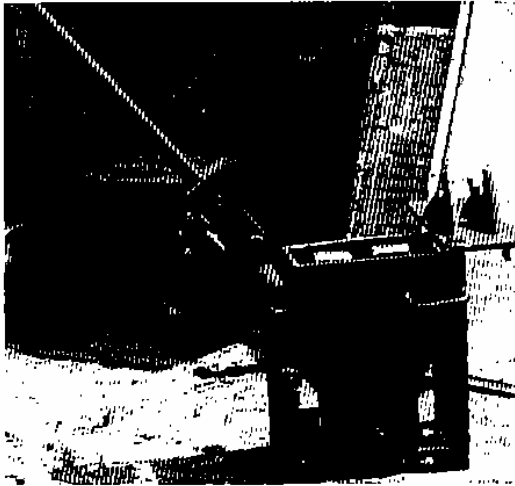

Category: manual press  
Production dimensions (l x w x h): 3.00 x 0.30 x 1.80 m  
Transportation dimensions (l x w x h): 0.60 x 0.40 x 0.80 m  
Packaged weight: 100 kg  
Energy source: human  
Energy consumption: not applicable  
Compression: static  
Available force: not communicated  
Compression pressure: not communicated  
Available pressure at the end of compression: not communicated  
Compression mode: simple  
Compression ratio: 1.50  
Compression mechanism: vertical stroke piston  
Number of moulds / table: 1  
Number of blocks / cycle: 1  
Theoretical output: 40 blocks/hour  
Daily theoretical output: 1.6 m<sup>3</sup>  
Categories of blocks: 1, 2  
Dimensions of blocks: 29.0 x 14.0 x 12.0 cm  
Factory price (EXW): B\*

The V.S. CINVA Ram, which was developed by Thomas Kubby of GATE, is a modified version of the famous Latin American machine it was named after. The modifications were developed on the basis of observations of local working conditions in Tanzania and problems encountered with other blockmaking machines. The main design objectives of the V.S. CINVA Ram were high resistance to rough use, prevention of overloading and simplification of manual operations.

### BOLYN CONSTRUCTIONS CO. LTD - Nigeria BOLYN SUPER BLOCK PRESS

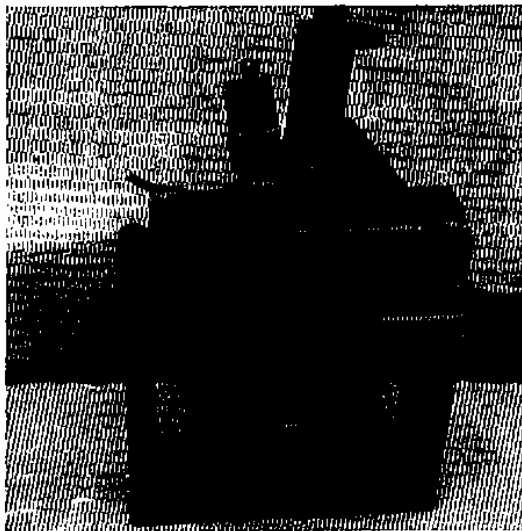

Category: manual press  
Production dimensions (l x w x h): 3.20 x 0.40 x 2.00 m  
Transportation dimensions (l x w x h): 0.80 x 0.50 x 0.95 m  
Packaged weight: 100 kg  
Energy source: human  
Energy consumption: not applicable  
Compression: static  
Available force: not communicated  
Compression pressure: not communicated  
Available pressure at the end of compression: not communicated  
Compression mode: simple  
Compression ratio: 1.55  
Compression mechanism: vertical stroke piston  
Number of moulds / table: 1  
Number of blocks / cycle: 1  
Theoretical output: 30 blocks/hour  
Daily theoretical output: 2.4 m<sup>3</sup>  
Categories of blocks: 1, 2  
Dimensions of blocks: 45.0 x 15.0 x 15.0 cm  
Factory price (EXW): B\*\*\*

The Bolyn Super Block Press, which produces bigger blocks, has been manufactured by this company to satisfy the demand of the Nigerian public who have been used to the bigger sandcrete blocks. This machine's design and manufacture were inspired by the V.S. CINVA Ram Block Press. It should be noted that if it were produced any bigger, the lateritic soil block would be too heavy to carry and too difficult to eject. The present size of 450 x 150 x 150 mm should be good enough.

## INVENTORY OF EQUIPMENT

### BOLYN CONSTRUCTIONS CO. LTD - Nigeria BOLYN TWIN BLOCK PRESS



Category: manual press  
Production dimensions (l x w x h): 3.00 x 0.45 x 1.80 m  
Transportation dimensions (l x w x h): 0.60 x 0.55 x 0.80 m  
Packaged weight: 180 kg  
Energy source: human  
Energy consumption: not applicable  
Compression: static  
Available force: not communicated  
Compression pressure: not communicated  
Available pressure at the end of compression: not communicated  
Compression mode: simple  
Compression ratio: 1.70  
Compression mechanism: vertical stroke piston  
Number of moulds / table: 2  
Number of blocks / cycle: 2  
Theoretical output: 80 blocks/hour  
Daily theoretical output: 2.6 m<sup>3</sup>  
Categories of blocks: 1, 2  
Dimensions of blocks: 29.0 x 14.0 x 10.0 cm  
Factory price (EXW): B\*\*\*

The Bolyn Twin Block Press is a modified version of the V.S. CINVA Ram designed to produce two blocks per cycle. It was developed by Bolyn Constructions Company Limited to meet the demand of clients in need of higher daily production. The principal features of this block press is that it now has two mould boxes and most of the components necessary for achieving a very good compaction have been strengthened. The operations are similar to the V.S. CINVA Ram Block Press.

### CARTEM PRODUCTS LIMITED - United Kingdom MANUAL ELEPHANT BLOCKMAKER

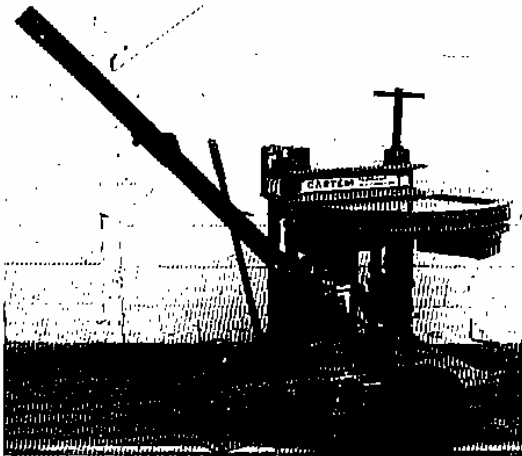

Category: manual press  
Production dimensions (l x w x h): 2.00 x 1.05 x 1.15 m  
Transportation dimensions (l x w x h): 1.50 x 1.28 x 1.15 m  
Packaged weight: 625 kg  
Energy source: human  
Energy consumption: not applicable  
Compression: static  
Available force: 440 kN  
Compression pressure: 10.8 MPa  
Available pressure at the end of compression: 10.8 MPa  
Compression mode: simple  
Compression ratio: 1.80  
Compression mechanism: vertical stroke piston and hydraulic jack  
Number of moulds / table: 3  
Number of blocks / cycle: 1  
Theoretical output: 120 blocks/hour  
Daily theoretical output: 3.9 m<sup>3</sup>  
Categories of blocks: 1, 2  
Dimensions of blocks: 29.0 x 14.0 x 10.0 cm  
Factory price (EXW): E\*

The Cartem Elephant Blockmaker is designed to produce soil blocks by means of a very simple hydraulic system. The machine consists of a rotary table carrying three moulds enabling the three basic operations to be performed at the same time, i.e. fill, press and eject. Pre-compaction, compaction and ejection are all manual operations.

## INVENTORY OF EQUIPMENT

### CERATEC - Belgium CERAMAN

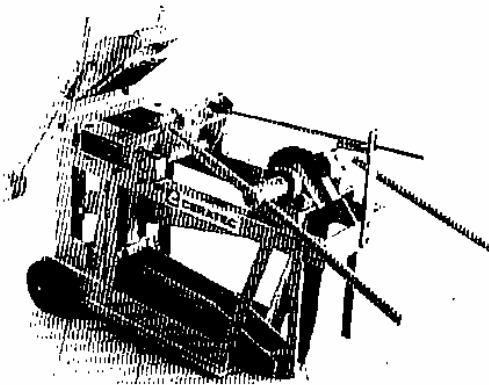

Category: manual press  
Production dimensions (l x w x h): 1.40 x 0.50 x 1.00 m  
Transportation dimensions (l x w x h): 1.49 x 0.66 x 1.16 m  
Packaged weight: 500 / 610 / 650 kg  
Energy source: human  
Energy consumption: not applicable  
Compression: static and dynamic  
Available force: 100 kN  
Compression pressure: 2.4 MPa + impact  
Available pressure at the end of compression: not communicated  
Compression mode: simple  
Compression ratio: 1.60 (+ hinged lid)  
Compression mechanism: vertical stroke piston and hinged lid  
Number of moulds / table: 1  
Number of blocks / cycle: 1 (or 2 small sized)  
Theoretical output: 190 blocks/hour  
Daily theoretical output: 5.5 m<sup>3</sup>  
Categories of blocks: 1, 2, other products  
Dimensions of blocks: 29.5 x 14.0 x 8.8 cm (other sizes available)  
Factory price (EXW): C\*\*

This manual press is a mobile and very robust machine intended for the moulding of untreated earth blocks and stabilized blocks, as well as fired bricks and roof tiles. It requires only two unskilled operators. Compression is achieved by turning the levers in one direction, whilst the automatic unbolting of the lid and the ejection of the products takes place by turning the levers in the opposite direction.

### CONCRETE MACHINERY SYSTEMS LTD - United Kingdom BREPAK

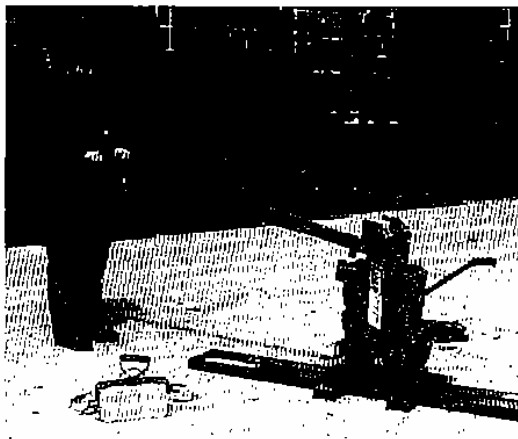

Category: manual press  
Production dimensions (l x w x h): 3.60 x 0.51 x 2.40 m  
Transportation dimensions (l x w x h): 0.84 x 0.62 x 0.92 m  
Packaged weight: 180 kg  
Energy source: human  
Energy consumption: not applicable  
Compression: static  
Available force: 440 kN  
Compression pressure: 10.8 MPa  
Available pressure at the end of compression: 10.8 MPa  
Compression mode: simple  
Compression ratio: 1.55 - 1.94  
Compression mechanism: vertical stroke piston and hydraulic jack  
Number of moulds / table: 1  
Number of blocks / cycle: 1  
Theoretical output: 60 blocks/hour  
Daily theoretical output: 1.9 m<sup>3</sup>  
Categories of blocks: 1 (2, 3 on request)  
Dimensions of blocks: 29.0 x 14.0 x 10.0 cm  
Factory price (EXW): D\*

The Brepak block press was developed in 1980 by D.J.T. Webb at the Building Research Establishment at Watford, England. The aim was to produce stabilized soil blocks of good appearance with a compaction pressure around 10 N/mm<sup>2</sup>, for increased strength and durability, facilitating wall construction without external rendering, despite low quantities of stabilizer. This machine is a small manual press that can be easily moved. It is fitted with a hydraulic jack to ensure high compression pressure.

## INVENTORY OF EQUIPMENT

### **NIGERIAN BUILDING AND ROAD RESEARCH INSTITUTE - Nigeria NBRII BLOCK MAKING MACHINE**



Category: manual press  
Production dimensions (l x w x h): 2.00 x 0.50 x 1.50 m  
Transportation dimensions (l x w x h): 0.62 x 0.60 x 0.95 m  
Packaged weight: 145 kg  
Energy source: human  
Energy consumption: not applicable  
Compression: static  
Available force: not communicated  
Compression pressure: 3.0 MPa  
Available pressure at the end of compression: 2.3 MPa  
Compression mode: simple  
Compression ratio: 1.50  
Compression mechanism: vertical stroke piston  
Number of moulds / table: 2  
Number of blocks / cycle: 2  
Theoretical output: 100 blocks/hour  
Daily theoretical output: 3.2 m<sup>3</sup>  
Categories of blocks: 2  
Dimensions of blocks: 29.0 x 14.0 x 10.0 cm  
Factory price (EXW): A\*\*

The machine developed by this institute is designed to produce two bricks or blocks per operation. Each block produced has the dimension of 29.0 x 14.0 x 10.0 cm. In addition, the brick has a frog which helps in binding mortar during brick-laying. Compression pressure of at least 3 N/mm<sup>2</sup> is produced by the machine and applied to the soil. On the average, a production output of 600 bricks per 8 hour working day has been recorded by a three man team.

## INVENTORY OF EQUIPMENT

### JEAN RIFFON - Belgium MECKA-21

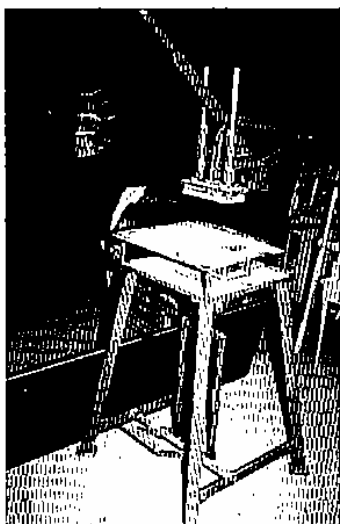

Category: manual press  
Production dimensions (l x w x h): 1.50 x 0.80 x 2.00 m  
Transportation dimensions (l x w x h): 0.80 x 0.80 x 2.00 m  
Packaged weight: 200 kg  
Energy source: human  
Energy consumption: not applicable  
Compression: dynamic and static  
Available force: not communicated  
Compression pressure: not communicated  
Available pressure at the end of compression: not communicated  
Compression mode: simple  
Compression ratio: 1.78  
Compression mechanism: vertical stroke piston.  
Number of moulds / table: 1  
Number of blocks / cycle: 1  
Theoretical output: 60 blocks/hour  
Daily theoretical output: 0.7 m<sup>3</sup>  
Categories of blocks: 1  
Dimensions of blocks: 22.0 x 10.5 x 6.0 cm  
Factory price (EXW): C\*\*\*

The Mecka-21 is a complete system, robust and requiring no particular maintenance of moving parts (joints are in Ertalyte). A lever arm with counterweight gives uniform compression of the materials in the block located on the table. The counterweight, apart from providing high compression with normal exertion, ensures that the lever arm returns into the upper position automatically as soon as it is released.

### RURAL INDUSTRIES INNOVATION CENTRE - Botswana CINVA RAM TYPE BLOCK PRESS



Category: manual press  
Production dimensions (l x w x h): 3.60 x 0.30 x 2.50 m  
Transportation dimensions (l x w x h): 0.60 x 0.40 x 0.80 m  
Packaged weight: 100 kg  
Energy source: human  
Energy consumption: not applicable  
Compression: static  
Available force: not communicated  
Compression pressure: not communicated  
Available pressure at the end of compression: not communicated  
Compression mode: simple  
Compression ratio: 1.50  
Compression mechanism: vertical stroke piston  
Number of moulds / table: 1  
Number of blocks / cycle: 1  
Theoretical output: 30 blocks/hour  
Daily theoretical output: 1.2 m<sup>3</sup>  
Categories of blocks: 1  
Dimensions of blocks: 30.0 x 15.0 x 11.0 cm  
Factory price (EXW): A\*\*\*

This press was produced in collaboration with GATE (Germany).

## INVENTORY OF EQUIPMENT

### SHELTERTECH - Zimbabwe SHELTERTECH BLOCK PRESS

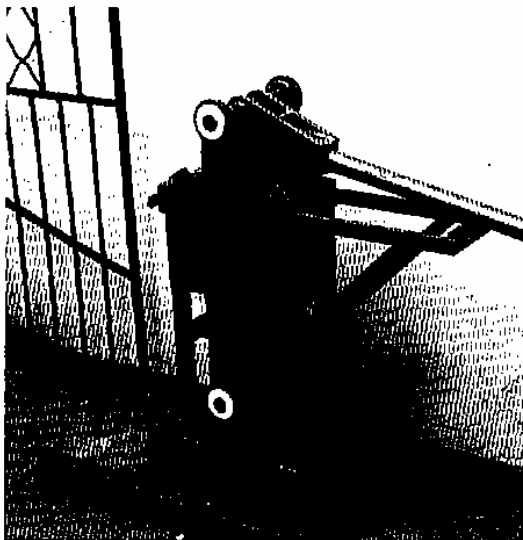

Category: manual press  
Production dimensions (l x w x h): 2.30 x 0.50 x 2.70 m  
Transportation dimensions (l x w x h): 1.52 x 0.52 x 1.05 m  
Packaged weight: 200 kg  
Energy source: human  
Energy consumption: not applicable  
Compression: static  
Available force: 85 kN  
Compression pressure: 1 - 2 MPa  
Available pressure at the end of compression: not communicated  
Compression mode: simple  
Compression ratio: 1.60  
Compression mechanism: vertical stroke piston and eccentric mechanism  
Number of moulds / table: 1  
Number of blocks / cycle: 1  
Theoretical output: 40 blocks/hour  
Daily theoretical output: 1.5 m<sup>3</sup>  
Categories of blocks: 1  
Dimensions of blocks: 29.5 x 14.0 x 11.5 cm  
Factory price (EXW): B\*\*\*

The press was developed in 1990 in conjunction with ITDG (United Kingdom). The press was extensively tested on a number of projects. It has not only been supplied to small scale production groups in Zimbabwe, but also to customers in Zimbabwe and to South Africa. The price includes the press, gauging shovel, sieve and shrinkage mould, but excludes packing and transport.

### SOCIÉTÉ D'ÉTUDES ET ENTREPRISE D'ÉQUIPEMENT - Côte d'Ivoire PRESSE IPNETP-LBTP

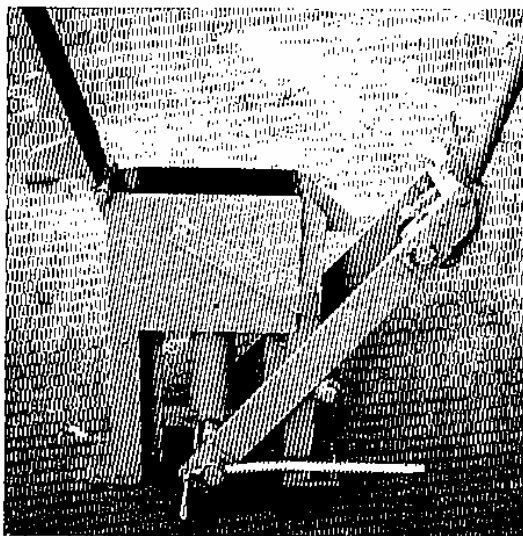

Category: manual press  
Production dimensions (l x w x h): 2.00 x 0.36 x 2.50 m  
Transportation dimensions (l x w x h): not communicated  
Packaged weight: not communicated  
Energy source: human  
Energy consumption: not applicable  
Compression: static  
Available force: not communicated  
Compression pressure: not communicated  
Available pressure at the end of compression: 1.5 - 2.0 MPa  
Compression mode: double  
Compression ratio: 1.70 - 1.90  
Compression mechanism: vertical stroke piston  
Number of moulds / table: 1  
Number of blocks / cycle: 1  
Theoretical output: 60 blocks/hour  
Daily theoretical output: 2.5 m<sup>3</sup>  
Categories of blocks: 1  
Dimensions of blocks: 29.0 x 14.0 x 13.0 cm  
Factory price (EXW): not communicated

This press was developed in 1986 by IPNETP-LBTP, Abidjan. The main advantage of the double compression mode of the press is to eliminate the manual precompression sometimes used on the same type of press. The compression ratio obtained for the manufacture of solid blocks is from 1.7 to 1.9, depending on the material used and the adjustment of the height of the mould. A movable partition enables half-blocks to be made to enable correct bonding patterns.



## INVENTORY OF EQUIPMENT

### SOCIÉTÉ NOUVELLE ABIDJAN INDUSTRIE - Côte d'Ivoire PRESSE À PARPAING

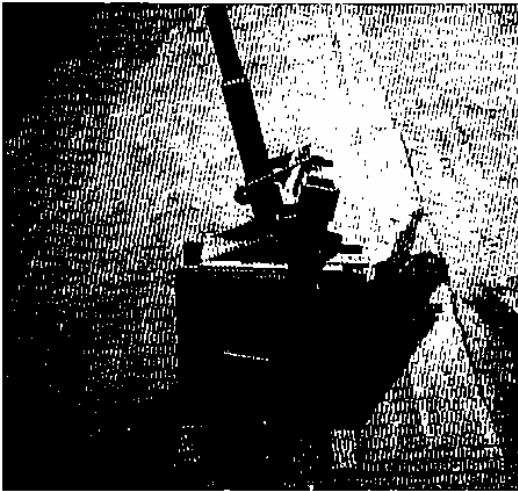

Category: manual press  
Production dimensions (l x w x h): 2.00 x 0.25 x 2.40 m  
Transportation dimensions (l x w x h): not communicated  
Packaged weight: 85 kg  
Energy source: human  
Energy consumption: not applicable  
Compression: static  
Available force: 45 kN  
Compression pressure: 1.1 MPa  
Available pressure at the end of compression: not communicated  
Compression mode: simple  
Compression ratio: not communicated  
Compression mechanism: vertical stroke piston  
Number of moulds / table: 1  
Number of blocks / cycle: 1  
Theoretical output: 60 blocks/hour  
Daily theoretical output: 2.3 m<sup>3</sup>  
Categories of blocks: 1  
Dimensions of blocks: 29.0 x 14.0 x 12.0 cm  
Factory price (EXW): B\*

This press is a small, robust, compact, well balanced machine, which is fixed to the ground on a concrete slab, and which requires little compression effort.

---

### TETRA STRUCTURE - France TPM

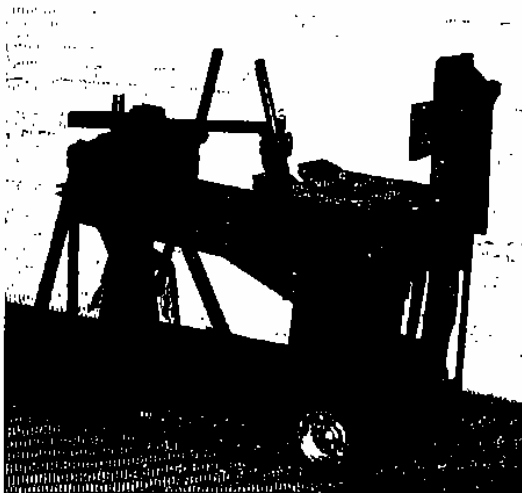

Category: manual press  
Production dimensions (l x w x h): 1.35 x 0.70 x 0.90 m  
Transportation dimensions (l x w x h): 1.50 x 0.55 x 1.02 m  
Packaged weight: 520 kg  
Energy source: human  
Energy consumption: not applicable  
Compression: static and dynamic  
Available force: 150 kN  
Compression pressure: 3.6 MPa + impact  
Available pressure at the end of compression: not communicated  
Compression mode: simple  
Compression ratio: 1.42 (+ hinged lid)  
Compression mechanism: vertical stroke piston and hinged lid  
Number of moulds / table: 1  
Number of blocks / cycle: 1 (or 2 small sized)  
Theoretical output: 190 blocks/hour  
Daily theoretical output: 5.7 m<sup>3</sup>  
Categories of blocks: 1, 2, other products  
Dimensions of blocks: 29.5 x 14.0 x 9.0 cm (other sizes available)  
Factory price (EXW): C\*\*

The TPM is a robust manual press. Various types of moulds can be used with it. It can be easily maintained locally. It can be very easily moved around the production area thanks to its wheels.

## INVENTORY OF EQUIPMENT

### UNATA - Belgium UNATA 1003

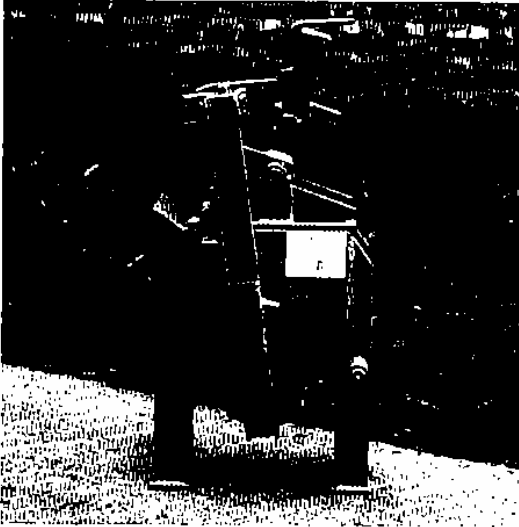

Category: manual press  
Production dimensions (l x w x h): 4.80 x 0.26 x 2.50 m  
Transportation dimensions (l x w x h): 0.49 x 0.31 x 0.95 m  
Packaged weight: 100 kg  
Energy source: human  
Energy consumption: not applicable  
Compression: static  
Available force: 100 kN  
Compression pressure: 2.5 MPa  
Available pressure at the end of compression: not communicated  
Compression mode: simple  
Compression ratio: 1.55  
Compression mechanism: vertical stroke piston  
Number of moulds / table: 1  
Number of blocks / cycle: 1  
Theoretical output: 120 blocks/hour  
Daily theoretical output: 3.5 m<sup>3</sup>  
Categories of blocks: 1  
Dimensions of blocks: 29.0 x 14.0 x 9.0 cm  
Factory price (EXW): B\*\*\*

This machine is inspired by the CINVA Ram. The first version of the machine was made available in 1982. It is a small manual press, easily transportable, robust and very simple to use.

### THE UNDUGU SOCIETY - Kenya ACTION PACK BLOCK PRESS

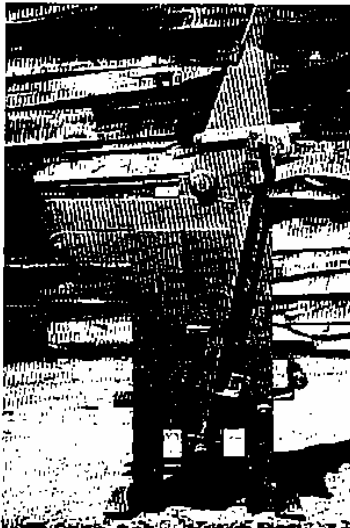

Category: manual press  
Production dimensions (l x w x h): 5.00 x 0.30 x 2.60 m  
Transportation dimensions (l x w x h): not communicated  
Packaged weight: not communicated  
Energy source: human  
Energy consumption: not applicable  
Compression: static  
Available force: not communicated  
Compression pressure: not communicated  
Available pressure at the end of compression: not communicated  
Compression mode: simple  
Compression ratio: not communicated  
Compression mechanism: vertical stroke piston  
Number of moulds / table: 1  
Number of blocks / cycle: 1  
Theoretical output: 90 blocks/hour  
Daily theoretical output: 3.4 m<sup>3</sup>  
Categories of blocks: 1  
Dimensions of blocks: 29.0 x 14.0 x 11.5 cm  
Factory price (EXW): A\*\*\*

This heavy duty, manually operated, locally manufactured, high compaction block press is widely known and used throughout Kenya and elsewhere in Africa. It was originally designed by ApproTEC staff, when working at Action Aid-Kenya's Appropriate Technology Unit. The press is an ideal tool for small businesses, building contractors, co-operatives, self-help groups and individuals.

## INVENTORY OF EQUIPMENT

### **URPATA SAHEL - Senegal URPATA 5005**

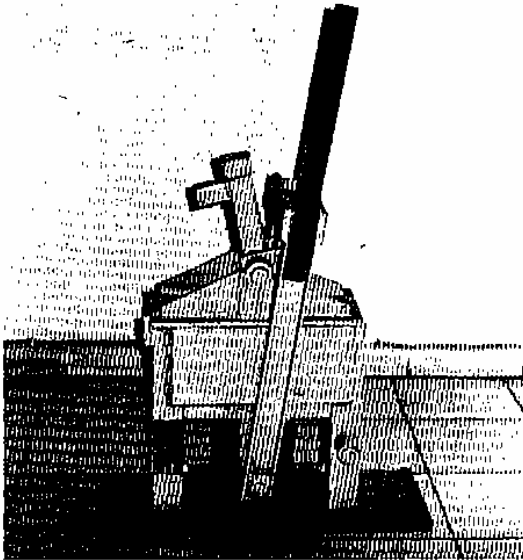

Category: manual press  
Production dimensions (l x w x h): 4.80 x 0.28 x 2.50 m  
Transportation dimensions (l x w x h): 0.50 x 0.35 x 0.75 m  
Packaged weight: 102 kg  
Energy source: human  
Energy consumption: not applicable  
Compression: static  
Available force: 150 kN  
Compression pressure: 3.7 MPa  
Available pressure at the end of compression: not communicated  
Compression mode: simple  
Compression ratio: 1.56  
Compression mechanism: vertical stroke piston  
Number of moulds / table: 1  
Number of blocks / cycle: 1  
Theoretical output: 50 blocks/hour  
Daily theoretical output: 1.50 m<sup>3</sup>  
Categories of blocks: 1  
Dimensions of blocks: 29.5 x 14.0 x 9.0 cm  
Factory price (EXW): 8\*\*

This press is simple to use and suitable for improving rural and urban housing. It has been manufactured, sold and distributed by Urpata Sahel since 1990. It was designed in collaboration with UNATA (Belgium).

## INVENTORY OF EQUIPMENT

### MOTORIZED PRESSES

#### AIDAN - France TB 200



Category: motorized press  
Production dimensions (l x w x h): 3.30 x 2.60 x 2.20 m  
Transportation dimensions (l x w x h): 3.30 x 1.65 x 1.70 m  
Packaged weight: 1 300 kg  
Energy source: diesel engine  
Energy consumption: 2.5 l/hour  
Compression: static  
Available force: 45 - 105 kN  
Compression pressure: 1.5 - 3.5 MPa  
Available pressure at the end of compression: not communicated  
Compression mode: simple  
Compression ratio: not communicated  
Compression mechanism: horizontal stroke hydraulic jack  
Number of moulds / table: 1  
Number of blocks / cycle: 1  
Theoretical output: 240 blocks/hour  
Daily theoretical output: 14.4 m<sup>3</sup>  
Categories of blocks: 1  
Dimensions of blocks: 30.0 x 25.0 x 10.0 cm  
Factory price (EXW): H\*\*

This machine consists of a hopper with screen, a press, a diesel engine driving the hydraulic pumps, a hydraulic distribution system and a control box including an automatic device using an electromechanical relay. The volume of fill of the mould can be adjusted, providing a choice of the width of the block of between 3 and 25 cm.

#### AIDAN - France TB 700

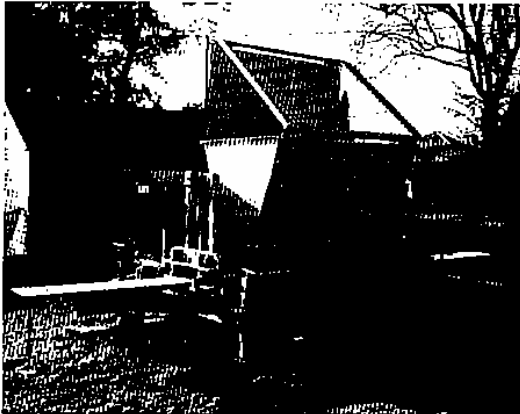

Category: motorized press  
Production dimensions (l x w x h): 6.50 x 2.00 x 3.00 m  
Transportation dimensions (l x w x h): 3.80 x 2.00 x 2.00 m  
Packaged weight: 3 600 kg  
Energy source: diesel engine (optional extra: electric motor)  
Energy consumption: 7 l/hour  
Compression: static  
Available force: 108 - 540 kN  
Compression pressure: 4.0 - 20.0 MPa  
Available pressure at the end of compression: not communicated  
Compression mode: simple  
Compression ratio: not communicated  
Compression mechanism: horizontal stroke hydraulic jack  
Number of moulds / table: 1  
Number of blocks / cycle: 1  
Theoretical output: 720 blocks/hour  
Daily theoretical output: 38.9 m<sup>3</sup>  
Categories of blocks: 1  
Dimensions of blocks: 30.0 x 25.0 x 9.0 cm  
Factory price (EXW): I\*\*

The mechanical principle of this machine is identical to that of the TB 200. It is fitted with a control box including an automatic device using a programmable automation management system. The automatic devices can be disengaged and enable manually commanded manufacture or automatic unloading of the hopper if necessary. These machines are fitted with an emergency stop mechanism. The width of the blocks can be selected by modifying the volume of fill (between 3 and 25 cm).

## INVENTORY OF EQUIPMENT

### ALTECH - France PACT 500

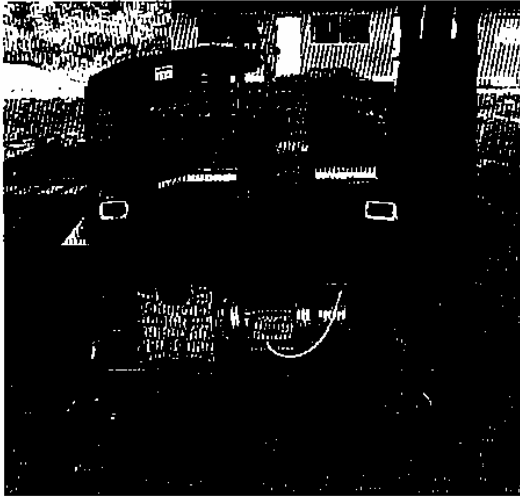

Category: motorized press  
Production dimensions (l x w x h): 1.30 x 1.00 x 1.30 m  
Transportation dimensions (l x w x h): 1.20 x 1.10 x 1.40 m  
Packaged weight: 800 kg  
Energy source: electric motor  
Energy consumption: 1.5 kWh  
Compression: static  
Available force: 300 kN  
Compression pressure: 7.2 MPa  
Available pressure at the end of compression: 6.0 - 7.0 MPa  
Compression mode: simple  
Compression ratio: 1.80  
Compression mechanism: vertical stroke piston  
Number of moulds / table: 4  
Number of blocks / cycle: 1 (or 2 small sized)  
Theoretical output: 460 blocks/hour  
Daily theoretical output: 13.7 m<sup>3</sup>  
Categories of blocks: 1  
Dimensions of blocks: 29.5 x 14.0 x 9.0 cm (other sizes available)  
Factory price (EXW): G\*

This is a small, entirely mechanical motorized press. The rotating plate fitted with four moulds enables compression, turning out and filling to take place simultaneously. The latter is carried out using a shovel to fill a fixed hopper. Easily moved around on its two pneumatic wheels, it is operational in a few minutes. The rotation of the plate may be manual or motorized.

### ALTECH - France GEO 1000

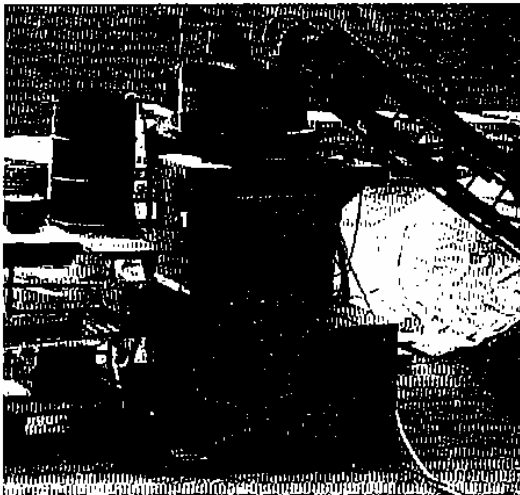

Category: motorized press  
Production dimensions (l x w x h): 2.50 x 1.00 x 1.80 m  
Transportation dimensions (l x w x h): 2.50 x 1.00 x 1.80 m  
Packaged weight: 1 200 kg  
Energy source: electric motor  
Energy consumption: 4 kWh  
Compression: static  
Available force: 300 kN  
Compression pressure: 7.2 MPa  
Available pressure at the end of compression: 7.2 MPa  
Compression mode: double  
Compression ratio: 2.20  
Compression mechanism: vertical stroke piston hydraulic jack  
Number of moulds / table: 1  
Number of blocks / cycle: 1 (or 2 small sized)  
Theoretical output: 360 blocks/hour  
Daily theoretical output: 10.7 m<sup>3</sup>  
Categories of blocks: 1  
Dimensions of blocks: 29.5 x 14.0 x 9.0 cm (other sizes available)  
Factory price (EXW): G\*\*\*

With its double compression hydraulic system driven by a single jack, the GEO 100 is a model of simplicity. Used in a mobile or fixed production unit, it is designed to produce 2,500 bricks per day with three operators. The single jack located towards the top is entirely protected and never comes into contact with the soil. The press is capable of producing a wide range of block sizes up to 40 x 20 x 10 cm. Mounted on a road chassis with its mixer, it weighs only 1,800 kg.

## INVENTORY OF EQUIPMENT

### APPRO-TECHNO - Belgium SEMI-TERSTAMATIQUE

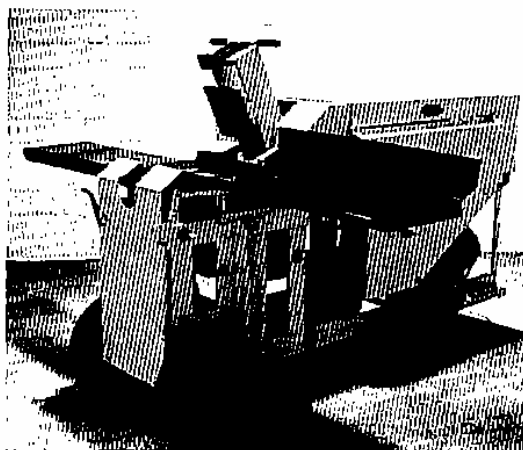

Category: motorized press  
Production dimensions (l x w x h): 2.20 x 0.65 x 1.10 m  
Transportation dimensions (l x w x h): 2.27 x 0.75 x 1.12 m  
Packaged weight: 1 600 kg  
Energy source: electric motor / diesel  
Energy consumption: 1.2 kWh / 1.2 l/hour  
Compression: static and dynamic  
Available force: 300 kN  
Compression pressure: 7.2 MPa + impact  
Available pressure at the end of compression: not communicated  
Compression mode: simple  
Compression ratio: 1.42 (+ hinged lid)  
Compression mechanism: vertical stroke piston and hinged lid  
Number of moulds / table: 1  
Number of blocks / cycle: 1 (or 2 small sized)  
Theoretical output: 300 blocks/hour  
Daily theoretical output: 8.9 m<sup>3</sup>  
Categories of blocks: 1, 2, other products  
Dimensions of blocks: 29.5 x 14.0 x 9.0 cm (other sizes available)  
Factory price (EXW): F\*\*\*

This machine is designed to withstand rough and intensive use even in severe climatic conditions. It can be easily maintained with a few tools. A powerful spring in the pushing mechanism avoids all the problems which could be caused by very poor quality soil or by over-filling the moulds. The moulds used are compatible with the Terstaram and Terstamatique presses. Different types of blocks can be produced. A wide range of moulds is available and they can be changed in less than 15 minutes.

### APPRO-TECHNO - Belgium TERSTAMATIQUE

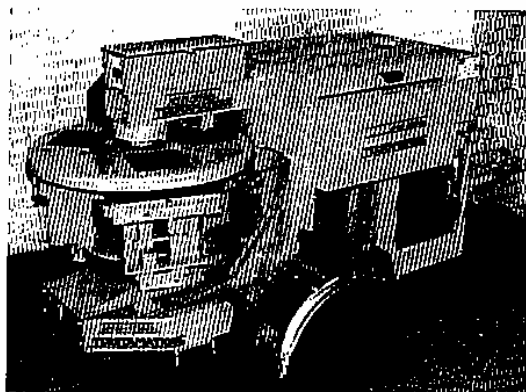

Category: motorized press  
Production dimensions (l x w x h): 2.70 x 1.70 x 1.50 m  
Transportation dimensions (l x w x h): 2.70 x 1.70 x 1.50 m  
Packaged weight: 2 585 kg / 2 515 kg  
Energy source: electric motor / diesel  
Energy consumption: 3.68 kWh / 1.7 l/hour  
Compression: static  
Available force: 300 kN  
Compression pressure: 7.2 MPa  
Available pressure at the end of compression: not communicated  
Compression mode: simple  
Compression ratio: 1.70 - 2.00 (+ precompression roller)  
Compression mechanism: vertical stroke piston and precompression roller (or Archimedean screw using forced feeding)  
Number of moulds / table: 3  
Number of blocks / cycle: 1 (or 2 small sized)  
Theoretical output: 980 blocks/hour (adjustable)  
Daily theoretical output: 28.4 m<sup>3</sup>  
Categories of blocks: 1, 2, other products  
Dimensions of blocks: 29.5 x 14.0 x 8.8 cm (other sizes available)  
Factory price (EXW): G\* (electric) / G\*\* (diesel)

This mobile and high speed automatic press completes the range of Terstaram and Semi-Terstaram presses, with which it has many parts in common, notably the moulds which are interchangeable. The turning table can hold up to three different moulds, the filling height and compression ratio of which are individually adjustable to suit each product perfectly. The speed of production is adjustable, thus allowing the operators to gradually become familiar with how to load and unload efficiently. A special compensation device prevents the press from jamming during operation.

## INVENTORY OF EQUIPMENT

### CARTEM PRODUCT LIMITED - United Kingdom POWERED ELEPHANT BLOCKMAKER

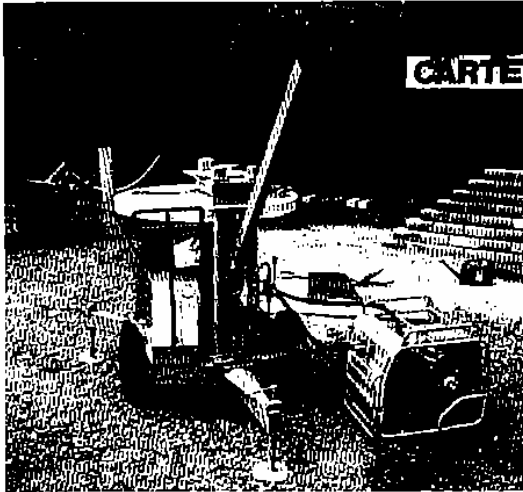

Category: motorized press  
Production dimensions (l x w x h): 2.00 x 0.50 x 1.15 m  
Transportation dimensions (l x w x h): 1.50 x 1.20 x 1.50 m  
Packaged weight: 660 kg  
Energy source: electric motor / diesel engine  
Energy consumption: 1.5 kWh / 0.5 l/hour  
Compression: static  
Available force: 440 kN  
Compression pressure: 10.8 MPa  
Available pressure at the end of compression: 10.8 MPa  
Compression mode: simple  
Compression ratio: 1.80  
Compression mechanism: vertical stroke piston and hydraulic jack  
Number of moulds / table: 3  
Number of blocks / cycle: 1  
Theoretical output: 240 blocks/hour  
Daily theoretical output: 7.8 m<sup>3</sup>  
Categories of blocks: 1, 2  
Dimensions of blocks: 29.0 x 14.0 x 9.0 cm  
Factory price (EXW): F\*

The CarTEM Elephant Blockmaker consists of a rotary table carrying three moulds. It is designed to produce soil blocks by means of a very simple hydraulic system. The hydraulic pressure is obtained either from an onboard electrically driven unit or by a separate, portable power pack. The machine is robust and easy to use. This makes it ideal for use in remote areas.

### CERATEC - Belgium CERAMATIC

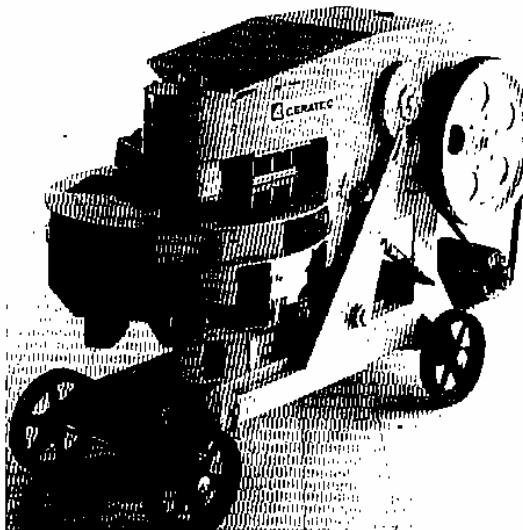

Category: motorized press  
Production dimensions (l x w x h): 2.00 x 1.00 x 1.40 m  
Transportation dimensions (l x w x h): 2.26 x 1.14 x 1.66 m  
Packaged weight: 2 400 kg  
Energy source: electric motor / diesel engine  
Energy consumption: 2.8 kWh / 0.6 l/hour  
Compression: static  
Available force: 300 kN  
Compression pressure: 7.3 MPa  
Available pressure at the end of compression: not communicated  
Compression mode: simple  
Compression ratio: 1.70 (+ precompression roller)  
Compression mechanism: vertical stroke piston and precompression roller  
Number of moulds / table: 3  
Number of blocks / cycle: 1 (or 2 small sized)  
Theoretical output: 750 blocks/hour  
Daily theoretical output: 17.3 m<sup>3</sup>  
Categories of blocks: 1, 2  
Dimensions of blocks: 29.5 x 14.0 x 7.0 cm (other sizes available)  
Factory price (EXW): G\*\*\*

The Ceramatic is an entirely mechanical automatic press. The rotating table holds three moulds which are respectively filled, compressed and turned out at the same time in the different parts of the machine. The driving power ensures that compression and ejection of the bricks is continuous and automatic, as well as the rotation of the table. Labour (two persons) is used only for loading the raw material and removing the finished products. The Ceramatic is equally suitable for manufacturing unstabilized or stabilized blocks (using cement or other binders) or fired bricks. It is immediately operational as soon as it arrives on site and can be moved around the production area thanks to its four wheels.

## INVENTORY OF EQUIPMENT

### **CITADOB INTERNATIONAL S.A. - Belgium PTC 180 T**

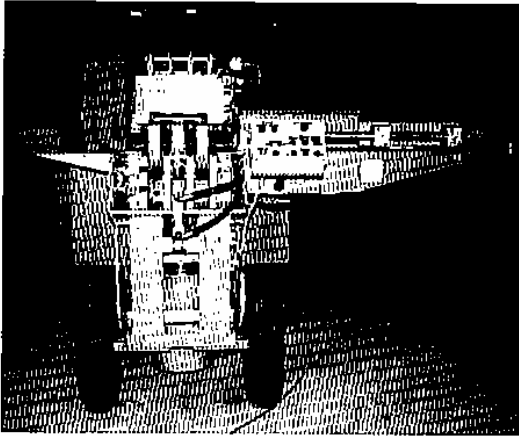

Category: motorized press  
Production dimensions (l x w x h): 2.00 x 3.00 x 1.50 m  
Transportation dimensions (l x w x h): 2.00 x 3.00 x 1.50 m  
Packaged weight: 1 800 kg  
Energy source: electric motor  
Energy consumption: 11 kWh  
Compression: static  
Available force: 1 000 kN  
Compression pressure: 16.0 MPa  
Available pressure at the end of compression: 12.8 MPa  
Compression mode: simple  
Compression ratio: 1.60 (+ hinged lid)  
Compression mechanism: vertical stroke piston and hinged lid  
Number of moulds / table: 1  
Number of blocks / cycle: 1  
Theoretical output: 180 blocks/hour  
Daily theoretical output: 11.5 m<sup>3</sup>  
Categories of blocks: 1, 2, 3, 4  
Dimensions of blocks: 40.0 x 20.0 x 10.0 cm (other sizes available)  
Factory price (EXW): I\*

The PTC 180 T is a hypercompressed earth block production unit. Thanks to its design, its size and its mobility, it is easy to use and perfectly suited to local production, even on the building site itself.



## INVENTORY OF EQUIPMENT

### MEGABRIK - France COMPACTA

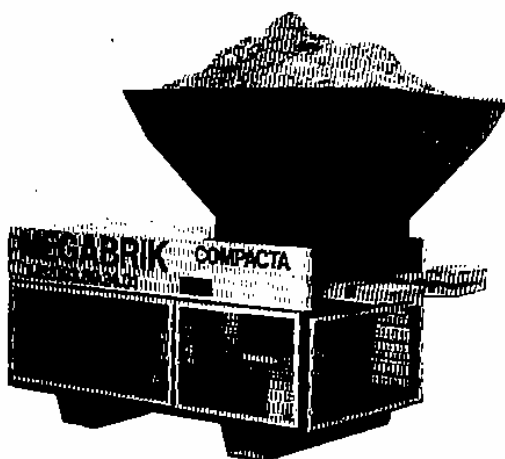

Category: motorized press  
Production dimensions (l x w x h): 2.00 x 1.10 x 1.50 m  
Transportation dimensions (l x w x h): 2.00 x 1.10 x 1.50 m  
Packaged weight: 2 000 kg  
Energy source: electric motor  
Energy consumption: 4 kWh  
Compression: static  
Available force: 320 kN  
Compression pressure: 5.3 MPa  
Available pressure at the end of compression: not communicated  
Compression mode: simple  
Compression ratio: 1.85  
Compression mechanism: vertical stroke piston  
Number of moulds / table: 2  
Number of blocks / cycle: 2  
Theoretical output: 480 blocks/hour  
Daily theoretical output: 23.0 m<sup>3</sup>  
Categories of blocks: 1  
Dimensions of blocks: 30.0 x 20.0 x 10.0 cm (other sizes available)  
Factory price (EXW): H\*

The press is fitted with an electronic sequencer which pilots the production cycle enabling the height of the blocks to be varied between 3 and 11 cm. The compression pressure can also be adjusted between 5 and 21 MPa depending on the type of material to be compacted. The Compacta is mounted in a trailer.

### OSKAM V/F - Netherlands OSKAM C.E.B.M.



Category: motorized press  
Production dimensions (l x w x h): 3.20 x 0.90 x 2.15 m  
Transportation dimensions (l x w x h): 2.50 x 0.90 x 1.80 m  
Packaged weight: 1 400 kg  
Energy source: diesel engine  
Energy consumption: 2.5 l/hour  
Compression: static  
Available force: 200 kN  
Compression pressure: 5.0 MPa  
Available pressure at the end of compression: 5.0 MPa  
Compression mode: simple  
Compression ratio: 1.80 / 2.00  
Compression mechanism: vertical stroke hydraulic jack  
Number of moulds / table: 1  
Number of blocks / cycle: 1  
Theoretical output: 300 blocks/hour  
Daily theoretical output: 8.9 m<sup>3</sup>  
Categories of blocks: 1, 2  
Dimensions of blocks: 29.0 x 14.0 x 9.0 cm (other sizes available)  
Factory price (EXW): G\*\*\* / H\*

This machine, originally designed in 1984, is a mobile motorized press. The rate of filling is controlled by a special device. The various operations of measuring out, filling, compression and turning out are automatic. The height of the block can be adjusted between 5 and 10 cm.

## INVENTORY OF EQUIPMENT

### SARET PPB - France T1

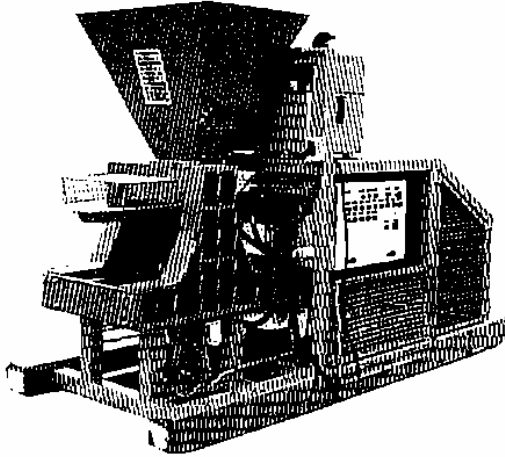

Category: motorized press  
Production dimensions (l x w x h): 3.40 x 1.80 x 2.40 m  
Transportation dimensions (l x w x h): 3.50 x 2.10 x 2.60 m  
Packaged weight: 4 800 kg  
Energy source: electric motor  
Energy consumption: 35 kWh  
Compression: static  
Available force: 700 kN  
Compression pressure: 10.0 - 17.0 MPa (adjustable)  
Available pressure at the end of compression: 17.0 MPa (maximum)  
Compression mode: simple  
Compression ratio: 2.00  
Compression mechanism: vertical stroke hydraulic jack  
Number of moulds / table: 1  
Number of blocks / cycle: 1  
Theoretical output: 300 blocks/hour  
Daily theoretical output: 11.7 m<sup>3</sup>  
Categories of blocks: 1  
Dimensions of blocks: 29.0 x 14.0 x 12.0 cm (other sizes available)  
Factory price (EXW): I\*\*

The T1 is a motorized press where the filling, compression and turning out cycle are done automatically. These operations are controlled independently of each other by an electro-mechanical device fitted with a release mechanism. This press is used in the T1A plant.

### TERRE 2000 - France PBT 40

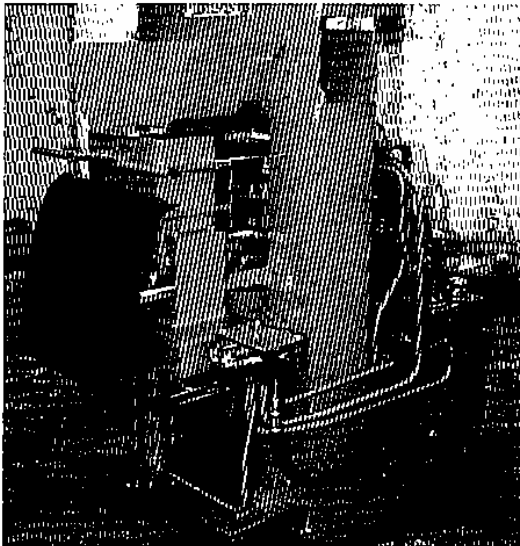

Category: motorized press  
Production dimensions (l x w x h): 1.60 x 1.00 x 1.70 m  
Transportation dimensions (l x w x h): 1.80 x 1.20 x 2.00 m  
Packaged weight: 600 kg  
Energy source: petrol engine  
Energy consumption: 1.5 l/hour  
Compression: static  
Available force: 400 kN  
Compression pressure: 9.0 MPa  
Available pressure at the end of compression: 9.0 MPa  
Compression mode: simple  
Compression ratio: 1.70 - 2.00  
Compression mechanism: vertical stroke hydraulic jack  
Number of moulds / table: 1  
Number of blocks / cycle: 1  
Theoretical output: 90 blocks/hour  
Daily theoretical output: 4.9 m<sup>3</sup>  
Categories of blocks: 1, 2  
Dimensions of blocks: 30.0 x 15.0 x 15.0 cm  
Factory price (EXW): G\*\*

This entirely hydraulic machine offers all the advantages of high compression presses, whilst remaining easy to transport, very economical (in terms of both investment and energy consumption) and very simple to operate. It has been designed to withstand all climatic conditions and requires little maintenance. Several presses used together in one production line can meet significant needs.

## INVENTORY OF EQUIPMENT

### TTETRA STRUCTURE - France TPSA 2

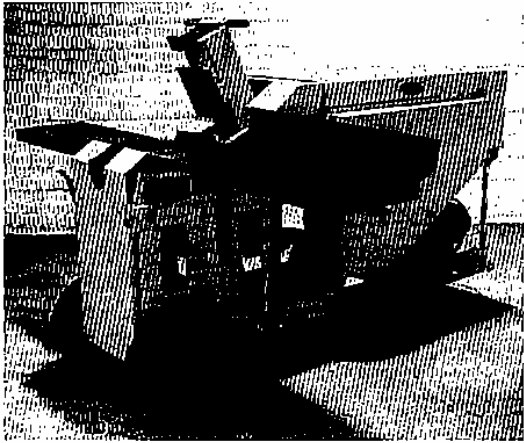

Category: motorized press  
Production dimensions (l x w x h): 2.20 x 0.65 x 1.10 m  
Transportation dimensions (l x w x h): 2.27 x 0.75 x 1.12 m  
Packaged weight: 1 000 kg  
Energy source: electric motor / diesel engine  
Energy consumption: 1.2 kWh / 1.2 l/hour  
Compression: static and dynamic  
Available force: 300 kN  
Compression pressure: 7.2 MPa + impact  
Available pressure at the end of compression: not communicated  
Compression mode: simple  
Compression ratio: 1.42 (+ hinged lid)  
Compression mechanism: vertical stroke piston and hinged lid  
Number of moulds / table: 1  
Number of blocks / cycle: 1 (or 2 small sized)  
Theoretical output: 300 blocks/hour  
Daily theoretical output: 8.9 m<sup>3</sup>  
Categories of blocks: 1, 2, other products  
Dimensions of blocks: 29.5 x 14.0 x 9.0 cm (other sizes available)  
Factory price (EXW): F\*\*\*

The motorized TPSA 2 press is a robust press fitted with wheels (for moving around on site only). Simple to use and to maintain, it can be used by a relatively unskilled operator. Several types of moulds can be used and take very little time to change.

## INVENTORY OF EQUIPMENT

### INTREX GmbH - Germany CLU 3000

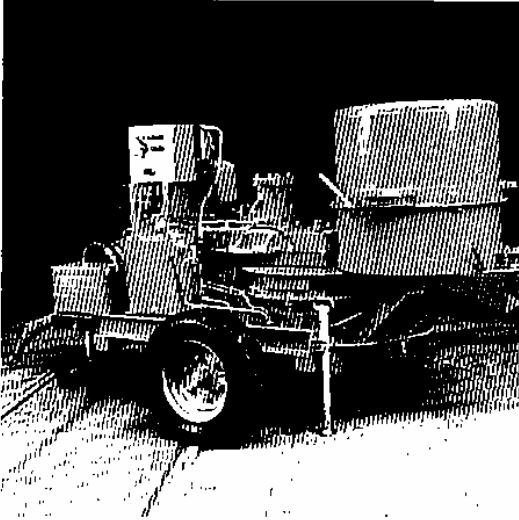

Category: production unit  
Production dimensions (l x w x h): 3.00 x 1.45 x 1.52 m  
Transportation dimensions (l x w x h): 3.20 x 1.65 x 1.88 m  
Packaged weight: 2 310 kg  
Energy source: diesel engine  
Energy consumption: 2.5 l/hour  
Compression: static  
Available force: 150 kN  
Compression pressure: 5.0 MPa  
Available pressure at the end of compression: not communicated  
Compression mode: simple  
Compression ratio: 1.80  
Compression mechanism: vertical stroke piston  
Number of moulds / table: 4  
Number of blocks / cycle: 1  
Theoretical output: 350 blocks/hour  
Daily theoretical output: 6.3 m<sup>3</sup>  
Categories of blocks: 1  
Dimensions of blocks: 25.0 x 12.0 x 7.5 cm (other sizes available)  
Factory price (EXW): H\*\*\*

The CLU 3000 mobile production unit is mounted on a frame fitted with two wheels with pneumatic tyres. A double level mixer allows the press and the mixer to operate simultaneously. The latter can also be used to produce mortar for laying the blocks.

### RAFFIN BERGER - France DYNATERRE 01-4 M



Category: production unit  
Production dimensions (l x w x h): 7.90 x 2.40 x 3.60 m  
Transportation dimensions (l x w x h): 5.80 x 2.40 x 3.60 m  
Packaged weight: 7 000 kg  
Energy source: electric motor  
Energy consumption: 12 kWh  
Compression: dynamic / static  
Available force: 350 kN  
Compression pressure: 1.0 MPa (adjustable)  
Available pressure at the end of compression: 1.0 MPa (adjustable)  
Compression mode: simple  
Compression ratio: 2.00  
Compression mechanism: vibrating table and vertical stroke hydraulic jack  
Number of moulds / table: 1 (4 stamps)  
Number of blocks / cycle: 4  
Theoretical output: 360 blocks/hour  
Daily theoretical output: 46.1 m<sup>3</sup>  
Categories of blocks: 1, 2, 3, other products  
Dimensions of blocks: 40.0 x 20.0 x 20.0 cm  
Factory price (EXW): J\*

The production unit includes a conveyor belt, a planetary mixer, a water tank, a hopper and a press. It is powered by an electric motor. A generator set is delivered as an optional extra. The feeding of the earth and the stabilizer is carried out by a hopper. The mixer is controlled manually. The filling, vibration, compression, turning out and evacuation operations are successively set in motion manually, and it is possible to repeat certain operations.

## INVENTORY OF EQUIPMENT

### PLANTS

LUCE P. - France

#### GEOLUCE 6000 - M.2



Category: plant  
Production dimensions (l x w x h): 10.00 x 6.00 x 3.00 m  
Transportation dimensions (l x w x h): 10.00 x 2.30 x 2.50 m  
Packaged weight: 36 000 kg  
Energy source: electric motor  
Energy consumption: 32.5 kWh  
Compression: dynamic by impact and static  
Available force: 6 000 kN  
Compression pressure: 25.0 MPa  
Available pressure at the end of compression: not communicated  
Compression mode: simple  
Compression ratio: 1.50 - 1.90  
Compression mechanism: 2 tamping heads driven by eccentric-powered sprung blades  
Number of moulds / table: 3 (4 stamps)  
Number of blocks / cycle: 4  
Theoretical output: 600 blocks/hour  
Daily theoretical output: 43.2 m<sup>3</sup>  
Categories of blocks: 1, 2, 3 and 4  
Dimensions of blocks: 30.0 x 20.0 x 15.0 cm  
Factory price (EXW): J\*\*\*

The GEOLUCE M.2 press consists of a rotating table 300 cm in diameter holding 3 moulds (other types hold 4, 5, or 6 moulds), a 1,200 litre hopper which automatically feeds the moulds, a tamping head and a stacker. Its particular feature is the use of very powerful mechanical tamping to ensure compaction. The mechanical system has been designed to be unaffected by high temperatures, which eliminates the risk of breakdown and makes operation and production very safe. The height of the blocks is adjustable between 5 and 15 cm.

LUCE P. - France

#### GEOLUCE 6000 - M.4

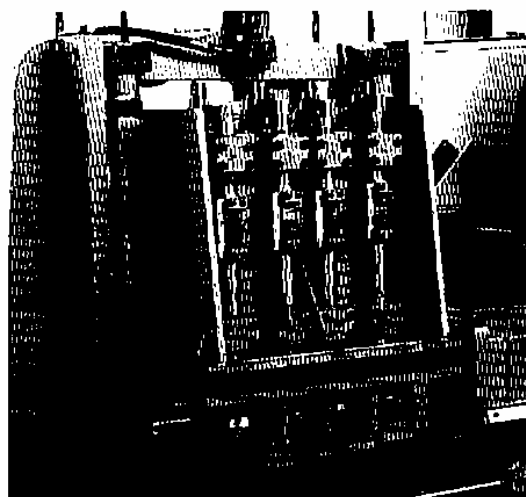

Category: plant  
Production dimensions (l x w x h): 10.00 x 6.00 x 3.00 m  
Transportation dimensions (l x w x h): 10.00 x 2.30 x 2.50 m  
Packaged weight: 37 000 kg  
Energy source: electric motor  
Energy consumption: 38 kWh  
Compression: dynamic by impact and static  
Available force: 10 000 kN  
Compression pressure: 42.0 MPa  
Available pressure at the end of compression: not communicated  
Compression mode: simple  
Compression ratio: 1.70 - 2.00  
Compression mechanism: 2 tamping heads driven by eccentric-powered sprung blades  
Number of moulds / table: 3 (4 stamps)  
Number of blocks / cycle: 4  
Theoretical output: 900 blocks/hour  
Daily theoretical output: 64.8 m<sup>3</sup>  
Categories of blocks: 1  
Dimensions of blocks: 30.0 x 20.0 x 15.0 cm  
Factory price (EXW): J\*\*\*

This press shares the same design as the GEOLUCE M.2 press and has the same advantages. Only the tamping head is different: it consists in 4 tamps which results in more powerful compaction (one tamp per block), and therefore in stronger blocks. The production cycle, however, is shorter (i.e. production is higher). The height of the blocks is adjustable between 5 and 15 cm.

## INVENTORY OF EQUIPMENT

### **SARET PPB - France TEROC T1A**

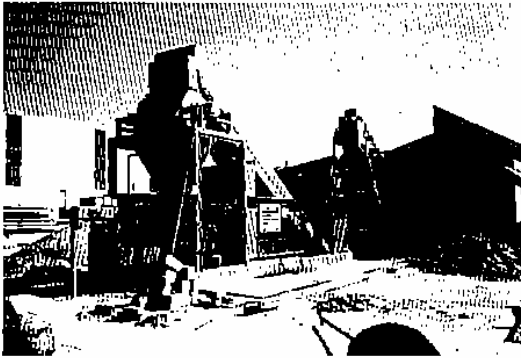

Category: plant  
Production dimensions (l x w x h): 5.90 x 1.80 x 3.40 m  
Transportation dimensions (l x w x h): 6.50 x 2.50 x 2.40 m  
Packaged weight: 7 000 kg  
Energy source: electric motor  
Energy consumption: 6.4 l/hour  
Compression: static  
Available force: 700 kN  
Compression pressure: 10.0 - 17.0 MPa (adjustable)  
Available pressure at the end of compression: 17.0 MPa (maximum)  
Compression mode: simple  
Compression ratio: 2.00  
Compression mechanism: hydraulic jack vertical stroke  
Number of moulds / table: 1  
Number of blocks / cycle: 1  
Theoretical output: 300 blocks/hour  
Daily theoretical output: 11.7 m<sup>3</sup>  
Categories of blocks: 1  
Dimensions of blocks: 29.0 x 14.0 x 12.0 cm  
Factory price (EXW): J<sup>†</sup>

The machine is a fixed production unit, moveable with the assistance of a crane or a winch or towable on site if equipped with the axles delivered as an optional extra. The production unit includes a multi-bucket chain, a rotating sieve, a small conical rotary hopper, a conveyor belt, a horizontal shaft mixer, a hopper, a T1 press, a device to evacuate the blocks and a stacking clamp. The unit is powered by a single engine. The filling, compression and turning out cycle is done automatically and is controlled independently of the other operations by an electro-mechanical device, which may be disengaged.

INVENTORY OF EQUIPMENT

**INDEX OF EQUIPMENT**

**Pulverizers**

Manufacturer	Country	Equipment	Page
ALTECH	FRANCE	BROYEUR PROJECTEUR	73
		BROYEUR TAMISEUR	73
APPRO-TECHNO	BELGIUM	BROYEUR DE TERRE TERSTARAM	74
		DÉSAGRÉGATEUR TERSTARAM	74
BOLYN CONSTRUCTIONS CO LTD	NIGERIA	SOIL SIEVE/DISINTEGRATOR	75
CERATEC	BELGIUM	CERADES H2 E/D	75
CITADOB INTERNATIONAL S.A.	BELGIUM	STATION DE CONCASSAGE/CRIBLAGE	76
OSKAM V/F	NETHERLANDS	KNUSTER	76
PARRY / ITW	UNITED KINGDOM	PENDULUM CLAY CRUSHER	77
TETRA STRUCTURE	FRANCE	TETRAMAC	77

**Mixers**

Manufacturer	Country	Equipment	Page
ALTECH	FRANCE	MALAXEUR 250 L	79
		MALAXEUR 320 L	79
APPRO-TECHNO	BELGIUM	TERSTAMIX	80
ATIKA MASCHINENFABRIK	GERMANY	TZ 200/125	80
CERATEC	BELGIUM	CERAMIX 250 LC/LF	81
CITADOB INTERNATIONAL S.A.	BELGIUM	STATION DE MALAXAGE	81
EDWARD BENTON & CO. LTD	UNITED KINGDOM	CRETEANGLE TEC 225	82
ESA-SED	FRANCE	CMD 250 LC/LF	82
		CMD 320 LC	83
		CMD 500 LC	83
OSKAM V/F	NETHERLANDS	T75	84
		T300/310	84
		T500	85
TETRA STRUCTURE	FRANCE	TETRAMIX	85

## INVENTORY OF EQUIPMENT

### **Manual presses**

Manufacturer	Country	Equipment	Page
ALTECH	FRANCE	GEO 50	88
APPRO-TECHNO	BELGIUM	TERSTARAM	88
AUSBILDUNGSVERBUND METALLGMBH	GERMANY	AVM CINVA RAM BLOCK PRESS	89
B. B. BROTHERS TECHNOLOGICAL CO.	NIGERIA	B. B. PRESS	89
BOLYN CONSTRUCTIONS CO. LTD	NIGERIA	V.S. CINVA RAM BOLYN SUPER BLOCK PRESS BOLYN TWIN BLOCK PRESS	90 90 91
CARTEM PRODUCTS LIMITED	UNITED KINGDOM	MANUAL ELEPHANT BLOCKMAKER	91
CERATEC	BELGIUM	CERAMAN	92
CONCRETE MACHINERY SYSTEMS LTD	UNITED KINGDOM	BREPAK	92
NIGERIAN BUILDING AND ROAD RESEARCH INSTITUTE	NIGERIA	NBRRI BLOCK MAKING MACHINE	93
JEAN RIFFON	BELGIUM	MECKA-21	94
RURAL INDUSTRIES INNOVATION CENTRE	BOTSWANA	CINVA RAM TYPE BLOCK PRESS	94
SHELTERTECH	ZIMBABWE	SHELTERTECH BLOCK PRESS	95
SOCIÉTÉ D'ÉTUDES ET ENTREPRISE D'ÉQUIPEMENT	CÔTE D'IVOIRE	PRESSE IPNETP-LBTP	95
SOCIÉTÉ NOUVELLE ABIDJAN INDUSTRIE	CÔTE D'IVOIRE	PRESSE À PARPAING	96
TETRA STRUCTURE	FRANCE	TPM	96
UNATA	BELGIUM	UNATA 1003	97
THE UNDUGU SOCIETY	KENYA	ACTION PACK BLOCK PRESS	97
URPATA SAHEL	SENEGAL	URPATA 5005	98



## INVENTORY OF EQUIPMENT

### **Motorized presses**

Manufacturer	Country	Equipment	Page
AIDAN	FRANCE	TB 200	99
		TB 700	99
ALTECH	FRANCE	PACT 500	100
		GEO 1000	100
APPRO-TECHNO	BELGIUM	SEMI-TERSTAMATIQUE	101
		TERSTAMATIQUE	101
CARTEM PRODUCT LIMITED	UNITED KINGDOM	POWERED ELEPHANT BLOCKMAKER	102
CERATEC	BELGIUM	CERAMATIC	102
CITADOB INTERNATIONAL S.A.	BELGIUM	PTC 180 T	103
MEGABRIK	FRANCE	COMPACTA	104
OSKAM V/F	NETHERLANDS	OSKAM C.E.B.M.	104
SARET PPB	FRANCE	T1	105
TERRE 2000	FRANCE	PBT 40	105
TETRA STRUCTURE	FRANCE	TPSA 2	106

### **Production units**

Manufacturer	Country	Equipment	Page
INTREX GMBH	GERMANY	CLU 3000	107
RAFFIN BERGER	FRANCE	DYNATERRE 01-4 M	107

### **Plants**

Manufacturer	Country	Equipment	Page
LUCE P.	FRANCE	GEOLUCE 6000 - M.2	108
		GEOLUCE 6000 - M.4	108
SARET PPB	FRANCE	TEROC T1A	109



## 6. DIRECTORY OF MANUFACTURERS AND DISTRIBUTORS

### MANUFACTURERS FROM EU COUNTRIES

NAME AND ADDRESS	PHONE - FAX - TELEX
<b>AIDAN FRANCE</b> TERRABLOCK DIVISION 185 CHEMIN DES SOURCES F - 06250 MOUGINS FRANCE	PHONE: (33) 93 75 33 69 FAX: (33) 93 75 39 99 TELEX:
<b>ALTECH International</b> PARC D'ENTRAIGUES F - 05200 EMBRUN FRANCE	PHONE: (33) 92 43 21 90 FAX: (33) 92 43 02 05 TELEX:
<b>APPRO-TECHNO</b> 24 RUE DE LA RIÈZE B - 5660 COUVIN (CUL DES SARTS) BELGIUM	PHONE: (32) (60) 37 76 71 FAX: (32) (60) 37 78 87 TELEX: 51622
<b>ATIKA MASCHINENFABRIK</b> POSTFACH 2164 D - 59209 AHLEN GERMANY	PHONE: (49) (2382) 8920 FAX: (49) (2382) 81812 TELEX: 238241
<b>AUSBILDUNGSVERBUND METALL GMBH</b> BERNHARD ADELUNG STRASSE 42 D - 65428 RUSSELSHEIM GERMANY	PHONE: (49) (6142) 630 71 ET (6142) 630 72 FAX: (49) (6142) 630 73 TELEX:
<b>CARTEM LTD</b> BILLEDON GB - LEICESTER LE7 9AE UNITED KINGDOM	PHONE: (44) (533) 116 259 67 33 FAX: (44) (533) 116 259 67 44 TELEX: 965 622
<b>CERATEC</b> 228 RUE DU TOUQUET B - 7783 PLOEGSTEERT BELGIUM	PHONE: (32) (2) 56 57 58 FAX: (32) (2) 56 55 05 TELEX: 57834

DIRECTORY OF MANUFACTURERS AND DISTRIBUTORS

EQUIPMENT	CATEGORY
TB 200 TB 700	MOTORIZED PRESS MOTORIZED PRESS
BROYEUR PROJECTEUR BROYEUR TAMISEUR MALAXEUR 250 L MALAXEUR 320 L GEO 50 PACT 500 GEO 1000	PULVERIZER PULVERIZER/SCREEN MIXER MIXER MANUAL PRESS MOTORIZED PRESS MOTORIZED PRESS
BROYEUR DE TERRE TERSTARAM DÉSAGRÉGATEUR TERSTARAM TERSTAMIX TERSTARAM SEMI-TERSTAMATIQUE TERSTAMATIQUE	PULVERIZER/SCREEN PULVERIZER MIXER MANUAL PRESS MOTORIZED PRESS MOTORIZED PRESS
TZ 200/125	MIXER
AVM CINVA RAM BLOCK PRESS	MANUAL PRESS
MANUAL ELEPHANT BLOCKMAKER POWERED ELEPHANT BLOCKMAKER	MANUAL PRESS MOTORIZED PRESS
CERADES H2 E/D CERAMIX 250 LC/LF CERAMAN CERAMATIC	PULVERIZER MIXER MANUAL PRESS MOTORIZED PRESS

**MANUFACTURERS FROM EU COUNTRIES**

NAME AND ADDRESS	PHONE - FAX - TELEX
<p><b>CITADOB</b>                      303 AVENUE LOUISE                      B - 1050 BRUSSELS                      BELGIUM</p>	<p>PHONE: (32) (2) 647 38 20 ET (2) 647 38 32                      FAX: (32) (2) 640 87 26                      TELEX: 20611</p>
<p><b>CONCRETE MACHINERY SYSTEM</b>                      SATELLITE BUSINESS PARK                      BLAKSWARTH ROAD                      GB - BRISTOL BS5 8AX                      UNITED KINGDOM</p>	<p>PHONE: (44) (117) 955 33 11                      FAX: (44) (117) 955 32 00                      TELEX: 44716</p>
<p><b>EDWARD BENTON &amp; CO. LTD</b>                      CRETEANGLE WORKS                      BROOK LANE / FERRING                      GB - WORTHING BN12 5LP                      UNITED KINGDOM</p>	<p>PHONE: (44) (1903) 24 13 49                      FAX: (44) (1903) 70 02 13                      TELEX: 87323</p>
<p><b>ESA-SED</b>                      150 ROUTE DE SAINT-ROMAIN                      B.P. 2                      F - 42153 RIORGES                      FRANCE</p>	<p>PHONE: (33) 77 71 97 77                      FAX: (33) 77 71 63 22                      TELEX: 300 985</p>
<p><b>INTREX GMBH</b>                      P.O. BOX 1328                      D - 42477 RADEVORMWALD                      GERMANY</p>	<p>PHONE: (49) (2336) 80 90 42                      FAX: (49) (2336) 80 94 38                      TELEX: 851/3025</p>
<p><b>LUCE P.</b>                      LE PUY RIGault                      F - 37420 SAVIGNY EN VERON                      FRANCE</p>	<p>PHONE: (33) 47 58 42 37                      FAX: (33) 47 58 91 37                      TELEX:</p>

DIRECTORY OF MANUFACTURERS AND DISTRIBUTORS

EQUIPMENT	CATEGORY
STATION DE CONCASSAGE/CRIBLAGE STATION DE MALAXAGE PTC 180 T	PULVERIZER/SCREEN MIXER MOTORIZED PRESS
BREPAK	MANUAL PRESS
CRETEANGLE TEC 225	MIXER
CMD 250 LC/LF CMD 320 LC CMD 500 LC	MIXER MIXER MIXER
CLU 3000	PRODUCTION UNIT
GEOLUCE 6000 - M2 GEOLUCE 6000 - M4	PLANT PLANT

DIRECTORY OF MANUFACTURERS AND DISTRIBUTORS

**MANUFACTURERS FROM EU COUNTRIES**

NAME AND ADDRESS	PHONE - FAX - TELEX
<p><b>MEGABRIK</b>                      LES ATELIERS DU PROGRÈS                      23 AVENUE MONT-FLEURY                      F - 06300 NICE                      FRANCE</p>	<p>PHONE: (33) 93 89 24 01                      FAX: (33) 92 04 07 91                      TELEX:</p>
<p><b>OSKAM V/F</b>                      POSTBUS 2584                      NL - 2940 AB LEKKERKERK                      NETHERLANDS</p>	<p>PHONE: (31) (180) 663 998                      FAX: (33) (180) 664 380                      TELEX:</p>
<p><b>PARRY ASSOCIATES</b>                      J.P.M. PARRY AND ASSOCIATES LIMITED                      OVEREND ROAD                      GB - CRADLEY HEATH B64 7DD                      UNITED KINGDOM</p>	<p>PHONE: (44) (1384) 56 91 71 - 56 91 72 - 56 49 91                      FAX: (44) (1384) 637 753                      TELEX: 334 132</p>
<p><b>RAFFIN-BERGER</b>                      GROUPE PTI                      52 AVENUE MARCEL PAUL                      F - 93297 TREMBLAY-EN-FRANCE                      FRANCE</p>	<p>PHONE: (33) (1) 49 63 74 00                      FAX: (33) (1) 49 63 74 99                      TELEX: 230 876</p>
<p><b>RIFFON J.</b>                      6 RUE J. WILGOT                      B - 5300 ANDENNE                      BELGIUM</p>	<p>PHONE: (32) (85) 84 39 41                      FAX: (32) (85) 84 48 21                      TELEX:</p>
<p><b>SARET PPB</b>                      ROUTE DÉPARTEMENTALE 26                      F - 30131 PUJAUT                      FRANCE</p>	<p>PHONE: (33) 90 15 25 25 - 90 15 25 13                      FAX: (33) 90 15 25 20 - 90 15 25 30                      TELEX:</p>
<p><b>TERRE 2000</b>                      ROUTE D'AVIGNON                      B.P. 113                      F - 13833 CHATEAURENARD                      FRANCE</p>	<p>PHONE: (33) 90 94 04 86                      FAX: (33) 90 94 62 46                      TELEX:</p>
<p><b>TETRA STRUCTURE</b>                      RUE DES SOIGNEUSES                      F - 59212 WIGNEHIES                      FRANCE</p>	<p>PHONE: (33) 27 60 06 34                      FAX: (33) 27 57 41 16                      TELEX:</p>
<p><b>UNATA</b>                      NIEUWLANDLAAN B-437                      B - 3220 AARSCHOT                      BELGIUM</p>	<p>PHONE: (32) (16) 56 10 22                      FAX: (32) (16) 56 30 14                      TELEX</p>

DIRECTORY OF MANUFACTURERS AND DISTRIBUTORS

EQUIPMENT	CATEGORY
COMPACTA	MOTORIZED PRESS
KNUSTER T 75 T 300/310 T 500 OSKAM C.E.B.M.	PULVERIZER MIXER MIXER MIXER MOTORIZED PRESS
PENDULUM CLAY CRUSHER	PULVERIZER/SCREEN
DYNATERRE 01-4 M	PRODUCTION UNIT
MECKA-21	MANUAL PRESS
T1 T1A	MOTORIZED PRESS PLANT
PBT 40	MOTORIZED PRESS
TETRAMAC TETRAMIX TPM TP5A 2	PULVERIZER/SCREEN MIXER MANUAL PRESS MOTORIZED PRESS
UNATA 1003	MANUAL PRESS



DIRECTORY OF MANUFACTURERS AND DISTRIBUTORS

**MANUFACTURERS FROM ACP COUNTRIES**

NAME AND ADDRESS	PHONE - FAX - TELEX
<p><b>B.B. BROTHERS TECHNOLOGICAL COMPANY</b>                      N° 118 JANTA ADAMU                      P.O. BOX 2839                      NI - JOS                      NIGERIA</p>	<p>PHONE:                      FAX:                      TELEX:</p>
<p><b>BOLYN CONSTRUCTIONS COMPANY LTD</b>                      P.O. BOX 1950                      SURULERE                      NI - LAGOS                      NIGERIA</p>	<p>PHONE: (234) (1) 96 69 51                      FAX:                      TELEX:</p>
<p><b>NIGERIAN BUILDING AND ROAD RESEARCH INSTITUTE</b>                      15 AWOLOWO ROAD IKOYI                      PMB 12568 IKOYI                      NI - LAGOS                      NIGERIA</p>	<p>PHONE: (234) (1) 68 33 84                      FAX:                      TELEX:</p>
<p><b>RURAL INDUSTRIES INNOVATION CENTRE</b>                      PRIVATE BAG 11                      RB - KANYE                      BOTSWANA</p>	<p>PHONE:                      FAX:                      TELEX:</p>
<p><b>SHELTERTECH</b>                      P.O. BOX CY 106                      CAUSEWAY                      ZW - HARARE                      ZIMBABWE</p>	<p>PHONE: (263) (4) 72 89 11                      FAX: (263) (4) 79 38 38                      TELEX: 230 876</p>
<p><b>SOCIÉTÉ D'ÉTUDES ET ENTREPRISES D'ÉQUIPEMENTS</b>                      04 B.P. 342                      CI - ABIDJAN 04                      CÔTE D'IVOIRE</p>	<p>PHONE: (225) 27 51 57 ET 27 44 87                      FAX: (225) 27 22 65                      TÉLEX: 43186 ET 43335</p>
<p><b>SOCIÉTÉ NOUVELLE ABIDJAN INDUSTRIE</b>                      01 B.P. 343                      CI - ABIDJAN 01                      CÔTE D'IVOIRE</p>	<p>PHONE: (225) 27 16 63 ET 27 46 13                      FAX: (225) 27 51 68                      TELEX: 42377</p>
<p><b>THE UNDUGU SOCIETY</b>                      P.O. BOX 40417                      KE - NAIROBI                      KENYA</p>	<p>PHONE: (254) (2) 55 22 11 ET 54 01 87                      FAX:                      TELEX:</p>
<p><b>URPATA SAHEL</b>                      AVENUE BOJRGUIBA                      LIBERTÉ II VILLA 1541                      B.P. 10423                      SN - DAKAR LIBERTÉ                      SENEGAL</p>	<p>PHONE: (221) 24 90 48 ET 25 10 34                      FAX: (221) 24 90 46                      TELEX: 1300</p>

DIRECTORY OF MANUFACTURERS AND DISTRIBUTORS

EQUIPEMENT	CATEGORY
B.B. PRESS	MANUAL PRESS
SOIL SIEVE / DISINTEGRATOR V.S. CINVA RAM BOLYN SUPER BLOCK PRESS BOLYN TWIN BLOCK PRESS	PULVERIZER/SCREEN MANUAL PRESS MANUAL PRESS MANUAL PRESS
NBRRI BLOCK MAKING MACHINE	MANUAL PRESS
CINVA RAM TYPE BLOCK PRESS	MANUAL PRESS
SHELTERTECH BLOCK PRESS	MANUAL PRESS
PRESSE IPNETP-LBTP	MANUAL PRESS
PRESSE À PARPAING	MANUAL PRESS
ACTION PACK BLOCK PRESS	MANUAL PRESS
URPATA 5005	MANUAL PRESS

## MANUFACTURERS FROM SOUTH AFRICA

NAME AND ADDRESS	PHONE - FAX - TELEX
<b>ECO BRICK SYSTEMS</b> 85 FOREST ROAD ZA - BRAMLEY 2090, JOHANNESBURG SOUTH AFRICA	PHONE: (27) (11) 887 92 36 - 440 19 23 FAX: (27) (11) 887 92 36 TELEX:
<b>HYDRAFORM CONCEPTS (PTY) LTD</b> P.O. BOX 17570 SUNWARD PARK 1470 200 RONDEBULT ROAD ZA - LIBRADENE 1459 SOUTH AFRICA	PHONE: (27) (11) 913 28 40 FAX: (27) (11) 913 14 49 TELEX:
<b>TECH-BUILD SERVICES</b> TECHTRON HOLDINGS P.O. BOX 8822 ZA - EDENGLLEN 1613 SOUTH AFRICA	PHONE: (27) (11) 609 55 85 - 435 41 36 FAX: (27) (11) 452 22 81 TELEX:

EQUIPMENT	CATEGORY
MARK III ECOBLOCK MARK III ECOMAXBLOCK MARK IV ECOMAXI MARK V ECO HOLLOWBLOCK MARK VI ECO STOCKBRICK MARK VII ECO PAVER	MOTORIZED PRESS MOTORIZED PRESS MOTORIZED PRESS MOTORIZED PRESS MOTORIZED PRESS
M5 STANDARD HYDRAFORM M5 MARK 2 HYDRAFORM M4 AGRI-VORM	MOTORIZED PRESS MOTORIZED PRESS MOTORIZED PRESS
BAMBA PRESS BAMBA SCREEN	MANUAL PRESS SCREEN



# 7. BRICKWORKS

---

## TYPES OF BRICKWORKS AND CAPITAL INVESTMENTS

This table which follows illustrates the various types of production unit. Other configurations are of course possible, but the options chosen follow a certain logic:

- for types 1 to 3, the progression is dictated by the desire to improve quality by using better equipment and methods for preparation and mixing;
- for types 4 to 6, the progression is dictated by increased mechanization in order to increase productivity without increasing the labour-force, or even whilst lowering it.

The table shows how compatible the various pieces of equipment are as regards their outputs and capital cost.

Brickworks using automated and industrialized equipment may achieve a productivity of as many as several tens of thousands of blocks per day, at the expense of a much higher investment and a much more complex technology. This type of investment should be particularly well evaluated and be the subject of specific analyses.

## BRICKWORKS

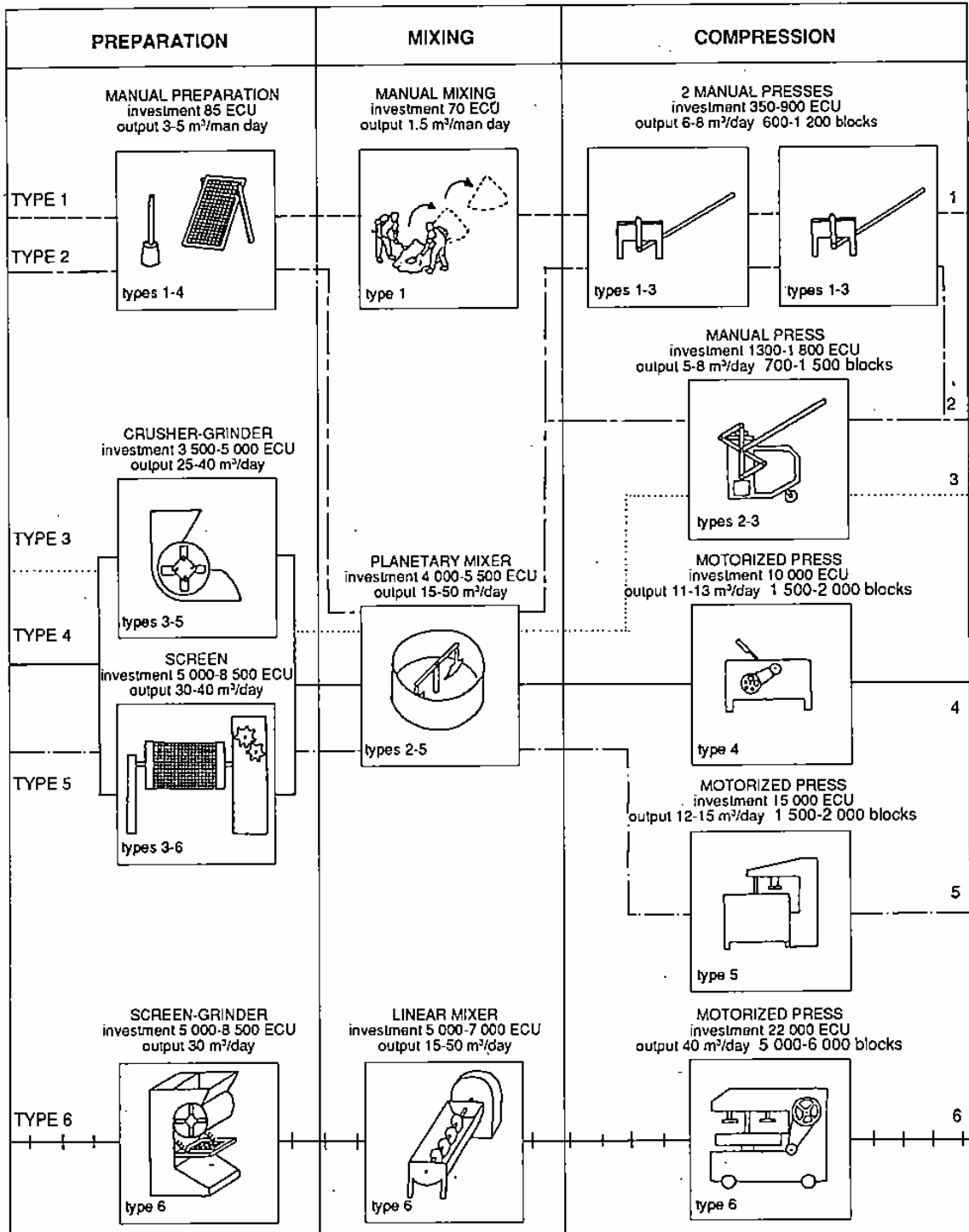

Here we consider only equipment specific to the production of compressed earth blocks, but as the columns summarizing capital investment show, the cost of transport equipment within the brickworks (wheelbarrows, conveyor belts, lifting gear, etc.) and tools may represent as much as half the total invested. Moreover, the figures quoted here do not take account of the

## BRICKWORKS

PRODUCTION AREA (m <sup>2</sup> )				WORKFORCE	INVESTMENT (ecus)			TYPES
enclosed area	covered area	open area	TOTAL	people	specific equipment	tool and transport	TOTAL	
10	30	340	380 m <sup>2</sup>	9-10	1,100	700	1,800	<b>TYPE 1</b> Productivity 600 - 1,000 blocks/day
15	100	515	630 m <sup>2</sup>	11-13	7,000	1,300	8,300	<b>TYPE 2</b> Productivity 1,200 - 1,500 blocks/day
15	100	515	630 m <sup>2</sup>	10-12	11,500	1,300	12,800	<b>TYPE 3</b> Productivity 1,200 - 1,500 blocks/day
15	55	735	805 m <sup>2</sup>	9-11	19,000	1,800	20,800	<b>TYPE 4</b> Productivity 1 500 - 2,000 blocks/day
25	50	2,225	2,300 m <sup>2</sup>	8-10	24,000	18,000	42,000	<b>TYPE 5</b> Productivity 1,500 - 2,500 blocks/day
100	300	4,500	4,900 m <sup>2</sup>	8-10	36,000	38,000	74,000	<b>TYPE 6</b> Productivity 5,000 - 6,000 blocks/day

infrastructure and the land which can require, especially for small brickworks, a capital investment equal to that in equipment and tools, nor other expenses and charges (e.g. insurances, taxes, etc.). These figures must therefore be regarded as basic approximations. Overall, the costs break down in such a way that investment in equipment specific to the production of compressed earth blocks may represent, in extreme cases, only 20 to 25% of the total invested.



## BRICKWORKS

### SEMI-MECHANIZED BRICKWORK

ASSUMPTIONS	INFRASTRUCTURE	EQUIPMENT
<b>TYPE OF PRODUCTION LINE</b>  Type 3 or 4	Covered paved area: 120 m <sup>2</sup> Hard, flat area: 380 m <sup>2</sup> Total area: 645 m <sup>2</sup>	1 motorized grinder 2 fixed screens 1 planetary mixer (250 l)
<b>PRODUCTIVITY</b> 1,400 to 2,000 blocks/day 7,000 to 12,000 blocks/week  (29.5 x 14 x 9 cm blocks)	Stock of soil: 75 m <sup>3</sup> (=10,000 blocks) Stock of blocks: 375 m <sup>2</sup> Circulations: 70 m <sup>2</sup>	2 manual presses 6 shovels 5 wheelbarrows
<b>DAILY QUANTITIES CONSUMED</b> 10 to 12 m <sup>3</sup> of soil 0.75 tons of cement (6%) 1,200 to 1,300 litres of water	<b>PERSONNEL</b>	2 flat bottom wheelbarrows 200 to 250 m <sup>2</sup> of tarpaulin
	14 to 15 people	

The brickworks shown below is that of Afotobo, Côte d'Ivoire, using a motorized press rather than two manual presses, although the layout is virtually identical.



22. General view, in the foreground: sieving and mixing.



23. Feeding the press, compression and removal of blocks.



24. Preparing the soil by sieving.

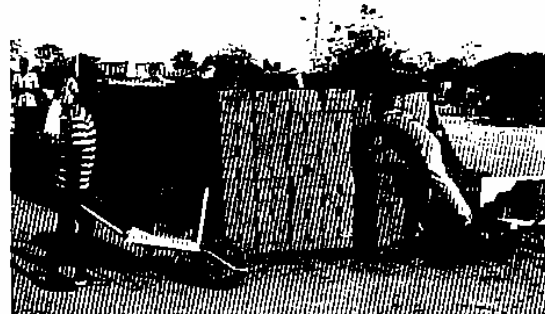

25. Transport and intermediate stocking of blocks for wet curing.



## BRICKWORKS

### FULLY MECHANIZED BRICKWORK

ASSUMPTIONS	INFRASTRUCTURE	EQUIPMENT
TYPE OF PRODUCTION LINE  Type 5	Covered paved area: 30 m <sup>2</sup> Hard, flat area: 100 m <sup>2</sup> Total area: 550 m <sup>2</sup>	1 bell excavator 1 conveyor belt 1 screen-grinder 1 soil-cement measuring out system 1 slide valve hopper 1 planetary mixer (320 l.) 1 motorized press 1 roller belt (2 m) 1 pallet trolley 250 to 300 m of packaging plastic for pallets (0.5 m rolls)
PRODUCTIVITY 1,500 to 2,500 blocks/day 7,500 to 15,000 blocks/week  (29.5 x 14 x 9 cm blocks)	Stock of soil: 150 m <sup>3</sup> Stock of blocks: 150 m <sup>3</sup> Possible extension: 90 m <sup>3</sup>	
DAILY QUANTITIES CONSUMED 11 to 18 m <sup>3</sup> of soil 0.6 to 1.1 tons of cement (6 %) 1,500 to 2,000 litres of water	PERSONNEL  5 to 6 workers	

The brickworks shown below is one which is in operation in Thoronet (France). It is located close to the building site which it was intended to serve, but is also open for external sales of blocks. Demand for its blocks is therefore regular and high, which explains why the areas set aside for stocking blocks is fairly limited. This type of brickworks mainly suits situations where the cost of labour is high and where maintenance staff are very highly qualified.

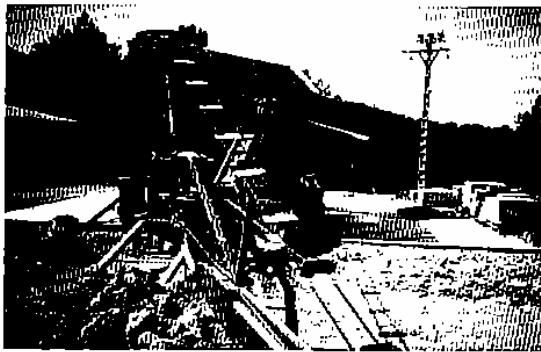

26. General view, in the foreground: blocks being removed.

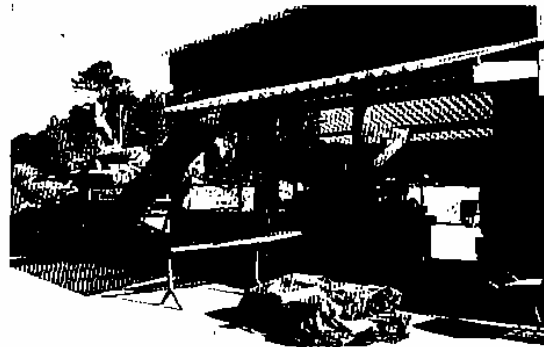

28. Roller conveyor.

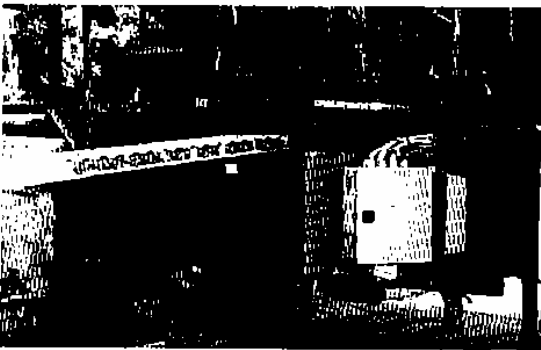

27. Bucket excavator.

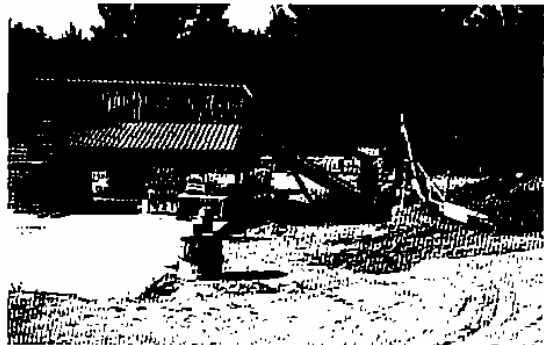

29. General view, in the foreground: feeding.



## **MANUFACTURING AND ORGANIZATION PARAMETERS: A QUALITY APPROACH**

### **Definition**

Quality can be defined as the capacity to produce CEBs as they have been defined in the light of their intended use, no better and no worse. In other words the primary objective is to produce the best blocks at the best price, and in doing so to satisfy both the end-user and the producer.

### **Method and tools**

This means that during project planning and production trials, a procedure of definition and evaluation should be undertaken. It should cover the various performance criteria of the products, raw material consumption, production costs, organizational methods and equipment needed.

When production starts, the results of this evaluation should be refined by adjusting the various parameters of the production process (both methods and inputs) and observing the results of the change. This enables one to define target quality levels, which may have been predefined in a market survey. In order not to stray from these levels, acceptable margins of tolerance will have to be defined, and these will then enable the methods of production monitoring and inspection to be defined. The higher the quality target, the lower the tolerance will be.

When procedures, tolerances and inspection frequencies have been defined, the levels of responsibility of the various people involved must be defined. Rectification decisions should not be taken lightly, but it should be possible to take them quickly in order not to halt production for too long, which is why it is vital to have an organizational pyramid which clearly defines the tasks allotted to each level of responsibility.

There are a large number of monitoring and inspection methods which depend on the type of production line in question, but these include:

- awareness-raising procedures aimed as much at the end-user as at the producer, since it is in fact inconceivable to introduce quality control procedures if the producers, at all grades, are not aware of their relevance. Several ways of doing this can be considered: training sessions, information leaflets, as well as the quality inspections themselves, which can be designed so as to have a long-lasting impact on the whole production team;
- quality control procedures which enable staff at different levels of responsibility to carry out the various tasks of counting, collecting information, and summarizing it for analysis.

The equipment needed for these control procedures may consist of blackboards, record-sheets, accounting books, etc. One can distinguish between counting, monitoring, control and recording operations. It is important to identify the correct level of responsibility and the correct equipment needed to perform each of these operations.

### **Quality control**

Quality control and monitoring procedures have two functions: they enable one both to ascertain the quality of the blocks and to keep production costs down. Tests which are objective and which enable one to measure quality indicators will need to be applied. The value of such tests will not depend on their complexity, but on the rigour with which they are carried out, however simple they may be. Such tests do not necessarily have to give results in the form of numbers, but merely have to confirm the acceptability or not of the product using comparative results. Quality control procedures must above all be suited to the skills and means of the brickworks.

The first type of quality control concerns the products - the blocks themselves - which should correspond to the defined target levels. The main parameters to observe are size, weight, appearance, mechanical strength and reaction to water.

The second type of control, manufacturing control, allows one to check that the methods of manufacturing used are operational and reproducible in everyday conditions. The quality of the components, quantities, proportions used, sizes etc. are checked.

The third type, organizational control, enables one to check that the methods and means placed at the disposal of each operation ensure optimum viability. This involves checking if there are shortfalls between initial estimates and actual results, notably as regards output.

Significant shortfalls are not necessarily due to the operators, but very often to the insufficient, or inappropriate, means allocated to each operation. The production of a quality CEB does not in fact rely only on its compression. Each operation (extraction, preparation, mixing, compression and curing) is vital to the final result, both from a qualitative and an economic point of view.

It is also indispensable to carry out equipment inspections, so that at any moment one can tell the age of the machines, the quantities produced, the dates of recent routine normal maintenance operations and the dates and nature of any repairs carried out. This enables one to check that maintenance is regularly done and also to identify the causes of breakdowns,

### **Acceptability checks**

Acceptability checks for blocks can consist only of simple tests which are easily carried out on site. They can equally be more comprehensive and involve laboratory tests. The latter is only justified for large markets, but may be unavoidable for a public client, depending on any standards in force. When taking samples, the quantity should be sufficient to be representative, but should not on the other hand be exhaustive. Conditions of acceptance, who is responsible for charges and the choice of laboratory should be carefully specified from the start, to avoid any litigation.



# 8. THE FEASIBILITY STUDY

---

## THE SIX PHASES OF A PROJECT

Six main phases must be gone through to turn the initial idea of building a brickworks into a working reality.

### Phase 1: preparation

The preliminary studies cover the theoretical design of the project, and include project identification, feasibility study, outline schedule, etc.

### Phase 2: detailed planning

This phase includes the technical and economic feasibility study, the market survey, the selection of equipment, the operational plan, and the financial plan.

### Phase 3: launch

The implementation of the plan covers a multiplicity of activities such as purchasing the equipment, installing the production units, running training programmes, starting up production and making prototypes.

### Phase 4: fine-tuning

Production is finally perfected, a quality assurance system is in place, and the marketing and sales campaign is launched.

### Phase 5: operation

Production "cruising speed" is reached and marketing and sales are at full pace.

### Phase 6: evaluation

Evaluation may be continuous and covers all aspects: technical, economic, social, etc.

It is essential for the success of the enterprise that each of these phases be carried out in earnest. The feasibility study, however, has an absolutely vital role to play.

## THE FEASIBILITY STUDY

Depending on the exact nature and degree of detail of the study and the subtlety of the financial analysis, the feasibility study can also be known as:

- a pre-feasibility study;
- a pre-investment survey;
- a banking report;
- etc.



## THE FEASIBILITY STUDY

The feasibility study serves amongst other things to bring together all the data relating to the parameters which will affect the operation of the brickworks. Their analysis leads to an evaluation of its economic potential and its future operation. Entrepreneurs are recommended to carry out this study extremely rigorously, in order to obtain the most reliable data possible. This will enable them to make the appropriate decisions with regard to its technical, economic and financial scale. In addition, investors and funders will use this study as a base to evaluate the risks incurred and to advance a loan.

In general, a feasibility study contains the following sections:

- context and historical background of the project;
- capacity of the market and of the production unit;
- equipment and production factors;
- location and site;
- technical aspects of the project;
- organization of the production unit and overheads;
- labour;
- implementation timetable;
- financial and economic evaluation.

## **FINANCIAL AND ECONOMIC EVALUATION**

This section deals with the various financial factors which must be taken into account, such as:

- initial investment;
- working capital;
- depreciation;
- foreign exchange requirements;
- financial plan;
- loan conditions;
- repayment schedule;
- estimated income;
- details of expenses;
- gross operating profit;
- cash flow projection;
- profitability;
- etc.

Certain points, however, are of particular importance:

- production cost;
- unit cost price;
- break-even point;
- degree of sensitivity.

## **PRODUCTION COST**

It is indispensable for the production cost to be calculated; it should be evaluated during the setting up of the project and then periodically checked. It will include the production unit's fixed costs and variable costs.

## THE FEASIBILITY STUDY

Fixed costs are independent of productivity, but are linked to the way the brickworks is set up; they include:

- financial charges (interest on loans): these are linked to initial investments, i.e. preparatory market and feasibility surveys, purchase of land or production sites, purchase of equipment, funding for initial expenses (stocks, salaries, equipment);
- depreciation: this should enable the initial investment to be replaced. It is calculated over the lifetime of the production unit or of the loan repayment, which could be 3, 5 to 10 years, depending on the case;
- management costs: these include salaries, social security payments and supplies which are independent of production;
- administrative costs: these include taxes and duties;
- infrastructure costs: these include rent, insurance and repairs.

Variable costs are linked to productivity, but independent of the nature of the production line; they include:

- production labour (wages, social services contributions, etc.);
- raw materials (soil, sand, cement, water, power, etc.);
- equipment and services linked to production (tools, work and transport);
- taxes on products, if applicable (VAT, etc.).

It should be noted that the production cost varies over time, and normally should display an overall tendency to fall despite the influence of factors pushing it up.

Factors reducing the production cost:

- improving labour efficiency (factors of 5 to 1 can be obtained);
- reduced level of debt;
- etc.

Factors increasing the production cost:

- inflation;
- increased costs;
- etc.

## **UNIT COST PRICE**

Together, fixed and variable costs for a given production make up the production cost. If this sum is divided by the number of blocks produced, this gives the unit cost price which then enables the sales price to be set in a informed manner, by adding a profit margin to the cost price. The unit cost price is very greatly affected by productivity.

The curve below shows how the unit production cost falls as productivity increases. The costs of raw materials and of stabilizers remain identical: if you are paying 1 monetary unit for 1 block then you will pay 1,000 monetary units for 1,000 blocks; the proportions are identical. Labour costs and fixed costs per block, however, will fall if productivity increases. This is because fixed costs (interest payments, rent, taxes, etc.) and salaries (if these are paid regardless of productivity) will be identical whether any blocks are being produced or not. For example, if fixed costs and salaries come to 1,000 monetary units per day, this will give a cost of 1,000 monetary units per block if only one block is produced, but a cost of 1 monetary unit per block if 1,000 blocks

## THE FEASIBILITY STUDY

are produced. Experience shows, however, that from a certain level of productivity onwards, the cost of production per block practically ceases to fall; this optimal degree of productivity is therefore the target to be aimed for. Ideally, the scale of the brickworks should be planned in such a way for this optimum level of productivity to occur at around 60 to 70% of the maximum theoretical output.

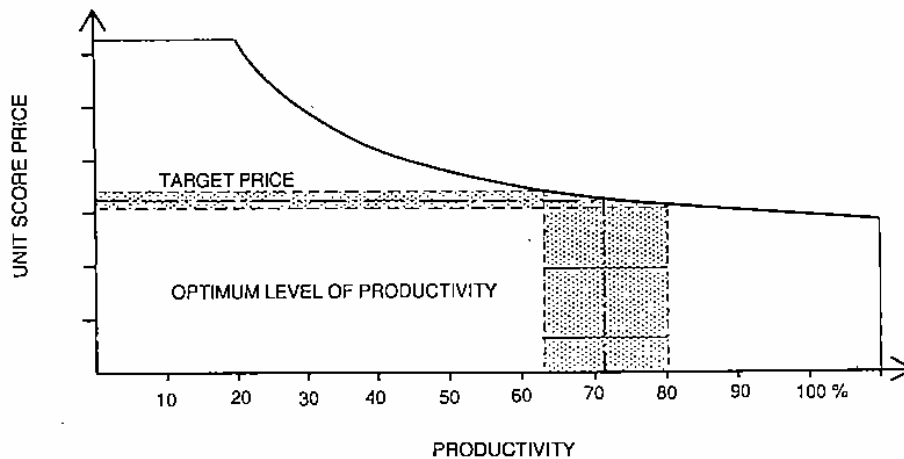

EXAMPLE OF VARIATION IN UNIT OF PRICE

### BREAK-EVEN POINT

The break-even point is the point below which the enterprise no longer makes a profit and begins to lose money. This point can be calculated mathematically or determined using graphs. To do this, a graph is drawn up showing production costs and sales income on one side and production and sales capacity on the other.

Curves showing the fixed and variable costs are then drawn onto this diagram, as well as the curve representing the total of these costs; (the graph showing the unit cost in relation to productivity is therefore an excellent source of information for this).

The curve showing the sales income in relation to the number of units sold is also drawn on. The point of intersection of the two latter curves gives the break-even point.

The graph below illustrates the operation of a brickworks which has a break-even point of 43% of capacity. Given that the optimum productivity level occurs at around 70% of the theoretical capacity, then the real break-even point occurs at 30% (= 70% x 43%) of the theoretical capacity.

This demonstrates one of the main advantages which earth block brickworks have over the large centralized production units used to produce other building materials. These typically have a break-even point which is around 85 to 95% of the maximum theoretical output.

## THE FEASIBILITY STUDY

With a break-even point of 30%, the brickworks has very little sensitivity to the actual outputs obtained or to fluctuations in sales.

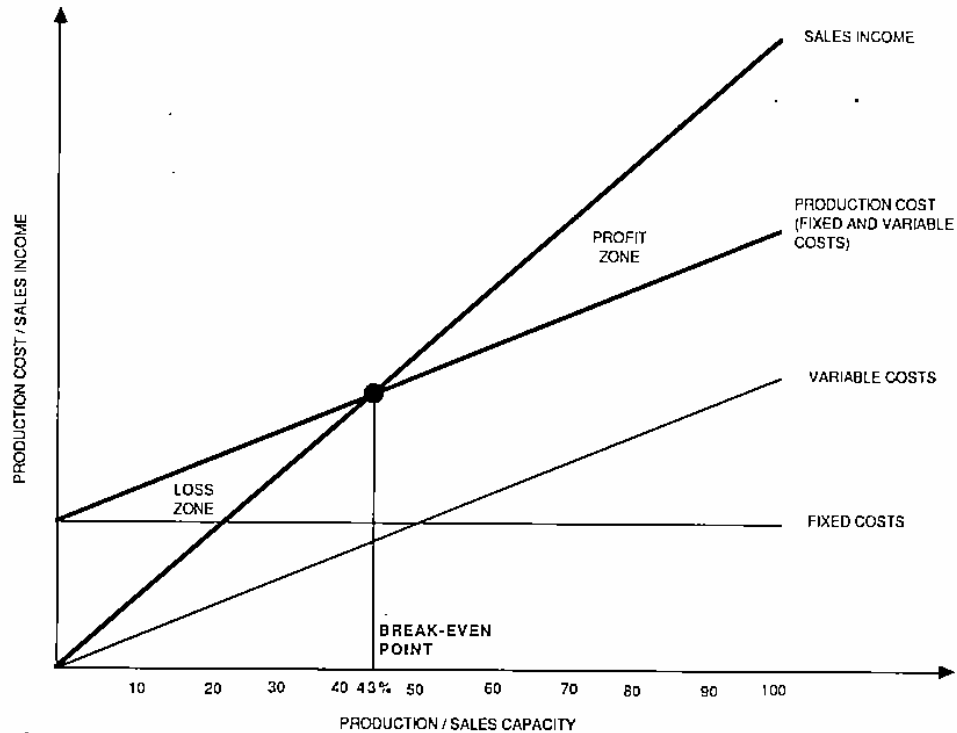

## THE DEGREE OF SENSITIVITY OF THE UNIT COST PRICE

It is useful to calculate the effect of the production cost on the unit cost price. This prevents being taken unawares if certain costs rise or if productivity falls. It can also indicate possible improvements in manufacturing technologies, plant organization or raw material inputs, by clarifying how each of these affects the unit cost price.

The factors which are worth exploring are in general the following:

- the proportion of hollows in the block;
- the distance over which the soil is transported;
- the amount of stabilization;
- the cost of the stabilizer;
- the level of wages;
- the number of employees.

## THE FEASIBILITY STUDY

The curve below illustrates the influence of the cost of stabilizer on the unit cost price of the compressed earth block.

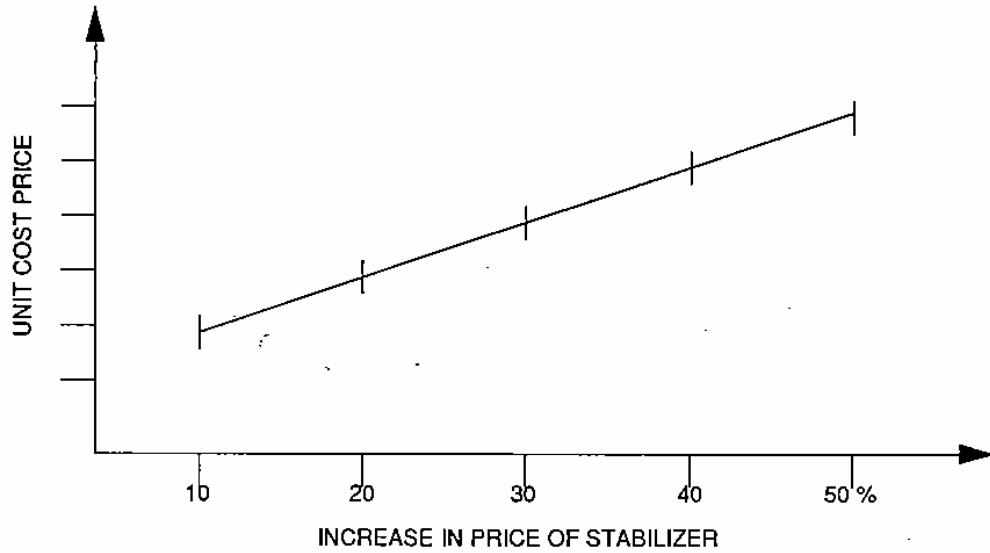

EXAMPLE OF THE SENSITIVITY OF THE UNIT COST PRICE

## **THE DEGREE OF SENSITIVITY OF THE BRICKWORKS**

In order to gain an idea of the overall sensitivity of the viability of the brickworks, it is possible to carry out a fairly complex calculation, usually computerized, where all the parameters which influence the production costs are made to vary ( $\pm 30\%$ ) from the reference costs. In addition, sales income is also made to vary ( $\pm 30\%$ ) from the reference figure.

## THE FEASIBILITY STUDY

The table below gives an example of a sensitivity analysis which enables the most unfavourable conditions which would have to come together before the exploitation of the brickworks became problematic to be determined. The brickworks will of course ideally be scaled in such a way that the triangle of negative figures should be as low as possible.

PROFIT (1,000 ecus)		SALES INCOME						
		- 30%	- 20%	- 1%	REF.	+ 10%	+ 20%	+ 30%
COST OF PRODUCTION	+ 30%	- 152	- 56	39	135	231	326	422
	+ 20%	- 100	- 4	90	186	282	378	473
	+ 10%	- 49	46	142	238	333	429	525
	DE REF.	2	97	193	289	385	481	576
	- 10%	53	149	245	340	436	532	628
	- 20%	105	200	296	392	488	583	679
	- 30%	156	252	347	443	539	635	731

EXAMPLE OF THE OVERALL SENSITIVITY OF THE VIABILITY OF A BRICKWORKS





**CENTRE FOR THE DEVELOPMENT OF INDUSTRY**

**A TOOL FOR  
THE DEVELOPMENT  
OF INDUSTRIAL ENTERPRISES  
IN ACP COUNTRIES**

The Centre for the Development of Industry (CDI) is an ACP-EU institution financed by the European Development Fund (EDF) under the Lomé Convention bringing together the **European Union** and the **70 ACP countries** (Africa, Caribbean and Pacific). Its objective is to encourage and support the creation, expansion and restructuring of **industrial companies** (mainly in manufacturing and agro-industry) in the ACP countries. To this effect, it promotes partnerships between ACP and European companies which may take various forms: financial, technical or commercial partnership, management contract, licensing or franchise agreement, subcontract, etc.

The CDI's services are easily accessible and are subdivided into four facilities (see table) to support the different stages in the creation, expansion and rehabilitation of industrial companies. In this framework, the CDI intervenes, free of charge, providing its own expertise, or makes a non-reimbursible financial contribution. The CDI does not finance the investment of the project but helps to seek out and put together a financing package.

The requests for assistance submitted to the CDI are evaluated on the basis of the financial and technical viability of the projects and their contribution as regards the development of the country concerned. Information submitted to CDI will be treated in complete confidentiality. The total amount invested in these projects, or the value of the assets in the case of existing companies, must be between 200,000 and 10 million ECU. Smaller companies may be accepted in certain cases: pilot projects, regrouping of several companies with a view to joint assistance, priority industrial sectors, etc.

By "project", CDI means an industrial unit or group of units in the process of being created or undergoing expansion, diversification, rehabilitation or privatisation.

---

CDI - CENTRE FOR THE DEVELOPMENT OF INDUSTRY - ACP-EU LOMÉ CONVENTION  
Avenue Herrmann Debroux 52, B-1160 Brussels, Belgium - Tel.: +32 2 679 18 11 - Fax: +32 2 675 26 03



ACP Group



European Union



**FACILITIES IN SUPPORT OF THE CREATION,  
EXPANSION, DIVERSIFICATION, REHABILITATION OR  
PRIVATISATION OF INDUSTRIAL ENTERPRISES**

	<b>FACILITY 1</b>	<b>FACILITY 2</b>	<b>FACILITY 3</b>	<b>FACILITY 4</b>
<b>TYPE OF OPERATION</b>	Programme of identification of projects and potential partners (Opportunity studies per country or per sector, business contacts)	Operations prior to implementation of a project (Search for partners, feasibility studies, market surveys, diagnostics, expertise; rehabilitation, diversification, privatisation or expansion studies, advice on the purchase of equipment)	Financial and legal structuring of the project (Assistance in assembling the financial and legal package, search for financing and support in contacts with finance institutions)	Project start-up and development (Advice on inspection and reception of new or second-hand equipment, supervision of installation, technical assistance, assistance in start-up, management and marketing, training)
<b>BENEFICIARIES</b>	Development, promotion and finance institutions	Promoters and/or companies of an ACP country or a European Union member country, acting either individually or jointly, wishing to undertake an industrial project in an ACP country		
<b>ACCESS</b>	Applicants may approach the CDI directly or contact one of the members of the CDI's ACP network or European Union network			
<b>TYPE OF CONTRIBUTION</b>	Advice, technical assistance or subsidy			
<b>AMOUNT</b>	Case by case	Max. 150,000 ECU per project and per year (The cumulated amount of all contributions to the same project/company must not exceed 300,000 ECU and must be less than 20% of the total investment, except in the case of pilot projects)		
<b>LIMITES OF CDI CONTRIBUTION</b>	Maximum 50% of the total cost	Maximum 2/3 of the total cost per project and per year (Beneficiary promoters/companies must contribute at least one third of the cost)		

## HOW TO PRESENT YOUR REQUEST

Applicants may approach the CDI directly or contact one of the members of the CDI's ACP or European Union networks, the names of which you will find in this leaflet.

## SUBSTANCE OF THE REQUEST

A clear description of the assistance requested from CDI is essential in every case.

In general, the information to be provided is as follows:

### **Identification of industrial projects and potential partners (facility 1)**

- description of the organisation putting forward the proposal and, if applicable, the companies on whose behalf this identification process is being conducted;
- description of and reasons for the proposed activity;
- detailed timetable for execution of the specific operations;
- detailed budget proposal.

### **Operations prior to implementation of a project (facility 2)**

- description of the company or promoter presenting a proposal, including information on their financial situation;
- description of the project under consideration;
- preliminary financing plan for the investment or development project;
- work plan covering the operations to be carried out;
- breakdown of the budget for the proposed operation.

### **Financial and legal structuring of the project (facility 3)**

- description of the existing enterprise and/or investment envisaged (sector, size, financial projections, etc.);
- project feasibility study covering the technical, economic and financial aspects;
- description of the proposed financial and legal structure;
- work programme and detailed budget proposal.

### **Project start-up and development (facility 4)**

- description of the company, including its financial position;
- description of the technical assistance and training programme;
- work programme, main assistance objectives;
- detailed budget proposal.

## THE CDI'S ACP ANTENNAE NETWORK

### WEST AFRICA REGION

- BENIN**  
 • Centre de promotion pour l'emploi et la petite et moyenne entreprise (CEPEPE)  
 Tél.: +229 31 44 47 Fax: +229 31 59 50
- BURKINA FASO**  
 • Ministère de l'Industrie, du Commerce et des Mines  
 Tél.: +226 107305 Fax: +226 107305
- CAPEVERDE**  
 • I.A.D.E.  
 Tél.: +238 61 44 44 Fax: +238 61 24 34
- CÔTE D'IVOIRE**  
 • Chambre de Commerce et de l'Industrie de Côte d'Ivoire  
 Tél.: +225 324700 Fax: +225 272117
- GAMBIA**  
 • MUSA  
 Tél.: +220 229 848 Fax: +220 229 024
- GHANA**  
 • Ghana Investment Promotion Centre (G.I.P.C.)  
 Tél.: +233 21 665 125 Fax: +233 21 663 801
- GUINEA**  
 • Office de promotion des investissements privés (O.I.P.I.P.)  
 Tél.: +224 444985 Fax: +224 413161
- GUINEA BISSAU**  
 • Ministério dos Recursos Naturais e da Indústria  
 Tél.: +245 215659 Fax: +245 210150
- LIBERIA**  
 • Subah-Belish Associates  
 Tél.: +231 221519 Fax: +231 226262
- Venture Development Incorporated  
 Tél.: +231 225229 Fax: +231 225217
- MALI**  
 • Centre d'assistance aux projets, entreprises et sociétés (CAPES)  
 Tél.: +223 222259 Fax: +223 228085
- MAURITANIA**  
 • Fédération des industries et des mines (FIM)  
 Tél.: +222 2 595 83 Fax: +222 2 595 83
- Association professionnelle promotion de la pêche artisanale et du crédit maritime mutual en Mauritanie  
 Tél.: +222 2 451 44 Fax: +222 2 450 46
- NIGER**  
 • Ministère de l'Industrie et de l'artisanat  
 Tél.: +227 733783 Fax: +227 733783
- Afalen  
 Tél.: +227 741821 Fax: +227 741812
- NIGERIA**  
 • N.I.O.B. Ltd.  
 Tél.: +234 1 663470
- New Nigeria Development Co. Ltd (N.N.D.C.)  
 Tél.: +234 62 200250 Fax: +234 62 35482
- G. Odeh and Associates  
 Tél.: +234 1 822712 Fax: +234 1 2662315
- Mitrac Ltd.  
 Tél.: +234 1 874 108 Fax: +234 1 261 44 96
- Grid Consulting  
 Tél.: +234 1 266 5657 Fax: +234 1 266 7905
- SENEGAL**  
 • Sonepi  
 Tél.: +221 25 51 80 Fax: +221 2445655/SIERRA

### LEONE

- Alfa Consultants Ltd.  
 Tél.: +232 22 229018 Fax: +232 22 229680
- TOGO**  
 • Chambre de Commerce, d'Agriculture et d'Industrie du Togo (CCA)  
 Tél.: +228 212065 Fax: +228 214730

### CENTRAL AFRICA REGION

- BURUNDI**  
 • B.N.D.E.  
 Tél.: +257 232888 Fax: +257 232775
- CAMEROON**  
 • BETA Conseil  
 Tél.: +237 432585 Fax: +237 431691
- CENTRAL AFRICAN REPUBLIC**  
 • C.C.I.M.A.  
 Tél.: +236 611668 Fax: +236 613561
- Kode Conseil, par  
 Tél.: +236 610035 Fax: +236 610035
- CHAD**  
 • O.B.T.  
 Tél.: +235 515364 Fax: +235 515884
- CONGO**  
 • B.D.E.A.C.  
 Tél.: +242 870212 Fax: +242 830266
- CODIS Conseil  
 Tél.: +242 837135 Fax: +242 836199
- GABON**  
 • ASIAFCO Gabon, Sarl  
 Tél.: +241 724061
- EQUATORIAL GUINEA**  
 • Ministerio de Industria, Comercio y Promoción Empresarial  
 Tél.: +240 9 2586 Fax: +240 9 3339
- RWANDA**  
 • Ministère de l'Industrie et de l'artisanat  
 Tél.: +250 76715
- SAO TOME E PRINCIPE**  
 • Ministério de Economia e Finanças  
 Tél.: +239 12 22747 Fax: +239 12 22182
- ZAIRE**  
 • SOHDE  
 Tél.: +243 12 25819

### EAST AFRICA REGION

- COMOROS**  
 • Banque de développement des Comores  
 Tél.: +269 73 08 18
- Centre d'appui au secteur privé (CASP)  
 Tél.: +269 73 03 38 Fax: +269 73 03 13
- ERITREA**  
 • Asmara Chamber of Commerce  
 Tél.: +291 1 121 388 Fax: +291 1 120 138
- ETHIOPIA**  
 • M. Ashenafi Shiferaw  
 Tél.: +251 1 553330 Fax: +251 1 553330
- KENYA**  
 • 4M Enterprises  
 Tél.: +254 2 744955 Fax: +254 2 750396
- MADAGASCAR**  
 • Société d'études et de réalisations pour le développement (SERDI)  
 Tél.: +261 2 21335 Fax: +261 2 29669
- Association thonière commission

### de l'océan indien

- Tél.: +261 2 32183 Fax: +261 2 32181/MAURITIUS  
 • Chambre de Commerce et d'Industrie de Maurice (CCIM)  
 Tél.: +230 208 3301 Fax: +230 208 0076
- SEYCHELLES**  
 • Development Bank of Seychelles  
 Tél.: +248 224471 Fax: +248 224274
- SUDAN**  
 • Sudan Development Corporation  
 Tél.: +249 11 452151 Fax: +249 11 452148
- TANZANIA**  
 • International Services & Supplies Ltd. (IS)  
 Tél.: +255 51 21401 Fax: +255 51 22 895
- Small Industries Development Organisation (SIDO)  
 Tél.: +255 51 27691 Fax: +255 51 21011
- Tanzania Development France Company Ltd.  
 Tél.: +255 51 46 144
- UGANDA**  
 • Centre for Trade Promotion Ltd.  
 Tél.: +256 41 24 29 62 Fax: +256 41 24 55 97

### SOUTHERN AFRICAN REGION

- ANGOLA**  
 • Ministerio da Industria  
 Tél.: +244 2 33 70 55 Fax: +244 2 39 2400
- BOTSWANA**  
 • Economic Consultancy (PTY) Ltd.  
 Tél.: +266 31 31 31 Fax: +266 31 20 90
- LESOTHO**  
 • Lesotho National Development Corporation (LNDC)  
 Tél.: +266 32 20 12 Fax: +266 31 0018
- MALAWI**  
 • Investment and Development Bank of Malawi Ltd. (INDEBANK)  
 Tél.: +265 62 00 55 Fax: +265 63 5703
- MOZAMBIQUE**  
 • Instituto Nacional de Desenvolvimento da Industria Local (INDIL)  
 Tél.: +258 1 42 21 79 Fax: +258 1 43 0226
- NAMIBIA**  
 • Investment Centre  
 Tél.: +264 61 22 99 33 Fax: +264 61 22 0278
- Chamber of Commerce & Industry  
 Tél.: +264 22 20 00 Fax: +264 33 690
- SWAZILAND**  
 • Swaziland Industrial Development Company  
 Tél.: +268 433 91 Fax: +268 45 619
- ZAMBIA**  
 • Small Industries Development Organisation (SIDO)  
 Tél.: +260 1 22 42 84 Fax: +260 1 22 2568
- ZIMBABWE**  
 • Zimbabwe Investment Centre  
 Tél.: +263 4 75 79 31 Fax: +263 4 75 7937

### CARIBBEAN REGION

- ANTIGUA and BARBUDA**  
 • BAHAMAS  
 • Bahamas Chamber of Commerce  
 Tél.: +1 809 3222145 Fax: +1 809 3224649
- BARBADOS**  
 • Barbados Investment and Development Corporation (BIDC)
- FIJI**  
 • Fiji Trade and Investment Board  
 Tél.: +679 31 59 08 Fax: +679 30 1783
- KIRIBATI**  
 • Ministry of Natural Resources Development  
 Tél.: +686 21099 Fax: +686 21120
- PAPUA NEW GUINEA**  
 • Department of Trade and Industry Central Government Offices  
 Tél.: +675 27 11 15 Fax: +675 25 2403
- SOLOMON ISLANDS**  
 • Ministry of Commerce & Primary Industry  
 Tél.: +677 262 30 Fax: +677 250 64
- TONGA**  
 • Tonga Development Bank  
 Tél.: +676 213 30 Fax: +676 22 755
- TUVALU**  
 • Development Bank of Tuvalu  
 Tél.: +688 20 850 Fax: +688 20 850
- WESTERN SAMOA**  
 • Development Bank of Western Samoa  
 Tél.: +685 228 61 Fax: +685 23 888
- VANUATU**  
 • Ministry of Economic Affairs  
 Tél.: +678 22770 Fax: +678 25640

- Tél.: +1 809 4275350 Fax: +1 809 4267802/BELIZE  
 • Belize Chamber of Commerce & Industry  
 Tél.: +501 2 75108 Fax: +501 2 274984
- DOMINICA (COM)**  
 • Insurance Marketing & Promotion Services Ltd.  
 Tél.: +1 809 4485372 Fax: +1 809 4485592
- DOMINICAN REPUBLIC**  
 • DOMINEX  
 Tél.: +1 809 5355540 Fax: +1 809 5333215
- GRENADA**  
 • Grenada Industrial Development Corporation (IDC)  
 Tél.: +1 809 4441035 Fax: +1 809 4444928
- GUYANA**  
 • The (private) Sector Commission of Guyana Ltd.  
 Tél.: +592 2 57170 Fax: +592 2 70725
- JAMAICA**  
 • JAMPRO Ltd.  
 Tél.: +1 809 9297190 Fax: +1 809 9249650
- ST CHRISTOPHER and NEVIS**  
 • Chamber of Commerce and Industry  
 Tél.: +1 809 4652980 Fax: +1 809 4654490
- ST LUCIA**  
 • St Lucia National Development Corporation  
 Tél.: +1 809 4523074 Fax: +1 809 4521841
- ST VINCENT and GRENADINES**  
 • St Vincent Development Corporation  
 Tél.: +1 809 4571358 Fax: +1 809 4572800
- SURINAME**  
 • Chamber of Commerce and Industry  
 Tél.: +597 473527 Fax: +597 474779
- TRINIDAD and TOBAGO**  
 • Caribbean Business Services Ltd.  
 Tél.: +1 809 633 2103 Fax: +1 809 637 2103

### PACIFIC REGION

- FIJI**  
 • Fiji Trade and Investment Board  
 Tél.: +679 31 59 08 Fax: +679 30 1783
- KIRIBATI**  
 • Ministry of Natural Resources Development  
 Tél.: +686 21099 Fax: +686 21120
- PAPUA NEW GUINEA**  
 • Department of Trade and Industry Central Government Offices  
 Tél.: +675 27 11 15 Fax: +675 25 2403
- SOLOMON ISLANDS**  
 • Ministry of Commerce & Primary Industry  
 Tél.: +677 262 30 Fax: +677 250 64
- TONGA**  
 • Tonga Development Bank  
 Tél.: +676 213 30 Fax: +676 22 755
- TUVALU**  
 • Development Bank of Tuvalu  
 Tél.: +688 20 850 Fax: +688 20 850
- WESTERN SAMOA**  
 • Development Bank of Western Samoa  
 Tél.: +685 228 61 Fax: +685 23 888
- VANUATU**  
 • Ministry of Economic Affairs  
 Tél.: +678 22770 Fax: +678 25640

## THE CDI'S EUROPEAN INSTITUTIONAL NETWORK

- AUSTRIA**  
 • Wirtschaftskammer Österreich  
 Auswirtschftsorganisation  
 Tél.: +43 1 50105 4403 Fax: +43 1 50206 255
- BELGIUM**  
 • Administration générale de la coopération au développement - AGCO  
 Tél.: +32 2 519 02 11 Fax: +32 2 500 65 85
- Ministère de la Région Wallonne - DARETEL  
 Tél.: +32 2 211 55 37
- Ministère de la Région Bruxelles-Capitale  
 Tél.: +32 2 513 97 00 Fax: +32 2 511 52 55
- DENMARK**  
 • The Industrialization Fund for Developing Countries - IFU  
 Tél.: +45 33 14 25 75 Fax: +45 33 32 25 24
- FINLAND**  
 • Finfund  
 Tél.: +358 0 348 434 Fax: +358 0 348 433 46
- Ministry of Foreign Affairs  
 Department for Development Cooperation  
 Tél.: +358 0 134 151 Fax: +358 0 134 162 09
- FRANCE**  
 • Assemblée des chambres françaises de Commerce et d'Industrie - ACFCI  
 Tél.: +33 1 40 69 37 00 Fax: +33 1 47 20 61 28

- Association régionale pour le développement et la coopération industrielle internationale - ADECI  
 Tél.: +33 91 14 42 28 Fax: +33 91 91 85 37
- INTERCO Aquitaine - Agence de coopération internationale  
 Tél.: +33 56 51 20 92 Fax: +33 56 40 28 19
- Institut régional de développement - IRCOD  
 Tél.: +33 26 70 31 31 Fax: +33 26 64 10 95
- Caisse française de développement - CFD  
 Tél.: +33 1 40 06 31 31 Fax: +33 1 47 42 75 14
- ERAI - Entreprise Rhône Alpes International  
 Tél.: +33 78 34 83 48 Fax: +33 78 34 59 85
- GERMANY**  
 • Deutsche Investition und Entwicklungsgesellschaft - O.E.G.  
 Tél.: +49 221 498 63 81 Fax: +49 221 498 61 11
- GREECE**  
 • Organization for the Development of Small and Medium Sized Industries and Handicrafts - EOMHEX  
 Tél.: +30 1 77 00 654 Fax: +30 1 77 78 694
- IRELAND**  
 • Irish Trade Board - ITB  
 Tél.: +353 1 269 50 11 Fax: +353 1 269 58 20

- ITALY**  
 • Ente Regionale per la Valorizzazione Economica del Territorio - ERVET  
 Tél.: +39 51 23 05 67 Fax: +39 51 22 23 52
- Istituto Nazionale per il Commercio Estero - ICE  
 Tél.: +39 6 59 921 Fax: +39 6 59 926 899
- GRAND-DUCHY OF LUXEMBOURG**  
 • Ministère des Affaires étrangères  
 Direction des Relations économiques Internationales et de la Coopération  
 Tél.: +352 478 23 62 Fax: +352 22 20 48
- Lux-Development s.a.r.l.  
 Tél.: +352 43 39 68 Fax: +352 43 38 08
- PORTUGAL**  
 • Banco de Fomento a Exterior - BFE  
 Tél.: +351 1 356 10 71 Fax: +351 1 352 27 58
- Banco Português do Atlântico - BPA  
 Tél.: +351 1 346 33 52 Fax: +351 1 342 32 94
- Fundo Para a Cooperaçao Economica - FCE  
 Tél.: +351 1 352 06 07 Fax: +351 1 315 85 43
- Investimentos, Comercio e Turismo de Portugal - ICEP  
 Tél.: +351 1 793 01 01 Fax: +351 1 794 08 26
- SPAIN**  
 • COPCA  
 Tél.: +34 3 48 49 605 Fax: +34 3 48 49 666
- Instituto Español de Comercio Exterior - ICEX  
 Tél.: +34 1 349 61 00 Fax: +34 1 431 61 28
- Sociedad para la Promoción y Reconversión Industrial - SPRI  
 Tél.: +34 4 47 97 000 Fax: +34 4 47 97 023
- Instituto de Fomento de Andalucía - IFA  
 Tél.: +34 5 490 00 16 Fax: +34 5 490 63 00
- Promociones Exteriores de Canarias - PRODEXCA  
 Tél.: +34 28 41 14 34 Fax: +34 28 41 43 04
- SWEDEN**  
 • Swedish International Development Cooperation Agency, Business and Enterprise Development Division - SIDA  
 Tél.: +46 6 698509 Fax: +46 6 249290
- Svedfund International - AB  
 Tél.: +46 6 7259400 Fax: +46 8 203093
- UNITED KINGDOM**  
 • Commonwealth Development Corporation - CDC  
 Tél.: +44 171 828 44 88 Fax: +44 171 828 65 05
- Department of Trade and Industry - DTI  
 Tél.: +44 171 215 57 50 Fax: +44 171 215 57 12

These lists of the CDI's ACP and European Union networks, published in November 1995, are regularly updated. If you would like to receive the most recent lists, together with the names and references of the people to contact, please send your request to:

**CDI**  
 Avenue Herrmann Debrox 52, B-1160 Brussels, Belgium  
 Tel.: +32 2 679 18 11 - Fax: +32 2 675 26 03  
 November 1995

## SERVICES OFFERED

### **INTERNATIONAL CENTRE FOR EARTH CONSTRUCTION - CRATerre-EAG**

CRATerre-EAG is an international scientific and technical organization based in Grenoble, France. In more than 20 years of activity in fifty countries, CRATerre-EAG has built up an expertise which covers all aspects of building with earth. The present offer of services is specific and covers only the technology of compressed earth blocks (CEB).

#### **Training**

CRATerre-EAG can provide a wide range of training to meet the client's needs. CRATerre-EAG's wide experience means that it can offer training in areas as diverse as soil identification, equipment operation and maintenance, CEB production, setting-up, quality control, etc. Training is preferably organized at CRATerre-EAG's own premises, where all the necessary specialized training aids are at our disposal, but CRATerre-EAG also has a long experience of providing on-site training.

#### **Technical assistance**

The client can call upon CRATerre-EAG's skills in all areas relating to CEB promotion, production and construction: for example, identification missions, geo-technical studies, feasibility studies, identification trials, equipment installation, production organization, introducing a quality approach, preparing specifications and norms, laboratory testing, brickwork management, market surveys, business strategy, devising building systems, architectural design, structural calculations, economic surveys, recommendations on building systems, evaluation, etc.

#### **Supply**

The client may entrust to CRATerre-EAG the entire process of purchasing production and laboratory equipment and materials, including the tasks of equipment selection, liaison with manufacturers, negotiations on sales price, purchase, follow-up on the manufacture of the equipment and delivery deadlines, equipment hand-over, transport and delivery.

#### **Dissemination**

The client may draw up, in collaboration with CRATerre-EAG, technical documents relating to the installation, utilization and maintenance of his equipment, plans for the construction of buildings, reports on testing, standards, etc.

#### **Research**

The client may commission CRATerre-EAG to research precise subject areas, the results of which will be used by the client, such as work on particular stabilizers, developing industrial waste recycling procedures, design of specific building systems, etc.

## SERVICES OFFERED

It is understood that CRATerre-EAG's services are not limited to CEBs but the client may equally call upon CRATerre-EAG to broaden the range of its area of competence in order to provide a more complete service, for example in the field of building materials production and implementation for roofing material, sanitation, joinery, etc.

CRATerre-EAG can provide technology transfer, on the understanding that all CRATerre-EAG's services must be covered by a contract.

### **CRATerre-EAG**

---

International Centre for Earth Construction

B.P. 53

F - 38092 VILLEFONTAINE CEDEX

FRANCE

Phone +33 74 95 43 91

Fax +33 74 95 64 21

## SERVICES OFFERED

### BUILDING ADVISORY SERVICE AND INFORMATION NETWORK - BASIN

BASIN is an international network of organizations which coordinates and disseminates expert advice and information on appropriate and proven building technologies. BASIN provides practical information, advice and technical assistance to individuals and organizations working in building construction in the developing world. BASIN provides its services free to its clients from developing countries. The network currently has four members, all leaders in their fields, who each provide an advisory service in their area of competence:

- the wall building advisory service (WAS) provided by GATE (Germany);
- the cements and binders advisory service (CAS) provided by ITDG (United Kingdom);
- the roofing advisory service (RAS) provided by SKAT (Switzerland);
- the earth building advisory service (EAS) provided by CRATerre-EAG (France).

#### Information and consultancy service

The network partners maintain databases of documents and publications, technologies and equipment, institutions and consultants and projects, which enable BASIN to offer technical enquiry and consultancy services.

BASIN itself, and its partners independently, work in cooperation with international bodies such as UNIDO and UNCHS to arrange training programmes on economic construction and local building materials.

Finally, specific training courses can be tailored to the needs of their client organizations.

#### Publications



BASIN identifies subject areas for which there is a demand for information and seeks to fulfil this demand by the production of technical briefs, production and construction manuals, product information guides, books and bibliographies, videos, etc. In addition, BASIN partners publish the bi-annual newsletter BASIN-NEWS. For further information, please contact:

WAS/BASIN  
GATE-GTZ  
P.O. Box 5180  
D-65726 ESCHBORN  
GERMANY  
Tel. (49) 6196 79 31 90  
Telefax (49) 6196 79 73 52  
Telex 407501-0 gtz d





GATE (German Appropriate Technology Exchange) a programme of the Deutsche Gesellschaft für Technische Zusammenarbeit (GTZ) GmbH, is a centre for the dissemination and promotion of appropriate technologies for developing countries.

ITDG  
Myson House  
Railway Terrace  
UX-RUGBY CV21 3HT  
UNITED KINGDOM  
Tel. (44) 1788 560 631  
Telefax (44) 1788 540 270  
Telex 317466 itdg g





IT (Intermediate Technology) is an independent British NGO, which aims to help increase the range of income-generating and employment opportunities in developing countries.

SKAT  
Vadianstrasse 42  
CH-9000 ST. GALLEN  
SWITZERLAND  
Tel. (41) 71 228 54 54  
Telefax (41) 71 228 54 55  
Telex 681226 skat ch



SKAT (Swiss Center for Development Cooperation in Technology and Management) is an information and documentation centre as well as a consulting group which specializes in energy, drinking water & sanitation and building materials in developing countries.

CRATerre-EAG  
BP 53  
F-38092 VILLEFONTAINE CEDEX  
FRANCE  
Tel. (33) 74 95 43 81  
Telefax (33) 74 95 64 21



CRATerre-EAG (International Centre for Earth Construction) is an international scientific and technical organization, dedicated to the promotion of earth as a building material.



# BIBLIOGRAPHY

---

There are now over 9,000 titles available on building with earth. The selection below presents the essential works which are required for a good understanding of building with earth in general and for the compressed earth block production process in particular.

## **EARTH CONSTRUCTION IN GENERAL**

CRATerre: Houben H., Guillaud H. *Earth Construction: a Comprehensive Guide*. United Kingdom, London, IT Publications, 1994. 210 X 297 mm, 372 pages, ill., tab., graph., bibl.

CRATerre: Doat P., Hays A., Houben H., Matuk S., Vitoux F. *Building with Earth*. India, New Delhi, The Mud Village Society, 1990. 180 x 255 mm, 284 pages, ill., tab., graph., bibl.

Norton J. *Building with Earth. A Handbook*. United Kingdom London, IT Publications, 1986. 210 x 297 mm, 68 pages, ill., graph., bibl.

CRATerre. *Earth Building Materials and Techniques. Select Bibliography*. Germany, Eschborn, GATE, 1991. 210 x 297 mm, 121 pages, ill.

CRATerre: Guillaud H., Houben H. *Modernité de l'architecture de terre en Afrique. Réalisations des années 80*. France, Grenoble, CRATerre-EAG, 1989. 160 x 240 mm, 190 pages, ill.

## **COMPRESSED EARTH BLOCKS: GENERAL**

CRATerre. *The Basics of Compressed Earth Blocks*. Germany, Eschborn, GATE, 1991. 210 x 297 mm, 27 pages, graph., ill., bibl.

CRATerre-EAG, GTZ-GATE, ONUDI. *Compressed Earth Blocks (video)*. United Kingdom, Rugby, DesignWrite Productions, 1994. VHS, 26 mn.

## **COMPRESSED EARTH BLOCKS: PRODUCTION**

CRATerre-EAG: Doat P., Guillaud H., Houben H., Rigassi V. *Compressed earth blocks: Manual of Production*. Germany, Eschborn, GATE, 1995. 210 x 297 mm, 104 pages, graph., ill., tab., bibl.

Mukerji K., Wörner H., CRATerre. *Soil Preparation Equipment. Product Information*. Germany, Eschborn, GATE, 1991. 210 x 297 mm, 19 pages, graph., ill.

Mukerji K., CRATerre. *Soil Block Presses. Product Information*. Germany, Eschborn, GATE, 1988. 210 x 297 mm, 32 pages, ill., bibl.

CRATerre; Mukerji K. *Stabilizers and Mortars (for Compressed Earth Blocks). Product Information*. Germany, Eschborn, GATE, 1994. 210 x 297 mm, 20 pages, graph., tab.



## BIBLIOGRAPHIE

### **COMPRESSED EARTH BLOCKS: CONSTRUCTION**

CRATerre-EAG: Doat P., Guillaud H., Houben H., Odul P., Joffroy Th. Compressed Earth Blocks: Manual of Design and Construction. Germany, Eschborn, GATE, 1995. 210 x 297 mm, 148 pages, graph., ill., tab., bibl.

CRATerre-EAG: Joffroy Th., Guillaud H. The basics of Building with Arches, Vaults and Cupolas. Switzerland, Saint Gallen, SKAT, 1994. 210 x 297 mm, 27 pages, graph., ill., bibl.

### **THE FEASIBILITY STUDY**

CDI. Manuel FINAN. Programme d'analyse financière et guide pour les études de faisabilité du CDI. Belgium, Brussels, CDI, 1994. Software for the IBM compatible.

### **FINANCING**

CDI. Financial Resources for Industrial Projects in ACP Countries. Belgium, Brussels, CDI, 1987. 210 x 297 mm, 114 pages.

### **PURCHASING EQUIPMENT**

CDI; BIVAC International / Bureau Veritas. Purchasing Industrial Equipment. Series "Contracts and Partnerships" no. 1. Belgium, Brussels, CDI, 1993. 210 x 297 mm, 82 pages, tab.

Dear Reader,

If you have knowledge of other preparation or production equipment for building with earth, we would be grateful if you could inform us by completing and returning the card below to the address indicated. If you wish, you may send us any other kind of information such as on projects or current building work. Do not hesitate to use additional sheets if necessary.

Commercial name of the machine : .....

Category :  pulverizer     screen     mixer     other : .....  
 manual press     motorized press     production unit     plant

Name of company :

Address : .....  
.....  
.....  
.....

Phone : ..... Fax : .....

Telex : .....

To be returned to the Earth Building Advisory Service (EAS),  
c/o CRATerre-EAG, B.P. 53, F-38092 Villefontaine Cedex, France.

Thanks to its technical qualities and economic advantages, the compressed earth block is now increasingly in demand in ACP (Africa, Caribbean, Pacific) countries as building material both for private housing and for public buildings such as schools, clinics, etc. Interest in the compressed earth block can also be explained by the low level of investment required for its processing and the rapidity with which production and construction skills can be acquired.

This guide will serve as a useful aid to decision-making when considering investment in the production and use of the compressed earth block. It presents an inventory of production equipment marketed by ACP and EU (European Union) countries which should enable project promoters to make the most appropriate choice when acquiring equipment. Details of the products, the technology, what is available from ACP-EU manufacturers, the selection criteria for production equipment as well as the methodology for carrying out a feasibility study on the development of this product are provided.

# OTHER TITLES

## **Series « Technologies »**

- 1 — Briquetting of vegetal residues
- 2 — Valorisation of phosphate in Africa
  - volume 1: phosphate fertiliser production
  - volume 2: phosphoric acid production
- 3 — Soap production
- 4 — Paint production
- 5 — Compressed earth blocks: production equipment
- 6 — Flexible polyurethane foam discontinuous process
- 7 — The intensive poultry farming industry in the Sahelian zone

## **Series « Contracts and partnerships »**

- 1 — Purchasing industrial equipment
- 2 — Setting up in ACP countries

## **Series « Tax and business »**

- 1 — Zimbabwe

## **Series « Project evaluation and financing »**

- 1 — Financial resources for industrial projects in ACP countries
- 2 — FINAN Manual
- 3 — Facilities and instruments for industrial cooperation

## **Series « Export development »**

- 1 — Exporting sea products