

Zhengbing Hu  
Sergey Petoukhov  
Matthew He *Editors*

# Advances in Artificial Systems for Medicine and Education

# **Advances in Intelligent Systems and Computing**

Volume 658

## **Series editor**

Janusz Kacprzyk, Polish Academy of Sciences, Warsaw, Poland  
e-mail: [kacprzyk@ibspan.waw.pl](mailto:kacprzyk@ibspan.waw.pl)

### *About this Series*

The series “Advances in Intelligent Systems and Computing” contains publications on theory, applications, and design methods of Intelligent Systems and Intelligent Computing. Virtually all disciplines such as engineering, natural sciences, computer and information science, ICT, economics, business, e-commerce, environment, healthcare, life science are covered. The list of topics spans all the areas of modern intelligent systems and computing.

The publications within “Advances in Intelligent Systems and Computing” are primarily textbooks and proceedings of important conferences, symposia and congresses. They cover significant recent developments in the field, both of a foundational and applicable character. An important characteristic feature of the series is the short publication time and world-wide distribution. This permits a rapid and broad dissemination of research results.

### *Advisory Board*

#### Chairman

Nikhil R. Pal, Indian Statistical Institute, Kolkata, India

e-mail: [nikhil@isical.ac.in](mailto:nikhil@isical.ac.in)

#### Members

Rafael Bello Perez, Universidad Central “Marta Abreu” de Las Villas, Santa Clara, Cuba

e-mail: [rbellop@uclv.edu.cu](mailto:rbellop@uclv.edu.cu)

Emilio S. Corchado, University of Salamanca, Salamanca, Spain

e-mail: [escorchado@usal.es](mailto:escorchado@usal.es)

Hani Hagrass, University of Essex, Colchester, UK

e-mail: [hani@essex.ac.uk](mailto:hani@essex.ac.uk)

László T. Kóczy, Széchenyi István University, Győr, Hungary

e-mail: [koczy@sze.hu](mailto:koczy@sze.hu)

Vladik Kreinovich, University of Texas at El Paso, El Paso, USA

e-mail: [vladik@utep.edu](mailto:vladik@utep.edu)

Chin-Teng Lin, National Chiao Tung University, Hsinchu, Taiwan

e-mail: [ctlin@mail.nctu.edu.tw](mailto:ctlin@mail.nctu.edu.tw)

Jie Lu, University of Technology, Sydney, Australia

e-mail: [Jie.Lu@uts.edu.au](mailto:Jie.Lu@uts.edu.au)

Patricia Melin, Tijuana Institute of Technology, Tijuana, Mexico

e-mail: [epmelin@hafsamx.org](mailto:epmelin@hafsamx.org)

Nadia Nedjah, State University of Rio de Janeiro, Rio de Janeiro, Brazil

e-mail: [nadia@eng.uerj.br](mailto:nadia@eng.uerj.br)

Ngoc Thanh Nguyen, Wroclaw University of Technology, Wroclaw, Poland

e-mail: [Ngoc-Thanh.Nguyen@pwr.edu.pl](mailto:Ngoc-Thanh.Nguyen@pwr.edu.pl)

Jun Wang, The Chinese University of Hong Kong, Shatin, Hong Kong

e-mail: [jwang@mae.cuhk.edu.hk](mailto:jwang@mae.cuhk.edu.hk)

More information about this series at <http://www.springer.com/series/11156>

Zhengbing Hu · Sergey Petoukhov  
Matthew He  
Editors

# Advances in Artificial Systems for Medicine and Education

 Springer

*Editors*

Zhengbing Hu  
School of Educational Information  
Technology  
Central China Normal University  
Wuhan  
China

Matthew He  
Halmos College of Natural Sciences and  
Oceanography  
Nova Southeastern University  
Fort Lauderdale, FL  
USA

Sergey Petoukhov  
Mechanical Engineering Research Institute  
Russian Academy of Sciences  
Moscow  
Russia

ISSN 2194-5357

ISSN 2194-5365 (electronic)

Advances in Intelligent Systems and Computing

ISBN 978-3-319-67348-6

ISBN 978-3-319-67349-3 (eBook)

DOI 10.1007/978-3-319-67349-3

Library of Congress Control Number: 2017952364

© Springer International Publishing AG 2018

This work is subject to copyright. All rights are reserved by the Publisher, whether the whole or part of the material is concerned, specifically the rights of translation, reprinting, reuse of illustrations, recitation, broadcasting, reproduction on microfilms or in any other physical way, and transmission or information storage and retrieval, electronic adaptation, computer software, or by similar or dissimilar methodology now known or hereafter developed.

The use of general descriptive names, registered names, trademarks, service marks, etc. in this publication does not imply, even in the absence of a specific statement, that such names are exempt from the relevant protective laws and regulations and therefore free for general use.

The publisher, the authors and the editors are safe to assume that the advice and information in this book are believed to be true and accurate at the date of publication. Neither the publisher nor the authors or the editors give a warranty, express or implied, with respect to the material contained herein or for any errors or omissions that may have been made. The publisher remains neutral with regard to jurisdictional claims in published maps and institutional affiliations.

Printed on acid-free paper

This Springer imprint is published by Springer Nature

The registered company is Springer International Publishing AG

The registered company address is: Gewerbestrasse 11, 6330 Cham, Switzerland

# Preface

Nowadays, the systems and methods of artificial intelligence find a wide spectrum of effective—and sometimes unexpected—applications in different fields of technologies and sciences. One of these areas is medical engineering, in which their application is aimed at increasing the effectiveness of diagnosing various diseases and selecting appropriate ways of treatment. The rapid development of artificial intelligence systems requires the intensification of training of a growing number of relevant specialists. At the same time, artificial intelligence systems have significant perspectives of their application inside education technologies themselves for improving the quality of training of specialists taking into account personal characteristics of such specialists and also the emergence of new computer devices.

In digital systems of artificial intelligence, scientists try to reproduce inherited intellectual abilities of human and other biological organisms. The profound study of genetic systems and inherited biological processes can give new approaches to create more and more effective methods of artificial intelligence. For this reason, intensive development of biomathematical studies on patents of living nature is required, which ensure noise immunity of genetic information, its quasi-holographic features, its connection with the Boolean algebra of logic used in technical systems of artificial intelligence, etc. In other words, study of genetic systems and creation of methods of artificial intelligence go in parallel manner to enrich each other.

The purpose of the First International Conference of Artificial Intelligence, Medical Engineering, Education (August 21–23, 2017, Moscow, Russia) is to present new thematic approaches, methods, and achievements of mathematicians, biologists, physicians, and technologists and also to attract additional interest of different specialists to this perspective theme. Its proceedings additionally include articles on specific tasks in various fields, where artificial intelligence systems can be applied in the future with great benefit.

The conference is organized jointly by Mechanical Engineering Research Institute of the Russian Academy of Sciences (IMASH RAN, <http://eng.imash.ru/>) and the “International Research Association of Modern Education and Computer Science” (RAMECS, <http://www.ramecs.org/part.html>). The organization of such

conference is one of the examples of growing Russian-Chinese cooperation in different fields of science and education.

The 32 contributions to the conference were selected by the programme committee for inclusion in this book out of all submissions.

Our sincere thanks and appreciation to the board members as listed below:

Rivner F. Ganiev, Russia  
 F. Chin, Hong Kong  
 Viktor A. Glazunov, Russia  
 C.Z. Wang, China  
 Janusz Kacprzyk, Poland  
 O.K. Ban, USA  
 Gyorgy Darvas, Hungary  
 Branko Dragovich, Serbia  
 K. Du, China  
 Nikolay A. Balonin, Russia  
 Elena Fimmel, Germany  
 J.W. Hu, China  
 Abir U. Igamberdiev, Canada  
 Valery V. Kozlov, Russia  
 Oleg P. Kuzovlev, Russia  
 X.J. Ma, China  
 Yuri I. Manin, Germany  
 V.E. Muchin, Ukraine  
 S.C. Qu, China  
 Y. Shi, USA  
 Plamen L. Simeonov, Germany  
 Alexey V. Borisov, Russia  
 Tatiana A. Rakcheeva, Russia  
 J. Su, China  
 J.Q. Wu, China  
 Q. Wu, China  
 Z.W. Ye, China  
 C.C. Zhang, Taiwan

Finally, we are grateful to Springer-Verlag and Janusz Kacprzyk as the editor responsible for the series “Advances in Intelligent System and Computing” for their great support in publishing these conference proceedings.

July 2017

Zhengbing Hu  
 Sergey V. Petoukhov  
 Matthew He

# Organization

## Honorary Chairs

- |             |                                                                                              |
|-------------|----------------------------------------------------------------------------------------------|
| R.F. Ganiev | Mechanical Engineering Research Institute of the Russian Academy of Sciences, Moscow, Russia |
| F. Chin     | The University of Hong Kong, Hong Kong                                                       |

## General Co-chairs

- |               |                                                                                              |
|---------------|----------------------------------------------------------------------------------------------|
| V.A. Glazunov | Mechanical Engineering Research Institute of the Russian Academy of Sciences, Moscow, Russia |
| C.Z. Wang     | Hubei University of Technology, China                                                        |

## International Program Committee

- |                 |                                                                                              |
|-----------------|----------------------------------------------------------------------------------------------|
| Janusz Kacprzyk | Systems Research Institute, Polish Academy of Sciences                                       |
| O.K. Ban        | IBM, USA                                                                                     |
| G. Darvas       | Institute Symmetrion, Hungary                                                                |
| B. Dragovich    | the Institute of Physics, Belgrade, Serbia                                                   |
| K. Du           | National University of Defense Technology, China                                             |
| N.A. Balonin    | Institute of Computer Systems and Programming, St. Petersburg, Russia                        |
| A.F. Dumansky   | Mechanical Engineering Research Institute of the Russian Academy of Sciences, Moscow, Russia |



E. Fimmel	Institute of Mathematical Biology of the Mannheim University of Applied Sciences, Germany
V.A. Glazunov	Mechanical Engineering Research Institute of the Russian Academy of Sciences, Moscow, Russia
J.W. Hu	Wuhan Ordnance Petty Officer School, China
A.U. Igamberdiev	Memorial University of Newfoundland, Canada
V.V. Kozlov	Steklov Mathematical Institute of the Russian Academy of Sciences, Moscow, Russia
O.P. Kuzovlev	Kolomensky Medical Center, Moscow, Russia
X.J. Ma	Huazhong University of Science and Technology, China
Yu.I. Manin	Max Planck Institute of Mathematics, Bonn, Germany
V.E. Muchin	National Technical University of Ukraine “KPI”, Ukraine
M. He	Nova Southeastern University, USA
S.C. Qu	Central China Normal University, China
Y. Shi	Bloomsburg University of Pennsylvania, USA
P.L. Simeonov	Charité University Medicine, Digital Pathology and IT, Institute of Pathology, Berlin, Germany
V.O. Soloviev	Mechanical Engineering Research Institute of the Russian Academy of Sciences, Moscow, Russia
J. Su	Hubei University of Technology, China
J.Q. Wu	Central China Normal University, China
Q. Wu	Harbin Institute of Technology, China
Z.W. Ye	Hubei University of Technology, China
C.C. Zhang	Feng Chia University, Taiwan

### **Steering Chairs**

Z.B.Hu	Central China Normal University, China
S.V. Petoukhov	Mechanical Engineering Research Institute of the Russian Academy of Sciences, Russia

### **Local Organizing Committee**

A.V. Borisov	Udmurt State University, Russia
T.V. Silova	MERI of the Russian Academy of Sciences, Moscow, Russia

L.V. Hazina	MERI of the Russian Academy of Sciences, Moscow, Russia
N.A. Ismailova	MERI of the Russian Academy of Sciences, Moscow, Russia
I.S. Javelov	MERI of the Russian Academy of Sciences, Moscow, Russia
I.D. Kireev	MERI of the Russian Academy of Sciences, Moscow, Russia
A.V. Kirichenko	MERI of the Russian Academy of Sciences, Moscow, Russia
I.S. Mamaev	MERI of the Russian Academy of Sciences, Moscow, Russia
E.N. Petyukov	MERI of the Russian Academy of Sciences, Moscow, Russia
T.A. Rakcheeva	MERI of the Russian Academy of Sciences, Moscow, Russia
H.F. Saberov	MERI of the Russian Academy of Sciences, Moscow, Russia
G. Zh. Sakhvadze	MERI of the Russian Academy of Sciences, Moscow, Russia
A.K. Skvorchevsky	MERI of the Russian Academy of Sciences, Moscow, Russia
I.V. Stepanyan	MERI of the Russian Academy of Sciences, Moscow, Russia
R.Y. Sukhorukov	MERI of the Russian Academy of Sciences, Moscow, Russia

## **Publication Chair**

Sergey Petoukhov	Mechanical Engineering Research Institute of the Russian Academy of Sciences, Moscow, Russia
------------------	----------------------------------------------------------------------------------------------------

# Contents

## Advances in Mathematics and Bio-mathematics

<b>The Genetic Coding, United-Hypercomplex Numbers and Artificial Intelligence.</b> . . . . .	2
Sergey Petoukhov, Elena Petukhova, Ludmila Hazina, Ivan Stepanyan, Vitaliy Svirin, and Tamara Silova	
<b>Exploring Structure and Evolution of the Genetic Code with the Software Tool GCAT</b> . . . . .	14
E. Fimmel, M. Gumbel, and L. Strüningmann	
<b>Matrix Representations of Genetic Codes and Human Emotions</b> . . . . .	23
Matthew X. He and Z.B. Hu	
<b>Matrices in Improvement of Systems of Artificial Intelligence and Education of Specialists</b> . . . . .	39
Nikolay A. Balonin, Sergey V. Petoukhov, and Mikhail B. Sergeev	
<b>A Mathematical Proof of Double Helix DNA to Reverse Transcription RNA for Bioinformatics</b> . . . . .	53
Moon Ho Lee, Han Hai, Sung Kook Lee, and Sergey V. Petoukhov	
<b>Tests of Parallel Information Processing on the Basis of Algebra and Formal Automata</b> . . . . .	68
A.V. Koganov and T.A. Rakcheeva	
<b>Control Strategy of Energy Storage for Frequency Coordination Dispatch Based on Improved Niche Genetic Algorithm</b> . . . . .	79
Daojun Chen, Nianguang Zhou, Cui Ting, Chenkun Li, Hu Guo, Lei Zhang, and Xunting Wang	
<b>Architecture and Method of Integrating Information and Knowledge on the Basis of the Ontological Structure</b> . . . . .	93
Yury Kravchenko, Ilona Kursitys, and Daniil Kravchenko	

**A Novel Approach to Estimating Databases Maximum Updating Time** ..... 104  
A.A. Baybulatov

**Modeling the Operation of an Adaptive Computing System Based on FGPN for Case Risk Management** ..... 113  
Aleksy Senkov and Evgenii Sorokin

**WAMS/SCADA Data Fusion Method Study Based on Time-Series Data Correlation Mining** ..... 120  
LiJin Zhao, Liang Huang, Qiansu Lv, Tao Yang, and Daqian Wei

**Evaluation of Library Information Cloud Nodes Configuration Scheme Based on DEA Method** ..... 134  
Quan Yuan and Wenbin Hu

**Anthropometrical Model in Pentacanon** ..... 147  
T. Rakcheeva

**Advances in Nederal Approaches**

**Intelligent Internet Technology for Personalized Health-Saving Support** ..... 157  
V.N. Krut'ko, A.M. Bolshakov, V.I. Dontsov, O.A. Mamikonova, A.M. Markova, A.I. Molodchenkov, N.S. Potemkina, and I.V. Smirnov

**Intelligence Self-Propelled Planar Parallel Robot for Sliding Cupping-Glass Massage for Back and Chest** ..... 166  
Sergey N. Sayapin

**Art of Recognition the Electromyographic Signals for Control of the Bionic Artificial Limb of the Hand** ..... 176  
Ivaniuk Natallia, Ponimash Zahar, and Karimov Vladimir

**Intelligent Recognition of Electrocardiograms Using Selective Neuron Networks and Deep Learning** ..... 182  
M. Mazurov

**Development of Microbiological Analyzer Based on Coherent Fluctuation Nephelometry** ..... 198  
A.S. Gur'ev, O. Yu. Kuznetsova, L.A. Kraeva, S.F. Rastopov, V.N. Verbov, I.A. Vasilenko, E.V. Rusanova, and A.Yu. Volkov

**Simulation of Two-Way Interaction between Blood Flow and Wall in Human Vessel** ..... 207  
E. Yatchenko and T. Rakcheeva

**Detection of Hidden Mineral Imbalance in the Human Body by Testing Chemical Composition of Hair or Nails** ..... 215  
S.A. Rustembekova, V.V. Gorshkov, M.M. Sharipova, and A.S. Khazova

<b>Virtual Concilium for Diagnostics of Heterogeneous Diseases . . . . .</b>	229
S.B. Rumovskaya, S.V. Listopad, and A.V. Kolesnikov	
<b>Advances in Technological and Educational Approaches</b>	
<b>Artificial Intelligence as Tutoring Partner for Human Intellect. . . . .</b>	238
V.I. Gromyko, V.P. Kazaryan, N.S. Vasilyev, A.G. Simakin, and S.S. Anosov	
<b>Fundamentals of Intelligent System for Estimation of Dynamical Interaction of Space Debris with Spacecrafts . . . . .</b>	248
B.V. Paliukh, V.V. Meshkov, V.K. Kemaykin, and Yu.G. Kozlova	
<b>A Software System for Thin-walled Parts Deformation Analysis . . . . .</b>	259
P.A. Eremeykin, A.D. Zhargalova, and S.S. Gavriushin	
<b>Design and Modeling of Adaptive Noise Suppression Systems with Morphological Approach . . . . .</b>	266
D. Rakov, J. Thorbeck, and M. Pecheykina	
<b>Analysis and Synthesis of Innovative Engineering Solutions and Technologies Based on Advanced Morphological Approach . . . . .</b>	274
B. Klimenko and D. Rakov	
<b>Efficiency Analysis of P-controller Neural Tuner and Adaptive Controller Based on Observer for DC Drive Speed Control Problem. . . . .</b>	284
Yuri I. Eremenko, Anton I. Glushchenko, and Vladislav A. Petrov	
<b>The Formation of the Optimal Composition of Multi-Agent System. . . . .</b>	293
N.Yu. Mutovkina, V.N. Kuznetsov, and A.Yu. Klyushin	
<b>Fuzzy Complex Assessment of Activities of the Agent in Multi-Agent System . . . . .</b>	303
N.Yu. Mutovkina	
<b>Analysis of Emergency Level at Sea Using Fuzzy Logic Approaches . . . . .</b>	314
Nelly A. Sedova, Viktor A. Sedov, and Ruslan I. Bazhenov	
<b>Investigation of Dynamic Behavior of Acetylene Production by Oxidative Pyrolysis of Natural Gas . . . . .</b>	323
G.N. Sanayeva, A.E. Prorokov, and V.N. Bogatikov	
<b>Development of a Piecewise Linear Model of the Oxidative Pyrolysis Process for the Control System Synthesis . . . . .</b>	333
G.N. Sanayeva, A.E. Prorokov, and V.N. Bogatikov	
<b>Author Index. . . . .</b>	343

# **Advances in Mathematics and Bio-mathematics**

# The Genetic Coding, United-Hypercomplex Numbers and Artificial Intelligence

Sergey Petoukhov, Elena Petukhova, Ludmila Hazina, Ivan Stepanyan, Vitaliy Svirin,  
Tamara Silova

Mechanical Engineering Research Institute, Russian Academy of Sciences, Moscow,  
M.Kharitonievsky pereulok, 4, Russia  
spetoukhov@gmail.com

**Abstract.** Scientists try to reproduce in devices of artificial intelligence intellectual properties of living organisms, which are connected with the genetic code system. This article is devoted to the study and modeling of the genetic system on the basis of mathematical formalisms, which are used in digital devices of artificial intelligence and technology of noise-immunity coding of information. The genetic code of amino acid sequences in proteins does not allow understanding and modeling of inherited processes such as inborn coordinated motions of living bodies, innate principles of sensory information processing, quasi-holographic properties, etc. To be able to model these phenomena, the concept of geno-logical coding, which is connected with logical functions and Boolean algebra, is put forward. Structured alphabets of DNA in their matrix form of representations are connected with dyadic groups of binary numbers and a new type of systems of multidimensional numbers. This type generalizes systems of complex numbers and hypercomplex numbers, which serve as the basis of mathematical natural sciences and many technologies. The new systems are called in a general case as “systems of united-hypercomplex numbers”. They can be widely used in models of multi-parametrical systems in the field of algebraic biology, artificial life, devices of biological inspired artificial intelligence, etc.

**Keywords:** Genetic Code, Boolean Algebra, Hypercomplex Numbers.

## 1 Matrix-algebraic Approach to the Study of Genetic Systems

Many devices of artificial intelligence are created on the basis of digital signal processing, where signals are represented in a form of a sequence of the numeric values of their amplitude in reference points. The theory of signal processing is based on an interpretation of discrete signals as a form of vector of multi-dimensional spaces. In each tact time a signal value is interpreted as the corresponding value of one coordinate of a multi-dimensional vector space of signals. In this way the theory of discrete signals turns out to be the science of geometries of multi-dimensional spaces. The number of dimensions of such a space is equal to the quantity of referent points for the signal. Metric notions and all other necessary things are introduced in these multi-

dimensional vector spaces for those or other problems of maintenance of reliability, speed and economy of the signal information. For example, the important notions of the energy and the power of a discrete signal appear in multi-dimensional geometry of the space of signals as forms of square of the length of a multi-dimensional vector-signal and of square of the length of a vector-signal divided by the number of dimensions of an appropriate space. On this geometrical basis, many methods and algorithms of recognition of signals and images, coding information, detections and corrections of information mistakes, artificial intellect and training of robots are constructed.

Scientists try to reproduce in devices of artificial intelligence intellectual properties of living organisms, which are connected with the genetic code system. We study the genetic code systems by means of their matrix forms of representations in the scientific direction of “matrix-algebraic genetics” [1-4].

Genetic information is written in DNA by means of sequences of 4 letters: adenine A, cytosine C, guanine G, thymine T (the RNA-alphabet also contains 4 letters: adenine A, cytosine C, guanine G, uracil U). Two questions arise:

- why is the genetic alphabet constructed by Nature on the base of 4 letters? (why not, for example, 30 or 50 letters?);
- why is the alphabet constructed on the base of these simple molecules though millions other molecules exist?

Likely answer is related to the fact that this set of 4 molecules possesses symmetrical properties since it has 3 pairs of binary-oppositional traits:

- 1) two letters are purines (A and G), and other two are pyrimidine's (C and T). From the standpoint of these traits one can denote  $A = G = 0$ ,  $C = T = 1$ . From the standpoint of these traits any DNA-sequence is represented by a corresponding binary sequence. For example, GCATGAAGT is 010100001;
- 2) two complementary letters (A and T) have two hydrogen bonds and other complementary letters (C and G) have three bonds. From the standpoint of these traits  $A = T = 0$ ,  $C = G = 1$ , and the same DNA-sequence GCATGAAGT is 110010010;
- 3) two letters are keto (G and T) and two other letters are amino (A and C). From the standpoint of these traits  $A = C = 0$ ,  $G = T = 1$ , and the sequence GCATGAAGT is 100110011.

Accordingly, each of DNA-sequences of nucleotides is the carrier of three parallel messages on three different binary languages. At the same time, these three types of binary representations form a common logical set on the basis of logical operation of modulo-2 addition: modulo-2 addition of any two such binary representations of DNA sequences coincides with the third binary representation of the same DNA sequence. One can remind here rules of the bitwise modulo-2 addition (denoted by the symbol  $\oplus$ ):  $0\oplus 0 = 0$ ;  $0\oplus 1 = 1$ ;  $1\oplus 0 = 1$ ;  $1\oplus 1 = 0$ . The mentioned three representations of the sequence GCATGAAGT form a common logical set: for example,  $101011110 \oplus 100110011 = 001101101$ .



This fact is the initial evidence in favor that the system of genetic coding uses Boolean algebra of logic with its binary tuples, dyadic groups of binary numbers and logical operations such as modulo-2 addition. Correspondingly one can think that there is a profound analogy between genetic organization of living bodies and computers based on Boolean algebra and dyadic groups of binary numbers. One can remind that modulo-2 addition is the group operation for dyadic groups of  $n$ -bit binary numbers. These groups are algebraically connected with Walsh functions, which are their algebraic characters and which we meet below. Dyadic groups of binary numbers are also connected with the notion of Hamming distance and they are used in genomic analysis and DNA-genetic encryption technique [5-7].

Science has led to a new understanding of life itself: "Life is a partner between genes and mathematics" [8]. So what mathematics is a partner of genes? It turned out that math of matrices and dyadic groups of binary numbers is a natural partner of the genetic coding system that has a property of noise-immunity coding at transmission of information along a chain of generations [1-4]. Information from the micro-world of genetic molecules dictates constructions in the macro-world of living organisms under strong noise and interference. This dictation is realized by means of unknown algorithms of multi-channel noise-immunity coding. For example, in accordance with Mendel's laws of independent inheritance of traits, colors of human skin, eye and hairs are genetically defined independently. So, each living organism can be considered as an algorithmic machine of multi-channel noise-immunity coding. To understand this machine we should use the known mathematical theory of noise-immunity coding, which is based on matrix representations of digital information. Hadamard matrices (their rows coincide with orthogonal complete systems of Walsh functions) are widely used in noise-immunity coding of information and in many other tasks of digital signals processing [9]. For example, they are employed on the spacecrafts "Mariner" and "Voyager" for the noise-immune transfer of photos of Mars, Jupiter, Saturn, Uranus and Neptune to Earth. Hadamard matrices are also used in quantum computers ("Hadamard gates") and in quantum mechanics as unitary operators. Complete systems of Walsh functions serve as a basis of the "sequency theory" [10], which has led to effective decisions in radio engineering, acoustics, optics, etc. In particular, problem of absorption of radio waves and acoustic waves, which is important for biological systems, is bypassed by means of the "sequency analysis". Hadamard matrices contain only components +1 and -1 and they are employed in the logical holography [11] and in the spectral analysis of systems of Boolean functions [12]. Let us say now about the connection of the genetic system with Hadamard matrices and their tensor families.

As known, exponentiation of Hadamard matrix  $[1 \ 1; -1 \ 1]$  in tensor (or Kronecker) powers ( $n$ ) gives a tensor family of Hadamard matrices  $[1 \ 1; -1 \ 1]^{(n)}$ , where each matrix has  $4^n$  entries ( $n=1, 2, 3, \dots$ ). Genetic DNA-alphabets of  $n$ -plets also contain  $4^n$  members: the alphabet of monopleths (A, C, G, T) contains 4 members; the alphabet of doublets (AA, AC, ...) contains  $4^2$  members; the alphabets of triplets (AAA, ACG, ...) contains  $4^3$  members, etc. These genetic alphabets can be represented in a form of the tensor family of genetic matrices  $[C, A; T, G]^{(n)}$ ,  $n=1, 2, 3$  (Fig. 1).

C	A
T	G

 ; 
 

CC	CA	AC	AA
CT	CG	AT	AG
TC	TA	GC	GA
TT	TG	GT	GG

CCC	CCA	CAC	CAA	ACC	ACA	AAC	CCC
CCT	CCG	CAT	CAG	ACT	ACG	AAT	CCT
CTC	CTA	CGC	CGA	ATC	ATA	AGC	CTC
CTT	CTG	CGT	CGG	ATT	ATG	AGT	CTT
TCC	TCA	TAC	TAA	GCC	GCA	GAC	TCC
TCT	TCG	TAT	TAG	GCT	GCG	GAT	TCT
TTC	TTA	TGC	TGA	GTC	GTA	GGC	TTC
TTT	TTG	TGT	TGG	GTT	GTG	GGT	TTT

**Fig. 1.** The tensor family of genetic matrices  $[C, A; T, G]^{(2)}$ ,  $[C, A; T, G]^{(2)}$  and  $[C, A; T, G]^{(3)}$ , which contain DNA-alphabets of 4 nitrogenous bases, 16 doublets and 64 triplets. Black (white) color indicates each of members of these alphabets, which corresponds to number +1 (-1) in accordance with the described algorithm.

Inside the DNA-alphabet of nitrogenous bases A, C, G and T, thymine T has a unique status and differs from other three letters:

1. only thymine T is replaced by another molecule U (uracil) in transferring from DNA to RNA;
2. only thymine T has not the functionally important amino group  $NH_2$ .

This binary opposition can be expressed as:  $A = C = G = +1, T = -1$ . Correspondingly in each of doublets and triplets its letters can be replaced by these numbers to represent it numerically as the product of these numbers (for example, the triplet CTA is represented by number  $1 * (-1) * 1 = -1$ ).

If each of members in the symbolic matrices  $[C, A; T, G]^{(n)}$  in Fig. 1 is replaced by its correspondence number +1 or -1, these genetic matrices become Hadamard matrices  $H, H^{(2)}$  and  $H^{(3)}$ . The sets of rows of these matrices contain complete orthogonal systems of Walsh functions for 2-, 4- and 8-dimensional spaces correspondingly. In particular, Walsh functions are used in logical holography, which can be applied to model known quasi-holographic properties of living bodies with its non-local record of information. Let us tell on this in more detail.

For example, in his experiments German embryologist Hans Driesch separated from each other two or four blastomeres of sea urchin eggs. The main result of Driesch's experiments was that fairly normal (although proportionally diminished) larvae with all of their organs properly arranged could be obtained from a single embryonic cell (blastomere) containing no more than 1/2 (if two first blastomeres were separated) or even 1/4 (in the case of four blastomeres separation) of the entire egg's material. Rather soon these effects were numerously confirmed and extended to

the species belonging to almost all taxonomic groups of metazoans, from sponges to mammals [13]. These experimental results testify that complete sets of “causes” required for further development are contained not only within whole eggs/embryos but also in their halves, quarters, etc. The similar properties exist in holograms, where one can restore a whole holographic image of a material object from a part of the hologram. A hologram has such property since each part of the hologram possesses information about all parts of the object (in difference to ordinary photos).

One can mention also known hypothesis about possible connections of holography with brain functions including associative memory, physiological processing visual information, etc. (see for example [14]). But the brain and the nervous system have appeared at a relatively late stage of biological evolution. A great number of species of organisms lived perfectly up to this, and is now living without neuronal networks. It is clear that the origins of the similarity between holography and nonlocal informatics of living organisms should be searched at the level of the genetic system.

Physical holography, which possesses the highest properties of noise-immunity, is based on a record of standing waves from two coherent physical waves of the object beam and of the reference beam. But physical waves can be modeled digitally. Correspondingly noise-immunity and other properties of optical and acoustical holography can be modeled by digitally, in particular, with using Walsh functions and logic operations concerning dyadic groups of binary numbers because Walsh transforms are Fourier transforms on the dyadic groups. This can be made on the base of discrete electrical or other signals without any application of physical waves. The pioneer work about «holography by Walsh waves» was [11]. The work was devoted to Walsh waves (or Walsh functions), which propagate through electronic circuits - composed of logical and analog elements - by the analogy with the optical Fourier transform holography. The Fourier analysis on dyadic groups is defined in terms of Walsh functions [12]. In this digital Walsh-holography, objects, whose digital holograms should be made, are represented in forms of  $2^n$ -dimensional vectors.

This digital Walsh-holography under the title «logical holography» was also considered later in some other works. All these works about the logical Walsh-holography considered possibilities of its application in engineering technologies without any supposition of its application in biology, in particular, in genetics. On the basis of our results about connections of the genetic code system with Walsh functions, Hadamard matrices, dyadic groups, cyclic permutations and logical modulo-2 addition, etc. we put forward the hypothesis that principles of the logical holography are appropriate for mathematical modeling properties of the genetic system [3]. This hypothesis leads to a new class of mathematical models of genetic structures and phenomena on the basis of logical holography and appropriate logical operations. Correspondingly we develop the theory of «genetic logical holography», where mathematics of the logical holography and logical operations is used for modeling genetic phenomena. The mathematical basis of this modeling approach is lattice functions, logical operations with them, dyadic spaces, dyadic groups of binary numbers, logic modulo-2 addition, dyadic convolution and dyadic derivatives of J. Gibbs in close relation with peculiarities of molecular-genetic systems. The new kind

of mathematics in modeling genetic phenomena gives possibilities of new heuristic associations and new understanding of the natural phenomena.

Mathematical formalisms of the logical holography and the theory of logic functions, including the dyadic convolutions and the dyadic derivatives of J. Gibbs, can be applied for comparative studying nucleotide sequences and also other biological string-like patterns and repetitions in them, which are under influence of genetic templates. For example the dyadic derivatives can be used in medical diagnosis for comparative analysis of bio-rhythms including cardiac arrhythmias. In the last case, components of each vector for calculation of its dyadic derivative coincide with values of variable time intervals in cardiac pulsations. Returning to the Mendel's laws of independent inheritance of traits (for example, colors of human skin, eye and hairs are inherited independently), it seems to be interesting to develop models of a multiplex-logical holography, where each of inherited traits is represented by its own logical hologram. In such approach a living body is a set of individual logical holograms of inherited traits.

As known, holographic methods in engineering allow quickly detecting individual elements in a huge image. The theory of genetic logical holography allows assuming that one of secrets of noise-immunity of genetic informatics is based on the similar possibilities of genetic logical holography. In an appropriate modeling approach, if one of DNA molecules mutates, the genetic logical holography – by analogy with classic physical holography - allows quickly detecting the mutated DNA in the whole logical hologram of a set of DNA molecules. In the result, the genetic information of this individual DNA molecule could be found to be incorrect for further using in organism automatically.

## **2 The Concept of the Geno-logical Coding**

The epoch-making discovery of the genetic code of the amino acid sequences in proteins has revealed the molecular genetic commonality in the diversity of species of living organisms. Some authors supposed that other kinds of genetic coding could also exist. For example, a supposition about the histone code is well known [15]. No mathematical approaches have been proposed to model such additional kinds of the genetic code.

It is obvious that the knowledge of the regularities of the genetic encode of structures of amino acid sequences is not enough for understanding and explaining the enormous class of inherited processes and principles of an algorithmic character: congenital coordinated motions of living bodies, innate principles of sensory information processing (including the psychophysical law of Weber-Fechner), congenital instincts and spatial representations, and so forth. We postulate that another kind of the biological code exists in parallel with the genetic code of amino acid sequences. We name conditionally this second code as "the geno-logical code" since - on the basis of our researches - we believe that this biological code is connected with logical operations and logical functions, dyadic groups of binary numbers, Walsh functions, logical holography and the spectral logic of systems of

Boolean functions. We believe that molecules DNA and RNA are not only the carriers of the genetic code of amino acid sequences but they are also participants of the geno-logic code, which encodes logical functions and which is connected with epigenetic mechanisms. DNA is an important part of this integrated coding system, peculiarities of which are reflected in structures of DNA-alphabets and in features of the degeneracy of the genetic code of amino acids. The integrated coding system contains not only the code of amino acid sequences but also the code of sets of logic functions. We are developing a relevant mathematical doctrine about this biological code. Below we describe our approaches to this theme.

As known, newborn turtles and crocodiles, when they hatched from eggs, crawl with quite coordinated movements to water without any training from anybody. Celled organisms, which have no nervous systems and muscles, move themselves by means of perfectly coordinated motions of cilia on their surfaces (the genetically inherited “dances of cilia”). In these inherited motions, a huge number of muscle fibers, nerve cells, contractile proteins, enzymes and so forth are acting in concert by analogy with the coordinated work of a plurality of parts of computers.

Computers work on the basis of networks of two-positional switches (triggers), each of which can be in one of two states: “yes” or “no”. But in physiology, the similar law “all-or-none” [16] for excitable tissues exists: a nerve cell or a muscle fiber give only their answers "yes" or "no" under action of different stimulus by analogy with Boolean variables. If a stimulus is above a certain threshold, a nerve or muscle fiber will fire with full response. Essentially, there will either be a full response or there will be no response. A separate muscle, which contains many muscle fibers, can reduce its length in a different degree due to the combined work of the plurality of its muscle fibers. Nervous system also can react differently to stimulus of a different force by means of combined excitations of its many nerve fibers (and also due to the ability to change the frequency of the generation of nerve impulses at their fixed amplitude).

R. Penrose [17] - in his thoughts about biological quantum computers - appeals to the known fact that tubulin proteins exist in two different configurations, and they can switch between these configurations like triggers to provide bio-computer functions.

Taking these known facts into account, we propose to consider a living organism as a genetically inherited huge network of triggers of different types and different biological levels, including trigger subnets of tubulin proteins, muscle fibers, neurons, etc. From this perspective, biological evolution can be represented as a process of self-organization and self-development of systems of biological trigger networks. Correspondingly, the Darwinian principle of natural selection can be interpreted in a certain degree as natural selection of biological networks of triggers together with appropriate systems of Boolean functions for coordinated work of these networks. In light of this it is not so surprising that the genetic system, that provides transmission of corresponding logic networks along the chain of generations, is also built on the principles of dyadic groups and operations of Boolean algebra of logic.

Computers work on the basis of binary numbers and Boolean algebra. Our results of studying molecular-genetic systems lead to the pieces of evidence that genetic systems work on the base of logical operations of Boolean algebra and dyadic groups

of binary numbers; it is important since the level of the molecular-genetic system is the deeper level than secondary levels of inherited nervous system or separate kinds of proteins such as abovementioned tubulin.

As known, for a creation of a computer, an usage of material substances for its hardware is not enough but logical operations should be also included to provide work of computer. These logical operations can successfully work in different kinds of hardware made from very different materials. The same situation is true for living bodies, where genetical systems should provide genetic information not only about material substances (proteins) but also about logic of interrelated operations in biological processes. One can remind that informatics is a scientific branch, which exists independent on physics or chemistry. For example, a physicist, who knows all physical laws but does not know the informatics, cannot understand the work of computers.

We think that the known genetic code of amino acid sequences defines material aspects of biological bodies and the geno-logic code defines logic rules and functions of their operating work. In the proposed new modeling approach about the geno-logic code, molecular-genetic elements (nitrogenous bases, doublets, triplets, etc.) and their ensembles are represented as Boolean functions or systems of these functions. Genetics can be additionally developed as a science about genetic systems of logic functions. Results of this development can be used not only for deeper understanding living matter but also for progress in the fields of artificial intellect and artificial life, where mathematical logic plays a key role. In this case computer systems and theoretical models should be developed, which are based on the special set of logic functions related with genetic systems. As known, artificial intellect, which possesses an ability of reproducing features of biological intellect, can not be constructed without usage of mathematical logic [18], and so the idea of the geno-logical coding is very natural. From the standpoint of the geno-logical approach, the genetic system is a part of such an intellectual substance, which is a living organism. One can think that the genetic system also is an intellectual substance, which communicates with other intellectual parts of living body to provide coordinated mutual functions.

E.Schrödinger noted [19]: *“from all we have learnt about the structure of living matter, we must be prepared to find it working in a manner that cannot be reduced to the ordinary laws of physics... because the construction is different from an anything we have yet tested in the physical laboratory”*. For comparison, the enzymes in the biological organism work in a million times more effectively than catalysts in the laboratory. Biological enzymes can accelerate a receiving of results of chemical reactions in  $10^{10}$ - $10^{14}$  times [20] (p. 5). We believe that such ultra-efficiency of enzymes in biological bodies is defined not only by laws of physics, but also by algebra-logical algorithms of the geno-logic coding, and therefore - in accordance with Schrödinger - this ultra-efficiency cannot be reduced to the ordinary laws of physics.

The American journal «Time» in 2008 year has announced the «personalized genetics» from the company «23andMe» as the best innovation of the year [21]. This innovation was recognized much more important than many others, including the Large Hadron Collider from the field of nuclear physics. The company «23andMe» proposes information about genetic peculiarities of persons at a low price. Now pos

sibilities of personalized genetics are developed intensively in many countries with huge financial supports. But this initial kind of «personalized genetics», which has limited possibilities, uses knowledge about the genetic code of protein sequences of amino acids without knowledge about the geno-logic code. It is natural to think that the cause of the body's genetic predisposition to various diseases is not only violations in amino acid sequences of proteins, but that geno-logical disorders in inheritance of various processes also play the important role. We believe that development of knowledge about the geno-logic coding will lead to “geno-logical personalized genetics” as a next step in human progress.

George Boole created his mathematics of logic to describe the laws of thought: his book in 1854 was titled «An Investigation of the Laws of Thoughts». Our reasoned statement about the existence of the geno-logical coding shows that our genetically encoded body is created on the basis of the same laws of logic, on which our thoughts are constructed (the unity of the laws of thoughts and body). It gives a new material for a discussion about the old problem: what is primary - thoughts or matter?

### 3 About United-hypercomplex Numbers

In the field of mathematical natural sciences and informatics, development of models and formalized theories depends highly on those mathematical notions and instruments, on which they are based. Different kinds of multi-dimensional numbers – complex numbers, split-complex numbers, quaternions of Hamilton, etc. – serve as the instrumental basis of many physical and other theories, which have led to creation of atomic stations, aero-plans and spaceships, electro-magnetic devices including computers, etc. Our matrix-algebraic analysis of genetic coding systems has discovered a way to generalize systems of complex numbers and hypercomplex numbers, which have matrix forms of their representations. To explain this way we briefly give here only one example of such generalized systems; other examples and their discussions are in our works [4, 22] in a close connection with genetic code structures.

Fig. 2 shows the  $(4 \times 4)$ -matrix  $W$ , each row of which coincides with one of Walsh functions. This matrix is decomposed into the sum of 4 sparse matrices:  $W = e_0 + e_1 + e_2 + e_3$ .

The decomposition (Fig. 2 top) consists of two sets of matrices – firstly  $e_0$  and  $e_1$  and secondly  $e_2$  and  $e_3$  -, each of which is closed under multiplication and defines the multiplication table, which coincides with the multiplication table of complex numbers (Fig. 2 bottom left). It means that each of expressions  $Z_L = a_0 * e_0 + a_1 * e_1$  and  $Z_R = a_2 * e_2 + a_3 * e_3$ , where  $a_0, a_1, a_2, a_3$  are real numbers, represents its own system of complex numbers in the unusual form of the sparse  $(4 \times 4)$ -matrix with their 2 independent parameters  $a_0, a_1$  and  $a_2, a_3$  correspondingly (Fig. 1 bottom right). It can be formulated also in the following way: each of the systems  $Z_L$  and  $Z_R$  is isomorphic to the usual system of complex numbers.

$$\begin{array}{|c|c|c|c|} \hline 1 & -1 & 1 & -1 \\ \hline 1 & 1 & -1 & -1 \\ \hline 1 & -1 & 1 & -1 \\ \hline -1 & -1 & 1 & 1 \\ \hline \end{array} = \begin{array}{|c|c|c|c|} \hline 1 & 0 & 0 & 0 \\ \hline 0 & 1 & 0 & 0 \\ \hline 1 & 0 & 0 & 0 \\ \hline 0 & -1 & 0 & 0 \\ \hline \end{array} + \begin{array}{|c|c|c|c|} \hline 0 & -1 & 0 & 0 \\ \hline 1 & 0 & 0 & 0 \\ \hline 0 & -1 & 0 & 0 \\ \hline -1 & 0 & 0 & 0 \\ \hline \end{array} + \begin{array}{|c|c|c|c|} \hline 0 & 0 & 1 & 0 \\ \hline 0 & 0 & 0 & -1 \\ \hline 0 & 0 & 1 & 0 \\ \hline 0 & 0 & 0 & 1 \\ \hline \end{array} + \begin{array}{|c|c|c|c|} \hline 0 & 0 & 0 & -1 \\ \hline 0 & 0 & -1 & 0 \\ \hline 0 & 0 & 0 & -1 \\ \hline 0 & 0 & 1 & 0 \\ \hline \end{array}$$
  

$$\begin{array}{|c|c|c|} \hline * & e_0 & e_1 \\ \hline e_0 & e_0 & e_1 \\ \hline e_1 & e_1 & e_0 \\ \hline \end{array} ; \begin{array}{|c|c|c|} \hline * & e_2 & e_3 \\ \hline e_2 & e_2 & e_3 \\ \hline e_3 & e_3 & e_2 \\ \hline \end{array} \quad Z_L = \begin{array}{|c|} \hline a_0, -a_1, 0, 0 \\ \hline a_1, a_0, 0, 0 \\ \hline a_0, -a_1, 0, 0 \\ \hline -a_1, -a_0, 0, 0 \\ \hline \end{array} ; \quad Z_R = \begin{array}{|c|} \hline 0, 0, a_2, -a_3 \\ \hline 0, 0, -a_3, -a_2 \\ \hline 0, 0, a_2, -a_3 \\ \hline 0, 0, a_3, a_2 \\ \hline \end{array}$$

**Fig. 2.** Top: the decomposition of the matrix W into 4 sparse matrices:  $W = e_0 + e_1 + e_2 + e_3$ . Bottom left: multiplication tables for the pair  $e_0$  and  $e_1$  and for the pair  $e_2$  and  $e_3$  coincide with the multiplication table of basic elements of complex numbers. Bottom right: unusual matrix representations of complex numbers  $Z_L = a_0 * e_0 + a_1 * e_1$  and  $Z_R = a_2 * e_2 + a_3 * e_3$ .

The classical identity matrix  $E = [1 \ 0 \ 0 \ 0; 0 \ 1 \ 0 \ 0; 0 \ 0 \ 1 \ 0; 0 \ 0 \ 0 \ 1]$  is absent in the set of matrices  $Z_L$  and  $Z_R$ , where each matrix has zero determinant. Consequently the usual notion of the inverse matrix  $Z_L^{-1}$  or  $Z_R^{-1}$  can't be defined in relation to the usual identity matrix E in accordance with the famous theorem about inverse matrices for matrices with zero determinant in the case of the complete set of matrices. But we analyze only very limited special sets of matrices  $Z_L$  and  $Z_R$ . The set  $Z_L$  has the matrix  $e_0$ , which possesses all properties of the identity matrix for any matrix  $Z_L$  since  $e_0 Z_L = Z_L e_0 = Z_L$  and  $e_0^2 = e_0$ . In the frame of the set of matrices  $Z_L$ , where locally the matrix  $e_0$  plays the role of the real unit, one can define - for any non-zero matrix  $Z_L$  - its inverse matrix  $Z_L^{-1} = ((a_0^2 + a_1^2)^{-1}) * (a_0 e_0 - a_1 e_1)$  in relation to the matrix  $e_0$ . This matrix  $Z_L^{-1}$  satisfies conditions:  $Z_L Z_L^{-1} = Z_L^{-1} Z_L = e_0$ . By analogy, the set of matrices  $Z_R$  has the matrix  $e_2$ , which possesses all properties of the identity matrix for any matrix  $Z_R$  since  $e_2 Z_R = Z_R e_2 = Z_R$  and  $e_2^2 = e_2$ . In the frame of the set of matrices  $Z_R$ , where locally the matrix  $e_2$  plays the role of the real unit, one can define - for any non-zero matrix  $Z_R$  - its inverse matrix  $Z_R^{-1} = ((a_2^2 + a_3^2)^{-1}) * (a_2 e_2 - a_3 e_3)$  in relation to the matrix  $e_2$ . This matrix  $Z_R^{-1}$  satisfies conditions:  $Z_R Z_R^{-1} = Z_R^{-1} Z_R = e_2$ . Multiplication of two members from the same set ( $Z_L$  or  $Z_R$ ) is commutative as it is true for complex numbers. But multiplication of two members from different sets (one member from  $Z_L$  and one - from  $Z_R$ ) is not commutative and gives a new matrix from one of these sets.

The total set of sparse matrices  $e_0, e_1, e_2, e_3$  does not contain the mutual identity matrix and therefore the total sum  $Z = Z_L + Z_R = (a_0 e_0 + a_1 e_1) + (a_2 e_2 + a_3 e_3)$  does not represent a system of hypercomplex numbers. It contains two blocks of complex numbers  $Z_L$  and  $Z_R$  united in the joint matrix. By this reason we call Z as the system of 2-block united-complex numbers. This system has operations of addition and non-commutative multiplication. It is one of many types of systems of  $2^n$ -block united-complex and united-hypercomplex numbers (briefly, U-hypercomplex numbers or more simply U-numbers), some of which are connected with different decompositions of genetic matrices [4, 22].



As known, from the time of construction of quaternions by Hamilton, hypercomplex numbers are created by means of extension of complex numbers, which have a single real unit and a single imaginary unit, via including additional imaginary units to a single real unit. We propose quite another way of extensions of complex numbers and hypercomplex numbers by means of including new independent real units (one or more real units, which we call local-real units) together with their particular complements of imaginary units (local-imaginary units):  $(a_0E_1+a_1e_1+ \dots +a_ke_k) + (b_0E_2+b_1q_1+ \dots +b_mq_m)+ \dots + (d_0E_n+d_1j_1+\dots +d_pj_p)$ , where each of expressions in brackets represents its own complex or hypercomplex system;  $E_1, E_2, \dots, E_n$  are local-real units;  $e_1, \dots, e_k, q_1, \dots, q_m, j_1, \dots, j_p$  are local-imaginary units;  $a_0, \dots, a_k, b_0, \dots, b_m, d_0, \dots, d_p$  – real coefficients. Our results reinforce the standpoint that living matter in its informational fundamentals is organized on algebraic bases. They seem to be used for development of algebraic biology, artificial intelligence, genetic biomechanics, biomechanics of man-machine systems, etc.

The notion of “number” is the main notion of mathematics and mathematical natural sciences. “Complexity of a civilization is reflected in complexity of numbers used by this civilization” [23]. “Number is one of the most fundamental concepts not only in mathematics, but also in all natural sciences. Perhaps, it is the more primary concept than such global categories, as time, space, substance or a field” [24]. Pythagoras studied figurate numbers and has formulated the idea: “numbers rule the world”. B. Russell noted that he did not know of any other man who has been as influential as Pythagoras was in the sphere of thought [25]. From this standpoint, there is no more fundamental scientific idea in the world, than this idea about a basic meaning of numbers. As Heisenberg noted [26], modern physics is moving along the same path along which the Pythagoreans walked. Our genetic-mathematical researches have led to new systems of multidimensional numbers and have given new materials to the great idea by Pythagoras since these materials have allowed putting forward the hypothesis for bio-mathematical modeling that multi-block U-numbers rule genetic-informational organization of living matter, or briefly «U-numbers rule living matter» [4, 22].

## References.

1. Petoukhov S. V.: Matrix Genetics, Algebras of the Genetic Code, Noise Immunity. RCD, Moscow, Russia (2008) (in Russian).
2. Petoukhov, S.V., He M.: Symmetrical Analysis Techniques for Genetic Systems and Bioinformatics: Advanced Patterns and Applications. IGI Global, Hershey, USA (2010).
3. Petoukhov S.V., Petukhova E.S.: Symmetries in genetic systems and the concept of geno- logical coding. - Information, 8(1), 2; doi:10.3390/info8010002 (2017).
4. Petoukhov S.V.: Genetic coding and united-hypercomplex systems in the models of algebraic biology. Biosystems, v. 158, August, pp. 31–46 (2017).
5. Mohammed Abo-Zahhad, Sabah M. Ahmed, Shimaa A. Abd-Elrahman, "Genomic Analysis and Classification of Exon and Intron Sequences Using DNA Numerical Mapping Techniques", IJITCS, vol.4, no.8, pp.22-36, 2012. <http://www.mecspress.org/ijitcs/ijitcs-v4-n8/v4n8-3.html>

6. Prakash Chandra Srivastava, Anupam Agrawal, Kamta Nath Mishra, P. K. Ojha, R. Garg, "Fingerprints, Iris and DNA Features based Multimodal Systems: A Review", *IJITCS*, vol.5, no.2, pp.88-111, 2013.DOI: 10.5815/ijitcs.2013.02.10. <http://www.mecs-press.org/ijitcs/ijitcs-v5-n2/v5n2-10.html>
7. Hamdy M. Mousa, "DNA-Genetic Encryption Technique", *International Journal of Computer Network and Information Security (IJCNIS)*, Vol.8, No.7, pp.1-9, 2016.DOI: 10.5815/ijcnis.2016.07.01. <http://www.mecs-press.org/ijcnis/ijcnis-v8-n7/IJCNIS-V8-N7-1.pdf>
8. Stewart I.: *Life's other secret: the new mathematics of the living world*. Penguin, New York, USA (1999).
9. Seberry J., Wysocki B.J., Wysocki T.A.: On some applications of Hadamard matrices. *Metrica*, 62, pp. 221-239 (2005).
10. Harmuth, H. F.: *Sequency theory*. Academic Press, N.-Y., USA (1977).
11. Morita Y., Sakurai Y.: *Holography by Walsh Waves*. In: *Proceedings of the Symposium (4th) Held at the Catholic University of America, Washington, D. C. on 16-18 April*, pp. 122-126 (1973).
12. Karpovsky M.G., Stankovic R.S., Astola J.T.: *Spectral Logic and its Applications for the Design of Digital Devices*. John Wiley & Sons Inc., New Jersey, USA (2008).
13. Belousov L.: *Morphomechanics of Development*. Springer International Publishing AG, Switzerland, (2015).
14. Pribram K.: *Languages of the Brain*. Englewood Cliffs, New Jersey, USA (1971).
15. Jenuwein Th., Allis C.D.: Translating the histone code. *Science*, v. 293, pp.1074-1080 (2001).
16. All-or-none law. [https://en.wikipedia.org/wiki/All-or-none\\_law](https://en.wikipedia.org/wiki/All-or-none_law) (this page was last modified on 26 March 2017).
17. Penrose, R.: *Shadows of the Mind*. Oxford University Press, Oxford, England (1996).
18. Yaglom I.M.: *The Boolean Structure and its Models*. Sovetskoye Radio, Moscow, USSR, 1980 (in Russian).
19. Schrödinger E.: *What is life?* University Press, Cambridge, England (1955).
20. Varfolomeev S.D.: *Chemical enzymology*. Akademia, Moscow, Russia (2005).
21. Hamilton A. *Invention of the year. The retail DNA test*. *Time*, Oct. 29 (2008).
22. Petoukhov S.V.: The genetic code, algebra of projection operators and problems of inherited biological ensembles. – <http://arxiv.org/abs/1307.7882>, 8th version of the article from 3 May 2017, pp. 1-93 (2017).
23. Davis P.J.: *Arithmetics*. – In: "Mathematics in the modern world", *Scientific American*, N. Y., USA, p. 29-45 (1964).
24. Pavlov D. G.: *Leading article. Hypercomplex numbers in geometry and in physics*, 1(1), p. 4-7 (2004) (in Russian).
25. Russel B.: *A History of Western Philosophy. - Book One, Part I, Chapter III*. Simon & Schuster/Touchstone N.Y., USA (1967).
26. Heisenberg W.: *Physics and Philosophy: The Revolution in Modern Science*. Penguin Classics N.Y., USA (2000).

# Exploring Structure and Evolution of the Genetic Code with the Software Tool GCAT

E. Fimmel<sup>1\*</sup>, M. Gumbel<sup>1</sup>, and L. Strüingmann<sup>1</sup>

<sup>1</sup>Institute for Mathematical Biology, Mannheim University of Applied Sciences  
{e.fimmel,m.gumbel,l.struengmann}@hs-mannheim.de  
<http://www.mbi.hs-mannheim.de>

**Abstract.** The genetic code can be seen as the major key to biological self-organisation. In fact, all living organisms regardless of whether they are plants, bacteria or mammals have the same molecular bases: Adenine, cytosine, guanine, and thymine. Unidimensional sequences of these bases contain the genetic information for the synthesis of proteins in all forms of life. Thus, one of the most fascinating questions is to explain why evolution has produced the current genetic code and why it exists in its present form.

Motivated by these fundamental questions, a new software tool – *Genetic Code Analysis Toolkit (GCAT)* – was developed which can be used to investigate properties of the genetic code in order to develop hypotheses about its origin and evolution. The main focus of the tool has been put on the graphical visualisation of the data.

In the present paper we will describe in short the tool GCAT and give a couple of applications presenting new results on circular codes and the structure of some ancient codes.

**Keywords:** Circular Codes, Genetic Information, Binary Dichotomic Algorithms, GCAT, Genetic Code Analysis Toolkit.

## 1 Introduction

The genetic code is a dictionary that translates triples of molecular bases into amino acids which are then combined to form proteins – the main ingredient for all kind of livings. Protein synthesis is therefore the essential mechanism that nature uses in forming life. A long evolutionary process has produced the current genetic code table passing through several ancient codes and the central and fascinating question is why the code is at it is. Is it optimised in any sense or is its present form just a *frozen accident*? After Watson and Crick [3] had discovered the DNA helix structure and then deciphered the encoding of 20 amino acids (plus a stop signal) by 64 codons, the scientific community was tempted to believe that

---

<sup>1</sup> Corresponding author.

the most central riddle of nature was solved and it was hoped that (genetic) diseases could be cured in the near future. However, even after the 1000-Genome-Project [20] we are still far from this paradisiac situation. Nowadays, it is clear that there are more secrets in protein synthesis than we know and it is believed that only interdisciplinary efforts by biologists, physicians, chemists, bioinformaticians and mathematician will help to fully understand this complex process.

About 20 years ago, a class of so-called *circular* genetic codes<sup>2</sup> were found statistically in genetic coding sequences [2]. These codes have remarkable properties that seem to play an essential role in the process of translation. They could be the reason for one of the fundamental features of the genetic code, the *noise immunity*: The ribosome apparently has mechanisms to detect and correct errors that arise during the translational process, for instance, those caused by unintentional insertion or deletion of a base in a sequence. The translation process in the ribosome is naturally error-prone and it is highly unlikely that a complex system like this develops without any error correcting or detecting mechanism. A series of publications [4, 5, 7, 8, 9] shows fascinating similarities between properties of circular codes and processes within protein synthesis. Moreover, a recent theory states that nature evolved from simpler ancient codes that had high error correcting features to more complex codes by paying the price of error correction and instead using a nested second code - a circular code. Thus, also from an evolutionary point of view circular code theory is of great importance and at the same time extremely difficult from a mathematical point of view.

Inherently one often needs to examine many particular cases in the above research in order to understand a pattern behind them for suggesting a theoretical explanation of a process. This is very time-consuming, if done manually, and in particular in the case of the genetic code one has to face a complexity that is comparable to those of a chess game on a  $8 \times 8$  chess board. Moreover, manual handling of such examples is error-prone and a manual investigation of *real* data, for instance sets of data from GenBank or from FASTA files, is completely impossible due to their sizes (compare also [1, 12, 15]). Thus, the only possible approach to achieve useful results on this field is to have a computer aid. However, there was no re-usable and expandable tool accessible for this kind of genetic data that had a user-friendly editor and a main focus on its graphical output. We hope to fill this slot by means of our software *Genetic Code Analysis Toolkit* (GCAT). GCAT is capable to handle sets of codons as well as genetic sequences from GenBank or FASTA files. A special feature of the tool is a comprehensive editor which, amongst other things, visualises graphically the processes implemented. This is one of the characteristics which distinguishes GCAT from other tools like Bioconductor [14] that require knowledge in scripting.

## 2 Software

GCAT is a Java-based application with a comprehensive user interface for a rich user

---

<sup>2</sup> More details can be found in Section 'Circular Codes' below.

experience. Although developed as a stand alone software, its architecture enables the integration of bioinformatic toolkits like Bioconductor or R [18] in general. Technically, GCAT consists of two major components:

1. GCAT comes with a domain model for nucleic bases and amino acids that is linked and integrated with BioJava [17]. BioJava is a feature rich frame-work for bioinformatics, and GCAT primarily uses it to import and export sequences from a file or web services.
2. Operations are the key functions in GCAT which are applied to a sequence or a set of codons. They either modify or analyze a collection of tuples and the result of an operation may be the input for another. Operations can be used in an interactive mode similar to a shell or a workbench like R Studio or Matlab or in batch mode. Each operation may also have a graphical user interface. All operations are designed as plug-ins that are loosely coupled with GCAT's core components. New plug-ins can easily be added even without re-compiling the software.

GCAT is freely available at <http://www.gcat.bio>.

### 3 Applications

In this section we discuss three applications of our tool GCAT that led to new results on the genetic code and its evolution. The first two show interesting properties of circular codes and the results in Theorem 1 and Theorem 2 lack theoretical proofs so far but have been purely obtained by investigating the data using GCAT. The third result sheds some light on a theory by Jiménez-Montano about the origin of the genetic code.

#### 3.1. Circular Codes

A fundamental feature of the genetic code is its noise immunity: It is resistant to mutational effects caused by e.g. insertion or deletion of a nucleic base or simply an incorrect grouping of codons as a consequence of a false reading frame. Such mutations can be fatal during the translation process, may result in nonfunctional proteins and can thus lead to genetic diseases like, first of all, some kinds of cancer, Tay-Sachs disease, or HIV.

In 1996, Arqués and Michel [2] selected, by means of statistical analysis, the 20 most frequent codons in the 3 different reading frames of genetic coding sequences. The analysis was done in large gene populations of prokaryotes and eukaryotes (later on extended to bacteria and viruses). Surprisingly, the set of codons they found formed a *circular code*. Such codes are a weaker version of *comma-free codes* which had been proposed by Crick in 1957 [3] as a solution for the frame-shift problem. Every out-of-frame codon can be recognised immediately by comma-free codes as it cannot belong to the code by definition. However, an experimental evidence that comma-free codes are used in nature has been missing. Circular codes have likewise the property of

detecting frame-shift mutations during the translation as every sequence of bases has at most one decomposition into codons from a circular code if read on a circle. However, the frame-shift error can only be detected eventually and after at most 13 bases. The property of circularity as well as that of comma-freeness are preserved under a systematic exchange of nucleic bases and a reversing permutation of the codon bases. This led to a systematic study and classification of circular codes in [4] using group theory.

Even though circular codes have been found in nature as subcodes of the genetic code and although they compile very well with the codon bias of coding sequences, it is not clear how nature uses their error detecting and error correcting features. This asks for a comprehensive and systematic statistical investigation of data sets from data bases like GenBank in order to better understand the properties of circular codes and their appearance in coding sequences as well as the possible role they play in forming the three dimensional structure of proteins. In GCAT many features have been implemented which are designed to carry out this analysis for either sets or sequences of codons. Below we list some examples of such functionalities of GCAT which have turned out to be useful when working with circular codes:

- **Test Sequence:** The tool tests the given set of codons for properties like comma-freeness, circularity, or self-complementarity.
- **Substitute Nucleotide Bases:** Applies one of the 24 possible permutations of nucleotide bases to all codons in a given code.
- **Split Sequence:** In this functionality of the tool different possibilities to split a given code according to some rules are collected. It includes the important BDA subunit (compare the corresponding subsection below) and splittings into comma-free subcodes.
- **Permute Nucleotide Bases Positions:** In each codon in a given code the order of bases is changed according to the same rule.
- **Analyse Sequence:** This functionality provides different statistical features for a given code like number of amino acids coded or codon usage in a sequence from a given file.

We close this subsection with a new theorem that was obtained by using the *Split Sequence* feature of our tool. However, it lacks a theoretical proof so far.

*Theorem 1. Any maximal circular code can be partitioned into 4 comma-free codes of size 5.*

In Figure 1 (a) an example is given where a maximal circular code is divided into four comma-free subcodes each of size five.

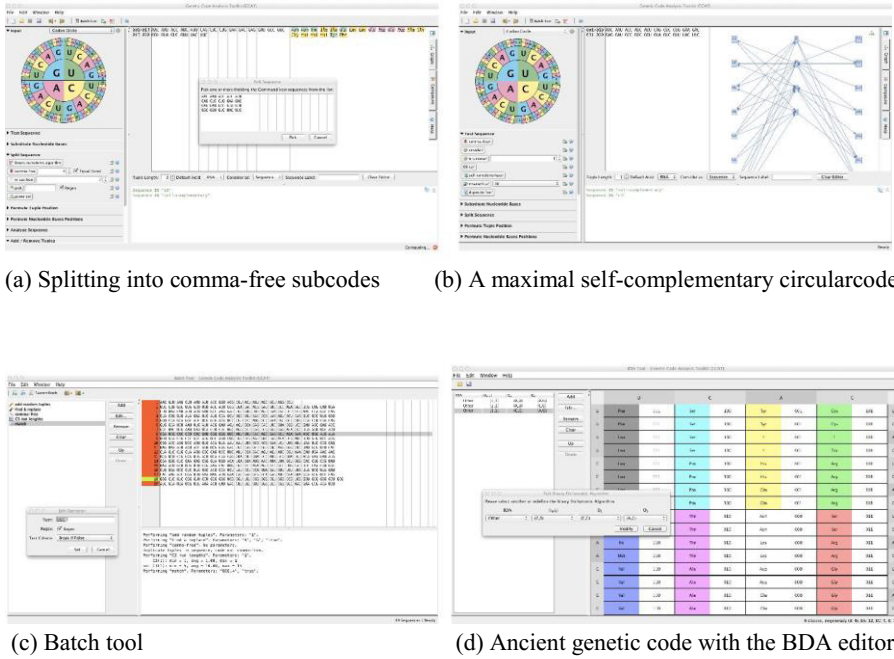

Fig. 1. Screenshots of GCAT.

### 3.2. Graphical Visualisation

In [5] a new graph theoretical approach to investigate properties of subcodes of the genetic code was suggested. Given a subcode  $X$  of the genetic code, i.e. a set of codons, one associates a directed graph to  $X$  by assigning to each codon  $N_1N_2N_3$  two edges: one connecting the first base with the second and third  $N_1 \rightarrow N_2N_3$  and a second edge connecting the first two bases with the last one  $N_1N_2 \rightarrow N_3$ . Figure 1 (b) shows an example of this graphical presentation. The directed graph associated to a code visualises the code's properties like circularity and comma-freeness very well. For instance, a code is circular if and only if its associated graph is acyclic, i.e. does not contain any circle, while comma-freeness is equivalent to a maximal path length not exceeding 2 (see [5] for more details). Using the same approach for dinucleotides instead of trinucleotides (codons) showed a beautiful similarity between the theory of dinucleotide circular codes and tournaments on four vertices (see [5]) while restricting to graphs with maximal path length equal to 1 even led to the discovery of a new class of strong comma-free codes (see [6]).

The tool GCAT can be used to display and investigate the graphs associated to subcodes of the genetic code. Various layouts (organic, stack, circle) of the graph can be displayed in the editor. Thus properties like maximal path length or acyclicity of the graph can be easily seen in GCAT. A new theorem that has been obtained using our tool is the following. It will be discussed in [7]:

*Theorem 2. A maximal circular code is self-complementary if and only if it satisfies*

the following two conditions:

- (i) the set of vertices is self-complementary;
- (ii) for any vertex  $v$  the number of outgoing edges of  $v$  equals the number of ingoing edges of its complemented vertex.

The necessity of the two conditions in Theorem 2 is easily established but the sufficiency again lacks a theoretical proof so far. In Figure 1 (b) an example is given where the graph of a maximal self-complementary circular code is displayed.

### 3.3. Binary Dichotomic Algorithms

When it comes to mutations, the essential question is how a codon can be read correctly by the ribosome. The investigations in [13, 10] showed that it is possible to determine a codon uniquely by applying a sequence of so called Binary Dichotomic Algorithms (BDA). Those algorithms ask chemical questions to the bases involved in the codon that might be performed by the ribosome.

GCAT contains such a component (1d) that analyses and links the structure of the genetic code to BDAs. A BDA partitions codons into two classes (0 or 1) and it is a generalisation of known partitions like the Rumer- [19], Parity-, Complementary- or Hidden-classification [11]. Fig. 2 shows an example for the Rumer-BDA.

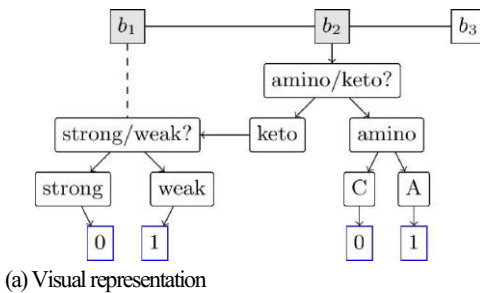

BDA	( $i1, i2$ )	$Q1$	$Q2$
Rumer	(2, 1)	(C, A)	{C, G}

(b) Table representation

**Fig. 2.** The Rumer classification is an important example for a binary dichotomic algorithm. Here a codon is classified into the classes 0 or 1 depending on the chemical properties of the bases at positions 1 and 2. (a) shows a visual representation of the algorithm. The first decision is related to base 2. If it is of type keto (i.e. U or G) the first base is also considered: If the first base is of type strong (C or G) a 0 is assigned and otherwise a 1. For instance, the codon CUG obtains 0. (b) lists the same information in a table format. ( $i1, i2$ ) indicates the involved bases for the first and second decision (or question),  $Q1$  and  $Q2$  are the bases used for the decision ( $Q$  like question).



When such a classification of a codon is repeated with different BDAs we can concatenate the classes to a binary word consisting of zeros and ones. This leads to a larger number of different words (or classes) and enables us to create more than two classes for a single codon. This method was used to address different questions: We have shown that it is possible with a set of six BDAs to create 64 classes [13], i.e. every codon can be distinguished uniquely. In particular, the ribosome is a possible biological entity that implements this mechanism. Weak base-pairs (i.e. A-U or U-A) are indistinguishable one from another in the minor groove of an RNA strand. Strong base-pairs (C-G or G-C) also cannot be distinguished in the minor groove, but display a different profile of hydrogen bonds compared to weak base pairs. These observations narrow down possible BDAs. However, it is still possible to create 64 classes with reading-head-compatible BDAs though [13]. This suggests a hypothesis for a possible error-detection mechanism in the translation process.

Another application is to match ancient codes by means of BDA classifications. The evolution theory according to Jiménez-Montano [16] claims that at the beginning there were only eight amino acids. Such a genetic code table could be perfectly fitted (see table 1). Here again, like in the Rumer-BDA above, the first two bases are required to classify the ancient amino acids. Fig. 1 (d) shows the BDA editor that produces this ancient code. We, again, close this section with the following theorem:

**Theorem 3.** *The ancient code by Jiménez-Montano can be produced by BDAs.*

**Table 1.** Ancient genetic code according to [16]. (a) This precursor code has eight amino acids represented by eight classes which can be fit with three BDAs shown in right table (b).

(a) Ancient code table						(b) BDAs			
	U	C	A	G		BDA	$(i1, i2)$	$Q1$	$Q2$
U	Leu 111	Pro 100	! 001	Arg 101	U	A1	(2, 1)	{A, U}	{A, G}
U	Leu 111	Pro 100	! 001	Arg 101	C	A2	(2, 1)	{A, U}	{U, C}
U	Leu 111	Pro 100	! 001	Arg 101	A	A3	(2, 1)	{C, G}	{A, G}
U	Leu 111	Pro 100	! 001	Arg 101	G				
C	Leu 111	Pro 100	! 001	Arg 101	U				
C	Leu 111	Pro 100	! 001	Arg 101	C				
C	Leu 111	Pro 100	! 001	Arg 101	A				
C	Leu 111	Pro 100	! 001	Arg 101	G				
A	Val 110	Ala 010	Asp 000	Gly 011	U				
A	Val 110	Ala 010	Asp 000	Gly 011	C				
A	Val 110	Ala 010	Asp 000	Gly 011	A				
A	Val 110	Ala 010	Asp 000	Gly 011	G				
G	Val 110	Ala 010	Asp 000	Gly 011	U				
G	Val 110	Ala 010	Asp 000	Gly 011	C				
G	Val 110	Ala 010	Asp 000	Gly 011	A				
G	Val 110	Ala 010	Asp 000	Gly 011	G				

## 4 Discussion and Conclusion

The Genetic Code Analysis Toolkit (GCAT) is a novel user-friendly and extensible software tool which is intended to be used by (theoretical) biologists, mathematicians and physicists to explore structural properties of the genetic code. The software is open source, so it can be developed further in order to establish hypotheses concerning structural properties of the genetic code and execute tests to prove these. In the present paper we have described in short some already implemented functionalities of the tool and have given some examples of its applications. A special feature of the tool is its graphical visualisation of the genetic code and a possibility to consider not only genetic codes consisting of trinucleotides but also  $n$ -nucleotides for every given natural  $n$ . It allows, for instance, to examine dinucleotide and tetranucleotide genetic codes that can be useful in order to study the evolution of the modern genetic code.

**Acknowledgments** We would like to thank Karin Adler for her contribution to ancient genetic codes. The authors are deeply grateful to Kristian Kraljic for his excellent work in the implementation of the GCAT and to the Karl Völker Foundation for their financial support during the work on the GCAT.

## References

1. Mohammed Abo-Zahhad, Sabah M. Ahmed, Shima A. Abd-Elrahman, "Genomic Analysis and Classification of Exon and Intron Sequences Using DNA Numerical Mapping Techniques", International Journal of Information Technology and Computer Science (IJITCS), vol.4, no.8, pp.22-36, 2012. DOI: 10.5815/ijitcs.2012.08.03
2. Arquès D. G. and Michel C. J.: *A complementary circular code in the protein coding genes*, J.Theor. Biol., 182, 45-58, 1996.
3. Crick F., Griffith J. S., and Orgel L. E.: *Codes without commas*, Proceedings of the National Academy of Sciences of the United States of America, 43, 1957, 416-421.
4. Fimmel E., Giannerini S., Gonzalez D., Strüngmann L.: *Circular codes, symmetries and transformations* J. of Mathematical Biology, (July 2014), 70(7):1623-44.
5. Fimmel E., Michel C.J., and Strüngmann L.: *n-nucleotide circular codes in graph theory*, Phil Trans.A, volume 374: 20150058, 2016.
6. Fimmel E., Michel C.J., and Strüngmann L.: *Strong comma-free codes*, submitted for publication.
7. Fimmel E., Michel C.J., and Strüngmann L.: *Self-complementarity in genetic codes*, in preparation.
8. Fimmel, E.; Strüngmann, L.: *On the hierarchy of trinucleotide n-circular codes and their corresponding amino acids*, J. Theor Biol., 2015, 364, 113-120.
9. Fimmel E., Strüngmann L.: *Codon Distribution in Error-Detecting Circular Codes*, Life 2016, 6(1), 14; doi:10.3390/life6010014.
10. Fimmel, E., Danielli, A., Strüngmann, L.: *On dichotomic classes and bi-jections of the genetic code*, J. Theor. Biol. 336 (0), 2013, 221?230.

11. Gonzalez D.L., Giannerini S., Rosa R.: *Strong short-range correlations and dichotomic codon classes in coding DNA sequences* Phys. Rev. E: Stat. Nonlin. Soft Matter Phys. Nov 2008. 78 (5 Pt 1), 051918.
12. Syed Mahamud Hossein, S.Roy,"A Compression & Encryption Algorithm on DNA Sequences Using Dynamic Look up Table and Modified Huffman Techniques", International Journal of Information Technology and Computer Science(IJTCS), vol.5, no.10, pp.39-61, 2013. DOI: 10.5815/ijitcs.2013.10.05
13. Gumbel M., Fimmel E., Danielli A., Strüngmann L.: *On Models of the Genetic Code generated by Binary Dichotomic Algorithms*. Biosystems 128 (2015) 9-18. <http://dx.doi.org/10.1016/j.biosystems.2014.12.001>.
14. Huber W., Carey V. J., Gentleman R., Anders S., Carlson M., Carvalho B. S., Bravo H. C. , Davis S., Gatto L., Girke T., Gottardo R., Hahne F., Hansen K. D., Irizarry R. A., Lawrence M., Love M. I., MacDonald J., Obenchain V. , Ole? A. K., Pag'es H., Reyes A., Shannon P., Smyth G. K., Tenenbaum D., Waldron L., Morgan M.: *Orchestrating high-throughput genomic analysis with bioconductor*, Nat Methods 12 (2) (2015) 115? 121. doi:10.1038/nmeth.3252. URL <http://dx.doi.org/10.1038/nmeth.325210> E. Fimmel et al.
15. J.K. Meher, M.R. Panigrahi, G.N. Dash, P.K. Meher,"Wavelet Based Lossless DNA Sequence Compression for Faster Detection of Eukaryotic Protein Coding Regions", International Journal of Image, Graphics and Signal Processing(IJIGSP), vol.4, no.7, pp.47-53, 2012. 10.5815/ijigsp.2012.07.05
16. Jim'enez-Monta~no, M. A.: *Protein evolution drives the evolution of the genetic code and vice versa*. Biosystems, (1999), 4(1-2):47?64.
17. Prlic A., Yates A., Bliven S. E., Rose P. W., Jacobsen J., Troshin P. V., Chapman M., Gao J., Koh C. H., Foisy S., Holland R., Rimsa G., Heuer M. L., Brandstätter-Müller H., Bourne P. E., Willis S.: *Biojava: an open-source framework for bioinformatics in 2012*, Bioinformatics 28 (20) (2012) 2693?2695. doi:10.1093/bioinformatics/bts494. URL <http://dx.doi.org/10.1093/bioinformatics/bts494>
18. R Development Core Team, R: *A Language and Environment for Statistical Computing*, R Foundation for Statistical Computing, Vienna, Austria, ISBN 3-900051-07-0 (2008). URL <http://www.R-project.org>
19. Rumer Yu.B.: *Translation of ?Systematization of Codons in the Genetic Code [I-III]? by Yu. B. Rumer (1966-1968)*. Phil. Trans. R. Soc. A, 2016, 374: 20150446
20. The 1000 Genomes Project Consortium: *A global reference for human genetic variation*. Nature, 2015, 526:7571, 68?-74, <http://dx.doi.org/10.1038/nature15393>

# Matrix Representations of Genetic Codes and Human Emotions

Matthew X. He<sup>1</sup>, Z. B. Hu<sup>2</sup>

<sup>1</sup>Nova Southeastern University Ft. Lauderdale, FL 33314, USA

<sup>2</sup>Central China Normal University Wuhan, China

hem@nova.edu, hzb@mail.ccnu.edu.cn

**Abstract.** The genetic code is encoded in combinations of the four nucleotides (A, C, G, T) found in DNA and then RNA. DNA defines the structure and function of an organism and contains the complete genetic information. Using the genetic code of the DNA, according to central dogma of molecular biology proteins are formed. In recent years, it has been suggested that our emotions are molecules. The peptides connect to human emotions that influence every move, function and thought. The peptides as information substances bring the messages to all our body cells. In this paper, we present recent advances in genetic code-based matrices generated by RNA bases (A, C, G, U) and then draw a parallel of matrices of emotions generated by primary emotions (Sadness, Happiness, Anger, Fear) = (S, H, A, F) along with facial expressions of markers. This parallel shows a similarity connection between universal genetic codes and the universality of facial expressions for emotions. We further show that the frequency of 64 compound emotions/facial expression markers follow a law of normal distribution.

**Keywords:** Genetic code, genetic matrix, human emotions, facial expressions, matrix of human emotions.

## 1. Introduction

It is well known that the genetic code is encoded in combinations of the four nucleotides (A, C, G, U) found in DNA and then RNA. The following table gives a complete list of 64 triplets (codons) with corresponding 20 amino acids with three (one) letter code and stop codons.

**Table 1.** The Universal Genetic Code and Amino Acids

		Second Position of Codon					
		U	C	A	G		
F i r s t  P o s i t i o n	U	UUU Phe [F]	UCU Ser [S]	UAU Tyr [Y]	UGU Cys [C]	U	T h i r d  P o s i t i o n
		UUC Phe [F]	UCC Ser [S]	UAC Tyr [Y]	UGC Cys [C]	C	
		UUA Leu [L]	UCA Ser [S]	UAA <i>Ter</i> [end]	UGA <i>Ter</i> [end]	A	
		UUG Leu [L]	UCG Ser [S]	UAG <i>Ter</i> [end]	UGG Trp [W]	G	
	C	CUU Leu [L]	CCU Pro [P]	CAU His [H]	CGU Arg [R]	U	
		CUC Leu [L]	CCC Pro [P]	CAC His [H]	CGC Arg [R]	C	
		CUA Leu [L]	CCA Pro [P]	CAA Gln [Q]	CGA Arg [R]	A	
		CUG Leu [L]	CCG Pro [P]	CAG Gln [Q]	CGG Arg [R]	G	
	A	AUU Ile [I]	ACU Thr [T]	AAU Asn [N]	AGU Ser [S]	U	
		AUC Ile [I]	ACC Thr [T]	AAC Asn [N]	AGC Ser [S]	C	
		AUA Ile [I]	ACA Thr [T]	AAA Lys [K]	AGA Arg [R]	A	
		AUG Met [M]	ACG Thr [T]	AAG Lys [K]	AGG Arg [R]	G	
	G	GUU Val [V]	GCU Ala [A]	GAU Asp [D]	GGU Gly [G]	U	
		GUC Val [V]	GCC Ala [A]	GAC Asp [D]	GGC Gly [G]	C	
		GUA Val [V]	GCA Ala [A]	GAA Glu [E]	GGA Gly [G]	A	
		GUG Val [V]	GCG Ala [A]	GAG Glu [E]	GGG Gly [G]	G	

Table 1 shows that there are 64 triplets or codons. One can see that some amino acids are encoded by several different but related base triplets. Also three triplets (UAA, UAG, and UGA) are stop codons. No amino acids are corresponding to their code. The remaining 61 triplets represent 20 different amino acids. These genetic code triplets form an 8x8 matrix. The number of variants of 64 codons is equal 64! which is approximately  $10^{89}$ . There have been many investigations and studies to give a formal characterization of the particular structure of the code which would also have a justification from physico-chemical and/or evolutionary points of view [Knight, R.D., Freeland, S. J., Landweber, L. F., 1999]. Swanson proposed a Gray code representation of the genetic code [Swanson, R., 1984]. A representation of the genetic code as a six-dimensional Boolean hypercube was proposed in [Jiménez-Montaña, M. A., Mora-Basáñez, C. R., Pöschel, T., 1994]. A Yang [Yang, C. M., 2003] introduced a topological approach to rearranging the Hamiltonian-type graph of the codon map into a polyhedron model. Universal metric properties of the genetic code were defined by means of the nucleotide base representation on the square with

vertices U or T =00, C=01, G=10 and A=11 in [Štambuk, N., 2000]. It was shown that this notation defines the Cantor set and Smale horseshoe map representation of the genetic code. Petoukhov [Petoukhov, S.V., 1999; 2001; 2002] recently discovered the "Biperiodic table of genetic code" shown below:

**Table 2.** Biperiodic Table of Genetic Code

CCC	CCA	CAC	CAA	ACC	ACA	AAC	AAA
CCU	CCG	CAU	CAG	ACU	ACG	AAU	AAG
CUC	CUA	CGC	CGA	AUC	AUA	AGC	AGA
CUU	CUG	CGU	CGG	AUU	AUG	AGU	AGG
UCC	UCA	UAC	UAA	GCC	GCA	GAC	GAA
UCU	UCG	UAU	UAG	GCU	GCG	GAU	GAG
UUC	UUA	UGC	UGA	GUC	GUA	GGC	GGA
UUU	UUG	UGU	UGG	GUU	GUG	GGU	GGG

This 8x8 matrix table demonstrates a great symmetrical structure and has led to many discoveries [He, M., Petoukhov, S.V., 2011; Petoukhov, S.V., 2016]. By using three fundamental attributive mappings, the stochastic characteristic of the biperiodic table and symmetries in structure of genetic code were recently investigated in [He, M., 2003; 2004; He, M., Petoukhov, S.V., Ricci, P.E., 2003].

In recent years, it has been suggested that our emotions are molecules. Candace Pert's theory [Pert, C.B., 1999] suggested peptides are connected to human emotions. Emotions can originate both in the head, influencing the body, and originate in the body, influencing the head through the peptides (and other ligands). Every move, function and thought is influenced by our emotions because they are the peptides (or information substances) which bring the messages to all our body cells. Pert's theory suggests our emotions are molecules and exist in real, concrete, biological form.

First proposed by Paul Ekman posits that there are six basic emotions which are universally recognized and easily interpreted through specific facial expressions, regardless of language or culture. These emotions are: happiness, sadness, fear, anger, surprise and disgust.

Most recent work published in the journal *Current Biology* [Jack, R.E., Garrod, O.G., Schyns, P.G., 2014] has challenged a commonly-held belief that there are six basic emotions of sadness, happiness, anger, fear, surprise and disgust, and suggested that all human behavior can be broken down into four basic emotions - **sadness, happiness, anger/disgust, and fear/surprise**. The study suggested that the

differences between surprise and fear and between anger and disgust are more for social reasons than survival ones.

This paper applies genetic matrices generated by RNA bases (A, C, G, U) and draws a parallel of emotion matrices generated by primary emotions (**SADNESS, HAPPINESS, ANGER/DISGUST, FEAR/SURPRISE**) = (**S, H, A, F**). We use primary emotion matrix to generate secondary compound matrix and tertiary compound matrix. Furthermore, we make a mapping between each primary emotion and a binary code of ((00), (11), (10), (01)) and draw a connection with 64 facial expressions of makers. This parallel shows a similar connection between universal genetic codes and the universality of facial expressions for emotions. We further show that the frequency of 64 compound emotions/facial expression markers follow a law of normal distribution.

## 2. Early Theories of Emotions

Emotions - happiness, sadness, fear, anxiety, and so on – are feelings we all experience at one time or another. But what precisely defines these feelings? Are there sensory signals from our body, diffuse molecular patterns of activity in our cortex or something else? Early theories of emotions were developed as briefly outlined below:

- James-Lange Theory: It proposes that an emotion starts with a physical reaction in the body, and then filters up to the head where we put a word to the response, and recognize it as an emotion.
- Canon-Bard Theory: We first feel the emotion in our heads, and then our body reacts (with increased heart rate, etc.).
- Dimensional theories of emotion: Emotions, even basic emotions, can be broken down into smaller fundamental elements combined in different ways and different amounts, just as all the elements of the periodic table are made of protons, neutrons, and electrons. In a dimensional theory, emotions such as happiness and sadness consist of different amounts of brain activation corresponding to affective dimensions such as valence and arousal [Hamann, S., 2012].
- Candace Pert's Theory: An emotion happens in the head and body simultaneously. Emotions are the peptides, they continually come into contact with our immune system, endocrine system, and nervous system, etc. Depending on our emotional state (happy, sad, angry, etc), different peptides are released, and different messages are sent throughout the body. For example, feelings of bliss and bonding are accompanied by the release of endorphins into the body's communication highway. Feelings of self-love are accompanied by a peptide called VIP. Each peptide has its own emotional tone or mood that you can experience [Pert, C. B., 1999]. This would explain why and how our health is affected by emotions.

In the early studies of emotions [James, W.,1884; Izard, C. E.,1977; Frijda, N. H., 1986], some basic emotions are classified by various theorist as summarized below:

**Table 3. Early classifications of emotions**

<b>Theorist</b>	<b>Basic Emotions</b>
Plutchik	Acceptance, anger, anticipation, disgust, fear, joy, sadness, surprise
Arnold	Anger, aversion, courage, dejection, desire, despair, fear, hate, hope, love, sadness
Ekman	Anger, disgust, fear, joy, sadness, surprise
Frijda	Desire, happiness, interest, surprise, wonder, sorrow
Gray	Rage, terror, anxiety, joy
Izard	Anger, contempt, disgust, distress, fear, guilt, interest, joy, shame, surprise

Furthermore, emotion structures were categorized as primary emotions, secondary emotions, and tertiary emotions as listed in the table below:

**Table 4. Early studies of emotion structures**

<b>Primary</b>	<b>Secondary</b>	<b>Tertiary</b>
<b>Love</b>	Affection	Adoration, affection, attraction, caring, compassion, fondness, liking, love, tenderness, sentimentality
	Lust	Arousal, desire, lust, passion, infatuation
	Longing	Longing
<b>Joy</b>	Cheerfulness	Amusement, bliss, cheerfulness, delight, elation, ecstasy, euphoria, gaiety, glee, happiness, jolliness, joviality, joy, jubilation, enjoyment, gladness, satisfaction,
	Zest	Enthusiasm, excitement, exhilaration, thrill, zeal, zest,
	Contentment	Contentment, pleasure
	Pride	Pride, triumph
	Optimism	Eagerness, hope, optimism
	Enthrallment	Enthrallment, rapture
	Relief	Relief
<b>Surprise</b>	Surprise	Amazement, astonishment, surprise



<b>Anger</b>	Irritation	Aggravation, agitation, annoyance, grouchiness, grumpiness, irritation
	Exasperation	Exasperation, frustration
	Rage	Anger, rage, outrage, fury, wrath, hostility, ferocity, bitterness, hate, loathing, scorn, spite, vengefulness, dislike, resentment
	Disgust	Disgust, revulsion, contempt
	Envy	Envy, jealousy
	Torment	Torment
<b>Sadness</b>	Suffering	Agony, anguish, hurt, suffering
	Sadness	Depression, despair, gloom, glumness, grief, hopelessness, misery, melancholy, sadness, sorrow, unhappiness, woe
	Disappointment	disappointment, Dismay, displeasure
	Shame	Guilt, regret, remorse, shame
	Neglect	Alienation, defeat, dejection, embarrassment, homesickness, humiliation, insult, insecurity, isolation, loneliness, neglect, rejection
	Sympathy	Pity, sympathy
<b>Fear</b>	Horror	Alarm, fear, fright, horror, hysteria, mortification, panic, shock, terror,
	Nervousness	Anxiety, apprehension, distress, dread, nervousness, tenseness, uneasiness, worry

### 3. Recent Studies of Emotions

In modern neurobiological terms, emotions are complex programs of actions triggered by the presence of certain stimuli, external to the body or from within the body, when such stimuli activate certain neural systems. Feelings of emotion, on the other hand, are perceptions of the emotional action programs. The experience of emotion is accompanied by activation of two major areas of the nervous system: the brain and the autonomic nervous system. Several key points are summarized at [Website: Boundless]:

- The limbic system, autonomic nervous system, and reticular activating system all interact in the physiological processing of emotion.
- The limbic system categorizes human emotional experiences as either pleasant or unpleasant mental states. Neurochemicals such as dopamine, noradrenaline, and serotonin are important components of the limbic system.
- The autonomic nervous system, together with the hypothalamus, regulates pulse, blood pressure, breathing, and arousal in response to emotional cues.

- When activated, the sympathetic nervous system prepares the body for emergency actions by controlling the glands of the endocrine system. Conversely, the parasympathetic nervous system functions when the body is relaxed or at rest and helps the body store energy for future use.
- The reticular activating system is believed to first arouse the cortex and then maintain its wakefulness so that sensory information and emotion can be interpreted more effectively.

Emotions are sometimes revealed through facial expressions. When these natural facial articulations involve the contraction of the same muscle groups in people of distinct cultural upbringings, this is taken as evidence of a biological origin of these emotions. Past research on facial expressions of emotion has focused on the study of six basic categories—happiness, surprise, anger, sadness, fear, and disgust. However, many more facial expressions of emotion exist and are used regularly by humans. Recent study describes an important group of expressions, which are called compound emotion categories as illustrated in Fig. 2 from [Du, S. C., Tao, Y. and Martinez, A. M., 2014].

Furthermore, facial movements have been associated with humans Hox genes [Gaufo GO, Wu S, Capecchi MR, 2004]. HOX genes are evolutionarily highly conserved. The HOX proteins which they encode are master regulators of embryonic development and continue to be expressed throughout postnatal life. Humans have Hox genes in four clusters.

**Table 5.** Hox genes clusters and corresponding chromosomes

cluster	chromosome	genes
HOXA	chromosome 7	HOXA1, HOXA2, HOXA3, HOXA4, HOXA5, HOXA6, HOXA7, HOXA9, HOXA10, HOXA11, HOXA13
HOXB	chromosome 17	HOXB1, HOXB2, HOXB3, HOXB4, HOXB5, HOXB6, HOXB7, HOXB8, HOXB9, HOXB13
HOXC	chromosome 12	HOXC4, HOXC5, HOXC6, HOXC8, HOXC9, HOXC10, HOXC11, HOXC12, HOXC13
HOXD	chromosome 2	HOXD1, HOXD3, HOXD4, HOXD8, HOXD9, HOXD10, HOXD11, HOXD12, HOXD13

Hoxa3, Hoxb3 and Hoxd3 direct the development of some of the nerves that control muscles responsible for some eye and facial movements [Gaufo GO, Wu S, Capecchi MR, 2004].

In 2009, more than 800 people were asked to fill in a questionnaire designed to study how they handle anger [Reuter, M., Weber, B., Fiebach, C.J., Elger, C., Montag, C., 2009]. Isolation of a gene called DARPP-32 helps explain the biological basis of anger and why some people fly into a rage at the slightest provocation, while others can remain calm.

Most recently in [Okbay, A., Baselmans, B. M. L, et al., 2016], for the first time in history, researchers have isolated the parts of the human genome that could explain the differences in how humans experience happiness. These are the findings of a large-scale international study in over 298,000 people.

#### 4. Matrix Representation of Human Emotions

In recent years, matrix representation has been used extensively for genetic code investigation [He, M., Petoukhov, S.V., 2011; Petoukhov, S.V., 2016]. All biological organisms are identical in their molecular-genetic bases (A, C, G, U), this discovery has led to a viewpoint about a nature of life: “*Life is a partnership between genes and mathematics*” as stated by Stewart in [Stewart, 1999].

Here we use four universal emotion codes from the Section I (**SADNESS, HAPPINESS, ANGER/DISGUST, FEAR/SURPRISE**) = (**S, H, A, F**) and define the following 2x2 universal emotion matrix:

**Table 6.** 2x2 Universal emotion matrix

<b>S</b>	<b>F</b>
<b>A</b>	<b>H</b>

Each letter code is not just a representation of an emotion; it has been revealed that each emotion has its own biological basis. Furthermore, the **S** is paired with the **H**; and the **A** is paired with the **F**. Furthermore, many more complex emotions exist and are expressed regularly by humans. Here using the same algorithm as for genetic code matrix, we generate a 4x4 and 8x8 compound emotion matrix, respectively.

**Table 7.** 4x4 Compound emotion matrix

<b>SS</b>	<b>SF</b>	<b>FS</b>	<b>FF</b>
SA	SH	FA	FH
<b>AS</b>	<b>AF</b>	<b>HS</b>	<b>HF</b>
AA	AH	HA	HH

**Table 8.** 8x8 Compound emotion matrix

<b>SSS</b>	<b>SSF</b>	<b>SFS</b>	<b>SFF</b>	<b>FSS</b>	<b>FSF</b>	<b>FFS</b>	<b>FFF</b>
SSA	SSH	SFA	SFH	FSA	FSH	FFA	FFH
<b>SAS</b>	<b>SAF</b>	<b>SHS</b>	<b>SHF</b>	<b>FAS</b>	<b>FAF</b>	<b>FHS</b>	<b>FHF</b>
SAA	SAH	SHA	SHH	FAA	FAH	FHA	FHH
<b>ASS</b>	<b>ASF</b>	<b>AFS</b>	<b>AFF</b>	<b>HSS</b>	<b>HSF</b>	<b>HFS</b>	<b>HFF</b>
ASA	ASH	AFA	AFH	HSA	HSH	HFA	HFH
<b>AAS</b>	<b>AAF</b>	<b>AHS</b>	<b>AHF</b>	<b>HAS</b>	<b>HAF</b>	<b>HHS</b>	<b>HHF</b>
AAA	AAH	AHA	AHH	HAA	HAH	HHA	HHH

Each cell of the matrix is a triplet of compound emotions or mix of emotions. Next we make the connection of this matrix representation with the matrix representation of facial expression of emotions. In order to make this connection, we define

**Table 9.** 2x2 Binary code-based universal emotion matrix

<b>S</b>	<b>F</b>
A	H

as

<b>0</b>	<b>0</b>
<b>0</b>	<b>1</b>
1	1
0	1

Using the same algorithm for this binary-code based matrix, we have the following:

**Table 10.** 4x4 Binary code-based compound emotion matrix

<b>00</b> <b>00</b>	<b>00</b> <b>01</b>	<b>00</b> <b>10</b>	<b>00</b> <b>11</b>
01 00	01 01	01 10	01 11
<b>10</b> <b>00</b>	<b>10</b> <b>01</b>	<b>10</b> <b>10</b>	<b>10</b> <b>11</b>
11 00	11 01	11 10	11 11

And

**Table 11.** 8x8 Binary code-based compound emotion matrix

<b>000</b> <b>000</b>	<b>000</b> <b>001</b>	<b>000</b> <b>010</b>	<b>000</b> <b>011</b>	<b>000</b> <b>100</b>	<b>000</b> <b>101</b>	<b>000</b> <b>110</b>	<b>000</b> <b>111</b>
001 000	001 001	001 010	001 011	001 100	001 101	001 110	001 111
<b>010</b> <b>000</b>	<b>010</b> <b>001</b>	<b>010</b> <b>010</b>	<b>010</b> <b>011</b>	<b>010</b> <b>100</b>	<b>010</b> <b>101</b>	<b>010</b> <b>110</b>	<b>010</b> <b>111</b>
011 000	011 001	011 010	011 011	011 100	011 101	011 110	011 111
<b>100</b> <b>000</b>	<b>100</b> <b>001</b>	<b>100</b> <b>010</b>	<b>100</b> <b>011</b>	<b>100</b> <b>100</b>	<b>100</b> <b>101</b>	<b>100</b> <b>110</b>	<b>100</b> <b>111</b>
101 000	101 001	101 010	101 011	101 100	101 101	101 110	101 111
<b>110</b> <b>000</b>	<b>110</b> <b>001</b>	<b>110</b> <b>010</b>	<b>110</b> <b>011</b>	<b>110</b> <b>100</b>	<b>110</b> <b>101</b>	<b>110</b> <b>110</b>	<b>110</b> <b>111</b>
111 000	111 001	111 010	111 011	111 100	111 101	111 110	111 111

Recognizing human emotions is a difficult task. Human emotion recognition system via feature extraction of facial expressions with combination of neural network for the recognition of different facial emotions (happy, sad, angry, fear, surprised, neutral etc..) were introduced in [Singh, D. 2012]. Machine learning approaches to facial

expression recognition provide a unique opportunity to explore the compatibility or incompatibility of different theories of emotion representation [Piatkowska E., Martyna J. 2012]. Most recently the human emotions are also analyzed from EEG Signal (Electroencephalogram) with different kinds of situation [Sreeshakthy, M, Preethi, J., Dhilipan A. 2016], and brain-computer interaction is utilized using neuro-scan machines like Encephalography (EEG) to identify the emotions of immobilized individuals [ Krishna, N. M., Devi, J. S., Yarramalle, S. 2017].

Facial expressions can be also captured by six facial semantic (eye zone and mouth zone) markers as listed below:

**Table 12.** Six facial semantic markers (eye/mouth zone)

<b>0</b>	<b>1</b>
eyebrows outer down	eyebrows inner down
eyebrows lowered	eyebrows raised
eyes closed	eyes open
mouth small	mouth broad
mouth corners down	mouth corners up
mouth closed	mouth open

By combining these six polar markers, 64 facial expressions are formed (eye zone: 2x2x2; mouth zone: 2x2x2; 8x8=64). Facial Expression Makers (FEM) are represented by the following 8x8 matrix:

**Table 13.** 64 facial expression markers

<b>FEM11</b>	<b>FEM12</b>	<b>FEM13</b>	<b>FEM14</b>	<b>FEM15</b>	<b>FEM16</b>	<b>FEM17</b>	<b>FEM18</b>
<b>FEM21</b>	<b>FEM22</b>	<b>FEM23</b>	<b>FEM24</b>	<b>FEM25</b>	<b>FEM26</b>	<b>FEM27</b>	<b>FEM28</b>
<b>FEM31</b>	<b>FEM32</b>	<b>FEM33</b>	<b>FEM34</b>	<b>FEM35</b>	<b>FEM36</b>	<b>FEM37</b>	<b>FEM38</b>
<b>FEM41</b>	<b>FEM42</b>	<b>FEM43</b>	<b>FEM44</b>	<b>FEM45</b>	<b>FEM46</b>	<b>FEM47</b>	<b>FEM48</b>
<b>FEM51</b>	<b>FEM52</b>	<b>FEM53</b>	<b>FEM54</b>	<b>FEM55</b>	<b>FEM56</b>	<b>FEM57</b>	<b>FEM58</b>
<b>FEM61</b>	<b>FEM62</b>	<b>FEM63</b>	<b>FEM64</b>	<b>FEM65</b>	<b>FEM66</b>	<b>FEM67</b>	<b>FEM68</b>
<b>FEM71</b>	<b>FEM72</b>	<b>FEM73</b>	<b>FEM74</b>	<b>FEM75</b>	<b>FEM76</b>	<b>FEM77</b>	<b>FEM78</b>
<b>FEM81</b>	<b>FEM82</b>	<b>FEM83</b>	<b>FEM84</b>	<b>FEM85</b>	<b>FEM86</b>	<b>FEM87</b>	<b>FEM88</b>

These 64 facial expressions can be represented by binary code-based 8x8 matrix.

**Table 14.** Binary code-based 64 facial expression markers of emotions

<b>E/M</b>	<b>000</b>	<b>001</b>	<b>010</b>	<b>011</b>	<b>100</b>	<b>101</b>	<b>110</b>	<b>111</b>
<b>000</b>	000 000	000 001	000 010	000 011	000 100	000 101	000 110	000 111
<b>001</b>	001 000	001 001	001 010	001 011	001 100	001 101	001 110	001 111
<b>010</b>	010 000	010 001	010 010	010 011	010 100	010 101	010 110	010 111
<b>011</b>	011 000	011 001	011 010	011 011	011 100	011 101	011 110	011 111
<b>100</b>	100 000	100 001	100 010	100 011	100 100	100 101	100 110	100 111
<b>101</b>	101 000	101 001	101 010	101 011	101 100	101 101	101 110	101 111
<b>110</b>	110 000	110 001	110 010	110 011	110 100	110 101	110 110	110 111
<b>111</b>	111 000	111 001	111 010	111 011	111 100	111 101	111 110	111 111

Furthermore, these facial expressions can be described with the following compound emotions:

**Table 15.** Approximate description of 64 facial expressions of emotions

<b>E/M</b>	<b>000</b>	<b>001</b>	<b>010</b>	<b>011</b>	<b>100</b>	<b>101</b>	<b>110</b>	<b>111</b>
<b>000</b>	Empty	Gloomy	Arrogant	Dumb	Reserved	Exceptional	Sanctimonious	Riveted
<b>001</b>	Tired	Shaken	Absentminded	Terrified	Commanding	Admonitory	Ashamed	Disenchanted
<b>010</b>	Meticulous	Guilty	Crafty	Enduring	Foolish	Pushing	Tender	Adventurous
<b>011</b>	Transcendent	Pathetic	Sarcastic	Exalted	Restrained	Euphoric	Naive	Jubilant Mood
<b>100</b>	Humiliated	Worried	Plaintive	Fragile	Hard Set	Diabolic	Disgusted	Collected
<b>101</b>	Hurt	Powless	Overstrained	Touched	Jealous	Furious	Dissatisfied	Hypnotized
<b>110</b>	Stubborn	Generous	Scoffing	Care free	Spoilt	Courteous	Engaging	Greedy
<b>111</b>	Camaraderie	Ecceentric	Desirous	Enthusiastic	Domesticating	Impulsive	Indiscreet	Triumphant

Comparing Table 8 with Table 15, one can make association between corresponding entries such as the entries “SSS” and “HHH” from Table 8 and the entries “Empty” and “Triumphant” from Table 15. It appears that these compound emotions are well connected with the facial expression markers. The binary code-based matrices as illustrated in Table 11 and Table 14 can be also used to the frequency distributions of these 64 compound emotions and facial expression markers. Let X be the number of one’s in Tables 11 and 14. Then the possible values of X are 0, 1, 2, 3, 4, 5, 6. Seven classes of the compound emotions (Table 8) and facial expression markers (Table 13) are divided. The frequency table of the compound emotions is given below.



**Table 16.** Frequency Distribution of Compound Emotions

X	Compound Emotions/Facial Expressions	Frequency
0	SSS	1
1	SSF SFS FSS SSA SAS ASS	6
2	SFF FSF FFS SSH SFA FSA SAF SHS FAS SAA ASF AFS HSS ASA AAS	15
3	FFF SFH FSH FFA SHF FAF FHS SAH SHA FAA AFF HSF HFS ASH AFA HAS AAF AHS HAS AAA	20
4	FFH FHF HFF SHH FAH FHA AFH HSH HFA AHF HAF HHS AAH AHA HAA	15
5	HHH HAH AHH HHF HFH FHH	6
6	HHH	1

It is easy to see that the table demonstrates a **normal distribution** of the random variable X as illustrated in Figure 1 as well.

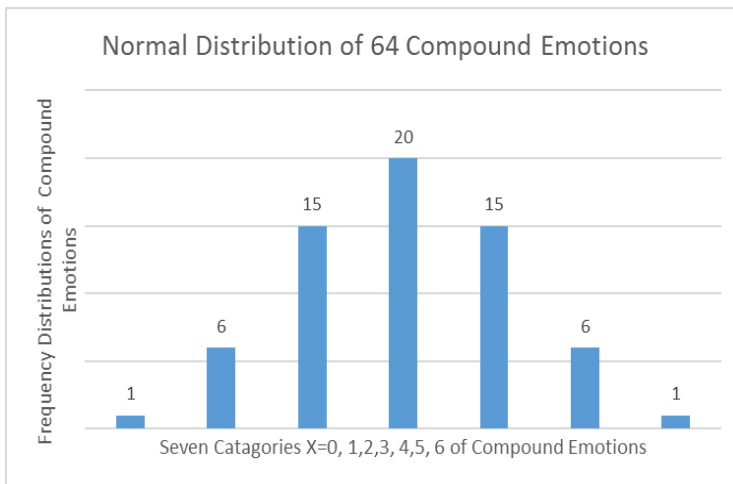
**Fig. 1.** Frequency Distribution of 64 Compound Emotions

Our study showed a close relation between genetic code based matrix and universal emotion based matrix. 64 universal genetics code can be generated by a four RNA bases of (A, C, G, U). Using 4 universal emotion code of (S, H, A, F), we generated 64 compound emotions. These 64 compound emotions are connected to 64 facial expressions of markers through binary code-based matrices. Furthermore, we demonstrated that the frequency distribution of 64 compound emotions (facial expression markers) obeys a law of normal distribution. It is hoped that these

relationships will help us further explore the biological bases of human emotions and possible direct connections between genetic codes and emotion codes.

## Reference

1. Du, S. C., Tao, Y. and Martinez, A. M. (2014), Compound facial expressions of emotion, *Proc Natl Acad Sci U S A*. 2014 Apr 15; 111(15): E1454–E1462.
2. Frijda, N. H. (1986), *The emotions*. New York: Cambridge University Press.
3. Gaufo GO, Wu S, Capecchi MR. (2004), Contribution of Hox genes to the diversity of the hindbrain sensory system. *Development (Cambridge, England)*. 131: 1259-66. PMID 14960494 DOI: 10.1242/dev.01029.
4. Hamann, S. (2012), Mapping Discrete and Dimensional Emotions onto the Brain: Controversies and Consensus, *Trends Cogn Sci* 16 (9), 458-466.
5. He, M., (2004), Genetic Code, Attributive Mappings and Stochastic Matrices, *Bulletin of Mathematical Biology*, Vol. 66/5, pp 965-973.
6. He, M. (2003), Double Helical Sequences and Doubly Stochastic Matrices, *Symmetry: Culture and Science: Symmetries in Genetic Information International Symmetry Foundation, Budapest, 2004*), pp. 307-330.
7. He, M., Petoukhov, S.V., (2011), *Mathematics of Bioinformatics: Theory, Practice, and Applications*, John Wiley & Sons.
8. He, M, Petoukhov S. V. and Ricci P. E., (2004), Genetic code, Hamming distance and stochastic matrices, *Bulletin of Math. Biology*, Vol 66, pp 1405-1421.
9. Izard, C. E. (1977), *Human emotions*. New York: Plenum Press.
10. Jack, R.E., Garrod, O.G., Schyns, P.G. (2014), Dynamic facial expressions of emotion transmit an evolving hierarchy of signals over time, *Curr Biol*. 2014, Jan 20;24(2):187-92. doi: 10.1016/j.cub.2013.11.064.
11. James, W. (1884), *What is an emotion?* *Mind*, 9, 188-205.
12. Jimenéz-Montaño, M. A., Mora-Basáñez, C. R., Pöschel, T. (1994), On the Hypercube Structure of the Genetic Code, In Hwa A. Lim und Charles A. Cantor, editors, *Proc. 3. Int. Conf. On Bioinformatics and Genome Research*, page 445, (World Scientific).
13. Knight, R.D., Freeland, S. J., Landweber, L. F. (1999), Selection, history and chemistry: the three faces of the genetic code. *TIBS* 24, pp 241-247.
14. N Murali Krishna, J Sirisha Devi, Srinivas Yarramalle, "A Novel Approach for Effective Emotion Recognition Using Double Truncated Gaussian Mixture Model and EEG", *International Journal of Intelligent Systems and Applications (IJISA)*, Vol.9, No.6, pp.33-42, 2017. DOI: 10.5815/ijisa.2017.06.04
15. Okbay, A., Baselmans, B. M. L, et al. (2016), Genetic variants associated with subjective well-being, depressive symptoms, and neuroticism identified through genome-wide analyses, *Nature Genetics* 48, 624–633, doi:10.1038/ng.3552
16. Pert, C.B. (1999), *Molecules of Emotion: The Science Behind Mind-Body Medicine*, Simon & Schuster, New York.
17. Petoukhov, S.V., (2001), *The Bi-periodic Table of Genetic Code and Number of Protons*, Moscow, 258 (in Russian).
18. Petoukhov, S.V., (1999), Genetic Code and the Ancient Chinese Book of Changes, *Symmetry: Culture and Science*, Vol. 10, Nos. 3-4, p. 211-226.

19. Petoukhov, S. V. (2002), Binary sub-alphabets of genetic language and problem of unification bases of biological languages, *IX International Conference Mathematics, computer, education*, Russia, Dubna, January 28-31, 191 (in Russian).
20. Petoukhov S.V., Petukhova E.S. (2016), Symmetries in genetic systems and the concept of geno-logical coding. - *Information*, 2017, 8(1), 2; doi:10.3390/info8010002.
21. Piątkowska E., Martyna J. (2012) Computer Recognition of Facial Expressions of Emotion. In: Perner P. (eds) *Machine Learning and Data Mining in Pattern Recognition. MLDM 2012. Lecture Notes in Computer Science*, vol. 7376. Springer, Berlin, Heidelberg.
22. Reuter, M., Weber, B., Fiebach, C.J., Elger, C., Montag, C. (2009), The biological basis of anger: associations with the gene coding for DARPP-32 (PPP1R1B) and with amygdala volume, *Behav Brain Res*. Sep 14;202(2):179-83.
23. Dilbag Singh, "Human Emotion Recognition System", *IJIGSP*, vol.4, no.8, pp.50-56, 2012. DOI: 10.5815/ijigsp.2012.08.07
24. Štambuk, N. (2000), Universal metric properties of the genetic code, *Croatica Chemica ACTA*, 73 (4) 1123-1139.
25. Steimer, T. (2002). The Biology of fear- and anxiety-related behaviors, *Dialogues Clinical Neuroscience*. 4:231-249
26. Stewart I., (1999), *Life's Other Secret: The New Mathematics of the Living World*, Penguin.
27. M. Sreeshakthy, J. Preethi, A. Dhilipan, "A Survey On Emotion Classification From Eeg Signal Using Various Techniques and Performance Analysis", *International Journal of Information Technology and Computer Science(IJITCS)*, Vol.8, No.12, pp.19-26, 2016. DOI: 10.5815/ijitcs.2016.12.03
28. Swanson, R. (1984), A Unifying Concept for the Amino Acid Code, *Bulletin of Mathematical Biology*, Vol. 46, No. 2, pp. 187-203.
29. Yang, C. M. (2003), The Naturally Designed Spherical Symmetry in the Genetic Code, <http://arxiv.org/abs/q-bio.BM/0309014>.

**Web Sources:** Boundless, "Biology of Emotion."

<https://www.boundless.com/psychology/textbooks/boundless-psychology-textbook/emotion-13/biology-of-emotion-68/biology-of-emotion-261-12796/>

# Matrices in Improvement of Systems of Artificial Intelligence and Education of Specialists

Nikolay A. Balonin<sup>1</sup>, Sergey V. Petoukhov<sup>2</sup>, Mikhail B. Sergeev<sup>3</sup>

<sup>1</sup>Saint Petersburg State University of Aerospace Instrumentation 67, B. Morskaia St., 190000, St. Petersburg, Russian Federation

<sup>2</sup>Mechanical Engineering Research Institute of the Russian Academy of Sciences, 4, Malyi Kharitonievsky pereulok, 101990, Moscow, Russian Federation

<sup>3</sup>Saint Petersburg State University of Aerospace Instrumentation 67, B. Morskaia St., 190000, St. Petersburg, Russian Federation

korbendfs@mail.ru, spetoukhov@gmail.com mbse@mail.ru

**Abstract.** This article is devoted to a significant role of matrices in digital signal processing, systems of artificial intelligence and mathematical natural sciences in the whole. The study of the world of matrices is going on intensively all over the world and constantly brings useful and unexpected results. Some of these results are presented in this paper. Special attention is paid to Hadamard matrices and some their modifications and extensions, which are important for developing systems of artificial intelligence and studying the genetic code. Training courses for specialists in many fields of science should be constantly updated with new knowledge about matrices and their practical applications.

**Keywords:** Hadamard matrices, Mersenne matrices, circulant, Fermat orders, signal processing, bioinformatics.

## 1. Introduction

Digital technologies of artificial intelligence and noise-immune coding of information are created on the basis of mathematics, where special kinds of matrices play a significant role. This article is devoted to matrices, which are used in these technologies or have a perspective to be used there and which are explored in education of appropriate specialists. For example, Hadamard matrices, which are considered below together with their modifications and extensions, play an important role in the spectral logic, noise-immune coding, quantum mechanics, quantum computers, spectral analysis, etc. Some of these matrices are applied in bioinformatics to study noise-immune properties of the genetic code systems [1, 2].

Scientists try to reproduce in devices of artificial intelligence intellectual properties of living organisms, which are connected with the genetic code system. For example, a spider possesses its inherited intellectual ability to weave its spider web using up to 7 kinds of filaments arranged in a certain order inside its spider web, which is tied to random external supports. Matrix-algebraic analysis of the molecular-genetic system with its structured DNA-alphabets (4 nitrogenous bases, 16 doublets and 64 triplets)

has allowed argumentum the concept of the geno-logical coding, which exists in parallel with the known genetic code of amino acid sequences in proteins, but which serves for transferring inherited processes along chains of generations. Simultaneously the matrix-algebraic analysis has revealed a connection of genetic alphabets with matrix formalisms of resonances in oscillatory systems with many degrees of freedom. Theory of matrices is a well-known part of control system theory that is an important part of Artificial Intelligent System (AIS) theory. Theories of mechanical movements use effective matrix models reflecting resonance points. In common observation AIS is connected with theme of very different resonances, all of it can be observed by formal way in the corresponding frames of rich models of matrix theory [3-5]. Different kinds of matrices are used in biometric person identification systems, web video object mining and in many other modern practical tasks [6-8].

Let us note that *matrix* by itself is one of the mysterious *educational objects* of the two previous centuries. Being quite bigger than vector, matrix consists in itself features of *complex numbers* (model of rich data) and, the same time, *operators* (model of system). Being born in the middle of century XIX, matrices were postulated and determined in many areas of mathematician science due the famous conjectures and inequalities, such as *Hadamard conjecture* estimated as “Fermat theorem” for combinatorial theme, *Ryser matrix conjecture* dedicated to the *ornamental* theme, *Hadamard inequality*, etc. [7-11]. Complex and hypercomplex numbers possess matrix forms of their representations. In computers information is usually stores in the form of matrices. The significance of matrix approach is emphasized by the fact that quantum mechanics has arisen in a form of matrix mechanics of Heisenberg, which has introduced matrices into the field of mathematical natural sciences, where they became now one of the most important mathematical tools.

Any living organism is a great chorus of coordinated oscillatory (also called vibrational) processes (mechanical, electrical, piezoelectric, biochemical, etc.), which are connected with their genetic inheritance along chains of generations. All living organisms are identical from the point of view of the molecular foundations of genetic coding of sequences of amino acids in proteins. This coding is based on molecules of DNA and RNA. From a formal point of view, a living organism is an oscillatory system with a large number of degrees of freedom. Matrices with their *eigen values* and *eigen vectors* are natural models of resonance properties of these and many other oscillatory systems.

Between integers and orthogonal (rational or irrational) square matrices of order  $n$  there is the following special correspondence: a prime number  $n$  corresponds to a simple or block-shaped ornament (pattern) of an orthogonal matrix with a given number of kinds of elements in it, which are called levels. The theory of mutual correspondence of numbers and extremal matrices (ie matrices with a maximal determinant) is developed, which simplifies the search for unknown matrices by means of the classification of matrices by types of numbers. The practical significance of this research direction is determined by the fact that the low-level matrices of the local maximum of the determinant are orthogonal and significant for the tasks of noise-immune encoding, compression and masking of video information [3]. Based on this theory and the variety of certain sequences of numbers (prime numbers  $p$ , powers of primes

$p^m$ , where  $m$  is a natural number, pairs of close primes  $p$  and  $p+2$ , Mersenne numbers  $2^k-1$ , where  $k$  is a natural number, Fermat numbers  $2^{2^k} + 1$ , where  $k$  is a non-negative integer, etc.), it is possible to dramatically accelerate the search for extremal matrices for practical problems [3, 4].

For example, a normalized Hadamard matrix  $\mathbf{H}$  with entries  $+1$  and  $-1$  has so called *core* of odd order  $n$ , that can be *circulant* (kind of ornament) if  $n$  is prime number [3]. In the same time this core, when it is a strictly orthogonal matrix with rational or irrational elements, is transformed into the so-called Mersenne matrix in the case of changing the signs of the elements into opposite elements in it and taking these elements equal to  $a = 1, -b, b \leq 1$ . Being some natural models of the world of integers, the matrices in question can also serve as models of the physical world. For example, a magnet is characterized by the total chaos of its elementary particles together with such a super object as lines of force of a magnetic field with some fixed and clear structure shown in Fig. 1 next to the matrix portrait with a circular pattern (ornament) of the Mersenne matrix.

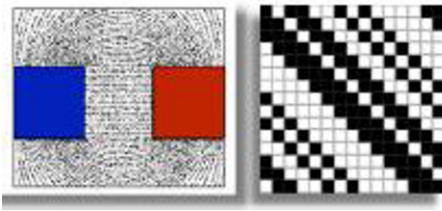
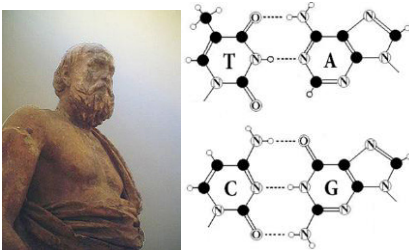

**Fig. 1.** Left: fixed structures of magnet fields. Right: a circulant Mersenne matrix

We place here a Mersenne matrix portrait, size 15. This circulant structure was found by mathematician M. Hall [12]. This matrix has so called pseudo-chaotic character of  $\{a, -b\}$ -sequences in every row of matrix together with fixed structure of circulant looking lines of main- and side-diagonals stuffed by only  $a$  or only  $-b$  entries. Thus, the Mersenne structure, being a characteristic of the object of the world of numbers – the number 15 – simultaneously serves as a model for the object of a complex physical world – the magnetic field. In addition, the two-cycle Mersenne structure, consisting of two phenomenological parts **A** and **B**, can serve as a model in many areas in which nature uses binary-oppositional structures, for example, in the physics of electromagnetic waves. It can also be used in the field of artificial intelligence systems for modeling rational and irrational thinking, pleasure and disgust emotions, chaotic regulation of reasonable activity, etc. It is a deep object for training specialists, and now we want to learn a lot more about ornamental matrices.

## 2. Primary Elements, Platonic Bodies and Numerical Background

Greek philosophers, building a geometric picture of the harmony of the universe, identified four regular polyhedra – icosahedron, octahedron, tetrahedron and cube –, which embodied in it four basic entities or "elements." Antique philosopher in Ancient Greece Plato was the founder of the Academy in Athens, the first institution of higher learning in the Western world, Fig. 2.



**Fig. 2.** Left: Plato (Πλάτων) – sculpture in Delphi. Right: four nitrogenous bases of DNA - adenine A, guanine G, cytosine C and thymine T

Plato believed that the atoms of these elements – water, air, fire and earth – have the form of these bodies, which have since been called the Platonic bodies, Fig. 3. The fifth element, the dodecahedron, caused the greatest doubts. In this case Plato made a vague remark: "... the fifth element, god determined and used it as a model of Universe." In DNA, the genetic information is recorded using different sequences of four nitrogenous bases, which play the role of letters of the alphabet: adenine A, guanine G, cytosine C, and thymine T (uracil U is used in RNA instead of thymine T). This evokes some associations with the ancient doctrine of Plato.



**Fig. 3.** Icosahedron, octahedron, tetrahedron, hexahedron (cube), dodecahedron

Orthogonal matrices can be hypothetically considered as the geometric concept inheriting an idea of primary elements. The separation (separability) and the necessity of the fifth element arises because of the multiplicity of the system of numbers 4 (even-odd and two states of multiplicity) and a special function of "1", which must play the dual role of 1 and 5 – in the same time is both the first element (in the tetrad) and the next element after 4.

Representatives of families of matrices are included in sequences with basic step 4, i.e. matrix families have orders of  $n = 4t - k$ ,  $k \leq 3$ . It is worthwhile to distinguish even orders that are divisible by 4, and other even orders that are divisible by 2.

It should be noted that for  $n > 4$ , the integral Hadamard matrix cannot be cyclic [4]. Only binary rational or irrational Mersenne matrix of odd order with elements, which can be considered as characteristics of the natural number  $n$ , is cyclic.

In this case, we say that the Mersenne matrix  $\mathbf{M}$  is only a part of the natural number  $n = 4t - 1$ , containing its hidden structure.

Let us say about the ornamental conjecture. The structure of  $\mathbf{M}$  is strong circulant (Fig. 1), if and only if  $n$  is Mersenne number, i.e.  $n = 2^k - 1$  (that gives name of all this sequence of orthogonal matrices),  $n$  is prime,  $n$  is product of two nearest prime numbers  $3 \times 5$ ,  $5 \times 7$ , and so on.

If we will take it more attentively, we will find some difference between circulant structures of Mersenne matrices of all these three types. Mersenne matrix, order 3 (or 7, 11, etc.), is different with Mersenne matrix, order  $3 \times 5 = 15$  (or  $5 \times 7$ ,  $11 \times 13$ , etc.) due orthogonal circulant matrices of the latest type cannot be skew. So we see here some exotic way to prove the fact that odd number  $n = 4t - 1$  is prime by fact of existence of its matrix *shadow*: a *skew circulant* Mersenne matrix. Let us note, that number theory operates with numbers, not with matrices. This fact is situated on the bound between numbers and matrices.

The applied side of projecting operators for modeling the phenomenological aspects of molecular genetic code systems was considered in [1].

### 3. Primary Elements as Coding in Biology

Science does not know why the genetic alphabet of DNA has been created by nature from just four letters, and why just these very simple molecules were chosen for the DNA-alphabet (out of millions of possible molecules).

But science knows that these four molecules are interrelated by means of their symmetrical peculiarities into the united molecular ensemble with its three pairs of binary-oppositional traits:

- (1) Two letters are purines (A and G), and the other two are pyrimidines (C and T). From the standpoint of these binary-oppositional traits one can denote  $C = T = 0$ ,  $A = G = 1$ . From the standpoint of these traits, any of the DNA-sequences are represented by a corresponding binary sequence. For example, GCATGAAGT is represented by 101011110;
- (2) Two letters are amino-molecules (A and C) and the other two are keto-molecules (G and T). From the standpoint of these traits one can designate  $A = C = 0$ ,  $G = T = 1$ . Correspondingly, the same sequence, GCATGAAGT, is represented by another binary sequence, 100110011;
- (3) The pairs of complementary letters, A-T and C-G, are linked by 2 and 3 hydrogen bonds, respectively. From the standpoint of these binary traits, one can



designate  $C = G = 0$ ,  $A = T = 1$ . Correspondingly, the same sequence, GCATGAAGT, is read as 001101101.

Let us remember that similar numerical background was used in the famous periodical Mendeleev table of chemical element. There is well known correspondence between  $n=4t-1$  and atom weights of alkalis and radioactive elements – 7 is Mersenne number and atom weight of Lithium  ${}^7\text{Li}$ , Uran  ${}^{235}\text{U}$  has atom weight  $235=59\times 4-1$ .

Orthogonal matrices with a fixed number of different (among themselves) elements – including the Hadamard matrices, the Mersenne matrices, the Fermat matrices, etc. and corresponding to the named numerical sequences – can serve as mathematical models in algebraic biology and bioinformatics.

Orthogonal matrices keep our attention as educational model of many appearances of nature: genetic codes, quasi-crystals, image-processing technologies and so on. Now we would like to tell about them by the more formal way then these obvious illustrations using pragmatic mathematic definitions and conjectures.

#### 4. Numerical Sequences, Relation to the Number Theory

**Definition.** A *quasi-orthogonal matrix*, order  $n$ , is a square matrix  $\mathbf{A}$ ,  $|a_{ij}| \leq 1$ , with maximum modulus 1 in each column (and row). It fulfills  $\mathbf{A}^T \mathbf{A} = \omega(n) \mathbf{I}$ , with  $\mathbf{I}$  the identity matrix and  $\omega(n)$  the *weight*. The entries values are called matrix “levels” [3].

A Hadamard matrix with entries  $\{1, -1\}$  is a two-level matrix. A Mersenne matrix with entries  $\{1, -b\}$ ,  $0 < b < 1$  is also a two-level matrix. The Mersenne matrices are two-level quasi-orthogonal matrices defined by their second level  $-b$ ,  $b = \frac{t}{t + \sqrt{t}}$ ,

$n=4t-1$  – order of matrix. Here  $t = \frac{n+1}{4}$  is a fundamental number, which plays a big

role in the Hadamard matrix theory. The numerator  $n+1$  is the order of the corresponding Hadamard matrix: every Mersenne matrix with the elements  $\{1, -b\}$  is the core of the normalized Hadamard matrix, taken with opposite signs (elements) to ensure the property: the quantity of the elements 1 exceeds the quantity of negative elements.

Although Hadamard matrices and Hadamard matrices are not orthogonal matrices in the strict sense of this word, when  $\mathbf{A}^T \mathbf{A} = \mathbf{I}$ , we shall call them orthogonal for brevity. The name of Hadamard matrices of Sylvester type is associated with the fact that they generalize the calculation of quasi-orthogonal matrices of even orders  $n = 2^k$ ,  $k$  is an integer. Apart from Sylvester orders  $n=2^k$ , the Mersenne numbers  $n=2^k-1$  embedded in the sequence of numbers  $4t-1$ . Fermat numbers are embedded in the  $4u^2+1$  sequence, that is, in its turn, embedded in the  $4t+1$  sequence.

We have called quasi-orthogonal matrices of odd orders  $n=2^k-1$  and  $n = 2^{2^k} + 1$  that have local maximum of determinant are Mersenne and Fermat matrices, respectively.

The main rule exists to expand general matrices. We can say about Hadamard matrix of order 12, while 12 is not power of 2. The same, we can say about Mersenne matrix of order 11, while the number 11 does not belong to Mersenne numbers: it belongs to sequence including Mersenne numbers. The definition of Mersenne matrices can be expanded to orders  $4t-1$ , and Fermat matrices – to “quadratic” orders  $4u^2+1$ . To note these matrices we fix the *function of level*,  $b = \frac{t}{t + \sqrt{t}}$  for all expanded Mersenne matrices,  $b=1$  is modulus level of Hadamard matrix. All numerical sequences have associated orthogonal matrices as parts of these numbers.

### 5. Golden Ratio Matrix $G_{10}$

The Fibonacci numbers plays so big role in number theory and genetically inherited biological laws of phyllotaxis, that we should give some extraordinary example of matrices connected with them.

Let us remember, the Fibonacci rule  $F(n)=F(n-1)+F(n-2)$  with initial conditions  $F(0)=F(1)=1$  allows to generate the Fibonacci numbers: 1, 1, 2, 3, 5, 8, 13, ... .

Among “Fibonacci-like” sequences there are Lucas numbers, which can be calculated with  $F(0)=2, F(1)=1$ . The resulting sequence 2, 1, 3, 4, 7, 11, 18, ... looks quite different from the previous one, but the ratio of numbers converges toward the golden ratio, just as ratio of Fibonacci numbers themselves do. Any Fibonacci-like sequence can be expressed as a linear combination of both sequences. There are starting pairs for which we can get a ratio different from the golden ratio  $x, x^2 = x + 1$ , but they are rare.

The famous quadratic equation  $x^2-x-1=0$  has two roots  $x_1 = \frac{1+\sqrt{5}}{2} = 1.618 \dots$  and  $x_2 = \frac{1-\sqrt{5}}{2} = -0.618 \dots$ , the first is recognized as the golden ratio and from  $x^2 - (x_1 + x_2)x + x_1x_2 = 0$  we have  $x_1x_2 = -1$ , so these two solutions are inversed by sign and value  $x_2 = -1/x_1$ . Now we are interested in orthogonal matrices, which entries equal to the golden ratio inverse value  $x_2 = -1/x_1 = -0.618 \dots$

Let us note that quadratic equation  $x^2+x-1 = 0$  has inversed roots: if we discuss level modulus less than 1, so we will take as the main solution some golden level  $g=0.618 \dots < 1$ . Now we will say continuous matrices, which are different from previously observed section matrices of the orthogonal (Hadamard) family, their level functions depend on more than one argument  $n$ . Therefore, for each  $n$  they generate not one, but a continuum of quasi-orthogonal matrices, described by a parametric dependence. This possibility follows from the interpretation of orthogonal or quasi-orthogonal matrix as a table of vector projections of the required orthogonal basis. We use the term “optimal” to denote matrices with maximal determinant.

This allows us to get non-varying matrices for this continuum, known as orthogonal (Hadamard) matrices [5]. Sub-optimal solutions are known for Cretan matrices [13] with a small number of levels. Below we show a continuous matrix  $A_{10}$ :

$$A_{10} = \begin{pmatrix} g & a & -c & -c & a & -a & a & b & b & a \\ a & g & a & -c & -c & a & -a & a & b & b \\ -c & a & g & a & -c & b & a & -a & a & b \\ -c & -c & a & g & a & b & b & a & -a & a \\ a & -c & -c & a & g & a & b & b & a & -a \\ -a & a & b & b & a & -g & -a & c & c & -a \\ a & -a & a & b & b & -a & -g & -a & c & c \\ b & a & -a & a & b & c & -a & -g & -a & c \\ b & b & a & -a & a & c & c & -a & -g & -a \\ a & b & b & a & -a & -a & c & c & -a & -g \end{pmatrix}$$

The upper module level from set of levels  $a \geq b \geq c \geq g$  is  $a=1$ . The second and the third levels depend on the lower level  $g$  as  $b^2+2(b-1)+2(g-c)+c^2=0, c=1/(g+1)$ . The colored matrix portrait represents the structure and levels of entries – every level has own color.

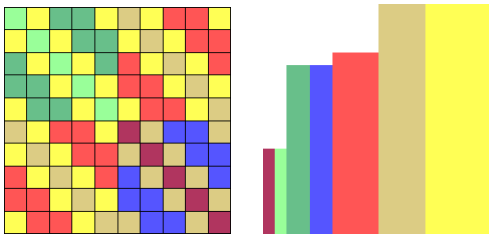

Fig. 4. Portrait of matrix  $A_{10}$  and histogram of moduli of its elements

The continuous matrix  $A_{10}$  (order 10) is a matrix with a low number of changeable levels and is notable by its solutions: two bounds (Fig. 5) of a continuum. One solution is the Belevitch matrix  $C_{10}$  since when  $b=c=a=1$  we have  $g=0$ . We call the second solution with  $b=c=g < a=1$  as the *golden ratio matrix*  $G_{10}$ .

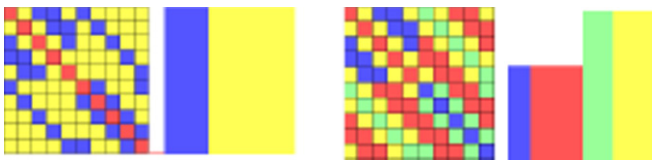

Fig. 5. Belevitch  $C_{10}$  and Golden ratio matrix  $G_{10}$  with histogram of entries

It is distinguished by the equation  $g^2+g-1=0$ , well known by its irrational roots called the *golden ratio* in the Fibonacci numbers theory. In this case we are interested in the lower level  $g=0.618$ . that proportional to the inversion of 1.618...

$$\mathbf{G}_{10} = \begin{pmatrix} g & a & -g & -g & a & -a & a & g & g & a \\ a & g & a & -g & -g & a & -a & a & g & g \\ -g & a & g & a & -g & g & a & -a & a & g \\ -g & -g & a & g & a & g & g & a & -a & a \\ a & -g & -g & a & g & a & g & g & a & -a \\ -a & a & g & g & a & -g & -a & g & g & -a \\ a & -a & a & g & g & -a & -g & -a & g & g \\ g & a & -a & a & g & g & -a & -g & -a & g \\ g & g & a & -a & a & g & g & -a & -g & -a \\ a & g & g & a & -a & -a & g & g & -a & -g \end{pmatrix}.$$

The value of modulus level  $g$  is constant. This implies, that golden ratio matrices and Hadamard-type matrices are two boundary solutions of a continuum matrix. Consequently, all golden ratio matrices are defined on orders  $n=10 \cdot 2^k$ . For them, as for all Hadamard family matrices, matrix  $\mathbf{G}_{10}$  is the starting point for the sequence of matrices, found by iterations  $\mathbf{G}_{2n} = \begin{pmatrix} \mathbf{G}_n & \mathbf{G}_n \\ \mathbf{G}_n & -\mathbf{G}_n \end{pmatrix}$ .

Such orthogonal matrices of orders 5, 10 and values, which are proportional to 10 (10, 20, 40, 80, 160, 320, 640, ..), are typical for image processing algorithms (usual photo sizes in a webcam or photo camera) [14]. Besides, number 10 is a foundation of geometrical figures (pentagrams) and it is connected with the golden ratio. Such theoretical approach of matrix and number theory tie was developed in our works [3, 4].

## 6. The advantage of Fermat Orders

Odd orders, for which the upper formally attainable bound of determinants of maximum determinant matrices is known, are obtained from the Guido Barba's inequality [15]. It states that matrices  $\mathbf{A}$  of orders  $n$  with modulus of entries  $\leq 1$  satisfy the inequality:  $|\det(\mathbf{A})|^2 \leq \det((n-1)\mathbf{I} + \mathbf{J}) = (n-1)^{n-1} (2n-1)$ , where  $\mathbf{I} = \text{diag}(1, 1, \dots, 1)$ ,  $\mathbf{J}$  – a unity matrix.

The maximum can be attained at orders, for which  $2n-1$  is a square. This necessary condition for extreme solutions follows the fact that optimal matrix entries are integers 1 and  $-1$ . We note that the Barba's bound is attainable for orders  $n=a^2+b^2$ ,  $b=a+1$  [3], nested in the same sequence  $4t+1$  that the Fermat numbers sequence is embedded.

For Fermat numbers different from 5,  $2n-1$  it is not a square, which means that the Barba's bound is not attainable. It is an optimistic determinant estimation, certainly not pragmatic, because it is irrational. The non-attainability of the bound is not critical.

Orders of matrices, which are described by certainly attainable integer values of the bound, are 5, 13, 25, 41, 61, 85, 113..., and the structures of every second one of these matrices of orders 13, 41, 85, ... are significantly more complex than those of the others. There is no algorithm to construct these matrices – the existence of matrices of the listed orders is theoretically possible, but not all of them are known [3, 5].

Matrices of orders equal to Mersenne numbers and Fermat matrices of prime orders  $F_k=3, 5, 17, 257, 65537\dots$  have an advantage over all other matrices, because they have an algorithm for their construction, which is a modified Sylvester algorithm. At the same time an irrational Mersenne matrix, after its irrational elements are rounded to integer values, becomes equal to the  $\{1, -1\}$ -core of the normalized Hadamard matrix, and the core of Fermat matrix after rounding its irrational elements to  $\{1, -1\}$  becomes equal to the regular Hadamard matrix of order  $4u^2$ .

Therefore, matrices of non-strict determinant optimums of orders equal to Mersenne numbers, are findable and can be used for indirect finding of Hadamard matrices that are strictly optimal by determinants. Based on the preliminary study we identified the following: skew-symmetric circulant Mersenne matrices correspond to prime Mersenne numbers; prime numbers and the symmetry types of circulant optimal and sub-optimal structures are synonyms of hyper quality of such different mathematical objects as numbers and matrices.

The first person (if not legendary Pythagoras), which noticed the correlation of objects from different areas of mathematics, was Karl Friedrich Gauss. In 1796 he discovered a relation between prime numbers and geometric figures, after he inscribed a regular heptadecagon into a circle. Later he formulated a generic case about the relation between the number of sides of a regular polygon that is inscribed in a circle, and the Fermat prime numbers.

The peculiarity of Fermat prime numbers allows us to formulate a conjecture about the relation of matrix orders and the maximums of their determinants.

**Conjecture.** Among all matrices of sequences containing Fermat numbers, only quasi-orthogonal matrices of the local maximum of the determinant [3], whose orders are equal to the prime Fermat numbers  $F_k = 3, 5, 17, 257, 65537\dots$  and which are rounded in their elements to +1 and -1, give matrices of the global maximum of the determinant.

First three Fermat matrices of orders 3, 5 and 17, the latter of which is shown on Fig.1, can be checked [1], and validate the conjecture. It was noted earlier, that  $2n-1$  is not a square for Fermat numbers different from 5.

The Barba bound  $B=(n-1)^{(n-1)/2}(2n-1)^{1/2}$  is an irrational and unattainable number for rounded by entries (integer) Fermat matrices. However, this is just an optimistic upper-bound of the determinant, an abstract bound deducted in work [13], which may or may not be attained by an integer matrix.

In case this optimistic and irrational bound  $B$  is unattainable, the pragmatic estimate differs from it by an irrational multiplier, multiplying by which makes the real bound integer-valued and attainable. Since the structure of Fermat matrices is known to us, and the irrational multiplier of the bound can be found, the determinant of a Fermat matrix of order  $n = F_k$  is estimated as  $F_{k-1}/(2F_k-1)^{1/2} \times B$ .

As noted above,  $F_{k-1}/(2F_k-1)^{1/2}$  is an irrational number, in the general case.

It gives a relative determinant value:  $|\det(\mathbf{A})|=(n-1)^{(n-1)/2}(2n-1)^{1/2}F_{k-1}/(2n-1)^{1/2}=(n-1)^{(n-1)/2}F_{k-1}$  (compared to bound  $B$ ) when  $n = F_k$  is an integer. This is an estimation of the attainable value of the integer matrix determinant.

The first Fermat number  $F_0=3$  is a starting one, there is no preliminary Fermat number, but this matrix, same with matrix with order 5, is known. In this matrix, the  $-1$  entries different from 1, stand on the diagonal.

For order  $F_1=5$  we have an integer-valued determinant correction, equal to 1. This is an exception, when the Fermat matrix determinant attains the Barba's bound and we have  $F_0/(2F_1-1)^{1/2}=3/9^{1/2}=1$ . The structure of the optimal matrix matches the starting one (for order 3), so these are two diagonal structures with simple forms.

The first matrix that is different from them is a Fermat matrix of order 17.

For  $F_2=17$  we have  $2F_2-1=33$ , which is not a square. A relative (accordingly Barba bound) determinant equals  $F_1/(2F_2-1)^{1/2}=5/33^{1/2}=0,8704\dots$ . It is an irrational number – a scale multiplier that is a correction to the unattainable Barba's bound  $B=16^8 \times 33^{1/2}$ . Their product is an integer  $5/33^{1/2} \times B = 5 \times 16^8 = 21474836480$  – determinant of the Fermat matrix of order 17. This estimation is equal to  $327680 \times 2^{16}$ .

## 7. Determinant Maximum of a Matrix of Order 257

Fermat matrices can be found for orders, where Fermat numbers are nested, for example, at 37, 65, etc. The determinant of a matrix of order 37 is equal to  $72 \times 9^{17} \times 2^{36}$ . The estimation of the determinant of a determinant maximum matrix of the 65 order equals to  $148 \times 16^{31} \times 2^{64}$ . The determinant of rounded by its entries Cretan matrix of order 37 approximately equals to  $7,22 \times 10^{28}$  and is less than the estimate  $8,25 \times 10^{28}$  of the integer matrix of this order.

For order 65 the determinant of a rounded Cretan matrix is  $5,65 \times 10^{58}$ , whereas some better estimation gives the value of  $5,81 \times 10^{58}$  for an integer matrix of this order.

The information provided above confirms the conjecture – determinant maximum can be attained only for matrices of orders equal to prime Fermat numbers. On orders equal to prime and composite numbers of a sequence, which nests the Fermat sequence (without them), the statement is not true. An interesting analogy is noticeable here: according to the conjecture, and the Gauss theorem, regular polygons with 37 and 65 angles cannot be built using just a ruler and a pencil compass.

We believe that the similarity of hyper objects of mathematics and the details of the Gauss theorem can apply, among others, to determinant maximum matrices. Extremal matrices of orders 257 and 65537 are very difficult to calculate and check the values of their determinants (to match with determinants of Fermat matrices) due to the large number of possible permutations. However, we calculated the Fermat matrix of order 257 using a modified Sylvester algorithm. The image of symmetric matrix is shown on Fig. 6.

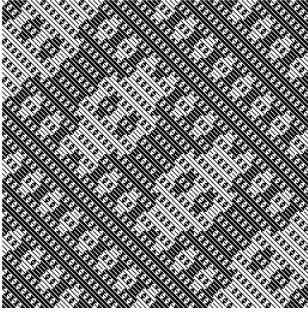

**Fig. 6.** Image of Fermat matrix of order 257

Our conjecture says, the Fermat matrix of order 257 has a relative (accordingly Barba bound) determinant value  $F_2/(2F_3-1)^{1/2}=0,7505\dots$ . This irrational number corresponds to the integer value of  $|\det(\mathbf{A})| = (n-1)^{(n-1)/2}F_{k-1} = 256^{128} \times 17$  (approximately  $3.06 \times 10^{309}$ ). This estimation is absent in the literature, it is a new bound. The correspondence of symmetries to matrix orders was studied in works [16, 17].

## 8. Conclusions

Mathematical matrices play a great role in developing systems and methods of artificial intelligence, digital signals processing, noise-immune communication and study of bio-informational phenomena. But the world of matrices is a very wide and has many unknown valuable objects and properties, which should be revealed for useful applications in mentioned and other fields. Some of these kinds of matrices are described in our article. In particular they enrich of wide and perspective usage of matrices in education of specialists in different branches of science and technology. Deep relations between theory of matrices and theory of numbers exist, which can produce new ideas and unexpected heuristic solutions. We use the received results to create new digital devices of artificial intelligence and new approaches in studying a wide class of inherited genetic phenomena in living organisms.

## 9. Acknowledgements

The authors wish to sincerely thank Tamara Balonina for converting this paper into printing format. The authors also would like to acknowledge the great help of Professor Jennifer Seberry with translation and discussion of the presented content with matrices. The research leading to these results has received funding from the Ministry of Education and Science of the Russian Federation according to the project part of the state funding assignment No 2.2200.2017/PP.

## References

1. Petoukhov S. V. The Genetic Code, Algebra of Projection Operators and Problems of Inherited Biological Ensembles. <http://arxiv.org/abs/1307.7882>, 8th version of the article from 3 May 2017, pp. 1–93.
2. Petoukhov S.V., He M. Symmetrical Analysis Techniques for Genetic Systems and Bioinformatics: Advanced Patterns and Applications. IGI Global: Hershey, USA, 2010.
3. Balonin N. A., Seberry J. Remarks on Extremal and Maximum Determinant Matrices with Real Entries  $\leq 1$ . *Informatsionno-upravliaiushchie sistemy [Information and Control Systems]*, 2014. No. 5(71), pp. 2–4. (In Russian).
4. Balonin N. A., Sergeev M. B. Mersenne and Hadamard Matrices. *Informatsionno-upravliaiushchie sistemy [Information and Control Systems]*, 2016, no. 1(80), pp. 92–94. (In Russian). doi:10.15217/issn1684-8853.2016.1.2
5. Osborn J. H. The Hadamard Maximal Determinant Problem, Honours thesis. University of Melbourne, 2002, 144 P. Available at: <http://maths-people.anu.edu.au/~osborn/publications/pubsall.html> (accessed: 15 May 2017).
6. Shanmukhappa A. Angadi, Sanjeevakumar M. Hatture, "Biometric Person Identification System: A Multimodal Approach Employing Spectral Graph Characteristics of Hand Geometry and Palmprint", *International Journal of Intelligent Systems and Applications (IJISA)*, Vol.8, No.3, pp.48-58, 2016. DOI: 10.5815/ijisa.2016.03.06.
7. Sudip Kumar Sahana, Mohammad AL-Fayoumi, Prabhat Kumar Mahanti, "Application of Modified Ant Colony Optimization (MACO) for Multicast Routing Problem", *International Journal of Intelligent Systems and Applications (IJISA)*, Vol.8, No.4, pp.43-48, 2016. DOI: 10.5815/ijisa.2016.04.05.
8. Siddu P. Algur, Prashant Bhat, "Web Video Object Mining: A Novel Approach for Knowledge Discovery", *International Journal of Intelligent Systems and Applications (IJISA)*, Vol.8, No.4, pp.67-75, 2016. DOI: 10.5815/ijisa.2016.04.08.
9. Hadamard, J. Resolution d'une Question Relative Aux Determinants. *Bulletin des Sciences Mathematiques*, 1893, vol. 17, pp. 240–246.
10. Ehlich H. Determinantenabschätzungen für Binäre Matrizen. *Math. Z.*, 1964, vol. 83, pp. 123–132.
11. Wojtas W. On Hadamard's Inequality for the Determinants of Order Non-Divisible by 4 *Colloq. Math.*, 1964, no. 12, pp. 73–83.
12. Hall, Marshall A Survey of Difference Sets, *Proc. Amer. Math. Soc.* 1956, no. 7, pp. 975-986.
13. Balonin N. A., Seberry, Jennifer, Sergeev M. B. Three level Cretan Matrices of Order 37. *Informatsionno-upravliaiushchie sistemy [Information and Control Systems]*, no. 2(74), 2015, pp. 2–3 (in Russian) doi:10.15217/issn1684-8853.2015.2.2.
14. Balonin N. A., Sergeev M. B. Expansion of the Orthogonal Basis in Video Compression. *Smart Digital Futures 2014. Intelligent Interactive Multimedia Systems and Services (IIMSC-2014)*, IOS Press, 2014. pp. 468–474.
15. Barba G. Intorno al teorema di Hadamard sui Determinanti a Valore Massimo, *Giorn. Mat. Battaglini*, 1933, no. 71, pp. 70–86.
16. Balonin N. A., Djokovic D. Z. Symmetry of Two Circulant Hadamard Matrices and Periodic Golay Pairs. *Informatsionno-upravliaiushchie sistemy [Information and Control Systems]*, 2015, no. 3(76), pp. 2–16, doi:10.15217/issn1684-8853.2015.3.16 (in Russian).



17. Balonin N. A., Djokovic D. Z. Negaperiodic Golay Pairs and Hadamard Matrices. *Informatsionno-upravliaiushchie sistemy* [Information and Control Systems], 2015, no. 5(78), pp. 2–17 (in Russian), doi:10.15217/issn1684-8853.2015.5.2.

# A Mathematical Proof of Double Helix DNA to Reverse Transcription RNA for Bioinformatics

Moon Ho Lee<sup>1</sup>, Han Hai<sup>1</sup>, Sung Kook Lee<sup>2</sup>, Sergey V. Petoukhov<sup>3</sup>

<sup>1</sup> Division of Electronics and Information Engineering, Chonbuk National University, Jeonju 54896, Korea

<sup>2</sup> Dept. of Economics, Indiana, University-Bloomington, Indiana, IN 47405, U.S.A

<sup>3</sup> Institute of Machines Studies, Russian Academy of Sciences, 101990 Moscow, Russia

<sup>1</sup>moonho@jbnu.ac.kr, <sup>1</sup>hhhtgy@jbnu.ac.kr, <sup>2</sup>lee950@umail.iu.edu,

<sup>3</sup>spetoukhov@gmail.com

**Abstract.** This paper presents a mathematical proof of deoxyribose nucleic acid (DNA) to ribonucleic acid (RNA) based on the block circulant Jacket matrix (BCJM) characteristics, which is used to develop a bioinformatics for the molecular communications. The DNA matrix decomposition is the form of the Kronecker product of identity and Hadamard matrices with pair complementarity. The RNA 4 by 4 genetic matrix is the anti-symmetric pair complementary of the core kernel. The variants of kernel of the Kronecker families are produced by permutations of the four letters C, A, U, G on positions in the matrix. Thus, we get 6 subset pattern of block circulant matrix, 6 upper-lower block symmetric matrix and 6 left-right block symmetric matrix. This decomposition of DNA to RNA leads very clearly to the Kronecker product of the symmetrical genetic matrices.

**Keywords:** DNA double helix, RNA, Kronecker product, identity & Hadamard matrix, symmetry, complementary.

## 1. Introduction

In 1953 [1], Nobel Prize award Watson and Crick had proved DNA double helix by the chemical and biology methods. Nowadays, it has not proved in mathematics view yet. In this paper, we prove mathematical of deoxyribose nucleic acid (DNA) double helix based on the block circulant Jacket matrix  $(1 \ 1; -1 \ 1)$ ,  $(1 \ -1; -1 \ -1)$  and the double stochastic permutation matrix as  $(1 \ 1; 1 \ 1)$ . A complementary strand ribonucleic acid (RNA) or DNA may be produced based on nucleobase complementarity. Each position in the sequences of the nucleotide bases will be complementary much like looking in the mirror and seeing the reverse of things such as 0 and 1 i.e., 2 bit case 00 01; 10 11. The complementarity of DNA in double helix prepares to use one strand as a template to build up the other. The DNA double helix plays an important role in DNA replication, which prepares genetic information to the next generation. The block circulant a pair of complementarity is also utilized in DNA transcription, which generates an RNA strand from a DNA template. The detection of natural realization of

the block circulant Jacket matrices (BCJMs) on the basis of parameters of the molecular genetic systems, which serves to transfer discrete genetic information, show that known advantages of BCJM [3-4] can be utilized in bioinformatics.

The DNA has two helical chains in the same axis. Both chains follow right handed helices, but the sequences of the two chains run in opposite directions [1]. However, we prove mathematical DNA double helix by the bioinformatics signal processing system. The four letter of the genetic code alphabet has 64 triplets. We can get 6 subset characteristic property of the block circulant matrix, 6 upper-lower symmetric block matrix and 6 left-right symmetric block matrix.

On the other hand, the DNA or RNA application of molecular communication has recently become a rapidly growing discipline within communications and information theory. In molecular communication, the transmitter encodes the information onto the molecules and releases them into the fluid medium; the molecules propagate through the fluid medium and the receiver, upon receiving the molecules, decodes the information by processing or reacting with the molecules by Brownian motion [7].

The main contributions of this paper are summarized as follows:

- We prove mathematical a DNA double helix to RNA reverse transcription based on the BCJMs.
- The RNA genetic matrix is the anti-symmetric pair complementary of the core RNA kernel i.e. 00 to 11 and 01 to 10.
- The 24 variants of kernels of the Kronecker families of genomatrices are produced by permutations of the four letters  $C, A, U, G$  on positions in the matrix. We get 6 subset pattern of block circulant, 6 upper-lower block symmetric and 6 left-right block symmetric matrix. Then, we propose the RNA Yin-Yang model.

This paper is organized as follows. In Section II, we derive the block circulant Jacket matrix. In Section III, we provide RNA genetic block circulant matrix. In Section IV, we discuss symmetric properties of genetic matrices and main results discussion in Section V. Finally, we conclude in Section VI.

## 2. Block Circulant Jacket Matrix

In this Section, we discuss the block circulant Jacket matrix [3-4].

*Definition 2.1:* Let  $[C]_N = \begin{pmatrix} C_0 & C_1 \\ C_1 & C_0 \end{pmatrix}$  be  $2 \times 2$  block matrix of order  $N = 2p$ . If

$[C_0]_p$  and  $[C_1]_p$  are  $p \times p$  Jacket matrices, then  $[C]_N$  is a Jacket matrix if and only if

$$C_0 C_1^{RT} + C_1^{RT} C_0 = [0]_N, \quad (1)$$

where  $RT$  is reciprocal transpose.

*Proof:* Since  $C_0$  and  $C_1$  are Jacket matrices, we have  $C_0 C_0^{RT} = p[I]_p$  and  $C_1 C_1^{RT} = p[I]_p$ . Note that  $[C]_N$  is Jacket matrix if and only if  $[C][C]^{RT} = NI_N$ . Then  $C$  is Jacket matrix if and only if

$$\begin{aligned} [C][C]^{RT} &= \begin{pmatrix} C_0 & C_1 \\ C_1 & C_0 \end{pmatrix} \begin{pmatrix} C_0 & C_1 \\ C_1 & C_0 \end{pmatrix}^{RT} \\ &= \begin{pmatrix} 2p[I]_p & C_0 C_1^{RT} + C_1^{RT} C_0 \\ C_0 C_1^{RT} + C_1^{RT} C_0 & 2p[I]_p \end{pmatrix} = NI_N. \end{aligned}$$

Hence  $[C]_N$  is a Jacket matrix if and only if

$$C_0 C_1^{RT} + C_1^{RT} C_0.$$

By using definition 2.1, we may construct many BCJMs.

*Example 2.1:* Let

$$C_0 = \begin{pmatrix} 1 & 1 \\ 1 & -1 \end{pmatrix}, C_1 = \begin{pmatrix} a & -a \\ -1/a & -1/a \end{pmatrix}.$$

Since  $C_0 C_0^{RT} = 2[I]_2$  and  $C_1 C_1^{RT} = 2[I]_2$ ,  $C_0$  and  $C_1$  are Jacket matrices of order 2. Moreover,

$$\begin{aligned} C_0 C_1^{RT} + C_1^{RT} C_0 &= \begin{pmatrix} 1 & 1 \\ 1 & -1 \end{pmatrix} \begin{pmatrix} -1/a & -a \\ -1/a & -a \end{pmatrix} + \\ &\quad \begin{pmatrix} a & -a \\ -1/a & -1/a \end{pmatrix} \begin{pmatrix} 1 & 1 \\ 1 & -1 \end{pmatrix} = [0]_2. \end{aligned} \quad (2)$$

Hence a circulant matrix

$$\begin{aligned} C_4 &= \begin{pmatrix} C_0 & C_1 \\ C_1 & C_0 \end{pmatrix} = \begin{pmatrix} 1 & 1 & a & -a \\ 1 & -1 & -1/a & -1/a \\ a & -a & 1 & 1 \\ -1/a & -1/a & 1 & -1 \end{pmatrix}_{a=1} \\ &= \begin{pmatrix} 1 & 1 & 0 & 0 \\ 1 & -1 & 0 & 0 \\ 0 & 0 & 1 & 1 \\ 0 & 0 & 1 & -1 \end{pmatrix} + \begin{pmatrix} 0 & 0 & 1 & -1 \\ 0 & 0 & -1 & -1 \\ 1 & -1 & 0 & 0 \\ -1 & -1 & 0 & 0 \end{pmatrix} = \begin{pmatrix} 1 & 1 & | & 1 & -1 \\ 1 & -1 & | & -1 & -1 \\ \hline 1 & -1 & | & 1 & 1 \\ -1 & -1 & | & 1 & -1 \end{pmatrix} \end{aligned} \quad (3)$$

is a BCJM.  $C_0$  and  $C_1$  are the Hadamard matrix.

The size of the circulant submatrices is  $2 \times 2$ , i.e., it has the property that block diagonal cyclic shifts. We can specify to these submatrices as circulant blocks. Then, the BCJM  $C_4$  can be rewritten as

$$C_4 \triangleq \underbrace{I_0 \otimes C'_0 + I_1 \otimes C_1}_{} \tag{4}$$

where

$$I_0 = \begin{pmatrix} 1 & 0 \\ 0 & 1 \end{pmatrix}, I_1 = \begin{pmatrix} 0 & 1 \\ 1 & 0 \end{pmatrix}, C'_0 = \begin{pmatrix} 1 & 1 \\ 1 & -1 \end{pmatrix}, C_1 = \begin{pmatrix} 1 & -1 \\ -1 & -1 \end{pmatrix}$$

and  $\otimes$  is the Kronecker product.

### 3. RNA GeneticBlock Circulant Matrix

From (4), similar fashion as an example of RNA sequence with the genetic matrix  $[C U; A G]^3$  is given by [5-6, 10]

$$P^1 = \begin{pmatrix} C & U \\ A & G \end{pmatrix}, P^2 = \begin{pmatrix} C & U \\ A & G \end{pmatrix} \otimes \begin{pmatrix} C & U \\ A & G \end{pmatrix}, P^3 = \begin{pmatrix} C & U \\ A & G \end{pmatrix}^2 \otimes \begin{pmatrix} C & U \\ A & G \end{pmatrix}, \tag{5}$$

where  $\otimes$  is the Kronecker product,  $C$  is cytosine,  $U$  is uracil,  $A$  is adenine and  $G$  is guanine. By analogy with theory of noise-immunity coding, mosaic gene matrix  $[C U; A G]^3$  can be represented by replacements of 64 triplets with strong roots ( $CC, CU, CG, AC, UC, GC, GU, GG$ ) and weak roots ( $CA, AA, AU, AG, UA, UU, UG, GA$ ) by means of numbers +1 and -1 respectively. Thus,  $[R]_8$  is the Rademacher singular matrix as shown in Table I.

**Table 1.**  $(C U; A G) 8 \times 8$  code

	000 (0)	001 (1)	010 (2)	011 (3)	100 (4)	101 (5)	110 (6)	111 (7)
000(0)	CCC 000	CCU 001	CUC 010	CUU 011	UCC 100	UCU 101	UUC 110	UUU 111
001(1)	CCA 001	CCG 000	CUA 011	CUG 010	UCA 101	UCG 100	UUA 111	UUG 110
010(2)	CAC 010	CAU 011	CGC 000	CGU 001	UAC 110	UAU 111	UGC 100	UGU 101
011(3)	CAA 011	CAG 010	CGA 001	CGG 000	UAA 111	UAG 110	UGA 101	UGG 100
100(4)	ACC 100	ACU 101	AUC 110	AUU 111	GCC 000	GCU 001	GUC 010	GUU 011
101(5)	ACA 101	ACG 100	AUA 111	AUG 110	GCA 001	GCG 000	GUA 011	GUG 010
110(6)	AAC 110	AAU 111	AGC 100	AGU 101	GAC 010	GAU 011	GGC 000	GGU 001
111(7)	AAA 111	AAG 110	AGA 101	AGG 100	GAA 011	GAG 010	GGA 001	GGG 000

Therefore, Table I encoding is given by

$$[R]_8 = \begin{pmatrix} 1 & 1 & 1 & 1 & | & 1 & 1 & - & 0 & -1 \\ 1 & 1 & 1 & 1 & | & 1 & 1 & - & 1 & -1 \\ -1 & -1 & 1 & 1 & | & -1 & -1 & - & 2 & -1 \\ -1 & -1 & 1 & 1 & | & -1 & -1 & - & 3 & -1 \\ \hline 1 & 1 & -1 & -1 & | & 1 & 1 & 1 & 4 & 1 \\ 1 & 1 & -1 & -1 & | & 1 & 1 & 1 & 5 & 1 \\ -1 & -1 & -1 & -1 & | & -1 & -1 & 1 & 6 & 1 \\ -1 & -1 & -1 & -1 & | & -1 & -1 & 1 & 7 & 1 \end{pmatrix} \quad (6)$$

The Eq. (6) is the DNA double helix.

Note that,

$$R_8 \triangleq \underbrace{I_0 \otimes C_0 \otimes P_2 + I_1 \otimes C_1 \otimes P_2}_{} \quad (7)$$

where  $I_0 = \begin{pmatrix} 1 & 0 \\ 0 & 1 \end{pmatrix}$ ,  $I_1 = \begin{pmatrix} 0 & 1 \\ 1 & 0 \end{pmatrix}$ ,  $C_0 = \begin{pmatrix} 1 & 1 \\ -1 & 1 \end{pmatrix}$ ,  $C_1 = \begin{pmatrix} 1 & -1 \\ -1 & -1 \end{pmatrix}$  and  $P_2$  is the permutation double stochastic matrix as  $P_2 = \begin{pmatrix} 1 & 1 \\ 1 & 1 \end{pmatrix}$ . The Eq. (6) is a certainly redundancy row repeated, and cancelled the repeated row. From the Rademacher matrix  $[R]_8$ , then we have

$$R'_8 = \begin{pmatrix} 1 & 1 & 1 & 1 & 1 & 1 & -1 & -1 \\ -1 & -1 & 1 & 1 & -1 & -1 & -1 & -1 \\ 1 & 1 & -1 & -1 & 1 & 1 & 1 & 1 \\ -1 & -1 & -1 & -1 & -1 & -1 & 1 & 1 \end{pmatrix} \quad (8)$$

Also, cancelled the repeated column, then (9) is singular RNA matrix

$$R''_4 = \begin{pmatrix} 1 & 1 & | & 1 & -1 \\ -1 & 1 & | & -1 & -1 \\ \hline 1 & -1 & | & 1 & 1 \\ -1 & -1 & | & -1 & 1 \end{pmatrix} = \begin{pmatrix} C_0 & C_1 \\ C_1 & C_0 \end{pmatrix}, \quad (9)$$

where,  $C_0 = \begin{pmatrix} 1 & 1 \\ -1 & 1 \end{pmatrix}$ ,  $C_1 = \begin{pmatrix} 1 & -1 \\ -1 & -1 \end{pmatrix}$ . The Eq. (10) becomes the DNA double helix to the

RNA single strand as shown in Fig. 1. We show that the information is replicated from DNA and transcript to the RNA. Finally, it is translated into protein.

Therefore,

$$R_4^r \triangleq \underbrace{I_0 \otimes C_0 + I_1 \otimes C_1}_{(10)}$$

Then,  $C_0$  has eigenvalue  $\lambda_1^{(1)}, \lambda_2^{(1)} = 1 \pm i$ , corresponding eigenvectors  $\zeta_1 = (1, -i)^T$ ,  $\zeta_2 = (1, i)^T$ , respectively. Also  $C_1$  has eigenvalues  $\lambda_1^{(2)}, \lambda_2^{(2)} = \pm\sqrt{2}$ , corresponding eigenvectors  $\zeta_1 = (-1 + \sqrt{2}, 1)^T$ ,  $\zeta_2 = (-1 - \sqrt{2}, 1)^T$ , respectively. Thus,

$$R_4^r \otimes P_2 \stackrel{[2]}{\Rightarrow} R_8 = R_{4 \times 2^k}, \text{ where, } k = 1. \tag{11}$$

The Eq. (11) is proved the RNA single strand to the DNA double helix; vice versa, perfectly.

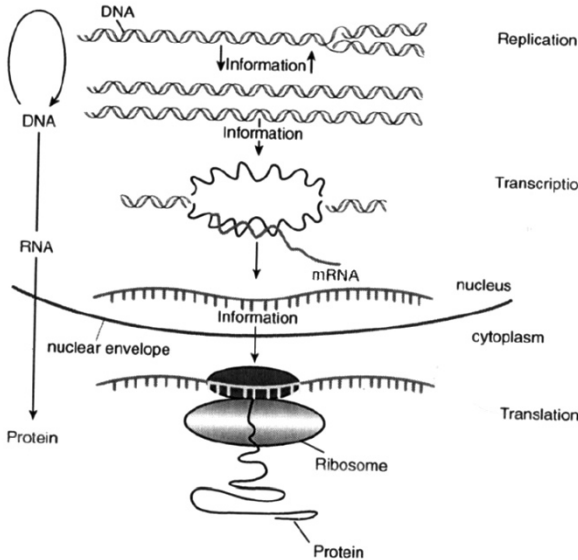

**Fig. 1.** Diagram of molecular biology, DNA  $\rightarrow$  RNA  $\rightarrow$  Protein [5].

These self-replication matrices are the orthogonal Hadamard matrix, but also symmetric pair complementarity of the core RNA. This processes of the RNA can be extended to as shown in Figure 2. The pair complementarity core RNA kernel is achieved by distinct interactions between nucleobases: adenine, uracil, guanine and cytosine. There is a pair complementarity core RNA kernel i.e. 00 to 11 and 01 to 10. From the Table II, we have derived two class of RNA pair genetic matrix such as a pair complementary with the block circulant. On the while, the four half pair of complementary block circulant RNA is given in Table III.

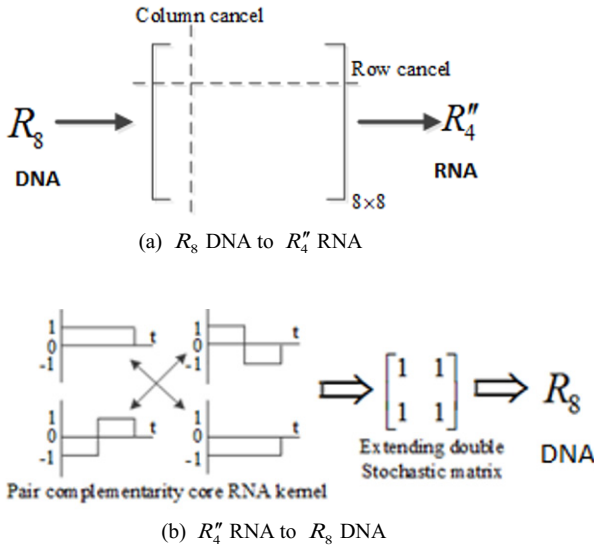

Fig. 2. Block Diagram: the construction RNA of  $4 \times 4$  to  $8 \times 8$  DNA matrix, vice versa.

Table 2. Two Anti-Pair RNA Genetic Matrix

RNA Class	RNA $4 \times 4$ Matrix	Pair Complementary: Sequence of Continuous Function
$\begin{pmatrix} A & G \\ C & U \end{pmatrix}$	$\begin{pmatrix} -1 & -1 & -1 & 1 \\ 1 & -1 & 1 & 1 \\ -1 & 1 & -1 & -1 \\ 1 & 1 & 1 & -1 \end{pmatrix}$	
$\begin{pmatrix} G & A \\ U & C \end{pmatrix}$	$\begin{pmatrix} 1 & -1 & -1 & -1 \\ 1 & 1 & -1 & 1 \\ -1 & -1 & 1 & -1 \\ -1 & 1 & 1 & 1 \end{pmatrix}$	

Example 3.1: we can get  $6 (= 4C_2)$  subclass  $[C U; A G]$  from block circulant case, i.e.,  $C=G, A=U$ , then, the following subclass pattern is given by



$$\begin{bmatrix} C & A \\ U & G \end{bmatrix} = \begin{bmatrix} 1 & -1 & 1 & -1 \\ 1 & 1 & -1 & -1 \\ 1 & -1 & 1 & -1 \\ -1 & -1 & 1 & 1 \end{bmatrix} = \begin{bmatrix} 1 & 0 \\ 0 & 1 \end{bmatrix} \otimes \begin{bmatrix} 1 & -1 \\ 1 & 1 \end{bmatrix}, \quad (12)$$

$$+ \begin{bmatrix} 0 & 1 \\ 1 & 0 \end{bmatrix} \otimes \begin{bmatrix} 1 & -1 \\ -1 & -1 \end{bmatrix}$$

**Table 3.** Four Half pair of complementary RNA

RNA Class	RNA $4 \times 4$ matrix $\begin{pmatrix} C_0 & C_1 \\ C_1 & C_0 \end{pmatrix}$	Half pair of complementary: sequence of continuous function
$\begin{pmatrix} A & C \\ G & U \end{pmatrix}$	$\begin{pmatrix} -1 & 1 & -1 & 1 \\ -1 & -1 & 1 & 1 \\ -1 & 1 & -1 & 1 \\ 1 & 1 & -1 & -1 \end{pmatrix}$	
$\begin{pmatrix} G & U \\ A & C \end{pmatrix}$	$\begin{pmatrix} 1 & 1 & -1 & -1 \\ -1 & 1 & -1 & 1 \\ -1 & -1 & 1 & 1 \\ -1 & 1 & -1 & 1 \end{pmatrix}$	
$\begin{pmatrix} C & A \\ U & G \end{pmatrix}$	$\begin{pmatrix} 1 & -1 & 1 & -1 \\ 1 & 1 & -1 & -1 \\ 1 & -1 & 1 & -1 \\ -1 & -1 & 1 & 1 \end{pmatrix}$	
$\begin{pmatrix} U & G \\ C & A \end{pmatrix}$	$\begin{pmatrix} -1 & -1 & 1 & 1 \\ 1 & -1 & 1 & -1 \\ 1 & 1 & -1 & -1 \\ 1 & -1 & 1 & -1 \end{pmatrix}$	

$$\begin{bmatrix} G & A \\ U & C \end{bmatrix} = \begin{bmatrix} 1 & -1 & -1 & -1 \\ 1 & 1 & -1 & 1 \\ -1 & -1 & 1 & -1 \\ -1 & 1 & 1 & 1 \end{bmatrix} = \begin{bmatrix} 1 & 0 \\ 0 & 1 \end{bmatrix} \otimes \begin{bmatrix} 1 & -1 \\ 1 & 1 \end{bmatrix}, \quad (13)$$

$$+ \begin{bmatrix} 0 & 1 \\ 1 & 0 \end{bmatrix} \otimes \begin{bmatrix} -1 & -1 \\ -1 & 1 \end{bmatrix}$$

$$\begin{bmatrix} G & U \\ A & C \end{bmatrix} = \begin{bmatrix} 1 & 1 & -1 & -1 \\ -1 & 1 & -1 & 1 \\ -1 & -1 & 1 & 1 \\ -1 & 1 & -1 & 1 \end{bmatrix} = \begin{bmatrix} 1 & 0 \\ 0 & 1 \end{bmatrix} \otimes \begin{bmatrix} 1 & 1 \\ -1 & 1 \end{bmatrix} + \begin{bmatrix} 0 & 1 \\ 1 & 0 \end{bmatrix} \otimes \begin{bmatrix} -1 & -1 \\ -1 & 1 \end{bmatrix}, \quad (14)$$

$$\begin{bmatrix} U & G \\ C & A \end{bmatrix} = \begin{bmatrix} -1 & -1 & 1 & 1 \\ 1 & -1 & 1 & -1 \\ 1 & 1 & -1 & -1 \\ 1 & -1 & 1 & -1 \end{bmatrix} = \begin{bmatrix} 1 & 0 \\ 0 & 1 \end{bmatrix} \otimes \begin{bmatrix} -1 & -1 \\ 1 & -1 \end{bmatrix} + \begin{bmatrix} 0 & 1 \\ 1 & 0 \end{bmatrix} \otimes \begin{bmatrix} 1 & 1 \\ 1 & -1 \end{bmatrix}, \quad (15)$$

$$\begin{bmatrix} A & C \\ G & U \end{bmatrix} = \begin{bmatrix} -1 & -1 & -1 & 1 \\ -1 & 1 & 1 & 1 \\ -1 & 1 & -1 & -1 \\ 1 & 1 & -1 & 1 \end{bmatrix} = \begin{bmatrix} 1 & 0 \\ 0 & 1 \end{bmatrix} \otimes \begin{bmatrix} -1 & -1 \\ -1 & 1 \end{bmatrix} + \begin{bmatrix} 0 & 1 \\ 1 & 0 \end{bmatrix} \otimes \begin{bmatrix} -1 & 1 \\ 1 & 1 \end{bmatrix}, \quad (16)$$

$$\begin{bmatrix} A & G \\ C & U \end{bmatrix} = \begin{bmatrix} -1 & -1 & -1 & 1 \\ 1 & -1 & 1 & 1 \\ -1 & 1 & -1 & -1 \\ 1 & 1 & 1 & -1 \end{bmatrix} = \begin{bmatrix} 1 & 0 \\ 0 & 1 \end{bmatrix} \otimes \begin{bmatrix} -1 & -1 \\ 1 & -1 \end{bmatrix} + \begin{bmatrix} 0 & 1 \\ 1 & 0 \end{bmatrix} \otimes \begin{bmatrix} -1 & 1 \\ 1 & 1 \end{bmatrix}. \quad (17)$$

Hence, we get 2 anti-pair as (A G; C U), (G A; U C) and 4 half pair as (A C; G U), (G U; A C), (C A; U G), (U G; C A) of complementary RNA.

#### 4. Symmetric Properties of Genetic Matrices

We considered the Kronecker family of the genomatrices with the kernel [C A; U G] and obtained some interesting properties of the mosaic genomatrices  $[CA;UG]^{(3)}$ . The new variants of kernels of the Kronecker families of genomatrices are produced by permutations of the four letters C, A, U, G on positions in the matrix.

### A. Symmetric Genetic Matrices for Upper to Lower

The 24 variants of such genomatrix exist, which differ from each other by dispositions of the letters inside the matrix. As an example of the standard genetic code,  $[U C; A G] [U C; A G]$  is given  $[UC AG]^T \otimes (UC AG) \otimes (UC AG)^T$ , where  $T$  is the transpose. Similar fashion as (8), we can get

$$\begin{aligned} & \begin{bmatrix} -1 & -1 & -1 & -1 & 1 & 1 & 1 & 1 & -1 & -1 & -1 & -1 & 1 & 1 & 1 & 1 \\ 1 & 1 & 1 & 1 & 1 & 1 & 1 & 1 & 1 & 1 & 1 & 1 & 1 & 1 & 1 & 1 \\ \hline -1 & -1 & -1 & -1 & -1 & -1 & -1 & -1 & -1 & -1 & -1 & -1 & -1 & -1 & -1 & -1 \\ -1 & -1 & -1 & -1 & 1 & 1 & 1 & 1 & -1 & -1 & -1 & -1 & 1 & 1 & 1 & 1 \end{bmatrix}^T \\ & = \left( [1\ 0] \otimes \begin{pmatrix} 1 \\ 1 \end{pmatrix} \otimes \begin{bmatrix} -1 & 1 \\ 1 & 1 \end{bmatrix} \right) + \left( [0\ 1] \otimes \begin{pmatrix} 1 \\ 1 \end{pmatrix} \otimes \begin{bmatrix} -1 & -1 \\ -1 & 1 \end{bmatrix} \right) \otimes \begin{bmatrix} 1 \\ 1 \\ 1 \\ 1 \end{bmatrix} \end{aligned} \quad (18)$$

The Eq. (18) is cancelled Kronecker product of  $[1111]^T$ , then we can get in (19) from  $R_8$  DNA to  $R_4''$  RNA.

$$\begin{aligned} R_4'' &= \begin{bmatrix} -1 & +1 & -1 & -1 \\ +1 & +1 & -1 & +1 \\ \hline -1 & +1 & -1 & -1 \\ +1 & +1 & -1 & +1 \end{bmatrix} \\ &= \underbrace{[1\ 0] \otimes \begin{pmatrix} 1 \\ 1 \end{pmatrix} \otimes \begin{bmatrix} -1 & 1 \\ 1 & 1 \end{bmatrix}} + \underbrace{[0\ 1] \otimes \begin{pmatrix} 1 \\ 1 \end{pmatrix} \otimes \begin{bmatrix} -1 & -1 \\ -1 & 1 \end{bmatrix}} \end{aligned} \quad (19)$$

*Example 4.1:* If  $A=U$ ,  $C=G$ , then we can get six subsets the Kronecker family of the genomatrices with the kernel  $[C A; U G]$

$$\begin{aligned} \begin{bmatrix} A & C \\ U & G \end{bmatrix} &= \begin{bmatrix} -1 & 1 & -1 & 1 \\ -1 & -1 & 1 & 1 \\ -1 & 1 & -1 & 1 \\ -1 & -1 & 1 & 1 \end{bmatrix} \\ &= [1\ 0] \otimes \begin{pmatrix} 1 \\ 1 \end{pmatrix} \otimes \begin{bmatrix} -1 & 1 \\ -1 & -1 \end{bmatrix} + [0\ 1] \otimes \begin{pmatrix} 1 \\ 1 \end{pmatrix} \otimes \begin{bmatrix} -1 & 1 \\ 1 & 1 \end{bmatrix} \end{aligned} \quad (20)$$

Similar way, we provide other subsets as follows:

$$\begin{bmatrix} A & G \\ U & C \end{bmatrix} = \begin{bmatrix} -1 & -1 & -1 & 1 \\ -1 & 1 & 1 & 1 \\ -1 & -1 & -1 & 1 \\ -1 & 1 & 1 & 1 \end{bmatrix} = \quad , \quad (21)$$

$$[1 \ 0] \otimes \begin{bmatrix} 1 \\ 1 \end{bmatrix} \otimes \begin{bmatrix} -1 & -1 \\ -1 & 1 \end{bmatrix} + [0 \ 1] \otimes \begin{bmatrix} 1 \\ 1 \end{bmatrix} \otimes \begin{bmatrix} -1 & 1 \\ 1 & 1 \end{bmatrix}$$

$$\begin{bmatrix} G & U \\ C & A \end{bmatrix} = \begin{bmatrix} 1 & 1 & -1 & -1 \\ 1 & -1 & 1 & -1 \\ 1 & 1 & -1 & -1 \\ 1 & -1 & 1 & -1 \end{bmatrix} = \quad , \quad (22)$$

$$[1 \ 0] \otimes \begin{bmatrix} 1 \\ 1 \end{bmatrix} \otimes \begin{bmatrix} 1 & 1 \\ 1 & -1 \end{bmatrix} + [0 \ 1] \otimes \begin{bmatrix} 1 \\ 1 \end{bmatrix} \otimes \begin{bmatrix} -1 & -1 \\ 1 & -1 \end{bmatrix}$$

$$\begin{bmatrix} C & U \\ G & A \end{bmatrix} = \begin{bmatrix} 1 & 1 & 1 & -1 \\ 1 & -1 & -1 & -1 \\ 1 & 1 & 1 & -1 \\ 1 & -1 & -1 & -1 \end{bmatrix} = \quad , \quad (23)$$

$$[1 \ 0] \otimes \begin{bmatrix} 1 \\ 1 \end{bmatrix} \otimes \begin{bmatrix} 1 & 1 \\ 1 & -1 \end{bmatrix} + [0 \ 1] \otimes \begin{bmatrix} 1 \\ 1 \end{bmatrix} \otimes \begin{bmatrix} 1 & -1 \\ -1 & -1 \end{bmatrix}$$

$$\begin{bmatrix} C & A \\ G & U \end{bmatrix} = \begin{bmatrix} 1 & -1 & 1 & -1 \\ 1 & 1 & -1 & -1 \\ 1 & -1 & 1 & -1 \\ 1 & 1 & -1 & -1 \end{bmatrix} = \quad , \quad (24)$$

$$[1 \ 0] \otimes \begin{bmatrix} 1 \\ 1 \end{bmatrix} \otimes \begin{bmatrix} 1 & -1 \\ 1 & 1 \end{bmatrix} + [0 \ 1] \otimes \begin{bmatrix} 1 \\ 1 \end{bmatrix} \otimes \begin{bmatrix} 1 & -1 \\ -1 & -1 \end{bmatrix}$$

$$\begin{bmatrix} G & A \\ C & U \end{bmatrix} = \begin{bmatrix} 1 & -1 & -1 & -1 \\ 1 & 1 & 1 & -1 \\ 1 & -1 & -1 & -1 \\ 1 & 1 & 1 & -1 \end{bmatrix} = \quad . \quad (25)$$

$$[1 \ 0] \otimes \begin{bmatrix} 1 \\ 1 \end{bmatrix} \otimes \begin{bmatrix} 1 & -1 \\ 1 & 1 \end{bmatrix} + [0 \ 1] \otimes \begin{bmatrix} 1 \\ 1 \end{bmatrix} \otimes \begin{bmatrix} -1 & -1 \\ 1 & -1 \end{bmatrix}$$

Hence, we show that 6 half pair of symmetric upper-lower RNA genetic matrices.

### B. Symmetric Genetic Matrices for Left to Right

In this subsection, we can also get 6 subsets the Kronecker family of the genomatrices with the kernel  $[C\ A; U\ G]$ . Thus, we get  $R_8$  DNA such as

$$\begin{pmatrix} 1 & 1 & 1 & 1 & 1 & 1 & 1 & 1 \\ 1 & 1 & 1 & 1 & 1 & 1 & 1 & 1 \\ 1 & 1 & -1 & -1 & 1 & 1 & -1 & -1 \\ 1 & 1 & -1 & -1 & 1 & 1 & -1 & -1 \\ \hline 1 & 1 & -1 & -1 & 1 & 1 & -1 & -1 \\ 1 & 1 & -1 & -1 & 1 & 1 & -1 & -1 \\ -1 & -1 & -1 & -1 & -1 & -1 & -1 & -1 \\ -1 & -1 & -1 & -1 & -1 & -1 & -1 & -1 \end{pmatrix} = \left[ \begin{array}{l} \left( \begin{array}{c} 1 \\ 0 \end{array} \right) \otimes (1\ 1) \otimes \left( \begin{array}{cc} 1 & 1 \\ 1 & -1 \end{array} \right) \\ + \left( \begin{array}{c} 0 \\ 1 \end{array} \right) \otimes (1\ 1) \otimes \left( \begin{array}{cc} 1 & -1 \\ -1 & -1 \end{array} \right) \end{array} \right] \otimes \begin{pmatrix} 1 & 1 \\ 1 & 1 \end{pmatrix}. \quad (26)$$

*Example 4.2:* Hence, if  $C=G$ ,  $U=A$ , then we can get 6 subsets 4 by 4 RNA

$$\begin{pmatrix} C & G \\ U & A \end{pmatrix} = \begin{pmatrix} 1 & 1 & 1 & 1 \\ 1 & -1 & 1 & -1 \\ 1 & -1 & 1 & -1 \\ -1 & -1 & -1 & -1 \end{pmatrix} \quad (27)$$

$$= \left[ \begin{array}{l} \left( \begin{array}{c} 1 \\ 0 \end{array} \right) \otimes (1\ 1) \otimes \left( \begin{array}{cc} 1 & 1 \\ 1 & -1 \end{array} \right) + \left( \begin{array}{c} 0 \\ 1 \end{array} \right) \otimes (1\ 1) \otimes \left( \begin{array}{cc} 1 & -1 \\ -1 & -1 \end{array} \right) \end{array} \right].$$

In this way, we provide other subsets such as

$$\begin{pmatrix} G & C \\ U & A \end{pmatrix} = \begin{pmatrix} 1 & 1 & 1 & 1 \\ 1 & -1 & 1 & -1 \\ -1 & 1 & -1 & 1 \\ -1 & -1 & -1 & -1 \end{pmatrix} = \left[ \begin{array}{l} \left[ \begin{array}{c} 1 \\ 0 \end{array} \right] \otimes [1\ 1] \otimes \left[ \begin{array}{cc} 1 & 1 \\ 1 & -1 \end{array} \right] + \left[ \begin{array}{c} 0 \\ 1 \end{array} \right] \otimes [1\ 1] \otimes \left[ \begin{array}{cc} 1 & -1 \\ -1 & -1 \end{array} \right] \end{array} \right], \quad (28)$$

$$\begin{aligned} \begin{bmatrix} U & A \\ C & G \end{bmatrix} &= \begin{bmatrix} -1 & -1 & -1 & -1 \\ 1 & -1 & 1 & -1 \\ 1 & -1 & 1 & -1 \\ 1 & 1 & 1 & 1 \end{bmatrix} = & , & (29) \\ \begin{bmatrix} 1 \\ 0 \end{bmatrix} \otimes [1 \ 1] \otimes \begin{bmatrix} -1 & -1 \\ 1 & -1 \end{bmatrix} + \begin{bmatrix} 0 \\ 1 \end{bmatrix} \otimes [1 \ 1] \otimes \begin{bmatrix} 1 & -1 \\ 1 & 1 \end{bmatrix} & \end{aligned}$$

$$\begin{aligned} \begin{bmatrix} A & U \\ G & C \end{bmatrix} &= \begin{bmatrix} -1 & -1 & -1 & -1 \\ -1 & 1 & -1 & 1 \\ -1 & 1 & -1 & 1 \\ 1 & 1 & 1 & 1 \end{bmatrix} = & , & (30) \\ \begin{bmatrix} 1 \\ 0 \end{bmatrix} \otimes [1 \ 1] \otimes \begin{bmatrix} -1 & -1 \\ -1 & 1 \end{bmatrix} + \begin{bmatrix} 0 \\ 1 \end{bmatrix} \otimes [1 \ 1] \otimes \begin{bmatrix} -1 & 1 \\ 1 & 1 \end{bmatrix} & \end{aligned}$$

$$\begin{aligned} \begin{bmatrix} G & C \\ A & U \end{bmatrix} &= \begin{bmatrix} 1 & 1 & 1 & 1 \\ -1 & 1 & -1 & 1 \\ -1 & 1 & -1 & 1 \\ -1 & -1 & -1 & -1 \end{bmatrix} = & , & (31) \\ \begin{bmatrix} 1 \\ 0 \end{bmatrix} \otimes [1 \ 1] \otimes \begin{bmatrix} 1 & 1 \\ -1 & 1 \end{bmatrix} + \begin{bmatrix} 0 \\ 1 \end{bmatrix} \otimes [1 \ 1] \otimes \begin{bmatrix} -1 & 1 \\ -1 & -1 \end{bmatrix} & \end{aligned}$$

$$\begin{aligned} \begin{bmatrix} C & G \\ A & U \end{bmatrix} &= \begin{bmatrix} 1 & 1 & 1 & 1 \\ -1 & 1 & -1 & 1 \\ 1 & -1 & 1 & -1 \\ -1 & -1 & -1 & -1 \end{bmatrix} = & , & (32) \\ \begin{bmatrix} 1 \\ 0 \end{bmatrix} \otimes [1 \ 1] \otimes \begin{bmatrix} 1 & 1 \\ -1 & 1 \end{bmatrix} + \begin{bmatrix} 0 \\ 1 \end{bmatrix} \otimes [1 \ 1] \otimes \begin{bmatrix} 1 & -1 \\ -1 & -1 \end{bmatrix} & \end{aligned}$$

In this example, we show that the 6 half pair of symmetric left-right RNA genetic matrices.

## 5. Discussion

In this Section, we propose our main results for  $24(=4 \times 4C_2)$  DNA class characteristic property. The main kernel of body in the equation is given by

$$\underbrace{\underline{E}}_{\text{Position}} \otimes \underbrace{\{(I_0 \otimes A) + (I_1 \otimes B)\}}_{\text{Main Body Kernel}} \otimes \underbrace{\underline{F}}_{\text{Extending}} \tag{33}$$

A RNA pattern of main kernel is same as the (10). The position matrix of  $E$  is the pattern of upper-lower and left-right symmetric genetic matrix as the Eqs. (19, 27). In same way, the extending matrix of  $F$  is the pattern of upper-lower and left-right symmetric genetic matrix as the Eqs. (18, 26).

The national flag of South Korea bears symbols of trigrams and Yin-Yang in the center. The pattern of Fig.3 is similar pattern as the Koreannational flag. The 24 variants of such genomatrix exist, which differ from each other by dispositions of the letters inside the matrix as shown in Fig. 3 such as left hand side  $\begin{bmatrix} 1 \\ 0 \end{bmatrix} \otimes [1 \ 1]$ , right hand side  $\begin{bmatrix} 0 \\ 1 \end{bmatrix} \otimes [1 \ 1]$ , upper position  $(1 \ 0) \otimes \begin{pmatrix} 1 \\ 1 \end{pmatrix}$ , lower position  $(0 \ 1) \otimes \begin{pmatrix} 1 \\ 1 \end{pmatrix}$  and center part  $I_0 \otimes C_0 + I_1 \otimes C_1$ , respectively.

The upper-lower and left-right symmetric genetic matrix is the pair complementary as  $(1 \ 0) \otimes \begin{pmatrix} 1 \\ 1 \end{pmatrix} \leftrightarrow (0 \ 1) \otimes \begin{pmatrix} 1 \\ 1 \end{pmatrix}$  and  $\begin{pmatrix} 1 \\ 0 \end{pmatrix} \otimes (1 \ 1) \leftrightarrow \begin{pmatrix} 0 \\ 1 \end{pmatrix} \otimes (1 \ 1)$ . The kernel of  $\begin{pmatrix} 1 & 1 \\ -1 & 1 \end{pmatrix}, \begin{pmatrix} 1 & -1 \\ 1 & 1 \end{pmatrix}, \begin{pmatrix} -1 & 1 \\ 1 & -1 \end{pmatrix}, \begin{pmatrix} -1 & -1 \\ -1 & -1 \end{pmatrix}, \begin{pmatrix} 1 & -1 \\ -1 & -1 \end{pmatrix}$  are shown in Fig. 3(b). This matrix rank is 2, then the kernel is also full diversity.

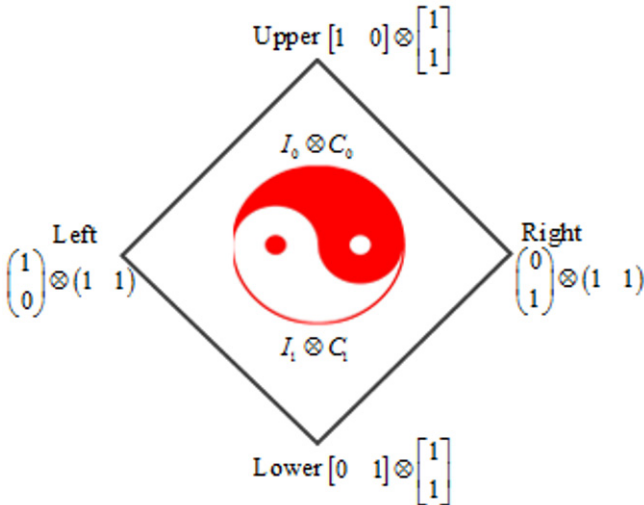

**Fig. 3.** General pattern of Block circulant, upper-lower symmetric and left-right symmetric genetic matrix

## 6. Conclusion

We have presented a simple method of developing a mathematical proof of double helix DNA to reverse transcription RNA. This method provided for its simplicity and clarity which it decomposes a DNA matrix in term of sparse matrices having only cancel column and row. Our results illustrate the feasibility of bioinformatics and it can be given a mathematical framework model. Our contribution have been to provide the mathematical proof of DNA to RNA as the pattern of upper-lower, left-right and central, i.e., similar fashion as Korea flag Goe making it possible to tackle some of the open problem in bioinformatics.

## Acknowledgments

This work was supported by the MEST 2015R1A2A1A 05000977, NRF, Korea.

## References

1. J. D. Watson, F. H. C. Crick, "Molecular structure of nucleic acids", Nature, vol. 171, no. 4356, pp. 737-738, April 1953.
2. H. M. Temin, "Nature of the provirus of rous sarcoma", National Cancer Institute Monograph, vol. 17, pp. 557-570, 1964.
3. Z. Chen, M. H. Lee, G. Zeng, "Fastcocyclic Jacket transform", IEEE trans. on Signal Processing, vol. 56, no. 5, May 2008.
4. M. H. Lee, H. Hai, X. D. Zhang, MIMO Communication Method and System using the Block Circulant Jacket Matrix, USA Patent 9,356,671, 05/31/2016.
5. He M., Petoukhov S. Mathematics of Bioinformatics: Theory, Practice, and Applications. John Wiley & Sons, Inc., USA, 2011.
6. S. K. Lee, D. C. Park, M. H. Lee, "RNA genetic 8 by 8 matrix construction from the block circulant Jacket matrix", Symmetric Festival 2016, 18-22 July 2016, Vienna, Austria.
7. K. V. Srinivas, A. W. Eckford, R. S. Adve, "Molecular communication in fluid media: The additive inverse Gaussian noise channel", IEEE Trans. on Information Theory, Vol. 58, no. 7, July 2012.
8. J. Hou, M. H. Lee, Ju Yong Park, "Matrices analysis of quasi-orthogonal space time block codes", IEEE Comm. Letters, vol. 7, no. 8, 2003.
9. E. R. Miranda, E. Braund, "Interactive musical biocomputer: an unconventional approach to research in unconventional computing", Symmetry: Culture and Science, vol. 28, no. 2, 7-20, 2017.
10. Petoukhov S.V., He M. Symmetrical Analysis Techniques for Genetic Systems and Bioinformatics: Advanced Patterns and Applications. - IGI Global, Hershey, USA, 2010, 271 p.



# Tests of Parallel Information Processing on the Basis of Algebra and Formal Automata

A. V. Koganov<sup>1</sup>, T. A. Rakcheeva<sup>2</sup>

<sup>1</sup>NIISI RAN, 36 Nakhimovsky st., corp.1, Moscow, 117218, Russia

<sup>2</sup>IMash RAN, 4, Bardina st., 117334, Moscow, Russia

**Abstract.** The work continues the studies on human ability to improve the performance of information processing using parallel computing. The performance of the test person at the decision of tasks is determined by the amount of information that treats employees in a unit of time. The complexity of the task is determined by the number of the specified logical operators, which need to be fulfilled for the solution. We study the dependence of its efficiency on the complexity of the tasks in the series. Productivity growth together the growth of complexity may mean either increasing the speed of brain structures involved in the decision, or activation of additional neural structures for parallel computing. We are building a series of tasks that determine the type of adaptation to increasing complexity. The new system of test based on universal algebra and automata theory. Previous tests showed in the experiments the effectiveness of the technique.

**Keywords:** A parallel account, a psychological test, algebra, associative, formal machine.

## 1 Introduction

This article continues the published earlier studies [1-3] on a person's ability to improve the performance of information processing using parallel execution of multiple specified logic operations. The article proposes new tests indicated the ability of the human brain in a series of presentations of the test problems. The overall goal is to identify the principles of organization of the human brain when performing a series of logical operations in the mind without notes or technical devices. The initial setting is the requirement to solve the problem as quickly as possible but without mistakes. We studied the method of adaptation of the brain to increase the complexity of the proposed task. We studied the method of adaptation of the brain to increase the complexity of the proposed task. Under the complexity of the task refers to the minimum number of operations of a given type that must be performed to guarantee a correct answer. There are several strategies for such an adaptation. Simple strategy: ignore the time for performing the task and focus on the correct calculation. The performance is constant and time increases in proportion to the complexity of the problem. Strategy acceleration is to increase the speed of calculations with increasing

complexity of the task. Productivity increases inversely proportional to the execution time of one operation. Strategy parallelism is to connect multiple processors to solve complex tasks (parallel computing). The effectiveness of this strategy for a task is measured by the ratio of the coefficient in time solutions to those involved in the decision processor. Parallel computing is feasible, if the efficiency is large enough. Finally strategy of decreasing the reliability of solutions with increasing complexity is possible. It corresponds to attempts to guess the correct answer by performing only a subset of the desired operations. It is possible, if the statistics of correct answers allows a good probability forecasting. Tests should counteract this strategy. The proposed methodology consists in presenting several series of the tasks with the control of the average decision time and the frequency of erroneous responses. Tasks are divided into two classes. For some tests, a parallel account is effective, and for others it is inefficient. The tasks of each class are divided into series. In each series, the complexity of the tasks is fixed relative to the obvious natural basis of operations. The number of tasks in each series is sufficient to estimate the probability of error in the subject. Before the beginning of the basic testing, the subject undergoes training on a special series of tasks of varying complexity. We consider the criterions of an adaptation strategy. 1. Performance is constant and does not depend on the complexity for tasks of both classes — a sequential account with a constant speed. 2. Productivity grows with increasing complexity in tasks of both classes — sequential counting with acceleration. 3. Performance grows with increasing complexity for tasks that allow for efficient parallelism, and performance is constant for tasks with inefficient parallelism — connecting parallel computing. To identify incomplete information processing, a method for evaluating brain performance in solving a series of test problems was developed. If there are a lot of mistakes, then the estimate drops sharply even with a short time for solving of the tasks. The information processed by the subject will be measured by the number of characters that he processed in solving the problem. If the problem is solved incorrectly, then all the information contained in it will be considered untreated, and it is excluded from the series. This principle gives an estimate of

$$W = \frac{QA(Kf-1)}{T(K-1)} \pm \frac{bQAK}{2T(K-1)\sqrt{N}},$$

Where  $W$  — performance evaluation;  $K$  — the number of different a priori possible answers in the problem;  $M$  — the number of possible values for a single element of the original data,  $Q = \log_2(M)$ ;  $A$  — the number of elements of the original data that need to be scanned to obtain a guaranteed correct answer in one presentation of the task;  $f$  — the empirical value of the proportion of correct answers;  $T$  — the average time for solving correctly solved problems of this complexity;  $N$  — the number of tasks presented in a series of one complexity. If there are no definite trends in performance change, or if it decreases with increasing complexity, then the uncertainty of the strategy is recorded. Previously published papers [1-5], in which described the testing of a group of subjects on the basis of two problems. The first

task is to calculate the maximum in a numeric table (parallelism is very effective). The second task is tracing a trajectory from a numerical table, in which the path was indicated by comparing the neighboring numbers. This task had several modifications, In this task the efficiency of additional processors is low. The test results showed that approximately 27% of the subjects resort to parallel computations for a large complexity of the problem, if the problem allows efficient parallelization. In addition, about 27% of subjects who did not resort to parallel computing, increased the speed of computation for high complexity problems. About 18% of the subjects showed uniform, consistent work. The method of work of some subjects (about 27%) could not be uniquely identified. The reliability of the results is higher than 97% for each subject with the established method of work. The results obtained led to the development of new tests, where calculations will be based on other elementary operations. In the first task, you need to determine how many characters "1" is contained in a table filled with numbers and letters. This problem allows an efficient parallel solution. In the second task, it is required to calculate the trajectory along a rectangular table in which columns there are permutations of line numbers. These permutations indicate where to go to the column next to the right. In fact, this is the calculation of the position in the permutation equals the product of permutations in columns. In this problem, parallelism efficiency is low. You should expect a sequential calculation of the answer by a person. Problems of this kind are reduced to the calculation of certain expressions in the algebra of numbers or in the algebra of permutations. We will consider a general approach to constructing tests of this type by calculating of expressions in generic algebras. Depending on the availability of associativity, parallel computations in them are effective or not. A class of algebras that are relatively simple for teaching subjects is proposed. Another class of tests involves calculating the final state of a given formal automaton with the initial state when a given input sequence is applied to it. There will be offered automata, which can be considered as generalizations of the relay and the trigger. In some modifications, they allow for an efficient parallel calculation, while in others they require sequential computation.

Currently, there is a lot of work with the analysis of efficiency of parallel implementation of the algorithms, which are devoted to research rather complex problems relating to practical applications of contemporary Informatics and Cybernetics, for example, [4,6]. The main direction of these works is connected with optimization of distributing complex tasks among the processors or different computers. The specificity of our tests is in the simplicity of the tasks available for the calculation of "the mind" of the person with minimal training. In the field of engineering and cognitive psychology is a lot of work on the analysis of the behavior of a person when necessary to solve several problems in one time interval, for example [7]. It is established that the person effectively uses the parallel processing of information when it involves different modalities of perception (e.g. music and dance). However, if you need parallel operation in one modality, many people have difficulties. For example, filtering noises in the perception of source data increases the percentage of errors in problem solving. The difference between our studies is the absence of an explicit division of the task into several subtasks. Such a division is

made by man himself, when he moves on to a parallel strategy of solution. It is noticed that subjects who have shown parallel work, as a rule, can not explain the method of solution, and with a consistent strategy, the subjects clearly explain their method. Probably, reflection is possible only at one center of brain activity.

To describe new tests, it will be convenient to denote  $rand\{M\}$  the operation of selecting one element from the specified finite set  $M$  with a uniform probability distribution over the set  $M$  and statistically independent of all other realizations of this operation over any sets. All tasks are performed on the computer screen.

## 2 The Task of Counting Characters

The initial information is presented in the form of a sequence  $y(1), \dots, y(N)$  of  $N$  symbols, possibly presented in the form of a table containing  $m$  rows and  $n$  columns. Values  $y(i)$  are letters and numbers from the alphabet  $Alp$ ;  $Alp' = Alp \setminus \{1\}$ . Several right cells of the last (bottom) line can be empty if  $N < nm$ . The answer to the problem is a number  $F$  in the range from 0 to  $N$ , equal to the number of characters '1' in the table. The complexity of the problem is a number  $N$ .

Formation of the next task in the series.

$$x(1) = rand\{1; \dots; N\}$$

$$x(l+1) = rand\{\{1; \dots; N\} \setminus \{x(1); \dots; x(l)\}\}, \quad l = \overline{1, F-1}.$$

$$X =_{def} \{x(1); \dots; x(F)\}$$

$$y(i) = \begin{cases} 1 & \leftarrow i \in X \\ rand\{Alp'\} & \leftarrow i \notin X \end{cases}$$

The number of tasks presented in a series of complexity  $N$  will be denoted  $K(N)$ , or  $K$  if the lengths of all series in the experiment are the same.

## 3 The Task of the Product of Permutations

The initial information is presented in the form of a table containing  $m$  rows and  $n$  columns, all  $nm$  cells. In each column there is a permutation  $\omega$  of numbers  $\{1; \dots; m\}$ , written down by a pair of numbers  $[i, \omega_j(i)]$  in each cell, where  $i$  the line number. One of the cells of the leftmost column is marked. From this point the

examinee must trace the trajectory indicated by permutations according to the following recurrence relation.

$i_1$  — the line marked in the first (left) column.

$i_{j+1} = \omega_j(i_j)$ ,  $j = 1, \dots, n-1$ . — A row in the column  $J+1$ .

The answer to the task is value  $\omega_n(i_n)$ . Mathematically, the problem's answer is equal to the value of a position of the product of permutations

$$\omega_n(i_n) = (\omega_n \cdot \dots \cdot \omega_1)(i_1).$$

But the recurrent process of computing is much more economical than the computation of the complete works of permutations. The complexity of the task, let's call the number of the columns  $n$ . We designate  $K(n)$  the number of imposed tasks in a series of complexity  $n$ , or  $K$  if the lengths of all series in the experiment are same. Formation of each task from the series should ensure statistical independence and uniform distribution of answers. It is possible to provide by the following step-by-step procedure. The parameters  $m$  and  $n$  are specified for a series.

$i_1 = \text{rand}\{1; \dots; m\}$ ; Specify a starting line number.

Permutation in each column  $j$  is calculated recurrence

$$\omega_j(1) = \text{rand}\{1; \dots; m\};$$

$$\omega_j(i+1) = \text{rand}\{1; \dots; m\} \setminus \{\omega_j(1); \dots; \omega_j(i)\}; \quad i = 1, \dots, m-1.$$

The first number in the cell is used to facilitate the search for the required string in the next column when moving the table from left to right. After reading the value  $\omega_j(i_j)$  we need to find the cell with the coordinates  $(\omega_j(i_j), j+1)$  in the table. In this cell contains two numbers  $(\omega_j(i_j), \omega_{j+1}(i_{j+1}))$ , and you want to read the value  $\omega_{j+1}(i_{j+1})$  to continue solving the problem, or to issue the response if the condition  $j+1 = n$  is satisfied (last column).

#### 4 The Automatic Tests of Parallelism

The basis of these tests is the concept of a formal automaton. The machine is represented by a diagram on the screen, which shows the transfer graph of the automation. The vertices of this graph represent the states of the automaton. These are

circles in which letters are inscribed. The letter in each circle is unique and denotes a status identifier. The edges of the graph are directed and are represented by arrows with marks. Marks denote the input symbol, which corresponds to a transition from one state to another in the direction of the arrow. In addition to the circuit of the automaton, the problem contains a finite sequence of input symbols, at the beginning of which the identifier of the initial state of the automaton is indicated. The answer of the problem is the identifier of the state to which the automaton comes after having worked out this input sequence from the specified initial state. With a fixed circuit of the automaton, we will measure the complexity of the problem with the length of the input sequence. In the general case, there is no effective parallel algorithm for solving such a problem. However, for some automata, the calculation of the final state can be obtained as the computation of certain characteristics of the input sequence that allow efficient parallel calculation.

We call a *relay* of general form any automaton with two input symbols, which has a sequence of inputs that conducts the automaton over all states without repeats. We call this sequence of states the main cycle of states, and the corresponding sequence of inputs is called the main sequence of inputs. Periodic feeding of the main sequence of inputs leads to a circular cycle of states over the main cycle. Since we consider the initial state to be fixed, then to each state there corresponds exactly one input symbol from the main sequence of inputs, which continues to move along the main cycle from this state. This symbol is called a cyclic input in this state. Another input symbol is called the jump input for this state. The main cycle allows us to give the states of the automaton a cyclic numbering in the order of traversal. Starting from zero, we get numbers modulo the number of states of the automaton. We call this numbering the main cyclic numbering. In each state, the cyclic input increments the state number by one modulo the number of states. Change the number when the input of the jump input is called the magnitude of the jump. In the general case, the magnitude of the jump is different in different states. An automatic *trigger* is a special case of a relay, in which the jump value in all states is zero. If all the states use the same cyclic input and the jump values are the same, then the automaton is called a homogeneous relay or a homogeneous trigger. If the cyclic inputs are alternated by the number of states and the jump values are the same, then the automaton is called *variational*. In other cases, the automaton is said to be *nonregular*. We analyze the effectiveness of a parallel solution of the automaton problem. We divide the state of the automaton into classes. Two states belong to the same similarity class (similar states) if they have the same cyclic inputs and jump values. Two states belong to the same functional class (equivalent states), if they are similar, and any input sequence translates them into similar states. We introduce the notation.  $M$  Is the number of states of the automaton.  $\Phi$  - number of functional classes of states.  $\varphi(A)$  — functional class of state with number  $A$ ; We denote  $[A]$  this state itself. Class of similarity of state  $[A]$  denote  $\xi(A)$ .  $L(\xi, x)$  — the amount of change of the status number from the similarity class  $\xi$  when the input is  $x \in \{0;1\}$ . If this is a cyclic input, then  $L = 1$ , and if it is a jump input, it is  $L$  equal to the jump value. We need one representative

of the state from each functional class  $\varphi$  whose number we will designate  $A(\varphi)$ .  $N$  — the length of the input sequence in the test task. Input sequence  $x(1), \dots, x(N)$ .  $A * x(1) * \dots * x(t)$  — the number of the state where the state with the number  $A$  will pass after the automatic transmission of the input sequence  $(x(1), \dots, x(t))$ .

If the problem is represented by the circuit of the automaton (general view relay), the initial state and the finite input sequence, then the parallel solution can be realized only by dividing the input sequence into several segments  $x(1 \div N_1), \dots, x(N_r + 1 \div N)$ , which are given by the boundaries  $N_0 = 0 < N_1 < \dots < N_r < N_{r+1} = N$ . Then you can make a parallel calculation of the offset of the status number after working off each segment. This corresponds to  $r + 1$  the parallelism level of the calculation. But since the initial state  $[0]$  is specified only for the first segment, then in order to work out each of the subsequent segments in parallel mode, it is simultaneously necessary to calculate exactly  $\Phi$  the hypotheses about the initial state for this segment. Thus, the parallelism of the level  $r + 1$  is realized by  $1 + \Phi r$  the processors. From the point of view of reducing the time of parallel counting, it is advantageous to choose these segments approximately equal in length, as far as integer division allows. On each segment, the calculation is carried out sequentially on a recurrence formula from the initial state, which will be the individual for each of the processors. We will assume that the processors are numbered as  $P_{\varphi, j}$ , where  $j$  is the number of the segment of the input sequence  $x(N_j + 1 \div N_{j+1})$  on which the given processor operates  $j = 1, \dots, r$ , and the initial state  $A(\varphi)$  for the calculation corresponds to the functional class  $\varphi$ , as a hypothesis about the real state at the end of the previous segment  $[0 * x(1) * \dots * x(N_j)]$ . In addition, there is a processor  $P_0 = P_{\varphi(0), 0}$ , which for the first segment is one, since the initial state is known exactly. The processor calculates the offset  $\Delta_{\varphi, j}$  of its hypothetical initial state after testing its portion of the input sequence. We consider a recurrence formula for each processor.

$$\Delta_{\varphi, j}(N_j) = 0; \quad B_{\varphi}(N_j) = A(\varphi);$$

$$\Delta_{\varphi, j}(t + 1) = \Delta_{\varphi, j}(t) + L(\xi(B_{\varphi}(t)), x(N_j + t + 1)) \pmod{M};$$

$$B_{\varphi}(N_j + t + 1) = B_{\varphi}(N_j + t) * x(N_j + t + 1);$$

$$t = 0, \dots, N_{j+1} - N_j - 1;$$

where at each step with the number  $t$  we get the number of the current hypothetical state  $B_{\varphi}(N_j + t) = A(\varphi) * x(N_j + 1) * \dots * x(N_j + t)$ , which corresponds to the hypothesis of the initial state of the segment. Consecutive assembly of the results:

$$f(1) = \Delta_{\varphi(0),0}(N_1) = B_{\varphi(0),0}(N_1);$$

$$f(j+1) = f(j) + \Delta_{\varphi(f(j)),j+1}(N_{j+2}) \pmod{M}; \quad j = 0, \dots, r-1;$$

The answer of the problem is  $f = f(r)$ . The lengths of the segments of the input sequence are approximately equal  $N/(r+1)$ , up to an integer rounding. The total number of iteration steps is  $T = 2 + r + N/r$ . If  $T > N + 1$ , then the parallelism gives a gain in the time of the solution of the problem. In this case, the parallel stage uses  $1 + \Phi r$  processors. And in response to the task of the assembly formulas, the results of the calculation are only from  $1 + r$  the processors. Therefore, the efficiency of the processors is not higher than  $\eta \leq (r+1)/(\Phi r + 1)$ . A parallel account is justified only for automata with a small number of classes of functional equivalence and only for sufficiently large lengths of a given input sequence.

For a homogeneous trigger machine, the number of the final state is given by

$$f = \sum_{i=1}^N x(i) \pmod{M},$$

For a homogeneous relay machine, the number of the final state is given by

$$f = 2N - \sum_{i=1}^N x(i) \pmod{M}$$

For an alternate trigger, if the input sequence contains arrays of zeros and ones, then

$$f = \begin{cases} m \pmod{M} \Leftarrow x(1) = 0 \\ m - 1 \pmod{M} \Leftarrow x(1) = 1 \end{cases}$$

Variative relays must be divided into two classes: with an even or odd jump. For an odd jump

$$f = Ns + (s-1) \left( \left( \sum_{j=0}^{N-\lfloor N/2 \rfloor} x(2j+1) \right) - \left( \sum_{i=1}^{\lfloor N/2 \rfloor} x(2i) \right) \right) \pmod{M}$$

These formulas allow an efficient parallel computation. There is no such formula for even jump values. Moreover, for an alternating relay with an even jump length, where  $\Phi = 2$ , the efficiency of using processors is not higher  $2/3$  with parallelism of 2,



and decreases until  $1/3$  with more parallelism. And for an odd jump length, parallelism may be appropriate only for sufficiently long input sequences. Therefore, it is extremely unlikely that a parallel method of solving a problem by a person in an inhomogeneous case. In a series of tasks, the input sequence can be generated by an algorithm  $x(i) = \text{rand}\{0;1\}$ ,  $i = \overline{1, N}$ .

## 5 Tests Based on Universal Algebra

Algebras of universal type with a finite number of elements are also a convenient tool for creating parallel tests. Algebra is determined by the table of operations on its elements. It is convenient to use binary operations. We write the binary operation  $\varphi: A \times A \rightarrow A$  in the usual form with the sign of the operation between the operands  $x\varphi y = z$ , where both operands and the result belong to the support of the algebra  $A$  (finite set). As a test, you can specify the chain of elements to which the operation is applied sequentially

$$xyz\dots v \mapsto x\varphi y\varphi z\varphi\dots\varphi v = (\dots((x\varphi y)\varphi z)\varphi\dots)\varphi v = w$$

This formula allows for efficient parallel computing if the operation is associative:  $(x\varphi y)\varphi z = x\varphi(y\varphi z)$ . If there is no associativity, the parallel calculation has a low efficiency. We assign two elements of the algebra  $x, x'$  to one functional class, if  $x\varphi a_1\varphi\dots\varphi a_n = x'\varphi a_1\varphi\dots\varphi a_n$  for any sequence of elements  $a_1, \dots, a_n$ . We denote  $\Phi$  the number of functional classes of elements of the algebra. Then for a non-associative algebra, parallel processing of  $r+1$  sections of the chain of calculations gives a guaranteed correct solution of the problem only if the  $1 + \Phi r$  processors work in the parallel stage. The final result uses data only from  $r+1$  the processor. Therefore, the efficiency factor of CPU usage is not higher  $\eta \leq (r+1)/(\Phi r + 1)$ . As a commutative and associative algebra, one can consider the addition or multiplication algebras with respect to a finite modulus  $[0; \dots; K | +(\text{mod } K + 1)]$  or  $[0; \dots; K | \square(\text{mod } K + 1)]$ . The calculations are greatly simplified if we take the number 10 as the module, which means  $K = 9$ . Then you can perform the usual addition and multiplication of single-valued numbers and at the same time discard all the digit of the result, except for the younger ones. If the chain contains operations, both addition and multiplication, you can not to transpose and to commute the operands. Such an algebra can be written in the form  $[+0; \dots; +K; \square 0; \dots \square K | *(\text{mod } K + 1)]$ . It is nonassociative. In practice, it is convenient to consider an algebra  $[+0; \dots; +9; \square 0; \dots \square 9 | *(\text{mod } 10)]$ . When the test problem is presented, the sign of the internal operation of the algebra ( $*$ ) can be omitted, since the element of the algebra itself bears the sign of the required

arithmetic operation. The result stores the operation prefix of the first left operand. Examples show the lack of commutativity and associativity:

$$+5 \square 7 = +5; \square 7 + 5 = \square 2;$$

$$(+7 \square 8) + 3 = +6 + 3 = +9; +7 * (\square 8 + 3) = +7 \square 1 = +7.$$

The subject needs to be explained that the "school" order of actions in this record does not work, and the expression must be calculated from left to right (Polish operations record). Note that tasks in which all operands have the same prefix of an arithmetic operation allow effective parallelization of the count. The use of one algebra in both tests is useful from the point of view of engineering psychology, since the subject's work is checked on the same operations, both in the parallel and in the sequential case.

## 6 Conclusio

We have shown that the theory of formal automata and universal algebras allow to build tasks with high and low efficacy of parallel computing. Parallel computing is effective for expression evaluation in associative algebras, and also for calculation of States of automata with a homogeneous structure. If these conditions are violated, the corresponding tasks require the sequential algorithm. There are tasks of both classes, which are convenient for human decision. So this unit can be used for test construction, identifying the strategy of human adaptation to the growth of the computational complexity of the task. Parallel computing is logged if an individual's performance grows only on the tasks with efficient parallelism.

## Reference

1. Koganov A. V. "The growing inductor spaces and the analysis of the parallel algorithms", The programming products and systems, the application to the international journal "The problems of the theory and practicum of the control", N 2, 2010, s. 33-38.
2. Koganov A. V., Zlobin A. I., Rakcheeva T. A. "The research of the possibility of the parallel processing of the information by man in the series of the tasks of the high complexity". // "The Computer research and modeling". 2013, t. 5, N 5; The Computer Research Institute (UGU), The Machine research institute at RAN in the name of A.A.Blagonravov, s. 845-861.
3. Koganov A. V., Zlobin A. I., Rakcheeva T. A. "The task of the calculation of the trajectory with homogenous the distribution of solutions". // "The Computer research and modeling". 2014, t. 6, N 5; The Computer Research Institute (UGU), The Machine research institute at RAN in the name of A.A.Blagonravov, s. 803-828.
4. George Popov, Nikos Mastorakis, Valeri Mladenov. Calculation of the acceleration of parallel programs as a function of the number of threads. <https://www.researchgate.net/publication/228569958> Article January 2010.

5. N. Chabbah Sekma, A. Elleuch, N. Dridi, "Automated Forecasting Approach Minimizing Prediction Errors of CPU Availability in Distributed Computing Systems", *International Journal of Intelligent Systems and Applications(IJISA)*, Vol.8, No.9, pp.8-21, 2016. DOI: 10.5815/ijisa.2016.09.02
6. N. Chabbah Sekma, A. Elleuch, N. Dridi, "Automated Forecasting Approach Minimizing Prediction Errors of CPU Availability in Distributed Computing Systems", *International Journal of Intelligent Systems and Applications(IJISA)*, Vol.8, No.9, pp.8-21, 2016. DOI: 10.5815/ijisa.2016.09.02
7. "Efficient multitasking: parallel versus serial processing of multiple tasks" (Rico Fischer and Franziska Plessow, *Front Psychol.* 2015; 6: 1366, doi: 10.3389/fpsyg.2015.01366)

# Control Strategy of Energy Storage for Frequency Coordination Dispatch Based on Improved Niche Genetic Algorithm

Daojun Chen<sup>1</sup>, Nianguang Zhou<sup>2</sup>, Cui Ting<sup>1</sup>, Chenkun Li<sup>1</sup>, Hu Guo<sup>1</sup>, Lei Zhang<sup>3</sup>, Xunting Wang<sup>4</sup>

<sup>1</sup>State Grid Hunan Electric Power Corporation Research Institute, Changsha 410007, China;

<sup>2</sup>State Grid Hunan Electric Power Corporation, Changsha 410014, China;

<sup>3</sup>Hunan Xiangdian Test and Research Institute Company Limited, Changsha 410007, China

<sup>4</sup>School of Electrical Engineering, Wuhan University, Wuhan 430072, China

**Abstract**—In order to reduce the operating cost of power frequency control, a control strategy based on energy storage optimization is presented. The aim of the control strategy is maximizes the use of power provided by new energy power supply and reduces the electric energy from real-time power grid; the operation cost is effectively reduced without influences on the power life by reasonable charge and discharge strategy of energy storage, by the improved niche genetic algorithm based on fuzzy clustering, a hour level of scheduling plan is given by this case. Based on the uncertainty on the energy demand and supply, the optimal value of the direct purchase of the frequency control is determined. The computation results show that under the same condition of system framework, load and operating environment, through reasonable and effective operation of the frequency control strategy, effectively reduce the operating costs of the system, has a high practical value.

**Keywords**—Frequency control; energy storage; improved niche genetic algorithm; operating cost.

## 1. Introduction

Recently, with the rapid development of the Internet industry, the energy consumption problem of data center becomes more and more serious. Illustrated by the example of Google, at an average utilization rate of energy efficiency reaching about 1.5, the energy consumption of millions of servers will be 260 MW [1,2]. In the distribution of data center's energy consumption, the energy supply of ENERGY STORAGE (Uninterrupted Power Supply) accounts for 10 to 15% of the total energy consumption.

Up to now, some studies have been conducted on how to reduce the operating cost of data center some progress have been made. [3] and [4] utilizes differences between the spot price and the prices of different regions to reduce the cost of data center .In

[5], considering how to make use of ENERGY STORAGE in data centers to shave off the peak power demands, a revenue maximization model is established and solved based on genetic algorithm by combining with linear programming.

In this paper, in order to reach the electricity command of data center while minimizing costs, we can consider provide different pricing schemes for electricity can be considered on the basis of different electricity purchasing schemes [6,8]. While regarding the direct power purchase from the local power plants as the main power of data center, electricity purchased by real-time price from the local power grid is considered as a supplement. As part of the remote grid and renewable energy supply would have surplus electricity from wind and light power, so data centers can get power at a lower price than the real-time market [7].

Since the power consumption for each task in data center is different, so the power demand of data center changes with the change of time and differences of task; The spot power price of local grid is fluctuating in terms of power supply, and the electric quantity from renewable energy is not a constant value. In this case, there is plenty of uncertainty on the energy demand and supply, which means it is necessary to determines the optimal value of direct power purchased by data center and the charge-discharge strategy of ENERGY STORAGE under the premise of maximizing the use of power provided by new energy power supply and reducing the electric energy from real-time power grid, in order to reduce the cost of data center without influencing the lifetime of ENERGY STORAGE.

With the purpose of determining the amount of the direct purchase power and the ENERGY STORAGE active control strategy in data center, this paper uses improved niche genetic algorithm based on fuzzy clustering to work on it, and verifies the result solved by the algorithm to ascertain its usefulness and effectiveness..

## 2. Data Center Power System

The requirements of data center for power supply and distribution system are continuity, stability, balance and classification [9-13]. Therefore, data centers are generally designed according to the Tier 4 level. It means redundant power links and power system are existed and all loads are powered by dual power supply with independent distribution channels. Figure 1 shows a typical power supply system architecture of data center [14].

In a typical planning cycle, the installed capacity and the design capacity are equal in the data center, in other words, the data center from the outset fully completed, therefore, a waste of capital and operating costs are very large [15].

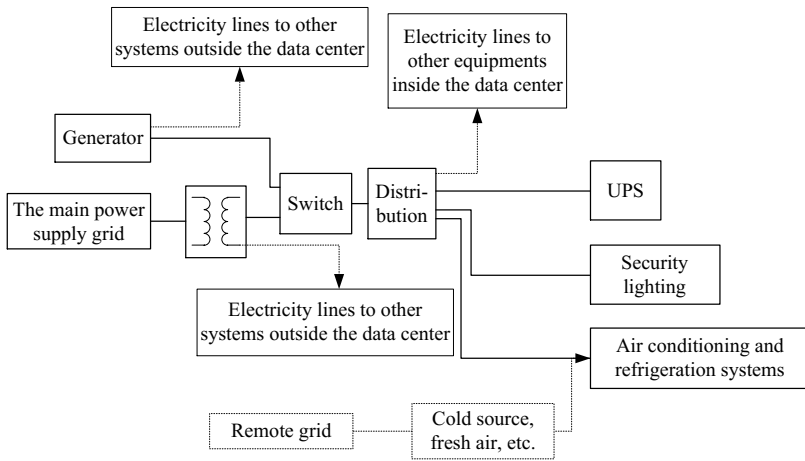

**Fig. 1. A typical data center power supply system architecture**

A ENERGY STORAGE(N+1,100kW) consists of three 50KW modules, 33% of additional capacity which is used as a backup at first. If the work load is 70KW, actually it is occupy 47% overall. In Tier4 design standard, capacity size problem is more serious. When the ENERGY STORAGE is a dual system, it means workload is 35kW each ENERGY STORAGE , only 35% of the rated power.

The capacity of the data center is shown in Table I.

**Table 1.** The Capacity of the Data Center

<i>Operating status</i>	<i>Types</i>	<i>Operating status</i>	<i>Types</i>
Using	Effective capacity	Available	Spare capacity
Stand-by	Idle capacity	Banned	Safety margin
Unavailable	Stranded capacity	-	-

According to estimates, if the capacity is properly managed in the case of using the same power supply and cooling capacity conditions, can reduce data center costs by 40% capacity of ENERGY STORAGE charging and discharging behavior.

### 3. Data Center Control Strategy Optimization

The notations and their meanings in the model are presented in the Table II.

**Table 2.** Notations and their meanings

<i>Notation</i>	<i>Meaning</i>	<i>Notation</i>	<i>Meaning</i>
$D(t)$	Power demand	$E_{pv}(t)$	Energy provided by pv
$P_{net}(t)$	Power exchange between Data center and the local power grid	$p_l(t)$	Unit price of electricity from direct power purchase
$E_{net}(t)$	Energy from local power grid	$p_{net}(t)$	Unit price of electricity in real time market
$P_l(t)$	Power provided by direct purchase of electricity	$p_s(t)$	Unit price of electricity from renewable energy
$E_l(t)$	Energy provided by direct purchase of electricity	$P_{grid}$	Maximum capacity of local grid
$P_{wind}(t)$	Power provided by wind power	$E_u(t)$	ENERGY STORAGE energy storage
$E_{wind}(t)$	Energy provided by wind power	$P_o(t)$	ENERGY STORAGE charge and discharge power
$P_{pv}(t)$	Power provided by pv		

Data Center ENERGY STORAGE control strategy optimization based on the local power grid real-time pricing curve and its own forecast load curves, combined with wind farms and photovoltaic plant power prediction, taking into account the running cost of ENERGY STORAGE, get the data center ENERGY STORAGE optimal control strategy (Planned output curve), get the aim to reduce data center capacity needs of the local power grid, improve the level of acceptance for renewable energy sources to reduce operating costs; At the same time, the strategy can reduce the cost by get the best purchase plan of direct power purchase, to achieve the overall maximization of social benefits.

#### A. Objective function

Data center operating costs is the sum of direct power purchase contract purchase cost, the costs for purchasing electricity from the local grid, and renewable energy and the operational cost of the ENERGY STORAGE.

$$\text{Cost of data center}_{\text{operational}}(t) = P_l(t)p_l(t) + P_{net}(t)p_{net}(t) + P_{wind}(t)p_s(t) + P_{pv}(t)p_s(t) + C_u \quad (1)$$

$$\min \text{ Cost of data center} \cong$$

$$\sum_0^t \text{ Cost of data center}_{\text{operational}}(t), \quad (2)$$

$$\forall t : \text{Constraints (5)(9)(10)(11)(12)}$$

In the above equation, Cost of data center<sub>operational</sub>( $t$ ) is total operating costs for per operation cycle;  $C_u$  is the operational cost of the ENERGY STORAGE;  $p_{net}(t)$  is unit price of electricity in real time market, its function is expressed as piecewise:

$$p_{net}(t) = \begin{cases} p_b(t), P_{net}(t) > 0 \\ p_s(t), P_{net}(t) < 0 \end{cases} \quad (3)$$

### B. Constraints

The constraint conditions of objective function (2) include:

- Power balance constraint

If the renewable energy power or direct power purchase cost less than the real-time electricity market, the data center should as much as possible purchase energy from renewable energy supply and use electricity of direct power purchase. When renewable energy and electricity of direct power purchase supply more than the demand for data center, excess electric energy should be charge for ENERGY STORAGE.

$$P_l(t) + P_{net}(t) + P_{wind}(t) + P_{pv}(t) \leq D(t) \quad (4)$$

In the above equation, when renewable energy and electricity of direct power purchase supply less than the demand for data center, ENERGY STORAGE will discharge content the data center needs. If ENERGY STORAGE discharge still can not content the needs of the data center, data centers need to buy power  $E_{net}(t)$  from the real-time electricity market by price  $p_{net}(t)$ .

$$P_l(t) + P_{net}(t) + P_{wind}(t) + P_{pv}(t) + P_u(t) = D(t) \quad (5)$$

$$0 \leq P_l(t) + P_r(t) \leq P_{grid} \quad (6)$$

- Data Center Availability

$E_u(t)$  is the energy stored in the battery over  $t$  time window, it is direct contact with ENERGY STORAGE' charge and discharge efficiency. Over a period of time  $t$ , ENERGY STORAGE charging and discharging energy is:

$$E_u(t) = \int_0^T E_u(t) dt \quad (7)$$

At the end of the period  $T$  ENERGY STORAGE residual energy can be written as:



$$E_r(t) = E_{int}(t) + \sum_0^T E_u(i) \quad (8)$$

In the above equation,  $E_{int}$  is the Initial energy of ENERGY STORAGE.

ENERGY STORAGE needs to content the limits of its own storage energy:

$$E_u^{\min} \leq E_r(t) \leq E_u^{\max} \quad (9)$$

In the above equation,  $E_u^{\min}$  and  $E_u^{\max}$  is upper and lower limits of ENERGY STORAGE stored energy.

Meanwhile ENERGY STORAGE also need to content their own capacity constraints:

$$-P_u^{\max} \leq P_u(t) \leq P_u^{\max} \quad (10)$$

$P_u^{\max}$  is the capacity of ENERGY STORAGE.

- Reserve constraint

Taking into account any time data centers are likely to be disconnected from the power grid, to ensure uninterrupted operation of the data center, ENERGY STORAGE maximum output needs be greater than the important load of power demand:

$$P_u^{\max} + P_{wind}(t) + P_{pv}(t) \geq D(t) \quad (11)$$

At the same time, due to the limited storage energy of ENERGY STORAGE, in order to ensure the important load in time interval  $t$  uninterrupted, the maximum energy from ENERGY STORAGE is greater than the energy demand of the data center during the period:

$$E_r(k-1) + \int_0^t P_{pv}(t)dt + \int_0^t P_{wind}(t)dt \geq \int_0^t D(t)dt \quad (12)$$

- ENERGY STORAGE Lifetime

Assume that cost of ENERGY STORAGE  $C_r$  is same in both cases of charging and discharging. If the purchase cost of a new ENERGY STORAGE is  $C_{purchase}$  that can sustain  $M_{cycles}$ , Which can be obtained for the cost  $C_r$  of a single charge and discharge cycles

$$C_r = \frac{C_{purchase}}{M_{cycles}} \quad (13)$$

If the life of ENERGY STORAGE is defined as  $Life$ , than the maximum number of times the batteries of the ENERGY STORAGE are allowed to charge and discharge over a longer period and  $t \in kT$ , will be

$$N \max = \frac{M_{cycles} * kT}{Life} \quad (14)$$

- Solving method

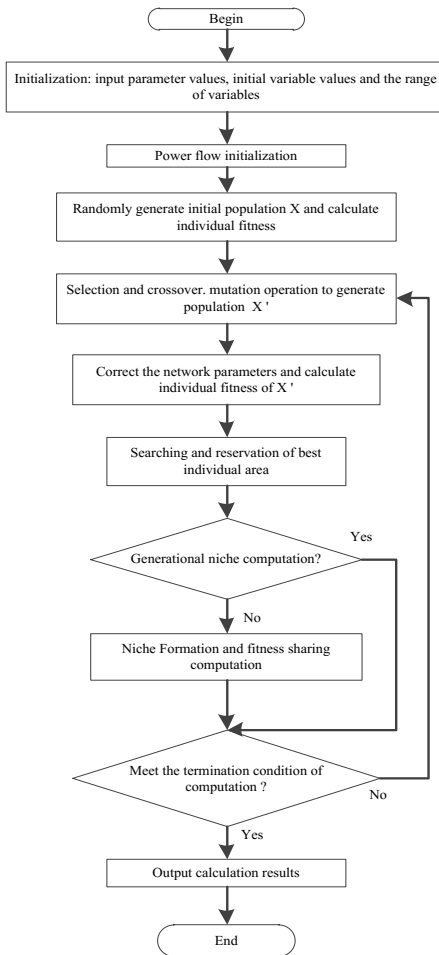

**Fig. 2.** Flow chart to solve the problem of stochastic optimization based on INGA

equation (2) to equation (14) constitute a data center ENERGY STORAGE control strategy model based on cost economic dispatch, In this paper, this problem is solved by the improved niche algorithm based on fuzzy clustering. The steps are shown in Figure 2.

## 4. Case Study

### A. Description of the original data

Based on the actual conditions of a data center, this paper adopts the above-mentioned method to determine the charge and discharge strategy. The maximum load of the data center is 1592kW and the daily load forecasting curve is shown in Figure 3. The ENERGY STORAGE with capacity of 4000kW can be recycled of charge and discharge for 6000 times and its purchase cost is 960000 dollars. The price of direct power purchase is 0.15\$/kWh and the price of electricity when ENERGY STORAGE transmits power to the grid is half of the real-time price. The daily forecasting curves of PV and wind power are shown in Figure 4 and Figure 5, respectively.

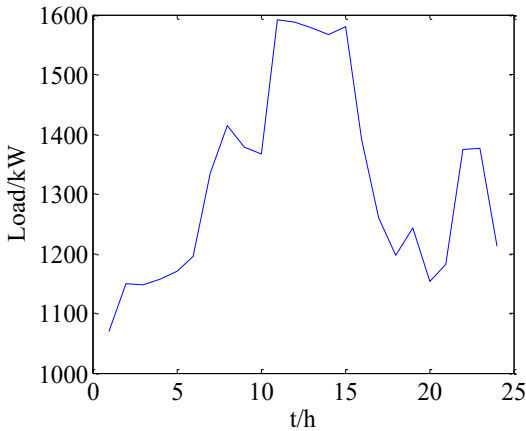

**Fig. 3.** Daily load forecasting

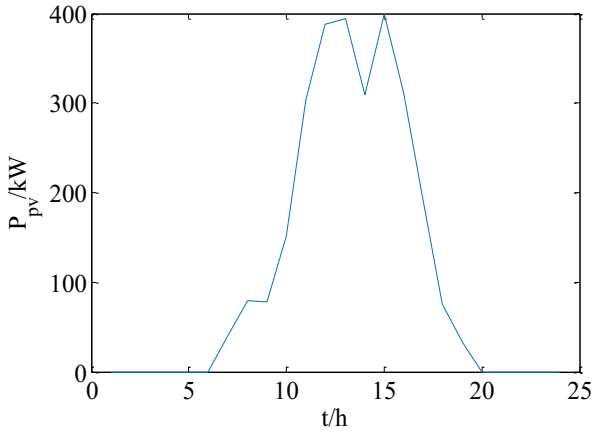

Fig.4. Daily PV forecasting curve

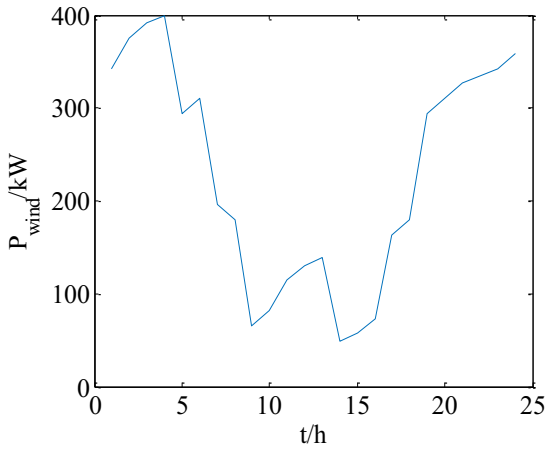

Fig.5. Daily wind power forecasting curve

The capacity, initial energy and the upper and lower limit of the stored energy which is the disposable size, are listed in Table III.

Table 3. Characteristic parameters of ENERGY STORAGE

$E_{int} /kW$	$E_u^{min} /kW$	$E_u^{max} /kW$	$P_o(t) /kWh$
3200	2400	4000	800

TOU is adopted for the electricity price of distribution network purchasing from higher grid, as shown in the following table IV[16].

**Table 4.** Electricity price of distribution network purchasing from higher grid

<i>Time</i>	<i>Price/[\$ • (kW·h)-1]</i>
9:00~12:00,18:00~22:00	0.071
13:00~17:00	0.062
23:00~8:00	0.052

The electricity price that the distribution network sells to users is according to real-time pricing. Based on the data provided by local power supply bureau, the curve of electricity price is shown in Figure 6.

*B. Calculation results and analysis*

The operation program of IDC based on cost control is solved by the DE algorithm in three scenes. Scene 1: ENERGY STORAGE is only used as a backup power supply; scene 2: ENERGY STORAGE can be charged and discharged but has no access to new energy power;

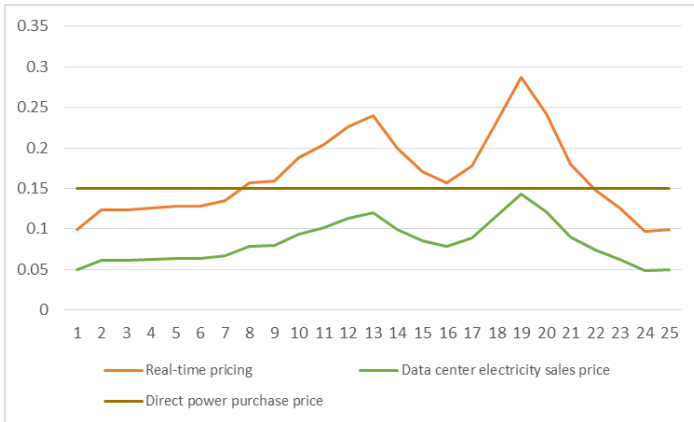

**Fig. 6.** Spot price of distribution network

scene 3: ENERGY STORAGE can not only be charged and discharged, but also has access to new energy power. The total operating cost, daily operating cost of ENERGY STORAGE and optimal program of direct power purchase is shown in the following table V.

*C. Calculation results and analysis*

The operation program of IDC based on cost control is solved by the DE algorithm in three scenes. Scene 1: ENERGY STORAGE is only used as a backup

power supply; scene 2: ENERGY STORAGE can be charged and discharged but has no access to new energy power; scene 3: ENERGY STORAGE can not only be charged and discharged, but also has access to new energy power. The total operating cost, daily operating cost of ENERGY STORAGE and optimal program of direct power purchase is shown in the following table V.

**Table 5.** Economic Operation Analysis

	<i>Operating costs</i>	<i>ENERGY STORAGE Daily operating costs/\$</i>	<i>Best Direct Power Purchase plan /kW</i>
Scene 1	5466.7	---	---
Scene 2	4698.3	63.41	1251.7
Scene 3	3437.1	60.01	848.11

The calculation results of scene 2 and scene 3 the charge and discharge power  $P_o$  of ENERGY STORAGE, the residual energy  $E_r$  of ENERGY STORAGE in each time period and the real-time exchange power  $P_{net}$  between the data center and the local power grid, which are shown in Figure 7. Figure 8 shows the convergence of the algorithm.

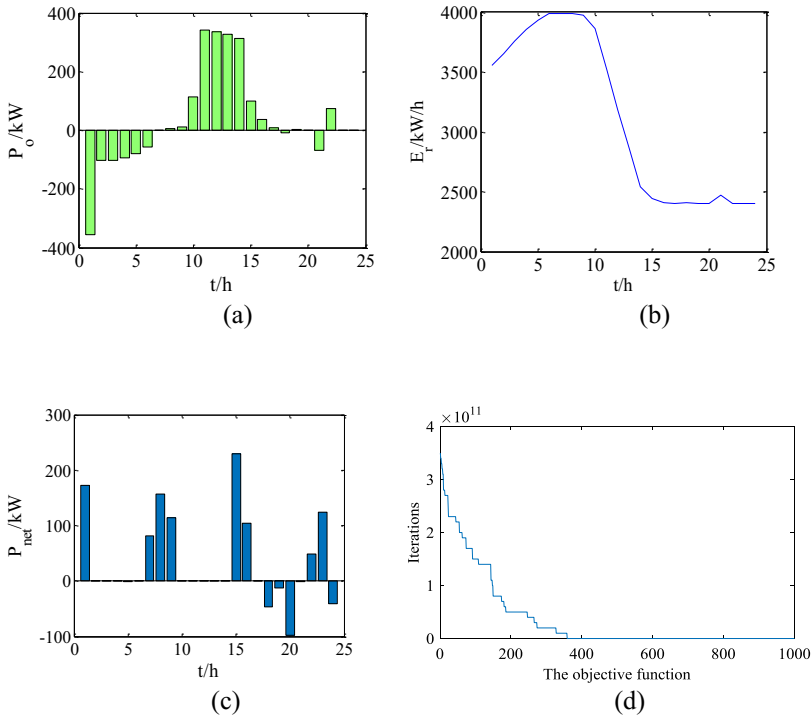

**Fig. 7.** Scene 2

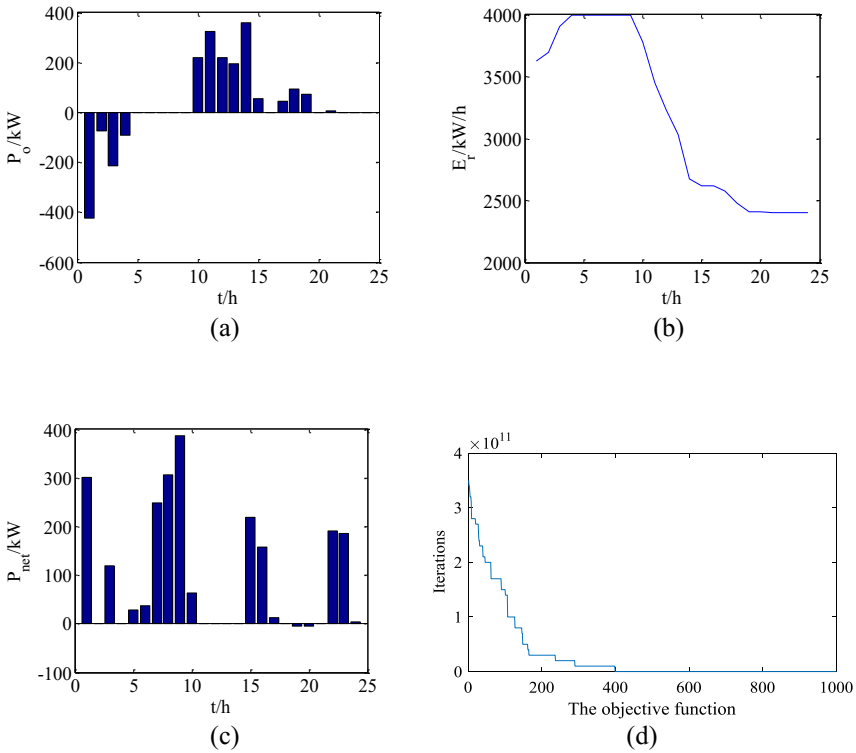

**Fig. 8.** Scene 2

It can be observed from the first two pictures of Figure 7 and Figure 8 that ENERGY STORAGE reaches the upper limit of the stored energy by charging in the first 6 hours with relatively low load. During the period of 10-15 with heavy load of the data center and high real-time electricity price, ENERGY STORAGE discharges to the power grid. During these two operating period, ENERGY STORAGE functions as peak load shifting.

During the time from 15 to 20, the load is heavy and the spot price is in the peak period, which makes the price of direct power purchase from the data center and the selling price of electricity is almost the same. Therefore, ENERGY STORAGE of the data center will transmit the previously stored power to the local power grid for arbitrage to reduce its cost in scene 2, as shown in Figure 8 (c). However, due to the low cost of new energy, the data center relies on direct power purchase and ENERGY STORAGE to maintain its operation, without purchasing electricity from power grid.

In the period of 15 to 20 with small load and low price of electricity, the data center charges and maintains its operation by direct power purchase and the local power grid.

## 5. Conclusions

This paper establishes an optimization model of control strategy of ENERGY STORAGE in data center with consideration of economic dispatch and solves the problem by the improved niche genetic algorithm based on fuzzy clustering.

The computation results show that under the premise of predictable data center load, the proposed control strategy determines the optimal value of direct power purchased by data center according to the fluctuations of real-time electricity price in local power grid, which maximizes the use of power provided by new energy power supply and reduces the electric energy from real-time power grid; the operation cost is effectively reduced without influences on the power life by reasonable charge and discharge strategy of ENERGY STORAGE. Under the same condition of system framework, load and operating environment, the operating cost of the system reduces by 40% and maintains a high level of safety and reliability through reasonable operation of ENERGY STORAGE, which reflects its good practical value.

## References

1. A. Qureshi, R. Weber, H. Balakrishnan, J. Gutttag, and B. Maggs. "Cutting the electricity bill for Internet-scale systems." *ACM SIGCOMM Computer Communication Review*, Vol. 39, No.4,2009, pp.123-134.
2. YUE Yu . Green Technology of Data Center and Its Development [J]. *ZTE Technology Journal*, 2015, 21(5): 45-49.
3. N. Buchbinder, N. Jain, and I. Menache. "Online job-migration for reducing the electricity bill in the cloud." In *NETWORKING*, Springer, 2011, pp. 172–185.
4. L. Rao, Lei, X. Liu, M. D. Ilic, and Jie Liu, "Distributed coordination of internet data centers under multiregional electricity markets." *Proceedings of the IEEE*, Vol. 100, No. 1,2012 pp. 269–282.
5. Leou Rong-Ceng. An economic analysis model for the energy storage systems in a deregulated market[C]//*IEEE International Conference on Sustainable Energy Technologies*. Singapore, 2008 : 744-749,
6. M. He, S. Murugesan, and J. Zhang, "Multiple timescale dispatch and scheduling for stochastic reliability in smart grids with wind generation integration," In *INFOCOM*, 2011 *Proceedings IEEE*, 2011, pp. 461–465.
7. A. Qureshi, "Power-demand routing in massive geo-distributed systems," PhD diss., Massachusetts Institute of Technology,2010.
8. J. A. P. Lopes, F. J. Soares, P. M. Almeida, and M. Moreira da Silva, "Smart charging strategies for electric vehicles: Enhancing grid performance and maximizing the use of variable renewable energy resources," In *EVS24 Intenational Battery, Hybrid and Fuell Cell Electric Vehicle Symposium*, Stavanger, Norveška. 2009.
9. ZHENG Yuan-yuan. Load Calculation and Analysis of the Data Center for Power Distribution System [J]. *Telecom Power Technologies*, 2015, 32(6): 135-138.
10. Saeid Soudi,"Distribution System Planning With Distributed Generations Considering Benefits and Costs", *International Journal of Modern Education and*



- Computer Science(IJMECS), vol.5, no.9, pp.45-52, 2013.DOI: 10.5815/ijmeecs.2013.09.07
11. Nashaat el-Khameesy, Hossam Abdel Rahman Mohamed,"A Proposed Model for Datacenter in -Depth Defense to Enhance Continual Security(Applied Study to ENR Datacenter – Egyptian National Railways)", International Journal of Information Technology and Computer Science(IJITCS), vol.5, no.4, pp.55-67, 2013.DOI: 10.5815/ijitcs.2013.04.07
  12. Rafiqul Z. Khan, Md F. Ali,"An Efficient Diffusion Load Balancing Algorithm in Distributed System", International Journal of Information Technology and Computer Science(IJITCS), vol.6, no.8, pp.65-71, 2014. DOI: 10.5815/ijitcs.2014.08.09
  13. Danial Rahdari, Amir Masoud Rahmani, Niusha Aboutalebey, Ali Sheidaei Karambasti,"A Distributed Fault Tolerance Global Coordinator Election Algorithm in Unreliable High Traffic Distributed Systems", International Journal of Information Technology and Computer Science(IJITCS), vol.7, no.3, pp.1-11, 2015. DOI: 10.5815/ijitcs.2015.03.01
  14. QIU Yikan. Electrical Power Supply and Distribution System Design of Data Center [J]. Moder Architecture Electric, 2015, 6(10): 6-10.
  15. SHUAI Zhikang,. Review on Transient Stability of Microgrid [J]. Automation of Electric Power Systems,2015,(16): 151-159.
  16. LIU Fang , LI Bing , ZHANG Fan . Battery energy storage systemoptimal allocation considering economy and reliability of distribution network [J] . Electric Power Construction, 2015, 36 (12) : 76-83.

# Architecture and Method of Integrating Information and Knowledge on the Basis of the Ontological Structure

Yury Kravchenko<sup>1</sup>, Ilona Kursityś<sup>1</sup>, Daniil Kravchenko<sup>1</sup>

<sup>1</sup>Southern Federal University, Rostov-on-Don, Russia  
yakravchenko@sfedu.ru

**Abstract.** The article considers the problem of information and knowledge integration and representation, which is related to a set of following sub-problems: the development of knowledge bases containing decision support rules and precedents; the development of object, ontological, fuzzy, semantic and analytical models to implement decision support processes; the development of modules to select models and to build decisions with the use of knowledge bases; the development of mathematical and simulation models. System analysis methodology states that automated decision of non-structured problems requires reducing them to structured problems by an expert. The research aims to develop universal models of intelligent accumulation and integration of knowledge while formalizing search semantics and decision support. In that context, architectures and methods used to reduce non-structured problems to structured ones are of a great interest. Let us state, that formalization of knowledge structuring processes is required to conduct system analysis of non-structured problems of accumulation and integration of knowledge from distributed heterogeneous sources. This problem is considered as classic artificial intelligence problem involving analysis of multi-disciplinary connections of different subject areas, on the basis of researching the model of semantic relations between knowledge elements. In creating intelligent systems of knowledge management, integration of simulation modeling, theory of agents and ontology building can establish the basis for such systems self-organization and effectiveness.

**Keywords:** Semantic models; knowledge search and processing; simulation models; decision support; information integration.

## 1 Introduction

The suggested research is based on the hypothesis, that developing models mentioned in the abstract allows adaptation of studied information flows in accordance with changing external conditions and integration of heterogeneous subject areas in terms of knowledge management problems shared solving in real time. The real environment for knowledge management problems solving is represented as a difficult-to-formalize aggregate of interconnected subject areas, where non-structured problems of knowledge elements reveal and identification appear and become updated. Such

real environment is characterized by following properties: partial observability, dynamics, continuity, episodic character, and stochastic behavior. Building the environment model, suitable for interpretation and effective processing of distributed heterogeneous sources of knowledge, is claimed to be the relevant scientific problem [1-3].

Partial observability of the environment for knowledge management problems solving is conditioned by the fact, that an autonomous agent can obtain only a few of spatial limits, determined by search depth and neighborhood rate of researched multidisciplinary connections. This is often the small part of the environment, characterized by essential incompleteness of information about relations on set of knowledge elements [4-5].

The authors propose to implement knowledge conversion to the data storage on the basis of ontological structures to provide decision support with the use of bioinspired search and semantic knowledge aggregation. In spite of subject area specific character, the ontology should be developed as a sequence of interrelated accumulation and processing operations applied for knowledge from distributed sources providing the integrated character of knowledge management systems. Let us consider knowledge accumulation as a transfer process of knowledge from heterogeneous sources into the data storage with the use of different methods, models, algorithms and tools. Any intelligent information system must be able to verify and improve available knowledge base, thus, to have tools of available formalized knowledge analysis, usage and storage. The purpose of analysis is to provide knowledge evolution.

## **2 The Ontology Building Process**

Regardless of subject areas specific character, the ontology should be built as a sequence of interrelated accumulation and processing operations applied for knowledge from distributed sources providing the integrated character of knowledge management systems. At the stage of knowledge areas identification, the first step is to determine a set of studied characteristics (Fig.1). The second is to select aprior information sources and to form knowledge bases and data storages, allowing assigning relations between knowledge categories. Knowledge bases from online information systems are the most appropriate to apply as knowledge sources using the mechanism of information storage development. The systems of electronic and non-electronic document archives with either centralized or non-centralized management system are connected in the same way. Knowledge from different sources can be integrated on the basis of the ontology, which building requirements are stored in previously formed specifications.

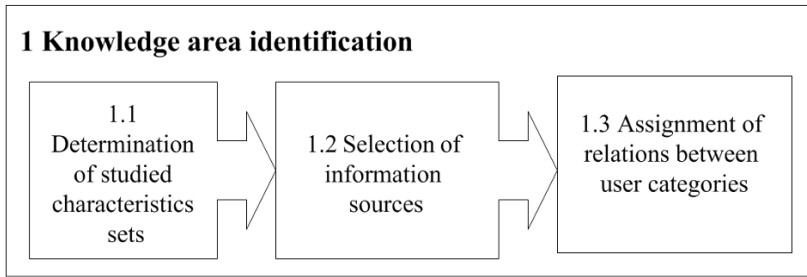
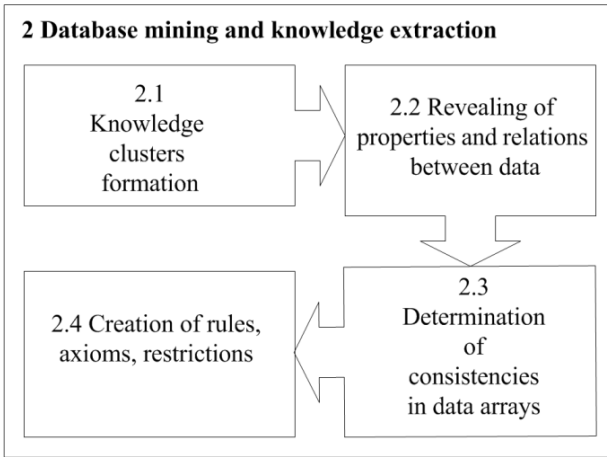

**Fig. 1.** The stage of knowledge area identification

To develop the precedent base, a set of typical information flows, for which precedents are selected, is to be determined. To formalize specialists' (experts or tutors) knowledge, it is necessary to create knowledge maps representing the degree of knowledge ownership by different categories of users. At the stage of aprior information mining and knowledge extraction, knowledge clustering is performed on the basis of data mining methods. Knowledge clustering is required to reveal properties and relations between different information units, allowing revealing consistencies in data arrays and creating new rules, axioms and restrictions (Fig.2).

This stage provides knowledge conceptualization in the form of precise descriptions in ontologies allowing the system to have the following opportunities:

- Intellectuality, to overcome ambiguity using implicit assumptions formalization. Conceptualization in ontologies is implemented on the basis of semantic relations, which form axioms, rules and restrictions.
- Specification of knowledge functional components in the form of shared dictionary.
- Knowledge distribution between different categories of system users.
- Knowledge systematization with the use of heterogeneous sources integration on the basis of multidimensional taxonomy represented in the shared dictionary.
- Meta-model functionality, when the ontology contains required concepts, relations and restrictions to build mathematical or simulation model of the problem solution with the use of system modules connected to these concepts (Fig.3);
- Generalization of knowledge area concepts, which helps us to create a content theory on the basis of the existing ontology [4-8].



**Fig. 2.** The stage of database mining and knowledge extraction

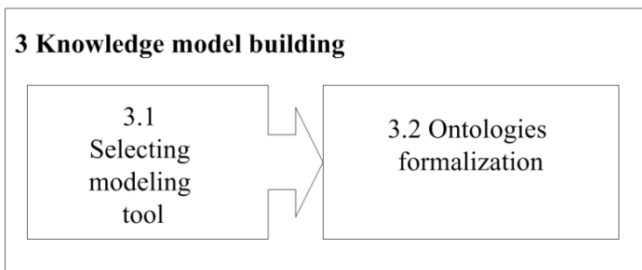

**Fig. 3.** The stage of knowledge models building

In terms of the research, the most convenient model of distributed ontological structure is a tuple  $O = \langle T, A \rangle$ , where  $O$  denotes an ontology;  $T$  denotes a taxonomy of input terms (concepts) of the ontology and a set of relations determined in the taxonomy;  $A$  denotes a set of axioms, rules and restrictions based on  $T$  [9-11].

Considering the ontology requirements we can divide them into common requirements and development requirements. Common requirements include:

- explicitness, to convey the concepts meaning clearly;
- coherence, to provide logical consistency of definitions;
- integrability, to merge distributed ontological structures into a single unit with the use of import relation. The import relation can be represented as a directed graph model  $I = \langle O, D \rangle$ , where  $O$  denotes ontologies,  $D$  denotes directed arcs starting from the imported ontology and coming into the importing one;

- minimal code affect, to represent the invariance to knowledge representation methods;
- minimal ontological obligations, to represent the essential assumptions about knowledge area only [10,12].

Ontology development requirements contain:

- additive development, based on the import relation to subdivide ontologies into basic and complementative ones. Thus, knowledge stored in the base ontology is expanded with knowledge from the complementative ontology without altering the original data structure;
- integrative development, to import a set of system-consistent basic ontologies into a single integrating source;
- shared development, to import non-hierarchical ontologies, when each ontology is considered as both basic and complementative for other ones;
- complex development and ontologies restructuring, which means simultaneous multidirectional ontologies development to obtain a simplified ontological structure with more effective set of imports and no loops;
- the development of fuzzy ontologies - considering distributed ontological structures we meet the fuzzy import problem. Fuzzy import with the determined membership function can be revealed in the process of ontology structure analysis [9].

In knowledge ontological structure, it is required to represent paradigmatic concepts relations, independent of the problem context, and variable syntagmatic concepts relations, appearing in a context of the problem solution. Paradigmatic relations contains relations of synonymy, homonymy, polysemy, generalization, aggregation, etc., transforming a dictionary into a thesaurus [11-13]. Syntagmatic relations are represented as semantic restrictions, rules and axioms.

Let us consider the levels of ontological knowledge formation:

1. The meta-ontology of common categories, to control syntactical concepts and constructions of subject areas;
2. The subject area ontology, to determine a set of concepts required to solve intellectual problems independently of the solving method;
3. The problem ontology, to determine concepts describing the methods of converting the subject area objects, their essence, performance order and application rules in specific situations.

Ontology formalization is implemented with the use of semantic nets assigning relations on the set of knowledge objects. Relations represent the main building elements of the knowledge structure.

In terms of knowledge formation levels mentioned above, the distributed ontological structure has the form of  $O = \langle T_1, T_2, T_3, A \rangle$ , where  $T_1$  denotes a meta-ontology of knowledge management common concepts, such as 'object', 'attribute', 'value', 'rela

tion', etc.  $T_2$  denotes a subject area ontology of distinctive subject area concepts, structured in accordance with the hierarchy set for a given research object. The completed subject area ontology represents a component of knowledge base and includes the following concepts: 'current project', 'management flows', 'mechanisms', 'lifecycle phase', etc.  $T_3$  denotes a concept ontology that includes concepts from the management area and problems, models and methods of decision support ('problems', 'problem situation', 'decision', 'knowledge area', etc.) [9].

### **3 Architecture of Information and Knowledge Integration Based on the Ontological Structure**

The suggested ontological model composes the basis of intellectual decision support system knowledge base in the conditions of uncertainty, since information is often represented by heuristic descriptions of information processes, i.e. is given in a fuzzy and indefinite way in a form of linguistic variables. The knowledge base rules are developed with the use of logical deduction mechanism when the expert's logic is represented as fuzzy sets comparable with an action or an event.

Let us introduce a multi-level architecture of information and knowledge integration on the basis of ontological structure (Fig.4). Ontological structure is represented as a tool to support engineering and knowledge management processes. Sets of studied characteristics are determined by creating specific dictionary to describe subject area and a explicit assumptions related to suggested meanings of dictionary elements relations. In particular, subject area ontology determines a language to model the nature and the structure of search area in terms of primitive categories and relations between them. There are two types of approaches to such language: 1) informal approaches, assuming only definitions of terms without specification of their meaning, 2) formal approaches, i.e. logical languages given by strictly formalized axiomatic theories. The methodology introduced by suggested architecture sets functional boundaries of knowledge integration for application ontology building optimally. The procedure is iterative: each iteration results to the next level of ontological structure: dictionary, glossary, semantic net, axiomatic theory. In accordance with that, primary dictionary is extended with definitions, relations and formal axioms with the rigor level depending on requirements.

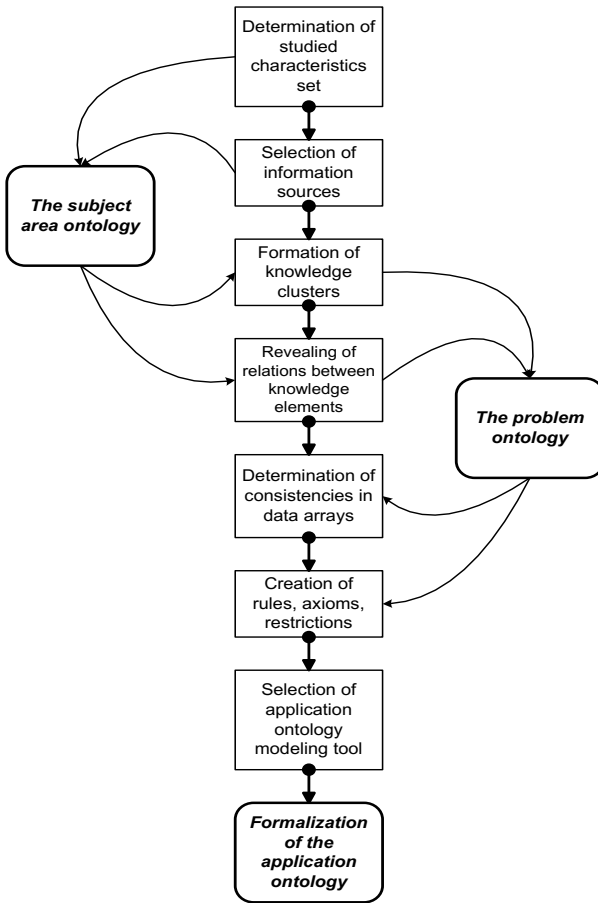

**Fig. 4.** The multi-level architecture of knowledge and information integration on the basis of the ontological structure

The architecture is developed to support information and knowledge integration in three directions:

- 1) subjects, defining targeted subject area included in designed information processes (subject area ontology);
- 2) functional aspects of researched problems, defining main regularities, rules, axioms and restrictions in data arrays (problem ontology);
- 3) properties (attributes) of researched objects of management (application ontology).



Let us introduce base conceptual categories of ontological structure building: active entities (actors), converting information processes; passive entities (objects) with their own properties (attributes) (Fig.5).

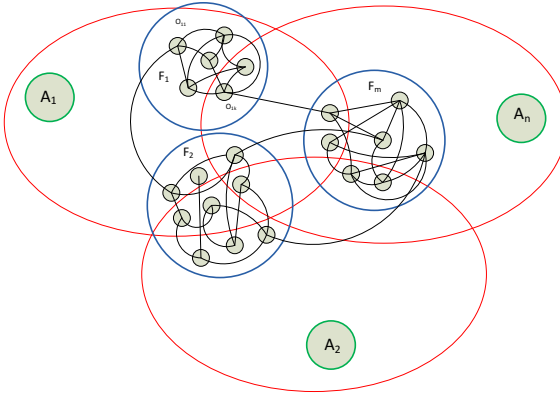

**Fig. 5.** Abstract multi-level ontological architecture of semantic relations between actors and functional areas together with passive entities (objects)

Thus, on the upper layer, concepts are divided into:

- actors - knowledge filters representing active elements (agents), creating the subject area based on multidisciplinary relations between different functional areas, able to activate, perform or control the information process;
- functional area, representing a certain information process composed of operations sequence in purpose to achieve the desired objective;
- objects, representing passive entities, which the information process works with; they have their own attributes (measured properties) and relations.

#### **4 Experimental Research of the Knowledge Integration Method on the Basis of Power Relaxation**

The method of information and knowledge integration in ontological structure is based on the power relaxation principle. In terms of abstract multi-level ontological architecture mentioned above, this method determines stable multidisciplinary relations. Let us introduce the concepts of multi-level neighborhood rate and multi-level search depth. The multi-level neighborhood rate denotes the local degree of relations between objects on the first level and between functional areas on the second one. The multi-level search depth denotes a possible number of objects on the first level and a possible number of functional areas on the second one in a sequence of semantic relations. Each relation in the sequence on the second level is weighted, and the weight coefficient takes the value equal to a number of relations between functional areas.

The method includes the following steps. Firstly, the structure element of the second (functional) level with the largest value of neighborhood rate is to be determined and taken as the "center of attraction" (if there are several of them, one is to be selected randomly). Then, depending on the purpose of integration, the search depth value of the second level is to be set. It is necessary to search other functional areas related to the "center of attraction", and the number of elements in the sequence cannot exceed the search depth value of the second level. In obtained subset of functional areas, the relations weights are to be determined. The maximum weight is selected as the objective value of selected subset. The researcher can introduce a variable, which value sets the acceptable deviation to the lower side from the objective value of weight. After functional areas are determined and included in the subset in accordance with the criterion of weight objective value considering acceptable deviation to the lower side, they are set as the areas to search stable multidisciplinary relations.

Inside selected functional areas, it is proposed to determine the first level structure element (an object) with the largest value of neighborhood rate and to take it as a "center of attraction" (if there are several of them, one is to be selected randomly). Then, depending on the purpose of knowledge integration, the value of the search depth of the first level is to be set.

Let us introduce the subject area formalized description in terms of the suggested method. A set of functional areas is denoted as  $F = \{F_1, F_2, F_3, \dots, F_z\}$ , where  $z = \overline{1, m}$ ,  $m$  is an integer constant (a number of functional areas), and  $F_z = \{O_{z1}, O_{z2}, O_{z3}, \dots, O_{zk_z}\}$ ,  $k_z$  is an integer constant (a number of objects (entities) in  $F_z$ ). If the relations between objects (entities) are set in terms of a single functional area, then  $\forall i, j \rightarrow i = \overline{1, k_z}; j = \overline{1, k_z}; i \neq j \exists C_z[i][j] = n$  where  $n$  is a number of relations between  $O_{zi}$  and  $O_{zj}$ ,  $z$  is an integer constant (an order number of the studied functional area). If all relations between objects (entities), including multidisciplinary ones, are assigned, then  $\forall a, b \rightarrow a = \overline{1, \sum_{z=1}^m k_z}; b = \overline{1, \sum_{z=1}^m k_z}; a \neq b \exists C_{interdisc}[a][b] = p$ , where  $p$  is a number of all relations between objects (entities) of multi-level ontological architecture, including multidisciplinary ones. Let us present a set of all objects (entities) of the architecture as follows:

$$O[d] = \{O_{z1}, O_{z2}, \dots, O_{zk_z}, O_{(z+1)1}, O_{(z+1)2}, \dots, O_{(z+1)k_{(z+1)}}, O_{(z+2)1}, O_{(z+2)2}, \dots, O_{(z+2)k_{(z+2)}}, \dots, O_{m1}, O_{m2}, \dots, O_{mk_m}\}$$

where

$$d = \sum_{z=1}^m k_z.$$

The results of subject area search are represented as a set of objects from different functional areas with stable multidisciplinary relations. Thus, the researcher obtains the formal knowledge integration procedure in the conditions of uncertainty.

## 5 Conclusion

The concrete scientific results of the research is composed of the multi-level architecture and the method of information and knowledge integration on the basis of onto

logical structure, which represent paradigmatic concepts relations, independent of the context of the solved problem, and variable syntagmatic concepts relations, appearing in a certain problem context. The authors developed software to build and experimentally research graph models of subject area ontographs, in order to estimate the efficiency of their usage in terms of solving the problem of revealing and analysis of new problematic situations on the basis of shared use of knowledge from heterogeneous sources.

## Acknowledgements

The study was performed by the grant from the Russian Science Foundation(project # 14-11-00242)in the Southern Federal University.

## References

1. Engels Rajangam, Chitra Annamalai,"Graph Models for Knowledge Representation and Reasoning for Contemporary and Emerging Needs – A Survey", International Journal of Information Technology and Computer Science(IJITCS), Vol.8, No.2, pp.14-22, 2016. DOI: 10.5815/ijitcs.2016.02.02
2. Lavendelis, E., Grundspenkis, J. MIPITS - An Agent based Intelligent Tutoring System // Proceedings of 2nd International Conference on Agents and Artificial Intelligence, 2010, pp. 5-13.
3. Bova V.V., Kravchenko Y.A., Kureichik V.V. Decision Support Systems for Knowledge Management. Software Engineering in Intelligent Systems. Proceedings of the 4th Computer Science On-line Conference 2015 (CSOC2015), Vol. 3. – Springer International Publishing AG Switzerland, 2015. – P.123-130.
4. Bova V.V., Kravchenko Y.A., Kureichik V.V. Development of Distributed Information Systems: Ontological Approach. Software Engineering in Intelligent Systems. Proceedings of the 4th Computer Science On-line Conference 2015 (CSOC2015), Vol. 3. – Springer International Publishing AG Switzerland, 2015. – P. 113-122.
5. Yu, M., Zhu, F.W. and Wang, P. (2016) Study on Knowledge Integration in Innovation Clustering Project. Open Journal of Social Sciences, 4, 177-186. <http://dx.doi.org/10.4236/jss.2016.411014>
6. Maleszka M., Mianowska B “A method for collaborative recommendation using knowledge integration tools and hierarchical structure of user profiles”, Knowledge-Based Systems, Volume 47, pp. 1-13, 2013.
7. Hernes M., Sobieska-Karpińska J. Knowledge integration in multi-agent decision support system for financial e-services // Proceedings of the Federated Conference on Computer Science and Information Systems, 2016, pp. 1283–1287
8. Amerland, D.: Google Semantic Search: Search Engine Optimization (SEO) Techniques That Gets Your Company More Traffic, Increases Brand Impact and Amplifies Your Online Presence. D.Amerland. Que Publishing, 2013. – 230 p.
9. Kravchenko Y.A., Kureichik V.V. Knowledge management based on multi-agent simulation in informational systems.Conference proceedings. 8th IEEE International Conference “Application of Information and Communication Technologies – AICT 2014”. – 15-17 October 2014, Astana, Kazakhstan. – P. 264-267.
10. Kerschberg, L., Jeong, H., Kim, W.: Emergent Semantic in Knowledge Sifter: An Evolutionary Search Agent based on Semantic Web Services. In: Spaccapietra, S.,

- Aberer, K., Cudre-Mauroux, P. (eds.) *Journal on Data Semantic VI. LNCS*, vol. 4090, pp. 187-209. Springer, Heidelberg (2006).
11. Kravchenko Yu.A. Synthesis of heterogeneous knowledge based on ontologies // *Izvestiya SFedU. Engineering Sciences*. – Taganrog: TTI SFEDU, 2012, № 11 (136). – P.216-221.
  12. Bova V.V., Leshchanov D.V., Kravchenko D.Yu., Novikov A.A. Computer ontology: problems and development methodology // *Informatics, computative technique and engineering education*. 2014. № 4 (19). P. 44-55.
  13. Bova V.V. Ontological model of data integration and knowledge in intelligent information systems // *Izvestiya SFedU. Engineering sciences*. 2015. № 4 (165). P. 225-237.

# A Novel Approach to Estimating Databases Maximum Updating Time

Baybulatov A.A.

Institute of Control Sciences of the Russian Academy of Sciences, Moscow, Russia

**Abstract.** Nowadays, a great variety of methods and models are available for software maintenance effort estimation. Each method or model provides desirable results for an appropriate type of software, maintenance technique, and estimated parameters. However, none of them is suitable for estimating databases updating time because of iterative nature of databases life cycle and routine technique for their updating. It is clear that Queueing theory is close to resolve this problem. Unfortunately, it does not meet the requirements of all kind of databases. In particular, it is not useful for critical infrastructure systems with high operational risk and for systems with indeterminate or “unknown” arrival jobs processes, which include nuclear power projects. The article revealed some weaknesses of Queueing theory when using it for nuclear power projects databases and proposed a novel approach based on Network calculus. An example of using the approach for a nuclear power plant instrumentation and control system database is also presented.

**Keywords:** Updating time, databases, Network calculus, Queueing theory, control systems, NPP.

## 1 Introduction

The problem of estimating databases updating time can be considered as a problem of software maintenance effort estimation, which in turn is a part of a larger problem of software development effort estimation [1] where the efforts mean timing budgets, human or financial resources. The first works in this field were made as early as in the 1960-ies [2], [3]. This problem is well known now [4]; lots of models and methods are in use. There are two major types of approaches [4]: expert and formal. Expert ones dominate [5]. Among formal, one can select parametric models [6], analogy-based methods [7], fuzzy logic modeling [8], and neural networks [9]. Methods based on some new ideas, for example, Grey Relational Analysis [10], are also being developed. The most elaborated and widely used formal models and methods are parametric ones. The most popular among them are Constructive Cost Models (COCOMO 81 and II) [11], [12]. In order to improve the estimation accuracy of parametric models some techniques can be used. For example, applications of neural networks to

COCOMO 81 and fuzzy logic technique to COCOMO II yield promising results [13], [14].

However, the majority of both expert and formal methods do not take into account the iterative nature of life cycle and focus on the “waterfall” model [15]. Some, more advanced methods work with iterations, but they are too complicated and need for special subtle calibration, e.g. with fuzzy logic [16], for a specific project. Studies show that both expert and formal methods have drawbacks [17], there is no “best” method, and the efficiency of methods depends on a specific problem and context [18].

As for database updating, it is usually considered as keeping database up to date by operations like adding, deleting, and editing its elements. Updating is not always fully automated and in some cases quite tedious and time-consuming. For systems with iterative life cycle updating corresponds to execution of similar processing operations repeatedly during arrival process. That is why one can assume that Queueing theory would be well suited for analyzing updating of such systems, namely calculating performance measures. Another possible way for solving this problem is using Network calculus. For the databases of nuclear power plant (NPP) instrumentation and control (I&C) systems Network calculus proved to be preferable.

## **2 The Network Calculus Advantages in Solving the Problem of Estimating NPP I&C Databases Maximum Updating Time**

Queueing theory has more than a century-long history [19], has been well-developed and operates with a variety of models from simple classic to sophisticated [20], [21]. It can be applied practically for any system containing a queue.

Network calculus is a relatively new branch of applied mathematics, which was introduced as an alternative to Queueing theory in the early 1990-ies [22] and some years later shifted towards min-plus algebra [23]. As its name implies, Network calculus was originally designed for solving problems encountered in communication networks; it has been successfully used in this field for about 20 years: a number of academic (e.g. Disco Deterministic Network Calculator [24]) and industrial (e.g. DelayLyzer [25]) tools based on Network calculus were developed. In recent years, some efforts have been made to adapt it for another application domain such as software maintenance, namely calculating software modification time [26].

In contrast to Queueing theory, which operates with probabilistic concepts, Network calculus works with bounds both at arrival processes and at service facilities, so, the results are automatically obtained as bounds. The major differences between Network calculus and Queueing theory are presented in Table 1.

**Table 1. Network calculus vs. Queuing theory.**

	<b>Queuing theory</b>	<b>Network calculus</b>
Arrival processes	Probability distributions	Deterministic bounds (envelopes)
Service facilities	Probability distributions	Deterministic bounds (service curves)
Results	Statistically mean values	Deterministic bounds (maximum, worst values)

Based on these differences let us explain the advantages of Network calculus in solving the problem of estimating NPP I&C databases maximum updating time.

If we consider results that both theories provide, we can find that Network calculus is preferable for two main reasons. Firstly, statistical concepts are difficult to use for any system because deterministic characteristics are needed for further calculations and plans. Secondly, for industrial critical infrastructure systems with high operational risk, which include NPP I&C, the worst predicted values are of special interest. When estimating timing budget, it is necessary to predict the maximum updating time but not the mean one.

Similarly, service facilities are more convenient to use if they are expressed in terms of bounds but not probability distributions.

If we consider arrival processes, we can find again that Network calculus is preferable. Deterministic bounds for arrival processes allow working with a wider class of jobs flows, and make the theory more tractable and intuitive.

Some real arrival process of a particular nuclear power project has been investigated. The comprehensive survey of jobs flows for updating I&C databases of Kudankulam NPP units 1 & 2 (India) was conducted [27]. It was revealed that the flows had the following characteristics: significant duration (more than 7 – 8 years), non-determinacy, non-ordinariness, not following normal or exponential distribution, the lack of correlation between packet size and time intervals between them, the lack of autocorrelation, non-homogeneity, non-stationarity, and a negative overall trend since the stage of commissioning.

The main conclusion drawn from the survey is that the flows were not Poisson; moreover, they might be referred to as indeterminate. Therefore, it is quite difficult to find a simple Queuing theory model for them and analyze it effectively. In this case, it would be better to consider the flows as “unknown” and carry out calculations not based on probability distributions [19]. It should be noted that a lot of complicated models are available [20], [21], but their use is not always justified.

### 3 The Problem of Estimating Databases Maximum Updating Time and a Novel Approach to its Solution

#### 3.1. Problem Definition

The problem of estimating databases updating time for systems with iterative life cycle can be set as follows. Arrival jobs for updating are flows. Database maintenance is iterative. One iteration corresponds to database updating cycle. After the cycle has been conducted, a functional database version is issued. It is necessary to estimate the time by which updating cycle can be conducted with the account of resulting queue. It is significant to note that it does not need to find the full time of database maintenance. The problem is to estimate the updating time, i.e. the time needed to get a workable (not final in the general case) database version.

For industrial critical infrastructure systems with high operational risk, which include NPPs, the problem should be set in a special way: the estimation of *maximum* updating time is of great importance. The reason, for example, for NPP I&C systems is as follows: since the updated NPP I&C database can be installed on technical means only during a unit outage period, the deadlines for the NPP I&C database updating can be strongly limited by scheduled-preventive maintenance or unscheduled outage.

For NPP I&C database the problem can be set as follows. Jobs flow for a certain period of the past is known. It is necessary to estimate the maximum time needed for database updating cycle to be conducted in the future. It is interesting to solve the problem for the operation stage.

#### 3.2. Network Calculus Background

Network calculus provides easy-to-use tools for calculating performance measures such as delay and backlog of queueing systems. The backlog is the amount of data held inside the system at some time. The delay is the stoppage that is experienced by data if all amount of data received before are served before. A system in Network calculus is considered as a black box taking (by arrival flow) and delivering (by departure flow) data. Arrival and departure flows are described by cumulative functions, i.e. the amount of data at the input and output observed at a certain time interval. These functions are always non-negative and wide-sense increasing. So, the delay and backlog at any time can be defined respectively as the horizontal and vertical deviations between them [23]. However, for practical calculations Network calculus uses bounds. As an arrival flow upper bound, the minimum arrival curve or empirical envelope [23]

$$E(t) = \sup_{\theta \geq 0} \{A(t + \theta) - A(\theta)\} \quad (1)$$



is used where  $A(t)$  is the arrival cumulative function.  $E(t)$  is also a non-negative and wide-sense increasing function. As a constraint for service facilities, a service curve, which is defined in an abstract manner and specifies the minimum guaranteed service, is used.

Network calculus states that the maximum values of the delay and the backlog (or the maximum updating time and the maximum queue length as for our problem) can be calculated using bounds not real cumulative functions [23]. However, for empirical envelope, Eq. (1), and arbitrary service curve these calculations turn out to be rather difficult. The calculations become simple and easy-to-use in the case of linear envelopes and linear service curves.

The most commonly used in Network calculus model of linear envelopes can be defined by the affine function [23]

$$E(t) = rt + b \quad (2)$$

where  $r$  is the arrival flow rate,  $b$  “burst”. In any particular case, it can be estimated according to a problem considered and expected results. In order to obtain the maximum values of delays and backlogs the straight line (2) must upper-bound the points of empirical envelope (1). However, for one particular empirical envelope many linear envelopes can be “drawn”, and it may be challenging to select needed one. The solution of an appropriate optimization problem proved to be a mathematically valid way for estimating linear envelopes from empirical ones [28].

The most popular model of linear service curves used in Network calculus can be defined by the rate-latency function [23]

$$S(t) = \begin{cases} R(t-T), & t > T \\ 0, & t \leq T \end{cases} \quad (3)$$

where  $R$  is the service rate,  $T$  service latency. Such service curves can be obtained experimentally.

It can be derived easily that in the case of linear envelopes and linear service curves, Eqs. (2) and (3), the maximum delay (updating time) and the maximum backlog (queue length) can be calculated using rather simple formulas [23]:

$$dl = \frac{b}{R} + T, \quad r \leq R, \quad (4)$$

$$bl = rT + b, \quad r \leq R. \quad (5)$$

### 3.3. Algorithm and Conditions of Applicability

For the problem of estimating databases maximum updating time to be solved with the help of Network calculus, it is required: an envelope and a service curve.

Thus, the algorithm of two independent branches can be used:

1. studying the arrival flow,
2. deriving a service curve.

The conditions of applicability of Network calculus, as follows from above, are obvious:

- the database life cycle must be iterative,
- the service rate must exceed the arrival flow rate.

As for arrival flow, it can be arbitrary.

The study of the arrival flow consists of two steps:

1. calculating an empirical envelope,
2. estimating a linear envelope from empirical one.

For calculating the empirical envelope, Eq. (1), data of arrival flow during some period in the past are used. In the case of non-stationary flow, the choice of this interval is important. The needed interval should contain all possible “bursts” and the flow rate on greater part of it must not exceed some constant value.

When estimating a linear envelope from empirical one, the optimization problem must be solved [28].

In order to derive a service curve one should experimentally analyze the dependencies between updating time and the amount of jobs for updating. It is necessary that the service curve should be of “rate-latency” type.

Finally, the numerical calculations are carried out according to Eqs. (4) and (5).

One of the important issues arising when solving this problem is the length of the interval for which the forecast is made. This interval should not be larger than the interval of calculating the envelope. After this interval has elapsed, recalculation of the envelope and appropriate maximum updating time can be made.

## 4 Using the Approach for NPP I&C Database

The approach proposed has been applied to the I&C database of Kudankulam NPP unit 1 (India). The estimation of database maximum updating time and corresponding queue length at the operation stage was conducted.

As mentioned above, the arrival flow was carefully investigated [27]. The mimic panel flow was considered for this problem. It was revealed that the flow consisted of random size packets arriving at random moments and did not follow exponential distribution. The flow was indeterminate but had a negative overall trend.

This flow is shown in Figure 1 where at the horizontal axis time in working days is depicted, at vertical packet size in mimic panels. Analyzing the drawing, one can assume that the first 150 working days is a sufficient interval for the envelope calculation.

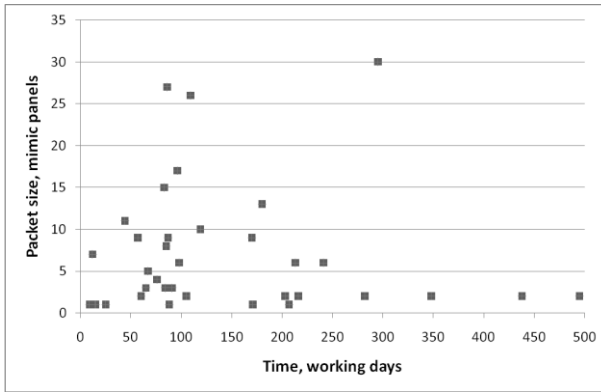

**Fig. 1.** The mimic panel flow at the operation stage (Kudankulam NPP unit 1, India).

The problem was solved as follows. Firstly, the arrival process was converted to a cumulative function, precisely sequence. Then, the empirical envelope was numerically calculated according to Eq. (1). After that, the linear envelope was estimated by solving optimization problem [28]:  $E=0,83t+89,8$ .

Figure 2 illustrates the calculation results: the arrival cumulative function, the empirical and linear envelopes. At the horizontal axis time in working days is depicted, at vertical number of mimic panels.

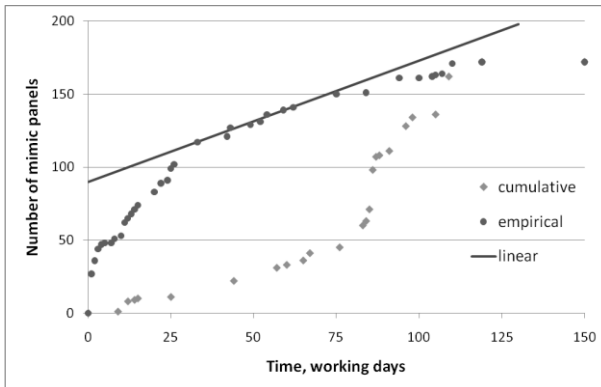

**Fig. 2.** The envelope calculation (cumulative – the cumulative function, empirical – the empirical envelope, linear – the linear envelope).

The service curve was obtained experimentally by analyzing the process of database updating [26]:  $S=33,39(t-0,12)$  if  $t > 0,12$ , and  $S=0$  if  $t \leq 0,12$ .

Thus, the maximum updating time and queue length calculated according to Eqs. (4) and (5) were  $dl = 2,8$  working days,  $bl = 89,9$  mimic panels.

The results obtained have shown good correspondence with practical experience on database updating. The real values of the maximum updating time and queue length have never exceeded the calculated ones.

## 5 Conclusion

Network calculus was originally created to study communication networks, but it can also be successfully used in other applications. Estimating databases updating time is one of the problems it turns out to be applied for. Furthermore, working with bounds at results shifts this problem to the problem of estimating databases maximum updating time, which is particular important for critical infrastructure systems with high operational risk. Bounds at arrival process allow working with arbitrary arrival processes, which suits for systems with indeterminate or “unknown” arrival flows. Therefore, working with bounds both at arrival processes and at results makes Network calculus perfectly suitable for a specific kind of systems. One of such systems is NPP I&C, for which the approach to estimating databases maximum updating time based on Network calculus has been successfully applied.

Future work can be directed towards extending the approach to processes with unavailable historical or empirical arrival data.

## References

1. Jørgensen, M.: What we do and don't know about software development effort estimation. *IEEE software* 31(2), pp. 37–40 (2014).
2. Farr, L., Nanus, B.: Factors that affect the cost of computer programming. Volume 1. – Technical Documentary Report No. ESD-TDR-64-448. Systems Development Corp. (1964).
3. Nelson, E.A.: Management Handbook for the Estimation of Computer Programming Costs. – Technical Documentary Report No. ESD-TR-67-66. Systems Development Corp. (1966).
4. Jørgensen, M., Shepperd, M.: A systematic review of software development cost estimation studies. *IEEE transactions on software engineering* 33(1), pp. 33–53 (2007).
5. Jørgensen, M.: A review of studies on expert estimation of software development effort. *Journal of Systems and Software* 70(1–2), pp. 37–60 (2004).
6. International Society of Parametric Analysts. *Parametric Estimating Handbook*. 4th edn. ISPA, Vienna (2008).
7. Idri, A., Amazal, F., Abran, A.: Analogy-based software development effort estimation: A systematic mapping and review. *Information and Software Technology* 58, pp. 206–230 (2015).
8. Yadav, R.K., Niranjana, S.: Software Effort Estimation Using Fuzzy Logic: A Review *International Journal of Engineering Research & Technology (IJERT)* 2(5), pp. 1377–1384 (2013).
9. E.Praynlin, P.Latha, "Performance Analysis of Software Effort Estimation Models Using Neural Networks", *International Journal of Information Technology and Computer Science (IJITCS)*, vol.5, no.9, pp.101-107, 2013. DOI: 10.5815/ijitcs.2013.09.11

10. M.Padmaja, D. Haritha, "Software Effort Estimation Using Grey Relational Analysis", *International Journal of Information Technology and Computer Science(IJITCS)*, Vol.9, No.5, pp.52-60, 2017. DOI: 10.5815/ijitcs.2017.05.07
11. Boehm, B.: *Software Engineering Economics*. Prentice-Hall, New Jersey (1981).
12. Boehm, B., Abts, C., Brown, A. W., Chulani, S., Clark, B. K., Horowitz, E., Madachy, R., Reifer, D. J., Steece, B.: *Software Cost Estimation with COCOMO II (with CD-ROM)*. Prentice-Hall, New Jersey (2000).
13. Anupama Kaushik, Ashish Chauhan, Deepak Mittal, Sachin Gupta, "COCOMO Estimates Using Neural Networks", *International Journal of Intelligent Systems and Applications (IJISA)*, vol.4, no.9, pp.22-28, 2012. DOI: 10.5815/ijisa.2012.09.03
14. Ashita Malik, Varun Pandey, Anupama Kaushik, "An Analysis of Fuzzy Approaches for COCOMO II", *International Journal of Intelligent Systems and Applications (IJISA)*, vol.5, no.5, pp.68-75, 2013. DOI: 10.5815/ijisa.2013.05.08
15. Royce, W.: *Managing the development of large software systems*. Proceedings of IEEE WESCON 26, pp. 328–338 (1970).
16. Anupama Kaushik, A.K. Soni, Rachna Soni, "A Type-2 Fuzzy Logic Based Framework for Function Points", *International Journal of Intelligent Systems and Applications (IJISA)*, vol.5, no.3, pp.74-82, 2013. DOI: 10.5815/ijisa.2013.03.08
17. Jørgensen, M., Boehm, B., Rifkin, S.: *Software Development Effort Estimation: Formal Models or Expert Judgment?* *IEEE Software* 26(2), pp. 14–19 (2009).
18. Shepperd, M., Kadoda, G.: *Comparing Software Prediction Techniques Using Simulation*. *IEEE Transactions on Software Engineering* 27(11), pp. 1014–1022 (2001).
19. Kingman, J.F.C.: *The first Erlang century – and the next*. *Queueing Systems* 63, pp. 3–12 (2009).
20. Sztrik, J.: *Basic Queueing Theory. Foundations of System Performance Modeling*. GlobeEdit (2016).
21. Asmussen, S.: *Applied Probability and Queues*. Springer, New York (2010).
22. Cruz, R.L.: *A Calculus for Network Delay. Part I: Network Elements in Isolation. Part II: Network Analysis Information Theory*. *IEEE Trans. on Information Theory* 37, pp. 114–131, pp. 132–141 (1991).
23. Le Boudec, J.-Y., Thiran, P.: *Network Calculus: A Theory of Deterministic Queueing Systems for the Internet*. Online Version of the Book Springer Verlag (2012).
24. Bondorf, S., Schmitt, Jens, B.: *The DiscoDNC v2 – A Comprehensive Tool for Deterministic Network Calculus*. In: *Proceedings of the 8th International Conference on Performance Evaluation Methodologies and Tools (VALUETOOLS 2014)*, pp. 44–49. Bratislava, Slovakia (2014).
25. Schmidt, M., Veith, S., Menth, M., Kehrer, S.: *DelayLyzer: A Tool for Analyzing Delay Bounds in Industrial Ethernet Networks*. In: *Fischbach, K., Krieger, U.R. (eds) Measurement, Modelling, and Evaluation of Computing Systems and Dependability and Fault Tolerance. Lecture Notes in Computer Science 8376*, pp. 260–263. Springer, Cham (2014).
26. Baybulatov, A.A.: *The method of calculating the software guaranteed modification time*. *Control Sciences* 1, pp. 58–64 (2016) (in Russian).
27. Baybulatov, A.A.: *An investigation of jobs flows for actualization of the NPP APCS Top-level information base*. In: *Proceedings of the 9-th International Conference "Management of Large-Scale System Development" MLSD'2016 2*, pp. 161–170. RAS ICS, Moscow (2016) (in Russian).
28. Baybulatov, A.A., Promyslov, V.G.: *The approximation of envelope in "Network calculus" applications*. *Control Sciences* 6, pp. 59–64 (2016) (in Russian).

# Modeling the Operation of an Adaptive Computing System Based on FGPN for Case Risk Management

Aleksey Senkov , Evgenii Sorokin

National Research University "Moscow Power Engineering Institute" in Smolensk, Russia  
a.v.senkov@mail.ru

**Abstract.** The article discusses problems of case risk management modeling using an example of an adaptive heterogeneous computer system. Existing approaches to complex system modeling, as a rule, do not allow modeling of systems that operate under risk conditions and are able to adapt to occurring risk events. An approach based on nested Petri nets is proposed (growing Petri nets). Growing Petri nets provide an opportunity to simulate the system operation in case of risk occurrence. An example of a growing Petri net for an adaptive computing system is given.

**Keywords:** Growing Petri nets, heterogeneous computing system, risk management.

## 1 Introduction

Risk management is a quite fast-growing area of research around the world today. With the exception of the rare cases in which risk management uses statically significant experience, risk assessments are of an assumption nature that determines the need for using fuzzy logic risk management.

An analysis of publications that reflect the use of fuzzy logic for risk management makes it possible to state that in the vast majority of publications only ways of applying fuzzy logic to reflect fuzzy expert assessments and deriving crisp risk assessments on their basis are shown. Even works performed within the specialized communities of actuaries [1, 2] only reflect a small area of fuzzy logic application, for example, in the course of fuzzy optimization or Analytic Hierarchy Process. At the same time, such important tools and techniques of fuzzy logic remain completely uncovered as fuzzy inference mechanisms [3, 4], fuzzy tree models [5, 6, 7], fuzzy Bayesian nets [8], fuzzy cognitive maps [9], fuzzy Petri nets [10] and other. Modeling with Petri nets is widely used for modeling multi-agent systems [11].

It should also be noted that in risk management, as a rule, there is no significant differentiation between preliminary and case management, introduced in [12]. Particularly little attention is paid to case management of risks. One of the tasks of such

management is modeling decision-making on risk management and assessing its effectiveness.

## 2 The Task of Modeling a Computing System

Let us consider the task of modeling case risk management using the example of an adaptive heterogeneous computing system. In the system under consideration, we define processors and permanent memory as separate blocks [13]. The processors are classified as follows.

1. Control processors – one or more processors that allocate tasks to groups of processors and select the type of drive used.
2. High-performance computational processors that execute chains of instructions for the shortest possible time.
3. Graphics processors designed to process graphic data flow.
4. Auxiliary processors – classical processors in their architecture, but slower at data processing that leads to their cheapness and availability in a large amount.

The drives will be of two types: HDD and SSD.

Operation of the system is based on the processing of user requests for computing or reading/writing information. If during the processing of the request it becomes obvious that the resources are insufficient and it takes a lot of time, the control processor dynamically allocates additional resources from what is available so that the work of the entire system is optimal (the control processor can't always determine the complexity of the task; this becomes clear due to the assessment in the course of work).

## 3 Growing Nested Petri Nets

To model such kind of faults and system response to them, let us introduce the mechanism of "growing" Petri nets. Such nets are based on Nested Petri Nets (NPN) [14, 15]. Like NPN, GNPN consists of a system net and elementary nets that correspond to net tokens.

The behavior of such models can be described by four types of steps:

1. a transfer step – firing of the system net transition according to standard Petri nets rules;
2. an object-autonomous step only changes the marking of the elementary net;
3. a horizontal synchronization step – simultaneous firing of two transitions in two elementary nets;
4. a vertical synchronization step – simultaneous firing of the system net transition together with some elementary nets transitions.

Unlike NPN, GNPN has growth mechanisms that are based on expert-defined patterns for certain risk situations.

Let us single out two types of GNP<sub>N</sub> growth.

1. Unified growth – involves developing a net without changing the current structure. In such situations, there is some pattern or a fixed-type net that can be mixed into the working system to perform certain actions, for example, to fix the problem. Such supplementary net can generally be applied for any transition of the elementary or system net.
2. Specialized growth – based on the specific features of the objects being modeled. It is used to develop the elementary net and involves interference in the structure – bypassing inefficient transitions, breaking links, etc.

The formal description of a growing nested Petri net has a form of the vector

$$GNPN = (Atom, Lab, SN, (gSN1, \dots, gSNk), (EN1, \dots, ENk), (gEN1, \dots, gENk), A, fS, fE),$$

where  $(gSN1, \dots, gSNk)$  is a finite set of supplementary Petri nets of the system model;

$(gEN1, \dots, gENk)$  is a set of supplementary Petri nets for elementary models;

$fS$  is a function of matching the supplementary model and the system net;

$fE$  is a function of matching the supplementary model and the elementary net.

## 4 Computing System Model Represented by GNP<sub>N</sub>

The system part of the computing system model described above is shown in Fig. 1.

In the initial position P1, the control processor waits for a request to compute or handle data. Transition T1 (SC1) provides vertical synchronization of the system net and the elementary net of the control processor shown in Fig. 2. The transition is allowed when the main processor is ready for processing and there is a request from the user. Vertically synchronizing transitions T2 and T6 divide the processing into computational operations using different types of processors (CPU, GPU, SCPU) or data handling operations using SSD and HDD drives.

Fig. 3 shows the elementary Petri net of a standard and a high-performance processors. The structure of such computers can be identical, but differ in the basic parameters of the work, which is hidden in the transitions of the presented model. The architecture of graphics processors for processing large data sets also affects the model appearance, which is shown in Fig. 4. In fact, the model shown in Fig. 1-4 is presented in the form of NPN.





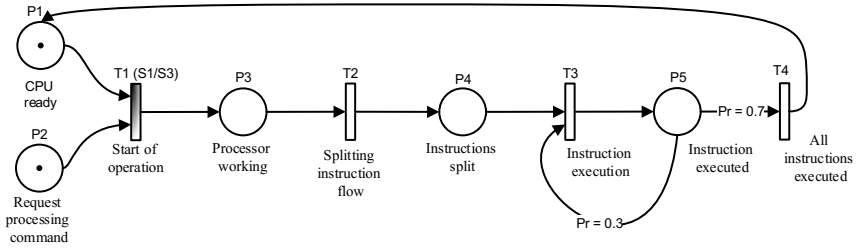

Fig.3. Elementary Petri net of standard and high-performance processors

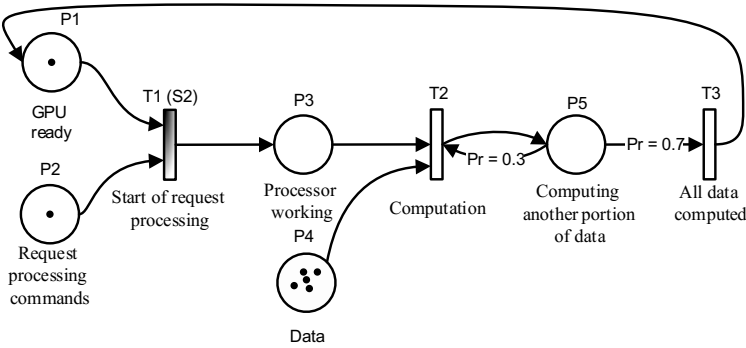

Fig. 4. Elementary Petri net of graphics processor

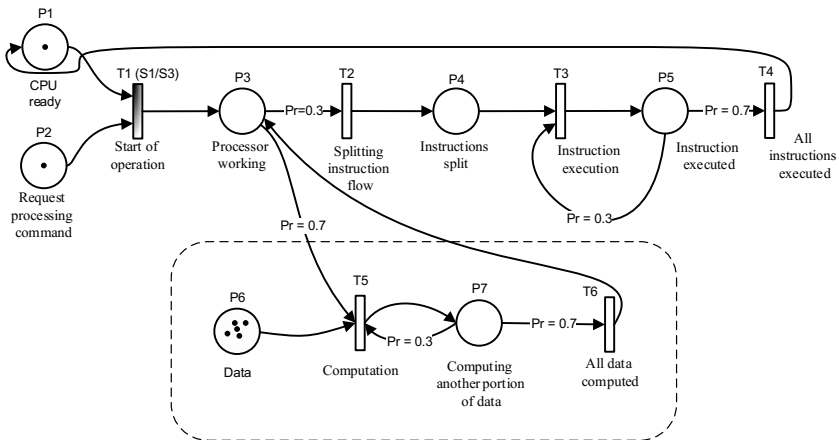

Fig. 5. Specialized growth of Petri net when combining standard and graphics processors

Shifting from NPN to GNPN will be shown in the following example. Assume a risk situation, in which transition T2 of the GPU elementary net cannot fire, and this is the only graphics processor in the system. A standard processor can solve tasks of a graphics one, which will certainly affect its performance, however, it will keep the system working. In relation to Petri net, specialized growth of the net will be launched, as shown in Fig. 5. In case of a risk situation, one of the computing system processors, in accordance with the defined priorities for firing the transitions, will first perform the functions of the graphics processor, and then perform its own tasks.

Similarly, in GNPN, the mechanisms for adapting the system to occurrence of other types of risk events can be built in, which are in fact measures for case management of risks.

## 5 Conclusion and future work

The suggested GNPN mechanism provides the possibility to model case risk management in complex systems, which in the long term will significantly improve such management.

In this article, the questions concerning the classical properties of Petri nets (such as reachability, boundedness of the net, and others) and their applicability to the proposed GNPN mechanism remain uncovered.

Further development of modeling case risk management in complex systems is attributed to supplementing GNPN with mechanisms for taking account of resources and assessing the effectiveness of decisions on case management of risks.

## Acknowledgments

The reported study was funded by RFBR, according to the research project No. 16-37-60059 mol\_a\_dk.

## References

1. Shang, K., Kossen, Z.: Applying Fuzzy Logic to Risk Assessment and Decision-Making. Casualty Actuarial Society. Canadian Institute of Actuaries, Society of Actuaries (2013).
2. Shapiro, A.F., Koissi, M.C.: Risk Assessment Applications of Fuzzy Logic. Casualty Actuarial Society. Canadian Institute of Actuaries, Society of Actuaries (2015).
3. Sugeno, M.: Fuzzy Identification of Systems and its Applications to Modeling and Control, pp. 116-132. IEEE Transactions on Systems, Man, and Cybernetics SMC-15(1) (1985).
4. Mamdani, E.H.: Application of Fuzzy Logic to Approximate Reasoning Using Linguistic systems, pp. 1182-1191. IEEE Transactions on Computers (1978).
5. Zeidler, J., Schlosser, M., Ittner, A., Posthoff, C.: Fuzzy decision trees and numerical attributes. Fuzzy Systems, pp. 985-990. Proceedings of the Fifth IEEE International Conference on Volume: 2 (1996).

6. Fan, L.T., Lai, F.S.: Toguchi, K.: Fault-Tree Analysis by Fuzzy Probability IEEE Transactions on Reliability, pp. 453-457. Volume: R-32, Issue: 5 (1983).
7. Gmytrasiewicz, P., Hassberger, J.A., Lee, J.C.: Fault tree based diagnostics using fuzzy logic. IEEE Transactions on Pattern Analysis and Machine Intelligence, pp. 1115-1119 Volume: 12, Issue: 11 (1990).
8. Pan, H., Liu, L. Fuzzy Bayesian networks – a general formalism for representation, inference and learning with hybrid Bayesian networks – IJPRAI. V. 14(7), pp. 941–962. (2000).
9. Styblinski, M.A., Meyer, B.D.: Fuzzy cognitive maps, signal flow graphs, and qualitative circuit analysis, pp. 549 – 556. Neural Networks (1988).
10. Pedrycz, W., Gomide F.: A generalized fuzzy Petri net model, pp. 295 – 301. IEEE Transactions on Fuzzy Systems, (1994).
11. Shiladitya Pujari, Sripati Mukhopadhyay, "Petri Net: A Tool for Modeling and Analyze Multi-agent Oriented Systems", International Journal of Intelligent Systems and Applications(IJISA), vol.4, no.10, pp.103-112, 2012. DOI: 10.5815/ijisa.2012.10.11
12. Senkov, A.: Risk Management: Intelligent Models, Methods and Software (in Russian), p. 222 (2016).
13. Reza Fotohi, Mehdi Effatparvar, "A Cluster Based Job Scheduling Algorithm for Grid Computing", International Journal of Information Technology and Computer Science(IJITCS), vol.5, no.12, pp.70-77, 2013. DOI: 10.5815/ijitcs.2013.12.09
14. Lomazova, I.A.: On Proving Large Distributed Systems: Petri Net Modules Verification, pp. 70–75. Proc. 4th Int. Conference on Parallel Computing Technologies. Lecture Notes in Computer Science. Vol. 1277 (1997).
15. Lomazova, I.A. Nested Petri nets — a Formalism for Specification and Verification of Multi-Agent Distributed Systems, pp. 195–214. Fundamenta Informaticae. Vol. 43. №1–4 (2000).

# WAMS/SCADA Data Fusion Method Study Based on Time-Series Data Correlation Mining

LiJin Zhao<sup>1</sup>, Liang Huang<sup>1</sup>, Qiansu Lv<sup>1</sup>, Tao Yang<sup>1</sup>, Daqian Wei<sup>2</sup>

1. Electric Power Research Institute of Guizhou Power Grid Co., Ltd, GuiZhou 550000, China
2. School of Electrical Engineering, Wuhan University, Wuhan 430072, China

**Abstract:** Hybrid measurement state estimation of WAMS data and the SCADA system is an effective method to improve the traditional state estimation. However, as the WAMS data and the SCADA data belong to different systems, there are great differences between them. To solve this problem, WAMS/SCADA data fusion method based on the correlation mining of time-series data is proposed in this paper. Firstly, WAMS/SCADA correlation estimation is done with the derivation of Pearson correlation coefficient. Then, solving the function model for the time difference issue and the alignment problem of correlation curves. After that, analyzing the measurement precision by considering the measurement weight and calculate the matrix of time series data weight to complete the optimization for the measurement precision. Finally, forming the effective fusion scheme based on the correlation of timing data. Simulation results on the IEEE 118 nodes system, with set a comparison of different hybrid measurement state estimation and different state estimation algorithm, effectiveness and stability of the proposed method has been proved.

**Keywords:** Time-series data; correlation mining; WAMS/SCADA data fusion.

## 1. Instruction

With the Power Grid becoming smarter and more integrative, real-time data transmission and analysis in Power Grid is much more important. SCADA plays an important role in traditional power system analysis for a long time<sup>[1-2]</sup>. As the WAMS proposed and perfected, it can provide a new method of monitoring and analyzing of Power Grid. Taking no account of time delay, the WAMS is able to monitor measurement data of the whole Power Grid and provide unprecedented data stream to

keep the Power Grid safe and stable<sup>[3-6]</sup>. However, it is difficult to analyze measurement data, make decisions and become a single reliable system source within a short time because of the inadequacy of deployment of WAMS and high-speed data sources<sup>[7-9]</sup>. Therefore, hybrid measurement data of SCADA and WAMS based on response is an important on-line method to estimate and analyze the Power Grid.

Because of the differences between WAMS and SCADA's technology platform, they are different in component, precision, transmission time delay and refresh rate<sup>[10-11]</sup>. At present, Researches mainly focus on building the correlation constraint between the WAMS and the SCADA and hybrid measurement state estimation by nonlinearity state estimation or OLS, or simply improving PMU measurement precision<sup>[12-14]</sup>. This method faces trade-offs with measurement data to reduce differences and enhance precision, which ignores the integrity of data largely and can make good use of the WAMS/SCADA data.

Therefore, by the method based on time-series data correlation mining to evaluate correlation of data, the WAMS/SCADA data fuses according to its correlation to make the best use of data after curve registration or curve alignment. The method based on time-series data correlation mining has been applied in many research field of subjects<sup>[15-21]</sup>. For example, it can study stream flows, temperature and precipitation when predicting flood disaster to improve precision. It can also propose advice on inflation and economic trend by analyzing CPI and GDP. What's more, it is able to locate the earthquake and earthquake scale according to wave sequence in different places<sup>[22-24]</sup>. The object of time-series data correlation analysis is heterogeneous data which is from different sources or different property. For example, the WAMS/SCADA data in this paper should be evaluated its correlation before regression analysis<sup>[25-28]</sup>.

WAMS/SCADA data fusion method based on time-series data correlation mining is proposed in this paper. The method firstly determines the correlation coefficient and evaluates its own correlation. Then solving the function model by time-series data curve alignment. Finally completing blended data fusion.

**1.1. WAMS/SCADA Correlation Evaluation**

**1.1.1. Correlation Coefficient Derivation**

**1.1.1.1. Upper and Lower Limit of Correlation Coefficient**

WAMS data and SCADA data are stable between two short periods. Before determining correlation coefficient, the upper and lower limit of correlation coefficient is needed. Pearson correlation coefficient proposed in this paper is widely used in weighing sequence correlation.

Assume that there are two correspondent groups of heterogeneous data:

$$\{(x_i, y_i), i = 1, 2, \dots, n\} \tag{1}$$

Accord with:  $(x, y) \square N(\mu_x, \mu_y, \sigma_x^2, \sigma_y^2, \rho)$

Then correlation coefficient of sample is:

$$\rho(X, Y) = \frac{\sum_{i=1}^n (x_i - \bar{x})(y_i - \bar{y})}{\sqrt{\sum_{i=1}^n (x_i - \bar{x})^2 \cdot \sum_{i=1}^n (y_i - \bar{y})^2}} \tag{2}$$

$\bar{x}$  is the average of sample  $X$ ,  $\bar{y}$  is the average of sample  $Y$

When  $\rho = \rho_0$ , simply getting the probability density function of  $\rho$ . After transferring, getting asymptotic distribution:

$$z = \frac{\phi(\rho) - \phi(\rho)^{n \rightarrow \infty}}{2\sqrt{n-3}} \square N(0,1) \tag{3}$$

From formula (4),  $\phi(x)$  is monotonic increasing function, its upper and lower limit of correlation coefficient is:

When  $\rho \geq \rho$ :

$$P \left\{ \rho \leq \phi^{-1} \left[ \phi(\rho) + 2z_{1-\frac{\alpha}{2}} \cdot \sqrt{n-3} \right] \right\} = 1 - \alpha \quad (4)$$

When  $\rho \leq \rho$ :

$$P \left\{ \rho \geq \phi^{-1} \left[ \phi(\rho) + 2z_{1-\frac{\alpha}{2}} \cdot \sqrt{n-3} \right] \right\} = 1 - \alpha \quad (5)$$

### 1.1.1.2. Determination of WAMS/SCADA Correlation Coefficient

According to the derivation of upper and lower limit of correlation coefficient, WAMS/SCADA correlation coefficient can be showed with:

$$\rho(S, W) = \frac{\sum_{t=1}^n (x_s - \tau_s)(x_w - \tau_w)}{\sqrt{\sum_{t=1}^n (x_s - \tau_s)^2 \cdot \sum_{t=1}^n (x_w - \tau_w)^2}} \quad (6)$$

In last formula,  $\rho(S, W)$  is the correlation coefficient of WAMS measurement data  $x_w$  and SCADA measurement data  $x_s$ .  $t$  is the initial moment of measurement data in some period.  $n$  is the cut-off moment of measurement data in some period.  $\tau_s$  is average of SCADA measurement sample.  $\tau_w$  is average of WAMS measurement sample.

Then getting the cross covariance function of WAAMS/SCADA measurement data:

$$C_{sw} = E \left\{ [x_s(t_1) - \tau_s][x_w(t_1) - \tau_w] \right\} \quad (7)$$

## 1.2. Method of Correlation Determination

To describe the correlation characteristic of sequence, firstly giving the definition of time-lag series. Assume that there are two groups of time-series data:



$$(X, Y) = \{(x_i, y_i), i = 1, 2, \dots, n\} \quad (8)$$

Defining the following sequence is the time difference series:

$$(X_i, Y_{i+m}) = \{(x_i, y_{i+m}), i = 1, 2, \dots, n - m\} \quad (9)$$

$$(X_i, Y_{i-m}) = \{(x_i, y_{i-m}), i = m + 1, 2, \dots, n\} \quad (10)$$

$$1 \leq m < n, m \in \mathbb{N}^+$$

Therefore, it is able to determine time-series data correlation of time difference sequence now.

$\rho(S, W)$  is a series of correlation coefficient vector, which is combined with the correlation coefficient of WAMS/SCADA measurement data according to sequential permutation. When WAMS/SCADA's initial moments  $t$  is synchronous, it is the most correlative moment.

## 2. Method of Time-series Data Curve Alignment

### 2.1 Curve Alignment Model Based on Correlation Coefficient

Correlation coefficient of the WAMS/SCADA time-series data helps to evaluate itself correlation. If the series is correlative and exists time deviation, differences in timer shaft should be removed by curve alignment. As for heterogeneous data, non-dimensional criterion is needed to align curve alignment combined with heterogeneous data.

Pearson correlation coefficient is a non-dimensional way to describe the correlation or similarity between series. However, continuity function need to be described by inner product. Completing curve alignment of heterogeneous data by building the following function:

$$\max_{h(t)} \left| r(x_1^*, x_2) \right| =$$

$$\max_{h(t)} \left| \frac{\int_T x_1^*(s)x_2(s)ds}{\sqrt{\int_T [x_1^*(s)]^2 ds} \sqrt{\int_T [x_2(s)]^2 ds}} \right| \quad (11)$$

$x_1^*(t) = x_1[h(t)]$  is the function after aligning.

## 2.2 Solving Model

Reference [9, 11] use EM algorithm to solve the problem of curve alignment optimization. But when the dimension of parameters is much more, it is difficult to get a satisfied solution. To solving the problem, objective function in this paper is used as expectation of likelihood function in EM algorithm and Generalized Expectation Maximization (GEM) is used to solve the model.

Main steps are listed:

- 1) Input WAMS/SCADA data in the same period.
- 2) Initialize time difference vector  $\Delta_0$ , and get the permitted errors of iteration.
- 3) Make time-series data become functions, function models can reference formula (13)
- 4) Get time difference vectors by General expectation maximization.
- 5) Redo step 3) and step 4) until convergence.

## 3. WAMS/SCADA Correlation Data Fusion

By derivation of correlation coefficient and curve alignment of WAMS/SCADA data, most of time-series data has been disposed, but the weight of time-series data depends on measurement precision. The WAMS/SCADA hybrid measurement state estimation precision depends on device measurement precision and time synchronism of hybrid measurement data:

$$\omega = r_t + r_m \quad (12)$$

$\omega$  is global error of measurement data.  $r_t$  is the error caused by time synchronism.

$r_m$  is the error from system.

The error  $r_i$  caused by synchronism is:

$$r_i = kt_d \quad (13)$$

$k$  is the gradient of measurement data.  $t_d$  is the deviation between measurement moment and hybrid measurement data synchronism moment.

With knowing the system error, global error can be gotten by solving the deviation between measurement moment and hybrid measurement data synchronism moment to work out the precision of mixed measured state estimation. WAMS data has better time scale characteristics. Therefore,  $r_i$  can be gotten by comparing WAMS time scale with the most correlative moment. Every measurement data has its own time delay  $t_d$ , which has the following probability density:

$$f(t_d) = \frac{1}{\sigma_i \sqrt{2\pi}} e^{-\frac{(t_d-t)^2}{2\sigma_i^2}} \quad (14)$$

$\sigma_i$  is variance of  $t_d$ .  $t$  is hybrid measurement data synchronism moment.

During precise calculation, errors of devices and time synchronism have no effect on each other. So the variance of global error can be described with:

$$W = \frac{I}{E[ee^T]} \quad (15)$$

## 4. Simulation Case

### 4.1. Simulation System and Estimation Indexes

In this paper, the following indexes are used to evaluate:

$$\rho_k = \frac{\sum_{i=1}^N |\hat{z}_{i,k} - z_{i,k}^t|}{\sum_{i=1}^N |z_{i,k} - z_{i,k}^t|} \quad (16)$$

$$\rho = \frac{1}{M} \sum_{k=1}^M \rho_k \quad (17)$$

Formula (19) shows correlation fusion of time-series data on moment  $k$ . Formula (20) shows correlation fusion of time-series data during the whole time.

$z_{i,k}^t$  is true value of measurement  $i$  on moment  $k$  in sequence.  $\hat{z}_{i,k}$  is estimated value of measurement  $i$  on moment  $k$  in sequence.  $N$  is dimension of measurement vectors.  $M$  is the number of measurement.

Case system use IEEE118 node bus system showed in Fig. 1. The SCADA measurement data used in case contains all active power and reactive power between lines in power system and all voltage amplitudes. The measurement data measures up Gaussian distribution. Its standard deviation is 0.02 and error mean is 0. PMU are equipped in Bus 2, 5, 8, 11 and 14. PMU contains bus voltage vectors and all outlet current vectors. The amplitude measurement measures up Gaussian distribution. Its standard deviation is 0.005 and error mean is 0. Phase angle measurement also measures up Gaussian distribution. Its standard deviation is 0.002 and error mean is 0.

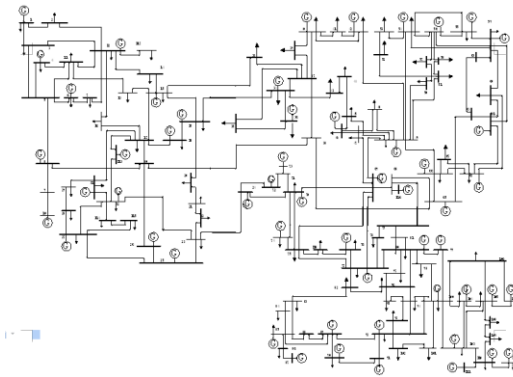

**Fig. 1.** IEEE 118 nodes system

## 4.2. Data Fusion Simulation Experiment

There are three cases in the simulation. They all experience stabilization period, disturbance period and returning stabilization period.

Case 1: Only use SCADA data to estimate state.

Case 2: Estimate state without WAMS/SCADA data

Case 3: Estimate state after WAMS/SCADA data fusion

The final results are showed with estimated standard deviation after state estimation. Case 3 use the correlation coefficient in some period to make that  $t$  is the datum. When they are not synchronous, the differences of data's stabilization will be removed by solving curve alignment function.

The simulation result is showed as Fig. 2:

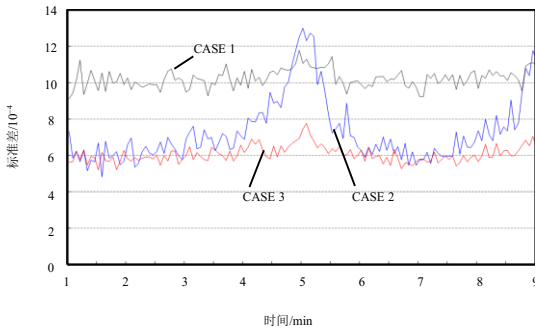

**Fig. 2.** Data fusion simulation results

From the figure, firstly, simulation data's precision is terrible and curve fluctuates when simply using SCADA data to estimate state. In Case 2, although state estimation can keep satisfied precision in stabilization period, the curve fluctuates when disturbing. In Case 3, state estimation keep satisfied precision both in stabilization period and disturbance period after correlation fusion. State estimation has been improved after time-series data correlation fusion.

**Table 1.** Different measurement measuring mixed state estimation results

Measurement time difference/s	1	0.9	0.8	0.7	0.6
CASE 1p/10-2	8.98	8.89	8.61	8.34	7.99
CASE 2p/10-2	4.27	4.27	4.27	4.27	4.27
Measurement time difference /s	0.5	0.4	0.3	0.2	0.1
ASE 2p/10-2	7.73	7.52	7.14	6.73	6.25
CASE 3p/10-2	4.26	4.27	4.27	4.26	4.27

From Table 1, estimation precision declines when time difference of the WAMS/SCADA measurement data increases. However, in Case 3, estimation precision almost keeps invariable and data keeps stable. So hybrid measurement data state estimation based on time-series data correlation data fusion will not be affected by time synchronism.

### 4.3. Comparison Among Cases

Two types of hybrid measurement estimation algorithm are listed to compare with the algorithm in the paper:

Case 1: Based on nonlinear state estimation.

Case 2: Based on nonlinear and linear state estimation.

Case 3: Based on time-series data correlation data fusion state estimation.

The final results are described with estimated standard deviation in three cases.

The results are showed as Fig. 3:

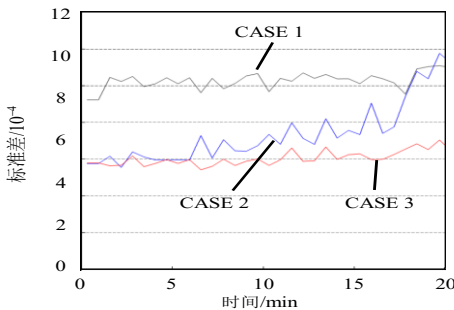

**Fig. 3.** More comparison algorithm simulation results

From the results, although the stability of using single nonlinear state estimation is good, precision is lower than the other two cases. Using mixed state estimation has improved a lot, but its stability is not as good as Case 3.

**Table 2.** Three kinds of simulation examples estimated standard deviation

BUS	CASE 1	CASE 2	CASE 3
	Standard	Standard	Standard
	estimate	estimate	estimate
	difference	difference	difference
	/10-3	/10-3	/10-3
1	0.8020	0.5545	0.5512
2	1.0026	0.6975	0.6975
3	0.9163	0.6308	0.6324
4	0.9441	0.6200	0.6205
5	0.8511	0.5644	0.5645
6	0.8806	0.6300	0.6267
7	0.9507	0.6835	0.6801
8	1.0514	0.6665	0.6612
9	0.8672	0.6520	0.6555
10	0.9535	0.6490	0.6501
11	0.9144	0.5795	0.5880
12	0.8738	0.5961	0.5961
13	0.8441	0.5660	0.5643
14	0.8863	0.5205	0.5201

From last table, data fusion based on time-series data correlation mining has better effective estimation than other traditional algorithm in stability or disturbance period.

## 5. Summary and Conclusion

Hybrid measurement data state estimation improves the state estimation which only use SCADA data with WAMS data. However, there is not an effective scheme to solve the problem of state estimation based on WAMS/SACDA data. The scheme of time-series data correlation fusion is proposed in this paper:

- 1) Pearson correlation coefficient function is introduced in this paper. Time-series WAMS/SCADA data correlation estimation is done by determining upper and lower limit and derivation of correlation coefficient.
- 2) In the case of time difference of time-series curves, optimizing data fusion by building and solving model function.
- 3) Calculating the matrix of time-series data weight to complete an effective scheme based on time-series correlation by analyzing measurement data.
- 4) The results are verified by IEEE 118 nodes system. The stability has improved a lot than other schemes.

### **Acknowledgment**

This project is supported by Key Projects of China Southern Power Grid (GZ2014-2-0049)

### **References**

1. Phadke A G, Synchronized phasor measurements in power systems [J]. IEEE Computer Applications in Power, 1993, 6(2): 10-15.
2. Phadke A G, Pickett B, Adamiak M, et al. Synchronized sampling and phasor measurements for relay and control[J]. IEEE Trans. on Power Delivery, 1994, 9(1): 442-452.
3. Yu Qinjie, Wang Xiaoru, You Jiaxun, et al, Equality constraints two-step state estimation model based on phasor measurements [J]. Power System Technology, 2007, 31(10): 84-88(in Chinese).
4. Qin Xiaohui, Bi Tianshu, Yang Qixun, A new method for hybrid nonlinear state estimation with PMU[J]. Automation of Power Systems, 2007, 31(4): 28-32(in Chinese).
5. LIU Jinfeng, WANG Shuyang Survey on applications of wide area measurement system in power system analysis [J] High Voltage Engineering, 2007, 33(7); 182-185.
6. DUAN Jundong, SUN Yankai, YIN Xiugang Voltage stability' online prediction using WAMS[J]. High Voltage Engineering, 2009, 35 (7) : 1748-1752.
7. Ding Junce, Cai Zexiang, Wang Keying, Mixed measurements stateestimation based on WAMS[J]. Proceedings of the CSEE, 2006, 26(2): 58-63(in Chinese)



8. Adelfio G, Chiodi M, D'Alessandro A, Luzio D, D'Anna G, Mangano G. Simultaneous seismic wave clustering and registration. *Computers & Geosciences*, 2012, 44:60-69.
9. Ye L, Keogh E. Time series shapelets: A new primitive for data mining. In: *Proc. of the 15th ACM SIGKDD Int'l Conf. on Knowledge Discovery and Data Mining*. New York: ACM Press, 2009. 947-956.
10. Liu X, Yang MCK. Simultaneous curve registration and clustering for functional data. *Computational Statistics & Data Analysis*, 2009, 53(4):1361-1376.
11. Yu Erkeng, Power system state estimation[M]. Beijing: China Water Power Press, 1985: 62-64(in Chinese).
12. State Grid Corporation of China. Technical specification for WAMS[S]. Beijing: State Grid Corporation of China, 2006(in Chinese).
13. Power System Relaying Committee of the IEEE Power Engineering Society. IEEE standard for synchrophasors for power systems [S]. New York: The Institute of Electrical and Electronics Engineers, Inc, 2005).
14. Liu X, Yang MCK. Simultaneous curve registration and clustering for functional data. *Computational Statistics & Data Analysis*, 2009, 53(4):1361-1376.
15. LI Dalu, LI Rui, SUN Yuanzhang. Data compatibility analysis of WAMS/SCADA hybrid measurements state estimation[J] *Proceedings of the CSEE*, 2010, 30 (16) : 60-66.
16. LI Dalu, LI Rui, SUN Yuanzhang. Data compatibility analysis of WAMS/SCADA hybrid measurements state estimation[J]. *Proceedings of the CSEE*, 2010, 30 (16) : 60-66.
17. YOU Jiaxun, HUANG Bin, GUO Chuangxin, etal State estimation using SCADA and PMU hybrid measurements [J] *High Voltage Engineering*, 2009, 35 (7) : 1765-1796.
18. WU Xing, LIU Tianqi, LI Xingyuan, LI Congshan Optimal Configuration of PMU Based on Data Compatibility of WAMS/SCADA and Improved FCM Clustering Algorithm [J] *Power System Technology*, 2014, (03): 756-761.
19. Zhengbing Hu, Yevgeniy V. Bodyanskiy, Oleksii K. Tyshchenko, Olena O. Boiko, "Adaptive Forecasting of Non-Stationary Nonlinear Time Series Based on the Evolving Weighted Neuro-Neo-Fuzzy-ANARX Model", *International Journal of Information Technology and Computer Science (IJITCS)*, Vol.8, No.10, pp. 1-10, 2016. DOI:10.5815/ijitcs.2016.10.01

20. Er. Garima Jain, Bhawna Mallick,"A Study of Time Series Models ARIMA and ETS",International Journal of Modern Education and Computer Science(IJMECS), Vol.9, No.4, pp.57-63, 2017.DOI:10.5815/ijmeecs.2017.04.07
21. Ayman E. Khedr, S.E.Salama, Nagwa Yaseen,"Predicting Stock Market Behavior using Data Mining Technique and News Sentiment Analysis", International Journal of Intelligent Systems and Applications(IJISA), Vol.9, No.7, pp.22-30, 2017. DOI: 10.5815/ijisa.2017.07.03
22. LIU Daowei1, SONG Dunwen1, WANG Hongyin2Voltage Stability Online Evaluation System Based on WAMS and EMS Power System Technology2014, (07): 1934-1938.
23. ZHOU Hong, LI Qiang, LIN Tao Power system disturbance and operation identification based on WAMS Electric Power Automation Equipment2011, (02): 7-11.
24. Li Hong, research on some issues of power system state estimation based on WAMS. [D] North China Electric Power University (Beijing), 2010.
25. JI Luyu , WU Junyong , ZHOU Yanzhen Transient Stability Prediction of Power System Based on WAMS Characteristic of Perturbed Voltage Trajectory Clusters [J]High Voltage Engineering 2015, (03): 807-814.
26. WANG Huaibao, SHEN Hong, ZHANG Ying, Grid Synchronization Method Based on Improved Adaptive Filter. [J]High Voltage Engineering 2014, (11): 3636-3641.
27. YANG Jun, LIU Pei, HU Wenping Method for Predicting Failure Rate of Power Transmission Equipment Based on Cloud Theory [J]High Voltage Engineering2014, (08): 2321-2327.
28. HU Jun, CAI Jingwen, HE Jinliang Factors Impacting Self-healing Overvoltage of Smart Distribution Network Connected with Micro grids[J]High Voltage Engineering2014, (05): 1559-1566.

# Evaluation of Library Information Cloud Nodes Configuration Scheme Based on DEA Method

Quan Yuan, Wenbin Hu

Library of Wuhan University of Technology, 430070, China

258173302@qq.com, 86-13886139567

**Abstract:** Aiming at the problem of evaluation of optimal scheme in group decision support system, The DEA C2GS2 model are improved according to the application characteristics of the system. In this paper, the relaxation vector is added into the model to analyze the influence of input factors on the evaluation results, First determine whether the program is likely to focus on production, That is to satisfy the application premise of C2GS2 model, Then determine which attributes affect the evaluation results of the program, Based on this, the group decision making scheme is adjusted, To achieve a more satisfactory results, The algorithm steps of evaluation and adjustment are given, Finally, a library information cloud nodes configuration example is given to verify the practicability of the model.

**Keywords:** DEA; Group decision support system; Library; decision-making system.

## 1. Instruction

In 1978, Chans et al an operational research scientist, first proposed a method called DEA (Data Envelopment Analysis), which was used to evaluate the relative effectiveness of different departments, so it was called effective DEA. Their first model is named  $C^2R$  model. From the perspective of the production function, this model is used to study with multiple input multiple output, especially with the “production” at the same time as the “scale” (in a certain input case, whether the output generated to meet the requirements in quantity, such as the number of results, yield and so on) and “technology” (in a certain input conditions, the output generated

in the production technology such as the quality of product quality, performance, quality of teaching and scientific research on whether to meet the requirements of the very fruitful method). In 1985 Chans et al. Gave another model, the  $C^2GS^2$  model. This model is used to study the “technical and effective”. In 1986 Chans et al study the case of an infinite number of decision units, and give a new data envelopment model  $C^2W$  model in order to further estimate the “effective production frontier” (represents a set of inputs that satisfy the requirements in a given input). In 1987, Chans puts forward a data envelopment model called cone ratio, named  $C^2WH$  model. This model can be used to deal with a lot of input and output. Flexible application of this model  $C^2R$  model can be identified in the *DEA* effective decision making units to classify or queue. These models and new models are being continuously improved and developed.

All of the above models can be regarded as a method to deal with the multiple objective decision making problem with multiple inputs (the input is smaller and the output is better) [1-3]. Because of the advantages of *DEA* in the processing of multiple input and multiple output problems, many scholars at home and abroad regard it as a method of decision making for complex systems. Castro C and BHAGAVATULA. N [4] adopt *DEA* model and multi-objective group decision making method to solve the practical engineering problems (national water resources planning, building safety evaluation, etc.). DERVAUX. B [5] used *DEA* model to evaluate of air logistics center location problem based on *DEA* model. PARADIJ. C [6] used *DEA* model to decide the investment and evaluate the bank project, and the *DEA* model is used to adjust the investment plan, which reduces the error of the investment estimate on the basis of *DEA* model. Wang Ying [7] et al. proposed a combined *AHP* and *DEA* method to evaluate logistics system based on the 2 stage, that is, using *AHP* to make the decision, and then use the *DEA* model to evaluate and adjust the system. Zou ping [8] et al. proposed a group decision making method based on *DEA* model, which solved the problem of group selection in the process of group decision making. From the above point of view, the *DEA* model is combined with other decision making methods (such as multi-objective programming method, *AHP*, etc.) to make decision and evaluation for complex system decision making.

The technical characteristics of *DEA* [9] is not in-depth understanding of the information structure on the output and input of the need to avoid the subjective influence, which can affect the degree between the input and output variables to determine how to adjust the input variables to increase the output results. Therefore, it

can be applied to the decision making problems of multi-hierarchy, multi-attributes and multi-objectives in complex systems. Using *DEA* model to determine which attributes affect the overall effect of the program, and then through the appropriate adjustment to make the program to achieve the optimal state. However, in the process of modeling, the accuracy of input and output values of *DEA* model is higher, and it may lead to no solution. Therefore, on the basis of the optimization scheme of group decision support system, *DEA* technology is used to evaluate and adjust the optimal scheme, so that the optimal scheme can reach the optimum state.

Before the description, the definition of several related terms: decision making unit in the *DEA* model, a set of decision variables of the same type is called a decision making unit; and a decision problem of group decision support system corresponds to a decision unit in *DEA* model; production possibility set in the *DEA* model, will be able to meet the constraints of the model curve or surface is called production possibility set in *DEA*. For the decision making problem of group decision support system, the production possibility set is the set of alternatives.

## 2. DEA $C^2GS^2$ Model

If a decision problem has  $n$  input data and output data, the data input and output of the decision making unit is shown in Figure 1[10].

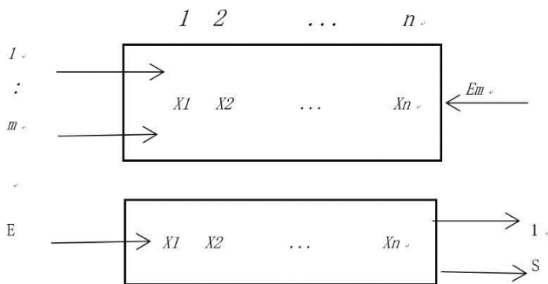

**Fig. 1. Schematic diagram of data input and output**

In Figure 1,  $Em$  is the input vector, and  $E$  is the output vector.

These problems can be considered as a pair of linear programming problems:

$$(P) \begin{cases} \max(\mu^T y_0) = V_p \\ \text{s.t.} \begin{cases} \omega^T x_i - \mu^T y_j \geq 0 \\ \omega \geq 0, \mu \geq 0 \\ i = 1, 2, 3, \dots, n \\ j = 1, 2, 3, \dots, n \end{cases} \end{cases} \quad (1)$$

Where  $x_i$  is the  $i$  input of the total input,  $x_i > 0$ ;  $y_j$  is the  $j$ th output total number,  $y_j > 0$ ;  $\omega$  is the weight coefficient corresponding to the input;  $\mu$  is the weight coefficient corresponding to the output;  $y_0$  is the output vector of decision making units.

$$(D) \begin{cases} \min \theta = V_D \\ \text{s.t.} \begin{cases} \sum_{i=1}^n x_i \beta_i \leq \theta x_0 \\ \sum_{j=1}^n y_j \lambda_j \geq y_0 \\ \sum_{i=1}^n \beta_i = 1 \\ \sum_{j=1}^n \lambda_j = 1 \\ \beta_i \geq 0, i = 1, 2, \dots, n; \\ \lambda_j \geq 0, j = 1, 2, \dots, n; \end{cases} \end{cases} \quad (2)$$

Where  $\beta_i$  and  $\lambda_j$  as well as  $\omega$  and  $\mu$  are the weight coefficient of input and output, and  $\theta$  is an any value between  $[0, 1]$ .  $x_0$  and  $y_0$  are the input and output vectors of decision making units respectively.

**Definition:** if the linear programming problem (P) has optimal solution  $\omega^0$ , and  $\mu^0$  satisfy as follows.

$$V_p = \mu^{0T} y_0 = 1 \quad (3)$$

The decision making unit  $(x_0, y_0)$  is a weak  $DEA$  efficient ( $C^2GS^2$ ). If it is satisfied as follows.

$$\omega > 0, \mu > 0$$

So the decision making unit  $(x_0, y_0)$  is called  $DEA$  efficient.

For the  $C^2GS^2$  model, the corresponding linear programming is (D). For the input and output decision-making units  $(x_0, y_0) \in T$  ( $T$  is the production possibility set), so it is satisfied as follows.

$$\sum_{i=1}^n x_i \beta_i \leq x_0$$

$$\sum_{j=1}^n y_j \lambda_j \geq y_0$$

The economic explanation of linear programming ( $D$ ) is in the production possibility set in  $T$ . When the output  $y_0$  remains unchanged, input  $x_0$  is tried best to decrease according to the same proportion with  $\theta$  ( $0 \leq \theta \leq 1$ ). If the output  $y_0$  cannot reduce by the same proportion with  $\theta$ , namely the optimal value of the linear programming problem ( $D$ ) is  $V_D = \theta^0 = 1$ , in the case of single input and single output, decision making units  $(x_0, y_0)$  is effective.

The economic meaning of  $C^2GS^2$  model is that the input vector  $x_0$  should be decreased according to the same proportion with  $\theta$  and at the condition of output vector  $y_0$  remaining unchanged, in order to upgrade the efficiency of decision making units in the production possibility set in  $T$ . If the input value cannot decrease (that is  $\theta = 1$ ), which shows that the decision-making unit  $(x_0, y_0)$  has reached the optimal production efficiency.

### 3. The Improvement of $C^2GS^2$ Model

In the *DEA*, the information configuration is regarded as a decision making unit. The evaluation indexes of group decision support system are composed by some attributes. For example, the evaluation indexes of library information cloud nodes configuration include using rate of library information cloud nodes, average waiting time of library information cloud nodes, the longest waiting queue of library information cloud nodes, and the total fee of library information cloud nodes. These attributes are composed the input vector of the decision unit of  $C^2GS^2$  model. The output vector of the  $C^2GS^2$  model corresponding to the decision problem is the evaluation index of technical performance, economy and service level.

$C^2GS^2$  model described in scheme evaluation is the precondition of the requirements of the program itself in the production possibility set  $T$ , and in the scheme decision-making system evaluation, the plan is to be built, therefore does not guarantee whether in production may be concentrated, need to determine, and then the evaluation scheme is reasonable. Based on this, this paper improves the  $C^2GS^2$  model, which add slacks value  $s^-$  and  $s^+$  to formula (2). Where  $s^-$  is on behalf of the input vector corresponding slacks, and  $s^+$  is on behalf of the output vector

corresponding slacks. The amount of relaxation and positive and negative responses to the input and output variables affect the overall effect of the program. Formula (4) is the improved  $C^2GS^2$  model.

$$(D') \begin{cases} \min \theta \\ s. t. \begin{cases} \sum_{i=1}^n \beta_i x_i + s^- = \theta x_0 \\ \sum_{j=1}^n \lambda_j y_j - s^+ = y^0 \\ \sum_{i=1}^n \beta_i = 1 \\ \sum_{j=1}^n \lambda_j = 1 \\ \lambda_j \geq 0, s^- \geq 0, s^+ \geq 0, \beta_i \geq 0 \end{cases} \end{cases} \quad (4)$$

Where  $\beta_i$  and  $\lambda_j$  are the weight of evaluation index system and the weight of evaluation index. According to the formula (4), the optimal solution can be used to judge whether the alternatives schemes are feasible in production, and then evaluate whether the scheme is reasonable and feasible.

This paper supposes that there are  $m$  attributes in the evaluation index system of a decision making scheme, which is denoted as  $D_m = \{D_1, D_2, \dots, D_m\}$ . There are  $n$  evaluation indexes, denoted as  $O_n = \{O_1, O_2, \dots, O_n\}$ . The weight of the evaluation index system is  $\omega_i$ . In group decision making evaluation index system, the attribute vector is greater than zero, evaluation index value is greater than zero, the optimal scheme of the decision problem is in production may be concentrated, which can be judged by the improved  $C^2GS^2$  model. Based on the above, as long as the optimal scheme of the evaluation is the optimal solution of the improved  $C^2GS^2$  model, then the scheme is likely to be concentrated in its production (detailed in reference [7]). In the improved  $C^2GS^2$  model,  $x_i$  corresponds to the attribute group decision-making evaluation index system for the value of the corresponding attribute weight;  $\beta_i$  is the evaluation index system for the corresponding weight value;  $y_j$  is the evaluation index value of evaluation index system;  $\lambda_j$  is the value of the evaluation index. For the improved  $C^2GS^2$  model, the value of slack  $s^-$  is corresponding to the adjustment of each input attribute. When  $s^-$  is positive, the value of the property is increased; When  $s^-$  is negative, the value of the property is indicated; When  $s^-$  is zero, that the property does not need to be adjusted, therefore, according to the evaluation results of modified  $C^2GS^2$  model to adjust the optimization scheme. When  $\theta = 1, s^- = 0$ , that shows that the scheme reached the optimal state.



#### 4. The Evaluation Steps of the Improved $C^2GS^2$ Model

Using the improved  $C^2GS^2$  model to carry out the evaluation of the specific implementation steps as shown in Figure 2.

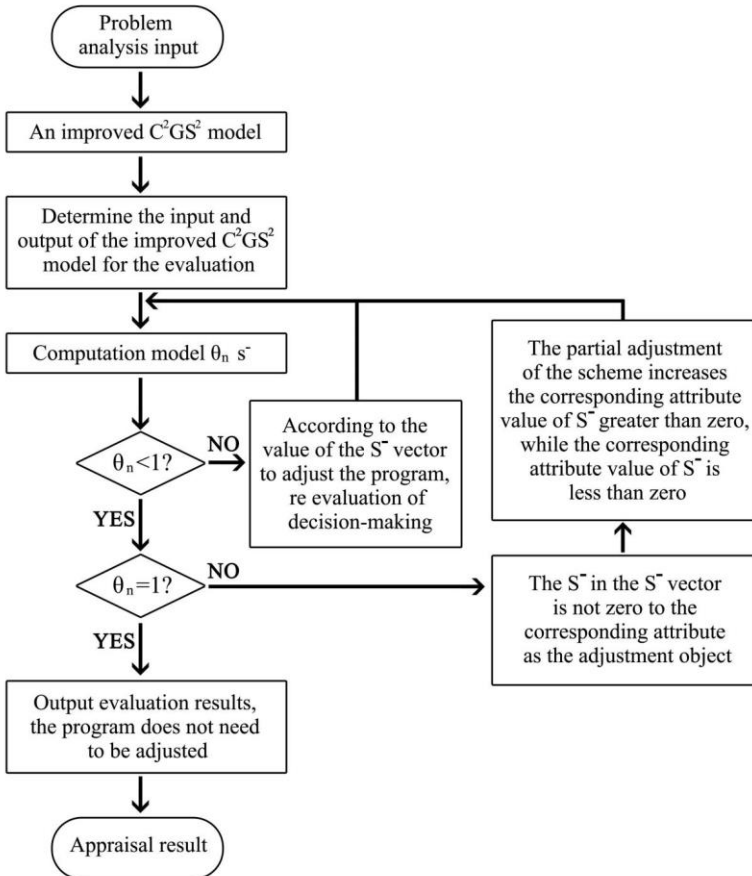

Fig. 2. The evaluation steps based on improved  $C^2GS^2$  model

- (1) The evaluation index system of group decision making scheme is obtained, and the group decision making scheme  $P$  is obtained.
- (2) The attributes of evaluation index system are taken as the input vector of the improved  $C^2GS^2$  model, the evaluation index value is taken as the output

vector, and assigns the attributes of evaluation index and the corresponding weight value of the attributes to  $\beta_i$  and  $\lambda_j$ .

- (3) Using the improved model to check whether the optimal scheme is in the production possibility set, when  $\theta \leq 1$  in the ( $D'$ ) computation, it determines the project belongs to the production possibility set to retain the scheme. On the other hand, when  $\theta > 1$  in the ( $D'$ ) computation, it is determined that the scheme does not belong to the production possibility set, which should be redone and adjusted the scheme.
- (4) It adjusts some attributes values of scheme with  $\theta_0 < 1$ , and the input value of the scheme is changed until the  $\theta_0 = 1$ , which expresses that the scheme is in the optimal condition.

## 5. Application Example

The library information resource allocation is a complex group decision-making problems, this is due to the characteristics of library information resources is random and dynamic, the number of people using the library resources, library information resources utilization of library resources time, user demand is discrete, random, but also for the needs of different groups of different level and different the time period of the information resources, thus bring difficulty to the library information resources allocation decision.

The use of library information resources allocation effect of group decision factors is the ratio of information resources of information resources, the average waiting time, queue length, the largest information resource information query cost (including information acquisition costs, the allocation of information resources of the operating costs), total demand allocation scheme, and the total number of information for information the proportion of. The utilization ratio of information resources is composed of different types of information. Then the evaluation index system of the information configuration group decision making scheme is shown in figure 3.

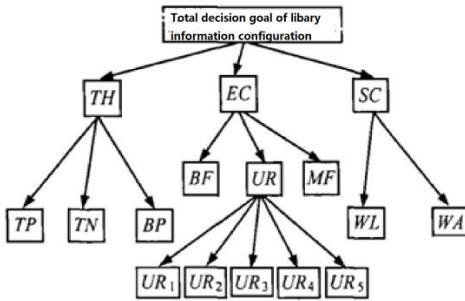

**Fig. 3.** Evaluation index system structure of library information configuration group decision making

TH-The technical performance; EC- economy; SC- information service level; WA- the average waiting time; UR- information utilization; BF- purchase cost information; MF- the information resources of the library operation expenses; TP- maximum waiting for captain information; TN- the total efficiency of the library information resource allocation scheme; BP- information service points center cloud information service node proportion; UR1- 1 type information node (node can guarantee the user below 10) utilization rate; UR2 - 2 type information node (node can guarantee the user below 50) utilization rate; UR3- 3 type information (node can guarantee the user bellow 100); UR4- 4 type information node (node can guarantee the user below 1000); UR5- 5 type information node (node can guarantee the user below 5000).

Through the group decision making method of group decision making system, the optimal scheme of library information resource allocation in a university in Wuhan of 2015 is given in Table 1, which is shown in table 2.

**Table 2.** The optimal scheme of library information resource allocation in a university in Wuhan of 2015

Node type	Type 1	Type 2	Type 3	Type 4	Type 5	Value of evaluation
Scheme 1	1	7	2	1	4	0.951
Scheme 2	1	7	2	2	3	0.919
Node number	1	6	2	1	2	-

Based on the data of table 2, we can conduct the optimal scheme of library information resource allocation according to the improved  $C^2GS^2$  model.

In the improved  $C^2GS^2$  model of library information resource allocation, the input variables are  $TP, TN, BP, WA, BF, MF, WL, UR1, UR2, UR3, UR4$ , and the output variables are  $TH, EC, SC$ .  $x_0$  is the library cloud information service node number, such as the vector  $x_0$  of scheme 1 is [1,7,2,1,4];  $y_0$  is the comprehensive evaluation value, such as the vector  $y_0$  of scheme 1 is 0.951. So we can establish the improved  $C^2GS^2$  model of library information resource allocation, which is shown in formula (5).

$$\left\{ \begin{array}{l} \text{s. t.} \left\{ \begin{array}{l} \min \theta \\ K_{TP} \times V_{TP} + K_{TN} \times V_{TN} + K_{BP} \times V_{BP} + K_{WA} \times V_{WA} + K_{BF} \times V_{BF} + K_{MF} \times V_{MF} + \\ K_{WL} \times V_{WL} + \sum_{i=1}^n (K_{URi} \times V_{URi}) + NS^- = x_0 \times \theta \\ K_{TH} \times V_{TH} + K_{SC} \times V_{SC} + K_{BC} \times V_{BC} - S^- = Value \\ K_{TP} + K_{TN} + K_{BP} + K_{WA} + K_{BF} + K_{MF} + K_{WL} + \\ \sum_{i=1}^n K_{URi} = 1 \\ K_{TH} + K_{BC} + K_{SC} = 1 \end{array} \right. \end{array} \right. \tag{5}$$

Where,  $\theta$  is vector  $\begin{bmatrix} \theta_1 \\ \theta_2 \\ \theta_3 \\ \theta_4 \\ \theta_5 \end{bmatrix}$ ,  $S^-$  is vector  $\begin{bmatrix} S_1^- \\ S_2^- \\ S_3^- \\ S_4^- \\ S_5^- \end{bmatrix}$ . The data of table 1 are plugged into

formula (5) to evaluate the optimal scheme of library information configuration. The results are shown in table 2.

**Table 2.** The first evaluation result of the optimal scheme

Scheme	$\theta^T = [\theta_1, \theta_2, \theta_3, \theta_4, \theta_5]$	$S^{-T} = [S_1^-, S_2^-, S_3^-, S_4^-, S_5^-]$
Scheme 1	[1,1,1,1,1]	[0,0,0,0,0]
Scheme 2	[1,0.75,1,0.82,1]	[0,-0.87,0,1.37,0]

The computation results show that the  $\theta$  values of two schemes all satisfy  $\theta \leq 1$ , so the two schemes are all in the “product possibility set” of library information configuration. The  $\theta$  values are all 1, and the values of  $s^-$  are all 0, which shows that scheme is in the optimal condition of this scheme configuration, and not need to adjust. The  $\theta$  values of type 2 and 4 are not 1 to scheme 2, which shows that this

scheme is not in the optimal condition, and can adjust the configuration of type 2 and 4 to make the scheme be in the optimal condition. The slack value of type 2 is negative and the slack value of type 4 is positive in  $s^-$ , which show that we need the decrease the number of type 2, and need to increase the number of tpye4. So we adjust the type 2 number as 6 in scheme 2, and adjust the type 4 number as 3 in scheme 2. Then we can get scheme 3, the result show in Table 3 after comprehensive evaluation computation.

**Table 3.** The library information configuration of scheme 3

Type	Type 1	Type 2	Type 3	Type 4	Type 5	Value
Scheme 3	1	6	2	3	3	0.942

We can evaluate the scheme 3 by substituting the data into formula (5). The evaluation results show in Table 4.

**Table 4.** The improved model evaluation results of scheme 3

Scheme	$\theta^T = [\theta_1, \theta_2, \theta_3, \theta_4, \theta_5]$	$S^{-T} = [S_1^-, S_2^-, S_3^-, S_4^-, S_5^-]$
Scheme 3	[1,1,1,1,1]	[0,0.05,0, -0.02,0]

From the Table 4, the  $\theta$  values of scheme 3 are all 1. Although he values of  $s^-$  are not all 0, there are very small, which shows that the adjustment scheme 3 is almost in the optimal condition. From the adjustment process of the above scheme, the scheme 2 decreases type 2 information node (node can guarantee the user below 50) and increases type 4 information node (node can guarantee the user below 1000), which satisfies the improvement of library imformation.

## 6. Conclusions

This paper discusses the application of DEA evaluation method, especially the  $C^2GS^2$  model and related algorithm in the evaluation of group decision system. As the precondition of the  $C^2GS^2$  model for the evaluation of the scheme is that the program itself is in the production possibility set, while in the general study of the program evaluation, we need to judge and then decide whether it is reasonable and feasible or not. To meet the requirements, the  $C^2GS^2$  model is improved so that the judgment

function of feasibility is increased, and the plane can be adjusted properly. In the end, the examination of the evaluation example of Library Information Cloud Nodes Configuration Scheme proves the improved  $C^2GS^2$  model that evaluates the group decision-making system to be feasible.

## Reference

1. Jagdeep Kaur, Pradeep Tomar, "Multi Objective Optimization Model using Preemptive Goal Programming for Software Component Selection", *International Journal of Information Technology and Computer Science(IJITCS)*, vol.7, no.9, pp.31-37, 2015. DOI: 10.5815/ijitcs.2015.09.05
2. Tushar Tyagi, Hari Mohan Dubey, Manjaree Pandit, "Multi-Objective Optimal Dispatch Solution of Solar-Wind-Thermal System Using Improved Stochastic Fractal Search Algorithm", *International Journal of Information Technology and Computer Science(IJITCS)*, Vol.8, No.11, pp.61-73, 2016. DOI: 10.5815/ijitcs.2016.11.08
3. Shahram Saeidi, "A Multi-objective Mathematical Model for Job Scheduling on Parallel Machines Using NSGA-II", *International Journal of Information Technology and Computer Science(IJITCS)*, Vol.8, No.8, pp.43-49, 2016. DOI: 10.5815/ijitcs.2016.08.05
4. Carlos Castro. Identifying The Best Compromises Between Multiple Performance Measures in Injection Molding (IM) Using Data Envelopment Analysis (DEA). ANTEC 2003 Conference Proceedings London: IEEE Press, 2003: 377-381.
5. B.Dervaux, H.Leleu, V.Valdmanis, D.Walker. Parameters of Control when Facing Stochastic Demand: A DEA Approach Applied to Bangladeshi Vaccination Sites [J]. *International Journal of Health Care Finance and Economics*, December 2003, Volume 3, Issue 4, pp 287–299.
6. Paradi.Joseph C; Schaffnit Claire. Commercial Branch Performance Evaluation And Results Communication In A Canadian Bank—A DEA Application [J]. *European Journal of Operational Research*, 2004, 156(3): 719-735.
7. Wang Ying, Sun Linyan, Chen Hong. Logistics Synthesis Evaluating On DEA /AHP Two-stage Model [J]. *Journal of Chang'an University (Natural Science Edition)*, 2003, 3 (23): 79-84.
8. Zou Ping, Li Chunmei. Research of group decision support method based on DEA model [J]. *Control and Decision*, 2002, 6(17): 944-947.

9. Wei Quanling. DEA method for evaluating relative effectiveness: a new field of operational research [M]. China Renmin University Press, 1988.
10. LI Tongning, Chen Xuezhong. DEA Method for Evaluating and Controlling the Estimating Accuracy of Project Investment [J]. Systems Engineering-Theory & Practice, 1999 (5): 96- 99.

# Anthropometrical Model in Pentacanon

Rakcheeva T.

A. Blagonravov Institute of Machines Science of the Russian Academy of Sciences (IMASH) 4,  
Maly Kharitonievskiy Pereulok, Moscow, 101990, RUSSIA  
rta\_ra@list.ru

**Abstract.** It is well known that human health is determined not only by the presence or absence of diseases, and by the harmonious development of the basic functional indicators, and by a harmonious figure including. The configuration anthropometrical canon gives structural metric organization of a human skeletal figure by inscribing into different regular geometrical figures. In this work the attempt is described to determine full number of configurational relations (pentacanon) for *a human skeletal figure* by inscribing into a pentagram. Pentacanon system supposes the decision of the inverse problem for recovery of anthropometrical model parameters. It was carried out the statistical analysis of pentacanon correspondence to the individual anthropometrical data. The comparative analysis of number of invariants obtained by the inscribing method for human skeletal figure into different ordinal simplexes is carried out also; the pentagram gives the greatest number of invariants. It is shown also that the same skeletal figure can be packed into internal pentagon using the “folding rule” method. “The whole history of medicine shows that the swift growth of knowledge in the field of general medical theory, clinical medicine and private pathology occurs after their anthropological irrigation.” [1]

**Keywords:** Anthropometry, harmonious physique, geometrical model, canon, pentacanon.

## 1 Introduction

Human body skeletal structure is a complex system of interconnected elements, united by common functional tasks. These tasks devoted to life support and creation have been solved constantly and, of have evolved into a perfect example of complex system structure. The study of norms of human figure structural organization has been known since ancient times. Contributions were made by Pythagoras, Policlet, Vitruvius, L. da Vinci, MA. Buonarroti, Agrippa, Durer and many others. If the first formulations of regularities determining the harmonious figure concerned the relationships between the individual elements of the figure, then over time another paradigm of relation to harmonious figure was formed as to the system of relations between constituent elements that form a harmonious whole. "The universal measure



must be observed in the length of the figures and not in their thickness" (L. da Vinci). "In every properly and normally constructed body, an exactly established law of the correct proportionality of its constituent parts must be observed - in general all parts of the body are in a certain relation to its overall height." (Vitruvius, 1st century BC).

The set of disparate metric relations (modular, proportional or more modern scale), called *canons*, has reached our days. In addition, there are well known the examples of revealing the structural properties of a human skeletal figure by inscribing into different regular geometrical figures, for example, into circle or square. Leonardo da Vinci's picture exemplifies such «configuration method». Other known example of this method is Henry Agrippa's picture where the human figure is inscribed into a pentagram. As long as each of the specified geometrical figures possesses certain symmetries, each variant of inscribed configuration allows to reveal the human figure symmetrical properties. The set of configuration invariants describing the metric properties of a *skeleton figure* (SF) through symmetries of the regular geometric figure into which it is inscribed can be called a *configuration canon*. As far as we know the complete mathematical analysis of the configurational relations was not carried out and Agrippa's figure is usually used as an art illustration.

Only at the beginning of the IX century did a need arise for exact measurements of the body in addition to a verbal description of its form. At the same time anthropology has emerged as an independent field of science and anthropometry became its center and support. The main task of anthropometry was to find mathematical formulas expressing the relations of various parts of the body. Thanks to the success of anthropometry, such formulas were found for the average figures of people in the population.

The purpose of this study is to attempt to form a pentagonal configuration anthropometric canon, called *pentacanon*. The basic statement of the work is the following.

*Pentacanon allows receiving ultimate system of anthropometrical relations, which is sufficient for all adult person segment identification.*

The proof of this statement is carried out below by a method of consecutive geometrical constructions.

SF inscribing into a pentagram is made elementary only for 5 distal points — head, hands and foets, which are combined with vertices of a pentagon. Full configurational inscribing of the human figure means search the additional points associated with pentagram geometry which are compatible with joints — internal points of a multisegmental human skeleton.

## **2 Human Skeletal Measuring System**

All the long-term experience of modern anthropometric studies also shows that anthropometric techniques based on bone, osteometric measurements should be used in clinical anthropology.

Firstly, let's consider all the traditional circuit of anthropometrical measurements (see Fig. 1): here  $H = v_1$  — growth,  $v_2, v_3$  — heights of a chin and shoulders;  $b_1, b_2, b_3$  — levels of navel, belt of hip-joint, pubis;  $h_1, h_2, h_3$  — levels of elbow, wrist, the ends of fingers;  $l_1, l_2$  — levels of knee, ankle;  $s_1, s_2$  — width of shoulders, hip belt,  $s_3$  — length of feet.

Base human SF is determined by set of the primary parameters, received in standard procedure of measurements:

$$\{v_1, v_2, v_3; b_2, b_3; h_1, h_2, h_3; l_1, l_2; s_1, s_2, s_3\}.$$

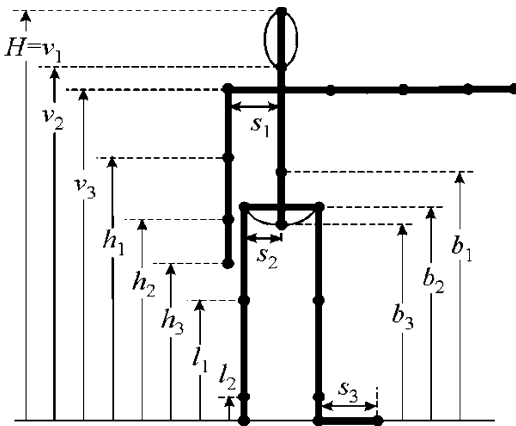

Fig. 1. Anthropometrical data

Let's consider primary SF circuit given in a graphic kind (as shown in Fig. 1) for the average anthropometrical data. This metric circuit allows up to pay attention to one relation:

$$b_3 - h_2 = 0, \tag{1}$$

as apparently from Fig. 1, a wrist is at a level of a pubis.

### 3 The Inscribing in the Pentagon

Distance from top up to a pubis we shall accept as unit radius of a circle with centre in the last:

$$C_1: v_1 - b_3 \equiv R = 1, \tag{2}$$

in which we shall inscribe a regular pentagon  $P_5$  (see Fig. 2). Using a compass, we shall transfer distal points and pairs of internal joints of hands and legs on the constructed straight lines, incidental to corresponding joints extremities. It turns out that for the "average" anthropometric data (the "average model" of the human SF), the

expected hit of the distal points in the pentagon apexes of  $P_5$  takes place with satisfactory accuracy.

Let's pay attention to two isosceles trapeziums, one of which is formed by legs, a segment of a basin and the bottom side of the pentagon, and the second - hands, a segment of a shoulder belt and a chord. Knowing length of the side of pentagon  $P_5$ , equal to  $2\sin\alpha$  (here  $2\alpha = 2\pi/5$  — the angle between pentagram rays), we can, using Pythagoras theorem, to make two equations connecting elements of a pentagon and SF. Marking existence of such nonlinear relations, we do not include them in the further system of determining relations.

It is possible to allocate still the third rectangular triangle, one of the vertices of which is in top, and the side of a pentagon serves as a hypotenuse. A head plus the neck, plus a forearm make a vertical cathetus of this triangle from where we have:

$$v_1 - h_1 = 2\sin 2\alpha. \tag{3}$$

The linear relation (3) given by a triangle is included in system of determining ratios. Executed inscribing of human SF into a pentagon reproduces the original Agrippa's figure. Except for a circle, Agrippa's figure contains still a pentagram. This pentagram, denoted by  $Pg_5$ , is inscribed into pentagon  $P_5$  and contain else small pentagon  $p_5$  (see Fig. 2).

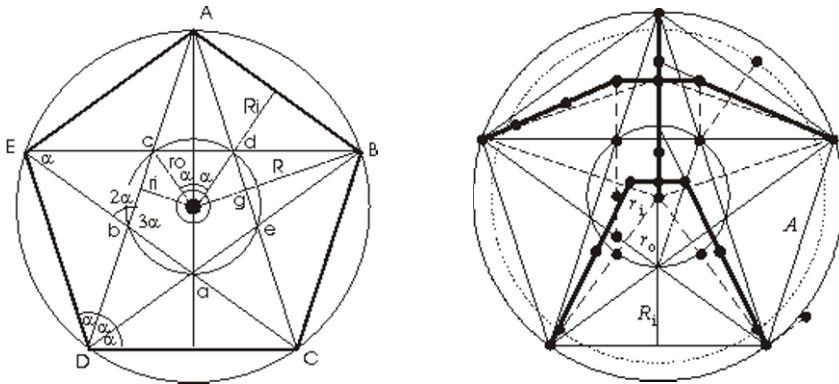

**Fig. 2.** Pentagram and Pentacanon

Characteristic parameters of the pentagonal structure contain the following set of constants  $C \equiv \{A, a, R_i, r_o, r_i\}$ , where  $A = 2R\sin\alpha$  — the side of  $P_5$ ,  $a = 8R\sin\alpha\cos^2 2\alpha$  — the side of  $p_5$ ;  $R_i = R\cos\alpha$  — the radius of inscribed circle into  $P_5$ ;  $r_i = R\cos 2\alpha$  and  $r_o = 2R\sin\alpha\sin 2\alpha$  — are the radii of inscribed and described circles of small pentagon  $p_5$  (see Fig. 2).

From the received circuit it is visible (see Fig. 2), that joints of hand fall to special points or lines of a pentagram. It allows us to formulate remaining required relations of a pentagram and SF which are easily formalized and have a linear kind.

A complete derivation of the in the form of 12 linear equations is given in [2-3]. Dedicated relations in the form of a system of equations form a complete linear

system of independent invariant pentacanon equations that determine also the synergy of the structural organization of the human figure.

#### 4 Inverse Problem and Statistical Analysis

Below is the solution of the system: on the left, in the parameters of the simplex  $\{A, R_i, r_o, r_i\}$ , which in turn are expressed in terms of the radius of the circumscribed circle  $R$  and the order of the simplex  $n = 5$ , and in the right column through the radius  $R$  and well known constant  $\varphi = (1+\sqrt{5})/2$ :

$$\begin{array}{ll}
 v_1 = 2R - \Delta b & = R(5\varphi + 6)/2\delta \\
 v_2 = 2R - r_o A^2/2R^2 - \Delta b & = R(5\varphi - 2)/\delta \\
 v_3 = R + 2r_i - \Delta b & = 7R\varphi/2\delta \\
 b_3 = R - \Delta b & = R(3\varphi + 2)/2\delta \\
 h_1 = 2R - (r_i + r_o) - \Delta b & = R(5\varphi + 1)/2\delta \\
 h_2 = R - \Delta b & = R(3\varphi + 2)/2\delta \\
 h_3 = 2R - (r_i + r_o) - R(A/2R_i)^2 - \Delta b & = R(15\varphi - 19)/2\delta \\
 l_1 = R - r_o & = R(\varphi - 1) \\
 l_2 = R - r_o - R(A/(2R_i))^2 & = R(5\varphi - 8) \\
 s_1 = Ar_o/R & = R(2 - \varphi)(3 - \varphi)^{1/2} \\
 s_2 = 2A\Delta b/r_o & = R(3 - \varphi)^{1/2}/\delta \\
 s_3 = r_i & = R(\varphi - 1)/2
 \end{array}$$

where  $b_2 = R$ ,  $\Delta b = b_2 - b_3 = r_o^2/(2R_i + 3r_o) = R(2 - \varphi)/(2\delta)$ ;  $\delta = (\varphi + 2)$ .

All 12 parameters of human SF calculated thus give the solution of the inverse problem in an obvious kind. They allow on one parameter — *to radius or to height* — to calculate parameters of the generalized skeletal design of the person and the sizes of separate joint elements and build an anthropometric model.

*This result supports the basic statement above.*

The pentacanon relations, alongside with other canons, have passed statistical check on precision and stability (all 32 relations have been considered). Data sampling was the measurement of human SF of modern young people mostly in the volume of 50 people without selection of harmonious folded figures, as well as literature data in the form of numerical tables or anatomical images of human SF.

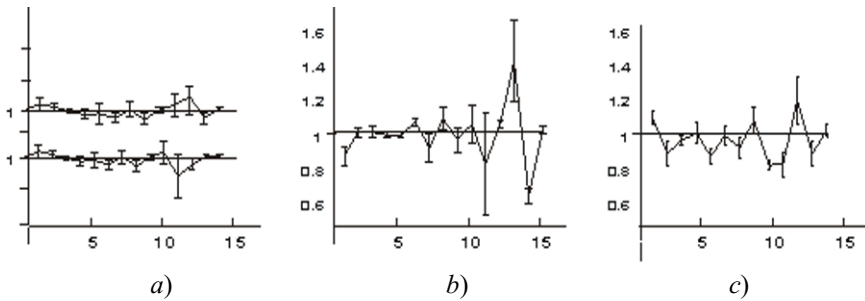

Fig. 3. Statistical analysis of the canons

All the ratios of pentacanon (*a*), proportional (*b*) and modular (*c*) canons are reduced to 1. Two graphs (see Fig. 3*a*) correspond to two options for determining hip-joint parameters in the pentacanon model, and this variation is also explained by this ambiguity. It can be seen from Fig. 3 that the pentacanon system has more stable and undisplaced relations. Such relations exist among the proportional ones, as well; for example, 2-5 (see Fig. 3), but these are the relations of the wurf relations for the human SF three-links, which are essentially nonlinear. For 12 human SF parameters, the numerical values of the ratio of the mean values of the parameters obtained from a sample of real figures to the corresponding values of the parameters determined by pentacanon with the intervals of variation of these relations in standard deviations are given below:

$$\begin{aligned}
 &v_1(1,01\pm 0,02), v_2(1,02\pm 0,02), v_3(1,02\pm 0,02), \\
 &b_2(1,04\pm 0,05), b_3(1,02\pm 0,04), \\
 &h_1(1,00\pm 0,04), h_2(1,02\pm 0,04), h_3(1,03\pm 0,04), \\
 &l_1(0,95\pm 0,05), l_2(1,01\pm 0,07), \\
 &s_1(0,95\pm 0,05), s_2(0,96\pm 0,06), s_3(0,95\pm 0,04).
 \end{aligned}$$

The results of both graphical comparison and statistical analysis indicate the adequacy of the model to the sample data.

## 5 SF-Invariants on Different Structures

The procedure for the configuration of inscribing the metric structure under study into other structures with known metric properties, such as regular (semi-regular) geometric shapes, gives a new method for searching structural patterns - *structural cognitive graphics*.

In the framework of this paper, a comparative analysis of the number of invariants obtained as a result of inscribing in simplexes of different orders (from 3 to 8) was made (see Fig. 4).

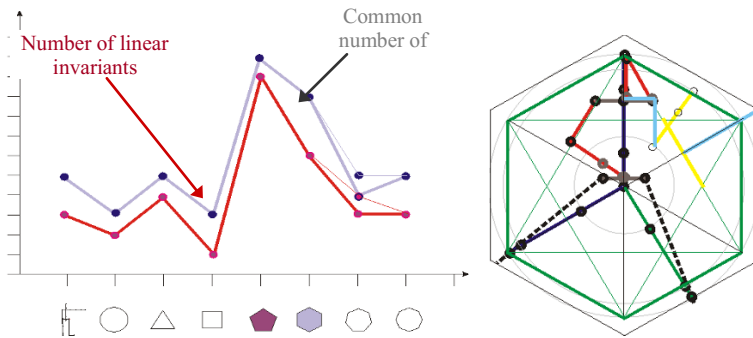

**Fig. 4.** Structural cognitive graphics: the number of SF-invariants; inscribing in hex

At the beginning of the horizontal axis, there are two additional marks, the first of which corresponds to the situation when the skeletal figure of a person appears as the reference structure, and the second one is a circle. The graph shows that the maximum number of invariants is given by a pentagon, a significant amount of it is given by a hexagonal structure (see Fig. 4); further complication of the structure is not accompanied by an increase in the number of invariants.

Thus, the choice of the pentagon as a structure for deducing the total number of invariants is not accidental, the pentagon occupies a special place in a series of simplex structures of low orders.

Thus, the pentacanon statement formulated above is proved. The proof is based on a conclusion of full system of the equations. Here we were limited to selection in initial system only the linear equations. Other variants of synthesis of system of the determining equations, in particular, the square-law equations mentioned above are possible also. Then the decision of a inverse problem needs more difficult method.

## 6 Pentagon Packing

It is interesting that the same rigid skeletal figure can be packed into internal pentagon using the “folding rule” method (see Fig. 5).

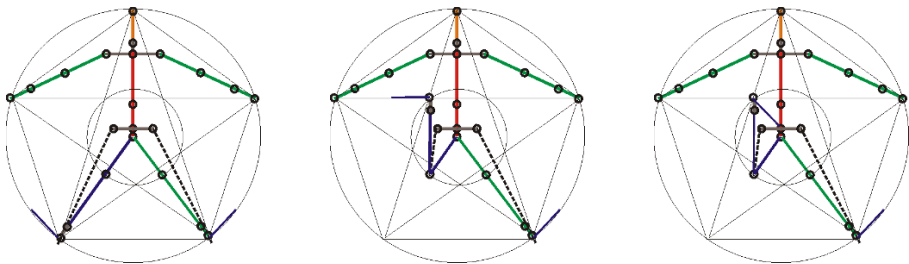

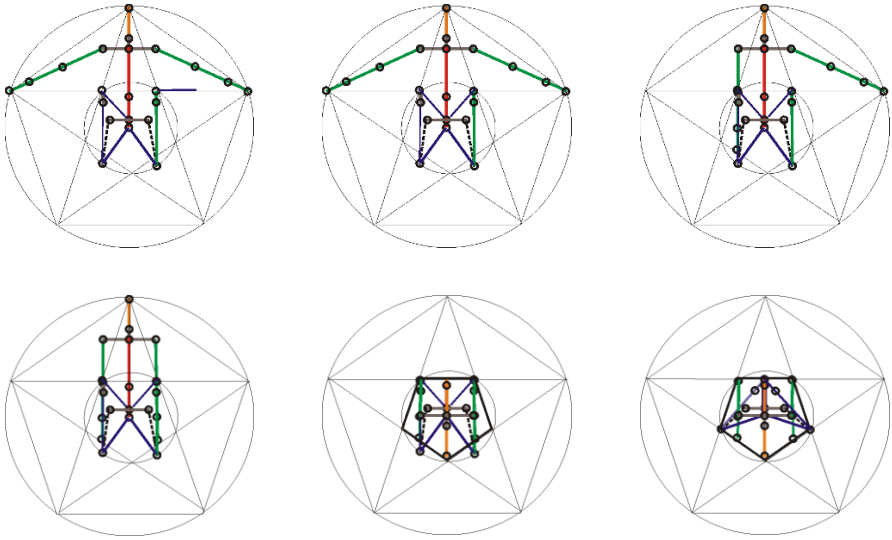

**Fig. 5.** The successive steps of the SF packing into internal pentagon

All folding performed on the articular divisions of the arms and legs, the trunk is folded at the waist level. The distal points of the folded SF, as can be seen from the figures, fall on the vertex points and lines of the small Pentagon.

## 7 Conclusion

"It is more important to know what kind of person has a disease than what sort of disease a person has." (IV century BC). This formulation expresses a universal, anthropologically oriented clinical approach, established in the course of the development of medical sciences. It is natural to believe that the university style of education should include an orientation toward a holistic approach in medicine. At the same time, it is necessary to use all possible means that contribute to the integral perception of information by students [4-6]. So, if a student of a medical university comes to the chair of anatomy and anthropology, where one can see the sculptures of the Greek god or goddess, then the notions of harmony, the canonical proportions of the human body and the amazing correlations between its segments will forever be associated with these images for him. [1].

The configuration canons origins, perhaps, go back much further than the Renaissance, to which the above mentioned examples of configurational inscription refer. As Vitruvius notes, the Greeks used irrational proportions in the study of the human body. He calls this system "geometric symmetry," distinguishing it from a system of proportions based on integer or fractional-rational numerical coefficients, called "arithmetical symmetry". In fact, irrational proportions can be obtained only by

geometric construction on the plane; therefore, if the investigated metric structure, in this case, the human SF, contains irrational relations, geometrical symmetries and the geometric canons formulated on their basis will be adequate means of describing the internal regularities.

It should be noted that the idea of searching for metric-structural regularities through comparison with a certain reference structure can be caught in the literature. "Geometric canons are one of the most interesting forms of generalization of concepts about ideal proportions of the body. Their construction was the result of the application of geometric constructions in artistic composition in general and in architecture in particular. The correspondence between architectonic sketches and body proportions should be understood more as a result of the use of architectonic, geometric diagrams for the analysis of the human body, and not as a result of the transfer of biological proportional laws to architecture." Perhaps we should only remove some categoricity of this statement - this process can be mutually inverse.

In conclusion, it is appropriate to quote the words of Marsilio Ficino (1492 y.): "Art by its perfection and accuracy is due to mathematics and its ability to count, measure and weigh; without mathematics all arts would be illusory. So, the canon is the result of subordination of the spirit to mathematical laws and at the same time comprehension of world harmony."

"Let neither the physiologist nor the practical doctor forget that medicine unites in itself all knowledge about laws that can determine the body and spirit" (R. Virchow, 1849 y.).

## References

1. Kornetov N.A. Conception of clinical anthropology in medicine. //Bulletin of Siberian Medicine, № 1, 7-30 (2008).
2. Rakcheeva T.A. Pentacanon. //Symmetry; Culture and Science. The journal of the Symmetrion. Vol. 17, N. 1-2, 1-208. Festival of symmetry, Materials. Budapest, pp.113-120 (2006).
3. Rakcheeva T.A. Pentacanon invariants of anthropometry. //Legislative and applied metrology. 6(106), 54-61 (2009).
4. Mohammadreza Mesbahi, Amir Masoud Rahmani,"Load Balancing in Cloud Computing: A State of the Art Survey", International Journal of Modern Education and Computer Science(IJMECS), Vol.8, No.3, pp.64-78, 2016.DOI: 10.5815/ijmeecs.2016.03.08
5. Pia S. Niemelä, Martti Helevirta,"K-12 Curriculum Research: The Chicken and the Egg of Math-aided ICT Teaching", International Journal of Modern Education and Computer Science(IJMECS), Vol.9, No.1, pp.1-14, 2017.DOI: 10.5815/ijmeecs.2017.01.01
6. Zoran Kotevski, Ivana Tasevska,"Evaluating the Potentials of Educational Systems to Advance Implementing Multimedia Technologies", International Journal of Modern Education and Computer Science(IJMECS), Vol.9, No.1, pp.26-35, 2017.DOI: 10.5815/ijmeecs.2017.01.03



# **Advances in Medical Approaches**

# Intelligent Internet Technology for Personalized Health-Saving Support

Krut'ko V.N.<sup>1,2</sup>, Bolshakov A.M.<sup>2</sup>, Dontsov V.I.<sup>1</sup>, Mamikonova O.A.<sup>1</sup>, Markova A.M.<sup>1</sup>, Molodchenkov A.I.<sup>1</sup>, Potemkina N.S.<sup>1</sup>, Smirnov I.V.<sup>1</sup>

<sup>1</sup>Institute for Systems Analysis, Federal Research Center "Computer Science and Control" of Russian Academy of Sciences; 9, 60-let Oktyabria str., 117312, Moscow, Russia,

<sup>2</sup>Sechenov First Moscow State Medical University; 8-2, Trubetskaya street, 119991, Moscow, Russia

**Abstract.** Multifactorial nature of human health and need in personifying the approach to each person leads to the fact that full implementation of healthy life style (HLS) technologies is possible only on the basis of artificial intelligence technologies, widely implemented in the preventive medicine via modern Internet technologies. Modern computer systems allow considering simultaneously big data of separate factors in health assessing and selecting of individualized recommendations for personal HLS. This article presents a concept and a structure of intelligent Internet technology for personalized health-saving support, which allow assessing health and preparing individual optimal recommendations for HLS.

**Keywords:** Health, health-saving, big data, healthy life style, Internet technology, preventive medicine, personalized medicine.

## 1 Introduction

Medical and demographic situation in many countries is one of the main obstacles for an effective socio-economic development. Human health has a multifactorial nature and, so it is necessary to personalize the approach to each patient, a full implementation of health-saving (HS) technologies is possible with active using of modern information technologies in the preventive medicine only.

At the assessment of health status and the selection of individualized recommendations, the modern computer systems allow simultaneous considering many individual factors, which gives people many opportunities in learning [1,2], choosing a healthy lifestyle (HLS) and personal HS [3,4]. Many such systems are available in clinical medicine. IBM Watson is the most famous. In the preventive medicine and HS they are significantly less applied and usually solve particular problems. Usually, a limited amount of data is used to diagnose separate health indicators. So, Internet service Mhealth [5] makes a conclusion about the general state of health and age-related changes based on data on physical activity during the day. Pulse data are widely used to assess stress and overall health [6]. When considering such services, it is worth re

membering about the differences between mHealth and fitness/wellness, however in modern Internet services their convergence is observed [7]. Most fully the main factors of HS: nutrition, physical activity, sleep, fitness - are presented in the Health Box [8].

There is no service integrating diagnostics and prevention of health and chronic diseases, diagnostics of biological age and prevention of age-related changes for a wide range of users. The advantage of our system is a systems approach and an attempt to take into account all the significant factors impacting health.

The literature tells that the HS technology may add 10-15 additional years of active healthy life [9]. The assessments conducted in many countries show that the increase of the life expectancy for one year may cause an increase in the country's gross domestic product for about 4% [10].

This article explores scientific and technical solutions and a new intelligent Internet technology for personalized support of health-saving processes, based on the analysis of big data of health and its key factors. Today our system is at the experimental testing stage. This article objective is to describe the basic principles, approaches and underlying methods, as well as the overall architecture of the system.

## 2 Concept and Structure of Intelligent Internet Technology for Personalized Health-Saving Support

### 2.1. Principles of Personalized Health-Saving Support

The main methodological principle of the proposed health-saving technology concept is *method of objectives management*.

The method is based on the control over the information environment, which means the quality control over the information objects (in our case - every person), i.e. help in the objectives formulation, development of the effective methods and the target reaching, information support and training for personal practical application of the proposed methods and technologies.

The key principle is *personification*, i.e. an individual approach to each person, considering his/her gender, age, habits and form of activity, together with data records about the person's genetic, psycho-physiological and medical characteristics, i.e. "health portrait".

Other important principles include:

The *principle of completeness* is understood as an intention to maximal recording of all the most significant processes affecting the human health; it is implemented in the N-dimensional "Control space of personal health".

The *principle of systematization* is a requirement to be based on the bio-psycho-socio-mental concept of health, i.e. to cover the whole health-important living environment.

The *principle of open evolutionary development and the principle of optimal balance between conservatism and revolutionary character* are associated with the scale

of the system, the permanent opening of new knowledge about health and methods for its correction.

This principle requires flexible, open, modular system design that allows a qualitative and quantitative developing, supplementing the bases with new information and the system with new algorithms and methods, connecting new external services to the system, while adhering to good conservatism for the proven methods preservation.

The *principle of standardization* stipulates that the existing standards of preventive medicine should be used (on the analogy of medical treatment standards).

There should also be developed new standards of new personalized prevention programs and information technologies for evaluation the efficiency of the means and methods of health improvement, personalized optimization and support of health programs application, monitoring of the obtained results and effects.

The *principle of health-saving motivation and psychological support* determines the interest of people, its attraction and retention in the HS sphere.

## 2.2. Cognitive Methods for Health-Saving Data Processing

The effective support of health-saving processes needs using big data of health and its key factors. We proposed and developed processing methods of the structured and unstructured (textual) medical data, enabling to obtain new knowledge about the effect of various factors on the health status from various data. The obtained knowledge is used to develop personal recommendations for health-savings and a healthy lifestyle. The most significant methods are given below.

The method for intelligent medical data and text processing is intended for:

- taking out the names of diseases, organs, body systems and body parts, medicinal prescriptions, patient data (age, gender etc.), severity of the disease etc. from the medicinal texts. The data taking out from medicinal texts is based on the Relational-situational method of search and text analysis [11, 12];
- revealing the correlation of a person's health status with the characteristics of his life style and other health-saving factors on the basis of machine learning. To do this we used such methods of intelligent data analysis as methods of classification, search for associations, forecasting, including neural networks;
- classifying the individuals and health-saving technologies by the selected characteristics to choose the classes and forms of HS-effects optimal for a certain person, for example, to solve the tasks of identifying the groups of people with a high risk of certain diseases and selecting for them optimal prevention schedules., Clustering and classification methods were used to solve these problems;
- assessing the severity of adverse health changes under the influence of risk factors affecting the person, and assessing the favorable health changes under the influence of beneficial factors which the person received after using the health-saving technologies.

The method of extraction data about the psychological and motivational health-saving characteristics, about the standards of application and the effectiveness of health-saving technologies from Internet is based on the sentiment analysis, psycholinguistics and is intended for:

- revealing the opinions of social media users concerning the efficiency of various health-saving technologies;
- assessing the health status of the Internet user by his messages;
- revealing the psychological and motivational characteristics of health-saving from the social media messages.

The method of the integrated health passport renewal is intended for the automated filling out the human health passport with data from various sources: social networks; case records; statistical databases; information provided directly by the patient etc.

To carry out the experimental studies of the developed methods, we created a test data set containing:

- 1) clinical data set, consisting of real patients case records of one of Russian clinics. The data set includes more than 1000 case records containing examinations data, medical history and results of additional studies (tomography, radiography, skin tests) in text form (conclusions) and the lab results (urinalysis, blood tests, microflora cultures) in a semi-structured form.
- 2) statistical data set, consisting the health status of the population of Russia and the world in conjunction with socio-economic indicators, potentially affecting the health of the population. It contains data of the Russian State Statistics Service on the diseases of the Russian population and the socio-economic situation in general and by regions, the World Bank's data on the health of the population and the socio-economic situation of all countries (262 countries). The data were collected for the past 15 years.
- 3) collections of scientific medicinal articles in Russian and English (about 2,1 million articles). These collections include the most authoritative sources of medical information, including PubMed publications and synopsis of theses. It is available at <http://health.isa.ru/>.
- 4) collection of websites materials about health, containing data on healthy life style and health support (about 30000 pages).
- 5) collection of social media messages, i.e. from blogs, forums, social networks, where real users discuss their health problems and which provide the opportunity to receive consultations from doctors in the Question-and-Answer form (about 10000 messages).

The total size of the test data array is more than 3 million of data sources with a volume of more than 3 GB.

### **2.3. Architecture of Internet Technology for Personalized Health-Saving Support**

In general the intelligent Internet technology for personalized health-saving support is intended for:

- development of recommendations on the selection of optimal personalized health-saving technology (or a set of technologies) which provides maximum improvement of the health status of the person, considering its individual characteristics, preferences and capabilities;
- Internet support of personal decisions of the person at choosing health-saving technologies on the basis of his health passport.

The architecture of System of Health-Saving (SHS) that implements this technology is shown in the Fig. 1. All main SHS modules and services are located on the server side of the system and are the framework that may be extended with new modules and services and modify the existing ones. The framework modules and services are combined into functional blocks: block of client applications; block of analysis and development of recommendations; health passport; block of data obtaining and entering in the health passport; database and knowledge base.

***Client Applications.*** Client applications are series of services that made on external applications that the SHS user interacts with: service of cognitive visualization of user's state, services of user's data input, services of recommendations output for the user. These are the basic services. Each client application may extend its functionality.

***Module for Data Getting and Entering to the Integrated Health Passport.*** The main purpose of this module is to collect data about the system user from various sources and to enter them to the health passport. The sources of information are: the client himself (manual or automated data input from test-questionnaires, distance testing systems, mHealth devices); case records stored in the databases of medicinal information systems (MIS) of healthcare facilities; social networks and forums etc.

***Health-Saving Services and Modules.*** The following main modules and services are included in this block: service for health problems estimation; sub-block of modules for making the recommendations on personalized health-saving; module of intellectual processing of medicinal data and texts; module of data extraction from the Internet and its structuring; module of estimation of health-saving technologies efficiency.

***Databases and Knowledge Bases.*** They included in the system contain a variety of data necessary for implementation the functions of all SHS blocks: data on the health

characteristics of patients and their health determinants; official standards and standards for the values of characteristics and factors; structured information on health-saving obtained from scientific texts and medicinal recommendations; description of the most effective health-saving means and methods etc.

A special role is played by a database containing the information on the health characteristics of certain patients and its health determinants: database of *integrated health passports*.

The term “integrated” emphasizes the importance of recording not only health characteristics but also health determinants in the health passport, which makes the difference between this passport and traditional health passports used in the medical and preventive sphere.

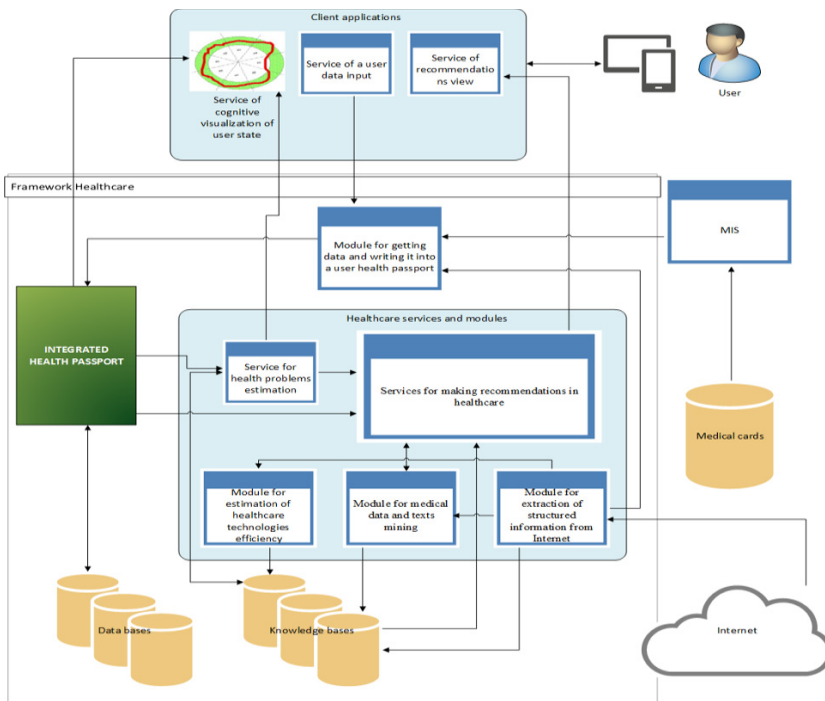

**Fig. 1.** The architecture of system of health-saving (SHS).

**Service for Health-saving Recommendations.** The final practical result of the Internet system for personalized health-saving is a personal user page that allows him to assess his health state and to obtain optimal personal recommendations.

The service of cognitive visualization allows you to visualize the user's state and to highlight graphically the problem areas in general and depending on the tasks that the user wants to solve with health-saving method.

This service allows the user to assess his state and its dynamics during the implementation of health-saving programs.

It is also used at the output of data of the user’s state monitoring, visualization of recommendation fragments, presentation of environmental characteristics and lifestyle.

To visualize the entered data about the user’s state, the service receives data from the health certificate on the server.

The assessment of problem health zones is done by a separate module-service on the server.

To obtain this information, the client application sends a request to the server. The service for the problem zones evaluation receives data about the user’s state from the health certificate, sends them to the knowledge base and sends the response from the knowledge base to the client application. The service for assessment of the problem body zones includes assessment of nutrition, physical and mental performance, psycho-emotional status and stress level and biological age factors (Fig. 2).

The module for the development of recommendations in the health-saving sphere is based on the diagnosis of problem health zones and includes several individualized personalized medical and preventive recommendations, and some general provisions on healthy lifestyle, prevention of age-related diseases and dispensary follow-up monitoring.

The basis for the recommendations is the information obtained from a personalized health passport, including those of the previous diseases and family history, test data and recommendations specific to each of the diagnostic and optimization modules and algorithms for adapting those recommendations to the personal user’s characteristics.

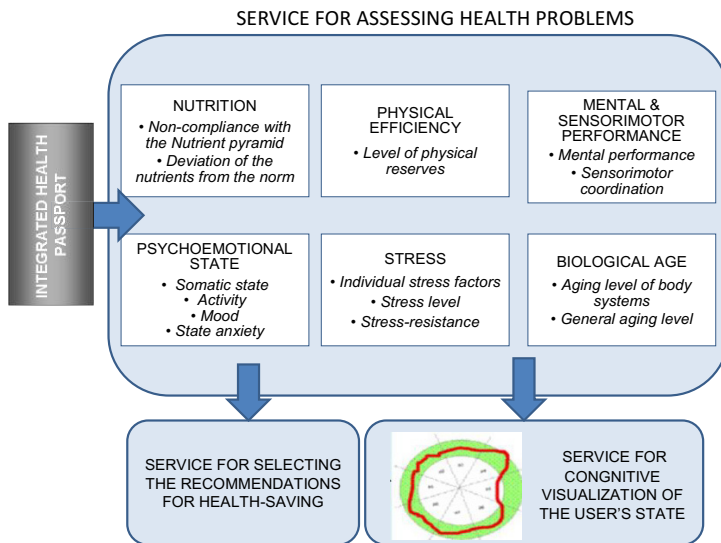

Fig. 2. Structure of service for health problem zones assessment.



### 3 Conclusion

The developed intelligent Internet technology for personalized health-saving support allows obtaining of a novel systemic result - a new, effective technology with no direct analogues in Russia and in the world, which makes it possible to give a reliable information on modern health-saving technologies to each person, to implement additional motivation to a healthy lifestyle and personal information support in solving the problem of optimizing the spectrum and methods of these technologies, considering personal characteristics and preferences of a person.

The expected results of this technology are: improving the quality of life, improving the demographic indicators, increasing the social activity of population, eliminating the risk of depopulation, ensuring social progress and sustainable economic development of the country as the basis for the well-being of every person, a healthy society developing.

### Acknowledgment

This work was financially supported by the Ministry of Education and Science of the Russian Federation. Grant No. 14.607.21.0123 (Unique Project Identifier RFMEFI60715X0123).

### References

1. Walid Mestadi, Khalid Nafil, Raja Touahni, Rochdi Messoussi, "Knowledge Representation by Analogy for the Design of Learning and Assessment Strategies", International Journal of Modern Education and Computer Science(IJMECS), Vol.9, No.6, pp.9-16, 2017.DOI: 10.5815/ijmeecs.2017.06.02
2. Zoran Kotevski, Ivana Tasevska, "Evaluating the Potentials of Educational Systems to Advance Implementing Multimedia Technologies", International Journal of Modern Education and Computer Science(IJMECS), Vol.9, No.1, pp.26-35, 2017.DOI: 10.5815/ijmeecs.2017.01.03
3. Takizawa, K., Takesako, K., Kawamura, M., Sakamaki, T.: Development of medical communication support system "health life passport". Stud Health Technol Inform 192, 1027 (2013).
4. Hsieh, S.H., Hsieh, S.L., Cheng, P.H., Lai F.: E-Health and health-saving enterprise information system leveraging service oriented architecture. Telemedicine and e-Health 18 (3), 205–212 (2012).
5. <https://www.gero.com/mhealth>
6. <https://welltory.com/ru/>
7. <http://wellnessproposals.com/>
8. <https://www.underarmour.com/en-ru/healthbox>
9. Khaw, K-T, Wareham, N, Bingham, S, Welch, A, Luben, R. et al.: Combined Impact of Health Behaviours and Mortality in Men and Women: The EPIC-Norfolk Prospective Population Study. PLoS Med 5(1), e12 (2008).

10. Bloom, D. E., Canning, D., Sevilla, J.: The Effect of Health on Economic Growth: Theory and Evidence. NBER Working Paper № 8587. November 2001.
11. Osipov, G.S., Smirnov I.V., Tikhomirov I.A.: Relational-situational method for text search and analysis and its applications. *Scientific and Technical Information Processing* 37(6), 432-437 (2010).
12. Shelmanov, A.O., Smirnov, I.V., Vishneva, E.A.: Information extraction from clinical texts in Russian. *Computational Linguistics and Intellectual Technologies: Papers from the Annual International Conference "Dialogue"* 14 (21), 537-549 (2015).

# Intelligence Self-Propelled Planar Parallel Robot for Sliding Cupping-Glass Massage for Back and Chest

Sergey N. Sayapin

A. Blagonravov Institute of Machines Science of the Russian Academy of Sciences, 4 Maly Kharitonievskiy Pereulok, Moscow, 101990, Russia  
S.Sayapin@rambler.ru

**Abstract.** There are numerous examples of effective using of sliding cupping-glass massage for disease prevention, treatment, rehabilitation, and removal of weariness. This is kind of massage including combination influences to patient's back and chest by cupping-glasses and massage. However, work of masseur is connected with a big physical stress that can be cause of pathological changes in spine. Moreover, masseur can make the massage only with one patient by two hands. As a result daily productivity of the masseur is limited. Therefore advanced intelligence carried massage robots are needed for sliding cupping-glass massage, being able to work autonomously without the presence of the masseur. A comparative analysis of modern robots is performed (including anthropomorphic one/two-armed massage robots) and any suitable robots for autonomous sliding cupping-glass massage haven't found. Therefore in this paper, a novel approach to a creation of intelligence self-propelled autonomous portable massage robot based on original planar parallel mechanism is presented. The planar massage robot based on triangular parallel structure with 3 d.o.f., called the Triangle, is designed for sliding cupping-glass massage for back and chest. Main massage manipulations of robot are presented along with a description of proposed locomotion algorithms. Locomotion and manipulation experiments are performed by pneumatic prototypes.

**Keywords:** Intelligence Massage Robot, 3DOF Parallel Structure, Planar Parallel Robot.

## 1 Introduction

It is known that a massage is now considered as one of the most effective non-drug methods of effective disease prevention, treatment, rehabilitation, removal of weariness. Therefore now massage is used in clinics, hospitals, and medical centers of many countries. All kinds of the massage are made by a masseur or a patient (self-massage) manually or by massage apparatuses [1, 2]. In order to augment an effect of traditional manual techniques, the masseur may use other massage techniques, for example, such as a sliding cupping-glass massage (SCGM) for back and chest. However, usually SCGM is independent kind of manual massage including combination influences to patient's back and chest by the cupping-glasses and massage. There are

numerous examples of effective using of SCGM in practice medicine [1, 2]. SCGM includes following basic massage movements of vacuum massage cupping glass (VMCG): straight, zigzag, spiral, and figure-of-eight. The masseur makes SCGM personally. Therefore the presence of the masseur is required, but he can make the massage only with one patient by two hands. As a result daily productivity of the masseur is limited. Moreover, the masseur usually performs laborious and monotonous manipulations all day long that lead to his fatigue. A work of the masseur is connected with a big physical stress that can be cause of pathological changes in spine and lumbar one. The self-massage also demands from patient of the big physical stress that is inadmissible for separate categories of patients. Therefore labor-intensive procedures of the massage should be robotized.

Currently, there are variable industrial robots [3-5], which can be used as a base half-autonomous or autonomous massage robots for SCGM, for example, such as anthropomorphic one/two-armed robots (similar to the KUKA lightweight robot) [6] or multi-module parallel robots (similar to the Logabex robot LX4) [3]. Unfortunately, now there are only few examples of practical use of anthropomorphic one-armed massage robots which was created similar to the industrial robots [7-9]. However, these one-armed robots have large sizes and weight, and therefore, they cannot be used in carried massage robotic systems. Furthermore, in case of the patient's body movements, the programmed motion of massage robot is not suitable. Thus, a creation of the carried massage robots for SCGM for back and chest being able to work autonomously without the presence of the masseur is an urgent task. Therefore modern rehabilitation medicine is needed of advanced intelligence carried massage robots, being able to work autonomously without the presence of the masseur [10]. I propose new concept of a self-propelled multifunctional intelligence autonomous carried planar massage robot for SCGM for back and chest based on a triangular parallel structure with 3 d.o.f., called the Triangle [11]. The description of design principles of the Triangle as future intelligence base block for various rehabilitation and other robotic systems that can self-propelled and self-reconfigure is presented below.

## 2 Description of the Triangle

The Triangle is based on the planar triangular parallel mechanism and therefore it has higher a specific stiffness and a bearing capacity, and lower specific weight. In Fig. 1 a structural scheme of the Triangle is shown. The proposed concept will allow be robotize the process of SCGM. As a result there are the following advantages:

- the Triangle is able to organize autonomous conduction of SCGM to several patients simultaneously, and holding cupping massage by several vacuum massage cupping-glasses (VMCG) in the sitting or standing, for example by three VMCG on chest and three VMCG on back of a patient at the same time and, as a result the daily productivity of the masseur increases,
- there is massage by sliding and stretching of muscle tissues at the same time the three VMCG that improves the performance of the process of massage,

- there is the autonomous SCGM to hard reached areas of the body such as back, and ensure the controlled movement of VMCG and VMCG bypass the moving parts of body that are not valid for massage effects, such as moles, sensitive and damaged skin, post-operative wounds, etc.,
- the autonomous SCGM does not require special facilities and can be performed at the bedside and at the home,
- the Triangle released extra time, which can be used to conduct other types of massage and, as a consequence, there is a possibility of increasing the number of patients served per shift,
- there is the reduction of the physical fatigue of the masseur, thereby increasing his productivity and improving health at the end of the work shift.

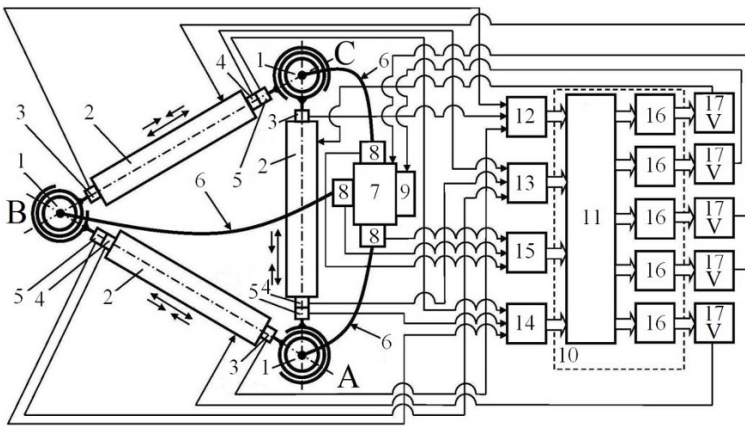
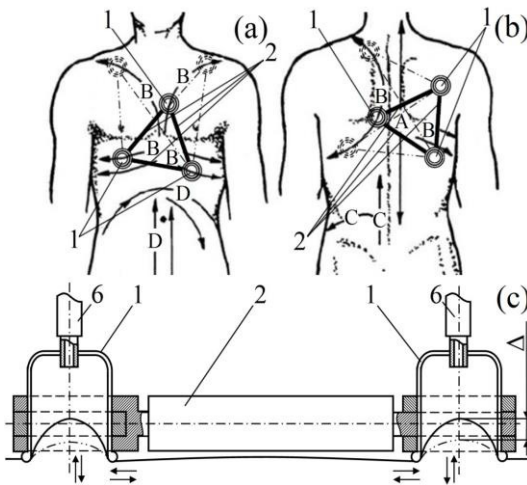

**Fig. 1.** The structural scheme of the Triangle.

The Triangle (Fig. 1) has a massage device based on the active triangular module **ABC** with the parallel structure. The sides **AB**, **BC** and **CA** are made in the form of similar rods. The ends of rods are pivotally connected at the vertices of the active triangular module **ABC** with the VMCG 1. Thus, each of the rods is provided a linear drive 2, a force sensor 3, a relative-displacement sensor 4, and a relative-velocity sensor 5. All vertices of triangle module **ABC** are executed with possibility of connection the like rods through them 2 for the formation of the additional active triangular parallel structures. Each of VMCG 1 is pivotally connected at the vertices of the active triangular module **ABC** and forms its device discrete fixation to the patient's body. In addition, each of the VMCG 1 is hermetically connected by a flexible hose 6 to a mated canal of an air distributor 7 of a degassing system provided with a pressure sensor 8, the air distributor 7 and a vacuum pump 9 electrically connected to a control system 10 in the form of a neural computer 11 with artificial neural network [12], digital-to-analogue converters (DAC), and relevant software (the main advantages of neural computer are associated with massively parallel processing, and as the result is high speed, low requirements for stability and accuracy of the parameters of the elementary nodes, resistance to interference and destruction). The inputs of the control

system 10 are connected through the data buses of analog–digital converters (ADC) to the outputs: of ADC 12, 13, 14 and 15 of the force sensors 3 for ADC 12; the relative-displacement sensors 4 for ADC 13; the relative-velocity sensors 5 for ADC 14; and the pressure sensors 8 for ADC 15. The outputs of the control system 10 are connected through the output data buses to the corresponding inputs of software and the following units, connected in series: DAC 16, power amplifiers 17, linear drives 2, air distributor 7, and vacuum pump 9. The control system 10 is made with the possibility of operational control and management in real-time.

The Triangle works as follows. On surface of the patient's body [1] an active triangle module **ABC** applied with VMCG 1 in its vertices (Fig. 2, a, b).



**Fig. 2.** Schemes of installation of the Triangle and its massage movements in the front view (a) and rear (b); the scheme of the local vacuum-massage and the massage by displacement and stretching the muscles through the massager (c).

The initial position of the active triangle module **ABC** is mounted on the massaged area of the patient's body arbitrary. Then the VMCG 1 degas by the vacuum pump 9 (Fig. 1) and after their individual suction and retraction of the skin on the value for reliable fixation of VMCG 1 and excluding injury of the patient's skin, which is determined visually, close the corresponding valve (in the figures not shown) of the air distributor 7 and record the value of the minimum allowable pressure with pressure sensors 8. Then, using the appropriate valves (on the pictures conventionally are not shown) of the air distributor 7 it is produced depressurization of VMCG 1 to the maximum pressure inside them, which ensures the possibility of their sliding mobility according to the patient's body without detachment from him. At this point, these valves of the air distributor 7 and with the help of pressure sensors 8 are fixed values, the maximum allowable pressures inside the VMCG 1. Further, control system 10 enters data, which include the contours of body areas massaged, associated with the base coordinate system and the coordinates of the areas of the body that are not valid

for massage effects, such as moles, sensitive and damaged skin, surgical wound, etc. Then the control system 10 gives the command to the vacuum pump 9 and the air distributor 7 to degas through the flexible hoses 6 and the respective valves of the air distributor 7 two fixed VMCG 1 on surface of the patient's body and one sliding VMCG. After reaching in these fixed and sliding VMCG the minimum allowable and maximum allowable pressures from the respective pressure sensors 8 through the ADC 15 receives analog signals into the control system 10 in which the control commands are formed, which through the corresponding DAC 16 and power amplifier 17 are fed to the closure of the valves of the air distributor 7 and the shutdown of the vacuum pump 9. After that, relative to the base coordinate system entering coordinates of the centers of the two fixed VMCG and one sliding VMCG and the distance between them. Then, the masseur gives a command to perform the programmed massage movements for the sliding VMCG.

In Fig. 2 (a, b) schemes of the SCGM in various diseases are shown: spinal osteochondrosis and lumbago (A); pneumonia and bronchitis (B); myositis and sciatica (C); colitis and hypertension (D) [1]. As we can see in the above diseases impose the straight movements of the one sliding VMCG 1 and its movements along the circular arcs. After receipt of the command to the control system 10 in the computer 11 (taking into account the previously entered data) the initial coordinates of the VMCG 1 for carrying out massage movements of the VMCG 1 are calculating, for example arcuate movements (B) (Fig. 2, a, b), from the condition of ensuring a minimum number of VMCG rearrangements required to convert the selected path of movement, which depend on the maximum strokes of the linear drives 2. The active triangle module **ABC** can be installed in the initial position in such way that each of his VMCG 1 will be able to alternately perform the rolling massage movement on different trajectories of the movements of **b** without its permutations (Fig. 2, b). The movement of the VMCG 1 on the surface of the patient's body is carried out by appropriately changing the lengths of the linear drives 2, controlled relative-displacement sensor 4. Thus the required speed of the massage movements of the VMCG 1 on the patient's body is provided by the speed control of axial movements of the linear drives 2 according to signals from the respective relative-velocity sensors 5. The geometric resistance of the active triangular module **ABC** (Fig. 1) allows you to define the coordinates of its vertices **A**, **B** and **C** by measuring by the relative-displacement sensor 4 of the lengths of all rods and control their movements similarly to the organization of spatial movements of the *I*-coordinate manipulator [13]. The relative-velocity sensor 5 allow to control the speed of movement of the sliding VMCG 1 at this stage of massage in accordance with the valid values, defined for this type of massage movements and introduced to the control system 10. It should be noted that all of the VMCG 1 in the course of their rearrangements through sliding motions on the massaged surface of the patient body, alternately become floating and unmovable. Here in, the process of their permutation. In the active triangular module **ABC** one of the VMCG 1 (closest to his move) and the other two are roaming and unmovable, respectively. While the maximum allowable air pressure sets in one roaming sliding VMCG, and in two fixed VMCG – minimum allowable air pressure. After that, the control system is commanded to switch on the linear drives 2, it is con

nected to the sliding VMCG 1 and produced a consistent change in their lengths at a given speed controlled by the relative-speed sensor 5. After moving the sliding VMCG 1 to a specified destination (or intermediate) point, determined by the relative-displacement sensor 4 associated with linear drive 2, the command is made to switch them off. Then displacement of the sliding VMCG becoming the fixed VMCG, and one of the two fixed VMCG is becoming roaming. The pressure in the displaced VMCG is the minimum, and another is allowable maximum. Further, similar to the previous cycle from the control system is commanded to switch on the linear drive 2, is connected to the moving VMCG and produced a consistent change in their lengths at a given speed controlled by the relative-speed sensor 5. Then similarly do the movement of third VMCG in final or intermediate point. After displacement of all VMCG in the calculation the initial coordinates two of the VMCG are made unmovable, and the third lying on the trajectory massage movements, for example the arc **B** (Fig. 2, b), make sliding cupping-glass and make her massage movements. Thus, the estimated initial coordinates of VMCG can be computed in such way that all VMCG will be on the trajectories required of massage movements depending on the desired massage motions, for example on the arcs **B** (Fig. 2, b). In this case, the massage can be performed sequentially and alternately. Permutations of triangular ABC module can be arranged in such way that the trajectory of all movements VMCG will coincide with the specified trajectory of massage movements in the process of permutations, i.e. there will not be "spurious" passages of VMCG.

Using the Triangle it's also able to produce a local vacuum massage and the massage by sliding and stretching of the muscle tissue [1, 2]. In Fig. 2 (c) the scheme of their conduct is shown. Local vacuum massage is performed at a fixed on the patient's body VMCG 1 by the vacuum in the air up to a pressure whose value is in the range from the maximum pressure to the minimum pressure. For its implementation by commands from the control system in the VMCG with established frequency and amplitude of the pressure change from the minimum permissible to the maximum and Vice versa. Management of alternate higher and lower pressure is carried out using the diffuser 7 and vacuum pump 9 according to the commands from the control system 10, formed as a result of processing the signals from the pressure sensors 8. The distance between the involved skin surface at the maximum pressure inside the jar and the involved skin surface with minimal pressure is  $\Delta$  (Fig. 2). The distance  $\Delta$  corresponds to the maximum value of the amplitude in the conduct to local vibration by varying the pressure in the VMCG.

Massage by sliding and stretching the muscle tissues is produced, while still fixed on the patient's body VMCG 1 by discharging air to the minimum allowable pressure. It is possible to carry out this type of massage as alternate movement of the linear actuators, as the simultaneous movement of two or more linear actuators. After fixing the VMCG 1 on the massaged area of the patient's body (Fig. 2) at the position at which the length of the linear actuator 2 correspond to their average values, the control system 10 is commanded to the linear drive 2 on decrease (increase) its length at a predetermined value, after reaching which the linear actuator 2 is stopped and is switched on for reverse, increasing (decreasing) its length to a set value. The process is repeated at a given rate, the required number of cycles. The maximum change in



length of the linear actuator 2 corresponds to a given vibration amplitude of the massage movements of compression-tension. The length's changing of the linear actuator 2 and the amplitude are controlled by the relative movement of the sensor 4 and the speed – with the help of relative velocity sensor 5. The efforts of the mechanical effects of VMCG 1 on the muscle tissue of the patient performing all types of massage are controlled by the force sensor 3. In case of exceeding the set value of the effort in conducting a moving cupping massage, on command from the control system 10 produces it is an increase in pressure in the VMCG 1 by the amount of the established step and take him for the maximum allowed pressure value and continue massage. In case of exceeding a predetermined force value during the massage by sliding and stretching of muscle tissue, control system 10 reduces the magnitude of the amplitude which is set by the permissible forces in the extreme positions of the linear actuator 2 and continue the massage.

In case of spontaneous detachment of one of vacuum massage cupping-glasses from the patient's body during the massage unplanned increase in her pressure happens, as in the control system 10 receives the corresponding signal from the pressure sensor 8. In response to the situation the control system 10 will give the appropriate command to the distributor valve 7 and vacuum pump 9. It should be noted that the active triangular bearing module **ABC** on the massaged area of the body of the patient occurs at three points in the form of VMCG 1. Therefore, in the case of the horizontal position of the patient gravity from 1/3 the weight of the active triangle module ABC will be enough for a snug fit to the surface of the seal body VMCG 1 and subsequent suction to the body after lowering the pressure to the minimum allowable value. This will mean that the VMCG 1 is recorded on the patient's body and the massage will continue in accordance with the established program. In case of the pressure decrease in the cupping-glass is not going to happen, from the control system 10 will receive the signal about the movement of the VMCG to a new location and repeat the procedure vacuum. And, in case of repeated unsuccessful attempts, from the control system 10 the massage therapist will receive the signal about emergency situation, for correction of which requires his involvement. After the liquidation of the emergency situation massage therapist, the massage procedure will be continued offline.

We implemented the Triangle concept with a real pneumatic prototype that uses nine syringes (60.0 ml) and three barrels (60.0 ml) as three linear pneumatic actuators with three pneumatic pumps and as three VMCG with three vacuum pumps (Fig. 3, a). The pneumatic prototype is operated manually.

We also performed locomotion experiments and SCGM of the patient's back by the pneumatic prototype (Fig. 3, b). In Fig. 3 (c) a prototype of VMCG is shown, which consists of one barrel 1, one syringe 2, and tubing 3 with a roller clamp 4 of an infusion system. This prototype is the same as VMCG with vacuum pump of the real pneumatic prototype (Fig. 3, a, b). Fig. 3 (d) illustrates the experimental relationships between skin uplift ( $y$ ) and a vacuum pressure ( $p$ ), and also between skin uplift ( $y$ ) and moving force ( $F$ ). Fig. 3 (d) also illustrates the relationship between moving force ( $F$ ) and vacuum pressure ( $p$ ). In the experiments, vacuum pressure loadings applied using the prototype of VMCG was subjected to the male's shoulder skin in the 60 year age range. The experiments were conducted by gently pressing barrel 1 of di

iameter 29.0 mm against the skin to ensure a good initial contact and then activating syringe 2 (vacuum pump) to create the vacuum inside the barrel of syringe 2 so that the skin is drawn into the barrel 1 (Fig. 3, c). The bulging of the skin as a result of cupping is shown in Fig. 3; all images were captured using a Canon digital camera IXUS 990 15. Moving forces ( $F$ ) were measured using the Dynamometer 5029 DPU-0.1-2 (GOST 13837-79). The vacuum pressures ( $p$ ) developed inside the prototype of VMCG were calculated using Boyle's Law:

$$p_i V_i = p_f V_f,$$

where the subscripts  $i$  and  $f$  refer to initial (before pumping,  $p_i=1000$  mbar) and final (after pumping) states and measured volumes of barrel 1 (prototype of VMCG, 60.0 ml) with tubing 3 (3.18 ml) and barrel (60.0 ml) of syringe 2 (vacuum pumping chamber) which is decreased by volume of skin uplift ( $V_{su}$ ). The volumes of skin uplift (Fig. 3, c) were calculated as volumes of ball segment ( $V_{su} = \pi y^2 (3r - y)/3$ ).

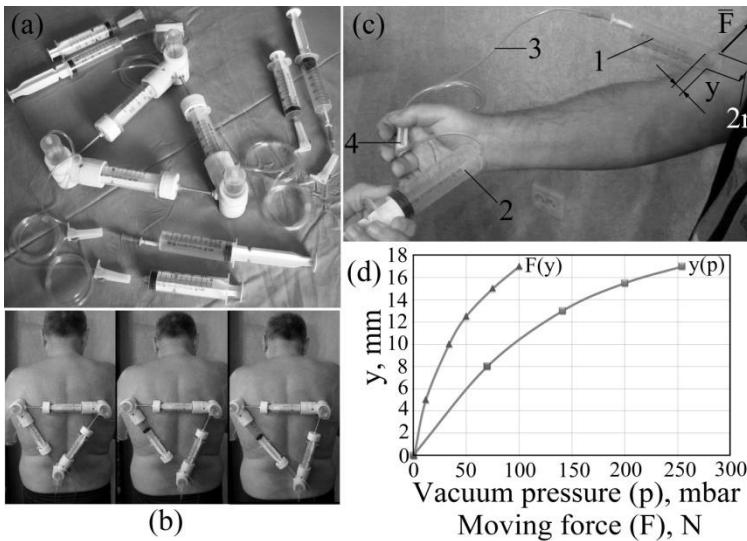

**Fig. 3.** The pneumatic prototype of the Triangle (a); SCGM of the back by the pneumatic prototype of the Triangle (b); the prototype of the VMCG (c); the experimental relationships between ( $y$ ) and ( $p$ ), and ( $F$ ) and ( $y$ ) for the prototype of the VMCG (d).

### 3 Conclusions

Any suitable robots for autonomous SCGM haven't found.

I presented the novel approach to a creation of intelligence self-propelled autonomous portable massage robot for SCGM for back and chest based on original planar parallel mechanism. The proposed novel concept of SCGM robot, called the Triangle, can be used in physiotherapy offices, hospitals, rehabilitation, sports and Wellness

centers, as well as at home to conduct autonomous self-massage hard to reach areas of the body.



The use of the Triangle will allow you to automate the process of SCGM and to improve its efficiency by increasing the number of simultaneously roaming the VMCG up to three more (with the capacity of moving massager additional linear actuators and the VMCG), as well as significantly increase the number of concurrent patients with a single therapist and reduce his physical weariness and fatigue. Thus it's possible additional installation of sensors at the vertices of a triangular active module ABC, e.g. ultrasound, which will allow you to extend the functionality of the massager moving.

## References

1. Dubrovsky, V.I., Dubrovskaya, A.V.: Therapeutic massage. GEOTAR-Media, Moscow (2004) (in Russian).
2. Beck M.F.: Theory & Practice of Therapeutic Massage (5th edn.). CENGAGE Learning, New York (2016).
3. Merlet, J.-P.: Parallel Robots (2nd edn.). Springer, Dordrecht (2006).
4. Farhan A. Salem, "Modeling, Simulation and Control Issues for a Robot ARM; Education and Research (III)", International Journal of Intelligent Systems and Applications(IJISA), vol.6, no.4, pp.26-39, 2014. DOI: 10.5815/ijisa.2014.04.03
5. Gopal Krishan, V. R. Singh, "Motion Control of Five Bar Linkage Manipulator Using Conventional Controllers Under Uncertain Conditions", International Journal of Intelligent Systems and Applications(IJISA), Vol.8, No.5, pp.34-40, 2016. DOI: 10.5815/ijisa.2016.05.05
6. Bischoff, R., Kurth, J., Schreiber, G., Koeppel, R., Albu-Schäffer, A., Beyer, A., Eiberger, O., Haddadin S., Stemmer A., Grunwald G., Hirzinger, G.: The KUKA-DLR Lightweight Robot arm-a new reference platform for robotics research and manufacturing. In: Robotics (ISR), 2010 41st international symposium on and 2010 6th German conference on robotics (ROBOTIK), pp. 741-748. VDE Verlag GmbH, Berlin (2011).
7. Golovin, V., Arkhipov, M., Zhuravlev, V.: Force training for position/force control of massage robots. In: New Trends in Medical and Service Robots, pp. 95-107. Springer International Publishing, Switzerland (2014).
8. Huang, Y., Li, J., Huang, Q., Liu, C.: Design and control of anthropomorphic BIT soft arms for TCM remedial massage. In: 2013 IEEE/RSJ International Conference on Intelligent Robots and Systems, pp. 1960-1965. IEEE, Tokyo, Japan (2013).
9. EMMA, the Robot Therapist. Innovation-The Singapore Magazine of Research and Technology 15(1), (2016), <http://www.innovationmagazine.com/volumes/v15n1/in-brief2.html>.
10. Iroju Olaronke, Ojerinde Oluwaseun, Ikono Rhoda, "State Of The Art: A Study of Human-Robot Interaction in Healthcare", International Journal of Information Engineering and Electronic Business(IJIEEB), Vol.9, No.3, pp.43-55, 2017. DOI: 10.5815/ijieeb.2017.03.06
11. Sajapin, S.N., Sajapina, M.S.: Russian Patent 2551939, Byull. Izobret., no 16 (2015).
12. Santosh Kumar Nanda, Swetalina Panda, P Raj Sekhar Subudhi, Ranjan Kumar Das, "A Novel Application of Artificial Neural Network for the Solution of Inverse Kinematics

- Controls of Robotic Manipulators", International Journal of Intelligent Systems and Applications(IJISA), vol.4, no.9, pp.81-91, 2012. 10.5815/ijisa.2012.09.11
13. Koliskor, A.Sh.: Development and study of industrial robots based on l-coordinates. Stanki i Instrument 12, 21-24 (1982), (in Russian).

# Art of Recognition the Electromyographic Signals for Control of the Bionic Artificial Limb of the Hand

Ivaniuk Natallia , Ponimash Zahar , Karimov Vladimir 

Moscow, Russia

ivaniuk@bi-on.ru, ponimash@bi-on.ru, karimov@bi-on.ru

**Abstract.** The LLC Bionic Natali company is a startup and has been engaging in creation of bionic artificial limbs of hands for more than 2 years. From the first steps, the project had been directed on the solution of a problem of development of the domestic bionic functional artificial limb of the hand based on neural network and others algorithms. In the project it had been created the functional system of management, system of tactile feedback which has increased controllability of a functional artificial limb is already realized and integrated, and also the functional bionic artificial limb of the hand. Based on this work it had been done the general representations and practical application of machine training, neural network and others algorithms. The technology of recognition of gestures of electromyographic activity based on neural network or an analog of network is the cornerstone. The bracelet is put on a hand (in case of disabled people, a stump), further noninvasive electrodes remove potential difference of neuromuscular activity; by means of an electric circuit there is data handling and their transmission to the processor where by means of a neural network there is a recognition of a gripper, further data are transferred for control of a bionic hand. Article belongs to the sections Lecture Notes in Artificial Intelligence (LNAI) and Lecture Notes in Bioinformatics (LNBI).

**Keywords:** The bionic artificial limb, neuronal net, electromyographic signals, system of control, EMG, Bionic Natali, recognition the electromyographic signals, Artificial Intelligence, machine learning.

## 1. Introduction

Now, in most cases in the absence of hand artificial limbs, which bear only the cosmetic purposes that, actually, is a manual model without functionality. Electromechanical artificial limbs which allow to replace partially functionality of a full-fledged hand are widespread poorly at present and have limited functionality, and also are available to still limited circle of users. Especially this situation is characteristic of Russia that is explained by influence of several factors: the certain structure of schemes of social insurance causing an order of financing of prosthetics for the state

account low consumer ability of the people who have lost a brush and, of course, absence in the market of decisions in various price segments with the significant level of functionality.

Now in a prosthetic repair active transition from static prostheses to bionic automated is observed. In the light of it, it is possible to assign tendencies in creation of artificial limbs of cheap and poor quality from the 3D press and on cheap accessories, and also development of more expensive artificial limbs, But the second tendency is connected with big problems available of technological base, namely small capacious accumulators, small engines, payments of processing, processors etc. However, despite all difficulties, the last conform to requirements, which are exposed by the state at a prosthetic repair, namely, the long term of use of prostheses 2-3 years.

As it has been noted earlier, within the project the hi-tech bionic artificial limb, which surpasses all internal functional electromechanical and cosmetic artificial limbs, is developed, and it will surpass foreign bionic artificial limbs in functionality by industrial production. The LLC Bionic Natali company has set for itself the task to make him available to most of disabled people because of considerable reduction of cost in comparison with foreign bionic artificial limbs (by 5-6 times). Also it should be noted about a know-how the project, creation of innovative system of reading on bigger quantity of electrodes, than in the current foreign bionic artificial limbs which is also radio and it is constructed on the principles of neural network and other algorithms.

The technology of recognition of gestures of electromyographic activity based on neural network or an analog of network is the cornerstone. The bracelet is put on a hand (in case of disabled people, a stump), further noninvasive electrodes remove potential difference of neuromuscular activity; by means of an electric circuit there is data handling and their transmission to the processor where by means of a neural network there is a recognition of a gripper, further data are transferred for control of a bionic hand.

## **2. Essence of Technical Solution**

Technical task, realized within works and development was the following:

- Reliable functional intellectual bionic artificial limb of an extremity with return of tactile communication by means of neuromuscular signals
- Way and control system of the auxiliary device, such as extremity artificial limb.

The main problems, which have been put before LLC Bionic Natali at implementation of the project:

1. Increase in accuracy of positioning of engines
2. Increase in accuracy of the obtained data at recognition of gripper
3. Increase in accuracy and probability of recognition of gripper

#### 4. Making decision on capture of a subject and increase in controllability of gripper

Within the carried-out scientific research works more than 1 year, basic divergences with data of muscular activity were found in disabled people and given to muscular activity at people without ablation. Distinctive feature is the range of frequencies at which the signal registers, and importance of maintenance of a tone of muscular activity at disabled people, otherwise there are artifacts of the movement, which at people without ablations are not registered.

Working with data, which is obtained from muscular activity, it has been shown that for optimum work of algorithms on capture recognition, it is necessary to execute the following main stages of processing:

- Filtration
- Preprocessing
- Then there is already a submission of data on neural network or an algorithm similar to it
- Post-data processing, additional training of neural or similar network

Decrease in cognitive load of the person and increase in effective management of an artificial limb is been reached due to use of a hybrid control system. This system combines ways of decoding of electro myosignal with elements of autonomous robotic manipulations:

- on capture of a subject at achievement of threshold value of distance to him by means of decision-making which doesn't demand participation of the user,
- about the beginning or the termination of performance of a gripper by means of information from additional sensors (temperature and distance),
- about force of compression of a subject by means of information from sensors.

Accuracy of classification and prevention of false operation of an artificial limb are reached due to simultaneous formation of the maximum value and average duration of excess of threshold value of a neuro-myosignal in a window of data in real time, then after centering and normalization there was made a decision on emergence of the operating signal. In addition, such parameter has been taken as dispersion of a window of a signal. [1]

Use of wireless data transmission between an artificial limb and system of reading provides usability of system and interchangeability of components, besides, a possibility of their use independently from each other.

The general structure of technical solution is been presented on the picture.

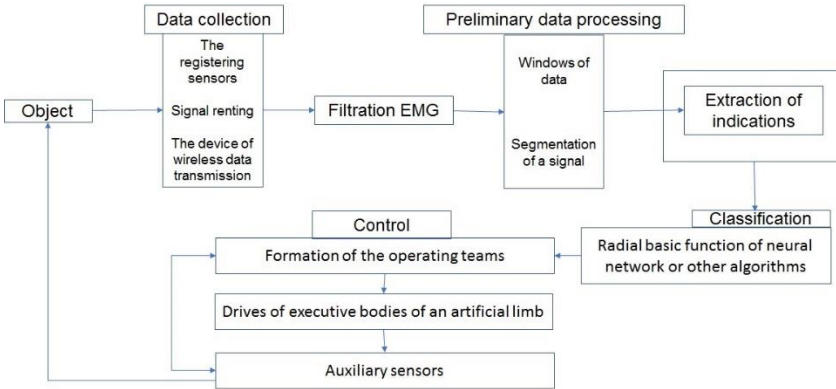

**Fig. 1.** The general structure of technical solution

Also in a picture, the example of an arrangement of sensors on the hand artificial limb is been shown below.

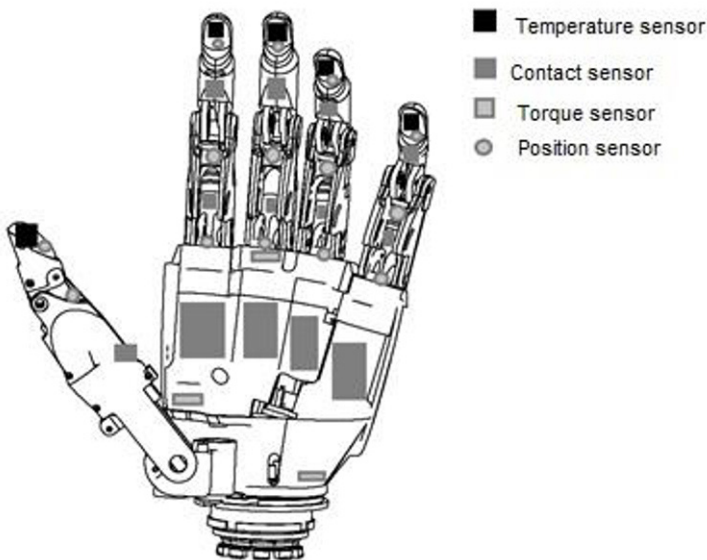

**Fig. 2.** Example of an arrangement of sensors on the hand artificial limb.

In a picture, the example of the scheme of realization of data collection in the form of myoelectric system of reading is been given below (poses. 1 – system of reading, poses. 2 – sensor of registration of biopotentials, poses. 3 – elastic cuff):



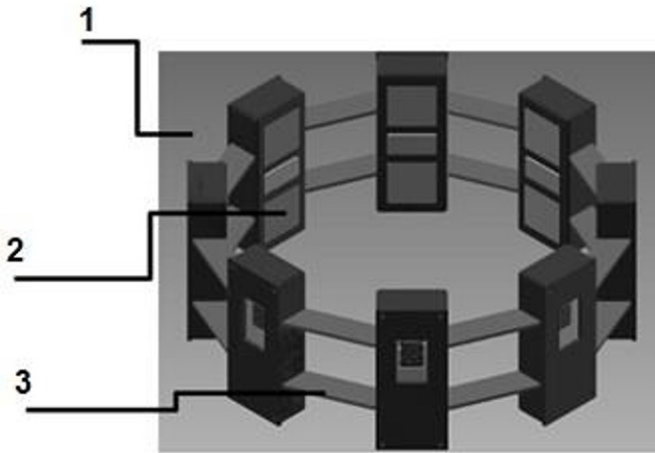

**Fig. 3.** The scheme of realization of data acquisition in the form of myoelectric system of reading

It is important to note that the assessment of efficiency of algorithms is carried out in two main parameters — the accuracy of work of an algorithm and volume of calculations — as the most important for use in real time. Signs for an algorithm of classification are been allocated from an initial signal, thus, the compactness hypothesis was carried out where each gesture is the class. If to achieve performance of this hypothesis, then practically any qualifier, including the simplest, can be suitable for classification such as "classification by a minimum of Euclidean distance". Each certain canal is not of particular interest as it is not possible to differentiate gesture on one channel. From the channel, it is possible to select only information on whether there was a reduction of a muscle, and further to distinguish concrete gesture on what muscles have been reduced and what aren't reduced. Our algorithm of preprocessing allows to define quite precisely whether muscles on this channel have been reduced.

According to the previous researches described in a source of information [1] for a condition of implementation of requirements of work in real time, the time of recognition of a signal has to occupy no more than 250 ms. For comfortable work of the user productivity or recognition accuracy (percentage of right cases of classification to all considered cases) has to be not lower than 95%, as shown in a source [2]. For the purpose of increase in accuracy of classification of gesture and prevention of false operation of a bionic extremity at a stage of preprocessing of a signal, along with calculation of the maximum value of a segment of the EMG-signal, the average duration of excess of threshold value of the EMG-signal in a window of data in real time is calculated. Then, after centering and normalization of the received signal, the decision on generation of the operating signal is made.

The all process of research had been under influence from the sources [4] and [5], the idea of use neuronal net in new spheres.

### 3. Conclusion

In spite of the fact, that huge amount of works has been done; there is still a big field for activity regarding selection and improvement of an algorithm on recognition of gripper. The similar work can be compared to art as we will compare selection of an algorithm to creativity. The current results of the LLC Bionic Natali company in this sphere - it is recognition with probability of 98% on 14 grippers on 8 sensors with amplifiers from a forearm. The concerning removal of data and recognition of capture in disabled people then in practice were difficulties at movements of muscles and pain at a spasm in long muscular tension. In this regard, there was been made a decision together with many medical centers to develop a method of restoration of muscles and to create the tool for their training. An important component is the mathematical analysis of these artifacts and their elimination for a possibility of practical application of bionic artificial limbs based on neural network and other algorithms in practice.

### References

1. M. Sh. Haziakhmetov. Properties of window dispersion of a myogramma as casual process. *Systems and means inform.*, 2014, volume 24, release 3, page 110-120.
2. Englehart K, Hudgins B: A robust, real-time control scheme for multifunction myoelectric control. *IEEE Trans Biomed Eng* 2003, 50(7):848-854.
3. Van den Broek EL, Lis'y V, Janssen JH, Westerink JHDM, Schut MH, Tuinenbreijer K: Affective Man-machine Interface: Unveiling human emotions through biosignals. *Biomedical Engineering Systems and Technologies: Communications in Computer and Information Science*. Berlin, Germany: Springer Verlag; 2010.
4. Ebenezer Obaloluwa Olaniyi, Oyebade Kayode Oyedotun, Khashman Adnan, "Heart Diseases Diagnosis Using Neural Networks Arbitration", *IJISA*, vol.7, no.12, pp.75-82, 2015. DOI: 10.5815/ijisa.2015.12.08.
5. M. A. H. Akhand, Mahtab Ahmed, M. M. Hafizur Rahman, "Convolutional Neural Network based Handwritten Bengali and Bengali-English Mixed Numeral Recognition", *International Journal of Image, Graphics and Signal Processing(IJIGSP)*, Vol.8, No.9, pp.40-50, 2016.DOI: 10.5815/ijigsp.2016.09.06.

# Intelligent Recognition of Electrocardiograms Using Selective Neuron Networks and Deep Learning

M. Mazurov

Russian Economic University  
mazurov37@mail.ru

**Abstract.** Proposed basic elements of neuron networks – selective neurons and selective perceptron. Shown the efficiency of the use of these elements of neuron networks for many known applications of neuron networks: image recognition, neuron games, object management and other applications, related to processing large amounts of data.

Describes the known image recognition methods, based on the use of neuron network on the neurons of the McCulloch-Pitts. Considered convolutional neuron network deep learning, neuron network type cognitron and neocognitron, allowing to image recognition, resistant to deformations, noise.

Proved the efficiency of image recognition using selective neuron networks using selective neurons. Neuron networks of this type do not require the calculation systems of weighting coefficients that provides a significant reduction of computation in the design. Justified the selective application of neuron networks for the intelligent recognition of contour images of standard electrocardiograms (ECG) and complex cardiogram for rhythm disturbances of the heart.

Developed an intelligent system for recognition of medical curves. The system was made on the basis of selective neuron networks, deep learning and convolutional transformations of special type. Despite the limited number of neuron layers, the developed system has allowed to obtain good quality diagnostic. With appropriate additional training, the system can be equipped with a large number of the reference standard ECG and the accuracy of diagnosis can be improved. It is planned to conduct the study of intelligent recognition methods ECG in the direction of the expansion of the database of diagnosed ECG, increasing the reliability of the recognition.

**Keywords:** Selective neuron networks, convolutional transformations, neuron networks, deep learning, diagnosis by ECG, intelligent diagnostic system ECG, diagnostic accuracy.

## 1 Introduction

In [1-3] proposed an efficient basic elements of neuronal networks - selective neurons and selective perceptrons. The efficiency of the use of these basic elements for most known applications of neuron networks: image recognition, neuron games, object

management and other applications related to processing large amounts of data. This work is devoted to substantiation of the effectiveness of the proposed selective neurons and selective perceptrons for pattern recognition of electrocardiograms.

In this paper, the application of selective neuron networks for contour recognition of images containing large amounts of data. Currently, image recognition is an advanced application area of neuron networks. Known methods of recognition based on the use of multilayer neuron networks perceptron type based on the neurons of McCulloch-Pitts, neuron networks such as Hopfield, Hamming, convolutional neuron networks, neuron networks and deep learning [4-9].

Improvement of neuron network applications is due to the increase in the number of neuron layers, by increasing the number of neurons in the layers, increasing the number of neuron layers, support functions. Such neuron networks include Hopfield networks, Hamming [9-13], which contains feedback, recurrent neuron networks, convolutional neuron networks [9-13], neuron networks deep learning [14-15] and others. A significant increase in the number of neurons leads to a significant increase in the number of weight connections, which in turn leads to a significant increase of the computational difficulties in the calculation of the weighting coefficients. It is also known that a significant increase of the weight coefficients leads to unreliable performance of the neuron network system as a whole. It is also known that the modification of the neuron network, associated with an increase in the required number of neurons, requires a virtually complete allocation of a neuron network.

To calculate the weighting coefficients used iterative procedures that use different technologies to refine the weighting coefficients after the next iteration [1,4]. Estimation of convergence of iterative procedures is a challenging task. For single layer perceptron such an estimate is possible using the Novikov theorem under fairly stringent restrictions on share many [16]. For more complex neuron networks, the assessment of the convergence of the used iterative procedures is even more challenging.

Currently, according to experts in the field of image recognition, the most effective and promising are convolutional neuron networks. These networks use some physiological bases of image recognition in the brain and produce a transformation of the original image in the form which is set up sensor detection of brain structures in the field of the visual analyzer. In this work it is assumed to show the effectiveness of selective neurons and selective neuron networks based on selective perceptrons in neuron networks. Will be given consideration convolutional neuron networks and principles of their functioning.

## **2 Image Recognition Using Multi-Layer Networks of Direct Distribution Layers of a Type of Single-Layer Perceptrons**

A single-layer perceptron the McCulloch-Pitts, which is the basic element of the known neuron networks, is shown in Fig. 1.

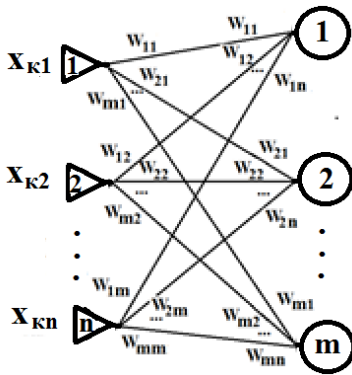

Fig. 1. A single-layer perceptron the McCulloch-Pitts

The number of recognizable objects, equal  $k = m$ . Each recognizable object corresponds to a vector of values  $\mathbf{x}_k = (x_{k1}, x_{k2}, \dots, x_{kn})$ .

The multilayer neuron network contains multiple single layers to each other. It provides more opportunities for processing input information. An example of a layered network containing three single layer shown in Fig. 2.

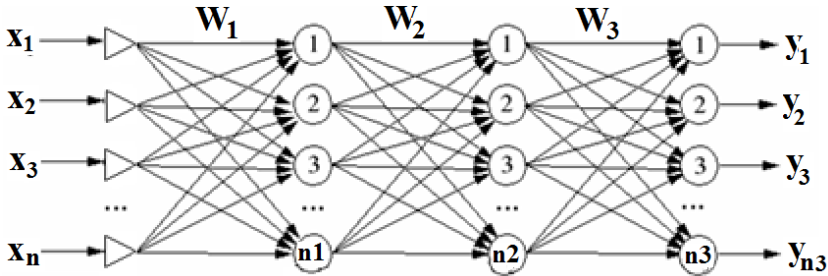
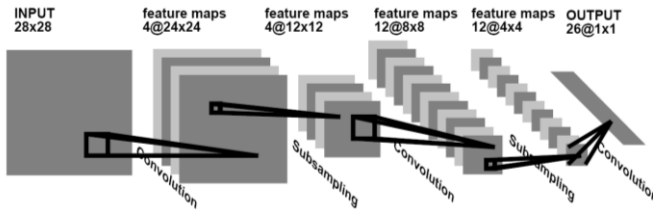

Fig. 2. The topology of the multilayer neuron network with layers of perceptrons a single-layer type

**A. Basis for the Functioning of Convolutional Neuron Networks for Image Recognition**

Convolutional neuron network is a prototype of the visual cortex of the brain. Visual cortex has small areas of cells that are sensitive to specific areas of the visual field. This idea is examined in detail by an original experiment Hubel and Wiesel [17], which showed that certain brain nerve cells reacted or activated only during visual perception of borders of a particular orientation. For example, some neurons were activated when perceived vertical boundaries, and some horizontal or diagonal. Hubel and Wiesel found that all these neurons are concentrated in the core of architecture and, together, form a visual perception. This idea of specialized components within

the system that solve particular tasks, for example, how cells in the visual cortex those are looking for specific characteristics, and identified Hubel and Wiesel. This idea is used in information technology, and this idea is the basis of convolutional neuron networks. The architecture of a typical convolutional neuron network shown in Fig. 3.



**Fig. 3.** The architecture of a typical convolutional neural network, deep learning, including: single layer, convolution layers, subsampling layer, layers regularizing layers

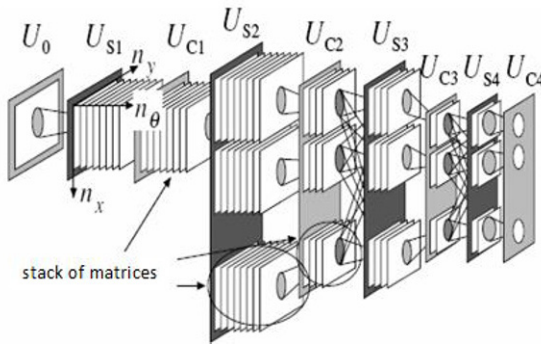

**Fig. 4.** The hierarchical structure of R-neocognitron

Each layer of the neocognitron consists of stacks of matrices. Each layer in a particular stack of matrices is responsible for a certain rotation angle of the image. The number of layer depends on the required precision in the definition of deployed images.

In the neocognitron there are two types of layers: a “simple” and “complex”, which consist respectively of “simple matrices” (recognize input information) and a “complex matrix” (summarize the information recognized).

Consider in more detail the components of convolutional neural networks.

**B. The structure of the Convolutional Neuron Network for Image Recognition**

Unlike full-binded in a convolutional layer neuron is connected only with a limited number of neurons of the previous layer, a convolutional layer similar to the application of the convolution operation that uses only the weight matrix of small size the convolution kernel, which move across the machined layer. In Fig. 5 shows an example of a convolutional layer the convolution kernel of size 3 x 3.

There are layers of, for example: subsampling layer, a layer of regularization, and others. Subsampling layer selects the maximum element. A layer of regularization is used to combat overfitting in neuron networks. There are several other layers to perform various support functions.

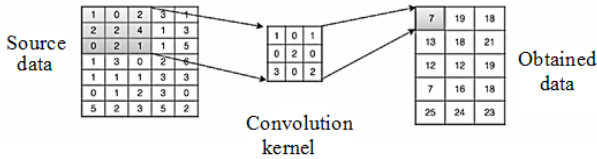

**Fig. 5.** An example of a convolutional layer with the convolution kernel of size 3 x 3.

### C. Advantages and Disadvantages of Convolutional Neuron Networks

Currently, convolutional neuron networks are considered one of the best tools for detection and classification of images. Compared with fully connected neuron network such as perceptron, this network has a much smaller number of custom scales as one kernel weights is used for the entire image, instead of doing for each pixel of the input image in their own personal weights. This allows training to demonstrate generalization of information, not on memorizing each pixel of the images shown in billions of weight coefficients, as does the perceptron.

Other positive qualities: easy parallelization of computations, and, consequently, the possibility of implementing the algorithms and the network training on graphics processors; the relative resistance to rotation and shift of the detected image; learning using the classical method of back propagation of error.

As disadvantages, it should be noted the presence of too many varied parameters of the network, it is unclear for what purposes do you need those settings. So, for variable parameters include: the number of layers, the dimension of the convolution kernel for each of the layers, the number of cores for each layer, a step of shifting the kernel in the processing layer, the need of the subsampling layers, the degree of reduction of their dimensionality, feature reduction dimensionality, the transfer function of neurons, the presence and output of the neuron network is fully connected at the output of convolutional. All these parameters significantly affect the results, but researchers are selected empirically. There are several tested and working configurations of the networks, but not enough recommendations, which need to design.

### D. Image Recognition with a Large Amount of Data Using the Selective Neuron Network

In the present work was implemented recognition complex contour images medical curves based on selective neuron networks such as single layer and multilayer perceptrons, based on the selective neurons. Selective detection was based on clustering of communication channels of individual neurons coming from the inputs neurons to the adders, implementing the configuration on the specific patterns of input

signals. Thus, neurons that form a neuron network, is the information filter tuned to the information coming from the individual input features. Such data filters will be called cognitive filters.

Consider the mathematical theory of selective perceptron. Let us denote the possible characteristic combination of objects at the input of the neuron in the form of vectors  $\mathbf{x}_1 = (x_{11}, \dots, x_{1n})$ ; ... ;  $\mathbf{x}_m = (x_{m1}, \dots, x_{mn})$ , where  $n$  is the number of elements of the code combination;  $m=50$  is the number of objects. All possible code combinations of the input features form the matrix  $A$  can be represented in the form

$$\mathbf{A} = \begin{pmatrix} x_{11}, x_{12}, \dots, x_{1n} \\ \dots & \dots & \dots \\ x_{m1}, x_{m2}, \dots, x_{mn} \end{pmatrix}.$$

Let a specific neuron contains a cluster of relations, characterized by code combination  $\mathbf{x}_i = (x_{i1}, \dots, x_{in})$ . When applying to the input neuron number  $i$  of the code word  $\mathbf{x}_j = (x_{j1}, \dots, x_{jn})$  of the input object will receive  $S_{ij} = \sum_{k=1}^n x_{ik}x_{kj} = (\mathbf{x}_i, \mathbf{x}_j)$ .

Values  $S_{ij}$  equal to the elements of the matrix  $B$ , is equal to  $B = A \cdot A^T$ , where  $A^T$  is the transpose of  $A$ . We get  $m \times m$  amounts  $S_{ij}$ . The highest will be the sum  $S_{ii} = \sum_{j=1}^n x_{ij}x_{ji} = (\mathbf{x}_i, \mathbf{x}_i) = N_i = N$ , where is  $N_i$  the number of units in the code word  $\mathbf{x}_i = (x_{i1}, \dots, x_{in})$ . The property  $S_{ij}$  amounts in that,  $S_{ij} < N$  is used for recognition of the input objects.

You can give a beautiful interpretation of the selective properties of single-layer perceptron, presenting the values of the matrix  $B = A \cdot A^T$  as a graph in three-dimensional space. From a physical point of view the values  $S_{ij} = f(i, j)$  are the values of the matrix  $B = A \cdot A^T$ , which is numerically equal to the sum after the arrival of the input signals through clusters of channels. To plot in three-dimensional space system was used Matlab-7. Values of  $i$  and  $j$  delayed along the axes.

As an example, was implemented for the selective detection of 33 images. Graphical interpretation of the electoral properties of the system is shown in Fig. 6.



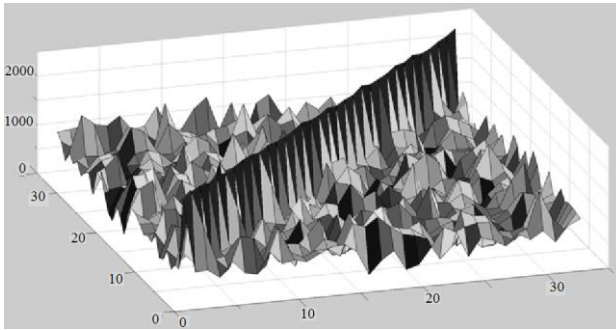

**Fig. 6.** Graphical interpretation selective properties of system

Selective cognitive filter for efficient object recognition - 33 images clearly visible from Fig. 6.

### 3 Comparative Evaluation of Computation the Volume of Calculations in Selective Neuron Networks, Computation the Volume of Calculations in Neuron Network Based on Neurons of the McCulloch-Pitts

Compare a first approximation, the number of operations required to implement image recognition with a large number of input data. Let the number of operations performed is equal to a single-layer perceptron  $N$ . We use a mathematical model of a perceptron in the form of a matrix of input data

$$A = \begin{pmatrix} x_{11}, x_{12}, \dots, x_{1n} \\ \dots \dots \dots \\ x_{m1}, x_{m2}, \dots, x_{mn} \end{pmatrix}$$

The output of the perceptron are

$$y = f(A \cdot x),$$

where  $\mathbf{x} = (x_1, \dots, x_m)$ ,  $f$  is a nonlinear threshold function;  $\mathbf{x}_k = (x_{k1}, \dots, x_{kn})$ ;  $k = (1, \dots, m)$ .

The totality of all calculations produced by the perceptron can be described by a set of matrix calculations  $B$

$$B = A \cdot A^T$$

Then use the effect of nonlinear functions  $f$  on the individual components of the matrix  $B$ .

We denote the total number of computational operations using  $N$ . When using neuron networks in perceptrons based on the neurons of the McCulloch-Pitts for receiving the output signal required identification of the matrix of weight coefficients in fact in this case

$$B = W \cdot W^T$$

To obtain the matrix  $W$  used usually different iterative procedure. Let  $r$  - the number of iterations, usually  $r$  equal to several tens, hundreds or more operations. Therefore, the number of operations, when using single-layer perceptron based neurons of the McCulloch-Pitts, will be the same  $rN$ , when using  $l$  layers, the number of operations is  $lrN$ .

In convolutional neuron networks the convolutional computation, subsampling layer, regularizing layers is usually performed also with the help of iterative procedures. Therefore, when using selective neuron networks a general decrease in the number of required computational operations are really in  $lr$  times less, i.e. less than a few tens, hundreds or more times. In connection with the foregoing, the use of selective neuron networks in any multilayer neuron networks can lead to a significant reduction in the amount of required computing operations.

The use of selective neuron networks can significantly reduce the amount of computation and simplify the task of designing the neuron network structure, which is usually a difficult task. In addition to the complexity, this task is always uncertain; it is usually done on the basis of intuition, practical experience. The use of selective neuron networks allows performing the task of constructing the neuron network structure more reasonably and effectively and quickly, because you can consider a specific characteristics vector of the input signals.

The use of selective neuron networks avoids the use of various optimization computational procedures, for example, different methods of finding the extremum: gradient method, stochastic gradient method and other. There is no need to use approximations of the nonlinear threshold function in the form of a differentiable function. No, in some cases, the need to use the widespread method of "back propagation of errors" based on your feedback. There is also an artificial method, that doesn't exist in real biological neuron networks. It is known that the system feedback to adjust the weighting factors in neuron networks is not found. Generally, in real neuron networks use weights and of the multipliers for these weighting factors is not found.

Consider the application of selective neuron networks and deep learning techniques for intelligent diagnostic electrocardiograms. Diagnosis by ECG is currently at a high level and is widely used in clinical practice. However, diagnosis by ECG, there are many problems. This growing variety of cardiac diseases, ambiguous interpretation of certain types of diseases. Very difficult cause of the disease, associated with heart rhythm disturbance that requires to diagnose a large number of cycles of the ECG,

obtained for example during Holter monitoring. A number of difficulties of cardiac diagnostics can be overcome through the use of intelligent diagnostics based on the use of selective neuron networks and deep learning methods for neuron networks.

#### **4 Known Methods of Diagnosis by Electrocardiograms and Their Comparison With the Methods of Intellectual Diagnostics**

Known methods of diagnosis by electrocardiograms are based on the decomposition of the cardiac signal into components and use decision rules based on estimation of the parameters of the components. For example, the parameters are of amplitude of teeth, P, Q, T. Accounting based on the ECG from the angle of the electric vector of the heart, ways of electrode placement, body position of the patient, the presence of noise and other factors leads to additional difficulties. Due to the presence of these difficulties the diagnosis is much more complicated. Another problem is the diagnosis of arrhythmias, which requires analysis of a large number of cycles of the ECG. The cycles themselves have a specific form, very different from the form of the standard ECG.

A promising method for medical diagnostics curves are the intellectual methods of analysis based on selective neural networks. Under this method creates a data Bank of typical medical curves, then a comparison is made given the medical curve with the curves from the data Bank. Then used the methods of selective neural networks, deep learning methods. Considerable complexity in the analysis of ECG is heart rate variability in shape, due to external factors. In connection with these reasons for ECG analysis method was used, described in [18].

The original ECG is compared with a reference ECG by the method of integral correlations, recognizing the similarities by the maximum of the correlation function. This method of proximity assessment function has allowed to reduce the variability in the shape of ECG on the resulting conclusion about the similarity between the original ECG and the standard ECG.

Use of the convolution changes made it possible to increase the accuracy of diagnosis to acceptable limits. Because this work suggests further continuation in the cooperation with doctors, cardiologists, there is reason to assume that the diagnostic accuracy will be even higher. It is also expected a significant expansion of a database from the reference cardiogram.

The advantage of the method of intellectual diagnostics of ECG and other medical curves using selective neuron network is the ability to diagnose heart rhythm disorders. In the diagnosis of arrhythmias requires more than one cycle of the ECG, and electrocardiogram data during several cycles of the ECG. Even within a few cycles of ECG its shape does not remain constant and may change. In some arrhythmias, the shape of the ECG is significantly different from the standard and requires analysis by a qualified technician.

Intelligent diagnostics ECG is also relevant due for use in medical practice and for other electrocardiographic curves obtained during the medical examination of a

patient. A brief look at the used electrocardiographic curves for clinical practice indicating the region, where they are used.

### A. Electrocardiographic Curves Used in Clinical Practice

Electrocardiography is a method of registration of the potential difference of the electric dipole of the heart in certain areas of the human body. A typical ECG is shown in Fig.7.

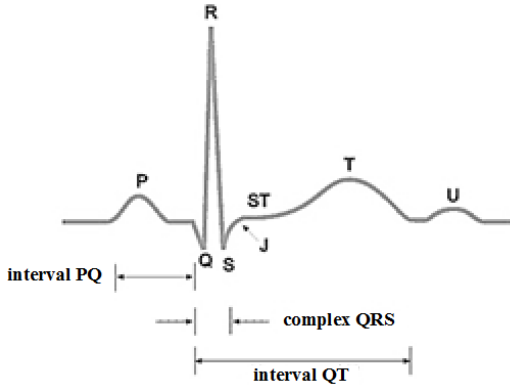

Fig. 7. The typical curve shape of the ECG

Vector-cardiography - method research the magnitude and direction of integrated electric vector of the heart during the cardiac cycle, the value of which varies continuously. A typical form of vector-cardiograph is shown in Fig. 8.

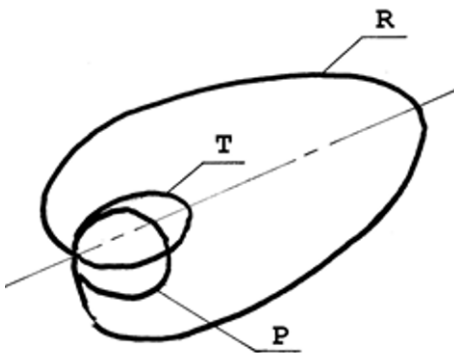
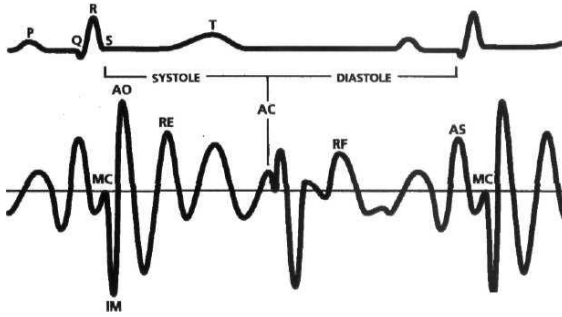

Fig. 8. The typical form of the curve vector-cardiography

Ballistocardiography is a method of registration of micro vibrations of the human body caused by ejection of blood from the heart during systole and the movement of

blood through the major veins. A typical form of ballistocardiogram shown in Fig. 9 bottom, top displayed ECG.



**Fig. 9.** A typical form of ballistocardiogram shown in Fig. bottom, top shows an ECG (given for work A. Wilson et al [19]).

Dynamic cardiography is a method of registration of the displacement of the center of gravity of the chest due to the motion of the heart and the moving mass of blood from the cavities of the heart into the vessels.

Echocardiography — a method of study of the heart based on the recording of ultrasonic vibrations, reflected from the surfaces of the walls of the ventricles and the Atria.

Auscultation — method of evaluation of sound phenomena in the heart on the surface of the rib cage. Used for evaluation of the heart valves.

Phonocardiography - a method of graphic registration of heart sounds from the surface of the chest. Normal phonocardiogram shown in Fig. 10.

Phonocardiography - a method of registration of acoustic phenomena occurring in the heart during its activity. She is an essential supplement to heart auscultation because it allows you to record sounds that are inaudible to the human ear.

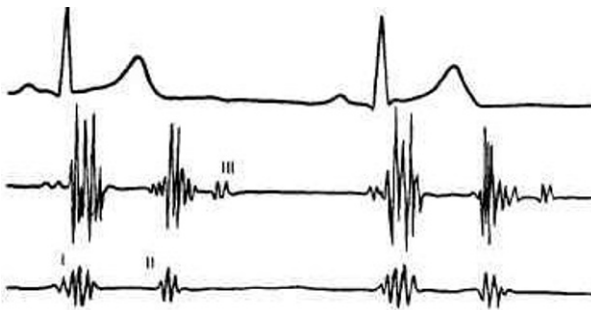

**Fig. 10.** Normal phonocardiogram shown below.

Rheography is a method of studying the blood supply to various organs and tissues, based on registration changes in full in the electrical resistance of tissues by passing through them an electric current of high frequency and low power.

Holter monitoring — daily monitoring of ECG with analysis of rhythm and other ECG data. Daily monitoring of ECG along with a large amount of clinical data allows to identify the different arrhythmias and heart rate variability, which in turn is an important criterion of the functional state of the cardiovascular system. The data of Holter monitoring are an example of Big Data. Diagnosis according to Holter causes considerable difficulties. For this diagnosis the appropriate use of selective neural networks.

We list next the major clinical forms of heart rhythm disorders.

## **B. The Main Clinical Forms of Arrhythmias**

Heart rhythm disorders is a change of the normal frequency, regularity and source of excitation of the heart, and disorders of the pulse, the linkage and consistency between the activation of Atria and ventricles.

In accordance with the mechanism of arrhythmias all cardiac arrhythmias can be divided into four types: 1) violations of automaticity; 2) violation of the excitability; 3) conduction disorders; 4) fibrillation of the Atria and ventricles. In reality, often have to deal with arrhythmias of combined character. Consider in more detail each arrhythmia type.

### *Violations cardiac automaticity.*

Violations cardiac automaticity is arrhythmia due to a violation of the electrophysiological activity of cardiac pacemakers. These arrhythmias include: sinus bradycardia, sinus tachycardia, sinus arrhythmia, atrioventricular tachycardia, nodal rhythm, idioventricular rhythm.

### *Violations of excitability.*

Violations of excitability of the heart underlie such arrhythmias as premature beats, ventricular tachycardia, polymorphic ventricular tachycardia, ventricular flutter and fibrillation, ventricular fibrillation and atrial fibrillation, sudden cardiac arrest. Arrhythmia — an extraordinary contraction of the heart.

### *Conduction disorders.*

Conduction disorders include transverse heart block, blockade of the right and/or left legs of bundle branch block syndrome Nolf—Parkinson—White.

### *Fibrillation.*

Fibrillation can occur in the Atria and the ventricles of the heart. Atrial fibrillation is divided into atrial fibrillation and atrial flutter.

Atrial fibrillation is the uncoordinated contractions of the Atria, which is electrocardiographically characterized by the disappearance of the prong R. atrial

Fibrillation leads to termination of hemodynamically effective atrial. It shows irregular small fluctuations of the Atria of different amplitude and shape with a frequency of 350-600 / min, which could not register on a normal electrocardiograph. Ventricular contraction is also irregular.

Atrial flutter — a violation of the processes of excitation and conduction in the Atria, which is electrocardiographically characterized by disappearance of P wave, and appearance instead of frequent low-amplitude oscillations. In this pathology the frequency of contractions of the Atria are more than 220 min, and ventricular — 120-180 min. at the same time there blockade of atrioventricular conduction 1:1, 2:1, 3:1, 4:1 and even 5:1.

Ventricular tachycardia is a frequent and mostly regular rhythm, originating: a) in the contractile ventricular myocardium; b) in the network of Purkinje; c) in the legs of bundle branch block. Most ventricular tachycardias is fundamentally related to the mechanism of the circular excitation - re-entry.

Atrial fibrillation ventricular — is a chaotic asynchronous excitation of individual muscle fibers or small groups of cardiac arrest and cessation of blood circulation. These arrhythmias are particularly dangerous as they are in the absence of the emergency response within 3-5 minutes can result in death. Electrocardiological ventricular fibrillation is characterized by the appearance of waves of low amplitude (less than 0.2 mV) and a different shape with a frequency of from 300 to 600 per min.

## 5 Intelligent System of Recognition of ECG

Was developed by the intelligent system of recognition of medical curves on the basis of the ECG. The system was made on the basis of the selective neuron networks [1-3], deep learning networks [14, 15], convolutional transformations of special type. When designing neuron networks deep learning the number one problem is the design of a neuron network structure. Currently, such design is realized mainly empirically. The design includes a multi-layer neuron network a significant amount of 10, 100, 1000, 10000 or more layers. Then this network is trained the with large data volume, for achieving the desired results for accuracy, stability, reliability. System is used for the Big Data type MNIST with various malformed numbers [20]. Example MNIST data shown in Fig. 11.

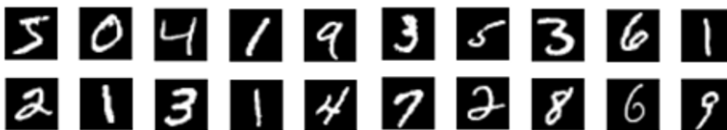

Fig. 11. Example MNIST data.

As the information base used typical ECG for the major types of cardiac diseases. ECG data were derived from reference [21]. Initially for testing of the intellectual method, we used a relatively small database of ECG in the amount of 100. The

developed system was tested using system Big Data MNIST. Despite the limited number of the used convolutional transformations and a small number of neural layers, the developed system has allowed to obtain good quality of diagnosis, about 70%. With appropriate refinement, the diagnostic accuracy can be significantly improved.

Base of reference ECG can naturally is increasing significantly with the aim of obtaining the product competitive in the market. We developed an intelligent system of obtaining opinions on ECG is not a competitor to existing systems for recognition of the ECG, and a useful complement but extension with new prospective opportunities.

Some examples of reference ECG, which were used for diagnosis, are illustrated in Fig. 12.

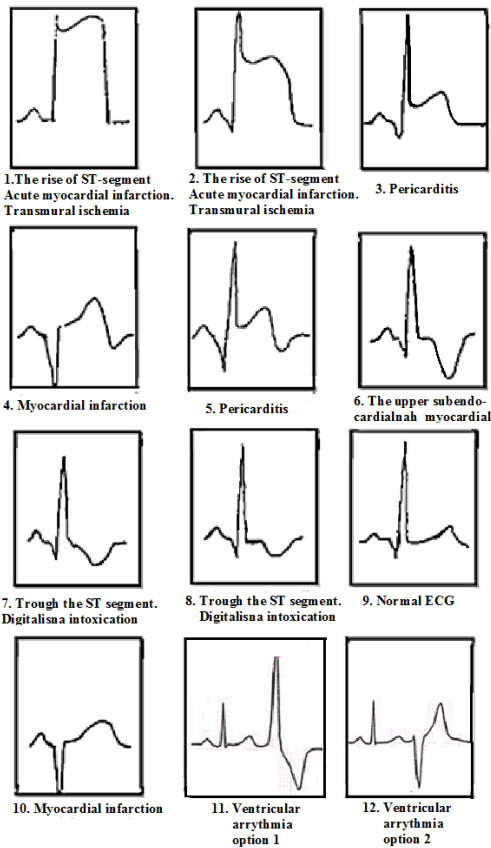

**Fig. 12.** Examples of reference ECG, which were used for diagnosis.

This work is produced in collaboration with the Cardiology center. Work is underway in two main areas, the first of which is intelligent recognition of coronary heart disease (CHD) and identification of complex for diagnose cardiac diseases. The second area - diagnosis of heart rhythm disturbances.



The complexity of such a diagnosis lies in the significant variability of the ECG, the occurrence of non-periodic heart rate variability in the amplitude of the elements of the ECG. For the diagnosis of arrhythmias is used Holter monitoring of rhythm for a considerable time, hours or even days. This method of pattern recognition of the ECG can improve the quality of diagnostics of arrhythmias due to the recognition of their characteristic properties.

## 6 Conclusion

In [1-3] proposed an efficient basic elements of neuron networks - selective neurons and selective perceptrons. The efficiency of the use of these basic elements for most known applications of neuron networks: image recognition, neuron games, object management and other applications related to processing large amounts of data. This work is devoted to substantiation of the effectiveness of the proposed selective neurons and selective perceptrons for pattern recognition of electrocardiograms.

Was developed by the intelligent system of recognition of medical curves based on ECG. The system was made on the basis from the selective neuron networks [1-3], deep learning networks [14, 15], convolutional transformations of a special type.

Despite the limited number of the used convolutional transformations and a small number of neuron layers, the developed system has allowed to obtain good quality diagnostic. With appropriate refinement, the diagnostic accuracy can be significantly improved. This work at the present time continues in partnership with experts within the Cardiology center in the direction of expand database of cardiac diseases and in extending the database of diseases, such as arrhythmias.

This article is the first publication about the intellectual methods of diagnosis medical curves on the example of ECG. We propose a more detailed and complete the development of the described methods software implementation using selective neuron networks, deep learning, convolutional transformations of special neuron networks with the aim of creating products suitable for implementation in market conditions.

## References

1. M. E. Mazurov, "Selective neuron network for recognition of complex objects". *Mathematical biology and bioinformatics: proceedings of the VI international Conf.* M.: MAKS Press. 2016. P. 82-83.
2. M. E. Mazurov, *Neuron, simulating the properties of real neurons*, The patent for invention № 2597495. 07.11.2014.
3. M. E. Mazurov, *Single-layer perceptron based on selective neurons*, The patent for the invention № 2597497. 13.01.2015.
4. S. Haykin, *Neural networks: full course. Neural Networks: A Comprehensive Foundation*, 2-e Izd. M.: "Williams", 2006. 1104 S.
5. L. Shapiro, J. Stockman, *Computer vision*, Bean. 2009. 763 S.

6. Navjot Kaur, Amardeep Singh , "Analysis of Vascular Pattern Recognition Using Neural Network", *International Journal of Mathematical Sciences and Computing(IJMSC)*, Vol.1, No.3, pp.9-19, 2015.DOI: 10.5815/ijmsc.2015.03.02
7. C. Bhanuprakash, Y. S. Nijagunarya, M. A. Jayaram, "Clustering of Faculty by Evaluating their Performance Appraisal by using Feed Forward Neural Network Approach", *International Journal of Intelligent Systems and Applications(IJISA)*, Vol.9, No. 3, pp.34-40, 2017. DOI: 10.5815/ijisa.2017.03.05
8. Hanan A. R. Akkar, Firas R. Mahdi, "Adaptive Path Tracking Mobile Robot Controller Based on Neural Networks and Novel Grass Root Optimization Algorithm", *International Journal of Intelligent Systems and Applications(IJISA)*, Vol.9, No. 5, pp.1-9, 2017. DOI: 10.5815/ijisa.2017.05.01
9. Mohd. Asyraf Mansor, Mohd Shareduwan M. Kasihmuddin, Saratha Sathasivam, "Enhanced Hopfield Network for Pattern Satisfiability Optimization", *International Journal of Intelligent Systems and Applications(IJISA)*, Vol.8, No. 11, pp.27-33, 2016. DOI: 10.5815/ijisa.2016.11.04
10. S. Lawrence, C. L. Giles, A. C. Tsoi, A. D. Back, "Face Recognition: a Convolutional Neural Network Approach", *IEEE Transactions on Neural Networks, Special Issue on Neural Networks and Pattern Recognition*. 1997. P. 1-24. (<http://www.neci.nec.com/~lawrence>).
11. Y. LeCun and Y. Bengio, *Convolutional Networks for Images, Speech, and Time-Series*, in Arbib, M. A. (Eds), *The Handbook of Brain Theory and Neural Networks*, MIT Press, 1995.
12. D. R. Lovell, A. C. Tsoi, *The Performance of The Neocognitron with D. R. Lovell, A. C. Tsoi The Performance of The Neocognitron Various S-Cell and C-Cell Transfer Functions*. University of Queensland, Australia: Technical Report, 1992. -10 p.
13. K. Fukushima, S. Miyake, I. Takayuki, "Neocognitron: A neural network model for a mechanism of visual pattern recognition", *IEEE Transaction on Systems, Man and Cybernetics SMC*-13(5):826-34. — 1983.
14. G. Hinton, L. Deng, D. Yu, G. Dahl, A. Mohamed, N. Jaitly, A. Senior, V. Vanhoucke, P. Nguyen, T. Sainath and B. Kingsbury, "Deep Neural Networks for Acoustic Modeling in Speech Recognition", *IEEE Signal Processing Magazine*, Vol. 29, No. 6, 2012, pp. 82 – 97.
15. D. Ciresan, U. Meier, J. Masci and J. Schmidhuber, "Multi-column Deep Neural Network for Traffic Sign Classification", *Neural Networks*, Vol. 34, August 2012, pp. 333 – 338.
16. A. B. Novikoff, "On convergence proofs on perceptrons", *Symposium on the Mathematical Theory of Automata*, 1962, 12, 615-622. Polytechnic Institute of Brooklyn.
17. D. H. Hubel, & Wiesel T. N., "Brain mechanisms of vision". *Scientific American*, 1979, vol. 241, pp.150-162.
18. M. E. Mazurov, *A method of obtaining informative electrocardiogram increased stability independent of the angle of the electrical axis of the heart*. The patent for the invention № 2580976. 16.10.2014.
19. A. Wilson, S. Virinderjit, J. Lindsey at all, "Diagnostic accuracy of seismocardiography compared," *Amer. J. Cardiol.*, 1993, vol. 71, No 1, p. 536-544.
20. Yann LeCun, Corinna Cortes, Christopher J. C. Burges, "MNIST handwritten digit database, Yann LeCun, Corinna Cortes and Chris Burges". Retrieved 17 August 2013.
21. A. A. Abashin, *Quick reference guide of criteria ECG*. 2014.

# Development of Microbiological Analyzer Based on Coherent Fluctuation Nephelometry

Gur'ev A.S.<sup>1,2,3</sup>, Kuznetsova O.Yu.<sup>4</sup>, Kraeva L.A.<sup>4</sup>, Rastopov S.F.<sup>2,5</sup>, Verbov V.N.<sup>4</sup>, Vasilenko I.A.<sup>1,6</sup>, Rusanova E.V.<sup>1</sup>, Volkov A.Yu.<sup>2,3</sup>

<sup>1</sup>M.F.Vladimirsky Moscow Regional Clinical and Research Institute (MONIKI), Moscow, Russian Federation

<sup>2</sup>Medtechnopark LTD, Moscow, Russian Federation

<sup>3</sup>Federal Research and Clinical Center of Physical-Chemical Medicine of Federal Medical Biological Agency (FRCC PCM), Moscow, Russian Federation

<sup>4</sup>Pasteur Institute of Epidemiology and Microbiology, Saint Petersburg, Russian Federation

<sup>5</sup>A.M. Prokhorov General Physics Institute of the Russian Academy of Sciences, Moscow, Russian Federation

<sup>6</sup>A.N.Kosygin Russian State University (Technologies. Design. Art), Moscow, Russian Federation

**Abstract.** Rapid antibiotic susceptibility testing of etiologically significant microflora is an actual problem in clinical microbiology. Microbiological analyzers based on traditional nephelometry have a number of limitations. Coherent fluctuation nephelometry (CFN) method is almost insensitive to cuvette quality and allows constructing microbiological analyzers of high usability providing detection of microbial growth starting from 103–104 CFU/ml. CFN based microbiological analyzers were used for rapid antibiotic susceptibility testing of bacterial isolates and urine microflora without isolation within 3–6 hours in two independent studies. In the first study, susceptibility of 18 clinical bacterial isolates to 5 broad-spectrum antibiotics was determined by the disk diffusing method (DDM), the serial dilutions method (SDM) and CFN-analyzer. The pairwise agreement between the results was from 74.6% to 84.6%, the agreement between all three methods was 70%. In the second study, susceptibility of bacteria cultures in 21 urine samples from patients with bacteriuria to 13 broad-spectrum antibiotics was determined by CFN-analyzer without isolating the bacteria, the corresponding isolates were tested by DDM. The agreement between the results was 87.8%. Thus, CFN-method provides the possibility to construct multichannel microbiological analyzers of high sensitivity and usability. Such analyzers allow rapid antibiotic susceptibility testing of both bacterial isolates and urine microflora without bacteria isolating. CFN-analyzer allows implementation of full cycle of analyses, from bacteriuria confirmation to antibiotic susceptibility testing on the day of urine samples collection.

**Keywords:** Coherent fluctuation nephelometry, microbiological analyzer, antibiotic susceptibility, bacteriuria, personalized medicine.

## 1 Introduction

Correct selection of antimicrobial drugs is of great significance in therapy of variety of diseases, especially in the light of antibiotic resistance problem and growing role of personalized medicine in drug prescription [1]. At the same time, the most widespread method of antibiotic susceptibility testing of clinical bacterial isolates remains the disk diffusion method, labor-intensive and time consuming (as usual it takes about 20 hours). Recent years the nephelometry based microbiological analyzers entered clinical laboratory practice for rapid antibiotic susceptibility testing of clinical cultures within 3-6 hours [2, 3], but for all that, the automation of microbiological laboratories remains on a low level [4].

Most widespread nonspecific optical method used for turbidity measurements is photometry; it has a variety of application in laboratory practice and other fields, for example in water quality assessment [5]. Despite of being simple and handy, photometry is not sensitive enough for microbial growth curve registration at low concentrations. Although nephelometry is much more sensitive than photometry, its sensitivity highly depends on the quality of cuvettes and optical path of the device because of parasitic light scattering. In traditional nephelometry it is fundamentally impossible to separate light, scattered by the particles under investigation, from the stray light caused by parasitic light scattering. It limits the sensitivity of analyzers based on traditional nephelometry and negatively influences its usability. In coherent fluctuation nephelometry (CFN) fluctuations of the intensity of light scattered by the particles suspended in the cuvette are detected. For CFN method implementation, two symmetrically located detectors are used and differential amplifier subtracts the signal from the detectors. For CFN method functioning, the coherent source of light (laser) must be used fundamentally, since only coherent light forms random interference pattern called speckle in the area of the detectors (speckle is usually considered to be noise and has to be reduced [6]). When the particles under investigation move in the cuvette, the speckle also fluctuates resulting in changing of the scattered light intensity on both detectors. Useful differential signal is formed mostly by moving scattering particles and the stray light from motionless cuvette forms stationary speckle, so that the differential signal from such stationary speckle almost equals zero [7]. Thus, CFN method is almost insensitive to cuvette and optical path quality, that allows easy detection of the intensity fluctuations of light scattered at very low angles  $3-7^\circ$ . Micron sized particles, such as bacteria, scatter light mostly at low angles (less than  $7^\circ$ ), while the stray light from the cuvette is scattered mostly at low angles too. That is why the stray light complicates using traditional nephelometry at low angles and limits its sensitivity to bacteria detection. In CFN method stray light is mostly ignored, so bacteria can be easily detected with high sensitivity using light scattered at low angles. That allows constructing simple CFN-based microbiological analyzers of high usability, providing detection of microbial growth starting from  $10^3-10^4$  CFU/ml [7], while the best traditional nephelometers in ideal conditions (flowing pipe without cuvette) demonstrate sensitivity limit of  $2.5 \times 10^4$  CFU/ml [8]. CFN method can be

easily combined with other optical detectors. Two-channel separate detection of light passed through the cuvette (photometry) and scattered at low angles (CFN) was used to increase the dynamic range of bacterial detection up to  $10^9$  CFU/ml. Application of microbiological analyzers of such design was successfully demonstrated for bacteriuria screening in adults and children [9, 10].

The aim of this work was to estimate the efficiency of CFN based microbiological analyzer use for rapid antibiotic susceptibility testing of clinical cultures. In this work the following tasks are set: 1) to work up a technique for rapid antibiotic susceptibility testing by microbiological CFN-analyzer; 2) to compare the results, obtained by CFN-analyzer and other conventional methods; 3) to investigate the possibility to test the urine microflora antibiotic susceptibility by microbiological CFN-analyzer (without bacteria isolating and identification).

## 2 Materials and Methods

Two independent studies were performed. In the first study, antibiotic susceptibility of clinical bacterial isolates was determined by disk diffusion method (DDM), serial dilutions method (SDM), and CFN-analyzer. In the second study, antibiotic susceptibility of bacteria cultures in urine samples from patients with bacteriuria was determined by CFN-analyzer without isolating of bacteria. The results were compared with DDM-determined susceptibility of corresponding bacteria, isolated by conventional methods. Both studies were performed using 12-channel CFN-analyzers (CFN-P-12, Medtechnopark LTD, Moscow, Russian Federation). Standard disposable photometric semi-micro cuvettes, chamber volume 1 ml, plugged up by disposable stoppers («LP ITALIANA SPA», Italy) were used. For preparation of antibiotic solutions, antibiotics were obtained from the department of new technologies, Pasteur Institute of Epidemiology and Microbiology (Saint-Petersburg, Russian Federation) and diluted in accordance with [11].

### 2.1. Study 1, materials and methods

18 freshly prepared clinical isolates were obtained from the laboratory of medical bacteriology, Pasteur Institute of Epidemiology and Microbiology; among them 7 strains of *E. coli*, 5 strains of *St. aureus*, 2 strains of *E. faecium*, and 1 strain of each of the following bacteria: *P. aeruginosa*, *Klebs. pneumoniae*, *St. epidermidis*, *Prot. Mirabilis* – 10 Gram-negative and 8 Gram-positive strains altogether. All isolates were tested simultaneously for susceptibility to 5 antibiotics (amoksiklav, cefepim, ceftriaxone, cefuroxime, ciprofloxacin) by DDM, SDM (macromethod in accordance with [11]), and CFN-analyzer. A dose of 1 ml of bacterial suspension in liquid broth was put into each of 11 disposable cuvettes for testing of each isolate by CFN-analyzer. One cuvette represented the positive control; into the rest 10 cuvettes freshly prepared solutions of antibiotics were added (2 concentrations for each of 5 antibiotics). Final concentrations of antibiotics in the cuvettes were equal to minimal inhibitory concentrations (MICs) according to [11]. To prepare bacterial suspension,

freshly prepared bacterial isolate in normal saline  $1.5 \cdot 10^8$  CFU/ml (0.5 MacFarland turbidity units) was diluted in Muller-Hinton broth in the ratio 1:1000, and prepared suspension was immediately used. Concentrations of stock antibiotic solutions were chosen so that the volumes of solutions put into the cuvettes were from 5 to 20  $\mu$ l. The cuvettes containing antibiotics and bacterial suspensions in broth were put into microbiological CFN-analyzer, and bacterial growth curves were detected for 6 hours. Inhibition of each antibiotic was assessed by comparison of growth curves with positive control. The example of typical growth curves for susceptible isolate, obtained by CFN-analyzer, is shown on figure 1.

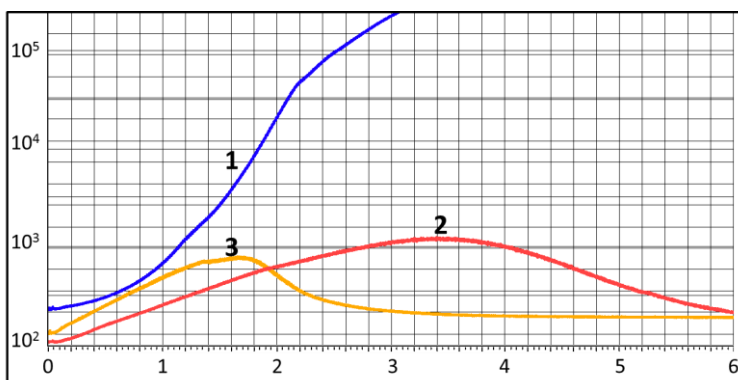

**Fig. 1.** Growth curves for clinical *E. coli* isolate susceptible to ceftriaxone; 1 – positive control (without antibiotic); 2 – ceftriaxone 8  $\mu$ g/ml; 3 – ceftriaxone 32  $\mu$ g/ml. X-axis represents time in hours, Y-axis – CFN signal in arb. units.

For assessment of pairwise agreement between the results obtained by DDM, SDM and CFN-analyzer, the percentage of matching results, the percentage of results with minor error (intermediate susceptibility obtained by one method, and resistance or susceptibility obtained by the other method), and the percentage of mismatched results (major error) were measured. For assessment of agreement between results obtained by all three methods, the percentage of matched and mismatched results was calculated.

## 2.2. Study 2, materials and methods

Study 2 was performed in microbiological laboratory of M.F. Vladimirsky Moscow Regional Clinical and Research Institute: 182 urine samples from patients of urological clinic were analyzed. All incoming samples were simultaneously tested by conventional microbiological methods and by CFN-analyzer for bacteriuria as described before [10], 21 positive urine samples were selected from the samples showing growth within 1 hour testing by CFN-analyzer. Conventional cultures showed growth in all 21 selected urine samples, and from one sample two bacterial strains were isolated. The susceptibility of cultures in urine samples, determined by CFN-analyzer, was compared with the susceptibility of corresponding isolates,

determined by DDM. The most resistant bacteria for each antibiotic defined the susceptibility of two-component association in urine sample. Microflora of urine samples was tested simultaneously for susceptibility to 9-10 antibiotics (196 analyses altogether) by DDM and CFN-analyzer. After isolation and identification by conventional methods, all isolates were tested by DDM in accordance with [11]. Bacterial strains defined the antibiotics choice. While testing antibiotic susceptibility of urine microflora by CFN-analyzer, selected urine samples were used as inoculum without bacterial isolation and identification.

For each inoculum, 23 disposable cuvettes were used; 940  $\mu\text{l}$  of Muller-Hinton broth and 40  $\mu\text{l}$  of inoculum were put into each cuvette for testing of microflora of each urine sample. One cuvette represented the positive control; into the rest 22 cuvettes freshly prepared solutions of antibiotics were added. Final concentrations of antibiotics in the cuvettes were equal to MICs according to [11]. Altogether 13 antibiotics were used (amoksiklav, ceftazidime, ceftriaxone, cefoperazone, cefepime, cefazolin, imipenem, rifampicin, doxyxycline, amikacin, ofloxacin, ciprofloxacin, vancomycin). Since Gram staining was not performed, 4 concentrations were used for amoksiclav (2 for Gram-negative and 2 for Gram-positive bacteria), and 2 concentrations for the rest of antibiotics. Concentrations of stock antibiotic solutions were chosen so that the volumes of solutions put into the cuvettes were 5 to 40  $\mu\text{l}$ . The cuvettes containing antibiotics and bacterial suspension in broth were put into microbiological CFN-analyzer, and bacterial growth curves were detected for 6 hours. Inhibition of each antibiotic was assessed by comparison of growth curves with the positive control (figure 1).

For assessment of agreement between results obtained by DDM and CFN-analyzer, the percentage of matching results, the percentage of results with minor error (intermediate susceptibility obtained by one method, and resistance or susceptibility obtained by the other method), the percentage of results with major error ("missed susceptibility"), and the percentage of results with very major error ("missed resistance") were calculated.

## **3 Results**

### **3.1. Study 1 results**

18 clinical bacterial isolates were tested simultaneously for susceptibility to 5 antibiotics, altogether 90 analyses were performed by DDM, SDM, and CFN-analyzer. According to results of DMM, 25% – 50% gram-positive and 50% – 70% gram-negative isolates were susceptible to used antibiotics (table 1).

**Table 1.** The results of 18 clinical isolates of antibiotic susceptibility testing by DDM.

Isolates	G <sup>-</sup> (10 isolates)			G <sup>+</sup> (8 isolates)		
	S	I	R	S	I	R
Amoksiklav(18)	6 (60%)	1 (20%)	3 (30%)	4 (50%)	3 (37.5%)	1 (12.5%)
Cefepime (18)	6 (60%)	1 (20%)	3 (30%)	3 (37.5%)	4 (50%)	1 (12.5%)
Ceftriaxone (18)	7 (70%)	1 (20%)	2 (20%)	3 (37.5%)	0	5 (62.5%)
Cefuroxime (18)	5 (50%)	1 (20%)	4 (40%)	4 (50%)	0	4 (50%)
Ciprofloxacin (18)	6 (60%)	1 (20%)	3 (30%)	2 (25%)	0	6 (75%)

The results of susceptibility testing by DDM, SDM, and CNF-analyzer showed, that pairwise agreement between results was 74.6% – 84.6%, the percentage of minor error was 9.6% – 11.5%, the percentage of major error was 3.8% – 14.1%, and agreement between all three methods was 70%. The data representing the results comparison is shown in table 2.

**Table 2.** Comparison of the results of 18 clinical isolates antibiotic susceptibility obtained by DDM, SDM, and CNF-analyzer.

Pairwise results comparison	CFN–DDM	CFN–SDM	DDM–SDM
Agreement, %	84.6	84.3	74.6
Minor error, %	11.5	9.6	11.3
Major error, %	3.8	6.0	14.1
Comparison of results of all three methods CFN-DDM-SDM			
Agreement, %	70.0	Mismatch, %	30.0

### 3.2. Study 2 results

Among 21 urine samples, selected by the results of microflora growth on CNF-analyzer, a monoculture was isolated from 20 samples and two-component association was isolated from 1 sample (*E. faecalis*, и *K. pneumoniae*). Concentration of bacteria in all 21 samples was  $1 \times 10^4$  to  $5 \times 10^7$  CFU/ml. Among them: 5 strains of *E. coli*, 4 strains of *E. faecalis*, 3 strains of each of the following bacteria: *S. haemolyticus*, *K. pneumoniae*, *E. faecium*, *Acinetobacter baumannii*, and 1 strain of *S. aureus*, altogether 11 Gram-negative and 11 Gram-positive strains. The data representing antibiotic susceptibility of isolates obtained by DDM is shown in table 3.



**Table 3.** The results of 22 strains, isolated from 21 urine samples, antibiotic susceptibility testing by DDM.

Isolates	G <sup>-</sup> (11 isolates)			G <sup>+</sup> (11 isolates)		
	S	I	R	S	I	R
Sucseptibility						
Amoksiklav (2)	1 (100%)	0	0	0	0	1 (100%)
Ceftazidime (19)	4 (44.4%)	0	5 (55.5%)	2 (20%)	1 (10%)	7 (70%)
Ceftriaxone (20)	4 (40%)	1 (10%)	5 (50%)	4 (40%)	1 (10%)	5 (50%)
Cefoperazone(19)	4 (44.4%)	0	5 (55.5%)	6 (60%)	0	4 (40%)
Cefepime (17)	6 (66.7%)	1 (11.1%)	2 (22.2%)	3 (37.5%)	0	5 (62.5%)
Cefazolin (13)	2 (25%)	0	6 (75%)	1 (20%)	1 (20%)	3 (60%)
Imipenem (20)	9 (90%)	0	1 (10%)	8 (80%)	0	2 (20%)
Rifampicin (20)	0	1 (10%)	9 (90%)	9 (90%)	0	1 (10%)
Doxyxycline (12)	5 (71.4%)	0	2 (28.6%)	3 (60%)	1 (20%)	1 (20%)
Amikacin (20)	9 (81.8%)	0	2 (18.2%)	6 (66.7%)	0	3 (33.3%)
Ofloxacin (19)	4 (44.4%)	2 (22.2%)	3 (33.3%)	6 (60%)	1 (10%)	3(30%)
Ciprofloxacin (20)	4 (40%)	1 (10%)	5 (50%)	5 (50%)	0	5 (50%)
Vancomycin (4)	0	0	0	1 (75%)	0	3 (75%)

The results of urine microflora susceptibility testing by DDM and CNF-analyzer showed the percentage of the results agreement – 87.8%, the percentage of minor error – 8.1%, the percentage of major error – 3.6%, and the percentage of very major error – 0.5%. The data representing results comparison is shown in table 4.

**Table 4.** Comparison of the results of 21 urine samples microflora antibiotic susceptibility obtained by DDM and CFN-analyzer.

Agreement, %	87.8
Minor error, %	8.1
Major error (missed susceptibility), %	3.6
Very major error (missed resistance), %	0.5

## 4 Discussion

In this work, the technique of antibiotic susceptibility testing by CFN-analyzer is described. The results of antibiotic susceptibility testing obtained by the “gold standard” (the serial dilution method), simple and widespread disk diffusion method and CFN-analyzer are comparable, so one can conclude the similar diagnostic significance of all three methods. High sensitivity of CFN-method allows reducing the time required for bacterial growth curve detecting in the presence of antibiotics down to 3-6 hours depending on the antibiotic. Hence, the time required for susceptibility determination by CFN-analyzer is significantly less than by DDM and SDM, so it allows obtaining susceptibility results directly on the day of analysis.

It is shown that not only isolates can be tested for antibiotic susceptibility by CFN-analyzer, but also urine microflora can be tested without bacteria isolation. Besides, while testing multi-microbial association, the susceptibility is defined by the most resistant strain (if at least one of the strains is resistant to given antibiotic, than whole association is resistant too). Therefore, CFN-analyzer allows rapid choosing the antibiotics to which all strains in urine sample are susceptible.

In the case of heavy bacteriuria with high bacterial count ( $10^6$  CFU/ml and higher), CFN-analyzer allows detecting such urine samples by the turbidity within 10 minutes [9]. Supplemented by such express method of bacterial identification as MALDI-TOF mass spectrometry, or at least by gram-staining procedure, CFN-analyzer allows implementing full cycle of analyses – bacteriuria confirmation, identification (or preliminary identification), and antibiotic susceptibility testing within 3-6 hours since urine samples collection.

## 5 Conclusions



CFN-method provides the possibility to construct multichannel microbiological analyzers of high usability. Such analyzers allow rapid antibiotic susceptibility testing of both bacterial isolates and urine microflora without bacteria isolating within 3-6 hours. CFN-analyzer allows implementing full cycle of analyses, from bacteriuria confirmation to antibiotic susceptibility testing on the day of urine samples collection.

## References

1. Medina E., Pieper D.H.: Tackling Threats and Future Problems of Multidrug-Resistant Bacteria. *Curr Top Microbiol Immunol* 398, 3-33 (2016).
2. Davenport M., Mach K.E., Shortliffe L.M.D., Banaei N., Wang T.H., Liao J.C.: New and developing diagnostic technologies for urinary tract infections. *Nat Rev Urol*, 14(5), 296-310 (2017).
3. Fontana C., Favaro M., Bossa M.C., Minelli S., Altieri A., Pelliccioni M., Falcione F., Di.Traglia L., Cicchetti O., Favalli C.: Improved diagnosis of central venous

- catheter-related bloodstream infections using the HB&L UROQUATTRO™ system. *Eur J Clin Microbiol Infect Dis*, 31(11), 3139-3144 (2012).
4. Bourbeau P.P., Ledebner N.A.: Automation in clinical microbiology. *J Clin Microbiol* 51(6), 1658-65 (2013).
  5. Chandrappa S, Dharmanna L, Shyama Srivatsa Bhatta U V, Sudeeksha Chiploonkar M, Suraksha M N, Thrupthi S, "Design and Development of IoT Device to Measure Quality of Water", *International Journal of Modern Education and Computer Science(IJMECS)*, Vol.9, No.4, pp.50-56, 2017.DOI: 10.5815/ijmecs.2017.04.06
  6. Madan Lal, Lakhwinder Kaur, Savita Gupta, "Speckle Reduction with Edge Preservation in B-Scan Breast Ultrasound Images", *International Journal of Image, Graphics and Signal Processing(IJIGSP)*, Vol.8, No.9, pp.60-68, 2016.DOI: 10.5815/ijigsp.2016.09.08
  7. Rastopov S.F.: Coherent fluctuation nephelometry: A high-sensitivity method for detecting particles in liquids. *InstrumExp Tech*, 54(6), 837-840 (2011).
  8. U.S. EPA. Detection of Biological Suspensions Using Online Detectors in a Drinking Water Distribution System Simulator. U.S. Environmental Protection Agency, EPA/600/R-10/005 (2010).
  9. Gur'ev A.S., Volkov A.Y., Dolgushin I.I., Pospelova A.V., Rastopov S.F., Savochkina A.Y., Sergienko V.I.: Coherent Fluctuation Nephelometry: A rapid method for urine screening for bacterial contamination. *Bull Exp Biol Med*, 159(1), 107-110 (2015).
  10. Gur'ev A.S., Kuznetsova O.Y., Pyasetskaya M.F., Smirnova I.A., Belyaeva N.A., Verbov V.N., Volkov A.Y. Rapid urine screening for bacteriuria in children using microbiology analyzer, combining photometric and coherent fluctuation nephelometric methods. *Journal of Infection and Immunity*, 6(4), 395-398 (2016). (In Russian)
  11. Guidelines for susceptibility testing of microorganisms to antibacterial agents (MYK 4.2.1890 04). *Clinical Microbiology and Antimicrobial Chemotherapy*, 6(4), 306-359 (2004). (In Russian)

# Simulation of Two-Way Interaction between Blood Flow and Wall in Human Vessel

Yatchenko E.<sup>1</sup>  and Rakcheeva T.<sup>2</sup> 

<sup>1,2</sup> A. Blagonravov Institute of Machines Science of the Russian Academy of Sciences (IMASH)  
4, Maly Kharitonievskiy Pereulok, Moscow, 101990, RUSSIA  
elenabl@yandex.ru

**Abstract.** The purpose of this work is to study the basic hemodynamic parameters and prediction of changes in the blood flow through the vessel carotid artery with pathological changes of the geometry by means of mathematical modeling. In this paper, this problem is considered on the example of a real vessel of the carotid artery, which images were made by magnetic resonance tomograph. With the presented methods able to calculate various hemodynamic parameters that are difficult to measure non-invasive. The work shows that modeling of geometric variations in the vessel mathematical model enables to visualize and anticipate complications nature.

**Keywords:** Mathematical modeling, hemodynamic, aneurysm.

## 1 Introduction

Cardiovascular diseases are the leading cause of death in most countries of the world. An extensive disease of blood vessels is aneurysms. Aneurysm is protrusion of the vessel wall due to its thinning or stretching. The most dangerous is that an aneurysm of blood vessels can be ruptured, causing hemorrhages. In connection with the high risk of deaths and multitude of cases, the study of the probability of aneurysm rupture is an actual topic today. At present, the use of mathematical modeling methods for the study of blood flow in the cardiovascular system is an important task, over which a large number of authors, research teams and organizations work.

The main difficulty in modeling biomechanical systems is that obtaining an analytical solution is not possible in view of the complexity of the geometry of the real vessels and the hydrodynamics of the blood flow. Thanks to development of computer technology it is possible to perform mathematical modeling of blood flow along the vessels using the methods of numerical hydrodynamics. [1, 2, 3, 4]. In this paper, we consider the problem of determining the physical characteristics of a vessel with an aneurysm, using the example of the real carotid artery, which geometry was scanned by magnetic resonance imager at the Physiotherapy and Rehabilitation Center of the Russian Ministry of Health.

## 2 Statement of the Problem and Methods of Solution

In the work the following parameters of the investigated vessel are calculated, blood velocity in the vessel and aneurysm, shear stress on the vessel wall, stretching and tension of the vessel wall, blood pressure in different areas. The geometry of a vessel without an aneurysm is also simulated to compare the effect of an aneurysm on the blood flow.

To calculate fluid motion, the Navier-Stokes equations system is used [5]. Blood is taken for incompressible fluid. The state of elastic continuous medium is generally described by the following three equations [5] continuum equation, the deformation-displacement relation, Hooke's law.

When constructing a mathematical model of blood flow through the vessel, the following notations are accepted (see Fig. 1).

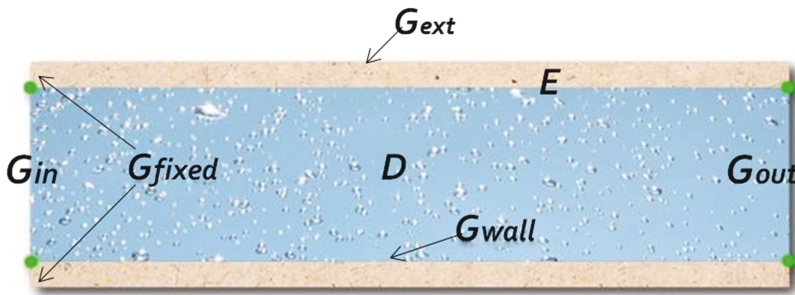

Fig. 1. Mathematical model of the blood flow along the vessel.

In the adopted notation, the behavior of the system under consideration is described by the following system of equations.

Let  $D$  be the region inside the vessel through which the liquid flows. At each point  $(x, y, z)$  of the domain  $D$  the system of Navier-Stokes equations is satisfied:

$$\rho \left( \frac{\partial u}{\partial t} + u \frac{\partial u}{\partial x} + v \frac{\partial u}{\partial y} + w \frac{\partial u}{\partial z} \right) = -\frac{\partial p}{\partial x} + \mu \left( \frac{\partial^2 u}{\partial x^2} + \frac{\partial^2 u}{\partial y^2} + \frac{\partial^2 u}{\partial z^2} \right),$$

$$\rho \left( \frac{\partial v}{\partial t} + u \frac{\partial v}{\partial x} + v \frac{\partial v}{\partial y} + w \frac{\partial v}{\partial z} \right) = -\frac{\partial p}{\partial y} + \mu \left( \frac{\partial^2 v}{\partial x^2} + \frac{\partial^2 v}{\partial y^2} + \frac{\partial^2 v}{\partial z^2} \right),$$

$$\rho \left( \frac{\partial w}{\partial t} + u \frac{\partial w}{\partial x} + v \frac{\partial w}{\partial y} + w \frac{\partial w}{\partial z} \right) = -\frac{\partial p}{\partial z} + \mu \left( \frac{\partial^2 w}{\partial x^2} + \frac{\partial^2 w}{\partial y^2} + \frac{\partial^2 w}{\partial z^2} \right),$$

$$\frac{\partial u}{\partial x} + \frac{\partial v}{\partial y} + \frac{\partial w}{\partial z} = 0.$$

Where  $t$  is time;  $\mu$  is the coefficient of kinematic viscosity;  $\rho$  is the blood density,  $p$  is the pressure,  $u, v, w$  are the coordinates of the flow vector.

The inner surface of the domain  $E$  is the  $G_{wall}$  domain. At the boundary of the vessel, the condition of "sticking" the liquid to the wall of the vessel was used, which means that the vector of motion of the vessel wall is equal to the vector of motion of the liquid at the boundary of the vessel:

$$u = \frac{\partial \delta_x}{\partial t}, \quad v = \frac{\partial \delta_y}{\partial t}, \quad w = \frac{\partial \delta_z}{\partial t},$$

where  $\delta_x, \delta_y, \delta_z$  are coordinates of the displacement vector of continuous medium (vessel) in relation to its initial position.

Blood presses against the vessel wall with force  $F=(F_x, F_y, F_z)$ , therefore, at the boundary  $G_{wall}$  the following relation holds:

$$F_x = n_x \cdot p, \quad F_y = n_y \cdot p, \quad F_z = n_z \cdot p.$$

where  $n_x, n_y, n_z$  are components of the normal vector to the boundary,  $p$  pressure.

$G_{in}$  is the boundary of the domain  $D$  corresponding to the beginning of the vessel. The direction of the input flow was assumed to be perpendicular to the surface corresponding to the entrance to the vessel:

$$u = n_x \cdot v_{inflow}, \quad v = n_y \cdot v_{inflow}, \quad w = n_z \cdot v_{inflow}$$

where  $v_{inflow}$  is blood velocity at the entrance to the vessel.

$G_{out}$  is the boundary of the domain  $D$  corresponding to the end of the vessel. To specify the boundary conditions at the output, the following condition was used:

$$p = 0.$$

Let  $E$  be the region corresponding to the wall of the vessel. At each point  $(x, y, z)$  of the region  $E$ , the system of equations of a continuous medium is satisfied:

$$(\lambda + \beta) \frac{\partial}{\partial x} \left( \frac{\partial \delta_x}{\partial x} + \frac{\partial \delta_y}{\partial y} + \frac{\partial \delta_z}{\partial z} \right) + \beta \left( \frac{\partial^2 \delta_x}{\partial x^2} + \frac{\partial^2 \delta_x}{\partial y^2} + \frac{\partial^2 \delta_x}{\partial z^2} \right) + F_x = \rho \frac{\partial^2 \delta_x}{\partial t^2},$$

$$(\lambda + \beta) \frac{\partial}{\partial y} \left( \frac{\partial \delta_x}{\partial x} + \frac{\partial \delta_y}{\partial y} + \frac{\partial \delta_z}{\partial z} \right) + \beta \left( \frac{\partial^2 \delta_y}{\partial x^2} + \frac{\partial^2 \delta_y}{\partial y^2} + \frac{\partial^2 \delta_y}{\partial z^2} \right) + F_y = \rho \frac{\partial^2 \delta_y}{\partial t^2},$$

$$(\lambda + \beta) \frac{\partial}{\partial z} \left( \frac{\partial \delta_x}{\partial x} + \frac{\partial \delta_y}{\partial y} + \frac{\partial \delta_z}{\partial z} \right) + \beta \left( \frac{\partial^2 \delta_z}{\partial x^2} + \frac{\partial^2 \delta_z}{\partial y^2} + \frac{\partial^2 \delta_z}{\partial z^2} \right) + F_z = \rho \frac{\partial^2 \delta_z}{\partial t^2},$$

where the coefficients  $\lambda$  and  $\beta$  are the Lamé parameters,  $\rho$  is the density of the continuous medium,  $F_x, F_y, F_z$  are the components of the mass density vector of the volume forces acting on the continuous medium.

Let  $G_{exit}$  be the outer surface of the region  $E$ . On the outer surface of the vessel, the external forces are 0:

$$F_x = 0, \quad F_y = 0, \quad F_z = 0.$$

At the entrance and exit from the vessel  $G_{\text{fixed}}$  the boundary is fixed, therefore:

$$\delta_x = 0, \quad \delta_y = 0, \quad \delta_z = 0.$$

The novelty of this work is that the method of bilateral interaction was implemented. The problems of solving the equations of hydrodynamics and the equations of an elastic continuous medium are solved separately by the finite element method. However, in the current problem statement, these tasks are related to a single system of equations (see Fig. 2, a). To solve it, the following iteration algorithm is used.

- I. The problem of an elastic continuous medium is solved independently of the problem of hydrodynamics:
  1. The initial data for elastic continuous media tasks are the following:
    - fixed areas defined at the ends of the vessel,
    - the fluid pressure on the inner wall of the vessel (at the first iteration, the pressure  $p = 0$ ).
  2. The equations of elastic continuous medium are used for calculation of the following quantities:
    - displacement  $\delta$  at each point of the vessel wall,
    - the strain tensor  $\varepsilon_{ij}$  at each point of the vessel wall,
    - stress tensor  $\sigma_{ij}$  at each point of the vessel wall.
- II. The problem of hydrodynamics is solved independently of the problem of elastic continuous medium motion:
  1. As initial data for the problem of hydrodynamics, we take:
    - a given input stream vector,
    - pressure at the outlet of the vessel,
    - the position of the walls of the vessel, taking into account the displacement  $\delta$ , counted at the stage of calculating the problem of elastic continuous medium.
  2. Using the equations of hydrodynamics, the following quantities are calculated:
    - velocity vector  $(u, v, w)$  to each point inside the vessel,
    - pressure  $p$  at each point inside the vessel.
- III. Estimation of the algorithm convergence:

1. If the calculated values are insignificantly (in accordance with the accepted threshold value  $\varepsilon_0$ ) differ from the values calculated at the previous iteration, then the algorithm stops.
2. If the deviation is significant, then the algorithm returns to step I.

### 3 Results and Analysis of Calculations

The geometry was prepared using the program MultiVox 5.5, GeomagicStudio 2013, Rhinoceros 5.0. ANSYS CFX was used to solve the problems of hydrodynamics; and ANSYS ADPL was used to solve the problems of an elastic continuous medium both with one of the numerical methods for solving partial differential equations - the finite element method. In calculations, blood is accepted as a Newtonian fluid with density of  $1050 \text{ kg/m}^3$  and a viscosity of  $0.004 \text{ Pa}$ . These parameters correspond to the average blood parameters of a healthy person. The temperature was not taken into account when calculating the flow. The speed of the input stream was measured using an ultrasonic sensor and amounted to  $0.3 \text{ m/s}$ . The boundary condition on the vessel wall for the blood is taken "without slipping". To determine the nature of the flow, the Reynolds number was calculated, which was more than 1000, and accordingly a turbulent flow model was used.

At the entrance to the vessel, a pulse flow, defined by a sinusoid with a period of 1 second, was set. The maximum flow velocity was  $0.3 \text{ m/s}$ , the minimum flow rate was  $0 \text{ m/s}$ . To stabilize the flow, 3 full cycles were calculated. For the analysis, only the last cycle is taken. Blood flows at different times in the last cycle are shown in Figure 2.

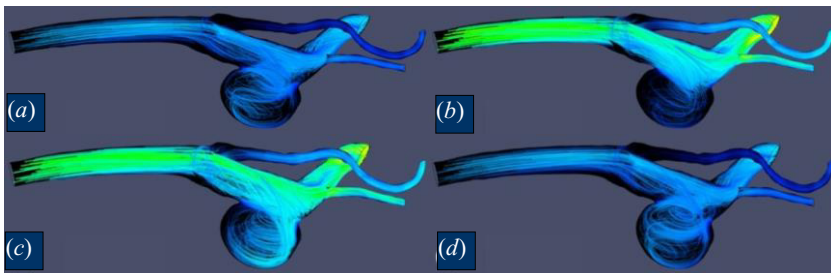
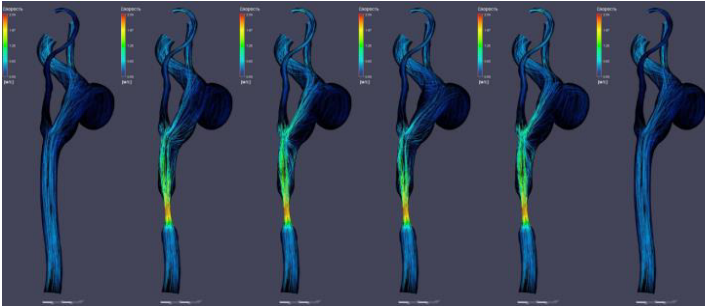

**Fig. 2.** Different times of pulsating flow: (a) –  $t_1 = 2c$ ., (b) –  $t_2 = 2.33c$ ., (c) –  $t_3 = 2.67c$ ., (d) –  $t_4 = 3c$ ..

It has been established that aneurysm ruptures are most often possible in a situation of vessel spasm. In connection with this, the spasm of the vessel was modeled to evaluate its effect on the blood flow in the vessel and aneurysm. At the time of spasm of the vessel the part of the vessel contracts, thereby preventing the normal flow of blood. The stenosis of the supply vessel was simulated, overlapping the clear space by 50%. Such parameters of the vessel as velocity of blood in vessel and aneurysm, wall tension in aneurysm, and wall shear stress in aneurysm were calculated.



To study the dynamic effect of stenosis on the blood streams along the vessel, a time interval of 5 seconds was modeled. The vessel is in the undeformed state for the first 1.5 seconds. The next 2 seconds the vessel is in a state of stenosis. The main phases of this time range are shown in Figure 3.



**Fig. 3.** Flow stream velocity in vessel into stenosis at the time points:  $t=1c$ ,  $1.5c$ ,  $2c$ ,  $2.5c$ ,  $3c$ ,  $5c$ .

The states of flows, pressures and wall shear stresses in the aneurysm of the spasmodic vessel are shown separately in close-up in Figure 4.

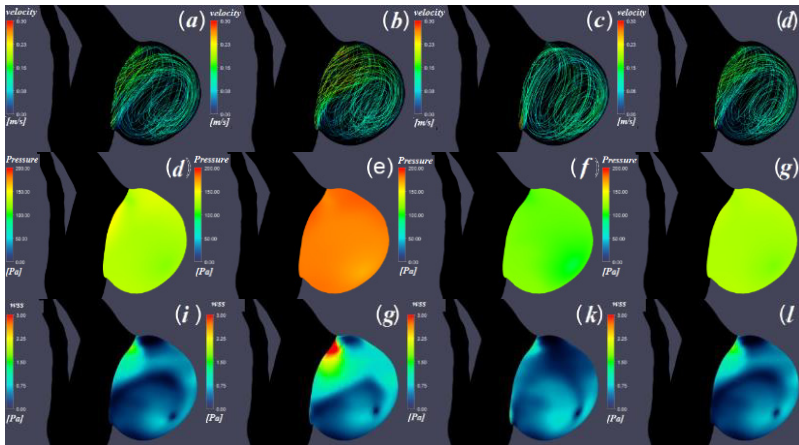
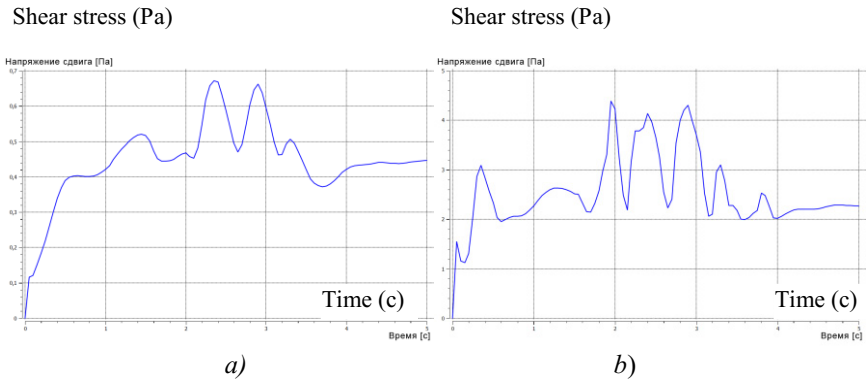

**Fig. 4.** Flows (a, b, c, d), pressures (e, f, g, h), wall shear stresses (i, j, k, l) in the aneurysm at time instants:  $t = 1c$ ,  $t = 1.5c$ ,  $T = 2c$ ,  $t = 5c$ .

The dependence of wall shear stress in the aneurysm (maximum and average values over the surface of the dome of the aneurysm) versus time is presented in the graphs of Fig. 5.

The first second for the analysis of graphs is not considered, because during this time the flow stabilizes. Before the stenosis of the vessel, the shear stress on the aneurysm wall averages about 0.45 Pa, but in some regions it reaches 2.5 Pa. After

stenosis, it rises to an average of 0.65 Pa, and in some areas its maximum value reaches 4.4 Pa so the increase is by 50-75%.



**Fig. 5.** Wall shear stresses in aneurysm: mean (a), and maximum (b) values.

The obtained graphs also show that after the stenosis of the supply vessel, wall shear stress in the aneurysm begins to oscillate (a standing wave appears in the aneurysm). The maximum value is much higher than wall shear stress in the normal state. After the vessel was brought back to its normal state, wall shear stress gradually normalized and assumed an initial value (see Fig. 6).

To compare the calculated characteristics of the pathological vessel with the norm, the situation with a virtually remote aneurysm was simulated. The results of comparison of the flow along the vessel with an aneurysm and a vessel with a virtually removed aneurysm are presented in Figure 6.

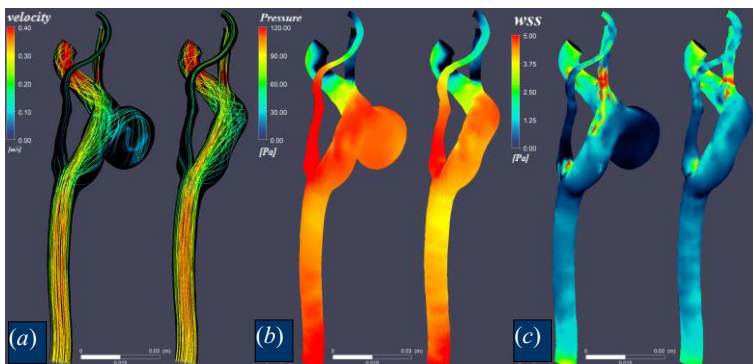

**Fig.6.** Distribution of characteristics of the dynamics of blood flow in a vessel with an aneurysm and without an aneurysm: a) flow stream velocity, b) blood pressure in the vessels, c) wall shear stress on the wall.

The obtained results indicate that after virtual removal of aneurysm, blood pressure in the vessel and wall shear stress on the wall were redistributed more evenly, and the maximum values were reduced.

## 4 Conclusion

The issues while analyzing medical images are poor quality, noisy image, low resolution and low contrast. The main aim is to improve the visual quality of images using new algorithms [6, 7, 8].

The impact of surgical intervention on hemodynamic today is an insufficiently studied problem, which requires further investigation. Mathematical modeling makes it possible to understand and visualize the processes that occur when blood passes through vessels and aneurysms, as well as the resulting changes that occur in the vascular system with various anatomical changes, for example, in vascular spasm. The use for these purposes of mathematical models based on the data of specific patients can potentially help in determining the probability of occurrence of consequences and determine surgical tactics.

## References

1. Skobtsov Yu.A., Rodin Yu.V., Overco V.S. Modeling and visualization of blood flow behavior in pathological processes (2008).
2. Xu Bai-Nan, Wang Fu-Yu, Liu Lei, Zhang Xiao-Jun, JuHai-Yue. Hemodynamics model of fluid—solid interaction in internal carotid artery aneurysms.//*Neurosurg. Rev.* Vol.34(1). pp.39-43 (2011).
3. Hassan T., Ezura M., Timofeev E.V., Tominaga T., Saito T., Takahashi A., Takayama K., Yoshimoto T. Computational Simulation of Therapeutic Parent Artery Occlusion to Treat Giant Vertebrobasilar Aneurysm. // *Am. J. Neurorad.* Vol.25(1). P.63-68 (2004).
4. Sforza D.M. Putman C.M. Cebal J.R. Haemodynamics of Cerebral Aneurysm. // *Annu Rev Fluid. Mech.* January 1. Vol.41. P. 91-107 (2009).
5. Oshima M., Kobayashi T., Takagi K., Tezduyar T. Fluid—structure interaction modeling of blood flow and cerebral aneurysm: Significance of artery and aneurysm shapes.// *Computer Methods in applied Mechanics and Engineering.* Vol. 198 (45-46). P.3613-3621 (2009).
6. Zheng C, Xia Y, Pan Y, Chen J Automated Identification of Dementia Using Medical Imaging: A Survey from a Pattern Classification Perspective // *Brain Informatics* (2015).
7. Yogesh Rao, Nisha Sarwade, Roshan Makkar, "Denoising and Enhancement of Medical Images Using Wavelets in LabVIEW", *International Journal of Image, Graphics and Signal Processing(IJIGSP)*, vol.7, no.11, pp.42-47, 2015.DOI: 10.5815/ijigsp.2015.11.06
8. Manoj Kumar, Manoj Diwakar, "A New Locally Adaptive Patch Variation Based CT Image Denoising", *International Journal of Image, Graphics and Signal Processing(IJIGSP)*, Vol.8, No.1, pp.43-50, 2016.DOI: 10.5815/ijigsp.2016.01.05

# Detection of Hidden Mineral Imbalance in the Human Body by Testing Chemical Composition of Hair or Nails

S.A.Rustembekova<sup>1</sup>, Dr. of Sci. in Med., PhD; V.V.Gorshkov<sup>2</sup>, Dr. of Sci. in Eng.,  
PhD; M.M.Sharipova<sup>3</sup>, PhD; A.S.Khazova<sup>4</sup>

<sup>1</sup>Research and Medical Center MICROELEMENT, Pur'eva St., 11A, Moscow, 119285, Russia

<sup>2</sup>A.N. Kosygin Russian State University, Malaya Kaluzhskaya St., 1, Moscow, 119071, Russia

<sup>3</sup>A.I. Yevdokimov Moscow State University of Medicine and Dentistry, Delegatskaya St., 20/1,  
Moscow, 127473, Russia

<sup>4</sup>Alla Khazova Clinic, Kuusinen St., 17/3, Moscow, 125252, Russia

<sup>2</sup>vlgorshkov@gmail.com

**Abstract.** The method of the detection of macro- and trace element balance in the human body by hair and nail testing (IMOPAVIN) is widely used in medical practice of Russian and foreign medical centers. This method is similar to the method which is called Hair Tissue Mineral Analysis (HTMA) in English publications. In this method reference limits for the content of individual elements as well as ratios of certain element pairs are specified. The measured levels of individual elements or ratios of specific element pairs lying beyond the reference ranges indicate mineral imbalance in the body correlated to various diseases. The method based on both the levels of individual elements and ratios of specific element pairs is offered to detect hidden mineral imbalance in the body. Hidden deficiency or excess of any macro- or trace elements was confirmed by laboratory tests (macro- and trace element levels in blood and urine) as well as clinically (correction of hidden mineral imbalance with the drugs designed for mineral balance correction). The method is based on the analysis of ratios in the pairs of elements, each having a normal level.

**Keywords:** Mineral imbalance, study of the human body mineralogram by testing hair and nails (IMOPAVIN), Hair Tissue Mineral Analysis (HTMA), hidden deviations of element levels.

## 1 Introduction

Macro- and trace elements are integral parts of many biostructures, particularly, active centers of some enzymes. They take part in critical biochemical processes, redox reactions, free-radical oxidation, protein synthesis, tissue growth and differentiation, interaction with internal nucleic acids and their monomer components.

Concentration of macro- and trace elements in healthy body is strictly balanced and maintained by homeostasis. Kinetics, distribution and deposition of metal ions are ruled by biochemical regulation mechanisms. Changes in the concentration of every macro- and trace elements are interrelated. Ion balance in biological substrates

(mainly in hair and nails) forms the picture of metabolic changes, in which metal-containing molecules are involved. метаболических изменениях, протекающих с участием металлосодержащих молекул. This is the basis of body mineralography grounded on hair and nails testing (ИМОПАВИН), which is similar to Hair Tissue Mineral Analysis (HTMA) in English publications [1]. It's noteworthy also that in some cases the analysis of hair and nails image may be used for certain disease diagnostics (see, for example, [2]).

Macro- and trace element content in biological substrates can be correlated to certain diseases [3, pp. 451–457]. Experience has shown that deviations of absolute content of individual macro- and trace elements from reference values as well as changes in relative content of element pairs determined by comparing of specific macro- and trace element ratios with the limits of corresponding reference ranges should be taken into account.

Conventional approach to deviations of any element ratios in case of ИМОПАВИН or HTMA does not allow to correct the revealed deviations. Therefore another approach should be offered. It is based on the search for hidden deviations of elements in a pair.

## 2 The Definitions Used

Hereinafter, the following definitions are used in the description:

*Basic elements* are C, H, O and N.

*Biologically allowable level (BAL)* is a critical element level in the body. If this level is exceeded organic changes in tissues can occur. Biologically allowable level is generally several times greater than upper limit of reference range. Up to now BAL has not been specified for some trace elements.

*Conditionally essential trace elements (CE)* are vitally important trace elements that are harmful in certain doses (Ag, Al, Au, B, Br, Co, Ge, Li, Ni, Si, V) (11 elements).

*Deficiency below LNL (times)* is a ratio of the lower reference limit to the element content measured. If element content is below the lower reference limit this figure will be  $> 1$ . The figure is applicable for only essential and conditionally essential elements.

*Deviation* is defined as:

- a) a distance from the measurement result to the reference range midpoint if half-width of the reference range is set equal to 1 (in this case deviation value of  $-1$  corresponds to the lower reference limit and deviation value of 1 corresponds to the upper one) for essential and conditionally essential elements. A deviation may be less than  $-1$  (below the lower limit) or more than  $+1$  (above the upper limit) if this value is out of the reference range; sometimes it is also known as “the deviation from the reference range

- midpoint” in this case;
- b) the same, but the lower bound of the norm coincides with zero in this case; that's why more informative is the parameter “above UNL,times” (expressed in the number of times).

*Element content ratio* is a ratio of the contents of two elements. The analysis of this ratio allows to find hidden deviations from reference value for one of the elements in this pair. Elements in pairs are typically either synergistic or antagonistic. In this case designation of *A/B* type means a ratio of *A* element content to *B* element content in the same biological sample.

*Element deficiency (D)* is a condition when an element content is below the lower normal level (LNL).

*Element excess (E)* is an element content that is more than UNL. 5 grades of excess can be distinguished: slight excess, excess with no extent information, moderate excess, significant excess and excess over biologically allowable level (for the elements, which BAL has already been specified). In some cases excess is denoted by such terms as “metabolic disorder”, “excessive accumulation” and “significant content”.

*Essential elements (E)* are vitally important elements. This group includes all structural elements (H, O, N, C; Ca, Cl, F, K, Mg, Na, P, S) and 8 trace elements (Cr, Cu, Fe, I, Mn, Mo, Se, Zn), a total of 20 elements.

*Excess above UNL (times)* is a ratio of the measured element content to the upper reference limit. If element content is above the upper reference limit this index will be  $> 1$ . For potentially toxic elements this figure coincides with deviation.

*Lower normal level (LNL)* is an area adjoining the lower reference limit (about 1–20% of the reference range) and lying mainly within this range with typically very small overlapping (about 5%) with exterior area.

*Macroelements* are elements contained in relatively large amount ( $>10^{-2}\%$ ). They include Ca, Cl, F, K, Mg, Na, P, S and form a group of structural elements together with basic elements.

*Metabolic disorder* is a condition when the amount of essential or conditionally essential elements is below the lower normal level (LNL) or above the upper normal level (UNL) and the amount of potentially toxic element is above the UNL. Impaired metabolism of any essential or conditionally essential element can be characterized by two figures:

- deviation (from the midpoint of the reference range for essential and conditionally essential elements and from the upper limit of the reference range for potentially toxic elements);
- deficiency below LNL (excess above UNL), number of times.

The need for simultaneous use of these two figures is caused by the fact that all tested elements differ in the reference range width relative to the midpoint as well as in LNL and UNL relative to the reference range width.

Potentially toxic elements have zero lower reference limit and therefore only the factor of excess above UNL (times) is used for these elements.

The values fallen within LNL and UNL areas are typically not considered as metabolic disorder (deficiency or excess). However these values make us monitor the follow-up dynamics of corresponding element contents.

*Potentially toxic trace elements (PT)* are the elements which consumption is rather harmful than useful. They include a total of 50 elements: As, Ba, Be, Bi, Cd, Ce, Cs, Dy, Er, Eu, Ga, Gd, Hf, Hg, Ho, In, Ir, La, Lu, Nb, Nd, Os, Pb, Pd, Pr, Pt, Rb, Re, Rh, Ru, Sb, Sc, Sm, Sn, Sr, Ta, Tb, Te, Th, Ti, Tl, Tm, U, W, Y, Yb, Zr.

*Reference range (RR)* is a range of element content in completely healthy person for whom illness is not expected. Reference limits were reported in several sources, e.g., [3; 4, pp. 626–633]. Elements content in hair and nails is measured in  $\mu\text{g/g}$ , e.g., phosphorus content of 100  $\mu\text{g/g}$  means that 1 g of hair contains 100  $\mu\text{g}$  of phosphorus.

*Trace elements* are a group of chemical elements (a total of 69) contained in the human body in tiny amounts (within  $10^{-3}$ – $10^{-12}\%$ ).

*Upper normal level (UNL)* is an area adjoining the reference range (about 1–20% of the reference range) and mainly lying within this range, usually with very small overlapping (not more than 5%) of exterior area.

*Warranted normal range (WNR)* is the reference range except for upper and lower normal areas.

The reference range is a range including warranted normal range as well as upper and lower normal areas. The measured content (of an element or elements ratio) lying out of this range indicate deviation from a norm.

### 3 Rationale for the Study of Macro- and Trace Element Content Ratios

#### 3.1 Selection of the pairs of macro- and trace elements for the study

The pairs of macro- and trace elements for the study of their content ratios were chosen with regard to the state of knowledge about their influence on human health reported in various literature sources [5, 6]. Such ratios are used for the study in various laboratories, particularly, in the laboratories listed on the website of Trace Elements (USA) [7] and MICROELEMENT Research and Medical Center (Russia) [8].

To prove the interrelations in the element pairs (of E/E type) mentioned above the following considerations should be taken [5].

1. **Calcium/magnesium.** Magnesium enhances calcium absorption (synergy), optimum calcium to magnesium ratio in a diet is 2:1. Increased magnesium content may reduce calcium digestion in the intestinal tract (antagonism). However significant magnesium insufficiency may lead to hypocalcemia. When magnesium level in blood is decreased kidneys restore the balance by retaining lesser calcium amount (synergy).

2. **Calcium/phosphorus.** Phosphorus enhances calcium absorption (synergy), optimum calcium to phosphorus ratio in a diet is 2:1. Excessive calcium leads to phosphorus deficiency (antagonism).
3. **Iron/copper.** Copper is critically important for iron digestion (synergy). Excessive iron consumption and accumulation leads to copper deficiency in the body (antagonism).
4. **Sodium/potassium.** Sodium and potassium are electrolytes contained in every fluid of the human body. They take part in a wide range of biochemical reactions. Increased sensitivity to sodium is associated with potassium deficiency in the human body (synergy). If sodium is present in excessive amount potassium level is decreased because of its enhanced excretion (antagonism). Such physiological mechanisms as potassium channels and membrane hyperpolarization are known to reduce excitability of the cell.
5. **Sodium/magnesium.** Magnesium ions take part in sodium metabolism. Sodium inhibits interstitial magnesium absorption (antagonism).
6. **Zinc/copper** is one of the most important constants in the human body. Zinc and copper are known physiological antagonists involved in the production of metallothionein. Zinc accumulation or increased consumption leads to copper deficiency in the body (antagonism).
7. **Calcium/potassium.** The treatment of hyperpotassemia mainly requires injection of calcium ions to stimulate potassium to migrate from extracellular water to the cell (antagonism).

### 3.2 Element content ratio as additional information source

The foregoing necessitates the study of balance for each pair mentioned above. These ratios are characterized by reference values not coinciding with the areas determined by the reference limits accepted for individual elements in each of these pairs. As a result both elements in any pair may be contained in normal amounts but the ratio of their contents falls out of the reference range for this pair. It was previously unclear how to restore the balance in such a pair and this was the reason for introduction of the term of hidden imbalance (deficiency or excess) for the elements included in one of the pairs listed above.

This statement can be illustrated as follows. Let us introduce the following notations:

$x_{nl}, x_{mu}$  are the lower and upper normal levels, respectively, for the element of a pair in the numerator;

$x_{dl}, x_{du}$  are the lower and upper normal levels, respectively, for the element of a pair in the denominator;

$u_{rl} = x_{nl}/x_{du}, u_{ru} = x_{mu}/x_{dl}$  are the lower and upper limits, respectively, of the total range for a pair of elements;

$u_l, u_u$  are the lower and upper limits, respectively, of the reference range for element content ratio.



The standard report on the study of mineral balance set forth on the site of Trace Elements [7] contains upper and lower reference limits for eight elements out of seven above listed pairs of essential elements (E/E) that are given in Table 1.

**Table 1.** Reference limits for individual essential elements from seven pairs selected for the study

Element	Reference limits, $\mu\text{g/g}$		Element	Reference limits, $\mu\text{g/g}$	
	Lower ( $x_l$ )	Upper ( $x_u$ )		Lower ( $x_l$ )	Upper ( $x_u$ )
Ca	220	970	Na	40	360
Mg	20	110	K	20	240
P	110	200	Zn	100	210
Fe	5	16	Cu	9	39

In turn, lower and upper limits of the total range (based on the data from Table 1) and the preset limits (specified on the site of Trace Elements) for the listed pairs are given in Table 2. As shown from the Table reference range for each of the selected essential element pairs (E/E) is in any case narrower than the corresponding total range. Hence, it is possible that the content ratio is out of the reference range for the pair whereas the content of each individual element of the pair is normal. This is why the method offered is practically reasonable. The situation is similar for ratios of potentially toxic and essential elements (PT/E).

**Table 2.** The limits of total range and reference range for seven pairs of essential elements selected for the study

Pair	Total range for the ratio (dimensionless)		Reference ratio (dimensionless)	
	Lower limit, $u_{rl}$	Upper limit, $u_{ru}$	Lower limit, $u_l$	Upper limit, $u_u$
Ca/Mg	2.00	48.50	3.00	11.00
Ca/p	1.10	8.82	1.60	3.60
Fe/Cu	0.13	1.78	0.20	1.60
Na/K	0.17	18.00	1.40	3.40
Zn/Cu	2.56	23.33	4.00	12.00
Na/Mg	0.36	18.00	2.00	6.00
Ca/K	0.92	48.50	2.30	6.20

### 3.3 Confirmation of hidden deviations

Hidden deficiency and excessive content of any macro- and trace elements listed in Table 1 were confirmed by laboratory tests (levels of macro- and trace elements in other biological substrates, specifically, in blood and urine) and clinical results (hidden mineral imbalance was corrected with the drugs intended for this purpose). Clinical data for some patients diagnosed with hidden disorders and the results of their treatment are given below for each of the element (E/E) ratios listed. The first 5 examples are related to the study of individual patients and example 6 is related to the

group of patients. Data on macro- and trace element content in hair as well as content ratios for the selected pairs (elements) before mineral balance correction for the first five examples are summarized in Table 3 where the following abbreviations are used: D – deficiency, E – excess, HD – hidden deficiency, HE – hidden excess.

**Table 3.** Macro- and trace element content in hair and content ratios for the selected pair of elements before mineral balance correction, for examples No. 1–5 (individual patients)

Pair	Ratio			Numerator			Denominator			Result	
	Value	Deviation	Status	Element	Value, $\mu\text{g/g}$	Deviation	Element	Value, $\mu\text{g/g}$	Deviation	Element	Hidden status
Ca/Mg	11.8	1.66	E	Ca	1282	0.52	Mg	108.6	-0.5	Ca	HE
Ca/P	6.75	1.11	E	Ca	1250	0.44	P	185.0	0.7	P	HE
Fe/Cu	4.39	1.06	D	Fe	36	0.68	Cu	8.2	-0.92	Cu	HD
Na/K	3,16	1.66	E	Na	476	0.88	K	150.3	-0.66	Na	HE
Na/Mg	5.09	1.46	E	Na	465	0.83	Mg	91.5	-0.86	Mg	HD

**Example 1. Calcium/magnesium (deficiency, hair):** hidden calcium excess. Female patient S., 46 years old, diagnosed with autoimmune thyroiditis, primary hypothyroidism, the stage of drug-induced euthyroidism.

**Example 2. Phosphorus/calcium (excess, hair):** hidden phosphorus accumulation. Female patient born in 1939 was under care in MICROELEMENT Research and Medical Center from 2011 to 2015 with hypothyroidism resulted from subtotal thyroid resection.

**Example 3. Iron/copper (excess, hair):** hidden copper deficiency. Female patient A., 14 years old. Diagnosis: atopic dermatitis, erythematous form. Gastroduodenitis, pancreopathy. Secondary bowel dysbacteriosis of II–III degree.

**Example 4. Sodium/potassium (excess, hair):** hidden sodium accumulation. Female patient S. born in 1947 diagnosed with autoimmune thyroiditis, primary hypothyroidism.

**Example 5. Sodium/magnesium (excess, hair):** hidden magnesium deficiency. Female patient, 54 years old, sought medical attention in outpatient clinic with complains of emotional lability, general weakness, paresthesia in upper and lower limbs, hypertension up to 140/90 mm Hg, pastosity of lower limbs, poor sleep and irritability.

**Example 6. Zinc/copper (deficiency, hair):** hidden zinc deficiency. The effect of “Hemmos” medication (Canyon Research and Production Enterprise, Russia) on macro- and trace element balance was tested in MICROELEMENT Research and Medical Center in 15 health volunteers. As a result hidden zinc deficiency was detected [9, p. 175].



**Table 4.** Explanation to deviation diagrams for essential and conditionally essential elements

Axial point “absolute content value”, $\mu\text{g/g}$ , $x$	Area	Deviation, $y$	Below LNL, times	Above UNL, times
$x_1$	Below LNL, deficiency	$y < -1 - d$	$>1$	$<1$
$x_2$	LNL	$\sim -1$ (specifically, $-1 - d < y < -1 - d + a$ )	$\sim 1$	$<1$
$x_3$	Reference (normal) value	$-1 - d + a < y < 1 - a + d$	$<1$	$<1$
$x_4$	UNL	$\sim 1$ (specifically, $1 + d - a < y < 1 + d$ )	$<1$	$\sim 1$
$x_5$	Above UNL, excess	$y > 1 + d$	$<1$	$>1$
$x_6$	Above UNL (within BAL), in the vicinity of BAL	$1 + d < y < (L - x_m)/l$	$<1$	$>1$
$x_7$	Above BAL	$y > (L - x_m)/l$	$<1$	$>1$

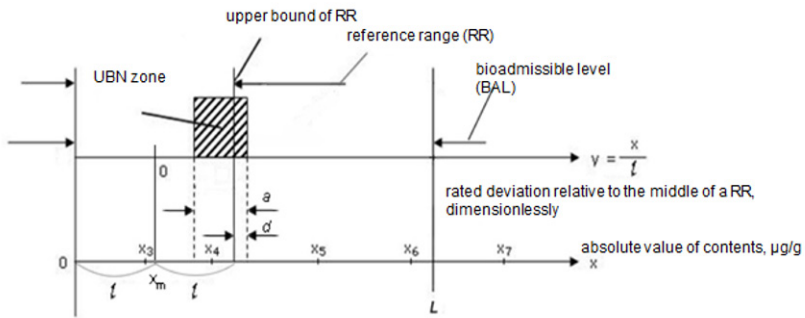

**Fig. 2.** Explanation to the procedure of comparing measurement results with reference range limits for potentially toxic elements

**Table 5.** Explanation to deviation diagrams for potentially toxic elements

Axial point “absolute content value”, $\mu\text{g/g}$ , $x$	Area	Deviation, $y$	Below LNL, times	Above UNL, times
$x_3$	Reference (normal) value	$0 < y < 1 - a + d$	<1	<1
$x_4$	UNL	$1 + d - a < y < 1 + d$	<1	~1
$x_5$	Above UNL, excess	$y > 1 + d$	<1	>1
$x_6$	Above UNL (within BAL), in the vicinity of BAL	$1 + d < y < (L - x_m)/l$	<1	>1
$x_7$	Above BAL	$y > (L - x_m)/l$	<1	>1

The following designations are accepted in these figures and tables for individual elements:

$x$  – absolute element content measured,  $\mu\text{g/g}$ ;

$x_m = (x_u - x_l)/2$  – mean value (midpoint) of the reference range (RR) where  $x_u$  and  $x_l$  are the upper and lower limits of the reference range, respectively;

$l$  – half-width of the reference range (for potentially toxic elements the reference range lower limit coincides with zero unlike essential and conditionally essential elements, for which this condition is not met);

$y = (x - x_m)/l$  – normalized (by half-width of the reference range) centered (relative to the midpoint of the reference range) element content value also called (normalized) deviation (from the midpoint of the reference range);

$L$  – biologically allowable level;

$a$  – width of the upper normal level (UNL) area and also of the lower normal level (LNL) area for essential and conditionally essential elements.

$d$  – overlap width (indicating how far the upper and lower normal areas go beyond the reference range; this value can either be found from the analysis of measurement error – several percent – or set equal to zero);

$x/x_u$  – the degree indicating how much times element content exceeds the upper reference limit (expressed in times of UNL excess);

$x_l/x$  – the ratio indicating how much times element content is lesser than the lower reference limit (below LNL, times) (this value is equal to zero for potentially toxic elements).

### 4.3 Stage 3. Detection of hidden deviations

After data decryption hidden deviations are determined for each individual element of the pairs listed in Table 1. Content ratio for the selected pair of elements (essential, conditionally essential and toxic ones) allows to identify hidden imbalance:

- hidden deficiency and excess of one of the elements in a pair by ratio of the two essential elements;

- hidden excess of potentially toxic element in a pair by ratio of potentially toxic and essential elements.

Hereinafter the following abbreviations are accepted:

RV – reference (normal) value;  
 D – denominator;  
 N – numerator;  
 NRV – reference value for element in the numerator;  
 DRV – reference value for element in the denominator;  
 NDUL – distance to the upper limit from element in the numerator;  
 DDLL – distance to the lower limit from element in the denominator;  
 NHE – hidden excess of element in the numerator;  
 DHD – hidden deficiency of element in the denominator;  
 NHD – hidden deficiency of element in the numerator;  
 DHE – hidden excess of element in the denominator;  
 E/E – ratio of the contents of two essential elements (dimensionless);  
 PT/E – ratio of the contents of potentially toxic and essential elements (dimensionless).

Abbreviations accepted for element content ratios in the selected pair of elements:

$x_n, x_d$  – the content of elements in the numerator and denominator, respectively;  
 $u = x_n/x_d$  – the ratio of element contents (this ratio is correct because lower reference limit is always positive for essential elements);  
 $u_l, u_u$  – the lower and upper limits of the reference range for ratio of element contents, respectively;  
 $l = (u_u - u_l)/2$  – half-width of the reference range for ratio of element contents (lower reference limit  $u_l = 0$  for the ratio of potentially toxic and essential elements);  
 $u_m = (u_u + u_l)/2$  – mean value (midpoint) of the reference range;  
 $v = (u - u_m)/l$  – normalized normalized (by half-width of the reference range) centered (relative to the midpoint of the reference range) ratio of elements also called (normalized) deviation (from the midpoint of the reference range);  
 $a_{rel}$  – width of the upper and lower normal areas for ratio of elements (the ratio of potentially toxic and essential elements does not have lower normal limit);  
 $d_{rel}$  – overlap width for ratio (indicating how far the upper and lower normal areas go beyond the reference range; this value can either be found from the analysis of measurement error – several percent – or set equal to zero);  
 $u/u_u$  – the degree indicating how much times element content ratio exceeds the upper reference limit (expressed in times of UNL excess);  
 $u_l/u$  – the ratio indicating how much times element content ratio is lesser than the lower reference limit (below LNL, times) (this value is equal to zero for ratio of potentially toxic and essential elements).

Index numbers for ratios are the same as for individual elements.

All possible cases of element relations in the selected pair are listed in the tables below (Table 6 for essential elements and Table 7 for potentially toxic and essential elements). A dash in the right-hand column indicates the absence of hidden deviations. Tables 6 and 7 allow to assess any hidden imbalance of individual elements by ratio of element contents in a pair and the content of each element.

**Table 6.** Possible relations between element content in the selected pair of elements and respective hidden deviations (in case of the pair of essential elements)

Ratio (R), $v$	Numerator (N), $y_n$	Denominator (D), $y_d$	Relation between NDUL (1- $y_n$ ) and DDLL (1 + $y_d$ )	Hidden deviation	
$R = RV$ ( $-1 - d_{rel} < v < 1 + d_{rel}$ )				-	
$R > RV$ ( $v > 1 + d_{rel}$ )	$N = NRV$ ( $-1 - d_n < y_n < 1 + d_n$ )	$D = DRV$ ( $-1 - d_d < y_d < 1 + d_d$ )	NDUL < DDLL (1 - $y_n < 1 + y_d$ )	NHE	
			NDUL > DDLL (1 - $y_n > 1 + y_d$ )	DHD	
		$D > DRV$ ( $y_d > 1 + d_d$ )		NHE	
		$D < DRV$ ( $y_d < 1 - d_d$ )		-	
	$N > NRV$ ( $y_n > 1 + d_n$ )	$D = DRV$ ( $-1 - d_d < y_d < 1 + d_d$ )			-
			$D > DRV$ ( $y_d > 1 + d_d$ )		-
			$D < DRV$ ( $y_d < 1 - d_d$ )		-
	$N < NRV$ ( $y_n < 1 - d_n$ )	$D = DRV$ ( $-1 - d_d < y_d < 1 + d_d$ )			NHD
			$D > DRV$ ( $y_d > 1 + d_d$ )		Unlikely, uncertain
		$D < DRV$ ( $y_d < 1 - d_d$ )		-	
	$R < RV$ ( $v < -1 - d_{rel}$ )	$N = NRV$ ( $-1 - d_n < y_n < 1 + d_n$ )	$D = DRV$ ( $-1 - d_d < y_d < 1 + d_d$ )	NDUL > DDLL (1 - $y_n > 1 + y_d$ )	NHD
				NDUL < DDLL (1 - $y_n < 1 + y_d$ )	DHE
$D > DRV$ ( $y_d > 1 + d_d$ )				-	
$D < DRV$ ( $y_d < 1 - d_d$ )				NHD	
$N < NRV$ ( $y_n < 1 - d_n$ )		$D = DRV$ ( $-1 - d_d < y_d < 1 + d_d$ )			-
			$D > DRV$ ( $y_d > 1 + d_d$ )		-
			$D < DRV$ ( $y_d < 1 - d_d$ )		-
$N > NRV$ ( $y_n > 1 + d_n$ )		$D = DRV$ ( $-1 - d_d < y_d < 1 + d_d$ )			DHE
			$D > DRV$ ( $y_d > 1 + d_d$ )		-
		$D < DRV$ ( $y_d < 1 - d_d$ )		Unlikely, uncertain	

**Table 7.** Possible relations between element content in the selected pair of elements and respective hidden deviations (the content of potentially toxic element is given in the numerator and that of essential one is given in the denominator)

Ratio (R), $v$	Numerator (N), $y_n$	Denominator (D), $y_d$	Hidden deviation
$R = RV$ ( $0 < v < 1 + d_{rel}$ )			-
$R > RV$ ( $v > 1 + d_{rel}$ )	$N = NRV$ ( $-1 - d_n < y_n < 1 + d_n$ )	$D = DRV$ ( $-1 - d_d < y_d < 1 + d_d$ )	NHE
		$D > DRV$ ( $y_d > 1 + d_d$ )	NHE
		$D < DRV$ ( $y_d < 1 - d_d$ )	-
	$N > NRV$ ( $y_n > 1 + d_n$ )		-
	$N < NRV$ ( $y_n < 1 - d_n$ )		-

#### 4.4 Stage 4. The use of the study results in diagnosis

Whenever imbalance of an element is detected either in obvious or in hidden form this allows to diagnose a particular disease with high confidence.

For further diagnostics various knowledge bases and artificial intelligence systems can be used [10, 11].

## 5 Conclusion

The analysis of data available demonstrates that some diseases are associated with imbalance of a number of elements (Ca, Mg, P, Fe, Cu, Na, K, Zn, etc.), and new diagnostic criteria should include not only the change of elements concentration in blood, hair and/or other fluids and tissues available for testing, but also detection of hidden element imbalance in biosubstrates.

Analysis of macro- and trace elements ratios allows obtaining additional information about mineral imbalances in a body. Earlier such ratios values beyond the references limits have been interpreted regardless of their connection with individual pair elements content. According to findings of other biosubstrates testing (blood and urine) together with clinical practice, joint consideration of above ratios (hair and nails) and the content of individual pair elements allows detection of hidden deviations by normal levels of individual elements.

The suggested approach cannot be used to automation of the procedure of hidden disorders detection by body mineralogram study following hair and nails testing (IMOPAVIN) or HTMA.

Considering abovementioned, it's noteworthy that not only diagnostic but also treatment and preventive measures in patients suffering from various diseases should ground on a number of detailed medical studies and should be conducted with consideration of knowledge of hidden element status disorders to assure pathogenetic element correction.



## Bibliography

1. Watts, D.: Trace Elements & Other Essential Nutrients: Clinical Application of Tissue Mineral Analysis. Writer's B-L-O-C-K (2006).
2. Trupti S. Indi, Yogesh A. Gunge, "Early Stage Disease Diagnosis System Using Human Nail Image Processing", International Journal of Information Technology and Computer Science(IJITCS), Vol.8, No.7, pp.30-35, 2016. DOI: 10.5815/ijitcs.2016.07.05
3. Braunwald, N.: Internal diseases. In 10 books. Book 2., "Medicine" Publishing House, Moscow (1993). (in Russian)
4. Rustembekova, S., Zaichick V.: Age- and sex-related differences in Al, Cd, Co, Cu, Fe, Mg, Mn, Mo, P, Pb, S and Zn levels in heard hair of health humans. Macro and Trace Elements. Mengen und Spurenelemente. 22th Workshop. Friedrich-Schiller-Universität, Vol. 1, pp. 230-236. Jena (2006).
5. Rebrov, V., Gromova, O.: Vitamins and microelements. "ALEF-V" Publishing House, Moscow (2003). (in Russian)
6. Avtsyn, A.P. et al.: Human microelement imbalance: causation, classification, organ pathology. Academy of medical Sciences of the USSR., "Medicine" Publishing House, Moscow (1991). (in Russian)
7. <http://www.traceelements.com/docs/Graph.pdf>, accessed date 25.05.2017.
8. <http://www.microelement.ru/templates/micro/images/2014/primer-imopavin-70-ch1.pdf>, accessed date 25.05.2017.
9. Rustembekova, S.: Microelements in thyroid diseases. LAMBERT Academic Press, Saarbrucken (2014).
10. Adane Nega Tarekegn, "Localized Knowledge based System for Human Disease Diagnosis", International Journal of Information Technology and Computer Science(IJITCS), Vol.8, No.3, pp.43-50, 2016. DOI: 10.5815/ijitcs.2016.03.05
11. Koushal Kumar, Gour Sundar Mitra Thakur, "Advanced Applications of Neural Networks and Artificial Intelligence: A Review", International Journal of Information Technology and Computer Science(IJITCS), vol.4, no.6, pp.57-68, 2012.

# Virtual Concilium for Diagnostics of Heterogeneous Diseases

S.B. Rumovskaya<sup>1</sup>, S.V. Listopad<sup>1</sup>, and A.V. Kolesnikov<sup>1,2</sup>

<sup>1</sup> Kaliningrad branch of FRC CSC RAS, Kaliningrad, Russia

<sup>2</sup> Immanuel Kant Baltic Federal University, Kaliningrad, Russia  
sophiyabr@gmail.com

**Abstract.** Heterogeneous diseases are medical and social problems with a high risk of complications, widespread prevalence and insufficient control on the scale of human society. Such diseases are characterized by polymorbidity and Rigelman situations, which requires the participation of a team of specialists of various profiles in diagnostic decision-making. The concept of "Virtual concilium" for modeling collective diagnostic decision-making is proposed. The use of the virtual concilium reduces the number of errors in the diagnosis and, accordingly, increases the quality of diagnostic decisions.

**Keywords:** Virtual concilium, hybrid intelligent systems, arterial hypertension.

## 1 Introduction

The study of collective problem solving methods and their modeling [1–4, etc.] is an important area of scientific research in system analysis and has great practical significance. A special role is played by research and modeling of collective solving of complex heterogeneous problems, containing subproblems, each of which has to be solved by a specialist or specialists of the relevant field of knowledge.

Tasks of medical diagnostics are examples of such problems. The often occurring polymorbidity [5], that is, the presence of several pathological processes simultaneously, changes and complicates the classical clinical picture. It requires participation of a team of experts of different specialties in diagnostic decision-making. Often, there are Riegelman's situation [6] – the presence of atypical symptoms and mirages, which leads to mistakes in diagnosis and treatment. The development of instrumental methods for researching and monitoring of the object's state entails the need of systems analyzing information from sensors. In these cases automating the collection, analysis of information and decision-making support (for example, [7–9]) is crucial for taking in account all detected signs and symptoms and, consequently, improve the quality of decisions.

Methods and tools for modeling the process of collective solution envisioning open the way for reducing the risks of incorrect diagnostic conclusions. The development of such methods is associated with the researches of G.M. Adelson-Velski, S.A. Ayvazyan, N.M. Amosov, P.K. Anokhin, R.M. Bayevsky, M.M. Bongard, V.I. Burakovsky, S.A. Gasparyan, I.M. Gelfand, A.N. Gorban, E.V. Gubler, E.S. Enyukov, Yu.I. Zhuravlev, V.P. Karp, B.A. Kobrynsky, A.N. Kolmogorov, A.S. Kronrod, O.I.

Larichev, L. Lasted, V.P. Leonov, V.I. Lishchuk, O.P. Mintser, N.S. Misyuk, G.I. Nazarenko, G.S. Osipov, A.B. Petrovsky, K.S. Simonyan, G.A. Khaya, D.S. Chernavsky, D. Cullen, P. Fisher, L. Landucci, E.T. Lee, J.H. Van Bommel and others. These works and researches in the field of artificial intelligence have led to the emergence of hybrid and synergistic intelligent systems, in particular, hybrid intelligent systems (HIS). Such systems integrate heterogeneous knowledge models over the heterogeneous model field, and thereby – model reasoning in decision-making teams. Decision support system "Virtual concilium" based on this technology will significantly reduce the number of errors and improve the quality of the decisions made.

The paper proposes the use of "Virtual concilium" for diagnosing heterogeneous diseases, particularly arterial hypertension (AH), to improve the quality of individual diagnostic decision-making in outpatient type medical institutions (MI) due to modeling team decision-making inherent to multidisciplinary hospitals.

## 2 Team Diagnostic Decision-Making

Analysis of the problematic environment of diagnostics, in particular AH, on the example of the Kaliningrad Regional Clinical Hospital showed:

1. a significant variety (cardiology, endocrinology, functional diagnostics, etc.), a significant amount of information (about 800 parameters of the patient's condition), presence in the reasoning of A.S. Narinyani NON-factors [10], quantitative, qualitative, graphic data (electrocardiogram (ECG), echocardiogram (EchoCG), etc.), i.e. diagnostic situations and knowledge about AH, accumulated in theoretical and practical medicine, are heterogeneous, and a doctor with experience of less than 5 years and especially the beginning physician is not able to study, evaluate and use them when diagnosing;
2. the universality of diagnostic coding contradicts the actuality of detailing the nomenclature of signs and symptoms, formats for recording data;
3. the imperfection of methods and means of medical informatics for consultations of a doctor who diagnose AH in conditions of limited resources, lack of time, shortage of experts;
4. AH is undiagnosed in 70 percent of patients in an outpatient clinic [11], and the level of awareness of the population about AH and blood pressure (BP) control in the country is growing unacceptably slowly.

Three main causes of this situation were identified [12]: inertness of doctors, a low adherence of patients to the treatment and problems of public health services in organization of care for chronic diseases. The inertness of doctors is a consequence of the factors of doubt in the degree of risk associated with high BP, especially in the elderly, the fear of reducing blood circulation in vital organs and the fear of side effects.

According to W.R. Ashby's law of requisite variety, only a diverse, coordinated analytical activity, the elements of which in combination solve one problem, will make the diagnostic result qualitatively better. The specific nature of this activity cor

responds to the concilium that is the collective work of physicians in a team (Figure 1).

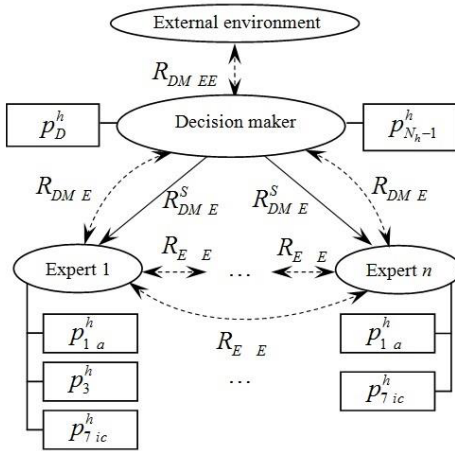

Notations:

$R_{DM EE}$ ,  $R_{DM E}$ ,  $R_{E E}$  – information relationship of complementarity "external environment – decision maker", "expert – decision maker", "expert – expert" respectively;  $R_{DM E}^S$  – cooperative relationship "decision maker – expert";

$p_i^h$  –  $i$ -th homogeneous diagnostic subproblem,  $i \in [1, N_h - 1]$

**Fig. 1.** The concilium conceptual model

The concilium conceptual model is expanded by subproblems distributed among the experts and the subproblem of the decision maker (DM). The last one form the diagnostic conclusion based on the experts' solutions of subproblems from the decomposition  $P^h$  of the heterogeneous diagnostic problem  $p_D$ .

To solve one diagnostic subproblem, single expert's knowledge may be sufficient (for example,  $p_3^h$ ), to solve another one, it is necessary to involve several experts and then either the partial solutions of the diagnostic subproblem can be additively united by the DM into the single solution ( $p_{1a}^h$ ) or the DM have to integrate and coordinate private solutions of the diagnostic subproblem ( $p_{7ic}^h$ ). The first two cases are investigated in the paper. The DM doesn't only solve the subproblem of private experts' opinions integration  $p_D^h$ , but also can participate in solving the subproblems ( $p_{N_h-1}^h$ ), if it's necessary.

This paper follows the hypothesis put forward in [13]: 1) at the present time, expert teams are the best in solving heterogeneous diagnostic problems; 2) the results of an automated solving of heterogeneous problem by the team decision-making model are no worse than by the real team of experts, and better than individual solutions. In ac

cordance with this hypothesis, the use of the team decision-making model (Figure 1) is actual for simulating collective problem solving in HIS.

"Virtual concilium" is a tool environment for synthesis and implementation of the method for solving heterogeneous diagnostic problems. It simulates the system "DM – experts", integrates the diverse knowledge of experts and is able to simulate both the reasoning of a single expert and the development of a common solution.

### 3 Team Decision-Making Modeling by "Virtual Concilium" on Example of Arterial Hypertension Diagnosis

The functional structure of "Virtual concilium" is shown in Figure 2. It's modular, flexible due to the presence of the library of preprocessing and diagnostics modules, as well as the interface for modifying structure of the concilium.

The architecture of "Virtual concilium" for the diagnostics of arterial hypertension (VCDAH) includes inter-model interfaces between modules implemented by various methodologies of hybrid intelligent systems:

- interfaces  $\zeta_{gf}$  between technological modules 1–9 for preprocessing of health indicators set, implemented by genetic algorithms (*g*), and functional fuzzy diagnostics modules 1–9, implemented by fuzzy systems (*f*);
- interfaces  $\zeta_{nf}$  between the functional ECG recognition module, implemented by the artificial neural network (*n*), and the functional fuzzy diagnostic modules 1, 3 and 6, implemented by fuzzy systems (*f*);
- interface  $\zeta_{ne}$  between the functional module for analysis of 24-hour ambulatory blood pressure monitoring (ABPM), implemented by the artificial neural network (*n*), and the functional diagnosis generation module, implemented by the expert system (*e*);
- interfaces  $\zeta_{fe}$  between the functional modules of fuzzy diagnostics 1–9, implemented by fuzzy systems (*f*), the functional diagnosis generation module, implemented by the expert system (*e*).

Table 1 describes functions performed by VCDAH modules.

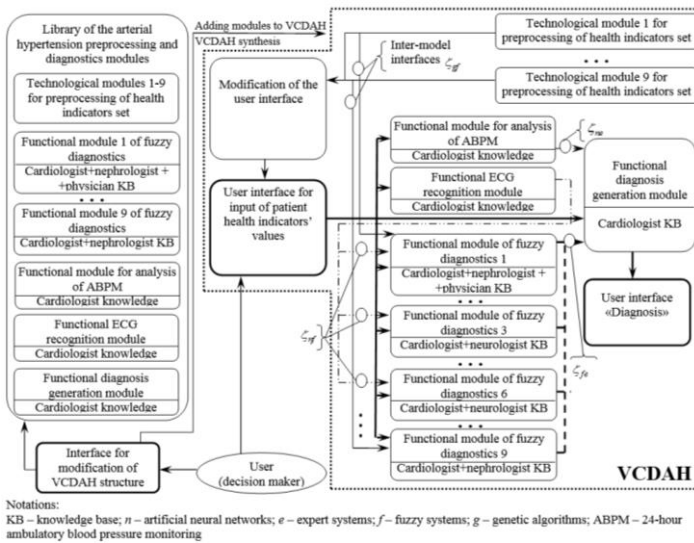

**Fig. 2.** The functional structure of "Virtual concilium" tool environment

Functions, inputs and outputs of all blocks, as well as interfaces of VCDAAH and the library of modules, are described in detail in [14].

**Table 1.** Architecture blocks of "Virtual concilium" for the diagnostics of arterial hypertension

Block name	Functions
The <i>i</i> -th technological module	Construction of an informative set of characteristics for diseases diagnostics (present by default). Minimizes the total number of input variables of the <i>i</i> -th functional module (implemented by the genetic algorithms methodology)
The <i>i</i> -th functional module of fuzzy diagnostics, including the knowledge base of the doctor(-s)	Classification of the patient's health state within the <i>i</i> -th diagnostic subproblem. It's present by default in "Virtual concilium" structure, but could be excluded by user (implemented by the fuzzy systems)
The functional ECG recognition module modeling the knowledge of the cardiologist	Classification of the patient's pathological state by its ECG (implemented by the artificial neural networks methodology)
The functional module for analysis of 24-hour ambulatory blood pressure monitoring (ABPM) modeling the knowledge of the cardiologist	Prediction of normal values of ABPM and the calculation of the patient's ABPM data deviation (implemented by the artificial neural networks methodology)
The functional diagnosis generation module including the knowledge base of the cardiologist	Composition of the final diagnosis of arterial hypertension (permanently present in "Virtual concilium", implemented by the expert system)

The concilium (Figure 2) launches the user interface of the DM "The interface for modification of VCDAH structure". It offers the possibility to include the functional and technological modules from the table above to the structure of VCDAH system. The selected technological modules solve technological subproblems from the group "Construction of an informative set of characteristics for diseases diagnostics" and pass the results to the block "Modification of the user interface". It deactivates the health indicators in the "User interface for input of patient health indicators' values" and corrects the work of the functional modules for solving subproblems AHD<sub>1</sub> – AHD<sub>9</sub>: diagnostics of target organ disease, risk factors, cerebrovascular diseases, metabolic syndrome and diabetes mellitus, diseases of the peripheral arteries, ischemic heart disease, endocrine hypertension, parenchymal nephropathy, and renovascular hypertension, respectively. Further, the "User interface for input of the patient health indicators' values" is activated, by means of which the values of the patient's health indicators (symptoms) are input to the functional modules of fuzzy diagnostics, solving subproblems AHD<sub>1</sub> – AHD<sub>9</sub>. AHD<sub>1</sub> – AHD<sub>9</sub> are models of the decision-making by experts such as cardiologist, neurologist, nephrologist, therapist, endocrinologist, urologist to identify the patient pathologies. These models transmit information about health-related condition to the functional module generating the diagnosis and solving subproblem "Assessment of the degree and stage of arterial hypertension and the risk of cardiovascular diseases". It simulates reasoning of DM – the cardiologist.

VCDAH library contains the functional module for ECG recognition (could be included to VCDAH structure using the "The interface for modification of VCDAH structure"), which transmits information (Table 1) to the functional modules of fuzzy diagnostics of target organ damage (AHD<sub>1</sub>), cerebrovascular diseases (AHD<sub>3</sub>) and ischemic heart disease (AHD<sub>6</sub>). In addition, VCDAH library contains the functional module for analysis of DABPM (could be included to VCDAH structure using the "The interface for modification of VCDAH structure") passing information about the required normal values of the 24-hour ambulatory blood pressure monitoring to the functional module generating the diagnosis.

The laboratory testing [15] of "Virtual concilium" prototype showed that it determines the correct diagnosis in 92% of cases. In addition, the duration of the diagnostic process per patient was investigated. It consists of three components: the duration of the diagnostics itself and making the records in the card, the duration of information processing and the duration of recording the conclusion. The sum of the last two components was reduced by "Virtual concilium" prototype approximately to 30 seconds.

The use of "Virtual concilium" should be performed as follows. DM-doctor examines the patient, and the nurse brings symptoms to the computer. "Virtual concilium" analyzes the information received and displays the final diagnosis in the form similar to an extract from the hospital's case history. DM-doctor, if he disagrees with the diagnosis, can repeatedly apply to "Virtual concilium". The preliminary results of the laboratory experiments with the prototype gave encouraging results and suggested that the introduction of "Virtual concilium" in MI of outpatient type would increase the efficiency and quality of the individual diagnostic solutions to the level of multidisciplinary hospitals, because of consultations with the synergetic collective artificial

intelligence system.

## 4 Conclusion

The development of modern society determines the successful and continuous functioning of its human and technical resources. In this regard, the differential diagnostics of nation's health and technical systems' state is especially important. Diagnostic decisions are made in conditions of limited resources, lack of time and experts, uncertainty of information about the environment and the investigated object. The value and variety of information processed during decision-making increases at an unprecedented rate. The automation of diagnostic process maintenance and the creation of corresponding software and hardware is advanced scientific field because of reducing the risks of incorrect diagnostic solutions. In this case, diagnostic objects, in particular, patients in medicine are considered as heterogeneous systems.

Nowadays doctors and diagnostic decisions support systems generally consider the patient unilaterally, one-dimensionally, from the point of view of single profession, single discipline, and single school. This is typical for homogeneous systems and leads to solving diagnostic problems non-systematically, when a variety of knowledge doesn't cooperate to achieve a common goal, and by definition doesn't create conditions for the emergence of a synergistic, systemic effect. There is the use of diverse knowledge models interacting with each other at the heart of "Virtual concilium ". These models are capable of simulating collective decisions and the variety of stored and processed information by which is relevant to the variety of information in diagnostic situations. Such systems are potentially capable of dynamically synthesizing a heterogeneous model field a new method of developing a diagnostic conclusion for each diagnostic object individually and applying it to make recommendations to the decision maker.

## Acknowledgments

The reported study was funded by RFBR according to the research project № 16-07-00272 A.

## References





1. Kolesnikov, A.V.: *Gibridnye intellektual'nye sistemy. Teoriya i tehnologiya razrabotki* [Hybrid artificial systems. Theory and development technology]. SPbGTU, St. Petersburg (2001).
2. Petrovskiy, A.B.: *Teoriya prinyatiya resheniy: universitetskiy uchebnik* [Decision-making theory: college textbook]. Akademiya, Moscow (2009).
3. Larichev, O.I.: *Teoriya i metody prinyatiya resheniy, a takzhe Khronika sobytiy v Volsheb-nykh stranakh: uchebnik* [Theory and methods of decision-making and also: Event history of Fairyland]. Logos, Moscow (2002).
4. Szuba, T.: *Computational Collective Intelligence*. Wiley, New York (2001).



5. Nurgazizova, A.K.: Proiskhozhdenie, razvitie i sovremennaya traktovka ponyatiy "komorbidnost'" i "polimorbidnost'" [Origin, evolution and modern interpretation of concepts "co-morbidity" and "polimorbidity"]. *Kazanskiy meditsinskiy zhurnal* [Kazanian medical journal] 95(2), 292–296 (2014).
6. Rigel'man, R.: *Kak izbezhat' vrachebnyh oshibok. Kniga praktikujushhego vracha* [How to avoid medical mistakes. The book of the clinician]. Praktika, Moscow (1994).
7. C.D. Katsis, I. Gkogkou, C.A. Papadopoulos, Y. Goletsis, P.V. Boufounou, "Using Artificial Immune Recognition Systems in Order to Detect Early Breast Cancer", *International Journal of Intelligent Systems and Applications(IJISA)*, vol.5, no.2, pp.34-40, 2013. DOI: 10.5815/ijisa.2013.02.04
8. Priti Srinivas Sajja, "Automatic Generation of Agents using Reusable Soft Computing Code Libraries to develop Multi Agent System for Healthcare", *International Journal of Information Technology and Computer Science(IJITCS)*, vol.7, no.5, pp.48-54, 2015. DOI: 10.5815/ijitcs.2015.05.07
9. Sahar S. Alqahtani, Sabah Alshahri, Ahood I. Almaleh, Farrukh Nadeem, "The Implementation of Clinical Decision Support System: A Case Study in Saudi Arabia", *International Journal of Information Technology and Computer Science(IJITCS)*, Vol.8, No.8, pp.23-30, 2016. DOI: 10.5815/ijitcs.2016.08.03
10. Narin'yani, A.S.: Nedoopredelennost' v sistemakh predstavleniya i obrabotki znaniy [Uncertainty in the systems of representation and processing of knowledge]. *Izvestiya AN SSSR, Seriya Tekhnicheskaya kibernetika* [Proceedings of USSR Academy of Sciences, Technical Cybernetics Series] 5, 3–28 (1986).
11. Plavunov, N.F., Stepanova, V.V., Karaulova, Yu.L., Kotovskaya, Yu.V., Kobalava, Zh., Moiseyev, V.S.: Rol' arterial'noy gipertonii v strukture i is-khodakh gospitalizatsiy mnogoprofil'nogo skoropomoshchnogo stacionara [The role of arterial hypertension in the patterns and outcomes of hospitalizations at a multidisciplinary emergency care hospital]. *Arterial'naya gipertenziya* [Arterial hypertension] 10(3), 30–36 (2004).
12. ESH/ESC: Guidelines for the management of arterial hypertension: The Task Force for the management of arterial hypertension of the European Society of Hypertension (ESH) and of the European Society of Cardiology (ESC). *Journal of Hypertension* 31(7), 1281–1357 (2013).
13. Kolesnikov, A.V., Kirikov, I.A., Listopad, S.V., Rumovskaya, S.B., Domanitskiy, A.A.: Reshenie slozhnykh zadach kommivoyazhera metodami funktsional'nykh gibridnykh intellektual'nykh sistem [Solving complex traveling salesman problem using functional hybrid intelligent systems]. IPI RAN, Moscow (2011).
14. Kirikov, I.A., Kolesnikov, A.V., Rumovskaya, S.B.: Funktsional'naya gibridnaya intellektual'naya sistema dlya podderzhki prinyatiya resheniya pri diagnostike arterial'noy gipertenzii [Functional hybrid intelligent decision support system for diagnosing of the arterial hypertension]. *Sistemy i sredstva informatiki* [Systems and Means of Informatics] 24(1), 153–179 (2014).
15. Kirikov, I.A., Kolesnikov, A.V., Listopad, S.V., Rumovskaya, S.B.: "Virtual'nyi konsilium" – instrumental'naya sreda podderzhki prinyatiya slozhnykh diagnosticheskikh reshenii ["Virtual consilium" – the tool environment for the complex diagnostic decisions support]. *Informatika i ee primeneniya* [Informatics and Applications] 10(3), 81–90 (2016).

# **Advances in Technological and Educational Approaches**

# Artificial Intelligence as Tutoring Partner for Human Intellect

V.I. Gromyko<sup>1</sup>, V.P. Kazaryan<sup>2</sup>, N.S. Vasilyev<sup>3</sup>,  
A.G. Simakin<sup>4</sup>, S.S. Anosov<sup>5</sup>

<sup>1</sup>Moscow Lomonosov State Univ., Moscow, Russia

<sup>2</sup>Moscow Lomonosov State Univ., Moscow, Russia

<sup>3</sup>Moscow Bauman State Tech. Univ., Moscow, Russia Moscow, Russia

<sup>4</sup>Russia Peoples' Friendship University, Moscow, Russia

<sup>5</sup>Public company Vozrozhdenie Bank, Moscow, Russia

<sup>1</sup>Gromyko.vladimir@gmail.com, <sup>2</sup>nik8519@yandex.ru

**Abstract.** System informational culture (SIC) has stated the next problem of post neo classical science man. How to educate trans disciplinary man of scientific culture (universal professional) capable to interpret and model knowledge by means of perception of humanitarian (art) and rational science unity? Co evolution of human mind and anthropogenic environment of computer instrumental systems (IS) occurs as subjective objectization of natural science knowledge (NSK). Authors have constructed model of artificial intelligence system of universal usage (AIUU) which supports continuous tutoring with the aim to form subject of SIC. Traditional education and known e-learning approaches can't cope with the task. Phenomenology of consciousness is grounded on development of rational part of mind. Classical universalities problem of philosophy has been resolved in the model with the help of human ability to glottogenes in semantic direction. In this way the language of categories ( $L_C$ ) has been discovered. AIUU functions on the principles of knowledge without premises and educated unknowledge in the form of *mathesis universalis* of  $L_C$ . It also uses the unity of human and NSK proper to inter discipline activity in the SIC. The system generates and maintains educational space of meanings in the form of personal ontological knowledge base ( $KB_O$ ). By means of  $KB_O$  artificial intelligence adaptively helps student to investigate any field of knowledge.  $L_C$  is applied to express semantic. Axiomatic method provides the unity of ideal (theory) and real (modeling in IS). Universal tutoring is stated to resolve the problem of any theory understanding by professional **clearness** reduction to its self evidence. By the example of the theory of algorithms study it is shown how the approach to education works.

**Keywords:** System informational culture, Super computer, Third world, Language of categories, Functor, Artificial intelligence, Ontological knowledge base, Cognogenes, Glottogenes, Universal tutoring, Axiomatic method, Rational objectization, Self creation, Semantic consciousness.

# 1 Introduction

Super computer ( $S_C$ ) artificial intelligence (AI) systems of universal usage (AIUU) must support not only counting; but cognitive and creating themselves (creative) functions of thinking. (Everywhere in the text notation of the kind  $S_C$  is functor; here  $C$  - computer [9]). In authors' project "Intellectual student's computer place" (ISCP) the aims are achieved by constructing universal intellectual interface supporting user's inter and trans disciplinary activity. The labor is grounded on personal rational objectization ( $O_R$ ) of the third world of knowledge (world-3). It is hard to fulfill it. Universal education is necessary for the development of rational part (C-2) of any student's consciousness (C-1). Intellectual interface resolves the problem of adaptive help in affaire of system labor with knowledge. ISCP will support student's experience - practice of semantic work under continuous tutoring. It will transform C-1 enriching its second semantic part C-2 by  $O_R$  of NSK. Thus,  $S_{NSK} = O_R$ . Student's self determination in SIC served by AIUU. Proposed educational technology [1] - [4] uses the strategy of adaptive aid in the field of unknown and applies axiomatic method (AM). It uses  $L_C$  for expression and investigation of SIC meanings.  $L_C$  gives self evident view on NSK and represents any idea in super visual form of  $S(S_{NSK})$ , fig.1. It allows introducing user into the life of scientific problems.

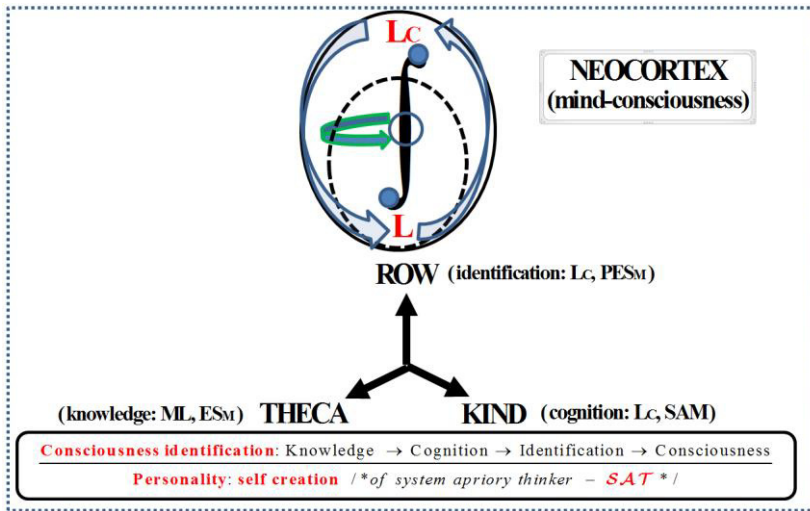

**Fig. 1.** Rational subjectization by means of  $O_R$ : natural language – L and language of categories –  $L_C$ ; multi discipline library – ML, (personal) educational space of meanings – (P)  $ES_M$ ; system axiomatic method – SAM.

This approach is new and actual. There are numerous investigations of different aspects and details of teaching and thinking process [5]-[8]. On the contrary, authors' project is synthetic one. The system of AIUU provides universal tutoring ( $T_U$ ). It

works with ontological knowledge base ( $KB_O$ ) marked by  $L_C$ , i.e.  $KB \rightarrow KB_O$ . It is similar to many teaching systems which even use natural language of access to bases but in our approach the notion of  $KB_O$  is different from common.

Intellectual interface helps researcher to form and support true personal presentations on space (geometry), relations (algebra), natural sciences models, informatics (algorithms, programs, networks). ISCP must adaptively interact with any applications and electronic resources in order to help student to understand meanings of the third world of knowledge. Intellectual tutoring system of ISCP needs huge power of  $S_C$ . Subject's universal continuous tutoring forms his (C-2) [1-4]. It is done in educational space (ES) transformed into the one of meanings ( $ES_M$ ) by means of  $L_C$ . With the help of universal education it is necessary to overcome professional restrictions of machine era and return to initially integrated presentations about the world. On the challenge of high scientific complexity of SIC it is necessary to answer by C-2 development by means of  $T_U$ . Modern cognitive revolution requires application of new strategic technology uniting science and education. AIUU should support SIC self-sufficiency and person's self-knowledge. Authors suggested solution of the problem by means of the AM and  $L_C$  use. AI will help to overcome contemporary educational crises.

## 2 Language of Categories. Glottogenes

Intellectual processes influence development of languages applying for meanings identification and expression.  $L_C$  allows to express and study the utmost mathematical abstractions. It is analogous to the specification languages displaying semantic of program complexes. In the similar way marking up documents by  $L_C$  one obtains  $ES_M$  [1, 3]. It can be also compared with parallel languages application when discovered parallelism of an algorithm improves  $S_C$  productivity.

Power of  $S_C$  must be used in AI systems not only for improving calculating operations but for realization of cognitive and creative functions of thinking. Human being's intellect develops by means of natural and rational languages integrity (fig. 1) which transforms thinking code and person's sub consciousness [1-4, 10-14].

The third world is cognated in the process of personal inter and trans disciplinary activity using synergy of meanings [15]. Subject's self organization occurs on the base of C-2. Person's mind is transformed by sequent bifurcations or intellectual breakthroughs [15, 16]. It is labor to understand and use meanings of SIC. Any student becomes researcher of the third world of the complex scientific knowledge. So, he needs adaptive help in real time which can be got only from AIUU.

Rational concretization of inductive system work in IS must be supported by conceptual universality of thinking in order to understand meanings of SIC. It is necessary to discover and express explicitly semantic of studied documents. Moreover, one needs comparing of different theories in order to investigate and understand scientific ideas. In such way  $L_C$  has been discovered. Now it can be applied by everybody in personal work with knowledge. Theory axioms expression on the  $L_C$  corresponds to the highest level of AM and opens the possibility for discovering general ideas.

### 3 The Universal Tutoring

In order to be productive in inter and trans disciplinary activity human being’s consciousness must be grounded on the system axiomatic method (SAM) and application of the technology of object oriented designing.  $T_U$  resolves personally the problem of science and education integrity. It helps subject’s uplifting by  $O_R$  levels.  $S_C$  becomes an instrument of cognition. AI system on the base of  $S_C$  will creat personal environment for development. First of all, libraries should be transformed into the bases of knowledge (KB). After that  $ES_M$  can be organized ontologically ( $KB_O$ ). Then work with any application will be ruled by  $S_C$  system ICPS. On this way personal  $ES_M$  will be constructed, maintained and applied to the student’s C-1 sophistication. The task of  $T_U$  in relation with super natural knowledge  $S_{NSK}$  consists in supporting the next integrated chain of inheritances:

$$T_U(S_{NSK}): \text{Truth} \Leftarrow \text{Obviousness} \Leftarrow \text{Self Obviousness} . \tag{1}$$

Person’s consciousness integrity is the basic property which must be conserved. for experimental work in computer IS [8]. Following the scheme (1) AI helps to the meanings identification organizing student’s labor in the field of unknown. *Mathesis universales* of  $L_C$  is used as the tool of “educated unknowledge”. It occurs in the cognitive process of the next kind:

$$\begin{aligned} & \text{Identification (subject) \& cognition:} \\ & \langle \text{Substance: clear} \rangle \Leftarrow \langle \text{Universal: hidden} \rangle \Leftarrow \langle \text{Intergrity: productive} \rangle; \tag{2} \\ & \langle \text{IAM: reality} \rangle \Leftarrow \langle \text{AM: axioms} \rangle \Leftarrow \langle \text{SAM: models} \rangle \Leftarrow \langle \text{L}_C: \text{descriptive meaning} \rangle . \end{aligned}$$

In this way growth of objective knowledge is done [13-15]. Inheritances (2) include three levels of AM. Theories start from initial (I)AM and are developed inductively. Modern AM takes form of algebraic systems and deals with operations and relations over elements. SAM is synthetic method serving for systems comparison with the help of morphisms [5]. Obvious view on NSK means understanding (level  $S_{NSK}$ ). Language  $L_C$  helps to do it so as it substantiates any idea in the clear visual form of  $S_{NSK}$ . Use of  $L_C$  includes experiment-practice of proper thinking and identification-thinking. It gives one personal ideas objectization [14,15]. Henceforth,  $T_U$  can be expressed in the form of  $S_{NSK}$  understanding:

$$T_U(S_{NSK}): \left\{ \begin{array}{l} \text{Thinking,} \\ \text{induction.} \end{array} \right\} \Leftarrow \left\{ \begin{array}{l} \text{Purpose,} \\ \text{conceptuality} \Leftarrow \text{cognition NSK.} \end{array} \right\} \Leftarrow \left\{ \begin{array}{l} \text{Creator (of himself),} \\ \text{identification } O_R \Leftarrow L_C . \end{array} \right\} \tag{3}$$

$T_U$  gives “eurhythmia” of student’s life:

$$(functions) : \left\{ \begin{array}{l} \text{Thinking (notions) = Idea (theory),} \\ \text{calculating.} \end{array} \right\} \Leftarrow \left\{ \begin{array}{l} \text{Problem,} \\ \text{cognitive.} \end{array} \right\} \Leftarrow \left\{ \begin{array}{l} \text{Natural Intellect,} \\ \text{creative.} \end{array} \right\} \tag{4}$$

According to (1) - (4) power of  $S_C$ , IS and soft ware modules of student's development AIUU give ground for  $T_U$  technology:

$$S_C + AIUU \Leftrightarrow S_{S_{NSK}} = S_{NSK} \cdot \tag{5}$$

Equivalence (5) is based on the *mathesis universales* of  $L_C$  [5,13]. Thus, educated unknowledge uses three levels of AM and conceptual description on  $L_C$  [1,4].

### 4 Artificial Intelligence

Let's display how AI system ICPS uses the inheritor links (1) - (4) of  $T_U$  technology while studying the recursive functions theory. SAM level starts from the notion of natural number object (NNO).

**Example 1.** Natural number self obviousness consists in enumeration possibility of any set of elements. In every category NNO is one satisfying to the next commutative diagram:

$$\begin{array}{ccc}
 \omega & \xrightarrow{s} & \omega \\
 \downarrow & & \downarrow \\
 1_{h^0} & \xrightarrow{g} & A
 \end{array}
 \tag{6}$$

It is important that system properties of algebra Peano  $\Omega^0 = (\omega, 0, s)$  are expressed in the visual form (6). The object  $\Omega^0$  in the category of SET is natural row of numbers  $\omega = N$ . Firstly, due to (6) one obtains  $O_R$  of the arithmetics. One can construct the tower of binary arithmetic operations looking at the second operand as parameter. It can be done by carrisation of all arithmetic operations  $\langle +, *, \uparrow, \uparrow\uparrow, \dots \rangle$  [16]. For the purpose one must pay attention to all symmetries of NNO. They are homomorphisms of algebra  $\Omega^0$ . These considerations discover sequence of one variable functions  $s_k : \Omega^0 \rightarrow \Omega^0, k = 0, 1, \dots,$

$$\langle s_1, s_2, s_3, s_4, \dots \rangle = \langle {}_n+ = (\lambda x)nx+, {}_n* = (\lambda x)nx*, {}_n\uparrow = (\lambda x)nx\uparrow, {}_n\uparrow\uparrow = (\lambda x)nx\uparrow\uparrow, \dots \rangle$$

All the morphisms admit description in the form of the commutative diagrams:

$${}_n+ : 0 \rightarrow 0_n, \begin{array}{ccc} N & \xrightarrow{s} & N \\ \downarrow & & \downarrow \\ N & \xrightarrow{s} & N \end{array}, 0_n = 0s^n, {}_0+ \equiv 1_N. \tag{7}$$

$${}_n* : 0 \rightarrow 0, \begin{array}{ccc} N & \xrightarrow{s} & N \\ \downarrow & & \downarrow \\ N & \xrightarrow{{}_n+} & N \end{array}, {}_0* \equiv 0, {}_1* \equiv 1_N, \tag{8}$$

$${}_n\uparrow : 0 \rightarrow 1, \begin{array}{ccc} N & \xrightarrow{s} & N \\ \downarrow & & \downarrow \\ N & \xrightarrow{{}_n*} & N \end{array}. \tag{9}$$

Addition (7) represents itself packing up of initial morphism  $S$ . Similar to it multiplication diagram (8) packs up  $_n+$  - previous operation (7) and, in its turn, the power operation (9) packs up the multiplication. In the same manner morphism  $s_4 \equiv_n \uparrow \uparrow = (\lambda x)nx \uparrow \uparrow$  is defined. It packs up function of power (9) and so on. In the last diagrams initial arrows are taken to be  $0 \circ s_k = 0s, k = 3, 4, \dots$ .

Secondly, NNO allows to objectivize the notion of the recursive function [20]. Commutative diagrams (6) - (9) can be considered as programs calculating arithmetic functions. Super position  $f \circ g$  of the functions  $f, g$  is also represented by commutative diagram which means composition of morphisms. Primitive recursion scheme (6) corresponds to calculable function  $f$  definition if there are calculable functions  $g, h$ . Class of primitively recursive functions forms algebra  $R$  [20],

$$R = \langle s, q \mid +, \circ, J \rangle, q = (\lambda x)x - [\sqrt{x}]^2, f \circ g = (\lambda x)f(g(x)), Jf = (\lambda x) \begin{cases} 0, & x = 0, \\ f((Jf)x), & x + 1. \end{cases}$$

“Goedelization” of  $R$  gives universal function  $(\lambda n)x D(n, x)$ .

Thirdly, tower of morphisms (6), (7),... allows to define Akkermann’s map  $A \notin R$ . Akkermann’s function  $A(n, n)$  can be constructed by double recursion [16]:

$$\begin{cases} A(0, x) = xss \\ A(ks, 0) = sign(k) \\ A(ks, xs) = A(k, A(ks, x)) \end{cases} . \tag{10}$$

Instead of (10) in our approach  $A(k, x)$  is obtained by index  $k$  uplifting in morphisms family  $A_k(x) \equiv xs_k, k = 1, 2, \dots$ , (6) - (9),... . After that Kantor’s diagonal method gives  $A(n, n) \notin R$ . Lastly, calculability of implicit and inverse functions is consequence of the minimization diagram

$$0! : N \times N \xrightarrow{\langle 1_N, f \rangle} N \times N \xrightarrow{\phi} N, \tag{11}$$

fulfilled for the unique arrow  $\langle 1_N, g \rangle$ . In more details, if there is another arrow  $\langle 1_N, g \rangle$  satisfying to (11) then  $(\exists! h)s^g = s^f \circ h$  where monomorphism  $h : N^N \rightarrow N^N$  connects the exponentials  $s^g : N \rightarrow N^N$  and  $s^f : N \rightarrow N^N$  [9]. It worth mentioning that carrization meaning is exponential [9]. Commutative diagrams (7) - (9), (11) define every recursive function in the form of a program

$$P = (D_1(f_1), D_2(f_2), \dots, D_r(f_r)). \tag{12}$$

There are morphisms  $\{f_1, f_2, \dots, f_r\}$  in (12) defined on one of the previous steps  $t = 1, 2, \dots, r$ . Gödel’s numeration  $P_\gamma$  of all programs (12) defines universal morphism



$(\lambda\gamma)xU(\gamma, x)$  representing any recursive function  $f_\gamma \in C$ . Thus,  $L_C$  visually clear expresses algorithm notion. Following the way (6) – (12) any student conceives self obviousness of the theory.

### 5 Intellectual Educational System

ICPS architecture for student’s rational self creation is presented on the fig. 2.

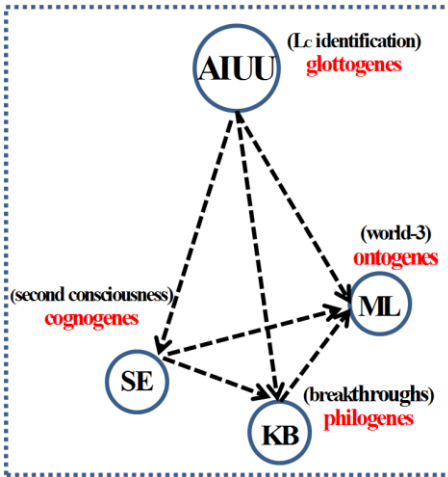

**Fig. 2.** Adaptive searching system of ICPS: model of student’s meta processes: ML – multi disciplinary library, KB – knowledge base, SE - educational system.

Scope of the third world meanings must be supported by AIUU system. It is responsible for the student’s personality integrity learning of  $L_C$  and his thinking development. It controls creation of the student’s C-2. System AIUU answers for student’s mind equipping by  $L_C$ . Subject’s adaptive work in multidisciplinary networks library is maintained by the class of processes named “cognition”. Its ES consists of all documents of the world-3. Processes named “meanings substance” are served by  $KB_O$ . It represents itself annals of the great mathematical generalizations. Class “cognogenes” gives growth of student’s objective knowledge [14] and controls student’s active thinking in the third world. AIUU marks automatically ES by means of  $L_C$ .

### 6 Ontological Knowledge Base

Cognogenes in the third world media is Archimedes’ lever point for education. Generalization with trend to the utmost mathematical abstractions is lever for the technology of C-2 self creation. Compulsory knowledge is factorized by naturalness and obviousness of cognition. Self creation occurs by means of intellectual breakthroughs

to understanding.  $L_C$  must become the tool of thinking. Rational self transcendation uses two ways of education as “two sides of one medal”. Direct inductive way results in generalization. Reverse conceptual way launches out the mechanism of notions specialization (inheritance), see fig. 3. Intellectual breakthroughs to generalization as personal courage act are maintained by AI system [12].

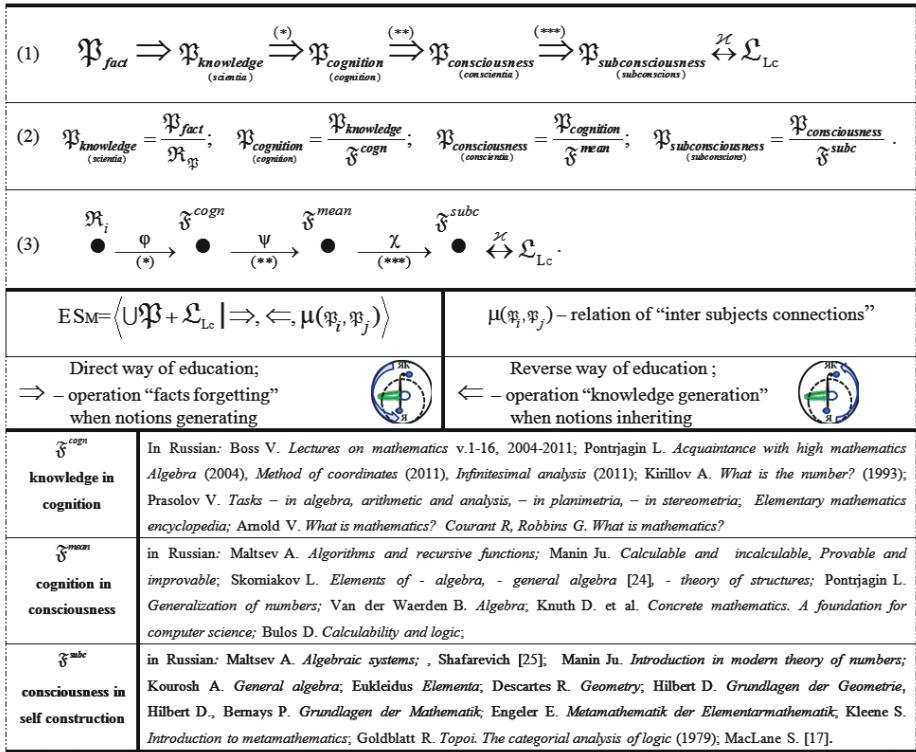

**Fig. 3.** Ontological data base  $DB_O$ : super subject educational space  $(ES_M) \mathfrak{R}_{ES_M} = \bigcup \mathfrak{R}_{\mathfrak{P}}$ ; subject  $\mathfrak{P}$ ; course  $\mathfrak{R}_{\mathfrak{P}} = \bigcup \mathfrak{R}_i$ ; discipline  $\mathfrak{R}_i$ ; language of categories  $\mathcal{L}_{L_C}$ ; factorization  $\mathfrak{P}/\mathfrak{R}/\mathfrak{F}$ ; filters  $\mathfrak{F}^{cogn}, \mathfrak{F}^{mean}, \mathfrak{F}^{subc}$ ; functors  $\varphi, \psi, \chi, \mathcal{L}$ .

$DB_O$  is the media of knowledge repository, investigation and use in full integrity of meanings. As it was said above, it is transformed into  $KB_O$ , see fig.3. Background knowledge is represented by  $L_C$ . Any discipline investigation goes through the next sequence of stages: fact  $\rightarrow$  knowledge  $\rightarrow$  cognition  $\rightarrow$  consciousness  $\rightarrow$  sub consciousness. They correspond to three levels of AM. So do all textbooks. There hierarchy in  $KB_O$  is shown in the chain (1) of the fig. 3. Study advances up to the SAM level and allows to obtain relation  $\mathcal{L}$ . System AIUU fulfils factorization of courses using generalization filters, see (2) on the fig. 3. The filters consist of textbooks cov

ering the highest philogenetic achievements in accordance with the chain (3), fig. 3. It defines functors being used for  $O_R$ . Student’s work in ICPS starts from a discipline  $\mathfrak{R}$  being immersed in educational space  $ES_M=S_{NSK}$ . Structure of  $KB_O$  allows to do it adaptively to student.

## 7 Conclusions

Education (believe in discovery) is understood fundamentally as guidance for human being’s change in his very nature (Heidegger’s “The Teachings of Plato on Truth”). AI can contribute to duality of education and truth as categories of being. Then second rational part C-2 of consciousness becomes necessary human organ of SIC subject P-2. Suggested educational model can be briefly expressed by the formula (13). Historic view on education shows that at the beginning professional (abbr. - prof) activity (person P-1) embraces NSK. After that cognition happens, see (13). In t SIC narrow specialization is replaced by harmonic man’s development especially concerning his rational part of mind. So person P-2 is system apriory thinker **SAT**.

$$\left\langle \left\langle \begin{array}{c} \text{Civilizatin Epoch:} \\ \text{neo classic} \\ \text{C-1=AM + NSK-prof} \\ \text{P-1 = art + prof} \end{array} \right\rangle \Leftrightarrow \left\langle \begin{array}{c} \text{Epoch of Culture:} \\ \text{post neo classic} \\ \text{C-2 = SAT + } O_R \text{ up to SAM} \\ \text{P-2 = SAT + cognition-prof} \end{array} \right\rangle \right\rangle \\
 \text{trans disciplinarity = SAM} \\
 \Leftrightarrow \left\langle \begin{array}{c} \text{SIC:} \\ \text{Man's Phenomenology: real-ideal;} \\ \text{Neuro Phenomenology: intellect super sensitiveness;} \\ \text{Evolutional epistimology: ontogenes falsificates gnoceology.} \end{array} \right\rangle \tag{13}$$

Education is occupied not only by volume and boundary of spirit (Descartes) but by rational sub consciousness development for person’s semantic activity. It concerns man’s mind self organization and intellectual self creation. AIUU is able to support these creating function. By authors’ opinion, it is possible to do it at the expense of displayable rational obviousness as the skeleton of knowledge self obviousness.  $S_C$  educational technology consists in supervising for C-2 molding. In such way homo sapience becomes rationales homo sapience. Classical rationality slogan “go ahead and you will believe it later” (d’Alembert) is now inversed Self-creation needs overtaking feed-back. Self creation requires certainty of ideas identification and intention to use mathematical glottogenes in the trend of  $L_C$ . Correspondence to spiritual action across itself (Pinker, [13], [14]; Popper [18], [19]) answers existential anthropological tradition of education. Synthetic development of man is considered as category of existence in IS. The trend of mankind thinking is two cultures dialog on the base of student’s return to reality by means of  $O_R$ . One may hope that education will do it.

The project fits the idea of Lomonosov Moscow State University future and has reached execution state at the inter universities level.

## References

1. Gromyko, V.I. Kazaryan, V.P. Vasilyev, N.S. Simakin, A.G. Anosov, S.S.: Consciousness technology. *J. Compl. Syst.*, 1(3), 46–61 (2016).
2. Vasilyev, N.S., Gromyko, V.I.: Propedeutic courses of mathematics under continuous teaching. *J. Hum. Herald MGTU.* 2, (28), 1-17 (2015). URL: <http://hmbul.bmstu.ru/catalog/edu/pedagog/228.html>
3. Vasilyev, N.S. Categorical model of probabilities theory for intellectual educational system. *J. Scien. and Innov.*, 12, 1-18 (2013). URL: <http://engjournal.ru/catalog/appmath/hidden/19.html>
4. Gromyko, V.I., Kazaryan, V.P., Vasilyev, N.S., Simakin, A.G., Anosov, S.S.: Rational education as technology of consciousness. *J. Compl. Syst.*, 3(8), 87-108 (2013).
5. Walid Mestadi, Khalid Nafil, Raja Touahni, Rochdi Messoussi, "Knowledge Representation by Analogy for the Design of Learning and Assessment Strategies", *International Journal of Modern Education and Computer Science(IJMECS)*, Vol.9, No.6, pp.9-16, 2017.DOI: 10.5815/ijmeecs.2017.06.02
6. Asoka S Karunananda, Philippe R Goldin, P D Talagala, "Examining Mindfulness in Education", *International Journal of Modern Education and Computer Science(IJMECS)*, Vol.8, No.12, pp.23-30, 2016.DOI: 10.5815/ijmeecs.2016.12.04
7. Benyahia Kadda, Lehireche Ahmed, "Semantic Annotation of Pedagogic Documents", *International Journal of Modern Education and Computer Science(IJMECS)*, Vol.8, No.6, pp.13-19, 2016.DOI: 10.5815/ijmeecs.2016.06.02
8. Maria Dominic, Sagayaraj Francis, "An Assessment of Popular e-Learning Systems via Felder-Silverman Model and a Comprehensive e-Learning System using the Tools on Web 2.0", *International Journal of Modern Education and Computer Science(IJMECS)*, vol.5, no.11, pp.1-10, 2013.DOI: 10.5815/ijmeecs.2013.11.01
9. MacLane, S.: *Categories for working mathematician*. Phys. Math., Moscow (2004). 352 p.
10. Kapra, F.: *Network of life. New scientific understanding of live systems*. Gelios, Moscow (2002). 336p.
11. Kapra, F.: *Hidden connections*. Sofia, Moscow (2004). 326 p.
12. Kassirer, E.: *Philosophy of symbolical forms*. Language. Univ. book, Moscow, St.-Pet. 1 (2000). 272p.
13. Pinker, S.: *Thinking substance. Language as window in human nature*. Librokom, Moscow (2013). 560 p.
14. Pinker, S.: *Language as instinct*. Edit, Moscow (2004). 456 p.
15. Knjazeva, E.N., Kurdumov, S.P.: *Synergy foundations. Synergic scope of life*. KomKniga, Moscow (2005). 240 p.
16. Manin, Ju.I.: *Mathematics as metaphor*. MCNMO, Moscow (2008). 400 p.
17. Campbell, D.T.: *Evolutional epistemology*. In: *Evolutional epistemology and logic of social sciences*. Karl Popper and his critics. Moscow (2000). 464 p.
18. Popper, K.R.: *Objective knowledge. Evolutional approach*. URSS, Moscow (2002). 384 p.
19. Popper, K.R.: *Suppositions and refutations. Scientific knowledge growth*. Ermak, Moscow (2004). 638p.
20. Maltsev, A.I.: *Algorithms and recursive functions*. Nauka, Moscow (1986). 368p.

# Fundamentals of Intelligent System for Estimation of Dynamical Interaction of Space Debris with Spacecrafts

B.V. Paliukh<sup>1</sup> , V.V. Meshkov<sup>2</sup> , V.K. Kemaykin<sup>3</sup> ,  
Yu. G. Kozlova<sup>4</sup> 

Tver State Technical University, Tver, Russia

<sup>1</sup>pboris@tvstu.ru, <sup>2</sup>vk-kem@mail.ru, <sup>3</sup>msf-tgtu@yandex.ru,

<sup>4</sup>jul\_kozl@mail.ru

**Abstract.** The principles underlying building of intelligent information systems for estimation of dynamical interaction of space debris and spacecraft is shown. It describes the knowledge database model based on these principles. This base represents the synthesis of theoretical and practical information in the field of estimating of the high-speed interaction of objects. The article reports practical results of base data preparation based on the findings of research.

**Keywords:** Intelligent information system; space debris; knowledge database; fuzzy systems; damage risk assessment.

## 1 Introduction

Spacecrafts (SC) are subject to space debris (SD) impacts. Therefore the solution of a problem of damage risk assessment and development of measures for its decrease and creation of protection systems for SC from exposure to superfast SD is very urgent [8]. The main information about exposure to SD on SC is given by ground bench tests with application of superhigh-velocity impacts. Computer simulation is used as supplement. The main method of bench tests is experimental superhigh-velocity impact and its purpose is to examine how SC or its components will be able to sustain collision in space with SD. However there are certain borders of opportunities in this area. There are difficulties with acceleration of large projectiles to typical speeds of collisions in Low Earth Orbit. These restrictions reduce damage prediction accuracy from collision with medium and small SD. Computer modeling serves as the connecting link between surfaces research results which were really affected by SD in space and researchers assumptions checking and calibrating the last. Models also allow extrapolating the data obtained in laboratory in the limited range to a wide range of conditions which cannot be reproduced in laboratories [7]. According to OST 134-1031-2003 "The general requirements for protection of space means from mechanical influence of high-speed particles of a natural and technogenic origin", an resistance indicator of SC to mechanical influence of high-speed particles of a natural and technogenic

origin is its undamage probability (UDP). It is probability that it doesn't happen any "dangerous" collision of a high-speed particle with a vulnerable surface of SC ( $n = 0$ ) during time  $\tau$ . UDP is calculated using the formula:

$$\text{UDP} = P_{n=0} = e^{-N} \quad (1)$$

Given that it is convenient to use GNP for operational estimates of an element of a vulnerable surface, value is defined as:

$$\bar{N} = N_{\text{ex}} S_{\text{el}} \tau \quad (2)$$

where  $N_{\text{ex}}$  is value of medium-integrated flux of high-speed particles with a critical mass of  $m_{\text{ex}}$ ,  $m_{\text{ex}}$  is extreme minimum value of SD mass at which the considered element of SC surface is damaged (according to the accepted criterion)  $\text{m}^{-2} \cdot \text{year}^{-1}$ ;  $S_{\text{el}}$  is the considered area of a vulnerable element of a surface of SC,  $\text{m}^2$ ;  $\tau$  is residence time of SC in SD to the environment (exploitation time of SC), year.  $N_{\text{kp}}$  flux is a determining factor of UDP for specified surface  $S_{\text{el}}$  and observation period of SC –  $\tau$ . The value of  $N_{\text{kp}}$  depends on the critical mass of  $m_{\text{ex}}$  or, equivalently, the critical diameter of  $d_{\text{ex}}$ -particles of SD which cause damage to protection of SC. It is expected that the density of SD material is known. The value of  $d_{\text{ex}}$  is defined with the help of ballistic limit equations (BLE). BLE represent ratios for determination of the minimum diameter (the minimum weight) of the flying particle at which wall damage occurs. The specified type of the equations is called the efficiency equations. When it determined UDP, damage function is built by means of BLE of efficiency. It shows dependence of  $d_{\text{kp}}$  on the speed of impact of  $V$ . The known BLE for a single wall and multilayered protection SC are considered in [1, 2, 5,7]. Analysis of calculations results and experimental data show that reliability of the analysis of protection SC against SD on UDP will be reached if BLE, which use at this case, are satisfied the following requirements [5]:

- BLE have to include all optimized variables;
- range of optimized variables change in BLE should be rather wide.

Thus, it is possible to allocate the following main problems which are inherent to a forecasting problem of interaction results of SC and SD:

- possibility of collecting of a large number of data about interaction of SD and SC and practical lack of their statistical stability that calls into question trust degree to the models constructed by methods of probability theory and classical mathematical statistics;
- insufficient reliability of forecasting results representation in the form of the determined defeat functions because many influencing factors have the fuzzy nature and difficult formalizations for traditional modeling methods application.

Within the conducted researches there is a problem of creation of the knowledge base of an intellectual information system which considers results of forecasting the dynamic interaction of orbital systems and space debris. This knowledge base is effectively applied in the conditions of uncertainty. Existence of statistical data gives an opportunity to consider as effective tools of technology of the operational accounting of data (OLAP) and their intellectual analysis (Data Mining): genetic algorithms and neural networks. Two aspects of information resource lie in the modern theory of the artificial intelligence (AI) at the heart of methods of the knowledge representation (KR) and representation of abilities:

- mathematical formalization or logical completeness of the considered information object;
- cognitive approach or understanding (perception/interpretation) of process of awareness of knowledge by the person.

The greatest distribution at practical developments in the field of artificial intelligence was gained by productional, frame models and semantic networks, and also a specific place was held by hybrid model, thanks to object-oriented approach of representation of knowledge [11]. For creation of KD the hybrid model of representation of knowledge in the form of a neuro and indistinct network formalism is chosen. Neural and fuzzy network constructed on its basis is isomorphic to matrixes of rules (knowledge), reflects the interrelations revealed in experimental data and has important human (intellectual) properties: representation of knowledge in a natural language, an interpretation of the received results and learning ability in real time. The main idea of the evaluation is concluded in the following: "The damage caused to SD depends on the sizes and the relative speed of SC and SD, their materials, an impact angle and degree of vulnerability of the impact site of SC element on which the impact fell". From these positions it is possible to consider defeat of SC as the problem of identification having the following properties [3]:

- it is necessary to establish dependence between input and output variables for evaluating results;
- input variables are associated with parameters of condition of an identification object and conditions of possible interaction. The quantity of SD and their characteristic taking into account features of SC is initial information for determination of the expected damage.
- the output variable is associated with a condition of SC after interaction with SD. Vulnerability (defeat) of SC in a flux of SD can be defined as a combination of probabilities of elements undamage, taking into account importance (criticality) of everyone components
- output and input variables can have quantitative and qualitative standards.
- the structure of interrelation between output and input variables is described by the rules IF <inputs>, THEN <output> which use qualitative standards of variables and representing fuzzy knowledge base.

Principles of creation of the knowledge base of intellectual system for estimation of results of SC and SD dynamic interaction include:

1. Principle of the linguistic description of the used variables at input and output.

According to this principle, inputs of an object and its output are considered as linguistic variables which are estimated by qualitative terms. The influencing factors and the output parameter (the undamage probability of SC (UDP)) with ranges of values [12] and used for the description term-sets are shown in table 1.

**Table 1.** Characteristics formed term-set

Name (linguistic variable)	Symbol	Variable range (universal set) and its dimension	Term-sets of linguistic variable value
<b>High-speed collision parameters</b>			
Interaction speed SD and SC in encounter point, $v_n$ , $\text{km}\cdot\text{s}^{-1}$	X1	$0\dots 20 \text{ km}\cdot\text{s}^{-1}$	Low (L), under medium (UM), medium (M), above medium (AM), high (H)
A corner between a particle speed vector and a normal to a surface $\theta$	X2	$0\dots\pm 180^\circ$	small (S), medium (M), normal (N),big (B),huge (H)
<b>Parameters of SD</b>			
particle diameter $d_p$	X3	$0.1\dots 1000 \text{ cm}$	small (S), medium (M), big (B)
particle speed $v_p$	X4	$3\dots 8 \text{ km}\cdot\text{s}^{-1}$	Low (L), medium (M), high (H)
density of the particle material $\rho_p$	X5	$2.5\text{-}8 \text{ g/cm}^3$	aluminum alloy ( $A_{ap}$ ), titanium alloy ( $T_{ap}$ ), stainless steel ( $S_{sp}$ )
particle mass $m_p$	X6	$10^{-5}\dots 10^3 \text{ t}$	small (S), medium (M), big (B)
<b>SC wall parameters</b>			
wall thickness $l_w$	X7	$0.13\text{-}0.4 \text{ cm}$	small (S), medium (M), big (B)
density of the wall material $\rho_w$	X8	$2.5\text{-}8 \text{ g/cm}^3$	aluminum alloy (Aa), titanium alloy (Ta), stainless steel (Ss)
hardness of the wall material by Brinell HB	X9	$60\text{-}150 \text{ MPa}$	small (S), medium (M), big (B)
<b>Bumper parameters</b>			
Bumper thickness $l_b$	X10	$0.03\text{-}0.055 \text{ cm}$	Small (S), medium (M), big (B)
hardness of the bumper material $\rho_b$	X11	$0.01\text{-}2.5 \text{ g/cm}^3$	Small (S), medium (M), big (B)
a gap between a bumper and a back wall of SC	X12	$0\dots 5 \text{ cm}$	small (S), medium (M), big (B)
value of material yielding stress of back wall $\sigma_w$	X13	$130\text{-}540 \text{ MPa}$	Low (L), medium (M),high (H)
Speed of SC, $v_s$	X14	$3\dots 8 \text{ km}\cdot\text{s}^{-1}$	Low (L), medium (M),high (H)
Undamage wall probability, UDP	P	$0.5\dots 0.999$	Low (L), medium (M),high (H)



2. Principle of use of one-dimensional and multidimensional membership functions of linguistic terms for the description of input and output variables.

In compliance with this principle fuzzy variables with functions of accessory of one or several arguments can be used as terms during a fuzzy logical conclusion. It is connected with initial division of space of input variables into classes. Generally it is considered independent variables on an input which form set of not crossed classes. Each input variable has own input sets, it allows to use simple and evident representation of membership function (for example, triangular or trapezoid), and also to apply simple computing procedures when carrying out all stages of fuzzy conclusion. As applied to solvable problems of assessment of interaction between SC and SD, such variables are the linguistic variables connected with parameters of SD, parameters of a wall of SC and a protective bumper. For hierarchical systems of fuzzy conclusion, it spring up a certain degree of blurring that can lead to loss of the importance of result. One of solutions of this problem is use of terms of linguistic variables with functions of accessory of several arguments. Methods of fuzzy clustering can be used when multidimensional membership function is being formed [10].

The way to assign multidimensional membership functions of linguistic variables terms includes the following stages:

- selection of linguistic variables and comparison of modeling subject characteristics to it;
- collecting statistical data about activity of a modeling subject;
- fuzzy clustering of statistical data for each linguistic variable;
- linguistic variable terms formation by giving to the received clusters of names;
- formalization of membership functions of terms. [4].

As an example it is considered the linguistic variable "speed of interaction between SD and SC in a meeting point", including, "a corner between a vector of particle speed and a normal to a surface of SC", "particle speed" and "speed of SC". Linguistic variables terms are formed by assignment names to the received clusters. For each term it is set in tabular form multidimensional membership function in the form of the matrix including arguments values matrix of  $X_i$  and a column of function values which is the appropriate for term line of a matrix of membership functions  $M_i$ .

3. The principle of dependence structure formation "input - output" in the form of a matrix of rules.

Matrixes of fuzzy conclusion rules are formed on the basis of empirical knowledge or experts knowledge in problem area, and they are presented in the form of fuzzy production of a standard look. By consideration of a problem of interaction between SC and SD it exists a large number of experimental and settlement data of the different nature and different in physical sense. In this regard it is quite difficult to find the expert who could create all necessary set of the fuzzy logical rules which are the basis for the fuzzy knowledge base as kernels of intellectual system. In such situation there

is a need of the solution of a problem of extraction of a set of fuzzy logical rules which will display in the best way regularities of "inputs –output" on a set of the available experimental data, without participation of the expert. The solution of this task is possible by carrying out the data mining based on genetic algorithms of optimization [3, 6].

The set of IF-THEN can be considered as a set of points in <inputs –output > space. The use of the device of a fuzzy logical conclusion allows restoring a multidimensional surface which connects values of output at various combinations of values of input variables on these points.

4. The principle of hierarchy of the knowledge base

Interpretation and control of the received results is connected with intellectual opportunities of the person on the limited volume of its random access memory. In this regard it is expedient to carry out classification of input variables and to construct on its basis so-called tree of a conclusion which will represent a system of hierarchically connected contours of mini-bases of a smaller dimension.

Derivation tree for the entered input variables is shown in fig. 1.

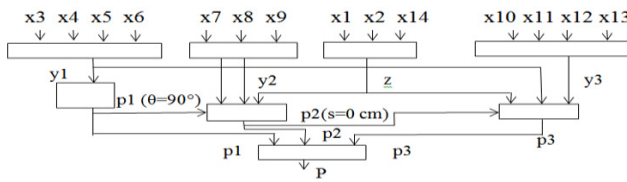

Fig.1. Derivation tree

Functional dependence  $P=P(x_1, x_2, x_3, \dots, x_{14})$  which connected  $x_1 \dots x_{14}$  inputs and  $P$  output, are replaced with the sequence of substitutions:

$$P=P(p_1, p_2, p_3), y_1=y_1(x_3, x_4, x_5, x_6), z= z(x_1, x_2, x_{14}), y_2=y_2(x_7, x_8, x_9) \quad (3)$$

where  $y_1, y_2, y_3, z, p_1, p_2$  and  $p_3$  are the intermediate outputs considered as linguistic variables. Due to the principle of hierarchy it is possible to consider almost an unlimited number of the input variables influencing assessment of an output variable. While a derivation tree is creating it is necessary to aspire to that the number of arguments (input arrows) in each knot of the tree satisfied to the rule  $7 \pm 2$ . Appropriateness of stepwise representation of expert knowledge is caused not only by natural hierarchy of objects of identification, but also need of the accounting of new variables in process of object knowledge accumulation.

5. The principle of two-stage setting up of fuzzy knowledge bases.

According to this principle, creation of model of the knowledge base is carried out step by step (fig. 2) which by analogy with classical methods can be considered as

stages of structural and parametrical identification. The configured settings are the weight of fuzzy IF-THEN rules and membership functions as form.

At the first stage creation of a matrix of rules is carried out according to available information. In the chosen subject area there is no possibility of involvement of the expert who would simulate this or that object (process) that is connected with its complexity and a certain novelty and its insufficient development. In this regard the process of creation of fuzzy knowledge bases is organized on the basis of the available experimental data obtained as a result of a research.

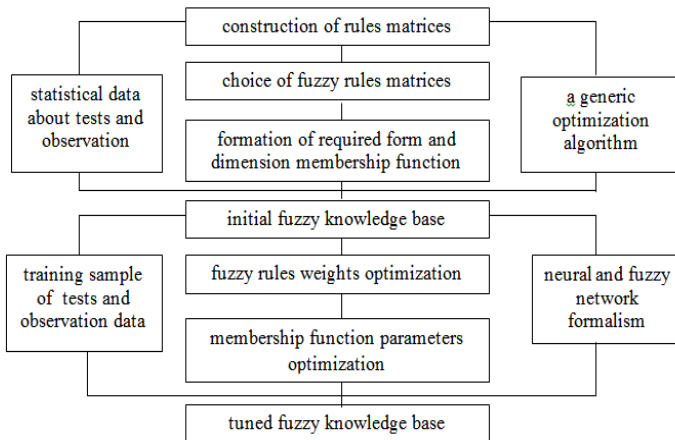

**Fig. 2.** Stages of setting up the fuzzy knowledge base

For the extraction of the rules the known mechanism of data mining realized in genetic algorithms of optimization is used. As a result of the creation of the set of rules matrices the initial knowledge base is formed. For ensuring reliability of the received estimates the second stage is provided at which training of a neural and fuzzy network formalism in examples, formed from experimental data is carried out. The essence of KB fine tuning stage consists in selection of such weights of fuzzy IF-THEN rules and such parameters of membership functions which minimize distinction between desirable (experimental) and model (theoretical) behavior of an object. The stage of the KB fine tuning is formulated as a problem of nonlinear optimization which can be solved by various methods among which the most universal method is one of the steepest descent. However, at a large number of input variables and fuzzy terms in the knowledge base application of a method of steepest descent demands search of the minimum from the different initial points that significantly increases machine timetable. In the work fine tuning of the fuzzy knowledge base with the application of the method of neural networks training known as a method of error backpropagation is offered [10].

6. Principle of multiloop tuning of the fuzzy knowledge base for the objects having hierarchical structure

It is necessary to allocate the contours solving independent problems of assessment during modeling the difficult systems having hierarchical structure. Each contour has to be learned independently. For this, it is necessary to form the training selections purposefully on each subtask. In the knowledge base constructed for area of ultra-high-speed impact of SC and SD it is possible to allocate three contours:

- the first contour allowing to estimate materials resistance of a design of SC to influence of SD. Data for rules extraction and matrixes creation can include all volume of results of the carried-out bench, polygon tests, at the same time the firing angle of targets is chosen  $90^\circ$ . Input data are characteristics of SD (impactor): the weight, density, the size and speed of a particle, and also property of wall material of SC: thickness, density and hardness of material according to Brinell. Output contour parameter is the received UDP value for wall material of SC at interaction with SD on corners  $\theta$  close to  $90^\circ$  (normal). Such approach considers limited opportunities of the test bench on impact speeds (to 5 km/s), but allows to use these results for carrying out training of the second contour;
- the second contour of interaction results assessment of SD with a single-layer wall of S. Data for extraction of rules include the known data on a picture of real collisions in space, results of ground bench tests and the analysis of defeat function graphs for single-layer constructive materials S. Input data are characteristics of SD (impactor), i.e. the weight, density, the size and speed velocity of a particle, interaction condition between SC and SD: a corner between a particle velocity vector and a normal to a surface of SC and the interaction speed between SD and SC in a meeting point, and also characteristics of a wall of SC, i.e. thickness, density and hardness of material according to Brinell. Output contour parameter is UDP value assessment for a single-layer wall of SC which can be interpreted as a result for the two-layer wall (protection with the bumper) provided that S distance between the wall and the bumper is close to 0 cm (small). Such approach allows to use the received results for training of the third contour;
- The third contour of interaction results assessment between SD and the two-layer wall of SC. Data for rules extraction include the same data as in the second contour, but in relation to the wall with the protective bumper. Input data are characteristics of SD (impactor) - the weight, density, the size and velocity of a particle, interaction condition between SC and SD: a corner between a vector of velocity of a particle and a normal to a surface of SC and the interaction velocity between SD and SC in a the point of meeting, the characteristic of SC wall: thickness, density and hardness of material according to Brinell, and also characteristics and features of placement of the bumper of protection: thickness and density of the bumper, tension of fluidity of material of the back wall and distance between the bumper and the back wall. Output parameter of the contour is UDP value assessment for the two-layer wall (protection with the bumper).

7. The principle of control (training) of KB in experimental data selections which contain both accurate and fuzzy (indistinct) values of input and output variables.

Fuzzy model control consists of finding of such parameters which minimize deviations between desirable and valid behavior of a model. At the same time it is supposed that the desirable model behavior is set by the fuzzy training selection.

The illegibility in experimental data is not an obstacle for the KB exact control. Under conditions when available experimental data are set by fuzzy numbers the problem of fuzzy KB control is carried out on the training selection with an accurate input and a fuzzy output. In this case modeling accuracy increases for fuzzy and accurate selection of data. When experimental data for creation of rules matrix in the "inputs- output" format are formed on the expert judgments basis, the training selection can include fuzzy values of input and output variables. For ensuring accuracy of the KB tuning fuzzy selection has to be 3-4 times more than accurate selection [9]. In a solvable task training selections are formed during tuning fuzzy knowledge database. The results of materials stability assessment of SC structure for influence of SD are used for tuning of the second contour. The examples created by the results of interaction between SD and a single-layer wall of SC are used for tuning of the third contour. So the training selection will include both accurate and fuzzy (indistinct) values of input and output variables. One of the most important aspects for complex intelligent information system creation is base data preparation based on the findings of modeling and experimental research of superhigh-speed interaction of particles. Modeling of effects of superhigh-velocity impact of space debris on shell elements of SC is conducted using modern software ANSYS, LS-DYNA, AUTODYN, ABAQUS, FlowVision and others. It shows some results of numeric evaluation of stress state of structural member of descent module at the impact of the debris in ANSYS (fig 3a). The generated aperture hole represents possible hazard not only on the orbit but in the dense layers of the atmosphere during module descent. Modeling in FlowVision has showed that the generated high- temperature gas flow can significantly extend the hole and break into the module (fig. 3b) posing a real threat for providing system and danger for operation of the module. Verification of models according to the experiment results will improve their reliability.

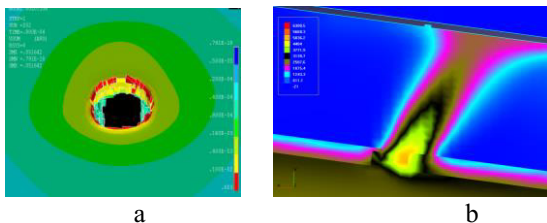

**Fig. 3.** Stress-state (a) of SC structural element made of an aluminum alloy during the impact of the debris having a 7mm diameter and velocity 4 km/s and the temperature field (b) in the damage zone

Generally the complex intelligent information system allows predicting effects of a SD particles impact and reducing the risk for SC.

## 2 Conclusions

The problem of forecasting outcomes of dynamic interaction between SC and-SD is difficult from a position of accurate solutions. Convenience of approach for assessment of high-speed interaction between SD and SC is defined by simplicity and demonstrativeness which are inherent in the mechanism of fuzzy logical conclusion. The formulated principles of building a fuzzy knowledge base summarize and they are development of the known provisions which define the solution of identification problems of a difficult objects condition by means of expert and experimental information. Realization of the specified principles within the projected intellectual information system will allow to solve a problem of detection in real time the SD posing a threat of SC, to predict results of its high-speed interaction for making timely and valid decisions on operational protection, development and design of active and passive protection measures of SC in orbit. The results of modeling and experimental research for base data preparation for system's work are represented. The further direction of researches is development of the procedure of training of multicircuit neuro fuzzy network on the basis of realization of "generative competitive neural networks" mechanisms.

The research was done within the government task of the Ministry of Education and Science of Russian Federation. The number for the publication is 2.1777.2017/4.6.

## References

1. Weijie Wang, Huairong Shen, Yiyong Li, "Study on the Impact Breakup Model of the Space Target Based on the Thin Plat", International Journal of Information Technology and Computer Science(IJTCS), vol.3, no.2, pp.46-52, 2011. DOI: 10.5815/ijitcs.2011.02.07
2. Protection manual. IADC-04-03.Version 5.0.Inter-agency space debris coordination committee.Prepared by the IADC WG3 members. October, 2012 [http://www.iadc-online.org/Documents/IADC-04-03\\_Protection\\_Manual\\_v5.pdf](http://www.iadc-online.org/Documents/IADC-04-03_Protection_Manual_v5.pdf).
3. Rotshteyn, A.P. (1999) Intellectual technologies of identification: fuzzy logic, genetic algorithms, neural networks. Universum. Vinnitsa.
4. Shushura A.N., Tarasova I.A. (2012) Way of a task of multidimensional functions of accessory of terms of linguistic variables in Information technologies and computer engineering, No 1, p. 39.
5. Mironov V.V., Tolkach M.A. (2016) The ballistic limit equations for optimization of system of protection of spacecrafts against mikrometeoroid and space debris in Space equipment and technologies. No 3(14). p.26.
6. Mityushkin Yu. I., Mokin B. I., Rotshteyn A. P. (2002) SoftComputing: identification of regularities indistinct knowledge bases. Universum. Vinnitsa.

7. Yongyuan Li, Yi Jiang, Chunping Huang, "Shape Design of Lifting body Based on Genetic Algorithm", *International Journal of Information Engineering and Electronic Business(IJIEEB)*, vol.2, no.1, pp.37-43, 2010. DOI: 10.5815/ijieeb.2010.01.06
8. Kurenkov V.I., Lukashev L.G., Yumashev L.P. (2004) Assessment of meteoric and technogenic danger of flight of the spacecraft. SGAU. Samara.
9. Shtovba S.D. (2007) Control of fuzzy model on the training selection with an fuzzy exit in Cybernetics and the system analysis, No. 3, pp. 26-32.
10. Zhengbing Hu, Yevgeniy V. Bodyanskiy, Oleksii K. Tyshchenko, Vitalii M. Tkachov, "Fuzzy Clustering Data Arrays with Omitted Observations", *International Journal of Intelligent Systems and Applications(IJISA)*, Vol.9, No.6, pp.24-32, 2017. DOI: 10.5815/ijisa.2017.06.03
11. Yevgeniy V. Bodyanskiy, Oleksii K. Tyshchenko, Daria S. Kopaliani, "An Extended Neo-Fuzzy Neuron and its Adaptive Learning Algorithm", *International Journal of Intelligent Systems and Applications(IJISA)*, vol.7, no.2, pp.21-26, 2015. DOI: 10.5815/ijisa.2015.02.03
12. Novikov L.S. "Impact of firm particles of a natural and artificial origin on spacecrafts". Moscow. 2009.

# A Software System for Thin-walled Parts Deformation Analysis

Eremeykin P.A.<sup>1</sup>, Zhargalova A.D.<sup>2</sup>, and Gavriushin S.S.<sup>2</sup>

<sup>1</sup>Mechanical Engineering Research Institute of the Russian Academy of Sciences,  
Moscow 101990, Russia

<sup>2</sup>Bauman Moscow State Technical University, Moscow 105005, Russia  
eremeykin@gmail.com

**Abstract.** This article concerns problems related with thin-walled parts processing. Emphasis is placed on a “soft” cutting modes method automation. The method is based on choosing the rational machining conditions and taking into account the technological deformations. The article highlights the issues arising during the system development. Authors suggest solutions using modern software libraries and techniques.

**Keywords:** Thin-walled part, numerical modeling, turning, software development, finite element analysis (FEA)

## 1 Introduction

It is known that thin-walled parts machining is prone to defects due to technological deformations which are conditioned by cutting and clamping forces. This problem is still actual despite existing accuracy increasing techniques.

Technologists often face the processing of thin-walled parts. Such parts are widely applied in aerospace industry [1]. Problems related with thin-walled parts machining are usually caused by technological deformities arising during processing. Regular cutting modes based on empirical data generally don't allow providing required quality parameters.

In practice to manage with the problem one can consider applying next technological measures: clamping with soft (unhardened) jaws, filling the hollow part with fusible technological aggregate, clamping with expanding mandrels. The relatively modern additive manufacturing technology is potentially able to cope with the problem but nowadays there are several significant limitations: poor accuracy, high roughness, quality instability [2]. The mentioned methods usually allow solving the problem, but they require extra time and production cost.

An alternative approach based on numerical modeling of deformations was suggested [3,4]. The method of “soft” cutting modes does not require additional tools or equipment and preparatory work for each workpiece. The main idea of the method is



to provide the required precision using existing equipment by choosing rational cutting conditions.

The cutting modes optimization is intensively investigating. There are different approaches to the problem. G. Sridhar and G. Venkateswarlu in [5] provide the method to optimize cutting modes based on empirical data and statistical analysis. The other important result of the article is discovering the influence of different processing parameters on cutting force and surface roughness. Authors of [6] adhere to an alternative approach. They suggest the technique that uses Finite Element Analysis (FEA) to build an adaptive system. In this case, cutting forces are iteratively calculated by the numeric model. M. F. Villumsen and T.G. Fauerholdt established [7] that modern FEA software is able to evaluate force magnitude even with taking chip formation into account. Although the first model was not so accurate, but authors earnestly assure that the result may be improved.

One can conclude that the numerical modeling is more appropriate than statistical analysis. With FEA a developer can capture significant domain phenomena and factors in the model. There is no need to perform experiments for each part or processing configuration. Thus the current article describes the “soft” modes method under assumption that a numerical model is used to calculate rational cutting conditions.

## 2 “Soft” Cutting Mode Method

We will consider the application of the method by an example: machining a cylindrical hollow workpiece. The process is schematically shown in the figure 1a and 1b. The figure 1a demonstrates the state of the workpiece clamped with three-jaw chuck. The deformed part turning leads to non-uniform material removal. The result of such processing is shown in the figure 1b. The  $\Delta$  denotes the lobing.

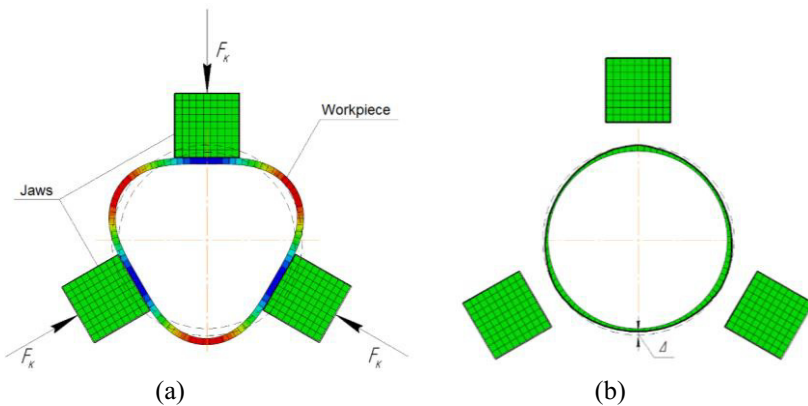

**Fig. 1.** Turning of thin-walled part

The “soft” cuttings modes method involves numerical modeling determining the value of  $\Delta$  before the processing starts. So it is possible to predict the result and correct cutting modes to satisfy design requirements.

CAE (Computer-aided engineering) modeling is a labor-intensive process which requires employing highly skilled specialists. Labor intensity reduction may be reached by applying automated software which allows creating the model for given design case relying on predefined parametric scripts. The software system tasks also include analysis and modeling result visualization.

### 3 Integrated Software System

The central concept of the system is to integrate the existing FEA software to solve modeling problem. The functionality of the FEA software must be rich enough to isolate a user of direct interaction with it. This will decrease the requirements for the qualification of technologists.

Every new technological task is characterized by specific features. During the system developing, the decision of building a modular architecture was made. The base set of modules satisfies the minimal functional requirements, but the ability to develop highly specialized custom modules allows applying the system in the given industry-specific conditions. The base modules composition:

1. Cutting mode calculation module
2. Model loader
3. Parameters editor
4. CAE interconnection module
5. Visualization and report module

### 4 Modules of the System

Cutting mode calculation module is intended to estimate the cutting force under the hard workpiece assumption. The cutting force calculated by empirical-analytic method [8] may be used to determine the starting point.

The model in the context of the project denotes the abstraction to describe some calculation case. So the model loader module extracts the information from the model and interpenetrates it.

Parameters editor allows the user to change the case variables described in the model. The examples of the variables are geometrical parameters of the workpiece, material properties and so on.

The CAE interconnection module includes two components: application programming interface (API) description and its basic implementation. The API description defines the rules of the interconnection between CAE software and the developed system. Due to the defined API, it is possible to develop a custom implementation of the interface to integrate the deformation analysis system with a new CAE program.

Visualization and report module provides basic functionality to build reports and view a graphical presentation of modeling results.

## 5 Programming Issues

The Java programming language is used to implement the deformation analysis system. Java allows ensuring fast development process along with a quite reliable product. Also, the advantages of Java are cross-platform code and robust object-oriented programming support. The developed system is predominantly oriented on working with Abaqus FEA software, but it doesn't exclude working with another one, eg ANSYS. Abaqus provides wide opportunities to automate modeling due to using Python as a domain programming script language.

The most rational way to build the modular architecture is using an existing programming platform. For Java language, there are two widely used platforms: Eclipse RCP and NetBeans Platform. The latter is used to develop the analysis system because it relies on Swing library, which has some advantages (eg Swing is part of standard Java development kit - JDK) compared with SWT, used in Eclipse RCP.

## 6 Modules Implementation

This chapter concerns specific issues related to programming implementation of each base module.

The programming of cutting modes calculation is complicated with manifold of different methods. The well-established methods are generally old and not designed for automated use. For example, the empirical-analytic method includes choosing the empirical coefficients from the heterogeneous tables. To solve the problem the production inference approach is used. The production inference is based on production rules with the structure as shown below:

IF <RHS > THEN <LHS>

where <RHS> stands for right-hand side and <LHS> - left-hand side. Left-hand side defines the condition when the rule is met. The right-hand side describes actions to perform. Drools library [9] uses text files and Excel tables to store the rules. The text format is convenient to express knowledge in form of formulas, and the Excel format is appropriate to tables of empirical coefficients. So it is suitable to use knowledge, derived from reference literature [8] without hard coding.

Firstly, the model loader must provide loading the calculation case into the developed analysis system. The system allows loading data from a database or Excel file. Java Database Connectivity (JDBC) driver is used to establish a connection. Depending on particular JDBC driver one can connect different databases. The mandatory components composition of the model includes two items: list of the variables and parametrized Python script. The list of the variables describes values required to run the script. In its turn, the script is used to perform modeling operations to determine

the magnitude of deformation. An example of such actions is force applying or geometrical modeling. A user is devoid of necessity to interact with FEA software, it is required to specify only parameters values.

The system uses graphical editor to present the parameters. It is shown in the figure 2.

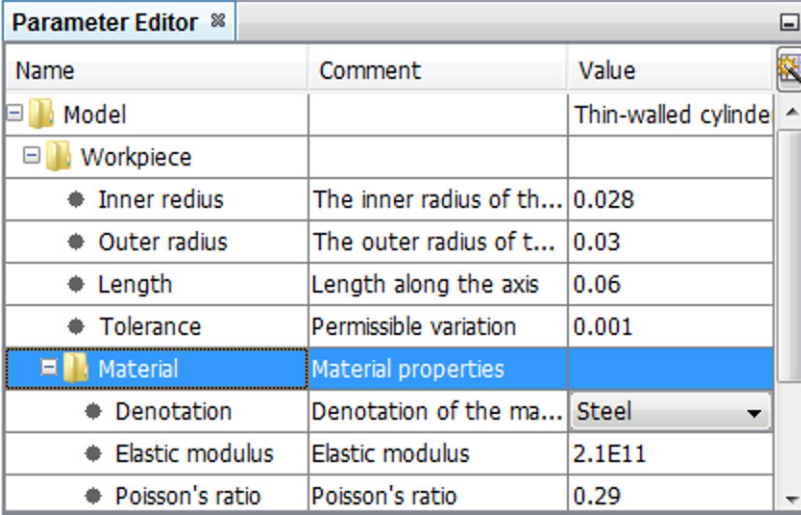

Name	Comment	Value
Model		Thin-walled cylinde
Workpiece		
• Inner radius	The inner radius of th...	0.028
• Outer radius	The outer radius of t...	0.03
• Length	Length along the axis	0.06
• Tolerance	Permissible variation	0.001
Material	Material properties	
• Denotation	Denotation of the ma...	Steel
• Elastic modulus	Elastic modulus	2.1E11
• Poisson's ratio	Poisson's ratio	0.29

Fig. 2. Parameter editor

All parameters are grouped into a hierarchical structure and the model is allowed having several parameters with the same names but in different groups. One should describe specific relations between parameters in the model file.

CAE interconnection module initiates calculation of deformations by compiled task. The calculation workflow is based on a Python script included into the current model and set parameters values. CAE system runs within the separate process. Many CAE systems provide running scripts written in a domain-specific language. These scripts can be invoked from command line interface (CLI) in batch mode. As it is said early, the interconnection module defines the API. Custom implementation of API allows connecting new systems, but the initial implementation uses CLI.

The graphical user interface (GUI) of the system is presented in the figure 3. In this case windows of parameter editor, visualization module and auxiliary text output are shown.

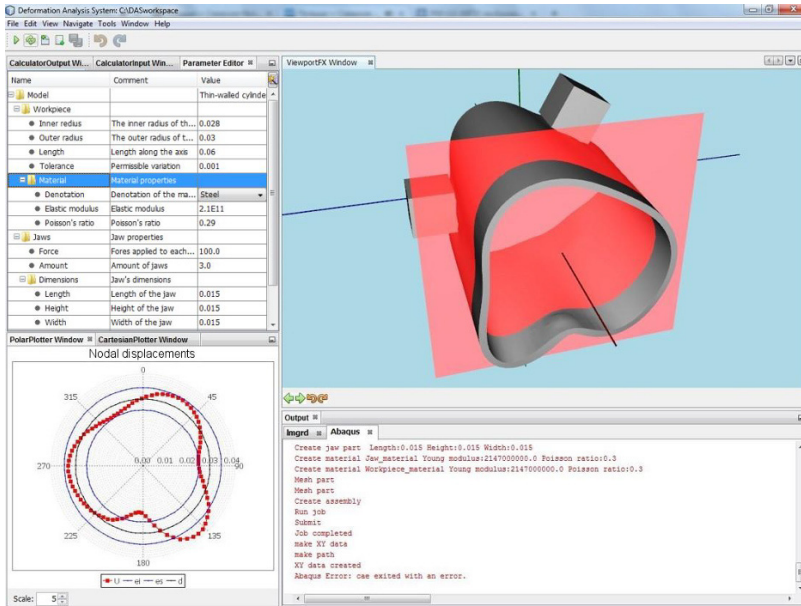

Fig. 3. Graphical user interface

## 7 Conclusions

1. “Soft” cutting mode approach allows avoiding using the additional equipment due to rational choosing cutting conditions and taking into account the workpiece deformation
2. To effectively implement the method of “soft” cutting modes, an information support system is required to automate the process of numerical simulation.
3. To calculate cutting forces the flexible approach, based on production rules was suggested
4. The integrated deformation analysis system is developed on the basis of open source software platforms and libraries and integration with the proprietary system

## References

1. Khairul Akmal Shamsuddin, A. R. Ab-Kadir, Mohd Hairizal Osman. A Comparison of Milling Cutting Path Strategies for Thin-Walled Aluminium Alloys Fabrication // The International Journal of Engineering And Science, 2013. - № .3.
2. Isaev A., Grechishnikov V., Pivkin P., Kozochkin M. et al. Machining of thin-walled parts produced by additive manufacturing technologies // 48th CIRP Conference on Manufacturing Systems - CIRP CMS, 2015.

3. Arbuzov E. V., Zhargalova A. D., Lazarenko G. P., Semisalov V. I. The problem of deformation of thin-walled parts during turning // *Nauka i obrazovanie*, 2014. - №2.
4. Gavriushin S.S., Zhargalova A.D., Lazarenko G.P., Semisalov V.I. The method for determining the conditions for thin-walled parts machining // *Izvestiya vysshih uchebnyh zavedenij. Mashinostroenie*, 2015. - №1. - p. 53-60
5. G. Sridhar, G. Venkateswarlu, "Multi Objective Optimisation of Turning Process Parameters on EN 8 Steel using Grey Relational Analysis", *International Journal of Engineering and Manufacturing (IJEM)*, vol.4, no.4, pp.14-25, 2014. DOI: 10.5815/ijem.2014.04.02
6. Ratchev S., Liu S., Huang W., Becker A. Milling error prediction and compensation in machining of low-rigidity parts // *International Journal of Machine Tools & Manufacture*, 2004.- № 44.
7. Villumsen M.F., Fauerholdt T.G. Prediction of Cutting Forces in Metal Cutting, Using the Finite Element Method, a Lagrangian Approach.// *Konferenzbeitrag, LS-DYNA Anwenderforum, Bamberg 2008*.
8. Kosilova A.G., Meshcheryakov R.K., *The reference book of the technologist of the machine builder. Vol. 2 - M. Mashinostroenie*, 1986. - 418 pp.
9. Drools Documentation. JBossDeveloper, 2016. URL: <http://docs.jboss.org/drools/release/6.4.0.Final/drools-docs/html/>

# Design and Modeling of Adaptive Noise Suppression Systems with Morphological Approach

D. Rakov<sup>1</sup>, J. Thorbeck<sup>2</sup>, M. Pecheykina<sup>3</sup>

<sup>1</sup>Institute of Machines Science named after A.A. Blagonravov of the Russian Academy of Sciences,

<sup>2</sup>Institute of Aeronautic and Astronautic, Berlin Technical University

<sup>3</sup>Moscow Power Engineering Institute (National Research University)

<sup>1</sup>rdl@mail.ru

**Abstract.** The possibility of the application of a morphological approach for structure synthesis and analysis of new adaptive systems under uncertainty conditions is considered. The process of creating of a morphological table has been carried out sequentially, with the following estimation of all variants located in it, generation, clustering and selecting alternatives. The main aim of a series of modeling and experiments conducted has been to determine sound insulation properties of soundproofing panels employing porous materials under varying stress. That advantageous effect has been achieved by the new so-called 4S-technology (Steerable Sound Suppression System). The creation of deformation zones on a surface and along the thickness of an insulating material, and also the interaction of that material with elastic membranes are the underlying principles of the effect. Varying the degree of deformations and, hence, the density of a sound insulation material, enables an adaptation to a desired degree of sound suppression, and also frequency band, which ultimately allows to create active and adaptive systems for sound insulation, alongside with passive ones.

**Keywords:** Adaptive systems, modeling, intelligence system design, noise insulation technologies, steerable sound suppression system

## 1. Introduction

The porous materials are applied for the sound absorption [1]. It is widely accepted, that it is basically impossible to get good soundproofing by use of thin-walled porous materials. So, the well-known acoustician Rupert Taylor [2] in his book "Noise" writes, that «to fix (a) thin porous mat with the purpose to detain the sound going from one point to another, is simply loss of time. The maximum that can be achieved such way, is to lower a level of noise on 3 dB on high frequencies. Certainly, the porous materials absorb the sound and as they partly reduce the energy of the sound, they reduce also the energy of the wave which passing through them. But to receive in the slightest degree the worth attenuation, the thickness of the absorbing material layer should be comparable to the length of a sound wave. As in practice it is

frequently necessary to deal with the sound waves several meters long, it's clear, that it is out of the question to use the absorbing materials directly as a sound insulator». Other experts also adhere to this point of view. However, our investigations have shown that it is possible to achieve an extraordinary reduction of noise level for thin-walled porous, cellular and fibrous materials. In particular, for a technical foam panel of 30 mm thickness and with a specific area weight of less than  $1 \text{ kg/m}^2$  the average of the sound reduction index can be up to 12 dB.

That effect has been achieved by the new so-called 4S-technology (Steerable Sound Suppression System). Varying the degree of deformations and, hence, the density of a sound insulation material, enables a variation of the degree of sound suppression, and also the frequency band, which allows to create active and adaptive systems for sound insulation, alongside with passive ones. The 4S-Effect is predominantly achieved by an interaction of a noise damping material with a film, a non-uniform deformation of the noise damping material and an effective process of controlling sound absorption by means of controlled stress variation.

## **2. Morphological Approach for the Adaptive Noise Insulation System**

At present, there are many methods for searching and synthesizing engineering solutions, including processing Big Data in Internet [3] and structural analysis for the realization of scientific and technical ideas [4].

The synthesis process provides the following stages on basis advanced morphological approach [5,6]. Effective solutions for noise insulation technologies are therefore required and the developed approach (inverse task) was applied to search the perspective noise insulation systems based on 4S-technology. Investigations on the previous subject have shown that it is possible to achieve an extraordinary reduction of noise level for thin-walled porous materials [7,8]. The creation of deformation zones on a surface and along the thickness of an insulating material, and also the interaction of that material with elastic membranes are the underlying principles of the effect. Varying the degree of deformations and, hence, the density of a sound insulation material, enables an adaptation to a desired degree of sound suppression, and also frequency band, which ultimately allows to create active and adaptive systems for sound insulation, alongside with passive ones. For the problem solving the following subtasks set be selected.

The creation of the morphological matrix (s. Table 1). The group of the basic characteristics is singled out in the object. The morphological matrix contains 1152 potential variants of engineering solutions.

Reference variants are entered to a morphological matrix, and then a set of variants is generated. At the next stage the generation of variants, their estimation and initial selection are carried out and some array of rational variants for the subsequent analysis is formed. Henceforth the clustering of the variants using the entered measure of similarity is carried out. For final analysis 60 generated rational variants, grouped in 8 clusters were chosen (fig 1). After clusters and variants,



analysis of the final choice sets from morphological matrix was made for optimization and experimental investigations (fig.2,3).

**Table 1.** Morphological matrix with possible 4S system variants

	<b>attribute (descriptors)</b>	<b>Option 1</b>	<b>Option 2</b>	<b>Option 3</b>	<b>Option 4</b>
1	<b>stress</b>	increased pressure	reduced pressure	combined	
2	<b>source of stress</b>	pneumatic	mechanical	electric	hydraulic
3	<b>membrane</b>	flexible	hard		
4	<b>control</b>	no	controlled	adaptive	
5	<b>combination of volume</b>	1	2	3	n
6	<b>combination of layers</b>	Homogeneous material	Heterogeneous material		
7	<b>kind of a material</b>	porous	cellular		

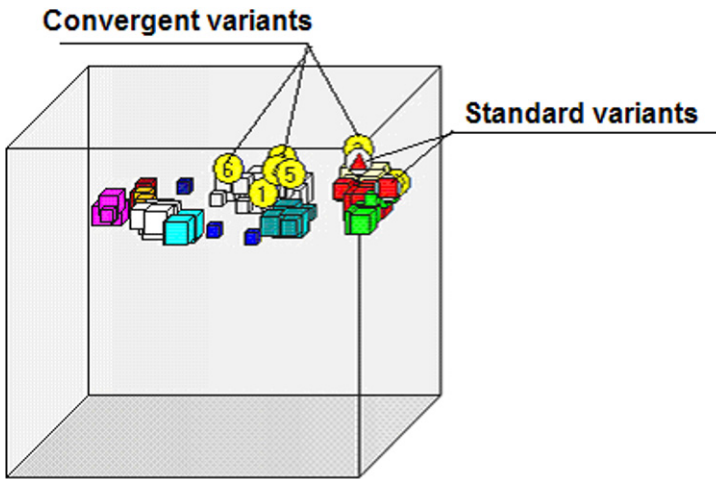

**Fig. 1.** Clusters and variants in the solutions space

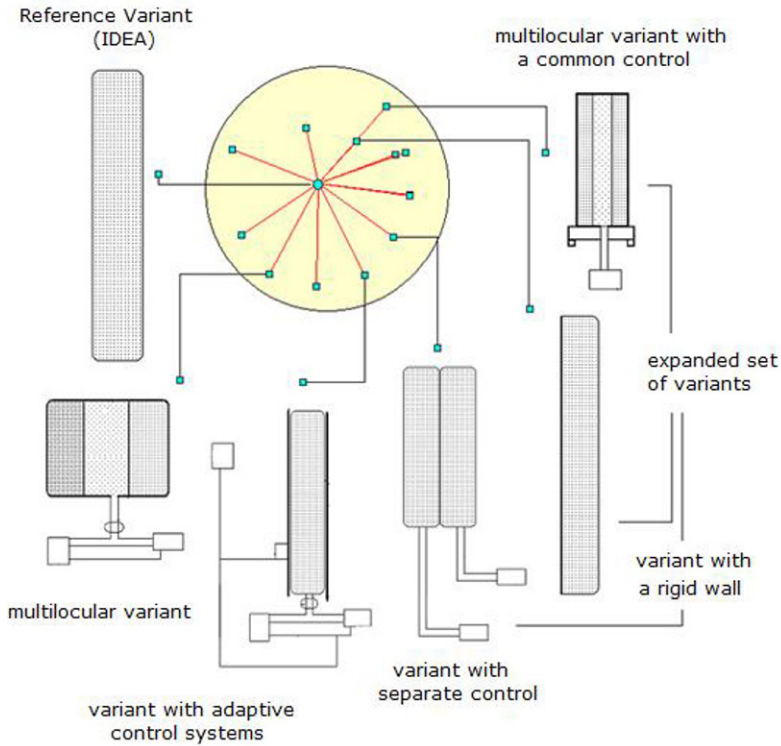

**Fig. 2.** Expanded set of variants with 4STechnology

### 3. Description of Experiment

The sound-proofing property has been investigated at different mechanical stresses. The stress in the test specimen was produced pneumatically (fig. 3, 4), using differential pressure. Sound insulation is measured in one-third octave bands covering the frequency range from 50 Hz to 5000 Hz. A pink noise generator was used as the acoustic source. The sound pressure level was measured with a noise level analyzer. The Experiments are conducted in Institute of Technical Acoustics (ISTA, Berlin Technical University) [3,4]. The Measurements were performed according to ISO 140-3 [9] using a source room of 74,5 cum and a receiving room of 52,75 cum volume.

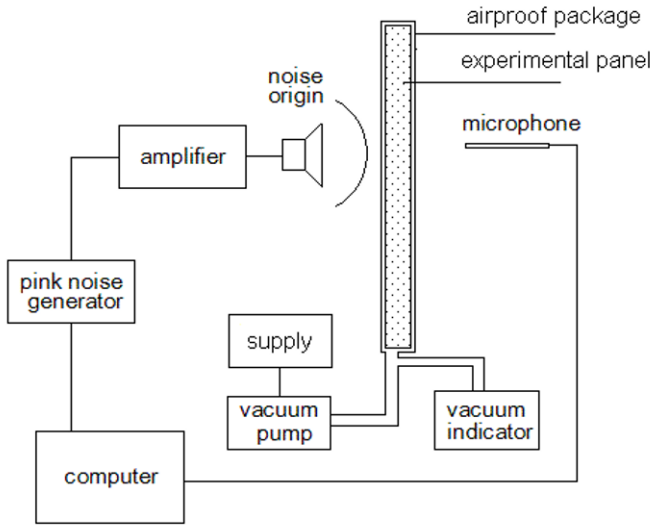

Fig.3. Experimental set-up

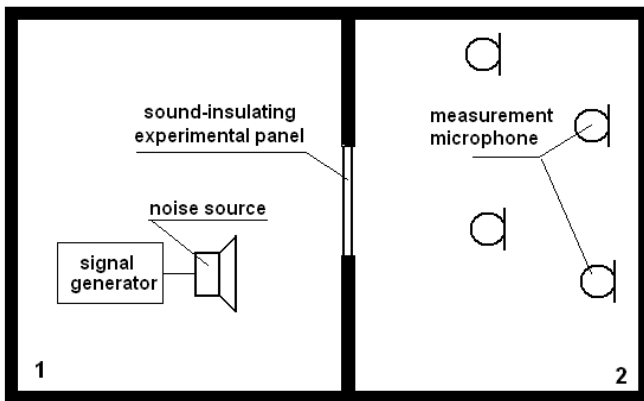
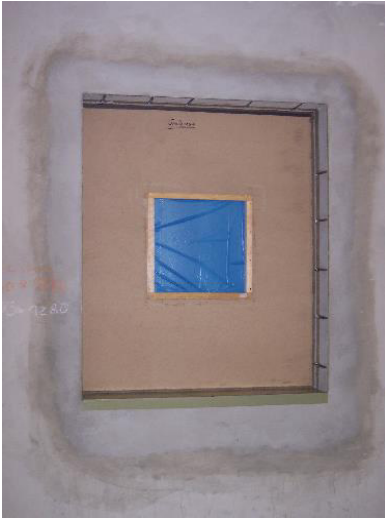

Fig. 4. Sound transmission from source room (1) to receiving room (2) according to experimental set-up

During the experiments the type of damping material, the degree of deformations, porosity, rigidity etc. have been varied. The experiments were conducted with specimen of size (400 x 400 mm, 530 x 530 mm and 2000 x 1000 mm) of different thickness (10,30,50 mm), density (20,30,35 kg/m<sup>3</sup>) and structure (fine porous foams and rough porous foams) (fig. 5).



**Fig. 5.** Sound-insulating experimental panel (size: 530 mm x 530 mm x 5mm), source room side (Test chamber at ISTA)



**Fig. 6.** Sound-insulating experimental panel enclosed in an airproof package (Vacuum (low pressure) pump and indicator in the rear)

#### 4. Results

In the appropriate low-pressure (stress range) the experimental panels exhibit different sound insulation properties. Pressure change is **less than 1 % from atmospheric** pressure. The average sound insulation achieved was 12 dB on the basis of the 4S-effect (fig. 6,7).

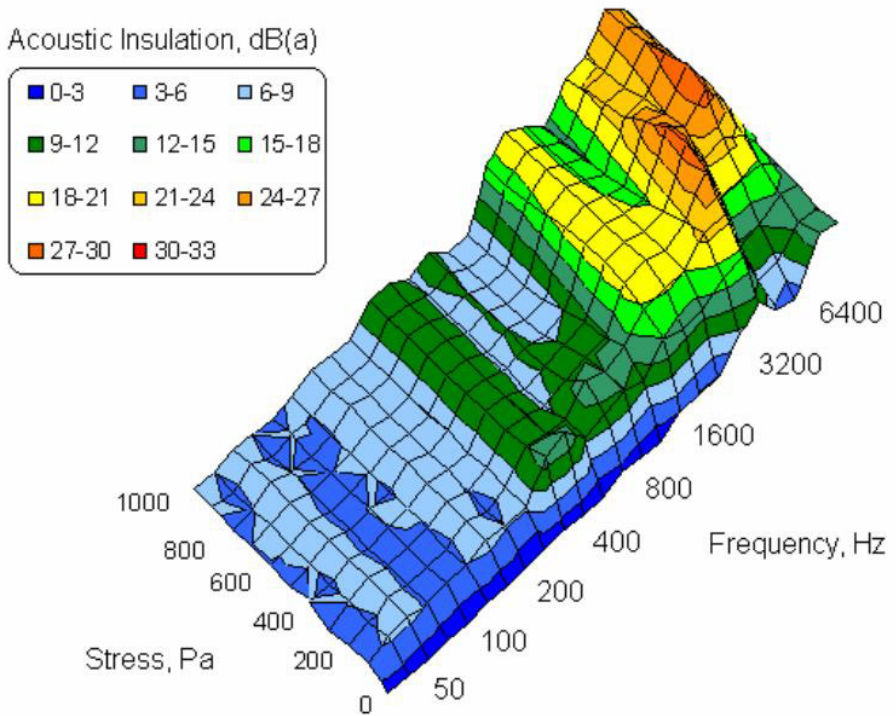

**Fig. 7.** Sound reduction index of foamed polyurethane under low-pressure.

## References

1. Bies, D.A., and C.H. Hansen (2003) *Engineering Noise Control: Theory and Practice*. London, U.K.: Taylor & Francis.
2. Taylor, R (1975) *Noise*. Second edition. Penguin Books, Harmondsworth, Middlesex.
3. K.K. Hashimova, "The Role of Big Data in Internet Advertising Problem Solution", *International Journal of Education and Management Engineering(IJEME)*, Vol.6, No.4, pp.10-19, 2016.DOI: 10.5815/ijeme.2016.04.02
4. Alovsat Garaja Aliyev, Roza Ordukan Shahverdiyeva, "Structural Analysis of the Transformation Processes of Scientific and Technical Ideas and Knowledge into Innovations in Technoparks", *International Journal of Engineering and Manufacturing(IJEM)*, Vol.7, No.2, pp.1-10, 2017.DOI: 10.5815/ijem.2017.02.01
5. Zwicky, F. (1969) *Discovery, Invention, Research – Through the Morphological Approach*, Toronto: The Macmillan Company.
6. Rakov D, Sinyev A. (2015) The Structural Analysis of New Technical Systems Based on a Morphological Approach under Uncertainty Conditions. *Journal of Machinery Manufacture and Reliability*, © Allerton Press, Inc., 2015, Vol. 44, No. 7, pp. 74–81. DOI: 10.3103/S1052618815070110

7. Rakov, D., Thorbeck J. (2008) Ein Beitrag zur Beeinflussung des Schalldämmungsverhaltens von akustischen Dämmelementen. *Lärmbekämpfung. Zeitschrift für Akustik, Schallschutz und Schwingungstechnik*. SPRINGER-VDI-VERLAG 2008, ISSN: 0174-1098, N1, 2008 (in German). - pp 41-43.
8. Rakov, D., Thorbeck, J. (2007) High Soundproofing Ability of Porous Materials under Stress Using 4S Technology. First CEAS European Air and Space Conference "Century Perspectives". Paper Nr CEAS-2007-469, 10-13 September 2007, Berlin, Germany, pp 849-852.
9. International Organization for Standardization: ISO 140-3. Acoustics - Measurement of sound insulation in buildings and of building elements - Part 3: Laboratory measurements of airborne sound insulation of building elements. 1995.

# Analysis and Synthesis of Innovative Engineering Solutions and Technologies Based on Advanced Morphological Approach

B. Klimenko<sup>1</sup>, D.Rakov<sup>2</sup>

<sup>1</sup>Moscow State Aviation Institute (National Research University)

<sup>2</sup>Mechanical Engineering Research Institute named A.A. Blagonravov of the Russian Academy of Sciences

<sup>1</sup>rdl@mail.ru

**Abstract.** The article deals with the analysis and synthesis of structural engineering solutions and technology based on advanced morphological approach. The developed approach is to generate a sequence of operations, comparison and selection of the set of rational choices (clusters) of technical solutions by means of a series of successive procedures. The developed algorithms allow to reduce the dimensions of the morphological set and improve the efficiency of search procedures. Implementation of the approach is demonstrated by the example of the analysis and synthesis of micro-arc oxidation technology and communications devices.

The proposed approach provides clarification and streamlining of structuring the problem to be solved. This increases the degree of informed decision-making and expanding a variety of options, including the choice is made, which makes it possible to improve the quality (technical level) to develop innovative systems.

**Keywords:** System theory and control theory, innovation systems and technologies, space solutions, advanced morphological approach.

## 1. Introduction

One of the features of the first stages of the creation of innovative Engineering Systems (ES) is the need to study a large number of variants of Technical Solutions (TS). Generally, an improvement of one parameter leads to the deterioration of other, that is why there is a constant need for mapping variants. The more variants are analyzed, the better is research and there is greater confidence in achieving this goal. Hence the selection and consideration of alternative variants - are the overriding problems of the process of innovation. An error in the initial position cannot be corrected in the future neither by perfect design models nor by experiment. However, it is clear that the wider the range of possible TS investigated, the greater the complexity of research. As a rule, only a limited number of variants can be processed in detail. Also, the results of studies on detailed framework should allow TS to make judgments not only on the specific embodiment, but also about a range of possible solutions (space solutions).

The result of structural synthesis is a choice of the rational structure of the system. The structure refers to certain semantic structure that describes a set of elements of the designed system and the relationships between them. When forming such a description one has to deal with uncertain structural bonds, non-metric features of the structure elements, and qualitative criteria. This solution to the problem of structural synthesis is the main content of the creative activity of an engineer and designer. The efficiency of the system being created basically depends on the structure and relationships between elements of the system.

For the stage of structural analysis and synthesis of innovative ES the intuitive (Brainstorming, Mind Mapping, TRIZ, synektik, etc.) and discursive (morphological analysis, cause-and-effect diagram, Osborn-Checklists etc.) techniques can be used [1-3]. The most common method among the discursive techniques is morphological analysis [4,5]. By frequency of use, morphological methods are the first among ranks of discursive approaches. Thus, according to statistics compiled in 2009 by German scientists, the total number of firms using the morphology is more than 40%, while regularly use it more than 20% [6]. Morphological synthesis is regarded as a methodology to streamline the problem to be solved.

## 2. Formulation of the Problem

Let TS synthesized with the desired degree of detail is compared with the vector  $X = (x_1, x_2, \dots, x_n)$  of dimension  $n$ , that characterizes the set of system parameters.

This  $X \in X_m$ , where  $X_m$  is morphological variety of system variants, and the synthesized vector elements  $x^*$  belongs to a variety of  $X_m$ . When you select a vector of elements of object  $x^*$  it is necessary to find a compromise between the desire for simulation accuracy and simplicity of the model. External conditions affecting the functioning of TS, are known and fixed, and the criterion of operation of TS is a function  $F(x)$ , only of the elements of  $x^* \in X_m$ . Design problem is to find

$$x^* = \arg \max_{x \in X_m} F(x). \quad (1)$$

The synthesis process provides for the establishment of morphological table (MT) and supplementary information tables. The main features (attributes), describing the performance of the object are highlighted. Depending on the task, the experts select significant  $P_n$  out of a set of main features  $P_p$ .

For each characteristic, alternatives (options) are chosen, i.e. possible variants for its execution or implementation. After decomposition and analysis of TS, morphological table (MT) is formed (Fig. 1) and the morphological variety of solutions (morphological variety of solutions) is set:

$$X_M = \{x_{Mi}, i = 1, n\}, \quad (2)$$



where,  $n$  is the number of variants TS (capacity of morphological set), i.e.  $|X_m| = n$ ;  $X_{mi}$  -  $i$ -th variant of the TS.

options  $\longrightarrow$

	$P^1$	$P^2$	$P^3$	...	$P^k$
--	-------	-------	-------	-----	-------

attributes  
 $\downarrow$

$P_1$	$P_1^1$	$P_1^2$	$P_1^3$	...	$P_1^k$
$P_2$	$P_2^1$	$P_2^2$	$P_2^3$	...	$P_2^k$
$P_3$	$P_3^1$	$P_3^2$	$P_3^3$	...	$P_3^k$
...	...	...	...	...	...
$P_n$	$P_n^1$	$P_n^2$	$P_n^3$	...	$P_n^k$

**Fig. 1.** Morphological Table

The built MT contains a plurality of reference (known solutions - from descriptions of patents, literature and technical documentation)  $X_{R0}$  variants from which data tables are constructed. For example, the table "reference variants" is created to assess the innovations for the subsequent analysis of the degree of innovativeness of the synthesized variants. Then, a generation TS, their evaluation and initial screening are performed. A variety of rational variants TS  $X_{RV}$  is set, where  $X_{RV} \leq X_M$ . The set of rational variants is defined as the sum of them:

$$X_R = X_{RV} + X_{R0}, \tag{3}$$

$$X_R = \{x_{Rk}, k = 1, p\},$$

where  $p$  is a number of variants of a set  $X_R$ , i.e.  $|X_R| = p$ .

Each variant TS  $X_{R1}, X_{R2}, \dots, X_{Rm}$ , contained in MT receives  $U$  evaluation depending on criterion, scoring evaluation of alternatives, and criteria importance coefficients  $w_1, w_2, \dots, w_i$  (Fig. 2).

	$X_{R1}$	$X_{R2}$	$X_{R3}$	...	$X_{mn}$	
$k_1$	$X_{11}$	$X_{12}$	$X_{13}$	...	$X_{1n}$	$W_1$
$k_2$	$X_{21}$	$X_{22}$	$X_{23}$	...	$X_{2n}$	$W_2$
$k_3$	$X_{31}$	$X_{32}$	$X_{33}$	...	$X_{3n}$	$W_3$
...	...	...	...	...	...	...
$k_i$	$X_{i1}$	$X_{i2}$	$X_{i3}$	...	$X_{in}$	$W_i$
	$U_1$	$U_2$	$U_3$		$U_n$	

Fig. 2. Fragment of a criteria table

Integral assessment of each option  $U_j$  is expressed as:

$$U_j = F(X_j, W), \tag{4}$$

where  $X_j$  is vector of estimates  $x_{ij}$ ,  $i = 1, m$ ,

$W$  - weight vector of  $w_i$  criteria

$F$  - function convolution of local estimates, which assigns to each of the alternatives the value of the assessment of  $U_j$  is the convolution of the vector  $X_j$ . The larger the value of  $U$ , the more this variant is preferred, i.e. if  $U(x_{Mi}) > U(x_{Mj})$  ( $U(x_{Mi})$  is  $U$ -value criterion for variant ( $x_{Mi} \in X_M$ ), then the variant of solution  $x_{Mi}$  is preferred over the variant  $x_{Mj}$ . Next clusters TS variants are formed. A  $X_R$  set is a union of disjoint subsets (clusters)  $X_{RS1}, X_{RS2}, \dots, X_{RSz}$  where  $z$  is number of clusters. The set of subsets  $\{X_{RS1}, X_{RS2}, \dots, X_{RSz}\}$  is a covering of the  $X_R$  set, where  $X_{RSi} \cap X_{RSj} = \emptyset$  and  $i \neq j$ . It is assumed that each variant of TS refers strictly to one cluster, i.e. there is a deterministic problem statement. Clustering is performed using the distance function  $\bar{x}_i, \bar{x}_j, \bar{x} \subset X_R$  with the following properties:

$$\begin{aligned}
 \rho(\bar{x}_i, \bar{x}_j) &\geq 0, \\
 \rho(\bar{x}_i, \bar{x}_j) &= 0; \bar{x}_i = \bar{x}_j, \\
 \rho(\bar{x}_i, \bar{x}_j) &= \rho(\bar{x}_j, \bar{x}_i), \\
 \rho(\bar{x}_i, \bar{x}_j) &\leq \rho(\bar{x}_i, \bar{x}_k) + \rho(\bar{x}_k, \bar{x}_j).
 \end{aligned}
 \tag{5}$$

The developed approach a function of the distance is

$$L_1\text{-norm} = \rho_1(x_i, x_j) = \sum_{k=1}^n |x_{ki} - x_{kj}|. \quad (6)$$

Options are analyzed for similarity measure defined as a fuzzy, non-negative real function

$$S(\bar{x}_i, \bar{x}_j) = S_{ij} \quad (7)$$

and satisfying the following conditions when comparing objects  $i$  and  $j$ :

$$\begin{aligned} 0 &\leq S(\bar{x}_i, \bar{x}_j) \leq 1, \\ S(\bar{x}_i, \bar{x}_j) &= 1, \\ S(\bar{x}_i, \bar{x}_j) &= S(\bar{x}_j, \bar{x}_i), \\ x_i &\neq x_j. \end{aligned} \quad (8)$$

Similarity measure is based on the distance measures:

$$\begin{aligned} S_{ij} &= \frac{1}{1 + \rho_{ij}^2}, \\ S_{ij} = 1 &\rightarrow \rho_{ij} = 0, \\ S_{ij} = 0 &\rightarrow \rho_{ij} = \infty. \end{aligned} \quad (9)$$

Field of study further narrows to several clusters, which are then investigated. To increase the degree of descriptiveness when choosing a converged variants  $X_{RK}$  are generated, i.e. variants with a maximum score for each of the criteria and "best" or "ideal" version of  $X_{RI}$ , i.e. TS having a maximum score. To compare the different options, the morphological space of solutions is constructed, in which the position of TS describes the properties of selected variants (Fig. 3). The sought-for TS  $x^*$  is searched for among the many options  $X_R$

$$x^* = \arg \max_{x \in X_R} F(x). \quad (10)$$

First reviewed the most promising options and clusters with the highest scores or similar in layout to the reference variants (Fig. 4).

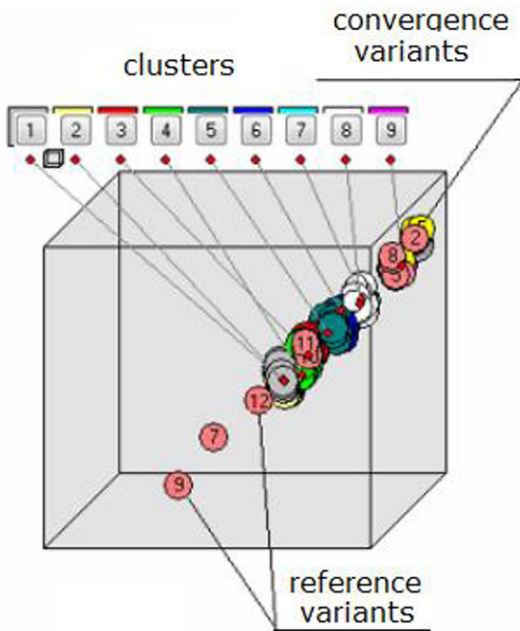

Fig. 3. Morphological Solutions Space

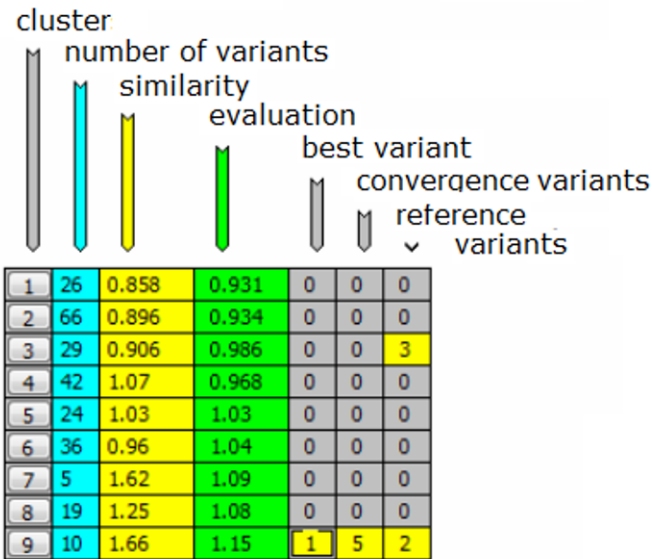

Fig. 4. Clusters comparison

Comparing the variants of TS we determine the best ones of which the final table is made, where, after all samples are taken a set of acceptable TS is left. At the output structural schemes ("white boxes") TS are generated, consisting of models of composition and structure. According to the basic provisions of the methodology software complexes of structural optimization "Synthesis" and "Okkam" are developed. Below are two examples of realization of advanced morphological approach.

### 3. Application of the Advanced Morphological Approach for the Synthesis of Plant Micro-Arc Oxidation

The peculiarity of micro-arc oxidation is that the process of forming the coating is carried out under the effect of surface micro-discharges, which provide a very significant and specific (thermal, plasma-chemical and others) impact on the forming coating and the electrolyte. As a result, the composition and structure of the resulting oxide layers have significantly different properties and their qualities are much higher in comparison with the conventional anodic films [7].

The volume of morphological set of micro-arc oxidation plants is 20736 variants. Later on, a number of valid criteria has been selected which characterized structural and economic indicators of TS. Further, the expert way were appointed weight coefficients based on the method of attributing points, which has the advantage of choosing the freedom of action in front of the ranking methods. The choice of coefficients is performed by experts who evaluate the importance of particular criteria on a scale from 1 to 100. The MT twelve reference (known) variants of TS generated from descriptions of patents and the known TS were recorded. In particular, under the numbers 4 and 5 were listed patent parameters, the characteristics of which need to be improved. 1648 variants were generated by random search, and a set of rational choices  $X_{RV}$  was selected (Formula 3) with the highest grades for further clustering (Fig. 5). All variants were designed to measure the similarity [9].

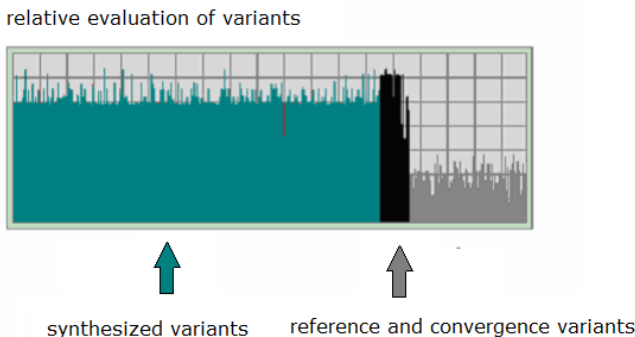

**Fig. 5.** Generation and selection of variants

9 clusters (formula 5) were formed from generated and selected variants which contain similar TS (Fig. 3) (Formula 9). First, the clusters with maximum grades were investigated (Fig. 4). Among all clusters, a cluster number 9 had the highest grade (14% higher than average) (Fig. 4) and was investigated in the first place. Variants 9 and 10 (enhanced TS) with high level of similarity and grades are in this cluster 9 and they are characterized by a high technical level (Fig. 6). Variants 5 and 6 with excellent economic parameters were excluded because of the inability to control coating process. The most typical TS of the cluster is variant 8. But after additional analysis, this TS was adjusted, as due to the mode used (attribute 6) solid ceramic coatings of large thickness cannot be obtained.

A specific feature of variants of the cluster is the management of the ongoing technological process by means of insulated-gate bipolar transistors (IGBT - Insulated-Gate Bipolar Transistor), which leads to the expansion of the management and control capabilities. [8] These variants differ from the other reference variants - inventions higher performance characteristics (Figure 7.).

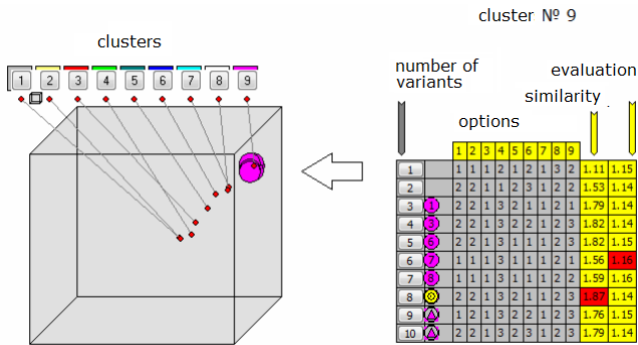

Fig. 6. Location of clusters in the morphological field of solutions

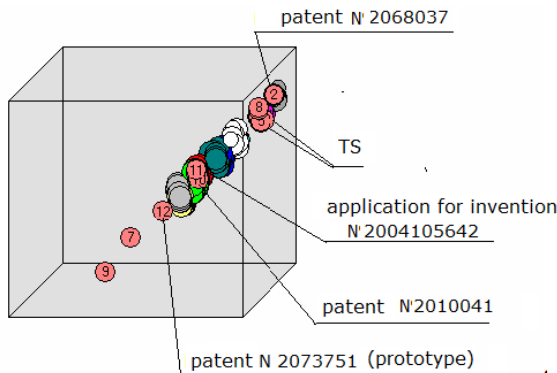
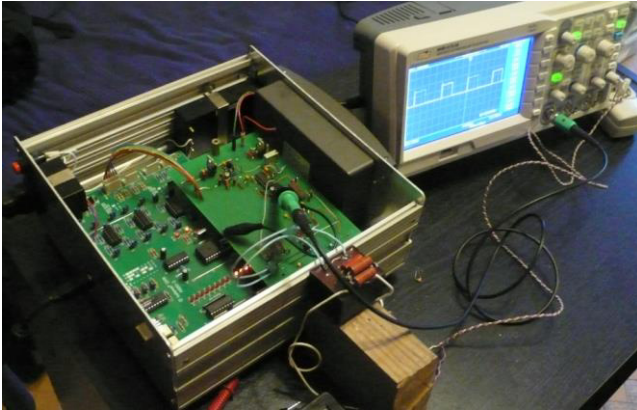

Fig. 7. Location of reference TR in the morphological field of solutions

Synthesized TS are characterized by wide process control capabilities particularly in the initial stage only anodic regime is realized, which allows a quick buildup of the ceramic coating, and further the anode-cathode regime is used for coating with variable frequency regulation by using insulated-gate bipolar transistors controlled by the microcontroller.

For the chosen technical solution, an experimental micro-arc plant (Fig. 8, 9) was set up with extensive processes regulation possibilities (current, voltage, frequency characteristics and the ratio of the anode and cathode components).



**Fig. 8.** Experimental micro-arc variant

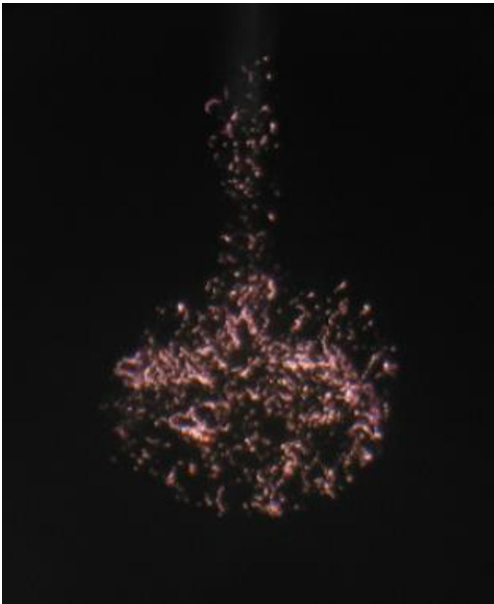

**Fig. 9.** The process of micro-arc oxidation

Found technical solutions allow us to achieve the following advantages [8,9]:

- The possibility of coating the complex-profile products, interior surfaces and hidden cavities;
- To obtain coating with 0.05 - 0.2 mm to 0.3 - 0.8 mm thickness, with adhesion, comparable to the strength of the substrate material;
- The ability to fully automate the process of micro-arc oxidation;
- Extensive process speed control (current, voltage, frequency characteristics and the ratio of the anode and cathode components).

## 4. Conclusion

The proposed approach, of course, does not allow to fully automate the decision-making process. But it gives clarification and streamlining of structuring the problem to be solved. Level of informed decision-making increases. After analyzing a multitude of solutions, it is possible to narrow down the information to let specialists to make a final decision.



The most expedient way is to use structural synthesis on the stage of conceptual search that absorbs only a few percent of the total project cost (around 4%).

## References

1. Levin M. (2015) *Modular System Design and Evaluation* // Springer International Publishing Switzerland, pp. 11–20.
2. Zwicky, F. (1969) *Discovery, Invention, Research – Through the Morphological Approach*, Toronto: The Macmillan Company.
3. Rakov D, Sinyev A. (2015) The Structural Analysis of New Technical Systems Based on a Morphological Approach under Uncertainty Conditions. *Journal of Machinery Manufacture and Reliability*, © Allerton Press, Inc., 2015, Vol. 44, No. 7, pp. 74–81. DOI: 10.3103/S1052618815070110
4. Ritchey, T. (2006) "Problem Structuring using Computer-Aided Morphological Analysis". *Journal of the Operational Research Society*, Special Issue on Problem Structuring Methods, (2006) 57, 792-801.
5. Rakov D, Timoshina A. (2010) Structure synthesis of prospective technical systems // *IEEE Aerospace and Electronic Systems Magazine*. 2010. - Volume: 25 -Issue: 2. - pp. 4 - 10. DOI: 10.1109/MAES.2010.5442170
6. Smerlinski M., Stephan M., Gundlach C. (2009) *Innovationsmanagement in hessischen Unternehmen. Eine empirische Untersuchung zur Praxis in klein- und mittelständischen Unternehmen*. Discussion Paper on Strategy and Innovation, Marburg, Juni 2009, ISSN 1864-2039
7. Rakoch A.G., Gladkova A.A., Linn Z., Strekalina D.M. (2015) The evidence of cathodic micro-arc discharges during plasma electrolytic oxidation of kight metallic alloys ans micro-arc discharge inyensity depending on pH electrolyte. *Surface and Coatings Technology*. 2015. T. 269. № 1. C. 138-144.
8. Klimenko B., Rakov D., Thorbek J. (2011) Device for microarc oxidation of valve metals and alloys. Patent RF № 2413040, 27.02.2011. MPK C25D 11/02.
9. Rakov D. (2011) Structural analysis and synthesis of new engineering systems on morphological approach. URSS, 160p.



# Efficiency Analysis of P-controller Neural Tuner and Adaptive Controller Based on Observer for DC Drive Speed Control Problem

Yuri I. Eremenko , Anton I. Glushchenko  and  
Vladislav A. Petrov 

A.A. Ugarov Sary Oskol technological institute (branch) NUST "MISIS", Sary Oskol, Russia  
a.glushchenko@ieee.org

**Abstract.** A problem of a DC drive adaptive control under the condition of its mechanics parameters uncontrolled drift is considered in this research. Two ways of adaptive systems development are used: linear controller neural tuner and a P-controller, which output signal is corrected using an adaptive system on the basis of a state observer. Its parameters are refined with the help of equations, which stability are provided with Lyapunov second method application. The task is to compare these two methods using a two-high rolling mill DC drive model, which inertia moment is changed smoothly. In order to do so, several experiments have been conducted with the same inertia moment change pace, but different initial P-controller parameter value. Having analyzed obtained results, it is concluded that the neural tuner, unlike the state observer, is able to keep the required transients quality (overshoot, in particular) irrespective to the plant inertia moment drift and initial conditions.

**Keywords:** DC Drive, Adaptive Control, Neural Tuner, Speed P-controller, Observer.

## 1 Introduction

High-power DC drives are widely used in power-intensive branches of industry. They are usually a combination of a thyristor converter and a DC motor [1]. As a rule, control systems for such drives are developed in accordance with the widely known cascade control principle [2]. Considering this principle, two control loops (the inner armature current loop and the outer speed control loop) are used to control the drive speed if it is lower than the nominal value  $n_{nom}$  (Fig.1).  $G$  is a setpoint,  $K_{sc}$  is a speed P-controller gain coefficient,  $W_{cc}(p)$  is an armature current PI-controller transfer function,  $k_{tc}$  is a thyristor converter gain coefficient,  $T_{tc}$  is a thyristor converter time constant,  $k_a$  is an armature winding gain coefficient ( $k_a = 1 / R_a$ , where  $R_a$  is an armature resistance),  $T_a$  is an armature winding time constant,  $c_t$  is a coefficient, which characterizes the electromechanical conversion of armature current to torque,  $K_{cs}$  is an armature current feedback coefficient,  $K_{ss}$  is a speed feedback coefficient,  $J$  is an inertia moment.

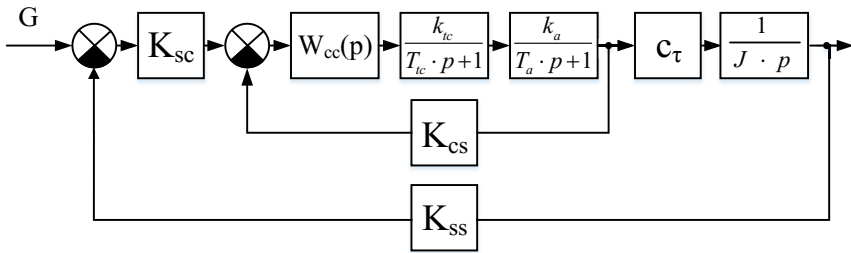

**Fig. 1.** DC drive block scheme

P- and PI-controllers are used in both these loops. The armature current loop is initially tuned to follow technical optimum requirements, whereas the speed loop could be tuned to follow symmetrical or technical optimums requirements depending on the desired transient quality [2]. In most cases such tuning allows to meet these requirements only just after the commissioning. However, DC parameters drift because of the motor nonlinearities, the drive functioning mode change, the mechanics and the armature winding wear. In addition to this, DC drive mechanics can also change its inertia moment value. Its uncontrolled drift eventually results in the fact that the transient quality does not follow the mentioned optimums requirements any more. In its turn, this leads to the drive energy consumption increase.

A way to solve this problem is to develop an adaptive control system. Methods to do so can be divided into classical and intelligent. The first group [3-7] includes methods, which require a plant model, a reference model or test signals usage. All these approaches face hardships being applied into industry, especially for the high-power plants. In addition to this, classical methods also include observer based techniques [8, 9]. Such observers do not require plant nonlinear model. Instead of this they are able to follow the plant parameters drift and correct the control action in accordance with this information. As for the intelligent methods, they also do not require the plant model at all. They include neural networks [10-12], fuzzy logic [13-16], genetic algorithms [17-20], expert systems [21] etc. We propose to use a neural tuner [22] combining the neural networks and the expert systems to solve considered problem.

This research is done in order to compare two methods of adaptive DC drive speed control, which do not require the plant model – the observer and the neural tuner. The task is to follow the mechanics parameter drift of the drive mathematical model to keep the transient quality. The drift is arranged as the inertia moment ( $J$ ) value change.

## 2 Neural Tuner

The two main parts of the tuner are the neural network and the expert system. The network is used to provide the tuner with the ability to be trained online to make it nonlinear. The expert system here is a rule base, which reflects an expert knowledge

and experience in which situations the controller needs to be tuned. The output signal of each rule, in case it has triggered, is a learning rate value, which is used to train the neural network. The network inputs receive information of the current drive state, its outputs are the controller parameters values.

The tuner is an augment to a conventional control scheme. It changes controller parameters to implement adaptation technique. This tuner is used to adjust speed P-controller parameter  $K_{sc}$  in the DC drive cascade control scheme under the condition of the drive mechanics parameters change. Such system flow chart is shown in Fig.2.

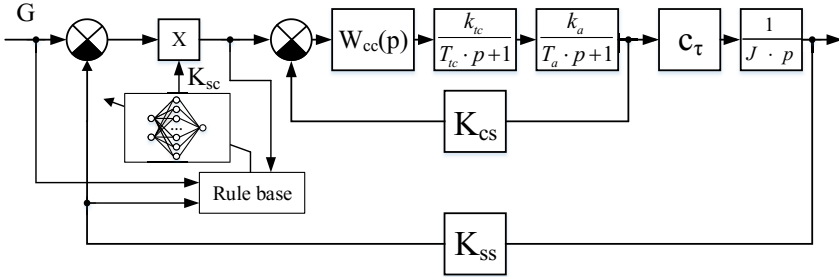

Fig. 2. DC drive adaptive control scheme with speed P-controller neural tuner

More detailed description of the tuner application to solve considered problem could be found in [22].

### 3 Observer to Identify Plant Parameters Drift

This section contains adaptive P-controller development details by applying observer to identify the DC drive parameters drift online (Fig.3). An approach is used, which is similar to mentioned above researches [8, 9]. We neglect the motor back-EMF (electro motive force) and consider the load torque as a constant.

The armature current ( $i_a$ ) is considered as the control action for the nonstationary part of the considered DC drive. Its output coordinate is the drive speed ( $\omega$ ). The unknown part of the plant is described with the help of the following transfer function:

$$W(p) = \frac{y}{u} = \frac{c_\tau}{J \cdot p}, \tag{1}$$

where  $y = \omega$ ;  $u = i_a$ .

The parameter  $c_\tau / J$  is to be identified.  $\hat{c}_\tau / \hat{J}$  is  $c_\tau / J$  estimation.  $\hat{\omega}$  is  $\omega$  estimation.  $\lambda$  and  $\beta$  are parameters influencing the quality of the observer functioning. They have the same sense as the step size in the gradient descent method.

The observer mathematical model can be described as (2).

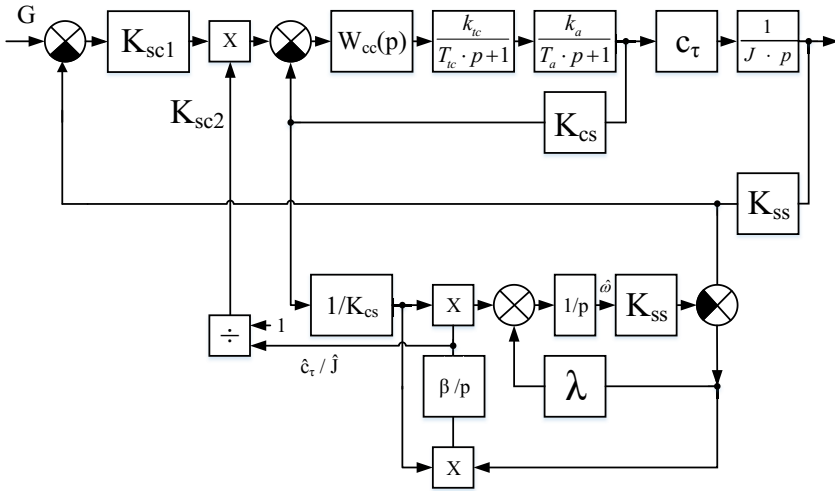

**Fig. 3.** Flow chart of DC drive adaptive control system with observer to identify  $c\tau / J$  value ( $K_{sc} = K_{sc1} \cdot K_{sc2}$ )

$$\begin{cases} \frac{d\hat{\omega}}{dt} = \frac{\hat{c}_\tau}{\hat{J}} \cdot i_a + \lambda \cdot K_{ss} \cdot (\omega - \hat{\omega}) \\ \frac{d(\hat{c}_\tau / \hat{J})}{dt} = \beta \cdot K_{ss} \cdot i_a \cdot (\omega - \hat{\omega}) \end{cases} \quad (2)$$

Initial conditions are  $\hat{\omega}(0) = 0, \hat{c}_\tau / \hat{J}(0) = 0$ .

Let denote  $e = \omega - \hat{\omega}, v = c_\tau / J - (\hat{c}_\tau / \hat{J})$  and consider that  $d\omega / dt = (c_\tau / J) \cdot i_a$ . Then the observer model using coordinates  $e$  and  $v$  can be rewritten as (3).

$$\begin{cases} \frac{de}{dt} = v \cdot i_a - \lambda \cdot K_{ss} \cdot e \\ \frac{dv}{dt} = -\beta \cdot K_{ss} \cdot i_a \cdot e \end{cases} \quad (3)$$

In their turn, the initial conditions are rewritten as  $e(0) = 0, v(0) = c_\tau / J$ . The Lyapunov function (4) is considered in order to check the observer asymptotical stability. The function  $V$  time derivative is (5).

$$V = \frac{1}{2} \cdot e^2 + \frac{1}{2} \cdot \frac{1}{\beta \cdot K_{ss}} \cdot v^2 \quad (4)$$

$$\frac{dV}{dt} = -\lambda \cdot K_{ss} \cdot e^2 \quad (5)$$

So the function  $V$  derivative is negative or nil. As a result,  $(\hat{c}_\tau / \hat{J})$  is asymptotically going closer and closer to  $(c_\tau / J)$  during simulation process. This process convergence depends on  $\lambda$  and  $\beta$  values. Their choice is the main problem of this method application. They are to provide much shorter transient time in the observer loop comparing to the speed loop of the DC drive.

The obtained value of  $(\hat{c}_\tau / \hat{J})$  is used to adjust speed P-controller, i.e.  $K_{sc}$  value. Having calculated the armature current controller parameters on the basis of the technical optimum, the speed P-controller parameter  $K_{sc}$  is calculated as (6).  $T_\mu$  is a non-compensatory time constant. It coincides to  $T_{tc}$  in this case.

$$K_{sc} = \frac{J \cdot K_{cs}}{4 \cdot T_\mu \cdot c_\tau \cdot K_{ss}}. \quad (6)$$

Let divide this equation into two multipliers (7).

$$K_{sc} = K_{sc1} \cdot K_{sc2} = \frac{K_{cs}}{4 \cdot T_\mu \cdot K_{ss}} \cdot \frac{J}{c_\tau}. \quad (7)$$

Here  $K_{sc1}$  is a constant value, whereas  $K_{sc2}$  has variable value, which is calculated by the observer and then inverted by the division block. So the P-controller in Fig.3 is the sequence of two series-connected links.

If  $J$  changes its value, the observer tries to keep the transient quality as required by  $K_{sc2}$  value change.

## 4 Experimental Results

A model of a reverse rolling mill DC drive has been used to conduct experiments in order to compare the neural tuner and the observer based control systems. The power of the rolling mill drive was 3.5 MW. The model (Fig.4) was developed in accordance with the scheme shown in Fig.2. In addition to this, the control system model without adaptation (on the basis of the scheme shown in Fig.1) and the system with the observer (on the basis of the scheme shown in Fig.3) were developed in MATLAB Simulink. Moreover, in all these models the back-EMF was taken into consideration in contrast to mentioned schemes, and its compensation was implemented.

The neural tuner was implemented as an S-function in Fig.4, as well as the drive mechanics, to provide an opportunity to change P-controller parameter (nominal value:  $K_{sc} = 1.745$  or  $K_{sc1} = 0.0529$ ,  $K_{sc2} = 33.06$ ) and the inertia moment  $J$  (nominal value:  $4798 \text{ kg} \cdot \text{m}^2$ ) during modelling experiments. The setpoint was changed steplike using the following graph:  $0 \text{ rpm} \rightarrow 60 \text{ rpm} \rightarrow 0 \text{ rpm} \rightarrow -60 \text{ rpm} \rightarrow 0 \text{ rpm}$ . The inertia moment value was changed smoothly in the range  $50\% \div 150\%$  of the nominal value during modelling. The pace of its changing was  $\Delta J = 24 \text{ kg} \cdot \text{m}^2$  per second. The following values were found experimentally for  $\lambda$  and  $\beta$ :  $\lambda = 50$ ,  $\beta = 0.005$ . The task was to keep the speed overshoot in the range of  $3.5\% \div 4.5\%$  of the setpoint value. The results of the first experiment are shown in Fig.5.

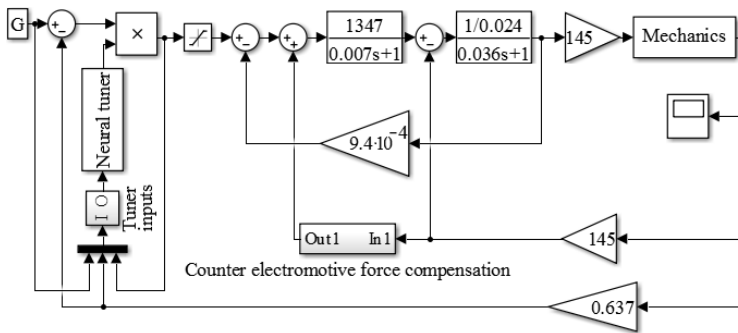

Fig. 4. DC drive model with speed controller neural tuner

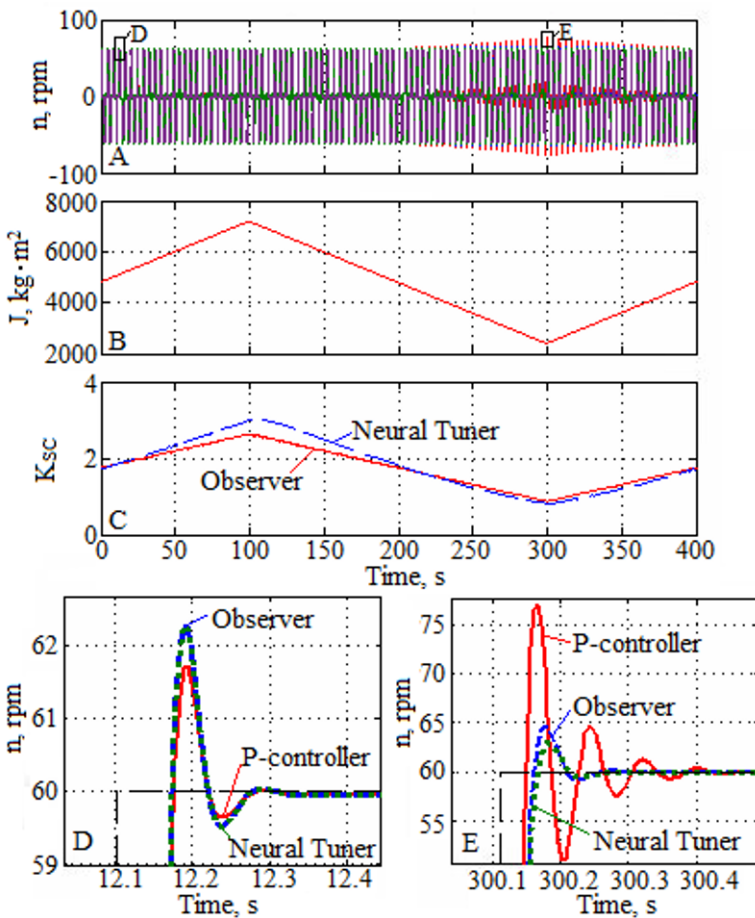

Fig. 5. First experiment results

At the beginning of the experiment (Fig.5D) all systems ensured almost equal control quality. We considered the time moment of maximal inertia moment  $J$  deviation from its nominal value (Fig.5E). The neural tuner and the observer application allowed to achieve almost the same results, whereas the conventional P-controller was not able to provide the required transient quality. In general, the curves in Fig.5B and Fig.5C have the same time behavior. So both adaptive systems compensated  $J$  value drift.

The second experiment results are shown in Fig.6. In this case it was decided to raise the initial  $K_{sc}$  ( $K_{sc1}$ ) value by 20% to model the situation when initial conditions were not optimal. For an instance, it was decided to install the adaptive control system at the rolling mill functioning at the moment, since the production process was continuous, there was no mill model to calculate  $K_{sc}$ ,  $K_{sc1}$ ,  $K_{sc2}$ , and controllers parameters were not optimal at that moment.

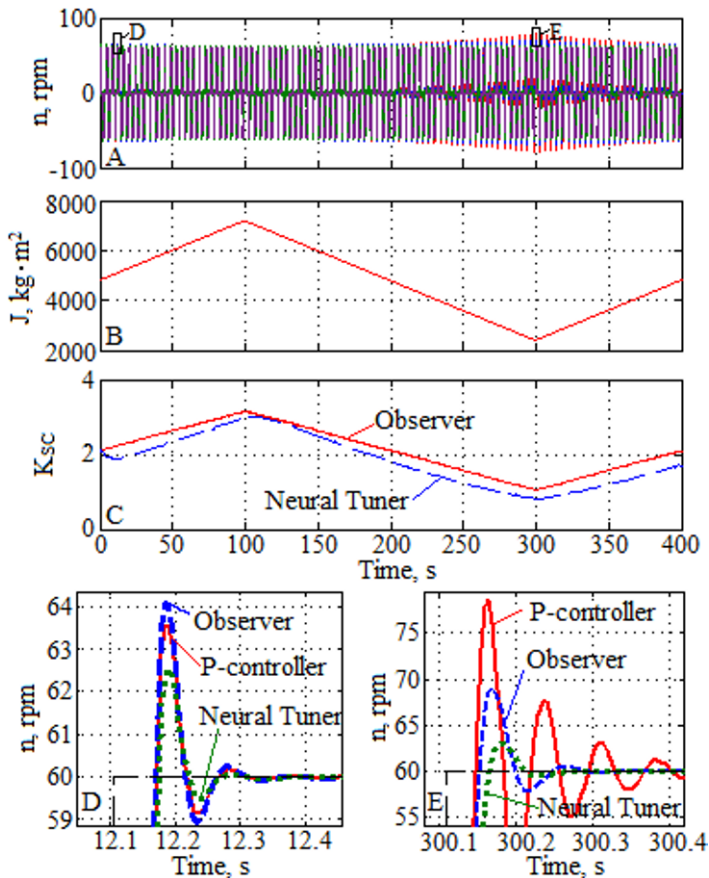

Fig. 6. Second experiment results

The tuner took into consideration the required overshoot. Its rule base used this value in its rules conditions. So despite the too high overshoot at the start moment, the tuner

was able to return the transient quality into required ranges. It can be seen in Fig.6D and Fig.6C, where the neural tuner curve firstly goes down despite the  $J$  upward trend (Fig.6B). But the observer based system did not consider the overshoot value, and the initial overshoot of about 7% was understood as normal and kept during the whole experiment. We considered again the moment of maximal inertia moment  $J$  deviation from its nominal value (Fig.6E). The tuner provided overshoot of about 4.5%, the observer – 13.3%, the P-controller – 33%.

So the tuner advantage is that it does not require the controllers initial parameters to be optimal. At the same time, in the case if they are optimal, it provides transients of the same quality as the observer does compensating the inertia moment value drift.

## 5 Conclusion

Two adaptive control systems for the DC drives have been compared in this research – the neural tuner and the observer based systems. The speed P-controller was tuned to follow the inertia moment value drift. Having analyzed the experiment results obtained from the rolling mill DC drive model, it was concluded that the neural tuner was able to keep the desired transient quality (overshoot of 3.5%÷4.5% of the setpoint value) for both situations when the initial P-controller tuning was and was not optimal. At the same time non-optimal P-controller parameters usage made the observer keep too high overshoot for the whole time. So the tuner advantage is that the control system does not need to meet the requirement to be optimally tuned before its installation.

## Acknowledgments.

This work was supported by the Russian Foundation for Basic Research. Grant No 15-07-06092.

## References

1. Leonhard, W.: Control of electrical drives. 3rd edn. Springer Science & Business Media, Berlin (2001).
2. Stashinov, Y.P.: On the issue of control system adjustment of a direct current drive on the modular optimum. Part 1. Russian Electrical Engineering 87.1, 1–5 (2016).
3. Han, J. et al.: Simple PID parameter tuning method based on outputs of the closed loop system. Chinese Journal of Mechanical Engineering 3(29), 465-474 (2016).
4. Shamsuzzoha, M.: IMC based robust PID controller tuning for disturbance rejection. Journal of Central South University 3(23), 581-597 (2016). doi: 10.1007/s11771-016-3105-1
5. Chang, W.D., Hwang, R.C., Hsieh, J.G.: A self-tuning PID control for a class of nonlinear systems based on the Lyapunov approach. Journal of Process Control 2(12), 233-242 (2002). doi: 10.1016/S0959-1524(01)00041-5
6. Landau, Y.D.: Adaptive Control – The Model Reference Adaptive Control. Dekker, New York (1979).



7. Fu, X., Zou, J., Yang, H.: Application of iterative feedback tuning in DC main drive system. *Chinese Journal of Mechanical Engineering* 4(42), 118-121 (2006).
8. Mapelli, F., et al.: A state observer for speed regulation in rolling mill drives. *Structural Dynamics* 3, 1193-1205 (2011). doi: 10.1007/978-1-4419-9834-7\_105
9. Son, Y.I., et al.: Robust cascade control of electric motor drives using dual reduced-order PI observer. *IEEE Transactions on Industrial Electronics* 62.6, 3672-3682 (2015).
10. Cozma, A., Pitica, D.: Artificial neural network and PID based control system for DC motor drives. In *Proceedings of 11th International Conference on Electrical and Electronic Equipment*, pp. 161-166, IEEE, Brasov, Romania (2008).
11. Guo, X., Zhang, T., Zhang, Q.: Study on PID neural network control system in the main electromotor of the fine rolling mill. In *Proceedings of 2010 2nd International Asia Conference on Informatics in Control, Automation and Robotics (CAR)*, vol.2, pp. 143-146, IEEE, Wuhan, China (2010). doi: 0.1109/CAR.2010.5456748
12. Kodali Vijaya Lakshmi, Paruchuri Srinivas, Challa Ramesh, "Comparative Analysis of ANN based Intelligent Controllers for Three Tank System", *International Journal of Intelligent Systems and Applications(IJISA)*, Vol.8, No.3, pp.34-41, 2016. DOI: 10.5815/ijisa.2016.03.04
13. Jie, S.U.N. et al.: Smith prediction monitor AGC system based on fuzzy self-tuning PID control. *International Journal of Iron and Steel Research* 2(17), 22-26 (2010). doi: 10.1016/S1006-706X(10)60053-2
14. Bansal, U.K., Rakesh, N.: Speed control of DC motor using Fuzzy PID controller. *Advances in Electronic and Electric Engineering* 9(3), 1209-1220 (2013).
15. Chakravorty, J., Ruchika, S.: Fuzzy logic based method of speed control of dc motor. *International journal of emerging technology and advanced engineering* 4(3), 64-66 (2013).
16. Krishna, K.B.M., Goud, B.V.S.: Fuzzy PID Control for Networked Control System of DC Motor with Random Design. *International Journal of Computer Applications* 7(52), 24-28 (2012).
17. T. Lakshmi Priyanka, K.R.S. Narayanan, T.Jayanthi, S.A.V. Satya Murty, "Simulation and Tuning of PID Controllers using Evolutionary Algorithms", *International Journal of Information Technology and Computer Science(IJITCS)*, vol.4, no.11, pp.50-57, 2012. DOI: 10.5815/ijitcs.2012.11.07
18. Suman, S.K., Giri, V.K.: Speed control of DC motor using optimization techniques based PID Controller. In *Proceedings of 2016 IEEE International Conference on Engineering and Technology (ICETECH)*, pp. 581-587, IEEE, India (2016).
19. Guimaraes, A.O., da Silva, J.P., Dantas, E.R.M.: Genetic algorithm applied to control of dc motor with disturbance rejection by feedforward action. *Control and Intelligent Systems* 1(43), 42-49 (2015). doi: 10.2316/Journal.201.2015.1.201-2599
20. Lopes, A.C. et al.: Using genetic algorithm to tune PI-controllers for the direct-drive synchronous wind generators. In *Proceedings of 2010 International Symposium Modern Electric Power Systems (MEPS)*, pp. 1-8, IEEE, Wroclaw, Poland (2010).
21. Alaiz, H., Calvo, J.L., Alfonso, J., Alonso, A., Ferreira, R.: Knowledge Based Expert System for PID Controller Tuning under Hazardous Operating Conditions. In: Herrero A., Gastaldo P., Zunino R., Corchado E. (eds) *Computational Intelligence in Security for Information Systems. Advances in Intelligent and Soft Computing*, vol 63, pp. 203-210. Springer, Berlin, Heidelberg (2009). doi: 10.1007/978-3-642-04091-7\_25
22. Eremenko, Y.I., Glushchenko, A.I., Petrov, V.A.: DC electric drive adaptive control system development using neural tuner. In *Proceedings of 2017 IEEE Conference of Russian Young Researchers in Electrical and Electronic Engineering (EIconRus)*, pp. 1-6, IEEE, Saint-Petersburg, Russia (2017). doi: 10.1109/EIconRus.2017.7910682

# The Formation of the Optimal Composition of Multi-Agent System

N.Yu. Mutovkina<sup>1</sup> , V.N. Kuznetsov<sup>2</sup> , A.Yu. Klyushin<sup>3</sup> 

Tver State Technical University, Tver, Russia

<sup>1</sup>letter-boxNM@yandex.ru, <sup>2</sup>bu-a-tstu@yandex.ru, <sup>3</sup>klalex@inbox.ru

**Abstract.** In article methods of formation of optimal composition of multi-agent system are considered. It is set that more perspective here are methods with use of receptions of a fuzzy logic. In the center of a research there is a question of matching of agents, in the best way of interacting with each other while solving the tasks and achieving the goals of the system. The efficiency of multi-agent system depends on how harmoniously the agents interact with each other. The problem of optimum composition of system appears at a stage of her creation and remains important throughout all time of her existence. Criteria of efficiency of multi-agent system are also defined in this article.

**Keywords:** Multi-agent system, intelligent agent, optimization, efficiency, choice, fuzzy logic, expert estimates.

## 1 Introduction

Today in world practice there is a set of the developments, devoted to multi-agent systems (MAS). The principal advantage of such systems consists that, with their help the global problem is solved by its decomposition and of using of collective intelligence for the decision of separate tasks. While some authors consider MAS as a set of software agents (executable programs with special characteristics) [1], [2], others – as set of the abstract intellectual agents, for example, economics (the formalized description of a character or of a group of persons of real system) [3], [4]; third authors – as of a command of robots (the physical entities of a certain purpose, created by a human). These areas have one thing in common: the agent is understood as the anthropomorphous entity, which has definite purposes and preferences, needing in resources for their achievement and showing at the same time some behavior, entity, which has a built-in mechanisms of motivation, mechanisms of formation of preferences [5]. Such agents are intellectual agents and are a study object in this work. Collective behavior of intelligent agents depends on the behavioral strategies of each of them. Adjustment of strategy of behavior of agents shall be based on coordination of their purposes, interests and actions, conflict resolutions by negotiations and readdressing of tasks. The success of the communication and cooperation of agents depends on how

friendly is the climate in MAS and to what extent agents are willing to make concessions.

The task of formation of the optimum composition MAS is one of the most important tasks, requiring the solution at MAS design stage. From how smoothly agents will act and the extent to which they possess the necessary competencies, directly the efficiency depends of the entire system, her success in achieving stated goal.

## 2 Theoretical Principles

The authors of the present study understand under the optimal composition of MAS such network structure, in which the relationship between agents determine their joint work, contributes to the achievement of the goal within the specified time with maximum efficiency [6, page 72]. The maximum efficiency of MAS is the achievement of the goal with the lowest cost in the allotted time without of causing any damage to agents and the environment. Thus, a prerequisite for efficient work of MAS is her optimal composition. The main characteristics of the optimal composition of MAS are: the coordinated interaction of agents, their dedication to a common goal, results of work of high quality under the condition of non-conflict behavior.

In MAS there should not be agents-antagonists, who put own goals above the overall objective. The danger of selfish behavior is that, as practice shows, the desire of agent achieve the own goal at the expense of achieving the common, often ends with the fact that none of the goals could not be achieved. Ignoring of a common goal for the sake of achievement of the personal purposes can bring to the agent only short-time positive effect, as such behavior often leads to crash of all system. The destruction of MAS leads to the fact, that none of the agents is no longer a part of her. This means that these agents cannot use system resources to implement the plan. In order, that the coordinated activities of agents in MAS was possible, each of them shall understand that achievement of a common goal always in a varying degree promotes achievement of the personal purposes. In any case, position of everyone separately of the taken agent in MAS isn't worse than its provision outside the system. Understanding this principle is the basis for the stability relationships in the MAS and, ultimately, the guarantee of its existence.

One more reason for "disputes" and violations of operation of MAS is distinction in submissions of agents about of optimal method of achievement of a common goal ( $G_0$ ). In this case it is necessary to apply the controlling influences, which leads to the compromise.

The third a reason for appearance of contradictions between agents in system is unfair and unequal the reward for their work. To avoid this reason of the conflicts in MAS, it is necessary to agree at the initial stage about amount of remuneration between all participants of system.

Depending on a stage of life cycle of optimization of composition of MAS can be carried out by two methods:

- 1) at the stage of establishing a system the selection of its optimum composition is reduced to the identification of the correspondences between the competences and personal characteristics of each agent and of works (tasks, functions), performed in MAS (or with her help);
- 2) at a stage of functioning of MAS the formation of her optimum composition comes down to a complex assessment of activities of each agent, his correlations and relations with other agents, to creation of the indistinct relations of preference and to the decision of the task fuzzy choice.

### 3 Formation of Optimum Composition the MAS at a Stage of Her Creation

Let  $X = \{x_1, x_2, \dots, x_i, \dots, x_n\}$  – the set of potential participants of MAS;

$Z = \{z_1, z_2, \dots, z_k, \dots, z_w\}$  – the set of tasks (operations, functions) for solution which system is created;

$Y = \{y_1, y_2, \dots, y_j, \dots, y_m\}$  – the set of competences and personal characteristics, which agents shall possess to be MAS part.

At a stage of creation of MAS the set  $Y$  can be partitioned into two subsets:  $Y_P = \{y_1^p, y_2^p, \dots, y_m^p\}$  – the set, containing only professional characteristics of the agent (competence),  $Y_r = \{y_1^r, y_2^r, \dots, y_m^r\}$  – the set, including personal qualities of the agent's, which defining a psycho-behavioral type of the agent. Such qualities are: benevolence, truthfulness, self-confidence, rationality and others [7].

To determine the composition of system of the expert-analyst sets fuzzy matching's on Cartesian works  $X \times Y$  and  $Y \times Z$  :

$$R = \{(u, v), \mu_R(u, v)\} \text{ and } S = \{(v, w), \mu_S(v, w)\}, \tag{1}$$

where  $R = "x \text{ has a } y"$ ,  $S = "y \text{ needed to perform } z"$ .

Then their a composition will be fuzzy matching  $R \circ S = \{(u, w), \mu_{R \circ S}(u, w)\}$ , setting on the  $X \times Z$ , for which the membership function will be calculated by the formula:

$$\mu_{R \circ S}(u, w) = \sup_{v \in Y} T\{\mu_R(u, v), \mu_S(v, w)\}, \tag{2}$$

where  $T$  – a  $t$ -norm as operation of minimization.

Composition of matching shows the suitability of agent  $i$  to perform work (task, function)  $k$ .

Next, to determine the inclusion of an agent in the MAS, it is necessary to develop rules of inclusion, for example:

1. in the system only those agents can be selected, for whom all elements  $w_{ik}$  an it is more than zero;

2. “core” of system should be only those agents, 75% of the elements for which more than 0,5;
3. on “semi-periphery” of system should be agents, 50% of elements  $w_{ik}$  a for whom are in the range from 0,2 to 0,5 and 50% of elements – more than 0,5;
4. remaining agents for whom the first condition is satisfied, but the second and third conditions aren't satisfied, are defining on “periphery” of system.

These rules do not take into account, that tasks (works, functions), performed in the system, may have different weights. In this case rules of selection of agents in MAS and the determination of their "place" in system are adjusted taking into account the entered scales of tasks.

#### 4 Formation of Optimum Composition the MAS at a Stage of Her Functioning

Optimal composition of MAC is identified by the results of her work after some time. The status of each agent is described by a set of the purposes, communications and parameters:

$$x_i = \langle Z, G_i, Y_{P_i}, Y_{r_i} \rangle, \quad (3)$$

where the variables  $Z$ ,  $Y_{P_i}$  and  $Y_{r_i}$  have the meaning, indicated above;

$G_i = \{g_1, g_2, \dots, g_l\}$  – is set of local target functions of the agent.

For formation optimum composition of the MAS at a stage of its functioning, the following algorithm is offered:

1. the analysis of the interaction between the agents is performed. The matrix of benevolence of the agents relative to each other is builds:

$$\mu_{F(t)} = \begin{bmatrix} f_{11} & f_{12} & \dots & f_{1n} \\ f_{21} & f_{22} & \dots & f_{2n} \\ \dots & \dots & \dots & \dots \\ f_{n1} & f_{n2} & \dots & f_{nn} \end{bmatrix}, \quad (4)$$

elements  $f_{ij} \in [0, 1]$  which show the attitude of the agent  $i$  towards the agent  $j$ . At the same time rules are applied: if  $0 \leq f_{ij} < 0.5$ , then the agent  $i$  expresses the neutral attitude towards the agent  $j$ ; if  $0.5 \leq f_{ij} \leq 0.8$ , then the attitude of the agent  $i$  towards the agent  $j$  is evaluated as benevolent; if  $0.8 < f_{ij} \leq 1.0$ , then it is considered that the agent  $i$  “is dissatisfied” with the agent  $j$ . Diagonal array elements (4) also accept values on the basis of the written rules and show the agent's attitude towards themselves, the activities in MAS. These elements are self-assessments of agents;

2. composition of a vector of psycho-behavioral types of the agents  $\mu_{r_{(t-1)}} = (r_1, r_2, \dots, r_i, \dots, r_n)$ , determined earlier when testing agents, and array elements (4) by the principle (2) is carried out. The vector of results of composition  $\mu_{r_{(t-1)} \circ F_{(t)}}$  shows the corrected psycho-behavioral types of agents taking into account their operation in system;
3. on Cartesian products  $X \times G$  and  $G \times Z$  fuzzy compliances are set:  $B = \text{"}x \text{ wants to achieve } g\text{"}$ ,  $C = \text{"}g \text{ coincides with the } z\text{"}$ . The result is calculated according to expression (2). The result is a fuzzy relation  $B \circ C = \text{"}x \text{ tends to } z\text{"}$ . This relation is expressed a matrix  $\mu_{B \circ C}$ , string values  $\alpha_{ik}$  of which specify a level of compliance of the purposes of the agent  $i$  to purposes MAS. Than these values are closer to zero, the personal purposes of the agent and the purpose of system are mismatched. On the contrary, the these values are closer to unit, the level of coherence of the agent and MAS is higher;
4. on  $X \times Y_p$  and  $Y_p \times Z$  fuzzy compliances  $R_p = \{(u, v_p), \mu_{R_p}(u, v_p)\}$  and  $S_p = \{(v_p, w), \mu_{S_p}(v_p, w)\}$  are set:  $R_p = \text{"}x \text{ possesses } y_p\text{"}$ ,  $S_p = \text{"}y_p \text{ required to perform } z\text{"}$ . Then the composition of compliances is the fuzzy compliance  $R_p \circ S_p = \{(u, w), \mu_{R_p \circ S_p}(u, w)\}$ , set on  $X \times Z$ . For it function of accessory will also be calculated by a formula (2). This compliance shows as far as competences (professional characteristics) which are possessed by agents are necessary for achievement of the goals of MAS. Levels of existence of such competences ( $\beta_{ik}$ ) are presented in the matrix form  $\mu_{R_p \circ S_p}$ ;
5. on  $X \times Y_r$  and  $Y_r \times Z$  indistinct compliances are also set  $R_r = \{(u, v_r), \mu_{R_r}(u, v_r)\}$  and  $S_r = \{(v_r, w), \mu_{S_r}(v_r, w)\}$ :  $R_r = \text{"}x \text{ possesses } y_r\text{"}$ ,  $S_r = \text{"}y_r \text{ required to perform } z\text{"}$ . Then the fuzzy compliance  $R_r \circ S_r = \{(u, w), \mu_{R_r \circ S_r}(u, w)\}$  set on  $X \times Z$ , for which function of accessory will also be calculated by a formula (1), will be composition of compliances. This compliance contains information ( $\delta_{ik}$ ) about presence at agents of the personal qualities necessary for successful achievement of the goals of system, and represents a matrix  $\mu_{R_r \circ S_r}$ ;
6. the analysis of the received results  $\mu_{r_{(t-1)} \circ F_{(t)}}$ ,  $\mu_{B \circ C}$ ,  $\mu_{R_p \circ S_p}$  and  $\mu_{R_r \circ S_r}$  is carried out on compliance to the rule base of selection of agents to MAS;
7. preliminary simulation of new interactions between agents is carried out on a basis:
  - separation of the main roles of agents in MAS and their distributions according to the received characteristics of agents;
  - determination of number and types of interacting agents;
  - determination of a set of possible strategy of agents;
  - determination of a set of communicative actions;

8. final fixing of agents in system is carried out on runtime of new jobs.

Indistinct compliances of  $R_r$  and  $S_r$  here cannot be considered as the psycho-behavioral type of each agent is already defined on a step 1) the given algorithm. Execution of a step 5) remains to the discretion of experts-analysts. The rule base mentioned in the item 6) of an algorithm, contains  $q$  of the rules formulated by experts-analysts, a look:

$R_1$ : IF  $0.5 \leq r_i \leq 0.8$  AND  $0.8 \leq \alpha_{ik} \leq 1.0$  AND  $0.85 \leq \beta_{ik} \leq 1.0$  AND  $0.75 \leq \delta_{ik} \leq 1.0$ , THEN the agent of  $i$  joins in MAS “kernel”;

$R_2$ : IF  $0.5 \leq r_i \leq 0.8$  AND  $0.5 \leq \alpha_{ik} < 0.8$  AND  $0.55 \leq \beta_{ik} < 0.85$  AND  $0.5 \leq \delta_{ik} < 0.75$ , THEN the agent  $i$  joins in “semi-periphery” of MAS;

$R_3$ : IF  $0.0 \leq r_i < 0.5$  AND  $0.8 \leq \alpha_{ik} \leq 1.0$  AND  $0.85 \leq \beta_{ik} \leq 1.0$  AND  $0.75 \leq \delta_{ik} \leq 1.0$ , THEN the agent  $i$  joins in “semi-periphery” of MAS;

...

$R_q$ : IF  $0.8 < r_i \leq 1.0$  AND  $0.0 \leq \alpha_{ik} < 0.3$  AND  $0.1 \leq \beta_{ik} < 0.3$  AND  $0.05 \leq \delta_{ik} < 0.3$ , THEN the agent “ $i$ ” is excluded from MAS.

Following to the provided rule set allows to create MAS “kernel”, its “semi-periphery” and “periphery”. In the central part of MAS – “kernel” the most effective agents are concentrated to whom big powers are delegated. These are agents-principals. The following on the significance are agents of a median part of system who, as a rule, are the chief performers of objectives. Agents from a peripheral part are engaged in execution of auxiliary operations. These are intermediary agents.

## 5 Practical Implementation

For the purpose of increase in creativity of educational process at the Tver state technical university (Russia, Tver) authors of this article developed MAS of support of adoption of creative decisions. Proposed in this article methods became the basis of the system. The source data for numeric example of application methods are listed in table.

**Table 1.** The source data

Parameter	Value
Number of agents	17
Number of tasks	10
Number of professional characteristics	8
Number of personal qualities	11
Number of steps	20

Experts, using algorithms of harmonize [6], [8], identified fuzzy matching (1) and calculated values of the membership function (2). Using rules 1) – 4), the experts identified the composition of the MAS at the stage of her formation (Fig. 1).

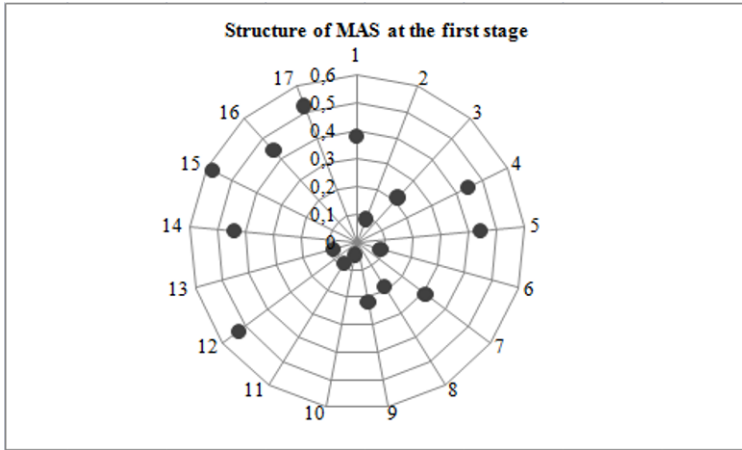

Fig. 1. Initial structure of MAS

Taking into account the adjustments expert opinions and weighting coefficients the significance of the elements of the sets  $Y_p$  and  $Y_r$ , was formed by the optimal composition MAS with a clear separation of the three zones (fig. 2).

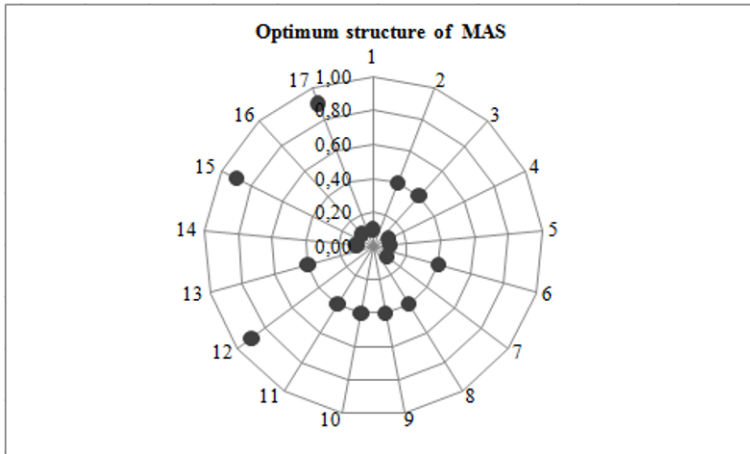
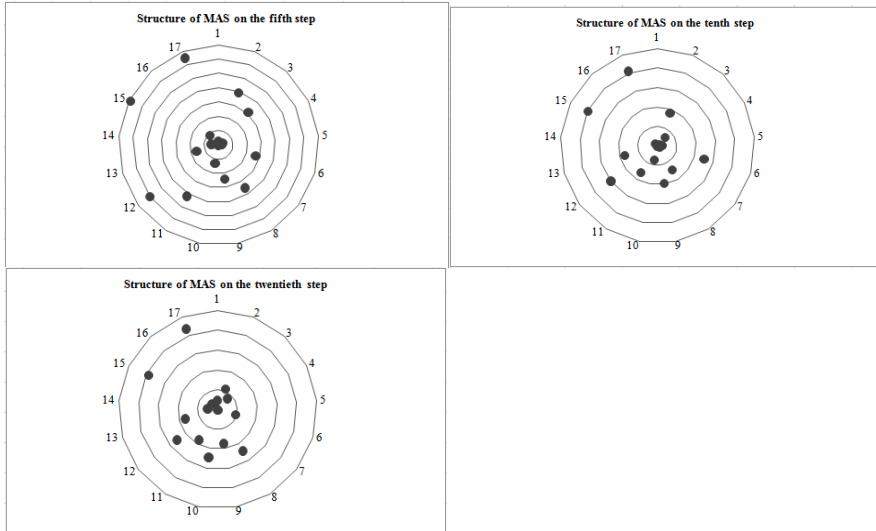

Fig. 2. The optimal composition MAS

Further, the behavior of the agents was studied for solving by them of creative problems. For modelling, we sets the conditional time, measured in units of. One unit is



two minutes. The behavior of the agents in the system on the fifth, tenth and twentieth cycle are presented in fig. 3.



**Fig. 3.** Variability in the behavior of agents

According to the results of a step-by-step analysis of the behavior of the agents on each step was found:

- the agents No. 15 and No. 17 have substantially strengthened its position as the agents-intermediaries; agent No. 12 is gradually moved from the periphery to semi-periphery and changed status from agent-intermediary to the agent-chief performer;
- the agents №№ 1, 4, 5, 7, 8, 9, 13, 14 and 16 retained their original position;
- the agents Nos. 2, 3, 6, are moved from semi-periphery to the center, and the agent No. 10 moved from the center to the semi-periphery;
- the agent No. 11 is closer to the center.

Overall, the MAS can be considered of stable since almost 65% of participants retained their initial positions. This means, that the evaluation of agents for their inclusion in the MAS is quite objectively and justified expectations of experts.

## 6 Conclusions

In article two models of formation of the MAS optimum composition are considered. The first model is applied at a stage of creation of system when an uncertainty level the highest. The experts who are realizing selection of candidates for MAS have no exact knowledge of competences of these candidates and know even less about as far

as they are sociable and capable to show adequate behavior. Therefore it is offered to build to experts on the basis of results of the testing held among candidates and own opinions the indistinct relations of preference on the basis of which the most suitable candidates for an involvement for MAS will be selected. At the same time expert estimates shall be coordinated what the procedures of coordination provided in [6], [8], [9] can be applied to.

The second model is intended for a case when MAS already functions. What at the same time each of the agents making MAS already is becomes more clear. Along with it the model of estimation becomes complicated as now it is necessary to analyze interactions and relations between agents. The indicator of a choice of the agent for his subsequent operation in MAS is the integral assessment of its professional activity in MAS and efficiency of its interaction with other agents inhabiting system. Professional activity of each agent is estimated by results of the solution of objectives and to its contribution to achievement of a common goal. As practice shows, most of all the device of a fuzzy logic and indistinct sets is suitable for carrying out estimation of this sort.

### Acknowledgments

Work is performed with assistance of the Russian Federal Property Fund, the project No. 17-01-00817A.

### References

1. Satyendra Singh Chouhan, Rajdeep Niyogi, "An Analysis of the Effect of Communication for Multi-agent Planning in a Grid World Domain", *International Journal of Intelligent Systems and Applications(IJISA)*, vol. 4, no. 5, pp. 8 – 15, 2012. DOI: 10.5815/ijisa.2012.05.02.
2. Shiladitya Pujari, Sripati Mukhopadhyay, "Petri Net: A Tool for Modeling and Analyze Multi-agent Oriented Systems", *International Journal of Intelligent Systems and Applications(IJISA)*, vol. 4, no. 10, pp. 103 – 112, 2012. DOI: 10.5815/ijisa.2012.10.11.
3. Ashok Sahai, Clement K. Sankat, Koffka Khan, "Decision-Making Using Efficient Confidence-Intervals with Meta-Analysis of Spatial Panel Data for Socioeconomic Development Project-Managers", *International Journal of Intelligent Systems and Applications(IJISA)*, vol. 4 no. 9, pp. 92 – 103, 2012. DOI: 10.5815/ijisa.2012.09.12.
4. Purba D. Kusuma, Azhari, Reza Pulungan, "Agent-Based Buyer-Trader Interaction Model of Traditional Markets", *International Journal of Intelligent Systems and Applications(IJISA)*, vol. 8, no. 11, pp. 1 – 8, 2016. DOI: 10.5815/ijisa.2016.11.01.
5. Mutovkina N. Yu. Semantic determination of tipe the agent in multi-agent system. Problem of interaction between agents / N.Yu. Mutovkina, A.Yu. Klyushin, V.N. Kuznetsov // *Open semantic technologies of design of intellectual systems = Open Semantic Technologies for Intelligent Systems (OSTIS-2013): materials III of the International scientific and technical conference (Minsk, on February 21-23, 2013) / editorial board: V.V. Golenkov (editor-in-chief) [and others]. – Minsk: BGUIR, 2013. – 592 p., pp. 309 – 316.*

6. Mutovkina, N.Yu. Methods of the coordinated optimization of modernization of the industrial enterprises: the dissertation for a degree of Candidate of Technical Sciences; specialties 05.13.01, 05.13.10. – Tver: TvGTU, 2009. 219 p.
7. Mutovkina, N.Yu. On the role of morals for enhance human capabilities / N.Yu. Mutovkina // Economy. Right. Management: the modern problems and tendencies of development. Materials XII of the International scientific and practical conference (on December 6, 2016, Krasnodar). [Electronic resource]. Access mode: <http://www.apriori-nauka.ru/media/economy/12-2016/Mutovkina.pdf>.
8. Mutovkina, N.Yu. The indistinct coordinated choice in the multi-agent systems in the determined conditions / N.Yu. Mutovkina, V.N. Kuznetsov, A.Yu. Klyushin // Management systems and information technologies. Voronezh: Scientific Book publishing house, No. 2 (60), 2015, pp. 55 – 61.
9. Saati, T. Decision-making. Method of the analysis of hierarchies / T. Saati. M.: Radio and communication, 1993. 278 p.

# Fuzzy Complex Assessment of Activities of the Agent in Multi-Agent System

N.Yu. Mutovkina 

Tver State Technical University, Tver, Russia  
letter-boxNM@yandex.ru

**Abstract.** In article the technique of an fuzzy complex assessment of the agent in multi-agent system from a line item of efficiency of his activities is considered. It is set that overall performance of the agent depends on three principal components: level of professional competence of the agent, his personal qualities and emotional background. In a technique the approach integrating both expert estimates, and the actual data about results of operation of the agent in system is applied. The system of the indices which are best characterizing separate aspects of activity of the agent in multi-agent system is offered. At the same time the key characteristic is the level of his professional competence. The fuzzy complex assessment of activities of the agent in system gives the chance to reveal more and less effective agents that is important for further acceptance of administrative decisions.

**Keywords:** Multi-agent system, intelligent agent, efficiency of activities, linguistic variable, fuzzy logic, expert estimates.

## 1. Introduction

Currently, multi-agent systems (MAS) and distributed artificial intelligence have become an integral part of people's lives and continues to actively develop in various fields of human activity, for example [1], [2], [3], [4], [5]. The basic principle of the design and implementation of a MAS is that every agent in such a system has only some knowledge and understanding of the task at hand. He can solve only a limited part of the global problem. Therefore, the number of agents in the MAS depends on the complexity of the task. It is very important to develop mechanisms of interaction of agents, which could contribute to the achievement of the overall objective, and not "taken away" from it. Every agent in the MAC gets the role, the complexity of which should not exceed its capabilities [6]. The distribution of tasks between agents in the system can be carried out by one of two principles:

- 1) "the rigid principle": the common goal (a global problem) is divided into private goals, subsystems come to light and specific jobs are issued, and then the

- 2) found solutions are aggregated. At the same time control is executed by uniform “Centre”;
- 3) “the soft principle”: assignment of roles and distribution of tasks happen during interaction between agents and, in general, are random. While such MAS there are resonant, synergistic effects.

No matter what principle applied when building MAS, include such components as: a set of the intellectual entities called by agents; the environment, having all necessary conditions for operation of agents; set of tasks (roles, functions); a set of certain correlations between agents that is provided with creation of different organization structures (configurations); a set of actions of the agents emerging in model their behavior [7].

To assess the performance of each agent is very difficultly. The activity of the agent is described by many indicators, that have not only quantitative, but also descriptive expression. For making managerial decisions it is necessary to have the aggregated assessment, which would include a minimum number of indicators, but at the same time would provide a full characterization of the evaluated object. The transition from the initial set of private indicators to the aggregate indicators is called an integrated estimation procedure. Input, output indicators and procedure of aggregation are called a system of integrated assessment [8].

This research is a part of a bigger research, which is developing a creation of models and methods of decision making in modern complex control systems in terms of vague uncertainty.

## 2. Theoretical Aspects of a Research

In the study of mechanisms for complex estimation two tasks are solved:

- 1) the aggregation of information, that adequately reflects the substance of the interaction of agents (solution of problem multi-criteria optimization);
- 2) the study of a manipulability of mechanisms of complex estimation which are mechanisms with reporting of information and the problem of manipulation appears in case of reporting of information in MAS [9].

In addition, as a source of information for estimation of activity of the agents, along with statistical data are the opinions of the experts, it appears the problem of manipulation in mechanisms of expertise. However, this problem is successfully solved in [10], so in this article on this question the author doesn't stop.

Getting a complex assessment of activities of the agent in MAS entail the following difficulties:

- 1) to build the analytical model MAS is not possible because of essential complexity, lack of experimental data for statistical modeling and unpredictability of agents behavior;

- 2) source of information are not only quantitative but also qualitative data. It uses not only statistical data but also the opinions of experts. The values of such input data cannot be set unambiguously;
- 3) qualitative assessment is not only characterized for certain input parameters, but also for the resulting criterion, which is the efficiency of activity of the agent in the system.

Solution to the problem is the transition from analytical or statistical models to Fuzzy models that can be built either on the basis of expert knowledge or based on observed data [11].

The activity of the agent in the MAS is determined by its behavior, which is based on two components—the rational and emotional [12]. The rational component ( $W$ ) is that the agent has a need to apply existing knowledge, skills and he understands that from his behavior in the system depends his the success and further development. That is, the rational component is the unification of the competence ( $Y_p$ ) of the agent and the level of development his positive personal qualities ( $Y_r$ ). The emotional component ( $\Psi$ ) describes the inner world of the agent and consists of its personal characteristics. Emotional background of an agent depends on: the working environment and of agents with which to interact; the information incoming to agent; the resources security of the agent and his self-assessment. On information, providing to the agent, often is superimposed interference, called “noise”. Noises can be generated by accident or intentionally, but in either case they make it difficult, and sometimes completely exclude a proper understanding of the information. This leads to errors in the agent activity, which are negatively affect on his emotional state. The self-esteem of the agent is expressed by the degree of satisfaction with the results of his own activities, that is, how the agent is satisfied with how he copes with own responsibilities according to the assigned role in the MAS.

Analysis of rational and emotional component is allowed to build a hierarchical structure of criteria of estimation of activity of the agents in the system. This structure is shown in table 1. Evaluation criteria are characterized by the importance and degree of severity. Not all criteria are of equal importance, it all depends on the initial conditions of the functioning of the MAS. The use of equal weights when summing assessments can lead to loss of information. The importance of the criteria can be defined either by using the method of analysis of hierarchies (Analytic hierarchy process – AHP) [13], or under rule Fishburne [14].

In brief, the AHP is as follows. At each level of the hierarchy is formed of paired comparisons matrices which have the appearance of back of symmetric matrices. To find the vector of priorities at corresponding the matrix of paired comparisons, it is necessary to determine the main own vector, which corresponds to the greatest own value of matrix. The elements of the vector of priorities will be calculated as the relationship of the elements of the eigenvector to the sum of its elements. Pairwise comparison matrix is forming for the criteria at all levels of the hierarchy. The elements of the vector of priorities of the criteria, which are comparing, are calculating. Then hierarchical synthesis is performed. With the help of this procedure the vector of priorities of criteria on lower level is established, which are well measurable.

The second approach to determining the significance of criteria consists in organizing them in descending order of significance (1) and application of rule of Fishburn (2):

$$y_1 \geq y_2 \geq \dots \geq y_i \geq \dots \geq y_N, \quad (1)$$

$$y_i = \frac{2 \cdot (N - i + 1)}{(N + 1) \cdot N}, \quad (2)$$

where  $y_i$  – the level of significance criteria  $i$ ;

$i$  – the sequence number of criterion;

$N$  – a number of criteria.

Fishburne's rule indicates, that about levels significance of criteria only the relation (1) known. Then estimate (2) corresponds to the maximum value of entropy of available information uncertainty about the assessment criteria. If all criteria have the same importance, it is a fair formula:

$$y_i = 1/N. \quad (3)$$

The importance of the criteria in the table 1 is defined by the formula (2).

**Table 1.** Priorities of criteria in two-level hierarchical model

Criteria of the first level of hierarchy	Priorities of criteria of the first level	Criteria of the second level of hierarchy	Priorities of criteria of the second level
Competence level	0,50	Reliability	0,50
		Potential	0,33
		Self-sufficiency	0,17
Personal qualities	0,33	Skill to communicate	0,50
		Truthfulness	0,33
		Absence of conflict	0,17
Emotional status	0,17	Assessment by the agent of level of the resource security	0,50
		Agent's self-assessment	0,5

To assess the severity of criteria of second hierarchy level, are applying fuzzy logic and fuzzy sets theory. The evaluation criteria are presenting in the form of linguistic variables with the corresponding term-sets. The transition from the clear meaning of a variable to a fuzzy meaning is carried out through the process of fuzzification. Fuzzification consists in transfer the measured accurate value in value membership function of the appropriate term of a linguistic variable. To build the membership functions of terms, has been used the posterior approach. Membership functions constitute a piecewise-linear functions, in particular, the trapezoid function [1]:

$$\mu(x; a, b, c, d) = \begin{cases} 0, & x < a, \\ \frac{x-a}{b-a}, & a \leq x < b, \\ 1, & b \leq x \leq c, \\ \frac{d-x}{d-c}, & c < x \leq d, \\ 0, & x > d, \end{cases} \quad (4)$$

where  $[a, d]$  – carrier of an fuzzy set;

$[b, c]$  – kernel of an fuzzy set (optimistic assessment of variable values) [1].

The accurate meaning is translating in the group of fuzzy numbers, which correspond to the membership functions of different terms of the linguistic variable. Thus, the criteria of the second level of model (table 1) is presenting as a merger of the membership functions of the relevant terms:

$$y_{ij} = \frac{\mu_{ij}^1}{T_1} \oplus \frac{\mu_{ij}^2}{T_2} \oplus \dots \oplus \frac{\mu_{ij}^k}{T_k}, \quad (5)$$

where  $y_{ij}$  – meaning of criterion  $i$  of level  $j$  of hierarchy;

$k$  – number of a term.

Using the fuzzy relation  $Y_i \times T$ , the fuzzy composite matrix  $M(Y_i)$  is built, lines of which represent meanings of membership functions of the appropriate terms for components of the bottom level of hierarchy.

Integrated assessment of the agent activities in MAS is obtained in two stages:

- 1) getting fuzzy evaluation of criteria for the first level in the hierarchy as a result of the multiplication of the vector of meanings of the weights of the criteria of the second level of hierarchy of criterion  $\vec{Y}_i$  on the matrix of meanings of membership functions of this criterion  $M(Y_i)$ ;
- 2) getting fuzzy evaluation of a key criterion, which is the agent's effectiveness in MAS, on the same principle as in point 1). This assessment is expressed as the vector, the quantity of elements in which is equal to number of the entered terms.

The procedure of a defuzzification is carried out for obtaining accurate meaning and can be realized by different methods. The most frequently used Centroid method, according to which the centers of mass of the relevant terms are calculated according to the formula (6) [15]:



$$CG(T) = \frac{\int_{\min}^{\max} z \cdot \mu(z) dz}{\int_{\min}^{\max} \mu(z) dz}, \quad (6)$$

where min and max values are the left and right points of an interval of the carrier of an output variable.

The physical analogue of Centroid method consists in finding the center of gravity of the flat figure, which is limited to the axes of coordinates and the schedule of the membership function of fuzzy set. The formula (6) is applied to the continuous sets. If the discrete fuzzy set is considered, then its defuzzification by a method of the Center of Gravity is executed on a formula:

$$CG(T) = \frac{\sum_{l=1}^q z_l \cdot \mu(z_l)}{\sum_{l=1}^q \mu(z_l)}. \quad (7)$$

A clear evaluation of the effectiveness of the agent in the MAC is calculated by the formula:

$$E = \frac{\sum_{i=1}^n CG(T_i) \cdot Z_i}{\sum_{i=1}^n Z_i}, \quad (8)$$

where  $n$  – number of terms;

$Z_i$  – an element  $i$  of a fuzzy assessment of efficiency of activities of the agent in MAS.

### 3. Practical Implementation

From all variety of criteria of effectiveness of agent in MAS, based on the results of the expert analysis, the following were selected:  $Y_p$  – level of competence of the agent, which is characterized by such criteria as:  $y_1^P$  – reliability of the agent,  $y_2^P$  – potential of the agent and  $y_3^P$  – self-sufficiency of the agent;  $Y_r$  – personal qualities of the agent, basic of which are:  $y_1^r$  – skill to communicate,  $y_2^r$  – truthfulness and  $y_3^r$  – absence of conflict of the agent;  $\Psi$  – an emotional component that includes:  $\psi_1$  – assessment by the agent of level of own resource security and  $\psi_2$  – level of satisfaction of the agent of results of own activities.

Reliability of the agent can be interpreted as the ratio of the number of tasks completed previously, to adopted tasks. Potential of the agent can be defined on the basis of execution of number of standard tasks for a unit of time. Self-sufficiency of the agent is equivalent his independence, i.e. a possibility of the agent to carry out certain tasks without involvement of other agents of MAS. Skill to communicate of the agent is the relation of number of its direct partner connections with other agents of system and the current number of agents in system. Truthfulness of the agent is interpreted as number of the messages proceeding from the agent which aren't containing "noise" in comparison with total number of the messages transferred by the agent to other participants of system. Absence of conflict of the agent is defined by quantity of conflict situations in which the agent participates (is their initiator) divided into total number of the conflicts in MAS for a certain time period.

After arrangement of priorities and calculation of coefficients of the significance of criteria for rule of Fishburn's (table 1) each of criteria of the bottom level of hierarchy was presented in the form of a linguistic variable, with corresponding a term set:

$$T = (T_1 - "low", T_2 - "average", T_3 - "high"). \tag{9}$$

All range of change of meanings of each criterion was partitioned into the levels, corresponding to terms of a linguistic variable (9), as shown in table 2.

**Table 2.** Weight factors of criteria and division of the ranges of change of meanings of criteria into levels

Crite- rion	Weight coeffi- cient	Range of changes of values of criteri- on in selection		Low level		Average lev- el		High level	
$y_1^p$	0,5	0,1	1	0,1	0,4	0,5	0,8	0,9	1
$y_2^p$	0,33	1	50	1	10	11	35	36	50
$y_3^p$	0,17	0,1	1	0,1	0,3	0,4	0,7	0,8	1
$y_1^r$	0,5	0,01	0,2	0,01	0,07	0,08	0,13	0,14	0,2
$y_2^r$	0,33	1	15	1	7	8	11	12	15
$y_3^r$	0,17	0	1	0	0,2	0,3	0,5	0,6	1
$\psi_1$	0,5	15	100	15	40	41	75	76	100
$\psi_2$	0,5	1	10	1	3	4	7	8	10

Membership functions of terms are described by ratios (4) and are provided in figures 1 – 3.

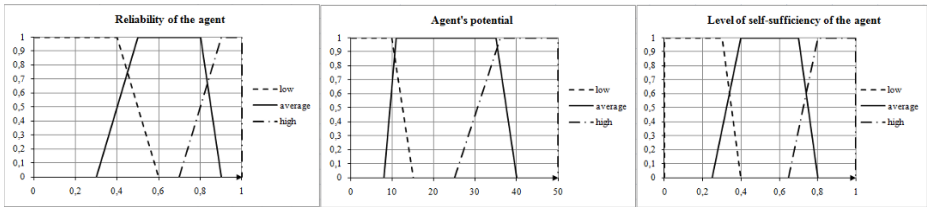

Fig. 1. Membership functions to criteria  $Y_p$

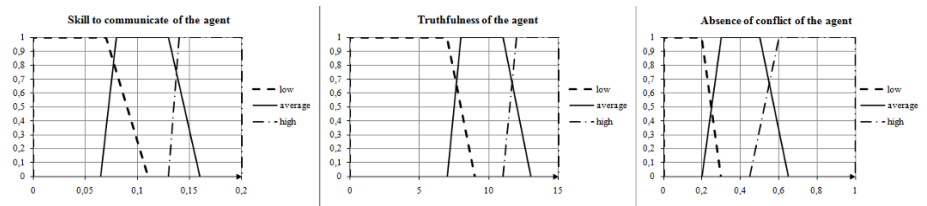

Fig. 2. Membership functions to criteria  $Y_r$

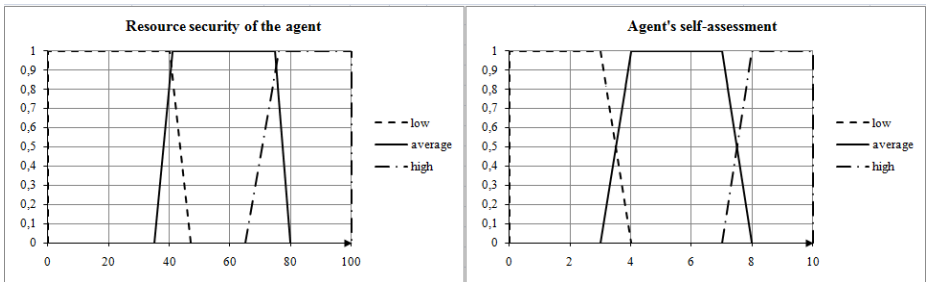

Fig. 3. Membership functions to criteria  $\Psi$

The agent, whose efficiency of activities is estimated, possesses the following characteristics:  $y_1^P = 0,85$ ,  $y_2^P = 37$ ,  $y_3^P = 0,34$ ,  $y_1^r = 0,1$ ,  $y_2^r = 12$ ,  $y_3^r = 0,53$ ,  $\psi_1 = 83$ ,  $\psi_2 = 7,5$ . According to the accepted rule of a fuzzification the following meanings of membership functions of the appropriate terms (table 3) were received.

**Table 3.** Meanings of membership functions

Criteria of the second level of hierarchy	Priorities of criteria of the second level	Meanings of membership functions of the appropriate terms		
		T1	T2	T3
Reliability	0,5	0	0,5	0,75
Potential	0,33	0	0,6	1,00
Self-sufficiency	0,17	0,60	0,6	0,00
Skill to communicate	0,5	0,25	1,0	0,00
Truthfulness	0,33	0	0,5	1,00
Absence of conflict	0,17	0	0,8	0,53
Assessment by the agent of level of the resource security	0,5	0	0,0	1,00
Agent's self-assessment	0,5	0	0,5	0,50

The result of the first stage of obtaining the integral estimation is the matrix of the kind:

$$M(Y) = \begin{bmatrix} 0.102 & 0.55 & 0.705 \\ 0.125 & 0.801 & 0.4201 \\ 0 & 0.25 & 0.75 \end{bmatrix}. \tag{10}$$

At the second stage the vector was received, which representing an fuzzy assessment of efficiency of activities of the agent in MAS:

$$\vec{Z} = [0.0922 \quad 0.5818 \quad 0.6186]. \tag{11}$$

The output variable  $E$  also has a term set (9) and is set by means of ratios (4). Her membership functions are provided in a figure 4.

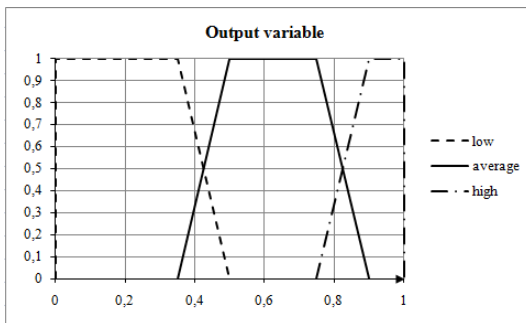

**Fig. 4.** Membership functions of an output variable  $E$

The centers of gravity of the appropriate terms were calculated by a formula (7):  $CG(T_{LL})=0,21$ ,  $CG(T_{AL})=0,617$ ,  $CG(T_{HL})=0,943$ . The accurate value of an output variable, calculated on a formula (8), made 0,74. This assessment is interpreted as “average efficiency” of activities of the agent in MAS. Really, the considered agent has no sufficient independence in case of the decision of tasks. At the same time it has a medium level of sociability (established circle of relationships, the caring from new contacts) and of the conflict-free (new contacts, as a rule, are a source of conflict). Despite the sufficient level of resources the agent is not using its full potential.

## 4. Conclusions

The article describes the techniques, developed by the author, for obtain a quantification of cumulative indicator of efficiency of activity of the agent in MAS. The technique is based on determination of the significance of criteria by which the assessment is carried out, and application of the theory of fuzzy sets, which well proved in case of the decision of difficult to formalize tasks.

The selected criteria are structured hierarchically. In this case complied with the condition, that the increase in a particular metric associated with the improvement of activities and condition of the agent. If for this index the opposite tendency is watched, then in the analysis it should be replaced with the conjugate. The most important criterion of the first level in the analysis is the level of competence of the agent.

On the basis of the carried-out estimation of activities of agents in MAS conclusions about overall performance of system in general are drawn and the instructions for increase in efficiency having advisory nature are worked out. In case of detection of absolutely ineffective agents, they are removed from the system.

## Acknowledgments

Work is performed with assistance of the Russian Federal Property Fund, the project No. 15-01-05545 A.

## References

1. Mohammed Mekidiche, Mostefa Belmokaddem, “Application of Weighted Additive Fuzzy Goal Programming Approach to Quality Control System Design”, *IJISA*, vol. 4, no. 11, pp. 14 – 23, 2012. DOI: 10.5815/ijisa.2012.11.02.
2. Haiying Ren, Siwei Li, “A Heterogeneous Agent-based Asset Pricing Model and Simulation”, *IJEM*, vol. 2, no. 4, pp. 9 – 18, 2012. DOI: 10.5815/ijem.2012.04.02.
3. E.V. Krishnamurthy, “Agent-based Models in Synthetic Biology: Tools for Simulation and Prospects”, *IJISA*, vol.4, no.2, pp. 58 – 65, 2012. DOI: 10.5815/ijisa.2012.02.07.
4. Mohammed Abbas Kadhim, M. Afshar Alam, Harleen Kaur, "A Multi-intelligent Agent System for Automatic Construction of Rule-based Expert System", *Interna*

- tional Journal of Intelligent Systems and Applications(IJISA), Vol.8, No.9, pp.62-68, 2016. DOI: 10.5815/ijisa.2016.09.08
5. Purba D. Kusuma, Azhari, Reza Pulungan, "Agent-Based Buyer-Trader Interaction Model of Traditional Markets", International Journal of Intelligent Systems and Applications(IJISA), Vol.8, No.11, pp.1-8, 2016. DOI: 10.5815/ijisa.2016.11.01
  6. Satyendra Singh Chouhan, Rajdeep Niyogi, "An Analysis of the Effect of Communication for Multi-agent Planning in a Grid World Domain", IJISA, vol. 4, no. 5, pp. 8 – 15, 2012. DOI: 10.5815/ijisa.2012.05.02.
  7. M. Wooldridge, *An Introduction to MultiAgent Systems*, Chichester: John Wiley & Sons Ltd, 2002. ISBN 0-471-49691-x.
  8. Burkov, V.N. *Theory of the active systems and enhancement of an economic mechanism* / V.N. Burkov, V.V. Kondratyev, V.V. Tsyganov, A.M. Cherkashin. M.: Science, 1984. 272 p.
  9. Burkov, V.N. *How to control the organizations* / V.N. Burkov, D.A. Novikov. Moscow: "Sinteg", 2003. 400 p.
  10. Mutovkina, N.Yu. *Methods of the coordinated optimization of modernization of the industrial enterprises: the dissertation for a degree of Candidate of Technical Sciences; specialties 05.13.01, 05.13.10.* – Tver: TvGTU, 2009. 219 p.
  11. Hodashinsky, I.A. *Methods of soft estimation of values: monograph* / I.A. Hodashinsky. Tomsk: Tomsk state university of management systems and electronics, 2007. 152 p.
  12. Mutovkina, N.Yu. *Behavioral models of intellectual agents in the course of information exchange* / N.Yu. Mutovkina, V.N. Kuznetsov, A.Yu. Klyushin // *Management systems and information technologies*. 2013. No. 1.1 (51), pp. 178 – 183.
  13. Saati, T. *Decision-making. Method of the analysis of hierarchies* / T. Saati. M.: Radio and communication, 1993. 278 p.
  14. Fishburn, P. *The theory of usefulness for decision-making* / P. Fishburn. M.: Science, 1978. 352 p.
  15. Mousumi Mitra, Atanu Das, "A Fuzzy Logic Approach to Assess Web Learner's Joint Skills", *IJMECS*, vol. 7, no. 9, pp. 14 – 21, 2015. DOI: 10.5815/ijmeecs.2015.09.02.

# Analysis of Emergency level at Sea Using Fuzzy Logic Approaches

Nelly A. Sedova<sup>1</sup> , Viktor A. Sedov<sup>1</sup> ,  
Ruslan I. Bazhenov<sup>2\*</sup> 

<sup>1</sup> Admiral Nevelskoi Maritime State University, Vladivostok, Russia

<sup>2</sup> Sholom-Aleichem Priamursky State University, Birobidzhan, Russia

nellyfish81@mail.ru, r-i-bazhenov@yandex.ru

**Abstract.** In this paper we propose a fuzzy model of the point rating method for evaluating emergency level at sea and using Mamdani algorithm as a method of fuzzy inference. The input linguistic variables are sea pollution, damage ship and dangers to human health or life. Using this information the rule base with 80 rules was created. Having tested the fuzzy model of assessing the emergency level in different situations at sea, adequate responses were produced.

**Keywords:** Fuzzy set, linguistic variable, term set, accident at sea, ship damage, sea pollution.

## 1. Introduction

Investigating marine accidents often has to evaluate multifactorial and difficultly formalized situations. The peculiarity of navigation lies in the great variety of situations that arise when at sea, and, therefore, the practice of safe navigation is apperceived with the accumulation of personal experience in navigation and is dependent on a deck officer's individual qualities.

In Russia, the procedure for investigating marine accidents is regulated by the Regulations on the Investigation of Accidents or Incidents at Sea (Order of the Ministry of Transport of the Russian Federation as of October 8, 2013 No. 308 "On Approval of the Regulation on the Investigation of Accidents or Incidents at Sea"). This Regulation establishes the procedure for investigating accidents to ships, accidents and incidents at sea, which occurred in direct connection with the ship operation. The Regulation specifies that the purpose of investigation of accidents to vessels is to establish the causes of accidents to vessels and take measures to prevent them in the future.

Wherein, the investigation of accidents to vessels includes the collection and analysis of evidence, the identification of causal factors, the preparation of appropriate recommendations to prevent such cases in future and, if necessary, recommendations on safety of navigation. Thus, an assessment of the emergency level is a necessary criterion for investigating accidents.

Assessing the level of safe navigation is an important task, yet the process is hard to formalize insofar as it is affected by numerous factors with complex relationships. Existing probabilistic methods have a major drawback, which consists in the fact that

the same probability of emergencies at sea leads to different economic and social consequences which are not differentiated by probabilistic methods [1].

To solve such class of difficult formalized tasks related to emergencies and safety, well-proven logical - linguistic methods based on the theory of fuzzy sets is used [2-6]. So, for example, in the paper [5] authors developed a fuzzy system for highway emergency support, the authors in [6] proposed a fuzzy control algorithm in the management of unconventional emergency.

Systems involving fuzzy logic in navigational tasks are offered, for example, by the authors in [7], where the quantitative human error assessment during abandon ship procedures issues is described, and the authors in [8] assessing the safety factors of ship berthing operations.

In this paper we propose a fuzzy model of the point rating method for evaluating emergency level at sea and using Mamdani algorithm as a method of fuzzy inference [9-11].

## 2. Description of the Fuzzy Model Assessment of Emergency Level at Sea

Analyzing the rating method of assessing emergencies at sea and emergencies classifier presented in [1], the following three criteria are defined which are necessary for forming the model (Figure 1): the criterion of Health and human life (group of persons) damage, the criterion of the degree of ship damage, and the criterion of the environmental pollution [12, 13].

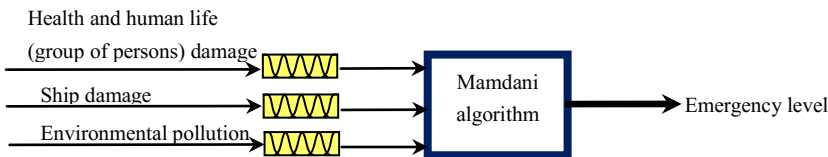

**Fig. 1.** Basic scheme of the fuzzy model assessment of emergency level at sea

Fuzzy model of assessment of emergency level at sea has three input and one output linguistic variables (LV) [14-16].

The first input LV, captures information about causing harm to human health and life (group of persons). It is determined by the number of injured or dead persons and characterized by a basic term-set {single, small, average, large, huge}, while the term “single” characterizes sea emergencies (SE) when one person is killed or goes missing or 5 people are injured; the term “small” – a SE when 2 people are killed or go missing or more than 5 people are injured; the term “average” – a SE when 3-4 persons are killed or go missing or more than 10 people are injured; the term “large” – a SE when 5 or more people are killed or go missing and more than 25 are injured; the term “huge” for a SE when 10 or more people are killed or go missing or more than 50 people are injured.



The term “single” of the first input LV has a membership function determined by the following formula:

$$\mu_{single}(x) = \begin{cases} 1, & x \leq 0,8, \\ \frac{3,5-x}{2,7}, & 0,8 < x < 3,5, \\ 0, & 3,5 \leq x. \end{cases}$$

The term “huge” of the first input LV of membership function is determined by the formula:

$$\mu_{huge}(x) = \begin{cases} 0, & x \leq 11,5, \\ \frac{x-0,8}{2,7}, & 11,5 < x < 14,2, \\ 1, & 14,2 \leq x. \end{cases}$$

The remaining terms of the first input linguistic variable of membership functions are defined by the following expressions:

$$\mu_{small}(x) = \begin{cases} 0, & x \leq 2,5, \\ \frac{x-2,4}{2}, & 2,5 \leq x \leq 4,5, \\ \frac{6,5-x}{2}, & 4,5 \leq x \leq 6,5, \\ 0, & 6,5 \leq x, \end{cases}$$

$$\mu_{average}(x) = \begin{cases} 0, & x \leq 5,5, \\ \frac{x-5,5}{2}, & 5,5 \leq x \leq 7,5, \\ \frac{9,5-x}{2}, & 7,5 \leq x \leq 9,5, \\ 0, & 9,5 \leq x, \end{cases}$$

$$\mu_{large}(x) = \begin{cases} 0, & x \leq 8,5, \\ \frac{x-8,5}{2}, & 8,5 \leq x \leq 10,5, \\ \frac{12,5-x}{2}, & 10,5 \leq x \leq 12,5, \\ 0, & 12,5 \leq x. \end{cases}$$

The second input LV is the information collected about the degree of damage to the ship, the following terms are basic term-sets: the term «small» – when the SE led to constructive damage to the hull, but did not result in the loss of seaworthiness; the term «average» – when the SE led to damage and restraint of ship operation; the term «critical» – a SE in which there was structural damage to the ship with the loss of seaworthiness and the occurrence of any operational constraints; the term «full» char

acterizes the emergency situation at sea leading to the loss of the ship or its full constructive destruction and loss of seaworthy condition.

Terms of the basic term-sets of the second input LV of membership functions are defined by the following expressions:

$$\mu_{small}(x) = \begin{cases} 1, & x \leq 6, \\ \frac{22,7-x}{16,7}, & 6 < x < 22,7, \\ 0, & 22,7 \leq x, \end{cases}$$

$$\mu_{average}(x) = \begin{cases} 0, & x \leq 17,8, \\ \frac{x-17,8}{12,2}, & 17,8 \leq x \leq 30, \\ \frac{42,6-x}{12,6}, & 30 \leq x \leq 42,6, \\ 0, & 42,6 \leq x, \end{cases}$$

$$\mu_{critical}(x) = \begin{cases} 0, & x \leq 37,7, \\ \frac{x-37,7}{12,3}, & 37,7 \leq x \leq 50, \\ \frac{60-x}{13}, & 50 \leq x \leq 63, \\ 0, & 63 \leq x, \end{cases}$$

$$\mu_{full}(x) = \begin{cases} 0, & x \leq 58,7, \\ \frac{x-58,7}{34}, & 58,7 < x < 92,7, \\ 1, & 92,7 \leq x. \end{cases}$$

The third input LV is the level of environmental pollution; it includes the following terms: “insignificant”, “weak”, “significant” and “big”. The term “insignificant” corresponds to the environment pollution in quantities of 0.3 to 1 ton of oil; the term “weak” – from 1 to 5 tons of oil; the term “significant” – from 5 to 50 tons of oil, and the term “big” corresponds to the contamination of the environment in quantities of more than 50 tons.

The terms of the third input LV membership functions are defined by the following expressions:

$$\mu_{insignificant}(x) = \begin{cases} 1, & x \leq 2,8, \\ \frac{12,6-x}{9,8}, & 2,8 < x < 12,6, \\ 0, & 12,6 \leq x, \end{cases}$$

$$\mu_{weak}(x) = \begin{cases} 0, & x \leq 8,7, \\ \frac{x-8,7}{11,3}, & 8,7 \leq x \leq 20, \\ \frac{32,8-x}{12,8}, & 20 \leq x \leq 32,8, \\ 0, & 32,8 \leq x, \end{cases}$$

$$\mu_{significant}(x) = \begin{cases} 0, & x \leq 27,2, \\ \frac{x-27,2}{12,8}, & 27,2 \leq x \leq 40, \\ \frac{51,3-x}{11,3}, & 40 \leq x \leq 51,3, \\ 0, & 51,3 \leq x, \end{cases}$$

$$\mu_{big}(x) = \begin{cases} 0, & x \leq 47,2, \\ \frac{x-47,2}{9,8}, & 47,2 < x < 57, \\ 1, & 57 \leq x. \end{cases}$$

The output linguistic variable corresponds to the emergency level at sea and is characterized by a basic term-set: {incident, serious incident, serious emergency, very serious emergency}. The corresponding membership functions specified by the following formulas:

$$\mu_{incident}(x) = \begin{cases} \frac{2,8-x}{2,8}, & 0 < x < 2,8, \\ 0, & 2,8 \leq x, \end{cases}$$

$$\mu_{serious\ incident}(x) = \begin{cases} 0, & x \leq 1,5, \\ \frac{x-1,5}{3}, & 1,5 \leq x \leq 4,5, \\ \frac{7,5-x}{3}, & 4,5 \leq x \leq 7,5, \\ 0, & 7,5 \leq x, \end{cases}$$

$$\mu_{serious\ emergency}(x) = \begin{cases} 0, & x \leq 6,5, \\ \frac{x-6,5}{3}, & 6,5 \leq x \leq 9,5, \\ \frac{12,5-x}{3}, & 9,5 \leq x \leq 12,5, \\ 0, & 12,5 \leq x, \end{cases}$$

$$\mu_{\text{very serious emergency}}(x) = \begin{cases} 0, & 11,6 \leq x, \\ \frac{x - 11,6}{3,4}, & 11,6 < x < 15. \end{cases}$$

The rule base of fuzzy productions fuzzy model assessment of emergency level at sea consists of 80 rules (Figure 2).

The implementation of the fuzzy model was carried out using Matlab software. Figure 3 shows a three-dimensional surface of the fuzzy inference and expresses the dependence of the output LV “emergency level at sea” of two input LV “degree of damage to the ship” and “harm to human health and life (group of persons)”.

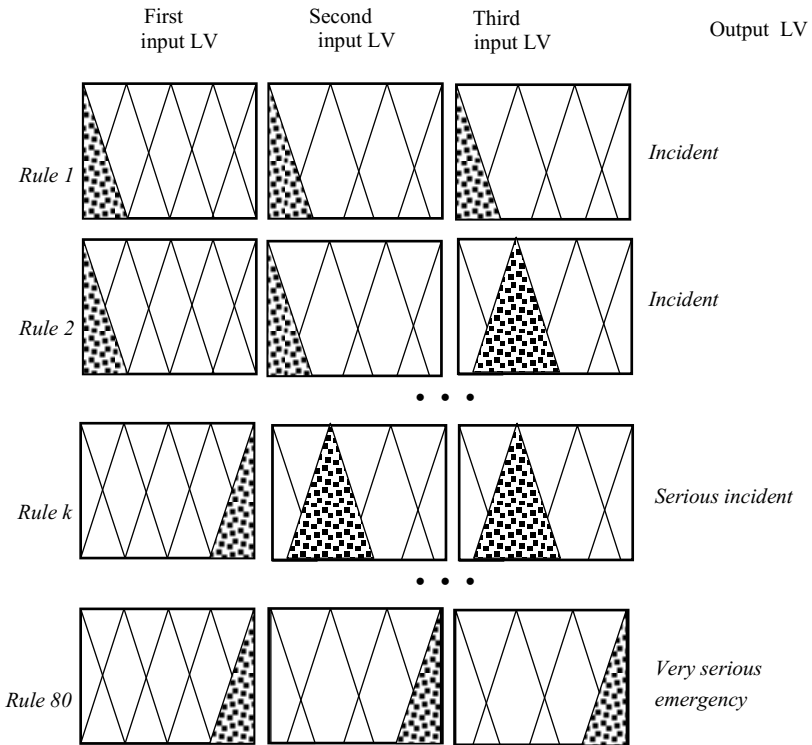
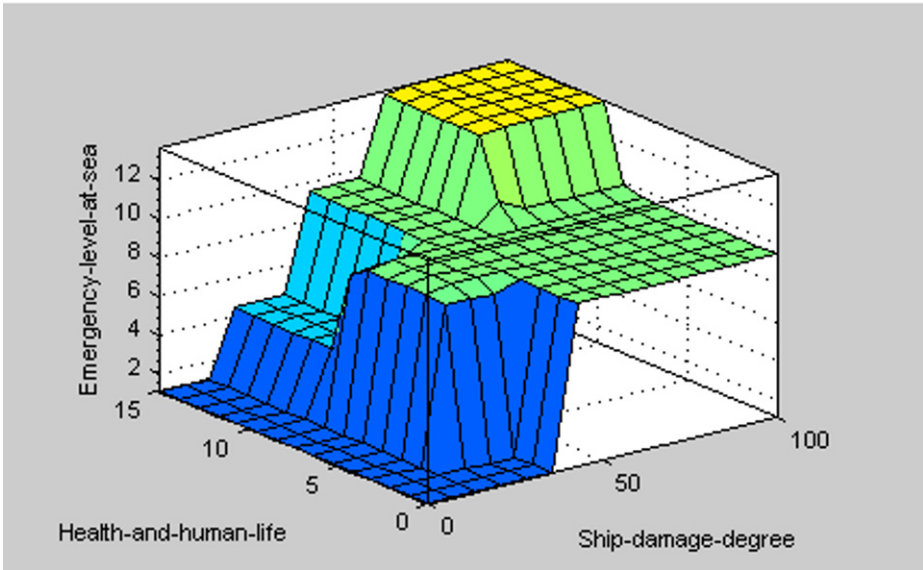

Fig. 2. Schematic view of rule base



**Fig. 3.** Three-dimensional surface of the fuzzy inference

We will consider several test cases to confirm the workability of this fuzzy model. The examples of the functioning of fuzzy model are shown in Figure 4.

**Example #1.** The ship at sea encountered a storm in which several people were injured, small deck equipment was damaged and a small amount of fuel in barrels was thrown overboard by waves. After the relevant information is entered we obtain a low emergency level at sea, designated by experts as an “incident” (Figure 4A).

**Example #2.** During an attack on the ship at sea by Somali pirates an armed clash occurred. As a result 10 people died, the ship was seriously damaged, there was a slight loss of fuel overboard, and a large oil spill around the ship. Preliminary analysis of this situation defines it as a “serious emergency,” and using fuzzy models to determine its level we find 9.5 points out of the maximum 15 (Figure 4B).

**Example #3.** There was a collision between two ships at high speed, during which one ship sunk completely, nearly 50 people drowned, there was a leak from the fuel tank, and the oil slick spread over a large area of the sea surface. This situation is defined by experts as a “very serious emergency” and the fuzzy model also determines the emergency level of such a situation as 15 points out of 15 (Figure 4C).

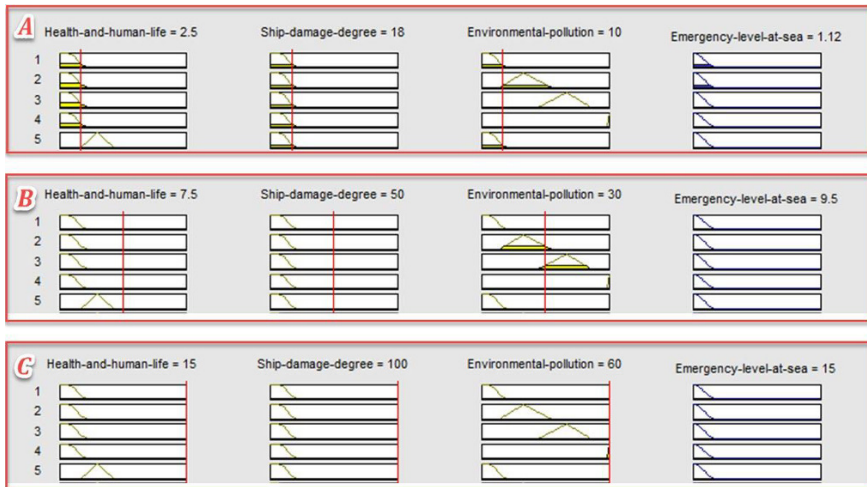

**Fig. 4.** Examples of the functioning fuzzy model

Having tested the fuzzy model of assessing the emergency level in different situations at sea, we concluded that it works correctly. This model will be the development basis of an automated system that determines the risk degree of ship collision to further select the best maneuver of avoidance.

### 3. Conclusion

The proposed model allows us to determine the emergency level at sea using information about harm to human health and life (for a group of persons), about the degree of damage to the ship and about the level of environmental pollution. For a description of the model 17 fuzzy sets were introduced, each depicted by a graphical and analytical representation. The base of fuzzy products consists of 80 rules. The represented model showed its adequacy in test cases.

### References

1. Sedova NA, Sedov VA, Glushkov SV (2016) The fuzzy model of the emergency level assessment at sea. *Vibroengineering Procedia* 8: 506-511.
2. Ishaya Emmanuel, "Fuzzy Logic-Based Control for Autonomous Vehicle: A Survey", *International Journal of Education and Management Engineering(IJEME)*, Vol.7, No.2, pp.41-49, 2017. DOI: 10.5815/ijeme.2017.02.05
3. Manjunatha K.C., Mohana H.S, P.A Vijaya, "Implementation of Computer Vision Based Industrial Fire Safety Automation by Using Neuro-Fuzzy Algorithms", *IJITCS*, vol.7, no.4, pp.14-27, 2015. DOI: 10.5815/ijitcs.2015.04.02
4. Lemus-Martinez C, Lemyre L, Pinsent C, Boutette P (2011) Fuzzy logic. A link for behavioral computer simulations of collaboration in emergency management. In: 15th

- World Multi-Conference on Systematics, Cybernetics and Informatics (WMSCI 2011). Int Inst Informatics & Systemics, Orlando, pp 143-148.
5. Zhu J, Zeng Z, Yang Z (2016) Empirical research on a fuzzy comprehensive evaluation of a highway emergency support capability. Proceedings of the 13th International Conference on Innovation and Management I&I: 1141-1151.
  6. Li X, Li C (2016) Research on situation assessment based on fuzzy algorithm in the management of unconventional emergency. Proceedings of the International Conference on Electronics, Mechanics, Culture and Medicine. ACSR-Advances in Computer Science Research 45: 306-309.
  7. Akyuz E (2016) Quantitative human error assessment during abandon ship procedures in maritime transportation. Ocean Engineering 120: 21-29. doi: 10.1016/j.oceaneng.2016.05.017
  8. Hsu WKK (2015) Assessing the Safety Factors of Ship Berthing Operations. Journal of Navigation 68: 576-588. doi: 10.1017/S0373463314000861.
  9. Luneva EE, Banokin PI, Yefremov AA (2015) Evaluation of social network user sentiments based on fuzzy sets. In: IOP Conference Series: Materials Science and Engineering 21st International Conference for Students and Young Scientists. IOP Publishing, p 012054. doi: 10.1088/1757-899X/93/1/012054
  10. Chernova IV, Sumin SA, Bobyr MV, Seregin SP (2016) Forecasting and diagnosing cardiovascular disease based on inverse fuzzy models. Biomedical Engineering 49: 263-267. doi: 10.1007/s10527-016-9545-y
  11. Bobyr MV, Titov VS, Nasser AA (2015) Automation of the cutting-speed control process based on soft fuzzy logic computing. Journal of Machinery Manufacture and Reliability 44: 633-641. doi:10.3103/S1052618815070067.
  12. Chernyi S, Zhilenkov A (2015) Modeling of complex structures for the ship's power complex using XILINX system. Transport and Telecommunication 16: 73-82. doi: 10.1515/ttj-2015-0008
  13. Antipin AF (2015) Improving response time of real time control systems based on multidimensional interval-logical controllers. Automation and Remote Control 76: 480-486.
  14. Antipin AF (2013) A Computer-aided System for Designing Multidimensional Logic Controllers with Variables Representing a Set of Binary Logic Arguments. Automation and Remote Control 74: 1573-1581.
  15. Yefremov AA (2014) New operations on fuzzy numbers and intervals. In: Proceedings of 2014 International Conference on Mechanical Engineering, Automation and Control Systems, MEACS 2014. IEEE Press, New York, pp 1-4. doi: 10.1109/MEACS.2014.6986900
  16. Nyrkov AP, Chernyi SG, Zhilenkov AA, Sokolov SS (2016) The use of fuzzy neural structures to increase the reliability of drilling platforms. Annals of DAAAM & Proceedings 26: 672-677.

# Investigation of Dynamic Behavior of Acetylene Production by Oxidative Pyrolysis of Natural Gas

G.N. Sanayeva<sup>1</sup>, A.E. Prorokov<sup>1</sup>, V.N. Bogatikov<sup>2</sup>

<sup>1</sup>Novomoskovsk Institute (Branch) of Dmitry Mendeleev University of Chemical Technology of Russia, Novomoskovsk, Russia

<sup>2</sup>Tver State Technical University, Tver, Russia

**Abstract.** Modern chemical-engineering systems, as a rule, are characterized by the complexity of chemical technology processes, the behavior in a context of the information uncertainty and deficiency as well as a vast number of internal and external factors exercising unpredictable influence on the entire system operation. Therefore, it is particularly important that chemical industries should solve the problem of defining valid states in order to ensure the process safety in various situations arising in a technological cycle. At the same time, the main task of effective diagnostics and process safety of chemical-engineering systems is the timely detections of malfunctions that can cause extraordinary situations, with the aim of their preventing and avoiding. In the paper the authors propose a technological model of acetylene production by oxidative pyrolysis of natural gas. The process operation uncertainty is stipulated by the feed composition variability (natural gas, oxygen), the temperature dependence of chemical kinetic constants, the equipment behavior during the operation ('coking up'), etc. The mathematical model includes the material and heat balance equations calculated for the oxidative pyrolysis reactor processes (mixing of the original components, oxidative pyrolysis, 'quenching' of oxidative pyrolysis products). The Matlab Simulink-based model allows us to plot graphs of transient processes in a reactor and to evaluate the effect of various factors on the acetylene content in the pyrolysis gas at the reactor outlet. The model adequacy is validated by statistical data obtained at the existing acetylene enterprise. The model can be used to evaluate indeterminate forms on the basis of finite-difference approximation for the purpose of defining different states of a system, as well as to design the oxidative pyrolysis process control system.

**Keywords:** Control system, Mathematical modeling, Simulation modeling, Oxidative pyrolysis, Acetylene, Process safety.

## 1 Introduction

The production of acetylene by the oxidative pyrolysis of natural gas is a complex chemical-engineering system characterized by a great number of internal and external disturbing influences, as well as by a wide range of output parameters which are the



performance indexes not only of different processing units but a production as a whole. At the same time, the abovementioned technology is a highly explosive and fire hazardous organic synthesis production, therefore the main task of the industrial process control is to prevent the emergency situations that eventually should improve the process safety [1]. The forecasting of emergency or pre-emergency situations occurrence at the production sites is complicated by the complexity and hierarchy of industrial organization. The process of oxidative pyrolysis is carried out in a context of the information deficiency and uncertainty caused by the short hold-up time of a reaction mixture in a reaction zone, the equipment behavior during operation ('coking up' of a number of elements), the temporally variability of reaction feed composition (natural gas and oxygen), the temperature dependence of kinetic constants in chemical reactions, as well as a number of other factors that can determine a technological safety of the process in question [2,3].

Due to the facts mentioned above, the investigation of dynamic behavior of the acetylene production by oxidative pyrolysis of natural gas in order to get a mathematical model suitable for creating a special system of state estimation and malfunction diagnostics is particularly relevant against the backdrop of solving the problem of process safety improving.

## 2 Oxidative Pyrolysis Process Description

The process of oxidative pyrolysis in the acetylene production is based on feeding the controlled amount of oxygen to a reaction zone for the purpose of burning a part of feedstock. The released heat is expended for heating raw material up to the reaction temperature and for the endothermic reaction of hydrocarbon splitting [4,5]. The amount of acetylene produced by oxidative pyrolysis of natural gas depends on the preheating temperature and the degree of mixing the initial reaction components, as well as on the ratio of their utilization.

One of the key features of the process is the release of large amount of heat in a small reaction volume under partial burning of feedstock. The heat should be rapidly and uniformly distributed within the reaction zone volume to support a uniform burning over the whole reaction site. To this end, it is necessary to mix thoroughly raw materials and oxygen and to provide conditions under which combustion would not begin before the feed mixture enters the reaction zone. The ratio of oxygen and hydrocarbon material is usually close to the lower flammable limit so the reactor design should maintain the stable flame and its uniform distribution over the reactor cross section.

The process operation taking place in the oxidative pyrolysis reactor consists of three stages: mixing the pyrolysis reaction components (natural gas and oxygen), which are preheated in a preheater up to 650°C, in the reactor mixer; oxidative pyrolysis in the reaction zone at temperature of about 1500°C; 'quenching' the reaction products in water in order to prevent the decomposition of generated acetylene into hydrogen and soot, and cooling the obtained pyrolysis gas to 100°C.

The design and material flows of the oxidative pyrolysis reactor are shown in Fig.1.

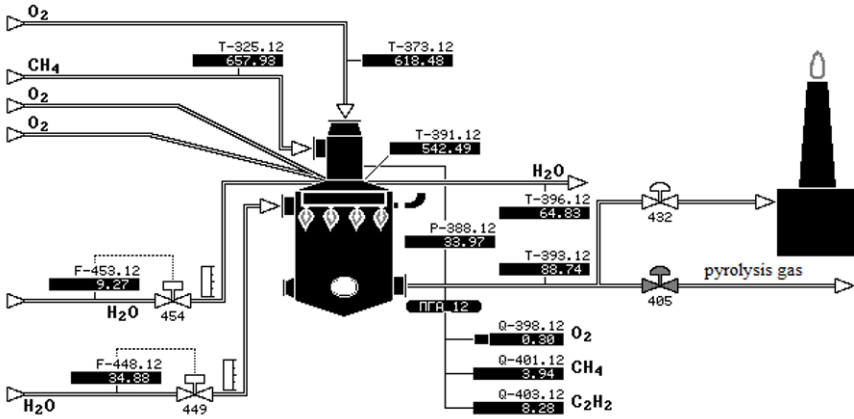

Fig. 1. Reactor of oxidative pyrolysis of natural gas

The physical limits of each stage are [4, 5]:

- The maximum permissible temperature of the oxidative pyrolysis reactor distribution grid is 710°C for the purpose of avoiding the premature ignition of mixture or the flame flash-back from the reaction chamber to a mixer.
- The concentrations of oxygen and methane at the reactor outlet are 0.8 and 9% (vol.) respectively, in an effort to avoid explosive concentrations during the explosion hazard process operation.
- Low-water discharge for ‘quenching’ the reaction products is 10m<sup>3</sup>/s.

In view of the above mentioned peculiarities of the oxidative pyrolysis process, it is necessary to develop an approach to the process study. It should be suitable for analyzing experimental data and obtaining the necessary information on the influence of various processing factors on the yield and characteristics of the processed products. This can be accomplished by means of mathematical model of the oxidative pyrolysis reactor.

### 3 Mathematical Model of Oxidative Pyrolysis Reactor

To solve the problems of status evaluation and decision-making when the acetylene production is managed as a complex dynamic object under uncertainty, a mathematical model of the oxidative pyrolysis reactor would be desirable [2, 3].

Since the reaction initial components are mixed at the identical temperature, *the mixer mathematical model* is only described by the material balance equation which, given that  $G_{mix} = G_{CH_4} + G_{O_2}$ , can be written in the following form:

$$V_{mix} \cdot \frac{d\rho_{mix}}{dt} = G_{CH_4} \cdot \rho_{CH_4} + G_{O_2} \cdot \rho_{O_2} - G_{mix} \cdot \rho_{mix}$$

where  $\rho_{CH_4}$ ,  $\rho_{O_2}$ ,  $\rho_{mix}$  are the densities of methane, oxygen, and methane-oxygen mixture respectively, kg/m<sup>3</sup>;  $G_{CH_4}$ ,  $G_{O_2}$ ,  $G_{mix}$  are methane, oxygen, and methane-oxygen mixture reaction consumptions respectively, m<sup>3</sup>/s;  $V_{mix}$  is the mixer volume, m<sup>3</sup>.

The reaction zone mathematical model is described by the material balance equations for the components of the corresponding chemical reactions:

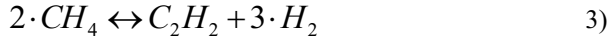
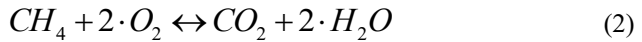
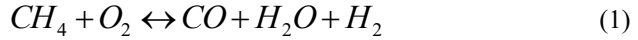

as well as the heat balance equation [4].

In accordance with the system of chemical equations (1) - (4), the material balance equations for each reaction component of  $CH_4 + O_2 \rightarrow CO + H_2O + H_2$  take the form:

$$V_p \cdot \rho_{mix} \cdot \frac{m_{CH_4}}{m_{mix}} \cdot \frac{dC_{CH_4}}{dt} = G_{mix} \cdot \rho_{mix} \cdot \frac{m_{CH_4}}{m_{mix}} \cdot (C_{CH_4}^{in} - C_{CH_4}) - \omega_{CH_4}^{(1)} \cdot V_p \cdot m_{CH_4}$$

$$V_p \cdot \rho_{mix} \cdot \frac{m_{O_2}}{m_{mix}} \cdot \frac{dC_{O_2}}{dt} = G_{mix} \cdot \rho_{mix} \cdot \frac{m_{O_2}}{m_{mix}} \cdot (C_{O_2}^{in} - C_{O_2}) - \omega_{O_2}^{(1)} \cdot V_p \cdot m_{O_2}$$

$$V_p \cdot \rho_{mix} \cdot \frac{m_{CO}}{m_{mix}} \cdot \frac{dC_{CO}}{dt} = G_{mix} \cdot \rho_{mix} \cdot \frac{m_{CO}}{m_{mix}} \cdot (C_{CO}^{in} - C_{CO}) + \omega_{CO}^{(1)} \cdot V_p \cdot m_{CO}$$

$$V_p \cdot \rho_{mix} \cdot \frac{m_{H_2O}}{m_{mix}} \cdot \frac{dC_{H_2O}}{dt} = G_{mix} \cdot \rho_{mix} \cdot \frac{m_{H_2O}}{m_{mix}} \cdot (C_{H_2O}^{in} - C_{H_2O}) + \omega_{H_2O}^{(1)} \cdot V_p \cdot m_{H_2O}$$

$$V_p \cdot \rho_{mix} \cdot \frac{m_{H_2}}{m_{mix}} \cdot \frac{dC_{H_2}}{dt} = G_{mix} \cdot \rho_{mix} \cdot \frac{m_{H_2}}{m_{mix}} \cdot (C_{H_2}^{in} - C_{H_2}) + \omega_{H_2}^{(1)} \cdot V_p \cdot m_{H_2}$$

where  $C_i^{in}$  is the concentration of the corresponding pyrolysis gas components at the reaction zone inlet, % (vol.);  $C_i$  is the concentration of the corresponding pyrolysis

gas components at the reaction zone outlet, % (vol.);  $\omega_i^{(k)}$  is the speed of the  $k$ -th chemical reaction for the component  $i$ , mol/(m<sup>3</sup>·s);  $\rho_i$  is the density of the component  $i$ , kg/m<sup>3</sup>,  $V_p$  is the reaction zone volume, m<sup>3</sup>;  $m_i$  is the molecular weight of the component  $i$ , kg/mol. The material balances for the chemical reactions (2) – (4) are described by similar equations.

The heat balance equation of the reaction zone is determined by the ratio:

$$c\rho \frac{dT^{in}}{dt} = G_{CH_4} \cdot r_{CH_4} + (T^{in} - T^{out})c\rho - Q_3 - Q_5$$

where  $\rho$  is the pyrolysis gas density, kg/m<sup>3</sup>;  $G_{CH_4}$  is the methane consumption, m<sup>3</sup>/s;  $r_{CH_4}$  is the specific heat of methane combustion, J/m<sup>3</sup>;  $T^{in}$ ,  $T^{out}$  are the pyrolysis gas temperatures at the reaction zone inlet and outlet, K. At the same time  $Q_3 = qze^{-E/RT^{out}}$ , where  $q$  is the reaction thermal effect (3) ( $\Delta H = -44$  kJ/mol);  $z$  is the concentration of the main reaction component (acetylene), % (vol.);  $E$  is the reaction activation energy (3), kJ/mol;  $R$  is the universal gas constant, kJ/(mol·K) [4].

Since there are no component conversions in the ‘quenching’ zone and the pyrolysis gas obtained due to the reaction zone combustion cools, the ‘quenching’ zone mathematical model is only described by the heat balance equations [6]:

- for the heat carrier (pyrolysis gas):

$$c \cdot \rho \cdot V_3 \cdot \frac{dT_{PG}^{out}}{dt} = G_{PG} \cdot c \cdot \rho \cdot (T_{PG} - T_{PG}^{out}) - k \cdot F \cdot (T_{PG}^{out} - T_w) - G_{PG} \cdot \alpha \cdot \rho$$

- for the cooling agent (water for ‘quenching’):

$$c_w \cdot \rho_w \cdot V_3 \cdot \frac{dT_w^{out}}{dt} = G_w \cdot c_w \cdot \rho_w \cdot (T_w^{in} - T_w^{out}) + k \cdot F \cdot (T_{PG}^{in} - T_{PG}^{out})$$

where  $\rho_w$  is the water density, kg/m<sup>3</sup>;  $c_w$  is the heat capacity of water, J/(kg·K);  $V_3$  is the ‘quenching’ zone volume, m<sup>3</sup>;  $G_w$  is the ‘quenching’ water consumption, m<sup>3</sup>/s;  $k$  is the heat transfer coefficient, W/(m<sup>3</sup>·K);  $F$  is the heat transfer surface, m<sup>2</sup>;  $\alpha$  is the heat transmission coefficient, W/(m<sup>3</sup>·K);  $T_{PG}$ ,  $T_{PG}^{out}$  are the pyrolysis gas temperatures at the ‘quenching’ zone inlet and the reactor outlet respectively, K;  $T_w^{in}$ ,  $T_w^{out}$  are the ‘quenching’ water temperatures at the reactor inlet and outlet respectively, K.

## 4 Transient Process Characteristics

To simulate the production of acetylene with the oxidative natural gas pyrolysis using MATLAB & Simulink, the general scheme of the oxidative pyrolysis reactor, the

material balances for each reaction, the heat balance diagrams for the reaction and quenching zones are compiled [6].

Figures 2-4 show the general scheme of the oxidative pyrolysis reactor as well as the material balance model for the  $\text{CH}_4 + \text{O}_2 \rightarrow \text{CO} + \text{H}_2\text{O} + \text{H}_2$  equation and the corresponding material balance model for the  $\text{CH}_4$  component respectively. The equations of the rest material balances for the corresponding components of chemical reactions (1) – (4) are presented similarly.

Figure 5 shows the curves of concentration changes of the main components involved in the reactions of acetylene production with oxidative natural gas pyrolysis, % (vol.).

Figures 6 and 7 show the heat balance models of the reaction and ‘quenching’ zones respectively. The temperature change curves in the reaction and ‘quenching’ zones are shown in Fig. 8.

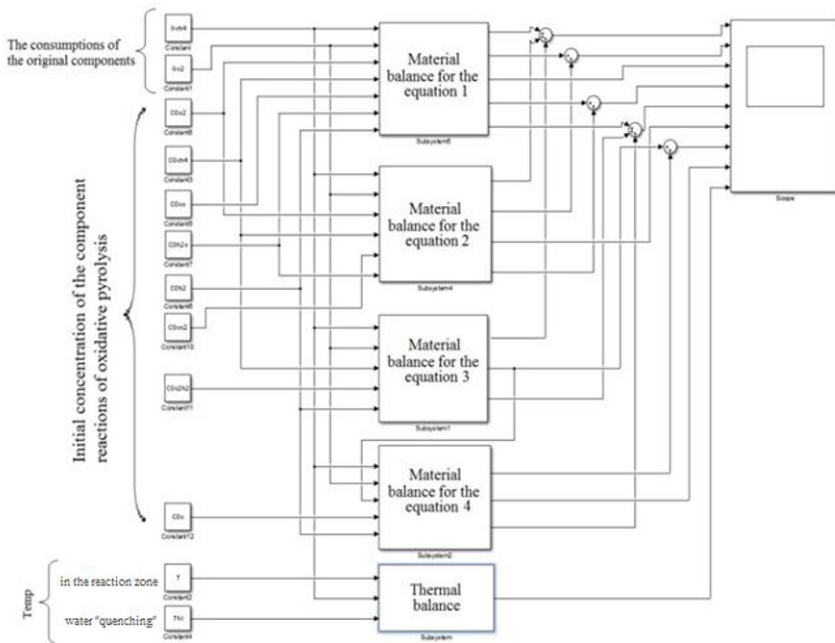

**Fig. 2.** General model of an oxidative pyrolysis reactor in Matlab

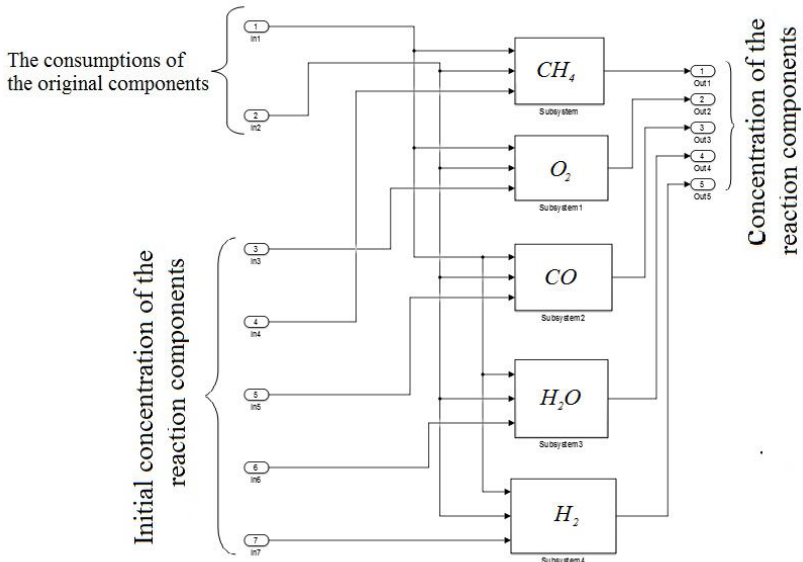

Fig. 3. Material balance model for  $CH_4 + O_2 \rightarrow CO + H_2O + H_2$  in Matlab

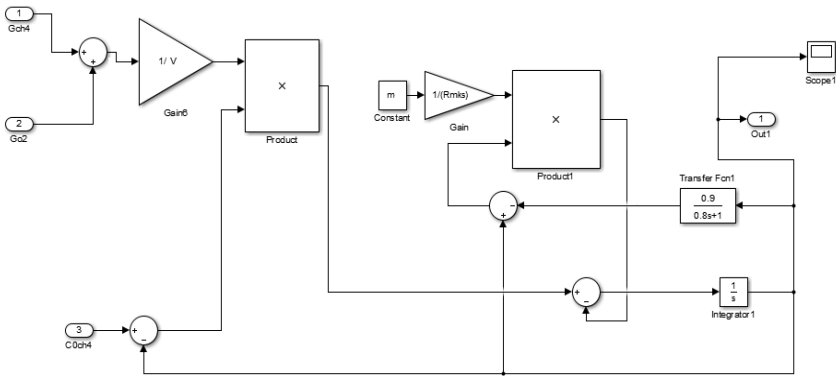

Fig. 4. Material balance model for  $CH_4$  in  $CH_4 + O_2 \rightarrow CO + H_2O + H_2$  in Matlab

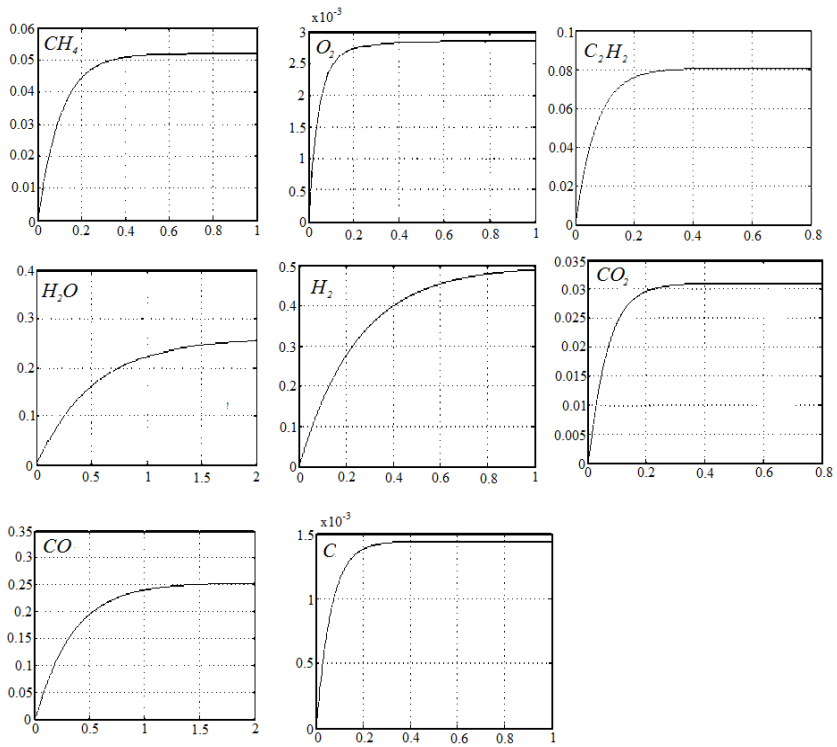

Fig. 5. Concentration-time curves of the main oxidative pyrolysis components, % (vol.), (s)

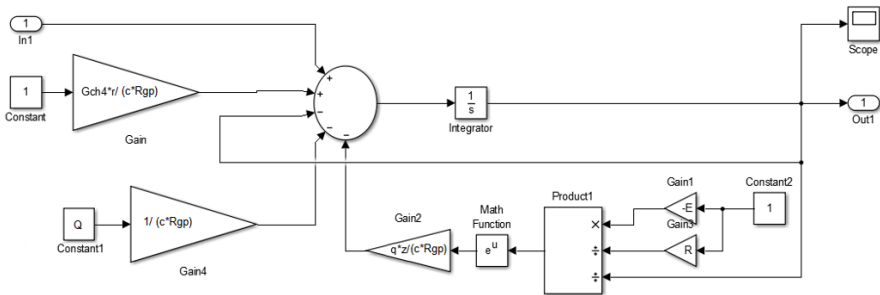

Fig. 6. Heat balance model of the reaction zone in Matlab

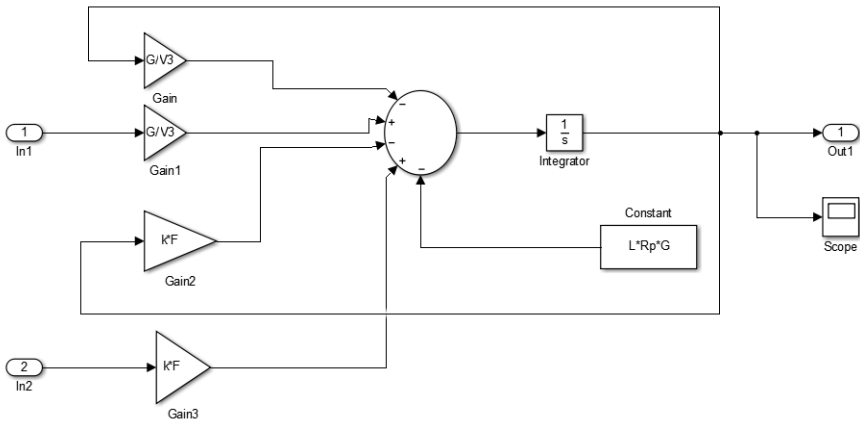

Fig. 7. Heat balance model of the 'quenching' zone in Matlab

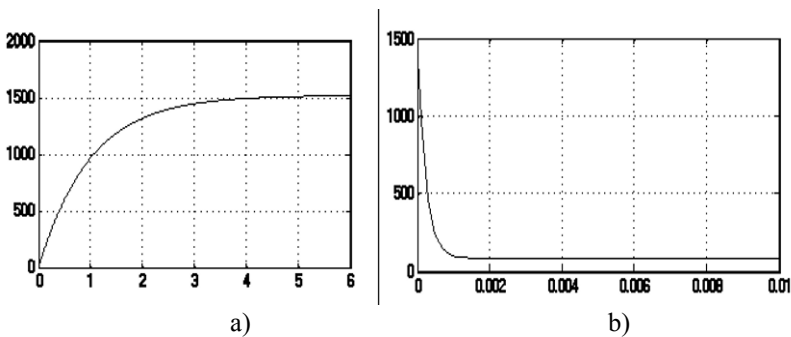

Fig. 8. Temperature-time curves, (OC), (s): a) in the reaction zone; b) in the 'quenching' zone

## 5 Model Verification

The model was verified with the work statistics of the pyrolysis department of Novomoskovsk JSC AZOT's acetylene shop. The static modes of the operating acetylene pyrolysis department and the modes obtained with the model were investigated. The verification results show the error did not exceed 5% which suggests that the model developed is appropriate and can be used to control the oxidative pyrolysis.

## 6 Conclusions

Based on the data analysis with the model developed we found that the acetylene content in the pyrolysis gas at the reactor outlet is mainly influenced by the preheating temperatures of the initial before-the reactor components and their consumption ratios.



The model developed can be used to solve uncertainties with a finite-difference approximation which will distinguish various process states as well as synthesize the control system of the oxidative pyrolysis in the acetylene production [7,8].

## Acknowledgments

The work was carried out with the financial support of the RFBR grant *Investigation of Risks in Controlling Dynamic Processes in Semi-Structured and Poorly Formalized Environments*, project No. 17-07-01368.

## References

1. Palyukh, B.V., Bogatikov, V.N., Oleinik, A.G., Alekseyev, V.V., Prorokov, A.E. New technologies for diagnosing states and managing the safety of industrial processes: a study guide for postgraduate and master's works. Tver, TvSTU (2012).
2. Mavlyankariev, S. Investigation of gas-phase methane oxidation by reactor profile measurements and microkinetic modeling. Berlin (2013).
3. Sanayeva, G.N., Prorokov, A.E., Bogatikov, V.N. Construction of a discrete model of the acetylene production with natural gas oxidative pyrolysis / Logistics and economics of resource-energy saving in industry (MNPК "LEREP-9-2015"). In: Collection of scientific papers on the materials of the IX International Scientific and Practical Conference LEREI-9-15, pp.105–109. Smolensk (2015).
4. Sanayeva, G.N., Prorokov, A.E., Bogatikov, V.N. Determination of the technological safety region and center of the acetylene production with natural gas oxidative pyrolysis / Logistics and economy of resource-saving in industry (MNPК "LEREP-9-2015"). In: Collection of scientific papers on the materials of the IX International Scientific and Practical Conference LEREI-9-15, pp.119–122. Smolensk (2015).
5. Elsayed Sallam, T. Medhat, A.Ghanem, M. E. Ali,"Handling Numerical Missing Values Via Rough Sets", International Journal of Mathematical Sciences and Computing (IJMSC), Vol.3, No.2, pp. 22-36, 2017.DOI: 10.5815/ijmsc.2017.02.03
6. Vent, D.P., Prorokov, A.E., Sanayeva, G.N., Toychkin, N.N., Palyukh, B.V., Semenov, N.N., Bogatikov, V.N., Alekseyev, V.V., Kemajkin, V.K. Mathematical models used in problems of diagnostics of technological systems. In: Software products, systems and algorithms, No. 3 (2015). <http://swsys-web.ru/mathematical-models-in-problems-of-diagnosis.html>. doi: 10.15827/2311-6749.16.160
7. Vijay Nehra,"MATLAB/Simulink Based Study of Different Approaches Using Mathematical Model of Differential Equations", International Journal of Intelligent Systems and Applications(IJISA), vol.6, no.5, pp.1- 24, 2014. DOI: 10.5815/ijisa.2014.05.01
8. Sanayeva, G.N., Prorokov, A.E., Bogatikov, V.N. On the possibility of using discrete models to diagnose the state of the acetylene production with natural gas oxidative pyrolysis. In: Energy, Information, Innovation-2015, vol. 1. Sections 1, 2, 3, 4, pp.225–228. Universum, Smolensk (2015).

# Development of a Piecewise Linear Model of the Oxidative Pyrolysis Process for the Control System Synthesis

G.N. Sanayeva<sup>1</sup>, A.E. Prorokov<sup>1</sup>, V.N. Bogatikov<sup>2</sup>

<sup>1</sup>Dmitri Mendeleev University of Chemical Technology of Russia, Novomoskovsk Institute (D. Mendeleev Branch), Novomoskovsk, Russia

<sup>2</sup>Tver State Technical University, Tver, Russia

**Abstract.** The efficiency of acetylene production by oxidative pyrolysis of natural gas substantially depends on compliance with the requirements to safety and effectiveness of functioning of the chemical and technological processes; wherefore there is a need for development of new approaches to diagnostics of states and to effective management of the considered process safety. For this purpose, functioning of chemical and technological process is considered as the sequential scheme of change of its states on some time interval. The condition of system in each instant is characterized by a set of process parameters. The area of process operating state is defined by sets of technological, design data and management parameters. For the processes in the oxidative pyrolysis reactor, for well-timed detection of the violations, leading to non-staff situations, according to the equations of the mass and heat balances, restrictions of piecewise linear models on the basis of a state division method are defined, and also the area and the center of safety are revealed. At emergence of any perturbations the center of safety can be displaced therefore the primal problem of a process control system consists of transfer of a management object to another state, steady from the point of view of ensuring technological safety, when maintaining of the required characteristics of the received product. With use of the received model the process control system of an oxidative pyrolysis is synthesized in which calculation of the technological safety center is carried out according to the criterion made taking into account a task power - and resource-saving. At the same time input data are the parameters received from objects of management concerning which the problem of non-linear programming for area definition and the safety center then proceeding from values of the revolting parameters values of settings for regulators are defined which develop the operating impacts on the corresponding actuation mechanisms.

**Keywords:** Oxidative pyrolysis, Acetylene, Piecewise linear model, Technological safety, Area of safety, Center of safety, Control system.

## 1 Introduction

The distinctive feature of safety systems of dynamic processes in weakly structured and poorly formalized environments of the industrial systems is complexity and

hierarchy of solving diagnostics problems for production processes security management. As a result, safety systems are man-machine systems consisting of informational subsystem of states diagnostics and a risk assessment of processes and their systems, and an organizational and technological subsystem of process safety control by the decision-maker. Complexity and hierarchy of the modern industrial and organizational complexes along with various informational technologies with information fields make the diagnostic procedures implementation and arising violations sources searching difficult.

It provides construction applicability of the special states assessment and violation diagnostics system for emergency and pre-emergency situations forecasting under performance of different chemical technology processes [1] which include acetylene production by oxidative pyrolysis of natural gas.

Production efficiency of acetylene an oxidative pyrolysis of natural gas substantially depends on compliance with the requirements to safety and effectiveness of functioning of the chemical and technological processes (CTP), wherefore there is a need for development of new approaches to diagnostics of states and to effective management of safety of an oxidative pyrolysis process.

Piecewise linear models give legible differentiation of system conditions; allow to consider both changes of technological duties and condition changes of devices and control systems of CTP; have higher operation speed action in comparison with the models constructed on the basis of the differential or algebraic equations. Besides, already at stages of piecewise linear models creation there is a possibility of a coordination problem solution of separate devices operation of the chemical and technological system (CTS), to judge what control system is to be like and to lay the foundation of CTS states diagnostics of and the creation of the management information system (MIS).

## **2 Total Characteristics of an Oxidative Pyrolysis Process**

Acetylene production by oxidative pyrolysis of natural gas falls into number of potentially dangerous chemical productions for which problems of states for safety definition in various situations arising in a production cycle are especially urgent. Technological safety thereof is interpreted by the functional property of the corresponding human-machine systems generally including: object of management; sources of dangers (technological process itself, processing equipment, control system) and potential victims of its harmful power and material emissions (as a rule, staff and environment) [2].

Technological safety is understood as a property of chemical and technological system to perform its functions without causing damage to an environment; to health of the production field stuff; to equipment and control system (CS); to cause any violations of chemical and technological process regulations (CTP) for the technological reasons capable to cause above called components of damage [1].

Incompleteness and ambiguity of information at oxidative pyrolysis process are caused by equipment characteristics change in the course of operation thereof

("coking up" of a number of elements), a vacillation in time of structure of reaction feed stock (natural gas and oxygen), a small residence time of a reaction mixture in the reaction zone, etc.

The technological process in the oxidative pyrolysis reactor (figure 1) consists of three stages [3]:

- hashing of initial components for pyrolysis reaction previously warmed up to  $650^{\circ}\text{C}$  in the reactor mixer;
- an oxidative pyrolysis in a reaction zone at a temperature about  $1500^{\circ}\text{C}$ ;
- "quench" (quick cooling) with water of reaction resultants (at reaction temperature acetylene is an unstable compound and can decompose into hydrogen and soot) for the purpose of cooling of the received pyrolysis gas up to the temperature below  $100^{\circ}\text{C}$ .

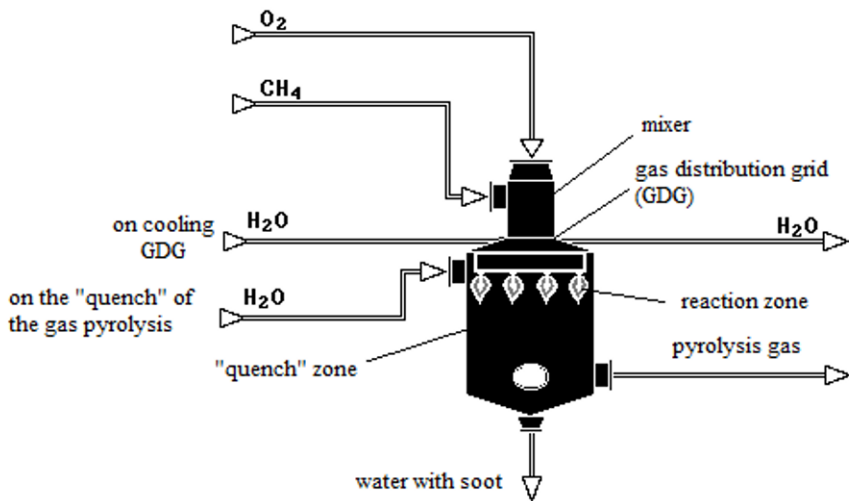

**Fig. 1.** The oxidative pyrolysis reactor

It should be noted that the amount of the acetylene received by a natural gas oxidative pyrolysis at outlet from the reactor depends on temperature of preheating and extent of reaction initial components hashing, and also on a ratio of their expenses.

Taking into account features of the considered process it is necessary to develop a special approach to its research suitable for the analysis of the experimental data and for obtaining of necessary information about influence of various technology factors on outlet and characteristics of processing products, and also for diagnostics of the considered process state [4].

To objectivate a possibility of a prediction of technological mode violations resulting in pre-emergency and emergency situations, the mathematical model is made including the mass and heat balances for each of stages of an oxidative pyrolysis process.

Creation of special system of state assessment and violations diagnostics using piecewise linear model of the specified process is expedient for the solution of technological safety increase of acetylene production.

### 3 Creation of Piecewise Linear Model of an Oxidative Pyrolysis Process

The main problem of efficient diagnostics system of acetylene preparation process by oxidative pyrolysis of natural gas is well-timed detection of the violations leading to emergency situations, and, to that effect, it is necessary to define the area of the safest technological process functioning in the normal mode, i.e. the area of the technological safety center [5].

At using piecewise linear approximation methods the functioning of an oxidative pyrolysis process is considered as the serial scheme of change of its states on some time interval  $(t_0, t_k)$ . The system state in each instant of  $t$  from this interval is characterized by a set of process parameters.

The rated modes area (area of operating state) of the process is defined by sets of technological, design data and management parameters. The technological process has restrictions of its functioning, and exceeding these restrictions means the process transition to an emergency situation. Thus, these restrictions "cut out" an  $n$ -dimensional area on a set of all conditions of process where the process does not result in emergency situations, i.e. the area of all operating states of process [1,5].

When using piecewise linear models for definition of safety area of oxidative pyrolysis process the system of the linear restrictions is received which play an important role in the monitoring organization of technological process state and on the basis of which classification of states of CTS is carried out. For a reaction zone by consideration of the main reaction of acetylene preparation  $2CH_4 = C_2H_2 + 3H_2$  the main restrictions of piecewise linear model have the appearance presented in table 1, where  $\rho$  – density,  $kg/m^3$ ;  $G$  – expense,  $m^3/c$ ;  $V_m, V_p, V_3$  – the volume of the mixer, the zone of reaction, the zone "trainings", respectively,  $m^3$ ;  $m_i$  – a molecular weight of a component  $i$ ,  $kg/mol$ ;  $C$  – concentration of a component, % (vol.);  $c$  – a thermal capacity of gas of a pyrolysis,  $J/(kg \cdot K)$ ;  $T$  – temperature,  $K$ ;  $k_i$  – a kinetic constant of chemical reaction,  $c^{-1}$ ;  $mix$  – methane and oxygen mix;  $PG$  – pyrolysis gas;  $W$  – water on "training";  $CH_4$  – methane;  $O_2$  – oxygen;  $C_2H_2$  – acetylene.

**Table 1.** Constitutive equations of the mass and heat balances and restriction of piecewise linear model for the oxidative pyrolysis reactor

Constitutive equations of system	Main restrictions of piecewise linear model
<p>Mixer: <math>V_{mix} \cdot d\rho_{mix}/dt = G_{CH_4} \cdot \rho_{CH_4} + G_{O_2} \cdot \rho_{O_2} - G_{mix} \cdot \rho_{mix}</math></p>	$G_{CH_4} \cdot \rho_{CH_4} + G_{O_2} \cdot \rho_{O_2} - G_{mix} \cdot \rho_{mix}^{min} > \Delta \rho_{mix}(k)$ $G_{CH_4} \cdot \rho_{CH_4} + G_{O_2} \cdot \rho_{O_2} - G_{mix} \cdot \rho_{mix}^{min} < \Delta \rho_{mix}(k)$
<p>Reaction zone: (for reaction <math>2 \cdot CH_4 = C_2H_2 + 3 \cdot H_2</math>):</p> <p><math>V_p \cdot \rho_{mix} \cdot (m_{CH_4}/m_{mix}) \cdot dC_{CH_4}/dt = G_{mix} \cdot \rho_{mix} \cdot (m_{CH_4}/m_{mix}) \cdot (C_{CH_4}^0 - C_{CH_4}) - A_{CH_4}(C_{CH_4}, C_{C_2H_2}, C_{H_2}, T);</math></p> <p><math>V_p \cdot \rho_{mix} \cdot (m_{C_2H_2}/m_{mix}) \cdot dC_{C_2H_2}/dt = G_{mix} \cdot \rho_{mix} \cdot (m_{C_2H_2}/m_{mix}) \cdot (C_{C_2H_2}^0 - C_{C_2H_2}) + A_{C_2H_2}(C_{CH_4}, C_{C_2H_2}, C_{H_2}, T);</math></p> <p><math>V_p \cdot \rho_{mix} \cdot (m_{H_2}/m_{mix}) \cdot dC_{H_2}/dt = G_{mix} \cdot \rho_{mix} \cdot (m_{H_2}/m_{mix}) \cdot (C_{H_2}^0 - C_{H_2}) + A_{H_2}(C_{CH_4}, C_{C_2H_2}, C_{H_2}, T);</math></p> <p><math>c \cdot \rho \cdot dT^{out}/dt = G_{CH_4} \cdot r_{CH_4} + c \cdot \rho \cdot (T^{in} - T^{600x}) - Q_3 - Q_5</math></p> <p><math>A_{CH_4}, A_{C_2H_2}, A_{H_2}</math> – change rate of quantity of the corresponding components of reaction</p>	$G_{mix} \cdot \rho_{CH_4}/m_{mix} \cdot C_{CH_4}^{in} - k_5 \cdot V_p \cdot (C_{CH_4}^0)^2 - (G_{mix} \cdot \rho_{CH_4}/m_{mix} - 2k_5 \cdot V_p \cdot C_{CH_4}^0) \cdot C_{CH_4}^{min} > \Delta C_{CH_4}(k);$ $G_{mix} \cdot \rho_{CH_4}/m_{mix} \cdot C_{CH_4}^{ex} - k_5 \cdot V_p \cdot (C_{CH_4}^0)^2 - (G_{mix} \cdot \rho_{CH_4}/m_{mix} - 2k_5 \cdot V_p \cdot C_{CH_4}^0) \cdot C_{CH_4}^{max} < \Delta C_{CH_4}(k);$ $G_{mix} \cdot \rho_{CH_4}/m_{mix} \cdot C_{C_2H_2}^{in} + k_5 \cdot V_p \cdot (C_{CH_4}^0)^2 - (G_{mix} \cdot \rho_{CH_4}/m_{mix} + k_5 \cdot V_p \cdot C_{C_2H_2}^0) \cdot C_{C_2H_2}^{min} > \Delta C_{C_2H_2}(k);$ $G_{mix} \cdot \rho_{CH_4}/m_{mix} \cdot C_{C_2H_2}^{ex} + k_5 \cdot V_p \cdot (C_{CH_4}^0)^2 - (G_{mix} \cdot \rho_{CH_4}/m_{mix} + k_5 \cdot V_p \cdot C_{C_2H_2}^0) \cdot C_{C_2H_2}^{max} < \Delta C_{C_2H_2}(k);$ $G_{mix} \cdot \rho_{CH_4}/m_{mix} \cdot C_{H_2}^{in} + k_5 \cdot V_p \cdot (C_{CH_4}^0)^2 - (G_{mix} \cdot \rho_{CH_4}/m_{mix} + k_5 \cdot V_p \cdot C_{H_2}^0) \cdot C_{H_2}^{min} > \Delta C_{H_2}(k);$ $G_{mix} \cdot \rho_{CH_4}/m_{mix} \cdot C_{H_2}^{ex} + k_5 \cdot V_p \cdot (C_{CH_4}^0)^2 - (G_{mix} \cdot \rho_{CH_4}/m_{mix} + k_5 \cdot V_p \cdot C_{H_2}^0) \cdot C_{H_2}^{max} < \Delta C_{H_2}(k);$ $((G_{CH_4} \cdot \rho_{CH_4} + G_{O_2} \cdot \rho_{O_2}) \cdot c \cdot T^{min} + G_{CH_4} \cdot r_{CH_4}) - G_{PG} \cdot c \cdot T^{max}_{PG} > \Delta T^{out}$ $((G_{CH_4} \cdot \rho_{CH_4} + G_{O_2} \cdot \rho_{O_2}) \cdot c \cdot T^{max} + G_{CH_4} \cdot r_{CH_4}) - G_{PG} \cdot c \cdot T^{min}_{PG} < \Delta T^{out}$
<p>Zone "trainings":</p> <p><math>c \cdot \rho \cdot V_3 \cdot dT^{out}_{PG}/dt = G_{PG} \cdot c \cdot \rho \cdot (T_{PG} - T^{out}_{PG}) - k \cdot F \cdot (T^{out}_{PG} - T^{out}_W) - G_{PG} \cdot \alpha \cdot \rho</math></p> <p><math>c_W \cdot \rho_W \cdot V_3 \cdot dT^{out}_W/dt = G_W \cdot c_W \cdot \rho_W \cdot (T^{in}_W - T^{out}_W) + k \cdot F \cdot (T^{out}_{PG} - T^{out}_W)</math></p>	$G_{PG} \cdot c \cdot \rho \cdot T_{PG} - G_{PG} \cdot \alpha \cdot \rho - k \cdot F \cdot T_W - (G_{PG} \cdot c \cdot \rho + k \cdot F) > c \cdot \rho \cdot \Delta T^{out}_{PG}$ $G_{PG} \cdot c \cdot \rho \cdot T^{(out)min}_{PG} - k \cdot F \cdot (T^{(out)min}_{PG} - T^{(out)max}_W) < \Delta c \cdot \rho \cdot \Delta T^{out}_{PG}$ $G^{min}_W \cdot c_W \cdot \rho_W \cdot (T^{in}_W - T^{out}_W) + k \cdot F \cdot (T_{PG} - T^{out}_W) > c_W \cdot \rho_W \cdot V_3 \cdot \Delta T^{out}_W$ $G^{max}_W \cdot c_W \cdot \rho_W \cdot (T^{in}_W - T^{out}_W) + k \cdot F \cdot (T_{PG} - T^{out}_W) < c_W \cdot \rho_W \cdot V_3 \cdot \Delta T^{out}_W$

The received ratios allow to predict gradual refusals being the result of deterioration in properties of the substances participating in CTP (for example, nonstationarity of composition of natural gas as one of initial components for reaction), properties of the

device (formation of soot on the surface of the reactor – "coking up"), etc. which lead to violation of the made restrictions and by that point to emergence of malfunctions in technological system [5].

#### 4 Scoping and Security Center the Oxidative Pyrolysis Process

The main problem of efficient diagnostics system and ensuring technological safety of an oxidative pyrolysis process is well-timed detection of the violations leading to emergency situations and, to that effect, it is necessary to define area of the safest functioning of technological process in the normal mode, i.e. the area of the technological safety center. For definition of safety area for a class of continuous technological processes including oxidative pyrolysis process, it is expedient to use state division method [6,8] allowing to list the possible not crossed areas of existence of variables of a state (table 1) on the basis of purely combinatorial search in the presence of restrictions of a type

$$x_{ik}^{(\min)} < x_i < x_{ik}^{(\max)}, (i=1, I; k=1, K_i), \quad (1)$$

where  $i$  – number of a variable of a state;  $k$  – number of a technological duty  $i$  of a variable, with any extent of differentiation.

The definition algorithm of the safety center area includes the following steps [2]:

*Step 1* – Determination of ranges of values of coefficients of a matrix  $A$  and the constant terms of  $b$  in which restrictions of a look are carried out

$$(X_{iq}^<, z) < 0, (i=1, \dots, I), \quad (2)$$

$$(X_{iq}^>, z) > 0, (i=1, \dots, I), \quad (3)$$

для  $x_{ik}^{(\min)} < x_i < x_{ik}^{(\max)}, (i=1, 2, \dots, I; k=1, 2, \dots, K_i)$ .

For this purpose, at the given restrictions  $x^{(\min)}$  and  $x^{(\max)}$  such ranges of change of system coefficients of  $a_{ij}^{(\min)}$  and  $a_{ij}^{(\max)}$  ( $i=1, I; j=1, I$ ), and also  $b_i^{(\min)}$  and  $b_i^{(\max)}$  ( $i=1, I$ ) should be found so that the system of restrictions (2)-(3) is fair.

*Step 2* – Formation of the purpose function. It is known from analytical geometry that the point deviation  $(x_1, y_1, z_1)$  from the plane, which is written down in the normalized look  $x \cos \alpha + y \cos \beta + z \cos \gamma + \rho = 0$  is equal:

$$d = x_1 \cos \alpha + y_1 \cos \beta + z_1 \cos \gamma - \rho$$

In this case coordinates of a point are formed by coefficients of a matrix  $A$  and the constant terms of  $b$ , and constant coefficients are the preset minimum and maximal values of variables of a state [7,8].

As a result the coefficients matrix  $A$  for the equation of reaction of acetylene preparation  $2CH_4 = C_2H_2 + 3H_2$  will take a form:

$$A = \begin{bmatrix} a_{11} & a_{12} & 0 \\ a_{21} & a_{22} & 0 \\ a_{31} & 0 & a_{33} \\ a_{41} & 0 & a_{43} \end{bmatrix},$$

where

$$a_{11} = -k \cdot V_r \cdot \left( 2 \cdot (C_{O_2}^0)^3 \cdot C_{CH_4}^0 \cdot (C_{CH_4})^{\max} + 3 \cdot (C_{O_2}^0)^2 \cdot (C_{CH_4}^0)^2 \cdot (C_{O_2})^{\max} - 4 \cdot (C_{O_2}^0)^3 \cdot (C_{CH_4}^0)^2 \right)$$

$$a_{12} = -k \cdot V_r \cdot \left( 2 \cdot (C_{O_2}^0)^3 \cdot C_{CH_4}^0 \cdot (C_{CH_4})^{\max} + 3 \cdot (C_{O_2}^0)^2 \cdot (C_{CH_4}^0)^2 \cdot (C_{O_2})^{\max} - 4 \cdot (C_{O_2}^0)^3 \cdot (C_{CH_4}^0)^2 \right)$$

$$a_{21} = -k \cdot V_r \cdot \left( 2 \cdot (C_{O_2}^0)^3 \cdot C_{CH_4}^0 \cdot (C_{CH_4})^{\min} + 3 \cdot (C_{O_2}^0)^2 \cdot (C_{CH_4}^0)^2 \cdot (C_{O_2})^{\min} - 4 \cdot (C_{O_2}^0)^3 \cdot (C_{CH_4}^0)^2 \right)$$

$$a_{22} = -k \cdot V_r \cdot \left( 2 \cdot (C_{O_2}^0)^3 \cdot C_{CH_4}^0 \cdot (C_{CH_4})^{\min} + 3 \cdot (C_{O_2}^0)^2 \cdot (C_{CH_4}^0)^2 \cdot (C_{O_2})^{\min} - 4 \cdot (C_{O_2}^0)^3 \cdot (C_{CH_4}^0)^2 \right)$$

$$a_{31} = -V_r \cdot \left( 4 \cdot k \cdot (C_{CH_4}^0)^3 \cdot C_{CH_4}^{\max} - 3 \cdot k \cdot (C_{CH_4}^0)^4 \right)$$

$$a_{41} = V_r \cdot \left( 4 \cdot k \cdot (C_{CH_4}^0)^3 \cdot C_{CH_4}^{\min} - 3 \cdot k \cdot (C_{CH_4}^0)^4 \right)$$

$$a_{33} = (G_{C_2H_4}^{out})^{\min} + V_r \cdot \left( 4 \cdot k \cdot (C_{CH_4}^0)^3 \cdot C_{CH_4}^{\max} - 3 \cdot k \cdot (C_{CH_4}^0)^4 \right)$$

$$a_{43} = (G_{C_2H_4}^{out})^{\max} - V_r \cdot \left( 4 \cdot k \cdot (C_{CH_4}^0)^3 \cdot C_{CH_4}^{\min} - 3 \cdot k \cdot (C_{CH_4}^0)^4 \right)$$

In designations of formulas (2)-(3) ( $X_{iq}^<, z < 0$ , ( $i=1, \dots, J$ ) и ( $X_{iq}^>, z > 0$ , ( $i=1, \dots, J$ ), this compliance is as follows:  $x_{iq}^<$  vectors – are formed by minimum and maximal values of variables of a state;  $z$  – are formed by coefficients of a matrix  $A$ .

The target function is formed according to the following algorithm:

1. a point is to be chosen of the possible range of variables  $z$ ;
2. reduction of the restriction equations to a normal look is carried out;
3. the point  $d_i$  deviation from border  $i$  is defined;
4. if the deviation of  $d_i$  is negative, coefficients with which this function is included into criterion reverse their sign. Thus, not the sum of deviations is formed-in target function, but the sum of distances;
5. if the deviation of  $d_i$  is positive, coefficients with which this function is included into criterion do not reverse their sign;
6. points 3-5 repeat until signs of deviations are defined to all borders.

Step 3 – the solution of a problem of non-linear programming:

$$\sum_{i=1}^{i=J} d_i(\bar{z}) \rightarrow \max$$



at restrictions (2) - (3), and also  $z_{\min} < z < z_{\max}$ .

The received decision determines the coordinates of the safety center in case of an equivalence of borders. If borders are not equivalent, it is necessary to enter weights for  $d_i(\bar{z})$ .

In the analysis of data received as a result of calculations under the received model it is revealed that parameters of output technological streams can only be controlled, and their control is exercised only due to change of values of input technological parameters. i.e. expenses and temperature. In this regard the presented piecewise linear model allows to carry out at change of value of any data recalculation of other input data at stabilization of values of output data in the field of the center of technological safety. For example, at change of methane consumption at pyrolysis reaction recalculation of a consumption of oxygen on reaction and natural gas on a heater torch is made, and also a recalculation of water discharge on pyrolysis gas "training" for the purpose of maintaining of output data values in the required range.

## 5 Synthesis of a Control System of an Oxidative Pyrolysis Process

At any perturbatopns the center of safety can be displaced, and therefore the main problem of a process control system consists of transfer a management object to another state, steady from the point of view of ensuring technological safety, with maintaining of the required characteristics of the received product. Thus maintaining of process in the field of the safety center ensures, among other things, its course as optimum from the point of view of power- and resource-saving.

The efficiency of acetylene production by an oxidative pyrolysis of natural gas substantially depends on rational expenditure of the used material and energy resources. The control system of acetylene receiving process (figure 2) includes, among other things, a heater of initial components for reaction (H) and an oxidative pyrolysis reactor (R).

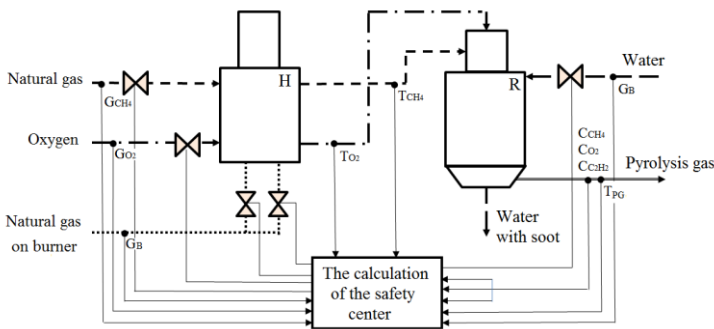

Fig. 2. The control system of acetylene receiving process

In the considered control system, the following *management contours* are allocated: maintaining of a expense ratio of initial components for reaction; temperature control of initial components before the reactor; flow control of water on pyrolysis gas "training".

*The operating parameters* of a control system are expenses of natural gas and oxygen, ( $G_{CH_4}$  and  $G_{O_2}$ ); a water discharge on "training" of pyrolysis gas, ( $G_w$ ).

As *the revolting parameters* are marked out concentration of  $C_2H_2$ ,  $O_2$  and  $CH_4$  on the reactor output, ( $C_{C_2H_2}$ ,  $C_{O_2}$ ,  $C_{CH_4}$ ); pyrolysis gas temperature on the reactor output, ( $T^{out}$ ).

In the considered scheme calculation of the center of technological safety is carried out according to the criterion made taking into account a task power and resource saving. At the same time input data are the parameters received from management objects in regard of which the problem of non-linear programming for definition of area and the center of safety is solved. Furthermore, proceeding from values of the revolting parameters, values of settings for regulators are defined which, in turn, develop the operating impacts on the corresponding actuation mechanisms.

## 6 Conclusions

The oxidative pyrolysis process model is developed as a result of method of division of states use, and also its process safety area is defined under normal operating conditions. It allows to trace emergency-producing capacity and to carry out this process in the most efficient way both in terms of receiving acetylene as a product of natural gas oxidative pyrolysis process, and environmental (emissions of harmful and dangerous substances in aqueous medium and the atmosphere) and maintenance staff impact mitigation.

## Acknowledgment

The paper is performed with the financial support of the Russian Federal Property Fund grant on the subject "Risks research through dynamic processes control in weakly structured and poorly formalized environments", the project No. 17-07-01368.

## References

1. Palyukh B.V., Bogatikov V.N., Oleinik A.G., Alekseev V.V., Prorokov A.E. New technologies for diagnosing states and managing the safety of industrial processes: a methodical guide for postgraduate and master's works. Tver: TvSTU, 2012. 72 p.
2. Investigation of Gas-Phase Methane Oxidation by Reactor Pro-Measurements and Microkinetic Modeling. Sardor Mavlyankariev aus Taschkent, zur Erlangung des akademischen Grades Doktor der Ingenieurwissenschaften - Dr. Ing. -Usbekistan. Berlin 2013. - 166 r.
3. Sanaeva G.N., Prorokov A.E., Bogatikov V.N. Construction of a discrete model of the process of acetylene production by oxidative pyrolysis of natural gas / Logistics

- and economics of resource-energy saving in industry (MNPК "LEREP-9-2015"). Collection of scientific papers on the materials of the IX International Scientific and Practical Conference LEREI-9-15. - Smolensk, 2015. P.105-109
4. Sanaeva G.N., Prorokov A.E., Bogatkov V.N. About definition of the region and the center of technological safety of the process of acetylene production by oxidative pyrolysis of natural gas / Logistics and economy of resource-saving in industry (MNPК "LEREP-9-2015"). Collection of scientific papers on the materials of the IX International Scientific and Practical Conference LEREI-9-15. - Smolensk, 2015. P.119-122
  5. Vent D.P., Prorokov A.E., Sanaeva G.N., Toychkin N.N., Palyukh B.V., Semenov N.N., Bogatkov V.N., Alekseev V.V., Kemajkin V.K. Mathematical models used in problems of diagnostics of technological systems [electronic resource] / Electronic scientific journal "Software products, systems and algorithms", 2015. - №3 (14.08. 2015). URL: <http://swwsys-web.ru/mathematical-models-in-problems-of-diagnosis.html> (date of circulation: 06/01/2016)
  6. Sanaeva G.N., Prorokov A.E., Bogatkov V.N. On the possibility of using discrete models to diagnose the state of the process of obtaining acetylene by oxidative pyrolysis of natural gas / Energy, Information, Innovation-2015 - EII-2015. November 26-27, 2015, Smolensk. In 2 volumes - Smolensk: Universum, 2015. Volume 1. Sections 1,2,3,4. P.225-228
  7. Qi Wang, Fenglian Fu, "Variational Iteration Method for Solving Differential Equations with Piecewise Constant Arguments", I.J. Engineering and Manufacturing, 2012, 2, 36-43. I.J. Engineering and Manufacturing(IJEM), vol.2, no.2, pp.36-43, 2012. DOI: 10.5815/ijem.2012.02.06
  8. Sekhri Larbi, Haffaf Hafid, "Linear Hybrid Automaton Generation Using Mapping Algorithm for Hybrid Dynamic Systems", International Journal of Information Technology and Computer Science(IJITCS), vol.6, no.10, pp.1-10, 2014. DOI: 10.5815/ijitcs.2014.10.01

# Author Index

## A

Anosov, S.S., 238

## B

Balonin, Nikolay A., 39  
Baybulatov, A.A., 104  
Bazhenov, Ruslan I., 314  
Bogatikov, V.N., 323, 333  
Bolshakov, A.M., 157

## C

Chen, Daojun, 79

## D

Dontsov, V.I., 157

## E

Eremenko, Yuri I., 284  
Eremeykin, P.A., 259

## F

Fimmel, E., 14

## G

Gavriushin, S.S., 259  
Glushchenko, Anton I., 284  
Gorshkov, V.V., 215  
Gromyko, V.I., 238  
Gumbel, M., 14  
Guo, Hu, 79  
Gur'ev, A.S., 198

## H

Hai, Han, 53  
Hazina, Ludmila, 2  
He, Matthew X., 23  
Hu, Wenbin, 134  
Hu, Z.B., 23  
Huang, Liang, 120

## K

Kazaryan, V.P., 238  
Kemaykin, V.K., 248  
Khazova, A.S., 215  
Klimenko, B., 274  
Klyushin, A. Yu., 293  
Koganov, A.V., 68  
Kolesnikov, A.V., 229  
Kozlova, Yu.G., 248  
Kraeva, L.A., 198  
Kravchenko, Daniil, 93  
Kravchenko, Yury, 93  
Krut'ko, V.N., 157  
Kursityis, Ilona, 93  
Kuznetsov, V.N., 293  
Kuznetsova, O. Yu., 198

## L

Lee, Moon Ho, 53  
Lee, Sung Kook, 53  
Li, Chenkun, 79  
Listopad, S.V., 229  
Lv, Qiansu, 120

## M

Mamikonova, O.A., 157  
Markova, A.M., 157  
Mazurov, M., 182  
Meshkov, V.V., 248  
Molodchenkov, A.I., 157  
Mutovkina, N. Yu., 293, 303

## N

Natallia, Ivaniuk, 176

## P

Paliukh, B.V., 248  
Pecheykina, M., 266  
Petoukhov, Sergey V., 39

Petoukhov, Sergey, 2  
 Petoukhov, Sergey V., 53  
 Petrov, Vladislav A., 284  
 Petukhova, Elena, 2  
 Potemkina, N.S., 157  
 Prorokov, A.E., 323, 333

**R**

Rakcheeva, T., 147, 207  
 Rakcheeva, T.A., 68  
 Rakov, D., 266, 274  
 Rastopov, S.F., 198  
 Rumovskaya, S.B., 229  
 Rusanova, E.V., 198  
 Rustembekova, S.A., 215

**S**

Sanayeva, G.N., 323, 333  
 Sayapin, Sergey N., 166  
 Sedov, Viktor A., 314  
 Sedova, Nelly A., 314  
 Senkov, Aleksey, 113  
 Sergeev, Mikhail B., 39  
 Sharipova, M.M., 215  
 Silova, Tamara, 2  
 Simakin, A.G., 238  
 Smirnov, I.V., 157  
 Sorokin, Evgenii, 113  
 Stepanyan, Ivan, 2

Strümgmann, L., 14  
 Svirin, Vitaliy, 2

**T**

Thorbeck, J., 266  
 Ting, Cui, 79

**V**

Vasilenko, I.A., 198  
 Vasilyev, N.S., 238  
 Verbov, V.N., 198  
 Vladimir, Karimov, 176  
 Volkov, A. Yu., 198

**W**

Wang, Xunting, 79  
 Wei, Daqian, 120

**Y**

Yang, Tao, 120  
 Yatchenko, E., 207  
 Yuan, Quan, 134

**Z**

Zahar, Ponimash, 176  
 Zhang, Lei, 79  
 Zhao, LiJin, 120  
 Zhargalova, A.D., 259  
 Zhou, Nianguang, 79