

Analysis and Design of Reinforced Concrete Bridge Structures

Reported by Joint ACI-ASCE Committee 343

John H. Clark
Chairman

Hossam M. Abdou
John H. Allen
Gerald H. Anderson
F. Arbabi
Craig A. Ballinger
James M. Barker
Ostap Bender
T. Ivan Campbell
Jerry Cannon
Claudius A. Carnegie
John L. Carrato
Gurdial Chadha
W. Gene Corley
W. M. Davidge
H. Everett Drugge
William H. Epp
Noel J. Everard
Anthony L. Felder

Om P. Dixit
Vice Chairman

Ibrahim A. Ghais
Amin Ghali
Joseph D. Gliken
C. Stewart Gloyd
Nabil F. Grace
Hidayat N. Grouni
C. Donald Hamilton
Allan C. Harwood
Angel E. Herrera
Thomas T. C. Hsu
Ti Huang
Ray W. James
Richard G. Janecek
David Lanning
Richard A. Lawrie
James R. Libby
Clellon L. Loveall
W. T. McCalla

Antoine E. Naaman
Andrzej S. Nowak
John C. Payne
Paul N. Roschke
M. Saiid Saiidi
Bal K. Sanan
Harold R. Sandberg
John J. Schemmel
A. C. Scordelis
Himat T. Solanki
Steven L. Stroh
Sami W. Tabsh
Herman Tachau
James C. Tai
Marius B. Weschsler
J. Jim Zhao

These recommendations, reported by the joint ACI-ASCE Committee 343 on Concrete Bridge Design, provide currently acceptable guidelines for the analysis and design of reinforced, prestressed, and partially prestressed concrete bridges based on the state of the art at the time of writing the report. The provisions recommended herein apply to pedestrian bridges, highway bridges, railroad bridges, airport taxiway bridges, and other special bridge structures. Recommendations for Transit Guideways are given in ACI 358R.

The subjects covered in these recommendations are: common terms; general considerations; materials; construction; loads and load combinations; preliminary design; ultimate load analysis and strength design; service load analysis and design; prestressed concrete; superstructure systems and elements; substructure systems and elements; precast concrete; and details of reinforcement.

The quality and testing of materials used in construction are covered by reference to the appropriate AASHTO and ASTM standard specifications. Welding of reinforcement is covered by reference to the appropriate AWS standard.

Keywords: admixtures; aggregates; anchorage (structural); beam-column frame; beams (supports); **bridges (structures)**; cements; cold weather construction; columns (supports); combined stress; composite construction (concrete and steel); composite construction (concrete to concrete); compressive strength; **concrete construction**; concretes; concrete slabs;

ACI Committee Reports, Guides, Standard Practices, and Commentaries are intended for guidance in planning, designing, executing, and inspecting construction. This document is intended for the use of individuals who are competent to evaluate the significance and limitations of its content and recommendations and who will accept responsibility for the application of the material it contains. The American Concrete Institute disclaims any and all responsibility for the stated principles. The Institute shall not be liable for any loss or damage arising therefrom.

Reference to this document shall not be made in contract documents. If items found in this document are desired by the Architect/Engineer to be a part of the contract documents, they shall be restated in mandatory language for incorporation by the Architect/Engineer.

construction joints; **construction materials**; continuity (structural); cover; curing; deep beams; deflection; earthquake-resistant structures; flexural strength; footings; **formwork (construction)**; frames; hot weather construction; **inspection**; lightweight concretes; **loads (forces)**; mixing; mixture proportioning; modulus of elasticity; moments; **placing**; **precast concrete**; prestressed concrete; prestressing steels; **quality control**; **reinforced concrete**; reinforcing steels; **serviceability**; shear strength; spans; **specifications**; splicing; strength; **structural analysis**; **structural design**; T-beams; torsion; ultimate strength method; water; welded-wire fabric.

Note: In the text, measurements in metric (SI) units in parentheses follow measurements in inch-pound units. Where applicable for equations, equations for metric (SI) units in parentheses follow equations in inch-pound units.

CONTENTS

Chapter 1—Definitions, notation, and organizations, p. 343R-4

- 1.1—Introduction
- 1.2—Definitions
- 1.3—Notation
- 1.4—Referenced organizations

ACI 343R-95 became effective Mar. 1, 1995 and supersedes ACI 343R-88. For the 1995 revision, Chapters 6 and 12 were rewritten.

Copyright © 1995, American Concrete Institute.

All rights reserved including rights of reproduction and use in any form or by any means, including the making of copies by any photo process, or by any electronic or mechanical device, printed or written or oral, or recording for sound or visual reproduction or for use in any knowledge or retrieval system or device, unless permission in writing is obtained from the copyright proprietors.

Chapter 2-Requirements for bridges, p. 343R-12

- 2.1-Introduction
- 2.2-Functional considerations
- 2.3-Esthetic considerations
- 2.4-Economic considerations
- 2.5-Bridge types
- 2.6-Construction and erection considerations
- 2.7-Legal considerations

Chapter 3-Materials, p. 343R-26

- 3.1-Introduction
- 3.2-Materials
- 3.3-Properties
- 3.4-Standard specifications and practices

Chapter 4-Construction considerations, p. 343R-37

- 4.1-Introduction
- 4.2-Restrictions
- 4.3-Goals
- 4.5-Site characteristics
- 4.6-Environmental restrictions
- 4.7-Maintenance of traffic
- 4.8-Project needs
- 4.9-Design of details
- 4.10-Selection of structure type
- 4.11-Construction problems
- 4.12-Alternate designs
- 4.13-Conclusions

Chapter 5-Loads and load combinations, p. 343R-51

- 5.1-Introduction
- 5.2-Dead loads
- 5.3-Construction, handling, and erection loads
- 5.4-Deformation effects
- 5.5-Environmental loads
- 5.6-Pedestrian bridge live loads
- 5.7-Highway bridge live loads
- 5.8-Railroad bridge live loads
- 5.9-Rail transit bridge live loads
- 5.10-Airport runway bridge loads
- 5.11-Pipeline and conveyor bridge loads
- 5.12-Load combinations

Chapter 6-Preliminary design, p. 343R-66

- 6.1-Introduction
- 6.2-Factors to be considered
- 6.3-High priority items
- 6.4-Structure types
- 6.5-Superstructure initial section proportioning
- 6.6-Abutments
- 6.7-Piers and bents
- 6.8-Appurtenances and details
- 6.9-Finishes

Chapter 7-Strength design, p. 343R-79

- 7.1-Introduction
- 7.2-Considerations for analysis, design, and review

7.3-Strength requirements

Chapter 8-Service load analysis and design, 343R-96

- 8.1-Basic assumptions
- 8.2-Serviceability requirements
- 8.3-Fatigue of materials
- 8.4-Distribution of reinforcement in flexural members
- 8.5-Control of deflections
- 8.6-Permissible stresses for prestressed flexural members
- 8.7-Service load design
- 8.8-Thermal effects

Chapter 9-Prestressed concrete, p. 343R-102

- 9.1-Introduction
- 9.2-General design consideration
- 9.3-Basic assumptions
- 9.4-Flexure, shear
- 9.5-Permissible stresses
- 9.6-Prestress loss
- 9.7-Combined tension and bending
- 9.8-Combined compression and bending
- 9.9-Combination of prestressed and nonprestressed reinforcement-partial prestressing
- 9.10-Composite structures
- 9.11-Crack control
- 9.12-Repetitive loads
- 9.13-End regions and laminar cracking
- 9.14-Continuity
- 9.15-Torsion
- 9.16-Cover and spacing of prestressing steel
- 9.17-Unbonded tendons
- 9.18-Embedment of pretensioning strands
- 9.19-Concrete
- 9.20-Joints and bearings for precast members
- 9.21-Curved box girders

Chapter 10-Superstructure systems and elements, p. 343R-113

- 10.1-Introduction
- 10.2-Superstructure structural types
- 10.3-Methods of superstructure analysis
- 10.4-Design of deck slabs
- 10.5-Distribution of loads to beams
- 10.6-Skew bridges

Chapter 11-Substructure systems and elements, p. 343R-123

- 11.1-Introduction
- 11.2-Bearings
- 11.3-Foundations
- 11.4-Hydraulic requirements
- 11.5-Abutments
- 11.6-Piers
- 11.7-Pier protection

Chapter 12-Precast concrete, p. 343R-142

- 12.1-Introduction

12.2-Precast concrete superstructure elements
12.3-Segmental construction
12.4-Precast concrete substructures
12.5-Design
12.6-Construction

Chapter 13-Details of reinforcement for design and construction, p. 343R-149

13.1-General
13.2-Development and splices of reinforcement

13.3-Lateral reinforcement for compression members
13.4-Lateral reinforcement for flexural members
13.5-Shrinkage and temperature reinforcement
13.6-Standard hooks and minimum bend diameters
13.7-Spacing of reinforcement
13.8-Concrete protection for reinforcement
13.9-Fabrication
13.10-Surface conditions of reinforcement
13.11-Placing reinforcement
13.12-Special details for columns

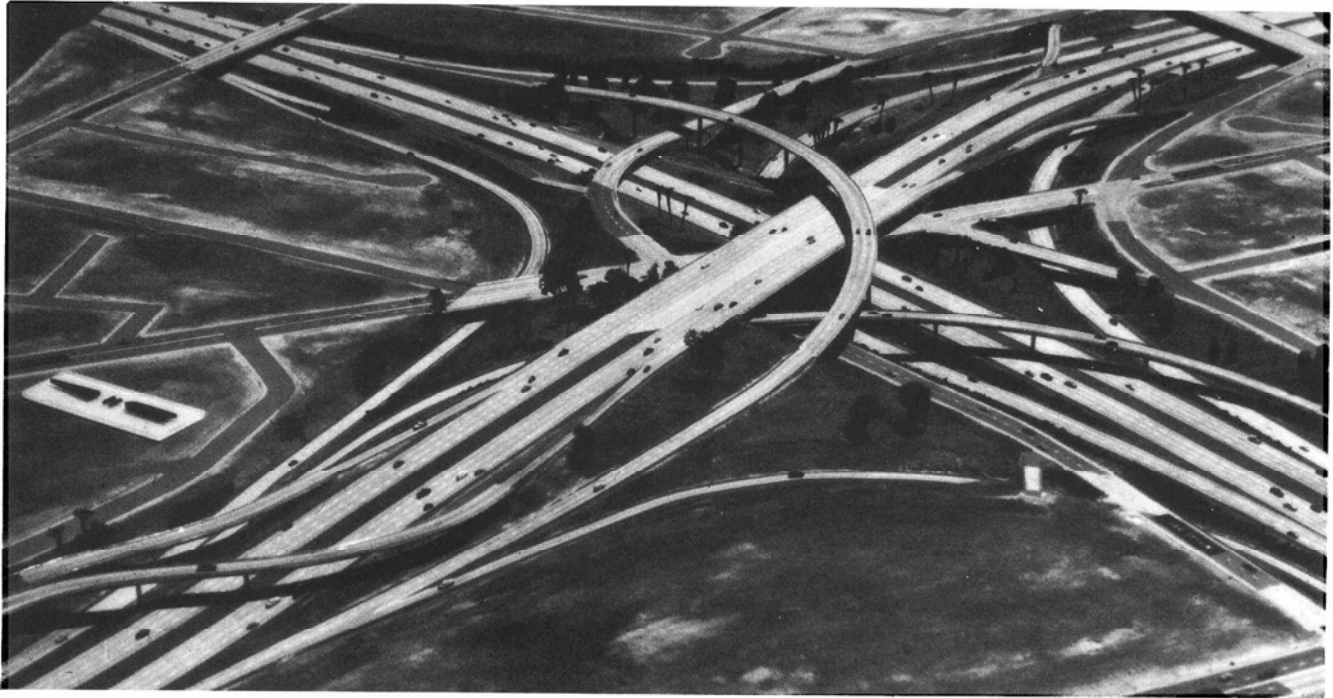

Complex highway interchange in California with fifteen bridge structures

CHAPTER 1-DEFINITIONS, NOTATION, AND ORGANIZATION

1.1-Introduction

This chapter provides currently accepted definitions, notation, and abbreviations particular to concrete bridge design practice which have been used in the preparation of this document.

Concrete bridge types commonly in use are described separately in Chapter 2, Requirements for Bridges, in Chapter 6,

1.2-Definitions

For cement and concrete terminology already defined, ref. ACI 116R. Terms not defined in ACI 116R or defined differently from ACI 116R are defined for specific use in this document as follows:

Aggregate, normal weight-Aggregate with combined dry, loose weight, varying from 110 lb. to 130 lb/ft³ (approximately 1760 to 2080 kg/m³).

Compressive strength of concrete (f'_c)—Specified compressive strength of concrete in pounds per square inch (psi) or (MPa).

Wherever this quantity is under a radical sign, the square root of the numerical value only is intended and the resultant is in pounds per square inch (psi) or (MPa).

Concrete, heavyweight-A concrete having heavy-weight aggregates and weighing after hardening over 160 lb/ft³ (approximately 2560 kg/m³).

Concrete, shrinkage-compensating-An expansive cement concrete in which expansion, if restrained, induces

compressive strains that are intended to approximately offset tensile strains in the concrete induced by drying shrinkage.

Concrete, structural lightweight-Concrete containing lightweight aggregate having unit weight ranging from 90 to 115 lb/ft³ (1440 to 1850 kg/m³). In this document, a lightweight concrete without natural sand is termed "all-lightweight concrete," and lightweight concrete in which all fine aggregate consists of normal weight sand is termed "sand-lightweight concrete."

Design load-Applicable loads and forces or their related internal moments and forces used to proportion members. For service load analysis and design, design load refers to loads without load factors. For ultimate load analysis and strength design, design load refers to loads multiplied by appropriate load factors.

Effective prestress-The stress remaining in concrete due to prestressing after all losses have occurred, excluding the effect of superimposed loads and weight of member.

Load, dead-The dead weight supported by a member (without load factors).

Load, live—The live load specified by the applicable document governing design (without load factors).

Load, service-Live and dead loads (without load factors).

Plain reinforcement-Reinforcement without surface deformations, or one having deformations that do not conform to the applicable requirements for deformed reinforcement.

Pretensioning-A method of prestressing in which the tendons are tensioned before the concrete is placed.

Surface water-Water carried by an aggregate except that held by absorption within the aggregate particles themselves.

1.3-Notation

Preparation of notation is based on ACI 104R. Where the same notation is used for more than one term, the uncommonly used terms are referred to the Chapter in which they are used. The following notations are listed for specific use in this report:

- a = depth of equivalent rectangular stress block
- a = constant used in estimating unit structure dead load (Chapter 5)
- a = compression flange thickness (Chapter 7)
- a_b = depth of equivalent rectangular stress block for balanced conditions
- a_t = fraction of trucks with a specific gross weight
- a_s = ratio of stiffness of shearhead arm to surrounding composite slab section
- A = effective tension area of concrete surrounding the main tension reinforcing bars and having the same centroid as that reinforcement, divided by the number of bars, or wires. When the main reinforcement consists of several bar or wire sizes, the number of bars or wires should be computed as the total steel area divided by the area of the largest bar or wire used
- Δ = axial load deformations and rib shortening used in connection with t-loads (Chapter 5)
- A_b = area of an individual bar
- A_c = area of core of spirally reinforced compression member measured to the outside diameter of the spiral
- A_e = area of longitudinal bars required to resist torsion
- A_e = effective tension area of concrete along side face of member surrounding the crack control reinforcement (Chapter 8)
- A_f = area of reinforcement required to resist moment developed by shear on a bracket or corbel
- A_g = gross area of section
- A_h = area of shear reinforcement parallel to flexural tension reinforcement
- A_t = total area of longitudinal reinforcement to resist torsion
- A_n = area of reinforcement in bracket or corbel resisting tensile force N_{ur}
- A_{px} = area of prestressed reinforcement in tension zone
- A_s = area of tension reinforcement
- A_s' = area of compression reinforcement
- A_{su} = area of bonded reinforcement in tension zone
- A_{se} = area of stirrups transverse to potential bursting crack and within a distance s_c
- A_{sf} = area of reinforcement to develop compressive strength of overhanging flanges of I- and T-sections
- A_{sh} = total area of hoop and supplementary cross ties in rectangular columns

A_{st} = total area of longitudinal reinforcement (in compression members)

A_t = area of one leg of a closed stirrup resisting torsion within a distance s

A_v = area of shear reinforcement within a distance s , or area of shear reinforcement perpendicular to flexural tension reinforcement within a distance s , for deep flexural members

A_{vf} = area of shear-friction reinforcement

A_{vh} = area of shear reinforcement parallel to the flexural tension reinforcement within a distance s_2

A_w = area of an individual wire

A_1 = loaded area, bearing directly on concrete

A_2 = maximum area of the portion of the supporting surface that is geometrically similar to, and concentric with, the loaded area

b = width of compressive face of member

b = constant used in estimating unit structure dead load (Chapter 5)

b = width or diameter of pier at level of ice action (Chapter 5)

b = width of web (Chapter 6)

b = width of section under consideration (Chapter 7)

b_e = width of concrete section in plane of potential bursting crack

b_o = periphery of critical section for slabs and footings

b_v = width of the cross section being investigated for horizontal shear

b_w = web width, or diameter of circular section

B = buoyancy

c = distance from extreme compressive fiber to neutral axis

C = construction, handling, and erection loads (Chapter 5)

C = stiffness parameter used in connection with lateral distribution of wheel loads to multibeam precast concrete bridges (Chapter 10)

C = ultimate creep coefficient (Chapter 5)

C_a = indentation coefficient used in connection with ice forces

C_e = exposure coefficient used in connection with wind forces

C_i = coefficient for pier inclination from vertical

C_m = factor used in determining effect of bracing on columns (Chapter 7)

C_r = factor relating shear and torsional stress properties equal to b_w times d divided by the summation of x^2 times y

C_t = creep deformation with respect to time (Chapter 5)

C_u = ultimate creep deformation (Chapter 5)

C_u = ultimate creep coefficient

C_w = shape factor relating to configuration of structure and magnitude of wind force on structure

CF = centrifugal force

d = distance from extreme compressive fiber to centroid of tension reinforcement

d = depth of section under consideration (Chapter 7)

d = depth of girder (Chapter 5)

d'	= distance from extreme compressive fiber to centroid of compression reinforcement	f_{citr}	= concrete stress immediately after transfer at center of gravity of prestressing steel
d_b	= nominal diameter of bar, wire, or prestressing strand	f_{cp}	= concrete bearing stress under anchor plate of post-tensioning tendon
d_c	= thickness of concrete cover measured from the extreme tensile fiber to the center of the bar located closest thereto	f_{ct}	= average splitting tensile strength of lightweight aggregate concrete
d_p	= effective depth of prestressing steel (Chapter 7)	f_f	= stress range
d_s	= effective depth for balanced strain conditions (Chapter 7)	f_i	= stress produced by i th loading (Chapter 5)
d_u	= effective depth used in connection with prestressed concrete members (Chapter 7)	f_{ic}	= loss in prestressing steel stress due to creep
D	= dead load	f_{ie}	= loss in prestressing steel stress due to elastic shortening
D	= diameter of lead plug in square or circular isolation bearing (Chapter 11)	f_{if}	= loss in prestressing steel stress due to friction
Df	= depth of footing	f_{ip}	= total loss in prestressing steel stress
DF	= distribution factor used in connection with live loads	f_{ir}	= loss in prestressing steel stress due to relaxation
DR	= derailment force	f_{is}	= loss in prestressing steel stress due to shrinkage
DS	= displacement of supports	f_{min}	= algebraic minimum stress level where tension is positive and compression is negative
e	= base of Napierian logarithms	f_{pc}	= compressive stress in the concrete, after all prestress losses have occurred, at the centroid of the cross section resisting the applied loads or at the junction of the web and flange when the centroid lies in the flange. (In a composite member, f_{pc} will be the resultant compressive stress at the centroid of the composite section, or at the junction of the web and flange when the centroid lies within the flange, due to both prestress and to bending moments resisted by the precast member acting alone)
e	= span for simply supported bridge or distance between points of inflection under uniform load (Chapter 10)	f_{pe}	= compressive stress in concrete due to prestress only, after all losses, at the extreme fiber of a section at which tensile stresses are caused by applied loads
e	= eccentricity of design load parallel to axis measured from the centroid of the section (Chapter 7)	f_{po}	= steel stress at jacking end of post-tensioning tendon
e_b	= M_y/P_y = eccentricity of the balanced condition-load moment relationship	f_{ps}	= stress in prestressing steel at design loads
e_n	= clear span length of slab (Chapter 10)	f_{pu}	= ultimate strength of prestressing steel
e_1	= length of short span of slab	f_{py}	= specified yield strength of prestressing tendons
e_2	= length of long span of slab	f_r	= modulus of rupture of concrete
E	= effective width of concrete slab resisting wheel or other concentrated load (Chapter 10)	f_s	= tensile stress in reinforcement at service loads
E	= earth pressure used in connection with loads (Chapter 5)	f_s'	= stress in compressive reinforcement
E_c	= modulus of elasticity of concrete	f_{sb}'	= stress in compressive reinforcement at balanced conditions
E_{ci}	= modulus of elasticity of concrete at transfer of stress	f_{se}	= effective stress in prestressing steel, after losses
E_{ps}	= modulus of elasticity of prestressing strand	f_t	= extreme fiber tensile stress in concrete at service loads
E_s	= modulus of elasticity of steel	f_y	= specified yield stress, or design yield stress of nonprestressed reinforcement
EI	= flexural stiffness of compression members	f_{ya}	= design yield stress of steel of bearing plate
EQ	= earthquake force	f_{yh}	= design yield stress of steel for hoops and supplementary cross ties in columns
f	= natural frequency of vibration of structure (Chapter 5)	F	= frictional force
f_a	= axial stress	F	= horizontal ice force on pier (Chapter 5)
f_a	= basic allowable stress (Chapter 5)	F_a	= allowable compressive stress
f_b	= bending stress	F_b	= allowable bending stress
f_b	= average bearing stress in concrete on loaded area (Chapter 8)	g	= acceleration due to gravity, 32.2 ft/sec ² (9.81 m/sec ²)
f_c	= extreme fiber compressive stress in concrete at service loads	G_A	= ratio of stiffness of column to stiffness of members at A end resisting column bending
f_c'	= specified compressive strength of concrete		
$f_{c,ds}$	= change in concrete stress at center of gravity of prestressing steel due to all dead loads except the dead load acting at the time the prestressing force is applied		
f_{ci}'	= compressive strength of concrete at time of initial prestress		

G_A	= degree of fixity in the foundation (Chapter 11)	l_a	= additional embedment length at support or at point of inflection
G_B	= ratio of stiffness of column to stiffness of members at B end resisting column bending	l_a	= distance from face of support to load for brackets and corbels (Chapter 7)
G_{avg}	= average ratio of stiffness of column to stiffness of members resisting column bending	l_{bd}	= basic development length for deformed bar in compression
G_{min}	= minimum ratio of stiffness of column to stiffness of members resisting column bending	l_d	= development length
h	= overall thickness of member	l_{dh}	= development length for deformed bars in tension terminating in a standard hook
h	= slab thickness (Chapter 6)	l_{hb}	= basic development length of hooked bar
h	= height of rolled on transverse deformation of deformed bar (Chapter 8)	l_n	= clear span measured face-to-face of supports
h	= height of fill (Chapter 5)	l_n	= length of tendon (Chapter 3)
h	= thickness of ice in contact with pier (Chapter 5)	l_u	= unsupported length of compression member
h	= asphalt wearing surface thickness (Chapter 5)	L	= live load
h_a	= thickness of bearing plate	L	= span length used in estimating unit structure dead load (Chapter 5)
h_c	= core dimension of column in direction under consideration	L	= bridge length contributing to seismic forces (Chapter 5);
h_f	= compression flange thickness of I- and T-sections	L	= length of compression member used in computing pier stiffness (Chapter 11)
h_a	= thickness of standard slab used in computing shrinkage	LF	= longitudinal force from live load
h_2	= thickness of bottom slab of box girder (Chapter 6);	M	= number of individual loads in the load combination considered
H	= average height of columns supporting bridge deck	M	= live load moment per unit width of concrete deck slab (Chapter 10)
H	= curvature coefficient (Chapter 9)	M_a	= maximum moment in member at stage for which deflection is being computed
I	= impact due to live load (Chapter 5)	M_b	= nominal moment strength of a section at simultaneous assumed ultimate strain of concrete and yielding of tension reinforcement (balanced conditions)
I	= impact coefficient	M_c	= factored moment to be used for design of compression member
I	= moment of inertia (Chapter 7)	M_{cr}	= moment causing flexural cracking at sections due to externally applied loads
ICE	= ice pressure	M_m	= modified moment (Chapter 7)
I_{cr}	= moment of inertia of cracked section with reinforcement transformed to concrete	M_{max}	= maximum factored moment due to externally applied loads, dead load excluded
I_e	= effective moment of inertia for computation of deflection (Chapter 8)	M_n	= nominal moment strength of section
I_g	= moment of inertia of gross concrete section about the centroidal axis, neglecting the reinforcement	M_{nx}	= nominal moment strength of section about x-axis
I_s	= moment of inertia of reinforcement about the centroidal axis of the member cross section	M_{ny}	= nominal moment strength of section about y-axis
k	= effective length factor for compression member (Chapters 7 and 11)	M_u	= factored moment at section, $M_u = \phi M_n$
k	= dimensionless coefficient for lateral distribution of live load for T- and I-girder bridge (Chapter 10)	M_{ux}	= factored moment at section about x-axis, $M_{ux} = \phi M_{nx}$
k	= coefficient for different supports in determining earthquake force (Chapter 5)	M_{uy}	= factored moment at section about y-axis, $M_{uy} = \phi M_{ny}$
k_e	= dimensionless coefficient for lateral distribution of live load for spread box-beam bridges (Chapter 10)	M_x	= applied design moment component about x-axis
K	= wobble friction coefficient of prestressing steel (Chapter 9)	M_y	= applied design moment component about y-axis
K	= constant used in connection with stream flow (Chapters 5 and 11)	M_1	= value of smaller factored end moment on compression member calculated from a conventional or elastic analysis, positive if member is bent in single curvature, negative if bent in double curvature
K	= value used for beam type and deck material (Chapter 10)	M_2	= value of larger factored end moment on compression member calculated by elastic analysis, always positive
K	= pier stiffness (Chapter 11)		
l	= length		

n	= modular ratio E_s/E_c	r	= radius of gyration of the cross section of compression member
n	= number of individual loads in the load combination considered (Chapter 5)	r	= base radius of rolled on transverse deformation of deformed bar (Chapter 8)
nb	= number of girders (Chapter 10)	R	= average annual ambient relative humidity, percent
n_e	= number of design traffic lanes (Chapter 10)	R_n	= characteristic strength (moment, shear, axial load)
N	= nosing and lurching force	RH	= mean annual relative humidity, percent (Chapter 5)
N	= minimum support length (Chapter 5)	s	= shear or torsion reinforcement spacing in direction parallel to longitudinal reinforcement
NB	= number of beams	s	= beam spacing (Chapter 6)
NL	= number of design traffic lanes	s_e	= spacing of bursting stirrups
N_u	= design axial load normal to the cross section occurring simultaneously with V_u , to be taken as positive for compression, negative for tension, and to include the effects of tension due to shrinkage and creep	s_2	= shear or torsion reinforcement spacing in direction perpendicular to the longitudinal reinforcement or spacing of horizontal reinforcement in wall
N_{uc}	= factored tensile force applied at top of bracket or corbel acting simultaneously with V_u , taken as positive for tension	s_w	= spacing of wires
o	= overhang of bridge deck beyond supporting member (Chapter 6)	S	= span length
o	= effective ice strength (Chapter 5)	S	= average beam spacing for distribution of live loads (Chapter 10)
OL	= overload	S	= shrinkage and other volume changes used in connection with loads or forces to be considered in analysis and design (Chapter 5)
P	= allowable bearing	S_h	= vertical spacing of hoops (stirrups) with a maximum of 4 in. (Chapter 11)
P	= minimum ratio of bonded reinforcement in tension zone to gross area of concrete section (Chapter 9)	S_h	= spacing of hoops and supplementary cross ties
P	= unit weight of air (Chapter 5)	SF	= stream flow pressure = KV^2
P	= proportion of load carried by short span of two-way slab (Chapter 10)	SN	= snow load
P	= load on one rear wheel of truck equal to 12,000 lb (53.4 kN) for HS15 loading and 16,000 lb (71.1 kN) for HS20 loading (Chapter 10)	t	= actual time in days used in connection with shrinkage and creep (Chapter 5)
P	= load above ground (Chapter 11)	t	= age of concrete in days from loading (Chapter 5)
P_b	= design axial load strength of a section at simultaneous assumed ultimate strain of concrete and yielding of tension reinforcement (balanced conditions)	t^*	= equivalent time in days used in connection with shrinkage (Chapter 5)
P_{cr}	= critical buckling load	t_w	= thickness of web in rectangular box section
P_n	= nominal axial load at given eccentricity	t_y	= temperature at distance y above depth of temperature variation of webs
P_{nx}	= nominal axial load at given eccentricity about x -axis	t_y'	= temperature reduction for asphalt concrete
P_{ny}	= nominal axial load at given eccentricity about y -axis	T	= temperature
P_{nxy}	= nominal axial load strength with biaxial loading	T	= maximum temperature at upper surface of concrete (Chapter 5)
P_o	= nominal load strength at zero eccentricity	T	= fundamental period of vibration of the structure (Chapter 5)
P_o	= at rest earth pressures (Chapter 5)	T^*	= minimum temperature of top slab over closed interior cells (Chapter 5)
P_s	= ratio of spiral reinforcement	T_c	= nominal torsional moment strength provided by concrete
P_u	= moment, shear, or axial load from the with loading (Chapter 5)	T_n	= nominal torsional moment strength
P_u	= factored axial load at given eccentricity, $P_u = \phi P_n$	T_s	= nominal torsional moment strength provided by torsional reinforcement
P_{ux}	= factored axial load strength corresponding to M_{ux} with bending considered about the x -axis only	T_u	= factored torsional moment at section
P_{uy}	= factored axial load strength corresponding to M_{uy} with bending considered about the y -axis only	v	= total applied design shear stress at section
P_{uxy}	= factored axial load strength with biaxial loading	v_c	= permissible shear stress carried by concrete
q	= dynamic wind pressure	v_{dh}	= design horizontal shear stress at any cross section
		v_h	= permissible horizontal shear stress

v_u	= factored shear stress at section	γ	= dual spacing used in connection with aircraft loads (Chapter 5)
V	= total applied design shear force at section	γ	= height of box girder (Chapter 6)
F	= horizontal earthquake force (Chapter 5)	y_1	= longer center-to-center dimension of closed rectangular stirrup
V	= velocity of water used in connection with stream flow (Chapter 5)	y_d	= mean thickness of deck between webs
V	= maximum probable wind velocity (Chapter 5)	y_t	= distance from the centroidal axis of cross section, neglecting the reinforcement, to the extreme fiber in tension
V_c	= nominal shear strength provided by concrete	Y_a	= depth of temperature variation of webs
V_{ci}	= nominal shear strength provided by concrete when diagonal cracking results from combined shear and moment	Y_s	= height of temperature variation in soffit slab
V_{cw}	= nominal shear strength provided by concrete when diagonal cracking results from excessive principal tensile stress in web	z	= quantity limiting distribution of flexural reinforcement
V_f	= factored shear force at section due to externally applied loads occurring simultaneously with M_{max}	z	= height of top of superstructure above ground (Chapter 5)
V_n	= nominal shear strength provided by concrete and shear reinforcement	α	= angle between inclined shear reinforcement and longitudinal axis of member
V_{nh}	= nominal horizontal shear strength provided by concrete and shear reinforcement	α	= angle of pier inclination from vertical (Chapters 5 and 11)
V_p	= vertical component of effective prestress force at section considered	α	= load factor used in connection with group loadings (Chapter 5)
V_s	= nominal shear strength provided by shear reinforcement	α	= total angular change of prestressing steel profile (Chapter 9)
V_u	= factored shear force at section	α_v	= total vertical angular change of prestressing steel profile (Chapter 9)
w	= unit structure dead load	α_h	= total horizontal angular change of prestressing steel profile (Chapter 9)
w_c	= unit weight of concrete	α_f	= angle between shear friction reinforcement and shear plane
w_c	= roadway width between curbs (Chapters 10 and 11)	α_i	= load factor for the i th loading (Chapter 5)
w_e	= road slab width from edge of slab to midway between exterior beam and first interior beam	α_x	= factor used in connection with torsion reinforcement
W	= wind load used in connection with application of wind loads to different types of bridges	β	= percent of basic allowable stress (Chapter 5)
W	= total weight of structure (Chapter 5)	β_b	= ratio of area of bars cut off to total area of bars at section
W	= crack width (Chapter 11)	β_c	= ratio of long side to short side of concentrated load or reaction area
W_f	= gross weight of fatigue design truck	β_d	= ratio of maximum factored dead load moment to maximum factored total load moment, always positive
W_i	= gross weight of specific trucks used in determining fatigue design truck	β_1	= factor used to determine the stress block in ultimate load analysis and design
W_h	= wind load applied in horizontal plane	γ	= unit weight of soil
W_p	= weight of pier and footing below ground	δ_b	= moment magnification factor for braced frames
W_s	= weight of soil directly above footing	δ_s	= moment magnification factor for frames not braced against sidesway
W_v	= wind load applied in vertical plane	λ	= correction factor related to unit weight of concrete
WL	= wind load applied on live load (Chapter 5)	μ	= coefficient of friction
WL	= wind load on live load	μ	= curvature friction coefficient (Chapter 9)
x	= shorter overall dimension of rectangular part of cross section	μ	= ductility factor (Chapter 11)
x	= tandem spacing used in connection with aircraft loads (Chapter 5)	ξ	= time-dependent factor for sustained loads (Chapter 8)
x	= width of box girder (Chapter 6)	$(\xi_{cr})_t$	= time-dependent factor for estimating creep under sustained loads (Chapter 5)
x_1	= shorter center-to-center dimension of closed rectangular stirrup	ξ_i	= instantaneous strain at application of load (Chapter 5)
x_1	= distance from load to point of support (Chapter 10)	$(\xi_{sh})_t$	= shrinkage at time t (Chapter 5)
x_2	= distance from center of post to point under investigation (Chapter 10)		
y	= longer overall dimension of rectangular part of cross section		

- $(\xi_{sh})_u$ = ultimate shrinkage (Chapter 5)
 ρ = ratio of tension reinforcement = A_f/bd
 ρ' = ratio of compression reinforcement = A_s'/bd
 ρ_b = reinforcement ratio producing balanced condition
 ρ_{min} = minimum tension reinforcement ratio = A_f/bd
 ρ_p = ratio of prestressed reinforcement = A_{ps}/bd
 ρ_s = ratio of volume of spiral reinforcement to total volume of core (out-to-out of spirals) of a spirally reinforced compression member
 ρ_v = $(A_s + A_h)/bd$
 ρ_w = reinforcement ratio = $A_s/b_w d$
 σ = moment magnification factor for compression members
 σ = effective ice strength (Chapter 5)
 τ_f = factor used in connection with prestressed concrete member design (Chapter 7)
 ϕ = strength-reduction factor
 ϕ = angle of internal friction (Chapter 5)

1.4-Referenced organizations

This report refers to many organizations which are responsible for developing standards and recommendations for concrete bridges. These organizations are commonly referred to by acronyms. Following is a listing of these organizations, their acronyms, full titles, and mailing addresses:

AASHTO

American Association of State Highway and Transportation Officials
 444 N. Capital Street, NW, Suite 225
 Washington, DC 20001

ACI

American Concrete Institute
 PO Box 19150
 Detroit, MI 48219

ANSI

American National Standards Institute
 1439 Broadway
 New York, NY 10018

AREA

American Railway Engineering Association
 50 F Street, NW
 Washington, DC 20001

ARTBA

American Road and Transportation Builders Association
 525 School Street, SW
 Washington, DC 20024

ASCE

American Society of Civil Engineers
 345 E. 47th Street
 New York, NY 10017

ASTM

American Society for Testing and Materials
 1916 Race Street
 Philadelphia, PA 19103

AWS

American Welding Society
 550 NW LeJeune Road
 PO Box 351040
 Miami, FL 33126

BPR

Bureau of Public Roads
 This agency has been succeeded by the Federal Highway Administration

CEB

Comite European du Beton
 (European Concrete Committee)
 EPFL, Case Postale 88
 CH 1015 Lausanne
 Switzerland

CRSI

Concrete Reinforcing Steel Institute
 933 N. Plum Grove Road
 Schaumburg, IL 60195

CSA

Canadian Standards Association
 178 Rexdale Boulevard
 Rexdale (Toronto), Ontario
 Canada M9W 1R3

FAA

Federal Aviation Administration
 800 Independence Avenue, SW
 Washington, DC 20591

FHWA

Federal Highway Administration
 400 Seventh Street, SW
 Washington, DC 20590

GSA

General Services Administration
 18 F Street
 Washington, DC 20405

HRB

Highway Research Board
 This board has been succeeded by the Transportation Research Board

PCA

Portland Cement Association
 5420 Old Orchard Road
 Skokie, IL 60077

PCI

Precast/Prestressed Concrete Institute
209 W. Jackson Blvd.
Chicago, IL 60606-6938

PTI

Post-Tensioning Institute
301 W. Osborn, Suite 3500
Phoenix, AZ 85013

TRB

Transportation Research Board
National Research Council
2101 Constitution Avenue, NW
Washington, DC 20418

Recommended references

The documents of the various standards-producing organizations referred to in this report are listed below with their serial designation, including year of adoption or revision. The documents listed were the latest effort at the time this report was written. Since some of these documents are revised frequently, generally in minor detail only, the user of this report should check directly with the sponsoring group if it is desired to refer to the latest revision.

American Concrete Institute

104R-71(82) Preparation of Notation for Concrete
116R-85 Cement and Concrete Terminology



O'Hare Field elevated roadway (photo courtesy of Alfred Benesch and Company)

CHAPTER 2-REQUIREMENTS FOR BRIDGES

2.1-Introduction

2.1.1 General-Design of bridge structures should be in accord with requirements established by the owner, adapted to the geometric conditions of the site and in accord with the structural provisions of the applicable codes and specifications.

The geometry of the superstructure is dictated by the specified route alignment and the required clearances above and below the roadway. These requirements are in turn directly related to the type of traffic to be carried on the bridge deck, as well as that passing under the bridge and, when the site is near an airport, low flying aircraft. Thus, geometric requirements, in general, will be dependent on whether the bridge is to carry highway, railway, transit, or airplane traffic and whether it is to cross over a navigable body of water, a highway, a railway, or a transit route. Drainage, lighting, and snow removal requirements should also be considered in the geometric design of the superstructure.

Once the overall geometry of the superstructure has been established, it should be designed to meet structural requirements. These should always include considerations of strength, serviceability, stability, fatigue, and durability. Before the reinforcing, prestressing, and concrete dimension requirements can be determined, an analysis should be performed to determine the internal forces and moments, the displacements, and the reactions due to the specified load-

ings on the bridge. This may be done using an elastic analysis, an empirical analysis, or a plastic model analysis as described in ACI SP-24. Because of their complexity, many bridge structures have been analyzed by using an empirical approach. However, by coupling modern day analytical techniques with the use of digital computers, an elastic analysis of even the most complex structural systems can now be accomplished. Model analyses may prove useful when mathematical modeling is of doubtful accuracy, and especially in cases where a determination of inelastic and ultimate strength behavior is important.

2.1.2 Alignment-The horizontal and vertical alignment of a bridge should be governed by the geometrics of the roadway or channels above and below.

If the roadway or railway being supported on the bridge is on a curve, the most esthetic structure is generally one where the longitudinal elements are also curved. Box girders and slabs, if continuous, are readily designed and built on a curve. Stringers and girders can be curved but are more difficult to design and construct. If the curve is not sharp, the girders or stringers can be constructed in straight segments with the deck constructed on a curve. In this case the following points require close examination:

- a. Nonsymmetrical deck cross section.
- b. Deck finish of the "warped" surface

- c. Vertical alignment of curbs and railing to preclude visible discontinuities.
- d. Proper development of superelevation.

Arches, cable-stayed, and suspension bridges are not easily adaptable to curved alignments.

2.1.3 Drainage—The transverse drainage of the roadway should be accomplished by providing a suitable crown or superelevation in the roadway surface, and the longitudinal drainage should be accomplished by camber or gradient. Water flowing downgrade in a gutter section of approach roadway should be intercepted and not permitted to run onto the bridge. Short continuous span bridges, particularly overpasses, may be built without drain inlets and the water from the bridge surface carried off the bridge and downslope by open or closed chutes near the end of the bridge structure. Special attention should be given to insure that water coming off the end of the bridge is directed away from the structure to avoid eroding the approach embankments. Such erosion has been a source of significant maintenance costs.

Longitudinal drainage on long bridges is accomplished by providing a longitudinal slope of the gutter (minimum of 0.5 percent preferred) and draining to scuppers or inlets which should be of a size and number to drain the gutters adequately. The positions of the scuppers may be determined by considering a spread of water of about one-half a lane width into the travel lane as recommended in "Drainage of Highway Pavements."²⁻¹ At a minimum, scuppers should be located on the uphill side of each roadway joint. Downspouts, where required, should be of rigid corrosion-resistant material not less than 4 in. (100 mm) and preferably 6 in. (150 mm) in the least dimension and should be designed to be easily cleaned. The details of deck drains and downspouts should be such as to prevent the discharge of drainage water against any portion of the structure and to prevent erosion at the outlet of the downspout.

Overhanging portions of concrete decks should be provided with a drip bead or notch within 6 in. (150 mm) of the outside edge.

2.2-Functional considerations

2.2.1 Highway bridges

2.2.1.1 Highway classification—Highways are classified by types for their planning, design, and administration. The classification in each jurisdiction is made in accordance with the importance of the highway, the traffic volume, the design speed, and other pertinent aspects. The following functional considerations are dependent upon the highway classifications:

2.2.1.2 Width—The roadway width (curb-to-curb, rail-to-rail, or parapet-to-parapet distance) is dependent on the number of traffic lanes, the median width, and the shoulder width. The preferred roadway width should be at least that distance between approach guardrails, where guardrails are provided, or the out-to-out approach roadway, and shoulder width as recommended in AASHTO HB-12. Reduced widths are sometimes permitted where structure costs are unusually high or traffic volumes unusually low. Where curbed

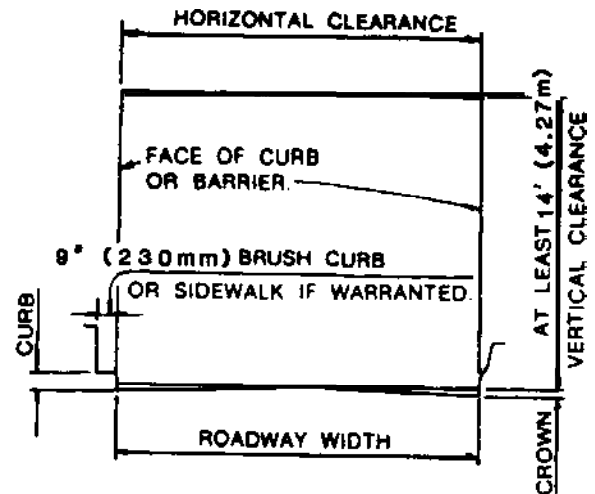

Fig. 2.2.1.3—Clearance diagram for bridges

roadway sections approach a structure, the same section should be carried across the structure.

Recommendations as to roadway widths for various volumes of traffic are given in AASHTO DS-2, DSOF-3, GD-2 and GU-2.

2.2.1.3 Clearances—The horizontal vehicular clearance should be the clear width measured between curbs or sidewalks, and the vertical clearance should be the clear height for the passage of vehicular traffic measured above the roadway at the crown or high point of superelevation (Fig. 2.2.1.3).

Unless otherwise provided, the several parts of the structure should be constructed to secure the following limiting dimensions or clearances for traffic:

- a. The minimum horizontal clearance for low traffic speed and low traffic volume bridges should be 8 ft (2.4 m); greater than the approach travelled way. The clearance should be increased as speed, type, and volume of traffic dictate in accordance with AASHTO DS-2, DSOF-3, GD-2, and GU-2.
- b. Vertical clearance on state trunk highways and interstate systems in rural areas should be at least 16 ft (5 m) over the entire roadway width, to which an allowance should be added for resurfacing. On state trunk highways and interstate routes through urban areas, a 16-ft (5-m) clearance should be provided except in highly developed areas. A 16-ft (5-m) clearance should be provided in both rural and urban areas, where such clearance is not unreasonably costly and where needed for defense requirements. Vertical clearance on all other highways should be at least 14 ft (4.25 m) over the entire roadway width to which an allowance should be added for resurfacing.

2.2.1.4 Sidewalks—Sidewalks, when used on bridges, should be as wide as required by the controlling and concerned public agencies, and preferably should be 5 ft wide (1.5 m); but not less than 4 ft (1.25 m).

2.2.1.5 Curbs—There are two general classes of curbs. These are "parapet" (nonmountable) and "vehicular mount-

2.2.2.2 Width-The width of the bridge should be based on the clearance requirements of *AREA Manual for Railway Engineering*, Chapter 28, Part 1, or to the standards of the railway having jurisdiction.

2.2.2.3 Clearances-Minimum clearances should be in accordance with the requirements of the railway having jurisdiction. Minimum clearances established by AREA are indicated in Fig. 2.2.2.3.

2.2.2.4 Deck and waterproofing--All concrete decks supporting a ballasted roadbed should be adequately drained and waterproofed. The waterproofing should be in accordance with the provisions outlined in *AREA Manual of Railway Engineering*, Chapter 29.

2.2.2.5 Expansion joints-To provide for expansion and contraction movement, deck expansion joints should be provided at all expansion ends of spans and at other points where they may be necessary. Apron plates, when used, should be designed to span the joint and to prevent the accumulation of debris on the bridge seats. When a waterproof membrane is used, the detail should preclude the penetration of water onto the expansion joint and bridge seat.

2.2.3 Aircraft runway bridges-The runway width, length, clearances, and other requirements should conform to the provisions of the Federal Aviation Agency or other air service agency having jurisdiction.

2.2.4 Transit bridges-A transit bridge or guideway differs from a conventional highway bridge in that it both supports and guides an independent transit vehicle. Special considerations are required in the design and construction to attain the desired level of ride comfort. A State-of-the-Art report for concrete guideways is given in ACI 358R.

2.2.5 Spans and profile

a) The clearances shown are for tangent track and new construction. Clearances for reconstruction work or for alteration are dependent on existing physical conditions and, where reasonably possible, should be improved to meet the requirements for new construction.

b) On curved track, the lateral clearances each side of track centerline should be increased $\frac{1}{2}$ in. (38 mm) per deg of curvature. When the fixed obstruction is on tangent track but the track is curved within 80 ft (24 m) of the obstruction, the lateral clearances each side of track centerline should be as follows:

Distance from obstruction to curved track, ft		Increase per deg of curvature, in.	
Feet	(Meters)	Inches	(Millimeters)
20	(6)	1-1/2	(38)
40	(12)	1-1/8	(28)
60	(18)	3/4	(19)
80	(24)	3/8	(9.5)

c) On the superelevated track, the track centerline remains perpendicular to a plane across top of rails. The superelevation of the outer rail should be in accordance with the recommended practice of the AREA.

d) In some instances, state or Canadian laws and individual railroads require greater clearances than these recommended minimums. Any facility adjacent to, or crossing over, railroad tracks should not violate applicable state laws, Canadian law, or requirements of railroads using the tracks.

2.2.5.1 General-In addition to providing the proper surface to carry the proposed traffic on the bridge, the structure should provide proper clearance for the facility being crossed.

2.2.5.2 Stream and flood plain crossings-The bridge should be long enough to provide the required waterway

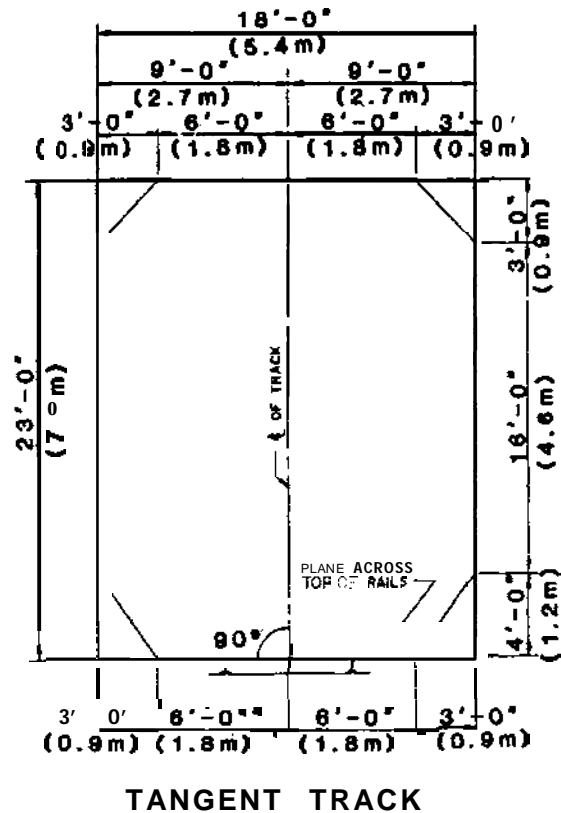

Fig. 2.2.2.3-Clearance diagram for railroads

opening below the high water elevation of the design flood. The opening provided should be an effective opening, i.e., be measured at a right angle to the stream centerline, furnish adequate net opening, have adequate upstream and downstream transitional cleanouts, be vertically positioned between the stable flowline elevation and the correct frequency highwater elevation, and be positioned horizontally to most efficiently pass the design volume of water at the design flood stage. Provision should be made for foreseeable natural changes in channel location and, if necessary, channel realignment should be made a part of the bridge construction project.

The bridge waterway opening and the roadway profile together determine the adequacy of the system to pass floods. The roadway and stream alignments determine the effectiveness of the provided opening and they influence the need for spur dikes, erosion protection, structure skew, and pier locations. Detailed guidelines are given in AASHTO HDG-7. Good practice usually dictates that the lowest elevation of the superstructure should not be lower than the all-time record high water in the vicinity of the crossing and that an appropriate clearance be provided above the design high-water elevation. The amount of clearance depends on the type of debris that should pass under the bridge during floods and the type of bridge superstructure. When costs of meeting this requirement are excessive, consideration should be given to other means of accommodating the unusual floods, such as lowering the approach embankment to permit overtopping. If any part of the bridge superstructure is below the all-time record high water, it should be designed for stream flow pressures and anchored accordingly.

Requirements for stream crossings should be obtained from the governmental agency having responsibility for the stream being crossed. For further recommendations, see *Hydraulic Design of Bridges with Risk Analysis*.²⁻⁴

2.2.5.3 Navigable stream crossings-Vertical clearance requirements over navigation channels vary from 15 to 220 ft (4.5 to 67 m) and are measured above an elevation determined by the U.S. Coast Guard, or in Canada by Transport Canada. Horizontal clearances and the location of the opening depend upon the alignment of the stream upstream and downstream of the bridge. In some cases auxiliary navigation channels are required.

2.2.5.4 Highway crossings (Fig. 2.2.5.4) - The pier columns or walls for grade separation structures should generally be located a minimum of 30 ft (9 m) from the edges of the through traffic lanes. Where the practical limits of structure costs, type of structure, volume and design speed of through traffic, span arrangement, skew, and terrain make the 30-ft (9-m) offset impractical, the pier or wall may be placed closer than 30 ft (9 m) and protected by the use of guard rail or other barrier devices. The guard rail should be independently supported with the roadway face at least 2 ft (600 mm) from the face of pier or abutment.

The face of the guard rail or other device should be at least 2 ft (600 mm) outside the normal shoulder line.

A vertical clearance of not less than 14 ft (4.25 m) should be provided between curbs, or if curbs are not used, over the

entire width that is available for traffic. Curbs, if used, should match those of the approach roadway section.

2.2.5.5 Railway crossings (Fig. 2.2.5.5)-In addition to the requirements shown in Fig. 2.2.5.5, it is good practice to allow at least 6 in. (150 mm) for future track raise. In many instances the railroad requires additional horizontal and vertical clearance for operation of off-track equipment. Piers located closer than 25 ft (7.5 m) from the track should meet the requirements of *AREA Manual for Railway Engineering*, Chapter 8, Subsection 2.1.5, to be of heavy construction or to be protected by a reinforced concrete crash wall extending 6 ft (2 m) above top of rail. In certain instances where piers are adjacent to main line tracks, individual railways may have more stringent requirements.

2.3-Esthetic considerations

A bridge should be designed to harmonize with its natural surroundings and neighboring structures. The attractiveness of a bridge is generally achieved by its shape and by the proper proportioning of the superstructure and piers in relation to the span of the bridge and its surroundings. Color and texture may be added for emphasis. Consideration should be given to the appearance of the bridge from the driver's or passenger's point of view, as well as someone viewing it from off the structure. A bibliography of books and articles on bridge esthetics has been published ([Reference 2-5](#)) and is available from the Transportation Research Board.

2.4-Economic considerations

2.4.1 Criteria for least cost-Least-cost criteria require consideration of all the factors contributing to the cost of the project. These include length and width of superstructure, type of superstructure including deck, railings, walks, medians; type of substructure including cofferdams, sheeting, and bracing, approach roadways including embankment, retaining walls and slope protection. Other factors such as special treatment for the road or stream being spanned, and pier protection, can also influence the least cost.

Each type of superstructure being considered has an optimum span range where its use is very competitive. It may, however, be used in spans outside that range and still meet the least-cost criteria, because of the compensating costs of other factors. One of the compensating factors often is the substructure because its contribution to the cost of the project is inversely proportional to the span length, while the superstructure cost increases with the span length. Wherever possible, consideration should be given to comparing bridge layouts having different span arrangements. Elimination of a costly river pier can usually justify a longer span.

Although this report stresses the design of the superstructure, the substructure of any bridge is a major component of its cost and for that reason offers an almost equally great potential for cost saving.

In the final analysis, however, true economy is measured by the minimum annual cost or minimum capitalized cost for its service life. Cost data on maintenance, repair or rehabilitation, and estimate of useful life are less easy to obtain, but no study of least cost can be complete without their consid-

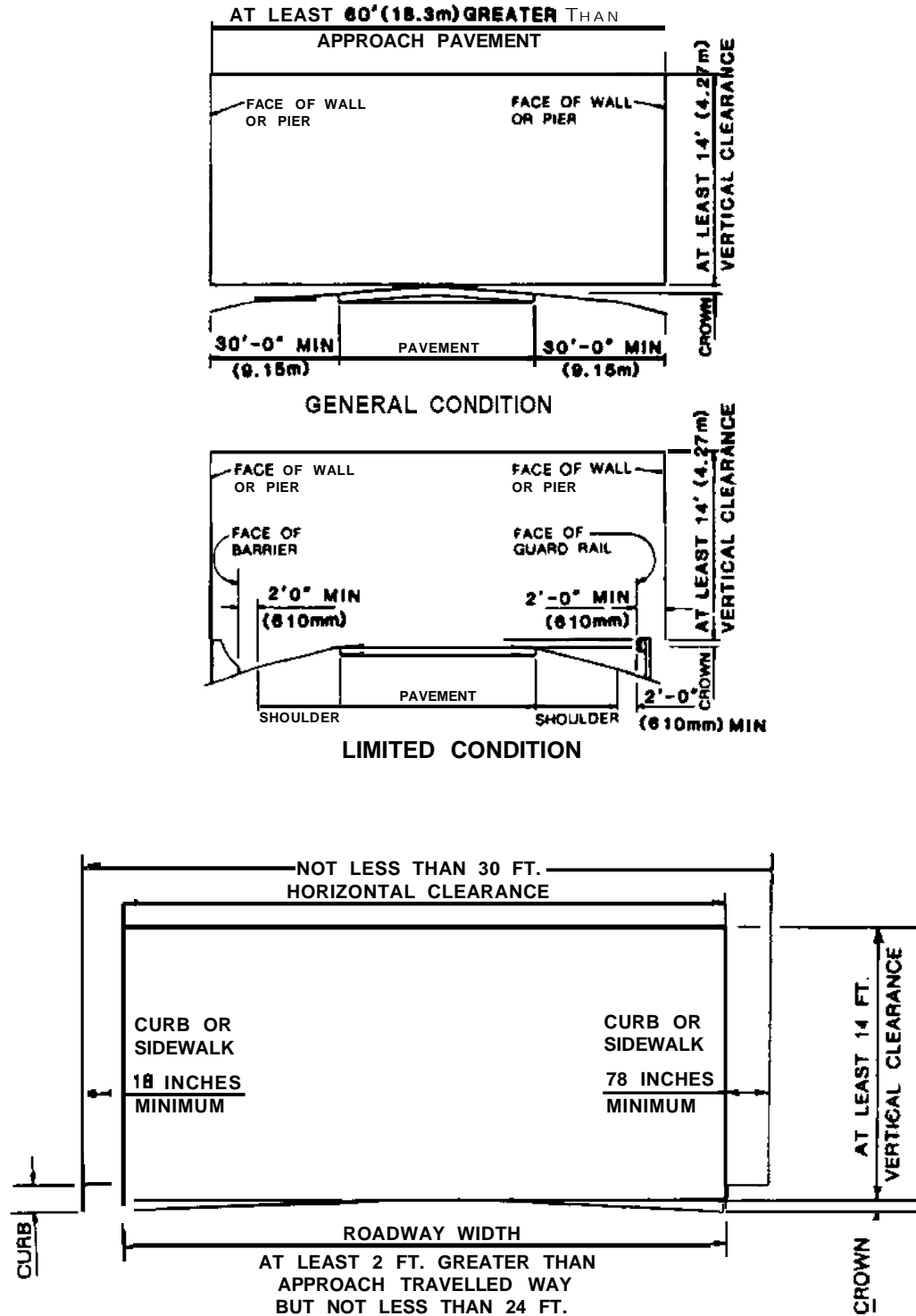

1) For recommendations as to roadway widths for various volumes of traffic, see AASHTO DS-2, DSOF-3, GD-2, and GU-2.

2) The barrier to face of wall or pier distance should not be less than the dynamic deflection of the barriers for impact by a full-size automobile at impact conditions of approximately 25 deg (0.44 rad.) and 60 mph (96.5 km/h). For information on dynamic deflection of various barriers, see AASHTO GTB.

Fig. 2.2.5.4-Clearance diagrams for underpasses

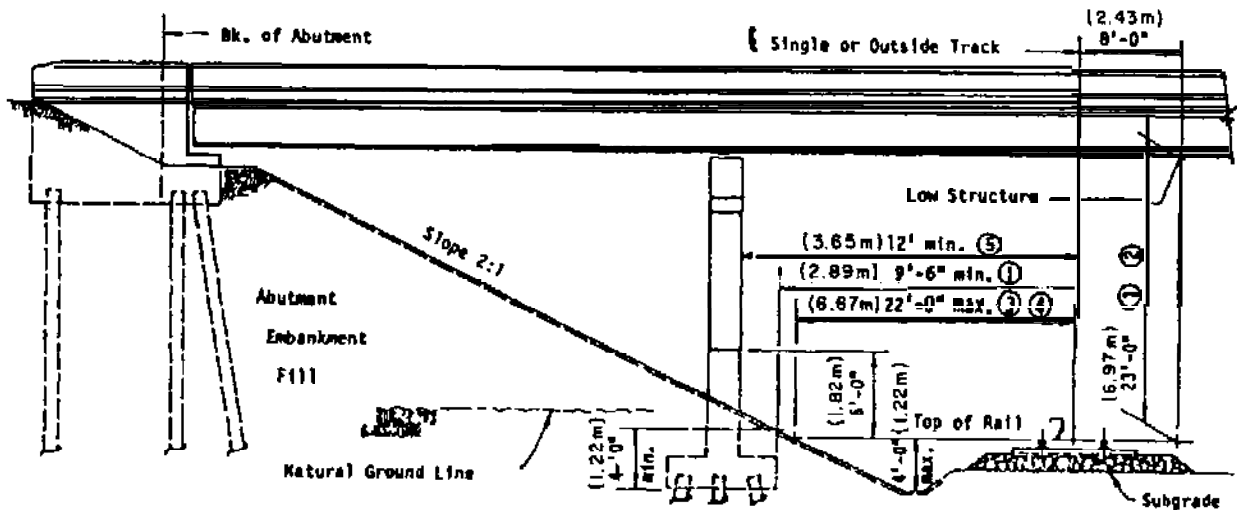

TYPICAL SECTION AT RIGHT ANGLE TO TRACK
NATURAL GROUND LESS THAN 4'-0" (1.22m) BELOW T/R

HIGHWAY - RAILROAD OVERHEAD GRADE SEPARATIONS NOMINAL DESIGN DIMENSIONS

Notes:

- 1 Do not reduce without the consent of the Railroad Company.
- 2 Do not reduce below 21'-6" (6.5m) without an I.C.C. Order.
- 3 This dimension may be increased up to 8'-0" (2.43m), on one side only, as may be necessary for off-track maintenance equipment when justified by Railroad Company.
- 4 This dimension may be increased up to 3'-0" (0.91m), where special conditions, such as heavy and drifting snow, are a problem.
- 5 Piers or columns are to be located so as not to encroach on drainage ditches.

All horizontal dimensions are at right angles.

Fig. 2.2.5.5-Clearances for railway crossings

eration. For cost of bridges within flood plains, see *Hydraulic Design of Bridges with Risk Analysis*.²⁻⁴

2.4.2 Alternative designs-The general statement that a competent engineer can establish the most economical structure by studies ignores factors which influence costs over which the engineer has no control. The economics of any given industry cannot be exactly forecast. The time of advertising most structures is not established at the time of design. The reasons for preparing alternative designs are:

- a. Increase competition by permitting several industries to participate.
- b. Make provisions to take advantage of the variations in the economy of the construction industry.
- c. To provide a yardstick whereby the various industries can measure the advantage and disadvantage of their competitive position. This results in industry improving

their procedures to reduce costs and eventually gives additional savings to the owner.

- d. To eliminate the intangible arguments by various segments of industry that their material would have resulted in a more economical structure.
- e. Most important reason for alternative designs is that the owner saves in the cost of the structure.

For more detailed information consult *Alternate Bridge Designs*.²⁻⁶

2.4.3 Value engineering-In addition to economic pressures, sociological pressures have focused more attention on the impact that a project has on both natural and cultural environments. Consequently, the bridge engineer is faced with the necessity of identifying a continually growing list of design parameters, along with the accompanying possibility of tradeoffs in the process of planning and designing. Selection

of not only a suitable type of substructure and superstructure, but a suitable location with the consideration of all these factors, can be very complex. A complete and objective result can be accomplished only if an organized approach is adopted. Value Engineering is one such system that can help engineers obtain an optimum value for a project.

Value Engineering is an organized way of defining a problem and creatively solving it. The Value Engineering Job Plan has five steps: 1) information phase, 2) analysis phase, 3) speculative phase, 4) evaluation phase, and 5) implementation phase. The Job Plan encourages engineers to search systematically, analyze objectively, and solve creatively. Details of the Value Engineering method can be obtained from *Guidelines for Value Engineering*²⁻⁷ or *Value Engineering for Highways*.²⁻⁸

Value Engineering can be used at various stages of a project, but the earlier the process is initiated, the greater the possible benefits. This is graphically illustrated by Fig. 2.4.3, taken from the book *Value Engineering in Construction*.²⁻⁹ Value Engineering when used only in the Value Engineering Change Proposal (VECP) produces limited benefits because only the low bidder on the “owner’s design” is permitted to submit a Value Engineering alternate. Its use is discussed in Section 4.12 of this report.

2.5-Bridge types

Bridges may be categorized by the relative location of the main structural elements to the surface on which the users travel, by the continuity or noncontinuity of the main elements and by the type of the main elements.

2.5.1 Deck, half-through, and through types (see Fig. 2.5.1)-To insure pedestrian safety, bridges designed with sidewalks should preferably permit an unobstructed view. This requirement is satisfied with deck bridges where the load-carrying elements of the superstructure are located entirely below the traveled surface.

In rare cases, clearances may justify a half-through or through-type structure when the difference between the bridge deck elevation and the required clearance elevation is small. In through-type structures, the main load-carrying elements of the superstructure project above the traveled surface a sufficient distance such that bracing of the main load-carrying element can extend across the bridge. Thus the bridge user passes “through” the superstructure.

In half-through structures, the main carrying elements are braced by members attached to and cantilevering from the deck framing system. The top flanges of half-through girders or top chords of half-through trusses are much less stable than those in deck and through structures. In the deck structure in particular, the roadway slab serves very effectively to increase the lateral rigidity of the bridge. The projecting elements of the half-through or through structures are very susceptible to damage from vehicles and adequate protection should be provided. These types also do not permit ready widening of the deck in the future.

2.5.2 Simple, cantilever, and continuous span types (see Fig. 2.5.2)-Concrete bridges may consist of simple, cantilever, or continuous spans. Continuous structures with vari-

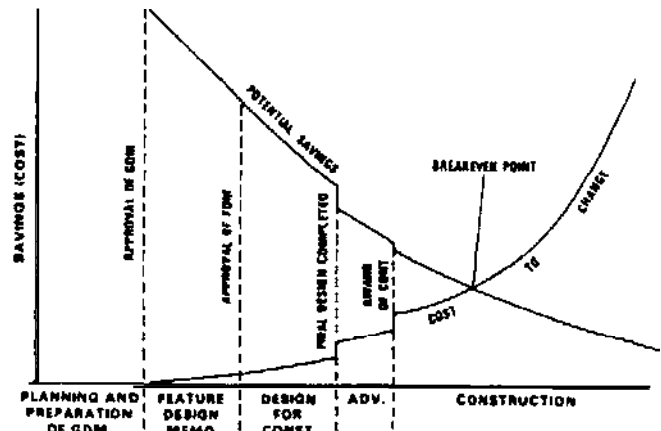

Fig. 2.4.3-Potential Value Engineering savings during civil works project life cycle

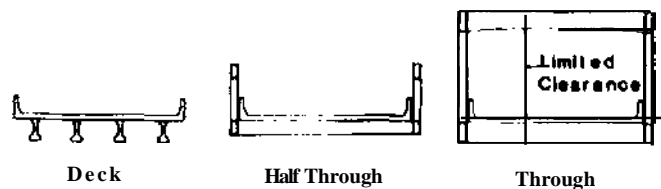

Fig. 2.5.1-Cross sections of bridge types

able moments of inertia for slabs, stringers, and girder systems require the least material. However, in the shorter span range the labor cost of constructing variable sections often offsets the material savings.

In the past the use of cantilever arms and suspended spans rather than continuous structures resulted from fear of the effect of differential settlement of supports. It should be recognized that these effects can now be readily considered by proper use of analytical methods and current knowledge in soil mechanics and foundation engineering. Because of the difficult problems of detailing and constructing the bearing which forms the hinge at the end of the cantilever, its use should be limited to special situations. It is also inadvisable to use hinges in areas subject to seismic loadings.

In the longer span range of slab, stringer, and girder-type bridges, the use of continuous structures with variable moments of inertia is strongly recommended. It should also be recognized that the designer may sometimes take advantage of the economy of a combination of bridge types. Short approach spans of slab or box beam construction may be combined with a single main arch span or with long box girder spans.

2.5.3 Slab, stringer, and girder types-These types may be either square or skew in plan and simply supported, cantilevered, or continuous over supports.

2.5.3.1 Slab type (see Fig. 2.5.3.1)-Slab-type concrete bridges consist of solid or voided slabs which span between abutments and intermediate piers. The use of slab bridges should be considered for spans up to 80 ft (25 m). The main longitudinal reinforcement may be prestressed or nonpre-

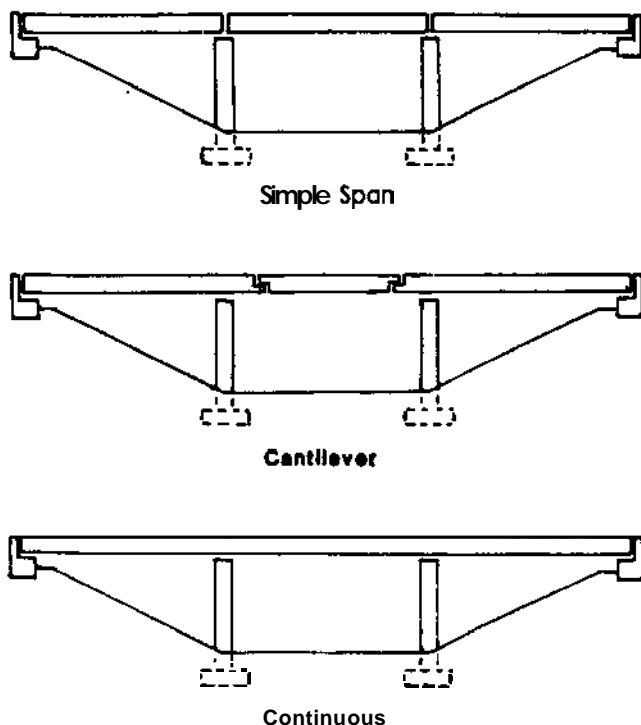

Fig. 2.5.2-Elevations of bridge types



Fig. 2.5.3.1-Cross sections of slab bridges

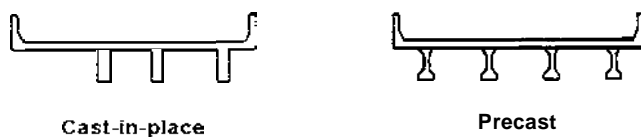

Fig. 2.5.3.2-Cross sections of stringer bridges

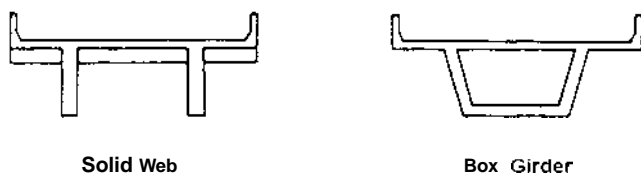

Fig. 2.5.3.3-Cross sections of girder bridges

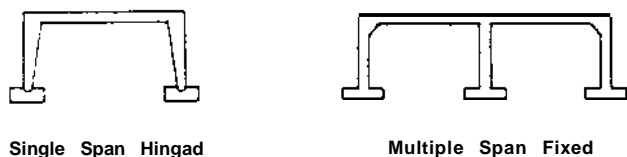

Fig. 2.5.4-Elevations of rigid frame bridges

stressed. Transverse prestressing can be used for transverse reinforcement in both cast-in-place slabs and those composed of longitudinal segments.

2.5.3.2 Stringer type (see Fig. 2.5.3.2)-The main structural elements of this type of concrete bridge consist of a series of parallel beams or stringers which may or may not be connected with diaphragms. The stringers support a reinforced concrete roadway slab which is generally constructed to act as the top flange of the stringer. Use of stringer bridges should be considered for spans ranging from about 20 to 120 ft (6 to 36 m). Stringers generally are spaced from 6 to 9 ft (1.8 to 2.7 m) on centers. Main reinforcement or prestressing is located in the stringers. When the stringers are prestressed, the concrete roadway slab may be reinforced or prestressed in two directions.

2.5.3.3 Girder type (see Fig. 2.5.3.3)-This type of concrete bridge consists of either longitudinal girders carrying cross beams that in turn carry the roadway slab, or longitudinal box girders whose bottom slab functions as the bottom flange of the girder. In both types the top slab serves the dual function of being the flange of the girder and the roadway slab of the bridge.

Solid web girders-This type of bridge differs from the stringer type in that the reinforced concrete roadway slab spans longitudinally and is supported on cross beams spaced 8 to 12 ft apart (2.4 to 3.6 m). In general only two girders are used. It is a feasible solution where large overhangs of the deck are desirable, and where the depth of construction is not critical. Spans of up to 180 ft (55 m) have been built.

Box girders-These girders may consist of a single cell for a two-lane roadway, multiple cells for multiple-lane roadways, or single or multiple cells with cantilever arms on both sides to provide the necessary roadway width, and to reduce the substructure cost and minimize right of way requirements.

Because of their superior torsional rigidity, box girders are especially recommended for use on curves or where torsional shearing stresses may be developed. This type of concrete bridge may have economical span lengths from less than 100 to about 700 ft (30 to 210 m). In the longer span range, variable depth, variable moment of inertia, cantilever construction, continuity design, pretensioned precast elements, precast post-tensioned components, post-tensioned construction, three-way prestressing for the whole bridge assembly, and introduction of continuity after erection should all be considered.

2.5.4 Rigid-frame type (see Fig. 2.5.4)-Rigid-frame bridges may be hinged or fixed, single or multiple spans. The main structural elements are generally slabs, but may be beams. Depending upon the roadway planning, each span may accommodate from one lane with shoulders to as many as four lanes with shoulders. A two-span structure can accommodate roadways in each direction with a narrow median. A three-span structure can accommodate roadways in each direction with a wide median. Overhangs may be introduced to span over embankment slopes and to reduce the moment at the knees of the first legs of a rigid-frame system. The base of legs or columns may be either hinged or fixed. In either case, the hinge action or fixity should be constructed to fit the design conditions. Feasible span lengths are similar to slab or stringer-type bridges.

The bridge may be square or skew to suit the geometric or hydraulic requirements. Where possible, large skews should be avoided by changing the alignment of the supported roadway or the obstruction being crossed. If this cannot be done, a detailed analysis should be used in design of the structure. In restricted locations, barrel-type bridges may be used to dispense with abutments. Both composite construction and two-way reinforcing or two-way prestressing may be applied to the slab-rigid-frame assembly.

2.5.5 Arch type—Arches generate large horizontal thrusts at their abutments, and are therefore ideally suited for crossings of deep gorges or ravines whose rock walls provide a relatively unyielding support. If founded on less suitable material, the deformation of the foundation should be taken into account in the analysis. Arches are also best suited for structures that have a sizable dead load-to-live load ratio. Arch construction may be made of cast-in-place or precast segmental elements, as well as being conventionally formed.

2.5.5.1 Spandrel or barrel arches (see Fig. 2.5.5.1)—These arches are often fixed at the springing lines on the abutments. Two-hinged and three-hinged arches are seldom used. More often, single spans are used. In this type of bridge, the spandrels act as retaining walls for earth fill which is placed on top of the arch to form the subbase for the roadway. It has distinct advantages for short spans, low rises, and heavy live loads. Spans up to 200 ft (60 m) have been used. However, in spans over 100 ft (30 m), the dead load due to the earth fill may become excessive.

2.5.5.2 Ribbed or open-spandrel arches (see Fig. 2.5.5.2)—This type of bridge is suitable for long spans. Both fixed and two-hinged arches are common. The three-hinged version is feasible but is seldom used.

Ribbed arches are better adapted to multiple spans than barrel arches. The roadway deck is supported on columns and cross beams. It may be a deck structure or half-through structure. In the latter case, hangers should be used to carry the roadway in the central portion of the arch. In this type of bridge, these are usually two separate arch ribs, but there may be more or the rib may be a solid slab, in which case the columns and cross beams may be replaced by walls. Spans up to 1000 ft (300 m) have been built.

2.5.5.3 Tied arches (see Fig. 2.5.5.3)—This type of arch should be used where the foundation material is considered inadequate to resist the arch thrust. Tied arches are always of the through or half-through type with hangers to carry floor beams. Both single-span and multiple-span tied arch bridges have been built with spans of 100 to 400 ft (30 to 120 m).

2.5.5.4 Long-span arches—Ribbed arches with precast box segments, post-tensioned during assembly, are suitable for long spans. In these bridges, post-tensioned diaphragms have been used.

2.5.5.5 Splayed arches or space frame—To achieve greater stability and structural stiffness, through-type arches may be inclined to each other to form a space frame. This results in a splayed arch system.

For shorter spans, vertical cable suspenders may be used. In the longer span range, diagonal-grid cable suspenders are recommended for attaining greater stiffness.

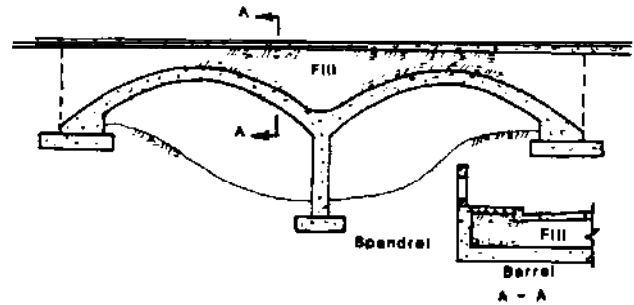

Fig. 2.5.5.1—Two span spandrel or barrel (earth filled) arch bridge

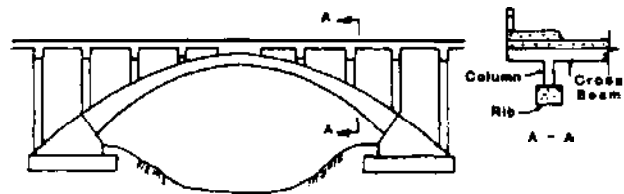

Fig. 2.5.5.2—Single span open spandrel or ribbed arch bridge

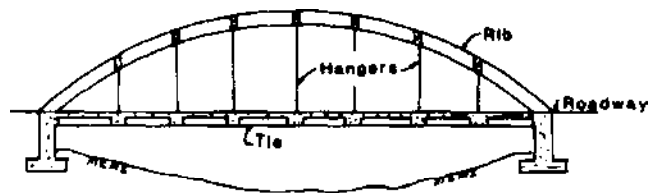

Fig. 2.5.5.3—Tied arch bridge

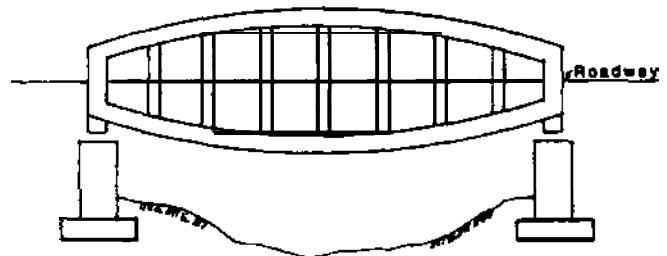

Fig. 2.5.6.1—Vierendeel truss bridge

The diagonal-grid concept may be further extended to the floor system by having a grid of beams running diagonally to the center line of the roadway.

2.5.6 Truss types—Although concrete truss bridges of triangular configuration have been built, their use is not recommended. The detail of reinforcement at a joint where many members meet is very difficult. Formwork, centering, and placing of concrete in sloping members is expensive.

2.5.6.1 Vierendeel truss (see Fig. 2.5.6.1)—While not used extensively, the Vierendeel truss offers some esthetic qualities, has simpler details because of the limited number of members at a joint, is easier to form and place, and can be precast or cast in place. If necessary, it can be erected by cantilever method without false work.

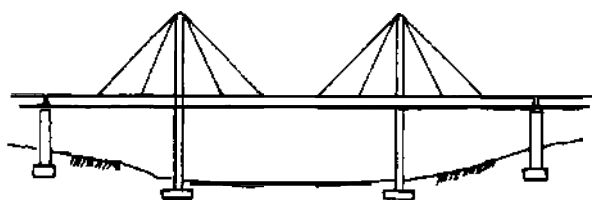

Fig. 2.5.7-Cable stayed bridge

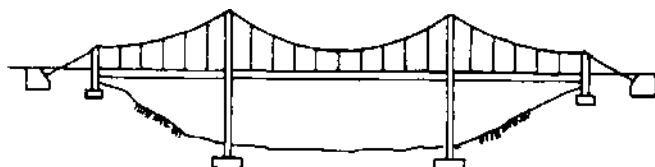

Fig. 2.5.8-Suspension bridge

Previously, a deterrent to the use of the Vierendeel truss was the difficulty in analyzing this highly indeterminate structure, but computer programs are now available to rapidly do this analysis.

The use of inclined chords, particularly in the end panel, is recommended. This inclination greatly reduces the bending stresses.

Because of the great depth needed for efficient use, the Vierendeel truss bridge is generally either a through or half-through type. It is also best suited for simple spans. Spans up to 500 ft (1.50 m) have been built.

2.5.7 Cable-stayed types (see Fig. 2.5.7)-The feasible span of concrete bridges can be greatly extended by the use of supplementary supports. In cable-stayed bridges the concrete deck, including the roadway slab and girders, acts as a part of the support system, functioning as a horizontal compression member. Cable-stayed bridges act as continuous girders on flexible supports, and offer the advantage of high rigidity and aerodynamic stability with a low level of secondary stresses. Spans of up to 1500 ft (460 m) are feasible.

The proper design of the pylon and configuration of the stays can add greatly to the esthetic appearance.

2.5.8 Suspension types (see Fig. 2.5.8)-In suspension bridges, intermediate vertical support is furnished by hangers from a pair of large cables. The deck does not participate except to span between hangers and to resist horizontal loads.

Because dead load is a very important factor, high-strength lightweight concrete should be considered. Spans of 1600 to 1800 ft (489 to 550 m) have been built.

2.6-Construction and erection considerations

In the design of a bridge, construction and erection considerations may be of paramount importance in the selection of the type of bridge to be built. Also, the experience of the available contractors, the ability of local material suppliers to furnish the specified materials, the skilled labor required for a particular structure type, and the capacity of equipment necessary for erection should be considered. The most eco-

nomical bridge design is one in which the total cost of materials, labor, equipment, and maintenance is minimized.

2.6.1 Cast-in-place and precast concrete-The decision to use or not to use precast concrete could be influenced by the availability of existing precast plants within transport distance. Precast concrete may be competitive in areas without existing precasting plants when a large number of similar components are required.

In large projects, a precasting plant located at the site should be considered to see if it would prove more economical.

In general, precast concrete members, because of better control of casting and curing processes, and because of the ease of inspection and rejection of an improperly fabricated member, are a better, more durable product.

For grade separation structures, if traffic problems are not a controlling factor, cast-in-place structures are generally more economical when the height of falsework is less than 30 to 40 ft (9 to 12 m) high.

2.6.2 Reinforced, partially prestressed, and prestressed-This report covers use of reinforced concrete, partially prestressed concrete, and fully prestressed concrete. The possible use of pretensioning or post-tensioning should be considered during the planning stage of a bridge project. In many cases the greatest economy can be realized by allowing the Contractor the option of using pretensioned, post-tensioned, or a combination of both. In these cases, the specifications should require submittal by the Contractor of proper design data.

2.6.3 Composite construction-Integration of the deck slab with the supporting floor system is covered by this document. Floor systems consisting of stringers, floor beams, or combinations can be used. Modular precast concrete planks (prestressed or regular reinforced) may be used as the bottom form for the deck slab between stringers. Properly designed, these planks can be made composite with the cast-in-place deck slab and the deck slab composite with the stringers. Consideration should be given in the design to construction loads supported prior to the cast-in-place concrete attaining its design strength. For short spans within the capacity of available handling equipment, the entire deck span may be precast in one piece and made composite with the cast-in-place slab.

2.6.4 Post-tensioned segmental construction-It is normal practice to build concrete bridges in segments such as precast I-beams with composite slabs or precast voided slabs or box beams that are attached together. In the post-tensioned segmental type, the individual member, box girder, I-beam, or arch is installed in several longitudinal segments and then post-tensioned together to form one member.

2.6.4.1 Box girders-In general, the longer spans, because of the need for greater and variable depths, have been cast-in-place, while the shorter spans lend themselves to constant depth precast units. It is customary to erect these bridges by the cantilever method, avoiding the use of falsework, but some have been erected using a limited amount of falsework and placing the bridge by "pushing" the completed segments into place from one end.

2.6.4.2 I-beams-Due to shipping limitations, the length of precast prestressed I-beam stringer bridges is less than 100 ft (30 m). By precasting the I-beam in two or more pieces and post-tensioning the pieces after erection, the feasible span can be greatly increased.

2.6.4.3 Arches-Arches of all types may be constructed of cast-in-place or precast segments. This method of construction is most adaptable to long spans and spans where centering for formwork is difficult to install. After constructing the arch ribs by the segmental method, the spandrel columns or suspenders and the roadway deck may be constructed in a more conventional manner.

2.7-Legal considerations

2.7.1 Permits over navigable Waterways-Preliminary plans of a proposed bridge crossing any navigable waterway should be filed with the Commandant, U.S. Coast Guard, addressed to the appropriate District Commander, and with other appropriate Governmental authority. A written permit with reference to horizontal and vertical clearances under the spans, and to the location of all river piers, should be obtained. Special permit drawings, 8 x 10 1/2 in. (203 x 267 mm) in size, showing the pertinent data must be prepared. These requirements are given in the latest issue of U.S. *Coast Guard Bridge Permit Application Guide* of the appropriate district. Since the Coast Guard districts do not follow state boundaries, the address of the Coast Guard District having jurisdiction can be obtained by contacting Chief, Office of Navigation, U.S. Coast Guard (G-NBR), Washington, D.C. 20593, Phone - 202/755-7620.

In Canada such permit requirements can be obtained from Chief NWPA, Program Division, Transport Canada, Coast Guard, Ottawa, Ontario, Canada K1A 0NT.

2.7.2 Environmental laws and national policy

a. The National Environmental Policy Act (NEPA) of 1969 (Public Law 91-190) requires that "all agencies of the Federal Government . . . include in every recommendation or report on major Federal actions significantly affecting the quality of the human environment, a detailed statement by the responsible official to outline:

"The environmental impact of the proposed action; any adverse environmental effects which cannot be avoided should the proposal be implemented; alternatives to the proposed action; the relationship between local short-term uses of man's environment and the maintenance and enhancement of long-term productivity; and any irreversible and irretrievable commitments of resources which would be involved in the proposed action should it be implemented."

b. Section 4(f) of the Department of Transportation Act (Public Law 89-670) declares that special effort should be made to preserve the natural beauty of the countryside and public park and recreational lands, wildlife and waterfowl refuges, and historic sites. The Secretary of Transportation . . . "shall not approve any program or project which requires the use of any publicly owned land from a public park, etc. unless (1) there is no feasible and prudent alternative to the use of such

land, and (2) such program includes all possible planning to minimize harm to such park, recreational area, wildlife and waterfowl refuge, or historic site resulting from such use."

- c. Historic preservation-The National Historic Preservation Act of 1966 and Executive Order 11593, Protection & Enhancement of Cultural Environment, require that Federal, or federally assisted projects must take into account the project's effect on any district, site, building, structure, or object that is included in the National Register of Historic Places and give the Advisory Council on Historic Preservation an opportunity to comment on the undertaking. Further, federal plans and programs should contribute to the preservation and enhancement of sites, structures, and objects of historical, architectural, or archeological significance.
- d. Clean Air Act-The impact of a bridge project on air quality must be assessed, and the project must be consistent with the state (air quality) implementation plan.

The Federal Highway Administration's policies and procedures for considering air quality impacts on highway projects are contained in *FHWA Program Manual*, Vol. 7, Chapter 7, Section 9 (Reference 2-10). This manual and any state or local standards may be used as a guide in determining the type of bridge projects for which air quality impacts are a reasonable concern.

- e. The Noise Control Act of 1972-This act establishes a national policy to promote an environment free from noise that jeopardizes health and welfare. For bridge projects where highway noise is a concern, *FHWA Program Manual*, Vol. 7, Chapter 7, Section 3 (Reference 2- 10) and/or state or local standards may serve as a guide in evaluating and mitigating noise impacts.
- f. The Federal Water Pollution Control Act Amendments of 1972.-Section 401 requires that applicants for a federal permit provide a water quality certificate by the appropriate state or interstate agency. If there is no applicable effluent limitation and no standards, the state water quality certifying agency shall so certify. If the state or interstate agency fails or refuses to act on a request for certification within a reasonable length of time (normally deemed to be 3 months, but not to exceed 1 year) after receipt of request, the certification requirements shall be waived. No permit will be granted until certification has been obtained or waived, or if certification has been denied.

Section 404 assigns to the Corps of Engineers the responsibility for issuing permits for the discharge of dredged or fill material. However, the environmental documentation for a bridge project must contain an analysis of the impact of any fill associated with that project.

- g. Fish and Wildlife Coordination Act-Section 2 requires that, "whenever the water of any stream or other body of water are proposed or are authorized to be . . . controlled or modified for any purpose whatever . . . by any department or agency of the United States, or by any public or private agency under Federal Permit or li-

cense, such department or agency shall first consult with the United States Fish and Wildlife Service, Department of the Interior, and with the head of the agency exercising administration over the wildlife resources of the particular state where ... (the facility is to be constructed...)” The environmental documentation for the bridge project should include an analysis of probable impacts on fish and wildlife resources and an analysis of any mitigative measures considered, and adopted or rejected.

- h. The Endangered Species Act of 1973-This act generally provides a program for the conservation, protection, reclamation, and propagation of selected species of native fish, wildlife, and plants that are threatened with extinction. Section 7 of this act provides that federal agencies shall take “such actions necessary to insure that actions authorized, funded or carried out by them do not jeopardize the continued existence of such endangered species and threatened species or result in the destruction or modification of habitat of such species.” The list of endangered and threatened species, published by the Fish and Wildlife Service in the Federal Register, shall be consulted to determine if any species listed or their critical habitats may be affected by the proposed project. Section 7 of this act establishes a consultation procedure to avoid and mitigate impacts on listed species and their habitats.
- i. Water Bank Act-Section 2 of this Act declares that . . . “It is in the public interest to preserve, restore and improve the wetlands of the Nation.” Bridge projects must be planned, constructed, and operated to assure protection, preservation, and enhancement of the nation’s wetlands to the fullest extent practicable. Efforts should be made to consider alignments that would avoid or minimize impacts on wetlands, as well as design changes and construction and operation measures, to avoid or minimize impacts.
- j. Wild and Scenic Rivers Act-Section 7 of this act provides generally, that no license shall be issued for any water resources project where such project would have a direct and adverse effect on a river or the values for which such river was designated by this act. A bridge is considered to be included in the term “water resources project,” and a permit is a license.
- k. Prime and Unique Farmlands-Impacts of bridge projects on prime and unique farmlands, as designated by the State Soil Conservation service (U.S.D.A.), must be evaluated. Efforts should be made to assure that such farmlands are not irreversibly converted to other uses unless other national interests override the importance of preservation or otherwise outweigh the environmental benefits derived from their protection. Analysis of the impact of a bridge project on any such land SHALL be included in all environmental documents.
- 1. Executive Order 11988, Floodplain Management-This Order sets forth directives to “avoid, to the extent possible, the long and short term impacts associated

with the occupancy and modification of floodplains and to avoid direct or indirect support of floodplain development wherever there is a practicable alternative.” An analysis of a bridge project’s effect on hydraulics should be included in the environmental documentation.

- m. Relocation assistance-The Uniform Relocation and Assistance and Real Property Acquisition Policies Act of 1970 applies to projects where federal funds are involved. If any federal funds are involved in a bridge project, the environmental documents shall show that relocated persons should be provided decent, safe, and sanitary housing; that such housing be available within a reasonable period of time before persons are displaced; that such housing is within the financial means of those displaced; and that it is reasonably convenient to public services and centers of employment.
- n. Executive Order 11990, Protection of Wetlands-Department of Transportation Policy is to avoid new construction in a wetland unless: (a) there is no practicable alternate to the construction, and (b) the proposed project includes all practicable measures to minimize harm to wetlands which may result from such construction.

Wetlands are defined as lands either permanently or intermittently covered or saturated with water. This includes, but is not limited to, swamps, marshes, bogs, sloughs, estuarine area, and shallow lakes and ponds with emergent vegetation. Areas covered with water for such a short time that there is no effect on moist-soil vegetation are not included in the definition, nor are the permanent waters of streams, reservoirs, and deep lakes. The wetland ecosystem includes those areas which affect or are affected by the wetland area itself; e.g., adjacent uplands or regions up and down stream. An activity may affect the wetlands indirectly by impacting regions up or downstream from the wetland, or by disturbing the water table of the area in which the wetland lies.

2.7.3 Plans, specifications, and contracts-These engineering documents together should define the work expressly, clearly, thoroughly, and without possibility of ambiguous interpretation. The plans should show all dimensions of the finished structure, in necessary and sufficient details to permit realization of the full intent of the design and to facilitate the preparation of an accurate estimate of the quantities of materials and costs. The plans should also state which specification (e.g., AASHTO M77) was followed, the loading the bridge was designed to carry, any other special loading, the design strengths of materials (concrete, steel, bearings), the allowable and design footing pressures, the design method used (load factor or working stress), and the design flood. The construction specifications and contracts should also define construction methods, procedures, and tolerances to insure workmanship, quality control, and application of unit costs when stipulated under the contract. The Contractor’s responsibilities should be clearly defined in detail, with everything expressly stated.

2.7.4 Construction inspection-The responsibilities of construction inspection for concrete bridges should always be clearly identified. Preferably, the owner should engage the designer of the bridge to inspect its construction, to review the contractor's procedures and falsework plans, which should be submitted prior to construction.

RECOMMENDED REFERENCES

The documents of the various standards-producing organizations referred to in this report are listed here with their serial designation, including year of adoption or revision. The documents listed were the latest effort at the time this report was written. Since some of these documents are revised frequently, generally in minor detail only, the user of this report should check directly with the sponsoring group if it is desired to refer to the latest revision.

American Association of State Highway and Transportation Officials

- IIB-12 Standard Specifications for Highway Bridges, 13th Edition, 1983
- DS-2 Design Standards-Interstate System, 1967
- DSOF-3 Geometric Design Standards for Highways Other Than Freeways, 1969
- GD-2 A Policy on Geometric Design of Rural Highways, 1965
- GU-2 A Policy on Urban Highways and Arterial Streets, 1973
- IIDG-7 Hydraulic Analysis for the Location and Design of Bridges, 1982
- GTB Guide for Selecting, Locating and Designing Traffic Barriers, 1977
- HM-14 Standard Specifications for Transportation Materials and Methods of Sampling and Testing

American Concrete Institute

- 345-82 Standard Practice for Concrete Highway Bridge

- Deck Construction
- 358R-80 State-of-the-Art Report on Concrete Guideways
- 504R-77 Guide to Joint Sealants for Concrete Structures
- SP-24 Models for Concrete Structures

American Railway Engineering Association Manual for Railway Engineering

- Chapter 8-Concrete Structures and Foundations
- Chapter 28-Clearances
- Chapter 29-Waterproofing

CITED REFERENCES

- 2- 1. "Drainage of Highway Pavements," *Hydraulic Engineering Circular*, No. 12, Mar. 1969, U.S. DOT, FHWA.
- 2-2. "Location, Section and Maintenance of Highway Traffic Barriers," NCHRP Ref. #118-197 1; TRB Washington, D.C.
- 2-3. "Handbook of Highway Safety Design and Operating Practices," U.S. DOT, FHWA, 1973.
- 2-4. "Hydraulic Design of Bridge with Risk Analysis," USDOT FHWA-T5-80-226, Mar. 1980.
- 2-5. "Bridge Aesthetics," a bibliography compiled by Martin P. Burke, Jr., P.E., published by Transportation Research Board.
- 2-6. FHWA Technical Advisory T 5140.12, Dec. 4, 1979, "Alternate Bridge Designs."
- 2-7. "Guidelines for Value Engineering," Task Force #19, AASHTO-AGC-ARTBA Joint Cooperative Committee.
- 2-8. "Value Engineering for Highways," Federal Highway Administration, U.S. Department of Transportation
- 2-9. "Value Engineering in Construction," Department of the Army, Office of the Chief of Engineers, Sept. 1974.
- 2-10. "Federal-Aid Highway Program Manual," Federal Highway Administration, U.S. Department of Transportation.

CHAPTER 3-MATERIALS

3.1-Introduction

The ultimate realization and performance of concrete bridges depend upon well conceived and executed designs, skilled construction, and the use of reliable materials. Materials used in construction of concrete bridges are presented and/or referenced in this chapter. Also, recommended specifications for materials acceptance, sampling, and testing are presented and/or referenced.

3.2-Materials

3.2.1 Sources-Materials should be supplied from sources approved before shipment. The basis for approval should be the ability to produce materials of the quality and in the quantity required. These approved sources should be used as long as the materials continue to meet the requirements of the specifications. It is recommended that materials be in compliance with the standard specifications listed in the following sections.

The sources of the materials should be identified and contracts for their supply executed well in advance of the time when concreting is expected to begin. Sufficient lead time should be provided for the evaluating, sampling, and testing of all material if sources have not been previously approved by an appropriate agency, such as a State Department of Transportation.

3.2.2 Specifications and standard practices-Material specifications and tests for highway bridges should be in compliance with current AASHTO "Standard Specifications for Highway Bridges;" for railway bridges in compliance with current AREA "Manual for Railway Engineering," Chapter 8. In addition, standard practices should be in accordance with ACI guidelines and ASTM material specifications.

3.2.3 Admixtures-Admixtures are materials used to modify the properties of concrete for a particular application. Generally, admixtures are employed to increase strength, improve workability and durability, and increase or decrease the time of setting. To insure the desired product, care should be exercised in selection, evaluation, and methods of addition. In evaluation, consideration should be given to the experience records of specific admixtures with concrete materials commonly used in the area. ACI 212.1R and 212.2R provide excellent resource information.

Air-entraining admixtures are used in bridge concrete to improve the durability of concrete in freeze-thaw cycling, particularly in the presence of deicing chemicals containing chlorides. Recommended air contents for various nominal coarse aggregate sizes are given in ACI 345. Specifications for air-entraining admixtures are given in ASTM C 260.

Water-reducing admixtures conforming to ASTM C 494, Type A or water-reducing and retarding admixtures conforming to ASTM C 494, Type D allow for a reduction in water-cement ratio and/or setting time for a given consistency of concrete. Concrete workability is maintained while strength is increased and concrete permeability reduced. Wa-

ter-reducing admixtures in combination with air entrainment will produce greater resistance to chlorides in a freeze-thaw environment. Additional economy will result where specifications permit reducing cement content.

High-range water-reducing admixtures, which reduce the quantity of mixing water by 12 percent or greater, are growing in use by manufacturers of precast concrete. Increased workability of the concrete mixture and accelerated compressive strength gain substantially reduce the time required to achieve stripping strengths. As in the case of conventional water-reducing admixtures, these admixtures can behave differently with different cements and temperatures. Two classes of high-range water-reducing admixtures are specified, denoting normal setting and retarding admixtures conforming to ASTM C 494, Types F and G, respectively.

Accelerating admixtures are used to increase high-early strength and decrease the setting time. Accelerators may be specified to facilitate early form removal or cold weather concreting.

Calcium chloride has been the most widely used accelerator since it is very effective and relatively economical. However, the use of calcium chloride in concrete promotes corrosion of metals in contact with it, due to the presence of chloride ions. Calcium chloride is not permitted where galvanized metal stay-in-place forms are used, or for use in prestressed concrete, or where dissimilar metals are embedded. It should not be used in any elements of concrete bridges/structures that may be exposed to additional chlorides. Calcium chloride should not be used as an admixture with lime-based slag cements, high-alumina cements, or with super-sulfated cements. Consideration should be given to obtaining the desired results without using an accelerating admixture, either by use of a water-reducer or high-early strength cement. AREA specifications do not permit the addition of calcium chloride. If used, calcium chloride should conform to ASTM D 98.

Calcium nitrite, although still under experimental evaluation by some states, can be added to reinforced concrete to inhibit corrosion and increase strength. Primary application has been with precast, prestressed concrete box and girder sections for bridges. The admixture should comply with ASTM C 494, Type C.

There are three classes of mineral admixture conforming to ASTM C 618: raw or calcined natural pozzolan (Class N), and two classes of fly ash (Class F and Class C). Class F has pozzolanic properties; Class C has some cementitious properties in addition to pozzolanic properties.

Mineral admixtures conforming to ASTM C 618 are used in concrete to reduce the heat of hydration in mass concrete, to improve the resistance of concrete to actions such as those caused by reactive aggregates, and to conserve cement by replacing a portion of the required cement except when high-early strength is required.

3.2.4 Aggregates-Aggregates for concrete consist of fine and coarse particles conforming to ASTM C 33. Both

AASHTO and AREA specifications require additional standard test methods. As a general guide, the maximum size of the aggregate should not be larger than one-fifth of the narrower dimension between sides of forms, one-third of the depth of slabs, or two-thirds (AREA specifies one-half) of the minimum clear spacing between reinforcing bars.

The sizes of the fine and coarse aggregates should be reasonably well graded from coarse to fine, and the maximum size of the coarse aggregate desired for specific structures should be specified. The sizes of coarse aggregates should conform to ASTM D 448. AREA specifications modify ASTM D 448 for the sizes of coarse aggregates.

Lightweight aggregates may be specified in concrete for structural elements. A prime consideration for bridge decks is a reduction of dead load by approximately 25 percent. Availability of lightweight aggregates at an economical price may be a concern in some areas. Abrasion and durability should be evaluated when lightweight aggregate is being considered for use in bridge decks or other exposed locations. Lightweight aggregates, if required or permitted by special provisions, should conform to ASTM C 330. AREA specifications modify ASTM C 330.

The basic physical and chemical characteristics of aggregate cannot be altered by processing, although the quantities of certain deleterious particles can be reduced. Preparation and handling affect such important aggregate properties as gradation, uniformity of moisture content, cleanliness, and in the case of crushed aggregate, particle shape, thereby having an important influence on concrete quality. Frozen aggregates or aggregates containing frozen lumps should be thawed before use. Aggregates should have a reasonably uniform moisture content when delivered to the mixer. Information covering selection and application of aggregates for concrete may be obtained from the report of ACI 221.

3.2.5 Cement—The type of cement should always be specified.

Cement should conform to one of the specifications for cement listed below:

- a. Portland cement types as designated in ASTM C 150
- b. Three shrinkage-compensating portland cements given in ASTM C 845 designated as Types K, M, and S. Recommended application is given in ACI 223.
- c. Portland blast-furnace slag cement or portland-pozzolan cement as given in ASTM C 595 for structural concrete.

The amount of cement used in the concrete should correspond to the specified job mixture.

3.2.6 Water—Water for washing aggregates and for use with cement in mortar or concrete should be clean and free from deleterious amounts of oil, salt, sugar, acid, alkali, organic materials, or other substances interfering with the required strength, density, impermeability, and durability of concrete and steel, or otherwise harmful to the finished product.

Nonpotable water should be tested and should meet the suggested limits of AASHTO T 26. Nonpotable water should not be used in concrete unless the following are satisfied: selection of concrete proportions shall be based on con-

crete mixes using water from the same source; mortar test cubes made with nonpotable mixing water shall have 7-day and 28-day strengths equal to at least 90 percent of strengths of similar specimens made with potable water; strength test comparison shall be made on mortars, identical except for the mixing water, prepared and tested in accordance with ASTM C 109. Cement paste setting should conform to ASTM C 191, and concrete setting to ASTM C 403.

3.2.7 Selection of concrete proportions—Recommendations for selecting proportions for concrete are given in ACI 211.1. Provision is given for selecting and adjusting proportions for normal weight concrete by the estimated weight and/or the absolute volume methods.

Recommendations for lightweight concrete are given in ACI 211.2. Provision is made for proportioning and adjusting structural grade concrete containing lightweight aggregate.

Concrete ingredients and proportions should be selected to meet the minimum requirements stated in the specifications and contract documents. Field experience or laboratory trial mixes are the preferred methods for selecting concrete mixture proportions.

ACI 318 limits chloride ion content for corrosion protection, depending on member type. An initial evaluation can be obtained by testing individual concrete ingredients for total chloride ion content. Additional information is given in ACI 201.2R and ACI 222R on the effects of chlorides on the corrosion of reinforcing steel. When coated reinforcement steel is used, the preceding guidelines may be more restrictive than necessary.

3.2.8 Curing materials—Freshly cast concrete should be protected from premature drying and excessive heat or cold. To insure continued hydration at an optimum rate, the concrete should be kept saturated by wet, membrane, or steam curing for a given length of time. Preservation of the concrete moisture content may be accomplished by using burlap cloth, enclosure steam curing, liquid membrane-forming compounds, or waterproof sheet materials.

Burlap cloth should be made of jute or kenaf conforming to AASHTO M182. The cloth should remain wet for the entire specified curing time.

The liquid membrane-forming compounds should be suitable for spraying on horizontal and vertical surfaces and should conform to ASTM C 309. The compounds covered by this specification are available in different colors and are suitable for use as curing media for fresh concrete. They also provide additional curing of the concrete after removal of forms or after initial moist curing. The application of Type 2, white pigmented compound is generally preferred because it reduces the temperature rise in concrete exposed to the sun. However, at times its application may lead to an unsightly appearance since the compound does not wear off readily or evenly. Type 1-D with fugitive dye may be found more desirable for structural barriers or substructure work.

Waterproof sheet material should conform to ASTM C 71. This material is placed on the surfaces of concrete for minimizing moisture loss during the curing period, and in the case of the white reflective-type materials for reducing tem-

perature rise in concrete exposed to the sun. Early application of this material may produce a smooth, glossy surface finish which is undesirable for a bridge deck.

The requirements of curing practice as prescribed by ACI 308 should be followed.

3.2.9 Joint materials-ACI 504R should be consulted for information on joint materials and construction.

3.2.9.1 Water stops-Water stops are used to prevent the infiltration of debris and water at construction, contraction, fixed and expansion joints. These are of metal, rubber, or plastics. Where the function of the joint is to provide movement, the water stops should be designed to permit such movement and be of a shape and thickness that will accommodate the force effects anticipated in the water stop. Spliced, welded, or soldered water stops should form continuous watertight joints.

Metal water stops may be made of copper or stainless steel strips. Copper water stops or flashings should conform to ASTM B 152 Copper No. 11000, electrolytic tough pitch type, light cold-rolled, soft annealed. Stainless steel water stops should conform to ASTM A 167, Type 316 L; No. 2 D Finish.

Rubber water stops may be molded or extruded. Their cross section should be uniform, free from porosity or other defects. The material for water stop may be compounded from natural rubber, synthetic rubber, or a blend of the two, together with other compatible materials which will produce a finished water stop conforming to the test requirements of ASTM D 412, D 572, D 746, D 747, D 792, and D 2240.

Plastic water stops should be fabricated by an extrusion process with a uniform cross section that is free from porosity or other defects. The material used for the water stop should be a homogeneous, elastomeric, plastic compound of basic polyvinyl chloride and other material which, after fabrication, should conform to the same ASTM test requirements as rubber water stops.

3.2.9.2 Joint fillers-Expansion joints may be filled with bituminous, cork, sponge rubber, or other approved expansion joint filler material. Preformed joints that are of bituminous type and are to be resilient should conform to ASTM D 175 1. Preformed joints that are of bituminous type and are less than $\frac{1}{4}$ in. thick, such as those used in parapet joints over piers of continuous structures, should conform to ASTM D 994.

Preformed joints that are nonbituminous should conform to ASTM D 1752, Type I, for sponge rubber material when resiliency is required and Type II for cork material when resiliency is not required.

Preformed joints that do not require the resiliency provided by rubber, and which are used for exposed concrete, may be made of polystyrene material conforming to AASHTO M 230. When the joint is not exposed, such as for a column hinged at a footing, the preformed material may consist of bituminous material conforming to ASTM D 994 or to cork material conforming to ASTM D 1752, Type II.

3.2.9.3 Joint sealants-Preformed expansion joints may be sealed with cold-application-type sealer, a hot-poured elastic type sealer, or an elastomeric-type joint seal. The

cold-application joint sealer should conform to ASTM D 1850. The hot-poured elastic type should conform to ASTM D 1190, and the elastomeric type should conform to AASHTO M 220.

3.2.9.4 Mechanically locked sealants-Numerous proprietary mechanically locked sealants in compression and/or tension are available. Prior to specifying sealants, test data and performance information should be obtained from the manufacturer, or an agency where testing or performance has been monitored and evaluated. Details for application and size selection are given in ACI 504R.

Mechanical locking of compression seals between armor-ing improves performance since direct compression alone cannot be relied on to keep the seal in place. For example, multi-unit modular joint systems, employing a number of transverse extruded steel sections having "locked in" elastomeric seals, are available. To insure joint sealing integrity, it is important to provide sufficient anchorage between the armor and concrete anchorage to withstand traffic impact. Good field inspection is necessary to insure proper installation.

Strip seals are widely used in concrete bridge decks for thermal movements up to 4 in. (100 mm). The preformed elastomeric seal element is mechanically locked between armored interfaces of extruded steel sections. During structure movements, a preformed central hinge enables the strip seal gland profile to fold between the steel extrusions. When properly sized and installed, watertightness is insured by wedge-action of the elastomeric lugs within the steel extrusions.

Steel used in the extrusions should conform to ASTM A 242, A 36, or A 588. The elastomer used in the seal or gland element should conform to the requirements of ASTM D 2628.

3.2.9.5 Steel joints-Due to the availability, effectiveness, and range of movement of mechanically locked glands or seals, open steel joints are becoming less attractive. Positive protection against joint leakage is required to prevent deterioration of bridge bearings and substructure units. Steel joints can be made watertight by specifying a neoprene trough. However, past experience indicates that regular maintenance is required to keep the trough free of debris.

Steel joints are either a sliding plate or finger type. The sliding is generally limited to thermal movements up to 4 in. (100 mm) and the steel finger type up to 8 in. (200 mm). The sliding plate and finger joints should be examined for possible warpage before installation by laying the plates together, loose, or on a flat surface. The steel should conform to ASTM A 36 or A 588. Neoprene, if used, should conform to ASTM D 412 and D 2240.

3.2.10 Bearings-The function of bridge bearings is to transfer loads from the superstructure to the substructure. Also, bearings should accommodate rotational movements of the superstructure elements. Bearing guidelines are in the process of being written by ACI Committee 554.

Expansion bearings should permit both longitudinal and rotational movements while transferring lateral loads such as wind. The coefficient of friction on mating surfaces should

be as low as practical; high frictional forces may increase the cost of substructure units.

Fixed bearings should allow rotational movement while transferring both lateral and longitudinal loads to the substructure units. Fixed bearings tie the superstructure to the substructure, thus preventing the bridge from potential down-grade translation.

Several types of bearings are available; some of the more common types are as follows:

3.2.10.1 Elastomeric bearings-Elastomeric bearings are either molded, single-unit laminated pads with integral layers of nonelastic shims or nonlaminated, molded, or extruded pads. The elastomer should be natural rubber or neoprene of Grade 55 + 5, durometer hardness material conforming to the tests of ASTM D 2240, D 412, D 573, D 395, D 1149, D 429, and D 746, Procedure B. Experience indicates that steel laminates are superior to other nonelastic laminates. Laminates should be rolled, mild steel sheets conforming to ASTM A 570, A 36, or A 611, Grade D. All components of laminated bearings should be molded together in an integral unit and all laminated edges should be covered by a minimum $\frac{1}{8}$ -in. (3-mm) thickness of elastomer.

3.2.10.2 PTFE slide bearings-Polytetrafluoroethylene (PTFE) slide bearings are self-lubricating and can be bonded to a rigid back-up material capable of resisting horizontal shear and bending stresses. Expansion bearings of PTFE are not recommended without providing an elastomer or rocker plate to accommodate rotation. Stainless steel or other equally corrosive-resistant material should be used for a smooth, low-friction mating surface. Stainless steel and unfilled PTFE made with virgin TFE resin should conform to ASTM A 240, Type 316 and D 1457, respectively.

3.2.10.3 Steel bearings-Steel bearings are either roller, rocker, sliding, or large built-up rocker types. Steel bearings are fabricated from materials conforming to ASTM A 36, A 572, or A 588. All structural steel bearing plates should be flat-rolled with smooth surfaces free of warp, having edges straight and vertical. If lubricated bronze plates are required, they should conform to ASTM B 22, Alloy 911 or B 100, Copper Alloy 510.

On painted structures, the upper 6 in. (150 mm) of anchor bolts, nuts, and washers should have a protective coating. If specified, galvanizing should conform to ASTM A 153 or B 633.

3.2.10.4 Pot bearings-Pot bearings consist of a circular steel piston and cylinder which confine an elastomeric pad. The elastomer is prevented from bulging by the pot and acts similarly to a fluid under pressure. The pot bearing serves as an economical alternate to built-up steel bearings for higher load applications. These bearings allow rotational movement either with or without lateral and longitudinal movement. Polyether urethane elastomer of pure virgin material conforming to ASTM D 2240, D 412, or D 395 is recommended for the rotational element. Longitudinal movement can be attained by incorporating a PTFE slide bearing. The steel cylinder and piston should preferably be machined from a single piece of steel conforming to ASTM A 588.

3.2.10.5 Shear inhibited disc bearings-Shear inhibited disc bearings consist of a load-bearing and rotational disc of polyether urethane enclosed between upper and lower steel bearing plates equipped with an internal shear restriction pin. Expansion is accommodated by using a recessed PTFE on the upper half of the top bearing plate. The PTFE surface supports an upper steel plate having a stainless steel surface. The upper steel plate is fitted with guide bars to restrict lateral movement.

The rotational element should be molded from polyether urethane conforming to ASTM D 412, D 395, and D 2240. Steel and stainless steel should conform to ASTM A 36 and ASTM A 167, Type 316, respectively, unless otherwise specified in the contract documents. PTFE should be made from pure virgin unfilled teflon resin conforming to ASTM D 638 and D 792.

3.2.11 Metal reinforcement

3.2.11.1 Reinforcing bars-All reinforcing bars should be deformed except plain bars may be used for spirals or for dowels at expansion or contraction joints. Reinforcing bars should be the grades required by the contract documents, and should conform to one of the following specifications:

- a. ASTM A 615
- b. ASTM A 616, including Supplement SI
- c. ASTM A 617
- d. ASTM A 706

Billet-steel reinforcing bars conforming to ASTM A 615, Grade 60 [minimum yield strength 60 ksi (414 MPa)], are the most widely used type and grade. The current edition of ASTM A 615 covers bar sizes #3 through #11, #14, and #18. ASTM A 615M covers metric bar sizes #10 through #55.

When important or extensive welding is required, or when more bendability and controlled ductility are required as a seismic-resistant design, use of low-alloy reinforcing bars conforming to ASTM A 706 should be considered. Before specifying A 706 reinforcing bars, however, local availability should be investigated.

3.2.11.2 Coated reinforcing bars-When coated reinforcing bars are required as a corrosion-protection system, the engineer should specify whether the bars are to be zinc-coated (galvanized) or epoxy-coated. The reinforcing bars to be coated should conform to the specifications listed in Section 3.2.11.1.

- a. Zinc-coated (galvanized) reinforcing bars should conform to ASTM A 767. Supplementary requirement § 1 should apply when fabrication of the galvanization includes cutting. Supplementary requirement S2 should apply when fabrication after galvanization includes bending.
- b. Epoxy-coated reinforcing bars should conform to ASTM A 775.
- c. Repair of damaged zinc coating, when required, should use a zinc-rich formulation conforming to ASTM A 767. Repair should be done in accordance with the material manufacturer's recommendations.
- d. Repair of damaged epoxy-coating, when required, should use a patching material conforming to ASTM

A 775. Repair should be done in accordance with the material manufacturer's recommendations.

For zinc-coated reinforcing bars (galvanized) in accordance with ASTM A 767, the engineer should specify class of coating, whether galvanization is to be performed before or after fabrication, and if supplementary requirement S3 applies. If the bars are to be galvanized after fabrication, the engineer should indicate which bars require special finished bend diameters, such as the smaller bar sizes used for stirrups and ties. All other reinforcement and embedded steel items in contact with or in close proximity to galvanized reinforcing bars should be galvanized to prevent a possible reaction of dissimilar metals.

On projects using both coated and uncoated bars, the engineer should clearly indicate on the plans which bars are to be coated.

3.2.11.3 Bar mats--Bar mat reinforcement consists of two layers of deformed reinforcing bars assembled at right angles to each other, and clipped or welded at the bar intersections to form a grid. The reinforcing bars used in mats should conform to the specifications listed in [Section 3.2.11.1](#). Whether clipped or welded mats are required depends on the size of the mat and the rigidity required for preserving the shape of the mat during handling. Clipping the bars should be adopted whenever possible, as welding decreases the fatigue strength of the bar steel because of the stress concentration effect of the weld. Bar mats should conform to ASTM A 184.

Clipped bar mats may be fabricated from zinc-coated (galvanized) reinforcing bars. Metal clips should be zinc-coated (galvanized). Nonmetallic clips may be used. Coating damage at the clipped intersections should be repaired in accordance with recommendations given in [Section 3.2.11.2\(c\)](#).

Clipped bar mats may be fabricated from epoxy-coated reinforcing bars. Metal clips should be epoxy-coated. Nonmetallic clips may be used. Coating damage at the clipped intersections should be repaired in accordance with the recommendations given in [Section 3.2.11.2\(d\)](#).

3.2.11.4 Wire--Wire should be plain or deformed wire as indicated in the contract documents. Spirals may be plain wire. For wire with a specified yield strength f_y , exceeding 60,000 psi (414 MPa), f_y should be the stress corresponding to a strain of 0.35 percent.

Plain wire should conform to ASTM A 82.

Deformed wire should conform to ASTM A 496, size D4 and larger.

3.2.11.5 Welded wire fabric--Welded wire fabric is composed of cold-drawn steel wires, which may or may not be galvanized, and fabricated into sheets by the process of electrical-resistance welding. The finished material consists essentially of a series of longitudinal and transverse wires arranged substantially at right angles to each other, and welded together at all points of intersection. The use of this material for concrete reinforcement should preferably be at a location where the application of the loading is static or nearly so. If the application of the loading is highly cyclical, the fatigue strength of the wire fabric should be considered when determining the sizes of the wires. For fatigue considerations ref-

erence should be made to ACI 215R. The steel wires for the fabric may be either plain or deformed. The engineer should specify the size and wire spacing, and whether the fabric is to be plain or deformed. For wire with a specified yield strength f_y , exceeding 60,000 psi (414 MPa), f_y should be the stress corresponding to a strain of 0.35 percent.

Welded plain wire fabric should conform to ASTM A 185, and welded intersections should not be spaced farther apart than 12 in. (300 mm) in the direction of the primary flexural reinforcement.

Welded deformed wire fabric should conform to ASTM A 497, and wire should not be smaller than size D4, and welding intersections should not be spaced farther apart than 16 in. (400 mm) in the direction of the primary flexural reinforcement.

Welded wire fabric made from a combination of either deformed or plain wires should conform to ASTM A 497 with the same exceptions previously listed for deformed fabric.

3.2.11.6 Prestressing tendons--Strands, wire, or high-strength bars are used for tendons in prestressed concrete.

a. Strands. Two grades of seven-wire, uncoated, stress-relieved steel strand are generally used in prestressed concrete construction. These are Grades 250 and 270, which have minimum ultimate strengths of 250,000 and 270,000 psi (172 and 186 MPa), respectively. The strands should conform to ASTM A 416. Supplement 1 of ASTM A 416 describes low-relaxation strand and relaxation testing. Recommended test procedures for stress relaxation are given in ASTM E 328.

b. Wire. Two types of uncoated stress-relieved round high-carbon steel wires commonly used in prestressed linear concrete construction are: Type BA wire for applications in which cold-end deformation is used for anchoring purposes (Button Anchorage) and Type WA wire for applications in which the ends are anchored by wedges and no cold-end deformation of the wire is involved (Wedge Anchorage).

Post-Tensioning systems commonly used are described in *Post-Tensioning Manual* by the Post-Tensioning Institute. Types WA and BA wire should conform to ASTM A 421. Supplement 1 of ASTM A 421 describes low-relaxation strand and relaxation testing. Recommended test procedures for stress relaxation are given in ASTM E 328.

c. Uncoated high-strength bars for prestressed concrete construction should conform to ASTM A 722. The specification covers two types of bars: Type I (plain) and Type II (deformed).

3.2.11.7 Structural steel, steel pipe, or tubing--Structural steel used with reinforcing bars in composite columns should conform to ASTM A 36, A 242, A 441, A 572, or A 588.

Steel pipe or tubing for composite columns should conform to ASTM A 53 (Grade B), A 500, or A 501.

3.2.12 Accessories

3.2.12.1 Bar supports--All reinforcement should be supported and fastened together to prevent displacement before and during casting of concrete. Bar supports may consist

of concrete, metal, plastic, or other acceptable materials. Details and recommended practices for bar supports are given in ACI 315.

Standardized, factory-made steel wire bar supports are the most widely used type. Where the concrete surface will be exposed to the weather in the finished structure, the portions of bar supports near the surface should be noncorrosive or protected against corrosion.

Bar supports for supporting zinc-coated (galvanized) or epoxy-coated reinforcing bars should be in accordance with the recommendations given in Section 13.11 of this document.

3.2.12.2 Side form spacers—Side form spacers, if needed, are placed against vertical forms to maintain prescribed clear concrete cover and position of the vertical reinforcing bars. The need for side form spacers is determined by the proportions of the form, the arrangement and placing of the reinforcing bars, the form material and forming systems used, and the exposure of the surface to weather and/or deleterious materials. In situations where spacers are needed, various devices can be used such as double-headed nails, form ties, slab or beam bolsters (wire bar supports), precast concrete blocks, proprietary all-plastic shapes, etc.

The engineer should specify the requirements for side form spacers including material, type, spacing, and location where required.

Section 1.9 of AREA Manual, Chapter 8, specifies that at all vertical formed surfaces that will be exposed to the weather in the finished structure, side form spacers spaced no further than 4 ft on center shall be provided. Spacers and all other accessories within $\frac{1}{2}$ in. of the concrete surface shall be noncorrosive or protected against corrosion.

3.2.12.3 Tie wire—The tie wire used to fasten reinforcing bars should be black annealed steel wire, 16-gage (1.6-mm diameter) or heavier. Tie wire for fastening zinc-coated (galvanized) or epoxy-coated reinforcing bars should be in accordance with the recommendations given in Section 13.11 of this document.

3.2.12.4 Bar splicing material—When required or permitted, welded splices or mechanical connections may be used to splice reinforcing bars.

All welding of reinforcing bars should conform to “Structural Welding Code-Reinforcing Steel” AWS D1.4. Reinforcing bars to be welded should be indicated on the drawings and the welding procedure to be used should be specified. Except for ASTM A 706 bars, the engineer should specify if any more stringent requirements for chemical composition of reinforcing bars than those contained in the referenced ASTM specifications are desired, i.e., the chemical composition necessary to conform to the welding procedures specified in AWS D 1.4.

Proprietary splice devices are available for making mechanical connections. Performance information and test data should be secured from manufacturers. Descriptions of the physical features and installation procedures for selected splice devices are given in ACI 439.3R.

3.2.12.5 Tensioning tendon components—Anchorages, couplers, and splices for post-tensioned reinforcement

should develop the required nominal strength of the tendons, without exceeding the anticipated set. Anchorages for bonded tendons should develop at least 90 percent of the specified ultimate strength of the prestressing steel when tested in an unbonded condition, without exceeding the anticipated set. Couplers and splices should be placed in areas approved by the engineer and enclosed in housings long enough to permit the necessary movements. They should not be used at points of sharp curvature and should be staggered.

Performance specifications for single unbonded strand post-tensioning tendons are provided in the *Post-Tensioning Manual* of the Post-Tensioning Institute. Unbonded tendon anchorages should be subjected to the following additional requirements as recommended in ACI 423.3R.

- a. *Static tests*—When an assembly consisting of the tendon and fittings is statically loaded, it should meet the requirements set forth in the ASTM tendon material specifications for yield strength, ultimate strength, and minimum elongation. If minimum elongation at rupture is not stated by ASTM specifications, the elongation of the assembly should not be less than 3 percent measured on not less than a 10-ft (3-m) gage length.
- b. *Cyclic tests*—The test assembly should withstand, without failure, 500,000 complete cycles ranging between 60 and 66 percent of the specified ultimate strength.
- c. When used in structures subjected to earthquake loadings, the test assembly should withstand, without failure, a minimum of 50 complete cycles of loading corresponding to the following percentages of the minimums specified ultimate strength in ksi (MPa):

$$60 + 2000/l_n + 100$$

$$(60 + 610/l_n + 30.5)$$

where l_n is the length of the tendon in feet (meters).

- d) Kinking and possible notching effects by the anchorage should be avoided, particularly where tendon assemblies will be subjected to repetitive or seismic loadings.

3.2.13 Appurtenances

3.2.13.1 General—Materials in contact with and partially embedded in concrete should be so constituted as to not be injurious to the concrete.

3.2.13.2 Forms—Metal forms that are to remain in place should be zinc-coated galvanized, both for appearance and durability. Material for metal forms should conform to ASTM A 446 Coating Designation G165. Any exposed form metal where the zinc coating has been damaged should be thoroughly cleaned and wire brushed, then painted with two coats of zinc oxide-zinc dust primer, Federal Specification IT-P-64 1d, Type II, no color added.

Details of formwork, design criteria and descriptions of common types are shown in ACI SP-4.

3.2.13.3 Form coatings—Oil or other types of coating used on forms to prevent sticking of the concrete should not cause softening or permanent staining of the concrete surface, nor should it interfere with any curing process which

might be used after form removal. Surfaces of forms made with lumber containing excessive tannin or other organic substance sufficient to cause softening of the concrete surface should be treated with whitewash or limewater prior to applying the form oil coating. Shellac, lacquers, and compounded petroleum oils are commercially available for form coating. The manufacturer of the coating should certify that the product will not be deleterious to concrete.

3.2.13.4 Galvanized materials-When steel bolts, nuts, and washers for anchoring railing posts, luminaires, pedestrian chain link fences, ladders, stairways, joint dams, bearings, as well as junction boxes, conduits and fittings, and exposed steel inserts are galvanized, the protective zinc covering should conform to ASTM A 153. When door frames and doors provided for access to cells of box girders, operator machinery, pump rooms, and floor drains fabricated of structural steel are galvanized, the protective zinc covering should conform to ASTM A 123.

3.2.13.5 Cast iron and stainless steel-The material for cast iron hardware such as scuppers and drains, embedded in concrete, should preferably conform to ASTM A 48. When steel fasteners are embedded in concrete and are subjected to alternate wetting and drying, the material should preferably consist of stainless steel conforming to ASTM A 276, Type 316.

3.2.14 Storage of materials

3.2.14.1 Cement-The handling and storage of cement should be such as to prevent its deterioration or the intrusion of foreign matter and moisture. The recommendations given in ACI 304 should be followed.

3.2.14.2 Aggregates-Aggregates should be handled and stored in such a manner as to minimize segregation, degradation, contamination, or mixing of different kinds and sizes. When specified, the coarse aggregate should be separated into two or more sizes to secure greater uniformity of the concrete mixture. Different sizes of aggregate should be stored in separate stock piles sufficiently removed from each other to prevent the material at the edges of the piles from becoming intermixed.

3.2.14.3 Metal reinforcement-Reinforcement should be stored above the surface of the ground and should be protected from mechanical injury and surface deterioration caused by exposure to conditions producing rust.

Prestressing tendons should be protected at all times against physical damage and corrosion, from manufacture to either grouting or encasing in concrete. Prestressing tendons should be packaged in containers or shipping forms for the protection of the steel against physical damage and corrosion during shipping and storage. A corrosion inhibitor which prevents rust or other results of corrosion should be placed in the package or form, or the tendons should be precoated with water-soluble oil. The corrosion inhibitor should have no deleterious effect on the steel or concrete or bond strength of steel to concrete. Care should be taken in the storage of prestressing tendons to prevent galvanic action.

3.3-Properties

Concrete is not a homogeneous material. Its properties

cannot be predicted with accuracy. They vary not only with the ingredients that make up concrete, but with the method of mixing, placing, and even the loading. The design engineer has only partial control of these variables, so it is necessary to understand them, the probable range of their variation, and their effect on the bridge structure. Only with a thorough understanding can the engineer design and detail a structure that functions properly.

3.3.1 Compressive strength-The design engineer specifies the strength of concrete needed to insure the structural adequacy. In the past it was always considered that the stronger the concrete the better. Today's designer should realize that some of the other properties that are directly related to the strength of the concrete may not make it desirable to allow concrete significantly stronger than specified.

3.3.2 Tensile strength-In determining the strength of a structure, the tensile strength of concrete is not directly considered. However, it can be a significant factor in deflection computations.

3.3.3 Modulus of elasticity and poisons ratio-The modulus of elasticity for most bridge structures, using normal weight concrete [(w_c between 90 and 150 pcf (1400 and 2400 kg/m³)], can be assumed to be that given in ACI 3 18-83

$$E_c = w_c^{1.5} 33 f_c' \text{ psi} \quad (E_c = w_c^{1.5} 0.043 f_c' \text{ MPa});$$

However, in ACI 363R-84, attention is called to the significant difference between actual tests made on many high-strength concretes and the ACI-318 formula.

If the structure being designed is of a significant size or if deflections are of significant importance, the designer should consider requiring tests to be made of the actual design mixture that would be used in the structure. Using the results of these tests in predicting deflections will be cost-effective, especially considering the time and effort necessary to correct the effects of improper camber and incorrectly predicted deflections.

Poisson's ratio may be assumed to be 0.2.

3.3.4 Creep-The inelastic strain of concrete under compressive stresses is generally a beneficial property. In this manner an indeterminate structure is able to adjust the dead load stresses to more efficiently utilize the inherent strength of the structure. However, when deflections due to creep become significant, it should be considered in the design. Creep decreases as the concrete ages, so one way to partially control creep is to prevent early loading of the structure or member. Creep also decreases with an increase in compressive reinforcement.

Creep can be as significant a property as the modulus of elasticity and should always be considered by the designer. Reference information for creep and shrinkage data is given in ACI 209R, Chapter 5.

3.3.5 Shrinkage-During the drying process concrete shrinks. The earlier the age that the concrete is dried, the greater the shrinkage. Since concrete is rarely exposed uniformly, the shrinkage of concrete is not uniform and internal shrinkage stresses are induced. Also, concrete sections are not restrained equally. This is particularly true at construc-

tion joints where fresh concrete is restrained by the previously cast concrete. The location of construction joints, the rate of concrete placement, and the concrete placing sequence can have a significant influence on the size and number of shrinkage-related cracks. The designer should be aware of the effects of shrinkage and creep and detail the structure to minimize the adverse effects.

The shrinkage coefficient for normal weight concrete should be established considering the local climatological conditions and the construction procedures. However, it should not be taken as less than an equivalent strain of 0.0002. Shrinkage coefficients for lightweight concrete should be determined for the type of aggregate used.

3.3.6 Thermal coefficient-Concrete and steel have approximately the same thermal coefficient of expansion so that within the normal ranges the two materials act together. If temperature changes were unrestrained and uniform, there would be no need for concern. However, most concrete bridges have some degree of restraint, whether built-in or resulting from poor maintenance, deterioration of bearings and expansion details, or horizontal movements of supports. In addition, concrete is not a good thermal conductor. This lack of conductivity results in significant temperature differentials, particularly between the upper and lower surfaces of the bridge. Thus stresses due to temperature effects are induced that can be of great significance.

Unlike creep and shrinkage, temperature effects are both shortening and lengthening; but because temperature shortening is additive to creep and shrinkage, the shortening effect is generally more critical. Unlike shrinkage and dead load stresses, the temperature effect is not a sustained load, and thus cannot be alleviated by creep. A method of calculating temperature differentials is given in [Section 5.4](#).

The thermal coefficient for normal weight concrete may be taken as 0.000006 F (0.000011 C). Thermal coefficients for lightweight concrete should be determined for the type of aggregate used.

3.3.7 State-of-the-art-For structures of greater than usual size, significance, or degree of complexity, the designer should consult the latest publications of ACI Committees: 209 Creep and Shrinkage, 363 High Strength Concrete, and 213 Lightweight Aggregates and Concrete. Currently these include SP-9, SP-27, SP-29, SP-76, ACI 209R, ACI 213R, and ACI 363R.

3.3.8 Reinforcement properties-The modulus of elasticity of deformed steel reinforcing bars or welded wire fabric may be taken as 29,000,000 psi (200,000 MPa). The modulus of elasticity for prestressing bars, strands, or wires should be determined by tests if not supplied by the manufacturer. When that information is not available, the following values may be used:

- Bars: 28000,000 psi (193,000 MPa);
- Strands: 27,000,000 psi (186,000 MPa);
- Wires: 29,000,000 psi (200,000 MPa);

3.4-Standard specifications and practices

The standard specifications for materials and practices referred to either directly or indirectly in this chapter are listed

here with their serial designation including the year of adoption or revision. These specifications are constantly reviewed and revised by members of the respective technical committees. It is recommended that documents with the most recent dates of issue be reviewed in conjunction with previous standard specifications; the latest revisions are not always in conformance with the requirements of the various agencies and owners. A list of ACI guidelines and standard practices is given for reference. An ASTM-AASHTO specification cross-reference is given at the end of this chapter for ease of comparing the two specifications. In many cases, however, there are significant differences between them.

3.4.1 ACI guidelines and standard practices

- 116R-78 Cement and Concrete Terminology
- 201.2R-77(Reaffirmed 1982)Guide to Durable Concrete
- 209R-82 Predictions of Creep, Shrinkage and Temperature Effects in Concrete Structures
- 211.1-8 1 (Revised 1984)Standard Practice for Selecting Proportions for Normal, Heavyweight, and Mass Concrete
- 2 12.1 R-8 1 Admixtures for Concrete
- 2 12.2R-8 1 Guide for Use of Admixtures in Concrete
- 213R-79(Reaffirmed 1984)Guide for Structural Lightweight Aggregate Concrete
- 215R-81 Considerations for Design of Concrete Structures Subject to Fatigue Loading
- 221R-84 Guide for the Use of Normal Weight Aggregates in Concrete
- 222R-85 Corrosion of Metals in Concrete
- 223-83 Standard Practice for the Use of Shrinkage-Compensating Concrete
- 304-73(Reaffirmed 1983)Recommended Practice for Measuring, Mixing, Transporting, and Placing Concrete
- 308-8 1 Standard Practice for Curing Concrete
- 315-80 Details and Detailing of Concrete Reinforcement
- 318-83 Building Code Requirements for Reinforced Concrete
- 345-82 Standard Practice for Concrete Highway Bridge Deck Construction
- 363R-84 State-of-the-Art Report on High-Strength Concrete
- 423.3R-83 Recommendations for Concrete Members Prestressed with Unbonded Tendons
- 439.3R-83 Mechanical Connections of Reinforcing Bars
- 504R-77 Guide to Joint Sealants for Concrete Structures
- 554-85 Committee Correspondence on Bearing Systems
- SP-4 Formwork for Concrete
- SP-9(OP); Symposium on Creep of Concrete
- SP-27(OP); Designing for Effects of Creep, Shrinkage, and Temperature in Concrete Structures
- SP-29(OP); Lightweight Concrete
- SP-76 Designing for Creep and Shrinkage in Concrete Structures

3.4.2 AREA Manual for Railway Engineering

- Chapter 8-Concrete Structures and Foundations, 1985.
- 3.4.3 *ASTM standards*
- A 36-84a Specification for Structural Steel
- A 48-83 Specification for Gray Iron Castings
- A 53-84a Specification for Pipe, Steel, Black and Hot-dipped, Zinc-Coated Welded and Seamless
- A 82-85 Specification for Cold-Drawn Steel Wire for Concrete Reinforcement
- A 123-84 Specification for Zinc (Hot-Galvanized) Coatings on Products Fabricated from Rolled, Pressed, and Forged Steel Shapes, Plates, Bars and Strip
- A 153-82 Specification for Zinc Coating (Hot-Dip) on Iron and Steel Hardware
- A 167-84a Specification for Stainless and Heat-Resisting Chromium-Nickel Steel Plate, Sheet, and Strip
- A 184-84a Specification for Fabricated Deformed Steel Bar Mats for Concrete Reinforcement
- A 185-85 Specification for Welded Steel Wire Fabric for Concrete Reinforcement
- A 242-85 Specification for High-Strength Low-Alloy Structural Steel
- A 276-86a Specification for Stainless and Heat-Resisting Steel Bars and Shapes
- A 416-85 Specification for Uncoated Seven-Wire Stress-Relieved Steel Strand for Prestressed Concrete
- A 421-80(1985) Specification for Uncoated Stress-Relieved Wire for Prestressed Concrete
- A 441-85 Specification for High-Strength Low-Alloy Structural Manganese Vanadium Steel
- A 446-85 Specification for Steel Sheet, Zinc-Coated (Galvanized) by the Hot-Dip Process, Structural (Physical) Quality
- A 496-85 Specification for Steel Wire, Deformed, for Concrete Reinforcement
- A 497-79 Specification for Welded Deformed Steel Wire Fabric for Concrete Reinforcement
- A 500-84 Specification for Cold-Formed Welded and Seamless Carbon Steel Structural Tubing in Rounds and Shapes
- A 501-84 Specification for Hot-Formed Welded and Seamless Carbon Steel Structural Tubing
- A 570-85 Specification for Hot-Rolled Carbon Steel Sheet and Strip, Structural Quality
- A 572-84 Specification for High-Strength Low-Alloy Columbium-Vanadium Steels of Structural Quality
- A 588-85 Specification for High-Strength Low-Alloy Structural Steel with 50 ksi (345 MPa) Minimum Yield Point to 4 in. Thick
- A 615-85 Specification for Deformed and Plain Billet-Steel Bars for Concrete Reinforcement
- A 615M-84a Specification for Deformed and Plain Billet-Steel Bars for Concrete Reinforcement (Metric)
- A 616-85 Specification for Rail-Steel Deformed and Plain Bars for Concrete Reinforcement
- A 617-82a Specification for Axle-Steel Deformed and Plain Bars for Concrete Reinforcement
- A 706-84a Specification for Low-Alloy Deformed Bars for Concrete Reinforcement
- A 709-85 Specification for Structural Steel for Bridges
- A 722-75(1981) Specification for Uncoated High-Strength Steel Bar for Prestressing Concrete
- A 767-84 Specification for Zinc-Coated (Galvanized) Bars for Concrete Reinforcement
- A 775-85 Specification for Epoxy-Coated Reinforcing Steel Bars
- B 22-85 Specification for Bronze Castings for Bridges and Turntables
- B 100-86 Specification for Rolled Copper-Alloy Bearing and Expansion Plates and Sheets for Bridge and Other Structural Uses
- B 152-86 Specification for Copper, Sheet, Strip, Plate, and Rolled Bar
- B 633-85 Specification for Electrodeposited Coatings of Zinc on Iron and Steel
- C 33-86 Specification for Concrete Aggregates
- C 109-86 Test Method for Compressive Strength of Hydraulic Cement Mortars (Using 2-in. or 50-mm Cube Specimens)
- C 150-85a Specification for Portland Cement
- C 171-69(1986) Specification for Sheet Materials for Curing Concrete
- C 191-82 Test Method for Time of Setting of Hydraulic Cement by Vicat Needle
- C 260-86 Specification for Air-Entraining Admixtures for Concrete
- C 309-81 Specification for Liquid Membrane-Forming Compounds for Curing Concrete
- C 330-85 Specification for Lightweight Aggregates for Structural Concrete
- C 403-85 Test Method for Time of Setting of Concrete Mixtures by Penetration Resistance
- C 494-86 Specification for Chemical Admixtures for Concrete
- C 595-86 Specification for Blended Hydraulic Cements
- C 618-85 Specification for Fly Ash and Raw or Calcined Natural Pozzolan for Use as a Mineral Admixture in Portland Cement Concrete
- C 845-80 Specification for Expansive Hydraulic Cement
- D 98-80 Specification for Calcium Chloride
- D 395-85 Test Methods for Rubber Property-Compression Set
- D 412-83 Test Methods for Rubber Properties in Tension
- D 413-82 Test Methods for Rubber Property-Adhesion to Flexible Substrate
- D 429-81 Test Methods for Rubber Property-Adhesion to Rigid Substrates
- D 448-80 Specification for Standard Sizes of Coarse Aggregate for Highway Construction
- D 496-74(1985) Specification for Chip Soap
- D 572-81 Test Method for Rubber Deterioration by Heat and Oxygen

- D 573-81 Test Method for Rubber Deterioration in an Air Oven
- D 746-79 Test Method for Brittleness Temperature of Plastics and Elastomers by Impact
- D 747-84a Test Method for Stiffness of Plastics by Means of a Cantilever Beam
- D 792-66(1979) Test Methods for Specific Gravity and Density of Plastics by Displacement
- D 994-71(1982) Specification for Preformed Expansion Joint Filler for Concrete (Bituminous Type)
- D 1149-86 Test Method for Rubber Deterioration-Surface Ozone Cracking in a Chamber (Flat Specimens)
- D 1190-74(1980) Specification for Concrete Joint Sealer, Hot-Poured Elastic Type
- D 1457-83 Specification for PTFE Molding and Extrusion Materials
- D 1751-83 Specification for Preformed Expansion Joint Fillers for Concrete Paving and Structural Construction (Nonextruding and Resilient Bituminous Types)
- D 1752-84(1978) Specification for Preformed Sponge Rubber and Cork Expansion Joint Fillers for Concrete Paving and Structural Construction
- D 1850-74(1979) Specification for Concrete Joint Sealer, Cold-Application Type
- D 2240-86 Test Method for Rubber Property-Durometer Hardness
- D 2628-81 Specification for Preformed Polychloroprene Elastomeric Joint Seals for Concrete Pavements
- E 328-86 Recommended Practice for Stress-Relaxation Tests for Materials and Structures
- 3.4.4 AASHTO materials specifications**
- M 6-81 Fine Aggregate for Portland Cement Concrete
- M 31-86 Deformed and Plain Billet-Steel Bars for Concrete Reinforcement
- M 32-81 Cold-Drawn Steel Wire for Concrete
- M 33-81 Preformed Expansion Joint Filler for Concrete (Bituminous Type)
- M 42-86 Rail-Steel Deformed and Plain Bars for Concrete Reinforcement
- M 43-82 Standard Sizes of Coarse Aggregate for Highway Construction
- M 45-83 Aggregate for Masonry Mortar
- M 53-86 Axle-Steel Deformed and Plain Bars for Concrete Reinforcement
- M 54-86 Fabricated Steel Bar or Rod Mats for Concrete Reinforcement
- M 55-81 Welded Steel Wire Fabric for Concrete Reinforcement
- M 80-77 Coarse Aggregate for Portland Cement Concrete
- M 85-84 Portland Cement
- M 105-85 Gray Iron Castings
- M 107-83 Bronze Castings for Bridges and Turntables
- M 108-82 Rolled Copper-Alloy Bearing and Expansion Plates and Sheets for Bridge and Other Industrial Uses
- M 111-80 Zinc (Hot-Galvanized) Coatings on Products Fabricated from Rolled, Pressed, and Forged Steel Shapes, Plates, Bars, and Strip
- M 138-86 Copper Sheet, Strip, Plate, and Rolled Bar
- M 144-86 Calcium Chloride
- M 148-82 Liquid Membrane-Forming Compounds for Curing Concrete
- M 153-84 Preformed Sponge Rubber and Cork Expansion Joint Fillers for Concrete Paving and Structural Construction
- M 154-79 Air-Entraining Admixtures for Concrete
- M 171-79 Sheet Materials for Curing Concrete
- M 173-84 Concrete Joint Sealer, Hot-Poured Elastic Type
- M 182-60 Burlap Cloth Made from Jute or Kenaf
- M 183-86 Structural Steel
- M 194-84 Chemical Admixtures for Concrete
- M 195-84 Lightweight Aggregates for Structural Concrete
- M 203-83 Uncoated Seven-Wire Stress-Relieved Strand for Prestressed Concrete
- M 204-82 Uncoated Stress-Relieved Wire for Prestressed Concrete
- M 213-81 Preformed Expansion Joint Fillers for Concrete Paving and Structural Construction
- M 220-84 Preformed Elastomeric Compression Joint Seals for Concrete
- M 221-81 Welded Deformed Steel Wire Fabric for Concrete Reinforcement
- M 222-86 High-Strength Low-Alloy Structural Steel with 50,000 psi Minimum-Yield Point to 4-in. Thick
- M 223-86 High-Strength Low-Alloy Columbium-Vanadium Steels of Structural Quality
- M 225-80 Deformed Steel Wire for Concrete Reinforcement
- M 230-70 Extruded Insulation Board (Polystyrene)
- M 232-84 Zinc Coating (Hot-Dip) on Iron and Steel Hardware
- M 240-85 Blended Hydraulic Cements
- M 251-74 Laminated Elastomeric Bridge Bearings
- M 275-79 Uncoated High-Strength Steel Bar for Prestressing Concrete
- T 26-79(1986) Quality of Water to be Used in Concrete
- 3.4.5 ASTM-AASHTO specification cross-reference**
- | ASTM specification | AASHTO specification |
|--------------------|----------------------|
| A 36-84a | M 183-86 |
| A 48-83 | M 105-85 |
| A 82-85 | M 32-81(1986) |
| A 123-84 | M 111-80(1986) |
| A 153-82 | M 232-84 |
| A 184-84a | M 54-86 |
| A 185-85 | M 55-81(1986) |
| A 416-85 | M 203-83 |

A 421-80(1985); M 204-82(1986);
 A 496-85 M 225-80(1986);
 A 497-79 M 221-81(1986);
 A 572-84 M 223-86
 A 588-85 M 222-86
 A 615-85 M 31-86
 A 615M-84a M 31M-86
 A 616-85 M 42-86
 A 617-82a M 53-86
 A 709-85 M 270-86
 A 722-75(1981); M 275-79(1986);
 B 22-85 M 107-83
 B 100-86 M 108-82(1986);
 B 152-86 M 138-86
 C 150-85a M 85-84
 C 171-69(1986); M 171-79(1986);
 C 260-86 M 154-79(1986);
 C 309-81 M 148-82(1986);
 C 330-85 M 195-84
 C 494-86 M 194-84
 C 595-86 M 240-85
 C 618-85 M 295-86
 D 98-80 M 144-86
 D 448-80 M 43-82(1986);

D 994-71(1982); M 33-81(1986);
 D 1190-74(1980) M 173-84
 D 1751-83 M 213-81(1986);
 D 1752-84 M 153-84
 D 2628-8 1 M 220-84

RECOMMENDED REFERENCES

The documents of the various standards-producing organizations referred to in this report are listed below with their serial designation, including year of adoption or revision. The documents listed were the latest effort at the time this report was written. Since some of these documents are revised frequently, generally in minor detail only, the user of this report should check directly with the sponsoring group if it is desired to refer to the latest revision.

American Association of State Highway and Transportation Officials.

Standard Specification for Highway Bridges, Thirteenth Edition, 1983.

American Welding Society.

D1.4-79 Structural Welding Code Reinforcing Steel

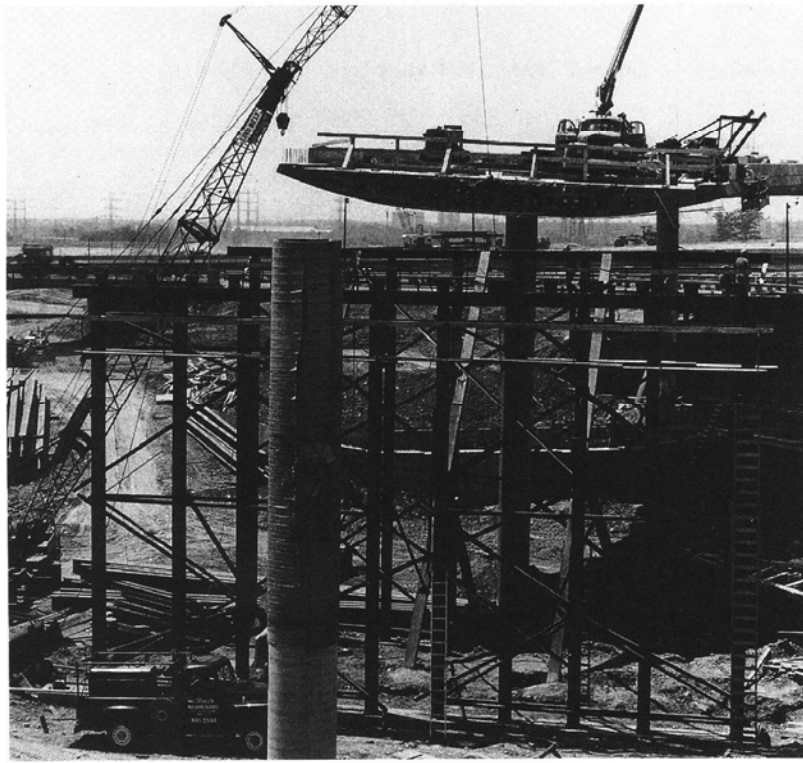

Complex construction site (photo courtesy of Ministry of Transportation and Communications, Ontario)

CHAPTER 4-CONSTRUCTION CONSIDERATIONS

4.1-Introduction

Every project progresses through various stages of development, starting with the recognition of the need and ending with a completed structure. The major steps in the evolution of a structure are:

- a. Preliminary engineering
- b. Design
- c. Construction

It is obvious that each phase of development affects the activities within the other phases. This chapter explores the influence of construction methods and procedures upon the design process.

4.1.1 Definition-Construction considerations may be defined as those details, procedures, and construction sequences that should be incorporated into design to cope with construction restrictions and limitations while insuring the constructibility of a structure. For quality assurance systems ACI 121R provides guidelines in establishing a project program for describing an organization's policies, practices, and procedures to comply with the contract documents.

4.1.2 Examples⁴⁻¹-Failure to consider construction restrictions during design generally results in additional expense and loss of time in rectifying the situation during construction, or unexpected maintenance expenses after the bridge is in service.

4.1.2.1 Section size-Some obvious construction considerations are involved in the design of a concrete section. The section should be large enough not only to carry the im-

posed loads, but to physically accommodate the required number of reinforcing bars or prestressing tendons, while providing proper clearances and concrete cover. Thus, the designer should consider the maximum size of aggregate and the adequate size of a vibrator to be used by the contractor for proper placement and consolidation of concrete.

If a poor choice of section size is made, a more exacting concrete placement, a revision of maximum aggregate size, or a design of the section may become necessary. A change order may be required with consequent delay of the project and probable cost increase.

4.1.2.2 Camber-More complex construction considerations are involved in the determination of camber in structures constructed in stages (Fig. 4.1.2.2). Several factors have to be assessed quantitatively:

- a. Variation of modulus of elasticity of concrete with time
- b. Variation in creep rates depending on age of concrete at the time of loading
- c. Variation in creep rates for downward and upward deflections.
- d. Changing loading conditions
- e. Effects of temperature variations

If improper camber calculations are made, the appearance and riding quality of the deck will be affected. The omission will become obvious some time after the completion of the structure. The defect, although annoying, will seldom be se-

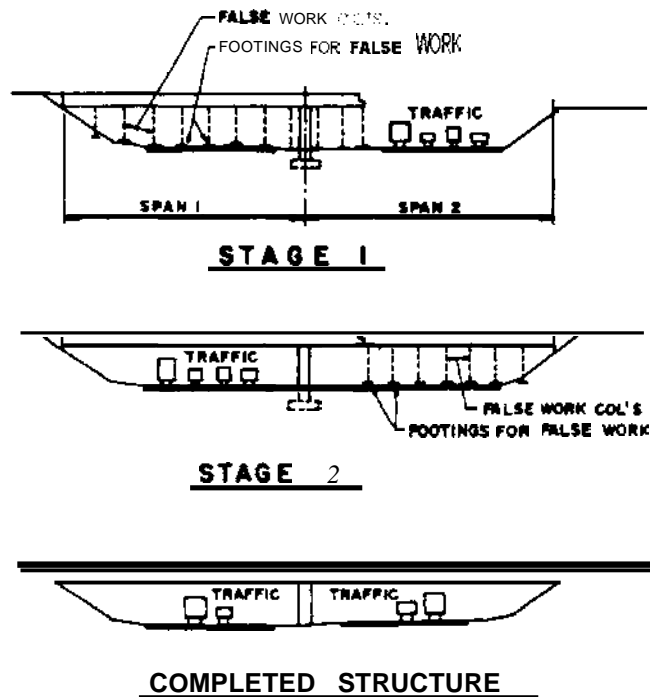

Fig. 4.1.2.2-Example of staged construction

rious. Since corrective measures are expensive, they will rarely be taken.

4.1.2.3 Construction sequence-The construction sequence is a very important consideration for large, continuous, multispan structures. A typical example is a composite precast, prestressed I-girder bridge with cast-in-place concrete deck. If the dimensions of the structure make it impossible to place the whole deck in one working day, it becomes necessary to provide a concrete placement diagram, specifying sequence and size of individual deck placement sections. The factors to consider are:

- a. Maximum size of a reasonable deck placement section
- b. Stresses at critical points during all stages
- c. Time interval between various sections
- d. Strength of concrete to be attained in one section before another one is allowed
- e. Effect of staged construction on deflections

If construction sequencing is neglected, the results can be serious. During placement of some of the deck sections, the stresses at critical points in the partially completed girder may exceed the design stresses, which are based on the assumption of continuity and composite action of the girder and the slab.

4.2-Restrictions

The construction phase must be considered during design to insure that the construction can be economically done in accordance with the design assumptions and to comply with construction restrictions imposed on the project by existing conditions or approving agencies.

Construction considerations originating in design assumptions usually deal with:

- a. Construction tolerances

- b. Stresses and deflections induced by construction sequences
- c. Effects of construction joint locations
- d. Measures to insure economy of construction

The construction considerations, having their source in restrictions imposed on the project, are numerous and may deal with any facet of the structure. The following tabulation gives examples of typical construction restrictions and their sources:

Owner-Project schedule (accelerated schedule will influence selection of the type of structure and construction sequence) .

Approving agencies-Construction clearances (these are sometimes more restrictive than clearances for the completed structure, thus influencing layout and type of structure selection).

Timing of specific construction activities-Encroachments on the flood plain, construction in forests during tire season, pile driving or other noisy activities next to hospitals and schools.

Access restrictions-Parks, city streets.

Maintenance of traffic-More and more structures are being built as replacements or widenings.

Site characteristics-Accessibility (narrow, twisting roads preclude use of long, prefabricated girders).

Adjacent structures-There may be weight and size limitation.

Climate-Short construction season will influence type of structure selection.

Materials-Quality of local aggregates may determine maximum strength of concrete that can be readily produced (lightweight aggregates, freeze-and-thaw-resistant aggregates are not available at many locations).

Project needs-Traffic requirements may require staged construction (traffic detours).

Avoidance of possible claims-Blasting, dewatering, pile driving (in many cases proper design can minimize or even eliminate these problems).

4.3-Goals

The designer should strive to achieve four primary goals in the completed structure: sufficient capacity, dependable durability, economy of construction, and pleasing appearance. In general, sufficient capacity in structures is achieved by adhering to appropriate codes, although it should be kept in mind that most codes are based on an acceptable minimum capacity while quite often a greater capacity may be warranted or desirable. The achievement of any of the goals requires engineering judgment.

The goals are interrelated; effort expended to better one goal invariably changes the others, but not necessarily for the worse. The goals are also influenced by availability of materials and by construction methods.

The ideal of constructing a bridge with an excess of capacity that is maintenance free and has a very pleasing appearance, at much less than the budget figure, is seldom attainable. Various factors have to be considered to determine the effect of each construction consideration on each

goal. Trade-offs can then be weighed to achieve the optimum result.

The importance of each of the goals varies with the political and social environment, as well as the geographical location of the project. Adequate capacity must always be insured. The appearance of a bridge is usually a more sensitive issue in an urban area location than in an industrial or a rural area (although obviously each case has to be considered and decided on its own merits).

When cost of construction is of prime importance, construction methods tend to control design. The designer should consider several methods to select the most economical way to build a particular project, recognizing in each method the applicable restrictions mentioned in the previous section. Once the most economical method and material has been determined, the designer decides how to use them to achieve acceptable appearance and adequate capacity and durability.

New construction methods and material strengths often create situations in which construction loads may govern the required strength of part or all of a structure. The designer should always keep construction loadings in mind. A close working relationship with qualified contractors should be developed to insure that allowable stresses are not exceeded during construction. Contractors are becoming increasingly involved with engineering requirements. The most efficient use of labor and materials leads to more engineering-intensive designs that require closer tolerances and higher stresses. The level of sophistication in design should take into account a reasonable level of the quality of construction that can be achieved.

In summary, the design engineer should recognize the applicable construction considerations during the design phase; the construction engineer should recognize the implications of the design criteria and be able to construct the project within these limitations. The result will be an economical product that is adequate in capacity, pleasing in appearance, and durable in service.

4.4-Planning

A conventionally scheduled design project, as opposed to fast-track projects, is characterized by a sequential progression in which each activity depends on work performed in a previous one. Because of this dependence, each phase should be completed before the next is begun. The design process should include the following activities:

- a Data collection
 1. Traffic during construction
 2. Falsework
 3. Stage construction requirements
 4. Construction restrictions
 5. Construction loads
 6. Allowable construction stresses
- b Layout
- c. Foundations
- d Structure type selection
- e. Details

As this list demonstrates, most construction considerations are based on data collected during the initial phase of design. Any construction requirement or restriction overlooked, during this period, may be a costly item to consider at a later stage. Costs of revisions escalate, particularly after various binding decisions on layout or type of structure have been made.

Thus, it is essential to deal with all construction considerations affected by external constraints at the earliest stages of project activities. On the other hand, construction considerations originating in design assumptions may be handled when the affected detail is being designed.

4.5-Site characteristics

In the past "forced solutions," using standard right angle structures requiring the realignment of streams or secondary roads, were often adopted under the guise of economy. Today it is axiomatic that the structure should fit the site. Some of the elements dictating the choice of structure include alignment, length, spans, depth, and foundations. Lately, with greater emphasis on esthetics, the requirement of visual harmony with the site in terms of shape, color, and texture has been added to this list. In addition, some site characteristics affect the design indirectly by placing various restrictions on construction.

4.5.1 Site accessibility-Many bridge construction sites are remote, and accessible only by narrow, winding roads. Such conditions generally favor structures that require minimum amounts of materials and field labor. When poor roads preclude transportation of long prefabricated girders, girders may be shipped in segments and assembled at the site.

4.5.2 Climate-The various ways climate influences construction should be considered in design.

4.5.2.1 General-In areas of severe climate, the construction season may be short, favoring structures that allow a great deal of shop fabrication. In areas subject to periodic floods or storms, even the substructure should be designed to permit some shop precasting and quick field assembly.

Because heating and cooling increase the cost of concrete, designs with precast in lieu of cast-in-situ elements may be preferred.

In very cold climates, a warm working area is necessary to allow the work to proceed. Low productivity and poor quality of workmanship generally result from work done in unfavorable conditions.

4.5.2.2 Air-entrained concrete-Air entrainment is used to develop freeze-thaw durability in concrete. The requirements for entrained air and compressive strength should be specified separately. Mixes with entrained air having strengths up to 6000 psi (47.5 MPa) can be produced in most areas. However, the designer should verify the capability of the local producers.

4.5.3 Materials availability-Materials of adequate strength and quality may not be available locally.

Concrete strengths of 4000 to 5000 psi (27 to 34 MPa) using commonly available local aggregates are generally possible. With superplasticizers and pozzolans, 8000 to 9000 psi (55 to 62 MPa) can be produced with local materials in most

areas. If it is necessary to bring in aggregates from other sources, the designer should evaluate the benefits gained by the additional cost.

High-quality, lightweight concrete aggregates, producing concrete weighing under 110 lb/ft³ (1760 kg/m³) and having $f'_c = 3500$ psi (24.1 MPa), are not readily available at all locations. The designer should evaluate whether the benefits of this more expensive, specialized concrete outweighs its disadvantages.

4.5.4 Temporary foundations—The load-carrying capacity of the surface soils at the construction site should be considered. If the falsework has to be supported by driven piles, the cost of structures constructed on ground-supported falsework increases and precast options may be more economical.

Another consideration is the ability of the soils to support construction equipment needed in common construction operations: pile drivers, cranes, trucks, etc. In swampy or steep, rocky areas, expensive construction roads may have to be built. In this case an evaluation should be made of measures which could reduce pile-driving activities, crane use, and similar operations.

4.6-Environmental restrictions

Obtaining environmental clearance for a bridge project can be a complicated process affecting many facets of design and construction. This section deals only with those construction restrictions which might affect the design of a bridge.

4.6.1 Falsework—When the use of ground-supported falsework is prohibited, the restriction should be known early in the design process. It can then be handled routinely by selecting an appropriate type of structure. Troublesome cases arise when the restriction on use of falsework is not readily apparent in the design plans and is only discovered during the construction stage.

Use of falsework within a flood plain may be permitted only between specific dates, resulting in an artificially short construction season. For all practical purposes this may require a structure that does not need ground-supported falsework.

The requirements for falsework located next to railway tracks may be so restrictive as to make the use of such falsework very expensive and perhaps impractical. For example, steel posts set in holes filled with concrete and concrete crash walls may be required. As a result, a structure not requiring ground-supported falsework may be preferred for such locations.

4.6.2 Earthwork—Excavation, pile driving, and similar activities are usually prohibited during the spawning season, within streams and lakes used by game fish. The restriction generally lasts only a few months each year and is not a serious handicap for an average project. However, it should be considered in the context of the other constraints, so that the combined restrictions do not make the completion of the project impossible.

With current emphasis on preservation of environment and historical heritage, a restriction on construction of access

roads is included in many contracts. In some cases, the restrictions are absolute, requiring the use of a cableway or a helicopter for construction of the intermediate supports and parts of the superstructure. Use of precast segments for both the superstructure and the piers is almost mandatory in such cases.

For construction within areas such as recreational parks, some agencies require immediate removal and disposal of excavated material. Such a requirement obviously favors designs that minimize the foundation and earthwork needed in construction.

4.6.3 Construction—In many western states, fires during dry summer months are greatly restricted. On-site field welding is also prohibited during particularly dangerous forest fire periods. Such restrictions should be considered during the design phase when the structure type is selected, particularly if a steel structure seems to be an attractive alternative.

On construction projects close to sensitive areas, such as schools and hospitals, there are strict limitations as to the time of construction activity and amount of noise. The activity usually involved in such situations is pile driving. The remedy may be to use auger-cast piles or spread footings. The former may be very expensive, and the latter may lead to future problems of support settlements. On the other hand, a careful selection of working hours may alleviate the problem. Obviously, the problem is much more easily dealt with if it is considered during the design phase.

4.7-Maintenance of traffic

Traffic considerations are involved in construction of most bridges, though there are cases where traffic is entirely diverted from the construction site. The effects of traffic on construction will be particularly felt in construction clearances at the crossing. Traffic clearances for construction are generally smaller than those for permanent structures because of lower speed limits and the temporary nature of the clearances. In many instances, however, additional requirements imposed by the permitting agency may make the lesser construction clearances unattainable, thus affecting the layout and span lengths.

4.7.1 Railroad clearances—As an example of the process involved in determining the governing clearances, consider the clearance diagram shown in Fig. 4.7.1. The required final clearance from the center line of track to the face of a pier may be as small as 10 ft (3 m) for tangent tracks, but the closest excavation for the foundation of the pier can be is 8 ft-6 in. (2.6 m), excluding the shoring and bracing. Thus the final clearance does not control the location of the pier and the designer should consider the size of footing, the depth of its location, the likely method of its construction, and the possibility of obtaining approval for a discretionary minimum clearance requirement.

4.7.2 Highway clearances—Prescribed temporary construction clearances often govern layout of spans. A typical example is the required vertical clearance over freeways in California, as shown in Table 4.7.2. The usual requirement is a clearance of 16 ft-6 in. (5 m) over the traveled way, but

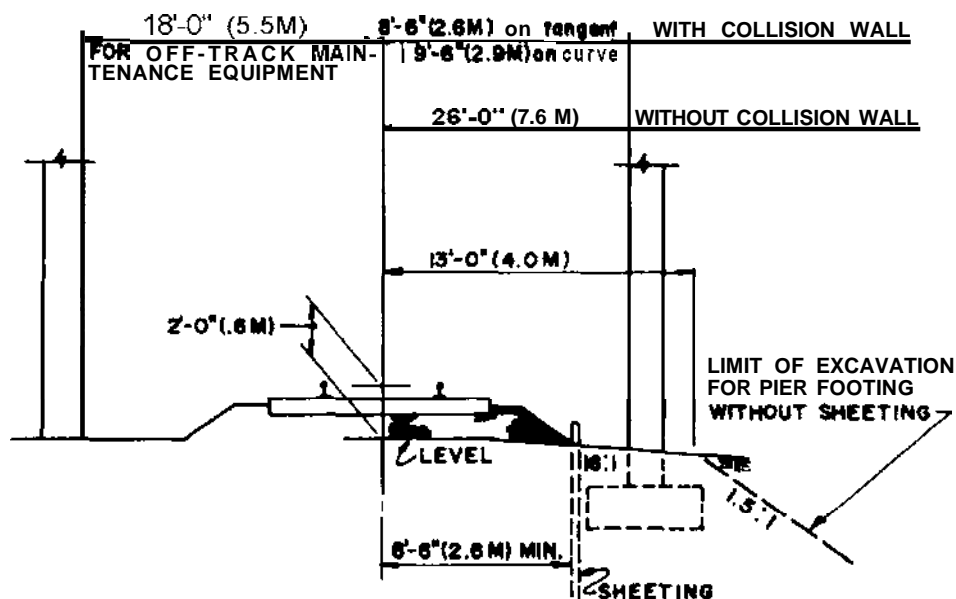

* Excavations for pier footings, without shoring of track roadbed, should not be made closer than the limit line shown with slope of 1.6 to 1 starting at subgrade 13'-0" (4 m) from center line of track. Excavations closer than this sloped limit should not be undertaken without prior approval by the railroad of plans for shoring of track roadbed, and in any instance will not be approved closer than 8'-6" (2.6 m) horizontally from center line of track to near edge of excavation.

Note: This example is not applicable in all locations. Some railroads and states have different requirements and restrictions.

Fig. 4.7.1-Example of typical railroad clearance⁴⁻²

Table 4.7.2-Example of falsework depth and span relationship⁴⁻²

Facility to be spanned	Minimum width of traffic opening, ft (m)	Opening width provides for	Required falsework span (b), ft (m)	Minimum depth required for falsework, ft (m)
Freeway	25 (7.6)	1 lane + (d);	32 (9.8);	1 ft 9 in. (0.53)
	37 (11.3)	2 lanes + (d);	44 (13.4);	2 ft 2 in. (0.66)
	49 (14.9)	3 lanes + (d)	56 (17.1);	2 ft 8 in. (0.81);
	61 (18.6)	4 lanes + (d)	68 (20.7);	3 ft 3 in. (1.0)
Nonfreeway	20 (6.1)	1 lane + (e)	27 (8.2)	1 ft 9 in. (0.53)
	32 (9.8)	2 lanes + (e)	39 (11.9);	1 ft 11 in. (0.58)
	40 (12.2)	2 lanes + (f)	47 (14.3);	2 ft 4 in. (0.71);
	53 (15.8)	3 lanes + (f)	59 (17.9);	2 ft 9 in. (0.84);
Special (a) roadways	20 (6.1)	1 lane + (e)	20 (6.1) (c)	1 ft 7 in. (0.48);
	32 (9.8)	2 lanes + (e)	32 (9.8) (c)	1 ft 9 in. (0.53)

(a) Uses such as fire or utility access or quasi-public road with very light traffic.

(b) Includes 7 ft (2.1 m) for two temporary guardrails.

(c) No temporary guard railing provided.

(d) 8 ft (2.4 m) and 5 ft (1.5 m) shoulders.

(e) 2 ft 4 in. (1.2 m) shoulders.

(f) 2 ft 8 in. (2.4 m) shoulders.

the temporary construction clearance may be as low as 14 ft-6 in. (4.4 m). However, for a structure constructed on ground-supported falsework, where a 40-ft (12.2-m) wide opening for traffic is needed, an adequate depth of falsework may be 2 ft-6 in. (0.75 m) to 3 ft-0 in. (1.0 m). This results in a final clearance of 17 ft-0 in. (5.2 m) to 17 ft-6 in. (5.3 m).

4.8-Project needs

Criteria governing the completion of an entire project may

impose restrictive construction considerations on the design of an individual structure within the project. These considerations may involve a prescribed construction sequence (perhaps even an accelerated schedule), special construction loads, or uniformity of details and appearance.

4.8.1 Construction sequence-The requirement of allowing the passage of traffic through the construction site generally leads to a stage-constructed structure.

4.8.1.1 Partial-width construction-Bridge replacement

projects usually require that the existing structure remain in service until a new one is completed, or that the new structure be constructed in the approximate location of the old one.

In such cases, about one-half of the new structure may be constructed adjacent to the old structure. After traffic is shifted to the completed half of the new structure, the old one is removed and the second half of the new structure is constructed. Typical construction considerations in such cases are:

- a. The partial-width structure should be stable at all times, either of itself or through use of temporary bracing
- b. The substructure of the new bridge should be of such a configuration as to permit half-width construction
- c. The deformations and creep shrinkage strains of the structure should be determined and provided for in the design and construction
- d. The part of the structure constructed first should be wide enough to accommodate the expected traffic
- e. If a portion of the existing structure is to be removed prior to the construction of the new structure, the amount of removal and staging of the removal should be determined by the design engineer to insure its stability
- f. The protection of the new structure during the removal of the old structure

4.8.1.2 Partial-length construction-In cases of multi-span bridges or multilevel interchanges, it may be necessary to construct the structure in stages, using either intermediate hinges or construction joints. A typical layout of a crossing over a highway, as shown in Fig. 4.1.2.2, may involve a span and a cantilever extending to some point into the adjacent span. These are constructed first, then the falsework is removed and the traffic shifted into the opening under the completed span. The remainder of the structure is then completed without interfering with rerouted traffic.

Typical construction considerations for such cases are:

- a. The initially constructed span may have to be designed as a simple span. It may be necessary to load the cantilever with temporary loads until the full dead load reaction is applied
- b. The camber for all affected spans should be calculated, based on the assumption of a reasonable construction sequence, taking into account creep and deflections due to all temporary loads. Improper camber may result in rough riding decks, poor drainage, and possibly a traffic hazard.

4.8.1.3 Detour bridges-In many cases, it may be possible to divert the traffic around the construction site by means of a detour. Sometimes an existing bridge at another location can be used. At other times it is necessary to construct a temporary bridge. Most agencies will impose the same design standards for temporary bridges as for permanent ones. However, the possibility should be thoroughly investigated, as substantial savings might be achieved by minor changes in the design requirements. Typically, the following construction considerations apply:

- a. Used materials may be permitted in the construction of a temporary bridge
- b. The contractor should be given complete latitude in selecting the basic material for the bridge (timber, steel, concrete)
- c. Use of prefabricated proprietary modular units should be allowed

4.8.2 Construction loads-For most structures, construction loads do not represent a major part of design loads. For structures constructed on falsework, all loads applied during construction are carried by the falsework. However, there are cases where construction loads represent major design loads and thus should be fully considered in the design.

4.8.2.1 Composite and segmental structures-Portions of these structures support all or part of their own formwork and construction loads. Also included are structures using a truss to construct some load-carrying elements that will later support the formwork and construction loads. Common construction considerations for these structures are the construction loads, their magnitude, and location. The structure may be designed to carry all the construction loads, or the contractor may be required to modify the original design for this purpose. Construction loads for structures using precast girders are usually smaller than the live loads and do not govern the design. Construction loads for segmental structures are quite large and generally control the design at various sections along the girder and at various times during erection. Requiring the contractor to redesign the structure for construction loads involves extensive engineering and expense. Furthermore, such contracts, being difficult to administer, can lead to disputes and litigation among the parties concerned, namely, the engineer, the owner, and the contractor. To avoid these possible difficulties, the designer may elect to estimate and design for the most likely construction loads. A conservative assumption may lead to some overdesign, but can avoid problems in the long run.

4.8.2.2 Earthmoving vehicles-On big freeway projects it may be necessary to move large quantities of embankment material from one side of the freeway to the other. Conventionally, one of the many overcrossing structures within the project is constructed first and used for moving the earth material by standard capacity dump trucks. However, an alternate approach used in some cases has proved to be fast and economical. One structure within the project may be designed for heavy earthmoving vehicles, with subsequent saving in cost of material moving. Fig. 4.8.2.2 shows typical axle loads for such vehicles.

The construction considerations for such cases may be:

- a. What is the size and weight of the heaviest construction vehicle likely to be used by the contractor?
- b. Is the provision for two-way traffic economically justifiable?
- c. Will the savings on the placement of embankment material outweigh the additional expense of the structure?

The answers to these questions should be evaluated by the design engineer working in cooperation with the owner.

A similar situation occurs when large amounts of earth should be moved from one side of a river crossing to the other.

4.8.3 Standardization-A uniform approach in the design of a number of structures within one larger project often results in an economy of the total project.

Generally each structure should be designed to fit a particular location; however, some economies may be realized in using the same type of structure for several locations.

Use of the same material in all the project structures is preferable. When materials of various strengths are available, only one or as few as possible should be used. The economics and the logic of specifying several strengths of concrete for a given project should be investigated and the decision made on merits of each individual case. To avoid placing errors, it is also preferable to use only one grade of reinforcing bars on a project.

4.9-Design of details

Generally, the economy of a structure is enhanced by striving for simplicity and repetitiveness in details, making each part of the structure easy to form, reinforce, fill with concrete, and strip.

4.9.1 Dimensions-Dimensions of elements should be large enough to accommodate reinforcement and permit placement and consolidation of concrete at the most congested point.

4.9.2 Repetitiveness-Forming of odd shapes is expensive. The multiple use of complicated formwork within a large project will help to reduce cost. Where voids are indicated, it is often advantageous to allow the contractor to substitute solid sections where structurally permissible. Giving the contractor a choice in the use of variations of details that do not materially affect the strength or the appearance of the structure is an effective way to increase the overall economy of a project. However, this permission should be given in the contract documents.

4.9.3 Slipforming-The overall economy of a project depends to a great degree on allowing the contractor the greatest possible freedom in selection of construction methods. Tall piers often can be constructed most economically by slipforming. It is difficult and expensive to slipform piers of a variable cross section. However, if the variability is restricted to one direction only, slipforming may become competitive.

4.9.4 Soffit lines-The top slab of box girders with widely spaced stems is usually of variable thickness. For the soffit line, a series of straight lines will function as well as a curve. Some saving may be achieved by giving the contractor a choice between using either a broken or a curved soffit line.

4.9.5 Placement of reinforcement-In cases where the reinforcement can be positioned a certain distance from the form face by the use of concrete or plastic blocks, there is usually no problem in maintaining proper cover. However, in cases where the reinforcement is next to a finished face (top reinforcement of slabs) or where the reinforcement is located inside a deep member, consideration should be given to some positive means of securing these bars in their proper

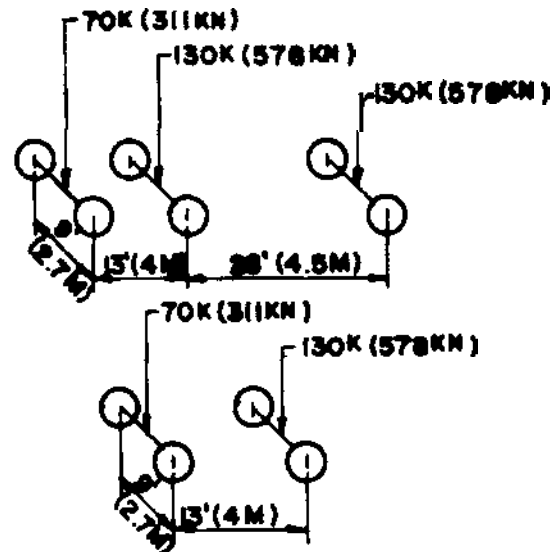

Fig. 4.8.2.2-Axle loads of typical earthmoving vehicles

places. In concrete slabs where workmen commonly walk on the top mat, a sufficient number of reasonably rigid bar chairs should be specified or detailed on the plans to insure that the constructed effective depth of the slab is as assumed in design. For bars located within deep members (e.g., two-layered arrangement of longitudinal reinforcement), additional supporting reinforcement should be detailed to fix their position. The cost of this auxiliary reinforcement is small compared to the cost of repair.

4.9.6 Placement of anchor bolts-In most instances where bolts are embedded in concrete, the placement demands a fairly high degree of accuracy. The simplest method of insuring the required accuracy involves the use of a prefabricated steel template/spacer to which the bolt heads are tack welded (incidentally, care shall be exercised to avoid welding on any other part of the bolt). The template is wired to adjacent reinforcement (if the reinforcing is too far away, additional reinforcement should be called for) and can be positioned accurately and kept in place during placement of concrete.

Some agencies require that the anchor bolts be set in holes drilled after the concrete has hardened. In this case the designer should space the reinforcement to provide ample tolerance to clear the drilled hole.

4.9.7 Hinges-The term "hinge" as used in the discussion that follows denotes a joint located within a structural member and constructed in such a way as to permit the assumption of no moment at the joint while allowing transfer of vertical and/or horizontal shear.

In terms of maintenance problems, hinges have been found to be particularly troublesome. These problems are caused by a combination of factors, some originating in design and others in common construction practices. In the past, there has been some difficulty in assessing all the forces acting upon various parts of a common hinge. Most hinges, even with the best expansion bearings, involve axial tension in the direction of the girders. ACI 318, Section 11.9, Special

Provisions for Brackets and Corbels, is quite helpful in clarifying this point.

Another point to recognize is that the ever-present “bump” at the hinge location can become quite large due to settlements, creep deformations, and deterioration. This can cause impact forces much greater than those used in design. For conventionally reinforced structures, the combination of high bending and shear stresses at most hinges requires placement of large amounts of horizontal and vertical shear reinforcement in addition to tensile reinforcement. This congestion of reinforcement makes the placement and consolidation of concrete difficult, and often results in rock pockets and honeycombs. Adequate proportioning of sections and proper supervision of construction are necessary. In many cases it may be advantageous to replace some of the conventional mild steel reinforcement with short post-tensioning tendons. The post-tensioning systems used should be those that allow stressing and anchorage of short tendons without seating loss.

A similar instance of theoretical hinges at bottoms (or tops) of columns needs careful attention to detail. For initially applied loads (dead loads) and depending on the care used in construction, these hinges will have almost no moment. However, after the application of large axial loads, and after some deterioration of the hinge materials takes place (e.g., expansion joint material compresses and becomes hard), the moments being transferred across such hinges can become quite large. Generally, the stresses induced at the hinge itself are rarely objectionable; however, at other joints of the structure, the additional moments and stresses caused by the partial fixity of the hinges may be greater than anticipated in the design.

4.9.8 Fixed end supports-In its pure form, this type of support is seldom used because full fixity cannot be achieved. The designer needs to review the design assumptions very carefully, particularly in view of likely location of construction joints and number of reinforcement splices. A 100 percent fixity is probably not a justifiable assumption, and therefore some increase in adjacent positive moments in design should be provided.

4.9.9 Accuracy of construction-The design assumptions and design methods do provide some consideration of the inaccuracy of construction. The phi factor used in load factor design does take into account some variability of quality of material, and the column design criteria assume a certain eccentricity of loads.

The accuracy of construction to be considered here deals with cases arising out of construction methods and procedures beyond these allowances that need to be considered by the designer.

4.9.9.1 Pile location-All pile footings should be large enough to accommodate the piles that may be driven or drilled out of exact location. The design should provide for a tolerance of 3 in. (75 mm) out of location for the pile group. A 3-ft (1.0-m) c. to c. minimum pile spacing and a 1.5-ft (0.5-m) minimum edge distance are considered normal for 12-in. (300-mm) piles. Where a greater accuracy is needed (such as single-line pile bents consisting of driven or drilled

piles and pile extensions above original ground), a pile-locating template should be used.

The designer is cautioned that a pile group having less than a 3-in. (75-mm) eccentricity may have within it piles located 6 in. (150 mm) or more out of location. The ACI 318, Section 15.5 provision for reduction of shear if the pile center lies within one-half the pile diameter of the $d/2$ distance from the column face should be used with judgment.

4.9.9.2 Precast elements-Precast segments have been used to assemble I-girders, box girders, slabs, whole superstructures, piers, columns, abutments, and walls. With use of match casting, there is a reasonable fit between the individual segments. Problems usually occur with longer girders (or higher piers) where small inaccuracies may add up to a sizable deviation from anticipated alignment. For girders, this may produce unsightly vertical sag or lateral wobble; piers and columns may have a bowed shape or be out of plumb in any direction.

The task of the designer is to provide for this eventuality by incorporating some method of correction into the design. For sagging girders it may be a provision for additional ducts for corrective post-tensioning, as well as an occasional cast-in-place segment. Cast-in-place segments also may be used for correcting alignment of piers and columns. Thin shims in conjunction with epoxy mortar also have been used for this purpose.

The design of segmental precast structures or parts of structures should readily permit adjustments during construction.

4.10-Selection of structure type

When several types of structure seem to be equally economical and suitable for a particular location, the decision may be deferred to the bidding process through preparation of alternative designs. Obviously, the additional expense of preparing two or more designs has to be justified by the possible savings. Such procedures are usually reserved for major structures. The two main requirements for such alternative designs-the equivalency of strength and appearance-are not easily met unless the intent is accurately described or illustrated. The additional time needed for review of such alternative designs also complicates the process.

The following sections outline some of the construction considerations connected with various types of concrete structures:

4.10.1 Concrete slab bridges-A concrete slab bridge is the simplest and least expensive structure that can be built within the span limitations for this type of superstructure. It can be conventionally reinforced, pretensioned or post-tensioned. It can be built on ground-supported falsework or constructed of precast elements.

4.10.1.1 Cast-in-place bridges-The simplicity of the concrete slab bridge may lead to overconfidence on the part of the contractor, often resulting in poor workmanship. Falsework founded on soft or shifting soils has led to differential settlements and bulges in the soffit line during construction. The solution may be to specify allowable soil-

bearing values for falsework design or to require use of pile-supported falsework.

Another problem often encountered during construction of slab bridges is the difficulty of keeping the top mat of reinforcing bars in its proper position. Since the workmen usually walk on these bars, supports have to carry construction loads, as well as the weight of the bars. If the size and the spacing of the bar chairs are not shown on the plans, only the minimal amount will be used during construction with undesirable consequences.

The designer, therefore, should make sure that a sufficient number of reasonably rigid bar chairs is called for on the plans to keep the top mat of reinforcement in its place.

4.10.1.2 Precast slab bridges-Precast slab bridges constructed as simple spans often exhibit poor riding qualities due to the discrepancy between the camber and actual deflections. Transverse joints at piers further impair the riding quality of the deck and often present serious maintenance problems. Providing reinforcement in the topping slab to develop continuity can alleviate this problem.

Precast slab bridges constructed with unreinforced grout keys in the longitudinal joints, between individual units, also develop maintenance problems. The grout keys often fail, allowing differential live load deflections between units. An asphalt concrete overlay does not solve the problem, since the cracks usually continue to show up through repeated overlays.

A reinforced concrete key or other positive connection between individual precast units, such as transverse post-tensioning, is helpful.

4.10.2 Reinforced concrete T-beams-This type of structure is usually constructed on ground-supported falsework. It is most suitable for bridges of short span lengths of 30 to 80 ft (9 to 24 m).

4.10.2.1 Reinforcement-Due to the narrow stem width, a multilayer arrangement of reinforcement in the positive moment region is required. This makes concrete placement difficult, often resulting in rock pockets. The selected width should accommodate the reinforcement while allowing easy placement and consolidation of the concrete.

The problem of maintaining the top mat of reinforcement in its proper position, as discussed in Section 4.10.1.1, is even more serious for thin slabs where a shift of reinforcement by $\frac{1}{2}$ in. (12 mm) in a 7-in. (178mm) slab will mean a change in effective depth of 10 percent.

Girder stirrups and bent-up slab reinforcement bars do provide some support for the top mat; however, the designer needs to be sure that the supports provided will prevent a downward displacement of the reinforcement under the probable construction loads.

4.10.2.2 Construction joints-Usually the T-beam superstructure is constructed in two separate stages: the stems and the slabs. To minimize cracks in the tops of stems due to temperature and shrinkage stresses, as well as possible differential settlement of falsework, some longitudinal reinforcement should be placed within the stems just below the construction joint.

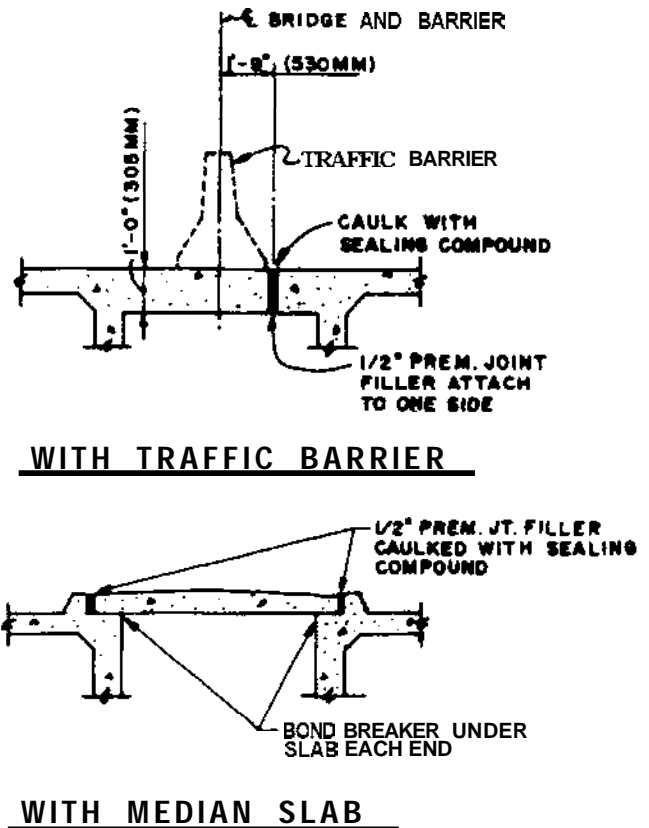

Fig. 4.10.2.3-Examples of longitudinal expansion joints for wide structures

4.10.2.3 Longitudinal joints-For very wide structures constructed full width, concrete placement and finishing becomes difficult and expensive. Temperature stresses and movements imposed on the substructure become rather large. For these reasons, a longitudinal joint within the structure becomes almost a necessity for bridges wider than about 60 to 70 ft (18 to 21 m).

A typical detail in such cases may involve: a construction joint, or an expansion joint, or a construction joint and an expansion joint with a closure slab as shown in Fig. 4.10.2.3.

The decision as to which detail to use will depend on the total width of structure; the magnitude of initial deflection and rotation to be accommodated by the joint; the amount of creep deflection accumulated by the first half before the second half is constructed; and finally by the need to provide for maintenance of traffic.

To minimize confusion of the drivers, the joint should be located on a lane line or within a median.

4.10.3 Precast, prestressed girders-These are most suitable for locations where the use of falsework is either prohibited, impractical, or too expensive. The construction time is usually shorter than that needed for cast-in-place girders. The girders are designed to carry dead load and construction loads as simple span units. Live load and superimposed dead load design may or may not use continuity and composite action with the cast-in-place slab.

The considerations mentioned for T-beams also apply to wide structures constructed with precast prestressed girders. The discussion of possible downward displacement of reinforcement during concrete placement mentioned in [Section 4.10](#), also applies.

4.10.3.1 Transportation and handling—Most state highway departments require a transportation permit for any load over 80 ft (24 m); long, and many will not issue permits for loads over 100 ft (30 m) in length. Thus, long girders may have to be brought to the site in segments and assembled there, resulting in increased cost of field work. Poor access roads can also require segmental construction.

Long, precast, prestressed girders are heavy and may be laterally unstable (particularly if the compression flange is narrow) until incorporated into the structure. Firm ground is needed to store the girders, as well as to support the required lifting cranes. Pickup points should be determined beforehand and lifting hooks installed. Once erected, and until the diaphragms are cast, the girders should be braced.

4.10.3.2 Camber—Multispan simple span bridges using precast, prestressed girders do not usually provide a comfortable ride. Some of the steps that can be taken to minimize this problem include:

- a. Make girders continuous for live loading by casting concrete between ends of girders
- b. Use a liberal depth for the girders
- c. Specify a maximum length of time that the girders may be stored without being loaded with at least some dead load

4.10.4 Nonprestressed reinforced concrete box girders—This type of structure is adaptable for use in many locations. It has been used in both metropolitan and rural areas, for single structures, or for entire interchanges. The popularity of this type of structure lies in its economy for a wide range of spans and layouts and its reasonably good appearance.

4.10.4.1 Reinforcement—The stem thickness selected should accommodate the reinforcement and allow proper placement and consolidation of concrete. Particularly in the case of boxes over 7 ft (2.13 m); deep, a stem thickness larger than the frequently used minimum of 8 in. (200 mm) should be considered.

The discussion of possible downward displacement of reinforcement during concrete placement mentioned in [Section 4.10.2.1](#) is equally valid here.

4.10.4.2 Construction joints—Temperature and shrinkage stresses, as well as possible settlement of falsework after the initial placement of concrete, often result in vertical cracks in the webs. Additional horizontal reinforcement in the webs near the construction joint has been found helpful in restricting the size of these cracks.

4.10.5 Post-tensioned concrete box girders—Post-tensioned box girder construction affords many advantages in terms of safety, appearance, maintenance, and economy. Long spans may be constructed economically, thereby reducing the number of piers and eliminating shoulder obstacles at overpasses. Obstacle elimination greatly enhances the recovery area for out-of-control vehicles.

4.10.5.1 Falsework—Construction methods for building post-tensioned concrete box girder bridges are many and varied. Construction on ground-supported falsework is prevalent in the western part of the United States. In recent years this method has gained acceptance in the eastern and mid-western states. The use of ground-supported falsework construction will increase as projects are evaluated to determine the most economical construction method.

Falsework construction methods may be modified when site restrictions dictate the elimination of ground-supported falsework. The falsework may be supported by an auxiliary truss spanning from pier to pier. An example of this method of construction is the Denny Creek Bridge ([Reference 4-3](#)) located in the Snoqualmie National Forest east of Seattle, Washington. The extreme ecological sensitivity of the area required an esthetically pleasing structure with minimal damage to the environment. To satisfy the restrictions, the winning contractor chose to cast the box girder section in forms, supported by a traveling truss. The truss, 330 ft (100 m); long and weighing 540 tons (4800 kN), moved forward span by span as construction progressed. Denny Creek Bridge was the first instance of the use of this system in the United States.

Another modification of ground-supported falsework occurred on the Napa River Bridge⁴⁻⁴ in California. Falsework towers at 70-ft (21-m) intervals with wide flange girders were used to support cast-in-place box girder cantilevers. The reuse of the towers and forms had an economic advantage over conventional construction. In addition, a required 70-ft (21-m) navigation channel was maintained during construction.

These are only a few of the possible modifications of falsework construction; many others have been successfully employed and new ones will be developed. Possible restrictions on each project should be thoroughly investigated so the most economical method of construction can be used.

4.10.5.2 Construction options—Post-tensioned box girder construction offers many options to both designers and builders for a successful project at minimum cost. The size of components cast at one time may be varied from partial spans or partial cross sections to entire spans. The components may also be precast and assembled with the post-tensioning tendons. The prestressing tendons, whether pre-tensioned or post-tensioned, can be located to place the required forces in the most efficient manner. The tendons may be straight, draped, continuous throughout the structure, or of partial lengths. For instance, the contractor on the Napa River Bridge used a longitudinal loop tendon system. The 12-strand tendons extended from the end of one cantilever to the other cantilever, where they looped around and returned.

Partial stressing of post-tensioning tendons may control shrinkage and temperature cracks until the concrete gains sufficient strength to allow full prestress application. Proper analysis of the structure and the use of some of these options, either alone or in combination, will result in cost savings while providing structural integrity.

4.10.6 Post-tensioned segmental construction^{4-5,4-6}—Since about 1970, when this European technology was intro-

duced into the United States, segmental construction has added a new dimension to the design and construction of post-tensioned concrete box girder bridges. The basic concept is to provide cost saving through standardization of details and multiple use of construction equipment.

Segmental concrete bridges may be precast by either the long line or short line system. The segments may also be cast-in-place. They may be erected by the method of balanced cantilevers, by progressive placement span by span, or by launching the spans from one end. Almost any combination may be used to provide the most cost-efficient use of materials, labor, and equipment. Both the designer and contractor should have the opportunity to evaluate and choose the proper combination.

4.10.6.1 Standardization-Standardization is accomplished by varying the details as little as possible. The webs may be sloped or vertical, but preferably should remain a constant thickness for the entire length of the structure. Ideally the only variation would be the spacing of the shear reinforcement.

Most existing projects have incorporated sloped webs. Many believe sloped webs are esthetically pleasing; as a practical matter they facilitate form stripping. However, engineers should consider the possible problems encountered by sloping the webs of variable depth box girders. A constant web slope means the width of the bottom slab decreases as the depth of the section increases. The forms should be fabricated to accommodate the variable dimensions. Sometimes the saving in substructure quantities due to reduced superstructure weight justifies the additional form cost.

The top slab should remain of constant cross section. An exception occurs when minor grade variations are accomplished by increasing or decreasing the top slab thickness. Any variations in the slab thickness should be confined to the top of the slab to eliminate modification of the inside forms.

The top slab may be of variable depth in the transverse direction. The design of the box girder section in the transverse direction is based on rigid frame analysis requiring a moment-carrying capability at the joints. The thickening of the joint area where the webs connect to the slab provides the moment capacity along with extra concrete to carry the shear stress occurring between the web and slab.⁴⁻⁷

Transverse prestressing of top slabs of 40 ft (12 m) or greater width, in conjunction with variable depth, proves especially advantageous from the viewpoint of economics and durability. If the transverse tendons are located close to the centerline of the slab at the ends of the cantilevers and extend in a straight line through the slab, the prestressing force will be in the correct position, relative to the neutral axis, to carry both the negative and positive moments. This of course assumes a normal crown. The same will not be true for segments with constant superelevation or with superelevation transition.

The bottom slab should have a constant thickness in both directions throughout, with two exceptions. The bottom slab may have to be thickened in the transverse direction at the web junctions for the previously mentioned reasons. Also, if the segments are erected by balanced cantilevers, the bottom

slab generally has to be thickened over the piers to carry the compressive stresses. However, the slab should be back to normal thickness within two or three segments away from the pier to return to normal casting procedures as quickly as possible and to minimize dead load.

4.10.6.2 Construction loads-The concept of construction loads having an influence on design as discussed in Section 4.3 becomes very important in segmental concrete design and construction. The amount of prestressing required in some areas may well be governed by construction loads. In other areas, service loads may govern. For the design to be complete, all loads should be considered even though the exact location and magnitude of the construction loads may not be known.

4.10.6.3 Design procedure-The proper design procedure is to investigate methods available to construct the bridge and to base the design on the most probable and the most economical method, recognizing the pertinent restrictions. Not only the method of construction, but the time or rate of construction, are important because of the many time-dependent factors (such as concrete creep and shrinkage) that can have significant effects on stresses and deformations. The designer should consider details of the assumed construction method, including locations and magnitudes of construction loads when preparing the plans and specifications. The project may then be opened up to alternative methods of construction consistent with the restrictions and with the stipulation that allowable stresses are not to be exceeded, including secondary and time-dependent effects. If construction loads are exceeded, or the timing is significantly different, it will be necessary for the contractor to provide a redesign.

In this way the contractor has the opportunity to develop the most economical method. Three situations can occur:

- a. The contractor can agree with the designer's assumptions and build the bridge according to the plans and specifications.
- b. The contractor can develop an economical construction scheme with smaller construction loads and redesign the bridge to save material and thereby produce some cost saving.
- c. The contractor can develop a more economical construction scheme with larger construction loads and redesign the bridge to provide some cost saving.

This system has some minor drawbacks. The projected cost savings should exceed the redesign costs by a significant amount to make the effort worthwhile. Included in the redesign costs should be the engineering costs involved in reviewing and approving redesigns. However, engineering costs are usually low when compared with construction costs on a project. Contractors have to spend money in preliminary designs to verify methods without any assurance of getting the work. Unsuccessful bidders probably will pass this cost on to subsequent projects.

The real advantage of this system is that it provides the contractor with an opportunity to bid the method most suitable to the contractor's expertise. Therefore, the cost saving is obtained through closer competition.

4.11-Construction problems^{4-8,4-9}

Prevention of the following examples of construction problems that have been encountered on concrete bridge projects should be considered during design.

4.11.1 Cracking due to shrinkage and creep-The subject of shrinkage and creep is quite complicated and involves a large number of factors, some easy to calculate and others difficult to predict. These factors include: strength of concrete; age at which the concrete will be subjected to stress, magnitude of maximum stresses, temperature variations, quality of concrete, quality of curing, and general quality of construction.

The designer works with a set of well defined design specifications and design procedures. The product is expected to be a properly designed structure that can be constructed and put into service on time, within budget, and without any major problems. The problems that develop usually come from factors that are at variance with the assumptions used in design. These variations can arise from changes in weather, variability of construction materials, and nonuniformity of workmanship. There are cases where rates of shrinkage have varied by as much as 100 percent from one batch of concrete to another on the same project. Similarly, variations of 50 percent in creep rates are not uncommon. Therefore, it is prudent and cost-effective for the designer to consider several rates of creep and shrinkage and to assess the probability of their occurrence and their effects on the structure, versus the cost of mitigating measures.

Some measures that have been used to reduce the undesirable effects of excessive shrinkage rates are: stage construction of long structures, selective use of high cement content, concrete additives, and liberal use of continuous nonprestressed reinforcement.

Another common reason for variations in creep rates is the discrepancy between assumed and actual concrete strength at the time of load application. This is particularly true in case of loads applied at a later time in the age of concrete; e.g., railings, curbs, overlays.

4.11.2 Temperature cracking-This problem often manifests itself on box girders where a very thick bottom slab is used to provide the necessary compressive area at the supports. Heat is generated by the hydration of the cement, with additional input from hot weather in some instances. The remedies to be considered during the design stage might be:

- a. Reduction of slab thickness (increased depth of structure);
 - b. More longitudinal reinforcement within the section
 - c. Reduction of applied moments by use of temporary supports, stays and tendons
- The designer might also specify:
- d. A reduction in rate of concrete placement
 - e. A reduction in cement content
 - f. The use of retarders and/or pozzolans in the mix
 - g. Cooling of mixing water and aggregates

In cases where the outdoor temperature represents a large part of the heat input, use of insulated forms should be considered. As always, the provision of required minimum ratios for temperature reinforcement should not be neglected.

4.11.3 Cracking due to tendons-Cracking of concrete along planes tangential to tendons has been observed on several structures. This cracking is the result of stresses exerted by the tendons on the concrete at locations where there is change in tendon alignment, whether intentional (as in curved girders, or in girders with draped tendons, etc.) or accidental (insufficient supports for tendons or workers stepping on them).

In cases of intentional curvature, the forces can be calculated and reinforcing provided as needed for tension in the plane normal to the tendons. In cases of unintentional curvature or kinks in the tendon path, the designer should anticipate and estimate not only in which direction the cracking may occur, but should also evaluate the cost of additional reinforcement versus the cost of better inspection. The use of rigid ducts and close spacing of duct supports is quite helpful.

4.11.4 Crushing of ducts-This problem occurs on post-tensioned structures in areas of duct curvature where ducts are closely placed or actually bundled. As a result, there is only a thin layer of concrete (sometimes none) to resist the radial tendon forces. This problem has surfaced on curved girders, as well as on girders with tendons draped in the vertical plane. The following remedies are available to the designer for consideration in these situations:

- a. The designer should be satisfied that the concrete section is large enough to accommodate the required reinforcement and ducts. "Large enough" is intended to mean that there is enough concrete around each duct to resist and distribute, without distress, the horizontal and/or vertical shears imposed by the tendons on the concrete. In practical terms, it means that the designer should select a comfortable depth for the structure, sufficient width for the girders, and reasonable spacing for the diaphragms.
- b. In cases of unavoidably tight tendon spacing, the designer should consider specifying metal saddles or spacers between the ducts. Metal duct saddles have been used on some projects and are available commercially.
- c. In some cases where it is too late for the other remedies, a carefully thought out post-tensioning sequence will help, although duct crushing may still occur. Grouting of such ducts will be difficult and may result in incompletely grouted ducts.

4.11.5 Construction joints-Almost all structures are designed on the assumption of a monolithic construction. However, it is very seldom that a structure can be constructed in such a manner; most structures have a number of construction joints and some (such as segmental bridges) have many of them. In situations where there will be a large number of construction joints within a structural member, there is normally no need to specify their location; however, in cases of only a few construction joints in a span or a pier, it is best to limit their location. Construction considerations in connection with construction joints are basically the need to assure a monolithic behavior of the structure, despite the presence of some degree of discontinuity represented by the construc-

tion joint. Continuity is achieved by insuring the transfer of joint forces (axial forces, moments, and shears) across the joint without distress.

4.11.5.1 Joint location-In cases where only a few joints are used, the preferred location in the span is at or near an inflection point. Here the moment is near zero, the shears are lower, and deflection is minimal-conditions favorable for a distress-free construction joint.

In cases where many construction joints are used in a span (segmental construction), the location of the joints depends on the construction method and available equipment and is usually not specified. Where joints are exposed, regularity of spacing and uniformity of appearance make the best impression and thus should be specified.

4.11.5.2 Joint configuration-Transfer of axial forces across the construction joint usually presents no problem as long as the joint surface is normal to direction of forces and the joint is always in compression, or there is sufficient reinforcement across the joint to properly carry the tensile forces.

Obviously the size of compressive or tensile forces to be transferred across a construction joint will depend to a great degree upon the rates of creep and shrinkage. In many structures, due to an unexpectedly large shrinkage rate, the prediction of compression on a given joint has been in error. Tensile stresses acting on the unreinforced plane have caused unsightly cracking and distress. Thus, the designer should check the axial forces on all construction joints, assuming varying rates of shrinkage and creep, and provide reinforcement across the joint for all doubtful cases. An alternate approach (although more conservative and expensive) is to provide continuous reinforcement across all construction joints as a policy requirement.

Transfer of shear forces across a construction joint presents a greater challenge and needs careful consideration. In slabs carrying direct traffic loads, a continuous shear key consisting of a ledge and cantilever has been used for many years without major problems, and thus may be considered a preferred solution for vertical shear transfer.

Vertical shear transfer across a construction joint within a girder web is a problem for segmental construction. The basic approach has been to develop the shear key in a form of mating serrated surfaces. Two configurations have been used: either a great number of shallow keys, or a small number of large keys.

Both types have had some successes and some failures. In regions of high shears, small shear keys are not usually adequate to transfer and distribute the forces beyond the construction joint plane. On the other hand, the large keys, although able to distribute the forces, often fail because of inadequate (or missing) reinforcement. Thus the solution seems to be to use small, unreinforced keys in regions of low shears and large, well reinforced keys in regions of high shears.

4.11.6 Cracking at anchorages-All research dealing with stress distribution behind anchor plates indicates the presence of tensile stresses in the vicinity of anchorages and the need to reinforce the concrete for these stresses.

Most stressing system manufacturers are aware of this and will usually require a proven and safe arrangement of a grillage behind the anchorage.

Where cracking of concrete at the anchorages has occurred, it was usually the result of:

- a. Reduction in the amount of reinforcement
- b. Misalignment of tendons and anchorages
- c. Poor quality of concrete

The designer may have some control over these items during shop plan review; however, the main burden of insuring quality construction rests with the contractor's engineer.

4.11.7 Misalignment of ducts-The usual path of prestressing ducts called for on the plans is a smooth curve. Any dips, peaks, or kinks will cause high local stresses, resulting in cracking of concrete and other undesirable effects. To prevent this, the contractor should have experienced and knowledgeable engineers in charge of construction, with authority to correct poor construction practices long before they become "cast in concrete," difficult and expensive to repair.

4.11.8 Miscellaneous-Over the years, various problems with post-tensioned concrete have surfaced, been solved and forgotten, to reappear elsewhere, and to demand new solutions. Some of these are as follows:

- a. Drainage pipes installed at low points on all ducts would correct this problem.
- b. Use of watertight tape and care in making duct splices should be helpful in this respect.
- c. In most cases, this problem has been found to result from improper alignment between the tendon and the anchorage. Any deviation from a 90-deg (1.57-rad.) angle between tendon and anchorage will result in large bending moments on the anchorage plates and on the tendons, leading to overstress and cracking. In some cases, the misalignment occurred after stressing because of rock pockets behind the anchorages. In all cases, the quality of construction was at fault, which is something that the designer cannot control with a great degree of certainty.

4.12-Alternate designs

4.12.1 General-Experience indicates that the lowest bids are received on those projects that allow the greatest flexibility in use of available construction methods and materials. Thus, during design it is imperative to avoid introducing unnecessary restrictions upon the anticipated construction process. Structures designed with only one construction method or prestressing system in mind rarely turn out to be economical. Naturally, there are exceptions, specifically in situations where the site conditions or the approving agencies impose restrictions upon the designer and the contractor in selection of type of structure or the method of construction. However, even under these conditions, permitting the contractor some latitude within defined limits, will result in a more economical project.

4.12.2 Value engineering change proposals⁴⁻¹⁰-Value engineering has become one of the accepted tools for reducing construction costs and for introducing innovative ideas and methods into the construction industry. However, a

questioning attitude still persists among some engineers toward value engineering change proposals. This attitude is founded in part upon the mistaken belief that accepting a change is an admission of a flaw in the original design. The main point to keep in mind is that the initial designer and the contractor are designing and constructing two different structures. The designer had to produce plans for a structure that could be built economically by the largest possible number of contractors, whereas the contractors would rather build the structure in a way most suitable to their expertise, their equipment, and often their accounting methods. Thus, acceptance of a value engineering change proposal should not be considered an acknowledgement of a flaw in design, but rather another construction consideration that came to light too late to be considered in original design.

The drawback to a value engineering change proposal is that it essentially forces the contractor to bid the project according to the designer's plans, with the hope of negotiating for the more economical scheme. During the negotiations there is always the possibility of the contractor's not reporting the entire cost savings. The contractor cannot base the bid on a more economical scheme since there is no assurance that the value engineering proposal will be accepted.

4.13-Conclusions

On most bridge projects, the designer, after reviewing the design considerations given in this chapter, can arrive at a proper decision or decisions. For projects at unusual sites or of unusual shapes or of major size, the designer should seek the advice of an engineer experienced in construction, particularly in the type of construction being considered. If such an engineer is not on staff, the designer should consider hiring a subconsultant who is experienced or should confer with one or more local contractors who are generally willing to share their knowledge and expertise. If these are not readily available, the designer should secure the services of a construction consultant having the necessary expertise.

RECOMMENDED REFERENCES

The documents of the various standards-producing organizations referred to in this report are listed here with their serial designation, including year of adoption or revision. The documents listed were the latest effort at the time this report

was written. Since some of these documents are revised frequently, generally in minor detail only, the user of this report should check directly with the sponsoring group if it is desired to refer to the latest revision.

American Concrete Institute

- 121R-85 Quality Assurance Systems for Concrete Construction
 318-83 Building Code Requirements for Reinforced Concrete

CITED REFERENCES

- 4-1. Tadros, G.; Ghali, A.; and Dilger, W.; "Construction Stages and Design Considerations for a Curved Box-Girder Bridge," *Canadian Journal of Civil Engineering*, V. 9, No. 3, 1982.
 4-2. "Highway Design Manual," Department of Transportation, State of California (p. 18 and p. 20).
 4-3. "Post-Tensioned Box Girder Bridge Manual," Post-Tensioning Institute, Phoenix, Arizona, 1978.
 4-4. Podolny, Jr., Walter, "Segmental Bridge Construction in the U.S.-A Look Ahead," Long Span Concrete Bridge Conference, Hartford, Connecticut, Mar. 1980.
 4-5. Joint PCI-PTI Committee on Segmental Construction, "Recommended Practice for Precast Post-Tensioned Segmental Construction," *PCI Journal*, V. 27, No. 1, Jan.-Feb. 1982.
 4-6. Harwood, Allan C., "I-205 Columbia River Bridge-Design and Construction Highlights," *PCI Journal*, V. 27, No. 2, Mar.-Apr. 1982.
 4-7. "Precast Segmental Box Girder Bridge Manual," Post-Tensioning Institute, Phoenix, Arizona, Prestressec Concrete Institute, Chicago, Illinois, 1978.
 4-8. Gerwick, Jr., Ben C., "Causes and Prevention of Problems in Large-Scale Prestressed Concrete Construction," *PCI Journal*, V. 27, No. 3, May-June 1982.
 4-9. Freyermuth, Clifford L., "Post-Tensioning Details for Long-Span Bridges," *PCI Journal*, V. 27, No. 6, Nov.-Dec. 1982.
 4-10. "Value Engineering in Preconstruction and Construction," 1981, Transportation Research Board NCHRP SYN 78.

CHAPTER 5—LOADS AND LOAD COMBINATIONS

5.1—Introduction

The loads recommended herein reflect current bridge design criteria set forth in AASHTO, the *Ontario Highway Bridge Design Code*,⁵⁻¹ and recent studies⁵⁻² for a wide variety of concrete bridges. In addition, the organization sponsoring the project may specify loads and criteria which will govern the design. The designer should look for and consider any unique or unusual conditions that may exist at the bridge site.

5.2—Dead loads

5.2.1 Structure dead loads—Structure dead loads are loads imposed on a member by its own weight and the weight of other structural elements supported by it, including rails, sidewalks, slabs, and beams. If rails and sidewalks are constructed after the main load-carrying system is self-supporting, then the weight of these items is included in superimposed dead loads.⁵⁻²

For the purpose of preliminary sizing of bridge members, the unit structure dead load of typical concrete bridges may be estimated from:

$$w = a + bL/100$$

where

- w = unit load in psf (kN/m²)
- a, b = constants from Table 5.2
- L = span length in ft (m)

5.2.2 Superimposed dead loads—Members should be designed to support the weight of superimposed dead loads including earth fill, wearing surface, stay-in-place forms, tracks and ballast, barrier walls, and railings, waterproofing, signs, architectural ornamentation, pipes, conduits, cables, and any other appurtenances installed on the structure.

The following values may be used as a first estimate of superimposed dead load:

Acting on Highway Bridges

Barrier railings (New Jersey curb)

450 to 600 plf (6.6 to 8.8 kN/m)

Allowance for future overlay

25 psf (1.2 KPa)

Acting on Railroad Bridges

Ballast and tracks

3500 plf (51.0 kN/m)

Tracks only

600 plf (8.8 kN/m)

Walkway

500 plf (7.3 kN/m)

5.3—Construction, handling, and erection loads

Consideration should be given to temporary loads caused by the sequence of construction stages, forming, falsework, or construction equipment and the stresses created by lifting and placing precast members. While one or more construction schemes are generally considered when evaluating the feasibility of the project, developing the actual construction

procedure should be done by the contractor. The stability of precast members, during and after construction, should be investigated and provisions made as needed. Effects of member shortening and redistribution of loads during prestressing should be considered.

Environmental loads due to wind, earthquake, and thermal effects should be considered during construction using an appropriate return period or reduced severity. Lower load factors may be used to account for the acceptability of higher temporary stress levels.

5.4—Deformation effects

5.4.1 Settlement of supports—Stresses and forces resulting from possible differential settlement of the supports should be considered in the design. Relaxation of such forces may be accounted for by using an effective modulus of elasticity adjusted for time-dependent effects.⁵⁻³

Preliminary design analyses may be made assuming differential settlements equal to a fraction of the average of adjacent span lengths as follows:

Pile foundations	1/500
Spread footings	
On soil	1/1000
On rock	1/2000

Values used on the final design should be determined from the project soils report or by consultation with the geotechnical engineer.

5.4.2 Shrinkage and creep—Shrinkage and creep are concrete deformations, which occur over a length of time (up to 20 years). In general, creep and shrinkage are influenced by:

- a. Mix design
- b. Water/cement ratio
- c. Aggregate properties
- d. Cement content
- e. Maturity (age) of concrete
- f. Ambient relative humidity
- g. Reinforcing steel percentage
- h. Size of member
- i. Shape of member
- j. Age at first application of load
- k. Duration of load

Table 5.2—Constants for typical structure dead loads

Structure type	Span range	a	b
Slab	20-150 ft	53	530
	6-16 m	2.54	0.8
Tee-beam	35-80 ft	70	164
	11-24 m	3.35	25.7
Slab and prestressed I-girders	50-130 ft	112	96
	16-40 m	5.36	15.1
Prismatic box girders (falsework construction)	80-160 ft	185	72
	24-49 m	8.86	11.3
Prismatic box girders (span-by-span construction)	150-350 ft	285	40
	46-107 m	13.65	6.3
Nonprismatic box girders (cantilever construction)	350-800 ft	0	94
	107-244 m	0	14.8

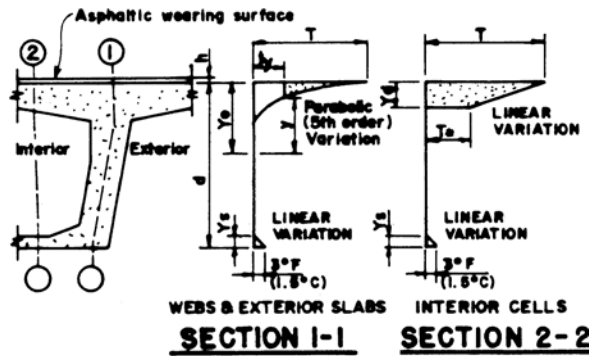

- d = Depth of girder
 h = Asphalt wearing surface thickness
 Y_o = Depth of temperature variation of webs - 48 inches (1200 mm)
 Y_s = Height of temperature variation in soffit slab - 8 inches (200 mm)
 Y_d = Mean thickness of deck between webs
 T = Maximum temperature at upper surface of concrete
 $T = 58 - 9h \text{ F} \quad (32 - 0.2h \text{ C})$
 T_b = Minimum temperature of top slab over closed interior cells
 $T_b = 58 - 9h - 2.25 Y_d \text{ F} \quad (32 - 0.2h - 0.05 Y_d \text{ C})$
 y = The distance above the depth of temperature variation
 t_y = Temperature at distance y
 $t_y = T (y/Y_o)^5$

Fig. 5.4—Temperature distribution for design.⁵⁻⁷

Depth of the investigation of the effects of creep and shrinkage depends upon the sensitivity of the structural system to these effects. Structural systems for which creep and shrinkage produce critical conditions should be investigated for a range of deformations likely to occur. In choosing the range of deformations, it should be kept in mind that the designer does not have adequate control, or even adequate knowledge, of all the conditions influencing creep and shrinkage. The guidance which follows is of a general nature and the designer is referred to ACI 209R and References 5-4, 5-5, and 5-6.

5.4.2.1 Shrinkage—Shrinkage is the reduction in volume which occurs in concrete during the hydration process due to loss of water not bound by hydration. Shrinkage occurring before the concrete has taken its initial set is not included in the shrinkage considered herein. The practice of staggered placement of concrete can reduce effects attributable to early plastic shrinkage, but is not effective in compensating for shrinkage which occurs over long periods of time.

Increased volume changes resulting from the use of expansive admixtures also should be considered in the design.

For preliminary design, ultimate shrinkage deformation in conventional reinforced concrete bridges in moderate climates, having a mean annual relative humidity between 50 and 90 percent, may be taken as a strain of 0.0002. The shrinkage coefficient for lightweight concrete should be determined by test for the type of aggregate to be used.

Rate of development of shrinkage may be approximated by the following expression:

$$(\xi_{sh})_t = (\xi_{sh})_u t / (35 + t)$$

$(\xi_{sh})_t$ = shrinkage of time t

$(\xi_{sh})_u$ = ultimate shrinkage

t = time in days from end of curing (7 days for normal curing, 1 to 3 days for steam curing)

This expression is based on a 6 in. (150-mm) thick slab of typical field-cast concrete, moist cured for 7 days, and drying at 70 F (20 C). Corrections are applied for other conditions. Correction for the thickness may be estimated⁵⁻⁶ by adjusting the time by the square of the rates of thickness as follows

$$t^* = t(h/h_o)^2$$

where

t^* = equivalent time

t = actual time in days

h = actual thickness

h_o = reference thickness, 6 in. (150 mm)

For more detailed information, the designer is referred to ACI 209R.

5.4.2.2 Creep—Creep (time-dependent deformation under constant load) and relaxation (time-dependent force under constant strain) are influenced by the factors noted previously, but are most strongly influenced by the age of the concrete (maturity) at the time of loading.

Creep deformation is approximately proportional to stress for normal service loads. Creep may be characterized by the creep coefficient, which is defined as the ratio of creep deformation to instantaneous elastic strain. The ultimate creep coefficient C_u for conventional reinforced concrete bridge members,⁵⁻³ in a moderate climate and loaded at an age of 28 days, may be taken for preliminary design as

$$C_u = 3.0 - 0.030RH$$

where

RH = mean annual relative humidity

The development of creep deformation with time may be approximated by the following expression

$$C_{(t)} = C_u t^{0.6} / (10 + t^{0.6})$$

where

t = age in days from loading

Creep strain at time t after loading is given by

$$(\xi_{cr})_t = (\xi_{cr}) C_{(t)}$$

where

(ξ_{cr}) = instantaneous strain at application of load

The designer should remember that total strain includes instantaneous strain, creep strain, and shrinkage strain. For more detailed information, the designer is referred to ACI 209R.

5.4.3 Axial load deformations—The effect of differential displacements at top of piers due to internal axial forces in the main longitudinal members should be considered in the analysis.

5.4.4 Thermal effects—Stresses or movements due to temperature changes and to temperature differential in the

member should be considered in the design. The thermal coefficient for normal weight concrete members may be taken as 0.000006 F (0.000011 C). The temperature range should be determined for the locality in which the structure is to be constructed. In the absence of site-specific data, the long-term change in temperature from the mean annual temperature may be taken as given in AASHTO:

	Temperature rise	Temperature fall
Moderate climate	30 F (17 C)	40 F (22 C)
Cold climate	35 F (19 C)	45 F (25 C)

Short-term (24- to 48-hr) temperature changes and solar radiation produce differential temperatures through the depth of a concrete bridge. Stresses produced by this nonuniform temperature distribution can be significant at the service load level. Such differential temperatures do not reduce the ultimate load capacity. A temperature distribution appropriate for calculation of the effects of differential temperature is shown in Fig. 5.4. The temperature distribution for a given site and structure may be derived by heat flow calculations on a section of the structure for prescribed values of air temperature, solar radiation, and thermal properties.

Stresses developed due to restraint of thermal expansion may be conceptually divided into three parts:

1. **Section restraint stresses**—Stresses arising from assumption that plane sections remain plane
2. **Flexural restraint stresses**—Stresses arising from the support restraints of member end rotation (i.e., continuous spans or fixed ends)
3. **Axial restraint stresses**—Stresses arising from support restraint of the overall longitudinal expansion and contraction

These stresses can be calculated using the procedures described in References 5-7 and 5-8.

5.4.5 Prestress effects—Stresses should be investigated for the initial prestress force and for the prestress force remaining after losses. Deformation of a member due to prestressing should be allowed for in the design.

5.4.6 Frictional forces—The horizontal force due to friction of sliding plate bearings, roller bearings, pin, and rocker bearings or stresses in elastomeric bearing pads should be allowed for in the design. Typical design values for friction are given in Table 5.4.6.

5.5—Environmental loads

5.5.1 Wind loads

5.5.1.1 Selection of procedures—The procedure outlined in 5.5.1.2 may be used for conventional bridge structures with span lengths not exceeding 400 ft (120 m). These structures are generally sufficiently stiff so that dynamic effects of wind need not be considered. Many longer span bridges and some pedestrian, pipe, conveyor, and sign bridges are sensitive to wind-induced oscillations. For these structures, a more detailed analysis, including a wind tunnel test, is recommended.⁵⁻²

In lieu of the procedure of 5.5.1.2, the simpler provisions of 5.5.1.3 may be used for conventional girder and slab bridges.

Table 5.4.6—Coefficients of friction

Bearing surfaces	Average coefficient of static friction
Steel-steel	0.20
Steel-self lubricating bronze (Lubrite)	0.10
Stainless steel-TFE* (reinforced)	0.06
Stainless steel-TFE (virgin)	0.03

*TFE = Polytetrafluoroethylene (Teflon).

5.5.1.2 General procedure—General procedures for calculation of wind loads on bridges should consider climatological conditions of the site, variation of wind speed with height above the ground, gustiness of the wind, shape of the structure, and its orientation to the mean wind direction and natural frequencies of the structure. The following procedure is based on Reference 5-1 and ANSI A58.1. The pressures given are pressures against rigid structures. Effects due to interaction between the dynamic characteristics of the structure and the wind are not included. These effects are not usually significant for concrete bridges.

Basic wind velocity pressures may be determined from the following formula

$$q = pV^2/(2g) \text{ in psf (kPa)}$$

where

- q = dynamic wind pressure, psf (kPa)
- V = maximum probable wind velocity, ft/sec (m/sec)
- p = unit weight of air, 0.08 lb/ft³ at 32 F (12.6 N/m³ at 0 C)
- g = acceleration due to gravity = 32.2 ft/sec² (9.81 m/sec²)

The maximum probable wind velocity, V , should be assumed to be not less than 100 mph (160 kph), unless a lower value can be justified for the structure site. Permanent features of terrain may allow a reduction of wind velocity at various angles to the structure. Gust factors and the channeling effect of roadways, valleys, and canyons should be considered in determining the wind velocity at the structure site. Gusts of 1.4 times the mean hourly wind velocities are common for mean velocities in the range of 50 to 100 mph (80 to 160 kph).

In the United States, Fig. 5.5.1 gives the basic wind speed at a height of 33 ft (10 m) above the ground associated with an annual probability of occurrence of 0.02 (50-year mean recurrence interval).

Similar data are available in Reference 5-1 for the Canadian provinces.

Wind load on the superstructure includes a horizontal load W_h and a vertical load W_v , both acting directly on the structure, and W_L acting on the live load.

The horizontal wind pressure W_h is applied to the total exposed area of the structure as seen in elevation at right angles to the longitudinal axis of the structure

$$W_h = C_e C_w q, \text{ in psf (kPa)}$$

where

- C_e = exposure coefficient

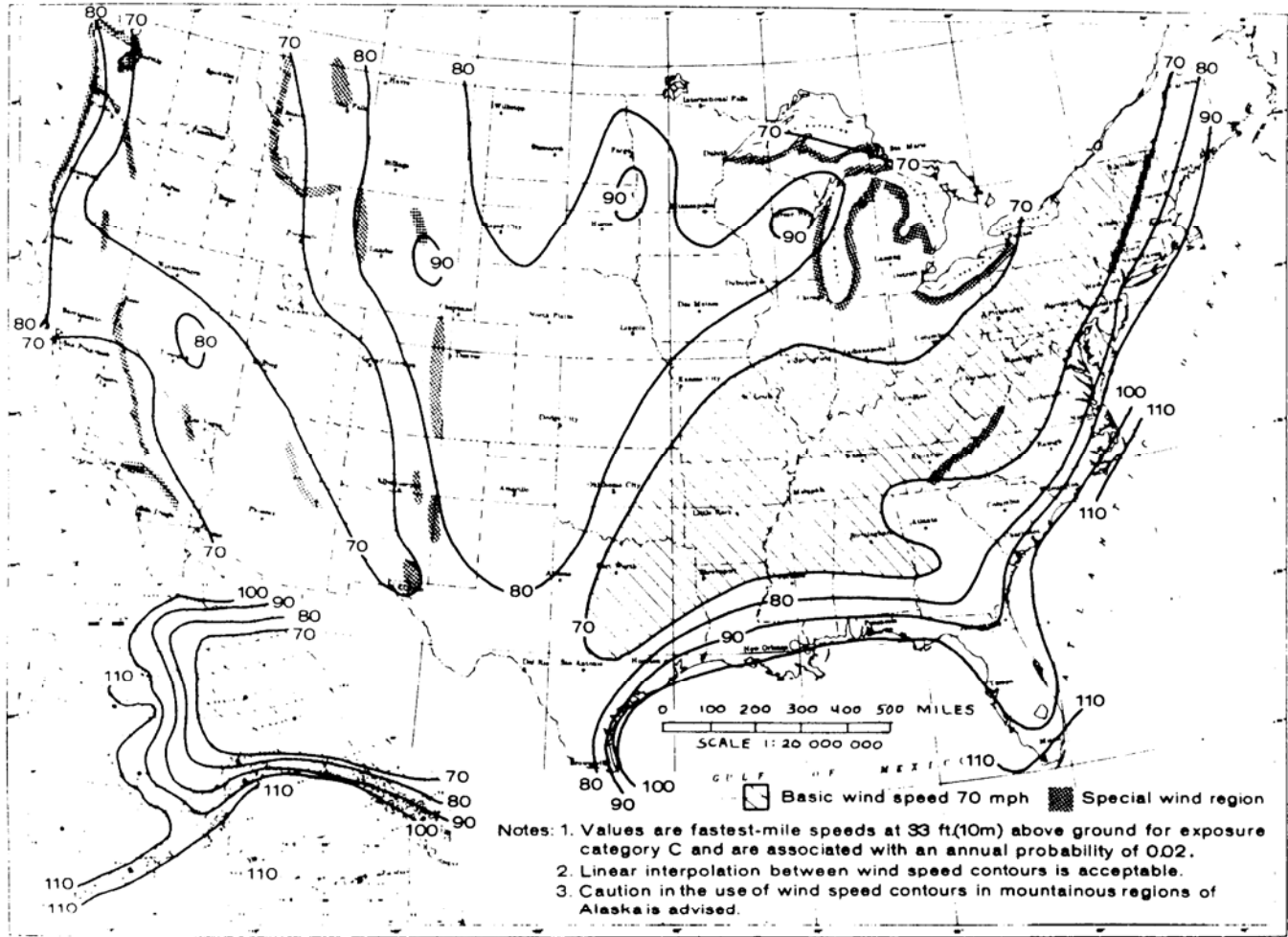

Fig. 5.5.1—Annual extreme fastest-mile speed 30 ft above ground. 50-year mean recurrence interval.

Table 5.5.1a—Range of shape factors, C_w^{5-9}

	Transverse loads	Longitudinal loads	
		0 skew	60 skew
Girder superstructures	1.2 to 1.9	0.1	0.3
Pony truss superstructures	1.6 to 1.8	0.1	0.5
Through truss superstructures	2.4 to 2.7	0.1	1.7

C_w = shape factor (Table 5.5.1a)

For the selection of shape factor values, consideration should be given to the following factors:

- Skew angle—Horizontal angle of wind to edge of structure.
- Pitch angle—Vertical angle of wind to structure.
- Aspect ratio—Ratio of length to width of structure.

Relative exposure—Members on the leeward side of bridge may receive partial wind pressure.

Turbulence—Affected by size, shape, and positioning of members.

For unusual structures, the shape factor, C_w , should be determined by a wind tunnel test.

The exposure coefficient, C_e , accounts for the vertical variation of mean wind speed, and is estimated by the following formula

$$C_e = 0.50 z^{0.2} \quad (0.65 z^{0.2})$$

where z = height of the top of the superstructure above the ground or water in feet (meters). The exposure coefficient should not be taken as less than 1.0.

The vertical wind load consists of an upward or downward pressure W_v over the total structure plan area applied at the windward quarter point of the transverse width of the structure

$$W_v = C_e q$$

The wind load on live load is treated as a uniformly distributed load on the exposed area of the live load using the bridge. The intensity of this load should be estimated using the formula for W_h already given, with $C_w = 1.2$, and V not exceeding 55 mph (90 kph). The exposed area should extend over the entire length of the structure. Areas below the top of a solid barrier or rail should be neglected.

For conventional concrete bridges, the wind load on live load may be taken as a linear load of 100 plf (1.5 kN/m), acting at 6 ft (1.8 m) above the top of the deck.

The wind loads acting on the superstructure are transmitted to the substructure by the bearings or other appropriate devices. The horizontal wind loads should be divided into transverse and longitudinal components by the skew angle factors tabulated in Table 5.5.1b.

The horizontal wind load acting directly on the substructure should be calculated using the expression for W_h . The shape factor should be 0.7 for circular cross sections, 1.4 for octagonal, and 2.0 for rectangular shapes. This load is applied in the direction of the wind. The possibility that a skew wind direction is most critical should be considered.

5.5.1.3 Simplified procedure—In lieu of the general procedure in 5.5.1.2, a simplified procedure may be used for conventional concrete girder bridges not exceeding 200 ft (60 m) in span. The loads specified are based on a wind speed of 100 mph (160 kph). Where the probable maximum wind speed can be reasonably ascertained, and is significantly different from this base value, the specified loads may be adjusted in proportion to the square of the wind speed.

a. For superstructure:

$W_h = 50$ psf (2.4 kPa) but not less than 300 lb per linear foot (4.4 kN/m) of the structure span length

$W_v = 20$ psf (1.0 kPa)

$W_L = 100$ plf (1.5 kN/m) acting at 6 ft (1.8 m) above the deck

b. For substructure:

Forces from superstructure:

$W_h = 50$ psf (2.4 kPa) transverse and 12 psf (0.6 kPa) longitudinal acting simultaneously

$W_L = 100$ plf (1.5 kN/m) transverse and 40 plf (0.6 kN/m) longitudinal acting simultaneously

$W_v = 20$ psf (1.0 kPa)

Forces on the substructure:

$W_h = 40$ psf (2.0 kPa)

5.5.2 Snowloads—Freshly fallen snow weighs from 5 to 12 lb/ft³ (0.8 to 1.9 kN/m³) while moistened snow compacted by rain will weigh from 15 to 20 lb/ft³ (2.4 to 3.1 kN/m³). Snow partially thawed and then refrozen may approach the density of ice. Because of this wide variation of weights, snow loads should be determined from weather records and experience at the site of the proposed structure.

Snow shelters provided over bridges should be designed for any probable snow drift depth of the region. Snow loads in excess of 20 psf (1.0 kPa) may be reduced by $(SN-20)/40$ for each degree that the shelter inclination with the horizontal exceeds 20 deg (0.35 rad), where SN is the anticipated snow load in psf (kPa).

Snow loads for unsheltered bridges are considered offset by accompanying decreases in the live loads. The snow load should be generally considered in the design in lieu of the live load, whenever the anticipated snow load exceeds the live load. Designers should also consider the weight of snow removal equipment.

5.5.3 Earthquake loads—Earthquake ground motion produces displacements of the structure relative to the ground. These displacements are calculated from dynamic analyses or equivalent static force analyses. For dynamic analysis, the response of a given mode of structure vibration is determined from the pseudo-velocity spectrum derived from the earthquake ground motion. Response of one or more normal modes of vibration are combined. For equivalent static force analysis, the effects of the relative motion between the ground and the structure are determined by

Table 5.5.1b—Skew angle factor for wind loads on substructures

Skew angle	Truss span		Girder span	
	Transverse horizontal or vertical	Transverse longitudinal horizontal	Horizontal or vertical	Longitudinal horizontal
0	1.00	0.00	1.00	0.00
15	0.93	0.16	0.88	0.12
30	0.87	0.37	0.82	0.24
45	0.63	0.55	0.66	0.32
160	0.33	0.67	0.34	0.38

applying inertia loads to the structure. These inertia loads are the product of structure weight and an effective acceleration coefficient. Reduction of inertia forces due to yielding may be either incorporated into the effective acceleration coefficient or considered separately. These parameters are influenced by the seismicity of the site area, soil profile at the site, and distance of the site from causative faults (if known). The problem is complex, both from the standpoint of establishment of the characteristics of the input motion and the analysis of the response.⁵⁻¹⁰

Analysis of the response of the structure to a given input motion may involve time-history analyses explicitly incorporating soil-structure interaction and yielding of various members. Also, linear elastic modal response techniques are commonly used. Yielding of various members is accounted for by reducing the member forces determined from the analysis by a factor dependent upon the assumed permissible ductility. For simple structures in areas of moderate seismicity, a pseudo-static analysis using a lateral load expressed as a percentage of gravity may be adequate. Analysis of structure response to seismic events is an analysis of imposed deformations. It is characterized by forces only for convenience of analysis.

Details should be designed to assure that the assumed ductility can be achieved.⁵⁻¹⁰ Since plastic hinging will typically occur in columns for major seismic events, confinement of column vertical reinforcing steel is a major concern. Adequate length of bearing seats is of particular importance. Bridges are generally long with respect to the wave length of the predominant frequency of ground motions. Supports can experience a movement that is out-of-phase with the superstructure.

Structures may be classified according to their importance to the community and differing standards prescribed accordingly.⁵⁻¹⁰

Simplification of Reference 5-10 is not possible without significant loss of content. Designers should therefore consult that reference for guidance in seismic design of bridges.

5.5.3.1 Historical—The first provision for earthquake design criteria in codes for bridges in the United States was established in the 1958 AASHTO Standard Specifications. These specifications were based in part on the lateral force requirements for buildings developed by the Structural Engineers Association of California,⁵⁻¹¹ as well as the equivalent static force approach. The following provision applies to bridges regardless of the location of the structures:

$$V = kW$$

where

V = horizontal earthquake force

W = total weight

k = 0.02 for spread footings on soils having an allowable bearing capacity greater than 3.5 tons/ft² (171 kPa)

k = 0.04 for spread footings on soils having an allowable bearing capacity less than 3.5 tons/ft² (171 kPa)

k = 0.06 for pile footings

Prior to the 1971 San Fernando earthquake, very little damage to bridges was known to have resulted from seismically induced vibration effects. Most of the damage on a worldwide basis was caused by permanent ground displacement. The San Fernando earthquake represented a major turning point in the development of seismic design criteria for bridges in the United States.

In 1973, the California Department of Transportation (CALTRANS) introduced new seismic design criteria for bridges which included the relationship of the bridge site to active faults; the seismic response of the soils at the bridge site; and the dynamic response characteristics of the bridge.

In 1975, AASHTO adopted interim specifications which were a slightly modified version of the 1973 CALTRANS provisions and made them applicable to all regions of the United States. In addition to these code changes, the 1972 San Fernando earthquake stimulated research activity on the seismic problems related to the bridges. The Applied Technology Council (ATC), with funding from the Federal Highway Administration (FHWA), developed recommended seismic design guidelines for bridges. In 1983, AASHTO adopted the ATC work as a guide specification.

5.5.3.2 ATC method—The ATC Seismic Specifications were developed for four seismic performance categories (SPC), A through D, to account for seismic risk varying from very small, Category A, to very high, Category D. The SPC is defined on the basis of both the acceleration coefficient for the site and the importance of the bridge.

The ATC earthquake guidelines are based on a low probability of the design forces being exceeded during the normal life expectancy of a bridge. Bridges and their components that are designed to resist these forces and that are constructed in accordance with the recommended design details contained in the provisions may suffer damage, but they will have a low probability of collapse due to seismically induced ground shaking.

The principles used for the development of the provisions are:

- a) Slight to moderate earthquakes should be resisted within the elastic range of the structural components without significant damage
- b) Realistic seismic ground motion intensities and forces are used in the design procedures
- c) Exposure to shaking from severe earthquakes should not cause collapse of the bridge. Where possible, damage should be readily detectable and accessible for inspection and repair.

Two different approaches were combined in the ATC specifications to satisfy the preceding philosophy. They are the “force design” and the “displacement control” criteria. Minimum requirements are specified for bearing support lengths of girders at abutments, columns, and hinge sections to allow for important relative displacement effects that cannot be calculated by current state-of-the-art methods. Member design forces are calculated to account for the directional uncertainty of earthquake motions and for the simultaneous occurrence of earthquake forces in two perpendicular horizontal directions. Design requirements and forces for foundations are intended to minimize damage, since damage to foundations would not be readily detectable.

The design displacement control criteria provided in ATC requirements for minimum bearing support lengths at the expansion ends of all girders are as follows:

Seismic performance	Minimum support length N	
Category A and B	$N = 8 + 0.02L + 0.08H$ (in.)	Eq. (5-1)
	or	
	$N = 203 + 1.67L + 6.66H$ (mm)	Eq. (5-2)
Category C and D	$N = 12 + 0.03L + 0.12H$ (in.)	Eq. (5-3)
	or	
	$N + 305 + 2.5L + 10H$ (mm)	Eq. (5-4)

N = minimum support length (in. or mm) measured normal to the face of an abutment or pier

L = length, ft or m, of the bridge deck from the bearing to the adjacent expansion joint, or to the end of the bridge deck. For hinges within a span, L is the sum of L_1 and L_2 , the distances to either side of the hinge. For single span bridges, L is the length of the bridge deck. These lengths are shown in Fig. 5.5.3.2.

For abutments

H = average height, ft or m, of columns supporting the bridge deck to the next expansion joint

H = 0 for single-span bridges

For columns and/or piers

H = column or pier height, ft, for Eq. (5-1) and (5-3) or m, for Eq. (5-2) and (5-4)

For hinges within a span

H = average height of the adjacent two columns or piers, ft, for Eq. (5-1) and (5-3) or m, for Eq. (5-2) and (5-4)

5.5.3.3 AASHTO specifications—The 1983 AASHTO *Standard Specifications for Highway Bridges* requires that “in regions where earthquakes may be anticipated, structures shall be designed to resist earthquake motion by considering the relationship of the site to active faults; the seismic response of the soils at the site; and the dynamic response

characteristics of the total structure.” Restraining features (hinge ties, shear blocks, etc.) should be provided to limit the displacement of the superstructure. These restraints should be designed to resist a force equal to 25 percent of the contributing dead load less the column shears due to the earthquake loading. Where an earthquake that could cause major damage to construction has a high probability of occurrence, lateral reinforcement shall be designed and detailed to provide adequate strength and ductility to resist expected seismic movements.

5.5.4 Earth pressures—Structural elements which retain fills should be proportioned to withstand the earth pressures, as determined by recognized soil mechanics methods, whether such pressures result from static loadings or dynamic effects, including those from seismic loadings. Under certain soil conditions, dynamic effects should be considered for loads during construction such as those resulting from compaction procedures and heavy construction equipment.

When vehicular traffic can come within a horizontal distance from the back of a structure or wall equal to one-half its height, the earth pressure should be increased by a live load surcharge of not less than 2 ft (0.6 m) of earth.

Where an adequately designed reinforced concrete approach slab supported at one end by the abutment is provided, no live load surcharge need be considered on the back of the abutment.

5.5.4.1 Active earth pressure—The active earth pressure used for the design of structures should be not less than an equivalent fluid pressure of 30 lb/ft³ (4.7 kN/m³). Values used in the United States for common well-drained backfill materials generally range from 35 to 40 pcf (5.5 to 6.3 kN/m³).

5.5.4.2 At rest earth pressure—Structures restrained against movement or deflection under the action of earth pressures should be designed to resist higher pressures than given previously for active earth pressures. At rest pressures in granular materials may be estimated to be

$$P_o = \gamma h / (1 + \sin \phi)$$

where

- γ = unit weight of soil
- h = depth of soil
- ϕ = angle of internal friction

5.5.4.3 Passive earth pressure—Passive earth pressures should generally not be considered for the reduction of effects of other design loads.

Expansion due to temperature rise of structures that do not contain deck expansion joints may be sufficient to develop passive earth pressures on the end walls. End walls of such structures should be designed to resist the passive earth pressures of the backfill material.

5.5.4.4 Drag force—Friction piles driven through fills, or other materials that settle during the life of the structure, should be designed to resist a drag force caused by negative friction unless the force is positively eliminated by isolating the piles from the settling soils. In lieu of a more accurate analysis, the drag force may be considered equal to the weight of unconsolidated earth enclosed by the pile group.

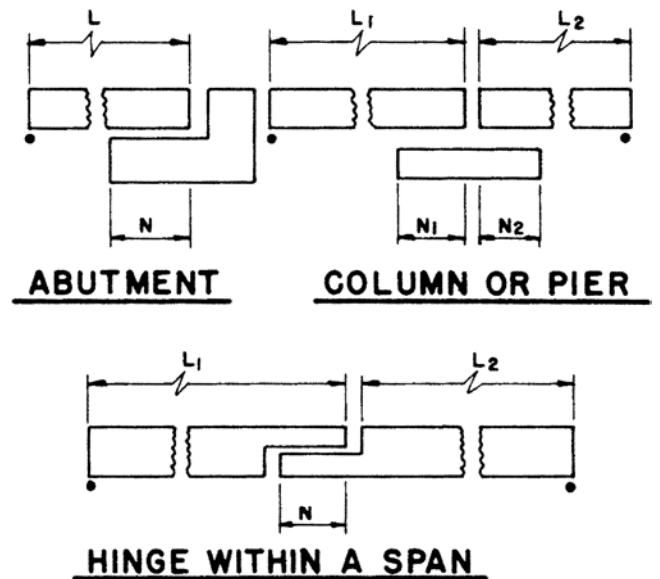

•EXPANSION JOINT OR END OF BRIDGE DECK

Fig. 5.5.3.2—Dimensions for minimum support length requirements.⁵⁻¹⁰

5.5.5 Buoyancy—Buoyancy should be considered, as it affects the design of the substructure, including piling, and of the superstructure. The adverse effects of buoyancy should be assumed to exist, unless water pressure can be positively excluded from beneath the foundation units.

5.5.6 Stream flow pressure—Stream flow pressure should be calculated by the formula

$$SF = KV^2 (0.515 KV^2)$$

where

- SF = stream flow pressure in psf (kPa)
- V = velocity of water in ft/sec (m/s)
- K = constant, being 1.4 for square pier ends, 0.5 for angled ends where the interior angle is 30 deg or less, and 2/3 for circular pier ends

5.5.7 Ice loads—Piers and other portions of structures which are subject to the weight of ice, ice pressures, or the force of floating ice should be proportioned accordingly. The designer should consult [References 5-12](#) and [5-13](#) for guidance in design of structures subject to ice loading.

5.5.7.1 Ice buildup on structures—Cables, hangers, guys, and their supporting members should be designed to withstand the weight of an ice coating having a thickness dependent upon the severity of the climate. This coating should not be less than 0.5 in. (13 mm) nor greater than 1.5 in. (40 mm), which might occur in northern Texas, eastern Oklahoma, Kansas, Illinois, Indiana, Iowa and states north of Pennsylvania. Wind pressures should be assumed to act on these increased surface areas.

Ice buildup on decks, beams, and truss members may be considered to be offset by an accompanying decrease in live loads and need not be included, except under special conditions.

Table 5.5.7.2—Indentation coefficient

Aspect ratio b/h	C_a
0.5	1.8
1.0	1.3
1.5	1.1
2.0	1.0
3.0	0.9
4.0 or greater	0.8

5.5.7.2 Dynamic ice pressures—Horizontal ice forces resulting from the pressure of moving ice should be calculated by the formula

$$F = 144 C_a C_i \sigma h b$$

where

- F = horizontal ice force on pier, lb (kN)
- C_a = indentation coefficient, see Table 5.5.7.2
- C_i = coefficient for pier inclination from vertical $\cos(3\alpha)$
- α = angle of pier inclination from vertical, deg
- σ = effective ice strength as specified in the following, psi (kPa)
- h = thickness of ice in contact with pier, ft (m)
- b = width or diameter of pier at level of ice action, ft (m)

Effective ice strength is normally taken in the range of 60 to 200 psi (400 to 1500 kPa) on the assumption that the ice crushes on contact with the pier. The values used should be based on an evaluation of the probable conditions of the ice at time of movement, on previous local experience, and on an assessment of an existing structure performance. The following guide to values of effective ice strength appropriate to various situations may be used:

1) $\sigma = 60$ psi (400 kPa) where breakup occurs at melting temperatures and where the structure of the ice has substantially disintegrated and the ice flows as small “cakes.”

2) $\sigma = 100$ psi (700 kPa) where breakup occurs at melting temperatures, but the ice is internally sound and moves in large pieces.

3) $\sigma = 150$ psi (1100 kPa) where at breakup there is an initial movement of the ice sheet as whole or where large sheets of sound ice may strike the piers.

4) $\sigma = 200$ psi (1500 kPa) where breakup of major ice movement may occur with ice temperature significantly below the melting point.

Due consideration should be given to the probability of extreme rather than average ice conditions at the site in question.

Piers should be placed with their longitudinal axis parallel to the principal direction of ice action. The horizontal ice force F calculated by the formula should be taken to act along the direction of the longitudinal axis with a transverse force not less than 15 percent of the horizontal force, acting simultaneously.

Where the longitudinal axis of the pier cannot be placed parallel to the principal direction of ice action, or where the direction of ice action may shift, the total force on the pier should be calculated by the formula, taking the width of the structure to be that normal to the longitudinal axis of the pier.

The resulting force, taking into account its assumed direction of action, should then be resolved into vector components parallel to and transverse to the longitudinal axis of the pier. In such conditions the transverse force should not be less than 20 percent of the total force.

In the case of slender and flexible piers, consideration should be given to the oscillatory ice forces associated with dynamic ice action and to the possibility of high momentary forces, structural resonance, and fatigue.

5.5.7.3 Static ice pressure—Ice pressure on piers frozen into ice sheets on large bodies of water should receive special consideration where there is reason to believe that the ice sheets are subject to significant thermal movements relative to the piers.

Design loads to pier sides and ends due to ice pressures from static ice sheets should not be less than 10,000 lb/linear ft (146 kN/m). This ice pressure should be assumed continuous or discontinuous on either side of pier as required to produce maximum stresses, but need not be applied simultaneously with loads to pier noses from floating ice.

5.5.8 Debris loads—Loads from impact of floating debris against piers or the superstructure should be considered in the design. Debris buildup against piers can also significantly increase streamflow forces. These loads should be established on the basis of local knowledge of the character of the stream. Debris loads should be included as environmental loads for combination with other loads.⁵⁻¹²

5.5.9 Wave action—Loads against piers and superstructure induced by wave action may be significant in exposed lake or sea coast locations. [Reference 5-14](#) should be consulted for determination of wave heights and forces on structures.

5.5.10 Ship impact—The possibility of ship impact should be considered in the design of bridges crossing navigable waters.⁵⁻¹⁵ If the risk of impact warrants protective measures, then piers should be protected from impact or designed to resist the maximum likely impact.

Factors to be considered in assessing the risk of impact and the maximum likely impact include:

- Vessel types and traffic volumes
- Bridge clearance, horizontal and vertical
- Navigational aids, including radar reflectors
- Interactions between vessels, current, and wind
- Protective devices include:
 - Dolphins and fenders
 - Protective embankments

Signal lights may be provided on the bridge to stop motor vehicle traffic in the event of a collision endangering the span.

5.6—Pedestrian bridge live loads

5.6.1 Deck live load—Pedestrian bridges should be designed for a live load of 100 lb/ft² (5.0 kN/m²) of walkway area between curbs or rails. This uniform load may be applied continuously or discontinuously over both length and width of structure to produce the maximum stresses in the members under consideration. For unusually wide and long bridges, special load reduction may be used.

The maximum live load deflection of the span should preferably not exceed one-thousandth of the span length. Structures

of the suspension type and especially the “ribbon” bridge-type⁵⁻¹⁶ should have a natural frequency that is higher than that of the pedestrian traffic, to avoid any possible effect of resonance. A natural frequency of vibration, in hz, greater than

$$f = \sqrt{600/l} \quad (\sqrt{183/l})$$

where l is the span length, ft (m), is desirable.⁵⁻¹⁷

5.6.2 Railing live load—The minimum design loading for pedestrian railing should be transverse and vertical uniform loads of 50 lb/linear ft (0.75 kN/m), acting simultaneously on each longitudinal member. Rail members located more than 5 ft (1.5 m) above the walkway are excluded from these requirements.

Posts should be designed for the transverse load acting at the center of gravity of the upper rail, or for high rails, at 5 ft (1.5 m) minimum above the walkway.

5.6.3 Provision for overload—Pedestrian bridges wide enough for vehicles should be designed for an infrequent load equal to the heaviest vehicle or equipment that is likely to be moved over the bridge, but not less than two 4000-lb (17.8-kN) axles spaced at 12 ft (3.6 m). The overload assumed should be listed on the plans.

5.7—Highway bridge live loads

5.7.1 Standard vehicular live loads—Design vehicular live loads should be developed from the vehicles actually in use or normally allowed on the highways, taking into consideration the possibilities of future higher legal loads and permissible occasional overloads.

In the United States, the standard design vehicular live load, together with the associated impact, centrifugal, and braking forces, curb, and railing loads, special alternate live load, and provision for overload, are contained in the “Standard Specifications for Highway Bridges” published by the American Association of State Highway and Transportation Officials.

The province of Ontario, based on a study of the actual and legally permitted loadings on the highways, has developed a vehicular configuration considerably more severe than the AASHTO standard. The Ontario standard vehicular loads, with associated curb and railing loads, centrifugal and braking forces, dynamic effects, and performance factors, are contained in the Ontario *Highway Bridge Design Code*.⁵⁻¹ Background information on the development of the Ontario standard loading can be found in References 5-18 and 5-19.

The loads specified in AASHTO and the Ontario code are applicable for the design of ordinary highway bridges with span lengths up to 400 ft (120 m).

5.7.2 Special truck loads

5.7.2.1 Logging trucks—The logging industry, particularly in the western United States, makes use of specially constructed roads for trucking equipment weighing considerably greater than allowed on the state highway systems. Bridges for logging roads should be designed for the trucking equipment and actual loads expected.

5.7.2.2 Military loads—For design of bridges for military loads or review of existing bridges for passage of mili-

tary loads, information should be obtained from the appropriate military manual.⁵⁻²⁰

5.7.2.3 Overload provisions—Provision should be made in the design for infrequent heavy vehicle loads. If the nominal design live load for which the structure is designed is less than the standard H20 loading, the design vehicle increased by 100 percent should be applied in any single lane without concurrent loading of any other lanes. The overload should apply to all parts of the structure affected except deck slabs.

Structures on major arterial streets or highways should be designed for specific overload of “permit” vehicles operating either without restrictions as to location, speed, and concurrent traffic or under police supervision. A typical vehicle for which unrestricted permits are issued is illustrated in Fig. 5.7.2.3. Combination of overload vehicle loads with other loads is discussed in Section 5.12.

5.7.3 Application of vehicular live loading

5.7.3.1 Design traffic lanes—For the purpose of design, the bridge roadway is divided into longitudinal design traffic lanes of equal width. The width of each lane depends upon the total width of roadway between curbs, and should be determined in accordance with the provisions of the relevant design specifications.

5.7.3.2 Traffic lane units—The standard vehicular live loading, whether truck loading or lane loading, occupies a width of 10 ft (3 m). In computing stresses, each lane loading or individual truck should be considered as a unit. Fractional load lane widths should not be used.

5.7.3.3 Positioning of live loads—The numbers and position of the vehicular loadings should be such as to produce the maximum effect on the member. Specific rules concerning the application of live loading, particularly with regard to continuous spans, are given in relevant design specifications.

5.7.4 Reduction in load intensity—Where maximum stresses are produced in any member by loading several traffic lanes simultaneously, the following percentages of the live loads should be used in view of the improbability of coincident maximum loading:

	<u>Percent</u>
First and second lanes	100
Third lane	70
Fourth lane, and subsequent lanes	40

The reduction in intensity of loads on transverse members such as floor beams should be determined, as in the case of main trusses or girders, using the number of traffic lanes across the width of roadway which are loaded to produce maximum stresses in the floor beams.

5.7.5 Distribution of loads to beams—Refer to Chapter 10.

5.7.6 Fatigue—In the design of concrete highway bridges, fatigue should be considered in design of reinforcing steel and prestressing steel in cracked sections. Steel requirements in deck slabs may be governed by fatigue. The extreme wheel or axle load will be the governing load for slab design. The number of load repetitions can be estimated from the estimated average annual daily truck traffic for the bridge. If the main longitudinal steel is to be investigated for fatigue,

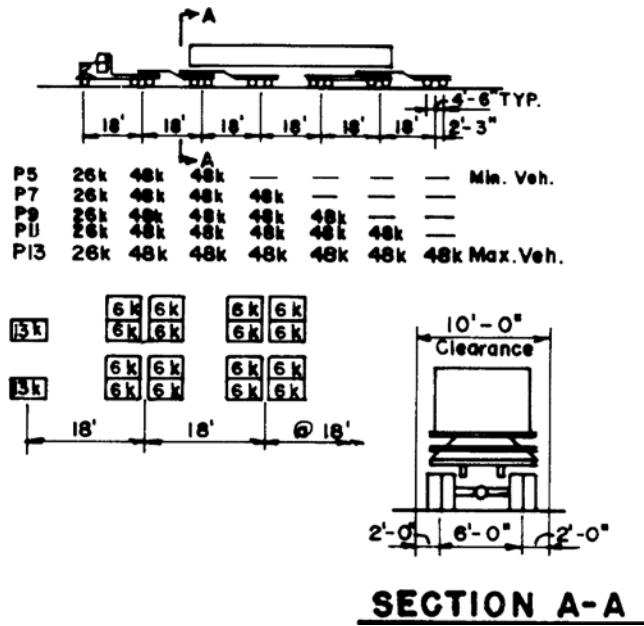

Fig. 5.7.2.3—Permit design live loads.

then it may be appropriate to consider an equivalent design vehicle for fatigue, as set forth in the next paragraph.⁵⁻²

The expected distribution of truck traffic should be represented by a fatigue design truck that is the same as the HS20-44 truck, except that its gross weight W should be selected, so that the number of cycles to failure for the fatigue design truck is the same as the total number of cycles to failure for the different trucks in the distribution. If specific information is available on the expected distribution of truck traffic, W_f should be determined from

$$W_f = \sqrt[3]{\sum_i a_i w_i^3} \quad \sum_i a_i = 1$$

in which a_i = the fraction of trucks with a weight W_i . If specific information is not available on the expected distribution of truck traffic, W_i should be equal to 50 kips (220 kN). If specific information is available on truck traffic volume, each lane of bridges on two-lane highways should be designed for the total truck traffic volume in both directions and each lane of bridges on highways of more than two lanes should be designed for the truck traffic volume in one direction. If specific information on the truck traffic volume is not available, each lane of bridges on major rural highways should be designed for an annual average daily truck traffic, AADTT, of not less than 400 times the total number of lanes, and each lane of bridges on major urban highways should be designed for an AADTT of not less than 600 times the total number of lanes. As used previously, AADTT excludes panel, pickup, and two-axle/four-wheel trucks, but includes buses.

5.8—Railroad bridge live loads

5.8.1 Design live loads—Design railway loads have been developed from engines and gross car loads which have been used. Cooper E80 loading is recommended for each track of main line structures. This train loading, together with the

associated impact, centrifugal, lateral, and longitudinal forces, is fully detailed in Chapter 8 of the *Manual of the American Railway Engineering Association*.

5.8.2 Provisions for overload—Allowance should be made for occasional overloads on the structure. The anticipated overload, including impact, when substituted for the design live load and impact, should not result in stresses that exceed the allowable stresses by more than 50 percent.

Where provisions are made for overloads to cross the structure at reduced speeds, the impact load for speeds less than 40 mph (60 kph) may be reduced in a straight line variation from full impact at 40 mph (60 kph) to 0.2 of the full effect at 10 mph (15 kph).

5.9—Rail transit bridge live loads

A comprehensive report on rail transit bridge live loads has been issued by ACI Committee 358. Loadings are classified according to heavy rail transit (similar to railway loadings and light rail transit. Loadings are specific to each project, depending upon the equipment chosen.

5.10—Airport runway bridge loads

5.10.1 Landing gear loads—Design landing gear loads for runway and taxiway bridges vary according to the type of service anticipated for the airport. Because of the increased use of larger, heavier aircraft for all types of service, structures should be designed for the heaviest aircraft probable at the airport. Table 5.10 lists the landing gear loads and dimensions of several airplanes presently in use throughout the world. A more complete list of aircraft dimensions and weights is provided in the Federal Aviation Agency's Advisory Circular, *Aircraft Data*.⁵⁻²¹ Definitive data for dimensions and weights of aircraft are available from manufacturers in standardized publications entitled *Airplane Characteristic, Airport Planning*. Fig. 5.10 shows general landing gear patterns for a variety of current commercial aircraft. Wheel spacing and spacing of axles in tandem groups is given in Table 5.10. For definite dimensions, see manufacturer's data on specific aircraft. Continental and intercontinental class airports should be designed to accommodate aircraft similar in size and weight to the Boeing 747.

5.10.2 Impact—Live loads produced by aircraft landing gear should be increased by the following percentages to account for vibration and impact effects on portions of the structure listed in Group A following.

Parking aprons and low-speed taxiways	30 percent
High-speed taxiways and runways	40 percent
Touch-down areas of runways	100 percent

The tire contact areas may be increased accordingly. Impact need not be considered for portions of the structure listed in Group B. Impact for structures covered with fill varies proportionally from the percentages shown for no fill to 0 percent for 10 ft (3 m) of fill.

Group A:

1) Superstructure, columns, and pedestals which support the superstructure with rigid, fixed, or expansion bearings, or which are rigidly attached to the superstructure, and legs or rigid frames

Table 5.10—Aircraft loads and wheel spacings

Aircraft model/series	Main landing gear				Each gear		(7) Maximum gross weight, lb
	(1)	(2)	(3)	(4)	(5)	(6)	
	Type of gear	y, dual spacing, in.	x, tandem spacing, in.	Contact area per tire, in. ²	Maximum gear load, lb	Number of wheels	
A300 B, B2	Dual-tandem	35	55	207	138,800	4	304,000
A300 B, B4	Dual-tandem	36.2	55	197	151,900	4	333,000
B52	Dual-dual	37	99	295	231,000	4	462,000
B707-320 B, C	Dual-tandem	34.6	56	218	152,000	4	320,000
B720	Dual-tandem	32	49	188	109,950	4	230,000
B727-100	Dual	34	—	233	73,500	2	154,700
B727-100C	Dual	34	—	233	76,900	2	161,900
B727-200	Dual	34	—	233	79,900	2	168,200
B727-Adv. 200	Dual	34	—	295	86,800 to 96,800	2	183,000 to 204,000
B737-100	Dual	30.5	—	160	51,000	2	107,000
B737-200	Dual	30.5	—	160	54,000	2	113,700
B737-Adv. 200	Dual	30.5	—	160	59,000	2	124,000
B737-300	Dual	30.5	—	160	62,000	2	130,500
B747	Dual-tandem*	44	58	204	166,500	4	778,000
B747 SP	Dual-tandem*	43.25	54	196	147,400	4	653,000
B757-200 Basic	Dual-tandem	34	45	159	102,900	4	221,000
B757-200 Option 1	Dual-tandem	34	45	159	105,600	4	231,000
B757-200 Option 2	Dual-tandem	34	45	159	108,900	4	241,000
B767 (1)	Dual-tandem	45	56	178	132,000	4	282,000
B767 (2)	Dual-tandem	45	56	210	142,600	4	302,000
BAC 1-11	Dual	20.38	—	145	50,800	2	107,000
C5A	Twin-triangular†	(4 groups)	—	230	165,000	6	763,000
C130	Single-tandem	—	60	356	71,300	2	150,000
C131	Dual	21.7	—	130	28,700	2	60,500
C133B	Dual-tandem	30	75.6	341	142,400	4	300,000
C135	Dual-tandem	36	60	230	132,000	4	278,000
C141	Dual-tandem	32.7	50.4	203	151,000	4	318,000
Concorde	Dual-tandem	26.4	66	250	184,300	4	388,000
DC3	Single	—	—	266	11,970	1	25,200
DC7C	Dual	30	—	272	67,900	2	143,000
DC8-10,20	Dual-tandem	30	55	224	130,900	4	275,600
DC8-30,40,50	Dual-tandem	30	55	213	149,700	4	315,300
DC8-55,61	Dual-tandem	30	55	209	155,800	4	328,000
DC8-62	Dual-tandem	32	55	220	167,700	4	353,000
DC8-63	Dual-tandem	32	55	220	170,100	4	358,000
DC9-10	Dual	24	—	161	43,080	2	90,700
DC9-20	Dual	24	—	161	47,500	2	100,000
DC9-30	Dual	24	—	161	51,300	2	108,000
DC9-40	Dual	24	—	161	54,150	2	114,000
DC9-50	Dual	24	—	161	57,480	2	121,000
DC9-80-81	Dual	28.12	—	195	67,500	2	141,000
DC9-80-82	Dual	28.12	—	195	71,500	2	150,500
DC9-80-83	Dual	28.12	—	195	75,000	2	161,000
DC10-10	Dual-tandem	54	64	254	189,300	4	413,000
DC10-20,30 main gear	Dual-tandem	32	55	254	211,300	4	510,000
DC10-20,30 center gear only	Dual	38	—	276	87,500	2	510,000
KC135A	Dual-tandem	36	60	250	145,000	4	312,000
L500	Dual-tandem	53	72	240	200,000	4	421,000
L1011	Dual-tandem	52	70	278	195,000	4	410,000

*B747 main undercarriage has four groups of four wheels each.

†C5A main undercarriage has four groups of six wheels each, wheel coordinates for each gear are:

Wheel	$\frac{x}{\text{in.}}$	$\frac{y}{\text{in.}}$
1	0.00	0.00
2	0.00	-36.40
3	0.00	111.20
4	0.00	147.60
5	64.00	32.47
6	64.00	78.72

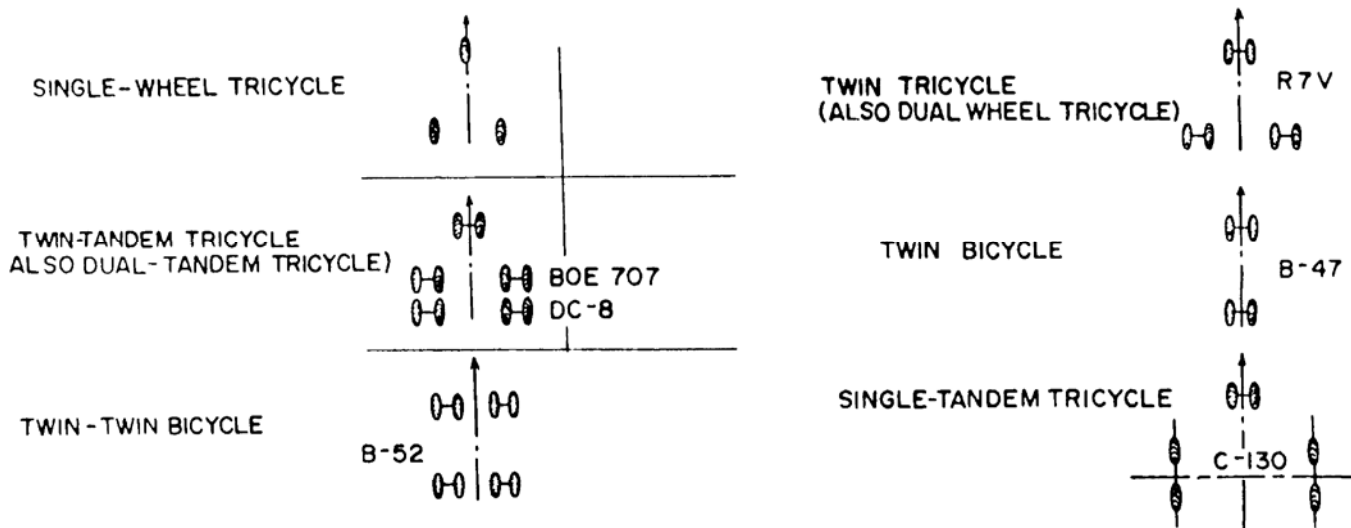

Fig. 5.10—Aircraft landing gear arrangements (terms “twin” and “dual” are used interchangeably).

2) The portion above the ground line of piles which are rigidly connected to the superstructure as in rigid frame structures

Group B:

1) Abutments, retaining walls, piers, pile caps, and piling which are not rigidly connected to the superstructure

2) Buried foundation units, footings, and supporting soil, and structures with 3 ft (1 m) or more of earth cover

5.10.3 Application of wheel loads

5.10.3.1 Slabs—Design wheel loads for slabs are equal to the tire pressures uniformly distributed over the tire contact area for each tire of the design aircraft. The width of transverse slab resisting the load effects of an individual (or dual) tire should not be assumed greater than the slab span, the spacing of tandem axles, or 7 ft (2.1 m), whichever is less.

The width of longitudinal slab resisting the load effects of an individual tire should not be assumed greater than the slab span, the tire spacing, or 7 ft (2.1 m), whichever is less. The resisting width for dual, dual-tandem or dual-dual tandem landing gear may be twice the transverse spacing of the tires in one gear, but should not exceed the slab span or the spacing of landing gear units.

5.10.3.2 Beams and girders—Due to the proximity of wheels, the total load of a landing gear unit may be assumed as a single rolling load when considering the effect on longitudinal or transverse beams and girders. The width of this single rolling load may be assumed equal to the distance out to out of tandem tires. Distribution of this load to longitudinal or transverse beams and girders may be based on the slab acting as a simply supported span between beams or girders or the distribution factors for highway bridge loads may be used.

When designing for dual-dual tandem landing gear such as used on the Boeing 747, all girders, if monolithic with slab between outside landing gear units, may be considered equally effective in resisting the total aircraft load.

The load distribution procedures listed previously are satisfactory for preliminary analysis or for the design of

minor structures. It is, however, recommended that the design of major taxiway and runway structures be based on the theoretical elastic analysis of load distribution or model tests of the proposed structures.

5.10.4 Braking forces—Substructure units and the connections between superstructure and substructure units should be designed to resist a longitudinal braking force equal to the following percentage of gross load of one aircraft, without impact, unless more exact braking information is available for the design aircraft. The designer should check the manufacturer's data for specific aircraft.

Parking aprons and low-speed taxiway	30 percent
High-speed taxiways and runways	80 percent

5.10.5 Provisions for crash landing loads—Structures located on portions of the runway where crash landings may be anticipated should be designed for the failure load of the landing gear.⁵⁻²¹ The Federal Aviation Agency requires that landing gears have a reserve strength capable of withstanding the impact of the aircraft dropping at a rate of 12 ft/sec (3.6 m/sec).

5.11—Pipeline and conveyor bridge loads

5.11.1 Fluid loads—Pipeline bridges should be designed to carry the heaviest fluid anticipated in the pipeline. Where a concrete pipe (or channel) acts as a structural member of the bridge, or is not specifically isolated from becoming stressed longitudinally by the live load deflection of the structure, stresses should be checked and reinforcement or prestressing added as necessary.

If pipeline bends occur on a structure, the load from the thrust blocks should be distributed to the substructure units, taking into account the stiffness of the units and the rigidity of the connection between the load and the units.

5.11.2 Solid loads—Structural members of ore bridges and other structures designed to carry solid or semifluid loads should be proportioned for a continuous or discontinuous loading, whichever produces the higher stresses. Forces

imposed by starting and stopping the conveyor should be considered acting with the live load.

5.11.3 Equipment loads—The effect of maintenance equipment on pipeline and ore bridges should be included with or in lieu of the live loads.

Catwalks should be designed for a live load of not less than 60 psf (3kN/m²) and the load should be either continuous or discontinuous over the walkway, whichever produces the higher stresses.

5.12—Load combinations

The loading groups listed in [Table 5.12a](#) and [Table 5.12b](#) represent the basic combinations of loads and forces to which a concrete bridge may be subjected. Each part of a bridge, and the foundation on which it rests, should be proportioned to resist the group loads applicable for the type of structure and the particular site. If, in the engineer's judgment, predictability of load conditions or materials of construction are different than anticipated by the specifications, these should be accounted for by appropriate changes in the allowable stresses, or load factors.

Service load design should be based on the percentage of basic allowable stress indicated, except no increase in allowable stresses should be permitted for members or connections carrying wind loads only. When designing rigid frame bridges, the condition that the lateral earth pressure could be less than predicted should be investigated using a load factor of 0.5 in loading group I. For this condition the percentage of allowable stress may be taken at 125 percent.

Variable loads, such as live, buoyancy, and wind, should be reduced or eliminated from the group whenever such reduction or elimination will result in a more critical loading for the member under consideration. When loading conditions under consideration produce stresses of opposite sign to the dead load stresses, or when the stability of the structure may be impaired with reduced dead load, the calculated dead load may be reduced as much as 25 percent.

Table 5.12a and Table 5.12b

Load factors

Notes

1. Permanent loads are loads which will be present on the structure due to the nature of the design and construction. Time-varying loads such as creep, shrinkage, and forces induced due to differential support displacements are assumed to be taken at a value appropriate to the time under consideration (i.e., adjusted for relaxation).

2. Where it produces a more critical condition, the lower value of earth pressure should be used. Factors for strength design methods are intended to account for future changes in the character of the backfill material.

3. Creep, shrinkage, and differential support displacements are time-varying restraint forces which should be adjusted for relaxation. They should be calculated using stiffness properties that take cracking into account. The double value factors for ultimate load represent the uncertainties in the calculated values. The factor value creating the most critical condition should be used.

4. Buoyancy and streamflow should be based on the water level appropriate to the other conditions being considered as acting simultaneously.

5. Nosing and lurching are for railroad bridges only.

6. Construction load is considered as part of a separate group (Group IV). If assumptions of construction loads are made in the design, they should be noted on the plans. If the contractor is required to provide stress analysis calculations to prove the suitability of the construction method and equipment, these requirements should be spelled out in detail in the plans.

7. In general only one environmental load is to be applied at a time except that wind on live load is considered in association with a reduced wind on the structure and ice may be considered to act concurrently with high water if appropriate to the site.

8. Wind for Group IV combination is assumed to act on any equipment left on the structure for extended periods.

9. These factors assume that the earthquake forces used are those associated with an event having a 90 percent probability of not being exceeded within 50 years.

Equations to be satisfied in design

Service load method

$$\sum_{i=1}^n \alpha_i f_i \leq \beta f_a$$

where

n = number of individual loads in the load combination considered

α_i = load factor for i th loading from [Table 5.12a](#)

f_i = stress produced by i th loading

β = percent basic allowable stress from [Table 5.12a](#)

f_a = basic allowable stress from [Chapter 8](#)

Strength method

$$\sum_{i=1}^n \alpha_i P_i \leq \phi R_n$$

where

n = number of individual loads in the load combination considered

α_i = load factor for the i th loading from [Table 5.12](#)

P_i = moment, shear, or axial load from the i th loading

ϕ = capacity-reduction factor from [Section 7.2](#) or [Section 9.2.1](#)

R_n = characteristic strength (moment, shear, axial load)

RECOMMENDED REFERENCES

The documents of the various standards-producing organizations referred to in this report are listed here with their serial designation, including year of adoption or revision. The documents listed were the latest effort at the time this report was written. Since some of these documents are revised frequently, generally in minor detail only, the user of this report should check directly with the sponsoring group if it is desired to refer to the latest revision.

Table 5.12a—Load factors

Design method			Service load			
Load group, percent basic stress			I 100 perm. + trans.	II 125 perm. + env.	III 140 + env.	IV 133 const.
Load cases	Notes					
<u>Permanent loads</u>						
Structural DL	D	1	1.0	1.0	1.0	1.0
Superimposed DL	D		1.0	1.0	1.0	1.0
Earth pressure	E	2	1.0/0.5	1.0/0.5	1.0/0.5	1.0/0.5
Creep	S	3	1.0	1.0	1.0	1.0
Shrinkage	S	3	1.0	1.0	1.0	1.0
Displ. of supts.	DS	3	1.0	1.0	1.0	1.0
Buoyancy	B	4	1.0	1.0	1.0	1.0
<u>Transient loads</u>						
Live load	L		1.0		1.0	
Impact	I		1.0		1.0	
Longit. force	LF		1.0		1.0	
Centrif. force	CF		1.0		1.0	
Nosing	N	5	1.0		1.0	
Construction	C	6				1.0
<u>Environmental loads</u>						
Wind	W	8		1.0	0.3	0.5
Wing on LL	WL				1.0	
Temperature	T			1.0	1.0	
Earthquake	EQ	9		0.5		
High water	SF			1.0	1.0	
Ice	B			1.0		

Table 5.12b—Load factors

Design method			Ultimate strength			
Load group			I	II	III	IV
Load cases	Notes					
<u>Permanent loads</u>						
Structural DL	D	1	1.3	1.3	1.3	1.3
Superimposed DL	D		1.3	1.3	1.3	1.3
Earth pressure	E	2	1.3/0.35	1.3/0.35	1.3/0.35	1.3/0
Creep	S	3	1.3/0.7	1.3/0.7	1.3/0.7	1.3/0
Shrinkage	S	3	1.3/0.7	1.3/0.7	1.3/0.7	1.3/0
Displ. of supt.	DS	3	1.3/0.7	1.3/0.7	1.3/0.7	1.3/0
Buoyancy	B	4	1.0	1.0	1.0	1.0
<u>Transient loads</u>						
Live load	L		2.2			
Impact	I		2.2			
Longit. force	LF		2.2			
Centrif. force	CF		2.2			
Nosing	N	5	2.2			
Construction	C	6				1.7
<u>Environmental loads</u>						
Wind	W	8		1.3	0.4	0.7
Wing on LL	WL				1.3	
Temperature	T			1.3	1.3	
Earthquake	EQ	9		1.0		
High Water	SF			1.3	1.3	
Ice	B			1.3		

Title

A = Axial load deformations and rib shortening
 B = Buoyancy
 C = Construction, handling, and erection loads (add to Group II)
 CF = Centrifugal force
 D = Dead load, including effects of prestressing force, if any
 DR = Derailment force (to be included with "overload" in loading groups)
 DS = Displacement of supports
 E = Earth pressure
 EQ = Earthquake (substitute for W in Group II)

F = Frictional forces
 I = Impact due to live load
 ICE = Ice pressure
 L = Live load
 LF = Longitudinal force from live load
 N = Nosing and lurching forces
 OL = Overload
 S = Shrinkage and other volume changes
 SF = Stream flow pressure
 SN = Snow load (substitute for W in Group II)
 T = Temperature
 W = Wind load
 WL = Wind load on live load

American Association of State Highway and Transportation Officials

- GSDB Guide Specification for Seismic Design of Highway Bridges, 1983
- HB-13 Standard Specifications for Highway Bridges, Thirteenth Edition, 1983
- LTS-1 Standard Specifications for Structural Supports for Highway Signs, Luminaires, and Traffic Signals, 1975.

American Association of Railway Engineers

Manual for Railway Engineering, Chapter 8

American Concrete Institute

- 209R-82 Prediction of Creep, Shrinkage, and Temperature Effects in Concrete Structures
- 358R-80 Report on Concrete Guideways

American National Standards Institute

- 58.1-1982 Building Code Requirements for Minimum Design Loads in Buildings and Other Structures

CITED REFERENCES

- 5-1. Ontario Ministry of Transportation and Communications, "Ontario Highway Bridge Design Code and Commentary," Downsview, Ontario, 1983.
- 5-2. "Recommended Design Loads for Bridges," *Journal of the Structural Division*, ASCE, V. 107, No. St. 7, July 1981, pp. 1161-1213.
- 5-3. Branson, D. E., *Deformation of Concrete Structures*, McGraw-Hill Book Company, New York, 1977.
- 5-4. Comité Euro-International du Béton (CEB), "CEB-FIP Model Code for Concrete Structures," *International System of Unified Standard Codes of Practice for Structures*, V. II, 1978.
- 5-5. Meyers, B. B., and Branson, D. E., "Design Aid for Predicting Creep and Shrinkage Properties of Concrete," *ACI JOURNAL*, *Proceedings*, V. 69, No. 9, Sept. 1972, pp. 551-555.
- 5-6. Bažant, Z. P., and Wittmann, F. H. (Ed.), *Creep and Shrinkage in Concrete Structures*, John Wiley and Sons, Inc., New York, 1982.
- 5-7. Priestley, M. J. N., "Design of Concrete Bridges for Temperature Gradients," *ACI JOURNAL*, *Proceedings* V. 75, No. 5, May 1978, pp. 209-217.
- 5-8. Elbadry, M. M., and Ghali, A., "Nonlinear Temperature Distribution and its Effect on Bridges," *IABSE Proceedings*, Zurich, 1983, pp. 66-83.
- 5-9. Highway Research Board *Report* 10, "Investigation of Wind Forces on Highway Bridges," 1953, National Academy of Sciences, National Research Council, Publication 272.
- 5-10. "Seismic Design Guidelines for Highway Bridges (ATC-6)," Applied Technology Council, Berkeley, California, 1981.
- 5-11. Seismology Committee, Structural Engineers Association of California, "Recommended Lateral Force Requirements," July 1959, revised Dec. 1959.
- 5-12. Bennett, Iven, "Glaze, Its Meteorology and Climatology, Geographical Distribution and Economic Effects," Headquarters Quartermaster Research and Engineering Command, U.S. Army Quartermaster Research and Engineering Center, Natick, Massachusetts, Environmental Protection Research Division, *Technical Report* EP-105, Mar. 1959.
- 5-13. "Ice Loads on Bridge Piers," *Structural Engineering Series*, No. 1, Jan. 1976, prepared by the Hydraulics and Review Branches, Federal Highway Administration, Washington, D.C.
- 5-14. *Shore Protection Manual*, V. I, U.S. Army Coastal Engineering Research Center, Ft. Belvoir, Va., 1973.
- 5-15. "Ship Collision with Bridges and Offshore Structures," *International Association for Bridge and Structural Engineers Reports*, V. 41, Zurich, Sept. 1982.
- 5-16. "Vibration Tests on Bircherweid Foot-Bridge," *International Civil Engineering Monthly*, V. II, No. 4, 1971/1972, pp. 189-192.
- 5-17. Matsumoto, Y., et al., "Dynamic Design of Foot Bridges," *Proceedings*, IABSE, 1978, pp. 17-78.
- 5-18. Csagoly, P., and Dorton, R. A., "Proposed Ontario Bridge Design Load," PR 186, Ministry of Transportation and Communications, Downsview, Ontario, Canada.
- 5-19. Csagoly, P.; Campbell, T.I.; and Agarwal, A.C., "Bridge Vibration Study," RR 181, Ministry of Transportation and Communications, Downsview, Ontario.
- 5-20. "Military Fixed Bridges," TM5-312, Superintendent of Documents, Washington, D.C.
- 5-21. Federal Aviation Agency, "Aircraft Data" AC #150/5325-5, 1975, and "Airplane Airworthiness," *Advisory Circular*.



Myrtle Creek Bridge in California used precast elements

CHAPTER 6-PRELIMINARY DESIGN

6.1-Introduction

The time invested in preparing the preliminary design of a bridge is perhaps the most critical period in the design process. The designers must take time to properly and meticulously consider all factors that influence the project. These factors transcend purely utilitarian and first-cost considerations.

At the preliminary design stage, consideration should be given to implement details that increase durability, reduce maintenance and facilitate inspection. Very often it is very difficult to incorporate these features in the final design if they had not been considered initially. An excellent source of information is the NCHRP Report 349 *Maintenance Considerations in Highway Design*.

In the preliminary design, it is recommended to have an interdisciplinary meeting where the points of view of the structural designer, together with those of soils, construction, maintenance, and inspection engineers, environmentalists, geologists, and other specialists, are considered in an open forum. By so doing, the final structure will be better and problems will be avoided during subsequent stages of design, construction, and particularly the useful life of the structure.

Bridges are important structures in transportation systems, and they should have a long service life. Bridges have an impact on the social life, as well as the economy, of the region and communities which they serve. Frequently, bridges are

very large structures that have a definite impact on the landscape. Bridges have been included in the coat of arms of many cities, recognizing the pride and identification communities have with these man-made structures.

This chapter includes many of the general factors which should be taken into consideration in the preliminary planning and design of bridges, as well as those that are specific for concrete bridges. A discussion of typical structural, esthetic, construction, operation, and maintenance aspects are presented for commonly used types of concrete bridge structures. The list is not intended to be complete. Therefore, suggestions contained herein should be regarded as general guidelines only.

Through preliminary design and approximate dimensional proportioning based on theory, practice, experience, and judgment, suitable geometries and dimensions may be established. This information should be confirmed by preliminary structural design computations. The same procedure should be followed for several types of structures and configurations. Preparation of scaled drawings of profile elevations of trial bridges and their components is a good aid to gain a sense of proportion and initial esthetic value. Preliminary cost estimates should be prepared for several alternatives.

The environmental, economic, and esthetic factors can then be evaluated to establish the basis for recommendations to be submitted to the proper agencies for approval. Upon receiving an approval, with or without further revisions, the

engineer can then perform the final design and produce a complete set of construction contract documents.

Several factors which have a direct bearing on the decision-making process should be reviewed. First, the high cost of construction site labor has forced changes toward industrialized construction methods. Methods and equipment for transporting and erecting concrete elements weighing over 100 tons (90 tonnes) are now available. Second, sociological demands have focused more attention on esthetic and environmental considerations. Consequently, the bridge engineer is faced with the necessity of identifying a growing list of environmental constraints, along with corresponding trade-offs in the design process. Third, technological progress has led to mass production of high-performance precast and prestressed concrete members with compressive strengths of over 10,000 psi (69 MPa). In longer span bridges, it may be economical to reduce superstructure dead loads using lighter weight concretes, higher strengths, and composite sections.

6.2-Factors to be considered

In selecting a type of structure for a particular site, the following factors should be evaluated (not necessarily listed in order of priority):

6.2.1 Loads

6.2.1.1 Permanent loads (time invariant)

- a. Dead loads (superstructure and substructure elements and superimposed loads, including present or future wearing courses and utilities carried by the structure)
- b. Earth pressures, at rest, active or passive (on abutments, piles located on sloping ground, and retaining walls, including hydrostatic forces)

6.2.1.2 Transient loads (time variant)

- a. Vehicular live load and its derivatives (static and dynamic effects, centrifugal and braking forces), and pedestrian loads. Where appropriate, loads imposed by other transportation modes such as rail transit, airplanes at airport bridges, heavy timber, and steel haulers at industrial locations.
- b. Wind loads (on structure and vehicles)
- c. Force effects due to strains induced by ambient temperature variations, temperature gradients, differential creep, shrinkage, relaxation of prestressing steel, and elastic shortening
- d. Secondary prestress effects
- e. Friction restraint in sliding bearings and shear resistance in neoprene pads
- f. Hydrodynamic loads (waves and currents)

6.2.1.3 Exceptional loads

- a. Earthquake, intensity, and duration depending on seismicity of the location. Consideration should be given to the potential for soil liquefaction
- b. Ice pressure and forces associated with floods
- c. Differential foundation settlement
- d. Collision of vehicles on a primary supporting element
- e. Construction loads, including heavy vehicles, lifting cranes, and dynamic effects while lifting segments
- f. Special permit vehicles

6.2.2 Geometry

- a. Number of lanes and width of shoulders and sidewalks to establish the total deck width
- b. Horizontal and vertical clearances, as affected by superelevations, structure depth, support widths, and overhead utilities
- c. Structure type: span length, span-depth ratio, precast or cast-in-place, etc.
- d. Obstruction of sight for traffic under bridge
- e. Detour or maintenance of traffic during construction
- f. Access for major utilities carried by or passing under the structure
- g. Horizontal and vertical curvatures, and skew angle if any
- h. Alignment with approaches
- i. Interference with aircraft corridors
- j. Icing effects where bridge curvature may increase accident potential
- k. Deck drainage
 1. Bridge profile for wind load and hydrodynamic forces
- m. Need for aircraft warning lights on high bridges
- n. Need for navigation lights on bridges over navigable water
- o. Need for fenders and other protection from ships for bridges over navigable water
- p. Need for crash walls for bridges over railroads

6.2.3 Corrosion protection-Corrosion protection is a factor that must be considered in all structures. With the increase in use of deicing salts in the colder climates, corrosion has become a major problem in bridges, particularly in the decks. Particular attention should be given also to corrosion protection in areas exposed to aggressive corrosive conditions such as marine and industrial environments.

During preliminary design this fact should be taken into consideration by providing enhanced drainage of the deck, avoiding areas where debris could accumulate, and directing runoff away from structural members.

The use of increased concrete cover, high-strength concrete, epoxy-coated bars, chemical admixtures in the concrete, and cathodic protection are some of the measures that can add to the resistance of the structure to corrosion.

6.2.4 Esthetic considerations-Due to their importance in the environment, bridges should be designed to blend with and enhance it. One source of information is ACI MP-1. *Esthetics in Concrete Bridge Design*.

Improving the appearance of a bridge can usually be done with a modest increase in cost.

Factors to be considered:

- a. Harmony with adjacent structures and the environmental setting
- b. Use of appropriate shapes and surface treatments befitting the locality or setting.
- c. Climatic factors that may have an impact on certain types of bridges
- d. Design of shapes and details that will assure good appearance after years of service of the structure

6.2.5 Subsurface conditions

- a. Bearing capacity of foundation: spread footings, piles, or caissons

- b. Uniform or differential foundation settlement
- c. Settlement or longitudinal movement of an adjacent embankment that affects the performance of the bridge
- d. Stability of cuts and fills adjacent to the structure
- e. Stability of the geological setting
- f. Corrosive soils
- g. Water table level and anticipated fluctuations

6.2.6 *First cost and ease of maintenance*

- a. Total time of construction
- b. Construction details and constructability: repetitive elements and simplicity of connections
- c. Protection of bearings, concrete, and reinforcing steel against deleterious elements such as salts, acid rain, sulfate exposure, and other chemical agents
- d. Total cost including approach cuts and fills
- e. Possibility of future widening
- f. Adaptability for repairs, replacement of the deck or bearings, or strengthening
- g. Access for inspection
- h. Availability of materials and construction expertise and facilities: local versus imported
- i. History of maintenance of similar existing structures and their performance in severe floods or seismic activity

6.2.7 *Life-cycle cost*-The total cost during the expected life of the structure should be considered using economic models, such as present worth analysis, when there are significant differences in maintenance, operation costs, and schedules for the bridge alternatives considered. Initial costs do not properly reflect true cost differences unless there are no significant cost differences in life-cycle costs after construction. A range of effective interest rates should be used to account for the difficulty in predicting long-term interest rates.

6.2.8 *Safety*

- a. Safety of construction crews and adjacent occupants from utilities, traffic (rail, highway, waterway), and falling debris
 - b. Minimizing traffic hazards in completed structure
 - c. Insuring redundancy of structural components by providing alternative paths in lieu of single load paths to insure against catastrophic failure. This is particularly important in seismic regions. Bridge spans shall be tied together to guarantee overall structural integrity
 - d. Detailing to enhance structural integrity
 - e. Providing proper warning signs, traffic signals, and illumination on and below the bridge
 - f. Selection of structure type such that support elements will not unnecessarily be exposed to collision damage. When exposure to damage is unavoidable, elements should be protected with barriers, earth berms, or by other appropriate means
 - g. Safety barriers to prevent debris or snow from being blown on tracks or roadways
 - h. Chain link fencing to inhibit pedestrians from throwing objects onto traveled way (road or track) below
- 6.2.9 *Waterway crossings-Special requirements***

- a. Bridge length, bridge under clearance and pier spacing to accommodate flood discharge
- b. Backwater effects upstream and on piers: ice jams and debris dams
- c. Scour potential and erosion of the abutments and approach fills
- d. Cofferdams
- e. Pier protection
- f. Navigational requirements and approvals
- g. Maintenance of waterway traffic during construction
- h. Stream flow and ice thrust loads

6.2.10 *Rail and transit bridges-Special requirements*

- a. Extra overhead and horizontal clearances
- b. Unusually heavy loadings such as unit trains, etc.
- c. Operational restrictions and approvals during construction
- d. Maintenance of rail traffic
- e. Deck details and maintenance requirements for ballast or direct fixation in transitways
- f. Provision for future track raising
- g. Provision for protection from exhaust emissions from locomotives to the structure and users in the case of underpasses
- h. Security fencing provisions and barrier walls for confinement purposes in case of derailments
- i. Esthetic effort to coordinate these structures and design them to be compatible with highway and pedestrian bridges and the surroundings

6.2.11 *Prestressed concrete-Special considerations*

- a. Cost of tooling (formwork, etc.)
- b. Length of production run
- c. Plan production versus on-site work
- d. Weights and sizes of elements for transportation and lifting
- e. Transportation and erection equipment limitations and costs
- f. Material versus production cost
- g. Availability of qualified personnel, materials, and facilities
- h. Construction sequencing and stage loading, particularly with regard to post-tensioned girders, precast, and cast-in-place segments

6.2.12 *Environmental exposure*

- a. Chemical agents such as acid rain and salt
- b. Industrial waste
- c. General climatic factors such as relative humidity, snow accumulation, and ice formation
- d. Abrasive erosion on piers

6.3-High priority items

In general, after considering the preceding factors, the following items should be finalized as early as practicable:

6.3.1 *Typical section and alignment: Vertical and horizontal*-To avoid wasteful redesigns during the final stages, it is essential to finalize, at the early design stages, bridge parameters such as roadway alignment, number of lanes, width of shoulders, type of curb and railing, waterway clearances, and the number and size of utilities to be carried across the struc-

ture. It is necessary that these items be shown in the preliminary design drawings, often called TS&L (type, size, and location) drawings, and submitted to all proper agencies for approval at the preliminary design phase.

6.3.2 Span length composition: *Uniform or varying*—For grade separation bridges, the total length is determined by the requirements of the facility passing under the structure. Long spans that provide more than the minimum legal clearances are desirable because of the increased safety, and are generally more pleasant in appearance. In some bridges the location and type of supports are dictated by foundation conditions, required clearances, safety, and esthetics. Long spans with few supports have pleasing appearances and create the least obstruction. However, sometimes they have a higher initial cost than shorter span structures dictated by the minimum requirements.

An analysis of the span composition versus cost is appropriate.

For river and valley crossings, the span lengths may be dictated by any combination of the following items:

- a. Foundation requirements
- b. Geological setting and stability
- c. Height of piers
- d. Esthetics and harmony with the environment
- e. Waterway area and other hydraulic considerations such as scour and high water levels during floods
- f. Navigational requirements, both during construction and service
- g. Type of debris expected during flood stages
- h. Reliability of flood magnitude predictions
- i. Ease of construction
- j. Economy
- k. Vessel collision requirements

The depth, difficulty, and cost of constructing foundations determines span length after other constraints are applied. Least overall first cost often results when substructure and superstructure costs are equal.

6.3.3 Special conditions—Special conditions include special subsurface conditions, existing utilities, or maintenance of traffic which might control the selection of the structure type, size, and location.

6.3.4 Combination with other structures—Combination with other structures such as dams and buildings.

6.3.5 Environmental impact factors—Factors that have a significant environmental impact should be identified and taken care of during the preliminary design stage. Some of the factors to be considered are:

- a. Wetlands
- b. Vegetation
- c. Animal life
- d. Disruption to existing communities (human, flora, fauna)
- e. Integration with the setting
- f. Views

6.4-Structure types

In the following subsections, the general characteristics of the common types of concrete bridge structures are given for

reference in preliminary studies. In [Section 2.5](#) more information is given on this subject. Unless otherwise specifically noted, the span-to-depth ratio and span lengths refer to highway bridges only. Bridges carrying railroads generally have smaller span-to-depth ratios and shorter spans. Whenever traffic beneath the proposed bridge has to be maintained during construction, the use of cast-in-place concrete may require special falsework. Falsework bents adjacent to the traffic should be protected.

In general, continuous structures with as few joints as possible should be selected. Transverse joints should be avoided if at all possible. Joints usually lead to higher initial costs and are the source of problems and higher maintenance costs in bridges. Decreasing the number of joints also helps to provide a smoother ride.

In longer bridges, expansion joints are unavoidable. The spacing of joints depends on climatic conditions, as well as the type of structure. In milder climates, spacing of joints as large as 300 ft (90 m) have been used successfully. Expansion joints should be placed at points of discontinuity, usually on top of bents.

When the main load-carrying elements are cast in place, the deck slab is also cast in place. If the main elements are precast, the deck slab may consist of precast deck planks with a cast-in-place topping. In this case, the planks and topping are generally designed and built for composite action between the precast and cast-in-place portions.

Precast butted boxes, double tees, and decked bulb tees (integral deck) may not need a cast-in-place concrete deck, in particular, when laterally post-tensioned.

6.4.1 Nonprestressed concrete slab bridges

Types	Span ranges	
	Highway	Railroad
Solid slabs	16 to 44 ft	12 to 24 ft
	(5 to 14 m)	(4 to 8 m)
Cored or voided slabs	40 to 65 ft	20 to 40 ft
	(12 to 20 m)	(6 to 12 m)
Waffle soffit slabs	40 to 80 ft	Not used
	(12 to 24 m)	

Depth-to-span ratios

Simple spans	1/15±	1/12±
Continuous spans	1/20 to 1/24	1/16±

Appearance: Neat and simple; desirable for short spans.

Construction: Simplest type for details and formwork.

Construction time: Shortest of any cast-in-place construction.

Maintenance: Very little except at transverse deck joints, when used. Bearings usually require little maintenance.

6.4.2 Nonprestressed concrete girder bridges

6.4.2.1 T-Beam (Fig. 6.4.1c)

	Span ranges	
	Highway	Railroad
	30 to 120 ft (9 to 36.5 m)	20 to 40 ft (6 to 12 m)

Depth-to-span ratios

Simple spans	1/13±	1/8±
Continuous spans	1/15±	1/10±

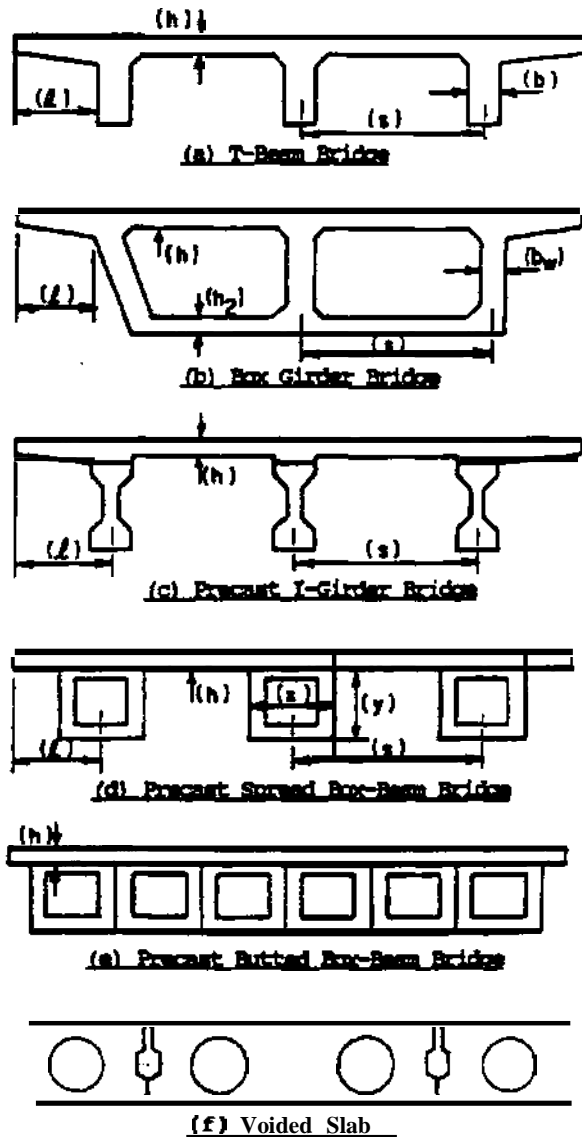

Fig. 6.4. Typical concrete bridge configurations

Appearance: Elevation is neat and simple. Bottom is cluttered. Horizontal widening of stems at piers is detracting. If required, the exterior girder should be designed with the widening on the inside face. Utilities, pipes, and conduits can be concealed between girders.

Construction: Requires a good finish on all surfaces; formwork may be complex.

Construction time: Usually somewhat longer than required for slab bridges due to more complex forming.

Maintenance: Low, except that bearing and transverse deck joint details may require attention. At stream crossings, with inadequate underclearance, floating debris may damage the girder stems.

6.4.2.2 Nonprestressed concrete box girder (Fig. 6.4.1.f)

Span ranges	
Highway	Railroad
80 to 200 ft (24 to 60 m)	50 to 100 ft (15 to 30 m)

Depth-to-span ratios

	Highway	Railroad
Simple	1/14±	1/11±
Continuous	1/18±	1/14±

Appearance: Neat and clean lines from all views; utilities, pipes, and conduits can be concealed between girders or within boxes.

Construction: Rough form finish is satisfactory on inside surfaces but removal of upper slab forming and supports is difficult and the material may be left inside.

Construction time: More than required for slab or T-Beam bridges due to staging of concrete placement.

Maintenance: Low, except that bearing and transverse deck joint details may cause some problems.

6.4.3 Prestressed concrete slab bridges

6.4.3.1 Cast-in-place post-tensioned

Type	Span ranges	
	Highway	Railroad
Solid slabs	Up to 100 ft (30.5 m)	Up to 20 ft (6 m)
Cored or voided slabs	Up to 150 ft (46 m)	Up to 40 ft (12 m)
Partial box voided slabs (slabs which typically are solid over the supports and a certain distance to each side, but voided at the central portion of the span)	Over 150 ft (46 m)	No data available

Depth-to-span ratios

Simple	1/20±	1/16±
Continuous	1/24 to 1/40*	1/18±

Appearance: Neat and simple; desirable for relatively short spans.

Construction: More complex than nonprestressed concrete. Sequence of prestressing and grouting requires supervision by specialists.

Construction time: Usually longer than as nonprestressed concrete slabs, because of draping of conduit, placing of anchors, attaining strength, and tensioning operations.

Maintenance: Very little except at transverse deck joints. Maintenance is required at bearings and post-tensioning embedments

6.4.3.2 Precast pretensioned (Fig. 6.4.1f)

Types	Span ranges	
	Highway	Railroad
Solid slabs	19 to 30 ft (6 to 9 m)	12 to 20 ft (4 to 6 m)
Cored slabs	30 to 80 ft (9 to 24 m)	24 to 40 ft (8 to 12 m)

Depth-to-span ratio

1/25 to 1/33	1/20±
--------------	-------

Appearance: Neat and simple; desirable for low short spans.

Construction: Details and formwork very simple; plant fabrication methods are suitable; field erection may be fast.

* For the larger span-to-depth ratios, a haunched slab is sometimes desirable. Haunches should be designed using the longest possible curves to present the best appearance

No falsework required; units placed by cranes; no prolonged impediment to traffic.

Construction time: Time for erection of precast elements at site is minimal.

Maintenance: Very little except at transverse deck joints, bearings, longitudinal joints, and connections between units.

6.4.4 Prestressed concrete girder bridges

6.4.4.1 *Cast-in-place, post-tensioned (Fig. 6.4.1a and Fig. 6.4.1 b)*

Types	Span ranges	
	Highway	Railroad
Constant-depth beams	40 to 120 ft (12 to 36 m)	Up to 80 ft (24 m)
Constant-depth box beams	80 to 300 ft (25 to 90 m)	Up to 110 ft (30 m)
Haunched beams	up to 200 ft (61 m)	No data available
Haunched box beams	Up to 700 ft (215 m)	No data available
Depth-to-span ratios		
Simple spans	1/22±	1/14±
Continuous spans	1/25 to 1/33	1/16±
Haunched girders	1/33 to 1/50	No data available

Appearance: From below, T-beams appear cluttered while a box girder is neat and clean, making it more attractive; elevation of both types is neat and simple. Bent caps should be hidden between girders. Drop caps should be avoided for best appearance.

Construction time: Somewhat longer than for nonprestressed concrete T-beam or box girder bridges.

Maintenance: Very low except that bearing and transverse deck joint details require attention. Addition of transverse, as well as longitudinal post-tensioning, greatly reduces the number of cracks.

6.4.4.2 *Precast T-Beam, I-girder, and box girder (Fig. 6.4.1.c, d, and e; and Fig. 6.4.4.2)*

	Highway	Railroad
	Span range	
	30 to 160ft (9 to 50 m)	Up to 110ft (33 m)
Depth-to span ratios		
T-beam and I-girder		
Simple spans	1/18±	1/14±
Continuous spans	1/20±	1/16±
Spread box girder		
Simple spans	1/18±	Not used
Continuous spans	1/22±	Not used
Butted box girder		
Simple spans	1/25±	1/16±
Continuous spans	1/28±	1/18±

Precast box beams ordinarily have a width x of 3 to 4 ft (0.9 to 1.2 m), and heights y of 1 ft-9 in. to 4 ft (0.5 to 1.2 m).

Appearance: I-beam is similar to T-beam, except for bulbous bottom of standard prestressed girder sections; spread

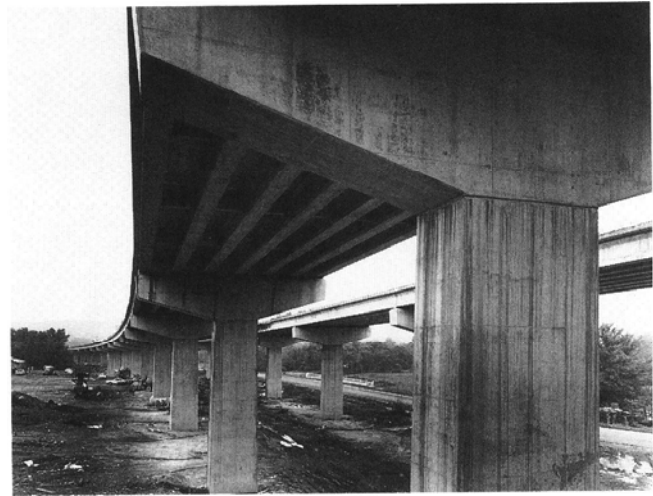

Fig. 6.4.4.2-Precast prestressed I-beam bridge

box beam is similar to T-beam; butted box girder is similar to cast-in-place box girder. Utilities, pipes, and conduits can be concealed between girders.

Exterior girder should be designed with flat exterior faces or with exposed flanges running continuously over bents by widening web into end blocks on the interior face of the exterior girder, in post-tensioned beams.

Construction: Longer span girders are more difficult to handle after fabrication in plant and at job site; standard girders are preferred; special sections are usually more expensive; standard forms are stocked by fabricators; members can be used as simple spans, but preferably girders should be made continuous for live load. Precast girders with the deck slab cast-in-place can also be used. No falsework is required except for long spans with precast segments post-tensioned; if the latter are stage-stressed by a cantilever method, the falsework may not be needed.

Very long T- and I-sections have shown substantial camber and differential camber. Camber of bulb T-beams on curved bridges (each simple span being composed of straight beams) has been reported as a major drawback.

Construction time: Erection time for precast elements at site is minimal, but formwork may be required for slabs between girders.

Maintenance: Low except that bearing and transverse deck joint details may require attention.

6.4.5 *Post-tensioned segmental bridges*-Bridges of the various types may be constructed in segments and post-tensioned to complete the final structure. The segments may be cast-in-place or precast. If cast-in-place, it is common practice to use the balanced cantilever construction method with traveling forms. If precast, the segments can be erected by any of four major methods: balanced cantilever, span-by-span, incremental launching, and progressive placing. There are also numerous variations of these, depending on the erection techniques used.

Segmental construction reduces or eliminates the need for centering or falsework. It permits the use of longer precast members which can be transported from the precast plant to the bridge site. It also requires much less time to construct at



Fig. 6.4.6-Rigid frame bridge



Fig. 6.4.8.1-Arch bridge

the site than a similar type cast-in-place. It permits construction in a planned manufacturing cycle using repetitive operations.

Balanced cantilever construction should be carefully designed where change in depth is required. Arch forms joining each other or joining straight drop in spans require esthetic consideration to produce the best appearance. Piers, bents, or columns must also be recipients of esthetic considerations, especially where they join the girders.

6.4.6 Rigid-frame bridges (Fig. 6.4.6)

Structural: Integral rigid negative-moment knees greatly reduce the positive span moment and overturning moment at foundation level; single rigid portal frames can be adapted to narrow water channels, railways, subways, and divided or undivided highways underneath; double-span rigid frames are suitable for divided multilane highways underneath, with sufficient median width; triple-span rigid frames can accommodate multilane divided highways with a wider center median. The horizontal member may be of most of the construction types described in Sections 6.4.1 through 6.4.4. Members with variable moment of inertia are advantageous and can be easily incorporated. Preliminary proportioning can start with a thickness at the knee approximately equal to twice that at the crown.

Appearance: Graceful and clean; well adaptable to stone facing.

Construction: Simple formwork, but strong. Usually requires curved formwork for variable depth.

Construction time: Similar to that of other cast-in-place types.

Maintenance: Low.

6.4.7 Jointless bridges-Movable joints in bridges are a source of problems, and therefore, their number should be minimized. Joints in the bridge deck are very costly to maintain, while detracting from the smoothness of traveling the

bridge. If maintenance is not adequate, water, deicing salts, and other chemicals may leak downward, creating corrosion problems in the supports if they are metallic, and areas where deterioration of the concrete may start due to cycles of wet and dry conditions and chemical action.

To avoid these problems there has been a tendency to eliminate joints as much as possible, particularly in medium length bridges. In many jurisdictions it is standard to build jointless bridges up to 300 ft (90 m) long.

The substructure should be designed with appropriate flexibility such as to maintain secondary stresses within tolerable limits.

Jointless bridges require careful consideration of stresses on the abutments and the design of the approach slab. It is preferable to use integral abutments with the approach slab made continuous with the bridge deck. An expansion joint is placed between the approach slab and the road pavement.

6.4.8 Arch bridges

6.4.8.1 General (Fig. 6.4.8.1)

Structural: The arch structure is primarily a compression member; constant depth for small spans and variable moment of inertia for medium and long spans; spans as long as 1000 ft (300 m) have been built; rise-to-span ratio varies with topography, but the higher the rise, the less the dead load thrust and temperature moment; for fixed arches, thickness at springing lines usually is slightly more than twice that at the crown; filled spandrels are used only with short spans; for medium and long deck spans, open spandrels with roadways carried by columns are the rule; in a through arch, the roadway deck is carried by hangers; long single spans are used over deep waterways and shorter multiple spans are more economical over wide shallow waters with excellent foundation conditions. Shape could be curvilinear, usually parabolic, or formed by straight segments whose vertexes follow a parabola.

Appearance: Graceful and attractive, especially over deep gorges, ravines, or large waterways.

Construction: Either using falsework or cantilever methods. The cantilever method is preferred when circumstances prevent the construction of regular falsework or make its construction too costly.

Construction time: Usually longer than for other types; use of prefabricated segments and post-tensioning when shorter time is desired.

Maintenance: Low.

6.4.8.2 Spandrel-filled arch (Fig. 6.4.8.2)

Structural: Suitable for short spans, 50 to 100 ft (15 to 30 m), and low spandrels, particularly if live loads are heavy. For longer spans, dead load stresses due to fill become excessive. Usually its first cost is higher than other types of arches. Used where esthetic considerations make it desirable.

6.4.8.3 Barrel arch (Fig. 6.4.8.3)

Structural: Suitable for spans longer than 100 ft (30 m); the spandrel area is open and the deck supported on walls. Arch rib is single unit with a width equal to or slightly less than the deck width. Generally fixed, but may be two-hinged. Top of arch rib at crown is just below the deck level.

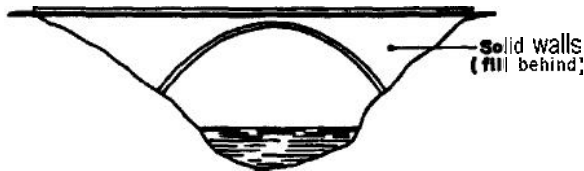

Fig. 6.4.8.2-Spandrel-filled arch

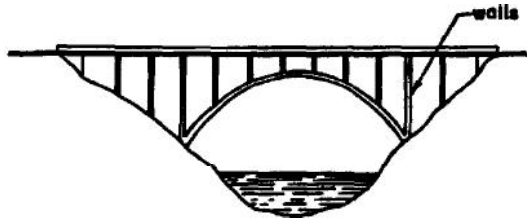

Fig. 6.4.8.3-Barrel arch

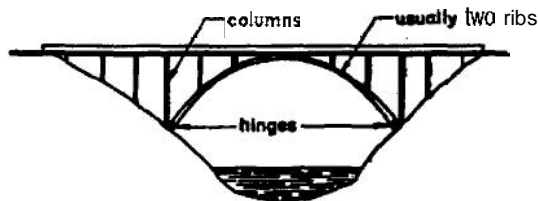

Fig. 6.4.8.4-Two hinged rib open spandrel arch

6.4.8.4 Two-hinged rib open-spandrel arch (Fig. 6.4.8.4)

Structural: Usually used in spans longer than 300 ft (90 m). The two hinges usually are placed at spring lines, either at the same level or not, depending on topography. Constant rib section is generally used. Design of the hinges requires special attention for heavy long-span arches. In deck-type arch bridges, the roadway is supported above the arch by columns carried by one or more arches; in through-type arch bridges, the roadway is supported below and between the arches by hangers. Ribs should be adequately braced transversely by cross struts. Top of deck arch rib at crown is generally well below deck level to permit use of columns.

6.4.8.5 Fixed-rib open-spandrel arch (Fig. 6.4.8.5)

Structural: Rib sections are generally variable; thinner sections at crown reduce temperature effects, moments, and dead load thrust; other factors the same as for two-hinged arch. Usually used in spans over 300 ft (90 m).

6.4.8.6 Tied arch (Fig. 6.4.8.6)

Structural: Tied-arch bridges are used where the supporting foundation cannot resist the arch thrust, or where clearance requirements below the bridge restrict the depth of construction. The horizontal thrust of the arch is resisted by the tie. The tied-arch is always used as a through span. The deck floor of a tied-arch bridge is always carried by hangers. Maintenance of ties and hangers is critical due to tension cracking. Prestressed ties and hangers should be considered to reduce maintenance. Spans usually are longer than 300 ft (90 m).

6.4.8.7 Stiffened arch (Fig. 6.4.8.7)

Structural: Very similar to tied-arch bridge, with the difference that the deck is provided with stiff longitudinal gird-

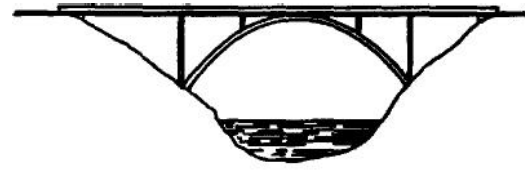

Fig. 6.4.8.5-Fix rib open-spandrel arch

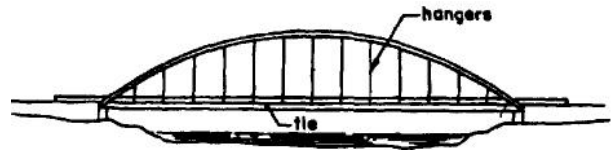

Fig. 6.4.8.6-Tie arch

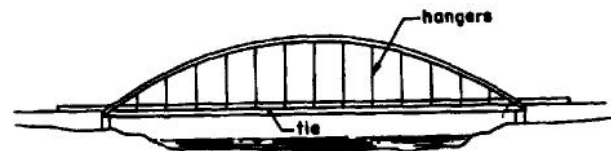

Fig. 6.4.8.7-Stiffened arch



Fig. 6.4.9-Cable stayed bridge

ers. The arch and deck girders combined provide for a more efficient system to resist the effect of moving live loads. Same range of spans, over 300 ft (90 m).

6.4.9 Cable-stayed bridges (Fig. 6.4.9)

Structural: Stayed girder bridges have been used with main span lengths as long as 1300 ft (396 m) (Dames Point

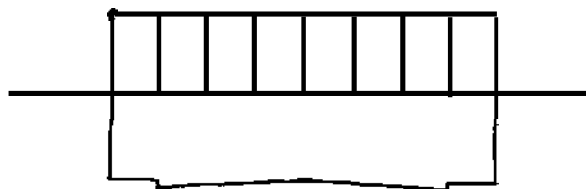

Fig. 6.4.11a-Vierendeel truss

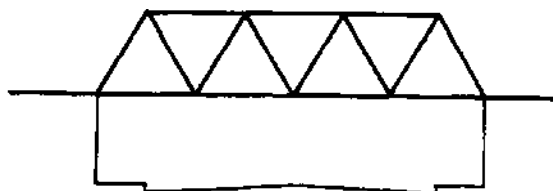

Fig. 6.4.11b-Warren truss



Fig. 6.4.11c-Pratt truss

Bridge, Jacksonville, FL). This type of bridge is being used in crossings where, previously, suspension bridges were the preferred alternative. Concrete has been used in the substructure, and many times in the towers and deck. Cellular piers, to carry towers and cable stays, have been used.

Towers have been built either solid or hollow, depending on the size and loads involved. Concrete box girders have been used extensively. They are either single or multiple cells depending on the deck width. Particular attention must be given during design to take care of stages of construction and the different load conditions, which in many cases are more critical than the final loads.

Protection of cable stays from fatigue and stress corrosion has been a problem, especially at cable anchorages. High-strength concrete has been used to reduce dead load (East Huntington, W.V.).

Appearance: Graceful and delicate; well adapted to both urban and rural environments.

Construction: At difficult crossings these bridges are simpler to construct than other common bridge types; stayed-type bridges are well adapted to long spans. Falsework usually is not necessary; deck may be constructed by the balanced cantilever method, or precast. Asymmetric structures have been successfully built at difficult locations.

Construction time: No more time than for other types of similar span length.

Maintenance: Above average because of complexity of suspension system.

6.4.10 Suspension bridges

Structural: Suspension bridges with concrete decks and girders have been built in North America with main spans as long as 680 ft (207 m); (Hudson Hope Bridge, Peace River, B.C.). Main supporting elements are a pair of large steel cables. Concrete deck system serves only to span between hangers, to stiffen the structure and to resist horizontal and live loads. To reduce dead load, high-strength and light-weight concrete can be used for longer spans. Requires large anchorages for suspension cables.

Appearance: Graceful, slender, well suited to long water crossings.

Construction: Requires no falsework, but placement of deck units should be properly staged. Lack of falsework removes any impedance to traffic underneath during construction.

Construction time: Probably somewhat greater than for a cable-stayed bridge.

Maintenance: Above average due to generally greater number of hangers.

6.4.11 Truss bridges (Fig. 6.4.11a, b, and c)

Structural: A truss bridge may be constructed as a simple, cantilever, or continuous structure. It may have parallel chords, inclined upper chord in a through type, or inclined lower chord in a deck type. It may be prestressed, precast, and field jointed, or precast and post-tensioned. For spans longer than usual with girders, in the range of 120 to 250 ft (36 to 76 m), it may prove competitive. A depth-span ratio of 1/10 or more should be used for a deck truss. The use of inclined chords, particularly in the end panel, is recommended. For about equal quantity of materials, a truss has less deflection than its girder counterpart.

Although nonprestressed cast-in-place concrete truss bridges of triangular configuration have been built, their use is not recommended. The detail of reinforcement at a joint where many members meet is very complex. Formwork, centering, and placing of concrete is expensive, therefore concrete truss bridges with structural steel diagonals offer a solution to some of the problems mentioned.

Some precast pretensioned concrete trusses have been built recently in which components are assembled into large modules. The modules are erected by large launching trusses and joined by external prestressing tendons.

While not used extensively, the Vierendeel truss offers some esthetic qualities, has simpler details because of the limited number of members at a joint, is easier to form and place, and can be precast or cast in place. If necessary, it can be erected by the cantilever method without falsework.

Appearance: Varies with shape, size, and design of the joints. It could be the least attractive of any bridge type, but if sensibly designed could be very interesting.

In general, the least number of parts produces the best appearance. A Warren truss presents a better appearance than a Pratt truss. A Vierendeel truss has the possibility of presenting the best appearance. For greater strength and rigidity in a Vierendeel truss, vertical members should be spaced closer near the supports; however, the variation of spacing should be a minimum, as such variations complicate deck details and increase cost.

Construction: Complicated forming slows the construction. Requires extensive falsework, making it difficult to continue traffic under the bridge unless cantilever method of construction is used.

Construction time: Usually quite long.

Maintenance: Above average because of complexity of tusses.

6.4.12 Special systems-This report should not be interpreted as having identified all concrete bridge types available for the application at a particular project. Special systems using creative design and innovative construction techniques are continually being developed and used. Each concrete bridge project should be evaluated independently. The following list of items is offered as a partial check list:

- a. Type of structure
- b. Span length
- c. Design loadings
- d. Number and width of lanes
- e. Sidewalk(s) and bicycle way
- f. Span-to-depth ratio
- g. Substructure protection
- h. Strength and type of concrete
- i. Grade of reinforcing steel
- j. Type of prestressing system
- k. Method of fabrication and erection
- l. Method of construction
- m. Site restrictions
- n. Environmental constraints
- o. Initial cost and maintenance costs

The information in this chapter could also be used in the preliminary design of special systems and unusual structures.

6.5-Superstructure initial section proportioning

The slab should be cantilevered from the exterior beam or web of the box girder. This produces a more pleasant appearance and is economical. Usually the cantilever length is from $\frac{1}{3}$ to $\frac{1}{2}$ of the girder spacing.

Height of parapet, including slab thickness, should be from $\frac{1}{2}$ to $\frac{1}{3}$ of the beam depth to provide a slender appearance to the beam. Minimum height to comply with safety requirements should be provided.

The girder spacing should be selected to accommodate the deck width and to minimize the cost while maintaining a pleasing appearance. In general, it is more economical to use a thicker slab with a wider girder spacing and cantilevered slabs $\frac{1}{3}$ to $\frac{1}{2}$ of the girder spacing. Usual girder spacings are in the range of 6 to 9 ft (2 to 3 m) for nonprestressed T-beam bridges, 7 to 11 ft (2 to 3.5 m) for nonprestressed box girder bridges, 8 to 16 ft (2.5 to 5 m) for precast prestressed I-beam bridges, and 7 to 12 ft (2 to 3.5 m) for spread precast, prestressed box-beam bridges.

For preliminary proportioning, the following slab thickness h may be used for AASHTO HS20 design loading:

Effective span length*		Slab thickness, h	
ft	m	in.	mm
6	1.8	$7\frac{1}{4}$	185
7	2.1	$7\frac{3}{4}$	195
8	2.4	8	205
9	2.7	$8\frac{1}{2}$	215
10	3.0	$8\frac{3}{4}$	220
11	3.4	9	230
12	3.7	$9\frac{1}{2}$	240
13	4.0	$9\frac{3}{4}$	250
14	4.3	10	260
15	4.6	$10\frac{1}{2}$	270
16	4.9	11	280

These recommended slab thicknesses will permit proper placement of reinforcement with the required concrete protection. In areas of adverse climatic conditions, a thicker slab may be required. The designer should check the current practice of the highway authority in the area where the bridge is to be built.

For precast butted box-beams, a top slab thickness of 3 in. (75 mm) may be used.

For nonprestressed concrete girders, the stem width should be at least 11 in. (280 mm) for up to eight longitudinal reinforcing bars. It is often necessary to increase this thickness over continuous supports to accommodate compressive forces.

For post-tensioned girders, a 12-in. (300-mm) minimum stem width provides for two rows of post-tensioning tendons. The bottom slab thickness of box girders should be approximately $\frac{1}{16}$ of the clear span between webs, but should not exceed the thickness of the top slab, or be less than $5\frac{1}{2}$ in. (140 mm). The bottom slab thickness may be increased near continuous supports to resist compressive forces.

The webs of box girder superstructures should have a minimum thickness b of 8 in. (200 mm) unless external prestressing is used. AASHTO recommends a minimum thickness of 8 in. (200 mm) with no longitudinal or vertical post-tensioning tendons, 12 in. (305 mm) with only longitudinal (or vertical) post-tensioning tendons, and 15 in. (381 mm) in webs with both longitudinal and vertical tendons. It is often beneficial to increase the thickness of webs near supports to provide adequate shear resistance.

For segmental precast segments, smaller dimensions than those indicated may be adequate depending on size, construction facilities available, etc.

Other esthetic effects can be created by inclining the parapet face inward to make it look bright, and inclining the webs of box girders to give a more slender appearance.

6.6-Abutments

6.6.1 Types-As shown in Fig. 6.6.1, there are two basic types of abutments: open-end (stub) (Figs. 6.6.1a through 6.6.1c); and closed-end or retaining (deep) (Fig. 6.6.1d through 6.6.1i). Each has several subtypes as follows:

* The effective span is measured as the clear distance between webs of T-beams or box girders or the top flanges of I-beams.

OPEN TYPESCLOSED TYPES**I. MECHANICALLY STABILIZED EARTH ABUTMENT**

Fig 6.6.1-Abutment types

6.6.1.1 Open-end abutments-These abutments are located near the top of the end slope of the approaching roadway embankment.

- Diaphragm or integral; the wall of the abutment is constructed monolithic with the superstructure
- Seat type; there is a joint between the superstructure and the abutment.
- Spill-through; often used when an additional span may

be needed in the future. It is built prior to constructing the approach embankment; thus, the approach roadway embankment spills through the columns.

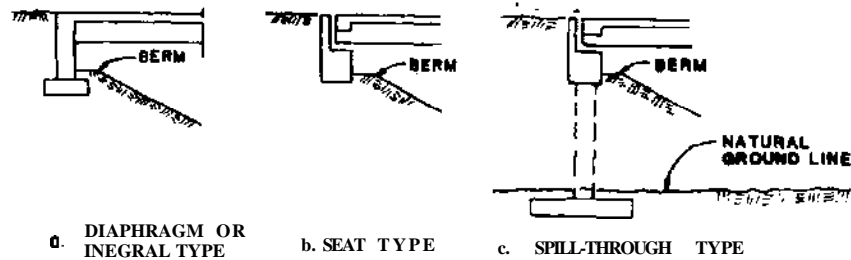
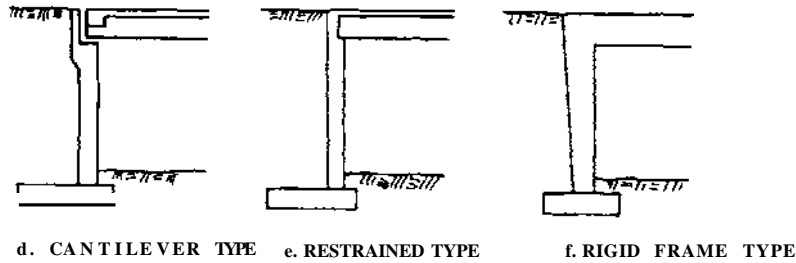
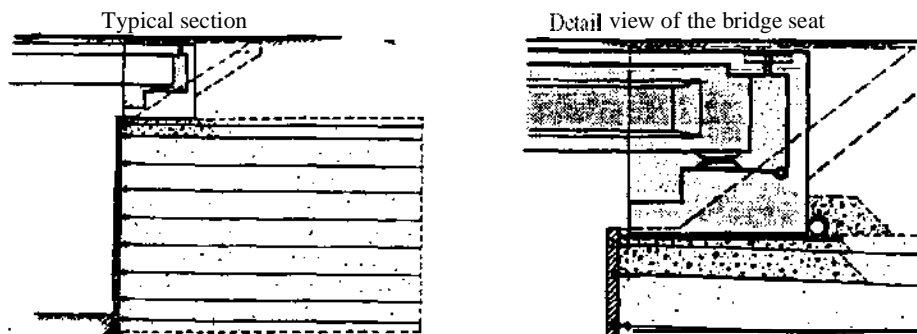
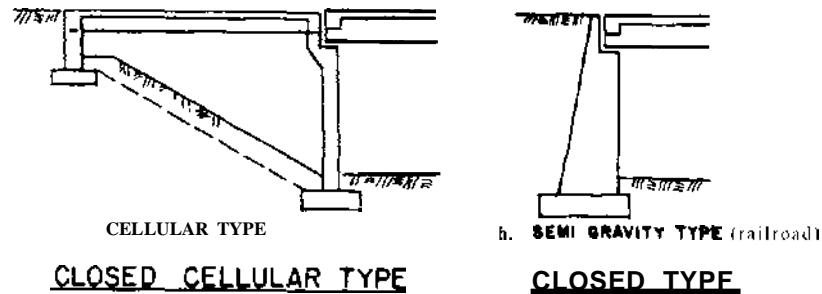
6.6.1.2 Closed-end abutments

- Cantilever; designed as a retaining wall resisting earth pressure through cantilever action. High abutments may have counterforts.
- Restrained; for short bridges, the superstructure may be

used to support the abutments against earth pressure. Where subsoil at the foundation level of the abutment is soft, struts may be placed under the pavement, extending from abutment to abutment.

- c. Rigid frame; in these bridges the abutment is integral with the superstructure.
- d. Cellular or vaulted; for tall abutments the effect of the earth pressure is reduced and the settlement of the approach roadway minimized by use of this type. The front wall is in effect a pier, but the short end span is hidden by the sidewalls.
- e. Gravity or semigravity; the earth pressure is resisted in full or in part by the weight of the thick wall. It is generally associated with bridges carrying railroad traffic.
- f. Mechanically stabilized earth; the earth pressure is resisted by precast concrete slab elements anchored by thin metallic or nonmetallic strips embedded in the embankment. The reaction of the end span is usually supported by a footing resting on the embankment.

6.6.2 Abutment type selection-Open-end abutments are usually more economical than closed-end abutments. Since most of the approach embankment can be placed before construction of the abutment, there is less potential settlement of road approaches than for the higher backfilled closed-end type. If used without side walls, open-end abutments allow flexibility for future widening of the roadways being spanned, and they greatly reduce the roadside hazard produced with a closed-end abutment with nominal horizontal clearance.

Of the open-end abutments, the diaphragm type is preferred over the seat type since it eliminates expansion bearings and troublesome deck joints. The diaphragm type, however, does not permit unlimited thermal or shrinkage movements and should not be used for structures over 300 ft (90 m) long, unless provision is made for movement by expansion joints elsewhere. When selecting the abutment type, consideration should be given to the drainage design.

Open-end abutments may not be suitable for river crossings where cost of protection (rip-rap or other measures) may offset the cost advantages of this abutment type.

6.6.3 Bridge abutment approach slab-A smooth transition from the approach roadway to the bridge deck is provided by using approach slabs which span over possible backfill settlement. The slab also helps in controlling runoff drainage from entering the backfill.

When an adequately designed concrete approach slab supported at one end by the bridge is provided, usually live load surcharge is not considered in the design of the abutment.

6.7-Piers and bents

The term "pier" pertains to an intermediate substructure unit between the abutments. A "bent" is a type of pier consisting of one or more columns in the substructure unit, with or without a cap.

6.7.1 Solid piers (Fig. 6.7.1)-These are located in streams where debris, ice, or fast current are present; are preferable for long spans, and may be supported on spread footings or pile foundations. A pier wall should have a maximum

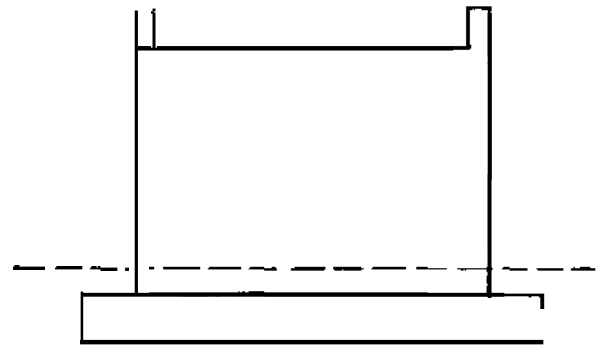

Fig. 6.7.1-Solid pier

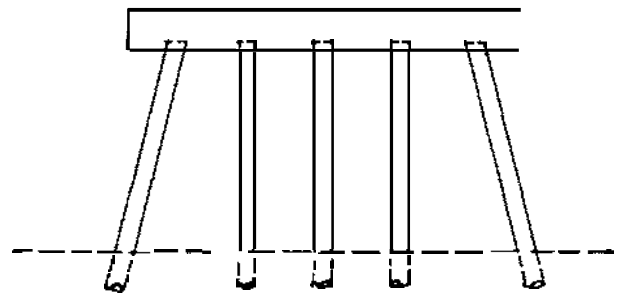

Fig. 6.7.2-Pile bent

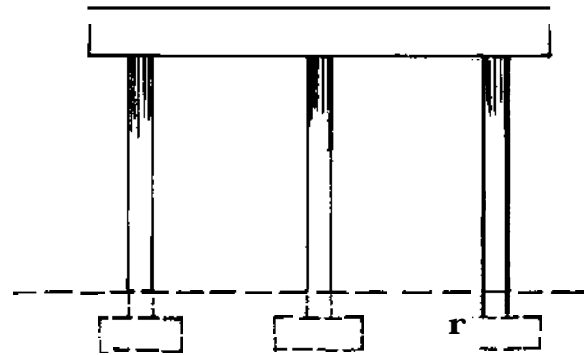

Fig. 6.7.3-Multi-column bent

imum height-thickness ratio of 15, but should not be less than 12 in. (300 mm) thick. This is the minimum thickness that should be used with two planes of reinforcing steel.

6.7.2 Pile bents (Fig. 6.7.2)-These are usually the most economical and are applicable for slab spans, T-beams, and other types of superstructures. They are suitable for stream crossings when debris is not a factor. The preferable minimum width of cap is 2 ft-6 in. (0.75 m).

When drilled shafts are used, they may be extended as circular columns having similar appearance to multicolumn bents. They may be connected by a grade beam or small wall at or below ground level.

Pile bents are unsightly for bridges 20 ft (6 m) or more in height.

6.7.3 Multicolumn bents (Fig. 6.7.3)-These generally support dry land structures. They may be supported on either

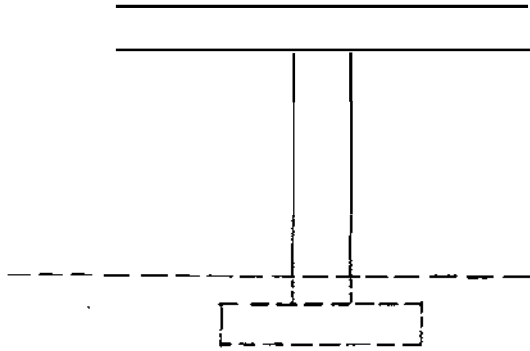

Fig. 6.7.4-Single-column pier

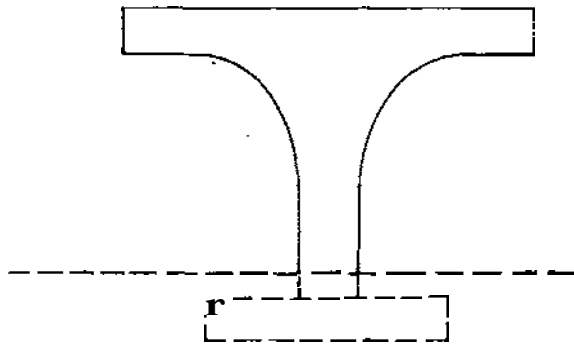

Fig. 6.7.5-Mushroom pier

spread footings or pile foundations. Columns may be circular, rectangular, or variable in section to provide esthetic effect. The height to thickness ratio of uniform section columns should be in the range of 12 to 15 for appearance, as well as structural reasons. Unnecessarily thick columns can produce high temperature and shrinkage stresses. Where large column bents are located in streams, debris walls of less thickness than the columns, extending from the footing to an elevation above high water, are generally used.

6.7.4 Single-column piers (Fig. 6.7.4)—They can sometimes be used to avoid skewed bents. They have a special advantage for viaducts over city streets where the location of columns is restricted. Their use should be avoided in areas of high seismicity.

6.7.5 Mushroom piers (Fig. 6.7.5)—They are similar to single-column bents, but without a double-cantilever girder cap. They resemble a column with an integral drop panel in flat slab construction. A slab bridge is carried continuously over such piers with the slab thickened over the piers, thus

forming a mushroom-like construction. They have been used for spans intermediate between slab bridges and continuous girder bridges.

6.7.6 Towers—For cable-stayed and suspension bridges, the towers may be single or twin, fixed or hinged at the base. Twin towers may have vertical or inclined legs. The details of towers are discussed in [Chapters 10 and 11](#).

6.8-Appurtenances and details

During the preliminary design, consideration should also be given to the appurtenances and details that may be necessary for the proper functioning and service of the structure. To maintain unity in the design, and avoid problems when the final plans are prepared, proposed solutions should be incorporated into the preliminary plans submitted for approval.

Among items to be considered are the following:

- Utilities
- Bicycle paths
- Protection to separate different types of traffic (automobiles and trucks, bicycles, pedestrians)
- Lighting
- Observation areas in scenic bridges
- Drainage
- Noise abatement

6.9-Finishes

The following components are candidates for architectural finish:

- Exterior railing
- Exterior edge of slab
- Exterior girder
- Column, bent or pier
- Wing wall
- Abutment face

Integral formed textures on these components up to 1½ in. (37.5 mm) thick can dramatically influence the appearance and provide at minimal cost increase a way to unify parts of a single bridge or coordinate several bridges, tunnels, and other related roadway structures.

The architectural finish can be produced with form liners or chemical retarder applied to the forms and washed or air blasted upon removal of the forms. *ACI 303R Guide to Cast-in-Place Architectural Concrete Practice* provides valuable information on architectural finishes.

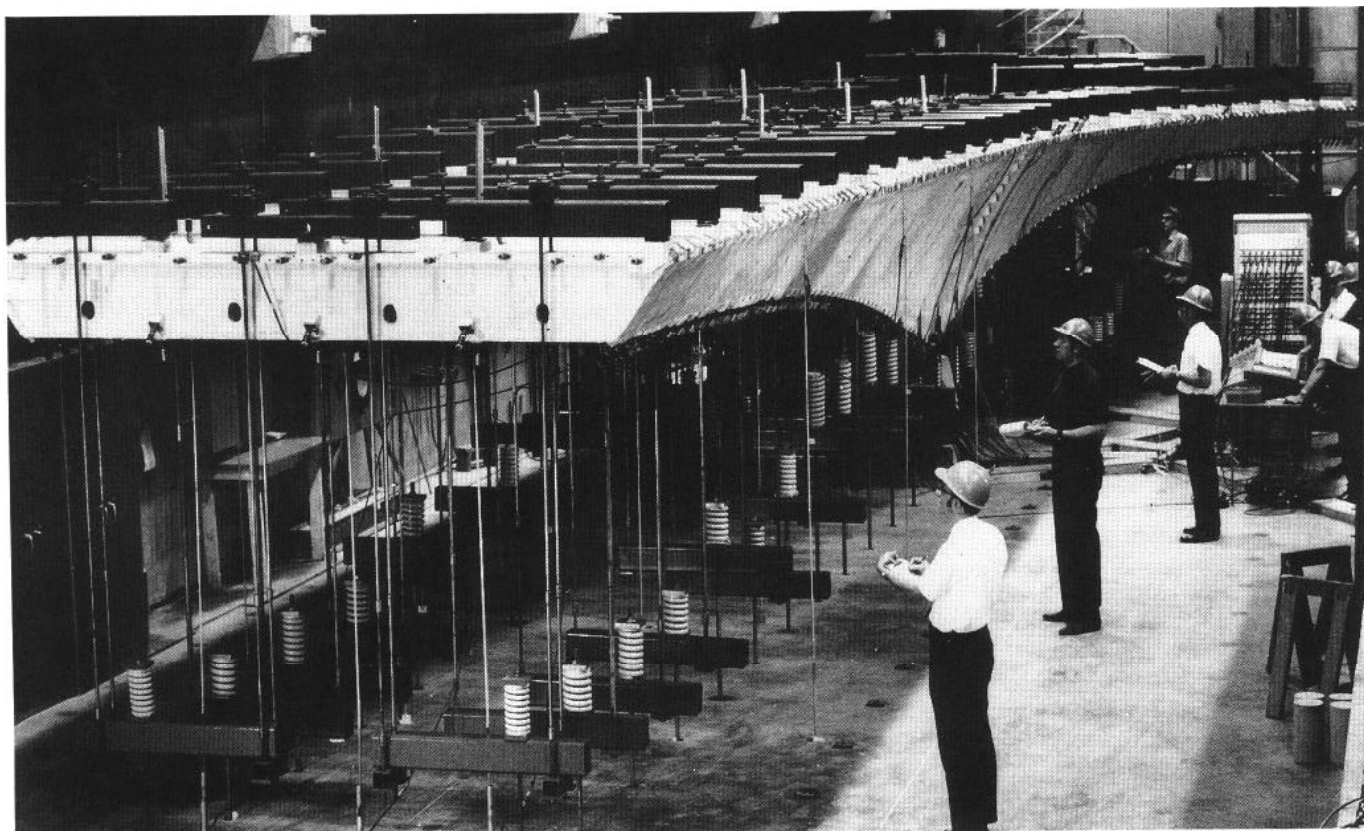

Structural tests of box girder bridge (photo courtesy of Portland Cement Association)

CHAPTER 7-STRENGTH DESIGN

7.1-Introduction

The recommendations in this chapter are intended for application to all structural elements of bridge structures, except those designed as shells, pipe culverts, and other unusual structures. They may also be applied to elements subjected to special loading conditions during the stages of fabrication and transportation of precast concrete and during placement of cast-in-place concrete.

7.2-General considerations for analysis, design, and review

7.2.1 General-All members of statically indeterminate structures should be designed for the maximum effects of the loads specified as determined by elastic analysis, except as provided for in Section 7.2.4 and 7.2.5. Recommended loads and load combinations are discussed in Chapter 5.

7.2.2 Stiffness-All assumptions, adopted for computing the relative flexural and torsional stiffnesses of continuous beams and rigid frame members, should be consistent throughout the analysis. The moments of inertia to be used in obtaining the relative stiffnesses of the various members can be determined from either the uncracked concrete cross section, neglecting the reinforcement, or from the transformed cracked section as long as the same method is used throughout the analysis of a continuous or rigid frame struc-

The effect of haunches should be considered both in determining bending moments and in designing members.

7.2.3 Span length-The span length of members, not built integrally with their supports, should be considered as the clear span plus the depth of the member. However, the span need not exceed the distance between centers of support.

In the analysis of continuous and rigid frame members, center-to-center distances between supports should be used for the determination of moments. Moments at faces of support may be used for design of members built integrally with supports.

7.2.4 Analysis-Various acceptable methods of analysis are described in Section 10.3. All methods of analysis should satisfy the conditions of equilibrium, displacement compatibility, and stability at all points in the structure, along with all magnitudes of loading up to the ultimate. In addition, all serviceability recommendations of Chapter 8 should be satisfied.

7.2.5 Redistribution-Negative moments calculated by elastic analysis at the supports of continuous nonprestressed flexural members for any assumed loading arrangement can be increased or decreased as follows (ACI 318)

$$20 \left(1 - \frac{\rho - \rho'}{\rho_c} \right), \text{percent} \quad (7-1)$$

where

- ρ = ratio of tension reinforcement = A_s/bd
 ρ' = ratio of compression reinforcement = A_s'/bd
 ρ_b = reinforcement producing balanced condition

The modified negative moments should be used for calculating moments at sections within the spans. Redistribution of negative moments should be made only when the section, at which the moment is reduced, is so designed that ρ or $\rho - \rho'$ is not greater than 0.50 ρ_b , where ρ_b is calculated as follows (ACI 318);

$$\rho_b = \frac{0.85\beta_1 f_c'}{f_y} \frac{87,000}{87,000 + f_y} \quad (7-2)$$

$$\rho_b = \frac{0.85\beta_1 f_c'}{f_y} \frac{600}{600 + f_y}$$

where

- f_c' = specified compressive strength of concrete
 f_y = design yield strength of nonprestressed reinforcement
 β_1 = factor used to determine the stress block in ultimate load analysis and design

Negative moments calculated by elastic analysis at the supports of continuous prestressed flexural members, where bonded reinforcement is provided at supports in accordance with Section 9.11, can be increased or decreased by not more than

$$(30 - 47c/d) \text{ percent} \quad (7-3)$$

for any assumed gravity loading arrangement. In the previous expression, c is the distance from the extreme compression fiber to the neutral axis, and d is the distance from the extreme compression fiber to the centroid of the tension steel.⁷⁻¹

The modified negative moments should be used for calculating moments at sections within spans for the same loading arrangement. In no case should the negative moments be increased or decreased by more than 20 percent.

Negative moments should not be redistributed where fatigue of reinforcement is a governing factor. This condition can occur where moving live loads contributes a significant part of the stresses in the reinforcement.

7.2.6 Composite concrete construction

7.2.6.1 General considerations-The recommendations of this section provide for the design of composite flexural members consisting of concrete elements constructed in separate placements, but so interconnected that the elements respond to superimposed loads as a unit.

The entire composite member, or portions thereof, may be used in resisting the shear and the bending moment. The individual elements should be investigated for all critical stages of loading.

If the specified strength, unit weight, or other properties of the various components are different, the properties of the individual components, or the most critical values, should be used in design.

In calculating the flexural strength of a composite member, no distinction should be made between shored and unshored members. However, unshored construction leads to higher stresses at service loads, and may pose a problem where fatigue is a major consideration.

All elements should be designed to support all loads introduced prior to the full development of the design strength of the composite member. Reinforcement should be provided as necessary to prevent separation of the components and to control cracking.

7.2.6.2 Shoring-When used, shoring should not be removed until the supported elements have developed the strength required to support the prevailing loads and to limit deflections and cracking at the time of shore removal.

7.2.6.3 Vertical shear-When an entire composite member is assumed to resist vertical shear, design should be in accordance with the requirements of Section 7.3.7, as for a monolithically cast member of the same cross-sectional shape.

Web reinforcement should be fully anchored into interconnected elements in accordance with Section 13.2.

Extended and anchored shear reinforcement may be included as ties for horizontal shear.

7.2.6.4 Horizontal shear-In a composite member, full transfer of horizontal shear forces should be assured at contact surfaces of interconnected elements. Design for horizontal shear should be in accordance with the recommendations of Section 7.3.15.

7.2.7 T-girder construction-In T-girder construction, the girder web and slab should be effectively bonded together. Full transfer of shear forces should be assured at the interface of the web and the slab.

The effective slab width used as a girder flange should not exceed one-fourth of the girder span; its overhanging width on either side of the web should not exceed six times the thickness of the slab nor one-half the clear distance to the next girder.

For girders having a slab on one side only, the effective overhanging slab width used as a girder flange should not exceed one-twelfth of the girder span, nor six times the thickness of the slab, nor one-half the clear distance to the next girder.

For isolated T-girders, where the flange is used to provide additional compression area, only that part of the flange adjacent to the girder web, with a thickness at least one-half the width of the girder web, should be used as compression area. Also, the total width of the flange used as compression area should not exceed four times the width of the girder web.

Load distributing diaphragms should be placed between the girders at span ends and within the spans at intervals not exceeding 40 ft (12 m). Diaphragms may be omitted where tests or structural analysis show adequate strength. Diaphragms for curved girders should be given special consideration.

7.2.8 Box girder construction

7.2.8.1 General-This section pertains to the design of simple and continuous spans of single and multiple cell box

girder bridges of moderate span lengths (see Section 6.5 for typical span lengths and depth-to-span ratios).

Box girders consist of girder webs and top and bottom slabs. To insure full transfer of shear forces, the girder web and top and bottom flanges should be effectively bonded together at their interfaces.

For curved girder bridges, torsion should be considered, and exterior girder shears should be increased to account for torsion.

7.2.8.2 Lateral distribution of loads for bending moment—The live load bending moment for each interior beam in a prestressed box beam superstructure should be determined using the method given in [Section 10.5](#).

7.2.8.3 Effective compression flange width—The effective width of slab used as a girder flange should not exceed one-fourth of the girder span; the overhanging width used as a flange on either side of the web should not exceed six times the least thickness of the slab, nor one-half the clear distance to the next web.

For webs having a slab on one side, only the effective overhanging width of slab used as a girder flange should not exceed one-twelfth of the girder span, nor six times the least thickness of the slab, nor one-half the clear distance to the next web.

7.2.8.4 Slab and web thickness—The thickness of the top slab for highway bridges should be at least 6 in. (150 mm) for nonprestressed construction and at least 5½ in. (140 mm) for prestressed construction.

For highway bridges, the thickness of the bottom slab should be at least one-sixteenth of the clear span between webs, or 5½ in. (140 mm), whichever is greater. The minimum thickness may be reduced to 5 in. (127 mm) for factory-produced precast elements.

The thickness of the bottom slab need not be greater than the top slab, unless required by design.

If required for shear, the web may be thickened in the area adjacent to the supports. The change in web thickness should be tapered over a minimum distance equal to twelve times the difference in web thickness.

For post-tensioned box girders, in order to accommodate the post-tensioning ducts, the webs should be at least 1.0 ft (300 mm).

The designer should note, however, that these minimum thickness recommendations may not be adequate for heavily reinforced members. For the top and bottom slabs in particular, where more than three layers of reinforcing are provided, the thickness should be sufficient to provide adequate clear cover, construction tolerances, and design depth.

7.2.8.5 Top and bottom slab reinforcement—Uniformly distributed reinforcement of at least 0.4 percent of the flange area should be placed in the bottom slab parallel to the girder span. A single layer of reinforcement may be provided. The spacing of such reinforcement should not exceed 18 in. (500 mm).

Minimum distributed reinforcement of 0.5 percent of the cross-sectional area of the slab, based on the least slab thickness, should be placed in the bottom slab transverse to the girder span. Such reinforcement should be distributed over

both surfaces with a maximum spacing of 18 in. (500 mm). All transverse reinforcement in the bottom slab should extend to the exterior face of the outside web in each group and be anchored by a standard 90 deg hook.

At least one-third of the bottom layer of the transverse reinforcement in the top slab should extend to the exterior face of the outside web in each group and be anchored by a standard 90 deg hook. If the slab extends beyond the last girder web, such reinforcement should extend into the slab overhang and have an anchorage beyond the exterior face of the web not less than that provided by a standard hook.

7.2.8.6 Diaphragms-Load distributing diaphragms or spreaders should be placed at 60 ft (18 m) intervals, maximum, unless tests or structural analysis show adequate strength. In addition, diaphragms should be placed at main supports to provide transfer of transverse wind loads to the substructure. On curved box girders the need for diaphragms and spacing requirements should be given special consideration.

7.2.9 Limiting dimensions for members

7.2.9.1 General—Because of the difficulty in placing concrete and the increase in maintenance costs, the use of thin or small members is seldom economically justifiable. The designer should exercise good judgment in choosing the optimum size of member.

7.2.9.2 Compression members—Circular compression members, constituting the principal supports of a structure, should have a diameter of at least 12 in. (300 mm). Rectangular compression members should have a thickness of at least 10 in. (250 mm) and a gross area not less than 100 in.² (62500 mm²). Auxiliary supports should be not less than 6 in. (150 mm) minimum dimension.

7.2.9.3 Flexural members—The width of the compression face of flexural members should not be less than 6 in. (150 mm). Structural slabs, including the flanges of T-girders, should not be less than 4 in. (102 mm) thick; however, in many situations, especially where more than two layers of reinforcing are required, a greater thickness may be needed to meet minimum cover recommendations of [Section 13.8](#), and to provide required design depth.

7.3-Strength requirements

7.3.1 Required strength—Bridge structures and structural members should be designed to have strength at all sections sufficient to safely resist the structural effects of the load groups which represent various combinations of loads and forces to which the structure may be subjected, as stipulated in [Section 5.12](#). Each part of such structures should be proportioned for the group loads that are applicable, and the maximum design required should be used. The serviceability requirements of Chapter 8 should also be satisfied to insure adequate performance at service load levels.

7.3.2 Strength—The design strength provided by a member or cross-section in terms of load, moment, shear, or stress should be taken as the nominal strength calculated in accordance with the recommendations and assumptions of this [Section 7.3](#), multiplied by a strength reduction factor ϕ . Strength reduction factor ϕ should be as follows (ACI 318):

Flexural, without axial load	0.90
Axial tension, and axial tension with flexure	0.90
Axial compression, and axial compression with flexure:	
Members with spiral reinforcement conforming to Section 13.3	0.75
Members with ties conforming to Section 13.3	0.70

Except for low values of axial load, ϕ may be increased in accordance with the following:

For members in which f_y does not exceed 60,000 psi (410 MPa) with symmetric reinforcement, and with $(h - d' - d_s)/h$ not less than 0.70, ϕ may be increased linearly to 0.90 as ϕP_n decreases from $0.10 f_c' A_g$ to zero.

For other reinforced members, ϕ may be increased linearly to 0.90, as ϕP_n decreases from $0.10 f_c' A_g$ or ϕP_b , whichever is smaller, to zero.

Shear and torsion	0.85
Bearing on concrete	0.70
Flexure in plain concrete	0.65

For prestressed members produced in plants meeting the requirements of PCI *Manual* MNI-116, the following strength reduction factors should be used (AASHTO *Standard Specifications for Highway Bridges* and AREA *Manual for Railway Engineering*, Chapter 8):

Flexure, with or without axial tension and for axial tension	0.95
Shear and torsion	0.90
Compression members, with prestress exceeding 225 psi (1.55 MPa); and with spiral reinforcement conforming to Section 13.3.2	0.80
Compression members, with prestress exceeding 225 psi (1.55 MPa); without spiral reinforcement	0.75
Bearing on concrete	0.75

For all other prestressed members not specifically covered, the factors for nonprestressed concrete should be used. Development lengths specified in Chapter 13 do not require a ϕ factor.

7.3.3 Design assumptions—The strength design of members for flexural and axial loads should be based on assumptions given in this section, and on satisfaction of the applicable conditions of equilibrium and compatibility of strains.

Strain in reinforcement and concrete should be assumed directly proportional to the distance from the neutral axis, except that, for deep flexural members with overall depth-to-clear span ratios greater than 2 $\frac{1}{3}$ for continuous spans and 4/5 for simple spans, a nonlinear distribution of strain should be considered (ACI 318).

Maximum usable strain at the extreme concrete compression fiber should be assumed equal to 0.003, excluding shrinkage, creep, and temperature strains (ACI 318).

Stress in reinforcement, below specified yield strength f_y for the grade of reinforcement used, should be taken as E_s times steel strain. For strains greater than that corresponding to f_y , stress in reinforcement should be considered independent of strain and equal to f_y (ACI 318).

Tensile strength of concrete should be neglected in axial tension strength calculations and in flexural tension strength

calculations of reinforced concrete, except when meeting the requirements of Section 8.7.

The relationship between the concrete compressive stress distribution and the concrete strain may be assumed to be rectangular, trapezoidal, parabolic, or any other shape that results in prediction of strength in substantial agreement with the results of comprehensive tests. These recommendations may be considered satisfied by an equivalent rectangular concrete stress distribution defined by the following (ACI 318):

- The concrete stress of $0.85 f_c'$ is assumed, uniformly distributed over an equivalent compression zone, bounded by the edges of the cross section and a straight line located parallel to the neutral axis at a distance $a = \beta_1 c$ from the fiber of maximum compressive strain.
- Distance c from the fiber of maximum strain to the neutral axis is measured in a direction perpendicular to that axis.
- Factor β_1 is taken as 0.85 for concrete strengths f_c' , up to and including 4000 psi (27.6 MPa). For strengths above 4000 psi (27.6 MPa), β_1 is reduced at a rate of 0.05 for each 1000 psi (6.89 MPa) of strength in excess of 4000 psi (27.6 MPa), but β_1 need not be less than 0.65.

7.3.4 Flexure

7.3.4.1 Minimum reinforcement of nonprestressed flexural members—At any section of a flexural member where tension reinforcement is required by analysis, the reinforcement provided should be adequate to develop a factored moment at least 1.2 times the cracking moment calculated on the basis of the modulus of rupture for normal weight concrete. The modulus of rupture should be obtained from tests, or may be taken as

$$7.5 \sqrt{f_c'} \left(0.623 \sqrt{f_c'} \right) \quad (\text{ACI 318})$$

The previous recommendations may be waived if the area of reinforcement provided at a section is at least one-third greater than that required by analysis based on the critical loading combinations.

As an aid to the designer, the minimum recommended reinforcement ratio ρ_{min}^{7-2} may be obtained from the following approximate expressions

$$\rho_{min} = \left[10 + \frac{(I/y_t)}{bd^2} \right] \left[\frac{(I/y_t)}{bd^2} \right] \frac{\sqrt{f_c'}}{f_y} \quad (7-4)$$

$$\rho_{min} = \left\{ 0.83 \left[10 + \frac{(I/y_t)}{bd^2} \right] \left[\frac{(I/y_t)}{bd^2} \right] \frac{\sqrt{f_c'}}{f_y} \right\}$$

$$\rho_{min} = 10.2 \left[\frac{(I/y_t)}{bd^2} \right] \frac{\sqrt{f_c'}}{f_y} \quad (7-5)$$

$$\rho_{min} = 0.847 \left[\frac{(I/y_t)}{bd^2} \right] \frac{\sqrt{f_c'}}{f_y}$$

$$\rho_{min} = 1.7 \left(\frac{h}{d^2} \right) \frac{\sqrt{f'_c}}{f_y}$$

$$\rho_{min} \approx \left[.141 \left(\frac{h}{d^2} \right) \frac{\sqrt{f'_c}}{f_y} \right] \quad (7-6)$$

Of the previous expressions, Eq. (7-4) is the most accurate and can be used for T-beams, box girders, and rectangular sections. Eq. (7-5) is a somewhat simpler expression that can be used for box girders or rectangular sections. The simplest expression, Eq. (7-6), can be used for the special case of rectangular sections.

These minimum reinforcement recommendations should be followed, even where analysis shows that the calculated moment would be resisted solely by the tensile strength of the concrete.

These minimum reinforcement recommendations do not apply to footings.

7.3.4.2 Maximum reinforcement of nonprestressed flexural members-For flexural members, the reinforcement ratio ρ_{min} provided should not exceed 0.75 of that ratio ρ_b , which would produce balanced strain conditions for the section under flexure (ACI 318).

Balanced strain conditions exist at a cross section when the tension reinforcement reaches its yield strength f_y , just as the concrete in compression reaches its ultimate strain of 0.003 (ACI 318).

7.3.4.3 Rectangular sections with nonprestressed tension reinforcement only-For rectangular sections, the design moment strength can be computed as follows (ACI 318R)

$$M_n = A_s f_y d \left(1 - 0.59 \rho f_y / f_c \right)$$

$$M_n = A_s f_y \left(d - \frac{a}{2} \right) \quad (7-7)$$

where

$$a = A_s f_y / (0.85 f'_c c b) \quad (7-8)$$

The balanced reinforcement ratio for rectangular sections with tension reinforcement only may be calculated as follows (ACI 318R)

$$\rho_b = \frac{0.85 \beta_1 f'_c}{f_y} \frac{87,000}{87,000 + f_y}$$

$$\left[\rho_b = \frac{0.85 \beta_1 f'_c}{f_y} \frac{600}{600 + f_y} \right] \quad (7-9)$$

7.3.4.4 Flanged sections with tension reinforcement only-When the compression flange thickness is equal to or greater than the depth of the equivalent rectangular stress

block, the design moment strength M_n may be computed by the equations given in Section 7.3.4.3. When the compression flange thickness is less than a , the design moment strength can be computed as follows (ACI 318R)

$$M_n = \left[(A_s - A_{sf}) f_y \left(d - \frac{a}{2} \right) + A_{sf} f_y (d - 0.5 h_f) \right] \quad (7-10)$$

where

$$A_{sf} = \frac{0.85 f'_c (b - b_w) h_f}{f_y} \quad (7-11)$$

and

$$a = \frac{(A_s - A_{sf}) f_y}{0.85 f'_c c b_w} \quad (7-12)$$

The balanced reinforcement ratio for flanged sections with tension reinforcement only can be computed as follows (ACI 318R)

$$\rho_b = \frac{b_w}{b} \left(\frac{0.85 \beta_1 f'_c}{f_y} \frac{87,000}{87,000 + f_y} + \frac{A_{sf}}{b_w d} \right)$$

$$\left[\rho_b = \frac{b_w}{b} \left(\frac{0.85 \beta_1 f'_c}{f_y} \frac{600}{600 + f_y} + \frac{A_{sf}}{b_w d} \right) \right] \quad (7-13)$$

For T-girder and box-girder construction the width of the compression face b should be equal to the effective slab width as defined in Section 7.2.7.

7.3.4.5 Rectangular sections with compression reinforcement-For rectangular sections and flanged sections in which the neutral axis lies within the flange, the design moment strength can be computed as follows (ACI 318R)

$$M_n = \left[(A_s - A'_s) f_y \left(d - \frac{a}{2} \right) + A'_s f_y (d - d') \right] \quad (7-14)$$

where

$$a = \frac{(A_s - A'_s) f_y}{0.85 f'_c b} \quad (7-15)$$

and the following condition should be satisfied

$$\frac{A_s - A'_s}{b d} \geq 0.85 \beta_1 \frac{f'_c d'}{f_y d} \frac{87,000}{87,000 - f_y}$$

$$\left[\frac{(A_s - A'_s)}{b d} \geq 0.85 \beta_1 \frac{f'_c d'}{f_y d} \frac{600}{600 - f_y} \right] \quad (7-16)$$

When the value of $(A_s - A_s')/bd$ is less than the value given by Eq. (7-17), so that the stress in the compression reinforcement is less than the yield strength, or when the effects of compression reinforcement are neglected, the design moment strength can be computed by the equations in Section 7.3.4.3. In these cases, the section is treated as if reinforced with tension steel only. Alternatively, a general analysis can be made based on stress and strain compatibility using the assumptions given in Section 7.3.3.

The balanced reinforcement ratio for rectangular sections with compression reinforcement can be calculated as follows (ACI 318R)

$$\rho_b = \frac{0.85\beta_1 f_c' (87,000 + f_y)}{f_y (87,000 + f_y + f_y)} \frac{f_{sb}'}{f_y} \rho_1$$

$$\left[\rho_b = \frac{0.85\beta_1 f_c' (600 + f_y)}{f_y (600 + f_y + f_y)} \frac{f_{sb}'}{f_y} \rho_1 \right] \quad (7-17)$$

where f_{sb}' = stress in compression reinforcement at balanced conditions

$$f_{sb}' = 87,000 \left(1 - \frac{d'}{d} \frac{87,000 + f_y}{87,000} \right) \geq f_y$$

$$\left[f_{sb}' = 600 \left(1 - \frac{d'}{d} \frac{600 + f_y}{600} \right) \geq f_y \right] \quad (7-18)$$

7.3.4.6 Other nonprestressed cross sections—For other cross sections and for conditions of nonsymmetrical bending, the design moment strength ϕM_n should be computed by a general analysis based on stress and strain compatibility, using the assumptions given in Section 7.3.3. The recommendations of Section 7.3.4.2 should also be satisfied.

7.3.4.7 Prestressed concrete members—The design moment strength for prestressed flexural members can be computed by the same strength design procedures and equations recommended for nonprestressed members. For prestressing tendons, f_{ps} should be substituted for f_y .

In lieu of a more accurate determination of f_{ps} based on strain compatibility, and provided that f_{se} is not less than $0.5f_{pu}$, the following approximate values should be used:⁷⁻³

- a. For members with bonded prestressing tendons,⁷⁻³ the equation $f_{ps} = f_{pu}(1 - 0.3c/d)$ can be approximated by

$$f_{ps} = f_{pu}(1 - 0.3c/d_u) \quad (7-19)$$

where

$$d_u = \frac{A_{ps} f_{pu} d_p + A_s f_y d}{A_{ps} f_{pu} + A_s f_y} \quad (7-20)$$

and

$$c = \frac{A_{ps} f_{pu} + A_s f_y - A_s' f_y}{0.85\beta_1 f_c' b + 0.3A_{ps} f_{pu}/d_u} \quad \text{for } \beta_1 c \leq h_f \quad (7-21)$$

or

$$c = \frac{A_{ps} f_{pu} + A_s f_y - A_s' f_y - T_f}{0.85\beta_1 f_c' b_w + 0.3A_{ps} f_{pu}/d_u} \quad \text{for } \beta_1 c \geq h_f \quad (7-22)$$

in which case

$$T_f = 0.85 f_c' (b - b_w) h_f \quad (7-23)$$

In the previous expressions, d_p is the effective depth of the prestressing steel. Design examples are given in Reference 7-3.

- b. For members with unbonded prestressing tendons and a span-to-depth ratio of 35 or less (ACI 318)

$$f_{ps} = f_{se} + 10,000 + \frac{f_c'}{100\rho_p}$$

$$\left[f_{ps} = f_{se} + 69 + \frac{f_c'}{100\rho_p} \right] \quad (7-24)$$

but f_{ps} in Eq. (7-24) should not be greater than f_{py} or $(f_{se} + 60,000)$ [$(f_{se} + 410)$].

- c. For members with unbonded prestressing tendons and with a span-to-depth ratio greater than 35 (ACI 318)

$$f_{ps} = f_{se} + \frac{f_c'}{300\rho_p} + 10,000$$

$$\left[f_{ps} = f_{se} + \frac{f_c'}{300\rho_p} + 69 \right] \quad (7-25)$$

but f_{ps} in Eq. (7-25) should not be greater than f_{py} or $(f_{se} + 30,000)$ [$(f_{se} + 205)$].

Nonprestressed reinforcement conforming to Section 3.2, when used in combination with prestressing tendons, may be considered to contribute to the tensile force and may be included in the moment strength calculations at a strength equal to the specified yield strength f_y .

The index of prestressed and nonprestressed reinforcement used for the computation of the moment strength of a member should be such that $c/d_u \leq 0.42$.⁷⁻³ For flanged sections, the steel area should be required to develop the compressive strength of the web only.

When a reinforcement index in excess of that previously recommended is provided, design moment strength should be based on the compression portion of the internal moment resisting couple. The following expressions satisfy the intent of this recommendation:

- a. For rectangular or flanged sections in which the neutral axis is within the flange (ACI 318R):

$$M_n = \left[f_c' b d_p^2 (0.36\beta_1 - 0.08\beta_1^2) \right] \quad (7-26)$$

- b. For flanged sections in which the neutral axis falls outside the flange (ACI 318R):

$$M_n = \left[f_c' b_w d_p^2 (0.36\beta_1 - 0.08\beta_1^2) + 0.85f_c' (b - b_w) h_f (d_p - 0.5h_f) \right] \quad (7-27)$$

The total amount of prestressed and nonprestressed reinforcement should be adequate to develop a factored load at least 1.2 times the cracking load, computed on the basis of the modulus of rupture f_r .

7.3.4.8 Special recommendations for slabs—The minimum area of flexural reinforcement for one-way, nonprestressed slabs in the direction of the span should be as recommended in Section 7.3.4.1. The maximum area of flexural reinforcement for one-way, nonprestressed slabs in the direction of the span should be as recommended in Section 7.3.4.2. The design moment strength ϕM_n of one-way, nonprestressed slabs may be computed as recommended in Section 7.3.4.3. The design moment strength ϕM_n of one-way, prestressed slabs may be computed as recommended in Section 7.3.4.7.

The minimum area of shrinkage and temperature reinforcement for one-way slabs transverse to the direction of the span should be as follows:

Slabs where Grade 40 or 50 deformed bars are used	0.0020
Slabs where Grade 60 deformed bars are used	0.0018

7.3.5 Nonprestressed compression members with or without flexure

7.3.5.1 General requirements—The design of members subject to combined flexure and axial load should be based on stress and strain compatibility using the assumptions given in Section 7.3.3. For prestressed members, refer to Chapter 9. Slenderness effects should be evaluated following the recommendations of Section 7.3.6.

Members subject to compression load only, or to combined axial load and flexural load, should be designed according to the recommendations of Section 7.3.5.3.

7.3.5.2 Limits for reinforcement of compression members—The area of longitudinal reinforcement for compression members should not be less than 0.01 or more than 0.08 times the gross area of A_g of the section.

The minimum number of longitudinal reinforcing bars in compression members should be four for bars within rectangular ties six for bars within circular ties, and six for bars enclosed by spirals conforming to Section 13.3.

For compression members with a larger cross section than required by considerations of loading, a reduced effective

area A_g may be used to determine the minimum longitudinal reinforcing. In no case, however, should this effective area be taken as less than one-half the total area.

7.3.5.3 Compression member strength—The following provisions may be used as a guide to define the range of the load-moment interaction relationship for members subject to axial load only or combined axial load and flexural load.

The design axial load strength ϕP_n of compression members with spiral reinforcement as recommended in Section 13.3 should not be greater than (ACI 318)

$$\phi P_n = 0.85\phi [0.85f_c'(A_g - A_{st}) + f_y A_{st}] \quad (7-28)$$

The design axial load strength ϕP_n of compression members with tie reinforcement as recommended in Section 13.3 should not be greater than (ACI 318)

$$\phi P_n = 0.80\phi [0.85f_c'(A_g - A_{st}) + f_y A_{st}] \quad (7-29)$$

All members subjected to a compression load should be designed for the maximum effects of factored moments and axial loads. The factored axial load P_u at the given eccentricity should not exceed ϕP_n as calculated in Eq. (7-28) or (7-29).

The balanced strain conditions for a cross section are defined in Section 7.3.4.2. For a rectangular section with reinforcement in one or two faces and located at approximately the same distance from the axis of bending, the balanced load strength ϕP_b and balanced moment strength ϕM_b can be computed as follows (ACI 318R):

$$\phi P_b = \phi (0.85f_c' b a_b + A_s' f_{sb}' - A_s f_y) \quad (7-30)$$

and

$$\phi M_b = [0.85f_c' b a_b (h/2 - a_f/2) + A_s' f_{sb}' (h/2 - d) + A_s f_y (h/2 - d_s)] \quad (7-31)$$

where

$$a_b = \left(\frac{87,000}{87,000 + f_y} \right) \beta_1 d$$

$$\left[a_b = \left(\frac{600}{600 + f_y} \right) \beta_1 d \right] \quad (7-32)$$

and

$$f_{sb}' = 87,000 - (d'/d)(87,000 + f_y) \leq f_y$$

$$\left[f_{sb}' = 600 - (d'/d)(600 + f_y) \leq f_y \right] \quad (7-33)$$

The design strength under combined flexure and axial load should be based on stress and strain compatibility using the assumptions given in Section 7.3.3. The strength of a cross

section is controlled by tension when the nominal axial load strength P_n is less than P_b . The strength of a cross section is controlled by compression when the axial load design strength P_n is greater than P_b . The combined axial load and moment strength should be multiplied by the appropriate capacity factor reduction ϕ as recommended in Section 7.3.2.2.

For members subject to combined flexure and compressive axial load, when the design axial load strength ϕP_n is less than the smaller of $0.10 f'_c A_g$ or ϕP_b , the ratio of reinforcement ρ provided should not exceed 0.75 of the ratio ρ_b that would produce balanced strain conditions for the section under flexure without axial load. For members with compression reinforcement, that portion of ρ_b , equalized by compression reinforcement, need not be reduced by the 0.75 factor.

7.3.5.4 Biaxial loading—In lieu of a general section analysis based on stress and strain compatibility for a condition of biaxial flexural loading, the design strength of rectangular members under such loading conditions may be approximated using the charts, tables, and formulas given in Reference 7-4, or the following expressions can be used to approximate the axial design strength of noncircular members subject to biaxial bending⁷⁻⁵

$$\phi P_{nx} = \frac{1}{1/\phi P_{nx} + 1/\phi P_{ny} + 1/\phi P_a} \quad (7-34)$$

when

$$P_u \geq 0.10 f'_c A_g \quad (7-35)$$

or

$$M_{ux}/\phi M_{nx} + M_{uy}/\phi M_{ny} = 1 \quad (7-36)$$

when the applied axial design load

$$P_u < 0.10 f'_c A_g \quad (7-37)$$

7.3.6 Slenderness effects in compression members

7.3.6.1 General—Wherever possible, the design of compression members should be based on a comprehensive analysis of the structure. Such analysis should be a second-order analysis, taking into account the deformation of the structure and the duration of the loads. When axial loads are of sufficient magnitude to reduce stiffness or increase fixed-end moments, such effects should be included.

In lieu of a second-order analysis, the design of compression members can be based on the approximate procedure recommended in the following sections.

7.3.6.2 Unsupported length—For purposes of determining the limiting dimensions of compression members, the unsupported length l_u should be the clear distance between lateral supports, except as recommended in Subsections (a) through (e) below:

- a. In pile bent construction, l_u for the pile should be the clear distance between the lowest lateral support, as de-

scribed in Subsection (c) below, and the lower extremity at which the pile may be assumed to be fixed, depending on the soil conditions.

- b. For compression members supported on spread or pile footings, l_u should be the clear distance between the top of the footing and the underside of the deepest flexural member, framing into the compression member in the direction of potential translation at the next higher level.
- c. For members restrained laterally by struts, ties, or beams, l_u should be the clear distance between consecutive struts in the vertical plane, provided that two such struts should meet the compression member at approximately the same level, and the angle between vertical planes through the struts should not vary more than 15 deg from a right angle. Such struts should be of adequate dimensions and have sufficient anchorage to restrain the member against lateral deflection.
- d. For compression members restrained laterally by struts or beams with brackets used at the junction, l_u should be the clear distance between the lower support or fixity of the base and the lower edge of the bracket, provided that the bracket width equals that of the strut or beam, and is at least one-half the width of the compression member.
- e. Where haunches are present, l_u should be measured to the lower extremity of the haunch in the plane considered.

The length which produces the greatest ratio of length to the radius of gyration of the section should be considered, as well as compatibility with the loading and support conditions.

7.3.6.3 Radius of gyration—The radius of gyration r may be equal to 0.30 times the overall dimension in the direction in which stability is being considered for rectangular members, and 0.25 times the diameter for circular members. For other shapes, r may be computed for the gross concrete section.

7.3.6.4 Effective length factor and lateral stability—The effective length of a compression member should be Kl_u , where the effective length factor K should not be less than (ACI 318)

- a. For compression members braced against side-sway, the effective length factor K should be 1.0, unless analysis shows that a lower value may be used.
- b. For compression members not braced against side-sway, lateral instability should be considered in determining the effective length Kl_u for all structures in which the total translational stiffness of the bracing elements is less than six times the sum of the combined translational stiffnesses of all the compression members in the level under consideration. All other structures may be assumed to be restrained against lateral instability. For structures subject to side-sway, the value of Kl_u should be determined with due consideration of cracking and reinforcement on relative stiffness. When determining the stiffness ratio of beams and columns to obtain K , the beam stiffness should be obtained

using Eq. (7-39), with β_d as zero. In no case should K be less than 1.0.

For compression members braced against side-sway, the effects of slenderness may be neglected when Kl_u/r is less than $34 \cdot 12M_1/M_2$. For compression members not braced against side-sway, the effects of slenderness may be neglected when Kl_u/r is less than 22. For all compression members with Kl_u/r greater than 100, an analysis should be made as defined in Section 7.3.6.1.

For evaluation of slenderness effects, M_1 is defined as the smaller factored end moment, calculated by conventional frame analysis. M_1 is positive if the member is bent in single curvature and negative if bent in double curvature. M_2 is defined as the larger factored end moment, calculated by conventional frame analysis, always positive.

7.3.6.5 Moment magnification-Compression members should be designed using the factored axial load P_u from a conventional frame analysis and a magnified factored moment M_c defined as follows (ACI 318)

$$M_c = \delta_b M_{2b} + \delta_s M_{2s} \quad (7-38)$$

where

$$\delta_b = \frac{C_m}{1 - P_u/\phi P_c} \geq 1.0 \quad (7-39)$$

$$\delta_s = \frac{1}{1 - \Sigma P_u/\phi \Sigma P_c} \geq 1.0 \quad (7-40)$$

and

$$P_c = \pi^2 EI / (Kl_u)^2 \quad (7-41)$$

In the previous expressions, ΣP_u and ΣP_c are the summations for all columns in a story. For frames not braced against side-sway, both δ_b and δ_s should be computed. For frames braced against side-sway, δ_s should be zero. In calculating P_c , K s should be computed according to Section 7.3.6.4(a) for δ_b and according to Section 7.3.6.4(b) for δ_s .

In lieu of a more accurate calculation, EI in Eq. (7-41) may be either

$$EI = \frac{E_c I_g / 5 + E_s I_{se}}{1 + \beta_d} \quad (7-42)$$

or conservatively

$$EI = \frac{E_c I_g / 2.5}{1 + \beta_d} \quad (7-43)$$

where β_d is defined as the ratio of maximum factored dead load moment to maximum factored total load moment, always positive (ACI 318).

In Eq. (7-39) C_m for members braced against side-sway and without transverse loads between supports, may be

$$C_m = 0.6 + 0.4M_1/M_2 \quad (7-44)$$

but not less than 0.4. For all other cases, C_m should be 1.0 (ACI 318).

If the computations show that there is no moment at both ends of a compression member, or that the computed end eccentricities are less than $(0.6 + 0.03h)$ in. [$(15 + 0.03h)$ mm], M_2 in Eq. (7-38) should be based on a minimum eccentricity of $(0.6 + 0.03h)$ in. [$(15 + 0.03h)$ mm] about each principal axis separately. The ratio M_1/M_2 in Eq. (7-41) should be determined as follows (ACI 318):

- When the computed end eccentricities are less than $(0.6 + 0.03h)$ in. [$(15 + 0.03h)$ mm], computed end moments may be used to evaluate M_1/M_2 .
- If computations show that there is essentially no moment at both ends of a compression member, the ratio M_1/M_2 should be equal to one.

When compression members are subject to bending about principal axes, the moment about each axis should be magnified by δ_b and δ_s and computed from corresponding conditions of restraint about that axis. In structures which are not braced against side-sway, the flexural members should be designed for the total magnified end moments of the compression members at the joint.

When a group of compression members on one level comprise a bent, or when they are connected integrally to the same superstructure and collectively resist the side-sway of the structure, δ_b and δ_s should be computed for the member group, as described in Section 7.3.6.5.

7.3.7 Shear strength required-The design of cross sections subject to shear should be based on

$$V_u \leq \phi V_n \quad (7-45)$$

where V_u is the factored shear force at the section under consideration, and V_n is the nominal shear strength computed by

$$V_n = V_c + V_s \quad (7-46)$$

where V_c is the nominal shear strength provided by the concrete in accordance with Section 7.3.8 or 7.3.9, and V_s is the nominal shear strength provided by the shear reinforcement in accordance with Section 7.3.11.

In determining the shear strength V_c whenever applicable, the effects of axial forces due to creep, shrinkage, and temperature changes, should be considered in restrained members, and the effects of inclined flexural compression in variable-depth members may be included.

The maximum factored shear force V_u at supports may be computed in accordance with (c) or (d) below when both of the following conditions (a) and (b) are satisfied (318):

- The support reaction in the direction of the applied shear introduces compression into the end regions of the member.

- b. No concentrated load occurs between the face of the support and the location of critical section as defined below in (c) or (d).
- c. For nonprestressed members, sections located less than a distance d from the face of the support may be designed for the same shear V_u as that computed at a distance d .
- d. For prestressed members, sections located less than a distance $h/2$ from the face of the support may be designed for the same shear V_u as that computed at a distance $h/2$.

For deep flexural members, brackets, corbels, slabs and footings, the recommendations of Section 7.3.14 through 7.3.16 should be followed.

7.3.8 Shear strength provided by concrete for nonprestressed members

7.3.8.1 Simplified strength calculations--Shear strength V_c should be computed by the provisions of (a) through (d) below, unless a more detailed calculation is made (ACI 318).

- a. For members subject to shear and flexure only

$$V_c = 2 \sqrt{f'_c} b_w d \quad (0.17 \sqrt{f'_c} b_w d) \quad (7-47)$$

- b. For members subject to axial compression

$$V_c = 2(1 + 0.005 N_u/A_g) \sqrt{f'_c} b_w d$$

$$[V_c = 0.17(1 + 0.073 N_u/A_g) \sqrt{f'_c} b_w d] \quad (7-48)$$

with N_u/A_g expressed in psi (MPa).

- c. For members subject to significant axial tension, the shear reinforcement should be designed to carry the total shear.
- d. At sections of members where the torsional moment T_u exceeds

$$\phi \left(0.5 \sqrt{f'_c} x^2 y \right) \quad \left[\phi \left(0.04 \sqrt{f'_c} x^2 y \right) \right]$$

$$V_c = \frac{2 \sqrt{f'_c} b_w d}{\sqrt{1 + (2.5 C_t T_u / V_u)^2}}$$

$$\left[V_c = \frac{0.17 \sqrt{f'_c} b_w d}{\sqrt{1 + (2.5 C_t T_u / V_u)^2}} \right] \quad (7-49)$$

where x is the smaller overall dimension, and y is the larger overall dimension of the rectangular cross section.

7.3.8.2 Detailed strength calculations--Alternatively, shear strength V_c may be computed by the more detailed provisions of (e) through (g) below (ACI 318):

- c. For members subject to shear and flexure only

$$V_c = [1.9 \sqrt{f'_c} + 2500 \rho_w (V_u d / M_u)] b_w d$$

$$\{V_c = [0.16 \sqrt{f'_c} + 17.2 \rho_w (V_u d / M_u)] b_w d\} \quad (7-50)$$

but not greater than $3.5 \sqrt{f'_c} b_w d$ or $(0.29 \sqrt{f'_c} b_w d)$. The quantity $V_u d / M_u$ should not be greater than 1.0 for computing V_c by Eq. (7-50), where M_u is the factored moment occurring simultaneously with V_u at the section under consideration.

- f. For members subject to axial compression, Eq. (7-50) may be used to compute V_c with a modified moment M_m , M_m substituted for M_u , and $V_u d / M_u$ not limited to 1.0, where

$$M_m = M_u - N_u(4h - d)/8 \quad (7-51)$$

However, V_c should not be greater than

$$V_c = 3.5 \sqrt{f'_c} b_w d \sqrt{1 + N_u / 500 A_g}$$

$$\left(V_c = 0.29 \sqrt{f'_c} b_w d \sqrt{1 + 0.29 N_u / A_g} \right) \quad (7-52)$$

Quantity N_u/A_g should be expressed in psi (MPa). When M_m as computed by Eq. (7-51), is negative, V_c should be computed by Eq. (7-52).

- g. For members subject to significant axial tension

$$V_c = 2(1 + N_u / 500 A_g) \sqrt{f'_c} b_w d$$

$$[V_c = 0.17(1 + 0.29 N_u / A_g) \sqrt{f'_c} b_w d] \quad (7-53)$$

where N_u is negative for tension. Quantity N_u/A_g should be expressed in psi (MPa).

7.3.9 Shear strength provided by concrete for prestressed members

7.3.9.1 Basic strength calculation--For members with an effective prestress force no less than 40 percent of the tensile strength of the flexural reinforcement, the shear strength V_c should be computed by equation (7-54), unless a more detailed calculation is made (ACI 318)

$$V_c = (0.6 \sqrt{f'_c} + 700 V_u d / M_u) b_w d$$

$$[V_c = (0.05 \sqrt{f'_c} + 4.8 V_u d / M_u) b_w d] \quad (7-54)$$

But V_c need not be less than $2 \sqrt{f'_c} b_w d$ ($0.17 \sqrt{f'_c} b_w d$), nor should V_c be greater than $5 \sqrt{f'_c} b_w d$ ($0.42 \sqrt{f'_c} b_w d$), or the value given in Section 7.3.9.3. The quantity $V_u d / M_u$ should not be greater than 1.0, where M_u is the factored moment occurring simultaneously with V_u at the section considered. When applying Eq. (7-54), d in the quantity $V_u d / M_u$ should be the distance from the extreme compression fiber to the centroid of the prestressed reinforcement.

7.3.9.2 Detailed strength calculations--Alternatively, the shear strength V_c may be computed in accordance with

(a) through (c) below, where V_c should be the lesser of V_{ci} or V_{cw} .⁷⁻³

a. Shear strength V_{ci} should be computed by

$$V_{ci} = 0.6 \sqrt{f'_c} b_w d + V_d + V_i M_{cr} / M_{max}$$

$$(V_{ci} = 0.05 \sqrt{f'_c} b_w d + V_d + V_i M_{cr} / M_{max}) \quad (7-55);$$

but V_{ci} need not be less than

$$1.7 \sqrt{f'_c} b_w d \text{ (} 0.14 \sqrt{f'_c} b_w d \text{)}$$

where

$$M_{cr} = (I/y_t) (6 \sqrt{f'_c} + f_{pe} - f_d)$$

$$[M_{cr} = (I/y_t) (0.5 \sqrt{f'_c} + f_{pe} - f_d)] \quad (7-56);$$

and values of M_{max} and V_i should be computed from the load combination, causing the maximum moment to occur at the section.

b. Shear strength V_{cw} should be computed by

$$V_{cw} = (3.5 \sqrt{f'_c} + 0.3 f_{pc}) b_w d + V_p$$

$$[V_{cw} = (0.29 \sqrt{f'_c} + 0.3 f_{pc}) b_w d + V_p] \quad (7-57)$$

V_{cw} may also be computed as the shear force corresponding to the dead load, plus live load that results in a principal tensile stress of $4 \sqrt{f'_c} (0.33 \sqrt{f'_c})$ at the centroidal axis of the member or at the intersection of flange and web, when the centroidal axis is in the flange. In composite members, the principal tensile stress should be computed using the cross section that resists the live load.

c. In Eq. (7-55) and (7-57), d should be the distance from the extreme compression fiber to the centroid of the prestressed reinforcement or $0.8h$, whichever is greater.

7.3.9.3 Strength reduction due to transfer length and bonding-In pretensioned members, in which the section at a distance $h/2$ from the face of the support is closer to the end of the member than the transfer length of the prestressing tendons, the reduced prestress should be considered when computing V_{cw} . This value of V_{cw} should also be the maximum limit for Eq. (7-54). Prestress force may be assumed to vary linearly from zero at the end of a tendon to a maximum at a distance from the end of the tendon equal to the transfer length. The transfer length may be assumed to be 50 diameters for strand and 100 diameters for single wire (ACI 318).

In pretensioned members, where the bonding of some tendons does not extend to the end of the member, a reduced prestress should be considered when computing V_c . The value of V_{cw} calculated using the reduced prestress should also

be taken as the maximum limit for Eq. (7-54). The prestress force, due to tendons for which bonding does not extend to the end of the member, may be assumed to vary linearly from zero at the point at which bonding commences to a maximum at a distance from this point equal to the transfer length. The transfer length may be assumed to be 50 diameters for strand and 100 diameters for single wire (ACI 318).

7.3.10 Lightweight concrete shear strength-All provisions for shear strength V_c and torsional moment strength T_c are recommended for normal weight concrete. When lightweight aggregate concrete is used, one of the modifications below is recommended (ACI 318):

- When f_{ci} is specified, provisions for V_c and T_c should be modified by substituting $f_{ci}/6.7$ for $\sqrt{f'_c}$ ($0.08 \sqrt{f'_c}$), but the value of $f_{ci}/6.7$ should not exceed $\sqrt{f'_c}$ ($0.08 \sqrt{f'_c}$).
- When f_{ci} is not specified, all values of $\sqrt{f'_c}$ ($0.08 \sqrt{f'_c}$) affecting V_c , T_c , and M_{cr} should be multiplied by 0.75 for "all lightweight" concrete and by 0.85 for "sand-lightweight" concrete. Linear interpolation may be used when partial sand replacement is used.

7.3.11 Shear strength provided by shear reinforcement

7.3.11.1 Types of shear reinforcement-Shear reinforcement may consist of stirrups or closed ties perpendicular to the axis of the member. In addition, for nonprestressed members, shear reinforcement may also consist of:

- Stirrups or closed ties making an angle of 45 deg or more with the longitudinal reinforcement.
- Longitudinal reinforcement with bent portion making an angle of 30 deg or more with the longitudinal tension reinforcement.
- Combinations of stirrups or closed ties and bent longitudinal reinforcement.
- Spirals.

Design yield strength of shear reinforcement should not exceed 60,000 psi (410 MPa).

Stirrups, closed ties, and other bars or wires used as shear reinforcement should extend to a distance d from the extreme compression fiber, and should be anchored at both ends in accordance with Section 13.2, to develop the design yield strength of the reinforcement.

7.3.11.2 Spacing limits for shear reinforcement-The spacing of shear reinforcement placed perpendicular to the axis of the member should not exceed $d/2$ in nonprestressed members, $0.75h$ in prestressed members, or 24 in. (0.60 m).

inclined stirrups and bent longitudinal reinforcement should be spaced so that every 45 deg line, extending toward the reaction from the middepth of the member $d/2$ to the longitudinal tension reinforcement, is crossed by at least one line of shear reinforcement.

When V_s exceeds $4 \sqrt{f'_c} b_w d$ ($0.33 \sqrt{f'_c} b_w d$), the maximum spacings previously given should be reduced by one-half (ACI 318).

7.3.11.3 Minimum shear reinforcement-A minimum area of shear reinforcement should be provided in all reinforced concrete flexural members (both prestressed and nonprestressed), where the factored shear force V_u exceeds

one-half the shear strength provided by the concrete ϕV_c except for:

- a. Slabs and footings.
- b. Beams with total depth not greater than 10 in. (0.25 m), two-and-one-half times the thickness of the flange, or one-half the width of the web, whichever is greater.

The previous minimum shear reinforcement recommendations may be waived if tests show that the required nominal flexural and shear strengths can be developed when shear reinforcement is omitted. Such tests should simulate the effects of differential settlement, creep, shrinkage, and temperature change, based on a realistic assessment of such effects occurring in service (ACI 318).

Where shear reinforcement is recommended as above, or by analysis, and where the factored torsional moment T_u does not exceed

$$\phi (0.5 \sqrt{f'_c} \Sigma x^2 y) [\phi (0.04 \sqrt{f'_c} \Sigma x^2 y)]$$

the minimum area of shear reinforcement for prestressed (except as provided for below) and nonprestressed members should be computed as follows (ACI 318)

$$\begin{aligned} A_s &= 50 b_w s / f_y \\ (\text{i.e., } 0.35 b_w s / f_y) \end{aligned} \quad (7-58)$$

where b_w and s are in in. (mm).

For prestressed members with an effective prestress force not less than 40 percent of the tensile strength of the flexural reinforcement, the minimum area of shear reinforcement may be computed by the lower of Eq. (7-58) or (7-59) (ACI 318);

$$A_v = \frac{A_{ps} f_{pu} s}{80 f_y d} \sqrt{\frac{d}{b_w}} \quad (7-59)$$

Where the factored torsional moment T_u exceeds $\phi(0.5 \sqrt{f'_c} \Sigma x^2 y)$ or $[\phi(0.04 \sqrt{f'_c} \Sigma x^2 y)]$, and where web reinforcement is recommended by this section or by analysis, the minimum area of closed stirrups should be computed as follows (ACI 318)

$$\begin{aligned} A_v V &\cdot 2A_t \cdot 50 b_w s / f_y \\ (\text{i.e., } 2A_t \cdot 0.35 b_w s / f_y) \end{aligned} \quad (7-60)$$

7.3.11.4 Design of shear reinforcement—Where the factored shear force V_u exceeds the shear strength ϕV , shear reinforcement should be provided to satisfy Eq. (7-45) and Eq. (7-46). The shear strength V_s should be computed in accordance with the following paragraphs (ACI 318)

$$V_s = A_v f_y d / s \quad (7-61)$$

where A_v is the area of shear reinforcement within a distance s .

When inclined stirrups are used as shear reinforcement

$$V_s = \frac{A_v f_y (\sin \alpha + \cos \alpha) d}{s} \quad (7-62)$$

When shear reinforcement consists of a single bar or a single group of parallel bars all bent up at the same distance from the support

$$V_s = A_v f_y \sin \alpha \quad (7-63)$$

but not greater than $3 \sqrt{f'_c} b_w d$ ($0.25 \sqrt{f'_c} b_w d$).

When shear reinforcement consists of a series of parallel bent-up bars or groups of parallel bent-up bars at different distance from the support, shear strength V_s should be computed by Eq. (7-62). Only the center three-fourths of the inclined portion of any longitudinal bent bar should be considered effective for shear reinforcement.

Where more than one type of shear reinforcement is used to reinforce the same portion of a member, the shear strength V_s should be computed as the sum of the V_s values computed for the various types.

Shear strength V_s should not be greater than $8 \sqrt{f'_c} b_w d$ ($0.67 \sqrt{f'_c} b_w d$).

7.3.12 Combined shear and torsion strength for nonprestressed members with rectangular, flanged, or box sections

7.3.12.1 General—Torsion effects should be included with shear and flexure, where factored torsional moment T_u exceeds $\phi(0.5 \sqrt{f'_c} \Sigma x^2 y) [\phi(0.04 \sqrt{f'_c} \Sigma x^2 y)]$. Otherwise, torsion effects may be neglected (ACI 318).

For members with rectangular or flanged sections, the sum $\Sigma x^2 y$ should be taken for the component rectangles of the section, but the overhanging flange width used in the design should not exceed three times the flange thickness (ACI 318).

A rectangular box section may be taken as a solid section, if the wall thickness t_w is at least $x/4$. A box section with a wall thickness less than $x/4$, but greater than $x/10$, may also be taken as a solid section, except that $\Sigma x^2 y$ should be multiplied by $4t_w/x$. When h is less than $x/10$, the stiffness of the wall should be considered. Fillets should be provided at interior corners of all box sections (ACI 318).

For a member having thin-walled open sections, consideration of the torsion caused by restrained warping may be necessary (ACI 318).

If the factored torsional moment T_u in a member is required to maintain equilibrium, the member should be designed to carry that torsional moment in accordance with **Section 7.3.12.2** (ACI 318).

In a statically indeterminate structure where reduction of torsional moment in a member can occur due to a redistribution of internal forces, the maximum factored torsional moment T_u may be reduced to $\phi(4 \sqrt{f'_c} \Sigma x^2 y / 3) [\phi(0.33 \sqrt{f'_c} \Sigma x^2 y / 3)]$. In such a case, the correspondingly adjusted mo-

ments and shears in adjoining members should be used in design (ACI 318).

In lieu of a more exact analysis, torsional loading from a slab should be uniformly distributed along the member (ACI 318).

Sections located less than a distance d or b , whichever is less, from the face of the support may be designed for the same torsional moment T_u as that computed at that distance d or b .

7.3.12.2 Torsional moment strength required-Design of cross sections subject to torsion should be based on

$$T_u \leq \phi T_n \quad (7-64)$$

where T_u is the factored torsional moment at the section considered, and T_n is the nominal torsional moment strength computed by

$$T_n = T_c + T_s \quad (7-65)$$

where T_c is the nominal torsional moment strength provided by the concrete in accordance with Section 7.3.12.3, and T_s is the nominal torsional moment strength provided by torsion reinforcement in accordance with Section 7.3. (ACI 318).

7.3.12.3 Torsional moment strength provided by concrete-Torsional moment strength should be computed by

$$T_c = \frac{0.8 \sqrt{f'_c} \Sigma x^2 y}{\sqrt{1 + \left(\frac{0.4 V_u}{C_t T_u} \right)^2}}$$

$$\left[T_c = \frac{0.07 \sqrt{f'_c} \Sigma x^2 y}{\sqrt{1 + \left(\frac{0.4 V_u}{C_t T_u} \right)^2}} \right] \quad (7-66)$$

For members subject to significant axial tension, torsion reinforcement should be designed to carry the total torsional moment, unless a more detailed calculation is made, in which T_c is given by Eq. (7-66) and V_c given by Eq. (7-49) is multiplied by

$$[(1 + N_u/500 A_g)/(1 + 0.29 N_u/A_g)],$$

where N_u is negative for tension (ACI 318).

7.3.12.4 Torsion reinforcement recommendations-Torsion reinforcement, where required, should be provided in addition to reinforcement required to resist shear, flexure, and axial forces.

Reinforcement required for torsion may be combined with that required for other forces, provided that the area furnished is the sum of individually required areas and the most restrictive recommendations for spacing and placement are met.

Torsion reinforcement should consist of closed stirrups, closed ties, or spirals, combined with longitudinal bars (ACI 318). The design yield strength of torsion reinforcement should not exceed 60,000 psi (410 MPa).

Stirrups, closed ties, and other bars used as torsion reinforcement should extend to a distance d from the extreme compression fiber and should be anchored according to Section 13.2 to develop the design yield strength of the reinforcement.

Torsion reinforcement should be provided at least a distance $(d + b)$ beyond the point theoretically required.

The spacing of closed stirrups should not exceed the smaller of $(x_1 + y_1)/4$, or 12 in. (0.3 m) (ACI 318).

The spacing of longitudinal bars not less than #3 (10 mm), distributed around the perimeter of closed stirrups should not exceed 12 in. (0.3 m). At least one longitudinal bar should be provided in each corner of the closed stirrups (ACI 318).

7.3.12.5 Design of torsion reinforcement-Where the factored torsional moment T_u exceeds the torsional moment strength ϕT_c torsion reinforcement should be provided to satisfy Eq. (7-64) and (7-65), where the torsional moment strength T_s should be computed as follows (ACI 318)

$$T_s = (A_t \alpha_t x_1 y_1 f_y) / s \quad (7-67)$$

where A , is the area of one leg of a closed stirrup resisting torsion within a distance s , and $\alpha_t = 0.66 + 0.33 (y_1/x_1)$, but not more than 1.50. Longitudinal bars distributed around the perimeter of the closed stirrups should be provided in accordance with Eq. (7-68) or (7-69). A minimum area of closed stirrups should be provided in accordance with Section 7.3.11.3.

The required area of longitudinal bars A_l distributed around the perimeter of the closed stirrups A , should be computed as follows (ACI 318)

$$A_l = 2A_t (x_1 + y_1) / s \quad (7-68)$$

or by

$$A_l = \left[\frac{400 x s}{f_y} \left(\frac{T_u}{T_u + V_u / (3 C_t)} \right) - 2 A_t \right] (x_1 + y_1) / s$$

$$\left\{ A_l = \left[\frac{2.76 x s}{f_y} \left(\frac{T_u}{T_u + V_u / (3 C_t)} \right) - 2 A_t \right] (x_1 + y_1) / s \right\} \quad (7-69)$$

whichever is greater. The value of A_l computed by Eq. (7-69) need not exceed that obtained by substituting:

$$50 b_w s f_y \quad (0.35 b_w s f_y) \text{ for } 2 A_t,$$

The torsional moment strength T_s should not exceed $4 T_c$.

7.3.13 Combined shear and torsion strength for prestressed members-No codes or specifications presently address torsion strength design for prestressed concrete

members. However, current proposed design procedures, based on model analogies or test results, can provide a rational approach applicable to bridge structures.

Design recommendations based on compression field theory, including a bridge girder design example, are given in [Reference 7-6](#).

Skew bending theory is presented in [Reference 7-7](#), along with a generalized design procedure, and proposed modifications to existing codes to incorporate prestressed concrete.

7.3.14 Shear-friction

7.3.14.1 General-The provisions of this section should be applied where it is appropriate to consider shear transfer across a given plane, such as (ACT 318):

- An existing or potential crack.
- An interface between dissimilar materials.
- An interface between two concretes cast at different times.

The design of cross sections subject to shear transfer, as described in this section, should be based on Eq. (7-45), where V_n is calculated in accordance with the provisions of Section 7.3.14.2.

A crack should be assumed to occur along the shear plane considered. The required area of shear friction reinforcement A_{vf} across the shear plane may be designed using either Section 7.3.14.2 or any other shear transfer design methods that result in a prediction of strength in substantial agreement with the results of comprehensive tests. The provisions of Section 7.3.14.2 should be followed for all calculations of shear transfer strength.

7.3.14.2 Shear-friction design method-When shear-friction reinforcement is perpendicular to the shear plane, the shear strength V_n should be computed as follows (ACI 318)

$$V_n = A_{vf} f_y \mu \quad (7-70)$$

where μ is the coefficient of friction listed below.

When shear-friction reinforcement is inclined to the shear plane, and shear force produces tension in the shear-friction reinforcement, the shear strength should be computed as follows (ACI 318)

$$V_n = A_{vf} f_y (\mu \sin \alpha_f + \cos \alpha_f) \quad (7-71)$$

where α_f is the angle between the shear-friction reinforcement and the shear plane, which should never be less than 30 deg.

For both case, ϕV_n should be equal to or greater than V_u .

The coefficient of friction μ in Eq. (7-70) and Eq. (7-71) should be as follows (ACI 318):

Concrete placed monolithically	1.4 λ
Concrete placed against hardened concrete with the surface intentionally roughened as specified below	1.0 λ
Concrete placed against hardened concrete not intentionally roughened	0.6 λ
Concrete anchored to as-rolled structural steel by headed studs or by reinforcing bars (see below)	0.7 λ

where $\lambda = 1.0$ for normal weight concrete, 0.85 for "sand-lightweight" concrete, and 0.75 for "all-lightweight" concrete. Linear interpolation may be applied when partial sand replacement is used.

Shear strength V_n should not be greater than $0.2f_c'Ac$ ($0.107f_c'Ac$) or $800Ac$ ($5.52Ac$ MPa); in kb (N), where Ac is the area of the concrete section resisting shear transfer. The design yield strength of shear-friction reinforcement should not exceed 60,000 psi (410 MPa).

The net tension across the shear plane should be resisted by additional reinforcement. Permanent net compression across the shear plane may be taken as additive to the force in the shear-friction reinforcement $A_{vf} f_y$, when calculating the required A_{vf} .

Shear friction reinforcement should be appropriately placed along the shear plane and should be anchored to develop the specified yield strength on both sides by embedment, hooks, or welding to special devices.

For the purpose of shear-friction, when concrete is placed against previously placed concrete, the interface for shear transfer should be clean and free of laitance. If μ is assumed equal to 1.0 λ , the interface should be roughened to a full amplitude of approximately $1/4$ in. (6 mm).

When shear is transferred between as-rolled steel and concrete using headed or welded reinforcing bars, the steel should be clean and free of paint.

7.3.15 Horizontal shear design for composite concrete flexural members-Provision should be made for full transfer of horizontal shear forces at contact surfaces of interconnected elements.

7.3.15.1 Calculations for shear-The design horizontal shear stress at any cross section may be computed by

$$v_{dh} = V/(b_d d) \quad (7-72)$$

where d is the depth of the entire composite section.

However, horizontal shear also may be investigated by computing, in any segment not exceeding one-tenth of the span, the actual change in compressive or tensile force to be transferred, and provisions made to transfer that force as horizontal shear between interconnected elements.

7.3.15.2 Allowable shear-Horizontal shear may be transferred at contact surfaces using the permissible horizontal shear stress v_h stated below:

- When minimum ties are provided and contact surfaces are clean and free of laitance, but not intentionally roughened, shear stress v_h should not exceed 36 psi.
- When minimum ties are provided and contact surfaces are clean, free of laitance, and intentionally roughened to a full amplitude of approximately $1/4$ in., shear stress v_h should not exceed 160 psi.
- For each percent of tie reinforcement crossing the contact surface in excess of the minimum specified below, permissible v_h may be increased by $72f_y$, 40,000 psi ($0.492f_y/276$ MPa).

7.3.15.3 Ties for horizontal shear-A minimum area of tie reinforcement should be provided between interconnected elements. Tie area should not be less than $50b_v s/f_y$, and tie

spacing should not exceed four times the least web width of support element, or 24 in. (0.6 m).

Ties for horizontal shear may consist of single bars or wire, multiple leg stirrups, or vertical legs of welded wire fabric (smooth or deformed). All ties should be adequately anchored into interconnected elements by embedment or hooks.

7.3.16 Special shear provisions for deep flexural members—The provisions of this section are recommended for members with l_n/d of less than 5 and loaded at the top or compression face.

The design of deep flexural members for shear should be based on Eq. (7-45) and (7-46), where shear strength V_c should be calculated by Eq. (7-73) or (7-77), and shear strength V_s should be calculated by Eq. (7-75) (ACI 318).

Shear strength V_n for deep flexural members should not be greater than $8\sqrt{f'_c}b_wd$ ($0.67\sqrt{f'_c}b_wd$), when l_n/d is less than 2. When l_n/d is between 2 and 5

$$V_n = .667(10 + l_n/d)\sqrt{f'_c}b_wd$$

$$[V_n = 0.055(10 + l_n/d)\sqrt{f'_c}b_wd] \quad (7-73)$$

The critical section for shear, measured from the face of the support, should be at a distance of $0.15l_n$ for uniformly loaded beams and $0.5a$ for beams with concentrated loads, but not greater than d .

Unless a more detailed calculation is made using Eq. (7-75), V_c should be computed by

$$V_c = 2\sqrt{f'_c}b_wd$$

$$(V_c = 0.17\sqrt{f'_c}b_wd) \quad (7-74)$$

Shear strength V_c may be calculated by

$$V_c = (3.5 - 2.5M_u/V_u d)(1.9\sqrt{f'_c} + 2500\rho_w V_u d/M_u)b_wd$$

$$[V_c = (3.5 - 2.5M_u/V_u d)(0.16\sqrt{f'_c} + 17\rho_w V_u d/M_u)b_wd] \quad (7-75)$$

except that the term $(3.5 - 2.5M_u/V_u d)$ should not exceed 2.5, and V should not be greater than $6\sqrt{f'_c}b_wd$ or $(0.5\sqrt{f'_c}b_wd)$. M_u is the factored moment occurring simultaneously with V_u at the critical section as previously defined.

Where the factored shear force V_u exceeds the shear strength ϕV_c , shear reinforcement should be provided to satisfy Eq. (7-45) and (7-46), where the shear strength V_s should be computed by (ACI 318)

$$V_s = \left[\frac{A_v}{s} \left(\frac{1 + l_n/d}{12} \right) + \frac{A_{vh}}{s_2} \left(\frac{11 - l_n/d}{12} \right) \right] f_y d \quad (7-76)$$

where A_v is the area of shear reinforcement perpendicular to the flexural tension reinforcement within a distance s , and A_{vh} is the area of shear reinforcement parallel to the flexural reinforcement within a distance s_2 .

The area of shear reinforcement A_v should not be less than $0.0015bs_2$, and s should not exceed $d/5$, or 18 in. (0.5 m). The area of shear reinforcement A_{vh} should not be less than $0.0025bs_2$, and s_2 should not exceed $d/3$, or 18 in. (0.5 m). The shear reinforcement required at the critical section, as defined above, should be used throughout the span.

7.3.17 Special shear provisions for brackets and corbels—The provisions of this section are recommended for brackets and corbels with a shear span-to-depth ratio l_d/d , not greater than 1.0, and subject to a horizontal tensile force N_{uc} not greater than Γ_n . The distance l_a should be measured at the face of the support. The depth at the outside edge of the bearing area should not be less than $0.5d$.

The section at the face of the support should be designed to simultaneously resist a shear V_u , a moment [$V_u l_a + N_{uc}(h - d)$], and a horizontal tensile force N_{uc} .

For all design calculations in this section, the strength reduction factor ϕ should be equal to 0.85.

The design of shear-friction reinforcement A_{vf} to resist shear V_u should be in accordance with Section 7.3.14. Shear strength V_n should be limited according to (a) and (b) below (ACI 318):

- For normal weight concrete, V_n should not be greater than $0.2f'_c b_w d$ ($0.017f'_c b_w d$) or $800b_w d$ ($5.52b_w d$), in.-lb (N).
- For “all-lightweight” or “sand-lightweight” concrete, V_n should not be greater than

$$(0.2 - 0.07l_d/d)f'_c b_w d \{ (5.52 + 1.93l_d/d)f'_c b_w d \},$$

$$\text{or } (800 - 280l_d/d)b_w d \text{ in.-lb (N).}$$

The reinforcement A_f to resist the moment [$V_u l_a + N_{uc}(h - d)$], should be computed in accordance with Sections 7.3.3 and 7.3.4.

Reinforcement A_n , to resist tensile force N_{uc} , should be determined from $N_{uc} \leq \phi A_n f_y$. The tensile force N_{uc} should not be less than $0.2V_u$, unless special provisions are made to avoid tensile forces. The tensile force N_{uc} should be regarded as a live load, even when the tension results from creep, shrinkage, or temperature change. The area of primary tension reinforcement A_s should be equal to the greater of $(A_f + A_n)$ or $(2A_{vf}/3 + A_n)$ (ACI 318).

Closed stirrups or ties parallel to A_s , with a total area A_h not less than $0.5(A_s + A_n)$ and spaced no further apart than the smaller of $d/4$ or 12 in. (305 mm) center to center, should be uniformly distributed within the three-quarters of the effective depth adjacent to A_s . The anchorage requirements of Section 13.2.13 should be followed for this reinforcement also.

The ratio $\rho = A_s/bd$ should not be less than 0.04 (f'_c/f_y).

At the front face of the bracket or corbel, the primary tension reinforcement A_s should be anchored by one of the following methods (ACI 318)

- a. By a structural weld to a transverse bar of at least equal size, with the weld designed to develop the specified yield strength f_y of the A_s bars.
- b. By bending the primary tension bars A_s back to form a horizontal loop.
- c. By some other means of positive anchorage.

The bearing area of the load on the bracket or corbel should not project beyond the straight portion of the primary tension bars A_s or beyond the interior face of the transverse anchor bar, if one is provided.

7.3.18 Special shear recommendations for slabs and footings

7.3.18.1 General-The shear strength of slabs and footings in the vicinity of concentrated loads or reactions should be governed by the more severe of the two conditions described in (a) and (b) below (ACI 318):

- a. Beam action for slabs or footings, with a critical section extending in a plane across the entire width, and located at a distance d from the face of the concentrated load or the reaction area. For this condition the slab or footing should be designed in accordance with Sections 7.3.7 through 7.3.11.
- b. Two-way action for slabs or footings, with a critical section perpendicular to the plane of the slab, and located so that its perimeter b_o is a minimum. However, the critical section need not approach closer than $d/2$ to the perimeter of the concentrated load or reaction area. For this condition, the slab or footing should be designed in accordance with Sections 7.3.18.2 and 7.3.18.3.

7.3.18.2 Slabs and footings without shear reinforcement-The design of slabs or footings for two-way action should be based on Eq. (7-42), where shear strength V_n should not be greater than the shear strength V_c computed by Eq. (7-77), unless shear reinforcement is provided in accordance with Section 7.3. For nonprestressed slabs and footings

$$V_c = (2 + 4/\beta_c) \sqrt{f'_c} b_o d$$

$$| V_c \leq 0.08 (2 + 4/\beta_c) \sqrt{f'_c} b_o d | \quad (7-77)$$

but not greater than $4 \sqrt{f'_c} b_o d$ ($0.33 \sqrt{f'_c} b_o d$). β_c is the ratio of long side to short side of the concentrated load or reaction area, and b_o is the perimeter of the critical section as defined above.

7.3.18.3 Slabs and footings with shear reinforcement-It is generally not economically feasible to choose a slab or footing thin enough to require shear reinforcement. However, shear reinforcement consisting of bars may be used in slabs and footings in accordance with (a) through (e) below:

- a. Shear strength V_n should be computed by Eq. (7-46), where the shear strength V_c should be in accordance

with Subsection (d) below, and shear strength V_s should be in accordance with (e) below.

- b. Shear strength V_n should not be greater than $6 \sqrt{f'_c} b_o d$ ($0.5 \sqrt{f'_c} b_o d$), where b_o is the perimeter of the critical section as defined in (c) below.
- c. Shear strength should be investigated at the critical section as defined in Section 7.3.18.1 and at successive sections more distant from the support.
- d. Shear strength V_c at any section should not be greater than $2 \sqrt{f'_c} b_o d$ ($0.17 \sqrt{f'_c} b_o d$), where b_o is the perimeter of the critical section as defined in (c) above.
- e. Where the factored shear force V_u exceeds the shear strength ϕV_c as given in (d) above, the recommended area A_v and the shear strength V_s of the shear reinforcement should be calculated in accordance with Section 7.3.11 and anchored in accordance with Section 13.2.

7.3.19 Transfer of moment to columns-When gravity load, wind, earthquake, or other lateral forces cause transfer of moment at connections of framing elements to columns, the shear resulting from moment transfer should be considered in the design of the lateral column reinforcement.

Lateral reinforcement not less than that computed by Eq. (7-55) should be provided within the connections of the framing elements to the columns, except for connections not part of a primary seismic load-resisting system that are restrained on four sides by beams or slabs of approximately equal depth.

7.3.20 Bearing strength-The design bearing strength of concrete should not exceed $\phi(0.85f'_c A_1)$, except as follows (ACI 318):

- a. When the supporting surface is wider on all sides than the loaded area, the design bearing strength on the loaded area may be multiplied by A_2/A_1 , but not more than 2.
- b. When the supporting surface is sloped or stepped, A_2 may be taken as the area of the lower base of the largest frustrum of a right pyramid or cone, contained wholly within the support, having for its upper base the loaded area, and having side slopes of 1 vertical to 2 horizontal.

This section does not apply to post-tensioning anchorages.

RECOMMENDED REFERENCES

The documents of the various standards-producing organizations referred to in this report are listed below with their serial designation, including year of adoption or revision. The documents listed were the latest effort at the time this report was written. Since some of these documents are revised frequently, generally in minor detail only, the user of this report should check directly with the sponsoring group if it is desired to refer to the latest revision.

American Association of State Highway and Transportation Officials
Standard Specifications for Highway Bridges, Thirteenth Edition, 1983

American Concrete Institute

Recommendations of Joint Task Group of ACI Committees 343 and 348 on Load and Resistance Factors for Concrete Bridges

318-83 Building Code Requirements for Reinforced Concrete

318R-83 Commentary on Building Code Requirements for Reinforced Concrete

American Railway Engineering Association

Manual for Railway Engineering

Prestressed Concrete Institute

MNL-116-85 Manual for Quality Control for Plants and Production of Precast and Prestressed Concrete Products, Third Edition

CITED REFERENCES

7-1. Naaman, Antoine E., "Partially Prestressed Concrete:

Review and Recommendations," *PCI Journal*, V. 30, No. 6, Nov.-Dec. 1985, pp. 30-71

7-2. "Bridge Design Practice-Load Factor," California Department of Transportation, Sacramento, CA, 1983, pp. 2-171 to 2-173.

7-3. Naaman, A. E., and Harajli, M. H., "Evaluation of the Ultimate Steel Stress in Partially Prestressed Flexural Members," *PCI Journal*, V. 30, No. 5, Sept.-Oct. 1985, pp. 54-81.

7-4. Portland Cement Association, "Biaxial and Uniaxial Capacity of Rectangular Columns," EB03 1.01D, Skokie, IL, 1967.

7-5. Portland Cement Association, "Notes on ACI 318-83," EB070.04D, Skokie, IL, 1984.

7-6. Collins, M. P., and Mitchell, D., "Shear and Torsion Design of Prestressed and Nonprestressed Concrete Beams," *PCI Journal*, V. 25, No. 5, Sept.-Oct. 1980, pp. 32-100.

7-7. Hsu, T. T. C., *Torsion of Reinforced Concrete*, Van Nostrand Reinhold Co., New York, 1984.



Completed box girder span at Corpus Christi, Texas (photo courtesy of Texas Highway Department)

CHAPTER 8-SERVICE LOAD ANALYSIS AND DESIGN

8.1-Basic assumptions

8.1.1 Nonprestressed members

For investigation of service load stresses, the straight line theory of stress and strain in flexure should be used and the following assumptions should be made:

- A section plane before bending remains plane after bending. Stress-strain relationship of concrete is a straight line under service loads within permissible service stresses.
- Strain in reinforcement and concrete should be assumed directly proportional to the distance from the neutral axis, except for deep flexural members with overall depth to clear span ratios greater than two-fifths for continuous spans and four-fifths for simple spans, a nonlinear distribution of strain should be considered.
- Tensile strength of concrete should be neglected in flexural calculations of reinforced concrete, except when meeting requirements of Section 8.7.
- Modular ratio $n = E_s/E_c$ may be taken as the nearest whole number, but not less than 6. Except in calculations for deflections, value of n for lightweight concrete should be assumed to be the same as for normal weight concrete of the same strength.

- In doubly reinforced flexural members, an effective modular ratio of $2 E_s/E_c$ should be used to transform compression reinforcement for stress computations. Compressive stress in such reinforcement should not exceed the permissible tensile stress.

8.1.2 Prestressed members-For investigation of stresses at transfer of prestress, at service loads, and at cracking loads, straight line theory may be used with the following assumptions:

- Strain varies linearly with depth through the entire load range.
- Before cracking, stress is linearly proportional to strain.
- At cracked sections, concrete resists no tension.
- In calculations of section properties, the transformed area of bonded reinforcement may be included in pre-tensioned members and in post-tensioned members after grouting.

8.2-Serviceability requirements

Moments, shears, and axial and torsional forces should be obtained by the theory of elastic analysis or as recommended in Chapter 10.

8.2.1 Nonprestressed flexural members-For members designed with reference to load factors and strengths by Chapter 7, stresses at service load should be limited to satisfy the recommendations for fatigue in Section 8.3 and for distribution of reinforcement in Section 8.4. The recommendations for deflection control in Section 8.5 should also apply.

For nonprestressed members designed with reference to service loads and allowable stresses, the serviceability requirements recommended in Section 8.4 and the strength requirements recommended in other chapters of this document may be assumed satisfied, if the service load stresses are limited to the values given in Sections 8.3 and 8.8.

8.2.2 Prestressed members-Design should be based on strength design and on behavior at service conditions at all load stages that may be critical during the life of the structure, from the time the prestress is first applied. Stresses at service conditions should be limited to values given in Section 8.7.

8.3-Fatigue of materials

8.3.1 Reinforcing bars-For straight hot-rolled bars with no welds and with no stress raisers more severe than deformations meeting the requirements of ASTM reinforcing bar specifications, the range between a maximum tension stress and minimum stress caused by live load plus impact, at service load, should not exceed

$$f_f = 21 - 0.33f_{min} + 8(r/h)$$

$$[f_f = 145 - 0.33f_{min} + 55(r/h)] \quad (8-1)$$

where

- f_f = stress range calculated as algebraic difference between maximum stress and minimum stress when tension is positive and compression is negative, ksi (MPa).
- f_{min} = algebraic minimum stress level, tension positive, compression negative, ksi (MPa).
- r/h = ratio of base radius to height of rolled-on transverse deformation; when actual value is not known, 0.3 is recommended (see Fig. 8.3).

Greater stress ranges may be used if determined by fatigue tests on similar bars. These recommendations are based on References 8-1 and 8-2.

For bars containing welds conforming to requirements of AWS D 1.4, the range between a maximum tension stress and minimum stress caused by live load plus impact at service load in the reinforcing element in the vicinity of the weld, should not exceed that allowed above or 18 ksi (124 MPa).⁸⁻¹

Reinforcing bars should not be welded without regard to steel weldability and proper welding procedures.

Fatigue stress limits need not be considered for concrete deck slabs with main reinforcement perpendicular to traffic and designed in accordance with the approximate methods given under Section 10.4.⁸⁻³⁻⁸⁻⁷

8.3.2 Prestressing steel-The stress range in prestressed reinforcement that may be imposed on minimum stress lev-

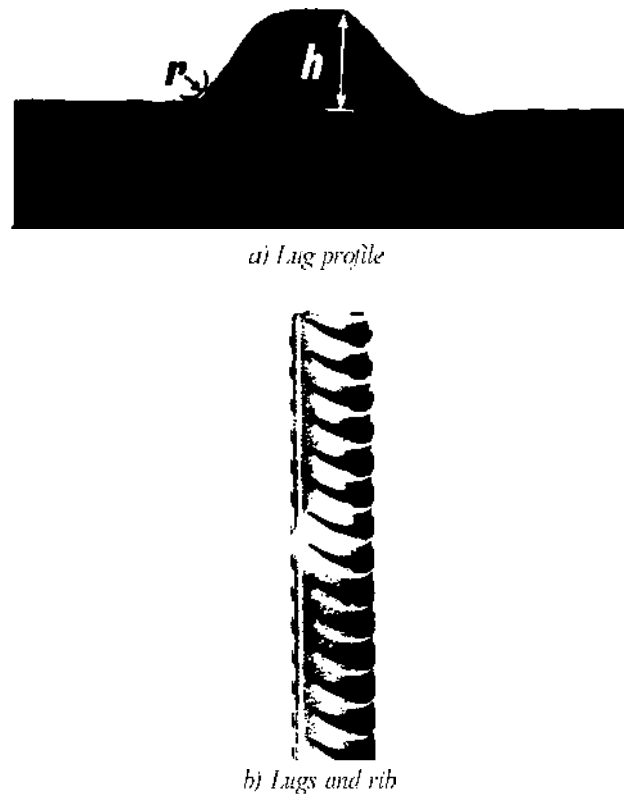

Fig. 8.3-Bar geometry

els up to 60 percent of the tensile strength, should not exceed the following:

Strand and bars	0.10 f_{pu}
Wires	0.12 f_{pu}

where f_{pu} is the ultimate strength of the prestressing steel. For additional information see References 8-2 and 8-8.

8.4-Distribution of reinforcement in flexural members

8.4.1 General-Only deformed reinforcement should be considered effective for principal reinforcement, except that plain bars or smooth wire may be used as spirals or reinforcement ties for confinement. To control flexural cracking of the concrete, tension reinforcement should be well distributed in zones of maximum tension.

When the design yield strength f_y for tension reinforcement exceeds 40,000 psi (276 MPa), cross sections of maximum tension stress should be proportioned so that the calculated stress in the reinforcement at service load f_s in kips/in.^2 (MPa) does not exceed the value computed by

$$f_s = \frac{z}{(d_c A)^{1/3}} \quad (8-2)$$

but f_s should not be greater than 0.6 f_y , where

A = Effective tension area in in.^2 (mm^2) of concrete surrounding the main tension reinforcing bars and having the same centroid as the reinforcement, divided by the number of bars or wires. When the

main reinforcement consists of several bar or wire sizes, the number of bars or wires should be computed as the total steel area divided by the area of largest bar or wire used.

d_c = Thickness of concrete cover measured from the extreme tension fiber to the center of the bar located closest thereto in in. (mm).

The quantity z in Eq. (8-2), should not exceed 175 kips/in. (30.2 MN/m) for members in moderate exposure conditions and 145 kips/in. (23.1 MN/m) for members in severe exposure conditions. Where members are exposed to very aggressive exposure or corrosive environments, such as deicer chemicals, the denseness and nonporosity of the protecting concrete should be increased, or other protection, such as a waterproof protecting system, should be provided in addition to satisfying Eq. (8-2).

8.4.2 T-beam flanges—Where flanges of T-beam construction are in tension, part of the flexural tension reinforcement should be distributed over the effective flange width, as defined in Section 7.2., or a width equal to one-tenth the span, whichever is smaller. If the effective flange width exceeds one-tenth the span, additional longitudinal reinforcement with area not less than 0.4 percent of the excess slab area, should be provided in the outer portions of the flange.

8.4.3 Deep members—If depth d of a member exceeds 36 in. (0.9 m), longitudinal crack control reinforcement should be provided near the side faces of the member and distributed in the zone of flexural tension. Area of reinforcement in in.^2 (mm^2) should be computed by

For depths d less than 100 in. (2.5 m)

$$A_s = 0.00024 (d - 30)A_e$$

$$[A_s = 0.00967 (d - 0.76)A_e] \quad (8-3)$$

For depths d greater than 100 in. (2.5 m)

$$A_s = (0.011 + 0.000058d)A_e$$

$$[A_s = (0.011 + 0.00228d)A_e] \quad (8-4)$$

Table 8—Recommended minimum thickness for constant depth members*

Superstructure type	Minimum depth†	
	ft	m
Bridge slabs with main reinforcement parallel or perpendicular to traffic	$\frac{L+10}{30}$	$\frac{L+3}{30}$
	but not less than 0.542 (0.164)	
T-girders	$\frac{L+9}{18}$	$\frac{L+2.75}{18}$
Box girders	$\frac{L+10}{20}$	$\frac{L+3}{20}$

* When variable depth members are used, table values may be adjusted to account for change in relative stiffness of positive and negative moment sections.

† Recommended values for continuous spans. Simple spans should have about a 10 percent greater depth.

L = Span length of member in ft (m).

where

A_e = Effective tension area of concrete along side face of member surrounding the crack control reinforcement and having the same centroid as that reinforcement with a depth equal to $d/2$.

Crack control reinforcement should be uniformly distributed along the side faces within the middepth $d/2$ on the tension side of the member, with spacing not more than $d/10$ or 12 in. (0.3 m). Such reinforcement may be included in strength computation if a strain compatibility analysis is made to determine stresses in individual bars or wires.⁸⁻⁹

8.5—Control of deflections

8.5.1 General—Flexural members of bridge structures should be designed to have adequate stiffness to limit deflections or any deformations which may adversely affect the strength or serviceability of the structure at service load.

8.5.2 Superstructure depth limitations—The minimum thicknesses stipulated in Table 8.5.2 are recommended, unless computation of deflection indicates that lesser thickness may be used without adverse effects.

8.5.3 Nonprestressed members

8.5.3.1 Computation of immediate deflection—Deflections which occur immediately on application of load should be computed by the usual methods or formulas for elastic deflections. Unless values are obtained by a more comprehensive analysis, immediate deflections should be computed using the modulus of elasticity E_c for concrete as recommended in Section 3.3 for normal or lightweight concrete and using an effective moment of inertia I_e for simple spans given by Eq. (8-3) or in accordance with the approximate method given in Reference 8-10, but not greater than I_g .

$$I_e = (M_{cr}/M_a)^3 I_g + (1 - (M_{cr}/M_a)^3) I_{cr} \quad (8-5)$$

where

I_e = Effective moment of inertia for computation of deflection

I_{cr} = Moment of inertia of cracked section with reinforcement transformed to concrete

I_g = Moment of inertia of gross section about the centroidal axis neglecting the reinforcement

M_a = Maximum moment in member at stage for which deflection is being computed

M_{cr} = Cracking moment = $f_r I_g / y_t$

y_r = Distance from the centroidal axis of gross section, neglecting the reinforcement, to the extreme fiber in tension

f_r = Modulus of rupture of concrete from tests, or if data is not available, the values given in Section 8.7.1 may be used

For continuous spans, the effective moment of inertia may be taken as the average of the values obtained from Eq. (8-3) for the critical positive and negative moment sections.

8.5.3.2 Computation of long-time deflections—In order to obtain the total deflections, the additional long-time deflection for both normal and lightweight concrete flexura

members may be estimated by multiplying the immediate deflection, caused by the sustained load considered, by the factor

$$\lambda = \xi / (1 + 50p') \tag{8-6}$$

where p' , the compression steel ratio, is the value at midspan for simple and continuous spans and at support for cantilevers. Tie-dependent factor ξ for sustained loads may be equal to:

5 years or more	2.0
12 months	1.4
6 months	1.2
3 months	1.0

8.5.4 Prestressed members

8.5.4.1 Computation of immediate deflection-Deflections which occur immediately on application of load should be computed by the usual methods or formulas for elastic deflections, using the moment of inertia of the gross concrete section for uncracked sections.

8.5.4.2 Computation of long-time deflection-The additional long-time deflection should be computed, taking into account the stresses in the concrete and steel under the sustained load, including the effects of creep and shrinkage of the concrete and relaxation of the steel.

8.6-Permissible stresses for prestressed flexural members

8.6.1 Temporary stresses-Flexural stresses in concrete immediately after transfer and before losses due to creep and shrinkage, should not exceed the following stresses based on f_{ci}' , the compressive strength of concrete at the time of initial prestress:

Compression:	
Pretensioned	$0.60f_{ci}$

Post-tensioned

$$0.55f_{ci}$$

Tension in members without bonded auxiliary reinforcement (nonprestressed or prestressed) in the tension zone - $3\sqrt{f_{ci}'} (0.25\sqrt{f_{ci}'})$.

Where the calculated tensile stress exceeds this value, bonded reinforcement should be provided to resist the total tensile force in the concrete, computed on the assumption of an uncracked section. Stress in prestressing steel due to the temporary jacking force should not exceed $0.80f_{pu}$, where f_{pu} is the ultimate strength of the prestressing steel, but not greater than the maximum value recommended by the manufacturer of the steel or of the anchorage.

8.6.2 Service load stresses-Flexural stresses in concrete at service load, after allowance for all prestress losses, should not exceed the following:

Compression - $0.40f_c'$.

Tension in precompressed tension zone:

With bonded auxiliary reinforcement to control cracking - $6\sqrt{f_c'} (0.5\sqrt{f_c'})$.

With bonded auxiliary reinforcement to control cracking, but exposed to corrosive environment or severe exposure conditions - $3\sqrt{f_c'} (0.25\sqrt{f_c'})$.

Without bonded auxiliary reinforcement - 0.

Stresses in pretensioning tendons immediately after transfer or in post-tensioning tendons immediately after anchoring should not exceed $0.70f_{pu}$.

Post-tensioned anchorage stress should not exceed 3000 psi (20.7 MPa).

The permissible stresses previously recommended may be exceeded, if it is shown by tests or analysis that performance will not be impaired.

8.7-Service load design

8.7.1 Flexure-Nonprestressed members may be designed using service loads and allowable stresses. The stresses in

Table 8.7.1-Allowable stresses

Description		Basic value	
		psi	MPa
For normal weight concrete			
Flexure			
Extreme fiber stress in compression	f_c	$0.4f_c'$	$0.4f_c$
Extreme fiber stress in tension (plain concrete)*	f_t	$1.6\sqrt{f_c'}$	$0.13\sqrt{f_c'}$
Modulus of rupture*	f_r	$7.5\sqrt{f_c'}$	$0.62\sqrt{f_c'}$
Shear			
Beams:			
Shear carried by concrete*	v_c	$0.95\sqrt{f_c'}$	$0.08\sqrt{f_c'}$
Maximum shear carried by concrete plus shear reinforcement	v	$5\sqrt{f_c'}$	$0.42\sqrt{f_c'}$
Slabs and footings:			
Shear carried by concrete*	v_c	$1.8\sqrt{f_c'}$	$0.15\sqrt{f_c'}$
Maximum shear carried by concrete plus shear reinforcement	v	$3\sqrt{f_c'}$	$0.25\sqrt{f_c'}$
Bearing on loaded area			
Bearing on loaded area subjected to high edge stresses due to deflection or eccentric loading	f_b f_t	$0.3f_c'$ $0.225f_c'$	$0.3f_c$ $0.225f_c$

*When lightweight aggregate concretes are used, the allowable stresses should be multiplied by 0.75 for "all-lightweight" concrete, and 0.85 for "sand-lightweight" concrete. Linear interpolation may be used when partial sand replacement is used.

concrete and reinforcement in flexure should not exceed the following (see also Table 8.7.1):

Extreme fiber stress in compression f_c $0.40f_c'$
 Extreme fiber stress in tension for
 plain concrete f_t $0.21f_r$
 f_r = modulus of rupture from tests. If data are not available,
 f_r may be assumed to be:

Normal weight concrete $7.5 \sqrt{f_c'} (0.623 \sqrt{f_c'})$
 "Sand-lightweight" concrete $6.3 \sqrt{f_c'} (0.523 \sqrt{f_c'})$
 "All-lightweight" concrete $5.5 \sqrt{f_c'} (0.456 \sqrt{f_c'})$

For a detailed summary of allowable shear stress v_c , see Section 8.7.4.2.

The bearing stress f_b on the loaded area should not exceed $0.30f_c'$, except when the supporting surface is wider on all sides than the loaded area. The allowable bearing stress on the loaded area may be increased by A_2/A_1 , but not by more than 2.

When the supporting surface is sloped or stepped, A_2 may be taken as the area of the lower base of the largest frustum of the right pyramid or cone contained wholly within the support and having for its upper base the loaded area, and having side slopes of 1 vertical to 2 horizontal.

When the loaded area is subjected to high edge stresses due to deflection or eccentric loading, the allowable bearing stress on the loaded area, including any increase due to the supporting surface being larger than the loaded area, should be multiplied by a factor of 0.75.

8.7.2 Development of reinforcement—The calculated tension or compression reinforcement at each section should be developed on each side of that section by proper embedment length, end anchorage, or for tension only, hooks. Development of reinforcement should be computed by procedures recommended in Chapter 13.

8.7.3 Compression members—The combined axial load and moment capacity of compression members should be 35 percent of that computed in accordance with the recommendations of Section 7.3.5.

Slenderness effects should be included according to the recommendations of Section 7.3.6. The term P_u in Eq. (7-36) should be replaced by 2.85 times the design axial load. In using the provisions of Sections 7.3.5 and 7.3.6, ϕ should be 1.0.

8.7.4 Shear

8.7.4.1 General—The design shear stress should be computed by

$$v = \frac{V}{b_w d} \quad (8-7)$$

where b_w is the width of web and d is the distance from the extreme compression fiber to the centroid of the longitudinal tension reinforcement. For a circular section, b_w should be the diameter and d need not be less than the distance from the extreme compression fiber to the centroid of the longitudinal reinforcement in the opposite half of the member. Whenever applicable, effect of torsion should be included in accor-

dance with the recommendations in Reference 8-11 and ACI 318.

When the reaction in the direction of the applied shear introduces compression into the end regions of member, sections located less than a distance d from the face of the support may be designed for the same shear v as that at a distance d .

8.7.4.2 Concrete—The shear stress carried by the concrete v_c should not exceed $0.95 \sqrt{f_c'}$ ($0.08 \sqrt{f_c'}$). When v exceeds v_c , shear reinforcement should be provided.

8.7.4.3 Reinforcement—Shear reinforcement should conform to the general requirements of Section 7.3.7.5. When shear reinforcement perpendicular to the axis of the member is used, the required area should be computed by

$$A_v = \frac{(v - v_c) b_w s}{f_s} \quad (8-8)$$

When $(v - v_c)$ exceeds $2f_c'$ ($0.17 f_c'$), the maximum spacing given in Section 7.3.7 should be reduced by one-half. The maximum shear carried by concrete, plus shear reinforcement, should not exceed $5 \sqrt{f_c'}$ ($0.42 \sqrt{f_c'}$).

8.7.4.4 Deep members—For deep members, brackets, corbels, and walls, the special provisions of ACI 318, Chapter 11 should be used.

8.8-Thermal effects

Stresses or movements due to seasonal and diurnal temperature changes should be provided for in the design as recommended in Article 5.4.

RECOMMENDED REFERENCES

The documents of the various standards-producing organizations referred to in this report are listed below with their serial designation, including year of adoption or revision. The documents listed were the latest effort at the time this report was written. Since some of these documents are revised frequently, generally in minor detail only, the user of this report should check directly with the sponsoring group if it is desired to refer to the latest revision.

American Association of State Highway and Transportation Officials

Standard Specifications for Highway Bridges, Thirteenth Edition, 1983.

American Concrete Institute

318-83 Building Code Requirements for Reinforced Concrete

American Welding Society

D1.4-79 Structural Welding Code for Reinforcing Steel

CITED REFERENCES

8-1. Helgason, T.; Hanson, J. M.; Somes, N. J.; Corley, W. G.; and Hognestad, E., "Fatigue Strength of High-Yield Reinforcing Bars," Report to the Highway Research Board, Na-

tional Cooperative Highway Research Program, Mar. 1975, 371 pp. Also NCHRP Digest No. 73, June 1975, 6 pp.

8-2. ACI Committee 215, "Considerations for Design of Concrete Structures Subjected to Fatigue Loading," *ACI JOURNAL, Proceedings* V. 71, No. 3, Mar. 1974, pp. 97-121.

8-3. Hawkins, N. M., "Fatigue Design Considerations for Concrete Bridge Decks," *ACI JOURNAL, Proceedings* V. 73, No. 2, Feb. 1976, pp. 104-115.

8-4. Rabbat, B. G., et al., "Fatigue Tests of Pretensioned Girders with Blanketed and Draped Strands," *PCI Journal*, V. 24, No. 4, July-Aug. 1979, pp. 88-114 (also PCA RD062.011).

8-5. Helgason, Th., et al., "Fatigue Strength of High-Yield Reinforcing Bars," NCHRP *Report No. 164*, Transportation Research Board, Washington, D.C., 1976, 30 pp. (also PCA RD 045.011).

8-6. Corley, W. G., Hanson, J. M. and Helgason, T., "Design of Reinforced Concrete for Fatigue," *Journal of the*

Structural Division, ASCE, June 1978, pp. 921-932 (also PCA RD059.011).

8-7. "Fatigue of Steel and Concrete Structures," IABSE V. 37, 1982, Lausanne, Switzerland, 895 pp.

8-8. Okada, K., et al., "Fatigue Failure Mechanism of Reinforced Concrete Bridge Deck Slabs," *Transportation Research Record No. 664*, Washington, D.C., 1978.

8-9. Frantz, G. C., and Breen, J. E., "Design Proposal for Side Face Crack Control Reinforcement for Large Reinforced Concrete Beams," *Concrete International*, American Concrete Institute, V. 2, No. 10, Oct. 1980, pp. 29-34.

8-10. Grossman, J. S., "Simplified Computations for Effective Moment of Inertia I_e and Minimum Thickness to Avoid Deflection Computations," *ACI JOURNAL, Proceedings* V. 78, No. 6, Nov.-Dec. 1981, pp. 423-439.

8-11. "Design of Concrete Beams for Torsion: A Design Aid," *PCA Bulletin* EB 106.011, 1983.



Post-tensioned concrete bridge in California cast monolithically with an integrated pier

CHAPTER 9-PRESTRESSED CONCRETE

9.1-Introduction

9.1.1 General-The design of prestressed concrete bridges differs from conventionally reinforced concrete bridges in the use of high-strength steel, generally combined with high-strength concrete, in which stresses are induced prior to the application of external loads. Prestressing of the steel and the concrete improve the behavior and strength of a concrete bridge. Prestressing the steel enables it to work at a higher stress level. Precompressing the concrete delays its cracking. While this active combination of the two materials should yield desirable results, it can also impose certain problems, by aggravating short-term dimensional changes and time-dependent deformations of the bridge.

Most of the principles for the layout of nonprestressed concrete bridges apply to prestressed ones. However, because of the lighter weight of prestressed bridges and the effects of prestressing, new concepts, techniques and methods have been developed for them. This chapter deals with those areas in which prestressed designs differ notably from nonprestressed designs.

9.1.2 Codes-The considerations included herein are essentially extracted from the AASHTO *Specifications for Highway Bridges*, the ACI 318 *Building Code Requirements for Reinforced Concrete* or the AREA *Manual of Railway Engineering*, Chapter 8, and have been extended to permit development of new types of concrete bridges and longer spans. Where conflicts exist between the recommendations of those three codes, or where those three codes are not followed, explanations are generally provided for the reasons underlying the recommendations of this chapter.

9.2-General design considerations

9.2.1 General-Prestressed concrete bridges should be designed by the strength method detailed in Chapter 7 and the service load design method detailed in Chapter 8.

9.2.2 Critical loads-Prestressed concrete bridges should be investigated for stresses and deformations for each load stage that may be critical during construction: stressing, handling, transportation, and erection, as well as during the service life of the bridge.

9.2.3 Crack control-Complete freedom from cracking may or may not be necessary at any particular loading stage. When cracking is permitted under service loadings, the possibility of fatigue failure and tendon corrosion should be investigated in accordance with the criteria recommended in References 9-1 and 9-2.

9.2.4 Deformation stresses-Account should be taken of the effects on adjoining structures of elastic and plastic deformations, deflections, changes in length and rotations caused by the prestressing. When those effects are additive to loading, temperature, and shrinkage effects, the analysis should consider them as acting concurrently. When the prestress in a member affects any other member to be designed by other individuals, the latter should be so informed.

9.2.5 Buckling-The possibility of buckling of a slender member or flange subjected to compressive loading, should be considered.

9.3-Basic assumptions

Basic assumptions for prestressed concrete members for the service load design method are specified in Section 8.1

and in Section 7.3 for the strength method.

$$f_f = f_{po} [1 - e^{-(Kl + \mu\alpha)}] \tag{9-1a}$$

9.4-Flexure, shear

Flexure and shear strength investigations should be made in accordance with Chapter 7.

When $(Kl + \mu\alpha)$ is not greater than 0.3, the following equation may be used

$$f_f = f_{po}(Kl + \mu\alpha) \tag{9-1b}$$

9.5- Permissible stresses

Permissible stresses for concrete and steel at service conditions should be those specified in Section 8.7.

where f_{po} is the stress at the jacking end, K and μ are wobble and curvature coefficients listed in Table 9.6.3.1, l is the length of duct from jacking end to point l , and α is the total angular change of prestressing steel profile from jacking end to point l from the end in radians.

9.6-Prestress losses

9.6.1 General--To accurately determine the effective prestress, allowance should be made for the following sources of prestress loss:

For tendons confined to a vertical plane, α is the sum of the absolute values of angular changes over length l . For tendons curved in three dimensions, the total tridimensional angular change a is obtained by adding, vectorially, the total vertical angular change a_v and the total horizontal angular change a_h . α_v and α_h are the sum of absolute values of angular changes over length l of the projected tendon profile in the vertical and horizontal planes respectively. The scalar sum of a_v and a_h can be used as a first approximation to represent a .

- a. Slip at anchorage.
- b. Friction losses due to intended and unintended curvature in the tendons.
- c. Elastic shortening of concrete.
- d. Creep of concrete.
- e. Shrinkage of concrete.
- f. Relaxation of steel stress.

The amount of prestress loss due to these causes depends on properties of the materials used in the bridge, the environment, and the stress levels at various loading stages. Accurate estimates of prestress loss require recognition that the losses resulting from most sources listed above are interdependent.

When the developed elevation and plan of the tendons are parabolic or circular, the total angular change a can be computed from

$$a = \sqrt{\alpha_v^2 + \alpha_h^2} \tag{9.2a}$$

9.6.2 Anchorage slip--slip at the anchorage affects losses for post-tensioned construction. The magnitude of the slip depends on the prestressing system used and generally does not vary with time. Calculations should be made in accordance with a method (9-3 to 9-6) consistent with recognition of the friction coefficients specified in Section 9.6.3.

where

- a = tridimensional angular change
- α_v = angular change in developed elevation
- α_h = angular change in plan

9.6.3 Friction losses

9.6.3.1 Post-tensioned construction--Friction losses should be based on the wobble and curvature coefficients listed in Table 9.6.3.1, and should be verified during stressing operations. Values of coefficients assumed for design and the acceptable ranges of jacking forces and steel elongations should be shown on the construction drawings. Losses due to friction between the prestressing steel and the duct enclosure should be estimated by the following equations

When the developed elevation and the plan of the tendon are generalized curves, then the tendon can be split up into small intervals and the previous formula can be applied to each interval so that

$$a = \Sigma \Delta \alpha = \sqrt{\Delta \alpha_v^2 + \Delta \alpha_h^2} \tag{9-2b}$$

Table 9.6.3.1-Friction coefficients for post-tensioning tendons*

Type of tendons and sheathing	Wobble coefficient, K		Curvature coefficient H
	per ft	per m	
Tendons in flexible metal sheathing	0.0010-0.0015	0.0033-0.0049	
- wires			0.15-0.25
- 7-wire strands	0.0005-0.0020	0.0016-0.0066	0.08-0.30
- high-strength bars	0.0001-0.0006		
Tendons in rigid and semi-rigid galvanized			
- 7-wire strands	0.0002	0.00066	0.15-0.25
Pregreased tendons	0.0003-0.0020	0.0010-0.0066	0.05-0.15
- wires and 7-wire strands			
Mastic-coated tendons	0.0010-0.0020	0.0033-0.0066	0.05-0.15
- wires and 7-wire strands			

* See also manufacturers' literature or test

Table 9.6.4.1-Elastic and time-dependent losses*

	$f'_c = 4000$ psi (28 MPa)	$f'_c = 5000$ psi (35 MPa)	$f'_c = 6000$ psi (42 MPa)
Pretensioning with strand		45,000 psi (310 MPa)	45,000 psi (310 MPa)
Post-tensioning with strand or wire	32,000 psi (221 MPa)	33,000 psi (228 MPa)	35,000 psi (241 MPa)
Post-tensioning with high tensile bars	22,000 psi (152 MPa)	23,000 psi (159 MPa)	24,000 psi (165 MPa)

* Applies to bridges exposed to average condition with prestress levels inducing maximum stresses close to those specified in Section 8.7.

As a first approximation, the tendon may be replaced by a series of chords connecting nodal points. The angular changes $\Delta\alpha_v$ and $\Delta\alpha_h$ of each chord are obtained from its slope in the developed elevation and in plan.

9.6.3.2 Pretensioned construction-For deflected prestressing tendons, account should be taken of losses occurring at hold-down devices where appropriate.

9.6.4 Elastic and time-dependent losses

9.6.4.1 Approximation of losses-For prestressed nonsegmental bridges with spans up to 120 ft. (37 m), constructed of normal-weight concrete with a strength of 3500 psi (24 MPa) or more at the time of prestressing, the values given in Table 9.6.4.1, mostly taken from the AASHTO specifications, can be used as approximate indicators of elastic shortening and time-dependent losses.

9.6.4.2 Calculation of losses-For stress and strength calculations of prestressed nonsegmental members with spans not greater than 150 ft (46 m) and normal weight concrete with a strength in excess of 3500 psi (24 MPa) at the time of prestress, more realistic values of losses than those given by Section 9.6.4.1 can be determined, as described in the AASHTO *Standard Specifications for Highway Bridges*, that is

Pretensioned construction:

$$\Delta f_p = \Delta f_e + \Delta f_c + \Delta f_r \quad (9-3)$$

Post-tensioned construction:

$$\Delta f_p = 0.5\Delta f_e + 0.8\Delta f_s + \Delta f_c + \Delta f_r \quad (9-4)$$

where

Δf_p = total loss in prestressing steel stress. The value of f_p does not include friction and anchorage slip effects

Δf_e = loss in prestressing steel stress due to elastic shortening

Δf_s = loss in prestressing steel stress due to shrinkage

Δf_c = loss in prestressing steel stress due to creep

Δf_r = loss in prestressing steel stress due to relaxation

Elastic shortening losses Δf_e can be estimated from the formula

$$\Delta f_e = (E_p/E_{ci})f_{cir} \quad (9-5)$$

where

E_{ps} = modulus of elasticity of prestressing strand

E_{ci} = modulus of elasticity of concrete at transfer of stress

f_{cir} = concrete stress at center of gravity of prestressing steel immediately after transfer. For bonded structures of usual design, the f_{cir} value should be at the section or, for continuous construction, the sections of maximum moment. For unbonded construction, the f_{cir} value should be calculated as the stress at the center of gravity of the prestressing steel averaged along the length of the member. Values of f_{cir} should be calculated using a steel stress reduced below the initial value by a margin dependent on elastic shortening, relaxation, and friction effects. For pretensioned members of usual design, steel stress can be $0.63f_{pu}$ for tendons stressed initially to $0.7f_{pu}$. The ultimate strength of the prestressing steel is f_{pu} .

For post-tensioned construction, Δf_e losses can be further reduced below those implied by Eq. (9-5) with proper tensioning procedures, such as stage stressing and retensioning.

Shrinkage losses f_s can be estimated from the formula

$$\Delta f_s = (17000 - 150R) \text{ psi}$$

or

$$(117.2 - 1.034R) \text{ MPa} \quad (9-6)$$

where

R = average annual ambient relative humidity, percent.

Creep losses Δf_c can be estimated from the formula

$$\Delta f_c = 12f_{cir} - 7\Delta f_{cds} \quad (9-7)$$

where

Δf_{cds} = change in concrete stress at center of gravity of prestressing steel due to all dead loads except the dead load acting at the time the prestressing force is applied. Values of Δf_{cds} should be calculated at the same section(s) for which f_{cir} is calculated

Losses due to relaxation of prestressing steel Δf_r can be estimated from the following

Pretensioning with 250 or 270 ksi (1725 or 1860 MPa) stress-relieved strands:

$$\Delta f_r = 20000 - 0.4\Delta f_e - 0.2(\Delta f_s + \Delta f_c), \text{ psi}$$

or

$$[138 - 0.4\Delta f_e - 0.2(\Delta f_s + \Delta f_c), \text{MPa}] \quad (9-8)$$

Post-tensioning with 250 to 270 ksi (1725 or 1860 MPa); stress-relieved strands

$$\Delta f_r = 20000 - 0.3\Delta f_e - 0.44 - 0.2(\Delta f_s + \Delta f_c), \text{psi}$$

or

$$[138 - 0.3\Delta f_f - 0.4\Delta f_e - 0.2(\Delta f_s + \Delta f_c), \text{MPa}] \quad (9-9)$$

Post-tensioning with 240 ksi (1655 MPa); stress-relieved wire

$$\Delta f_r = 18000 - 0.4\Delta f_e - 0.3\Delta f_f - 0.2(\Delta f_s + \Delta f_c), \text{psi}$$

or

$$[124 - 0.4\Delta f_e - 0.3\Delta f_f - 0.2(\Delta f_s + \Delta f_c), \text{MPa}] \quad (9-10)$$

Post-tensioning with 145 to 160 ksi (1000 to 1103 MPa); bars

$$\Delta f_r = 3000 \text{ psi (21 MPa)} \quad (9-11)$$

where

Δf_f = friction loss below the level of 0.70
 f_{pu} computed according to [Section 9.6.3.1](#).

Eqs. (9-8), (9-9), and (9-10) are appropriate for normal temperature ranges only. Relaxation losses increase with increasing temperatures. For prestressing steels with low relaxation properties (ASTM A 416 and E 328), relaxation losses can be a quarter of those given by Eqs. (9-8), (9-9), and (9-10).

9.6.4.3 Losses for deflection calculations—For camber and deflection calculations of prestressed nonsegmental members with spans up to 150 ft. (46 m); and normal-weight concrete with a strength in excess of 3500 psi (24 MPa) at the time of prestress, losses calculated from [Eqs. \(9-5\) and \(9-6\)](#) should utilize values for f_{cir} and f_{cds} , computed as the stress at the center of gravity of prestressing steel averaged along the length of the member.

9.6.4.4 Loss calculations for unusual bridges—For segmental construction, lightweight concrete construction, stage prestressing, spans greater than 150 ft. (46 m) or for bridges where more exact evaluation of prestress losses are desired, calculations should be made in accordance with a method supported by proven research data. Examples include the time-steps method described in [Reference 9-5 and 9-7 to 9-12](#) and the general procedure developed in [Reference 9-13](#). An appropriate method providing most data needed for such calculations is detailed in [Reference 9-1 and 9-14](#). Calculations should preferably utilize data from control tests on the materials to be used, the methods of curing, am-

bient service conditions, and pertinent structural details for the construction. Where such data are not collected, the values prescribed in [Reference 9-1](#) could be used.

9.6.4.5 Effect of nonprestressed reinforcement—The presence of a substantial amount of ordinary nonprestressed reinforcement, such as in partial prestressing, may result in a significant decrease in prestress losses in the steel; it may also lead to an increase in the loss of compression in the concrete caused by prestress losses.⁹⁻¹⁵

9.7-Combined tension and bending

Prestressed concrete tension members, whether or not subjected to bending with or without nonprestressed reinforcement, can be designed by the strength method by applying the equations of equilibrium, considering stress, and strain compatibility and including the effects of prestressing, shrinkage, and creep. The moment produced by deflection and axial tension may be neglected except in very special cases.

Prestressed concrete tension members should be investigated as to stresses and deformations at various loading stages, taking into account the effect of shortening under prestress and recovery under external load. Typical behavior of prestressed concrete tension members is described in [Reference 9-16](#), and various design approaches are developed in [References 9-5, 9-6, 9-9, and 9-17](#).

9.8-Combined compression and bending

Prestressed concrete members under combined compression and bending, with or without nonprestressed reinforcement, can be designed by the strength method based on the same principles and assumptions for members without prestressing by applying the equations of equilibrium, considering stress and strain compatibility and including the effects of prestressing, shrinkage and creep. These members should be investigated as to stresses and deformations at various critical loading stages, taking into account the shortening under prestress and external load. Members for which the total effective prestress force divided by the gross area of the concrete section is less than 225 psi (1.55 MPa), should contain the minimum longitudinal reinforcement specified in [Section 7.3](#). For members with average prestress exceeding 225 psi (1.55 MPa), those minimum requirements can be waived, provided analysis shows adequate strength and stability. Except for walls or piles, all prestressing steel should be enclosed by spirals or closed No. 3 (#10) size lateral ties conforming to the requirements of [Section 13.3](#).

For compression members with kl_d/r values exceeding the limits specified in [Section 7.3](#), an analysis of column strength should be made, taking into account the effect of additional deflection on the moments. Appropriate design methods to account for slenderness effects are described in [Reference 9-2, 9-5 and 9-18 through 9-20](#).

9.9-Combination of prestressed and nonprestressed reinforcement-partial prestressing

Members may be reinforced by a combination of prestressed and nonprestressed reinforcement. Such members

should be designed by the strength method, considering the stress and strain compatibility of the various steels, including the effect of prestressing, shrinkage and creep. Members so designed should be checked for serviceability requirements, particularly with regard to extent of cracking, amount of deflection or camber at various stages of loading, and fatigue. Design methods for service and ultimate loads, as well as for various serviceability criteria can be found in [References 9-21](#) through [9-31](#).

9.10-Composite structures

9.10.1 General—Composite structures in which the deck is assumed to act integrally with the beam should be interconnected in accordance with Section 9.10.2 through 9.10.4 to transfer shear along contact surfaces and to prevent separation of elements.

9.10.2 Shear transfer—Full transfer of horizontal shear forces should be assured at contact surfaces of interconnected elements. Similar to the design for vertical shear ([Section 7.3](#)), the design for horizontal shear transfer should be based on strength requirements in accordance with the following relation

$$V_u \leq V_{nh} \quad (9-12)$$

where V_u is the factored shear force at section considered, ϕ is the strength reduction factor for shear, and V_{nh} is the nominal horizontal shear strength.

9.10.3 Shear capacity—The following values of nominal shear resistance may be assumed at the contact surface of minimum width b_v :

$V_{nh} = 80b_v d$ in pounds ($0.552b_v d$ in MN) when contact surfaces are clean, free of laitance, and intentionally roughened to a full amplitude of at least $\pm 1/4$ in. (± 6 mm).

$V_{nh} = 80b_v d$ in pounds ($0.552b_v d$ in MN) when minimum ties are provided in accordance with Section 9.10.4, and the contact surfaces are clean and free of laitance, but not intentionally roughened.

$V_{nh} = 350b_v d$ in pounds ($2.413b_v d$ in MN) when minimum ties are provided in accordance with Section 9.10.4, and the contact surfaces are clean, free of laitance, and intentionally roughened to a full amplitude off $1/4$ in. (± 6 mm).

When the factored shear force V_u exceeds $350b_v d$ in pounds ($2.413b_v d$ in MN), the design should be in accordance with [Section 11.7](#) of ACI 318, which is based on evaluating shear friction at the interface.

9.10.4 Vertical ties—All web reinforcement should extend into the cast-in-place decks. The minimum total area of vertical ties per linear foot of span should not be less than the area of two No. 3 bars spaced at 12 in. (300 mm). Web reinforcement may be used to satisfy the vertical tie requirement. The spacing of vertical ties should not be greater than four times the average thickness of the composite flange and in no case greater than 24 in. (600 mm).

9.10.5 Shrinkage stresses—In structures with a cast-in-place slab on precast beams, the differential shrinkage tends

to cause tensile stresses in the slab and in the bottom of the beams. Because the tensile shrinkage develops over an extended time period, the effect on the beams is reduced by creep. Differential shrinkage may influence the cracking load and the beam deflection profile. When these factors are particularly significant the effect of differential shrinkage should be added to the effect of loads.

9.11-Crack control

9.11.1 General—Where permissible, tensile stresses under full service live load exceed the values recommended in [Section 8.7](#), or when unbonded construction is used, the provisions of this section on crack control should be applied. The provisions of this section are not applicable to bridges composed of precast segments having epoxy-glued joints. Flexural tensile stresses at joints between adjacent segments should be limited to zero, unless nonprestressed reinforcement is added to balance the tensile stresses as calculated.

9.11.2 Construction using bonded tendons—Flexural tensile stresses for longitudinal bending only, evaluated for full service live load and assuming an uncracked section, should not exceed the following:

For secondary road bridges in noncorrosive environments — $12\sqrt{f'_c}$ psi ($\sqrt{f'_c}$ MPa).

For secondary road bridges in corrosive environments or primary road bridges in noncorrosive environments — $6\sqrt{f'_c}$ psi ($0.5\sqrt{f'_c}$ MPa).

For primary road bridges in corrosive environments — $3\sqrt{f'_c}$ psi ($0.25\sqrt{f'_c}$ MPa).

When using the allowable tensile stresses previously given, the effects of temperature gradients through the members during service should be included in the analysis. Localized stress concentrations should be considered. Sufficient area of bonded steel should be placed in the area of tension to distribute the cracks. An example of analysis for temperature induced stresses can be found in [Reference 9-32](#).

A primary road is one in which full service live load is experienced regularly on an hourly basis and for which a repair would cause a major disruption of traffic. A secondary road is one in which traffic is infrequent and a disruption tolerable. A corrosive environment exists in coastal areas, in wet city smog, and in places where road salt can attack the concrete being considered. These flexural stresses are maximum values imposed for esthetic reasons or for protection of the reinforcement against corrosion. They could be exceeded, provided it is shown by an accurate analysis or by tests that performance will not be impaired.

9.11.3 Construction using unbonded tendons—In order to control and limit cracking of beams with unbonded tendons under occasional overloads, a minimum amount of bonded reinforcement, whether prestressed or not, should be used as follows

$$A_{sa} = \rho A_g \quad (9-13)$$

where A_{sa} is the area of bonded steel (all grades), A_g is the gross area of concrete, and ρ is given by:

$$\rho = 0.0025 - 10^{-6} A, \text{ for } A, \text{ in in.}^2$$

$$\rho = 0.0025 - 0.155 \times 10^{-4} A, \text{ for } A, \text{ in mm}^2 \quad (9-14)$$

The bonded reinforcement should be uniformly distributed over the precompressed tension zone as close as possible to the extreme tension fiber.

The bonded reinforcement may be reduced to that which, in combination with the unbonded tendons, develops a flexural strength equal to that for the same tendons bonded, provided the tensile stress in the member does not exceed $7.5 \sqrt{f'_c}$ psi ($0.62 \sqrt{f'_c}$ MPa), under an occasional overload of $D + 1.2(L + I)$, where I represents impact effects. Tensile stresses from all sources should be considered; in particular, tensile stresses arising from differential temperature distributions, differential shrinkage between composites slabs and girders, support settlement in continuous beams, and local effects due to tendon anchorage.

9.12-Repetitive loads

The possibility of failure of steel reinforcement due to repeated loads should be investigated in regions where flexural cracking is expected at design loads.

9.12.1 Construction using unbonded tendons-In construction with unbonded tendons subjected to repetitive loads, special attention should be given to the possibility of fatigue in the anchorages and couplers.⁹⁻³⁴⁻⁹⁻³⁶ Generally, the stress range in the tendon at the anchorage is quite small and the possibility of fatigue failure is remote unless large deflections are repeatedly produced or the seating of the anchorage is poor.

9.12.2 Diagonal tension-The possibility of inclined diagonal tension cracks forming under repetitive loading at appreciably smaller stresses than under static loading should be considered in the design.⁹⁻³⁴

9.12.3 Fatigue-Pertinent information on the fatigue characteristics of prestressing steels, anchorages, and prestressed beams are summarized in Reference 9-34. Some additional information can be found in Reference 9-5.

9.13-End regions and laminar cracking

9.13.1 Cracking-Cracking results from the flow of tendon stress from a concentrated area at the anchorage to the linear distribution associated with the member. Three types of cracking are possible: bursting or splitting, spalling, and section change.^{9-36,9-37} Bursting or splitting cracks propagate along the tendon axis and initiate at a distance equal to the bearing plate width beneath the loaded surface. Spalling cracks initiate at the end face of the member, some distance removed from the tendon axis, and propagate parallel to the longitudinal axis of the member. Section change cracks result from too sharp a transition from the linear stress distribution necessitated by one section shape to that necessitated by the adjacent section shape. Section change cracks may also be caused by bursting stresses, if the center of the tendon anchorage is located closer than the bearing plate width to a thinner section. Under sustained load, all three crack types

increase in width and length. Additional information on the cracking behavior of post-tensioned girder anchorage zones and their design can be found in References 9-38 and 9-39.

9.13.1.1 Bursting or splitting cracks-For a single tendon anchorage, the possibility of cracking can be readily assessed using information given in many texts.^{9-6,9-8} Data for a single centrally loaded anchorage can be extended to multiple anchorages by assuming each anchorage to act as a single anchorage centrally placed on an area whose semi-axes are defined by the distance to the nearest edge or half the distance to the adjacent anchorage.⁹⁻⁴⁰ The maximum bursting stress should not exceed $6 \sqrt{f'_{ci}}$ psi ($0.5 \sqrt{f'_{ci}}$ MPa) for an end region without reinforcement⁹⁻²⁸ and $\{[(6 \sqrt{f'_{ci}}) + 3000(A_{se}/b_e s_e)] \text{ psi} \{[(0.5 \sqrt{f'_{ci}} + 0.44(A_{se}/b_e s_e)] \text{ MPa}\}$ for a region with reinforcement. A_{se} is the area of each stirrup used as reinforcement, s_e is the spacing of stirrups, and b_e the width of the section in the plane of the potential crack. Bursting reinforcement should extend over the length of the bursting zone for which the computed stress exceeds $4 \sqrt{f'_{ci}}$ psi ($0.33 \sqrt{f'_{ci}}$ MPa). Even where a centrally-loaded bursting zone is well reinforced, the increment of load between the visual observation of a bursting crack and its spontaneous propagation is small; bursting cracks are not likely in pretensioned beams.

9.13.1.2 Spalling cracks-The critical location for spalling cracks should be determined by finding the longitudinal plane on which the difference in moment between that caused by the linear stress distribution in the member and that caused by the stress at the tendon anchorages is a maximum. The possibility of cracking in both horizontal and vertical planes should be considered. Stresses and the amount of reinforcement to control cracking should be determined using the approximate method described in References 9-41 and 9-42 or the more exact procedure described in Reference 9-36. If the stress caused by the difference in moment exceeds $\phi 4 \sqrt{f'_c}$ psi ($\phi .33 \sqrt{f'_c}$ MPa), reinforcement is necessary to control the crack growth, although spalling cracks will not propagate spontaneously until their length exceeds half the specimen depth. Reinforcement to control spalling cracks should be placed within one-fifth of the overall depth of the end of the member from its end, with the end stirrup as close to the end of the beam as practicable. In any member, the amount of spalling reinforcement should be not less than that required to resist 4 percent of the prestressing forces when acting at a unit stress of 20,000 psi (138 MPa). This requirement can be waived if the required force is less than $\phi 12 b_e \sqrt{f'_c}$ ($\phi b_e \sqrt{f'_c}$). Spalling cracks are likely in both post-tensioned and pretensioned beams.

9.13.1.3 Section change cracks-The possibility of section change cracks due to too sharp a section transition should be evaluated using the same procedure as for spalling cracks.⁹⁻³⁷

9.13.1.4 Reinforcement details-Reinforcement to control cracking should consist of closed hoops, extending over the full depth of the member and properly anchored to develop their yield strength within the depth outside the outermost crack. For end-region crack control, a large number of small

diameter stirrups is more effective than a small number of large diameter stirrups.

9.13.2 End blocks-For beams with post-tensioning tendons, end blocks are frequently needed to distribute the large concentrated prestressing forces. Where all tendons are pre-tensioned, end blocks are generally not required and may increase spalling stresses.⁹⁻⁴¹

9.13.3 Bearing under anchorages

9.13.3.1 Maximum stresses-Bearing stresses beneath post-tensioning anchorages should not exceed values calculated from the formulas:^{9-33,9-43,9-44}

a. Immediately after tendon anchoring:

$$f_{cp} - 0.80f_{ci}' \sqrt{A_2/A_1} - 0.2 \leq 1.25f_{ci}' \quad (9-15)$$

b. After allowance of prestress losses:

$$f_{cp} = 0.6f_c' \sqrt{A_2/A_1} \leq f_c' \quad (9-16)$$

where

A_1 = Bearing area of anchor plate of post-tensioning tendon

A_2 = Maximum area of the anchorage surface that is geometrically similar to and concentric with the anchor plate and does not overlap the similar area surrounding an adjacent anchorage

Consideration of the strength reduction factor ϕ is already incorporated in Eq. (9-15) and (9-16).

9.13.3.2 Conical anchorages-Where conical-shaped anchorages are used with surfaces inclined at angles between 70 and 15 deg to the tendon axis, allowable stresses should be based on the maximum area of the anchorage and stresses should be reduced 15 percent below those calculated from Section 9.13.

9.13.3.3 Plate thickness-The thickness of the bearing plate h_a should be greater than that given by the formula⁹⁻⁴⁰

$$h_a = (2f_{ci}'/f_{ya})A_2/A_1 \quad (9-17)$$

where A_1 and A_2 have the values specified in Section 9.13, and f_{ya} is the yield strength of the bearing plate. If a lesser thickness of bearing plate is used, area A_1 in Section 9.13.3.1 should be the area enclosed within a perimeter located a distance h_a outside the perimeter of the anchorage.

9.13.4 Inclined tendons--Large increases in spalling stress occur for small inclinations of the tendon force.⁹⁻⁴⁰ Where cracking is predicted, reinforcement sufficient to control spalling should be provided to carry at its yield strength, 1.3 times the component of the tendon force acting transverse to the surface of the member.

9.13.5 Laminar cracking-In beam flanges and slabs, laminar in-plane cracks may occur, especially in areas having high concentrations of ducts and tendons in either one or two directions. Laminar cracking is due to a substantial reduction in the tensile area of concrete available to resist principal tension resulting from any cause. To reduce the

development and extension of laminar cracks, it is good practice to provide a percentage of through-slab ties of at least 0.1 percent, with 0.2 percent preferred for severe cases. Additional information can be found in Reference 9-45.

9.14-Continuity

9.14.1 General-Continuous beams and other statically indeterminate structures should be designed to possess satisfactory service load behavior and specified safety factors at ultimate load. Behavior should be determined by elastic analysis, taking into account the secondary reactions, moments, shears, axial deformation, due to prestressing, creep, shrinkage, temperature, restraint of attached structural elements and foundation settlement.

9.14.2 Continuous bridges

9.14.2.1 General-For cast-in-place continuous bridges or bridges made continuous by post-tensioning over two or more spans, the effects of secondary moments due to the reactions induced by prestressing should be included in stress calculations for checking serviceability behavior and for design by the service load method. For bonded and unbonded construction, in which sufficient bonded steel is provided at the supports to assure control of cracking (Section 9.11), negative moments due to factored loads, calculated by elastic theory for any assumed loading arrangement, may be increased or decreased by not more than (20 - 47 c/d) percent,⁹⁻⁴⁶ but not more than 20 percent, provided that these modified negative moments are also used for the final calculations of moments at other sections in the span for the assumed loading arrangement. In the previous expression, the value of c is the distance from the extreme compression fiber to the neutral axis, and d is the distance from the extreme compression fiber to the centroid of the tensile force in the steel.

For design by the strength method, the moments to be used should be the algebraic sum of the moments due to the reactions induced by prestressing (with a load factor of 1.0) and the moments, including redistribution effects, due to the service loads multiplied by the strength design load factors specified in Chapter 5.

9.14.2.2 Minimum dead load-In the application of strength design load factors, where the effects of dead and live loads are of opposite sign, the case of a dead load factor of 0.9 should be included in the investigation.

9.14.3 Bridges composed of girders made continuous

9.14.3.1 General-When structural continuity is assumed in calculating live loads, plus impact and composite dead load moments, the effects of creep and shrinkage should be considered in the design of bridges incorporating simple span precast, prestressed girders and deck slabs continuous over two or more spans.

9.14.3.2 Positive moment connection at piers-Provision should be made in the design for the positive moments that may develop in the negative moment region due to the combined effects of creep, shrinkage, and temperature in the girders and deck slab plus the effects of live load plus impact in remote spans. Shrinkage and elastic shortening of the piers should also be considered.

Nonprestressed positive moment connection reinforcement at piers may be designed for a service load stress of 0.6 times the yield strength, but not to exceed 36,000 psi (248 MPa).

9.14.3.3 Negative moments-Negative moment reinforcement should preferably be proportioned by the strength design method.

The effect of initial precompression due to prestress in the girders, may be neglected in the negative moment calculation if the maximum precompression stress is less than $0.4f'_c$, and the continuity reinforcement ratio ρ in the deck slab is less than 0.015.

With long span composite bridges at maximum girder spacing, made continuous for live load through a cast-in-place slab, creep and shrinkage effects may produce negative restraining moments. These effects are to be considered not only at the supports, but throughout the span.

9.14.3.4 Compressive stress at piers under service loads-The compressive stress in ends of girders at interior supports, resulting from the addition of the effects of prestressing and service live load bending, should not exceed $0.60f'_c$.

9.15-Torsion

9.15.1 General-A concrete member under torsion, when prestressed, generally possesses higher resistance against cracking because the axial compression in the member reduces the principal tensile stress. However, the failure of such a member under torsion can be sudden and explosive because of the energy stored in the member. Hence, while prestressing can improve the elastic behavior of a concrete member subjected to torsion, it can also cause an undesirable mode of failure.

9.15.2 Curved bridges-The behavior of a curved bridge under torsion can be improved by prestressing. Prestressing can be designed to reduce the bending of the member, thus leaving a higher reserve strength to carry the torsion. If a simply supported beam has stiff intermediate and end diaphragms, torsional moments can be transferred to the supports. A bridge with redundant reactions could be prestressed to reduce the torsion on the curved structure. For example, a continuous multigirder bridge on a curve with transverse diaphragms can be post-tensioned with more prestress on the outer girders than the inner ones, to apply a counter-torque which reduces the torsion on the bridge.

9.15.3 Design neglecting torsional stiffness-A capacity in excess of that causing torsional cracking can be utilized if torsional stiffness effects are neglected in the analysis for the distribution of the loads to the various resisting elements of the bridge. Adequate torsional capacity should be provided through the addition of nonprestressed steel in the form of ties, spirals, and longitudinal bars. Information on post-cracking torsional behavior and reinforcement requirements for adequate torsional resistance is contained in Ref. 9-47 through 9-50.

9.15.4 Design including torsional stiffness-Where reliance is placed on torsional stiffness effects in the analysis for the distribution of loads to the resisting elements of the

bridge, the maximum principal tensile stress evaluated by elastic theory and for the load factors specified in Section 7.3 should not exceed $\phi 4\sqrt{f'_c}$ psi ($\phi 0.33\sqrt{f'_c}$ MPa). Tensile stresses from all sources should be considered including those arising from differential temperature distributions.

9.16-Cover and spacing of prestressing steel

The minimum concrete cover should be provided according to Section 13.8.

The minimum clear spacing between prestressing tendons should satisfy the requirements of Section 13.7.

9.17-Unbonded tendons

9.17.1 General-In bridge construction, unbonded tendons are used less frequently than bonded tendons (1) because of the difficulty of ensuring adequate corrosion protection, (2) because of the lowering of the ultimate strength relative to that for bonded tendons, (3) because of susceptibility to catastrophic failure, and (4) because wide cracks might develop under overloads unless members are adequately reinforced with additional bonded steel. However, unbonded tendons can be and have been used for prestressed suspension bridges, for box girders where the tendons can be inspected, where safety from corrosion can be insured and where the greater ease of construction has resulted in a more economical structure. When unbonded tendons are used, "Recommendations for Concrete Members Prestressed with Unbonded Tendons," by ACI-ASCE Committee on Prestressed Concrete^{9-35,9-51} can be referred to as a minimum standard, particularly applicable sections which are incorporated in various sections of this report, namely; Corrosion Protection, Section 9.17.2, and Crack Control, Section 9.11.2.

9.17.2 Corrosion protection-To insure corrosion protection, unbonded tendons MUST be properly coated with a material having, as nearly as possible, the following properties:

1. Free from cracks and not brittle or fluid over the entire anticipated range of temperatures (usually taken as -40 F to 160 F) (-40 C to 70 C).
2. Chemically stable for a period of at least 50 years.
3. Nonreactive to chlorides and to material used for casing and sheathing.
4. Noncorrosive for tendons and anchorages.
5. Impervious to moisture.
6. Adherent to tendons.

Sheaths used on unbonded tendons should prevent the intrusion of cement paste and the escape of coating material. They should have sufficient tensile strength and water-resistance to avoid damage and deterioration during transit, storage at job site, and installation.

The anchorage zones of bridges with unbonded tendons should be detailed with special care to avoid deterioration, as well as that of the surrounding concrete, due to road salts and other corrosive agents.

9.18-Embedment of pretensioning strands

Pretensioning strands should be embedded in accordance

with Section 13.2.

9.19-Concrete

9.19.1 Admixtures-Admixtures to obtain high-early strength or to increase the workability of low-slump concrete, meeting the requirements of ASTM C 494, may be used if known to have no injurious effects on the steel or the concrete. Calcium chloride or an admixture containing chloride ions in other than trace amounts should not be used. Sea water should not be used as mixing water.

9.19.2 Strength-Concrete strength required at given ages should be indicated on the construction drawings. The strength at transfer should be adequate for the requirements of the anchorages or of transfer through bond, as well as for camber or deflection requirements. For pretensioned seven-wire strand, the minimum strength at transfer should be 3000 psi (21 MPa); for $3/8$ -in. (9.5-mm) strands and smaller, and 3500 psi (24 MPa) for $7/16$ -in. (11.1-mm) and $1/2$ -in. (12.7-mm) strands. AASHTO recommends the use of a minimum strength at transfer of 4000 psi (28 MPa); for pretensioned members and 3500 psi (24 MPa); for post-tensioned members.

9.20-Joints and bearings for precast members

9.20.1 General-Design and detailing of the joints and bearing should be based on the forces to be transmitted, and on the effects of dimensional changes due to shrinkage, elastic deformation, creep, and temperature. Joints should be detailed to allow sufficient tolerances for manufacture and erection of the members. Permissible ultimate bearing stresses for concrete increase with the confining effects of surrounding concrete and reinforcement, and decrease as the stiffness of the loading plate decreases or the eccentricity of the load area relative to the centroid of the resisting area increases. Bearing stresses should not exceed the values specified in Section 7.3.

9.20.2 Design criteria-Fixed bearings should be detailed to provide for stress concentrations, rotations, and the possible development of horizontal forces by friction, shrinkage, and creep, or other restraints. Expansion bearings should be detailed to provide for stress concentrations, rotations, and 125 percent of the horizontal movements due to elastic shortening, creep, shrinkage, and temperature effects. Desirable characteristics for bearings are specified in AASHTO 1983, Sections 1.5.23 (H) and 1.7.32 through 1.7.38.

9.21-Curved box girders

In curved prestressed box girder construction, the radial tendon forces which are normal to the web plane should be taken into consideration. Local tendon-induced bending, shear, and the force transfer from tendon to flanges should be considered in the design and detailing.

RECOMMENDED REFERENCES

The documents of the various standards-producing organizations referred to in this report are listed below with their serial designation, including year of adoption or revision. The documents listed were the latest effort at the time this re-

port was written. Since some of these documents are revised frequently, generally in minor detail only, the user of this report should check directly with the sponsoring group if it is desired to refer to the latest revision.

American Association of State Highway and Transportation Officials

Standard Specifications for Highway Bridges, Thirteenth Edition, 1983.

American Concrete Institute

318-83 Building Code Requirements for Reinforced Concrete

ACI-ASCE 423 Recommendations for Concrete Members Prestressed with Unbonded Tendons

American Railway Engineering Association

Chapter 8, *Manual for Railway Engineering*

American Society for Testing Materials

A416-85 Specification for Uncoated Seven-Wire Stress-Relieved Steel Strand for Prestressed Concrete

C494-82 Specification for Chemical Admixtures for Concrete

E328-78 Recommended Practice for Stress-Relaxation Tests for Materials and Structures

CITED REFERENCES

9-1. PCI Committee on Prestress Losses, "Recommendations for Estimating Prestress Losses," *PCI Journal*, V. 20, No. 4, July-Aug. 1975.

9-2. Nathan, N. D., "Applicability of ACI Slenderness Computations to Prestressed Concrete Sections," *PCI Journal*, V. 20, No. 3, May-June 1975, pp. 68-85.

9-3. Huang, T., "Anchorage Take-Up Loss in Post-Tensioned Members," *PCI Journal*, V. 14, No. 4, Aug. 1969, pp. 30-35.

9-4. State of California, Division of Highways, *Manual of Bridge Design Practice*, Third Edition, Sacramento, CA, 1983.

9-5. Naaman, A. E., *Prestressed Concrete Analysis and Design Fundamentals*, McGraw-Hill Book Company, New York, 1982, 670 pp.

9-6. Lin, T. Y., and Burns, N. H., *Design of Prestressed Concrete Structures*, Third Edition, John Wiley and Sons, New York, 1981, 646 pp.

9-7. Subcommittee 5, ACI Committee 435, "Deflection of Prestressed Concrete," *Prestressed Concrete Institute*, V. 60, No. 12, Dec. 1963, pp. 1967-1727.

9-8. Libby, J. R., *Modern Prestressed Concrete: Design Principles and Construction Methods*, Third Edition, Van Nostrand Reinhold Co., New York, 1984, 629 pp.

9-9. Nilson, A. H., *Design of Prestressed Concrete*, John Wiley and Sons, New York, 1978, 526 pp.

9-10. Tadros, M. K.; Ghali, A.; and Dilger, W. H., "Time-Dependent Analysis of Composite Frames," *Journal of the Structural Division*, ASCE, V. 103, No. ST4, April 1977, pp. 871-884.

- 9-11. Tadros, M. K.; Ghali, A.; and Dilger, W. H., "Long-Term Stresses and Deformations of Segmental Bridges," *PCI Journal*, V. 24, No. 4, Jul.-Aug. 1979, pp. 66-87.
- 9-12. Scordelis, A., "Analytical Models for Nonlinear Material, Geometric, and Time-Dependent Effects," in *Proceedings*, International Symposium on Nonlinearity and Continuity in Prestressed Concrete, M. Z. Cohn, ed., V. 2, University of Waterloo, Canada, June 1983, pp. 25-43.
- 9-13. Huang, T., "Study of Prestressed Losses Conducted by LeHigh University," *PCI Journal*, V. 27, No. 5, Sept.-Oct. 1982, pp. 48-61.
- 9-14. Zia, P.; Preston, H. K.; Scott, N. L.; and Workman, E. B., "Estimating Prestress Losses," *Concrete International*, V. 1, No. 6, June 1979, pp. 32-38.
- 9-15. Tadros, M. K.; Ghali, A.; and Dilger, W. H., "Effects of Nonprestressed Steel on Prestress Loss and Deflection," *PCI Journal*, V. 22, No. 2, Mar.-Apr. 1977, pp. 50-63.
- 9-16. Wheen, E. J., "Prestressed Concrete Members in Direct Tension," *Journal of the Structural Division*, ASCE, V. 105, No. ST7, July 1973, pp. 1471-1487.
- 9-17. Naaman, A. E., "Optimum Design of Prestressed Tension Members," *Journal of the Structural Division*, ASCE, V. 108, No. ST8, Aug. 1982.
- 9-18. PCI Committee on Prestressed Concrete Columns. "Recommended Practice for the Design of Prestressed Concrete Columns and Bearing Walls," *ACI JOURNAL, Proceedings* V. 21, No. 6, Nov.-Dec., 1976, pp. 16-45.
- 9-19. Alcock, W. J., and Nathan, N. D., "Moment Magnification Tests of Prestressed Concrete Columns," *PCI Journal*, V. 22, No. 4, Jul.-Aug. 1977, pp. 50-61.
- 9-20. Nathan, N. D., "Slenderness of Prestressed Concrete Columns," *PCI Journal*, Vol. 28, No. 2, Mar.-Apr. 1983, pp. 50-77.
- 9-21. Naaman, A. E., and Siriaksom, A., "Serviceability Based Design of Partially Prestressed Beams-Parts 1 and 2," *PCI Journal*, V. 24, No. 2, Mar.-Apr. 1979, pp. 64-89 and V. 24, No. 3, May-June 1979, pp. 40-60.
- 9-22. Naaman, A. E., "A Proposal to Extend Some Code Provisions on Reinforcement to Partial Prestressing," *PCI Journal*, V. 26, No. 2, Mar.-Apr. 1981, pp. 74-91.
- 9-23. Collins, N. P., and Mitchell, D., "Shear and Torsion Design of Prestressed and Nonprestressed Concrete Beams," *PCI Journal*, V. 25, No. 5, Sept.-Oct. 1980, pp. 32-100.
- 9-24. Nawy, E. G., and Huang, P. J., "Crack and Deflection Control of Pretensioned Prestressed Beams," *PCI Journal*, V. 22, No. 3, May-June 1977, pp. 30-43.
- 9-25. Branson, D., and Trost, H., "Application of the I-Effective Method to Partially Prestressed Member Deflection," *PCI Journal*, V. 27, No. 5, Sept.-Oct. 1982, pp. 62-77. (See also discussion in V. 28, No. 6, Nov.-Dec. 1983, pp. 131-136.)
- 9-26. Menn, C., "Partial Prestressing from the Designer's Point of View," *Concrete International*, V. 5, No. 3, Mar. 1983, pp. 52-59.
- 9-27. Naaman, A. E., "Time-Dependent Deflection of Prestressed Beams by the Pressure-Line Method," *PCI Journal*, V. 28, No. 2, Mar.-Apr. 1983, pp. 98-119.
- 9-28. Huber, A. W., "Practical Design of Partially Prestressed Concrete Beams," *Concrete International*, V. 5, No. 4, Apr. 1983, pp. 49-54.
- 9-29. Cohn, M. Z., ed., *Nonlinearity and Continuity in Prestressed Concrete*, *Proceedings of an International Symposium*, University of Waterloo, Canada, July 4-6, 1983.
- 9-30. Tadros, M. K., "Expedient Service Load Analysis of Cracked Prestressed Concrete Sections," *PCI Journal*, V. 27, No. 6, Nov.-Dec. 1982, pp. 86-111. (See also discussion V. 28, No. 6, Nov.-Dec. 1983, pp. 137-158.)
- 9-31. Cohn, M. Z., ed., *Partial Prestressing: From Theory to Practice*, V. 1 and 2, Martinus Nijhoff Publishers, Dordrecht, The Netherlands, 1986.
- 9-32. Elbadry, M. M., and Ghali, A., "Temperature Variations in Concrete Bridges," *Journal of the Structural Division*, ASCE, V. 109, No. 10, Oct. 1983, pp. 2355-2374.
- 9-33. ACI Committee 201, "Guide to Durable Concrete," *ACI JOURNAL, Proceedings* V. 74, No. 12, Dec. 1977, pp. 573-609.
- 9-34. ACI Committee 215, "Guide for Design of Concrete Structures Subjected to Fatigue Loading," *ACI JOURNAL, Proceedings* V. 71, Mar. 1974, pp. 97-121.
- 9-35. ACI-ASCE Committee 423, "Tentative Recommendations for Concrete Members Prestressed with Unbonded Tendons," *ACI JOURNAL Proceedings*, V. 66, No. 2, Feb. 1969, pp. 81-87.
- 9-36. Welsh, W. A., Jr. and Seven, M. A., "Investigation of Prestressed Reinforced Concrete for Highway Bridges, Part V: Analysis and Control of Anchorage Zone Cracking in Prestressed Concrete," *Engineering Experiment Station Bulletin*, No. 497, University of Illinois, Urbana, IL, 1968.
- 9-37. Hawkins, N. M., "The Behavior and Design of End Blocks for Prestressed Concrete Beams," *Civil Engineering Transactions*, Institution of Engineers, Australia, Oct. 1966.
- 9-38. Stone, W. C., and Breen, J. E., "Behavior of Post-Tensioned Girder Anchorage Zones," *PCI Journal*, V. 29, No. 1, Jan.-Feb. 1984, pp. 64-109.
- 9-39. "Design of Post-Tensioned Girder Anchorage Zones," *PCI Journal*, V. 29, No. 2, Mar.-Apr. 1984, pp. 28-61.
- 9-40. Guyon, Y., *Prestressed Concrete*, V. 1, Wiley & Sons, New York, 1953, pp. 127-212.
- 9-41. Gergely, P., and Sozen, M. A., "Design of Anchorage Zone Reinforcement in Prestressed Concrete Beams," *PCI Proposed Revision of ACI 318-63, "Building Code Requirements for Reinforced Concrete," ACI JOURNAL, Proceedings* V. 67, No. 9, Sept. 1970, pp. 700-701.
- 9-42. Marshall, W. T., and Mattock, A. H., "Control of Horizontal Cracking in the Ends of Pretensioned Prestressed Concrete Girders," *PCI Journal*, V. 7, No. 5, Oct. 1962, pp. 56-74.
- 9-43. Hawkins, N. M., "Discussion of Proposed Revision of ACI 318-63, Building Code Requirements for Reinforced Concrete," *ACI JOURNAL, Proceedings* V. 67, No. 9, Sept. 1970, pp. 700-701.
- 9-44. Hawkins, N. M., "The Bearing Strength of Concrete Loaded Through Flexible Plates," *Magazine of Concrete Research*, V. 20, No. 63, June 1968.
- 9-45. Gerwick, Ben C., Jr., "Causes and Prevention of

Problems in Large-Scale Prestressed Concrete Construction," *PCI Journal*, V. 27, No. 3, May-June 1982, pp. 59-75.

9-46. Naaman, A. E., "Partially Prestressed Concrete: Review and Recommendations," *PCI Journal*, V. 30, No. 6, Nov.-Dec. 1985, pp. 30-71.

9-47. Wyss, A. N., and Mattock, A. N., "Full Scale Torsion, Shear, and Bending Tests of Prestressed Girders," *PCI Journal*, V. 23, No. 2, Mar.-Apr. 1978, pp. 22-41.

9-48. McGee, D., and Zia, P., "Prestressed Concrete Under Torsion, Shear, and Bending," *ACI JOURNAL, Proceedings*

V. 73, No. 1, Jan. 1976.

9-49. Zia, P., and Hsu, T. T. C., "Design for Torsion and Shear in Prestressed Concrete," *ASCE Preprint 3424*, ASCE Convention, Chicago, Oct. 1978, 17 pp.

9-50. Mitchell, D., and Collins, M. P., "Detailing for Torsion," *ACI JOURNAL, Proceedings* V. 73, No. 9, Sept. 1976, pp. 506-511.

9-51. ACI-ASCE Committee 423, "Recommendations for Concrete Members Prestressed with Unbonded Tendons," *Concrete International*, V. 5, No. 7, July 1983, pp. 61-76.



Completed Pine Valley Bridge in California post-tensioned segmental construction

CHAPTER 10-SUPERSTRUCTURE SYSTEMS AND ELEMENTS

10.1-Introduction

The type of concrete bridge superstructure to be used can be chosen from a wide variety, and the most suitable choice depends on the geometry of the bridge, the span length, and the method of construction. This chapter describes possible bridge types and discusses their suitability for various situations.

Analysis of the superstructure to determine the displacements, the internal forces, and the reactions may be done using one of various techniques available to the designer. The use of a computer greatly simplifies this task and makes it possible to employ techniques for the analysis which would have been otherwise impractical. The methods of analysis available and the idealized structural models which can be employed for bridges are discussed. Empirical equations which may be used to determine the bending moment and shear in slabs and beams of bridge structures of common types and simple geometry are presented.

10.2-Superstructure structural types

10.2.1 Nonprestressed concrete slab bridges

10.2.1.1 General-In this simplest type of bridge superstructure, the deck slab also serves as the principal load-carrying element. The concrete slab, which may be solid, cored, or ribbed, is supported directly on the substructure.

10.2.1.2 Cast-in-place-A cast-in-place solid slab may be used for spans below 40 ft (12 m). For spans over 40 ft (12 m), voided slabs become more economical by saving weight and materials; circular void forms are normally used. Cast-in-place may be simply supported or continuous spans.

10.2.1.3 Precast-Precast slab decks usually consist of a number of precast voided slab sections placed side by side. The individual slab units are made to act integrally, either by the use of longitudinal shear keys or by casting a concrete slab on top. Precast slabs are usually used for simple spans of less than 50 ft (15 m). Longer spans can be achieved using box sections.

10.2.2 Nonprestressed concrete girder bridges-This type of superstructure consists of a deck slab supported by nonprestressed concrete longitudinal girders. The two most common forms are T-beams and box girders. They are normally cast-in-place concrete, as large precast units are usually limited to prestressed concrete.

The spans may be simply supported or continuous. Simple spans are generally prismatic, but continuous spans may be haunched. Diaphragms are normally provided at piers and abutments. Intermediate diaphragms, particularly at mid-span, may be used to improve load distribution.¹⁰⁻¹

The analysis should take into consideration the interaction, where appropriate, of the axial, flexural, and torsional stiffnesses of the longitudinal girders and transverse components (the transverse components consist of the deck slab and, if present, floor beams and diaphragms). This is particularly important in the case of end spans with large skew angles, especially for multigirder bridges, since the magnitudes of reactions are significantly affected.

10.2.3 Prestressed concrete slab bridges

10.2.3.1 General-Prestressed, cast-in-place, post-tensioned concrete slab bridges are particularly suitable for expressway interchanges, where complex configurations are

frequently required. The inherent torsional stiffness of slabs makes them suitable for curved continuous structures and structures with single column intermediate supports. The prestressed slab can be used over a wide range of spans from solid slabs in the short spans, through round voided slabs in the intermediate range, to rectangular voided slabs in the longer range.

10.2.3.2 Cast-in-place—Cast-in-place prestressed slabs may be used for simple spans, but are more commonly used for continuous spans. For post-tensioned voided slabs, the section should be solid over the piers and the abutment bearings. Transverse post-tensioning of the solid sections at piers with single supports is usually required. This form of construction lends itself to round column piers which can often overcome skew problems in complex interchange layouts. At fixed piers, the slabs are generally cast integral with the piers. At expansion piers, sliding pot bearings are used. Continuous multispan decks can be used to reduce the number of deck expansion joints, thereby minimizing maintenance problems. Such structures on horizontal curves or single column supports require particular attention to torsional stresses.^{10-2,ACI SP-35} Radial movement in horizontally-curved decks may be utilized to reduce or eliminate expansion joints.¹⁰⁻³

In the past, post-tensioned slabs using rigid round void forms have sometimes exhibited longitudinal cracking over the voids.¹⁰⁻³ This has been effectively controlled by using light transverse post-tensioning throughout the length of the bridge, and limiting the longitudinal prestress force to an average value on the cross section of $0.16f_c'$.

10.2.3.3 Precast—Precast pretensioned concrete slabs are used in many of the same applications as precast non-prestressed concrete slabs. They are usually limited to straight square spans and are not adaptable to varied deck geometries. Simple spans may be made partially-continuous for live load in the same way as precast beams or box girders.

10.2.4 Prestressed concrete girder bridges

10.2.4.1 General—Prestressed concrete girder bridges cover a wide range of spans and types. In the short span range, precast AASHTO beams with a composite cast-in-place nonprestressed concrete slab are frequently used for simple spans. A similar form of construction is used for partially-continuous spans using I-girders and box girders in the medium span range. In the medium to long span range, continuous precast segmental box girders are common, while the longest spans are generally cast-in-place segmental box girders.

10.2.4.2 Cast-in-place—For cast-in-place construction, the girders and slab are generally formed together and both cast before formwork and supports are removed. This construction is fully composite for dead load and live load. The usual cross sections are T-beams and box girders. Spans are usually continuous, and transverse post-tensioning of the slab is frequently prescribed to allow the use of thinner slabs or a reduced number of longitudinal girders at a larger spacing. Since longitudinal post-tensioning is required on site, transverse post-tensioning is usually economical and normally used.

The design and analysis items given for reinforced concrete girder bridges also apply to prestressed girder bridges. For the box girder sections, a detailed transverse live load analysis of the section should be carried out. Temperature effects are important for box girders, due to the possibility of large differential temperatures between the top and bottom slabs.¹⁰⁻⁵

For cast-in-place segmental construction built by the balanced cantilever method, a knowledge of the exact construction loads is necessary in order to calculate stresses and deformations at each stage. A knowledge of the creep characteristics of the concrete is essential for calculating deformations after the addition of each segment, and also to calculate the redistribution of moments after completion and final stressing.^{10-1,10-6}

10.2.4.3 Precast—Standard precast prestressed beams cover spans up to the 140 ft (43 m) range. After the beams are erected, forms for the slabs are placed between the beams, and a reinforced concrete slab cast in place. The slab and beams act compositely for superimposed dead load and live load. Intermediate diaphragms are not normally used, and the design and analysis items given for reinforced concrete girder bridges, Section 10.2, also apply to prestressed multi-beam type bridges.

Precast prestressed beams can be made partially continuous for multi-span bridges. This system is not only structurally efficient, but has the advantage of reducing the number of deck joints. Support moments are developed due to superimposed dead load, live load, differential temperature, shrinkage, and creep.¹⁰⁻⁶ Continuity for superimposed dead load and for live load can be achieved by casting diaphragms at the time the deck concrete is placed. Reinforcing steel placed longitudinally in the deck slab across the intermediate piers will resist the tension from negative moments at the supports. At the diaphragms, the bottom flanges of adjacent beams should be connected to resist the tensile stress due to positive moments generated by differential temperature, shrinkage, and creep. Continuous spans, beyond the range of the typical precast girders, normally can be achieved using segmental precast pretensioned girders. These girders, temporarily supported on bents, with joints near points of minimum moment, are post-tensioned for continuity after placement of the deck slab. The maximum lengths of segments are usually determined by shipping length and weight restrictions.

The forms of construction previously described using I-girders can also be utilized for precast box girders. This form of construction is useful when the superstructure construction depth is minimized due to clearance requirements. For short and medium spans, closed boxes with precast top slabs are used, but for long spans, trapezoidal open boxes, with the deck cast in place, are often more economical. This method reduces the weight for handling and shipping.

Precast segmental construction employs single or multiple cell boxes with transverse segments post-tensioned together longitudinally. For medium spans, the segments may be erected for the full span on falsework before post-tensioning. Longer spans are usually erected by the balanced cantilever

method, where each segment is successively stressed after erection. The design and analysis considerations given for cast-in-place segmental construction also apply to precast segmental construction. The deformation of the structure during cantilever erection is dependent upon the time difference between segment precasting and erecting. The design calculations may need to be repeated if the construction schedule differs from that assumed at the design stage.

Elastic analysis and beam theory are usually used in the design of segmental box girder structures. For box girders of unusual proportions, other methods of analysis which consider shear lag should be used to determine the portion of the cross section effective in resisting longitudinal bending. Shear keys should be provided in webs of precast segments to transfer shear forces during erection. Possible reverse shearing stresses in the shear keys should be investigated, particularly in segments near a pier. At the time of erection, the shear stress carried by the concrete section engaged by the shear key should not exceed $2\sqrt{f'_c}$ (0.17 $\sqrt{f'_c}$), unless a more detailed analysis is made in accordance with Section 7.3. The design and construction of segmental bridges is discussed in detail in literature.

10.2.5 Rigid frame bridges

10.2.5.1 General-A rigid frame is a structure consisting of a continuous longitudinal member rigidly connected with the vertical or inclined members which support it. A "rigid connection" is a connection designed to resist and transfer bending moments, shears, and axial forces without relative displacement among the ends of various members meeting at the connection.

Each vertical or inclined member of the frame should be connected to the foundation in a manner that will prevent horizontal movements at the base. Rigid frames should be considered free to sway longitudinally due to the application of loads, unless prevented from movement by specifically designed external restraints.

For the analysis of the frame, column bases should be assumed to be pin-ended or partially fixed, unless the characteristics of the foundations permit them to be designed and constructed as fully fixed. When a pin-end condition is assumed for the analysis of the superstructure, the base of column, footing, and piling should be designed to resist the moment resulting from an assumed degree of restraint, compatible with the column to footing connection, type of footing, and the characteristics of the foundation material.

The influence of longitudinal forces, changes in temperature, shrinkage, and the yielding, horizontally and vertically, of foundations can be of critical importance. It is necessary to give proper attention to important changes in the moment of inertia of the frame elements, as they may be cracked or noncracked. In determining the elastic response of the frame, the moment of inertia of the entire superstructure cross section and that of the full cross section of the bent or pier should be used.

10.2.5.2 Types of rigid frames-For a solid slab structure, the slab may be of uniform thickness throughout. Alternatively, the slab thickness may be increased at the supports

by the introduction of haunches, or the soffit of the slab may be curved or be formed of a number of straight segments.

T-beam or box girder cross sections reduce the dead load bending moments throughout the structure, but are only economical for longer spans.

In general, skew frames should be analyzed in three dimensions. The finite strip or finite element methods are recommended for this analysis. For preliminary design purposes, the frame may be treated as a right angled frame with the calculated moments and thrusts multiplied by a factor equal to the square of the secant of the skew angle.

The reinforcement at the obtuse corners of skew frames should receive special consideration. A skew angle greater than 50 deg (0.87 rad) is impractical for rigid frame-type bridges.

10.2.6 Arch bridges

10.2.6.1 General-Arch spans are not suitable for most bridge locations, due to geometry restrictions or lack of a firm foundation. Fixed arch spans should not be considered unless the foundation's conditions, which prevail at the site, provide the required resistance to the arch reactions. At sites where falsework may be difficult to construct, precast segmental construction using tie-backs should be considered.

On spans less than 100 ft (30 m), the arch geometry should be such that the axis of the ring conforms to either the equilibrium polygon for full dead load, or the equilibrium polygon for full dead load, plus one-half live load over the full span, whichever produces the smallest bending stresses. On short spans the deflection of the arch axis is small and the secondary moments (represented by the thrust times the deflection) may be neglected in the arch design.

On spans over 100 ft (30 m), it is imperative that the arch centroidal axis coincides with the equilibrium polygon for full dead load. Any live load system will disturb the above equilibrium polygon and cause an elastic deflection of the rib. This deflection creates additional moments which cause further deflection, thus creating still more moments. If the rib is too flexible, the arch ring may not be able to regain equilibrium and will fail radially by buckling. To prevent this type of failure, the arch ring should be designed for the ultimate load and moments including the elastic and deflection effects. For a complete analysis, consideration should be given to elastic shortening, creep, shrinkage, temperature, variation in modulus of elasticity, and all other effects that may change the length of the arch rib.

Arch ribs should be investigated for resistance against transverse buckling. For buckling in the transverse direction, it may be assumed that the arch rib is a straight column with a length equal to the span and an axial load equal to the horizontal thrust. The resistance to buckling can be based on column design criteria.

10.2.6.2 Types-The spandrel arch may be either the open spandrel column-type or the filled spandrel-type. In lieu of a complete analysis of the entire structure, an open spandrel arch may be designed for concentrated loads applied at the points of spandrel support. The amount of live load concentration at each point should be determined from the live load on the roadway deck, placed to produce maxi-

mum stress at the section under consideration. In filled spandrel construction, the equivalent uniform live load or distributed axle load may be used for the arch design.

The three-hinged arch is statically determinate and is recommended for short spans. The hinges may be reinforced concrete or steel-pinned shoes. Concrete hinges are esthetically preferable, since they are hardly noticeable compared to steel hinges. Full fixity at the foundations may be assumed if these are sufficiently rigid and the dead load reaction produces a soil pressure as uniform as possible at the base of the foundations.

10.2.7 Truss bridges-Vierendeel trusses are preferred to triangular trusses in order to avoid congestion of reinforcement at joints. Vierendeel trusses may have parallel chords or inclined upper chords in through bridges. Because of their greater depth, the deflection of Vierendeel trusses is usually smaller than that of girder bridges of similar span length. Because of the smaller bending stresses, inclined end posts are preferred over upright end posts. Panels having lengths greater than the truss height are generally more economical than square or upright arrangements. In the analysis of Vierendeel trusses, the entire structure should be considered a rigid frame to determine the axial, flexural, and shear loads in each member. Vierendeel trusses with upper or lower lateral systems should be analyzed as rigid space frames.

Members of Vierendeel trusses may be precast in a plant and field-jointed. The availability of high-strength concrete, high-strength reinforcing bars, and prestressing strands makes this type of bridge adaptable to moderately long spans, but it is not a common form of construction.

10.2.8 Cable-stayed bridges

10.2.8.1 General-Cable-stayed bridges are not economical for spans below 500 ft (150 m). The cable-stayed span is characterized by the straight, inclined cables which support the deck system at one or several locations.¹⁰⁻¹⁵

Short spans may be analyzed by the linear elastic theory. Cable-stayed bridges may behave nonlinearly for two reasons: (a) the stiffness of the cables is dependent upon their tension and their length, which in turn affects the sag of the cable; (b) the displacements of the structure may be too large to be ignored in the analysis. Successive approximations can be used for the analysis. The displacements are first calculated by a linear analysis using the original geometry. This is followed by a new linear analysis using deformed geometry based on the results of the first analysis. This is repeated until the displacements do not change appreciably. Three or four iterations are usually sufficient.¹⁰⁻¹⁴

Cable-stayed bridges generally have satisfactory aerodynamic characteristics, but the suspended spans should be designed to minimize the generation of vertical and torsional oscillations. The aerodynamic stability may need to be checked by wind tunnel model tests.

10.2.8.2 Stiffening system--The stiffening system and the cable supporting system share loads, depending on their relative stiffness and the amount of live load superimposed on the bridge. Hence, the stiffness factors should be carefully determined to avoid errors in the stress determination. Under dead load and median temperature, the stiffening system

may be assumed to be supported by the bearings and cable supports. Live load and effects of change in temperature are resisted by nonyielding supports at the bearings and yielding supports at the cable connections. The added longitudinal compression in the stiffening element due to the horizontal component of the force in the stays should be considered and can be utilized as a prestressing force.

10.2.8.3 Towers-The towers supporting the stay cables may be one of the following types:

- a. Twin vertical or inclined legs with one or more cross struts to provide lateral stability. This type is required where two planes of cables are used.
- b. Twin inclined legs meeting at a common apex. This type is used for single plane cable systems or where a double cable system is splayed horizontally from the tower.
- c. A single vertical leg tower, used only for single plane cable systems.

For any of the above types, the towers may be hinged or fixed at the base. Fixed bases are more common because temporary fixing systems are not needed during erection. On the other hand, a fixed base produces substantial longitudinal bending moments in the tower legs due to longitudinal movements of the top of the tower.

10.2.8.4 Cable systems-The stay cable system may be in single or double planes. A variety of fan or harp configurations may be used.¹⁰⁻¹⁶

The individual cables may be of the following types:

- a. Parallel wire construction. A series of parallel wires make up the circular-shaped cross section of the cable.
- b. Parallel strand, closed construction. A series of helically wound strands, either singly or, more commonly, in parallel, make up the circular shape of the cable cross section.

In cable-stayed spans where the suspension system is virtually straight, concrete encasement of the cable should be considered. This encasement serves to protect the cable from corrosion, and also to reduce live load deflections, hence providing added safety against fatigue stresses at the end connections. However, to fully realize these benefits, the cable should be pretensioned prior to the concrete encasement to such a level that tensile stress will not develop in the concrete under the full combined dead and live loads.

The design of the cable-stay system should take into account not only the axial dead load, live load, and temperature stresses, but also the flexural stresses in the cable which could initiate fatigue failure. These flexural stresses normally originate at points of curvature change and movement.

10.2.9 Suspension bridges

10.2.9.1 General-Suspension bridges with concrete towers, decks, and stiffening systems are less common than cable-stayed bridges, but may be economical for spans over 500 ft (150 m) in special circumstances.^{10-16,10-17} The suspension bridge has vertical hangers connecting the suspension cables to the stiffening system. The cables may be self-anchored to the deck or supported by independent concrete anchorages.

Deflections for similar span lengths are greater than for cable-stayed bridges. Suspension bridges should always be analyzed by nonlinear deflection theory methods.

Suspension spans should be designed to minimize the generation of vertical and torsional oscillations from wind, and aerodynamic stability should be checked by wind tunnel model tests.

10.2.9.2 Stiffening system--The stiffening system distributes the live load to the hangers and is stressed primarily by live load, temperature, and wind. The dead load stress is small, resulting only from spanning the short distance between hangers.

The stiffening system and deck are normally combined by the use of box girders, or solid or voided concrete slabs. The stiffening system may be constructed by the segmental method. If the cable system is self-anchored, the added longitudinal compression in the stiffening system and deck should be considered.

10.2.9.3 Towers--There are always two cables, therefore, the towers are the twin leg-type with one or more cross struts, and are usually fixed at the base.

10.2.9.4 Suspension system--The main cables may be of parallel wire, parallel strand, or helical strand construction. The helical strands should be prestretched before erection. The strands usually are formed into circular cables, but may be open-type, where the strands are separated into an open box-like shape by means of spacers. All wires should be galvanized.

The hangers are usually galvanized wire ropes or bridge strands socketed at both ends.

10.3-Methods of superstructure analysis

10.3.1 General--The analysis of bridge superstructures is normally based on elastic or model analysis methods. All sections should be proportioned to resist the forces determined from the results of the analysis. The analysis should recognize stresses occurring from temperature, shrinkage, creep, method of construction, transport and handling of units, prestress, and other conditions which may affect the design. Empirical methods may be employed for superstructures of common types and simple geometry as specified in Sections 10.4 and 5.

10.3.2 Elastic methods--The forces present in the component parts of the superstructure should normally be established in accordance with a recognized elastic analysis, except when an empirical method of analysis applies. The available elastic analytical methods considered suitable for bridge analysis are:

- Simplified methods. The beam analogy, in which the superstructure is analyzed assuming it to be a beam for evaluating longitudinal moments and shears, should be restricted to simple structures. For structures of variable width, substantial horizontal curvature, or with skew angles exceeding 20 deg (0.35 rad), this method should be used for preliminary design only.
- Refined methods. The following general methods can be applied to more complex structures: grillage analo-

gy, folded plate, orthotropic plate theory, finite strip, and finite element methods.^{10-7-10-9,10-19,10-20}

The most suitable method of analysis should be selected for the solution of each particular problem. The accuracy of the results obtained depends on how closely the assumptions inherent in the method of analysis conform to the actual structure.

10.3.3 Model analysis--If analytical methods cannot be used or if adequate facilities are readily available, model testing should be considered. Model testing may be used to advantage when skew or irregularly shaped superstructures are required.^{10-21 and ACI SP-24} The modeling material may be plastic, microconcrete, or other material which adequately approximates the behavior of the prototype. The effect of scale should be considered.

10.3.4 Nonlinear methods--Suitable nonlinear methods are not generally used for analysis of the usual types of structure. Special structural types such as cable stayed and suspension bridges, however, may require nonlinear methods in order to give satisfactory results.

10.4-Design of deck slabs

10.4.1 General--This section covers thin deck slabs supported by beams for highway bridges, and deck slabs which are the longitudinal load carrying members. A deck slab may be designed by any procedure satisfying the conditions of equilibrium and geometrical compatibility, provided it is shown that the strength furnished is at least that required by the criteria of Chapter 7, and that the design meets the serviceability criteria of Chapter 8.

In the case of beam-supported thin deck slabs having appropriate confinement in the plane of the slab, an allowance may be made for the favorable effect of arching action on slab strength.¹⁰⁻²²⁻¹⁰⁻²⁷ Where arching action cannot be included, the following empirical methods may be used.

10.4.2 Empirical methods

10.4.2.1 Limitations--The method described here applies to monolithic concrete deck slabs carrying highway loads (AASHTO-1983). It should not be used where the skew angle exceeds 20 deg (0.35 rad).

For greater skew, the slab design should be based on model tests, a rational analysis based on principles of the theory of plates, or other methods.^{10-20,10-28-10-30} The reinforcement at the obtuse corners of skew spans should receive special consideration.¹⁰⁻³¹

10.4.2.2 One-way slab--The design of one-way slabs¹⁰⁻²⁰ should be based on the analysis of a strip of unit width at right angles to the supports considered as a rectangular beam. Bending moment per unit width of slab, due to a standard truck load, should be calculated according to empirical formulas given below, unless more exact methods are used. In the following:

- M = live load moment per foot width of slab, in ft-lb (kNm/m)
- e_n = clear span length of slab, in ft (m);
- E = effective width of slab resisting a wheel or other concentrated load, in ft (m)

P = load on one rear wheel of truck, in lbs (N): 12,000 lbs for HS 15 loading (54 kN), 16,000 lbs for HS 20 loading (72 kN);

- a. Main reinforcement perpendicular to traffic [spans 2.0 to 24 ft (1.7 to 7.3 m), inclusive]. The live load moment for simple spans should be determined by the following formula

$$M \text{ (lb ft/ft)} = (e_n \text{ (ft)} + 2) P \text{ (lb)}/32$$

$$[M \text{ (kNm/m)} = (e_n \text{ (m)} + 0.61) P \text{ (kN)}/9.7]$$

In slabs continuous over three or more supports, 80 percent of the previous calculated value should be used for both positive and negative.

- b. Main reinforcement parallel to traffic. Longitudinally reinforced slabs should be designed for the appropriate HS truck or lane loading, whichever causes larger design moment. The effective width of slab resisting a wheel load should be estimated to be $E \text{ (ft)} = 4 + 0.06 e_n \text{ (ft)}$, [$E \text{ (m)} = 1.22 + 0.06 e_n \text{ (m)}$], but not to exceed 7.0 ft (2.1 m). The effective slab width resisting lane load should be $2E$.

For simple spans, the maximum live load moment per ft width of slab, without impact, may be approximated by the following formulas

HS 20 loading:

Spans up to and including 50 ft (15 m):

$$M \text{ (lb ft/ft)} = 900 e_n \text{ (ft)};$$

$$[M \text{ (kNm/m)} = 13.1 e_n \text{ (m)}]$$

Spans 50 to 100 ft (15 to 30 m):

$$M \text{ (lb ft/ft)} = 1000 [1.3 e_n \text{ (ft)} - 20];$$

$$\{M \text{ (kNm/m)} = 14.6 [1.3 e_n \text{ (m)} - 6.1]\}$$

HS 15 loading:

Use 75 percent of the values obtained from the formulas for HS 20 loading. Moments in continuous spans should be determined by a suitable analysis using the truck or appropriate lane loading.

Edge beams should be provided for all slabs having main reinforcement parallel to traffic. The beam may consist of a slab section additionally reinforced, a beam integral with and deeper than the slab, or an integral reinforced section of slab and curb. The edge beam should be designed to resist a live load moment of $0.10 P e_n$ for simple spans. For continuous spans, 80 percent of the previous calculated value should be used for both positive and negative moments, unless a greater reduction results from a more exact analysis.

10.4.2.3 Two-way slab—Two-way slabs are supported on all four sides by beams, girders, or walls and are reinforced in both directions. For rectangular slabs simply supported on all four sides, the proportion of the load carried by

the short span of the slab may be estimated by the following equations:¹⁰⁻³²

For load uniformly distributed, $p = e_2^4 / (e_1^4 + e_2^4)$;

For load concentrated at center, $p = e_2^3 / (e_1^3 + e_2^3)$;

where

p = proportion of load carried by short spans

e_1 = length of short span of slab

e_2 = length of long span of slab

Where e_2 exceeds one-and-one-half times e_1 , the entire load should be assumed to be carried by the short span. For a concentrated load, the effective slab width E for the load carried in either direction should be determined in accordance with **Section 10.3.2(a)** and **(b)**.

Moments obtained should be used in designing the center half of the short and long spans. The area of reinforcement in the outer quarters of both short and long spans may be 50 percent of that required in the center. For other supporting conditions at the edges, the formulas for p can be adjusted to account for the restraining effects at the edges. At the ends of the bridge and at intermediate points where the continuity of the slab is broken, the edges should be supported by diaphragms or other suitable means.

10.4.2.4 Ribbed slabs—A two-way system consisting of a slab with closely spaced ribs of similar size, equally spaced in two directions, may be analyzed by the empirical methods as an equivalent two-way slab. For two-way systems in which the ribs are not equally spaced or are of different size, an elastic analysis may be used in which the system is treated as an equivalent orthotropic plate or a grid.¹⁰⁻¹⁹ A model analysis may also be used.

10.4.2.5 Cantilever slabs

- a. Truck loads. Cantilever slabs may be designed to support truck wheel loads, ignoring the effect of edge support along the end of the cantilever.

1. Main reinforcement perpendicular to traffic. The effective slab width in ft (m), perpendicular to traffic, for each wheel load should be $E = 0.8 x_1 + 3.75$ ($0.8 x_1 + 1.14$), where x_1 = distance in ft (m); from load to point of support.

2. Main reinforcement parallel to traffic. The effective slab width, parallel to traffic, for each wheel load should be $E = 0.35 x_1 + 3.2$ ($0.35 x_1 + 0.98$), but not to exceed 7.0 ft (2.1 m).

- b. Railing loads. The effective width of slab resisting railing post loadings should be estimated as $E = 0.8 x_2 + 3.75$ ($0.8 x_2 + 1.14$) if no parapet is used, and $E = 0.8 x_2 + 5.0$ ($0.8 x_2 + 1.52$) if a parapet is used. In the previous expressions, x_2 is the distance in ft (m) from the center of the post to the point under investigation.

10.5-Distribution of loads to beams

Analysis based on elastic theory is recommended to find the transverse distribution of the bending moment. For the analysis, the structure may be idealized in one of the following ways:

- a. A system of interconnected beams forming a grid.
b. An orthotropic plate.

c. An assemblage of thin plate elements or thin plate elements and beams.

Several methods of analysis are available¹⁰⁻¹⁹ which can be applied with the use of a computer. In addition to the moments in the direction of the span, the computer-aided analysis can give moments in the transverse members. A theoretical analysis is particularly recommended for bridges which have large skew or sharp curvature.

10.5.1 T-beam or precast i-girder and box girder bridges-In lieu of an analysis based on elastic theory for the distribution of live loads to longitudinal beams, the following empirical method authorized by AASHTO (1983) may be used for T-beam or precast I-girder bridges and for box-girder bridges. The distribution of shear should be determined by the method prescribed for moment.

10.5.1.1 Interior beams-The live load bending moment for each interior longitudinal beam should be determined by applying to the beam the distributing fraction (DF) of the wheel load (both front and rear) as defined in Table 10.5.1.1.

10.5.1.2 Exterior beams

a. T-beam or precast I-girder bridges. The dead load to be considered as supported by the outside roadway beam is the weight of the beam plus that portion of the floor slab carried by the stringer or beam. Curbs, railings, and wearing surface, if placed after the slab has cured, may be considered equally distributed to all roadway stringers or beams.

When the outside roadway beam supports the sidewalk live load, as well as traffic live load and impact, the allowable stress in the beam may be increased 25 percent for the combination of dead load, sidewalk live load, traffic live load, and impact, providing the beam has no less carrying capacity than would be required if there were no sidewalks. To permit future widening, an exterior beam should never have less carrying capacity than an interior beam.

b. Box girder bridges. The dead load considered as supported by the exterior girder should be determined in the same manner as given previously in (a).

The wheel load distribution to the exterior girder should be $w_e/7$ (w_j2.13). The width w_e to be used in determining the wheel load distribution to the exterior girder, is the top slab width measured in ft (m) from the midpoint between girders to the outside edge of the slab. The cantilever dimension of any slab extending

beyond the centerline of the exterior girder should not exceed S/2, where S is the girder spacing.

10.5.1.3 Total capacity of longitudinal beams-The combined design load capacity of all the beams and stringers in a span should not be less than required to support the total load in the span.

10.5.1.4 Bending moments for T- and I-girder bridges with cross girders-The following equations are applicable for T- and I-girder rectangular (non-skew) bridges, simply-supported or continuous.¹⁰⁻³³ Each span should be provided with at least one cross girder at the center. The depth of the cross girder should be greater than or equal to three-fourths the depth of the main girder.

The wheel loads, both front and rear, are to be multiplied by a distribution factor DF, and the resulting loads applied to a single beam in a position which gives maximum bending moment. The distribution factor for an interior or exterior main girder is given by

$$DF = 2 (n_e/n_b) \cdot k S/e$$

where

- n_e = number of design traffic lanes
- n_b = number of girders, $3 \leq n_b \leq 10$
- S = girder spacing in ft (m), where $6 \leq S \leq 16$, ($2 \leq S \leq 5$)
- e = span in ft (m) for a simply-supported bridge
- e = distance between points of inflection under uniform load for a continuous bridge

The dimensionless coefficient k is given by one of the following equations

For $n_b = 3$ to 5,

$$k = 0.08 w_c - n_e (0.10 n_e - 0.26) - 0.20 n_b - 0.12$$

For $n_b = 6$ or 7,

$$k = 0.09 w_c - n_e (0.10 n_e - 0.26) - 0.20 n_b - 0.12$$

For $n_b = 8$ to 10,

$$k = 0.10 w_c - n_e (0.10 n_e - 0.26) - 0.20 n_b - 0.12$$

where

w_c = roadway width between curbs in ft (m), $20 \leq w_c \leq 78$, ($6 \leq w_c \leq 24$).

Table 10.5.1.1-Distribution factor for bending moments in interior main beams

Kind of floor	Distributing factor (DF)	
	Bridge designed for one traffic lane	Bridge designed for two or more traffic lanes
T-beam and precast I-girder bridges	$S/6.5$ (S/1.98). If S exceeds 6 ft (1.8 m), use*	$S/6.0$ (S/1.83). If S exceeds 10 ft (3.0 m), use †
Box-girder bridges	$S/8.0$ (S/2.44). If S exceeds 12 ft (3.7 m), use *	$S/7.0$ (S/2.13). If S exceeds 16 ft (4.9 m), use †
Spread box-beam bridges	See Section 10.5.2	
Multibeam precast concrete beams (adjacent)	See Section 10.5.3	

* In this case, the load on each beam will be the reaction of the wheel loads assuming the flooring between the beams to act as a simple beam
 † average beam spacing in ft (m).

When the SI system of units is used, w_c will be in meters and the coefficients of w_c in the equations of K will be 0.26, 0.30 and 0.33, respectively.

10.5.2 Spread box-beam bridges-For spread box-beam superstructures, the lateral distribution of live load for bending moment can be determined as follows:¹⁰⁻³⁴

- a. Interior beams. The live load bending moment in each interior beam can be determined by applying to the beam the fraction (DF) of the wheel load (both front and rear) determined by the following equation

$$DF = 2n_e/n_b - k_e S/e$$

where

- n_e = number of design traffic lanes
- n_b = number of beams, $4 \leq n_b \leq 10$
- S = beam spacing in ft (m), where $6.75 \leq S \leq 11.00$ ($2 \leq S \leq 13.35$)
- c = span-length in ft (m) (for continuous structures use length between points of inflection under uniform load);

$$k_e = 0.07 w_c n_e (0.1 n_e 0.26) - 0.20 n_e 0.12$$

- w_c = roadway width between curbs in ft (m), $32 \leq w_c \leq 66$ ($9.7 \leq w_c \leq 20$)

When the SI system of units is used, w_c will be in meters and the coefficient of w_c in the equation fork, will be 0.23.

- b. Exterior beams. The live load bending moment in the exterior beams should be determined by applying to the beams the reaction of the wheel loads obtained by assuming the flooring to act as a simple span between beams, but the reaction should not be less than $2n_e/n_b$.

10.5.3 Multi-beam precast concrete bridge-A multi-beam bridge is constructed with precast nonprestressed or prestressed concrete beams which are placed in contact side by side on the supports. The interaction between the beams is developed by continuous longitudinal shear keys and lateral bolts which may, or may not, be prestressed.

In calculating bending moments in multibeam precast concrete bridges, conventional or prestressed, no longitudinal distribution of wheel load should be assumed. The lateral distribution should be determined by the following:

The live load bending moment for each section should be determined by applying to the beam the fraction of a wheel load (both front and rear), determined by the following relations

$$DF = [(12n_e + 9) nb] (S + n_e/10) + [(3 - 2n_e/7) (1 - C/3)^2]$$

or when C is 3 or greater, use

$$DF = [(12n_e + 9) nb] (S + n_e/10)$$

where

- n_e = number of design traffic lanes
- n_b = number of beams
- c = $K(w_e/e)$, a stiffness parameter

w_c = roadway width between curbs in ft (m)

c = span length in ft (m) (for continuous structures, use length between points of inflection under uniform load).

Values of K to be used in $C = K(w_e/e)$:

Beam type and deck material	K
Nonvoided rectangular beams	0.7
Rectangular beams with circular voids	0.8
Box section beams	1.0
Channel beams	2.2

10.5.4 Transverse floor beams-In calculating bending moments in floor beams, no transverse distribution of the wheel loads should be assumed. If longitudinal beams are omitted and the slab is supported directly on floor beams, the floor beams should be designed for live loads determined in accordance with the following formula: fraction of wheel load to each beam = $S/6$ ($S/1.83$), where S = spacing of beams in ft (m). If S exceeds 6 ft (2 m), the load on the beam should be the reaction of the wheel loads, assuming the flooring between beams is acting as a simple beam.

10.5.5 Position of loads for shear-In calculating end shears and end reactions in transverse floor beams and longitudinal beams, no longitudinal distribution of the wheel load should be assumed for the wheel or axle load adjacent to the end at which the stress is being determined,

Lateral distribution of the wheel load should be produced by assuming the flooring to act as a simple span between stringers or beams. For loads in other positions on the span, the distribution for shear is determined by the method prescribed for moment.

10.6-Skew bridges

10.6.1 General-Empirical or simplified methods of analysis mentioned in Section 10.3 can be used for skew bridges, provided adjustments for skew are made. The analysis may be performed by one of the methods mentioned in Clause 10.2.3.2b and in Subsection 10.3.3. Design tables based on such methods may be employed.^{10-28,10-34}

10.6.2 Bending moments-The bending moment in the longitudinal direction in a skew bridge is generally smaller than the bending moment in a rectilinear bridge of the same span.¹⁰⁻³⁵ However, torsion moments exist about the longitudinal axis in skew bridges, increasing shear forces in the vicinity of the obtuse corners.

10.6.3 Reactions-The reactions and shear due to dead load in a skew bridge are higher at the obtuse angle compared to the values at an acute angle. The nonuniformity in distribution of reaction or shear increases with the increase in skew angle. The risk of the reaction becoming very small or negative at an acute angle should be avoided. This can be achieved in post-tensioned bridges by appropriate choice of the prestressing forces and the tendon profiles. The higher reactions at the obtuse comers should be accounted for in the design of bearings and the supporting elements.

The California Department of Transportation has developed the chart shown in Fig. 10.6.3 to adjust the shears and reactions in skew bridges. The factors shown are applied to the shears and reactions calculated for a rectilinear bridge

having the same span. For shear design the factor is assumed to vary linearly from the maximum shown at the support to unity at midspan. These factors are applied to all spans of a skew bridge regardless of end condition. Curved bridges having large skews over 45 deg should be analyzed by an exact method.

End diaphragms in skew bridges, either box or multigirder, increase the difference between reactions and multiply the risk of having negative reactions. A diaphragm at midspan has little beneficial effect in transmitting eccentric live load from one girder or web to another. Additional diaphragms have negligible effects. In some cases, the diaphragms in box girder skew bridges may have a harmful effect. Thus, in view of the extra time and the cost they require, the diaphragms may be dispensed with.¹⁰⁻³⁶

RECOMMENDED REFERENCES

The documents of the various standards-producing organizations referred to in this report are listed below with their serial designation, including year of adoption or revision. The documents listed were the latest effort at the time this report was written. Since some of these documents are revised frequently, generally in minor detail only, the user of this report should check directly with the sponsoring group if it is desired to refer to the latest revision.

American Association of State Highway and Transportation Officials

Standard Specifications for Highway Bridges, Thirteenth Edition, 1983.

American Concrete Institute

SP-24 Models for Concrete Structures

SP-35 Analysis of Structural Systems for Torsion

CITED REFERENCES

10-1. Bassi, K. G.; Lin, W.; and Richardson, B. S., "Continuous, Post-Tensioned, Torsionally Stiff Concrete Bridges," International Symposium on Concrete Bridge Design, Toronto, Apr. 1967.

10-2. Campbell, T. I.; Francis, L. N.; and Richardson, B.S., "A Long-Curved Post-Tensioned Bridge Without Expansion Joints," *Canadian Journal of Civil Engineering*, V. 2, No. 3, 1975, pp. 262-269.

10-3. Csagoly, P., and Holowka, M., "Cracking of Voided Post-Tensioned Concrete Bridge Decks," Ministry of Transportation and Communications, Ontario, RR 193, 1974.

10-4. Elbadry, M., and Ghali, A., "Nonlinear Temperature Distribution and Its Effects on Bridges," International Association for Bridges and Structural Engineering, Periodica 311983, *Proceedings*, P-66183, pp. 169-191.

10-5. Ghali, A., and Favre, R., *Concrete Structures: Stresses and Deformations*, Chapman and Hall, London, 1986

10-6. Tadros, M. K.; Ghali, A.; and Dilger, W. H., "Long-Term Stresses and Deformations of Segmental Bridges," *Journal of the Prestressed Concrete Institute*, V. 24, No. 4, July-Aug. 1979, pp. 66-89.

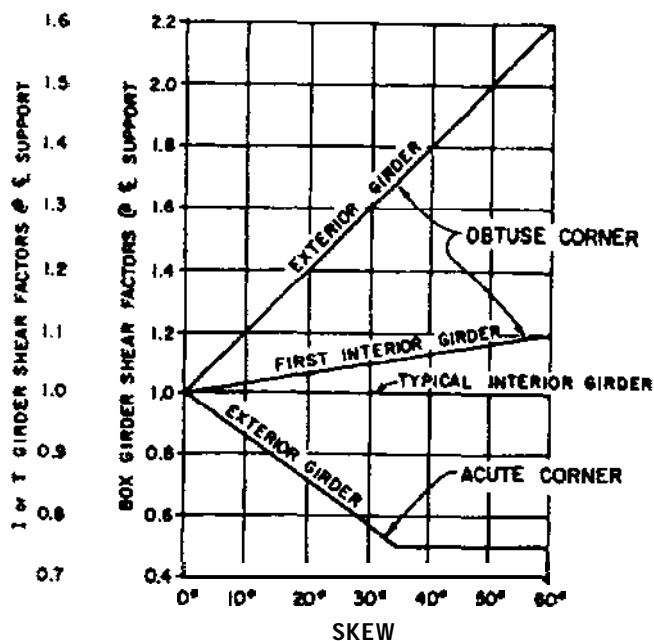

Fig. 10.6.3-Shear factors for skew bridges

10-7. Scordelis, A. C.; Davis, R. E.; and Lo, K. S., "Load Distribution in Concrete Box Girder Bridges," International Symposium on Concrete Bridge Design, Toronto, Apr. 1967.

10-8. Scordelis, A. C., and Meyer, C., "Wheel Load Distribution in Concrete Box Girder Bridges," College of Engineering, University of California, Berkeley, January 1969.

10-9. Sisodiya, R. G., and Ghali, A., "Analysis of Box Girder Bridges of Arbitrary Shape," *Publications, International Association of Bridges and Structural Engineering*, V. 33-1, 1973, pp. 203-218.

10-10. "Precast Segmental Box Girder Bridge Manual," Prestressed Concrete Institute and Post-Tensioning Institute, 1978.

10-11. Libby, J. R., "Segmental Box Girder Bridge Superstructure Design," *ACI JOURNAL, Proceedings* V. 73, No. 23, May 1976, pp. 279-290.

10-12. Ballinger, C. A.; Podolny, W.; and Abrahams, M. J., "A Report on the Design and Construction of Segmental Prestressed Concrete Bridges in Western Europe-1977," FHWA, Washington, D.C.

10-13. "Recommended Practice for Segmented Construction in Prestressed Concrete," *PCI Journal*, Mar.-Apr. 1975.

10-14. Mathivat, J., *The Cantilever Construction of Prestressed Concrete Bridges*, John Wiley and Sons, New York, 1983.

10-15. Podolny, Jr., Walter, "Cable-Stayed Bridges of Prestressed Concrete," *PCI Journal*, V. 18, No. 1, Jan.-Feb. 1973, pp. 68-79; *Closure-PCI Journal*, V. 18, No. 5, Sept.-Oct. 1973, pp. 115-116.

10-16. Van De Pitte, D., "Prestressed Concrete Suspension Bridges," Proceedings on World Conference of Prestressed Concrete, 1967.

10-17. Dudra, J., "Design and Construction of Hudson Hope Bridge," *Journal of the Prestressed Concrete Institute*,

Apr. 1966.

10-18. Tung, David H. H., "Torsional Analysis of Single Thin-Walled Trapezoidal Concrete Box Girder Bridges," International Symposium on Concrete Bridge Design, Toronto, Apr. 1967.

10-19. Jaeger, L. G., and Bakht, B., "The Grillage Analogy in Bridge Analysis," *Canadian Journal of Civil Engineering*, V. 9, No. 2, June 1982, pp. 224-235.

10-20. Brown, T. G., and Ghali, A., "Semi-Analytic Solution of Skew Plates in Bending," *Proceedings*, Institution of Civil Engineers, London, Mar. 1974, pp. 19-22.

10-21. Mehmel, A., and Weise, H., "Model Investigation of Skew Slabs on Elastically Yielding Point Supports," Cement and Concrete Association, London, 1965.

10-22. *Ontario Highway Bridge Design Code*, V. II, Supplement S7, Ministry of Transportation and Communications, Ontario, 1979.

10-23. Hewitt, B. E., and Batchelor, B. deV., "Punching Shear Strength of Restrained Slabs," *Journal of the Structural Division*, ASCE, V. 101, S19, Sept. 1975, pp. 1937-53.

10-24. Dorton, R. A.; Holowka, M.; and King, J. P. C., "The Conestogo River Bridge-Design and Testing," *Canadian Journal of Civil Engineering*, V. 4, No. 1, 1977, pp. 18-39.

10-25. Batchelor, B. deV.; Hewitt, B. E.; Csagoly, P.; and Holowka, M. "Investigation of the Ultimate Strength of Deck Slabs of Composite Steel/Concrete Bridges," Transportation Research Record 664, *Bridge Engineering*, V. 1, Transportation Research Board, Sept. 1978.

10-26. *Ontario Highway Bridge Design Code*, Second Edition, Ministry of Transportation and Communications, Ontario, 1983.

10-27. *Ontario Highway Bridge Design Code*, Commemorative

Ministry of Transportation and Communications, Ontario, 1983.

10-28. Rusch, H., and Hergenroder, A., "Influence Surfaces for Moments in Skew Slabs," Cement and Concrete Association, London.

10-29. "Analysis of Continuous Skewed Slab Bridge Structures," Ohio Department of Highways, 1961.

10-30. Schleicher, C., and Wegener, Borwin, "Continuous Skew Slabs," *Veb Verlag Lur Bauwesen*, Second Edition Berlin.

10-31. Kennedy, J. B., and Tamberg, K. G., "Problems of Skew in Concrete Bridge Design," *Report No. 44 144*, Department of Highways, Ontario.

10-32. Culham, G. A., and Ghali, A., "Distribution of Wheel Loads on Bridge Girders," *Canadian Journal of Civil Engineering*, V. 4, No. 1, 1977, pp. 57-65.

10-33. Motarjemi, D., and Van Horn, D. A., "Theoretical Analysis of Load Distribution in Prestressed Concrete Box-Beam Bridges," *Fritz Laboratory Report No. 315.9*, Lehigh University, Oct. 1969.

10-34. Ghali, A., "Design of Simply-Supported Skew Concrete Girder Bridges," Second International Symposium on Concrete Bridge Design, ACI SP-26, Chicago, IL, Apr. 1969, pp. 206-234.

10-35. Ghali, A., "Analysis of Continuous Skew Concrete Girder Bridges," *Concrete Bridge Design*, ACI SP-23, Proceedings of Symposium, Toronto, Apr. 1967, pp. 137-169.

10-36. Sisodiya, R. G., and Ghali, A., "Diaphragms in Single and Double Cell Box Girder Bridges with Varying Angle of Skew," *ACI JOURNAL*, *Proceedings* V. 69, No. 7, July 1972, pp. 415-419.



Overcrossing in California with curved alignment and curved soffit (note flared integrated pier and unobtrusive abutments)

CHAPTER 11-SUBSTRUCTURE SYSTEMS AND ELEMENTS

11.1-Introduction

The quality of a bridge project, its visual impact, and economic viability is not determined solely by the type of superstructure chosen. Of almost equal importance is the proper selection of the substructure system and the details of the elements for that system. This chapter is intended to be a guide to making the selection as the designer proceeds through the bridge design process. Guidance is supplied for abutments, piers, foundations, and pier protection.

Connections of substructure units to superstructure systems can be accomplished by several different methods. The subject of bearings and other types of connections typical to concrete structures is addressed in this chapter.

11.2-Bearings

11.2.1 Description-A wide variety of bearings is available for bridge structures. The main purpose of any bearing is to transfer the superstructure load, both vertical and horizontal. In addition, the bearing should accommodate translational and/or rotational movements. In some cases the bearing will transmit eccentric loads.

11.2.2 Types and design criteria

11.2.2.1 Elastomeric bearings (Fig. 11.2.2.1)-Elastomeric bearing pads have been used in the U.S. since about 1960. They are popular in the short span range up to and in-

cluding 400 ft (122 m), with maximum reactions of about 400 kips (1800 kN). They are economical and have proven to be excellent in service.

Two main types of elastomeric bearings are used, plain pads, consisting of elastomer only, and reinforced pads, consisting of layers of elastomer restrained at their interfaces with integrally bonded steel or fabric reinforcement. The elastomer material may be polyisoprene (natural rubber) or polychloroprene (neoprene).

Tapered elastomeric bearings should not be used. Where necessary, tapered wedge steel plates should be provided. In some cases the wedge should be tapered transversely, as well as longitudinally. In locations where it is expected that the bearings will be subjected to temperatures below -25°F (-32°C) for several days, consideration should be given to specifying natural rubber and requiring special testing by the manufacturer for the temperature range expected.

Because of their compressibility, elastomeric bearings can readily accommodate rotational movements anticipated in a normal type structure. In relatively short bridges the longitudinal movement caused by temperature changes is accommodated by the shear deflection of the bearing, as shown in Fig. 11.2.2.1 (a). When the expected longitudinal movement exceeds the allowable shear deflection, sliding plates can be installed, as shown in Fig. 11.2.2.1 (b).

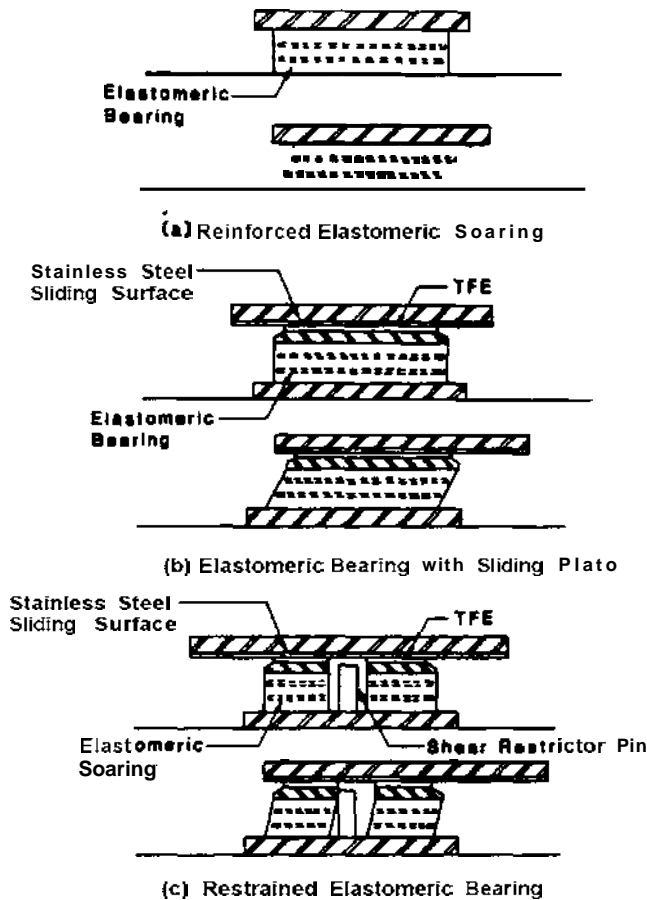

Fig. 11.2.2.1-Elastomeric bearings

If some combination of loads is possible which would cause a shear force greater than one-fifth of the simultaneously occurring compression force, or if the dead load stress in the bearings is less than 200 psi (1.38 MPa), the bearing should be secured against horizontal movement. When the bearing is anchored at both the top and bottom surfaces, the anchorage should be such that no tension is possible in the vertical direction. One example is shown in Fig. 11.2.2.1(c). If welding is used as a means of attachment, care should be taken to limit the temperature in the plate adjacent to the elastomer to 400 F (204 C).

The Transportation Research Board (TRB) of the National Research Council has funded research into the design and construction of elastomeric bearings. The first report (NCHRP No. 248) was published in 1982. The project is being continued and state-of-the-art reports will be issued.

11.2.2.2 Sliding bearings [Fig. 11.2.2.1(c)]-When the expected expansion or contraction of the bridge superstructure due to temperature changes is so large that the corresponding elastic deflection of the pier top would produce too great a horizontal force, sliding bearings should be used. This is particularly true when the piers are short and heavy. Sliding bearings are also used at abutments to accommodate movements due to earth pressures.

Sliding bearings may be fabricated with plain or reinforced elastomeric pads bonded to a polytetrafluoroethylene

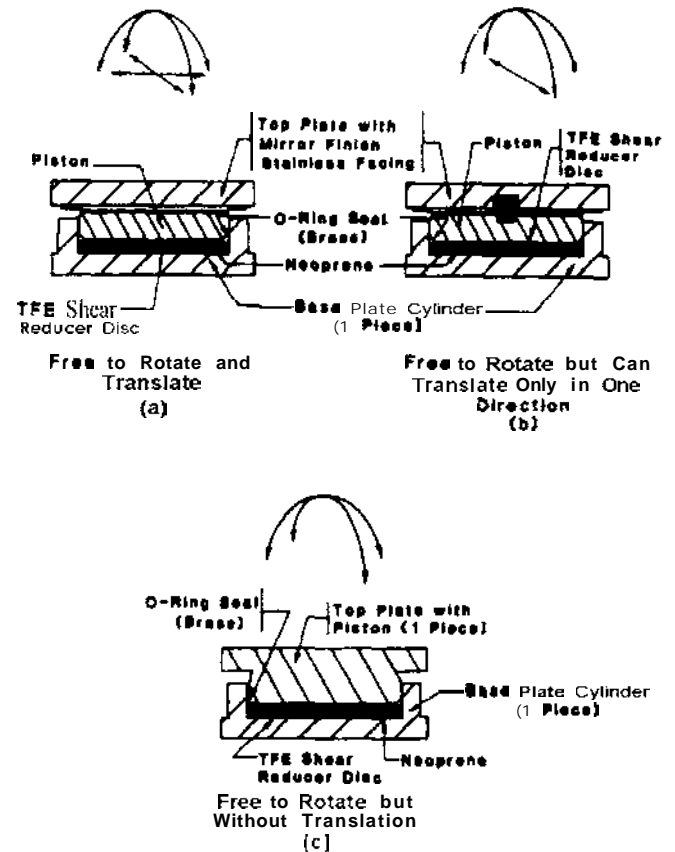

Fig. 11.2.2.3-“High” load bearings

(PTFE) surface. The underside of the sole plate should have a stainless steel plate to provide the proper sliding surface,

11.2.2.3 “High” load bearings-In straight bridges with right angle piers, the rotational movement that should be accommodated occurs about one easily predicted axis. In curved bridges, or straight bridges with large skews, the rotational movement occurs about more than one axis and is not readily predictable. To resolve this problem, “pot” bearings having the ability to accommodate rotational movement about any axis that has been developed. Fig. 11.2.2.3 illustrates graphically the main elements of this type of bearing. The term “pot” is derived from the shape of the bearing base plate. As shown, the bearing can provide free translation in any direction, as well as rotational freedom [Fig. 11.2.2.3(a)], or it may be restrained against translation in one direction, [Fig. 11.2.2.3(b)], or all directions [Fig. 11.2.2.3(c)].

The pot bearing also permits the use of high allowable bearing stresses since the confined elastomer acts like a hydraulic fluid. These bearings are manufactured by a number of companies, and the bridge designer should maintain a file of the latest information furnished.

11.2.2.4 Steel bearings-In the past, all bridge bearings consisted of structural steel plates and shapes. Many of these types of bearings are still being used. Fig. 11.2.2.4(a) shows a typical roller bearing suitable for use on short span bridges.

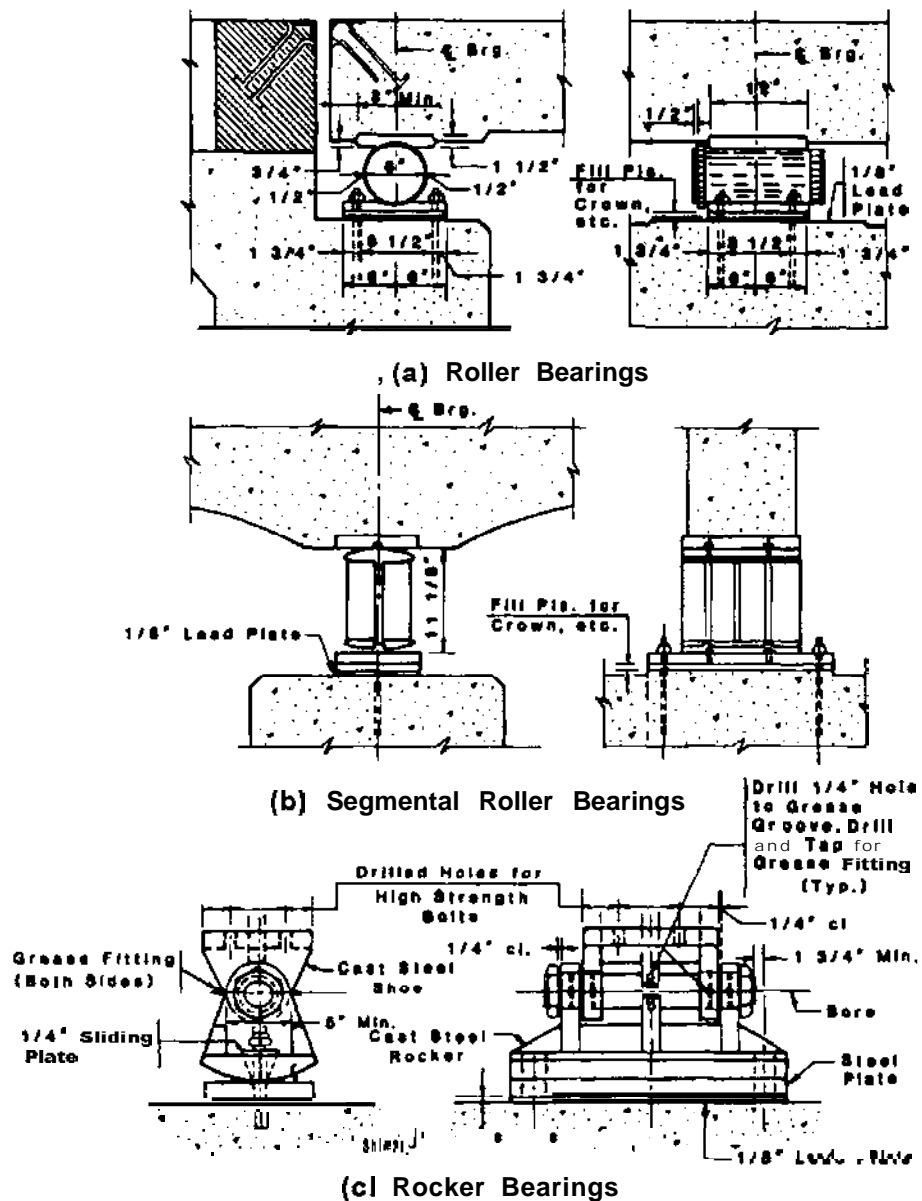

Fig. 11.2.2.4-Steel bearings

Because the bearing capacity is directly related to the diameter of the roller, this type has a very limited capacity of about 50 kips (220 kN). Fig. 11.2.2.4(b) shows a segmental roller bearing used on cast-in-place concrete girder bridges. Since the diameter of the bearing surface is much greater than a roller bearing of the same height, and the weight is much less than a solid cylinder, the bearing can be economically used to carry significant loads of up to 250 kips (1100 kN).

For larger loads, rocker-type bearings as shown in Fig. 11.2.2.4(c) can be designed. The diameter of the bearing surface can be tailored to fit the need. The material can be either steel castings or structural steel weldments.

The bearings shown in Fig. 11.2.2.4 are expansion bearings providing longitudinal movement. Transverse movement is restricted. In the case of the segmental roller and rocker, the permissible longitudinal movement is limited and care should be taken in setting the bearings to adjust the in-

clination of the bearing to suit the actual temperature of the bridge at the time of setting.

Fixed bearings for bridges that have segmental roller or rocker-type expansion bearings are generally the same type, but with the rocker or roller has a flat bottom and is welded to the masonry plate.

11.2.2.5 Bearings in seismic zones-At locations requiring the bridge to be designed for seismic forces and movements, bearings are the most critical component of the bridge. Discussion of the forces and movements is given in Chapter 5, and the designer should give special consideration to the latest state-of-the-art criteria. Guidance is given in ATC 6¹¹⁻¹ and in AASHTO publication GSDB. Without proper modification, all of the bearing types previously discussed are unsuitable for use in seismic areas.

11.2.2.6 General criteria-The allowable bearing pressure on concrete should be $0.30f'_c$ (see AASHTO for further requirements). The steel masonry plate should be designed

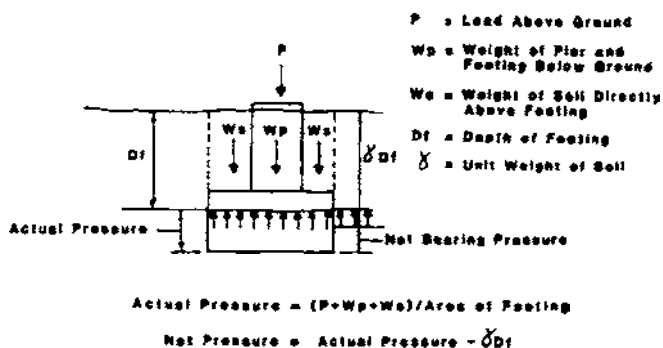

Fig. 11.3.3—Net bearing pressure

for this allowable bearing stress using an allowable flexural stress of $0.55f_y$.

One or more fixed bearings should be provided in each bridge structure. A fixed bearing is designed to prevent any horizontal movement between the superstructure and substructure.

Expansion bearings should be designed to accommodate the contributory movement due to elastic shortening, creep, shrinkage, and temperature multiplied by 125 percent. Where lateral restraint is desired in the bearings, the bearing restraints should be designed for 15 percent of the axial dead load.

11.3-Foundations

11.3.1 General—The function of a foundation is to transfer the loads from the bridge elements above ground to the soil or rock without objectionable vertical or lateral movement. Selection and design of the proper foundation is dependent upon the design structural loading conditions, bridge pier geometry, and surface and subsurface conditions at the site, plus interpretation of field data and laboratory tests combined with engineering judgment.

The foundation should be located as high as possible, since costs increase significantly with depth. Even though costs do increase significantly with depth, the foundation elevation should be deep enough to provide long term bearing support to prevent undue total and differential settlement to resist lateral forces and to avoid problems from ground movement (e.g. frost heave), scour, and/or future deepening of a channel area. Depending on site conditions, this may most economically be accomplished by open excavation, driving piles, or drilling piers.

11.3.2 Investigation procedures—An excellent guide to the type of information that should be obtained is provided in the *AASHTO Foundation Investigation Manual (1978)*. Additional information on soils engineering and foundation design may be found in [References 11-2 through 11-16](#) and *ASTM Special Technical Publications No. 444 and 670*. It is recommended that the structural engineer work closely with a geotechnical engineer experienced in the requirements of foundations that are unique to bridges. The following is a partial list of the information that should be obtained (Refer-

ences 11-17 through 11-18 and *ASTM Special Reports No. 399, 412 and 479*):

- Distribution, classification and physical properties of the soil and underlying rock.
- Determination of the allowable bearing capacity of the selected foundation.
- Determination of design lateral earth pressure for the abutment walls and wingwalls.
- Prediction of settlement of the foundation soils.
- Determination of high and low water levels, velocity of stream, and depth of scour. Prediction of the future lowering of the stream bed and future scour depth during the life of the bridge for stream crossings.
- Determination of ground water level and depth of frost line or depth of zone of significant volume change in expansive clay subsoils.
- Location, depth, type, and possible influence of the foundations of adjacent existing or future structures or underground utilities.
- Stability of abutment slopes.

11.3.3 Spread footings—Spread footings are classified as shallow when the depth of foundation below the surrounding final ground line is less than the least width of the footing or deep when depth of foundation is greater than the width of the footing. Shallow footings are generally the most economical and should be considered unless ruled out by other dominant factors.

Shallow spread foundations should be proportioned so that the maximum net contact pressure under the combined effects of dead, live, and transient loads does not exceed the allowable net bearing pressure determined by the geotechnical engineer. Net bearing pressure is defined in Fig. 11.3.3. Foundation movement should be estimated by the geotechnical engineer for the appropriate loading conditions. The expected foundation movement should be within tolerable limits for the bridge structure. The allowable net bearing pressure may be limited by the movement requirements, either vertical or lateral.

Many superstructure types are sensitive to the differential settlement of piers. In general, simple spans are not affected, and long continuous spans are less sensitive than short spans. Especially sensitive are arches or short continuous spans where adjacent piers are founded on subsoils that vary greatly.

Settlement of footings, particularly abutment footings, may be influenced not only by the load from the bridge superstructure, but by the fill supporting the approach roadway. Settlement can also be caused by vibratory loadings, such as railroad loadings on shallow footings, which bear on loose to medium dense granular soils. An estimate should be made of the differential settlement that the proposed superstructure can accommodate. This estimate should be used by the geotechnical engineer in determining the allowable soil pressure or pile capacity.

Spread footings for bridges located in seismic areas should be designed using the criteria given in ATC-6, "Seismic Design Guidelines for Highway Bridges." Additional infor-

mation can be found in ASTM *Special Technical Publication* No. 450, 1969.

11.3.4 Drilled piers

11.3.4.1 General-Drilled piers are, in effect, deep spread footings. The development of special equipment for their installation has made drilled pier foundations time saving as well as economical. It is expected that their use in bridges will become more widespread. Although primarily used to transfer the bridge loads to a deep strong layer such as hardpan or rock by end bearing, drilled piers can function by transferring the load to the soil through friction. This ability is seldom considered in the design, since its neglect results in a more conservative design, but when the possibility for negative skin friction exists, as in drilled piers supporting abutments, the additional load due to negative skin friction should be included in sizing the bearing area. ACI 336.3R describes in detail the design and construction procedures for drilled piers.

The cost of drilled piers is directly related to the amount of material excavated and concrete placed, so it is advantageous to minimize the size of the shaft. Most drilling equipment can construct a bell having a diameter equal to three times the shaft diameter. Bells can be enlarged by hand, but this is expensive. The condition of the soil at the bottom of the pier should be inspected by a qualified soils engineer. The minimum size of the shaft to permit this is 3 ft (0.9 m).

The shaft diameter should be selected with consideration of moment capacity, the placing and spacing of reinforcing steel, the placement of concrete, and the necessary cover over the steel.

11.3.4.2 Construction consideration-Since drilled piers are usually constructed from the ground level prior to excavation for the foundation, allowance should be made for a reasonable tolerance in location. This is usually specified as 4 percent of the diameter of the shaft. To accommodate this tolerance, dowels for the column extension above the drilled pier should not be set directly in the subpier shaft, but in a cap constructed after the excavation has been completed. This permits accurate location of the column dowels.

Drilled piers are often subjected to horizontal loads, some anticipated in the design and some caused by construction operations, unforeseen soil conditions or future construction, such as trenches. For this reason, a minimum amount of reinforcing, usually 0.5 percent of the gross area of the shaft, should be provided for the full height or nearly the full height of the shaft.

11.3.4.3 Classes of subpiers-Drilled piers can be classified as belled piers, which are enlarged at the base to increase the bearing area, and rock-socketed piers, which have sockets drilled into solid rock to increase the end bearing capacity. The belled piers are generally more economical and are always used unless the spacing of the piers (bridge columns) causes the bells to overlap. Belling can be done only if there is an adequate layer of cohesive material just above the proposed bottom of the drilled pier and there is no bearing seam in that layer. New techniques in soil testing, such as in-situ pressure meters that measure the in-place strength of the bearing layer, have permitted the use of larger allow-

able bearing pressures. Allowable pressures as high as 30 kips/ft² (1.45 MPa) have been used to design pier bells founded on hard silt layers.

11.3.5 Piles

11.3.5.1 General-Timber piles have been used for centuries, and excavations at old building sites reveal that they are in good condition when located below the permanent ground water table. Iron or steel piles have been used since the middle of the nineteenth century, and since early in the twentieth century, special shapes called H piles and steel pipe piles have become standard. Reinforced concrete piles were developed at the turn of the century, and numerous shapes and methods of installation have been invented and patented. Prestressed concrete piles have been developed recently and have been used extensively in structures where large quantities of piles have been required. An excellent description of the history of piles and pile driving is found in "Pile Foundations."¹¹⁻¹⁹

While the primary function of a pile is to transmit the load of the structure to a suitable soil stratum below the surface of the ground without excavation, it also has other properties which may or may not be a factor in the design, such as:

- It is capable of anchoring structures against uplift or overturning forces.
- It may improve the properties of the soil through which it is driven by consolidation.
- It can resist lateral loads by bending as well as by direct action through battered piles.
- It can function as an unsupported column, where support furnished by the upper soil layers is removed by scour or an adjacent excavation.

11.3.5.2 Classes of piles-A pile can transmit the load into the adjacent soil by skin friction or end bearing, and is generally referred to as a friction or bearing pile. Actually, there is usually friction on any pile, unless specific means are taken to eliminate it, and there is likewise some end bearing. However, it is common practice to design a pile as either transmitting all its load through friction, neglecting end bearing, or as solely end bearing and neglecting friction. For large piles, both friction and end bearing capacities can be used. Piles have also been used solely to compact the upper strata of soil, but this use for bridge structures is rare.

11.3.5.3 Pile design-The design of piles for footings and bents requires considerable experience and the best of good engineering judgment. It is the designer's responsibility to select types of piles which meet the field requirements and, in addition, fulfill the requirements for economy, availability, and practicability for the particular conditions prevailing at the site. 11-19-11-30 Details for design of concrete piles are given in ACI 543R.

For pile foundations in seismic areas, consideration should be given to the fact that battered piles are much stiffer than vertical piles under seismic loading. It may be desirable to use only the more flexible vertical piles. This is discussed in AASHTO's "Guide Specifications for Seismic Design of Highway Bridges." Numerous failures have occurred during earthquakes in concrete piles just below the pile cap. This is probably due to the abrupt change of stiffness at that location

and the lack of confining lateral reinforcement in the pile. The designer should consider these critical areas.

In designing and detailing the footing or cap for the piles, consideration should be given to providing a reasonable amount of tolerance in the location of the pile. It is reasonable to expect the center of the pile group to be within 3 in. (75 mm) of the design location, but the location of each individual pile need not be so restricted. A reasonable design should assume that the individual piles could be out of location by at least 6 in. (150 mm).

11.3.5.4 Design criteria—The design loads for piles should not be greater than the least of the following values:

- a. Capacity of the pile as a structural member.
- b. Capacity of the pile to transfer its load to the ground.
- c. Capacity of the ground to support the load transmitted to it by the pile or piles.

Required penetrations are initially estimated on the basis of soil borings and then substantiated by test piles, which are piles driven by the contractor to ascertain the proper length before ordering the remainder of the piles. These piles are not used for load testing. The test piles are generally furnished 10 ft (3 m) longer than the estimated length and driven to refusal or to a capacity 50 percent greater than the required design capacity. The capacity may be determined by load tests or by dynamic analyses, such as the wave equation analysis, or by both. Other dynamic formulae may be used with judgment, especially if correlated with a load test of the wave equation. From the results of the test pile, the engineer determines the proper length and capacity of the permanent piles. In addition, consideration also should be given to the following:

- a. The difference between the supporting capacity of a single friction pile, as against a group of friction piles.
- b. The effect of driving piles and the pile loads on adjacent structures.
- c. The possibility of scour and its effects.
- d. The possibility of negative skin friction (“downdrag”).

The recommended values of allowable loads and stresses for an acceptable design of concrete piles are listed in ACI 543R.

11.3.5.5 Pile load tests—Pile load tests may be recommended for any of the following conditions:

- a. At locations or in types of materials where the ordinary methods of determining safe pile loads are not considered reliable.
- b. For cast-in-drilled-hole piles in unproven soil formations.
- c. Where it is desired to demonstrate that piles may safely be loaded beyond the indicated safe loads obtained by the application of standard pile driving formulae.
- d. For very large or heavily loaded piles or for unusual or innovative installations.
- e. Critical uplift forces.

In general, the loading test should be carried out following the procedures described in ACI 543R or ASTM D 1143.

11.3.5.6 Anchorage for uplift—The possibility of uplift should be investigated.

Uplift capacity of a pile can best be determined by a tensile pile field test. Often this can be done in conjunction with load bearing tests by using reaction piles of the type and length to be installed for the foundation.

The uplift capacity can be estimated by considering such factors as soil shear strength, pile spacing, shape, length, size, and weight, and weight of the soil surrounding the pile or pile group.

Reinforced or prestressed concrete piles, which are subjected to uplift, should have dowels or reinforcing bars anchoring the piles to the footing. Strands of sufficient length to develop the uplift force may be extended from prestressed concrete piles into the footing. This is acceptable and common practice. Timber piles should not be used when uplift is expected, unless an adequate anchorage that will fix the pile to the footing is provided, and provided the tapering of the timber pile is taken into account in the design. Steel piles, when subjected to uplift, should be provided with adequate anchorage devices, such as bars welded to the piles, or with a sufficient bond length to develop the applied uplift force.

11.3.5.7 Construction considerations—Piles should be spaced close enough together to minimize the cost of the cap or footing, and yet far enough apart, if friction piles, to minimize the reduction in pile capacity caused by group action. Other effects of closely spaced piles can be damage caused by the driving of adjacent piles. This damage may be structural in nature, such as collapse of casings, splitting of casings, permitting inflow of ground water, and damage to green concrete. Such damage is usually remedied by neglecting the supporting effect of the damaged pile and replacing it with another pile. Close spacing may also cause lateral displacement of adjacent piles and heave of surrounding soil that lifts the already driven piles. In this case, the affected piles are redriven to establish their capacity. Specifications should be written to cover these anticipated problems. Consideration should also be given to various methods of installation, and whether it is practical to obtain required penetrations with the type of pile being evaluated.

11.3.6 Special types

11.3.6.1 Caissons—When the subsoil at the pier location consists of a deep strata of sand that has a possibility of scour to a significant depth, or when deep penetration through overlying soils is required, the use of piles or drilled piers becomes expensive or impractical, and caissons may be used. By definition, caissons are shells within which the excavation is made.

Current practice is to construct caissons by the open-dredge method. The portion of the caisson below the bed of the stream is a thick-walled concrete box with multiple cells designed to function as a permanent part of the foundation. The portion of the caisson above the bed consists of steel sheet piling which is removed after completion of the pier. The concrete walls of the caisson are constructed thick enough so that the caisson sinks under its own weight when the soil within the caisson is excavated. All excavation is done under water while maintaining a positive head of water within the caisson. Control of the sinking is done by selective excavation within the caisson cells. To insure control

and minimize drifting, the caisson should have at least four cells. Upon reaching the proper founding depth, the bottom is cleaned and sealed with a thick layer of concrete.

The water in the caisson is then pumped to an elevation below the top of the concrete walls of the caisson, a footing is constructed upon the walls, and the pier is completed. Fig. 11.3.6.1 illustrates a caisson constructed using a sand island. Other methods are also used. A further description of caissons can be found in [References 11-5 and 11-31](#).

11.3.6.2 Other types--When special subsoil conditions exist, foundations should be adapted to suit the conditions. In most cases, these adaptations are merely variations of the three usual types, i.e. spread, piles or drilled piers. When subsoils change drastically from one pier location to the next, consideration should be given to using different types of foundations on adjacent piers.

Loose granular soil can be compacted or stabilized by grouting or chemical injections to form a natural raft. Rock anchors can be used to anchor footings resting on rock with a sloping surface or bedding.

11.3.7 Special considerations

11.3.7.1 Cofferdams--When the pier site is dry during most of the construction season, the excavation to the bottom of the footing can usually be made by open excavation. When adjacent construction precludes this, or when the water level is or is expected to be above the ground surface, the excavation is generally made within a cofferdam.

Cofferdams are dams with a brief service life, built around the pier foundation so that construction operations can be performed in the dry area below the adjacent water level. They can be single wall, double wall, or cellular, braced or unbraced. They are usually constructed of steel sheet piling, but have been made of precast concrete, overlapping cast-in-place concrete piles, or slurry walls. The portion of the cofferdam above the footing level is always removed, but the part below may be left in place and, if anchored to the footing, may provide additional protection against scour. [References 11-32 and 11-33](#) are recommended for guidance on this subject.

When single wall steel sheet piling cofferdams are used in river piers, unless the pier is founded on rock, a concrete seal coat is required. The determination of that seal coat thickness is generally the responsibility of the design engineer. The design criteria for seal coats may include, in addition to the weight of the seal coat itself, the weight of the steel sheet piling, an allowance for friction between the sheet piling and the surrounding earth, and the uplift resistance of the permanent piles, if any. The design plans should clearly state what high water elevation was used in designing the seal coat and should require ready means of flooding the cofferdam if this elevation is exceeded.

11.3.7.2 Impact during construction--Consideration should be made in the design of bridge piers for possible accidental impacts during the life of the structure. It is also prudent to consider the possible effect of an accidental impact during the construction period. Piers under construction with no superstructure load on them are less stable than piers carrying the superstructure. Specifications should call the con-

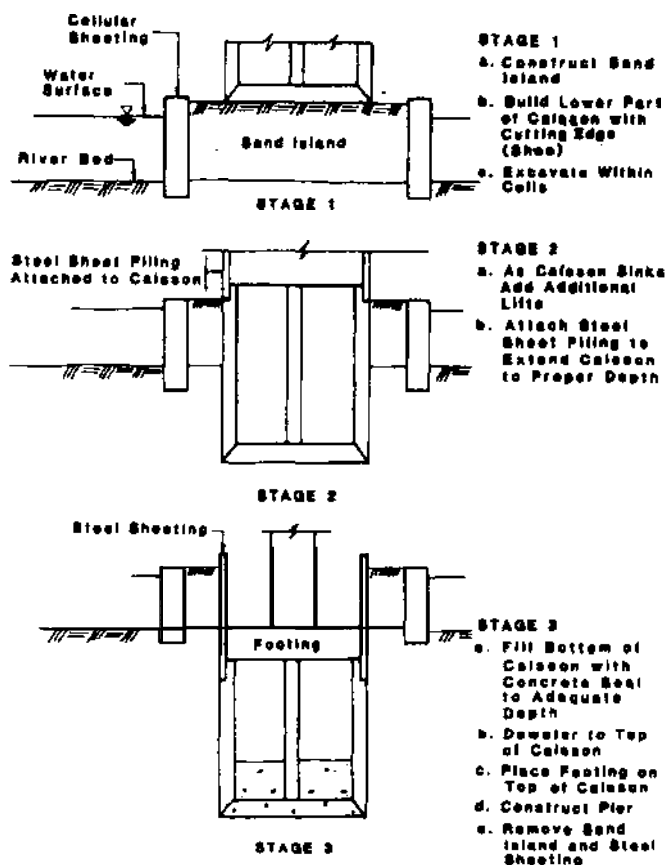

Fig. 11.3.6.1--Open-dredged caisson using sand island

tractor's attention to the need to protect against impacts caused by factors beyond the contractor's control, such as adjacent traffic, barge, or boat traffic.

11.4 Hydraulic requirements

11.4.1 General--AASHTO *Bulletin HDG-7* has been prepared by a task force of experienced hydraulic engineers, and it is highly recommended as an excellent reference on the subject of bridge hydraulics.

11.4.2 Bridge location--The location and orientation of a bridge relative to a stream channel is extremely important. The alignment of piers and abutments, as well as the waterway provided, either exacerbate or ameliorate problems at a bridge crossing. The selection of the location is an important first step in a successful bridge project.

11.4.3 Waterway opening--Before a determination is made for the length and height of a bridge, the stream channel should be studied for different stages of flow. Sometimes the major portion of flood flow follows a quite different path of flow orientation than at low flow and provisions should be made for such an eventuality. The designer should determine what controls the stream cross section and how the flow is distributed throughout the flood plain. Crossing near and above confluences is often affected by backwater from the other stream. The key to a good solution is to place the bridge waterway opening in the best location to accommodate all stages of flow, but providing a waterway area does not necessarily mean that water will flow through it. Oftentimes the

U.S. Geological Survey or a state agency has records or data available for determining the flow characteristics of a stream.

11.4.4 Scour-The introduction of a bridge in a river channel can change the natural stream environment and often causes scour and bank erosion with severe consequences. A number of bridges have failed because of bed and bank scour at piers and abutments. Extra precautions in regard to this phenomenon at the time of design and construction will pay great dividends. Some of these precautions may involve founding the piers on piles at river crossings, instead of spread footings, and extensive rip-rapping of the river banks.

Estimating depth and extent of scour is not a simple matter. Research and field studies have been made, but experienced judgment is also needed. Piles, if used, should be specified for penetration or tip elevation as well as their load capacity. In some cases it may be necessary to assume that scour lowers the river bottom below the pile footing and the piles designed to function as free standing columns with a lateral force acting on them.

11.4.5 Spur dikes-The spur dike, as used in bridge construction, is a projection of earth or rock built integral with the approach embankment, extending upstream and downstream, to "guide" the flood flow under the end spans of a bridge. The spur dike usually forms a portion of an ellipse, and is sloped and shaped to minimize turbulence and scour, especially when large quantities of flow are diverted from a flood plain to the bridge opening. These dikes are used extensively in the southern and central sections of the U.S., where flood plains are quite wide. Cost effectiveness dictates that the bridge structure cannot span the entire flood plain, and the approach roadway is placed on an embankment that becomes a wing dam during floods.

11.4.6 Slope protection-Approach roadway embankments and spill-through abutments are vulnerable to attack by flood water at most crossings. Some kind of protection is desirable, but a grassed slope is often a simple solution, above the flood line and rip-rap below. Excessive clearing of trees and brush upstream from a bridge can cause the flow to accelerate and aggravate scour at the bridge. However, the tendency to remove trees and other obstructions has greatly decreased in recent years due mostly to environmental concerns.

A source of available material for slope protection is always of primary concern. Dumped rip-rap, consisting of graded stone of sizes appropriate for the flow velocities and depth of flow, is the most common type of protection. A filter blanket of graded gravel or filter cloth is usually needed beneath the stone rip-rap to prevent leaching of the underlying embankment material. Although the appearance of hand-placed rip-rap is preferred by some engineers, its extra cost is difficult to justify.

Slope paving under bridge ends is commonly a concrete slab, sometimes jointed and reinforced with a wire fabric or reinforcing steel. If care is not taken in providing a drainage system and anchorage at the toe, a slope failure is likely to occur. Such failures are very difficult to repair, making the self healing stone rip-rap a superior solution. Concrete slope

paving is more commonly found under bridge ends that are adjacent to roads and freeways.

11.5-Abutments

11.5.1 General-Abutments are the substructure elements used at the end of the bridge to support the superstructure and to retain the embankment that supports the approach roadway.

Generally, several types of abutments would be satisfactory for a particular bridge site; economics is usually the prime factor in selecting the type to be used. For river or stream crossings, the minimum required channel width and waterway area generally set the abutment location and type. For highway overpasses, minimum horizontal clearances and sight-distances should be maintained. An abutment located at or near the top of a slope is not a collision obstacle, but one located at the bottom may be. In this case, safety may dictate. Esthetics is also a factor when selecting an abutment type and location.

11.5.2 Loads and stability-Abutments should be designed for horizontal loads due to earth pressure of the approach roadway embankment, as well as the vertical loads from the superstructure. They should be stable against overturning and sliding. The foundations of the abutment should be designed to prevent excessive differential settlement and lateral movement.

Vertical loads from the superstructure and dead load of the abutment itself are generally well-defined, but consideration should also be given to live and dead loads from the approach roadway. These loads are carried by the abutment footing as dead load plus live load surcharge, or by the abutment backwall as the reaction of a reinforced concrete approach slab. In all cases, the designer should consider not only the effects of maximum loads, but also the effects of minimum loads.

Horizontal design loads require a great deal of judgment on the part of the engineer. Although the abutment functions as a retaining wall, the horizontal movement of the top is much more critical, and design earth pressures should reflect this. The abutment is often restrained by the bridge superstructure or by the wing walls from deflecting in the classical manner that reduces the "at rest" pressure to active pressure. Some designers increase the active pressure normally used for retaining walls by 50 percent when designing abutments; earth pressures also depend on the type of material used in constructing the roadway embankment.

Piles installed in abutments that are set on fill are often subject to excessive downdrag and sometimes lateral deformation due to settlement within and under the fill. Therefore, they should be installed through casings or sleeves with the annular space filled with pea gravel.

Certain types of structures, such as rigid frame bridges or short, single span bridges with fixed bearings at each abutment, cause much greater soil pressures due to live load action or temperature. Other types, such as "spill through" abutments, require careful evaluation of earth pressures acting on the piles, caissons, or columns supporting the abutment cap. It is often assumed that the earth pressure acting

on these elements acts on a width twice as great as the actual width of the element.

Abutments of bridges located in seismic zones are subject to much greater forces; the AASHTO "Guide Specifications for Seismic Design of Highway Structures" should be used as a reference. To minimize potential loss of bridge access arising from abutment damage, monolithic or end diaphragm abutments are strongly recommended. Settlement or approach slabs should be provided and adequately linked to abutments using flexible ties.

11.5.3 Types of abutments

11.5.3.1 Sill abutments [Fig. 11.5.3 (a) (b) and (c)]-

The sill abutment is constructed at the top of the slope after the roadway embankment is close to final grade. Many consider this abutment the best means of avoiding most of the problems that cause rough riding approach pavements. It eliminates the difficulties of obtaining adequate compaction adjacent to the relatively high walls of closed abutments. In addition, depending on the type of support used, the differential settlements of abutment and embankment under the approach pavement can be minimized.

A berm is usually constructed at the front of the abutment. The approach embankment may settle by forcing up or bulging the slope in front of the abutment; the weight of the berm helps prevent this.

11.5.3.2 Spill through abutments [Fig. 11.5.3 (d)]-

This type of abutment is frequently used where an additional span is to be added to the bridge at a later date. It may also be used to satisfy some unique construction problem. It is supported on columns or stems that extend upward from the natural ground, or it may be supported on drilled caissons or piles that are constructed prior to placing the embankment.

It is very difficult to properly compact the embankment materials that are to be placed around the columns and under the abutment cap. Early settlement and erosion are problems frequently encountered with this type of abutment.

If the abutment is to be used as a future pier, it is important that the wings and back wall be designed for each removal. Construction joints are generally formed with preformed joint material. Reinforcement bars are not extended through the joints. Threaded inserts with bolts can be used to carry tension stresses across joints, depending upon the intent of the design.

11.5.3.3 Closed abutments [Fig. 11.5.3(e) (f) and (g)]

Full-closed abutments-A full-closed abutment is built close to the roadway or stream being crossed, and it retains the full height of roadway embankment. This type of abutment is the most costly; however, it may be desirable where right of way is critical. By reducing the span length and superstructure cost, the total structure cost may be reduced. Rigid frame structures use a full retaining abutment poured monolithically with the superstructure. If both abutments are connected by fixed bearings to the superstructure (as in rigid frames), the abutment wings are joined to the abutment walls by a mortised expansion joint. For a nonskewed abutment, this enables the abutment wall to rotate about its base and allow for superstructure contraction and expansion due to temperature and shrinkage, assuming the rotation is possible. It

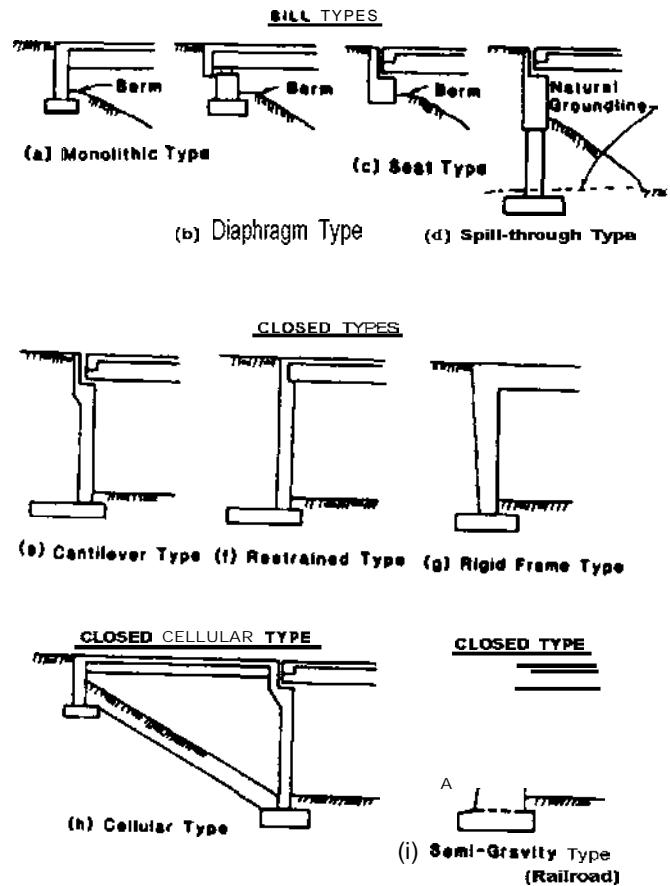

Fig. 11.5.3-Abutment types

also allows differential settlement to occur between the wing and abutment footings. This differential settlement is not uncommon, due to the different loads on the two foundations.

An objectionable feature of full-closed abutments is the difficulty associated with placing and compacting material against the back of the abutment wall and between the wing walls. It is possible that this type of abutment may be shoved out of vertical alignment if heavy equipment is permitted to work near the walls, or if one end of the bridge is backfilled prior to the other; severe cracking may result. The placement of the embankment after abutment construction may cause foundation settlement. For these reasons, as much of the roadway embankment as possible should be in place before starting abutment construction. Backfilling should be prohibited until the superstructure is in place. Other disadvantages of full-closed abutments are minimum horizontal clearance, minimum sight distance, collision hazard, and settlement.

Semi-closed abutments-The semi-closed abutment is built part way up the end slope of the roadway embankment, and it provides more horizontal clearance and sight distance than a full-closed abutment. Located on the embankment slope, it becomes less of a collision hazard for a vehicle out of control.

The discussion about full-closed abutments generally applies to semi-closed types. They are used primarily in two-span highways over highway crossings as a substitute for a

shoulder pier and sill abutment. These abutments generally are designed with a fixed base, allowing wing walls to be rigidly attached to the abutment body. Wings and body are usually poured monolithically.

11.5.3.4 Closed cellular abutments [Fig. 11.5.3(h)]—These abutments are also called vaulted abutments. Generally, these abutments are a combination of a solid pier (front wall) and a sill-type abutment, with precast concrete beams spanning between the front wall and the sill abutment. The side walls act as curtains to hide what is in effect a short end span. Provisions should be made for access to the vault and for ventilation.

Cellular abutments are often used where the main span superstructure would require too tall a sill-type abutment. They are also used to shorten the main spans, particularly on bad skews, and the side walls provide an attractive esthetic treatment for an otherwise awkward situation.

11.5.4 Retaining walls—Retaining walls, except for the retaining function of abutments, are not considered a structural element of a bridge. Retaining walls are used to confine soil so that roadways can be properly supported or protected. Excellent aids for the design of retaining walls are the *AREA Manual*, Section 5, Chapter 8.

Because retaining walls confining soils that support highways or railroads have a much more critical role than typical building retaining walls, greater care should be taken in their design and detailing. Proper drainage of the soil being retained is necessary.

11.5.5 Wing walls—Wing walls are retaining walls that adjoin abutments. They may be separated from the abutments, or they may be monolithic with the abutments. They may have separate foundations, or they may be cantilevered horizontally and vertically from the abutment, and they generally support parapets that are designed for impact loads. The tops of the parapets are usually sloped to prevent vehicles from colliding with the end of the wing wall.

The junction of the wing wall with the abutment proper requires special attention. The wing wall will tend to deflect differently than the abutment, both in magnitude and direction. If the wing wall is monolithic with the abutment, stresses at the junction will require special reinforcement. These stresses are a combination of vertical and horizontal bending and shear, plus torsion. If the wing wall is separate, special joints and details are needed to prevent unsightly gaps or offsets.

It is generally recommended that wing walls of closed abutments be separated from the abutment proper, but wing walls of sill-type abutments be monolithic. Wing walls may be parallel to the road or stream being crossed, they may be parallel to the roadway crossing the bridge, or they may be flared. The choice is generally made on the basis of esthetics and safety.

11.5.6 Joints at abutments—The ideal solution to the roadway joint at the abutment is to eliminate it. In short span concrete bridges, this can be done by making the deck slab monolithic with the back wall of the abutment [Fig. 11.5.3(a)]. For bridges in the overall length range up to 300 ft (91 m), the deck slab and girders may be cantilevered be-

yond the back wall of the abutment and a diaphragm back wall (integral with the girders) placed against the soil [Fig. 11.5.3(b)]. These details effectively eliminate the expansion joint at the end of a bridge.

For all other cases, an expansion joint should be placed between the end of the deck slab and the back wall of the abutment to permit unrestrained movement of the superstructure. These joints are of many types; for a discussion of the various types, see ACI 504R.

Another phenomenon that should be considered when the approach roadways are concrete is the tendency for the pavements to grow or lengthen, due to minute cracks being filled with dirt during cold periods. This lengthening, if not properly controlled by adequate joints and maintenance, can damage the abutment back walls. If a reinforced concrete approach slab is used, a joint can be placed between the approach slab and the abutment back wall, or it may be located at the end of the approach slab away from the bridge.

11.6-Piers

11.6.1 General description—Bridge piers serve the general purpose of transmitting vertical and horizontal loads to the foundation. In addition to the requirement to carry loads to the foundation, bridge piers often are required to resist superstructure rotations, which are the result of moments induced by frame action when piers are cast monolithically with the superstructure.

Reinforced concrete is the material usually used in bridge pier construction. Another type of pier utilizing concrete is a composite column that is a combination of structural steel and concrete. This is sometimes appropriate where steel piles are utilized in a pile bent that needs to be increased in section strength or to present a smooth wall for esthetics and for protection against drift hangup. Also, it is possible that site conditions might dictate that bridge piers be constructed using precast concrete. This is best accomplished using precast concrete segments post-tensioned together vertically, and is covered in [Section 11.65](#).

Often, bridge piers are the most decisive factor in obtaining proper esthetics for a bridge structure. Proper location, selection of a suitable configuration that blends well with both the superstructure and the terrain, and careful proportioning of section dimensions have a significant influence on structure appearance.

11.6.2 Pier configurations¹¹⁻³⁴—It is essential that pier configurations be compatible with the type of superstructure that they support, and also with the type of connection made to the superstructure. Piers may be constructed to be integral with the superstructure or they might be connected by a pinned or an expansion-type of bearing.

Pier configurations may be single shafts or multiple column bents. Single shaft piers generally blend well with required esthetic treatments and offer minimal restriction to drift in a stream. Multiple column bents are usually very efficient from a structural viewpoint and are advantageous for use in very wide structures, since joints in the cap can minimize transverse shrinkage problems.

Generally, section shapes are either rectangular or circular, unless some special consideration is given to architectural treatment. With today's increased concern for visual impact, more consideration should be given to special shapes. Often, suitable architectural treatment can be achieved with circular or rectangular sections by providing items such as recessed areas with brick veneer or a form liner,

Circular shafts are advantageous, based on the following:

- Ease of forming, since many contractors have ready access to steel forms.
- Better flow characteristics, particularly when the stream flow direction changes between low and flood stage and where the river changes its course from season to season.
- It is never at a skew in a framed structure and therefore avoids the problem of increased stiffness due to a pier axis alignment that has a stiffness component in the longitudinal direction of the superstructure.
- Spirals or round ties make the placement of reinforcement relatively easy. Spiral reinforcing is also efficient in providing lateral support to vertical reinforcing. This becomes important in seismic areas where the outer cover of concrete may spall off due to severe dynamic loadings. Properly designed spiral reinforcing provides excellent ductility under seismic loading. Similar ductility

can be provided as needed in tied circular columns by the use of closely spaced ties welded to form a continuous loop.

Advantages of the rectangular shape are as follows:

- It can be proportioned to place section strength in the direction needed.
- More reinforcement can be placed in areas of higher strain to produce greater moment capacity.
- For moments produced by change in length of the superstructure between two fixed piers, rectangular shafts have a greater moment capacity versus moment-generated ratio than do circular shafts.
- Rectangular wall-type piers offer little resistance to stream flow, but only if they are parallel to the stream flow.

Fig. 11.6.2(a) to Fig. 11.6.2(h) from Reference 11-34 show typical pier configurations and approximate dimensions for use in initial design. Such dimensions should be refined in final design. These figures also provide some direction as to what configurations are suitable for various heights of substructure.

For river piers, configurations should be based on consideration of flow characteristics. The alignment of a shaft should be made, as close as possible, to the direction of stream flow at higher stages. Circular ends of rectangular shafts that are closely aligned with the stream flow will pro-

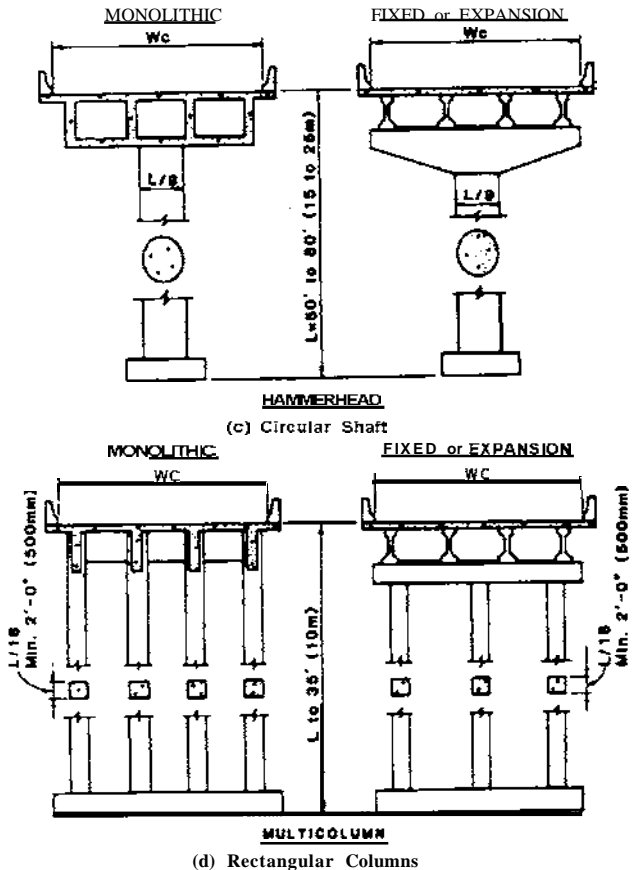
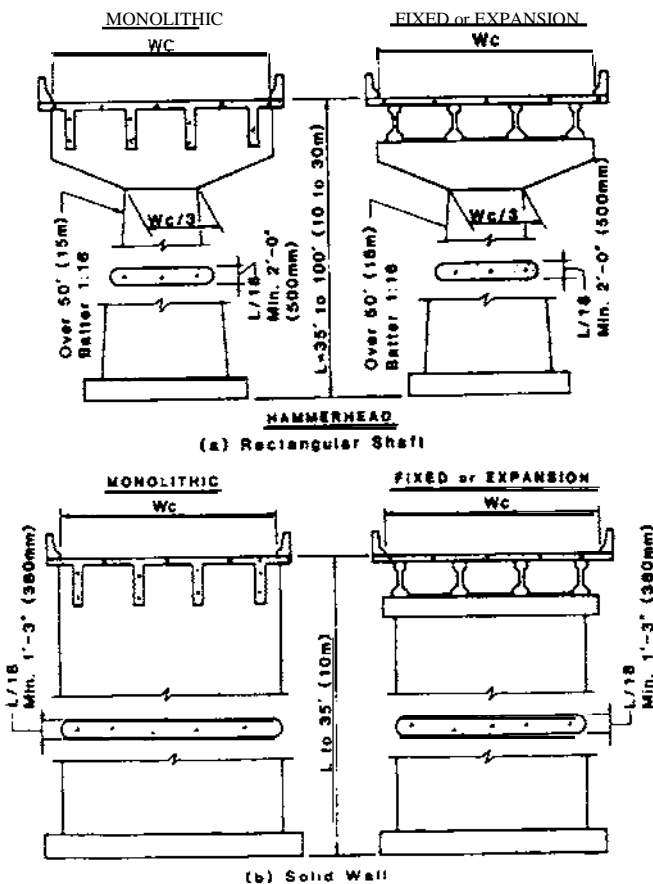

Fig. 11.6.2(a) and (b)-Hammerhead and solid wall piers

Fig. 11.6.2(c) and (d)-Circular shaft hammerhead and multi-column piers

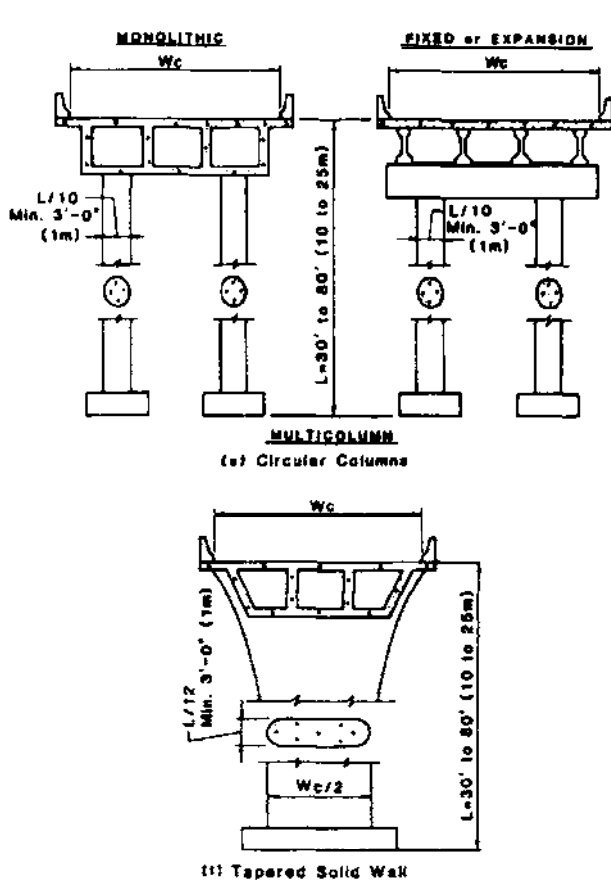

Fig. 11.6.2(e) and (f)-Multicolumn piers and tapered solid wall piers

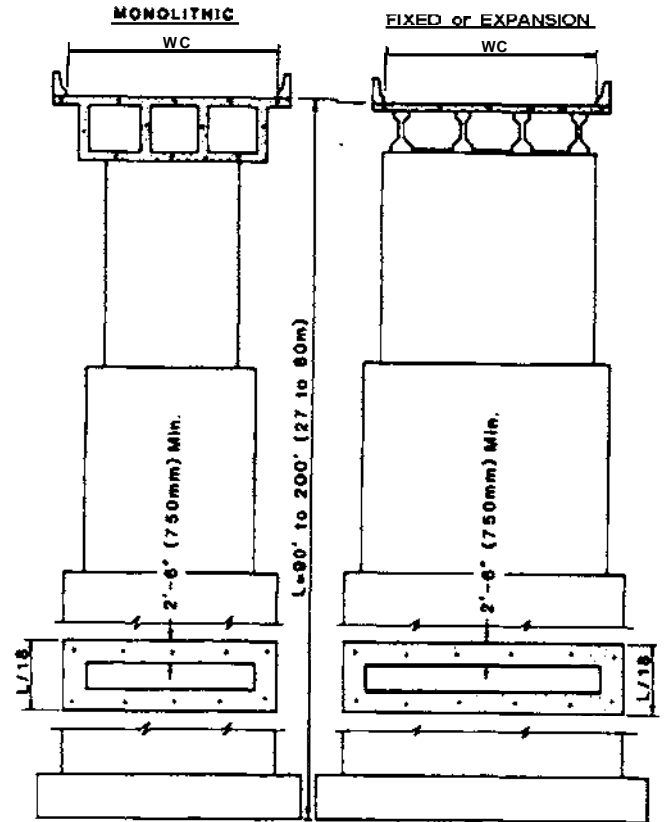

Fig. 11.6.2(g)-Voided box section piers

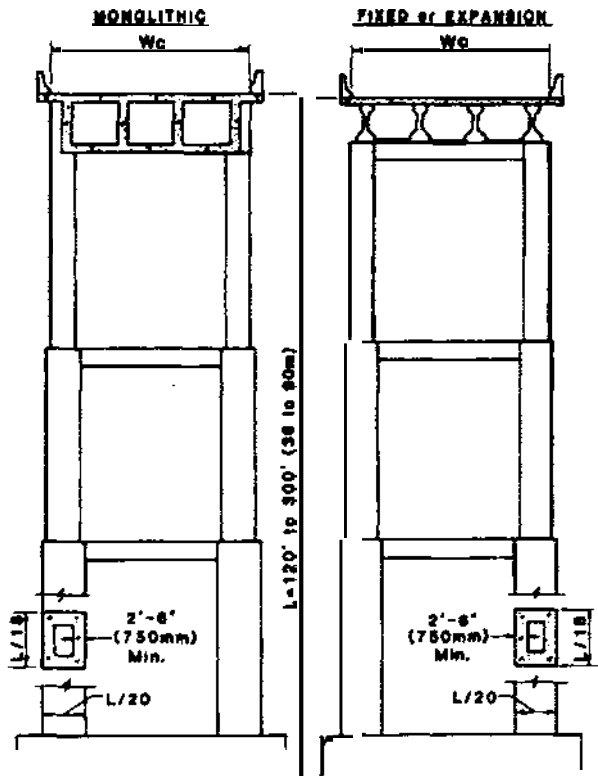

Fig. 11.6.2(h)-Multistory bent piers

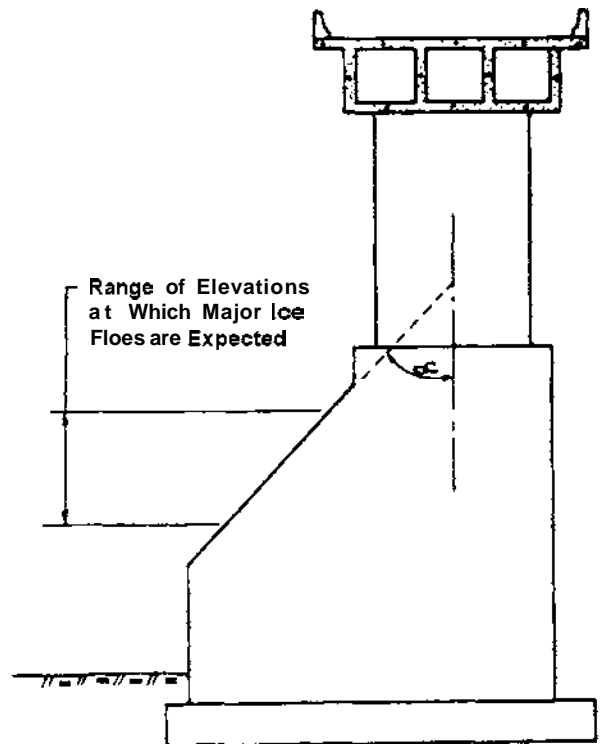

Fig. 11.6.2(j)-Piers with ice breaker

vide flow characteristics similar to circular shafts. Therefore, if the stream flow pressure equation (Section 5.5) $SF = KV^2$ is used to calculate pressure, a value of $K = 0.67$ is suitable for use.¹¹⁻¹³

In streams carrying large ice floes, a configuration should be selected that will pass the floe without forming dangerous ice jams. A thick sheet of moving ice striking a pier could do several things; it could pivot about the pier, fail in one of several possible mechanisms, or come to rest between two piers, or a pier and adjacent bank creating a potentially dangerous situation. Sloping nose piers shown in Fig. 11.6.2(j) serve to break up such ice sheets and reduce the force. When a sheet of ice impinges on a sloping pier nose, the sheet tends to ride up on the nose, and when a sufficient area is supported above the water, the sheet fails in shear and flexure. Calculations for design ice pressure are given in Section 5.5.

11.6.3 Connections to the superstructure-Types of connections of superstructure to piers should be consistent with the type of superstructure. In addition, when selecting a type of connection, consideration should be given to the desirability of moment connections, potential uplift, seismic motion, magnitude of potential lateral forces, and other such items. The following are types of connections to be considered.

11.6.3.1 Monolithic connections-By definition, this type of connection is one where the concrete for the superstructure and the substructure is cast together to act as a framed unit, where moments are transferred through the connection from the superstructure to the substructure and vice versa [Fig. 11.6.3.3(a) and (b)]. Construction joints are normally provided between the pier and the superstructure in order to minimize problems due to shrinkage of the fresh concrete in the pier shaft form. Construction joints are also sometimes provided in the superstructure to reduce shrinkage and creep effects acting on the piers as a result of the superstructure shortening between two framed piers.

Vertical reinforcing in the piers should be extended a development length past the pier superstructure connection in order to provide sufficient moment strength in the pier shaft.

If the pier is equal in width to the out-to-out spacing of the main superstructure load carrying members, the entire shaft cross section may be extended into the superstructure. Where the width of the superstructure extends beyond the plan dimension of the column, pier caps should be provided and designed to transmit the longitudinal moments by torsion.

The desirability of using a monolithic pier superstructure connection depends on relative pier stiffness. A framed pier that is properly proportioned will increase support restraints sufficiently to substantially reduce the overall moment requirement in the superstructure. Piers that are short and correspondingly stiff will cause very high moments due to changes in length of the superstructure (elastic shortening, temperature, shrinkage, creep effects) and therefore, be very inefficient. In cases such as this, it is recommended to provide sliding bearings at the top of all but one of the piers to eliminate these undesirable moments.

11.6.3.2 Bearings-The subject of bearings and bearing design is discussed in Section 11.2. In considering the effect

of bearings on pier design, the following can produce loads and moments to be considered in pier design:

- a. Transverse or longitudinal shear restraints in the bearings can cause pier shaft bending.
- b. Lateral loads, applied some distance above the pier top, can introduce a moment at the top of the pier when such loads are applied in the transverse direction against a series of bearings (this moment is transmitted to the pier by the variation of bearing loads).
- c. Vertical loads on bearings not only produce direct load in a pier shaft but also moments when bearings are placed eccentrically.
- d. Specially designed connections (Fig. 11.6.3.2) can produce a frame moment restraint at the top and bottom of a pier shaft along with a direct load transmitted through the bearing. This type of connection is common with precast cantilever superstructure construction.

11.6.3.3 Articulated hinges-Articulated hinges are an efficient way to reduce the effect of pier stiffness, when such stiffness exceeds that which is structurally efficient.

Details are shown in Figs. 11.6.3.3(a) to (f). Note that the stiffness is reduced with a hinge at the bottom of the column (b). With the articulated hinge at the top of the column (c), all moment stiffness is eliminated. If an articulated hinge is provided top and bottom of the column (d), then an expansion condition is created where structural stability is provided by other piers or abutments in the structure.

11.6.4 Design considerations

11.6.4.1 General-All bridge piers and compression members should be designed by strength design procedures with appropriate consideration given to serviceability at a working stress level. The primary serviceability criteria

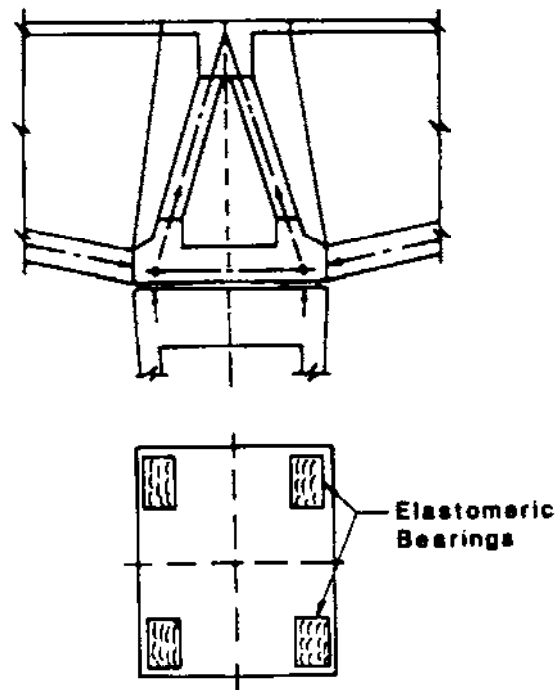

Fig. 11.6.3.2-Special moment connections of superstructure to pier

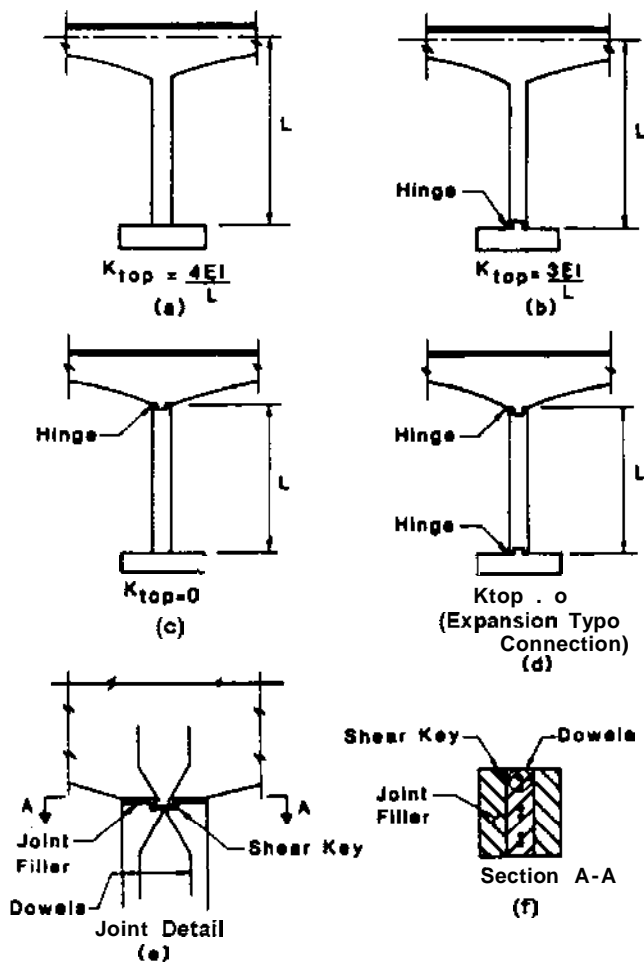

Fig. 11.6.3.3(a) to (f)—Monolithic and hinged connections

should be a crack control evaluation. The recommendations given in Section 8.4 should be followed.

The capacity analysis should be based on a concrete ultimate compressive strain of 0.003 and should consider stress and strain compatibility for both direct load and moment. The strength for pure compression, balanced conditions, and pier bending should be as given in Chapter 7.

11.6.4.2 Slenderness—Slenderness considerations involve control of the slenderness ratio kl/r and computation of secondary moments at the ultimate state.

In most cases, kl/r should be limited to a maximum of 100. The effective length value k is computed as discussed in Section 11.6.4.3, and the radius of gyration r is computed as 0.25 times the diameter of a round column and 0.30 times the depth of a rectangular column. If kl/r exceeds 100, a precise secondary analysis should be made that includes the influence of axial loads and variable moment of inertia on member stiffness and fixed end moments. This analysis should also include the effects of creep due to long term loads, along with the effect of deflections on moments and forces. For columns with a kl/r value less than 22, secondary effects might be ignored.

Secondary effects should be computed using a secondary analysis as previously suggested, or by using an approximate

method for developing secondary moment effects. Several approximate methods are appropriate. The moment magnifier given in ACI 318 and explained in ACI 318R is the most straightforward approach and usually is the most practical procedure for making this analysis. As an alternative, it would be acceptable to use the P-Delta method, as described in References 11-35, 11-36, and 11-37, which may result in reduced amounts of reinforcement in the pier over the previous simplified analysis.

11.6.4.3 Effective length factors—The effective length factor k is used in computing both the slenderness ratio kl/r and the critical buckling load P_{cr} . The factor is given to convert any column or pier into an equivalent pin-ended column bent in single curvature. The variation in effective length factor can be considerable, depending upon end conditions and the braced or unbraced condition.

The effective length factor can be selected from the charts shown in ACI 318R. The chart for unbraced frames should be used. It may also be determined by the following equations for braced piers¹¹⁻³⁸

$$k = 0.7 + 0.05 (G_c + G_B) \leq 1.0 \quad (11-1)$$

$$k = 0.85 + 0.05 (G_{min}) \leq 1.0 \quad (11-2)$$

Use the smaller of the two values.

Use the following equations for unbraced piers¹¹⁻³⁹

$$\text{For } G_{avg} \leq 2k = \frac{20 - G_{avg}}{20} \sqrt{1 + G_{avg}} \quad (11-3)$$

$$\text{For } G_{avg} \geq 2k = 0.9 \sqrt{1 + G_{avg}} \quad (11-4)$$

where

$$G_A = \frac{\frac{EI}{L} \text{ Columns}}{\frac{EI}{L} \text{ Members resisting column bending at A end of column}}$$

In computing effective length factors for monolithic connections, it is important to properly evaluate the degree of fixity in the foundation. The following values can be used:

GA

- 1.5 Footing anchored on rock
- 3.0 Footing not anchored on rock
- 5.0 Footing on soil
- 1.0 Footing on multiple rows of piles

In determining these effective length factors, the designer should use some judgment as to whether there is a braced or an unbraced condition. It is reasonable to assume that most bridge analysis should use the unbraced condition.

11.6.4.4 Biaxial bending—All pier section analysis should be done using strength design procedures. For biaxial bending, either an actual stress and strain compatibility anal-

ysis should be made or an approximate analysis that will simulate such.

As an approximate analysis when $P_u > 0.1 f'_c A_g$, the reciprocal load equation

$$1/P_{nxy} = 1/P_{nx} + 1/P_{ny} + 1/P_g \quad (11-5)$$

should be used. This equation generally gives conservative results and is practical to use.

In reality, most bridge piers will be subjected to ultimate loads where $P_u < 0.1 f'_c A_g$. The elliptical equation

$$(M_{ux}/\phi M_{nx})^2 + (M_{uy}/\phi M_{ny})^2 \leq 1.0 \quad (11-6)$$

gives a reasonably good simulation of the stress and strain compatibility analysis.

11.6.4.5 Irregular shapes—The capacity analysis for irregular and unsymmetrical shapes is somewhat similar to the capacity analysis for biaxial bending. However, simple approximate solutions are not readily available. A stress and strain compatibility analysis is suitable for determining the capacity of these unusual shapes. This analysis is most suitably carried out by using a computer.

In the analysis of many irregular shapes, consideration should be given to using an increased concrete strain of 0.004 at the ultimate load provided, however, the strength of the section where the strain is greater than 0.003 is not included in the computation of the required strength of the member.

In shapes where thin walls exist, it is important that these thin portions of the section be analyzed for shear capacity and requirements. This is particularly important when considering large dynamic loads due to seismic action.

In areas where a detailed seismic analysis is required, the columns theoretically should be designed for the maximum compressive load due to gravity and seismic loading acting simultaneously on the column. However, there is little guidance available for computing the vertical seismic load. In general, it would not significantly change the results if the vertical seismic load was ignored.

11.6.4.6 Tie requirements—It has been generally accepted that up to a point near the crushing strain of concrete, lateral reinforcement does little to enhance the structural performance of a column. Beyond this point, however, the tied column is liable to exhibit a brittle failure due to the fact that ties are normally widely spaced, and after any concrete deterioration, there is inadequate support for the main vertical reinforcing against buckling and for the concrete core against crushing. Spiral columns usually have spirals at a much closer spacing, and these perform better when the concrete starts to deteriorate. This normal close spacing of spirals is adequate to restrain the vertical reinforcing against buckling.

Spiral columns also have the added benefit that the spiral reinforcing creates a hoop tension confining concrete, and thereby increasing the strength and ductility of the concrete core. Closely spaced ties, whose ends are adequately anchored inside the concrete core, will increase the strength

and ductility of tied columns, but this increase will not be as significant as the same volume of closely spaced spirals. It is not feasible to design a pier to withstand all damage from severe seismic action. Therefore, current design practice is to provide for ductility at potential plastic hinge areas, such as in the piers, through increased hoops and ties or spirals.

It is recommended that the normal requirements for hoops and ties be #4 hoops at 1 ft (300 mm) vertical spacing with ties, not to exceed 2 ft (600 mm) transversely. As previously suggested, these spacings should be reduced in potential plastic hinge regions. Potential plastic hinge zones occur at the bottom of piers for simply supported girder-type structures and at the top and the bottom of piers for framed-type structures. Ties should have hooks anchored in the compressive zone (confined core).

The New Zealand Concrete Design Code gives guidance for determining lateral reinforcing in the potential plastic hinge regions. However, the recommendations of ATC-6¹¹⁻¹ are rapidly gaining acceptance in the U.S. and should be used where feasible. This code indicates that the length of the potential plastic hinge region should not be less than a column diameter for a circular column, or the longer column cross section dimension for rectangular columns, or one-sixth of the clear height of the column but not less than 18 in. (450 mm) and, if applicable, this length should be increased to cover the entire distance where the moment exceeds 0.8 times the end moment. At no time should it be necessary for the potential hinge length to extend over more than one-half of the pier height. In situations where the maximum design load on the pier exceeds $\phi(0.3)f'_c A_g$, the anticipated length taken from the previous criteria should be increased by 50 percent.

In potential plastic hinge regions, it is recommended that the maximum center-to-center spacing of transverse reinforcing not be less than the larger of one-fourth of the smaller column dimension (column diameter for circular columns), or 8 in. (200 mm).

In circular columns, ρ_s should not be less than the greater of

$$\rho_s = 0.45 [(A_g/A_c) - 1] & \tau / f_{yh} \quad (11-7)$$

or

$$\rho_s = 0.12 f'_c / f_{yh} \quad (11-8)$$

In rectangular columns, the total area of hoops and supplementary cross ties in each of the principal directions of the cross section within the spacing s_h should not be less than the greater of

$$A_{sh} = 0.3 s_h h_c f'_c / f_{yh} [(A_g/A_c) - 1] \quad (11-9)$$

or

$$A_{sh} = 0.12 s_h h_c f'_c / f_{yh} \quad (11-10)$$

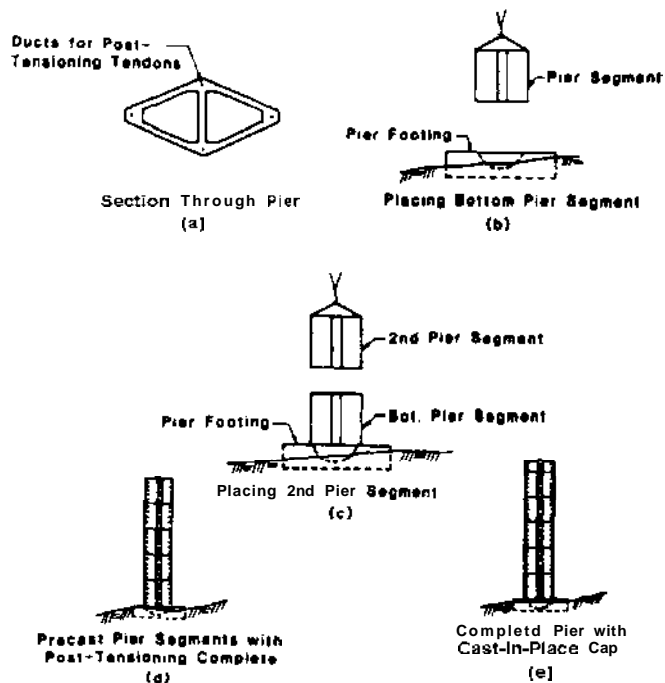

Fig. 11.6.5(a) to (e)-Post-tensioned pier construction

In rectangular shafts, it is recommended that the center-to-center spacing of tied bars not exceed the larger of one-third of the column cross section dimension in that direction or 8 in. (200 mm).

It is apparent that many piers that have wide cross sections may have sufficient strength in the transverse direction of the bridge to sustain seismic loads in the same direction without yielding. This elastic response to a severe earthquake would require a capacity to resist a lateral seismic load which is 4 to 6 times the usual code lateral seismic load. If such large strength is available (both in bending and in shear), then it would be only necessary to provide special detailing of reinforcement for horizontal loading in the longitudinal direction of the bridge.

11.6.5 Post-tensioned piers-For very tall or highly loaded piers, a nonprestressed reinforced pier may not be practical. In such cases, post-tensioned piers may be used, and these are usually segmental construction.

Precast segmental piers are also used in special cases where particular construction requirements are specified. Either the environment is fragile enough that the contractor will have minimum access dictated by the locale or the construction schedule, or the construction season is so short that precasting of the piers is necessary to obtain a strict construction schedule. A prime example of this is mountainous regions, where the environmental constraints are severe and the summer season is short. In such a case, the pier segments can be precast during the winter and erected the following spring. By precasting, intricate and interesting shapes can be economical since the forms are reused. Each segment is match cast to the previous segment to insure exact seating when erected. Erection of a segmental pier, once the foundation is cast, is simple. Using strands, both the foundation and

the shaft will require post-tensioning ducts placed prior to pouring concrete [Fig. 11.6.5(a) and (b)]. Erection continues by placing segment on segment [Fig. 11.6.5(c) and (d)] until the desired height is obtained. Keys should be placed in each section to aid in alignment. With all of the segments in place, the pier is ready for stressing and then grouting, followed by casting the pier cap [Fig. 11.6.5(c) and (d)]. Joints between precast segments may be grouted with cement or epoxy-injected. Joint edges should be sealed against water penetration.

The weight of each individual segment should be kept at approximately 40 tons (350 kN) to obviate the need for special transport trucks or special overload permits. This weight restriction will also help in erection, since most bridge cranes can handle up to 40 tons (350 kN); for piers less than 100-ft (30-m) high.

Generally, tensile stresses are not allowed under AASHTO group loading conditions for the post-tensioning design, tendons or bars may be used for the post-tensioning system. If bars are used, an anchorage system in the footing is required.

11.6.6 Detailing

11.6.6.1 Splices-Construction joints in piers, doweled connections to footings, and reinforcing length limitations often require splicing of the main vertical reinforcing within the pier height. Reinforcing splices can be made by lap splicing bars #11 and smaller, using mechanical splices, or by welding. It is recommended that splices of adjacent bars at the same vertical location be avoided, and vertical locations for splices be at least 3 ft (1 m) apart.

For lap splices where only alternate bars are spliced at the same location, a Class "B" splice length, as defined in [Section 13.2](#), should be considered adequate. Proper clear spacing between bars should be maintained in lap splice areas, and mechanical splices should be detailed according to the manufacturer's recommendations.

When welded splices are unavoidable, it is recommended the splices be prepared in accordance with AWS D 1.4. Care should be taken during welding operations to protect adjacent bars from damage. Shielding devices are normally provided for protection from splatter and errant contact with a welding rod. It is also recommended that when Grade 60 bars are specified as welded, the reinforcement should be in accordance with ASTM A 706.

11.6.6.2 Development requirements-When a pier shaft has a moment resisting connection with a footing or with a monolithic cap, full development of the vertical reinforcing beyond the interface should be provided. This development length may consist of a combination of the equivalent embedment length of a hook or a mechanical anchorage, plus additional embedment length of the vertical reinforcing. This required additional embedment length will often dictate the required size of footing. Pedestals may also be used in lieu of increasing the footing depth.

If more vertical reinforcing is provided than actually required by a capacity analysis, then the required development length and the resultant required footing depth may be reduced to provide only the capacity required.

11.6.6.3 Dynamic earthquake requirements—For routine design, it is generally not cost-effective to design a bridge structure to resist very large inertia loads resulting from elastic response to severe earthquake action. Instead, the design should be for smaller earthquake loads with the structure being detailed to provide ductility in the piers. Ductility becomes important when plastic hinge zones form, since it gives significant energy dissipation. The value μ , known as the ductility factor, is used to measure ductile action and is defined as the ratio of the maximum displacement under the design earthquake to the theoretical yield displacement. An acceptable maximum design value of μ is 6.

As indicated in [Section 11.6.4.6](#), adequate lateral pier reinforcement is most helpful in producing ductility. A general design procedure suggested for ductile structures that includes plastic hinge areas in piers should be:

- Design plastic hinge sections to have a dependable flexural strength which is at least equal to the required flexural strength. The dependable strength should be ϕ times the ideal strength, based on the specified material strengths of the steel and concrete.
- Design all sections, other than plastic hinge areas, for flexure and shear. This should be based on an analysis using plastic hinge flexural capacities, based on over-strength materials and including an allowance for strength increase due to steel strain hardening. Design the plastic hinge areas for shear.

11.7-Pier protection^{11-40,11-41}

11.7.1 Fender systems—In the case of bridge piers located in the vicinity of navigation channels and subject to the danger of damage from ship collision, provision should be made to protect the piers from collisions. The need and cost of fender systems can be avoided by using longer spans that extend beyond physical channel limits.

In addition to such measures as adequate channel delineation, warning lights on the structure, and other applicable aids to navigation, consideration should be given to the construction of fenders at the piers.

The amount of protection offered by the fenders should be based on a prediction of the probable magnitude of a collision, taking into account the size and speed of vessels using the channel.

Fenders may take the form of actual physical barriers, independent of the pier and isolating it completely from the impact of a collision, or they may act as cushions, limiting the magnitude of forces transmitted to the pier. In either case, they should be designed as energy absorbing devices.

Timber-rubbing planks may be placed vertically around the fender system to deflect small boats; all timber used in fender systems should be pressure treated.

Essential requirements for fender piling are as follows:

- High energy absorption capacity before rupture to eliminate damages to the main structure.
- High internal damping.
- High fatigue strength.
- Appreciable elastic movement.
- Capability of absorbing inclined impacts and rubbing

forces to eliminate damage to fendering.

- Combined with the main structure, sufficient static resistance and mass to cause plastic deformation of the ship's hull.

Consideration might be given to prestressed concrete in the design of fender systems because of its excellent energy absorption. Prestressed sections should be properly confined with spirals or ties.

11.7.2 Debris walls—Multiple column piers located in areas of streams where drift is anticipated, should have a debris wall between the columns to minimize the possibility of debris hangup. Debris hangup on piers can, in some instances, restrict the waterway opening, cause extreme flooding upstream of the bridge and, in extreme cases, cause collapse of the bridge. Debris walls should provide smooth, exposed faces capable of deflecting debris through the structure. Normally, debris walls should extend 3 to 5 ft (1 to 2 m) above the design high water elevation for the bridge and at least 2 ft (0.6 m) below the probable scour elevation.

11.7.3 Crash walls—Railroads passing under bridge structures that use multiple column piers will often require crash walls either in front of or integral with the piers that are adjacent to the tracks. These crash walls should provide a smooth surface to a passing train. On occasion, similar crash walls might be provided along with guardrail for multiple column piers that are adjacent to highways with heavy truck traffic.

RECOMMENDED REFERENCES

The documents of the various standards-producing organizations referred to in this report are listed below with their serial designation, including year of adoption or revision. The documents listed were the latest effort at the time this report was written. Since some of these documents are revised frequently, generally in minor detail only, the user of this report should check directly with the sponsoring group if it is desired to refer to the latest revision.

American Association of State Highway and Transportation Officials

FIM-2 Foundation Investigation Manual, 1978

GSDB Guide Specifications for Seismic Design of Highway Bridges, 1983

HIDG-7 Hydraulic Analyses for the Location and Design of Bridges

American Concrete Institute

336.3R-72 Suggested Design and Construction Procedures for Pier Foundations (Revised 1985);

543.R-74 Recommendations for Design, Manufacture and Installation of Concrete Piles

318-83 Building Code Requirements for Reinforced Concrete (Reapproved 1980);

318R-83 Commentary on Building Code Requirements for Reinforced Concrete

SP-53 Reinforced Concrete Structures in a Seismic Zone, 1977

American Railway Engineering Association Manual for Railway Engineering
Chap 8 "Concrete Structures." *Manual of Railway Engineering*

American Society of Testing and Materials
STP 444 Performance of Deep Foundations, 1969
STP 450 Vibration Effects of Earthquakes on Soils and Foundations, 1969
STP 670 Behavior of Deep Foundations, 1979
STP 399 V-Average Shear and Cone Penetration Resistance Testing of In-Situ Soil, 1966
STP 412 Use of Nuclear Meters in Soil Investigations, 1968
STP 479 Special Procedures for Testing Soil and Rock for Engineering Purposes, 1970
A 706-84a Low-Alloy Steel Deformed Bars for Concrete Reinforcement
D 1143-81 Method of Testing Piles under Static Axial Compressive Load

American Welding Society
D 1.4-79 Structural Welding Code-Reinforcing Steel

Concrete Reinforcing Steel Institute
CRSI Handbook, 1984 (6th Edition)

Transportation Research Board
NCHRP 248 Elastomeric Bearings Design, Construction and Material, 1982
REC 982 Bridges and Foundations, 1984
NCHRP SYN 107 Shallow Foundations for Highway Structures, 1983

CITED REFERENCES

11-1. "Seismic Design Guidelines for Highway Bridges," ATC-6; Applied Technology Council, 1983.
11-2. Lambe, T. W., and Whitman, R. V., *Soil Mechanics*. John Wiley & Sons, Inc., New York, 1979.
11-3. "Design Manual-Soil Mechanics, Foundations, and Earth Structures." U.S. Department of the Navy, Naval Facilities Engineering Command, NAVFAC DM-7.2, Washington, D.C., May 1982.
11-4. Zeevaert, L., *Foundation Engineering*. Van Nostrand Reinhold Co., New York, 1985.
11-5. Tschebotarioff, G. P., "Foundations, Retaining and Earth Structures," McGraw-Hill Book Co., New York, 1973.
11-6. Terzaghi, K., and Peck, R. B., "Soil Mechanics in Engineering Practice," Second Edition, John Wiley and Sons, New York, 1967.
11-7. Teng, W. C., *Foundation Design*, Prentice-Hall, 1962.
11-8. Jumikis, A. R., *Foundation Engineering*. Intext Educational Publishers, 1971.
11-9. Dunham, C. W., *Foundations of Structures*,

McGraw-Hill Book Co., Second Edition, New York, 1962.

11-10. Leonards, G. A., et. al., *Foundation Engineering*, McGraw-Hill Book Co., New York, 1962.

11-11. Parcher, J. V., and Means, R. E., *Soil Mechanics and Foundations*, C. E. Merrill Publishing Co., 1968.

11-12. Tomlinson, M. J., "Foundation Design and Construction," Second Edition, Wiley Interscience, A Division of John Wiley and Sons, Inc., New York, 1969.

11-13. Bowles, J. E., *Foundation Analysis and Design*, McGraw-Hill Book Co., Third Edition, New York, 1982.

11-14. Hammond, R., *Modern Foundation Methods*, McLaren, London, 1967.

11-15. Carson, B. A., "Foundation Construction," McGraw-Hill Book Co., New York, 1965.

11-16. McClure, G. S., and Herman, G. J., "A Study of Ice Formations and Their Effects on Bridges," *Highway Research Report*, Montana State Highway Commission, Apr. 1965.

11-17. "Subsurface Investigations for Design and Construction of Foundations of Buildings: Part I," American Society of Civil Engineers, *Journal of the Soil Mechanics and Foundations Division*, V. 98, No. SM5, May 1972, pp. 481-490.

11-18. "Subsurface Investigations for Design and Construction of Foundations of Buildings: Part II," American Society of Civil Engineers, *Journal of the Soil Mechanics and Foundations Division*, V. 98, No. SM6, June 1972, pp. 557-575.

11-19. Chellis, R. D., *Pile Foundations*, McGraw-Hill Book Co., New York, 1961.

11-20. "Behavior of Piles," Proceedings of the Conference Organized by the Institution of Civil Engineers in London, Sept. 15-17, 1970, The Institution of Civil Engineers, London, 1971.

11-21. Li, S. T., and Liu, T. C., "Prestressed Concrete Piling--Contemporary Design Practice and Recommendations," *Journal of the American Concrete Institute*, V. 67, No. 3, Mar. 1970, pp. 201-220.

11-22. Gerwick, Jr., B. C., "High Capacity Prestressed Concrete Piling," Proceedings of the International Conference on Planning and Design of Tall Buildings, Technical Committee No. 11, *Discussion No. 1*, V. 1A, 1972, pp. 985-989.

11-23. Anderson, A. R., and Moustafa, S. E., "Dynamic Driving Stresses in Prestressed Concrete Piles," *Civil Engineering*, ASCE, V. 40, No. 8, Aug. 1971, pp. 55-58.

11-24. Anderson, A. R., and Moustafa, S. E., "Ultimate Strength of Prestressed Concrete Piles and Columns," *Journal of the American Concrete Institute*, V. 68, No. 8, Aug. 1970, pp. 620-635.

11-25. Li, S. T., and Ramakrishnan, V., "Optimum Design of Prestressed Concrete Combined Bearing and Sheet Piles," *Journal of the Prestressed Concrete Institute*, V. 17, No. 5, Sept.-Oct. 1972, pp. 39-48.

11-26. Li, S. T., and Ramakrishnan, V., "Optimum Prestress, Analysis, and Ultimate Strength Design of Prestressed Concrete Bearing Piles," *Technical Report* prepared for the Engineering Division, Civil Works, Office of the

Chief of Engineers, Dept. of the Army, Washington, D.C., 1969.

11-27. Li, S. T., and Ramakrishnan, V., "Optimum Prestress, Analysis, and Ultimate-Strength Design of Prestressed Concrete Combined Bearing and Sheet Piles," Technical Report prepared for the Engineering Division, Civil Works, Office of the Chief of Engineers, Dept. of the Army, Washington, D.C., Apr., 1970.

11-28. Bruce, R. N., and Hebert, D.C., "Splicing of Precast Prestressed Concrete Pile: Part I-Review and Performance of Splices," *Journal of the Prestressed Concrete Institute*, V. 19, No. 5, Sept.-Oct. 1974, pp. 70-97.

11-30. Li, S. T., and Ramakrishnan, V., "Ultimate Energy Design of Prestressed Concrete Fender Piling," *Journal of the Waterways, Harbors and Coastal Engineering Division*, ASCE, V. 98, No. WW4, Nov. 1971, pp. 647-662.

11-31. Peck, R. B., Hanson, W. E., and Thombum, T. H., *Foundation Engineering*, Second Edition, John Wiley and Sons, Inc., New York, 1974.

11-32. Bradley, J. N., "Hydraulics of Bridge Waterways," US. Federal Highway Administration, *Design Series No. 1*, 1970.

11-33. "Guide to Bridge Hydraulics," University of Toronto Press, Canada, 1973.

11-34. Heins, C. P., and Lawrie, R. A., "Design of Modern

Concrete Highway Bridges," John Wiley & Sons, Inc., New York, 1984.

11-35. Wood, B. R.; Beaulieu, D.; and Adams, P. F., "Column Design by P-Delta Method," ST 2, *Journal of the Structural Division*, ASCE, Feb. 1976.

11-36. Wood, B. R.; Beaulieu, D.; and Adams, P. F., "Further Aspects of Design by P-Delta Method," ST 3, *Journal of the Structural Division*, ASCE, Mar. 1976.

11-37. MacGregor, J. G., and Hage, S. E., "Stability Analysis and Design of Concrete Frames," ST 10, *Journal of the Structural Division*, ASCE, Oct. 1977.

11-38. Cranston, W. B., "Analysis and Design of Reinforced Concrete Columns," *Research Report 20*, Paper 41.020, Cement and Concrete Association, London, 1972, 54 pp.

11-39. Furlong, R. W., "Column Slenderness and Charts for Design," ACI JOURNAL, *Proceedings* V. 618, No. 1, pp. 9-17, Jan. 1971.

11-40. "Bridge Pier Ship Collision," National Research Council, Marine Board Report, Jan. 1984.

11-41. "Criteria for the Design of Bridge Piers with Respect to Vessel Collision in Louisiana Waterways," prepared for the Louisiana Department of Transportation and Development and the Federal Highway Administration by Modjeski and Masters, Consulting Engineers, Nov. 1984.



Construction of precast concrete box girder bridge (photo courtesy of Texas Highway Department)

CHAPTER 12-PRECAST CONCRETE

12.1-Introduction

12.1.1 General-Precast concrete, manufactured either at a plant or at the bridge site, offers many potential advantages in quality control, speed of construction, and frequently, economy. 12-1-12-5 Precast concrete bridges, both short and long spans, have been built in many environments, from highly urbanized to rural.

Precast concrete bridge elements are generally joined with other precast or cast-in-place elements to perform as if constructed monolithically. 12-1-1 Precast concrete components may be fully or partially prestressed, or they may be reinforced only with conventional reinforcement.

Standardized shapes for highway bridge girders and slabs, developed by a joint AASHTO-PCI committee, have been widely used for span lengths up to 160 ft (49 m) (PCI STD-101, 107, 108, 114 and 115). Special shapes for short-span railway bridges have also been standardized by a joint AREA-PCI committee (AREA, Chapter 8). Precast substructure elements such as piles have been used for many years; AREA Committee 8 has standardized precast concrete caps for precast concrete piles.

Precast concrete elements are usually produced in well established precasting plants. Typically, those plants employ reusable forms. Considerable regional differences exist in

the readily available shapes. In fact, from state to state, large variations exist in the products and shapes customarily used. Therefore, in the preliminary planning stage, depending on the scope of the project, it may be advisable to contact local precasters to determine which shapes are readily available.

12.1.2 Advantages and limitations-Precasting offers favorable conditions for forming (ease of building and stripping), placement of reinforcement, and placing and curing of concrete because the casting is done in a controlled environment. Precasting can be particularly advantageous in adverse environmental conditions, such as heavy precipitation, freezing, or hot, dry weather. Precasting also facilitates rejection of a member which does not meet specifications.

Precast concrete bridge construction methods frequently offer substantial economical savings because on-site labor can be minimized, formwork supports eliminated, erection performed during more favorable seasons and conditions, labor and equipment utilized with maximum efficiency, and advantage taken of mechanization in manufacture. Higher-strength materials are often used with precast concrete, permitting the use of thinner sections, which results in a savings in material.

Precast concrete members can readily be erected over existing highways, railroads, waterways, deep canyons, and at

other locations where the use of falsework to support forms for cast-in-place concrete is impractical or undesirable. Erected precast beams may support formwork for a subsequent cast-in-place concrete deck. Special construction methods such as balanced cantilever, spliced girders, span-by-span progressive placing, incremental launching, cantilever and suspended span, or stayed girder may be applicable under special circumstances.

Railway companies utilize precast concrete frequently for short spans because it is economical and can shorten construction time drastically. As a rule, railroads procure standard precast concrete components in large quantities and transport them by rail to their own storage yards. When a bridge is to be built, a special construction train takes all materials, bridge members, and construction equipment to the bridge site.

Optimum use of precasting is achieved by selecting it in the preliminary design phase. If precast concrete elements are substituted into a structure, with details drawn as a cast-in-place construction, full advantages of precasting the elements may not be realized.

The size of precast segments may be limited by economic and practical considerations. Designers should evaluate structural lightweight concrete and hollow and thin sections made of high-strength concrete as a means of reducing the weight of precast concrete segments. Weight reduction facilitates more economical transportation and erection of the elements.

In selecting the size and shape of precast bridge members, site conditions and the capabilities of local contractors should be considered. When feasible, contractors should be allowed to submit an equivalent precast alternate.

12.2-Precast concrete superstructure elements

A wide variety of precast elements are available for short span bridges (see subsections 4.9.9, 4.10.1, 4.10.3, 4.105, Fig. 6.5.1, including References 12-3 and 12-6). Most precast elements are standard shapes made with reusable forms, which are carried in stock by precasting plants. For medium and long-span bridges, special elements may be more suitable.

12.2.1 Standard pretensioned concrete I-beams—The most common precast bridge members are the AASHTO-PCI Standard Pretensioned I-beams.^{12-2,12-4} Many states have their own unique shapes, and most of them contain less concrete than comparable AASHTO beams. In 1988, the new PCI standard bulb-tees (BT-54, BT-63 and BT-72) contained in PCI STD 115-87 were accepted by AASHTO. They are now preferred for spans of 70-150 ft (21-46 m); by some states.

Generally, precast pretensioned I-beams are longitudinal beams supporting a composite cast-in-place deck [see subsection 4.10.3 and Figs. 2.5.3.2 and 6.5.1(c)]. This construction is usually continuous for live load, as mentioned in sections 9.14.3 and 10.2.4.3 and References 12-7 and 12-8. Spans for this type of construction range from 30 to 160 ft (9 to 49 m).

12.2.2 Precast pretensioned deck panels—Thin precast

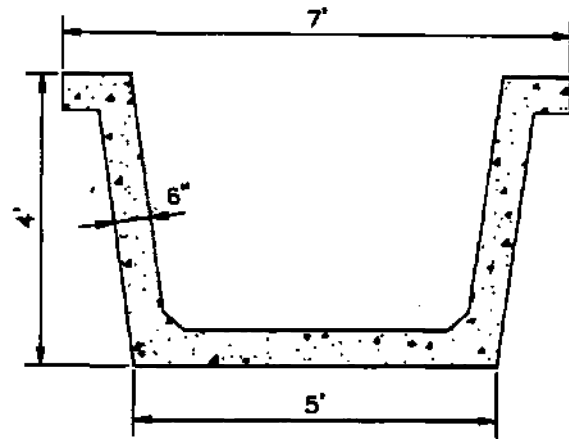

Fig. 12.2.3.1—Precast trapezoidal channel

deck panels, serving as stay-in-place forms for a cast-in-place deck, are sometimes used in conjunction with the precast pretensioned I-beams. Deck panels may be saw-cut diagonally to fit the ends of skew bridges. Careful attention must be paid to the bearing of precast panels on the tops of the supporting beams (Reference PCI JR-343).

12.2.3 Precast trapezoidal concrete beams—Precast trapezoidal channel sections, developed in Canada, are shown in Fig. 12.2.3.1. They also require a cast-in-place deck and are suitable for spans of 100 to 150 ft (30 to 45 m).¹²⁻¹

12.2.4 Complete precast superstructures—Complete precast concrete superstructures, requiring no cast-in place deck, are used frequently.¹²⁻⁶ The precast units serve as the supporting members, as well as the deck. Single tees, double tees, tri-tees, multi-stem sections (also known as rib deck), voided slabs (or hollow core slabs) shown in Fig. 2.5.3.1, bulb tees, butted box beams [Fig. 6.5.1(c)], and inverted channels fall in this category. A serious drawback of the smaller box beams is the fact that they can not be inspected from the inside by ordinary means. When superstructure units deteriorate, epoxy repairs may be contemplated, but usually entire members have to be replaced.

Superstructure units are placed side by side with a longitudinal keyed joint between units. Inverted channels, box beams, and some of the other units may either be conventionally reinforced or pretensioned. Pretensioned units are ordinarily furnished with square ends, but the various tee-shapes and box beams can easily be made with skew ends. Nonprestressed units, mostly inverted channel units, are usually made to fit the skew, as shown in Fig. 12.2.4.1. When units having square ends (normal units) are used in a skew bridge, they are arranged as in Fig. 12.2.4.2.

Due to variations in concrete and prestressing forces, the camber of pretensioned concrete superstructure units may not be uniform. Unexpected changes in camber may occur when the units are hauled long distances and over rough roads. This can be an important factor when units are delivered to sites in the mountains or in remote areas. Bowing and warping of such pretensioned units may result from improper storage, transportation, rough handling, etc.

Thus, the tops of pretensioned channels and boxes may not line up well enough to provide a smooth riding surface. On minor unpaved or low-volume roads, a gravel or asphalt topping, underlain by a waterproof membrane, can serve as a riding surface. Likewise, an allowance must be made for horizontal misalignment. Substructure dimensions should allow for extra superstructure width; a common allowance is $\frac{1}{2}$ in. (13 mm) for each longitudinal joint.

Special attention is required for fastening these units together, otherwise maintenance problems will arise after only a few years. Load transfer across longitudinal joints is usually accomplished by continuous shear keys, filled with non-shrink grout, combined with tie bolts and/or welded connections.^{12-9,12-10 part 6} As an alternate, transverse post-tensioning combined with longitudinal continuous grout keys between units may be used.¹²⁻¹¹ This later alternative often includes a 2-in.- (50-mm-) thick high-density concrete overlay.

To obtain a better, more durable structure, a composite reinforced concrete slab, 4-in. (100-mm) or thicker, can be cast on top of the precast units. Extra transverse reinforcing steel should be provided in the cast-in-place slab across the longitudinal joints between precast units. Alternatively, transverse post-tensioned tendons can be installed just below the top of the units, as previously mentioned.¹²⁻¹¹

An example of the advantages of precast concrete superstructure units is the 5900-ft- (1.8-km-) long bridge carrying Highway US 95 across Lake Pend Oreille near Sandpoint,

Idaho (see Fig. 12.2.4.3). Except for one 83 ft (25 m) navigation span, the trestle contains 154 spans of 35 ft (11 m), interspersed with 25 braced spans of 17 ft (5 m). The superstructure is made up of 6-ft- (2-m-) wide pretensioned concrete rib-deck units. Pretensioned box girders in the navigation span weigh 32 tons (29 metric tons) each.

The entire deck was overlaid with a 4 in. (100 mm) cast-in-place concrete topping. All pile caps and superstructure units were manufactured in Spokane, Washington, and hauled 75 miles (120 km) to the bridge site. The structure was completed in 1981.

12.2.5 Precast concrete slabs for redecking-Existing bridges-Precast concrete deck slabs have been used for replacing worn-out bridge decks, particularly when the bridge cannot be closed to traffic during rehabilitation. Such deck slabs are usually pretensioned.

12.3-Segmental construction

12.3.1 General-Main longitudinal elements, comprising a partial or complete transverse cross section of a bridge, may be precast in lengths shorter than the span. Such shorter elements are erected and prestressed together longitudinally to act as an integral unit. These shorter elements are an example of transverse segments as referred to in section 12.1. This method is known as segmental construction.

Segmental construction is most commonly used in precast box girder bridges (see "AASHTO Guide Specifications for Design and Construction of Segmental Concrete Bridges")

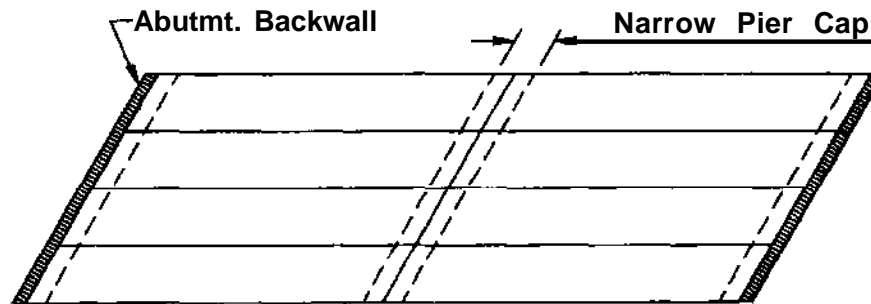

Fig. 12.2.4.1-Plan view of bridge with skew units

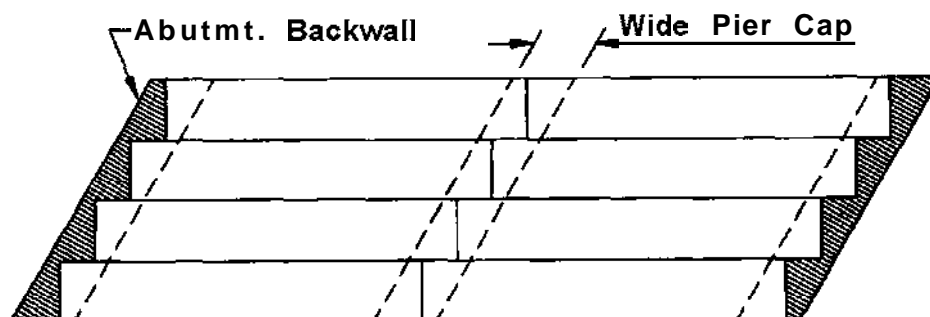

Fig. 12.2.4.2-Plan view of skew bridge with normal units

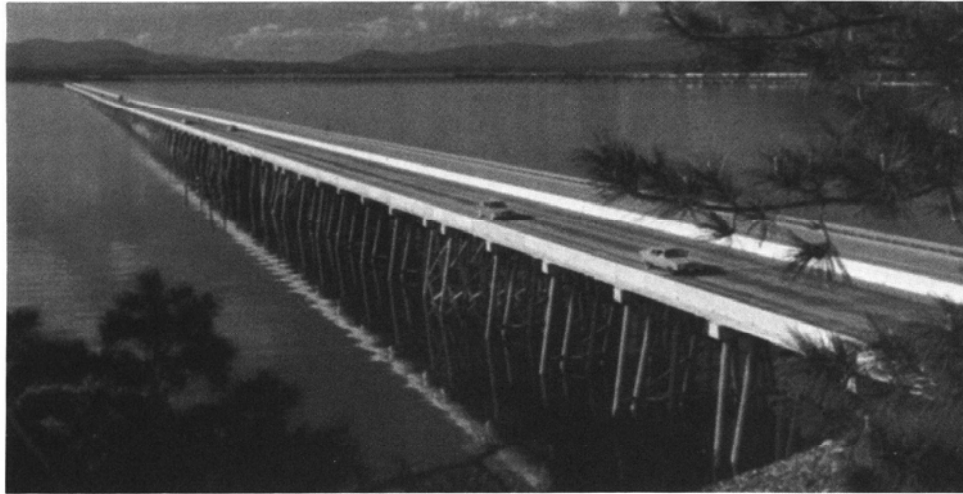

Fig. 12.2.4.3-Sandpoint Bridge over Lake Pend Oreille (photo: Will Hawkins)

Reference GSCB or subsection 4.10.6, 6.5.5 and Fig. 2.5.3.3). Segmental construction may also be used to extend the length of precast pretensioned I-beam spans, as covered in section 12.3.2. Transverse precast deck slab segments, described below, are also segmental construction.

As indicated previously, the manufacture of precast concrete elements is particularly appropriate for trestle structures and viaducts, where many identical spans and pile bents are needed. The bridge crossing Albemarle Sound near Edenton, North Carolina, built in 1988, is an excellent example of such construction. A major portion (78 percent) of this 3.5-mile- (5.6-km-) long two-lane highway structure is a low-level trestle, divided into 260-ft- (79-m-) long continuous bridge units; the bridge units are segmental post-tensioned slab bridges. The deck slabs are 34-ft-wide \times 20-ft-long (10.4 \times 6.1 m), and they weigh 55 tons (50 metric tons) each. Square precast prestressed concrete piling is connected directly into the deck units. Two other superstructure alternatives and various substructure systems had been included in the bid documents. As a result, the cost was cut significantly.¹²⁻¹²

Another excellent example of post-tensioned precast concrete construction is the Bahrain Causeway, completed in 1986. This is the largest bridge project in the Middle East (see Reference 12-13 for a detailed account of this important project).

12.3.2 Spliced girder construction—In situations where a full-span girder may be too long or too heavy to be shipped, the precast girder may be fabricated in relatively short segments. Those segments will then be transported to the bridge site, where they are field-spliced to produce the full girder length. Splicing may be done before or after the girders are erected in their final position. Continuity at the girder splices may be achieved by post-tensioning, conventional reinforcement, or embedded structural steel shapes. Bulb tees and AASHTO I-girders are the most common sections in spliced girder applications.¹²⁻¹⁴

Segment size is selected to accommodate various construction and open layout of a bridge is governed by site con-

ditions. The maximum practical girder length is controlled by transportation limitations and facilities at the precasting plant. Also, splices should be placed at locations which are accessible at the construction site, or splice locations may be dictated by the flexural stresses in the girders. Splicing makes precast concrete a competitive construction for span ranges of 150-250 ft (45-75m). Splicing can also be economical for shorter spans of 100-150 ft (30-45 m).

12.4-Precast concrete substructures

Precast pretensioned concrete piling has been standardized since 1963.¹²⁻² A small pipe may be embedded along the axis of the pile to facilitate jacking.

Precast concrete pier caps have been used in railroad and highway trestle structures. Precast concrete pile caps usually have large openings to receive the piling. A cast-in-place concrete plug or grout is needed to connect the piling to the cap. As an alternative, steel plates with stud anchors can be embedded in the precast concrete cap beams. Pipe piles or H piles can then be welded to the cap in the field. This eliminates waiting for the grout to harden.

Precast columns and pier shafts may be constructed by erecting precast segments vertically with prestressing forces applied during and after completion of construction. Other large substructure members, such as pier caps, which may be too large to precast as a single unit, may be precast in segments and post-tensioned together after erection. Abutments made up entirely of precast concrete components are being built by many railroad companies.

“Mechanically stabilized earth” is a generic term describing reinforced earth structures. These are specialized proprietary earth-retaining systems using precast reinforced concrete or metal-facing panels. Mechanically stabilized earth systems have been used widely in the U.S. and Europe to build highway bridge abutments. They are especially suitable in situations where large settlements are anticipated.

For many years, precast concrete caissons and floating-box piers have been economical for large bridges spanning over waterways.¹²⁻¹

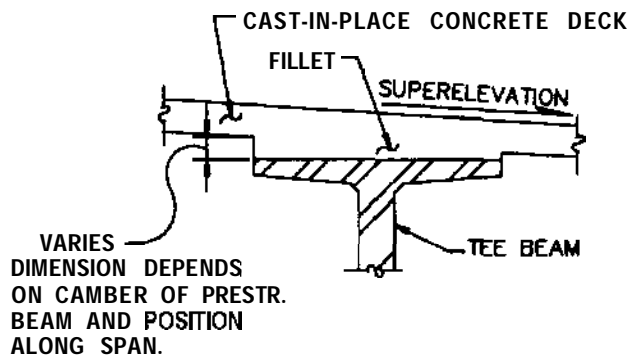

Fig. 12.5.6.1—Wide beam with superelevated CIP deck

12.5-Design

12.5.1 General—All loading and restraint conditions from manufacture to completion of the structure should be considered in the design of precast concrete systems. This includes form removal, yard storage, transportation, storage at the site, final erection, and joining of the precast segments. If the structure is to behave as an integral unit, the effects at all interconnected and adjoining elements should be properly evaluated.

Design of joints and connections should include the effects of all forces to be transmitted, including those caused by shrinkage, creep, temperature gradients, and variations in ambient temperature, settlement, elastic deformation, wind, earthquake, and erection loads, as well as dead and live loads. Details should also be designed to provide for adequate manufacturing and erection tolerances.

12.5.2 Erection requirements—Erection forces should be treated as dynamic loads. Impact and unforeseen shifts in load distribution should be taken into account. A liberal factor of safety (5.0 is suggested) is appropriate when determining the load capacity of lifting devices.^{12-6,12-10} Anchorage of the lifting devices must be adequate to prevent pull-out failure. The lifting forces may be applied either to the member at a specific angle, or they may be effective over a range of angles. Consideration should also be given to sway or swing of the component, which can put additional strain on the lifting devices and may cause local concrete crushing. Stability problems caused by the imposed lifting forces and bending moments should be considered.

12.5.3 Handling precast units—Prestressed concrete units are generally sensitive to positions other than the final erected position, and temporary tensile stresses should be evaluated for all positions that may occur during handling, turning, and storage. Some techniques for preventing damage to precast concrete units are:

- a. additional conventional reinforcement.
- b. external steel beams bolted to the unit.
- c. handling units in pairs.
- d. temporary additional prestress.
- e. cables on each side of the member, along with queen posts.

12.5.4 Design for erection loads—Particularly for segmental construction, the designer should consider the erection

sequence and equipment loads which could be applied to the structure. The erection sequence directly affects the structural deflections. The magnitude of this effect depends on the age of concrete when loaded and the sequence of applying prestress loads.

Equipment reactions and segment weights can be substantial during construction. In many instances where construction is done from above, e.g., erection with a launching gantry or delivering segments over completed portions of the structure, the stresses during erection may be the largest to which the structure will ever be subjected.

12.5.5 Creep, shrinkage, and dead load deflection—Creep of concrete is inversely related to the age of concrete at loading. Consequently, deflection due to creep can be reduced when loads are applied to older concrete. In this sense, precast concrete members have an advantage over cast-in-place construction because members can be precast well in advance of load application.

Deflections due to creep and shrinkage may adversely affect the serviceability of a bridge. For continuous structures, such deflections may produce undesirable secondary stresses. Differential deflections of adjacent members may cause unexpected overstress.

In order to predict creep and shrinkage, many variables have to be known or assumed, as covered in section 5.4.2. Simple formulas for determining creep and shrinkage are provided by the AASHTO bridge specifications (Reference HB-15, section 9.16.2.1); these are intended for highway bridges (see also Reference 12-15).

12.5.6 Crown and superelevation—Whenever possible, bridge seats are level, and the precast concrete units are set vertically. For units which are relatively wide at the top, the “fillets” may contain a considerable volume of cast-in-place concrete, as illustrated in Fig. 12.5.6.1. Fillets are the spaces between the bottom of cast-in-place deck and the horizontal top surfaces of the precast units. Since the camber of prestressed beams is not constant, the thickness of fillets varies from one beam to the next. Field adjustment of fillet thickness is done routinely. For large superelevation (more than 5 percent) combined with wide units, such as standard bulb tees or spread boxes, extra formwork and concrete for the fillets may entail unwanted expense. Obviously, for high superelevation, shorter spans with shapes having smaller top width can be advantageous.

Except for narrow roadways, butted box beams are installed perpendicular to the crown or superelevation, as shown in Fig. 12.5.6.2. They have to be anchored securely to avoid lateral creep.

12.6-Construction

12.6.1 Manufacturing—Precast concrete members can be manufactured by firms regularly engaged in the production of precast concrete in existing plants or at a specially constructed job site plant. Existing precasting facilities will usually provide superior facilities, trained workers, and established quality control procedures for the materials and manufacturing operations. A job site precasting plant may prove necessary when extremely large precast segments are

NOTE: CONCRETE END BLOCKS TO BE
CAST-IN-PLACE AFTER SUPER-
STRUCTURE HAS BEEN COMPLETED.

RAILING AND WARING SURFACE NOT SHOWN

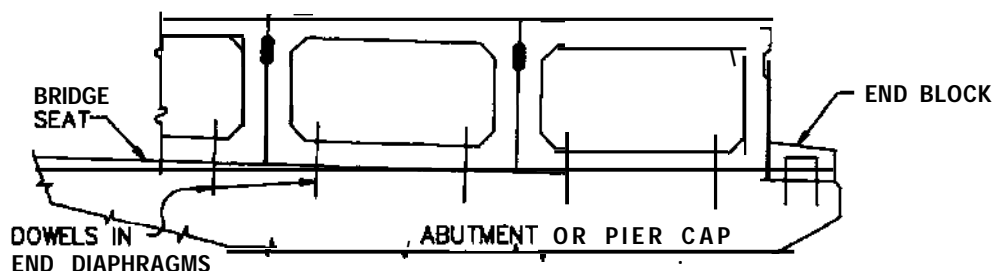

Fig. 12.5.6.2-Superelevated deck with butted box beams

required, or where transportation costs are excessive. Job site precasting can result in significant cost savings for large construction projects.

12.6.2 Transportation and erection-The ability to transport and erect often determines the size and shape of the precast elements (see Reference 12-6, pp. 734-750). Units of moderate weight and size can be transported economically by trucks and erected by crane. Rail transportation, supplemented by other means, may be used for long distance shipments and heavy or over-sized segments. Barge transportation may be the most economical and practical for movement to water sites. Erection considerations involve the availability of cranes, derricks, launching gantries, site restrictions, and others.

12.6.3 Joints and connections-Properly detailed and constructed joints and connections are essential to the success of precast concrete bridge construction. Joints and connections should be designed to transmit all forces and, furthermore, be feasible to construct under actual job site conditions. Since visible joints affect the appearance of the bridge structure, well designed joints will enhance the structure's esthetics.

12.6.4 Falsework-Falsework should be designed for both primary and secondary effects with an adequate margin of safety. For instance, when continuous structures are post-tensioned, the post-tensioning forces may induce secondary moments and change the magnitude of reactions. Falsework should be capable of supporting any increase in applied loads due to secondary effects.

Care should be taken in the design of the foundation of falsework in order to avoid both excessive and uneven settlement. To compensate for settlement, provisions for vertical adjustment should be provided.

Temporary bents often have a significant effect on the behavior of a bridge. When a temporary bent is removed, there is a redistribution of stresses which should be evaluated and, if significant, these stresses must be considered in the design.

RECOMMENDED REFERENCES

The documents of the various standards-producing organizations referred to in this report are listed below with their serial designation.

American Railway Engineering Association
Manual for Railway Engineering

American Association of State Highway and Transportation Officials

- | | |
|-------|--|
| HB15 | Standard Specifications for Highway Bridges |
| GSCB | Guide Specifications for Design and Construction of Segmental Concrete Bridges |
| GSCBS | Guide Specifications for Thermal Effects in Concrete Bridge Superstructures |

Precast/Prestressed Concrete Institute

- | | |
|---------|--|
| STD 101 | Standard Prestressed Concrete Beams for Highway Bridge Spans 30 to 140 Ft |
| STD 107 | Standard Prestressed Box Beams for Highway Bridge Spans to 103 Ft |
| STD 108 | Standard Prestressed Concrete Slabs for Highway Bridge Spans to 55 Ft |
| STD 114 | Prestressed Concrete Channel Slabs for Short Span Bridges |
| STD 115 | Standard Prestressed Concrete Bulb-Tee Beams for Highway Bridge Spans to 150 ft |
| JR-343 | Recommended Practice for Precast/Prestressed Concrete Composite Bridge Deck Panels |

CITED REFERENCES

- 12-1. "Precast Concrete Elements for Transportation Facilities," NCHRP *Synthesis* No. 53, Transportation Research Board, Washington, D.C., 1978.
- 12-2. "Tentative Standards for Prestressed Concrete Piles, Slabs, I-Beams, and Box Beams for Bridges and Interim Manual for Inspection of Such Construction," by Joint Committee of AASHTO and PCI; AASHTO, 1963, 28 pp.
- 12-3. Heins, Conrad P., and Lawrie, Richard A., "Design of Modern Concrete Highway Bridges," John Wiley & Sons, New York, 1984, pp. 362-470.
- 12-4. Lin, T.Y., and Burns, Ned H., "Design of Prestressed Concrete Structures," Third Edition, John Wiley & Sons, New York, 1981.
- 12-5. Gerwick, Ben C., Jr., "Construction of Prestressed Concrete," Second Edition, Wiley Interscience, New York, 1993.

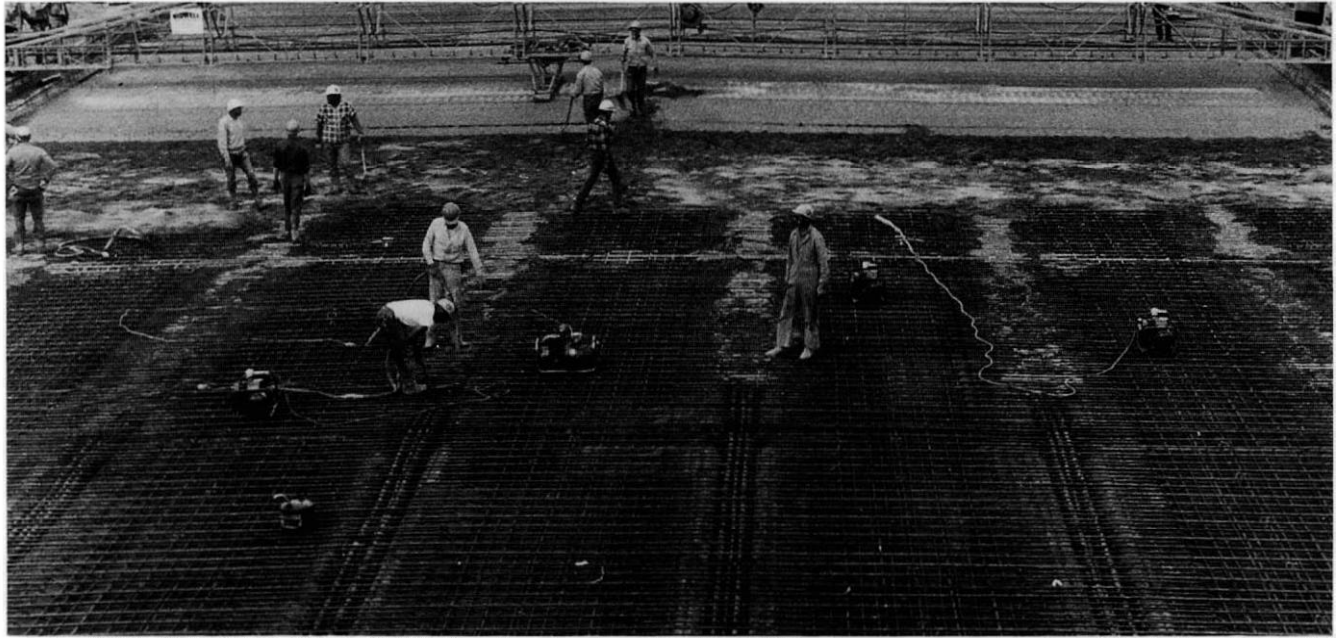

Reinforcing bars in box girder bridge with post-tensioning backs in girders

CHAPTER 13-DETAILS OF REINFORCEMENT FOR DESIGN AND CONSTRUCTION

13.1-General

Details of reinforcement and bar supports not covered in this chapter should be in accordance with ACI SP-66 or the "Manual of Standard Practice,"^{13-F} published by the Concrete Reinforcing Steel Institute.

13.2-Development and splices of reinforcement

13.2.1 Development of reinforcement-General-The calculated tension or compression in the reinforcement at each section should be developed on each side of that section by embedment length, hooks or mechanical devices, or a combination thereof. Hooks may be used in developing reinforcing bars in tension only.

Tension reinforcement in flexural members may be developed by bending it across the web, or by making it continuous with the reinforcement on the opposite face of the member, or by anchoring it there.

The critical sections for development of reinforcement in flexural members are at points of maximum stress and at points within the span where adjacent reinforcement terminates, or is bent. The recommendations in Section 13.2 should be followed.

Reinforcement should extend beyond the point at which it is no longer required to resist flexure for a distance equal to the effective depth of the member or $12d$ (12 nominal bar diameters), whichever is greater, except at supports of simple spans and at the free end of cantilevers.

Continuing reinforcement should have an embedment length not less than the development length l_d beyond the point where bent or terminated tension reinforcement is no longer required to resist flexure.

Flexural reinforcement should not be terminated in a tension zone unless one of the following conditions is satisfied:

- a. The shear at the cutoff point does not exceed two-thirds of that permitted, including the shear strength of the web reinforcement provided.
- b. The stirrup area in excess of that required for shear and torsion is provided along each terminated bar or wire over a distance from the termination point equal to three-fourths the overall depth of the member. The excess stirrup area A_v should not be less than $60b_w s f_y$ or $(0.4b_w s f_y)$, where b_w is the web width of the flexural member, s is the stirrup spacing, and f_y is the specified yield strength. The spacing s should not exceed $d/8B_b$, where B_b is the ratio of the area of the reinforcement cut off to the total area of tension reinforcement at the section.

For #11 (#35) and smaller bars, the continuing bars provide double the area required for flexure at the cutoff point, and the shear does not exceed three-fourths of that permitted.

13.2.2 Development of positive moment reinforcement-At least one-third of the positive moment reinforcement in simple members and one-fourth of the positive moment reinforcement in continuous members should extend along the same face of the member into the support. In beams, such reinforcement should extend into the support at least 6 in. (150 mm).

When a flexural member is part of the lateral load resisting system, the positive moment reinforcement required to be extended into the support should be anchored to develop the specified yield strength f_y in tension at the face of the support.

At simple supports and at points of inflection, positive moment tension reinforcement should be lifted to a diameter such that l_d computed for f_y by Section 13.2 satisfies Eq. (13-1), except Eq. (13-1) need not be satisfied for reinforcement

terminating beyond the centerline of simple supports by a standard hook, or a mechanical anchorage equivalent to a standard hook

$$l_d \leq M_n / V_u + l_a$$

where

- M_n = nominal moment strength assuming all reinforcement at the section to be stressed to the specified yield strength f_y
- V_u = factored shear force at the section
- l_a = at a support, embedment length beyond the center of the support
- l_a = at point of inflection, limited to the effective depth of the member or $12 d_b$, whichever is greater

The value at M_n / V_u may be increased 30 percent when the ends of the reinforcement are confined by a compressive reaction.

13.2.3 Development of negative moment reinforcement- Negative moment reinforcement in a continuous, restrained, or cantilever member, or in any member of a rigid frame, should be anchored in or through the supporting member by embedment length, hooks, or mechanical anchorage. Negative moment reinforcement should have an embedment length into the span as required by Section 13.2.

At least one-third of the total tension reinforcement provided for negative moment at a support should have an embedment length beyond the point of inflection, not less than the effective depth of the member $12d_b$ or one-sixteenth of the clear span, whichever is greater. This recommendation accounts for a possible shifting of the moment diagram due to the changes in loading, settlement of supports, or other causes, in addition to the typically approximate nature of moment calculations. If these calculations are carried out to a higher degree of accuracy and accounted for possible moment shifting, this distance could be justifiably decreased.

13.2.4 Development of reinforcement in special members- Adequate anchorage should be provided for tension reinforcement in flexural members where reinforcement stress is not directly proportional to factored moment, such as sloped, stepped, or tapered footings; brackets; deep flexural members; or members in which the tension reinforcement is not parallel to the compression face.

13.2.5 Development length of deformed bars and deformed wire in tension- The development length l_d in in. (mm) of deformed bars and deformed wire in tension should be computed as the product of the basic development length of (a) and the applicable modification factor of factors of (b), (c), and (d), but l_d should not be less than recommended in (e):

- a. The basic development length should be:
 - For #11 (#35) and smaller bars (Note 1):

$$0.04 A_b f_y / \sqrt{f_c'} \text{ or } (0.02 A_b f_y / \sqrt{f_c'})$$
 but not less than (Note 2):

$$0.0004 d_b f_y \text{ or } (0.06 d_b f_y)$$
 - For #14 (#45) bars (Note 3):

$$0.085 f_y / \sqrt{f_c'} \text{ or } (0.025 f_y / \sqrt{f_c'})$$

For #18 (#55) bars (Note 3):

$$0.1 f_y / \sqrt{f_c'} \text{ or } (0.35 f_y / \sqrt{f_c'})$$

For deformed wire:

$$0.03 d_b f_y / \sqrt{f_c'} \text{ or } [(3 d_b f_y / 8) \sqrt{f_c'}]$$

where f_c' is the specified compressive strength of the concrete, and A_b is the area of an individual bar.

- b. The basic development length should be multiplied by the applicable factor or factors for:
 - Top reinforcement (Note 4) 1.4
 - Reinforcement with f_y greater than 60,000 psi (400 MPa) 2 - $60,000/f_y$ or (2 - $400/f_y$).
- c. Lightweight aggregate concrete:
 - When f_{ct} (average splitting tensile strength of lightweight aggregate concrete) is specified and concrete is proportioned in accordance with Section 3.2, the basic development length may be multiplied by $6.7 f_c' / f_{ct}$ or $(f_c' / 1.8 f_{ct})$, but not less than 1.0.
 - When f_{ct} is not specified, the basic development length should be multiplied by 1.33 for "all lightweight" concrete or by 1.18 for "sand-lightweight" concrete. Linear interpolation may be applied when partial sand replacement is used.
- d. A recent research project investigating the anchorage of epoxy-coated reinforcing bars shows that the bond strength is reduced when the coating prevents adhesion between the bar and the concrete.¹³⁻² At the time this report was being prepared, ACI Committee 318 was in the process of evaluating proposed changes to the ACI 318 Building Code, which included, as a result of this research project, the addition of tension development length modification factors for epoxy-coated reinforcing bars. According to results of this research project, the modification factor for the tension development length of epoxy-coated reinforcing bars should be 1.5 if the bars have either a clear cover of less than 3 bar diameters or the clear spacing between the bars is less than 6 bar diameters, otherwise the modification factor should be 1.2. The report also noted that the product of the factor for "top reinforcement" and the factor for "epoxy-coated reinforcement" need not be greater than 1.7.
- e. The basic development length may be multiplied by the applicable factor(s) for:
 - Reinforcement being developed in the length under consideration and spaced laterally at least 6 in. (150 mm) on center and at least 3 in. (70 mm) clear from the face of the member to the edge bar, measured in the direction of the spacing 0.8
 - Reinforcement in a flexural member in excess of that required by analysis, where anchorage or development for f_y is not specifically required $(A, \text{required}) / (A_s \text{ provided})$.
 - Reinforcement enclosed within a spiral not less than $1/4$ -in. - (5-MM-) diameter and not more than 4-in. - (100-mm-) pitch 0.75.
- f. The development length l_d should not be less than 12 in. (300 mm), except in the computation of lap splices

by Section 13.2.15 and development of web reinforcement by Section 13.2.

Notes:

1. The constant carries the unit of 1/in. (1/mm).
2. The constant carries the unit of $\text{in.}^2/\text{lb}$ (mm^2/N).
3. The constant carries the unit of in. (mm).
4. Top reinforcement is horizontal reinforcement placed so that more than 12 in. (300 mm) of concrete is cast in the member below the reinforcement.

13.2.6 Development length of deformed bars in compression-The basic development length l_{bd} for deformed bars in compression should be computed as $0.02 d_b f_y / \sqrt{f'_c}$ or $(d_b f_y / 4) \sqrt{f'_c}$, but should be not less than $0.0003 d_b f_y$ or $(0.04 d_b f_y)$ when the constant 0.0003 (0.04) carries the unit of $\text{in.}^2/\text{lb}$ (mm^2/N). Where bar area in excess of that required by analysis is provided, the basic development length may be multiplied by the ratio of area required to area provided. The basic development length may be reduced by 25 percent when the bars are enclosed by spirals not less than $1/4$ -in.- (5-mm-) in diameter and not more than 4-in.- (100-mm-) pitch. The final development length should not be less than 8 in. (200 mm). Hooks should not be considered effective in developing bars in compression.

13.2.7 Development length of bundled bars-The development length of individual bars within a bundle, in tension, or compression, should be that for the individual bar, increased by 20 percent for a three-bar bundle, and 33 percent for a four-bar bundle.

13.2.8 Development of standard hooks in tension-The development length l_{dh} in in. (mm) for deformed bars in tension terminating in a standard hook (Section 13.6) should be computed as the product of the basic development length l_{hb} and the applicable modification factor or factors, but l_{dh} should not be less than $8d_b$ or 6 in. (150 mm), whichever is greater.

The basic development length l_{hb} for a hooked bar with f_y equal to 60,000 psi (400 MPa) should be $1200d_b / \sqrt{f'_c}$ or $(100d_b / \sqrt{f'_c})$, where the constant 1200 (100) carries the unit of $\text{lb}/\text{in.}^2$ (N/mm^2).

The basic development length l_{hb} should be multiplied by the applicable factor(s):

- For all bars with f_y other than 60,000 psi (400 MPa) $f_y/60,000$ or $(f_y/400)$.
- For #11 (#35) bars and smaller, side cover (normal to plane of the hook) not less than $2\frac{1}{2}$ in. (60 mm), and for 90 deg hooks with cover on the bar extension beyond the hook not less than 2 in. (50 mm) 0.7.
- For #11 (#35) bars and smaller, with hook enclosed vertically or horizontally within ties or stirrup ties spaced not greater than $3d_b$, where d_b is the diameter of the hooked bar 0.8.
- For bars being developed by a standard hook at discontinuous ends of members with both side cover and top (or bottom) cover over the hook less than $2\frac{1}{2}$ in. (60 mm), and for a 90 deg hook only, end cover less than 2 in. (50 mm), the hooked bar should be enclosed within ties or stirrups spaced not greater

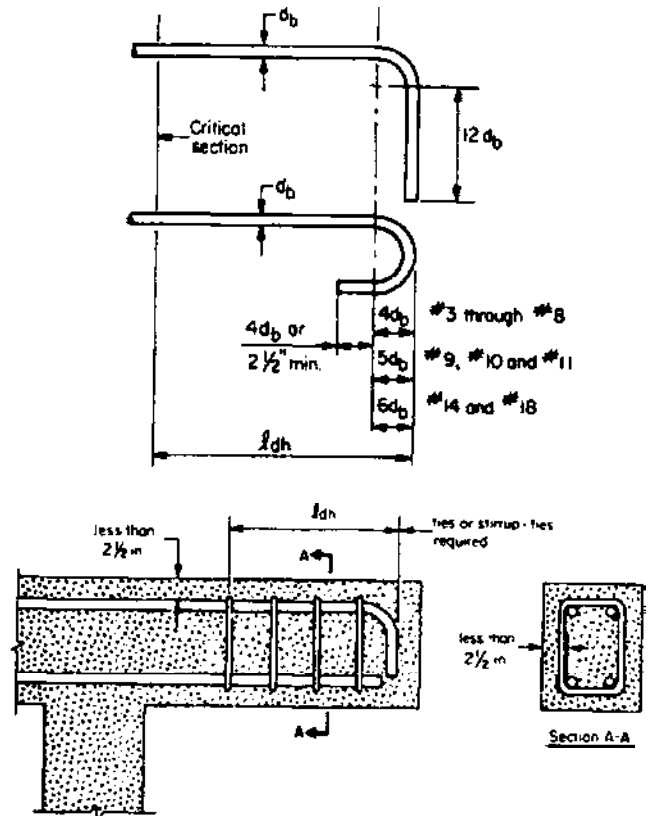

Fig. 13.2.8.-Hooked bar details

than $3d_b$, where d_b is the diameter of the hooked bar

- 1.0.
- Where reinforcement is in excess of that required by analysis and anchorage or development for f_y is not specifically required $(A_s \text{ required})/(A_s \text{ provided})$.
- Lightweight aggregate concrete 1.3.

For details of hooks, ties, or stirrups and the measurement of l_{dh} , see Fig. 13.2.8.

13.2.9 Development length combination-Development of reinforcement may consist of a combination of a hook or mechanical anchorage plus additional embedment length of reinforcement between the point of maximum bar stress and the mechanical anchorage.

13.2.10 Development of welded wire fabric-The yield strength of welded smooth wire fabric may be considered developed by embedment of two cross wires with the closer cross wire not less than 2 in. (50 mm) from the point of critical section. However, the development length l_d measured from the point of critical section to the outermost cross wire should not be less than $0.27A_w f_y / s_w \sqrt{f'_c}$ or $(3.3A_w f_y / s_w \sqrt{f'_c})$, where A_w is the area of an individual wire, and s_w is the spacing of the wires to be developed. The development length l_d may be modified by $(A_s \text{ required})/(A_s \text{ provided})$ for reinforcement in excess of that required by analysis, and by the factor of Section 13.2 for lightweight aggregate concrete, but should not be less than 6 in. (150 mm), except in the computation of lap splices by Section 13.2.

The development length l_d in in. (mm), of welded deformed wire fabric measured from the point of critical sec-

tion to the end of the wire should be computed as the product of the basic development length of this section and the applicable modification factor(s) of Section 13.2, but l_d should not be less than 8 in. (200 mm), except in the computation of lap splices by Section 13.2 and development of web reinforcement by Section 13.2.

The basic development length of welded deformed wire fabric, with at least one cross wire within the development length not less than 2 in. (50 mm) from the point of critical section should be

$$0.03d_b(f_y - 20,000) / \sqrt{f'_c} \text{ or } 3d_b(f_y - 140/8) / \left(\sqrt{f'_c} \right)$$

but not less than

$$0.20A_w f_y / \left(s_w \sqrt{f'_c} \right) \text{ or } \left[2.5A_w f_y / \left(s_w \sqrt{f'_c} \right) \right]$$

where the constants 20,000 and 140 have units of psi and MPa, respectively.

The basic development length of welded deformed wire fabric, without cross wires within the development length should be determined the same as deformed wire,

13.2.11 Development length of prestressing strand- Three- or seven-wire pretensioning strand should be bonded beyond the critical section for a development length in in. (mm), not less than

$$(f_{ps} - 2f_{se}/3)d_b \text{ or } [(f_{ps} - 2f_{se}/3)d_b/7]$$

where d_b is the strand diameter in in. (mm) f_{ps} (stress in prestressed reinforcement at nominal strength) and f_{se} (effective stress in prestressed reinforcement) are expressed in kips per square in. (MPa). and the expression in the parenthesis is used as a constant without units. Investigation may be limited to cross sections nearest each end of the member that are required to develop full design strength under the specified factored loads.

Where bonding of a strand does not extend to the end of a member, and the design includes tension at service loads in the precompressed tensile zone as permitted by Section 9.5, the development length previously recommended should be doubled.

13.2.12 Mechanical anchorage- Any mechanical device capable of developing the strength of the reinforcement without damage to the concrete may be used as anchorage.

13.2.13 Development of web reinforcement- Web reinforcement should be carried as close to the compression and tension surfaces of a member as cover requirements and the proximity of other reinforcements permit. The ends of single leg, single U-, or multiple U-stirrups should be anchored by one of the following means:

- A standard hook plus an embedment of $0.5l_d$. The 0.51, embedment of a stirrup leg should be the distance between the middepth of the member $h/2$ and the start of the hook (point of tangency).
- An embedment of $h/2$ above or below the middepth on the compression side of the member for a full development length l_d , but not less than $24d_b$, or 12 in. (300 mm) for deformed bars or wire.

- For #5 (#15) bars and D31 wire and smaller, bending around the longitudinal reinforcement through at least 135 deg (2.35 rad.), plus for stirrups with design stress exceeding 40,000 psi (300 MPa), an embedment of 0.331. The 0.331, embedment of a stirrup leg should be the distance between the middepth of the member $h/2$ and the start of the hook (point of tangency).
- For each leg of welded smooth wire fabric forming single U-stirrups, either two longitudinal wires spaced 2 in. (50 mm) along the member at the top of the U, or one longitudinal wire located not more than $d/4$ from the compression face, and a second wire closer to the compression face and spaced not less than 2 in. (50 mm) from the first wire. The second wire may stirrup leg beyond a bend, or on a bend which has an inside diameter of bend not less than $8d_b$.
- For each end of a single leg stirrup of welded smooth or deformed wire fabric, two longitudinal wires at a maximum spacing of 2 in. (50 mm) and the inner wire at least the greater of $d/4$ or 2 in. (50 mm) from the middepth of the member. The outer longitudinal wire at the tension face should not be farther from the face than the portion of primary flexural reinforcement closest to the face.
- Pairs of U-stirrups or ties placed to form a closed unit should be considered properly spliced when the lengths of laps are $1.7l_d$. In members at least 18-in.- (500-MM-) deep, splices with $A_b f_y$ not more than 9000 lb (40 kN); per leg should be considered adequate if stirrup legs extend the full available depth of the member.

Between the anchored ends, each bend in the continuous portion of a single U- or multiple U-stirrup should enclose a longitudinal bar. Longitudinal bars bent to act as shear reinforcement, if extended into a region of tension, should be continuous with the longitudinal reinforcement, and if extended into a region of compression, should be anchored beyond the middepth of the member as specified for development length in Section 13.2 for that part of f_y required to satisfy Eq. (7-60).

13.2.14 Splices of reinforcement-General- Splices of reinforcement should be made only as required or permitted on the design drawings, or in the specifications, or as authorized by the engineer.

Lap splices should not be used for bars larger than #11 (#35). Bars #14 and #18 (#45 and #55) may be lap-spliced in compression only to #11 (#35) and smaller bars, and in compression only to smaller size footing dowels.

Lap splices of bundled bars should be based on the lap splice length recommended for individual bars within a bundle, and such individual splices within the bundle should not overlap. The length of lap for bundled bars should be increased 20 percent for a three-bar bundle and 33 percent for a four-bar bundle. Bars spliced by noncontact lap splices in flexural members should not be spaced transversely farther apart than one-fifth the required lap splice length, or 6 in. (150 mm).

Welded splices and mechanical connections may be used unless otherwise prohibited or restricted. A full-welded

splice is one in which the bars are butted and welded to develop in tension at least 125 percent of the specified yield strength f_y of the bar. A full mechanical connection is one in which the bars are connected to develop in tension or compression at least 125 percent of the specified yield strength f_y of the bar. Welded splices and mechanical connections not meeting these recommendations may be used in accordance with Section 13.2.

When required or permitted, all welding of reinforcing bars should conform to AWS D1.4, "Structural Welding Code-Reinforcing Steel."¹³⁻³ Welding of wire to wire, and welding of wire or welded wire fabric to reinforcing bars or structural steels, should conform to applicable provisions of AWS D1.4 and supplementary requirements specified by the engineer. The engineer should also specify any desired or stringent requirements for preparation or welding, such as the removal of zinc or epoxy coating than those contained in AWS D1.4; any desired or stringent requirements for chemical composition of reinforcing bars than those contained in the referenced ASTM Specifications; and special heat treatment of welded assemblies if required.

13.2.15 Splices of deformed bars and deformed wire in tension-The minimum length of lap for tension lap splices should be as required for Class A, B, or C splices, but not less than 12 in. (300mm), where

Class A splice	1.0 l_d
Class B splice	1.3 l_d
Class C splice	1.7 l_d

where l_d is the tension development length for the specified yield strength f_y calculated in accordance with Section 13.2.

Lap splices of deformed bars and deformed wire in tension should conform to Table 13.2.15.

Welded splices or mechanical connections used where the area of reinforcement provided is less than twice that required by analysis should meet the requirements of Section 13.2.

Welded splices or mechanical connections used where the area of reinforcement provided is at least twice that required by analysis should meet the following:

- a. Splices should be staggered at least 24 in. (600 mm) and in a manner to develop at every section at least twice the calculated tensile force at that section, but not less than 20,000 psi (140 MPa); for the total area of reinforcement provided.
- b. In computing the tensile force developed at each section, spliced reinforcement may be rated at the specified splice strength. Unspliced reinforcement should be rated at that fraction of f_y defined by the ratio of the shorter actual development length to l_d required to develop the specified yield strength f_y .
- c. Splices in "tension tie members" should be made with a full-welded splice or full mechanical connection in accordance with Section 13.2, and splices in adjacent bars should be staggered at least 30 in. (800 mm).

13.2.16 Splices of deformed bars in compression-The minimum length of lap for compression lap splices for deformed bars in compression should be the development

Table 13.2.15-Tension lap splices

$\frac{A_s \text{ provided}^*}{A_s \text{ required}}$	Maximum percent of A_s spliced within required lap length		
	50	75	100
Equal to or greater than 2	Class A	Class A	Class B
Less than 2	Class B	Class C	Class C

* Ratio of area or reinforcement provided to area of reinforcement required by analysis at the splice location.

length in compression, computed in accordance with Section 13.2, but not less than

For f_y of 60,000 psi (400 MPa) or less:

$$0.0005f_y d_b \text{ or } (0.07f_y d_b)$$

For f_y greater than 60,000 psi (400 MPa):

$$0.0009f_y - 24)d_b \text{ or } [(0.13f_y - 24)d_b]$$

or 12 in. (300 mm).

When the specified compressive strength of the concrete is less than 3000 psi (20 MPa), the length of lap should be increased by one-third.

When bars of different sizes are lap-spliced in compression, the splice length should be the larger of the compression development length of the larger bar or the lap splice length of the smaller bar.

In tied compression members where ties throughout the lap length have an effective area of at least $0.0015hs$, where h is the total depth of the member and s is the spacing of the tie, the lap splice length may be 0.83 of that previously recommended, but not less than 12 in. (300 mm). Tie legs perpendicular to dimension h should be used in determining the effective area.

For splices within the spiral of a spirally-reinforced compression member, 0.75 of the lap splice length previously recommended may be used, but the lap length should not be less than 12 in. (300 mm).

For end bearing splices in which the bars are required for compression only, the compressive stress may be transmitted by bearing of square cut ends held in concentric contact by a suitable device. The ends of the bars should terminate in flat surfaces within $1\frac{1}{2}$ deg of a right angle to the axis of the bars and should be fitted within 3 deg of full bearing after assembly. End bearing splices should be used only in members having closed ties, closed stirrups, or spirals.

Welded splices or mechanical connections used in compression should meet the recommendations for full welded or full mechanical connections (Section 13.2).

13.2.17 Splices of welded deformed wire fabric in tension-The minimum length of lap for lap splices of welded deformed wire fabric measured between the ends of each fabric sheet should not be less than $1.7l_d$ or 8 in. (200 mm), and the overlap measured between the outermost cross wires of each fabric sheet should not be less than 2 in. (50 mm). l_d is the development length for the specified yield strength f_y computed in accordance with Section 13.2.

Lap splices of welded deformed wire fabric, without cross wires within the lap splice length, should be determined the same as for deformed wire.

13.2.18 Splices of welded smooth wire fabric in tension—The minimum length of lap for lap splices of welded smooth wire fabric should be in accordance with the following:

- a. When the area of reinforcement provided is less than twice that required by analysis at the splice location, the length of the overlap measured between the outermost cross wires of each fabric sheet should not be less than one spacing of the cross wires plus 2 in. (50 mm), or less than $1.5l_d$, or 6 in. (150 mm). l_d is the development length for the specified yield strength f_y , computed in accordance with Section 13.2.
- b. When the area of reinforcement provided is at least twice that required by analysis at the splice location, the length of the overlap measured between the outermost cross wires of each fabric sheet should not be less than $1.5l_d$, or 2 in. (50 mm).

13.3-Lateral reinforcement for compression members

13.3.1 Spirals—Spiral reinforcement for compression members should consist of evenly spaced continuous spirals held firmly in place by attachment to the longitudinal reinforcement, and held true to line by vertical spacers. The spirals should be of size and assembled to permit handling and placing without being distorted from the designed dimensions. Spiral reinforcement may be plain or deformed bars, smooth or deformed wire, with a minimum diameter of $\frac{3}{8}$ in. (10 mm). Anchorage of spiral reinforcement should be provided by one and one-half extra turns of spiral bar or wire at each end of the spiral unit. Splices in spiral reinforcement should be lap splices of $48d_b$, but not less than 18 in. (450 mm), or welded. The clear spacing between spirals should not exceed 3 in. (80 mm), or be less than 1 in. (25 mm) or one-and-one-third times the maximum size of coarse aggregate used. Spirals should extend from the top of the footing or other support to the level of the lowest horizontal reinforcement in the members previously supported.

The ratio of spiral reinforcement ρ_s should not be less than the value given by $\rho_s = 0.45 (A_g/A_c - 1) f_c' / f_y$, where A_g is the gross area of the section, A_c is the core area of the section measured to the outside diameter of the spiral, and f_y is the specified yield strength of the spiral reinforcement not more than 60,000 psi (400 MPa).

13.3.2 Ties—All nonprestressed bars for tied compression members should be enclosed by lateral ties of the following minimum sizes:

U.S. Customary:

#3 size ties (#10 longitudinal bars and smaller)

#4 size ties (#11, #14, #18 longitudinal bars or bundled longitudinal bars)

Metric:

#10 size ties

Deformed wire or welded wire fabric of equivalent area may be used. The vertical spacing of the ties should not exceed 16 longitudinal bar diameters, 48 tie bar or wire diameters, or the least dimension of the member. This spacing

may be increased in compression members which have a larger cross section than required by conditions of loading. When bars larger than #10 (#30) are bundled with more than two bars in any one bundle, the tie spacing should be reduced to one-half of that previously recommended. Ties should be located vertically not more than half a tie spacing above the top of the footing or other support and should be spaced not more than half a tie spacing below the lowest horizontal reinforcement in the members previously supported. The ties should be arranged so that every corner and alternate longitudinal bar has lateral support provided by the corner of a tie having an included angle of not more than 135 deg, and no bar should be farther than 6 in. (150 mm) on either side from a laterally supported bar. Where the bars are located around the periphery of a circle, a complete circular tie may be used.

13.3.3 Prestressing steel—Except when used in walls, all prestressing steel should be enclosed by spirals as recommended in Section 13.3 or by lateral ties at least #3 (#10) in size and spaced as recommended in Section 13.3.

13.3.4 Oversized members—In a compression member which has a larger cross section than required by conditions of loading, the lateral reinforcement requirements may be waived where structural analysis or tests show adequate strength and feasibility of construction.

13.3.5 Seismic areas—In seismic areas, where an earthquake which could cause major damage to construction has a high probability of occurrence, lateral reinforcement for compression members should be designed and detailed to provide adequate strength and ductility to resist expected seismic movements.^{13-4, ACI 318}

13.4-Lateral reinforcement for flexural members

13.4.1 Compression reinforcement—Compression reinforcement in beams should be enclosed by ties or stirrups, satisfying the size and spacing recommendations in Section 13.3, or by welded wire fabric of an equivalent area. Such ties or stirrups should be provided throughout the distance where compression reinforcement is required.

13.4.2 Torsion or stress reversal—Lateral reinforcement for flexural members, subject to stress reversals or to torsion at supports, should consist of closed ties, closed stirrups, or spirals extending around the flexural reinforcement.

Closed ties or stirrups may be formed in one piece by overlapping standard stirrup or tie end hooks around a longitudinal bar, or formed in one or in two pieces, lap-spliced with a Class C splice (lap of $1.7l_d$), or anchored in accordance with the recommendations in Section 13.2.

13.4.3 Seismic areas—In seismic areas, where an earthquake that could cause major damage to construction has a high probability of occurrence, lateral reinforcement should be designed and detailed to provide adequate strength and ductility to resist expected seismic movements.¹³⁻⁴

13.5-Shrinkage and temperature reinforcement

Reinforcement for shrinkage and temperature stresses should be provided near exposed surfaces of walls and slabs not otherwise reinforced. For Grade 60 (400 MPa) deformed bars or welded wire fabric (smooth or deformed), a mini-

imum area of reinforcement equal to 0.18 percent of the gross concrete area should be provided. The spacing of stress-relieving joints should be considered in determining the area of shrinkage and temperature reinforcement. The preceding minimum area of reinforcement should be increased proportionately for large joint spacings.

For Grade 40 (275 MPa) or 50 (345 MPa) deformed bars, a minimum area of reinforcement equal to 0.20 percent of the gross concrete area should be provided.

Shrinkage and temperature reinforcement should not be spaced farther apart than three times the wall or slab thickness, or 18 in. (500 mm).

At all required sections, reinforcement for shrinkage and temperature stresses should develop the specified yield strength f_y in tension in accordance with the recommendations in Section 13.2.

Bonded or unbonded prestressing tendons may be used for shrinkage and temperature reinforcement in structural slabs. The tendons should provide a minimum average compressive stress of 100 psi (0.7 MPa) on the gross concrete area, based on effective prestress after losses. Spacing of tendons should not exceed 6 ft (2 m). When the spacing is greater than 54 in. (1.4 m), additional bonded reinforcement should be provided.

Mass concrete is defined as any large volume of cast-in-place concrete with dimensions large enough to require that measures be taken to cope with the generation of heat and attendant volume change to minimize cracking. For mass concrete walls, slabs and footings less than 48-in.- (1.2-m-) thick, minimum shrinkage and temperature steel should be $0.0015A_g$. No less than one-half or more than two-thirds of this total quantity should be placed in any one face. Maximum bar spacing should be limited to 12 in. (300 mm). For members more than 48-in.- (1.2-m-) thick, minimum shrinkage and temperature steel in each face should be such that $A_s = 2a_s/100$, where A_s is the area of bar, d_c is the distance from the centroid of reinforcement to the concrete surface, and s is the spacing of the bar (ACI 207.2R). The minimum bar size and maximum spacing should be #6 (#20) at 12 in. (65 mm) on center.

13.6-Standard hooks and minimum bend diameters

13.6.1 Standard hooks-Standard hooks for end anchorage of reinforcing bars should be either a 180 deg bend plus a $4d_b$ extension, but not less than $2\frac{1}{2}d_b$ in. (60 mm) at the free end of the bar, or a 90 deg bend plus a $12d_b$ extension at the free end of the bar, where d_b is the nominal diameter of the bar (see Fig. 13.2.8).

For stirrup and tie hooks only:

- For #5 (#15) bars and smaller, a 90 deg bend plus a $6d_b$ extension at the free end of the bar, or
- For #6, #7 and #8 (#20 and #25) bars, a 90 deg bend plus a $12d_b$ extension at the free end of the bar, or
- For #8 (#25) bars and smaller, a 135 deg bend plus a $6d_b$ extension at the free end of the bar.

13.6.2 Minimum bend diameters-Main reinforcement-The finished diameter of bend measured on the inside of the bar, other than for stirrups and ties in sizes #3 through #5

Table 13.6-Minimum diameters of bend

Bar size	Minimum diameter	
#3 through #8	{#10 through #25}	6 bar diameters
#9, #10, and #11	{#30 and #35}	8 bar diameters
#14 and #18	{#45 and #55}	10 bar diameters

(#10 and #15), should not be less than the values shown in Table 13.6.

13.6.3 Minimum bend diameters-Ties and stirrups-The finished inside diameter of bend for stirrups and ties should not be less than four bar diameters for size #5 (#15) and smaller, and six bar diameters for sizes #6 to #8 (#20 to #25), inclusive. The inside diameter of bend in welded wire fabric, smooth or deformed, for stirrups and ties should not be less than four wire diameters for deformed wire larger than D6 and two wire diameters for all other wires. Bends with an inside diameter of less than eight wire diameters should not be less than four wire diameters from the nearest welded intersection.

13.7-Spacing of reinforcement

13.7.1 Cast-in-place concrete-For cast-in-place concrete, the clear distance between parallel bars and/or tendon ducts in a layer should not be less than one and one-half times the nominal diameter of the bars or tendon ducts, one and one-half times the maximum size of the coarse aggregate, or $1\frac{1}{2}$ in. (40 mm). When required or permitted by the engineer, this minimum distance may be decreased.

13.7.2 Precast concrete-For precast concrete manufactured under plant control conditions, the clear distance between parallel bars in a layer should not be less than the nominal diameter of the bars, one and one-third times the maximum size of the coarse aggregate, or 1 in. (25 mm).

13.7.3 Multilayers-Where positive or negative reinforcement is placed in two or more layers with the clear distance between layers not more than 6 in. (150 mm), the bars in the upper layers should be placed directly above those in the bottom layer with the clear distance between the layers not less than 1 in. (25 mm) or the nominal diameter of the bars.

13.7.4 Lap splices--The clear distance limitation between bars should also apply to the clear distance between a contact lap splice and adjacent splices or bars.

13.7.5 Bundled bars-Groups of parallel reinforcing bars bundled in contact to act as a unit should be limited to four in any one bundle. Bars larger than #11 (#35) should be limited to two in any one bundle in flexural members; bundled bars should be located within stirrups or ties. Individual bars in a bundle cut off within the span of a flexural member should terminate at different points with at least a $40d_b$ stagger. Where spacing limitations and minimum concrete cover are based on bar size, a unit of bundled bars should be treated as a single bar of a diameter derived from the equivalent total area.

13.7.6 Walls and slabs-In walls and slabs, the principal reinforcement should not be spaced farther apart than one and one-half times the wall or slab thickness, or more than 18 in. (500 mm).

13.7.7 Pretensioning steel—The clear distance between pretensioning steel at the end of a member should not be less than four times the diameter of individual wires, three times the diameter of strands, or one and one-third times the maximum size of the coarse aggregate. Closer vertical spacing and bundling of strands may be permitted in the middle portion of the span.

13.7.8 Post-tensioning ducts—The clear distance between post-tensioning ducts at the end of a member should not be less than $1\frac{1}{2}$ in. (40 mm), or one and one-third times the maximum size of the coarse aggregate.

The inside diameter of the duct for a post-tensioning steel bar, strand, or wire should be at least $\frac{1}{4}$ in. (6 mm) greater than the outer diameter of the post-tensioning steel. When more than one bar, strand, or wire is used in a tendon, the area of the duct should be at least two times the area of prestressing steel within the duct.

Ducts for post-tensioning steel may be bundled if the concrete can be satisfactorily placed and when provision is made to prevent the steel, when tensioned, from breaking through the duct. The clear distance limitation between ducts previously recommended should be maintained in the end 3 ft (1 m) of a member.

13.8—Concrete protection for reinforcement

13.8.1 Minimum cover—The following minimum concrete cover is recommended for prestressed and nonprestressed reinforcement:

	Minimum cover in. (mm)
Concrete cast against and permanently exposed to earth	3 (70)
Concrete exposed to earth or weather:	
Principal reinforcement	2 (50)
Stirrups, ties, and spirals	$1\frac{1}{2}$ (40)
Concrete bridge slabs:	
Top reinforcement	2 (50)
Bottom reinforcement	$1\frac{1}{2}$ (40)
Concrete not exposed to weather or in contact with the ground:	
Principal reinforcement	$1\frac{1}{2}$ (40)
Stirrups, ties, and spirals	1 (30)

13.8.2 Bundled bars—For bundled bars, the minimum concrete cover should be equal to the lesser of the equivalent diameter of the bundle or 2 in. (50 mm), but not less than that recommended in Section 13.8.

13.8.3 Corrosive environments—In corrosive or marine environments or other severe exposure conditions, the amount of concrete protection should be suitably increased, and the denseness and nonporosity of the protecting concrete should be considered. Coated reinforcement or other protection should be provided.

13.8.4 Future extensions—Exposed reinforcing bars, inserts, and plates intended for bonding with future extensions should be protected from corrosion.

13.9—Fabrication

Reinforcement should be fabricated to the shapes shown on the design drawings. All bars should be bent cold unless otherwise permitted by the engineer. Reinforcing bars should be fabricated in accordance with the fabricating tolerances given in SP-66.

Placing drawings showing all fabrication dimensions and locations for placing of reinforcement and bar supports should be submitted for review and acceptance. Acceptance should be obtained before fabrication.

Reinforcing bars should be shipped in bundles, tagged, and marked in accordance with the recommendations in the “Manual of Standard Practice.”¹³⁻¹

13.10—Surface conditions of reinforcement

All reinforcement, at the time concrete is placed, should be free of mud, oil, or other materials that may adversely affect or reduce the bond. Research has shown that a normal amount of rust increases bond. Normal rough handling generally removes excessive rust, which would be loose enough to reduce bond.

Reinforcement, except prestressing steel, with rust, mill scale, or a combination of both should be considered satisfactory, provided the minimum dimensions, including height of deformations and weight of a hand-wire-brushed test specimen are not less than the applicable ASTM specification requirements (see Section 3.2.).

Prestressing steel should be clean and free of excessive rust, oil, dirt, scale, and pitting. A light oxide is permissible.

13.11—Placing reinforcement

13.11.1 General—All reinforcement should be supported and fastened before the concrete is placed, and should be secured against displacement within the placing tolerances permitted. The placing of bars should be in accordance with the recommendations in “Placing Reinforcing Bars.”¹³⁻⁵ Reinforcing bars in the top layer of bridge decks should be tied at all intersections, except where spacing is less than 1 ft (300 mm) in each direction, then alternate intersections should be tied.

Tolerances on placing reinforcement should conform to ACI 117.

Substitution of different size or grade of reinforcing bars should be permitted only when authorized by the engineer.

Reinforcing bars supported from formwork should rest on bar supports made of concrete, metal, plastic, or other acceptable materials. On ground or mud mat, supporting concrete blocks may be used. Where the concrete surface will be exposed to weather, the portions of all bar supports within $\frac{1}{2}$ in. (15 mm) of the concrete surface should be noncorrosive or protected against corrosion.

13.11.2 Zinc-coated (galvanized) bars—Zinc-coated (galvanized) reinforcing bars supported from formwork should rest on galvanized wire bar supports, on wire bar supports coated with dielectric material, or on bar supports made of dielectric material or other acceptable materials. All other reinforcement and embedded steel items in contact with or in close proximity to galvanized reinforcing bars should be gal-

vanized, unless otherwise required or permitted. They should also be fastened with zinc-coated or nonmetallic-coated tie wire or other acceptable materials.

13.11.3 Epoxy-coated bars-Epoxy-coated reinforcing bars supported from formwork should rest on coated wire bar supports, on bar supports made of dielectric material, or other acceptable materials. Wire bar supports should be coated with dielectric material for a minimum distance of 2 in. (50 mm) from the point of contact with the epoxy-coated reinforcing bars. Reinforcing bars used as support bars should be epoxy-coated. In walls reinforced with epoxy-coated bars, spread bars, where specified, should be epoxy-coated. Proprietary combination bar clips and spreaders used in walls with epoxy-coated reinforcing bars should be made of corrosion-resistant material or coated with dielectric material. Epoxy-coated reinforcing bars should be fastened with epoxy-, plastic-, or nylon-coated tie wire or other acceptable materials.

13.11.4 Welded wire fabric-welded wire fabric reinforcement should be supported as recommended for reinforcing bars.

13.11.5 Splices-All reinforcement should be furnished in full lengths as indicated on the design drawings, or in the specifications. Splices in reinforcement not indicated on the design drawings or in the specifications, should be permitted only when authorized by the engineer. All splices should be in accordance with the recommendations given in Section 13.2.

13.11.6 Welding-When required or acceptable, all welding of reinforcing bars should be in accordance with the recommendations given in Section 13.2. Welding of crossing bars (tack welding) should not be permitted for assembly or reinforcement unless authorized by the engineer.

After completion of welding on zinc-coated (galvanized) or epoxy-coated reinforcing bars, coating damage should be repaired in accordance with the recommendations given in Section 3.2. All welds and all steel splice members used to splice bars should be coated with the same material used for repair of coating damage. Suitable ventilation should be provided when welding zinc-coated (galvanized) or epoxy-coated reinforcing bars.

13.11.7 Mechanical connections-Mechanical connections should be installed in accordance with the manufacturer's recommendations, and as accepted by the engineer. After installation of mechanical connections on zinc-coated (galvanized) or epoxy-coated reinforcing bars, coating damage should be repaired in accordance with the recommendations given in Section 3.2. All parts of mechanical connections used on coated bars, including steel splice sleeves, bolts, and nuts should be coated with the same material used for repair of coating damage.

13.11.8 Field bending and cutting-Reinforcing bars partially embedded in concrete should not be field bent except as indicated in the Contract Documents or when permitted by the engineer. If zinc-coated (galvanized) or epoxy-coated reinforcing bars are field bent, coating damage should be repaired in accordance with the recommendations given in Section 3.2.

Coated reinforcing bars should not be cut in the field except when permitted by the engineer. When zinc-coated (galvanized) bars or epoxy-coated bars are cut in the field, the ends of the bars should be coated with the same material used for repair of coating damage.

13.11.9 Storage and handling of coated reinforcing bars-Coating damage due to handling, shipment, and placing should be repaired in accordance with the recommendations given in Section 3.2.

Equipment for handling epoxy-coated reinforcing bars should have protected contact areas. Bundles of coated bars should be lifted at multiple pick-up points to prevent bar-to-bar abrasion from sags in the bundles. Coated bars or bundles of coated bars should not be dropped or dragged. Coated bars should be stored on protective cribbing. Fading of the color of the coating should not be cause for rejection of epoxy-coated reinforcing bars. Coating damage due to handling, shipment, and placing need not be repaired in cases where the damaged area is 0.1 in.² (60 mm²) or smaller. Damaged areas larger than 0.1 in.² (60 mm²) should be repaired in accordance with Section 3.2. The maximum amount of damage, including repaired and unrepaired areas, should not exceed 2 percent of the surface area of each bar.

13.12-Special details for columns

13.12.1 Offsets-Where longitudinal bars are offset bent, the slope of the inclined portion of the bar with the axis of the column should not exceed 1 in 6, and the portions of the bar above and below the offset should be parallel to the axis of the column. Adequate horizontal support at the offset bends should be treated as a matter of design, and should be provided by lateral ties, spirals, or parts of the construction. Lateral ties or spirals so designed should be placed not more than 6 in. (150 mm) from points of bend. The horizontal thrust to be resisted should be assumed as one and one-half times the horizontal component of the computed force in the inclined portion of the bar.

Offset bars should be bent before they are placed in the forms (see Section 13.9). Bundled bars should not be offset bent.

Where a column face is offset 3 in. (70 mm) or more, longitudinal bars should not be offset bent. Splices of longitudinal bars adjacent to the offset column faces should be made by separate dowels lapped as required herein.

13.12.2 Splices-Where the factored load stress in the longitudinal bars in a column, calculated for various loading conditions, varies from f_y in compression to $1/2f_y$ or less in tension, lap splices, butt welded splices, mechanical connections, or end bearing splices may be used. The total tensile strength provided in each face of the column by the splices alone, or by the splices in combination with continuing unspliced bars at the specified yield strength f_y , should be at least twice the calculated tension in that face of the column but not less than required by Section 13.12.

Where the factored load stress in the longitudinal bars in a column, calculated for any loading condition exceeds $1/2f_y$ in tension, lap splices designed to develop the specified yield

strength f_y in tension, or full welded splices or full mechanical connections should be used.

At horizontal cross sections of columns where splices are located, a minimum tensile strength at each face of the column equal to one-fourth the area of vertical reinforcement in that face multiplied by f_y should be provided.

13.12.3 Composite columns-Structural steel cores in composite columns should be accurately finished to bear at end bearing splices, and positive provision should be made for alignment of one core above the other in concentric contact. Bearing may be considered effective to transfer 50 percent of the total compressive stress in the steel core. At the column base, provision should be made to transfer the load to the footing, in accordance with Section 11.3. The base of the structural steel section should be designed to transfer the total load from the entire composite column to the footing, or it may be designed to transfer the load from the steel section only, provided it is placed to leave an ample section of concrete for transfer of the portion of the total load from the reinforced concrete section of the column to the footing by means of bond on the vertical reinforcement and by direct compression on the concrete.

RECOMMENDED REFERENCES

The documents of the various standards-producing organizations referred to in this report are listed below with their serial designation, including year of adoption or revision. The documents listed were the latest effort at the time this report was written. Since some of these documents are revised frequently, generally in minor detail only, the user of this report should check directly with the sponsoring group if it is desired to refer to the latest revision.

American Concrete Institute

SP-66	ACI Detailing Manual-1980
117-81	Standard Tolerances for Concrete Construction and Materials
318-83	Building Code Requirements for Reinforced Concrete
207.2R-73 (Reaffirmed 1980)	Effect of Restraint, Volume Change and Reinforcement on Cracking of Massive Concrete

CITED REFERENCES

- 13-1. *Manual of Standard Practice*, CRSI Publication MSP-1-86, Concrete Reinforcing Steel Institute, Schaumburg, IL, 1986.
- 13-2. Treece, R. A., and Jirsa, J. O., "Bond Strength of Epoxy-coated Reinforcing Bars," Research Project sponsored by the Concrete Reinforcing Steel Institute and the Reinforced Concrete Research Council, Department of Civil Engineering, The University of Texas at Austin, 1987.
- 13-3. "Structural Welding Code-Reinforcing Steel," AWS Publication D1.4-79, American Welding Society, Miami, 1979.
- 13-4. "Seismic Design Guidelines for Highway Bridges (ATC-6)," Applied Technology Council, Berkeley, CA, Oct. 1981.
- 13-5. "Placing Reinforcing Bars," Fifth Edition, Concrete Reinforcing Steel Institute, Schaumburg, IL, 1986.

ACI 343R-95 was submitted to letter ballot of the committee and approved in accordance with ACI Balloting procedures.