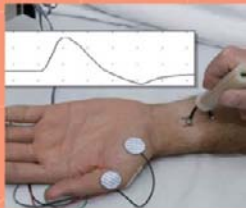
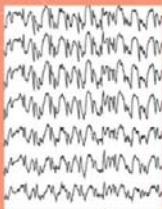
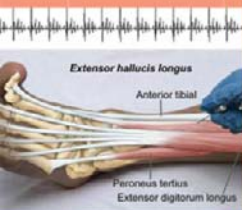


CONTEMPORARY NEUROLOGY SERIES

# CLINICAL NEUROPHYSIOLOGY

THIRD EDITION



JASPER R. DAUBE  
DEVON I. RUBIN

OXFORD

# **CLINICAL NEUROPHYSIOLOGY**

**Third Edition**

**SERIES EDITOR**

Sid Gilman, MD, FRCP

William J. Herdman Distinguished University Professor of Neurology  
University of Michigan

**Contemporary Neurology Series**

- 53** SLEEP MEDICINE  
Michael S. Aldrich, MD
- 54** BRAIN TUMORS  
Harry S. Greenberg, MD,  
William F. Chandler, MD, and  
Howard M. Sandler, MD
- 56** MYASTHENIA GRAVIS AND  
MYASTHENIC DISORDERS  
Andrew G. Engel, MD, Editor
- 57** NEUROGENETICS  
Stefan-M. Pulst, MD, Dr. Med., Editor
- 58** DISEASES OF THE SPINE AND  
SPINAL CORD  
Thomas N. Byrne, MD, Edward C. Benzel,  
MD, and Stephen G. Waxman, MD, PhD
- 59** DIAGNOSIS AND MANAGEMENT  
OF PERIPHERAL NERVE DISORDERS  
Jerry R. Mendell, MD, John T. Kissel, MD,  
and David R. Cornblath, MD
- 60** THE NEUROLOGY OF VISION  
Jonathan D. Trobe, MD
- 61** HIV NEUROLOGY  
Bruce James Brew, MBBS, MD, FRACP
- 62** ISCHEMIC CEREBROVASCULAR  
DISEASE  
Harold P. Adams, Jr., MD, Vladimir  
Hachinski, MD, and John W. Norris, MD
- 63** CLINICAL NEUROPHYSIOLOGY OF  
THE VESTIBULAR SYSTEM,  
Third Edition  
Robert W. Baloh, MD and Vicente  
Honrubia, MD
- 65** MIGRAINE: MANIFESTATIONS,  
PATHOGENESIS, AND  
MANAGEMENT, Second Edition  
Robert A. Davidoff, MD
- 67** THE CLINICAL SCIENCE OF  
NEUROLOGIC REHABILITATION,  
Second Edition  
Bruce H. Dobkin, MD
- 68** NEUROLOGY OF COGNITIVE AND  
BEHAVIORAL DISORDERS  
Orrin Devinsky, MD and  
Mark D'Esposito, MD
- 69** PALLIATIVE CARE IN NEUROLOGY  
Raymond Voltz, MD, James L. Bernat, MD,  
Gian Domenico Borasio, MD, DipPallMed,  
Ian Maddocks, MD, David Oliver, FRCGP,  
and Russell K. Portenoy, MD
- 70** THE NEUROLOGY OF EYE  
MOVEMENTS, Fourth Edition  
R. John Leigh, MD, FRCP and  
David S. Zee, MD
- 71** PLUM AND POSNER'S DIAGNOSIS  
OF STUPOR AND COMA,  
Fourth Edition  
Jerome B. Posner, MD, Clifford B. Saper,  
MD, PhD, Nicholas D. Schiff, MD, and  
Fred Plum, MD
- 72** PRINCIPLES OF DRUG THERAPY  
IN NEUROLOGY,  
Second Edition  
Michael V. Johnston, MD and  
Robert A. Gross, MD, PhD, Editors
- 73** NEUROLOGIC COMPLICATIONS OF  
CANCER, Second Edition  
Lisa M. DeAngelis, MD, and  
Jerome B. Posner, MD
- 74** NEUROLOGIC COMPLICATIONS  
OF CRITICAL ILLNESS,  
Third Edition  
Eelco F.M. Wijdicks, MD, PhD, FACP

# CLINICAL NEUROPHYSIOLOGY

## Third Edition

*Edited by*

**Jasper R. Daube, MD**

*Consultant, Department of Neurology, Mayo Clinic, Rochester, Minnesota;  
Professor of Neurology, College of Medicine, Mayo Clinic*

**Devon I. Rubin, MD**

*Consultant, Department of Neurology, Mayo Clinic, Jacksonville, Florida;  
Associate Professor of Neurology, College of Medicine, Mayo Clinic*

**OXFORD**  
UNIVERSITY PRESS

2009



**OXFORD**

UNIVERSITY PRESS

Oxford University Press, Inc., publishes works that further  
Oxford University's objective of excellence  
in research, scholarship, and education.

Oxford New York  
Auckland Cape Town Dar es Salaam Hong Kong Karachi  
Kuala Lumpur Madrid Melbourne Mexico City Nairobi  
New Delhi Shanghai Taipei Toronto

With offices in  
Argentina Austria Brazil Chile Czech Republic France Greece  
Guatemala Hungary Italy Japan Poland Portugal Singapore  
South Korea Switzerland Thailand Turkey Ukraine Vietnam

Copyright © 2009 by Mayo Foundation for Medical Education and Research

Published by Oxford University Press, Inc.  
198 Madison Avenue, New York, New York 10016

www.oup.com

Oxford is a registered trademark of Oxford University Press

All rights reserved. No part of this publication may be reproduced,  
stored in a retrieval system, or transmitted, in any form or by any means,  
electronic, mechanical, photocopying, recording, or otherwise,  
without the prior permission of Mayo Foundation for Medical Education  
and Research. Inquiries should be addressed to Scientific Publications,  
Plummer 10, Mayo Clinic, 200 First Street SW, Rochester, MN 55905

Library of Congress Cataloging-in-Publication Data  
Clinical neurophysiology / [edited by] Jasper R. Daube, Devon I. Rubin. — 3rd ed.  
p. ; cm. — (Contemporary neurology series ; 75)

Includes bibliographical references and index.

ISBN-13: 978-0-19-538511-3

1. Electroencephalography. 2. Electromyography. 3. Nervous system—Diseases—Diagnosis.

4. Evoked potentials (Electrophysiology) 5. Neurophysiology.

I. Daube, Jasper R. II. Rubin, Devon I. III. Series.

[DNLN: 1. Nervous System Diseases—diagnosis. 2. Electroencephalography. 3. Electromyography.

4. Evoked Potentials. 5. Nervous System Diseases—therapy. 6. Neurophysiology.

W1 CO769N v.75 2009/WL 141 C64155 2009]

RC386.6.E43C585 2009

616.8'047547—dc22

2008042251

Nothing in this publication implies that the Mayo Foundation endorses any of the products mentioned in this book. The science of medicine is a rapidly changing field. As new research and clinical experience broaden our knowledge, changes in treatment and drug therapy occur. The author and publisher of this work have checked with sources believed to be reliable in their efforts to provide information that is accurate and complete, and in accordance with the standards accepted at the time of publication. However, in light of the possibility of human error or changes in the practice of medicine, neither the author, nor the publisher, nor any other party who has been involved in the preparation or publication of this work warrants that the information contained herein is in every respect accurate or complete. The opinion and suggestions herein are solely that of the author and not necessarily shared by the publisher. Readers are encouraged to confirm the information contained herein with other reliable sources, and are strongly advised to check the product information sheet provided by the pharmaceutical company for each drug they plan to administer.

9 8 7 6 5 4 3 2 1

Printed in the United States of America  
on acid-free paper

# Foreword

Clinical neurophysiology is a mature field. Many of its techniques are standard operating procedures. Clinical neurophysiological approaches are logical extensions of the neurologic examination and can add information that is helpful in making a diagnosis. Because of its usefulness, clinical neurophysiology is practiced by a large percentage of neurologists and physiatrists. Even the neurologists and physiatrists who do not actively practice clinical neurophysiology are expected to understand it. Therefore, it is important for practitioners to understand the fundamental facts and principles of the field and to be current with key advances.

Clinical neurophysiology is also a large field. Like neurology, it encompasses a wide spectrum of issues and illnesses, ranging from the peripheral nervous system to the central nervous system. As in neurology, it is difficult to be an expert in all aspects of clinical neurophysiology, and most practitioners have a focused interest in the field. However, as is true for neurology, clinical neurophysiology has an essential unity. Problems are approached physiologically with methods that measure the electric activity of the nervous system. This is another reason for practitioners to be acquainted with the whole field even if they practice only a part of it.

Currently, there is considerable interest and activity in clinical neurophysiology. Numerous societies in the United States and throughout the world are devoted to this field, and their membership is growing. The two principal societies in the United States are the American Association of Neuromuscular and Electrodiagnostic Medicine, with its journal *Muscle and Nerve*, and the American Clinical Neurophysiology Society, with its journal *Journal of Clinical Neurophysiology*. The umbrella organization for the societies worldwide, the International Federation of Clinical Neurophysiology has members in 58 countries and its journal *Clinical Neurophysiology*. There are several examining bodies for competence in clinical neurophysiology. In the United States, the American Board of Psychiatry and Neurology examines for competence in the broad field, the American Board of Electrodiagnostic Medicine examines in the area commonly known as electromyography, and the American Board of Clinical Neurophysiology examines in the area of electroencephalography.

Where can a physician turn to learn the basics of clinical neurophysiology and be sure the information is up-to-date? When Mayo Clinic neurologists speak about clinical neurophysiology, they speak with special authority. The Mayo Clinic has been a central force in the United States in many areas of the field. In the area of electromyography, Dr. Edward Lambert, a pioneer in the field, made many basic observations that still guide current practice, and, of course, he identified an illness that now bears his name. He has trained many leaders of modern electromyography in the United States. In electroencephalography, Dr. Reginald Bickford was a pioneer and was active in many areas, including evoked potentials and even early attempts at magnetic stimulation of the brain. Many other leaders in electroencephalography have been at the Mayo Clinic, and four of them, in addition to Dr. Bickford, have been presidents of the American Clinical Neurophysiology Society. No one is better suited to orchestrate the writing of a textbook on *Clinical Neurophysiology* than Dr. Jasper Daube, a leader in clinical neurophysiology at Mayo and former head of the Neurology Department there. Dr. Daube is well recognized internationally as an expert in electromyography; he is very knowledgeable about all areas of the subject, basic and applied. He is an outstanding leader with a gift for organization. He has been ably assisted by Dr. Devon I. Rubin, another Mayo clinical neurophysiologist, who has worked with Dr. Daube on several projects in addition to this book.

For all these reasons, it is nice to see this third edition of *Clinical Neurophysiology*. Its many chapters cover the field in a broad way. The first several chapters discuss the basic issues of neuronal generators, biologic electricity, and measurement techniques central to all areas of clinical neurophysiology. A new chapter in this section deals with fundamental membrane and synaptic physiology. Next, the individual areas of the field are discussed: areas including classic electromyography, electroencephalography, and evoked potentials and extending to autonomic nervous system testing, sleep, surgical monitoring, motor control, vestibular testing, and magnetic stimulation. The text is organized for physicians who want to know how to make an assessment of a particular symptom, of a particular system, or for a particular disease. There is valuable information on the use of clinical neurophysiologic testing in a practical setting. Each chapter has periodic summaries of key points, which help understanding and learning. The book is profusely illustrated and has an accompanying CD that includes instructions with pictures of standard nerve conduction studies, anatomical illustrations for performing needle EMG on standard muscles, protocols for the approach to a wide range of clinical problems, and normal value tables.

Clinical neurophysiology, even though mature, like all other fields of medicine, is evolving. Analysis and management of data are becoming more heavily computerized. New methods of quantification are now possible and are being used clinically. New techniques are being developed. Perhaps most important, increasing emphasis is placed on how to improve patient care with better integration of clinical neurophysiologic testing; the third section of the book is devoted to these issues. This authoritative third edition should serve both students and practitioners, keeping them up-to-date about important new advances.

Mark Hallett, MD  
Human Motor Control Section  
National Institute of Neurological Disorders and Stroke  
Bethesda, Maryland  
Past Editor-in-Chief, *Clinical Neurophysiology*

# Preface

*Clinical Neurophysiology* is the result of more than 60 years of experience at the Mayo Clinic in training clinicians in the neurophysiologic methods for assessing diseases of the central and peripheral nervous systems. The lectures and handouts that were developed initially by Doctors Reginald Bickford and Edward Lambert in electroencephalography and electromyography, respectively, were the seeds of what has grown into the far-reaching field of endeavor of clinical neurophysiology at Mayo Clinic. The clinical neurophysiology teaching programs at Mayo Clinic Rochester, Jacksonville, and Arizona have continued to evolve into a formal, unified, 2-month course in clinical neurophysiology that provides trainees with the knowledge and experience needed to apply the principles of neurophysiology clinically.

The development of clinical neurophysiology at Mayo has paralleled developments in the field of medicine at large. The expansion during the past 25 years of neurophysiology of diseases of the central and peripheral nervous system has been recognized by the American Board of Psychiatry and Neurology, by the American Board of Medical Specialties with a Special Qualifications Examination in Clinical Neurophysiology, and by the Accreditation Council for Graduate Medical Education Residency Review Committee for postresidency fellowships in Clinical Neurophysiology.<sup>1</sup>

The Mayo course in clinical neurophysiology serves as an introduction to clinical neurophysiology for residents, fellows, and other trainees. The course includes lectures, small group seminars, practical workshops, and clinical experience in each of the areas of clinical neurophysiology. The faculty for the course consists entirely of Mayo Clinic staff members. These staff members are the authors of the chapters of this textbook.

Over the years, the material for the clinical neurophysiology course was consolidated from individual lecture handouts into manuals. Persons outside Mayo who had learned about these manuals by word of mouth increasingly requested them. The success of these manuals prompted us to publish the first edition of *Clinical Neurophysiology* in 1996 and a second edition in 2002. The continued evolution and expansion of the field of clinical neurophysiology has resulted in this third edition.

The organization of our textbook is unique: it is built around the concept of testing systems within the nervous system, rather than separated by individual techniques. The book consists of three major sections. The first section is a review of the basics of clinical neurophysiology, knowledge that is common to each of the areas of clinical neurophysiology. The second section considers the assessment of diseases by anatomical system. Thus, methods for assessing the motor system are grouped together, followed by those for assessing the sensory system, higher cortical functions, and the autonomic nervous system. The third section explains how clinical neurophysiologic techniques are used in the clinical assessment of diseases of the nervous system.

This third edition includes new approaches, such as those described in the new chapters on EEG coregistration with MRI imaging in epilepsy and motor unit number estimate studies in peripheral neuromuscular diseases. The underlying physiologic and electronic principles in *Clinical Neurophysiology* have not changed but the approach to teaching them with bullet points and key points has provided simplification and clarification. The clinical problems in which each of the clinical neurophysiologic approaches can add to the diagnosis and management of neurologic disease have been detailed, especially the assessment of clinical symptom complexes with electroencephalography (EEG). The discussion of pediatric EEG disorders, ambulatory EEG, new equipment and digital analyses, magneto-EEG, electromyographic (EMG) techniques, motor unit number estimates, myoclonus on surface EMG, segmental sympathetic reflex, and postural hypotension has

been expanded. Chapters on EMG quantification and single fiber EMG have been reorganized, and major revisions have been made in the discussion of sensory potentials, somatosensory evoked potentials, acoustic reflex testing, cardiovagal function, physiologic testing of sleep, and assessment of sleep disorders. New approaches have been expanded in each of the four chapters on monitoring neural function during surgery, particularly with motor evoked potentials.

For the first time, this edition also includes a CD with material immediately available during clinical electromyography. Pictures are provided, depicting nerve conduction study and somatosensory evoked potential techniques used in the Mayo Clinic EMG Laboratories including accompanying Mayo normal values, images depicting muscle surface anatomy with superimposed illustrated muscles for localization during needle EMG, and algorithms used for assessment of common problems in the clinical EMG laboratory and during intraoperative monitoring. The CD also contains the “EMG Sound Simulator and Synthesizer,” a unique, downloadable, interactive program that teaches EMG waveform recognition, and motor unit potential assessment and interpretation. Interactive CNP learning has been shown to be more effective than lectures.<sup>2</sup>

## REFERENCES

1. Burns, R., J. Daube, and H. Royden Jones. 2000. Clinical neurophysiology training and certification in the United States: 2000: American Board of Psychiatry and Neurology, Neurology Residency Review Committee. *Neurology* 55:1773–8.
2. Schuh, L., D. E. Burdette, L. Schultz, and B. Silver. 2008. Learning clinical neurophysiology: Gaming is better than lectures. *Journal of Clinical Neurophysiology* 25(3):167–9.

# Acknowledgments

The authors of the third edition of *Clinical Neurophysiology* have made our work as editors both educational and enjoyable. Each of the authors is active in clinical neurophysiology practice, education, and research. They bring their experiences to bear in the chapters they have written. Thus, our task was the remarkably easy one of organizing and coordinating the material. The editors and authors appreciate the skill and professionalism of Roberta Schwartz of the Sections of Scientific Publications; she has had an integral part in the development of this textbook. The work of the medical illustrators, Paul Honerman, David Factor, and David Cheney, and of Raj Alphonse and others in the Media Support Services at the Mayo Clinic, have been invaluable in the development and preparation of the supplemental material including that in the accompanying CD.

Mayo Neurology leadership has continued to encourage and support the Division of Clinical Neurophysiology in its combined efforts to provide trainees with the broad background of knowledge they will need as they enter active practice. This support has provided strong encouragement for this book. The staff in the Division of Neurophysiology—including staff at all three Mayo Clinic sites in Jacksonville, Florida; Rochester, Minnesota; and Scottsdale, Arizona—have contributed in a major way to the clinical neurophysiology course on which this textbook is based. The laboratory directors have been particularly important: Drs. Eric Sorenson, Devon Rubin, and Benn Smith, chairs of the Divisions of Clinical Neurophysiology and directors of the Electromyography Laboratories at the three Mayo Clinics; Dr. Phillip Low, director of the Autonomic Reflex Laboratory and the Nerve Physiology Laboratory; Dr. Elson So, director of the Electroencephalographic Laboratory; Dr. Michael Silber, director of the Sleep Disorders Center; and Dr. Robert Fealey, director of the Thermoregulatory Sweat Laboratory.

The support of the Mayo Foundation has been critical in the development of new directions and unique training programs in clinical neurophysiology. We acknowledge not only this support but also the help given by many others: the trainees who have participated in our clinical neurophysiology program and the students in our courses in continuing medical education who have given us feedback on our teaching material, the technicians who have been a major part of our teaching program and who have provided a helpful critique of our activities, Jean M. Smith and the other secretarial staff who have worked diligently to keep the project on track, and other physicians at our institution who have found our help in clinical neurophysiology useful in the care of their patients.

Jasper R. Daube, MD and Devon I. Rubin, MD

*This page intentionally left blank*

# Contents

Contributors xxv

## SECTION 1 BASIC NEUROPHYSIOLOGY AND AN INTRODUCTION TO ANALYSIS OF ELECTROPHYSIOLOGIC WAVEFORMS

1. **ELECTRICITY AND ELECTRONICS FOR CLINICAL NEUROPHYSIOLOGY 5**  
*Terrence D. Lagerlund*  
BASIC PRINCIPLES AND DEFINITIONS IN ELECTRICITY 5  
CIRCUIT ANALYSIS 7  
RESISTIVE–CAPACITIVE AND RESISTIVE–INDUCTIVE CIRCUITS 9  
CIRCUITS CONTAINING INDUCTORS AND CAPACITORS 10  
FILTER CIRCUITS 14  
TRANSISTORS AND AMPLIFIERS 16
2. **ELECTRIC SAFETY IN THE LABORATORY AND HOSPITAL 21**  
*Terrence D. Lagerlund*  
INTRODUCTION 21  
ELECTRIC POWER DISTRIBUTION SYSTEMS 21  
ELECTRIC SHOCK 22  
LEAKAGE CURRENT 25  
ELECTRIC SAFETY PRINCIPLES AND IMPLEMENTATION 27  
ELECTRIC STIMULATION SAFETY 30
3. **VOLUME CONDUCTION 33**  
*Terrence D. Lagerlund, Devon I. Rubin, and Jasper R. Daube*  
PRINCIPLES 33  
SOURCES OF ELECTRICAL POTENTIALS 34



CURRENT SOURCES: MONOPOLES, DIPOLES, AND  
QUADRUPOLES 38

VOLUME CONDUCTION THEORY: ELECTRIC PROPERTIES IN  
VOLUME CONDUCTORS 41

APPLICATIONS OF VOLUME CONDUCTION PRINCIPLES 43

**4. DIGITAL SIGNAL PROCESSING 53**

*Terrence D. Lagerlund*

DIGITAL COMPUTERS IN CLINICAL NEUROPHYSIOLOGY 53

DIGITIZATION 56

COMMON USES OF DIGITAL PROCESSING 59

AVERAGING 60

DIGITAL FILTERING 62

TIME AND FREQUENCY DOMAIN ANALYSIS 63

**5. BASICS OF NEUROPHYSIOLOGY 69**

*Jasper R. Daube and Squire M. Stead*

INTRODUCTION 69

CELL MEMBRANE 69

RESTING POTENTIAL 76

LOCAL POTENTIALS 78

ACTION POTENTIALS 82

SYNAPTIC TRANSMISSION 88

CLINICAL CORRELATIONS 93

**6. ELECTROPHYSIOLOGIC GENERATORS IN CLINICAL  
NEUROPHYSIOLOGY 97**

*Terrence D. Lagerlund*

STRUCTURAL GENERATORS 97

**7. WAVEFORMS AND ARTIFACTS 103**

*Jasper R. Daube*

INTRODUCTION 103

CONTINUOUS WAVEFORMS 103

EVENT RECORDING 106

COMBINATIONS OF CONTINUOUS WAVEFORMS AND  
EVENTS 108

WAVEFORM ALTERATIONS 108

PHYSIOLOGIC ALTERATION OF WAVEFORMS 108

ARTIFACTUAL WAVEFORMS 111

## **SECTION 2 ELECTROPHYSIOLOGIC ASSESSMENT OF NEURAL FUNCTION**

### **Part A Assessment of Cortical Function**

#### **8. ELECTROENCEPHALOGRAPHY: ADULT, NORMAL, AND BENIGN VARIANTS 119**

*Barbara F. Westmoreland*

INTRODUCTION 119

RECORDING THE ELECTROENCEPHALOGRAM 119

DISPLAY OF EEG ACTIVITY 119

ACTIVATION PROCEDURES 120

ARTIFACTS 123

NORMAL EEG ACTIVITY OF ADULTS 124

BENIGN VARIANTS 130

#### **9. EPILEPTIFORM ACTIVITY 137**

*Joseph F. Drazkowski*

INTRODUCTION AND OVERVIEW OF EPILEPTIFORM  
ACTIVITY 137

SPECIFIC FOCAL INTERICTAL DISCHARGES 138

GENERALIZED EPILEPTIFORM PATTERNS 141

ICTAL DISCHARGES 145

EPILEPTIFORM ACTIVITY WITH A POTENTIAL SEIZURE  
ASSOCIATION 148

#### **10. ADULT EEG: ABNORMAL NONEPILEPTIFORM ACTIVITY 151**

*Barbara F. Westmoreland*

INTRODUCTION 151

TYPES OF EEG ABNORMALITIES 152

FOCAL INTRACRANIAL PROCESSES CAUSING EEG  
ABNORMALITIES 154

ELECTROENCEPHALOGRAPHIC MANIFESTATIONS OF DIFFUSE  
DISORDERS 159

EVALUATION FOR SUSPECTED BRAIN DEATH 164

- 11. ELECTROENCEPHALOGRAPHY: ELECTROENCEPHALOGRAMS OF INFANTS AND CHILDREN 167**  
*Barbara F. Westmoreland*
- INTRODUCTION 167
- NEONATAL EEG PATTERNS 168
- DEVELOPMENTAL CHANGES DURING INFANCY, CHILDHOOD, AND ADOLESCENCE 173
- BENIGN VARIANTS IN CHILDREN 175
- ABNORMALITIES 175
- 12. AMBULATORY ELECTROENCEPHALOGRAPHY 187**  
*Jeffrey R. Buchhalter*
- INTRODUCTION 187
- INDICATIONS 187
- TECHNOLOGY 188
- CLINICAL APPLICATIONS 189
- 13. PROLONGED VIDEO ELECTROENCEPHALOGRAPHY 193**  
*Cheolsu Shin*
- INTRODUCTION 193
- EQUIPMENT 194
- CLINICAL APPLICATION 195
- 14. ELECTROENCEPHALOGRAPHIC SPECIAL STUDIES 203**  
*Gregory A. Worrell and Terrence D. Lagerlund*
- INTRODUCTION 203
- QUANTITATIVE METHODS OF ELECTROENCEPHALOGRAPHIC ANALYSIS 203
- MAGNETOENCEPHALOGRAPHY 211
- 15. ELECTROENCEPHALOGRAPHY IN THE SURGICAL EVALUATION OF EPILEPSY 215**  
*Joseph F. Drazkowski*
- BACKGROUND 215
- PRESURGICAL SELECTION AND EVALUATION 216
- ROUTINE EEG IN THE SURGICAL EVALUATION OF PATIENTS WITH SEIZURES 218
- PREOPERATIVE VIDEO-EEG MONITORING 218

PRESURGICAL EVALUATION WITH CONTINUOUS OR CHRONIC  
INTRACRANIAL MONITORING 219

INTRAOPERATIVE ELECTROCORTICOGRAPHY 223

**16. MOVEMENT-RELATED CORTICAL POTENTIALS AND  
EVENT-RELATED POTENTIALS 229**

*Virgilio Gerald H. Evidente and John N. Caviness*

MOVEMENT-RELATED CORTICAL POTENTIALS 229

EVENT-RELATED POTENTIALS 232

**Part B Sensory Pathways**

**17. SENSORY NERVE ACTION POTENTIALS 239**

*Eric J. Sorenson*

INTRODUCTION 239

PATHOPHYSIOLOGY OF SNAPs 240

METHODS OF STUDY OF SNAPs 243

MEASUREMENTS 247

TECHNICAL FACTORS 248

PLANNING THE STUDY AND FINDINGS IN DISEASES 251

**18. SOMATOSENSORY EVOKED POTENTIALS 257**

*Jonathan L. Carter and J. Clarke Stevens*

INTRODUCTION 257

GENERATORS AND ORIGIN OF SEP<sub>s</sub> 258

METHODS 258

RECORDING 260

LOCALIZATION 268

CLINICAL APPLICATIONS 269

**19. BRAIN STEM AUDITORY EVOKED POTENTIALS IN CENTRAL  
DISORDERS 281**

*Jonathan L. Carter*

INTRODUCTION 281

AUDITORY ANATOMY AND PHYSIOLOGY 283

GENERATORS OF THE BRAIN STEM AUDITORY EVOKED  
POTENTIALS 283

BRAIN STEM AUDITORY EVOKED POTENTIALS: METHODS 284

FACTORS AFFECTING THE BAEP RESPONSE 286

INTERPRETATION OF BAEPs 287

CLINICAL APPLICATIONS 288

**20. AUDIOGRAM, ACOUSTIC REFLEXES, AND EVOKED OTOACOUSTIC EMISSIONS 295**

*Christopher D. Bauch and Wayne O. Olsen*

INTRODUCTION 295

AUDIOGRAM 296

ACOUSTIC REFLEX 298

EVOKED OTOACOUSTIC EMISSIONS 301

APPLICATIONS 303

**21. BRAIN STEM AUDITORY EVOKED POTENTIALS IN PERIPHERAL ACOUSTIC DISORDERS 305**

*Christopher D. Bauch*

INTRODUCTION 305

STIMULI 306

ELECTRODES 306

INTERPRETATION 306

APPLICATIONS 308

**22. VISUAL EVOKED POTENTIALS 311**

*Jonathan L. Carter*

INTRODUCTION 311

VISUAL SYSTEM ANATOMY AND PHYSIOLOGY 312

VISUAL EVOKED POTENTIALS: METHODS 312

FACTORS AFFECTING THE VEP RESPONSE 314

INTERPRETATION OF VEPs 317

LOCALIZATION OF VISUAL SYSTEM LESIONS 318

**Part C Motor Pathways**

**23. COMPOUND MUSCLE ACTION POTENTIALS 327**

*James C. Watson and Jasper R. Daube*

INTRODUCTION 327

GENERAL CLINICAL APPLICATIONS 328

RECORDING CMAPs 329

STIMULATION 332

CMAP MEASUREMENTS	334
F WAVES	338
AXON REFLEXES (A WAVES)	342
PHYSIOLOGIC VARIABLES AFFECTING THE CMAP	343
CMAP CHANGES IN DISEASE	344
FINDINGS IN PERIPHERAL NERVE DISORDERS	346

**24. ASSESSING THE NEUROMUSCULAR JUNCTION WITH REPETITIVE STIMULATION STUDIES 369**

*Andrea J. Boon*

INTRODUCTION	369
ANATOMY AND PHYSIOLOGY OF THE NEUROMUSCULAR JUNCTION	370
TECHNIQUE	372
CRITERIA OF ABNORMALITY	377
RAPID RATES OF STIMULATION	378
SELECTION OF NERVE–MUSCLE COMBINATIONS	379
CLINICAL CORRELATIONS	380

**25. MOTOR EVOKED POTENTIALS 385**

*Jeffrey A. Strommen*

INTRODUCTION	385
TECHNIQUE	386
MEP PHARMACOLOGY	392
APPLICATIONS	393
CONTRAINDICATIONS AND RISKS	395

**Part D Assessing the Motor Unit**

**26. ASSESSING THE MOTOR UNIT WITH NEEDLE ELECTROMYOGRAPHY 403**

*Devon I. Rubin*

INTRODUCTION	404
KNOWLEDGE BASE OF NEEDLE EMG	404
TECHNIQUE OF NEEDLE EXAMINATION	405
CONDUCTING THE NEEDLE EXAMINATION	405

POTENTIAL COMPLICATIONS DURING NEEDLE EXAMINATION	409
EMG SIGNAL ANALYSIS	412
NEEDLE ELECTRODE CHARACTERISTICS	412
SKILLS OF EMG WAVEFORM RECOGNITION	413
ORIGIN OF EMG POTENTIALS	415
NORMAL EMG ACTIVITY	417
ABNORMAL SPONTANEOUS ELECTRIC ACTIVITY	424
ABNORMAL ELECTRICAL ACTIVITY—VOLUNTARY MUPs	437
ABNORMAL ELECTRICAL ACTIVITY—DISORDERS OF CENTRAL CONTROL	445
PATTERNS OF ABNORMALITIES	445
<b>27. QUANTITATIVE ELECTROMYOGRAPHY</b>	<b>451</b>
<i>Benn E. Smith</i>	
INTRODUCTION	451
CHARACTERISTICS OF THE MOTOR UNIT POTENTIAL	453
CHARACTERISTICS OF THE RECORDING EQUIPMENT	454
PROPERTIES OF MUPs EVALUATED USING STANDARD ELECTRODES	456
PROPERTIES OF MUPs MEASURABLE ONLY WITH SPECIAL ELECTRODES	460
QUANTITATIVE ANALYSIS OF SINGLE MUPs	462
PROPERTIES OF INTERFERENCE PATTERN AND METHODS OF INTERFERENCE PATTERN ANALYSIS	467
TURNS AND AMPLITUDE ANALYSIS OF THE INTERFERENCE PATTERN	469
POWER-SPECTRUM ANALYSIS	471
AUTOMATED METHODS OF ANALYSIS OF SPONTANEOUS ACTIVITY	472
<b>28. SINGLE FIBER ELECTROMYOGRAPHY</b>	<b>475</b>
<i>C. Michel Harper, Jr.</i>	
INTRODUCTION	475
TECHNIQUE	477
PITFALLS OF SFEMG	483
CLINICAL APPLICATIONS OF SFEMG	486

- 29. QUANTITATIVE MOTOR UNIT NUMBER ESTIMATES    493**  
*Jasper R. Daube*  
 INTRODUCTION    493  
 MUNE BY STANDARD EMG    495  
 MUNE BY STANDARD MOTOR NCS    496  
 QUANTITATIVE MUNE    497  
 CLINICAL APPLICATIONS    510

**Part E   Reflexes and Central Motor Control**

- 30. H REFLEXES    519**  
*Ruple S. Laughlin*  
 INTRODUCTION    519  
 PHYSIOLOGIC BASIS    519  
 TECHNIQUE    521  
 PEDIATRIC H REFLEXES    524  
 CLINICAL APPLICATIONS    524
- 31. CRANIAL REFLEXES AND RELATED TECHNIQUES    529**  
*Benn E. Smith*  
 INTRODUCTION    529  
 BLINK REFLEX    530  
 LATERAL SPREAD OF THE FACIAL NERVE RESPONSE:  
 ASSESSMENT OF FACIAL SYNKINESIS AND HEMIFACIAL  
 SPASM    535  
 JAW JERK (MASSETER REFLEX)    537  
 MASSETER INHIBITORY REFLEX    538  
 GREAT AURICULAR SENSORY NERVE CONDUCTION  
 STUDIES    540  
 TRIGEMINAL CONTACT HEAT EVOKED POTENTIAL STIMULATOR  
 STUDIES    540
- 32. LONG LATENCY REFLEXES AND THE SILENT PERIOD    543**  
*John N. Caviness*  
 INTRODUCTION    543  
 LONG LATENCY REFLEXES    543  
 THE SILENT PERIOD    546



**33. MOVEMENT DISORDERS 551**

*John N. Caviness*

INTRODUCTION 551

TECHNIQUES 552

EEG 553

SURFACE EMG: NORMAL PATTERNS 554

TREMOR 554

MYOCLONUS 559

PSYCHOGENIC JERKS 568

STARTLE DISORDERS 568

PERIODIC LIMB MOVEMENTS OF SLEEP 568

DYSTONIA 569

TICS, CHOREA, AND ATHETOSIS 571

VOLUNTARY MOVEMENT ABNORMALITIES 571

**34. VERTIGO AND BALANCE 575**

*David A. Zapala and Robert H. Brey*

INTRODUCTION 575

LABORATORY EXAMINATION: VOR-BASED MEASURES 582

LABORATORY EXAMINATION: VSR-BASED MEASURES 599

CLINICAL APPLICATIONS OF VESTIBULAR TESTING:  
ASSESSING SENSORINEURAL SYNDROMES OF THE  
LABYRINTH 607

VESTIBULAR REHABILITATION 610

**Part F Autonomic Function**

**35. AUTONOMIC PHYSIOLOGY 617**

*William P. Cheshire, Jr.*

INTRODUCTION 617

SYMPTOMS AND DISEASES 617

GENERAL ORGANIZATION OF THE AUTONOMIC  
SYSTEM 619

SYMPATHETIC FUNCTION 621

SYMPATHETIC INNERVATION OF THE SKIN 622

MUSCLE SYMPATHETIC ACTIVITY 623

- AUTONOMIC CONTROL OF HEART RATE 624
- CARDIOVASCULAR REFLEXES 624
- MAINTENANCE OF POSTURAL NORMOTENSION 626
- 36. QUANTITATIVE SUDOMOTOR AXON REFLEX AND RELATED TESTS 629**  
*Phillip A. Low*
- INTRODUCTION 629
- LABORATORY EVALUATION OF AUTONOMIC FUNCTION 629
- QUANTITATIVE SUDOMOTOR AXON REFLEX TEST 630
- IMPRINT METHODS OF SWEAT MEASUREMENT 634
- 37. EVALUATION OF ADRENERGIC FUNCTION 637**  
*Phillip A. Low*
- INTRODUCTION 637
- SKIN VASOMOTOR REFLEXES 637
- 38. THERMOREGULATORY SWEAT TEST 645**  
*Robert D. Fealey*
- INTRODUCTION 645
- ROLE OF THERMOREGULATORY SWEAT TESTING:  
CLINICAL SYNDROMES AND PROBLEMS  
EVALUATED 646
- METHOD 650
- THERMOREGULATORY SWEAT DISTRIBUTION 653
- REPORTING RESULTS 656
- DIFFICULTIES AND PITFALLS IN INTERPRETATION 657
- 39. CARDIOVAGAL REFLEXES 661**  
*William P. Cheshire, Jr.*
- INTRODUCTION 661
- HEART RATE RESPONSE TO DEEP BREATHING 662
- THE VALSALVA MANEUVER 665
- CARDIOVAGAL SCORING 670
- POWER SPECTRUM ANALYSIS 670
- HEART RATE RESPONSE TO STANDING 671
- OTHER TESTS OF CARDIOVAGAL FUNCTION 672

**40. ELECTROPHYSIOLOGY OF PAIN 677**

*Rose M. Dotson and Paola Sandroni*

INTRODUCTION 677

QUANTITATIVE SENSORY TEST 678

AUTONOMIC TESTS 681

MICRONEUROGRAPHY 683

LASER EVOKED POTENTIALS 684

CONTACT HEAT EVOKED POTENTIALS 688

**Part G Sleep and Consciousness**

**41. ASSESSMENT OF SLEEP AND SLEEP DISORDERS 697**

*Michael H. Silber, Cameron D. Harris, and Peter J. Hauri*

INTRODUCTION 697

TECHNIQUES USED IN STUDYING SLEEP 698

STAGING OF SLEEP 706

ASSESSING RESPIRATION DURING SLEEP 712

ASSESSING MOVEMENTS IN SLEEP 715

ASSESSING OTHER PHYSIOLOGIC VARIABLES 718

PERFORMANCE OF A SLEEP STUDY 718

ASSESSING SLEEP DISORDERS 719

**Part H Intraoperative Monitoring**

**42. CEREBRAL FUNCTION MONITORING 727**

*Elson L. So and Frank W. Sharbrough*

INTRODUCTION 727

TECHNICAL FACTORS IN INTRAOPERATIVE EEG MONITORING 727

EFFECTS OF ANESTHESIA ON ELECTROENCEPHALOGRAPHY  
SYMMETRICAL EEG PATTERNS DURING ANESTHESIA 731

PREOPERATIVE FOCAL ABNORMALITIES SEEN WITH  
ANESTHESIA 732

CLINICAL APPLICATIONS 733

EEG CHANGES DURING CAROTID ENDARTERECTOMY 733

SEP RECORDING DURING CAROTID ENDARTERECTOMY 735

OTHER MONITORING TECHNIQUES DURING CAROTID  
ENDARTERECTOMY 735

EEG MONITORING DURING CARDIAC SURGERY    736

BISPECTRAL ANALYSIS OF EEG FOR MONITORING DEPTH OF  
ANESTHESIA    736

EEG MONITORING FOR EPILEPSY SURGERY    736

**43. BRAIN STEM AND CRANIAL NERVE MONITORING    739**

*Brian A. Crum*

INTRODUCTION    739

METHODS    740

APPLICATIONS    743

**44. SPINAL CORD MONITORING    751**

*Jeffrey A. Strommen*

INTRODUCTION    751

GENERAL PRINCIPLES OF INTRAOPERATIVE  
MONITORING    752

EQUIPMENT AND ELECTRICAL SAFETY    753

MONITORING METHODS—SOMATOSENSORY EVOKED  
POTENTIALS    754

MOTOR EVOKED POTENTIALS    760

ELECTROMYOGRAPHY AND NERVE CONDUCTION  
STUDIES    765

TYPES OF SPINAL SURGERIES    768

**45. PERIPHERAL NERVOUS SYSTEM MONITORING    777**

*C. Michel Harper, Jr.*

INTRODUCTION    777

METHODS    778

APPLICATIONS    780

**SECTION 3    APPLICATIONS OF CLINICAL  
NEUROPHYSIOLOGY: ASSESSING SYMPTOM COMPLEXES  
AND DISEASE ENTITIES**

**46. ASSESSING CENTRAL NERVOUS SYSTEM SYMPTOMS    791**

*Elson L. So*

INTRODUCTION    791

ASSESSMENT OF MOTOR SYMPTOMS OF CENTRAL ORIGIN    791

ASSESSMENT OF SENSORY SYMPTOMS OF CENTRAL ORIGIN    792

ASSESSING IMPAIRMENT OF CONSCIOUSNESS AND COGNITION 792  
ASSESSING IMPAIRMENT OF VISCERAL FUNCTION AND SLEEP 792  
IDENTIFYING DISEASE TYPES 793  
PROGNOSIS 793  
ASSESSING CLINICAL DISORDERS WITH EEG 793

**47. APPLICATION OF CLINICAL NEUROPHYSIOLOGY: ASSESSING PERIPHERAL NEUROMUSCULAR SYMPTOM COMPLEXES 801**  
*Devon I. Rubin and Jasper R. Daube*

CLINICAL NEUROPHYSIOLOGY IN THE ASSESSMENT OF PERIPHERAL NERVOUS SYSTEM DISORDERS 802  
ASSESSING CLINICAL DISORDERS: ASSESSMENT WITH EMG AND NCS 806  
RADICULOPATHIES 806  
COMMON FOCAL MONONEUROPATHIES 808  
PERIPHERAL NEUROPATHY 810  
BRACHIAL PLEXOPATHY 817  
GENERALIZED WEAKNESS 822  
MYOPATHY 823  
MYALGIAS, MUSCLE STIFFNESS, AND EPISODIC MUSCLE WEAKNESS 827  
NMJ DISORDERS 827  
POLYRADICULOPATHY 829  
MOTOR NEURON DISEASE 830  
FACIAL WEAKNESS 831  
ANOMALOUS INNERVATION 831  
UNEXPECTED FINDINGS ON NERVE CONDUCTION STUDIES: CAUSE AND ACTION 835

**Glossary of Electrophysiologic Terms 839**

**Index 869**

# Contributors

## **Christopher D. Bauch, PhD**

Chair, Division of Audiology, Mayo Clinic, Rochester, Minnesota; Associate Professor of Audiology, College of Medicine, Mayo Clinic

## **Andrea J. Boon, MD**

Consultant, Department of Physical Medicine and Rehabilitation, Mayo Clinic, Rochester, Minnesota; Assistant Professor of Neurology and of Physical Medicine and Rehabilitation, College of Medicine, Mayo Clinic

## **Robert H. Brey, PhD**

Consultant, Division of Audiology, Mayo Clinic, Rochester, Minnesota; Professor of Audiology, College of Medicine, Mayo Clinic

## **Jeffrey R. Buchhalter, MD, PhD**

Supplemental Consultant, Department of Neurology, Mayo Clinic, Scottsdale, Arizona; Associate Professor of Neurology, College of Medicine, Mayo Clinic; Chief, Division of Pediatric Neurology, Phoenix Children's Hospital, Phoenix, Arizona

## **Jonathan L. Carter, MD**

Consultant, Department of Neurology, Mayo Clinic, Rochester, Minnesota; Associate Professor of Neurology, College of Medicine, Mayo Clinic

## **John N. Caviness, MD**

Consultant, Department of Neurology, Mayo Clinic, Rochester, Minnesota; Professor of Neurology, College of Medicine, Mayo Clinic

## **William P. Cheshire, Jr., MD**

Consultant, Department of Neurology, Mayo Clinic, Jacksonville, Florida; Professor of Neurology, College of Medicine, Mayo Clinic

## **Brian A. Crum, MD**

Consultant, Department of Neurology, Mayo Clinic, Rochester, Minnesota; Assistant Professor of Neurology, College of Medicine, Mayo Clinic

## **Jasper R. Daube, MD**

Consultant, Department of Neurology, Mayo Clinic, Rochester, Minnesota; Professor of Neurology, College of Medicine, Mayo Clinic

## **Rose M. Dotson, MD**

Formerly, Consultant, Department of Neurology, Mayo Clinic, Rochester, Minnesota; Formerly, Assistant Professor of Neurology, College of Medicine, Mayo Clinic; Presently, University Hospitals Medical Pediatrics, Chardon, Ohio

## **Joseph F. Drazkowski, MD**

Consultant, Department of Neurology, Mayo Clinic, Scottsdale, Arizona; Associate Professor of Neurology, College of Medicine, Mayo Clinic

**Virgilio G. H. Evidente, MD**

Consultant, Department of Neurology, Mayo Clinic, Scottsdale, Arizona; Associate Professor of Neurology, College of Medicine, Mayo Clinic

**Robert D. Fealey, MD**

Consultant, Department of Neurology, Mayo Clinic, Rochester, Minnesota; Assistant Professor of Neurology, College of Medicine, Mayo Clinic

**C. Michel Harper, Jr., MD**

Consultant, Department of Neurology, Mayo Clinic, Rochester, Minnesota; Professor of Neurology, College of Medicine, Mayo Clinic

**Cameron D. Harris**

Associate, Sleep Disorders Center, Mayo Clinic, Rochester, Minnesota; Assistant Professor of Medicine, College of Medicine, Mayo Clinic

**Peter J. Hauri, PhD**

Supplemental Consultant, Department of Psychiatry and Psychology, Mayo Clinic, Rochester, Minnesota; Emeritus Professor of Psychology, College of Medicine, Mayo Clinic

**Terrence D. Lagerlund, MD**

Consultant, Department of Neurology, Mayo Clinic, Rochester, Minnesota; Associate Professor of Neurology, College of Medicine, Mayo Clinic

**Ruple S. Laughlin, MD**

Consultant, Department of Neurology, Mayo Clinic, Rochester, Minnesota; Instructor in Neurology, College of Medicine, Mayo Clinic

**Phillip A. Low, MD**

Consultant, Department of Neurology, Mayo Clinic, Rochester, Minnesota; Professor of Neurology, College of Medicine, Mayo Clinic

**Wayne O. Olsen, MD**

Emeritus Consultant, Department of Otorhinolaryngology, Mayo Clinic, Rochester, Minnesota; Emeritus Professor of Otolaryngology, College of Medicine, Mayo Clinic

**Devon I. Rubin, MD**

Consultant, Department of Neurology, Mayo Clinic, Jacksonville, Florida; Associate Professor of Neurology, College of Medicine, Mayo Clinic

**Paola Sandroni, MD, PhD**

Consultant, Department of Neurology, Mayo Clinic, Rochester, Minnesota; Associate Professor of Neurology, College of Medicine, Mayo Clinic

**Frank W. Sharbrough, MD**

Consultant, Department of Neurology, Mayo Clinic, Rochester, Minnesota; Professor of Neurology, College of Medicine, Mayo Clinic

**Cheolsu Shin, MD**

Consultant, Department of Neurology, Mayo Clinic, Rochester, Minnesota; Associate Professor of Neurology and Assistant Professor of Pharmacology, College of Medicine, Mayo Clinic

**Michael H. Silber, MB ChB**

Consultant, Department of Neurology, Mayo Clinic, Rochester, Minnesota; Professor of Neurology, College of Medicine, Mayo Clinic

**Benn E. Smith, MD**

Consultant, Department of Neurology, Mayo Clinic, Scottsdale, Arizona; Associate Professor of Neurology, College of Medicine, Mayo Clinic

**Elson L. So, MD**

Consultant, Department of Neurology, Mayo Clinic, Rochester, Minnesota; Professor of Neurology, College of Medicine, Mayo Clinic

**Eric J. Sorenson, MD**

Consultant, Department of Neurology, Mayo Clinic, Rochester, Minnesota; Associate Professor of Neurology, College of Medicine, Mayo Clinic

**Squire M. Stead, MD, PhD**

Senior Associate Consultant, Department of Neurology, Mayo Clinic, Rochester, Minnesota; Assistant Professor of Neurology, College of Medicine, Mayo Clinic

**J. Clarke Stevens, MD**

Consultant, Department of Neurology, Mayo Clinic, Rochester, Minnesota; Professor of Neurology, College of Medicine, Mayo Clinic

**Jeffrey A. Strommen, MD**

Consultant, Department of Physical Medicine and Rehabilitation, Mayo Clinic, Rochester, Minnesota; Assistant Professor of Physical Medicine and Rehabilitation, College of Medicine, Mayo Clinic

**James C. Watson, MD**

Consultant, Department of Neurology, Mayo Clinic, Rochester, Minnesota; Assistant Professor of Neurology, College of Medicine, Mayo Clinic

**Barbara F. Westmoreland, MD**

Consultant, Department of Neurology, Mayo Clinic, Rochester, Minnesota; Professor of Neurology, College of Medicine, Mayo Clinic

**Gregory A. Worrell, MD, PhD**

Consultant, Department of Neurology, Mayo Clinic, Rochester, Minnesota; Associate Professor of Neurology, College of Medicine, Mayo Clinic

**David A. Zapala, PhD**

Consultant, Section of Audiology, Mayo Clinic, Jacksonville, Florida; Assistant Professor of Audiology, College of Medicine, Mayo Clinic



*This page intentionally left blank*

# **CLINICAL NEUROPHYSIOLOGY**

**Third Edition**

*This page intentionally left blank*

## SECTION 1

# BASIC NEUROPHYSIOLOGY AND AN INTRODUCTION TO ANALYSIS OF ELECTROPHYSIOLOGIC WAVEFORMS

---

Clinical neurophysiology is an area of medical practice focused primarily on measuring function in the central and peripheral nervous systems, the autonomic nervous system, and muscles. The specialty identifies and characterizes diseases of these areas, understands their pathophysiology, and, to a limited extent, treats them. Clinical neurophysiology relies entirely on the measurement of ongoing function—either spontaneous or in response to a defined stimulus—in a patient. Each of the clinical neurophysiology methods measures function by recording alterations in physiology as manifested by changes in electrical waveforms, electromagnetic fields, force, or secretory activities. Each of these variables is measured as a waveform that changes over time. Electrical measurements in which the voltage or current flow associated with activity is plotted on a temporal basis are the most common measurements used in clinical neurophysiology, but other measures such as blood pressure, pulse, sweat production, and respiration are also sometimes measured. Knowledge of the basics of neurophysiology, including the origin and generation of electrical activity and the recording, measurement, and analysis of the waveforms generated by the electrical signals, is critical in learning how to perform and apply the methods of clinical neurophysiology in the study of disease.

The first section of this introductory textbook reviews the basic concepts of neurophysiology, including the generation, recording, and analysis of the waveforms studied in the practice of clinical neurophysiology. The principles of electricity and electronics needed to make the recordings are reviewed in Chapter 1. To make the appropriate measurements, clinical neurophysiologists rely on equipment with technical specifications; this requires that they understand the basic principles reviewed in Chapter 1. All electrical stimulation and recording methods require applying electrical connections that pass small amounts of current through human tissue. Although the risks of harm from this current flow are small, they must be understood. The principles of electrical safety necessary to minimize, reduce, or eliminate any risk are discussed in Chapter 2. These unchanging principles are of critical importance to the practice of clinical neurophysiology.

The circuits reviewed in Chapter 1 describe the familiar forms of electricity found in the home and in business. Electrical recordings made from human tissue are distinctly different because the electric currents are carried by charged ions that are present throughout the tissue, rather than by electrons as in wires. Electric currents flowing throughout the human body are limited by the resistance and capacitance of the tissues. While the resistance

and capacitance vary among different tissues, it does not stop it, resulting in widespread flow of electricity throughout the body, referred to as *volume conduction*. Volume conduction produces the unique aspects of the generation and recording of physiologic waveforms recorded from human tissue. The immutable principles of volume conduction described in Chapter 3 are applicable to the many forms of electrical recording used in clinical neurophysiology, whether the waveforms are recorded from the head (electroencephalography), nerves (nerve conduction studies), muscles (electromyography), or skin (autonomic function testing).

Measurement of current flow, or potential differences, between areas of the body was first made using analog electronic devices that have been replaced entirely by digital recordings throughout clinical neurophysiology. The basic principles of digital techniques

for selecting, displaying, and storing the waveforms are described in Chapter 4.

Virtually all tissues (and the cells composing them) in the human body have electric potentials associated with their activities. These potentials are much larger for nerve and muscle tissue than for other tissues and can easily be recorded for analyzing function and its alteration with disease, just as they can for the heart. Chapters 5 and 6 review the basic concepts of neurophysiology, including the generators and processes on a cellular level that give rise to the signals recorded in clinical neurophysiology. Chapter 6 describes the underlying physiology of all electrical waveforms, whatever be their sources. The range of alterations that occur in these waveforms in disease and the electric artifacts that occur in association with the physiologic waveforms are reviewed in Chapter 7.

# Electricity and Electronics for Clinical Neurophysiology

Terrence D. Lagerlund

## **BASIC PRINCIPLES AND DEFINITIONS IN ELECTRICITY**

Electric Charges and Force  
Electric Potential  
Electric Current and Resistors  
Capacitors  
Coils (Inductors)

## **CIRCUIT ANALYSIS**

Kirchhoff's First Law  
Rules for Seats of Electromotive Force, Resistors, Capacitors, and Inductors  
Kirchhoff's Second Law

## **RESISTIVE–CAPACITIVE AND RESISTIVE–INDUCTIVE CIRCUITS**

Resistive–Capacitive Circuits and Time Constant  
Resistive–Inductive Circuits and Time Constant

## **CIRCUITS CONTAINING INDUCTORS AND CAPACITORS**

Inductive–Capacitive Circuits  
Inductive–Resistive–Capacitive Circuits  
Root-Mean-Square Potentials or Currents  
Calculation of Reactance  
Calculation of Impedance and the Phenomenon of Resonance

## **FILTER CIRCUITS**

High-Pass Filters  
Low-Pass Filters

## **TRANSISTORS AND AMPLIFIERS**

Semiconductors and Doping  
Diodes and Rectification  
Transistors and Amplification  
Differential Amplifiers

## **SUMMARY**

## **BASIC PRINCIPLES AND DEFINITIONS IN ELECTRICITY**

### **Electric Charges and Force**

Electric charges are of two types, designated *positive* and *negative*. Charges exert electric forces on each other; like charges repel,

opposite charges attract. An electric charge can be thought of as generating an electric field in the surrounding space. The field around a positive charge points radially outward in all directions from that charge, whereas the field around a negative charge points radially inward. Numerically, the electric force  $F$  on charge  $q$  in a region of space in which there is an electric field  $E$  is given by  $F = qE$ . Thus, the

electric field can be thought of as the electric force per unit charge ( $E = F/q$ ).

Ordinary matter consists of atoms containing a nucleus composed of positively charged protons and uncharged neutrons. Negatively charged electrons occupy the space around the nucleus, to which they normally are bound by the attractive electric force between them and the nucleus. In unionized atoms, the net charge of the electrons is equal and opposite to the charge of the nucleus, so that the atom as a whole is electrically neutral. The charge carried by  $6.24 \times 10^{18}$  protons is one coulomb (the SI [Système International] unit of electric charge).

### Key Points

- There are positive and negative electric charges.
- Electric force between two charges depends on the charges and the distance between them.
- Electric field is force per unit charge.

## Electric Potential

Energy (work) is required to move a charge in an electric field because of the electric force acting on that charge. The energy required,  $U$ , is proportional to the charge,  $q$ ; thus, it makes sense to talk about the energy per unit charge. This quantity is called the *electric potential* ( $V = U/q$ ) and is measured in volts; one volt is one joule of energy per coulomb of charge. The energy required to move a charge in a uniform electric field is also proportional to the distance moved. It can be shown that the difference in electric potential between two points at a distance  $l$  apart in a region of space containing an electric field  $E$  is given by  $V = El$ . Electric potential in a circuit is somewhat analogous to pressure in fluid dynamics.

To have continuous movement of charges, as in an electric circuit, energy must be supplied continuously by a device such as an electrochemical cell, or a *battery* of such cells (which convert chemical energy to electric energy), or an electric generator (which converts mechanical energy to electric energy). Such a device is called a *seat of electromotive force* (EMF). The EMF of a battery or generator is equal to the energy supplied per unit of charge and is measured in volts. The rate at which energy  $U$

is supplied is called *power* ( $P = dU/dt$ ); it is measured in watts. One watt is one joule per second.

### Key Points

- Energy required to move a charge in an electric field is proportional to charge.
- Electric potential is energy per unit charge (measured in volts).
- Electrochemical cells and batteries convert chemical energy to electric energy.
- Electric generators convert mechanical energy to electric energy.
- Power is the rate at which energy is supplied (measured in watts).

## Electric Current and Resistors

The movement of electric charges is called *electric current*. The current  $i$  is numerically equal to the rate of flow of charge  $q$  ( $i = dq/dt$ ) and is measured in amperes. One ampere is one coulomb per second. Current in a circuit is somewhat analogous to flow in fluid dynamics. A *conductor* is a substance that has free charges that can be induced to move when an electric field is applied. For example, a salt solution contains sodium and chloride ions. When such a solution is immersed in an electric field, the sodium ions move in the direction of the field, while the chloride ions move in the opposite direction. The direction of flow of current is determined by the movement of positive charges and, hence, is in the direction of the applied electric field. A metal contains free electrons. When an electric field is applied, the electrons (being negatively charged) move in the direction opposite to the electric field, but the current by convention is still taken to be in the direction of the field (i.e., opposite to the direction of charge movement). The current flowing in a conductor, for example a wire, divided by the cross-sectional area  $A$  of that conductor is called the *current density* ( $J$ ), that is,  $J = i/A$ .

Movement of charges in an ordinary conductor is not completely free; there is friction, which is called *resistance*. Many conductors are *linear*, that is, the electric field that causes current flow is proportional to the current density in the conductor. The resistivity ( $\rho$ ) of a substance determines how much current it will conduct for a given applied electric field and

is numerically equal to the ratio of the electric field to the current density ( $\rho = E/J$ ). The resistivity is a constant for any given substance. In contrast, the resistance  $R$  of an individual conductor (also called a *resistor* in this context), which is equal to the ratio of the potential difference ( $V$ ) across the resistor to the current flow  $i$  in the resistor ( $R = V/i$ , called *Ohm's law*), depends on the geometry of the resistor as well as on the material of which it is made. Resistance is measured in volts per ampere, or *ohms*. The resistance  $R$  of a long cylindrical conductor of length  $l$ , cross-sectional area  $A$ , and resistivity  $\rho$  is given by  $R = \rho l/A$ .

Sometimes it is more convenient to discuss the conductivity of a substance,  $\sigma = 1/\rho$ . This is the ratio of the current density to the electric field ( $\sigma = J/E$ ). Similarly, the conductance  $G$  of a resistor is the reciprocal of the resistance ( $G = 1/R$ ). Ohm's law in terms of conductance may be written as  $G = i/V$ .

### Key Points

- Current is the rate of flow of charge (measured in amperes).
- A conductor has free charges that move when an electric field is applied.
- The conductors in metal are negatively charged electrons.
- Current density is charge per unit cross-sectional area.
- Linear conductors obey Ohm's law (current flow is proportional to potential difference).
- Resistance is the ratio of potential difference to current flow (measured in ohms).

## Capacitors

A capacitor is a device for storing electric charge; it generally consists of two charged conductors separated by a dielectric (insulator). A capacitor has the property that the charge  $q$  stored is proportional to the potential difference  $V$  across the capacitor:  $q = CV$ , where  $C$ , the charge per unit potential, is called the *capacitance*. Capacitance is measured in coulombs per volt, or Farads (F).

### Key Points

- A capacitor is two charged conductors separated by an insulator.

- Charge stored in a capacitor is proportional to potential difference.
- Capacitance is charge stored per unit potential (measured in Farads).

## Coils (Inductors)

A coil (also known as an *inductor* or *electromagnet*) is a device that generates a magnetic field when a current flows in it. Physically, it consists of a coil of wire that may be wrapped around a magnetic core; for example, a ferromagnetic substance such as iron, cobalt, or nickel. A coil has a property, called *inductance*, that is analogous to the mechanical property of inertia; it resists any change in current flow (either increase or decrease). More precisely, a coil is capable of generating an EMF in response to any *change* in the current flowing in it; the direction of the EMF is always such as to oppose the current change, and numerically the potential difference  $\bar{V}$  across a coil is proportional to the rate of change of the current  $i$  in the coil:  $\bar{V} = -L (di/dt)$ , where  $L$  is the inductance of the coil and the minus sign indicates that the potential is in the direction opposite to the current change. Inductance is measured in volt-seconds per ampere, or Henrys (H).

### Key Points

- A coil (inductor) generates a magnetic field when current flows in it.
- A coil generates an EMF in response to a change in current flow.
- The potential difference across a coil is proportional to the rate of change of current.
- Inductance is the potential difference divided by rate of change of current (measured in Henrys).

## CIRCUIT ANALYSIS

A *circuit* is a closed loop or series of loops composed of circuit elements connected by conducting wires. Circuit elements include a source of EMF (power supply), resistors, capacitors, inductors, and transistors.



## Kirchhoff's First Law

For any loop of a circuit, the energy per unit charge (potential) imparted to the loop must equal the energy per unit charge dissipated (principle of conservation of energy). Stated another way, if electric potential is to have any meaning, a given point can have only one value of potential at any given time. If we start at any point in a circuit and, in imagination, go around the circuit in either direction, adding up algebraically the changes in potential that we encounter, we must arrive at the same potential when we return to the starting point. In other words, the algebraic sum of the changes in potential encountered in a complete traversal of a circuit loop must be zero. This is Kirchhoff's first law.<sup>1</sup>

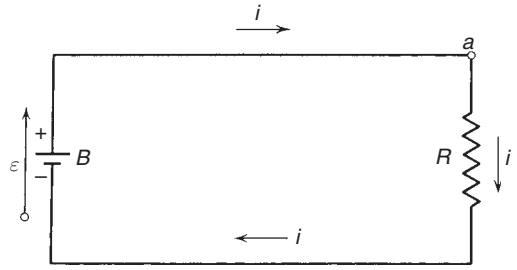
### Key Points

- Energy is conserved in an electric circuit.
- Therefore, the sum of all changes in potential around an entire circuit is zero.

## Rules for Seats of Electromotive Force, Resistors, Capacitors, and Inductors

To apply Kirchhoff's first law to a circuit, the following rules must be used to determine the algebraic signs of the potentials across circuit components:

1. If a seat of EMF  $\varepsilon$  is traversed in the direction of the EMF (i.e., from the negative to the positive terminal), the change in potential is  $+\varepsilon$ ; in the opposite direction, it is  $-\varepsilon$ .
2. If a resistor is traversed in the direction of the current, the change in potential is  $-iR$ ; in the opposite direction, it is  $+iR$ .
3. If a capacitor is traversed in the direction of its positively charged plate to its negatively charged plate, the change in potential is  $-q/C$ ; in the opposite direction, it is  $+q/C$ .
4. If an inductor is traversed in the direction of the current flow, the change in potential is  $-L(di/dt)$ ; in the opposite direction, it is  $+L(di/dt)$ .



**Figure 1-1.** A simple electric circuit containing an electromotive force,  $\varepsilon$ , current,  $i$ , and a resistor,  $R$ . The application of Kirchhoff's first law to the circuit starts at point "a."  $B$  is a battery (seat of electromotive force) (From Halliday, D., and R. Resnick. 1962. *Physics. Part II, Rev. 2nd ed.*, 790. New York: John Wiley & Sons. By permission of the publisher.)

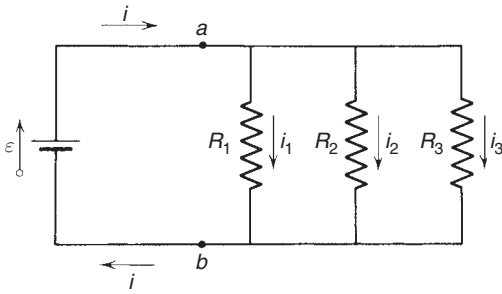
Figure 1-1 shows a simple circuit containing a source of EMF and a resistor, to which Kirchhoff's first law may be applied to determine the current flow, as follows:

$$\begin{aligned} -iR + \varepsilon &= 0 \\ \varepsilon &= iR \\ i &= \varepsilon/R \end{aligned}$$

Thus, the current is given by the EMF divided by the resistance. A similar analysis can be made when a circuit contains multiple sources of EMF, or multiple resistors, connected in series. The effective net EMF is the algebraic sum of the individual EMFs. The effective net resistance is the sum of the individual resistances.

## Kirchhoff's Second Law

A *node* is a junction point of two or more conductors in a circuit. The node cannot act as a repository of electric charge; therefore, the sum of all the current flowing into a node must equal the sum of all the current flowing out of the node (otherwise, charge would be constantly accumulating at the node). This is Kirchhoff's second law. By using this law for each node in the circuit, together with the first law for each loop in the circuit, any arbitrary circuit problem, no matter how complex, can be expressed as mathematical equations. Whether the equations can be solved and how difficult it is to obtain a solution depend on the



**Figure 1-2.** A circuit containing an EMF,  $\varepsilon$ , and three resistors ( $R_1$ ,  $R_2$ ,  $R_3$ ) in parallel.  $a$ , junction point (node);  $b$ , junction point (node);  $i$ , current. (From Halliday, D., and R. Resnick. 1962. *Physics. Part II. Rev.*, 2nd ed., 800. New York: John Wiley & Sons. By permission of the publisher.)

nature of the circuit and the elements it contains and on the mathematical skills available for the task.

Figure 1-2 shows a circuit containing a single source of EMF connected to three resistors in parallel. Kirchhoff's second law is applied to the junction of the three resistors, and Kirchhoff's first law is applied to each branch of the circuit, to give four independent equations in the four current variables  $i$ ,  $i_1$ ,  $i_2$ , and  $i_3$ , as follows:

$$\begin{aligned} i &= i_1 + i_2 + i_3 \\ -i_1 R_1 + \varepsilon &= 0 \\ -i_2 R_2 + \varepsilon &= 0 \\ -i_3 R_3 + \varepsilon &= 0 \end{aligned}$$

These equations are solved for the four currents as follows:

$$\begin{aligned} \varepsilon &= i_1 R_1 = i_2 R_2 = i_3 R_3 \\ i_1 &= \varepsilon / R_1 \\ i_2 &= \varepsilon / R_2 \\ i_3 &= \varepsilon / R_3 \\ i &= i_1 + i_2 + i_3 \\ &= \varepsilon (1/R_1 + 1/R_2 + 1/R_3) \end{aligned}$$

Equivalent resistance:

$$R = \frac{1}{(1/R_1 + 1/R_2 + 1/R_3)}$$

The net current  $i$  in the circuit can be calculated from Ohm's law, using an effective net resistance given as the reciprocal of the sum of the reciprocals of the three resistances in parallel.

### Key Points

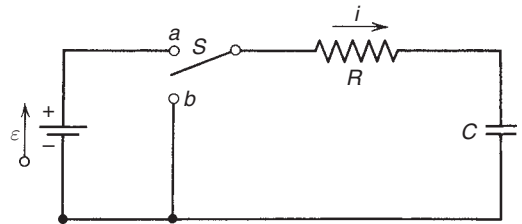
- A node is a junction point in an electric circuit.
- Charge is conserved in a circuit.
- Therefore, the sum of current flowing into a node equals the sum of current flowing out of a node.

## RESISTIVE-CAPACITIVE AND RESISTIVE-INDUCTIVE CIRCUITS

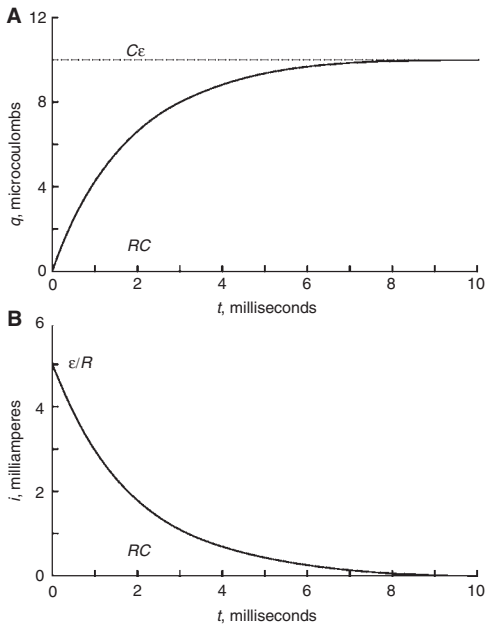
### Resistive-Capacitive Circuits and Time Constant

Figure 1-3 shows a resistive-capacitive (RC) circuit containing a single source of EMF connected to a resistor and capacitor in series. When the switch is placed in position  $a$ , the current flows in such a way as to charge the capacitor. Because of the presence of the resistor, the capacitor is not charged all at once but gradually over time. When Kirchhoff's first law is applied to this circuit and use is made of the fact that the current is charging the capacitor at the rate  $i = dq/dt$ , a differential equation results that can be solved for the charge or current as a function of time.

Figure 1-4A shows the exponential rise in the charge  $q$  on the capacitor, and Figure 1-4B shows that the current  $i$  (which is the slope of the curve representing  $q$  against time) falls exponentially to zero as the capacitor becomes fully charged. The *time constant* of the RC circuit is the time required for the current to fall



**Figure 1-3.** A circuit containing an EMF,  $\varepsilon$ , a resistor,  $R$ , and a capacitor,  $C$ . With the switch,  $S$ , in position  $a$ , the capacitor is charged. In position  $b$ , it is discharged. (From Halliday, D., and R. Resnick. 1962. *Physics. Part II. Rev.*, 2nd ed., 802. New York: John Wiley & Sons. By permission of the publisher.)



**Figure 1-4.** A, The variation of charge,  $q$ , with time,  $t$ , during the charging process. B, The variation of current,  $i$ , with time,  $t$ . For  $R = 2000 \Omega$ ,  $C = 1.0 \mu\text{f}$ , and  $\epsilon = 10\text{V}$ . (From Halliday, D., and R. Resnick. 1962. *Physics. Part II. Rev.*, 2nd ed., 804. New York: John Wiley & Sons. By permission of the publisher.)

to  $1/e$  (37%) of its initial value; it is also the time needed for the charge to rise to  $1 - 1/e$  (63%) of its final value;  $e$  is the base of the natural logarithm ( $e = 2.718282$ ). The time constant is equal to  $RC$ .

When the switch shown in Figure 1-3 is placed in position b, the direction of current flow is reversed and the capacitor is discharged. Application of Kirchhoff's first law to this circuit yields a differential equation that can be solved for the charge or current as a function of time.

In this situation, both the charge on the capacitor and the current (slope of the curve representing  $q$  against time) fall exponentially with time with the same time constant,  $RC$ . The current is negative in this case (i.e., it flows counterclockwise in the circuit as the capacitor is discharged).

### Key Points

- In a resistive–capacitive (RC) circuit, the capacitor is charged gradually over time.
- The charge on the capacitor approaches its maximum value with an exponential time constant.

- The time constant is  $RC$ .
- The current decays exponentially to zero with the same time constant.
- During discharge of the capacitor, the charge and current both decay exponentially.

## Resistive–Inductive Circuits and Time Constant

A circuit containing a resistor  $R$  and an inductor  $L$  (an *RL circuit*) as well as a source of EMF can be studied by similar methods. Because of the inductance, the current flow in this circuit does not rise immediately to its eventual value when a switch is closed but rather rises exponentially with a time constant (time to reach 63% of final value) given by  $L/R$ . This is caused by the “inertial” effect of the inductor. The form of the exponential rise in current is similar to the shape of the exponential rise in charge shown for the previous RC circuit in Figure 1-4A. Similarly, when a switch bypasses the source of EMF in this circuit, the current will not drop to zero immediately but will fall off exponentially in time with time constant  $L/R$  because of the effect of the inductor.

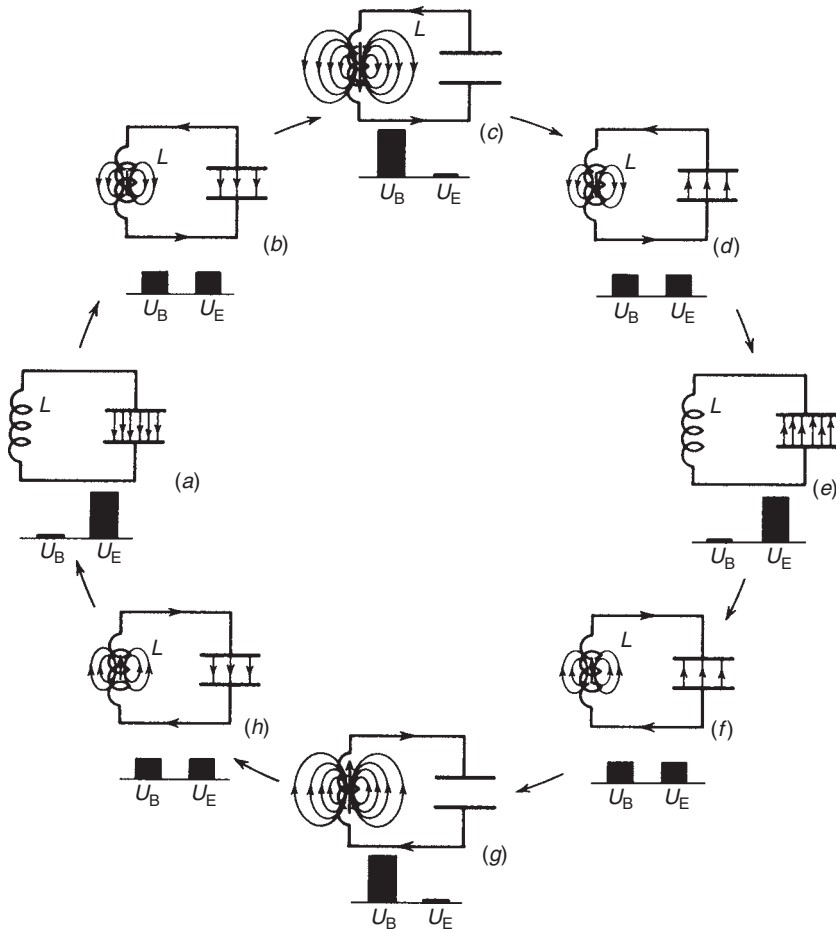
### Key Points

- In a resistive–inductive (RL) circuit, current flow gradually increases over time.
- The current approaches its maximum value with an exponential time constant.
- The time constant is  $L/R$ .
- When EMF is removed, the current in a RL circuit decays exponentially to zero.

## CIRCUITS CONTAINING INDUCTORS AND CAPACITORS

### Inductive–Capacitive Circuits

Figure 1-5 shows an ideal circuit containing a capacitor and an inductor, an *inductive–capacitive*, or *LC*, circuit. The circuit is *ideal* because it contains no resistance. In stage (a), the capacitor is fully charged and there is no current flow. All the energy present in the circuit is stored as electric energy ( $U_E$ ) in the capacitor. By stage (b), a current flow



**Figure 1-5.** A simple LC circuit showing eight stages (a–h) in one cycle of oscillation. The bar graphs under each stage show the relative amounts of magnetic ( $U_B$ ) and electric ( $U_E$ ) energy stored in the circuit at any time. (From Halliday, D., and R. Resnick. 1962. *Physics. Part II. Rev.*, 2nd ed., 944. New York: John Wiley & Sons. By permission of the publisher.)

has partially discharged the capacitor but at the same time has created a magnetic field in the inductor. The total energy is split between electric energy in the capacitor and magnetic energy in the inductor ( $U_B$ ). At stage (c), the current flow has reached its maximum and the capacitor is fully discharged. The inductance effect, however, causes the current to continue to flow, now charging the capacitor in the opposite direction, as shown in stages (d) and (e). In stages (f) through (h), the scenario is repeated, with the capacitor discharging and the current flowing in the opposite direction. Finally, stage (a) is reached again, and the entire cycle repeats. Thus, this LC circuit is an oscillator, and the charge on the capacitor is a cosine function of time; similarly, the current in the circuit is a sine function of time. The *time*

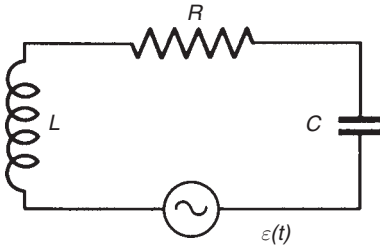
*constant*  $\tau$  of this circuit is the square root of LC, and the frequency of oscillations is  $1/2\pi\tau$ .

### Key Points

- An ideal inductive–capacitive (LC) circuit has no resistance and demonstrates continuous oscillations.
- The frequency of oscillation depends inversely on the square root of LC.

## Inductive–Resistive–Capacitive Circuits

A more realistic circuit is shown in Figure 1–6; it contains a resistor, capacitor, and inductor.



**Figure 1-6.** An AC circuit containing a generator,  $\varepsilon(t)$ , inductor,  $L$ , resistor,  $R$ , and capacitor,  $C$ . (From Halliday, D. and R. Resnick. 1962. *Physics. Part II. Rev.*, 2nd ed., 952. New York: John Wiley & Sons. By permission of the publisher.)

It also contains a source of alternating current EMF (an AC generator). This is a device that generates an EMF  $\varepsilon(t)$  that varies sinusoidally over time (which is exactly what the electric power company generators do) with a frequency of  $f$  (typically 60 Hz for line power in the United States).

If the AC generator is omitted, the circuit behaves as a damped oscillator; if the capacitor is initially charged up and then switched into the circuit, the current in the circuit will vary sinusoidally over time, but its amplitude decays exponentially to zero because of power dissipation in the resistor.

If, on the other hand, the AC generator supplies energy continuously at a fixed frequency  $f$ , then the current flow in the circuit also varies sinusoidally with the frequency  $f$  of the driving EMF, although there generally is a phase shift (effectively, a time delay) between the current and the driving EMF. For such a circuit, it can be shown that the amplitude of the current flow  $i_0$  is directly proportional to the amplitude of the driving EMF  $\varepsilon_0$ , that is,  $i_0 = \varepsilon_0/Z$ . This is analogous to the situation in a direct current (DC) circuit containing a battery and a resistor, in which current is proportional to the EMF of the battery ( $i = \varepsilon/R$ , Ohm's law). The quantity in the AC circuit that is analogous to resistance in a DC circuit is *impedance* ( $Z$ ); like resistance, it is measured in ohms. Impedance is determined by all three circuit elements ( $L$ ,  $C$ , and  $R$ ); also, unlike DC resistance, impedance is a function of the frequency  $f$  of the AC generator.

### Key Points

- A realistic inductive–capacitive circuit has resistance.

- Oscillations in an LRC circuit are damped unless power is continuously supplied by an alternating current EMF.
- When a generator supplies power to an LRC circuit, the current flow is proportional to the EMF of the generator.
- Impedance is the ratio of the amplitude of the applied EMF to the amplitude of the current flow (measured in ohms).
- Impedance depends on  $L$ ,  $R$ , and  $C$  and also is dependent on the frequency of the applied EMF of the generator.

### Root-Mean-Square Potentials or Currents

Often, when measuring potentials and currents in AC circuits that vary sinusoidally with time, it is more convenient to deal with an average potential or current than the amplitude (the peak positive or negative value) over a cycle. A simple average is not useful, however, because it is always zero; that is, the values are positive for half the cycle and negative for the other half. The most useful “average” quantity that can be used is the *root-mean-square* (rms) potential or current. This is defined as the square root of the average of the squares. Because the square of a quantity, whether negative or positive, is always positive, the rms value over a cycle is nonzero. It can be shown that the rms value of a sinusoidally varying quantity is equal to the amplitude divided by the square root of two (approximately 0.707 times the amplitude). When it is said that the line voltage for electric service in the United States is 120V, an rms value is implied; the amplitude of the voltage variation is actually  $\pm 170$  V. Similarly, the rating of a fuse or circuit breaker is an rms current rather than current amplitude.

### Key Points

- Root-mean-square values of potential and current are more commonly used than amplitudes.
- Root-mean-square values are the square root of the average of the squares over an entire cycle.
- An rms value is approximately 0.707 times the amplitude.

## Calculation of Reactance

In general, impedance ( $Z$ ) is made up of three parts: the resistance ( $R$ ), the reactance of the capacitor ( $X_C$ ), and the reactance of the inductor ( $X_L$ ). *Reactance*, which is measured in ohms, is the opposition that a capacitor or inductor offers to the flow of AC current; it is a function of frequency.

The reactance of a capacitor is inversely proportional to the frequency and the capacitance ( $X_C = 1/2\pi fC$ ). Thus, it is least at high frequencies, becomes progressively greater at lower frequencies, and is infinite at zero frequency (DC), because an ideal capacitor uses a perfect insulator between the plates that is not capable of carrying any direct current. (The only reason a capacitor appears to conduct AC current is that AC current is constantly reversing direction; the capacitor in this case is merely being charged, discharged, and charged again in the opposite polarity [Fig. 1–5].) The reactance of an inductor is directly proportional to the frequency and the inductance ( $X_L = 2\pi fL$ ). Thus, it is zero at zero frequency (DC) and increases progressively with increasing frequency. This happens because the effect of an inductor is to oppose changes in current, and the more rapidly the current changes, the greater the induced EMF opposing that change will be.

### Key Points

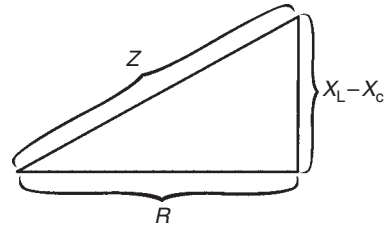
- Reactance is the opposition that a capacitor or inductor offers to the flow of AC current (measured in ohms).
- Reactance of a capacitor is inversely proportional to capacitance and frequency.
- Reactance of an inductor is directly proportional to inductance and frequency.

## Calculation of Impedance and the Phenomenon of Resonance

After the reactances and resistances have been calculated, the impedance is calculated as follows:

$$Z = \sqrt{R^2 + (X_L - X_C)^2}$$

The right triangle shown in Figure 1–7 (with impedance  $Z$  being the hypotenuse) symbolizes in geometric form the relationship among



**Figure 1–7.** A right triangle symbolizing the relationship among resistance ( $R$ ), inductive and capacitive reactance ( $X_L - X_C$ ), and impedance ( $Z$ ).

impedance, resistance, and reactance. Note that the capacitive reactance  $X_C$  is *subtracted* from the inductive reactance  $X_L$  in calculating impedance. This, together with the frequency dependence of the reactances described above, leads to an important phenomenon in AC circuits: there is always one frequency at which the impedance of an LRC circuit is a minimum. This frequency may be calculated by setting  $X_C = X_L$ , because when this is true, impedance  $Z$  equals resistance  $R$  (the smallest possible value). It may be shown by this method that the frequency at which impedance is a minimum is exactly equal to the frequency of oscillations of the LC or LRC circuit without an AC generator (the frequency of the circuit shown in Fig. 1–5). This can be restated as follows: when an LRC circuit is driven by an AC source of EMF, the largest current flow occurs when the frequency of the driving EMF is exactly equal to the natural, or resonant, frequency of the circuit. The current flow at driving frequencies above or below the resonant frequency is less; that is, the impedance of the circuit is greater. This phenomenon is known as *resonance*; it is exploited in tuner circuits to select a signal of one particular frequency (i.e., one broadcast station) and to reject signals of all other frequencies. Similar circuits can be used as narrow band-pass filters to eliminate all but a narrow range of frequencies from a signal or as notch filters to eliminate a narrow range of frequencies from a signal.

### Key Points

- Impedance in an LRC circuit depends on resistance, capacitive reactance, and inductive reactance.
- A right triangle symbolizes in geometric form the calculation of impedance;



the difference in inductive and capacitive reactance is on one side and the resistance is on the other side of the triangle.

- The impedance is the hypotenuse of the triangle.
- There is a particular frequency at which the impedance of an LRC circuit is a minimum.

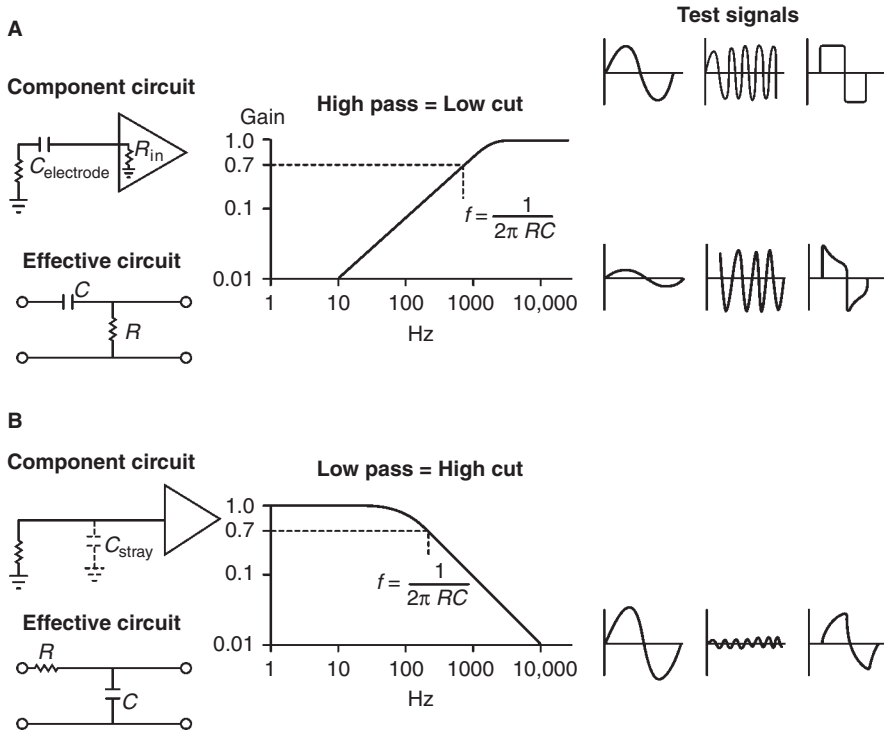
## FILTER CIRCUITS

### High-Pass Filters

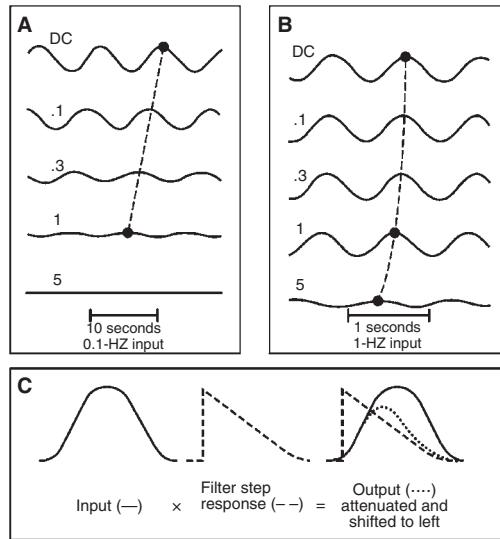
Figure 1–8A shows a simple high-pass (low-frequency) filter circuit, which consists of a capacitor  $C$  in series with and a resistor  $R$  in parallel with the output circuit. The input potential  $V_{in}$  is applied between the input terminal and ground, and the output potential  $V_{out}$  is developed across the resistor  $R$ . This circuit may be analyzed in two ways. First, it may be treated as an RC circuit similar to that shown in Figure 1–3, with the input potential  $V_{in}$  taking

the place of the battery EMF. The output potential  $V_{out}$  is proportional to the current  $i$  in the circuit. This decreases exponentially to zero with time constant (TC) equal to  $RC$  when the input potential is “turned on” and the capacitor charges, and it becomes negative and decreases exponentially when the input potential is “turned off” and the capacitor discharges. This accounts for the shape of the output in response to a square-wave calibration pulse.

Alternatively, one can imagine applying a sinusoidal AC potential to the input of this filter circuit. The current  $i$  is then equal to the input potential divided by the impedance  $Z$  of the circuit, which can be calculated from the resistance and capacitive reactance. When the formula for impedance given earlier is used, the ratio of the output to the input potential  $V_{out}/V_{in}$  can be calculated as a function of frequency  $f$ . The calculation shows that the output is strongly attenuated at low frequencies (when  $f$  is near zero) but is essentially equal to the input at high frequencies (when  $f$  is large). The cut-off frequency  $f$  of the high-pass filter is usually specified as the frequency at which the



**Figure 1–8.** A, A high-pass (low-frequency) filter circuit. B, A low-pass (high-frequency) filter circuit. C, Capacitor; R, resistor; TC, time constant. The effects on square waves and on EMG signals are shown to the right.



**Figure 1-9.** A high-pass filter shifts the latency of lower frequency waveforms more than higher frequency. Note the greater effect on the 0.1-Hz waveform than on the 1.0-Hz waveform.

attenuation factor  $V_{out}/V_{in}$  is one divided by the square root of two, or 0.707; this occurs when  $f = 1/2\pi RC$ . Equivalently, the time constant of the filter is given by  $1/2\pi f$ , where  $f$  is the filter cut-off frequency.

High-pass filters can alter waveforms by shifting the phase. The phase shift or time delay is more prominent with lower frequency inputs. (Fig. 1-9).

### Key Points

- A high-pass (low-frequency) filter circuit is an RC circuit with the capacitor in series and the resistor in parallel.
- The shape of a square-wave calibration pulse after high-pass filtering is determined by the behavior of the RC circuit.
- By calculating the impedance of the filter circuit, the filter output in response to a sinusoidal input can be found.
- The output is attenuated at low frequencies but is nearly equal to the input at high frequencies.
- The cut-off frequency of the filter (at which the attenuation factor is 0.707) is  $1/2\pi RC$ .

### Low-Pass Filters

Figure 1-8B shows a simple low-pass (high-frequency) filter circuit, which consists

of a resistor  $R$  in series with and a capacitor  $C$  in parallel with the output circuit. This is also an RC circuit, but the output potential  $V_{out}$  in this case is developed across the capacitor and is proportional to the charge on the capacitor. Comparison with Figure 1-4 shows that the output potential increases exponentially to a maximum with TC equal to RC when the input potential is “turned on” and the capacitor charges, and it decreases exponentially when the input potential is “turned off” and the capacitor discharges. This accounts for the shape of the output in response to a square-wave calibration pulse. In practice, the time constant of a high-frequency filter is discussed less often than that of a low-frequency filter, because it is much smaller, for example only 2 ms for a 70-Hz filter, and cannot be measured on electroencephalographic (EEG) tracings made at standard paper speeds by visual inspection of the calibration pulse.

This filter circuit can also be analyzed in the context of a sinusoidal AC input potential. The output potential  $V_{out}$  is equal to the current flow times the capacitive reactance  $X_C$  (the equivalent of Ohm’s law for a capacitor, with reactance substituting for resistance in an AC circuit), and the current  $i$  is equal to the input potential  $V_{in}$  divided by the total impedance  $Z$ , which is the same as before. When the formula for impedance given earlier is used, the ratio of the output to the input potential  $V_{out}/V_{in}$  can



be calculated as a function of frequency  $f$ . The calculation shows that the output is attenuated at high frequencies but becomes nearly equal to the input at low frequencies. The cut-off frequency  $f$  of the low-pass filter is usually specified as the frequency at which the attenuation factor  $V_{\text{out}}/V_{\text{in}}$  is one divided by the square root of two, or 0.707; this occurs when  $f = 1/2\pi RC$ , as for the high-pass filter.

Note that the only essential difference between a high-pass filter and a low-pass filter is the source of the output potential (to be fed to the amplifier); the high-pass filter develops its output potential across the resistor  $R$ , whereas the low-pass filter develops its output potential across the capacitor  $C$ .

### Key Points

- A low-pass (high-frequency) filter circuit is an RC circuit with the resistor in series and the capacitor in parallel.
- The shape of a square-wave calibration pulse after low-pass filtering is determined by the behavior of the RC circuit.
- By calculating the impedance of the filter circuit, the filter output in response to a sinusoidal input can be found.
- The output is attenuated at high frequencies but is nearly equal to the input at low frequencies.
- The cut-off frequency of the filter (at which the attenuation factor is 0.707) is  $1/2\pi RC$ .

## TRANSISTORS AND AMPLIFIERS

### Semiconductors and Doping

Transistors are constructed of materials called *semiconductors*, which have resistivities intermediate between those of good conductors (such as metals) and insulators (most non-metals). Silicon and germanium are the most frequently used substances. They are very poor conductors when in pure form, but when *doped* with trace quantities of elements capable of acting as electron donors or acceptors, they become semiconductors. The resistivity of the semiconductor can be altered by controlling the doping process.

Doping the tetravalent base material, silicon or germanium, with a pentavalent element

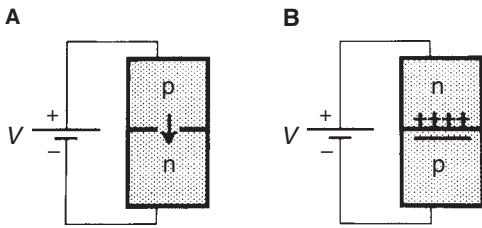
such as arsenic provides extra “free” electrons that can conduct an electric current. Because these electrons carry negative charge, the semiconductor that results is referred to as an *n-type semiconductor*. Alternatively, the base material can be doped with a trivalent element such as gallium. An absence of sufficient electrons to fill all of the orbitals is the result; the unfilled, or electron-deficient, areas are called *holes*, and they behave as positive charges that are free to move and, thus, conduct a current. The resulting semiconductor is referred to as a *p-type semiconductor*. (What actually happens is that electrons from a neighboring atom move to fill in the hole, resulting in a hole moving to a new position.) Thus, n-type semiconductors have electrons available for conducting current, whereas p-type semiconductors have holes (a potential space for electrons) available for conducting current.

### Key Points

- Transistors are made of semiconductors such as silicon and germanium doped with trace quantities of other elements.
- N-type semiconductors have extra “free” electrons that act as negative charges to conduct current.
- P-type semiconductors have an absence of sufficient electrons to fill all orbitals (“holes”) that act as positive charges.

## Diodes and Rectification

A useful electronic device can be made when two or more dissimilar semiconductors are adjacent. When an n-type semiconductor slab is fused along one face with a p-type semiconductor, electrons diffuse from the n region to the p region, filling some of the empty holes of the p region, up to the point at which the relative attraction of the holes for electrons is exactly counterbalanced by the effect of the electric field set up between the regions by the migration of electrons. This leaves the p region with a net negative charge and the n region with a net positive charge. If such a device is connected in a circuit to a source of EMF with the positive potential applied at the p region, a process called *forward biasing*, the electric field across the junction is reduced and further migration of electrons from n to p occurs,



**Figure 1-10.** A, A forward-biased pn semiconductor junction permits current flow. B, A reverse-biased junction prevents current flow. V, Potential across the semiconductor junction. (From Misulis, K. E. 1989. Basic electronics for clinical neurophysiology. *Journal of Clinical Neurophysiology* 6:41–74. By permission of the American Clinical Neurophysiology Society.)

which constitutes a current flowing (by convention) from the p to the n terminal (Fig. 1-10). If, however, the positive potential is applied at the n region, a process called *reverse biasing*, the electric field across the junction is actually increased and current flow is blocked, because in the region of the junction, the electrons that would carry current in the n region have been depleted and the “holes” that would carry current in the p region have also been filled.

This type of device is called a *diode*; it allows current flow only in one direction. If a sinusoidal AC potential is applied to such a device, *rectification* results—the current flow is pulsatile but constrained to a single direction. This is the first step that occurs in power supply circuits that convert AC line voltage to DC voltages suitable for use in most electronic circuits.

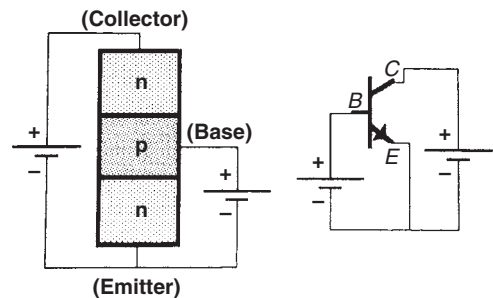
### Key Points

- Joining an n-type to a p-type semiconductor creates a diode.
- A diode allows current flow only in one direction.
- A diode “rectifies” an AC potential (the first step in converting AC to DC for use in electronic circuits).

## Transistors and Amplification

A *transistor* is a device that controls the transfer of electric charge across a resistor. Junction bipolar transistors (the most common type) can be made in two forms called *nnp* and *pnp*. Both are composed of a three-layer sandwich of semiconductors of different types. The

names *nnp* and *pnp* refer to the types of semiconductors and their order in the sandwich; npn transistors, for example, have a positively doped material in the middle layer and negatively doped materials in the outer layers. In an npn transistor, the primary movement of electrons is from one of the outer layers (the *emitter*), which is connected to the negative terminal of an external battery or power supply, to the other outer layer (the *collector*), which is connected to the positive terminal, through the middle layer (the *base*). Under resting conditions, little current flow occurs, because although the emitter–base np junction is forward biased and can conduct current, the base–collector pn junction is reverse biased and blocks current (Fig. 1-11). However, if a small positive potential is applied to the base through an external connection, the junctional electric field at the base–collector pn junction is reduced, because some electrons entering the p-type base are allowed to leave through the external connection, preventing the filling of holes in the base. This allows a continuous movement of electrons from the emitter through the base into the collector. The middle, or base, layer is very thin, so that even a small positive potential applied to the base is sufficient to facilitate a large conductance between collector and emitter. Thus, a small controlling voltage across base and emitter governs the flow of a much larger current through the collector-to-emitter circuit. This, in effect, is the basis of an electric amplifier.



**Figure 1-11.** An npn junction bipolar transistor showing the potential applied between the emitter, E, and base, B, that controls the flow of current between the emitter and the collector, C. The figure on the right shows the circuit, using the conventional symbol for the transistor (From Misulis, K. E. 1989. Basic electronics for clinical neurophysiology. *Journal of Clinical Neurophysiology* 6:41–74. By permission of the American Clinical Neurophysiology Society.)

Because the gain, or amplification, of a single transistor is limited, multiple stages of amplification are used in an EEG or electromyographic (EMG) machine. For example, six stages of amplification, each with a gain of 10, give an overall amplification factor of 1,000,000. A complete EEG or EMG amplifier contains preamplification stages, which typically boost the signal from the patient by a factor of 10 to 1000, followed by low-frequency, high-frequency, and 60-Hz notch filter circuits, followed by driver amplification stages that provide the remaining amplification and produce an output signal capable of driving the oscilloscope display or the pen motors of the paper display unit or the analog-to-digital converter in a digital instrument.

**Key Points**

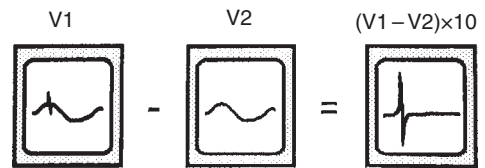
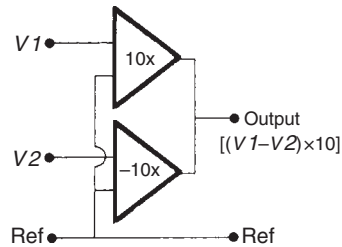
- A transistor is a solid-state device that controls the transfer of electric charge across a resistor.
- Junction bipolar transistors are a three-layer sandwich of semiconductors of different types (npn or pnp).
- The outer layers are the emitter and the collector, while the thin middle layer is the base.
- A small controlling voltage applied to the base governs the flow of a much larger current from collector to emitter.
- This is the basis of an electronic amplifier.
- Multiple stages of amplification are used to achieve an overall gain of many orders of magnitude.

**Differential Amplifiers**

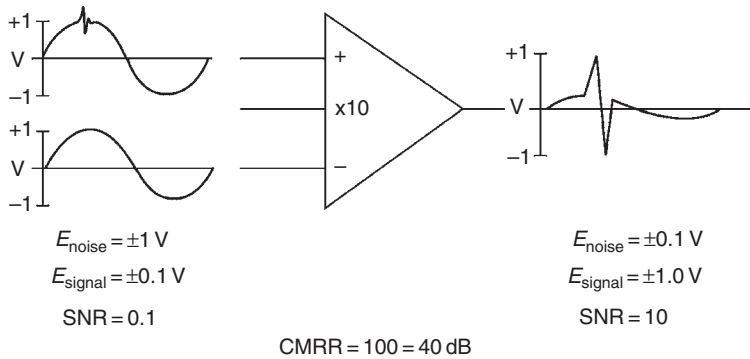
The type of amplifier used predominantly in clinical neurophysiology is the *differential amplifier*. This type of amplifier is constructed to amplify only the *difference* in the potential between its two inputs. This is one way of reducing contamination of the physiologic signal by electrical noise—for example, 60-Hz noise from line voltage devices—because this noise tends to be the same at all electrode positions and cancels out when a difference in potential is formed. Physiologic signals, on the other hand, are usually different at different electrode positions.

A differential amplifier is actually composed of two amplifier circuits (two transistors), one for the *G1* input and one for the *G2* input (the nomenclature *G1* and *G2* is still in common use, even though it originated in the early days of EEG and EMG when vacuum tube amplifiers were used; *G* was used to indicate a *grid* in the vacuum tubes). The *G2* transistor is connected to a negative power supply voltage, and the *G1* transistor is connected to a positive power supply voltage. The outputs of both transistors are connected together (Fig. 1–12). In this fashion, increased current flow in the emitter-to-collector circuit of the *G1* transistor produces a positive change in the output potential, whereas increased current flow in the emitter-to-collector circuit of the *G2* transistor produces a negative change in the output potential.

Although an ideal differential amplifier would be sensitive only to the difference in potential between the two inputs, in practice, a large enough signal applied to both inputs simultaneously, called *common mode*, produces a small output signal (Fig. 1–13). This occurs because the input impedance and the gain and frequency response of the two transistors in the differential amplifier are not



**Figure 1–12.** A differential amplifier constructed from two single-ended amplifiers, with input potentials *V1* and *V2* with respect to the reference (Ref), the second of which produces an inverted output; the net output is given by the product of the amplifier gain (10 in this case) and the difference in potential between the two inputs (From Misulis, K. E. 1989. Basic electronics for clinical neurophysiology. *Journal of Clinical Neurophysiology* 6:41–74. By permission of the American Clinical Neurophysiology Society.)



**Figure 1-13.** A differential amplifier with a small signal on one input and a large artifactual signal on both inputs. The small signal is amplified while the large signal is reduced, but the common mode rejection is not sufficient to totally eliminate the large signal.

quite identical. The common mode rejection ratio (CMRR) of a differential amplifier can be calculated as the applied common input potential divided by the output potential.<sup>2</sup> For modern amplifiers, this ratio is approximately 10,000. However, if the electrode impedances are high or differ significantly between the *G1* and the *G2* inputs, the effective signal perceived by the two transistors in the differential amplifier can differ significantly and the CMRR can be drastically reduced, thus allowing significant amounts of noise to contaminate the signals being recorded.

Even though the differential amplifier output depends on the difference in the potentials at its two inputs, each input potential as perceived by the amplifier is relative to a common reference, or *ground*, potential. This ground potential is in practice equal to the potential at a single ground electrode that must be attached to the patient. For example, the ground electrode for EEG recording is typically placed on the mastoid process; occasionally other locations, such as the frontal area, are used. As long as the electrode-to-patient connections are adequate (i.e., have low enough impedance), the location of the ground electrode does not matter. Because each input of the differential amplifier receives a potential that is relative to the same ground and these potentials are subtracted in the output, the potential of the ground electrode cancels out. However, if there is a very poor (i.e., one with high impedance) electrode connection or, in the extreme case, if an electrode is left unconnected, the differential amplifier

input effectively becomes the ground electrode potential. In addition to introducing more 60 Hz and other noise into the recorded signal, artifacts and mislocalization of cerebral electric activity can result by the unexpected introduction of a signal coming from an EEG ground electrode into one or more channels.

### Key Points

- Predominantly differential amplifiers are used in clinical neurophysiology.
- They amplify only the difference in potential between two inputs, reducing contamination by electrical noise.
- A differential amplifier has two transistor amplifier circuits connected to opposite-polarity power supply voltages.
- Slight differences in the two transistors cause some output when a large signal reaches both inputs simultaneously.
- CMRR is the ratio of the common input potential to the output potential.
- If one input of a differential amplifier is of very high impedance, the ground electrode becomes the input.

### SUMMARY

This chapter reviews the basic principles of electric and electronic circuits that are important to clinical neurophysiology. Knowledge of these basic principles and how to solve simple circuit problems is necessary for a complete understanding of the proper operation

of equipment used in clinical neurophysiology and of the terminology and specifications given in equipment manuals.

### **Circuit definitions**

- Resistance—opposition to direct current flow; ratio of potential (voltage) to current.
- Conductance—ability to conduct direct current; ratio of current to potential (voltage).
- Capacitance—ability to store charge; ratio of charge to potential (voltage).
- Inductance—ability due to magnetic effects to produce a potential when current changes; ratio of potential (voltage) to rate of current change.
- Reactance—opposition to alternating current flow by capacitance or inductance; ratio of potential (voltage) to AC current in a capacitor or inductor.
- Impedance—net opposition to current flow by both resistance and reactance; ratio of potential (voltage) to current in an AC circuit.

### **Filter characteristics**

- High-pass filter—attenuates signals at low frequency while leaving high-frequency signals unchanged.
- Low-pass filter—attenuates signals at high frequency while leaving low-frequency signals unchanged.
- Cut-off filter frequency—frequency at which there is a 30% attenuation in signal amplitude.
- Filter phase shift—Time delay (latency change) caused by a filter, especially affecting low-frequency components of a signal.
- Filter time constant—resistance times capacitance, inversely related to the cut-off filter frequency.

### **REFERENCES**

1. Halliday, D., and R. Resnick. 1962. *Physics. Part II. Rev.*, 2nd ed. New York: John Wiley & Sons.
2. Misulis, K. E. 1989. Basic electronics for clinical neurophysiology. *Journal of Clinical Neurophysiology* 6:41–74.

## Chapter 2

---

# Electric Safety in the Laboratory and Hospital

*Terrence D. Lagerlund*

### **INTRODUCTION**

#### **ELECTRIC POWER**

##### **DISTRIBUTION SYSTEMS**

#### **ELECTRIC SHOCK**

Requirements for Electric Current to Flow Through the Body

Physiologic Effect of Electric Current

Factors Reducing Risk of Electric Shock

Factors Increasing Risk of Electric Shock in Hospitals

#### **LEAKAGE CURRENT**

Origin

Methods by Which Leakage Current Reaches Patients

Methods to Reduce Leakage Current Reaching Patients

### **ELECTRIC SAFETY PRINCIPLES AND IMPLEMENTATION**

Equipment Grounding

Tests for Equipment Grounding and Leakage Current

Rules for Electric Safety

Electric Safety Procedures for Technicians

### **ELECTRIC STIMULATION SAFETY**

Stimulating Near Pacemakers and Other Implanted Electrical Devices

Transcranial Electrical and Magnetic Stimulation

Therapeutic Cortical and Deep Brain Stimulation

### **SUMMARY**

### **INTRODUCTION**

The principles of electrical safety are of great importance in clinical neurophysiology. All of the electrophysiologic studies that are performed require the application of electrical connections to equipments that, through connections with the patient, pass small amounts of electrical current to the patient. Although small, there is always an inherent risk to the

tissue through which current passes. This chapter discusses the concepts of electrical safety in clinical neurophysiology.

### **ELECTRIC POWER DISTRIBUTION SYSTEMS**

The electric systems of buildings are designed to distribute electric energy from one central



point of entrance to all the electric appliances and receptacles. Power companies provide electric energy at high voltage (typically 4800 or 4160 V for a hospital or medical clinic) to minimize transmission losses. A step-down transformer converts the high-voltage energy to safer, usable voltages (usually 120 and 240 V). Figure 2-1 shows the wiring of a typical 120 V circuit. The secondary coil of the transformer has a center tap that acts as the return path (“neutral”) for the circuit; it is connected to earth ground through a grounding stake at the electrical junction site. Each of the two outer ends of the 240 V secondary coil can be used to drive one 120 V circuit; this provides a *hot line* whose potential is 120 V from ground. This hot line incorporates a circuit breaker that limits current flow to a level (e.g., 20 A) that will not cause excessive heating in wiring in the building. For reasons explained later, each receptacle also includes a ground contact connected to earth ground through a conductor separate from the “neutral” conductor (see Fig. 2-1).

**Key Points**

- Electric power for a building is distributed from a step-down transformer to wall outlets and lighting.

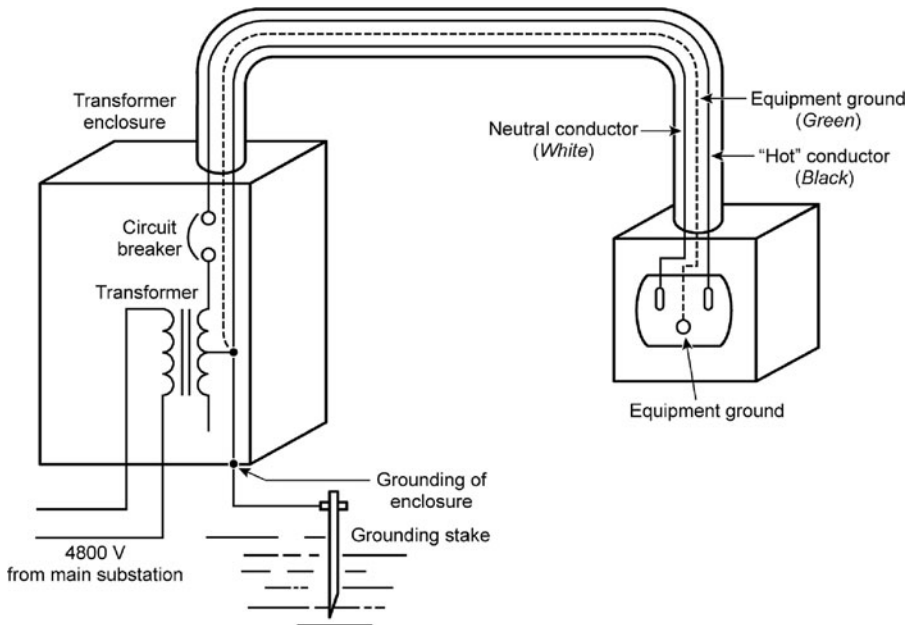
- A “neutral” wire acts as the return path and is connected to earth ground.
- A “hot” wire carries 120 or 240 V electricity to lights and appliances.
- An equipment ground wire provides a separate pathway to ground from the “neutral” wire.

**ELECTRIC SHOCK**

Electric shock is the consequence of the flow of current through the body. The effect of electric shock depends both on the magnitude of the current flow and the path taken by the current in the body, which is determined by the points of entry and exit.

**Requirements for Electric Current to Flow Through the Body**

When an externally generated current flows through the body, it has a point of entrance and a point of exit. The current may be thought of as originating from some electric apparatus, or source, flowing through a conducting material from the apparatus to the body, flowing



**Figure 2-1.** Scheme of a building’s electric power distribution system showing a step-down transformer, circuit breaker, grounding stake, and a third wire for equipment grounding in the conduit. (From Cromwell, L., F. J. Weibell, and E. A. Pfeiffer.1980. *Biomedical Instrumentation and Measurements*, 2nd ed., 437. Englewood Cliffs, NJ: Prentice-Hall. By permission of the publisher.)

through the body, and finally flowing through a second conducting material from the body to *ground*. Thus, to have an electric shock, there must be at least two connections to the body: one to the current source and the other to ground. An apparatus can act as a source of current either (1) because a point of connection between it and the body, such as an exposed metal part of the chassis or other metal contacts or terminals, is in direct continuity with the hot line through a very low resistance path caused by some fault such as a mechanical break in insulation or fluid spilled into the circuit or inadvertent direct connection of electrode lead wires to energized, detachable power-line-cord plugs<sup>1</sup> or, more commonly, (2) because of a low-level leakage of current through a moderate resistance path, which may be inherent in the design of the apparatus. A further requirement for significant electric shock is that the entire pathway to, through, and out of the body must have a sufficiently low resistance for normal line voltage to be hazardous.

An additional requirement for a lethal electric shock is that the current must take a path through the body that includes the heart (e.g., when current enters through one arm and exits through the other), because the mechanism of lethal shock is almost invariably the induction of ventricular fibrillation.

### Key Points

- Current flow through the body requires a point of entry (current source) and a point of exit (any ground connection).
- The current source is usually leakage from internal circuitry to the chassis or other metal contacts or terminals.
- For an electric shock to be lethal, the current must take a path through the body that includes the heart.

## Physiologic Effect of Electric Current

For currents that enter and leave the body through the skin, the usual situation outside of hospitals, Figure 2–2 shows the approximate amounts of current associated with various physiologic effects, ranging from minimal perception (0.5–1 mA) to severe burns and physical injury (6–10 A). Because current flow in a limb leads to involuntary muscle contraction

through direct depolarization of muscle fibers, a victim of electric shock may not be able to let go of the source of the current when it exceeds about 10–20 mA. The threshold for induction of ventricular fibrillation is approximately 100 mA. The externally applied current spreads out as it passes through the body, so that the fraction passing through the heart is small, less than 0.1% in most situations depending on entry and exit points.

In hospitals, one of the two required contacts between an external source or ground and the body may be an intracardiac catheter. If current enters or leaves through this device, essentially the entire current flows through the myocardium. In this case, the threshold for inducing ventricular fibrillation is far less than for externally applied current. In humans, this threshold is estimated to be approximately 50  $\mu$ A, but experiments in dogs have shown that as little as 20  $\mu$ A is sufficient.<sup>2</sup> Furthermore, the results of a recent study have suggested that the threshold for induction of cardiovascular collapse (which is less than the threshold for inducing ventricular fibrillation) is the more relevant quantity, and this threshold is only 20  $\mu$ A.<sup>3</sup> The threshold may be significantly lower in persons with preexisting heart disease.

### Key Points

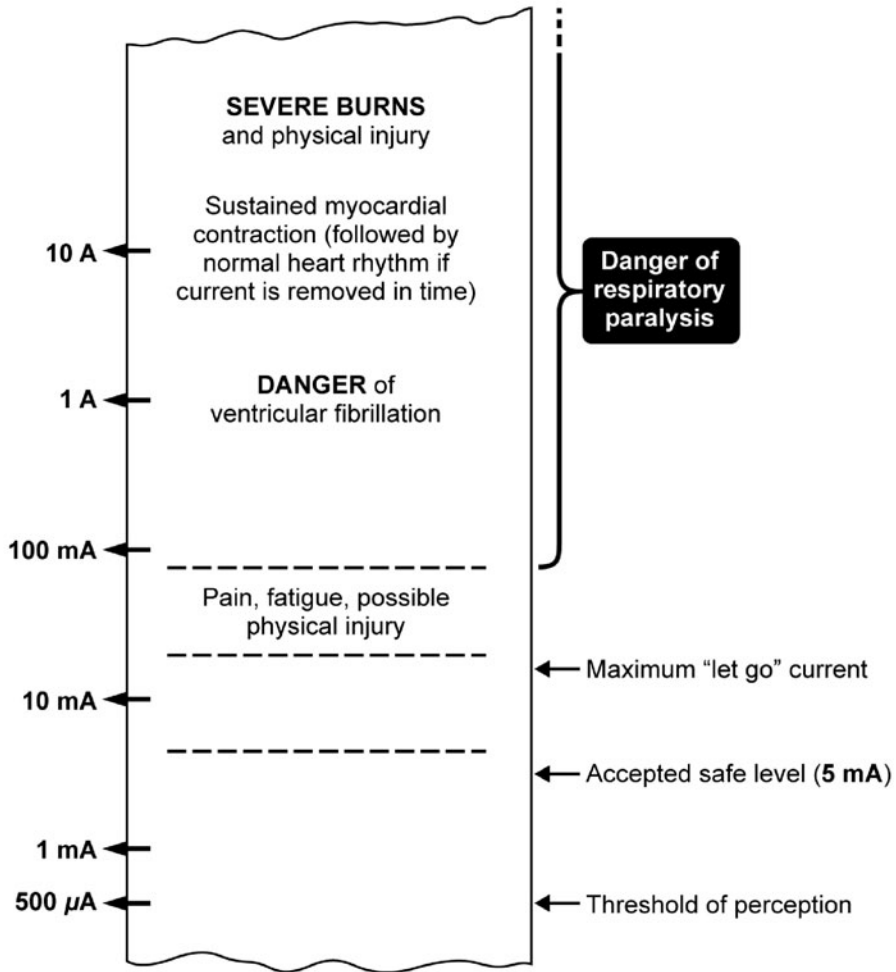
- Electric currents below 0.5–1 mA cannot be perceived.
- Currents over 20 mA lead to involuntary muscle contraction, making it impossible to let go of the source of current.
- Externally applied currents over 100 mA may cause ventricular fibrillation.
- Currents as small as 20–50  $\mu$ A entering the heart through an intracardiac catheter may cause ventricular fibrillation.

## Factors Reducing Risk of Electric Shock

The risk of electric shock or electrocution from appliances is reduced by several factors, including the following:

1. Leakage currents that are available from most electric appliances are relatively small.
2. People using appliances are often not connected to ground.





**Figure 2-2.** Effects of 60 Hz AC electric current flow of various magnitudes produced by a 1-second external contact with the body. (From Cromwell, L., F. J. Weibell, and E. A. Pfeiffer.1980. *Biomedical instrumentation and measurements*, 2nd ed., 434. Englewood Cliffs, NJ: Prentice-Hall. By permission of the publisher.)

- 3. Contacts with the source of leakage current and with ground usually have high resistance, for example, dry, intact skin.
- 4. Healthy, alert people can withdraw from a source of current in most cases.
- 5. The hearts of healthy people require significant electric currents to induce ventricular fibrillation.

significantly greater because of the following factors:

- 1. Leakage currents that may be available from appliances are relatively large because patients may be attached to many instruments (thus providing multiple current sources), conducting fluids may get into instruments through spillage or leakage, and instruments may be used by many persons or used in many locations (or both), thus increasing the chance of fault caused by misuse or wear. In the operating room, instruments such as electrosurgical units may present special risks to the patient if proper

### Factors Increasing Risk of Electric Shock in Hospitals

The risk of electric shock or electrocution from appliances in hospitalized patients is

precautions for electric safety are not followed.<sup>4,5</sup>

2. Through attached electric instruments, patients are often grounded or they may easily contact grounded objects, for example, metal parts of beds, lamps, and instrument cases.
3. Contacts with the source of leakage current and with ground are often of low resistance because connections to monitoring devices purposely minimize skin resistance (e.g., electrodes applied with conducting paste) or bypass it altogether (e.g., indwelling catheters). Furthermore, patients with conductive intracardiac catheters, such as pacemaker leads and saline-filled catheters, have a direct low-resistance pathway to the heart. Because only tiny currents flowing in such a path may induce lethal ventricular fibrillation, such patients are called “electrically susceptible.”
4. Weakened or comatose patients cannot withdraw from a source of current.
5. Patients’ hearts may be more susceptible (through disease) to electric current-induced ventricular fibrillation.

### Key Points

- The risk of electric shock from appliances is reduced by factors such as low leakage current, high resistance of contact with leakage current source, and ability to withdraw from source of current.
- Factors increasing the risk of electric shock include patient attachment to multiple instruments, contact with grounded objects, low-resistance contacts such as indwelling catheters, and patients with cardiac disease or those unable to withdraw from current source.

## LEAKAGE CURRENT

### Origin

One of the most important parameters in electrical safety is leakage current. This is an easy parameter to measure on biomedical instruments but is often misunderstood because there are multiple kinds of leakage current and the maximal value allowed for leakage current

varies by the class of the instrument and local governmental regulations. Leakage current in an electric apparatus may originate in several ways, including the following:

1. There is always a finite internal circuit resistance between the power line (hot wire) and the instrument chassis, known as *instrument ground*; this may be decreased by faults in the wiring or by breakdown of insulation. A resistance as large as 5 M $\Omega$  still allows 24  $\mu$ A to flow between the “hot” conductor and ground, which may be enough to induce ventricular fibrillation in an “electrically susceptible” patient.
2. The capacitance between the “hot” conductor and the chassis resulting from internal circuitry or external cabling may provide a relatively low-impedance pathway for alternating current. A capacitance as small as 440 picofarad (pF) still allows 20  $\mu$ A to flow between the “hot” conductor and ground.
3. The inductive coupling between power-line circuits and other circuit loops, such as ground loops when there are multiple ground connections to the patient, can induce ground-path current flow as well. In addition to the leakage currents available from equipment-to-patient ground connections, leakage currents may be introduced by similar mechanisms into other leads or connections to the patient.

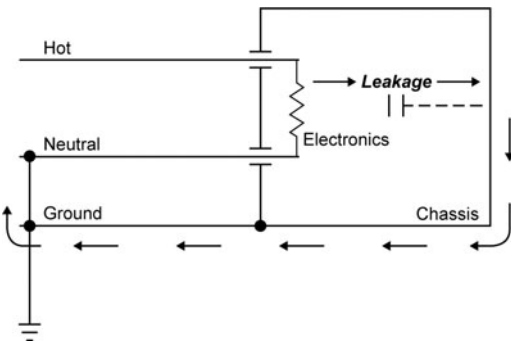
### Methods by Which Leakage Current Reaches Patients

Leakage currents may reach patients when contact is made either directly or through another person to exposed metal parts or to the chassis of electric equipment. Leakage currents may also reach patients through a direct connection of the chassis (*equipment ground*) to the patient; in the past such a direct *patient ground* connection was made to reduce noise in recording of physiologic signals. Finally, leakage currents may reach patients through resistive or capacitive (or possibly inductive) coupling to leads other than the patient ground.

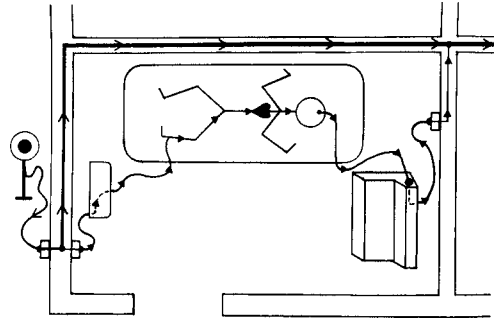
## Methods to Reduce Leakage Current Reaching Patients

Many methods are used in modern hospital electric distribution systems and in biomedical instruments to decrease the risk of electric shock by reducing the available leakage currents, including the following:

1. The chassis and all exposed metal parts of electric appliances are grounded through a separate ground wire, through the round pin of electric plugs. Any leakage currents that would otherwise flow to a subject in contact with the chassis are instead shunted through this low-resistance pathway to ground. Because the leakage currents in properly functioning equipment are small, the ground wire in the building's power distribution system usually carries very little current, unlike the neutral wire, which carries the full operating current. Hence, the potential drop between the equipment chassis and the earth ground connection located at the electric distribution panel of the building is minimal, and the equipment ground potential remains very close to the earth ground potential (Fig. 2-3).
2. Hospital rooms that have exposed metal parts, for example, window frames, bathroom plumbing, shelving, and door frames, may also connect these to earth ground through the same grounding system used for electric outlets. All such grounded



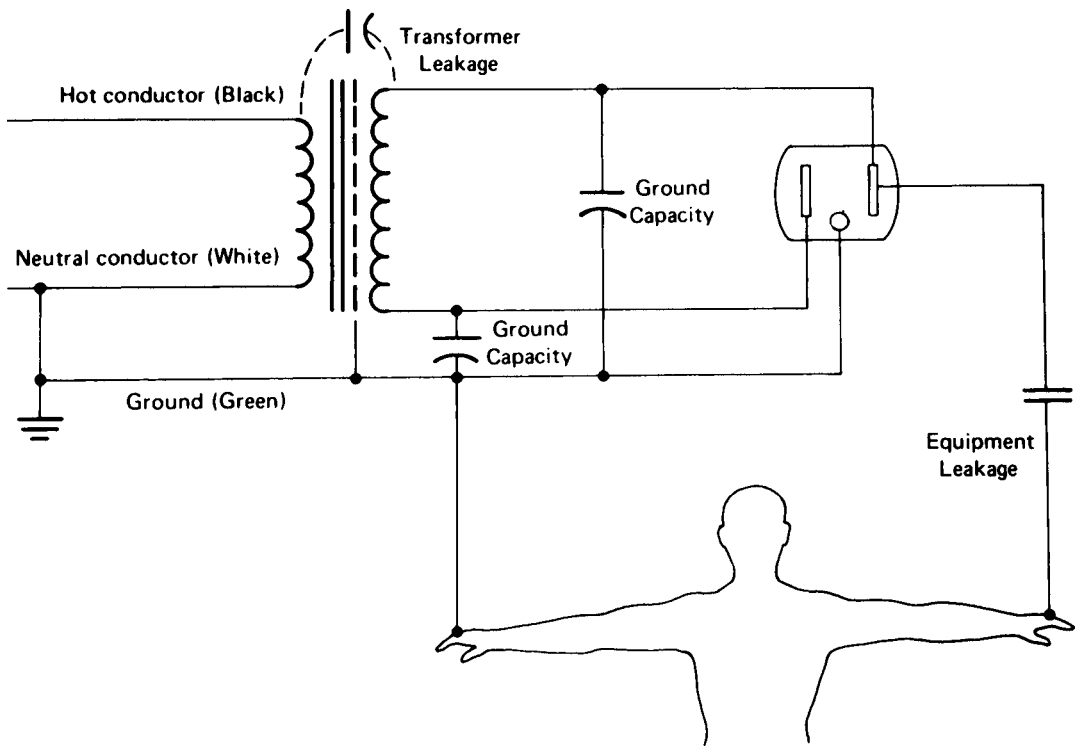
**Figure 2-3.** The power cord ground wire conducts leakage current from an electric apparatus chassis to earth ground. (From Seaba, P. 1980. Electrical safety. *American Journal of EEG Technology* 20:1-13. By permission of the American Society of Electroneurodiagnostic Technologies.)



**Figure 2-4.** Excessive leakage current from a floor polisher flows through the building wiring to an EEG machine and an ECG monitor attached to the patient through different wall plugs. This ground loop was created by the use of two outlets physically distant from one other, producing a difference in the equipment ground potentials between the two outlets. (From Seaba, P. 1980. Electrical safety. *American Journal of EEG Technology* 20:1-13. By permission of the American Society of Electroneurodiagnostic Technologies.)

points in one room should be connected to a single ground wire, an *equipotential grounding system*. Also, all biomedical equipment connected to a patient should draw power from the same group of outlets to avoid large *ground loops* (Fig. 2-4).

3. When necessary, isolation transformers may be used to eliminate the neutral-to-ground connection entirely, thereby reducing the risk of shock when a patient connected to a biomedical instrument comes in contact with an earth ground (Fig. 2-5). However, isolation transformers do not eliminate entirely the risk of shock, because they may have significant leakage currents.
4. Appliances can be constructed with non-metallic cases to minimize the chances of patients contacting the equipment chassis.
5. Appliances should have short line cords, and the use of extension cords should be avoided to minimize capacitive and resistive leakage currents between the hot and the ground wires. Note that each foot length of cord unavoidably introduces about  $1 \mu\text{A}$  of leakage current into the ground connection.
6. Direct connections of patients to earth ground should be avoided. In particular, inadvertent electric paths between ground and patients that bypass the normally high skin resistance (especially



**Figure 2-5.** An isolation transformer used to reduce equipment leakage current. The equipment is connected to the secondary coil of the transformer, which is electrically isolated from the power line hot and neutral conductors. (From Cromwell, L., F. J. Weibell, E. A. Pfeiffer, and L. B. Usselman. 1973. *Biomedical instrumentation and measurements*, 387. Englewood Cliffs, NJ: Prentice-Hall. By permission of the publisher.)

paths provided by intracardiac catheters) should be avoided by using nonconductive materials.

7. Current that may flow through all connections between a patient and the equipment, both signal and ground, should be limited to no more than  $50\ \mu\text{A}$  ( $10\ \mu\text{A}$  for “electrically susceptible” patients, i.e., Type CF) through the use of current limiters or inductive or optical coupling devices. Alternatively, when practical, battery-powered equipment that has no direct connection to line voltage or to ground can be used.

### Key Points

- Leakage currents reach a patient through
  - Contact with equipment metal chassis
  - Connection of equipment ground to patient
  - Resistive or capacitive coupling to patient leads.

- Reduce leakage currents to a patient by
  - Battery-powered equipment
  - Avoid connection of patient to ground
  - Short line cords (no extension cords)
  - Ground all equipment metal chassis through a separate ground wire
  - Connect all equipment to same group of outlets
  - Equipotential grounding system
  - Limit current flow to patient to less than  $10\ \mu\text{A}$
  - Isolation transformer.

## ELECTRIC SAFETY PRINCIPLES AND IMPLEMENTATION

### Equipment Grounding

Proper grounding of electric equipment (i.e., providing a low-resistance pathway from the equipment chassis to an earth ground) is

usually accomplished through the grounding wire in the line cord that connects to the round pin in the plug and thence to the building's electric grounding system. Failure of this ground connection may occur in several ways. There can be a failure of attachment of the grounding wire in the line cord to the equipment chassis, a break in continuity of the grounding wire within the cord, or a failure of connection of the grounding wire to the grounding pin. Also, the grounding pin may make poor contact with the wall receptacle because of a reduction in contact tension caused by mechanical wear. The grounding pin can also be deliberately bypassed using a so-called cheater (3-prong to 2-prong) adapter. Defects also can occur in building wiring, such as an improper or omitted connection of the wall receptacle's grounding terminal to a ground wire or an interruption of the ground connection somewhere in the building's wiring. This is particularly likely if metal conduit, rather than a wire, provides the ground connection since conduit is subject to corrosion and loss of mechanical contact. Particularly in newly constructed or remodeled rooms and buildings, it is advisable to visually inspect and to electrically test the ground connection in all wall receptacles. Because the ground connection is only for electric safety purposes, the lack of it in no way affects operation of the electric equipment and, therefore, will remain undetected if not specifically checked.

### Key Points

- Grounding of electric equipment is accomplished by the grounding wire in the line cord and in the building wiring.
- Failures of grounding can occur at any step along the path from the equipment chassis to the earth ground.

### Tests for Equipment Grounding and Leakage Current

Each hospital, laboratory, or clinic should establish an electric safety program that includes selecting equipment that meets appropriate safety standards, testing new equipment after purchase to verify that standards are met, inspecting and retesting equipment periodically thereafter to ensure

that damage through use and misuse does not compromise safety, educating all those who use the equipment (especially technicians) in electric safety principles, and ensuring that certain basic minimal safety tests are performed each time a biomedical apparatus is plugged in, turned on, and connected to a patient.

Tests that should be performed on building wiring at the time of installation include the following:

1. Visually inspect the wiring of all wall receptacles to ensure that it is correct.
2. Measure the resistance between each wall receptacle ground (and other grounded objects in the room) and a ground known to be adequate, such as a cold water pipe or an independent grounding bus. This resistance should be less than  $0.1 \Omega$ .<sup>6</sup>
3. Measure the contact tension provided by the wall receptacle, that is, the force required to withdraw the ground pin of a test plug from the receptacle. This should be at least 10 ounces.
4. Test all outlets when first installed and periodically thereafter with an approved electrical tester that measures polarity and ground resistance.

These tests, except the first, should also be performed periodically, for example, every 6–12 months, and the receptacles whose contact tension has degraded below 10 ounces should be replaced. Tests that should be performed on each biomedical instrument at the time of purchase and periodically thereafter, for example, every 6–12 months, include the following:

1. Visually inspect the line cord and plug for signs of damage, wear, or breakage.
2. Measure the resistance between the ground pin of the plug and the instrument chassis. This should be less than  $0.1 \Omega$ .
3. Measure the chassis-to-earth ground (enclosure) leakage current using certified leakage meter. This measurement should be made with the equipment's grounding pin disconnected (to ensure safety even if the building grounding system is faulty) and under four separate conditions. This should include

both normal and reverse polarity of the hot and neutral wires (to ensure safety even if the wall receptacle is erroneously wired with opposite polarity) and with the equipment power switch “on” and “off.” In all four conditions, this current should not exceed  $100\ \mu\text{A}$  for normal operation (Type B, BF, CF applied parts) and  $500\ \mu\text{A}$  for single fault conditions.<sup>6</sup>

4. Measure the leakage current from each terminal that connects to a patient, including the patient ground to earth ground, under the same four conditions (patient leakage from applied part to earth ground). This is the maximal leakage current that the equipment can supply to a patient who is grounded through a second connection. For use with “electrically susceptible” patients, this current should not exceed  $100\ \mu\text{A}$  (Type B, BF applied parts) and  $10\ \mu\text{A}$  (Type CF applied parts) for normal operation and  $500\ \mu\text{A}$  (Type B, BF applied parts) and  $50\ \mu\text{A}$  (Type CF applied parts) for single fault conditions.<sup>6</sup>
5. Measure the leakage current from the power-line hot wire to each terminal that connects to a patient, including the patient ground, under the same four conditions (patient leakage via F-type applied part caused by external voltage on the applied part). This is the maximal current that can be absorbed by the equipment from a patient who accidentally comes in contact with a 120 V power line. For use with “electrically susceptible” patients, this current should not exceed  $100\ \mu\text{A}$  (Type B, BF applied parts) and  $10\ \mu\text{A}$  (Type CF applied parts) for normal operation and  $500\ \mu\text{A}$  (Type B, BF applied parts) and  $50\ \mu\text{A}$  (Type CF applied parts) for single fault conditions.<sup>6</sup>

### Key Points

- Each hospital, laboratory, or clinic should establish an electric safety program that includes selecting equipment that meets appropriate safety standards and testing new equipment after purchase to verify that standards are met.
- These tests should also be performed periodically, for example, every 6–12 months.

## Rules for Electric Safety

In addition to a program of periodic testing and inspection, electric safety requires that all persons using electric equipment in the laboratory or hospital are familiar with the following rules:

1. Do not ever directly ground patients or allow patients to come into contact with grounded objects while connected to a biomedical instrument. If an instrument does not meet UL 60601-1, EN/IEC 60601-1 Medical Electrical Equipment—Part 1 General Requirements for Safety and Essential Performance, then patient–ground connections should be made to only one instrument at a time.<sup>7</sup>
2. Ensure that every electric device or appliance, for example, lamps, electric beds, electric shavers, and radios, that a patient might accidentally come in contact with is connected to an adequate earth ground, such as through use of an approved three-prong or double-insulated grounded plug.
3. Use only safe, properly designed, and pretested electric equipment. All biomedical devices directly connected to patients must have isolation or current-limiting circuits if they are to be used with “electrically susceptible” patients. All line-powered equipment should have three-prong grounded plugs. In general, patients should not be allowed to bring their own electric appliances from home for use in a hospital room.
4. Ensure that all electric equipment in use has had a safety inspection done recently (within 6–12 months), as indicated by a dated electrical safety inspection tag or sticker.
5. Connect all patient-connected equipment to outlets in the same area or cluster to avoid large ground loops.
6. Never use an extension cord on patient-connected equipment because this adds leakage current through its internal capacitance and resistance and, thus, provides another chance for ground connection failure. In the operating room or situations with direct cardiac



connection, equipment should be tested before every use.

7. Cover all electric connections to intracardiac catheters with insulation to eliminate electric continuity between external devices or ground and the catheter whenever possible.
8. Have a defibrillator available at all building locations where patients have cardiac catheters in place.
9. Do not ignore the occurrence of any electric shocks, however minor; investigate their causes. Thoroughly test any equipment that may have been involved before putting it back into service. Also, do not ignore any abnormal 60 Hz interference or artifact in an electrophysiologic recording; this finding may indicate that some device is leaking current into the patient.
10. Follow certain safety procedures, including routine safety checks, each time an electric device is to be connected to a patient.

### Electric Safety Procedures for Technicians

The following procedures should be followed by technicians while performing an electrophysiologic test requiring line-powered equipment on a patient, especially portable studies performed in a patient's room:

1. Check the physical condition of the equipment. Is there any evidence of liquid spills, cord wear, or damage? Is the plug bent or broken? Is the equipment labeled with a current electric safety inspection sticker?
2. Inspect the patient area for any two-wire ungrounded appliances. Have them unplugged and removed.
3. Inquire about any other instruments attached to the patient. Are they labeled with a current electric safety inspection sticker?
4. Choose an outlet in the same area or cluster used by other patient-connected devices. Before plugging in the equipment, check the contact tension of the chosen receptacle with a simple device

that should be carried with all portable equipment.

5. Turn on the instrument and calibrate it before connecting it to the patient. Major electric problems may show up during calibration; furthermore, electric surges occur as the instrument is turned on and leakage currents may be higher while it is starting up.
6. Disconnect the patient from the instrument before turning it off or on.

### ELECTRIC STIMULATION SAFETY

In addition to the issues of electrical safety of all biomedical equipment discussed above that relate to the electrical supply voltage and leakage currents, clinical neurophysiology studies such as evoked potentials, nerve conduction studies, and transcranial electrical and magnetic stimulation studies, as well as therapeutic devices such as nerve, spinal cord, cortical or deep brain stimulators, involve stimulating neural tissue with electrical currents (or strong magnetic fields), which introduces additional safety considerations related to tissue damage from stimulation and effects on nearby implanted electrical devices such as pacemakers.

### Stimulating Near Pacemakers and Other Implanted Electrical Devices

Peripheral nerve stimulation has been in use for decades without risk or harm. Patients with pacemakers or implanted cardiac defibrillators are sometimes referred for nerve conduction studies and needle EMG. Potential risks, such as induction of ventricular or atrial fibrillation, alteration of pacing mode, or cardiac tissue damage from the electrical current, may result in limitation of performance of studies in these patients. However, in a small study of 10 patients with pacemakers or implanted cardiac defibrillators who underwent nerve conduction studies with stimulation at common sites, no abnormalities in the devices occurred and the electrical impulses generated during the studies were never detected by the sensing amplifier.<sup>8</sup>

## Transcranial Electrical and Magnetic Stimulation

Stimulation of brain, spinal cord, peripheral nerve, and muscle is being used increasingly for both diagnostic and therapeutic purposes. Stimulators are isolated from ground and routinely allow less than 300 V or 100 mA. Most stimulation is done with constant current rather than constant voltage to better assure similar local current flows, despite varying tissue impedance. Transcranial electric stimulation may be as high as 800 V to the scalp; the high impedance of the skull results in only small current flow reaching the brain. While current flow through neural tissue is low in all of these applications, safety considerations remain important.<sup>9</sup> Direct stimulation of the cortex for localization of motor cortex and other eloquent brain regions uses at most short trains of brief pulses that have been shown in animal models to have no deleterious effects.<sup>10</sup> More recent chronic deep brain stimulation therapy uses much longer, rapid trains of stimuli, but with very low current densities.<sup>11</sup>

Transcranial magnetic stimulation is widely used in Europe for diagnosis of demyelinating diseases with no safety issues other than institutional requirements.<sup>12</sup> Transcranial electric stimulation with trains of three to five pulses at up to 800 V has also been found to be safe and effective with only rare, minor complications such as scalp burns or masseter contraction.<sup>13</sup>

## Therapeutic Cortical and Deep Brain Stimulation

Deep brain stimulators have been used to treat a variety of movement disorders including essential tremor, Parkinson's Disease, and dystonia.<sup>14,15</sup> Such stimulators typically apply 100-200 Hz extracellular electrical stimulation to target brain areas such as thalamus, subthalamic nucleus, or globus pallidus. There have also been research trials of deep brain stimulation and cortical stimulation for treatment of epilepsy. The stimulator itself is a pacemaker-like, battery-powered pulse generator implanted subcutaneously with wires connecting to the implanted electrodes. The output of the pulse generator can be programmed by a clinician. The stimulation

voltage, pulse duration (pulse width), and frequency can be adjusted within limits to achieve optimal effectiveness in treating symptoms with minimal side effects.

There are two recognized types of tissue response to implanted electrodes: (1) A passive tissue response can result from surgical trauma and the mechanical and chemical properties of the implant. (2) An active tissue response results from electrochemical reaction products formed at the tissue–electrode interface and from physiologic changes associated with neural activity induced by stimulation. The manner and degree to which neural injury occurs depends on both the stimulation parameters and the neural substrate being stimulated.

There is an interface between the metal stimulating electrodes and the ionic conductor of the body, which has an impedance  $Z(V)$  that is in general nonlinear (dependent on the voltage across the interface,  $V$ ). Since the circuit used to deliver the electrical stimulus is a constant-voltage device, a changing impedance of the electrode–tissue interface leads to changes in the magnitude and time course of the current that flows through the tissue, which is the primary determinate of the effects of electrical stimulation on neurons.<sup>16</sup>

Tissue damage may result from products of electrochemical reactions at the electrode–tissue interface. These reactions depend upon the potential of the electrode and the time course of the stimulus pulse. Electrode geometry and area may also be important, since the current density on a metal electrode passing current in an ionic conductor is nonuniform.

In addition to electrochemical mechanisms, physiologic mechanisms involving synchronous activation of populations of neurons also contribute to neural damage. Physiologic changes associated with neural excitation are correlated with the charge rather than the charge density (charge divided by electrode area). Thus, both charge and charge density must be limited to avoid tissue damage.<sup>17</sup> For cortical stimulation, another concern is the threshold for kindling of brain tissue, which is the development of spontaneous epileptic seizures due to long-term synaptic potentiation and other mechanisms. Kindling is usually thought to occur only if an after-discharge is seen as a result of electrical stimulation, since in experimental animals no kindling is seen with subthreshold stimuli (those that do not produce after-discharges).



Stimulation frequency may also have an effect on tissue damage, since stimulus frequency determines how often the activated neurons fire, and it is possible that cellular respiration cannot keep up with the increased demands of neuronal ionic pumps for ATP during high frequency firing. Thus, higher stimulation frequencies may be associated with a lower charge threshold for neural damage. Deep brain stimulation uses comparatively high (100–200 Hz) frequencies.

### Key Points

- Electric stimulation of neural tissue at the currents needed for activation is safe if kept away from pacemakers and other implanted electrical devices.
- Care must be taken to prevent local tissue injury.

### SUMMARY

This chapter reviews the principles of electric safety that are relevant to clinical neurophysiologic studies. Knowledge of these principles is necessary both for those involved in evaluating and purchasing test instruments and for those involved in maintaining and using them. All those who order, perform, interpret, or supervise electrophysiologic testing share the legal responsibility for patient safety, including electric safety.

### REFERENCES

1. Anonymous. 1993. Risk of electric shock from patient monitoring cables and electrode lead wires. *Health Devices* 22:301–3.
2. Starmer, C. F., H. D. McIntos, and R. E. Whalen. 1971. Electrical hazards and cardiovascular function. *New England Journal of Medicine* 284:181–6.
3. Swerdlow, C. D., W. H. Olson, M. E. O'Connor, D. M. Gallik, R. A. Malkin, and M. Laks. 1999. Cardiovascular collapse caused by electrocardiographically silent 60-Hz intracardiac leakage current. Implications for electrical safety. *Circulation* 99:2559–64.
4. Litt, L., and J. Ehrenwerth. 1994. Electrical safety in the operating room: Important old wine, disguised new bottles. *Anesthesia and Analgesia* 78:417–19.
5. McNulty, S. E., M. Cooper, and S. Staudt. 1994. Transmitted radiofrequency current through a flow directed pulmonary artery catheter. *Anesthesia and Analgesia* 78:587–9.
6. UL 60601-1, EN/IEC 60601-1 Medical Electrical Equipment—Part 1 General Requirements for Safety and Essential Performance.
7. NFPA99, ANSI/AAMI ES1 Safe Current Limits for Electromedical Apparatus.
8. Schoeck, A. P., M. L. Mellion, J. M. Gilchrist, and F. V. Christian. 2007. Safety of nerve conduction studies in patients with implanted cardiac devices. *Muscle & Nerve* 35:521–4.
9. Shannon, R.V. 1992. A model of safe levels for electrical stimulation. *IEEE Transactions on Biomedical Engineering* 39(4):424–6.
10. Swartz, B. E., J. R. Rich, P. S. Dwan, et al. 1996. The safety and efficacy of chronically implanted subdural electrodes: A prospective study. *Surgical Neurology* 46(1):87–93.
11. Kenney, C., R. Simpson, C. Hunter, et al. 2007. Short-term and long-term safety of deep brain stimulation in the treatment of movement disorders. *Journal of Neurosurgery* 106(4):621–5.
12. Foerster, A., J. M. Schmitz, S. Nouri, and D. Claus. 1997. Safety of rapid-rate transcranial magnetic stimulation: Heart rate and blood pressure changes. *Electroencephalography and Clinical Neurophysiology* 104(3):207–12.
13. MacDonald, D. B. 2002. Safety of intraoperative transcranial electrical stimulation motor evoked potential monitoring. *Journal of Clinical Neurophysiology* 19(5):416–29.
14. Putzke, J. D., R. E. Wharen Jr., Z. K. Wszolek, M. F. Turk, A. J. Strongosky, and R. J. Uitti. 2003. Thalamic deep brain stimulation for tremor-predominant Parkinson's disease. *Parkinsonism and Related Disorders* 10(2):81–8.
15. Sydow, O., S. Thobois, F. Alesch, and J. D. Speelman. 2003. Multicentre European study of thalamic stimulation in essential tremor: A six year follow up. *Journal of Neurology, Neurosurgery, and Psychiatry* 74:1387–91.
16. Grill, W. 2005. Safety considerations for deep brain stimulation: Review and analysis. *Expert Review of Medical Devices* 2(4):409–20.
17. Agnew, W. F., D. B. McCreery, T. G. H. Yuen, and L. A. Bullara. 1990. Effects of prolonged electrical stimulation of the central nervous system. In *Neural prostheses fundamental studies*, ed. W. F. Anew, and D. B. McCreery, 226–52. Englewood Cliffs, NJ: Prentice-Hall.

## Chapter 3

---

# Volume Conduction

Terrence D. Lagerlund, Devon I. Rubin, and Jasper R. Daube

### PRINCIPLES

#### SOURCES OF ELECTRICAL POTENTIALS

Cortically Generated Potentials in Volume Conductors  
Peripherally Generated Potentials in Volume Conductors

#### CURRENT SOURCES: MONOPOLES, DIPOLES, AND QUADRUPOLES

Spatial Distributions of Potentials

#### VOLUME CONDUCTION

##### THEORY: ELECTRIC PROPERTIES IN VOLUME CONDUCTORS

Effect of Volume Conductor Resistive–Capacitive Properties on EEG  
Effect of Volume Conductor Resistive–Capacitive Properties on Nerve Conduction Studies and Needle EMG

Distant Recordings in Volume Conductors

#### APPLICATIONS OF VOLUME CONDUCTION PRINCIPLES

SEP and Brain stem Auditory Evoked Potential Applications  
Effect of Volume Conduction on Electroencephalography (EEG) Applications  
Dipole Source Localization in EEG  
Nerve Conduction Study Applications  
Needle EMG Applications

#### SUMMARY

#### APPENDIX

Calculating Potentials in Infinite Homogeneous Media  
Potentials in Nonhomogeneous Media  
Homogeneous Sphere Model  
Multiplanar and Multiple Sphere Models

### PRINCIPLES

Electrophysiologic studies involve bioelectric potentials generated by sources inside the body, such as the brain, peripheral nerve, and muscle, that may be some distance away from the recording electrodes. The sources of these

potentials may be either active or passive. *Active sources* are ionic channels that open or close in response to changes in transmembrane potential, neurotransmitter binding, intracellular calcium, or second messengers, allowing small currents to flow into or out of the cell body, dendrite, axon, or muscle fiber. *Passive*

*sources* are areas of neuronal membrane that permit current flow into or out of the cell by passive leakage or capacitive effects. These current sources or sinks (active or passive) lead to widespread extracellular currents flowing in the conducting medium throughout the body, called a *volume conductor*. The transfer of electric potentials to a site a distance away from the generator is called *volume conduction*. Volume conductors may be homogeneous, such as a cylinder containing an electrolyte solution; however, in clinical neurophysiology the body acts as a nonhomogeneous volume conductor.

Some of the currents in the volume conductor reach the skin surface, where the current causes a potential difference across the space between two recording electrodes. This difference in potential can be detected and amplified by a differential amplifier. The source of the electrical potentials, the type of volume conductor, the propagation of current through the volume conductor, relationship between the recording electrode montages, and distances of the electrodes from the electrical generator all have an effect on the potentials recorded in clinical neurophysiology. *Volume conduction theory* describes the spread of electrical current throughout the body and plays an important role in the responses recorded in clinical neurophysiology.

### Key Points

- Currents generated by sources in the body flow in the conducting medium (volume conductor) to reach electrodes.
- Current flow causes potential differences between electrodes which can be amplified and recorded (Ohm's law).

## SOURCES OF ELECTRICAL POTENTIALS

### Cortically Generated Potentials in Volume Conductors

The potential generated by a population of neurons is equal to the sum of the potentials generated by the individual neurons. Cerebral cortical neurons have extensive dendritic trees

in which multiple synapses may be active simultaneously and in which multiple regions of active membrane are capable of generating action potentials. In this case, the potentials generated by each neuron are a sum of the potentials generated by multiple active and passive areas of membrane. Only if the responsible neuronal generators are arranged regularly and activated more or less synchronously is sufficient summation obtained to allow recording of potentials at a considerable distance from the generators.

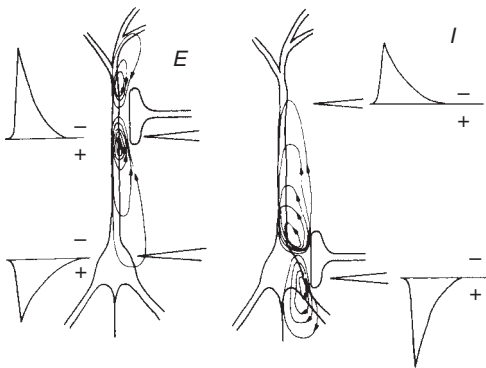
In the cerebral cortex, the generator of spontaneous electroencephalographic (EEG) activity, the pyramidal neurons are arranged in a regular manner, with the main axes of the dendritic trees parallel to one another and perpendicular to the cortical surface. Thousands of these cortical pyramidal neurons are activated more or less simultaneously by synapses made by a single axon or small groups of axons, producing significant extracellular current flow. Under these circumstances, the longitudinal components of current flow from different neurons add together, and the transverse components of flow cancel out, producing a laminar current along the main axes of the neurons. Depending on whether the activated synapse is excitatory or inhibitory, the direction of current flow across the cell membrane is either inward or outward. The synaptic transmembrane current flow is accompanied by an opposite outward or inward current flow at another location along the dendritic tree, called *passive source* or *sink*, which produces a dipole, as described in the following section. An excitatory postsynaptic potential (EPSP) occurs when positive ions flow intracellularly, called *inward current flow*, and an inhibitory postsynaptic potential (IPSP) occurs when negative ions flow intracellularly, called *outward current flow*. Thus, the local extracellular potential produced by an EPSP is negative and that produced by an IPSP is positive.

The orientation of the dipole created by synaptic activity in the cerebral cortex depends on both the type of synaptic activity, whether an EPSP or IPSP, and the location of the synapses, whether superficial or deep. An EPSP located superficially in the cerebral cortex, that is, along the distal branches of the pyramidal cells, produces a dipole with a superficial negative and a deep positive pole.

A deep EPSP, for example, caused by a synapse near the cell body or on the basal dendrites, produces a dipole with a superficial positive and a deep negative pole.<sup>1</sup> The IPSPs and EPSPs located at similar depths in the cerebral cortex produce dipoles oriented opposite to one another (Fig. 3–1). A *deep* IPSP produces an extracellular potential field similar to that of a *superficial* EPSP.

At a macroscopic level, the potential field generated by synchronous activation of many cortical pyramidal cells behaves like that of a dipole layer. This has been called an *open field* configuration, in contrast to the fields generated by neurons with dendritic arborizations that are distributed radially around the cell body and called *closed fields*. Closed-field potentials are equivalent to the field produced by a set of radially oriented dipoles at the surface of a sphere; such a field is negligible at a distance because both the radial and tangential components of current flow cancel each other in this configuration.

Because the dendrites of cortical pyramidal cells are perpendicular to the cortical, or pial,



**Figure 3–1.** Patterns of current flow near a neuron caused by synaptic activation. *E*, Current flow caused by activation of an excitatory apical dendritic synapse depolarizes the cell membrane, producing a current sink. The extracellular potential, shown on the left, has a negative polarity at the synapse. *I*, Current flow caused by activation of an inhibitory synapse near the cell body hyperpolarizes the cell membrane, producing a current source. The extracellular potential, shown on the right, has a positive polarity at the synapse. (From Lopes da Silva, F., and A. van Rotterdam. 1993. Biophysical aspects of EEG and magnetoencephalogram generation. In *Electroencephalography: Basic principles, clinical applications, and related fields*, ed. E. Niedermeyer, and F. Lopes da Silva, 3rd ed., 78–91. Baltimore: Williams & Wilkins. By permission of the publisher.)

surface, many dipole-like sources of EEG and evoked potential waveforms are radial in direction, that is, they are perpendicular to the surface of the scalp. These generators typically reside at the apex of cortical gyri. However, cortical generators located in the walls of sulci—where the cortical surface is perpendicular to the scalp surface—may create potential fields that correspond to a tangentially oriented dipole. A classic example of this is the potential field of the centrottemporal spike discharges often seen in benign rolandic epilepsy of childhood.

### Key Points

- Currents generated by sources in the body flow in the conducting medium (volume conductor) to reach electrodes.
- Potentials generated by a population of neurons are the sum of the potentials generated by individual neurons.
- Regular arrangement and synchronous activation of many neurons are required for recording potentials at a distance.
- In EEG and cerebral evoked potentials, the summated EPSPs and IPSPs from cerebral cortical neurons are the source of the electrical recordings.
- Parallel pyramidal cells activated simultaneously in cerebral cortex allow effective summation of EPSPs and IPSPs.
- These cortical sources assume the configuration of a dipole layer with the dipoles perpendicular to the pial surface.
- Radial dipoles are formed by activation of PSPs in gyral cortex, and tangential dipoles by PSPs in cortex in sulci.

## Peripherally Generated Potentials in Volume Conductors

Spontaneous activity may arise from any central or peripheral neuromuscular structure. Voluntary potentials are initiated in the cortex and bring about voluntary movement by traveling to muscle via the corticospinal tracts, motor neurons in the ventral horn of the spinal cord, and peripheral motor nerves to the muscles. The synchrony and size of fibers in spontaneous activity and voluntary activation is sufficient to allow clinical recording of these

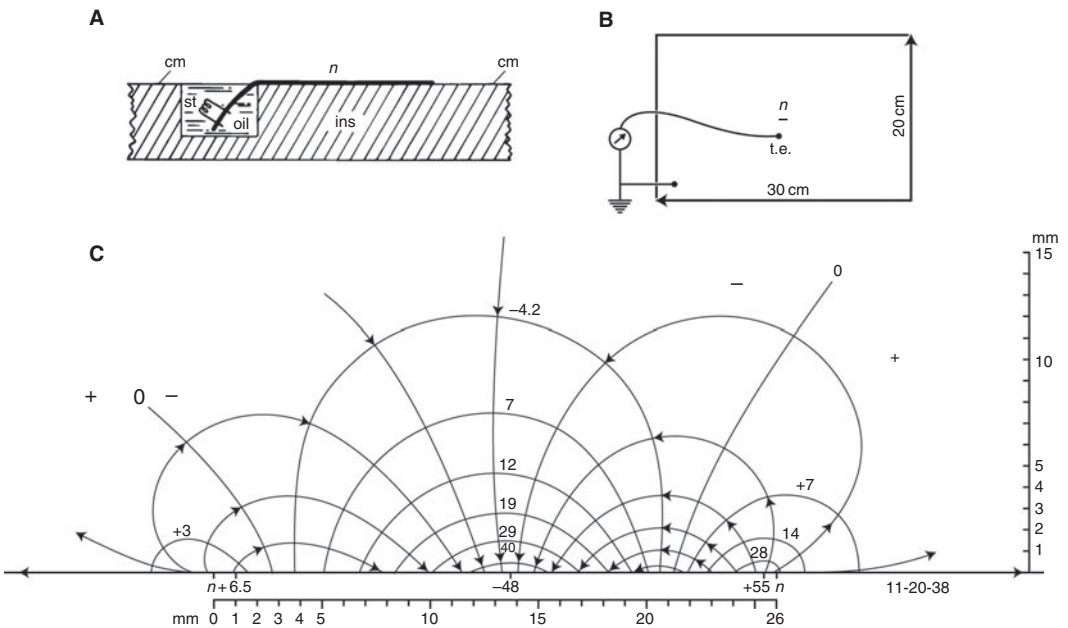
potentials *only* in muscle by recording individual muscle fiber potentials or the muscle fibers in a motor unit with a needle electrode (*motor unit potential*).

Peripheral evoked potentials are initiated by stimulation of peripheral motor and sensory nerves or of the motor cortex. Potentials from motor cortex stimulation travel peripherally to anterior horn cells and muscles. They can be recorded from the spinal cord (as motor evoked potentials), peripheral nerve, and muscle (as compound muscle action potentials). Peripherally activated sensory potentials travel peripherally to sensory nerve endings and centrally to the cortex via the dorsal roots and the dorsal columns of the spinal cord. Summated sensory evoked potentials can be recorded in peripheral nerve (sensory nerve action potentials, SNAPs), spinal cord, and cortex (as somatosensory evoked potentials, SEPs).

The peripheral and spinal cord motor and sensory fibers serve to carry information from one area of the nervous system to another. The potentials in these structures are, therefore, all

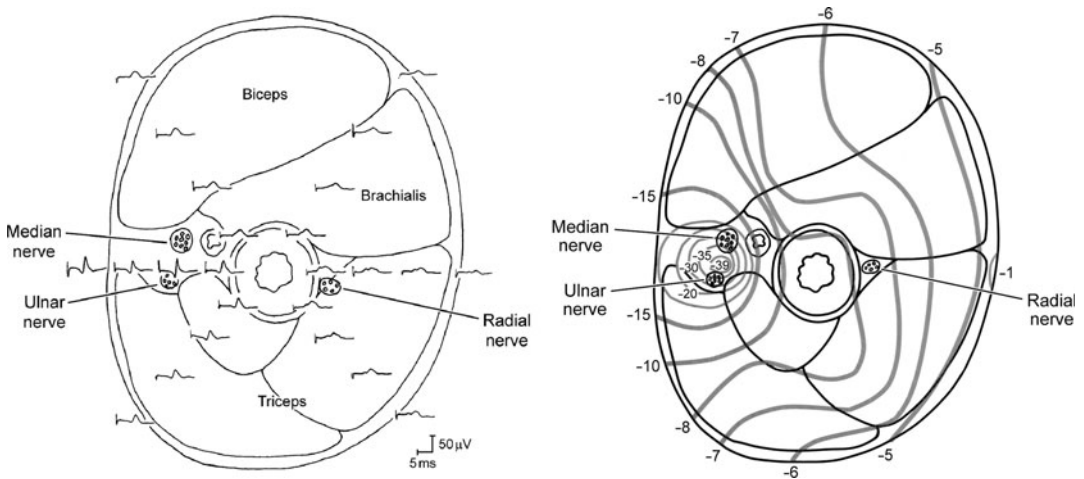
traveling potentials that have unique properties in volume conductors with distinctly different appearances based on their location relative to the recording electrodes. The nerve and muscle fiber action potentials are typically recorded from the overlying skin as close as possible to the generating or propagating source; however, the recording electrodes are often located some distance away from the nerve or muscle generator with current passing through intervening tissue before reaching the recording electrodes.

Fibers in peripheral nerve and muscle can be recorded individually, but most commonly are recorded from the synchronous volley of action potentials in multiple, closely grouped, parallel fibers that produce the nerve and muscle action potentials recorded clinically. The waveforms from these groups of parallel fibers generate a nerve action potential. A traveling nerve action potential in a peripheral nerve can be represented by two dipoles placed end-to-end. Figure 3-2 shows the current flow and potential fields surrounding a nerve action potential.



**Figure 3-2.** Nerve action potential recorded from a nerve on a volume conductor. A, The volume conductor in cross section showing isolated stimulation of the nerve in an oil bath. B, Nerve (n) recorded between testing electrode (t.e.) moved to different locations on the volume conductor and reference electrode. C, Current flow (lines with arrows) and potential fields (numbered lines) showing the decreasing positive and negative voltage at increasing distance from the nerve. (From Lorente de No R. 1947. *A study of nerve physiology*, Vol. 2, 384-477. New York: The Rockefeller Institute for Medical Research. By permission of the publisher.)

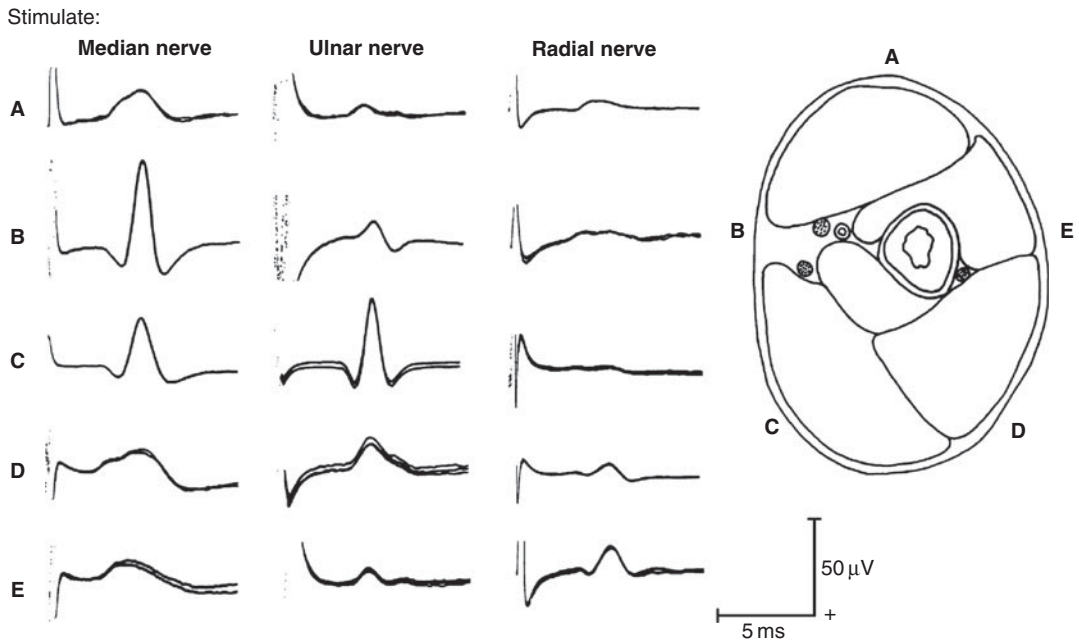




**Figure 3-3.** Schematic diagram of the cross section of the upper arm showing the major nerves and muscles and the humerus. *A*, Median nerve action potentials with stimulation at the wrist were recorded from 24 locations with six surface recordings around the arm and from a needle electrode inserted to three depths at the six points. *B*, Cross section of the potential fields derived from the recorded median nerve action potentials at the 24 points. Note the marked distortion of the potential by the humerus.

The configuration and size of these potentials depends on the relationship of the recording electrode to the generator and may be seen as positive waveforms, biphasic waveforms, or triphasic waveforms when recorded from peripheral nerve, muscle, or dorsal column axons.

Volume conduction of nerve action potentials is shown in Figures 3-3 and 3-4. Figure 3-3*A* illustrates the distribution of the potential field surrounding a median nerve action potential in the upper arm. The distribution of isopotential lines constructed from these recordings shows the distortion of the



**Figure 3-4.** Surface recordings of the median, ulnar and radial SNAP from the skin at five sites around the upper arm. Recordings all at the same amplifier sensitivity. Note that while the potential can be recorded around the arm, there is a rapid fall off in amplitude away from the nerve.

potential field by the humerus (Fig. 3–3B). The spread of nerve action potentials across the skin overlying the upper arm nerves is shown in Figure 3–4.

### Key Points

- Peripheral EMG, motor and sensory nerve action potentials, and motor-evoked potentials are the summated activity of parallel bundles of individual nerve or muscle fibers.
- Sensory evoked potentials at the cortex are the summated EPSPs and IPSPs from cerebral cortical neurons.
- Potentials recorded from muscle may be
  - Voluntary motor unit potentials (MUPs)
  - Spontaneous potentials in muscle (e.g., fibrillation potentials)
  - Evoked compound muscle action potentials (CMAPs).
- Potentials from nerve are
  - Sensory nerve action potentials (SNAPs)
  - Nerve action potentials (NAPs).

## CURRENT SOURCES: MONOPOLES, DIPOLES, AND QUADRUPOLES

Every electrical potential has a source of current. A single source or sink of current is referred to as a *monopole*. The magnitude of the current density decreases with distance away from the current source and can be measured along *equipotential lines*. Each equipotential line represents a constant potential along the course of the line. In a monopole the equipotential lines form circles around the current source or sink, and the magnitude of current falls off inversely with distance from the source (Fig. 3–5A).

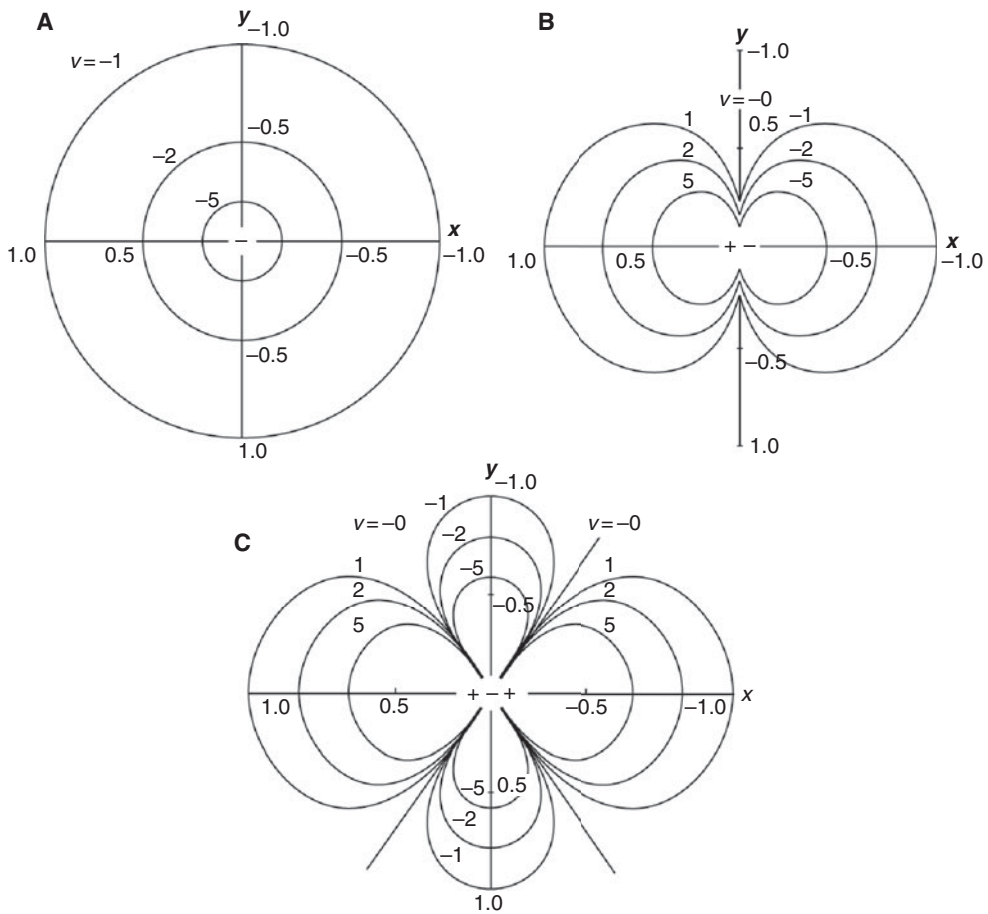
In the nervous system, adjacent current monopoles of opposite polarity constitute a current *dipole* (Fig. 3–5B). In a dipole, current flows from the positive to the negative pole, and sets of potential lines are generated away from the dipole. Similar to the monopole, the magnitude of current falls off inversely with distance from the source. This is a more realistic generator than an isolated monopole because the current emanating from

the source can flow through the medium to the sink where it is absorbed. In respect to the potentials they produce at distant recording sites, many neuronal current generators may be well described in terms of a current dipole. For example, as noted above, the main contributors to spontaneous EEG activity are the excitatory and inhibitory postsynaptic potentials in the dendritic trees of cortical pyramidal neurons. The arrangement of synapses on the dendritic trees produces a current source and sink separated by a significant distance, and this constitutes an electric dipole. The characteristic organization of the cortical pyramidal neurons, that is, oriented parallel to each other and perpendicular to the cortical surface, allows the potentials from many such dipole sources to summate effectively.

The potentials of such dipoles fall off inversely with the square of the distance from the source. The lines of current flow around a dipole form curved paths (Fig. 3–5B). The equipotential surfaces are perpendicular to the lines of current flow and have a figure-8 configuration around the dipole.<sup>2</sup> The zero potential surface is a plane halfway between the two poles of the dipole (Fig. 3–5B).

Two adjacent current dipoles of opposite orientation placed end-to-end effectively act as two end-to-end dipoles or *quadrupole* (Fig. 3–5C). The potential of a quadrupole falls off inversely with the cube of the distance from the source, and the equipotential surfaces around the quadrupole have a cloverleaf configuration (Fig. 3–5C). A quadrupole is a fair approximation of the potential generated by an action potential propagating along an axon: The axonal membrane has a negative polarity outside and a positive polarity inside at the peak of the action potential. However, on either side of this peak, the membrane is positive outside and negative inside (Fig. 3–2).

In the simplest form of a volume conductor, a homogeneous medium without boundaries in which generators and recording electrodes are embedded, the recorded potential can be calculated from the configuration of source currents. The formulas used to calculate the potential are listed in the Appendix.



**Figure 3-5.** Equipotential lines in a volume conductor for different current source distributions: A, A point source or monopole; B, a dipole; C, a quadrupole (two oppositely directed dipoles); similar to the equipotential lines around an action potential propagating along an axon. The arrows represent lines of current flow. The distribution of the potential field in the volume conductor is shown in millimeters on the horizontal and vertical scales. (From Stein, R. B. ed. 1980. *Nerve and muscle: membranes, cells, and systems*. New York: Plenum Press. By permission of the publisher.)

### Key Points

- A single current source (monopole) in a conductor creates a potential that varies inversely with distance from source.
- A current dipole's potential varies inversely as square of distance from source and depends on the angle from the dipole axis.
- A quadrupole (two adjacent, end-to-end dipoles) has a potential that varies inversely with the cube of distance from source.

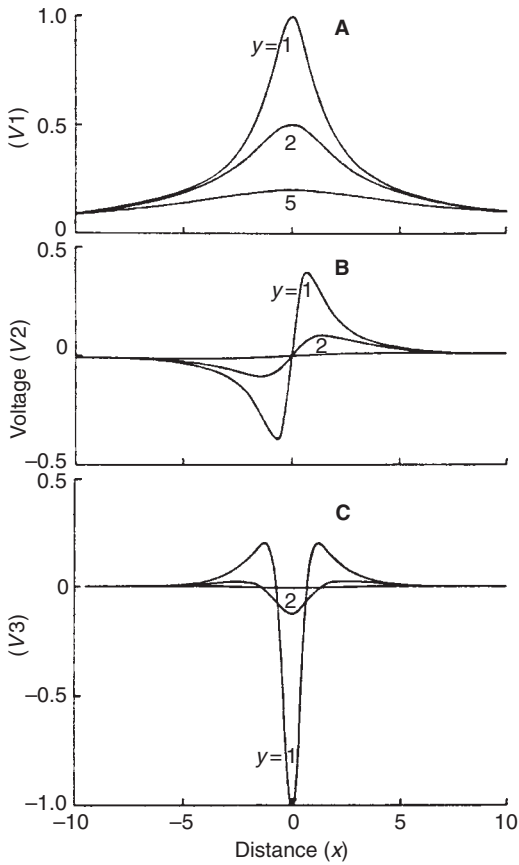
### Spatial Distributions of Potentials

The spatial distributions of potentials vary with the source. The sharpness of a potential from

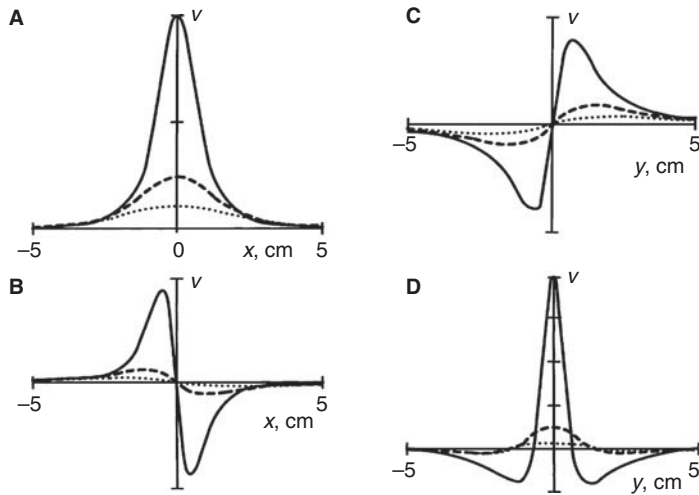
a monopole source increases with decreasing distance (Fig. 3-6). The configuration of a dipole potential depends on the reference electrode location, *distant or closely spaced (bipolar)*, and on the orientation of the electrodes relative to the dipole (*perpendicular or parallel*).

A dipole recorded relative to a *distant reference* at points along a line *perpendicular* to the dipole axis is a *single peak* whose sharpness increases with decreasing distance from the source (Fig. 3-7A). This situation applies to scalp potentials produced by a radially oriented cortical dipole generator. For example, a radially oriented cortical dipole is seen frequently in EEG recordings because of the radial orientation of the cortical pyramidal neurons.





**Figure 3-6.** Potentials recorded along a line located at various distances from a current source (1, 2, and 5 cm), as a function of position along the line: A, a current monopole, B, a dipole, and C, an action potential source. (From Stein, R. B. ed. 1980. *Nerve and muscle: Membranes, cells, and systems*. New York: Plenum Press. By permission of the publisher.)



**Figure 3-7.** Potentials recorded along a line located at various distances from a current dipole (solid curve, 1 cm; dashed curve, 2 cm; dotted curve, 3 cm) as a function of position along the line. A, Referential recording, with the line perpendicular to dipole axis; B, bipolar recording for line perpendicular to dipole axis; C, referential recording, with the line parallel to dipole axis; D, bipolar recording for line parallel to dipole axis.

For the same dipole source with bipolar recording, the potential differences at points along a line *perpendicular* to the dipole axis may also be plotted as a function of distance along the line. The potential obtained with this recording is *biphasic*, with increasing sharpness with decreasing distance (Fig. 3-7B).

For a dipole source, the potential recorded relative to a *distant reference* at points along a line *parallel* (tangential) to the dipole axis is *biphasic*, and its sharpness increases with decreasing distance from the source (Figs. 3-6B and 3-7C). This occurs with a tangentially oriented cortical dipole generator that is often present when the cortical generator region is deep in a sulcus or fissure in which the cortical surface is perpendicular to the scalp surface, for example, the spikes with benign rolandic epilepsy of childhood.

For a dipole source with bipolar recording, the potential difference at points *parallel* to the dipole axis is a triphasic potential whose sharpness increases with decreasing distance from the source (Fig. 3-7D).

The potential with a quadrupole source recorded relative to a distant reference along a line *parallel* to the quadrupole axis is triphasic; its sharpness increases with decreasing distance from the source (Fig. 3-6C). This situation approximates an action potential propagating along an axon parallel to the line of the recording electrodes.

### Key Points

- Spatial distributions of potentials generated by different sources can be displayed by plotting potential against distance.
- Waveform configurations in a volume conductor depend on location of the reference electrode, orientation of the electrodes to the generator, and distance of the electrodes from the generator as summarized in the following table:

	Reference	Orientation to dipole	Waveform configuration	Nearer generator
A	Distant	Perpendicular	Single peak	Sharper peak
B	Bipolar	Perpendicular	Biphasic	Sharper peak
C	Distant	Parallel	Biphasic	Sharper peak
D	Bipolar	Parallel	Triphasic	Sharper peak

## VOLUME CONDUCTION THEORY: ELECTRIC PROPERTIES IN VOLUME CONDUCTORS

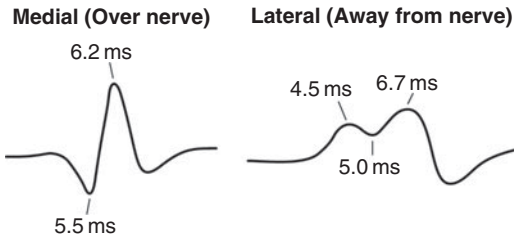
In general, a volume conductor such as the body can be characterized by its *conductivity* (or *resistivity*) and its *capacitive* properties (dielectric constant), which may vary from tissue to tissue. This may be modeled by dividing the entire volume conductor into many small regions, each of which is assumed to be homogeneous, that is, the conductivity and capacitance are the same throughout.

### Effect of Volume Conductor Resistive–Capacitive Properties on EEG

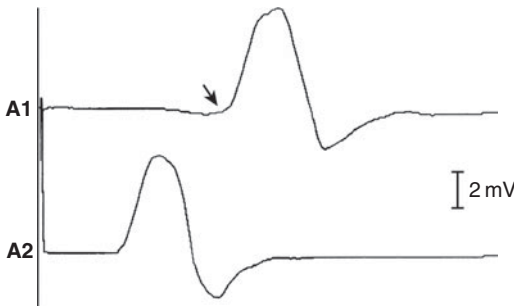
The capacitive properties of the volume conductor can be ignored at the frequencies of interest in EEG recordings. Thus only a conductivity value for each region, together with the geometry of the region, is needed to characterize the volume conductor. In the noncapacitive (purely resistive) volume conductor, EEG potentials are always in phase, or synchronous, with the current sources, and the conductive properties of the medium are independent of frequency.

### Effect of Volume Conductor Resistive–Capacitive Properties on Nerve Conduction Studies and Needle EMG

In contrast to the capacitive properties of the volume conductor during EEG recordings, in peripheral recordings in a resistive–capacitive medium, volume conduction is frequency dependent. The result is that the source currents and recorded potentials are out of phase,



**Figure 3-8.** Median nerve action potentials with stimulation at the wrist and an ipsilateral knee reference are recorded medially over the course of the median nerve and laterally, opposite the median nerve. Latency of the components of the action potential over the nerve is significantly shorter than that recorded on the opposite side of the arm.



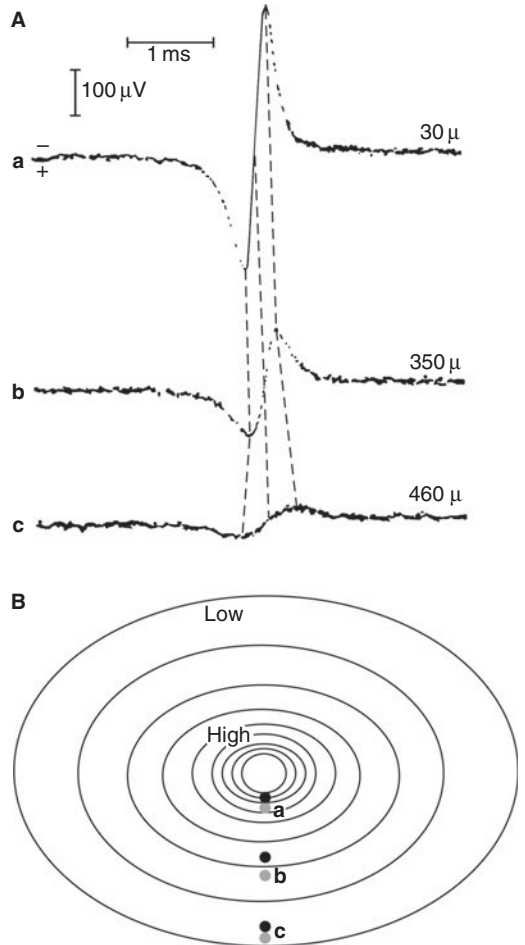
**Figure 3-9.** Compound muscle action potentials recorded from the extensor digitorum brevis muscle at the knee and ankle with peroneal nerve stimulation at the ankle and knee. The additional positivity seen at the knee is contributed by activation of anterior compartment muscles at a distance, such as the extensor hallucis longus.

which can result in erroneous latency measurements of propagating nerve action potentials with distant references (Fig. 3-8). The latency recorded at a distance from the nerve is shorter than that recorded at the same level over the nerve. A more common issue is the presence of an initial positivity on a muscle action potential generated by a segment of muscle at a distance from the recording site (Fig. 3-9).

### Distant Recordings in Volume Conductors

In clinical neurophysiology, the electrical current arising from neurons, axons, or muscle fibers are recorded with recording electrodes placed at different sites on the body. Two electrodes record the potential differences that are generated from the neural structures. In

some instances, the recording electrodes are placed in close proximity to the electrical generator; however, in many instances the generator is located at a longer distance away from the recording electrodes. While two recording electrodes on an equipotential line of a current source will record no potential difference, in most recordings the two electrodes will be on different isopotential lines and a potential difference will be recorded.

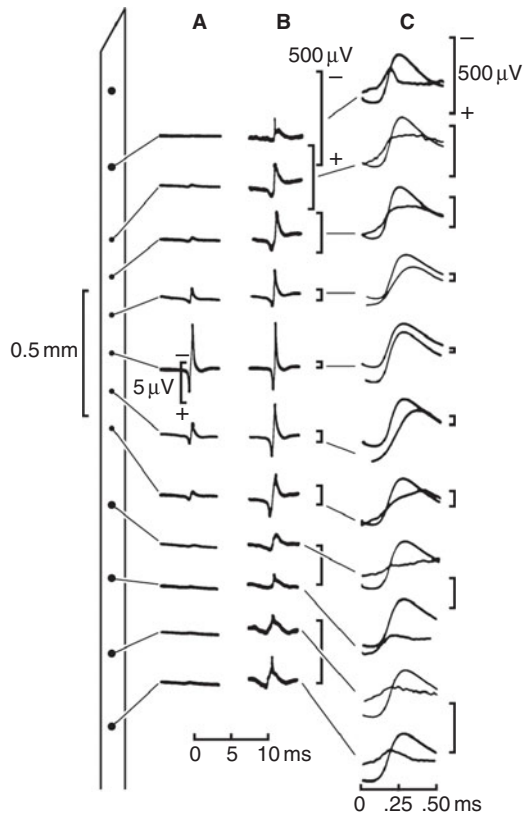


**Figure 3-10.** A, Muscle fiber action potential recorded from a frog muscle fiber in a volume conductor at three distances ( $\mu$  = micro) from the fiber (from Haakenson. 1951. *Acta Physica Slovaca* 39:291-312). B, Schematic diagram of the spatial current gradients in a volume conductor that result in the change in muscle fiber action potential with distance from the fiber (a, electrode pair with a high spatial gradient; b, electrode pair with an intermediate spatial gradient; c, electrode pair with a low spatial gradient) with an exponential reduction in both amplitude and rise time from the initial positive peak to the negative peak due to filtering of fast frequency components.

When differences in a potential are large between two adjacent points, a high *spatial gradient* (or high rate of change of a potential) is present. In regions where the spatial gradient from the source is high at the site of recording, the potential is called a *near-field potential*. In contrast, when the potential is recorded far from the current source, the spatial gradient is low, and these recorded potentials are known as *far-field potentials*.

When using a bipolar recording montage, potentials near the generator and each recording electrode located on equipotential lines with a larger spatial gradient between the two will be recorded as a large response, because large potential differences will be recorded. In contrast, if using a bipolar recording montage where both electrodes are far from the generator source, both electrodes will be recording current along isopotential lines with a low spatial gradient and, therefore, a low amplitude response will be recorded.

Volume conduction theoretically allows the potentials from motor units to be recorded anywhere in the body. For practical purposes, it means that they can be recorded at some distance from the generator. The effect of spatial gradients are shown schematically in Figure 3-10B and on a muscle fiber action potential in Figure 3-10A. The capacitance of the intervening tissue results in filtering of the fast frequencies and distortion of the signal as shown in Figure 3-11.



**Figure 3-11.** Motor unit potential recordings at short increments along a recording needle electrode. A, Identical amplification of all waveforms. B, Amplification increased along the needle (as shown by the 500- $\mu$ V bracket). C, Change in rise time at a fast sweep speed (compare the 5-mV response superimposed on all of the smaller responses). The amplitude decreases markedly at short distances from the site of the muscle fibers, but can be recorded two millimeters away. At these sites not only is the amplitude markedly reduced by resistance, but also the rise time is slowed by tissue capacitance.

### Key Points

- A volume conductor has properties of conductivity (or resistivity) and capacitive (dielectric constant) properties.
- Different body regions have different conductivities and dielectric constants which influence volume conduction.
- In EEG recordings capacitive properties can be ignored, so that each region need be characterized only by conductivity.
- The frequency dependence for volume conduction in a resistive-capacitive medium alters peripheral recordings significantly.
  - Nerve conduction latency measurement becomes erroneous when recorded at a distance from the generator.
  - Nerve and muscle action potential amplitudes decrease rapidly as distance from the generator increases.
- Rise time slows as distance from the generator increases.
- Nerve and muscle action potentials recorded at a distance from the generator are positive.

## APPLICATIONS OF VOLUME CONDUCTION PRINCIPLES

### SEP and Brain stem Auditory Evoked Potential Applications

SEPs are action potentials elicited along the peripheral and central somatosensory pathways

that are induced by stimulation of the sensory fibers of a peripheral nerve. Different types of potentials are recorded: action potentials that propagate along the peripheral nerve and spinal cord, and current that is generated at the sensory ganglion within the brain stem or thalamus which eventually reaches the somatosensory cortex. SEPs may be recorded at different points along the sensory conduction pathway, such as along the peripheral nerve at the knee or elbow, along the lumbar or cervical spine, and at the scalp.

### EFFECT OF VOLUME CONDUCTION ON POTENTIAL COMPONENTS DUE TO PROPAGATING GENERATORS

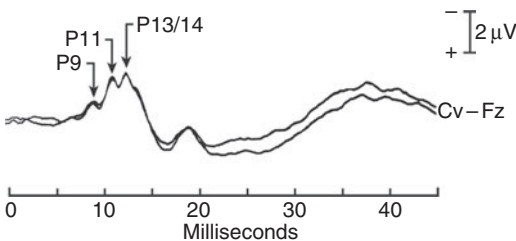
When recording from various electrodes placed at different locations along the path of a complex propagating generator, such as an action potential source, the time at which the propagating potential is seen at each location is different because of the finite velocity of propagation of the generator. (Note that volume conduction of electric potentials from the generator to the recording electrode is essentially instantaneous, because electric disturbances propagate at the speed of light in a conducting medium.) These differences in time of recording the electrode is what is typically seen and analyzed during SEP recordings with a standard recording montage from different sites along the conduction pathway (Fig. 3-12). SEPs at the cervical segments of the spinal cord are combinations of the synchronous, traveling potentials in nerve fiber bundles as

described above, and localized potentials generated by groups of neurons in the dorsal horn of the spinal cord. The configuration of these potentials depends on the location of the recording electrodes.

### STATIONARY POTENTIALS PRODUCED BY PROPAGATING GENERATORS

However, when a propagating generator passes through an interface between volume-conducting regions of different sizes or conductivities, a potential can be induced *simultaneously* at all recording electrodes during the time at which the generator is crossing the boundaries between regions with differing properties.<sup>3</sup> Such a potential, which does not appear at different times in different recording locations, has been referred to as a *stationary potential*. This effect may be observed in SNAPs and SEP recordings when recording at a single site as a consequence of the change in geometry of the volume conductor as a propagating nerve impulse travels from a limb to the trunk (Fig. 3-13). The artifactual occurrence of stationary potentials seen at the interface of differently sized volume conducting regions is illustrated.

The same effect may also influence the morphology of a brain stem auditory evoked potential (BAEP) recording because of changes in volume conductor properties along the central auditory pathways caused by the complicated anatomy of the posterior fossa. These stationary potentials can be seen only in derivations in which the first and second electrodes between which the potential is measured are on opposite sides of the boundary between the regions with differing sizes or conductivities; generally, this occurs only when recording with respect to a relatively distant reference electrode.<sup>4</sup>



**Figure 3-12.** Median SEP recorded from the cervical spinal cord (Cv-Fz). The origins of these typical peaks are P9 from the brachial plexus; P11 from the dorsal root entry zone; and P13/14 from dorsal horn and dorsal column/medial lemniscus.

### Key Points

- Propagating action potentials are recorded from various locations at different times due to finite propagation velocity.
- A stationary potential occurs when a propagating action potential passes an interface between regions of different sizes or conductivities, generally when recording with respect to a relatively distant reference.

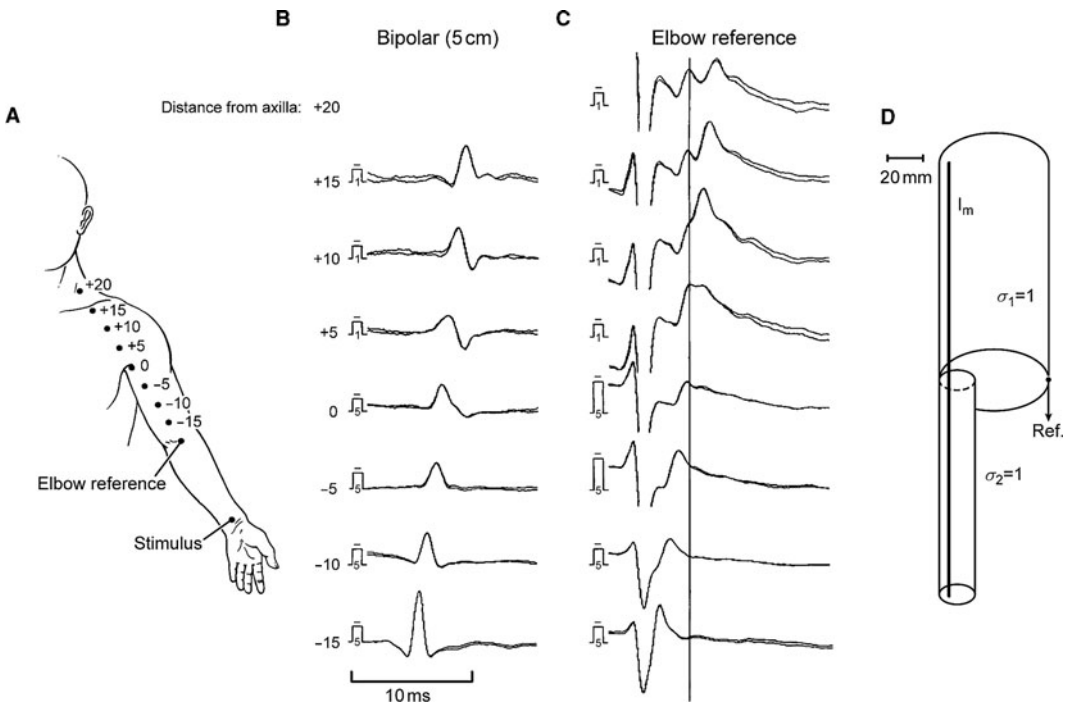
- SEPs are complex waveforms made up of combinations of traveling waves in fiber pathways and cell groups in the spinal cord or cortex.
- Evoked potentials from spinal cord are SEPs.

## Effect of Volume Conduction on Electroencephalography (EEG) Applications

In recording spontaneous scalp EEG activity or the late components of the somatosensory and visual evoked potential that are recorded from scalp electrodes, it is desirable to measure the potentials at each scalp electrode position with respect to a distant, totally *inactive* reference electrode. In fact, it is not possible to find an inactive reference. Even if a physically distant reference position were chosen, as on a limb, volume conduction between

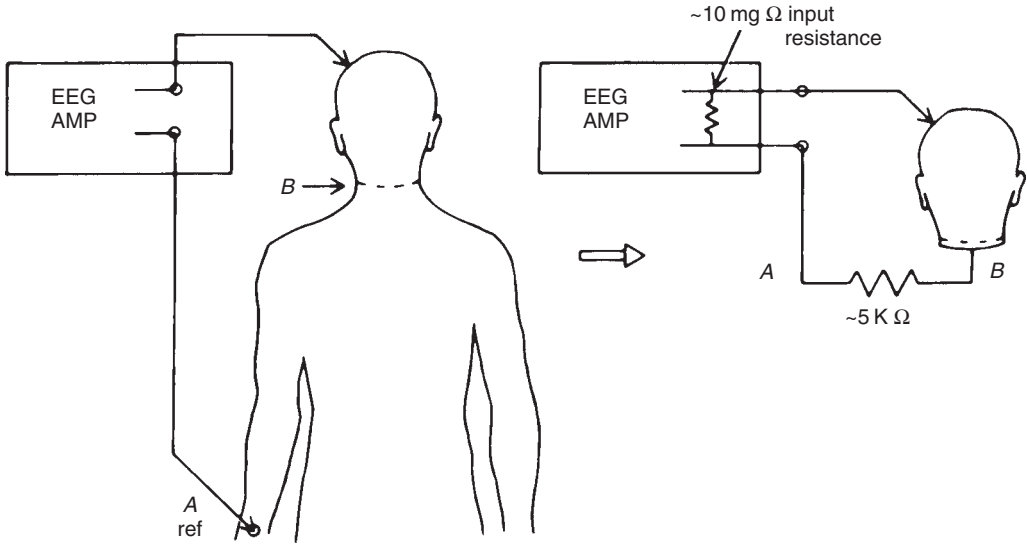
the head and the distant position would make the reference *active*; that is, the reference electrode would be electrically equivalent to a reference at the neck (still relatively close to intracranial generators), with a slight additional resistance that is negligible in its effect because of the very large input resistance of the EEG amplifier (Fig. 3-14). In addition, such a distant reference would have unacceptable characteristics in that very large artifacts, for example, those produced by the electrocardiogram, movement, and muscle, would probably be seen in the recording.

Properties of the volume-conducting medium between intracranial generators and scalp electrodes can have a major effect on the recorded potentials. When the poorly conducting skull is breached by openings, for example, naturally occurring openings such as the orbits or external auditory meatus or iatrogenic openings such as craniotomy defects, long current paths through the opening may cause appreciable electric potentials to be recorded in

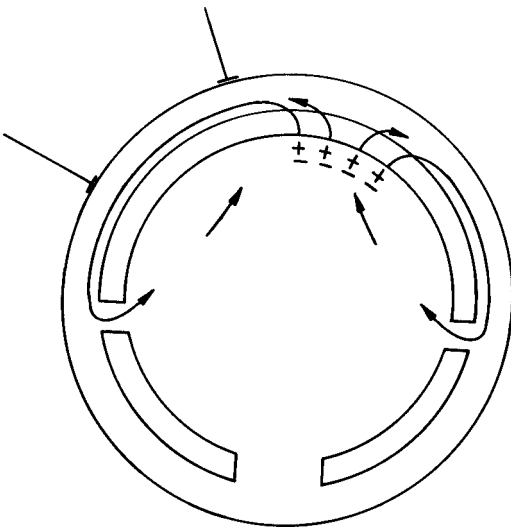


**Figure 3-13.** Traveling and stationary evoked potentials. *A*, Recording electrode sites from upper arm and shoulder with median nerve stimulation. *B*, Median nerve traveling action potentials evoked at the wrist and recorded along the arm and across the shoulder with bipolar (closely spaced electrodes). *C*, Elbow reference recordings showing fixed latencies stationary potentials at the shoulder. *D*, Action potential propagation from a smaller to a larger volume conductor region (two joined cylinders of unequal diameter but equal conductivities), illustrating the theoretical source of the stationary potential.





**Figure 3-14.** The futility of using a distant reference for scalp EEG recording. The right arm reference (A) is electrically equivalent to a neck reference (B), except for a slight additional resistance in series. AMP, amplifier. (From Nunez, P. L. ed. 1981. *Electric fields of the brain: The neurophysics of EEG*. New York: Oxford University Press. By permission of the publisher.)



**Figure 3-15.** The effect of skull openings on scalp-recorded potentials; the large skull resistivity—80 times that of scalp or brain—leads to long current paths through skull openings that may cause appreciable potentials to be recorded far from the generators. (From Nunez, P. L. ed. 1981. *Electric fields of the brain: The neurophysics of EEG*. New York: Oxford University Press. By permission of the publisher.)

areas that are, in fact, far from the generators (Fig. 3-15). Amplitude asymmetries, that is, differences between homologous regions on the opposite side of the head, are the most commonly observed effects of skull defects,

with higher amplitudes occurring on the side of the opening. A regional increase in the thickness of the conducting medium between intracranial generators and overlying electrodes may lead to a significant focal attenuation of electric activity, as in the case of a subdural hematoma or a collection of fluid. For *extracranial* generators such as the eyes, which have a constant electric dipole movement that induces changing electric potentials when they move, the effect of skull openings is reversed; that is, the amplitude of potentials caused by these generators is usually attenuated in the region of a large skull defect.

**Key Points**

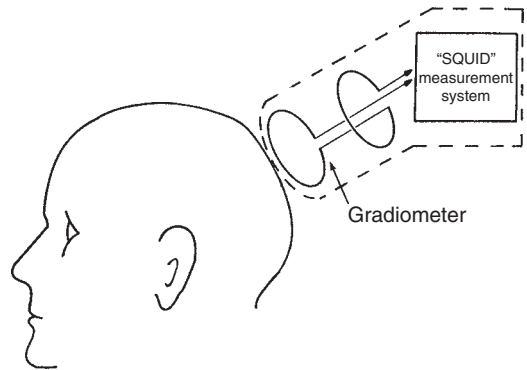
- There is no totally inactive reference for EEG; a distant body reference is electrically equivalent to a neck reference.
- Naturally occurring or surgical skull openings affect volume-conducted potentials, causing amplitude asymmetries.

**Dipole Source Localization in EEG**

In many clinical neurophysiologic studies, particularly EEG and evoked potential studies, conducted for clinical or research purposes, localization of the generators of a particular

waveform or activity is of paramount importance. Volume conductor theory, as discussed in this chapter, provides a way to calculate the surface potential distribution that would result from a known configuration of intracranial generators, the *forward problem*. However, it is also desirable to have a way to determine the type, location, strength, and orientation of all of the generators of a given scalp surface-recorded waveform or activity, the *inverse problem*. Unfortunately, for any given potential distribution recorded from the scalp surface, the number of possible configurations of generators that could equally produce that distribution well is infinite; in general, the inverse problem does not have a unique solution. If the problem can be constrained by independent anatomical or physiologic data, however, then a solution to the inverse problem may be possible.<sup>5</sup> For example, if there is reason to believe that a particular EEG waveform or evoked potential peak is generated by a localized intracranial source that may be well represented as a single electric dipole, then a model of the volume conductor properties of the head, such as the three-sphere model discussed above under Multiplanar and Multiple Sphere Models (see Appendix) can be coupled with an appropriate mathematical algorithm to find the location, orientation, and strength of the single dipole whose predicted scalp-potential distribution best fits the observed scalp potential.<sup>6,7</sup>

The inherent uncertainties in the geometry and electric properties of the volume conductor limit the accuracy with which dipole localization based on scalp-recorded potentials can be performed. A new technique for improving source localization derives from the magnetic field that any electrical current generates. Thus, intracranial current sources generate magnetic fields that, with appropriate sensing devices, may be detected at various locations outside the head. These magnetic fields, unlike scalp-recorded potentials, are unaffected by the intervening medium, and calculations of source locations from magnetic field maps thus may be performed without a need for complex and possibly inaccurate volume conduction models. With a sensitive magnetic detector, for example, a magnetometer or magnetic gradiometer (Fig. 3-16), and a special type of high-gain, low-noise amplifier, specifically, a superconducting quantum interference device, or SQUID, it is possible



**Figure 3-16.** A magnetoencephalographic recording device consists of a magnetic field gradiometer (two coils with opposite polarities connected in series) and a SQUID amplifier. (From Nunez, P. L. ed. 1981. *Electric fields of the brain: The neurophysics of EEG*. New York: Oxford University Press. By permission of the publisher.)

to record the magnetic equivalent of the EEG or evoked potentials known as the *magnetoencephalogram* (MEG) or the *evoked magnetic fields* (EMFs). This technique has been applied to research as well as clinical applications, and has allowed intracranial generators to be localized accurately and noninvasively.<sup>8-11</sup> Clinical applications include localizing the seizure focus by determining the generators of interictal spikes and focal slow waves in patients with intractable partial epilepsy who are being considered for epilepsy surgery and using somatosensory magnetic evoked fields to accurately locate the somatosensory cortex as part of the planning process for a surgical procedure, for example, resection of a brain tumor. Middle- and long-latency auditory magnetic evoked fields have also been used to accurately locate auditory and speech reception cortical regions and to noninvasively lateralize cortical language function.

### Key Points

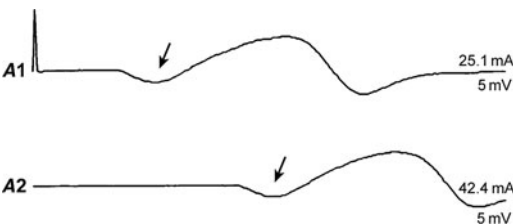
- Finding the location, strength, and orientation of all generators of scalp-recorded waveforms is the “inverse problem.”
- The “inverse problem” has no unique solution for an arbitrary number and configuration of generators.
- Attempts to solve the “inverse problem” often depend on assuming there is just one (or a few) dipole generators.
- Magnetoencephalographic recordings may be more suitable than EEG for solving the “inverse problem.”



## Nerve Conduction Study Applications

Volume conduction has an important effect on the responses recorded during nerve conduction studies. In motor conduction studies, the typical recording montage of G1 over the motor endplate and G2 over the muscle tendon allows for recording of an initially negative (upward deflection from baseline) waveform with a maximal amplitude. A biphasic, negative-positive waveform is recorded. When a triphasic waveform with an initial positivity is recorded during motor nerve conduction studies, the initial positive waveform component is generated from muscle fiber action potentials that have an endplate region at some distance away from the G1 recording electrode. These distant muscle fiber action potentials propagate through the conducting medium to the recording electrode and produce a positive deflection. This initial positivity may be the result of the G1 electrode placed at the wrong site (off of the endplate zone) on the muscle being recorded from. In this case, the initial positivity will be present with stimulation at any site along the nerve (Fig. 3–17).

Alternatively, the initial positivity may be generated from a muscle distant from that being recorded, either from a physiologic phenomenon or due to overstimulation during the nerve conduction study (NCS) with stimulus spread to another nerve. The latter situation is commonly seen with peroneal motor conduction studies, recording from the extensor digitorum brevis, in which stimulation at the knee causes depolarization of the anterior compartment muscles of the leg (such as the anterior tibialis), which is recorded from the distant electrodes over the foot (Fig. 3–9). It is also often seen in situations where there is severe



**Figure 3–17.** Initial positivity recorded on a median motor conduction study due to active electrode location off the site of generation (end plate region).

atrophy of the muscle being recorded from, where some stimulation of a neighboring nerve produces a recordable response. An example of this is in severe carpal tunnel syndrome, when the ulnar nerve is inadvertently stimulated and the response from ulnar muscles are readily recorded over the thenar eminence.

Other morphologic features of the waveforms also result from volume conduction. As mentioned previously, the G2 electrode is not truly “inactive.” The G2 electrode, even when placed over the digit, contributes to the compound muscle action potential, particularly in the ulnar and tibial motor nerve conduction studies.

Sensory nerve conduction studies may produce biphasic (negative-positive) or triphasic (positive-negative-positive) waveforms. Triphasic (initially positive) waveforms are common with sensory nerve conduction studies since, in contrast to motor NCS where the recording electrodes are placed immediately over the site of action potential generation, the action potential is always generated at a distance from the G1 recording electrode and propagates toward and then away from the electrodes.

### Key Points

- When a triphasic waveform with an initial positivity is recorded during motor nerve conduction studies, the initial positive waveform component is generated from muscle fiber action potentials that have an endplate region at some distance away from the G1 recording electrode.
- An initial positivity on motor NCS may be generated from a muscle distant from that being recorded, either from a physiologic phenomenon or due to overstimulation during the NCS with stimulus spread to another nerve.
- The G2 electrode contributes to the compound muscle action potential, particularly in the ulnar and tibial motor nerve conduction studies.
- Triphasic, initially positive waveforms are common with sensory nerve conduction studies, since the action potential is always generated at a distance from the G1 recording electrode and propagates toward and then away from the electrodes.

## Needle EMG Applications

Volume conduction plays a role in the recording of EMG waveforms. The source of all EMG waveforms are the action potentials of individual muscle fibers. As previously discussed, these action potentials can be considered quadrupoles that propagate along the muscle fiber. These action potentials are recorded as a triphasic (positive-negative-positive) potential as the current sources of the potential travel past a stationary recording electrode. Since the spatial gradient and current density are higher nearer the generator, a triphasic muscle fiber action potential will have (1) a higher amplitude due to the recording of higher density of current charge, (2) a more rapid rise time in the peak of the potentials due to the higher density of equipotential lines and (3) more rapid rate of change in the current density as the propagating action potential passes, with proximity of the recording needle electrode to the generator (Fig. 3–11).

The volume conduction concepts also help to explain how the motor unit potentials differ in morphology when recorded with a concentric needle electrode compared to a monopolar electrode. With a concentric needle electrode, the “active” and “reference” recording sites are very close to each other and, as a result, current that is generated at a distance from the electrode (such as action potentials of distant muscle fibers in the motor unit) is recorded at the point where the spatial gradient is low and therefore the difference in current recorded at each site is minimal, essentially canceling out a recorded potential. In contrast, recording the same motor unit potential recorded with a monopolar needle electrode, in which the “active” recording site is much closer to the generator compared to the “reference” electrode (which is usually placed at a distance on the skin), will show a greater difference in the electrical potentials generated from distant muscle fibers. This results in higher amplitude and longer duration motor unit potentials when recorded with a monopolar electrode.

### Key Points

- Muscle fiber action potentials recorded during needle EMG are recorded as a triphasic (positive-negative-positive) potential as the current sources of the potential

travel past a stationary recording electrode.

- With a concentric needle electrode, the “active” and “reference” recording sites are very close to each other and, as a result, the recorded difference in current that is generated at a distance from the electrode (from distant fibers) is minimal.
- Motor unit potentials recorded with a monopolar needle electrode, in which the “active” recording site is much closer to the generator compared to the “reference” electrode, are of higher amplitude and longer duration than those recorded with a concentric needle electrode.

## SUMMARY

This chapter reviews the principles of volume conduction as applied to the potentials recorded in clinical neurophysiologic studies. Knowledge of these principles is necessary for proper interpretation of EEG, EMG, NCS, SEP, VEP, and BAEP recordings in order to extract information concerning the function and location of the neural structures that generate the recorded activity or waveforms.

## REFERENCES

1. Niedermeyer, E., and F. Lopes da Silva, eds. 1993. *Electroencephalography: Basic principles, clinical applications, and related fields*, 3rd ed. Baltimore: Williams & Wilkins.
2. Stein, R. B. ed. 1980. *Nerve and muscle: Membranes, cells, and systems*, 65–86. New York: Plenum Press.
3. Dumitru, D., and J. A. DeLisa. 1991. AAEM minimonography #10: Volume conduction. *Muscle Nerve* 14:605–24.
4. Stegeman, D. F, A. van Oosterom, and E. J. Colon. 1987. Far-field evoked potential components induced by a propagating generator: Computational evidence. *Electroencephalography and Clinical Neurophysiology* 67:176–87.
5. van Oosterom, A. 1991. History and evolution of methods for solving the inverse problem. *Journal of Clinical Neurophysiology* 8:371–80.
6. Scherg, M. 1992. Functional imaging and localization of electromagnetic brain activity. *Brain Topography* 5:103–11.
7. Wong, P. K. 1991. Source modelling of the rolandic focus. *Brain Topography* 4:105–12.
8. Cohen, D., and B. N. Cuffin. 1991. EEG versus MEG localization accuracy: Theory and experiment. *Brain Topography* 4:95–103.

9. Stok, C. J., H. J. Spekreijse, M. J. Peters, H. B. Boom, and F. H. Lopes da Silva. 1990. A comparative EEG/MEG equivalent dipole study of the pattern onset visual response. *Electroencephalography and Clinical Neurophysiology Suppl.* no. 41:34–50.
10. Papanicolaou, A. C., P. G. Simos, J. I. Breier, et al. 1999. Magnetoencephalographic mapping of the language-specific cortex. *Journal of Neurosurgery* 90:85–93.
11. Nakasato, N., and T. Yoshimoto. 2000. Somatosensory, auditory, and visual evoked magnetic fields in patients with brain diseases. *Journal of Clinical Neurophysiology* 17:201–11.
12. Lorente de No R. 1947. *Potential fields in homogenous conductors*. New York: Rockefeller Press.

## APPENDIX

### Calculating Potentials in Infinite Homogeneous Media

The simplest form of a volume conductor is a homogeneous medium without boundaries in which generators and recording electrodes are embedded. In this situation, the recorded potential can be calculated from the configuration of the source currents.

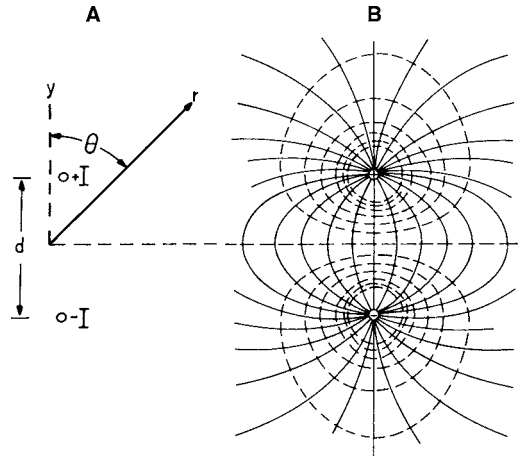
#### MONOPOLE, DIPOLE, AND QUADRUPOLE SOURCES

A single source, or sink, of current is referred to as a *monopole*. The potential relative to a distant reference at distance  $r$  from a monopole source in an infinite homogeneous medium of conductivity  $\sigma$  (resistivity  $\rho = 1/\sigma$ ) is given by

$$V = \frac{I}{4\pi\sigma r}$$

The potential relative to a distant reference measured at distance  $r$  from a dipole source in an infinite homogeneous medium of conductivity  $s$  is given by  $V = Id(\cos \theta)/4\sigma\pi r^2$ , where  $I$  is the magnitude of the dipole current source,  $d$  is the pole separation, and  $\theta$  is the angle between the dipole axis and the line from the dipole to the measurement point (Fig. 3–18A); this formula is valid only for  $r \gg d$ . Thus, the potential of a dipole falls off inversely with the square of the distance from the source. The lines of current flow around a dipole form curved paths (Fig. 3–5B). The equipotential surfaces are perpendicular to the lines of current flow and have a figure-8 configuration around the dipole.<sup>2</sup> The zero potential surface is a plane halfway between the two poles of the dipole, because on this plane  $\theta = 90^\circ$  and  $\cos \theta = 0$  (Fig. 3–18B).

Two adjacent current dipoles of opposite orientation placed end-to-end constitute a current quadrupole. The potential of a quadrupole falls off inversely with the cube of the distance from the source, and the equipotential surfaces around the quadrupole have a “cloverleaf” configuration. A quadrupole is a fair approximation of the



**Figure 3–18.** A current dipole. A, Coordinate system showing definition of  $r$  and  $d$ . B, Lines of current flow (solid) and equipotential lines (dashed) in a volume conductor. (From Nunez, P. L. ed. 1981. *Electric fields of the brain: The neurophysics of EEG*. New York: Oxford University Press. By permission of the publisher.)

potential generated by an action potential propagating along an axon: the axonal membrane has a negative polarity outside and a positive polarity inside at the peak of the action potential. However, on either side of this peak, the membrane is positive outside and negative inside. Nerve action potentials have positive sources ahead of and behind the depolarization, and a central negative sink (the area of nerve depolarization).

### Potentials in Nonhomogeneous Media

In contrast to the volume conduction in a simple, homogeneous conducting medium, when a monopolar source is located in two hemi-infinite regions of differing conductivity with a planar interface between them, the lines of current flow change at the interface. This occurs because the current density (current per unit area) flowing in the direction parallel to the interface is less in the region of higher conductivity. Consequently, if the source is located in the region of lower conductivity, the lines of current flow bend outward as they enter the region of higher conductivity. If the source is located in the region of higher conductivity, the lines of current flow bend inward as they enter the region of lower conductivity.

There are a number of inhomogeneities in the body, such as interfaces between limbs or body regions and interfaces between the body and the external environment. Sources located a short distance under the skin surface, for example, superficial nerve action potentials or EEG activity from cortical sources 2–3 cm deep, can be approximated as a plane with a volume conductor of high conductivity on one side of the region and of air on the other side with essentially zero conductivity on the other side. No current flow penetrates from the high conductivity region to the zero conductivity region, and the lines of current flow are

completely reflected at the interface. Consequently, potentials measured at the interface, that is, surface-recorded potentials, caused by underlying generators are twice as large as they would be for the same generators in an infinite homogeneous medium. Some extracellular currents from a generator in a volume conductor reach the skin surface, where the current causes a potential drop across the space between two electrodes (Ohm's law). This potential difference can be measured by a recording system with a differential amplifier.

## Homogeneous Sphere Model

For sources located in the head, such as cortical and subcortical generators of EEG and evoked potentials, a spherical volume conductor model is a reasonable approximation to the actual geometry. The simplest model assumes a uniform conductivity within a sphere with a dipole source located at the *center* of the sphere. At points near the center of the sphere the potential is the same as that expected in an infinite homogeneous medium, but at the surface of the sphere the lines of current flow are confined to the spherical volume and the current density is greater. Thus, scalp surface recordings are three times greater in amplitude than intracerebral recordings. Brain stem generator of short latency auditory evoked potential peaks are amplified in that manner.

## Multiplanar and Multiple Sphere Models

An air-body interface surface is only one of the inhomogeneities that affects volume conduction. For EEG and scalp-recorded evoked potentials, the other inhomogeneities of importance are the differing conductivities of

brain, cerebrospinal fluid (CSF), skull, and scalp. Both multiplanar and multiple sphere models have been used to investigate the effects of these regions.

For dipole sources located in the cerebral cortex and for subdural recording electrodes, a model using two planar interfaces (brain-CSF and CSF-skull) can be used. This model predicts that the measured potentials would be approximately equal to those that would be recorded in an infinite homogeneous medium. For cortical dipole sources with scalp surface-recording electrodes, a model using five regions (brain, CSF, skull, scalp, and air) and four planar interfaces predicts that the measured potentials would be approximately equal to one-fourth of those that would be recorded in an infinite homogeneous medium. This may be compared with the factor-of-2 augmentation of potentials predicted by the single planar interface model; the predicted relative attenuation (by a factor of 8) is caused mainly by the effects of the poorly conducting skull, whose conductivity is only about 1/80 that of brain or scalp. The effect of the skull may be diminished markedly in subjects who have a skull defect, for example, because of previous surgery. The EEG activity in the vicinity of such a defect may be several times greater in amplitude than the EEG activity in surrounding regions where the skull is intact.

For deep dipole sources such as BAEP generators, a multiple sphere model with four regions (brain, skull, scalp, and air), three spherical interfaces, and a dipole in the center is appropriate. For scalp surface-recording electrodes, this model predicts that the measured potentials would be approximately equal to twice those that would be recorded in an infinite homogeneous medium. This may be compared with the factor-of-3 augmentation of potentials predicted by the homogeneous sphere model; the predicted relative attenuation (by a factor of 2/3) caused by the poorly conducting skull is not nearly as great for deep sources as it is for superficial, or cortical, generators.<sup>12</sup> The effect of skull defects on potentials from deep sources is correspondingly less than that from superficial sources.

*This page intentionally left blank*

## Chapter 4

---

# Digital Signal Processing

*Terrence D. Lagerlund*

### **DIGITAL COMPUTERS IN CLINICAL NEUROPHYSIOLOGY**

Introduction  
Digital Clinical Neurophysiology  
Digital Electroencephalography  
Construction Of Digital Systems

### **DIGITIZATION**

Principles  
Analog-to-Digital Conversion

### **COMMON USES OF DIGITAL PROCESSING**

**AVERAGING**  
Evoked Potentials and Nerve  
Conduction Studies

Repetitive Transient Waveforms  
Movement-Associated Potentials

### **DIGITAL FILTERING**

Types of Digital Filters  
Characteristics of Digital Filters

### **TIME AND FREQUENCY DOMAIN ANALYSIS**

Interval Analysis  
Autocorrelation Analysis  
Fourier (Spectral) Analysis  
Statistical Analysis  
Pattern Recognition

### **SUMMARY**

## **DIGITAL COMPUTERS IN CLINICAL NEUROPHYSIOLOGY**

### **Introduction**

Digital computers can perform types of signal processing not readily available with analog devices such as ordinary electric circuits. Because of their large storage capacities and rapid, random-access retrieval, they can make the process of obtaining, storing, retrieving, and viewing clinical neurophysiology data easier. Also, because of their sophisticated computational abilities, they may aid in extracting from waveforms information that

is not readily obtainable with visual analysis alone. Furthermore, they are well suited for quantification of key features of waveforms. This may be useful in accurate clinical diagnosis of electroencephalographic (EEG), electromyographic (EMG), and evoked potential studies, and it also lends itself to serial comparisons between studies performed on the same subject at different times or between two groups of subjects in scientific investigations. Digital computers may also partially automate the interpretation of clinical neurophysiology studies. This chapter discusses the uses of digital signal processing and storage that are common to many types of physiologic studies.



**Key Points**

- Digital computers can make it easier to obtain, store, retrieve, and view clinical neurophysiology data.
- They can be used to extract information not readily obtainable with visual analysis alone.
- They can quantify key features of waveforms.
- They can facilitate serial comparisons between studies on the same subject at different times.
- They can partially automate the interpretation of clinical neurophysiology studies.

**Digital Clinical Neurophysiology**

In recent years, digital instruments have largely replaced analog instruments. The advantages of digital over the analog recordings that had been used for the early work in each of the fields of clinical neurophysiology derive from the unique capabilities of digital recording technology. These capabilities include:<sup>1</sup>

- Convenient storage and retrieval of records
- Montage reformatting
- Filter, sensitivity, and time base changes
- Reliability of interpretation
- Rapid location of events and features of interest
- Annotating recordings
- Quantitative analysis of background activity and transients

The disadvantages of digital instruments include the following:

- **Cost**—Digital instruments may be more expensive, particularly in the long term, because with the rapid evolution of computer technology, digital instruments become obsolete more rapidly than their analog counterparts did.
- **Maintenance**—Repair of digital instruments requires more knowledge than is required for analog machines, and troubleshooting is more complex. Maintenance personnel must be knowledgeable about computers and computer software as well as hardware. Digital instruments may be less fault-tolerant, and equipment failures

may be more catastrophic with digital systems, with possible loss of an entire study because of system failure.

- **Incompatible data formats**—In marked contrast to the relatively standard data formats used in the personal computer industry that facilitate sharing of data, digital instruments use data formats that are proprietary to each manufacturer, and in general, studies recorded on the instruments of one manufacturer cannot be read on those of another. This limits the ability to share studies between laboratories. To surmount this difficulty, some companies now offer reader programs for personal computers that are capable of reading the data formats used by many different manufacturers, but these programs are an additional expense.
- **Obsolescence of data formats**—As digital systems evolve and new models are released, recording formats may change over time even with the same manufacturer; thus, eventually, it may be impossible to use current systems to review studies acquired on older instruments.

However, the advantages of digital recording outweigh the disadvantages, and all fields of clinical neurophysiology are moving steadily toward digital technology. The greatest impact of digital recordings has been in EEG, as discussed in the following section.

**Digital Electroencephalography**

Although the accuracy of visual reproduction of the EEG waveforms on digital EEG instruments was limited in the past by the resolution of the screen display, this limitation has been largely overcome by the ready availability of personal computer graphics cards and monitors with resolutions of 1280×1024 pixels or higher. Furthermore, digital EEG may be combined with digital video recording for the evaluation of patients with seizures or spells. With the combination of EEG and video, the EEG can be correlated with clinical behavior during transient spells or seizures. Moreover, by recording both the EEG and video in a digital format, events of interest can be located quickly during prolonged recordings and the video can be displayed nearly instantaneously, compared to analog video recordings

that require time-consuming tape searches for the segment of interest. Also, digital recording of video significantly facilitates the editing and copying of video segments.

Applications of the unique capabilities of digital recording technology are illustrated in the following discussion of digital EEG:<sup>1</sup>

- Linear display—In contrast to pen-based analog recordings on paper, in which the movement of the pen along the arc of a circle (rather than perpendicular to the direction of paper movement) causes a nonlinear distortion of waveform morphology when high-amplitude pen excursions occur, a digital display accurately represents the waveform morphology independently of signal amplitude.
- Convenient storage and retrieval of records—Multiple digital recordings (typically hundreds of EEG studies) may be kept online for quick retrieval, and larger numbers of older recordings (thousands of studies) may be archived on digital media (such as CD-ROM, DVD-ROM, or BD-ROM) that require very little storage space and from which they may be readily retrieved when needed. This significantly reduces storage space requirements compared with analog recordings on paper and eliminates the need for microfilming paper recordings. With standard computer networks, recordings (including digital video, when applicable) may be viewed on appropriately configured personal computers located at sites remote from the instruments used for recording without a need to physically transport the record. Wide area networks allow records to be accessed at essentially unlimited distance from the recording location, and currently available high-speed network connections to homes allow reading of emergency and after-hours recordings in the reviewer's home.
- Montage reformatting—On digital instruments, the EEG montage is selected at the time the EEG is reviewed, rather than at the time of recording. Digital instruments record all data using a referential montage with a single common reference electrode (such as  $C_z$  or an average ear reference). All other montages then can be reconstructed by simple arithmetic operations on the recorded

referential data. In addition to the routine bipolar and referential montages, special montages such as a common average reference or a laplacian (source) montage may be used.

- Filter, sensitivity, and time base changes—In a similar fashion, the high- and low-frequency filters and notch filter, the vertical display scale (sensitivity), and the horizontal display scale (time base) are selected at the time the EEG is reviewed, rather than at the time of recording.
- Reliability of interpretation—A recent study comparing the accuracy of interpretation of digital vs. analog EEG recordings demonstrated a clear advantage of digital EEG review,<sup>2</sup> which most likely is related to the ability to view the same EEG segment using several different montages, filters, and sensitivities. In this study, two experienced board-certified electroencephalographers each read 89 pediatric EEGs recorded digitally. The studies were read either in conventional analog paper format, using a digital display but without use of digital tools such as montage reformatting, digital filtering, time base or sensitivity adjustment at review time, or using all the features of a digital system. The inter-reader agreement ( $\kappa$ ) was calculated for each reading condition.  $\kappa$  values of 0–0.39 represent poor agreement, 0.40–0.59 fair agreement, 0.60–0.74 good agreement, and 0.75–1.00 excellent agreement. As shown in Table 4–1, the inter-reader agreement in classification of records as normal vs. abnormal and focal vs. nonfocal was best when interpretation was done using digital tools.
- Rapid location of events and features of interest—Typical digital EEG instruments allow rapid paging or scrolling through the record in the forward or reverse direction as well as skipping directly to specific times or specific events (marked by the technologist or another person reviewing the EEG).
- Annotating recordings—During the recording, technologists may enter textual comments about the recording conditions or the patient's behavior; these replace the comments that would be written on a paper record. Also, the reviewer may mark entire "pages" of the EEG record or mark



Table 4-1 **Inter-Reader Agreement (kappa) in Classification of EEG Records**

Reading condition	Normal vs. abnormal	Focal vs. nonfocal
Paper (analog)	0.69	0.46
Digital without reformatting	0.61	0.5
Digital with reformatting	0.81	0.65

individual waveforms or features and label these with text descriptions.

- Quantitative analysis of background activity and transients—This may include interval analysis, autocorrelation analysis, spectral analysis, statistical analysis, and pattern recognition (such as automatic spike or seizure detection) as well as cross-correlation and cross-spectral analyses, interpolation, topographic displays, multivariate statistical methods, cortical projection techniques, and source localization.

## Construction Of Digital Systems

A digital (computerized) system for acquisition, storage, and display of physiologic waveforms has the following key components:

- Electrodes
- Amplifiers and filters
- Analog-to-digital converters
- Solid-state digital memory
- Digital processor (central processing unit)
- Magnetic or optical disk (or tape) storage
- Screen or printer for waveform display

The electrodes, amplifiers, and filters in a digital system are essentially identical to those in an all-analog system. The amplified signal for each channel is sent to an analog-to-digital converter (ADC), which converts it by the process of *digitization* to digital form and stores it in solid-state memory. A digital processor is capable of moving digital data around in memory and processing or manipulating it; it may also send data to a magnetic or optical disk or tape storage media for permanent storage, or it may generate displays of waveforms and related textual annotations on a screen or printer.

## DIGITIZATION

### Principles

Electric signals derived from an electrode or some other type of transducer may be used to represent electric or nonelectric physiologic quantities (such as potential in microvolts, current in milliamperes, pressure in millimeters of mercury, or oxygen saturation in percentage) in one of two ways. An *analog* signal takes on any potential (voltage) within a specific range (e.g.,  $-3$  to  $3$  V). The potential generally is directly proportional to the physiologic quantity represented by the signal; therefore, that potential is an *analog* of the physiologic quantity. Analog signals are generally *continuous* in the sense that the potential varies continuously as a function of time. In contrast, a single digital signal may take on only one of two possible potentials (e.g.,  $0$  or  $3$  V); such a signal may represent one of two possible states (on or off; yes or no) or one of two possible digits ( $0$  or  $1$ ) and is said to represent one *bit* (*binary digit*) of information. Multiple digital signals may be used to represent a physiologic quantity as a binary number (a series of  $0$ s and  $1$ s forming a quantity in a base  $2$  number system; that is, the rightmost digit has a value of  $2^0 = 1$ , the second digit from the right has a value of  $2^1 = 2$ , the third digit has a value of  $2^2 = 4$ , etc.). Digital signals are *discrete* and *discontinuous* (i.e., they have only two possible states), and the nearly instantaneous transition from one state to another is made only at specific times. This is the only format in which digital computers can store and process information, and it is most suited to performing complex and accurate arithmetic operations (e.g., adding, subtracting, multiplying, dividing) or logical operations (logical conjunction, disjunction, negation). Analog representations are more suited for human interpretation; for

example, a waveform display generally uses vertical displacement as an analog to the physiologic quantity, such as the potential being displayed, and horizontal displacement as an analog to elapsed time.

**Key Points**

- An analog signal takes on any potential (voltage); the potential is directly proportional to the quantity measured.
- Analog signals are continuous (vary continuously as a function of time).
- A digital signal takes on only one of two possible potentials and represent one of two possible states or digits 0 or 1.
- Digital signals are discrete and discontinuous (the transition from one state to another is made only at specific times).

that can be detected by the ADC and corresponds to a change of 1 in the least significant bit ( $2^0$ ). A typical value might be 1 mV (for the *amplified* signal reaching the ADC).

- Number of bits in ADC ( $n$ )—This determines the range of digitized (output) values. For an ADC that can accept positive or negative inputs, 1 bit is required for sign (+ or -), and the fractional resolution is then 1 part in  $2^{n-1}$ . A typical value might be 9–16 bits (corresponding to  $\pm 1$  part in 256 to 1 part in 32,768).
- Input range—This determines the maximum and minimum input potentials. Input potentials above or below the maximum or minimum are called *overflow* or *underflow*, respectively. A typical value might be  $\pm 2$  V.

**Analog-to-Digital Conversion**

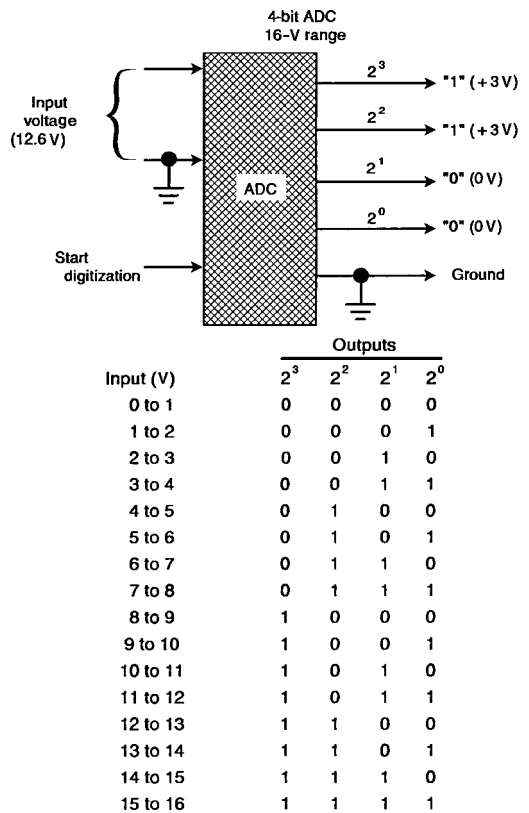
*Digitization*, or analog-to-digital conversion, is the process by which analog signals are converted to digital signals. It is the transformation of *continuous* potential changes in an analog signal representing a physiologic quantity to a sequence of discrete digital numbers (binary integers). Digitization is performed by a complex circuit known as an *analog-to-digital converter* (ADC). There are two aspects to digitization: *quantization* and *sampling*.

**QUANTIZATION**

*Quantization* describes the assignment of a digital number to the instantaneous value of the potential input to the ADC. A simple example is shown in Figure 4–1, which shows a 4-bit ADC, whose input is an analog signal in the range 0–16 V, and whose output is a 4-digit binary number that can take on the values 0, 1, 2, . . . , 15. In this example, any input potential between 12 and 13 V will result in the same output (12); thus, the resolution of the ADC (also known as the *quantum size*) is 1 V. The input range of the ADC is 0–16 V.

In general, the following three terms characterize quantization:

- Quantum size (ADC resolution)—This determines the minimum potential change



**Figure 4–1.** Scheme of a 4-bit ADC. Inputs consist of the continuous signal to be digitized (range 0–16 V) and a start digitization pulse from a clock that is used to initiate digitization at appropriate times. Outputs consist of four digital signals (+3 or 0 V representing “1” and “0”) that together can encode a 4-bit integer (range 0–15).

The three quantization parameters are related by the formula:

$$\text{Input Range} = \pm \text{ADC Resolution} \times (2^{n-1} - 1)$$

where  $n$  = number of bits. Note that the input range of the ADC should match as closely as possible the expected range of amplified potentials. If the range of a signal exceeds the ADC range, the ADC will either overflow or underflow and the signal will be distorted (*clipped*), but if the range of a signal is too small compared with the ADC range, much of the resolution of the ADC will be wasted and the effective resolution may be insufficient, again distorting the signal significantly (Fig. 4-2).

### Key Points

- Quantization is the assignment of a digital number to the instantaneous potential of the signal.
- Important parameters of quantization are quantum size, number of bits, and input range.

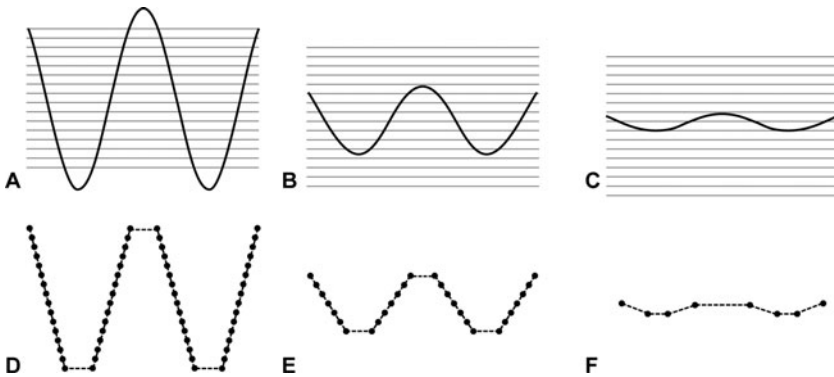
### SAMPLING

In digitization, the conversion of the continuous analog signal to digital form is usually performed at discrete equidistant time

intervals. The following two terms characterize sampling:

- Sampling interval—This determines the temporal resolution of the digitizer. A typical value may range from 0.01 ms (for brain stem auditory evoked potentials) to 5 ms or more (for EEG).
- Sampling frequency—This is the reciprocal of the sampling interval and is measured in hertz (Hz) ( $s^{-1}$ ).

In addition to determining the temporal resolution of the digitizer, the sampling frequency determines the maximum frequency in the signal to be digitized that can be adequately represented. The *sampling theorem* (*Nyquist theorem*) states that if a signal contains component frequencies ranging from 0 to  $f_N$ , then the minimum sampling frequency that can be used for the digitized data to adequately represent the frequency content of the original signal is  $2f_N$ , where  $f_N$  is the Nyquist frequency. The Nyquist frequency can be calculated from the sampling interval as  $f_N = 1/(2 \times \text{sampling interval})$ . For example, if  $f_N = 50$  Hz, then the sampling frequency must be at least 100 Hz (sampling interval of 0.01 second or less). This sampling frequency is the *minimum* necessary to avoid *gross* distortion of the input signal; a larger sampling frequency (by a factor of 3-5) may be necessary in many applications to



**Figure 4-2.** Effect of quantization parameters, that is, ADC resolution and input range, on the fidelity with which an analog signal can be represented digitally. In A, the signal exceeds the input range, so that its digital representation (D) is clipped. In B, the signal uses more than 50% of the input range and is relatively well represented (E). In C, the signal uses less than 15% of the input range and, because of the limited resolution of the ADC, it is poorly represented (F). (From Spehlmann, R. 1985. *Evoked potential primer: Visual, auditory, and somatosensory evoked potentials in clinical diagnosis*, 35-52. Boston: Butterworth Publishers. By permission of the publisher.)

achieve adequate resolution of fine details in the waveforms being digitized.

Sampling rates for clinical neurophysiological recordings are:

EMG—1,000,000 Hz (1.0  $\mu$ s sampling interval)  
 BAER—100,000 Hz (10  $\mu$ s sampling interval)  
 EEG—200 Hz (5 ms)

### Key Points

- Conversion of an analog signal to digital is performed at discrete equidistant time intervals (sampling).
- The Nyquist frequency is the maximum frequency present in the signal.
- The sampling theorem states that the minimum sampling frequency is twice the Nyquist frequency.

### ALIASING

Sampling at a frequency lower than  $2f_N$  produces *aliasing*. Aliasing is distortion of a signal caused by *folding* of frequency components in the signal *higher* than  $f_N$  onto lower frequencies. For example, a sine wave of 75 Hz, if sampled at 100 Hz, will appear in the digitized data as a sine wave of frequency 25 Hz, not 75 Hz. Aliasing *must always be avoided* or else the digitized data will be a gross misrepresentation of the true signal. In practice, aliasing is avoided by *filtering* the input signal before digitization to remove all frequencies above the Nyquist frequency (Fig. 4-3).

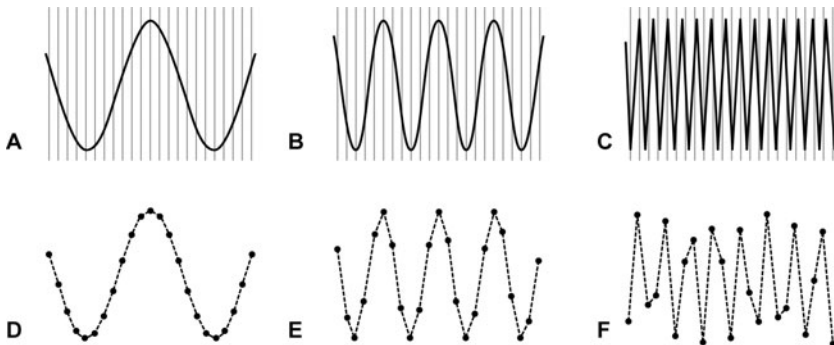
For example, if the sampling interval in use is 5 ms, the Nyquist frequency is 100 Hz. A 70-Hz low-pass filter with 6 dB per octave slope would attenuate frequencies of 100 Hz to 0.57 of their original amplitude, which may not be enough. A 50-Hz low-pass filter with 12 dB per octave slope would attenuate frequencies of 100 Hz to 0.2 times their original amplitude, which may be enough to prevent significant contamination of the digitized signal by aliased frequency components, provided that the amplitude of the faster components in the original signal is relatively small.

### Key Points

- Sampling at a frequency lower than twice the Nyquist frequency produces aliasing (distortion of the signal).
- Aliasing is avoided by filtering the signal prior to digitization to remove frequencies above the Nyquist frequency.

## COMMON USES OF DIGITAL PROCESSING

One common use of digital signal processing in clinical neurophysiology is signal averaging, particularly in evoked potential and sensory nerve conduction studies. Averaging may also be applied to repetitive transient waveforms and event-related potentials (such as movement-associated potentials). A second



**Figure 4-3.** Effect of sampling interval and aliasing on the fidelity with which an analog signal can be represented digitally. In A, the sampling frequency is 14 times that of the signal frequency and the signal is well represented (D). In B, the sampling frequency is only six times the signal frequency, and the representation is less accurate but still acceptable (E). In C, the sampling frequency is only 1.5 times the signal frequency, and thus less than the Nyquist frequency; the consequent aliasing causes the digital representation (F) to be entirely misleading in that it appears to have a frequency that is approximately half the true frequency. (From Spehlmann, R. 1985. *Evoked potential primer: Visual, auditory, and somatosensory evoked potentials in clinical diagnosis*, 44. Boston: Butterworth Publishers. By permission of the publisher.)

major use of digital signal processing is for digital filtering. Less common but still important uses are in time–frequency analysis, including interval and Fourier (spectral) analysis, autocorrelation analysis, statistical analysis, and automated pattern recognition. Other uses tend to be more specialized to particular types of clinical neurophysiologic studies; some of these are discussed elsewhere in this book.

**Key Points**

- Signal averaging is performed in evoked potential studies and averaging of repetitive transient waveforms.
- Digital filtering can be useful for many types of clinical neurophysiology studies.
- Spectral analysis, autocorrelation, statistical analysis, and pattern recognition are other uses of digital processing.

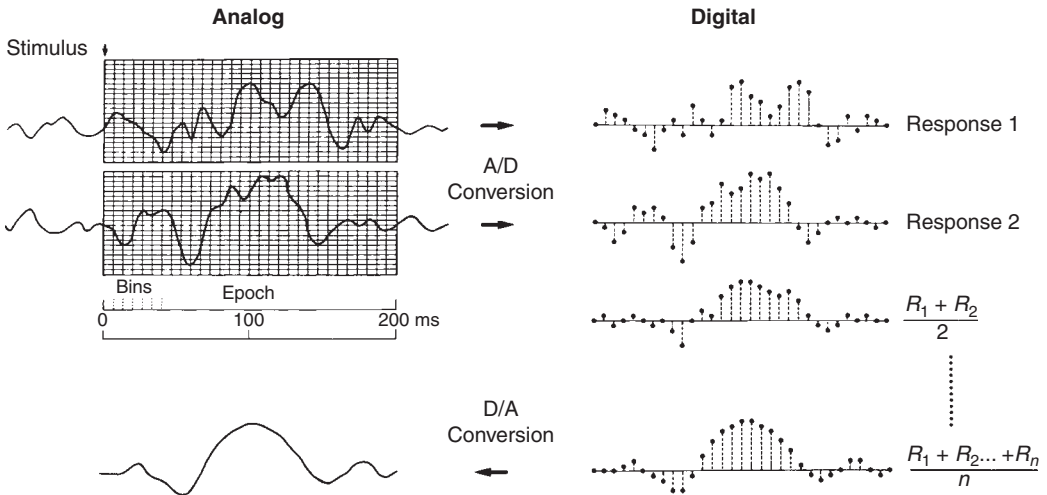
**AVERAGING**

**Evoked Potentials and Nerve Conduction Studies**

Digital averaging devices for nerve conduction studies and evoked potentials are used routinely in clinical neurophysiology. Their function is similar regardless of the type of

signal averaged, although for different types of studies the epoch length for averaging differs significantly. Epoch lengths of 200–500 ms are typical for visual and long-latency auditory evoked potentials. Epoch lengths of 30–100 ms are typical for middle-latency auditory evoked potentials and for nerve conduction studies. Epoch lengths of 10–20 ms are typical for brain stem auditory evoked potentials and electrocochleograms.

The basic operation of an averager is shown in Figure 4–4. After each stimulus, the input signal is digitized at several discrete sampling times within a fixed-length epoch that begins at the time of the stimulus. Digitized values of potential at each discrete sample time, each characterized by its latency (time after the stimulus), are averaged for many stimuli; the resulting averaged signal may be displayed on a screen or printed on paper. The stimulus-dependent portions of the signal (the evoked potential or nerve action potential) are similar in amplitude and latency in each epoch averaged and appear in the averaged result, whereas the stimulus-independent (random) portions of the signal (noise and background neuronal activity among others) differ substantially from epoch to epoch and are suppressed by averaging. The suppression factor, which often is called the *signal-to-noise ratio*, for truly random signals is  $\sqrt{n}$ , where

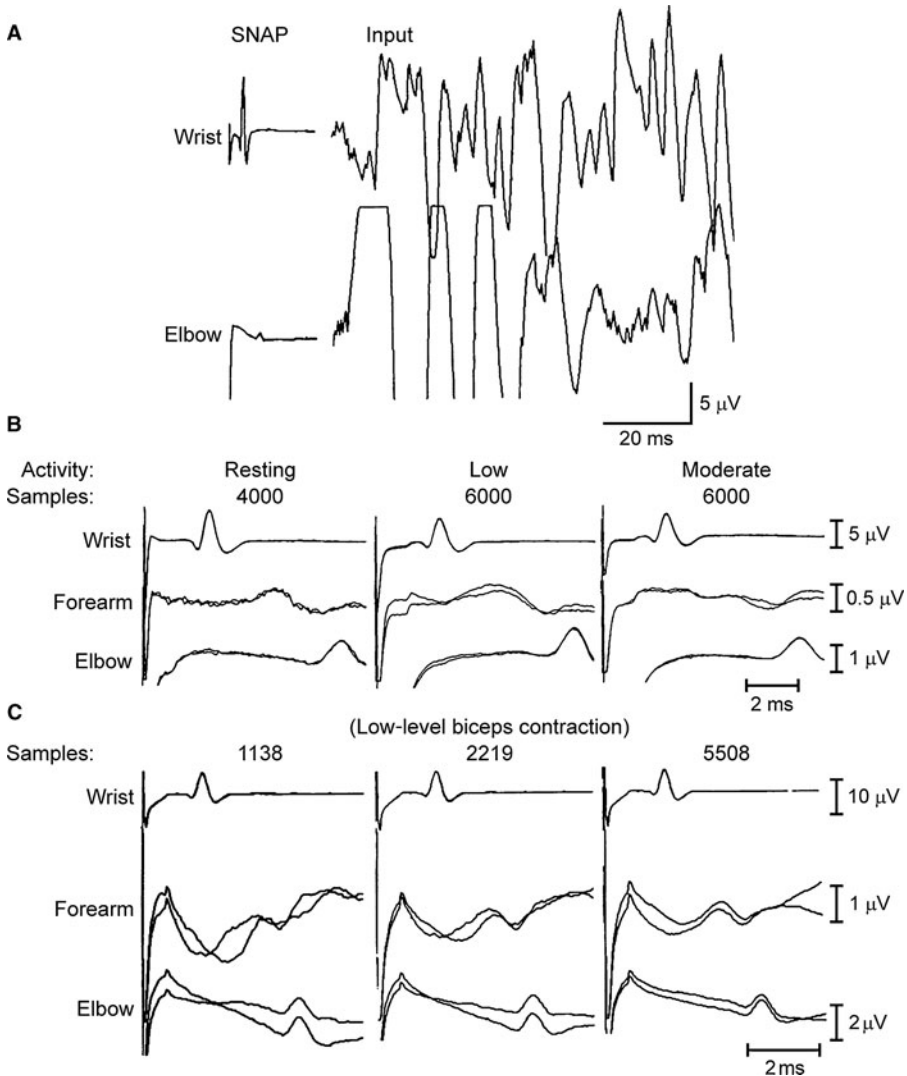


**Figure 4–4.** Operation of an averager. Analog signals recorded after each stimulus are digitized by an ADC during a fixed-length time window, or epoch that begins at the time of the stimulus. The resulting digital representations are totaled and divided by the number of epochs averaged. The digital result can be displayed by an analog device such as an oscilloscope after conversion from digital to analog form. (From Spehlmann, R. 1985. *Evoked potential primer: Visual, auditory, and somatosensory evoked potentials in clinical diagnosis*, 37. Boston: Butterworth Publishers. By permission of the publisher.)



$n$  is the number of epochs averaged.<sup>3</sup> For example, achieving a signal-to-noise ratio of 20 requires averaging 400 epochs. The required signal-to-noise ratio and, hence, the number of epochs depend on the type of signal being averaged and the amount of background activity or noise. For example, typical brain stem auditory evoked potentials are about  $0.5\ \mu\text{V}$  in amplitude, whereas background EEG activity

may be  $50\ \mu\text{V}$  or more, requiring a signal-to-noise ratio of 100 (10,000 epochs averaged). In contrast, sensory nerve action potentials are typically  $10\ \mu\text{V}$  or more in amplitude, with noise that is comparable, requiring a signal-to-noise ratio of only 2–3 (4–9 epochs averaged). It is important to remember that there is a limit to the degree of improvement of the recorded waveform with averaging (Fig. 4–5).



**Figure 4-5.** Averaged median sensory nerve action potential (SNAP) at three levels with increasing sample number (note comparison of input signals with actual potential). *A*, Input signal to be averaged and the averaged SNAPs at the wrist and elbow. *B*, Increasing level of contraction obscures the forearm waveform with low level contraction and makes it unrecognizable at moderate levels, despite 6000 averages. Even larger numbers of averages at moderate contraction, did not bring out the forearm waveform. *C*, The patient is flexing the elbow at a low level of activation showing improvement in averages in the forearm and elbow with increasing numbers of averages.

A number of methods of averaging will enhance the quality and reliability of the recording:

- Multiple runs to assure reproducibility of waveforms
- Filtering before averaging
- Artifact rejection by amplitude criteria
- Preamplifier block by extremely high voltages such as cautery in surgery
- Stimulator trigger by known artifact source, such as ECG

### Key Points

- Epoch length for averaging differs among different types of evoked potentials and nerve conduction studies.
- Digitized values of potential at different times (latencies) after the stimulus are averaged for many stimuli.
- Stimulus-dependent portions of the signal appear in the averaged result; stimulus-independent portions (noise) do not.
- The degree of noise suppression depends on the number of stimuli (epochs) averaged.

## Repetitive Transient Waveforms

Repetitive transient waveforms that are not stimulus-related may also be averaged, such as epileptic spikes in an EEG or iterative EMG discharges. The epoch for averaging in this case is a time “window” around the waveform; for example, from a specified time before to a specified time after the peak of the waveform. The waveforms to be averaged and the reference times defining the “windows” around them may be determined manually by positioning a cursor over the peak of each successive waveform to be averaged or automatically using sophisticated transient detection programs capable of identifying all waveforms of interest and locating their peaks and onsets. After the epochs have been defined, averaging proceeds in the same way as for evoked potentials.

### Key Points

- Averaging of repetitive transient waveforms use an epoch representing a time “window” around the waveform.

- The reference time defining the epoch is usually the peak of the waveform determined manually or by software.

## Movement-Associated Potentials

*Movement-associated potentials*—one class of event-related potentials—are a cerebral activity associated with, and generally preceding, a movement (voluntary or involuntary). They are obtained by simultaneously recording several EEG channels and one or more EMG channels—the latter to determine the time of occurrence and other characteristics of the movement. An EMG channel may act as a “trigger” for the averager, but the epoch for averaging usually begins *before* the onset of the muscle activity as recorded by the EMG channel and may extend up to or beyond the time of the muscle activity. Hence, this type of averaging is often called *back averaging*. It requires somewhat more sophisticated processing than ordinary *forward averaging*, because the signal being averaged must be digitized continuously and stored in memory so that when a “trigger” occurs, digitized data for the previous 0.5–1 second may be included in the average.

### Key Points

- Cerebral activity associated with a movement (movement-associated potentials) is obtained by averaging EEG.
- An EMG channel may act as a “trigger” for the averager.
- The epoch for averaging begins before the muscle activity as recorded by the EMG channel (back averaging).

## DIGITAL FILTERING

### Types of Digital Filters

A digital filter is a computer program or algorithm that can remove unwanted frequency components from a signal.<sup>4</sup> Just as for analog filters, they may be classified as low-pass, high-pass, band-pass, or notch filters. Most digital filters function by forming a linear combination (weighted average) of signal amplitudes at the current time and various past times. The

two types of commonly used digital filters are the *finite impulse response* (FIR) filter and the *infinite impulse response* (IIR) filter. The FIR filter output is a linear combination only of the input signal at the current time and past times. This type of filter has a property such that its output necessarily becomes zero within a finite amount of time after the input signal goes to zero. The IIR filter output is a linear combination of both the input signal at the current time and past times (*feed-forward* data flow) and the output signal at past times (*feedback* data flow). This type of filter has the property that its output may persist indefinitely in the absence of any further input, because the output signal itself is fed back into the filter. IIR filters can be unstable and also have the undesirable property of noise buildup, because noise terms created by arithmetic round-off errors are fed back into the filter and amplified. For these reasons, FIR filters are easier to design. However, IIR filters often require less computation than FIR for comparable sharpness in their frequency responses and, hence, are often used for filtering signals in “real time.”

### Key Points

- Digital filters include low-pass, high-pass, band-pass, or notch.
- Two common types of digital filters are finite impulse response (FIR) and infinite impulse response (IIR).
- FIR filters use a linear combination of the input signal at multiple time points.
- IIR filters use a linear combination of the input signal and the output (filtered) signal at multiple time points.

## Characteristics of Digital Filters

Digital filters have several characteristics that distinguish them from analog filters.

- They can be constructed and modified easily because they are software programs rather than hardware devices.
- They can easily be designed to have relatively sharp frequency cutoffs if desired; for example, much sharper than the typical 6 dB per octave roll-off of an analog filter.

- They need not introduce any time delay (phase shift) in the signal, as invariably happens with ordinary analog filters; thus, time relationships between different channels can be preserved even if different filters are used for each.<sup>5</sup>

An example of a segment of EEG contaminated by muscle artifact as it appears before and after application of a digital filter is shown in Figure 4–6.

## TIME AND FREQUENCY DOMAIN ANALYSIS

### Interval Analysis

*Interval analysis* is a method of determining the frequency or repetition rate of waveforms, which is similar to what is done by visual inspection. It is based on measuring the distribution of intervals between either zero or other level crossings or between maxima and minima of a signal.<sup>6</sup> A zero crossing occurs when the potential in a channel changes from positive to negative or vice versa (Fig. 4–7A). A level crossing (used less often than a zero crossing) occurs when the potential in a channel changes from greater than to less than a given value (e.g., 50  $\mu\text{V}$ ) or vice versa. The number of zero crossings or other level crossings per unit time is related to the dominant frequency of the signal (Figs. 4–7D and 4–7E). For example, a sinusoidal signal that crosses zero 120 times every second has a frequency of  $\frac{1}{2}(120) = 60$  Hz.

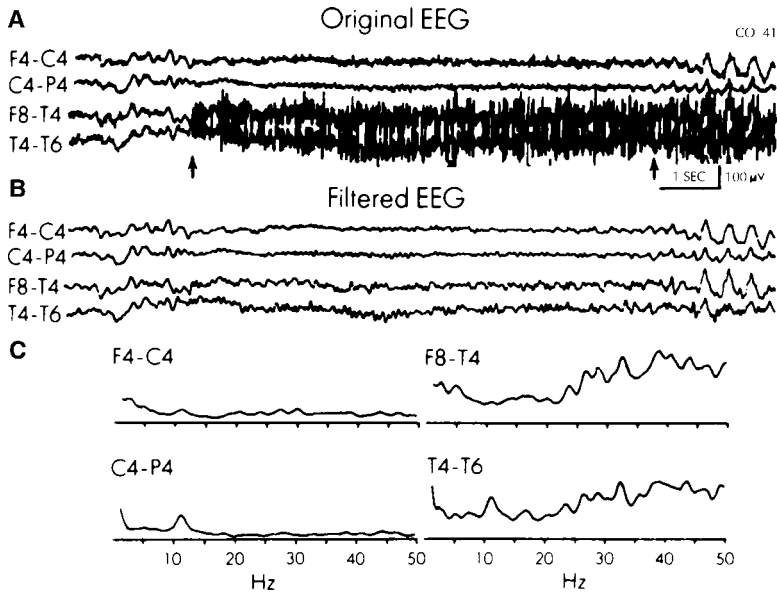
### Key Points

- Interval analysis finds the frequency of waveforms by measuring the distribution of intervals between zero crossings.
- Level crossings are sometimes used instead of zero crossings.

### Autocorrelation Analysis

*Autocorrelation analysis* may be used to recognize the dominant rhythmic activity in a signal and to determine its frequency. It is based on computing the degree of interdependence





**Figure 4-6.** Example of digital signal filtering. An electroencephalogram contaminated, *A*, by scalp EMG artifact was filtered, *B*, using a low-pass digital filter. *C*, The frequency spectra of the unfiltered signals show the large high-frequency (20 Hz) muscle activity components in the last two channels before filtering (From Gotman, J., J. R. Ives, and P. Gloor. 1981. Frequency content of EEG and EMG at seizure onset: Possibility of removal of EMG artifact by digital filtering. *Electroencephalography and Clinical Neurophysiology* 52:626–39. By permission of Elsevier Science Ireland.)

(correlation) between *successive* values of a signal. A signal that is truly random, such as white noise, will have no correlation between successive values. In contrast, a signal with rhythmic components has an autocorrelation significantly different from zero. The *autocorrelation function* (ACF) is defined as the correlation between a signal and that same signal delayed by time  $t$ , expressed as a function of  $t$ . The ACF at  $t = 0$  is always 1, that is, 100% correlation. For a periodic signal (one with rhythmic components), it is an oscillating function of  $t$  with a frequency like that of the dominant rhythmic component in the original signal (Fig. 4-7C).

### Key Points

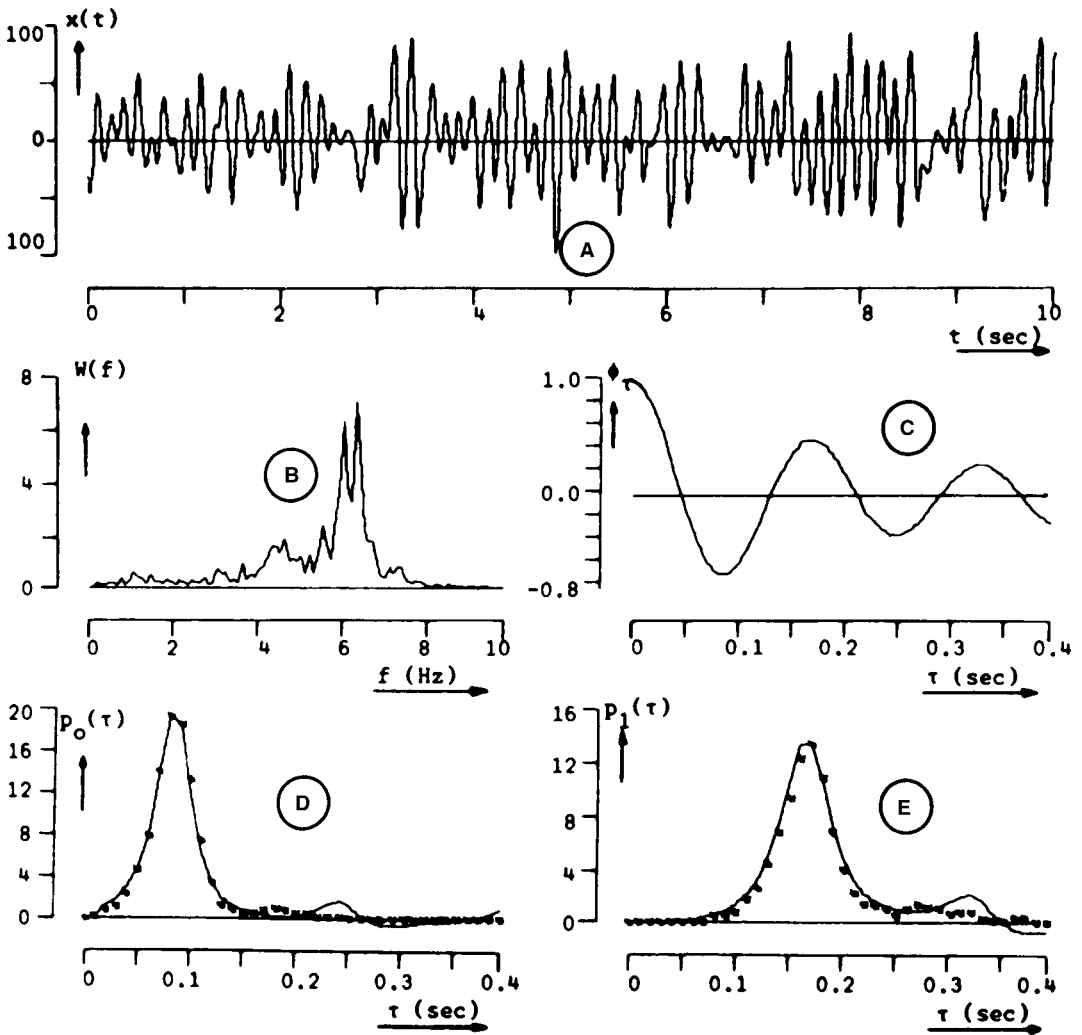
- Autocorrelation analysis can find the frequency of the dominant rhythmic activity in a signal.
- It involves computing the correlation of successive values of a signal to the same signal delayed by a time  $t$ .
- The autocorrelation is an oscillating function of  $t$  with a frequency like that of

the dominant rhythmic component in the signal.

### Fourier (Spectral) Analysis

*Fourier analysis* is the representation of a periodic function as a Fourier series—a sum of trigonometric functions, that is, sines and cosines. A Fourier series may be used to approximate any periodic function. The greater the number of terms in the series, the greater the accuracy of the approximation will be. The Fourier transform is a mathematical method to analyze a periodic function into a sum of a large number of cosine and sine waves with frequencies of  $f$ ,  $2f$ ,  $3f$ ,  $4f$ , etc., where  $f$  is the lowest, or *fundamental*, frequency in the function analyzed, and  $2f$ ,  $3f$ , etc., are *harmonics*. The input of the Fourier transform is the periodic function, or signal, to be analyzed. The output is the amplitude of each sine and cosine wave in the series.

In working with *discrete* data, that is, a signal sampled at equal time intervals  $0$ ,  $T$ ,  $2T$ ,  $3T$ , ...,  $(N - 1)T$ , a discrete Fourier transform



**Figure 4-7.** Examples of several types of signal analysis: A, an EEG signal; B, its power spectrum; C, its autocorrelation function; D, the distribution density function of intervals between any two successive zero crossings; and E, the distribution density function of the intervals between successive zero crossings at which the signal changes in the same direction, that is, from positive to negative or vice versa. (From Lopes da Silva, F. H. 1987. Computerized EEG analysis: A tutorial overview. In *A textbook of clinical neurophysiology*, ed. A. M. Halliday, S. R. Butler, and R. Paul, 61–102. Chichester, England: John Wiley & Sons. By permission of John Wiley & Sons.)

is used. In this case, the fundamental frequency can be shown to be  $f = 1/NT$ . The input of the discrete Fourier transform is the  $N$  digitized values representing the signal at times  $0, T, 2T, \dots, (N - 1)T$ , where  $T$  is the sampling interval. The output is the amplitudes of  $N/2 - 1$  sine waves at frequencies  $f, 2f, \dots, (N/2 - 1)f$  and of  $N/2 + 1$  cosine waves at frequencies  $0, f, 2f, \dots, (N/2)f$ . Note that there is no “data reduction”; the number of input values ( $N$ ) equals the number of output values.

By convention, both the cosine and sine waves of a given frequency are often lumped together into one quantity describing the *amount* of that frequency present in the signal. This quantity is called the spectral *intensity* or *power*, and a plot of this as a function of frequency is the *power spectrum* (Fig. 4-7B). The intensity, or power, is the square of the *amplitude*. The *phase* (phase angle) for any given frequency describes how much of that frequency is in the form of a cosine wave

and how much is a sine wave. The following formulas relate these quantities; here,  $C$  is cosine wave amplitude and  $S$  is sine wave amplitude:

$$\begin{aligned} \text{Intensity } I &= A^2 = C^2 + S^2 \\ \text{Amplitude } A &= \sqrt{I} = \sqrt{C^2 + S^2} \\ \text{Phase } \phi &= \text{Arctan} \left( \frac{S}{C} \right) \end{aligned}$$

Note :  $\phi = 0^\circ$  for pure cosine wave  
 $\phi = 90^\circ$  for pure sine wave

### Key Points

- Fourier (spectral) analysis analyzes a periodic function into a sum of a large number of cosine and sine waves.
- Applied to discrete (digitized) data, the Fourier transform gives the frequency content (spectrum) of the signal.
- Power (intensity) is the square of signal amplitude; phase represents the relative amount of cosine and sine waves.
- The power spectrum is a plot of spectral intensity against frequency.

## Statistical Analysis

Statistical analysis of a digitized signal may be a useful data reduction technique. In effect, it treats digitized values at successive time points as independent values of a random variable. In this technique, one may plot the amplitude distribution—the number of digitized samples of the signal having a given amplitude value vs. the amplitude itself—and visually inspect the shape of the distribution. Alternatively, one may calculate the *moments of the probability distribution* of signal amplitudes, including the following:<sup>6</sup>

First central moment, mean voltage  $m_1$  (*center* of distribution)

Second central moment, variance  $m_2$  and standard deviation  $\sigma = \sqrt{m_2^2}$  (*width* of distribution)

Third central moment  $m_3$  and skewness  $\beta_1 = m_3/(m_2)^{3/2}$  (*asymmetry* of distribution)

Fourth central moment  $m_4$  and kurtosis excess  $\beta_2 = m_4/(m_2)^2$  (*peakedness* or *flatness* of distribution).

### Key Points

- Statistical signal analysis involves finding the amplitude distribution (number of samples having a given amplitude).
- The statistical moments of the distribution can be calculated.

## Pattern Recognition

Pattern recognition algorithms are designed to detect a specific waveform in a signal that has characteristic features, such as a motor unit potential in an EMG or a sharp wave in an EEG. The characteristic features may be defined in the time domain (e.g., durations, slopes, and curvature of waveforms), in the frequency domain (after filtering signal), or in both. One common approach in developing a pattern recognition algorithm is as follows: (1) Define a set of candidate features and a method to calculate them; (2) Calculate the chosen features for a visually selected collection of waveforms of the type to be detected, the *learning set*, and for a collection of similar waveforms determined *not* to be of the required type, the *controls*; and (3) Determine by statistical analysis whether it is possible to reliably separate the two groups of waveforms on the basis of the calculated features. For example, one could calculate the rising and falling slope of candidate sharp waves, compute these slopes for true epileptic sharp waves and for other transients such as muscle artifacts or nonepileptic sharp transients in background activity, and determine whether a certain range of slopes characterizes the true sharp waves. These techniques have been used with some success to detect spikes and sharp waves, spike-and-wave bursts, sleep spindles and K-complexes, and seizure discharges in EEG recordings<sup>7</sup> and to detect motor unit potentials, fibrillation potentials, and other iterative discharges in EMG recordings.

### Key Points

- Pattern recognition algorithms detect waveforms that have characteristic features.

- Features may be defined in the time domain, the frequency domain, or both.
- The algorithm is trained on a learning set of chosen features and controls, then applied to arbitrary signals.
- Spike and sharp wave detection and seizure detection algorithms are examples with common clinical use.

## SUMMARY

This chapter reviews the principles of digitization, the design of digitally based instruments for clinical neurophysiology, and several common uses of digital processing, including averaging, digital filtering, and some types of time-domain and frequency-domain analysis. An understanding of these principles is necessary to select and use digitally based instruments appropriately and to understand their unique features.

## REFERENCES

1. Fisch, B. J. 1999. *Fisch and Spehlmann's EEG primer: Basic principles of digital and analog EEG*, 3rd ed. Amsterdam: Elsevier.
2. Levy, S. R., A. T. Berg, F. M. Testa, E. J. Novotny Jr., and K. H. Chiappa. 1998. Comparison of digital and conventional EEG interpretation. *Journal of Clinical Neurophysiology* 15:476–80.
3. Misulis, K. E. 1994. *Spehlmann's evoked potential primer: Visual, auditory, and somatosensory evoked potentials in clinical diagnosis*, 2nd ed., 25–37. Boston: Butterworth-Heinemann.
4. Maccabee, P. J., and N. F. Hassan. 1992. AAEM minimonograph #39: Digital filtering: Basic concepts and application to evoked potentials. *Muscle & Nerve* 15:865–75.
5. Gotman, J., J. R. Ives, and P. Gloor. 1981. Frequency content of EEG and EMG at seizure onset: Possibility of removal of EMG artefact by digital filtering. *Electroencephalography and Clinical Neurophysiology* 52:626–39.
6. Lopes da Silva, F. H. 1987. Computerized EEG analysis: A tutorial overview. In *A textbook of clinical neurophysiology*, ed. A. M. Halliday, S. R. Butler, and R. Paul, 61–102. Chichester, England: John Wiley & Sons.
7. Gotman J. 1999. Autonomic detection of seizures and spikes. *Journal of Clinical Neurophysiology* 16:130–40.

*This page intentionally left blank*

## Chapter 5

---

# Basics of Neurophysiology

*Jasper R. Daube and Squire M. Stead*

### **INTRODUCTION**

#### **CELL MEMBRANE**

Transmembrane Ion Gradients

Active Transport

Equilibrium Potential

Ion Channels

Neuronal Excitability

#### **RESTING POTENTIAL**

Steady State

Sodium Pump

Role of Extracellular Calcium

Role of Glial Cells

#### **LOCAL POTENTIALS**

Ionic Basis

Characteristics of Local Potentials

#### **ACTION POTENTIALS**

Threshold

Ionic Basis of Action Potentials

Excitability

Propagation

Patterns of Activity

#### **SYNAPTIC TRANSMISSION**

Biosynthesis, Storage, Release, and

Reuptake of Neurochemical

Transmitters

Postsynaptic Effects of

Neurochemical Transmitters

Classic Neurotransmission

Neuromodulation

Electrical Synapses

#### **CLINICAL CORRELATIONS**

Pathophysiologic Mechanisms

Energy Failure

Ion Channel Blockade

#### **SUMMARY**

Revision of “Transient Disorders and Neurophysiology.” Chapter 5 in *Medical Neurosciences*. (Ed. E. E. Benarroch, B. F. Westmoreland, J. R. Daube, T. J. Reagan, and B. A. Sandok.) Lippincott Williams & Wilkins 1999—with permission.

### **INTRODUCTION**

To become proficient in the practice of clinical neurophysiology, one should have an understanding of the basic principles underlying the

activity of excitable cells. The following discussion applies to both myocytes and neurons.

### **CELL MEMBRANE**

#### **Transmembrane Ion Gradients**

The plasma membrane is a phospholipid lipid bilayer with the polar phosphate (hydrophilic) heads abutting the extracellular matrix and cytoplasm. The nonpolar lipid (hydrophobic)

Table 5-1 Relative Ionic Concentrations in Mammalian Neurons

	Sodium	Potassium	Chloride	Calcium
Internal concentration	Low	High	Low	Low
External concentration	High	Low	High	High
Resting permeability	Low	High	Moderate	Low

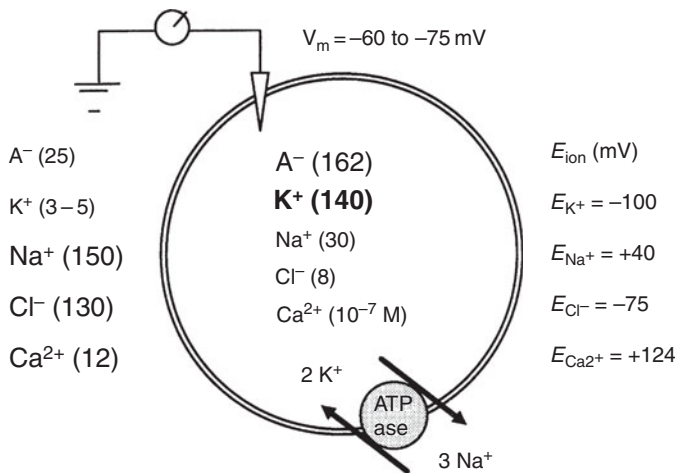
tails constitute the middle of the bilayer. Embedded in the lipid bilayer are protein macromolecules, including ion channels, ligand receptors, and ionic pumps, that are in contact with both the extracellular fluid and the cytoplasm. The lipid bilayer is relatively impermeable to water soluble molecules, including ions such as sodium ( $\text{Na}^+$ ), potassium ( $\text{K}^+$ ), chloride ( $\text{Cl}^-$ ), and calcium ( $\text{Ca}^{2+}$ ). These ions are involved in electrophysiologic activity and signal transmission (Table 5-1). The concentrations of sodium, chloride, and calcium are higher extracellularly, and the concentrations of potassium and impermeable anions, largely protein molecules ( $\text{A}^-$ ), are higher intracellularly (Fig. 5-1). Maintenance of transmembrane ion concentration depends on the balance between (1) passive diffusion of ions across ion channels, or "pores," of the membrane, driven by their concentration gradient

and (2) active, energy adenosine triphosphate (ATP)-dependent transport of ions against their concentration gradient, via ATP-driven ion pumps.

In the central nervous system, astrocytes provide a buffer system to prevent excessive accumulation of extracellular potassium ions.

### Active Transport

Nerve and muscle cells obtain energy from glucose and oxygen via the glycolytic pathways, the Krebs cycle, and the electron transport system. These pathways provide the energy for normal cell function in the form of ATP. ATP is partly consumed in generating the resting potential by a mechanism in the membrane, which moves potassium in and sodium out of the cell, with slightly more sodium being moved



**Figure 5-1.** Transmembrane ion concentrations, equilibrium potential, and resting membrane potential. The semipermeable cell membrane determines a differential distribution of ions in the intracellular and extracellular compartments. Sodium and chloride predominate extracellularly, and potassium and nondiffusible ( $\text{A}^-$ ) ions predominate intracellularly. Transmembrane ion composition is maintained by the activity of ATP-dependent pumps, particularly sodium/potassium adenosine tri-phosphatase (ATPase). The different transmembrane concentrations of diffusible ions determine the equilibrium potential of each ion ( $E_{ion}$ ). The contribution of each ion to the membrane potential depends on the permeability of the membrane for that particular ion. Increased permeability to an ion brings the membrane potential toward the equilibrium potential of that ion. At rest, the membrane is predominantly, but not exclusively, permeable to potassium. There is continuous leakage of potassium out of the cell and of sodium into the cell, driven by both their concentration gradient and electrical gradient. The ion gradient is restituted by the activity of sodium/potassium ATPase, which is electrogenic (as it exchanges two potassium for three sodium ions) and contributes to the maintenance of the resting potential.

than potassium. This movement is referred to as active transport, and the system through which it occurs is the sodium pump. The sodium pump moves sodium out of the cell and potassium into the cell against their concentration gradients. Chloride moves out of the cell passively with sodium.

## Equilibrium Potential

The diffusible ions (sodium, potassium, and chloride, but not calcium) tend to move across the cell membrane according to their concentration gradients. The molecular motion of ions is a source of energy known as the *diffusion pressure*. For example, the intracellular concentration of potassium is 30 times higher than the extracellular concentration,  $[K_o^+]$ ; therefore, potassium tends to diffuse from intracellular to extracellular fluid. The opposite occurs with sodium. As ions diffuse across the cell membrane, a separation of charges develops because the nondiffusible negatively charged intracellular ions (principally proteins) have a charge opposite that of the diffusible ions. Two regions that accumulate different charges have an electrical potential difference. The voltage that develops as a diffusible ion moves across the membrane and produces an electrical pressure that opposes the movement of the ion. The net ionic movement continues until the electrical pressure equals the diffusion pressure. At this time, the system is in equilibrium.

At equilibrium, random ionic movement continues, but no net movement of ions occurs. The electrical potential that develops across the membrane at equilibrium is called the *equilibrium potential*, and this potential is different for each ion. The equilibrium potential of an ion ( $E_{ion}$ ) is the voltage difference across the membrane that exactly offsets the diffusion pressure of an ion to move down its concentration gradient. Therefore, the equilibrium potential is proportional to the difference between the concentration of the ion in the extracellular fluid and the concentration in the intracellular fluid. An algebraic representation of the equilibrium potential can be derived because the physical determinants of the diffusion pressure and electrical pressure expressed are known. The final equation is the Nernst equation.

Electrical pressure is defined by

$$W_e = E_m \times Z_i \times F$$

in which  $W_e$  = electrical pressure (work required to move an ion against a voltage);  $E_m$  = absolute membrane potential;  $Z_i$  = valence (sign and number of charges on the ion);  $F$  = Faraday (amount of charge per mole of electrons, in Coulombs).

Diffusion pressure is defined by

$$W_d = R \times T \times (\ln[C_e]/\ln[C_i])$$

in which  $W_d$  = diffusion pressure (work required to move an ion against a concentration gradient);  $R$  = universal gas constant (energy per degree per mole);  $T$  = absolute temperature;  $\ln$  = natural logarithm;  $[C_e]$  = extracellular ion concentration;  $[C_i]$  = intracellular ion concentration.

At equilibrium

$$W_e = W_d$$

and therefore

$$E_m = (R \times T)/(\ln[C_e]/\ln[C_i])$$

By rearrangement, the equilibrium potential is

$$E_m = ((R \times T)/(Z_i \times F)) \times \ln([C_e]/[C_i])$$

This equation is known as the *Nernst equation* and is an important relationship that defines the equilibrium potential,  $E_m$ , across the cell membrane for any ion in terms of its concentration on the two sides of a membrane. By substituting for the constants at room temperature, converting to a base 10 logarithm, and converting to millivolts, we get a useful form of the equation:

$$E_m = (61.5 \text{ mV}/Z_i) \log_{10}([C_e]/[C_i])$$

We may use these equations to calculate the equilibrium potential for any ion if we know the concentrations of that ion on the two sides of the membrane. The Nernst potential assumes 100% permeability of the selected ion. Lower ionic conductances decrease the magnitude of this potential. In the resting state, the approximate neuronal equilibrium potentials of the major ions are  $K^+ = -100 \text{ mV}$ ,  $Na^+ = +40 \text{ mV}$ ,  $Cl^- = -75 \text{ mV}$ ,  $Ca^{2+} = +124 \text{ mV}$  (Fig. 5-1).



The contribution of a given ion to the actual voltage developed across the membrane with unequal concentrations of that ion depends not only on its concentration gradient but also on the permeability ( $P$ ) of the membrane to that ion. Permeability is the ease with which an ion diffuses across the membrane and is a reflection of the probability that the membrane channel that conducts the ion will open. For example, an ion with a high concentration gradient that has very low permeability (e.g., calcium) does not contribute to the resting membrane potential. If a membrane is permeable to multiple ions that are present in differing concentrations on either side of the membrane, the resultant membrane potential is a function of the concentrations of each of the ions and of their relative permeabilities (Fig. 5-2).

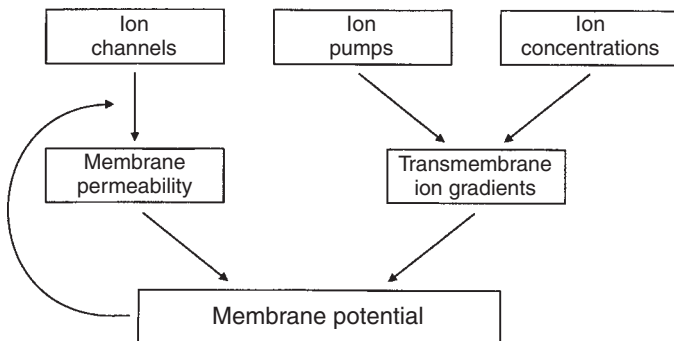
The Goldman equation combines these factors for the major ions that influence the membrane potential in nerve and muscle cells. Such calculations, on the basis of the actual ionic concentrations and ionic permeabilities, agree with measurements of these values in living cells. These equations also show that a change in either ionic permeability or ionic concentrations can alter membrane potential. If the concentration gradient of an ion is reduced, there will be a lower equilibrium potential for that ion. If the resting membrane potential is determined by the equilibrium potential of that ion, the resting potential will decrease. In contrast, if the permeability for an ion is increased by opening of channels for that ion, the membrane potential will approach the

equilibrium potential of that ion, and it may increase or decrease, depending on whether the membrane potential is above or below the equilibrium potential.

The movements of ions that occur with normal cellular activity are not sufficient to produce significant concentration changes; therefore, membrane potential fluctuations are normally due to permeability changes caused by channel opening and closing. Increased permeability (i.e., opening of the channel) to a particular ion brings the membrane potential toward the equilibrium potential of that ion. In an electrical model of the membrane, the concentration ratios of the different ions are represented by their respective equilibrium potentials ( $E_{Na}$ ,  $E_K$ ,  $E_{Cl}$ ); their ionic permeabilities are represented by their respective conductances (Table 5-2). The conductance (the reciprocal of the resistance) for a particular ion is the sum of the conductances of all the open channels permeable to that ion. The movement of ions across the membrane is expressed as an ion current. By Ohm's law, this current depends on two factors: the conductance of the ion and the driving force for the ion. The driving force is the difference between the membrane potential and the equilibrium potential of that ion.

## Ion Channels

Ion channels are intrinsic membrane proteins that form hydrophilic pores (aqueous pathways)



**Figure 5-2.** Variables that determine the membrane potential. Transmembrane ion gradients determine the equilibrium potential of a particular ion. The transmembrane gradients depend on the activity of ATP-driven ion pumps and the buffering effects of the astrocytes on extracellular fluid composition. Membrane permeability to a particular ion depends on the opening of specific ion channels. This opening can be triggered by voltage (voltage-gated channels), neurotransmitters (ligand-gated channels), or intracellular chemicals such as calcium, ATP, or cyclic nucleotides (chemically gated channels). Increased membrane permeability to a given ion (the opening of the ion channel) brings the membrane potential toward the equilibrium potential of this ion.

Table 5–2 Characteristics of Different Membrane Potentials

Characteristic	Local potentials			Action potential
	Generator potential	Synaptic potential	Electrotonic potential	
Graded and localized	+	+	+	–
All-or-none spread	–	–	–	+
Active membrane channel	Na <sup>+</sup> , K <sup>+</sup>	Na <sup>+</sup> , Ca <sup>2+</sup> , K <sup>+</sup> , Cl <sup>–</sup>	None	Na <sup>+</sup> , K <sup>+</sup> , sometimes Ca <sup>2+</sup>
Initiated by	Sensory stimulus	Neurotransmitter	Generator, synaptic, or action potentials	Electrotonic potential

through the lipid bilayer membrane. They allow the passive flow of selected ions across the membrane on the basis of the electrochemical gradients of the ion and the physical properties of the ion channel. Most channels belong to one of several families of homologous proteins with great heterogeneity in amino acid composition. They are defined on the basis of their ion selectivity, conductance, gating, kinetics, and pharmacology.

In general, the transmembrane portion of the protein forms the “pore,” and the specific amino acids in the region of the pore determine ion selectivity, conductance, and voltage sensitivity of the channel. Amino acids in the extracellular or intracellular portion (or both) of the protein channel determine the gating mechanism and the kinetics of inactivation. Ion channels vary in their selectivity; some are permeable to cations (sodium, potassium, and calcium) and others to anions (primarily chloride). The open state predominates in the resting membrane for a few channels; these are mostly the potassium channels responsible for the resting membrane potential (see below). Most ion channels are gated; that is, they open in response to specific stimuli. According to their gating stimuli, ion channels can be subdivided into (1) voltage-gated channels, which respond to changes in membrane potential; (2) ligand-gated channels, which respond to the binding of a neurotransmitter to the channel molecular complex; and (3) chemically gated channels, which respond to intracellular molecules such as ATP, ions (particularly calcium), and cyclic nucleotides. Important examples of chemically gated channels include the cyclic

nucleotide-gated channels found in many sensory receptors (e.g., photoreceptors in the retina).

Mechanoreceptors are activated by mechanical distortion of the cell membrane and are sometimes referred to as stretch-activated channels. Gating stimuli may interact in some channels. For example, the ion permeability of some ligand-gated channels is affected by membrane voltage or intracellular factors (or both). Voltage-gated channels are critical for neuronal function. They control excitability, spontaneous neuronal activity, generation and conduction of action potentials, and neurotransmitter release. Sensitivity to voltage is due to a voltage sensor at the pore. A region of the pore acts as a selectivity filter, which regulates ion permeability according to the size and molecular structure of the ion. The range of voltage for activation and the rate of activation (opening) and inactivation (closing) are important variables in voltage-gated channels.

Voltage-gated cation channels are responsible for the maintenance of neuronal excitability, generation of action potentials, and neurotransmitter release (Table 5–3). They are members of a family of proteins with a common basic structure consisting of a principal subunit and one or more auxiliary subunits. The amino acid composition of a subunit determines ion selectivity, voltage sensitivity, and inactivation kinetics of the channel. Voltage-gated sodium channels are critical for the generation and transmission of information in the nervous system by action potentials. In neurons, sodium channels are concentrated in the

Table 5–3 Examples of Ion Channels

Ion channel	Equilibrium potential	Location	Function
Voltage-gated Na <sup>+</sup>	+35	Nodes of Ranvier Entire unmyelinated axon Axon hillock	Initiation and conduction of action potential
K <sup>+</sup>	−90	Diffuse along internode Diffuse in neurons	Repolarization of action potential Decrease neuronal excitability and discharge
Ca <sup>2+</sup>	+200	Dendrite Soma  Axon terminal	Slow depolarization Burst firing Oscillatory firing Neurotransmitter release
Chemically gated Cl <sup>−</sup> (GABA)	−75	Dendrite Soma	Synaptic inhibition
Cation channel (L-glutamate, acetylcholine)	0	Dendrite	Synaptic excitation

Note: GABA,  $\gamma$ -aminobutyric acid.

initial segment of the axon (the site of generation of action potentials) and in the nodes of Ranvier (involved in rapid conduction of action potentials). In muscle, these channels participate in excitation–contraction coupling.

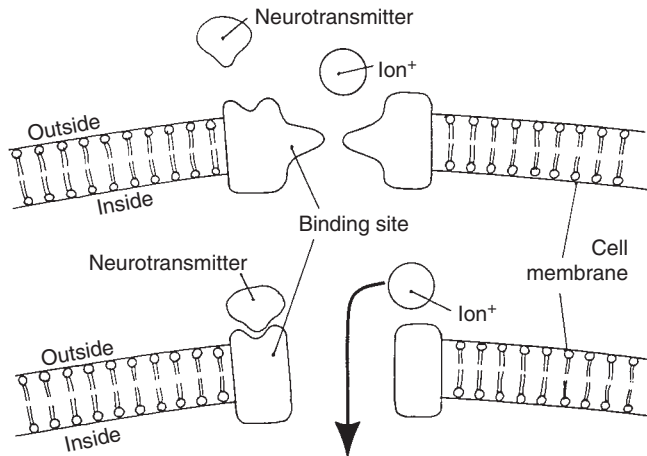
There are several varieties of voltage-gated calcium channels, and they have different distributions, physiology, pharmacology, and functions (Table 5–4). Calcium influx occurs not only through voltage-gated channels but also through ligand-gated and cyclic nucleotide-gated channels. Calcium ions are important in the regulation of numerous processes in neurons, including modulation of neuronal firing pattern, neurotransmitter release, signal transduction, enzyme activation, intracellular transport, intermediate metabolism, and

gene expression. Intracellular calcium is also necessary for muscle contraction and glandular secretion. These functions depend on levels of calcium in the cytosol that are determined by the calcium influx through various channels, release from intracellular stores (particularly the sarcoplasmic reticulum), and counterbalancing active mechanisms of reuptake and extrusion.

Large numbers of voltage-gated potassium channels determine much of the pattern of activity generated by neurons. They are primarily responsible for the resting membrane potential, repolarization of the action potential, and control of the probability of generation of repetitive action potentials. Ligand-gated channels open in response to the binding

Table 5–4 Voltage-Gated Calcium Channels

Channel type	Location	Function
T	Apical dendrites	Modal bursting or tonic firing
L	Soma, dendritic shafts, and spines	Slow action potentials
N	Skeletal muscle	Excitation–contraction coupling
P/Q	Synaptic terminals	Neurotransmitter release
	Synaptic terminals	Neurotransmitter release
	Dendritic shafts and spines	Persistent depolarization



**Figure 5-3.** The plasma membrane consists of a phospholipid bilayer that provides a barrier to the passage of water-soluble molecules, including ions. Passage of ions across the membrane depends on the presence of transmembrane proteins, including ion channels and ion pumps. Ion channels provide an aqueous pore for the passage of ions across the membrane, according to their concentration gradients. The opening of an ion channel, or pore, may be triggered, or gated, by several stimuli, such as voltage (voltage-gated channel) or neurotransmitters (ligand-gated channel). In the example shown here, a neurotransmitter (such as glutamate) binds to a specific ligand-gated cation channel, and this produces a change in the spatial configuration of the channel protein, allowing the pore to open and the cation to pass through the membrane. Changes in the amino acid composition of the ion channel protein affects its ion selectivity, gating mechanism, and kinetics of channel opening (activation) and closing (inactivation).

of neurotransmitters (Fig. 5-3). They include (1) nonselective cation channels permeable to sodium, potassium, and, in some cases, calcium; and (2) anion channels permeable to chloride. These channels are discussed in relation to synaptic transmission.

### Key Points

- Permeability of membrane ion channels and activity of ATP-driven ion pumps determine ion concentration gradients across the membrane.
- Ion channels are transmembrane proteins that form a pore for the passive movement of ions.
- Different ion channels provide selective permeability to different ions.
- Ion channels are opened by a voltage change or neurotransmitter binding.
- Most of the rapid communication signals in the nervous system are handled by voltage-gated ion channels.
- An ion's equilibrium potential is the electrical potential that exactly balances the opposing concentration gradient-driven movement of an ion across the membrane.
- Diffusion of an ion across the membrane (permeability) depends on the ion channel.

- Ions with greater permeability have a greater influence on the membrane potential.
- Opening an ion channel moves the membrane potential toward that ion's equilibrium potential.

### Neuronal Excitability

Neuronal excitability is defined as the ability of the neuron to generate and transmit action potentials. It depends on the membrane potential, which determines the gating of the sodium channels. The membrane potential depends on the transmembrane ion concentration (which determines the equilibrium potential) and ion permeability. Increased permeability to an ion moves the membrane potential toward the equilibrium potential of that ion. In the absence of a stimulus, the membrane potential of the neuron, or resting membrane potential, is dominated by its permeability to potassium, whose channels are open; therefore, this potential varies between  $-60$  and  $-80$  mV. Because the threshold for opening voltage-gated sodium channels that are needed to trigger and propagate action potentials is approximately  $-50$  to  $-55$  mV, any change

Table 5–5 Ionic Basis of Local Potentials

Ion	Equilibrium potential, mV	Effect of increased permeability on membrane potential	Examples of local potentials
Na <sup>+</sup>	+40	Depolarization	Generator potentials Excitatory postsynaptic potential
Ca <sup>2+</sup>	+200	Depolarization	Excitatory postsynaptic potential
K <sup>+</sup>	–90	Hyperpolarization	Inhibitory postsynaptic potential
Cl <sup>–</sup>	–75	Hyperpolarization, depolarization, or no change	Inhibitory postsynaptic potential

of the membrane potential in this direction will increase the probability of triggering an action potential. An increase in membrane permeability to sodium or calcium increases excitability, and an increase in permeability to potassium or chloride decreases excitability (Table 5–5).

## RESTING POTENTIAL

The resting potential is the absolute difference in electrical potential between the inside and the outside of an inactive neuron, axon, or muscle fiber. If an electrical connection is made between the inside and the outside of a neuron, the cell acts as a battery and an electrical current will flow. The potential is generally between –60 and –80 mV, with the inside of the cell negative with respect to the outside. The resting potential can be measured directly by using a microelectrode. The tip of such an electrode must be less than 1  $\mu\text{m}$  in diameter to be inserted into a nerve or muscle cell. By connecting the microelectrode to an appropriate amplifier, the membrane potential can be recorded and displayed. The machine registers the potential difference between the two electrical inputs, which is displayed as a vertical deflection of a spot of light that moves continuously from left to right across the screen. A negative membrane potential is registered as a downward deflection; thus, when a microelectrode enters a neuron or muscle fiber, the oscilloscope beam moves down to a new position.

The resting membrane potential is the transmembrane voltage at which there is no net

flow of current across the membrane. Its value determines spontaneous neuronal activity and neuronal activity in response to extrinsic input. Because the resting potential is the absolute difference in potential between the inside and the outside of the cell, it represents transmembrane polarity. A decrease in the value of the resting membrane potential means less negativity inside the cell and the membrane potential moves toward zero; this constitutes depolarization. When the membrane potential becomes more negative than the value of the resting potential, the potential moves away from zero; this is hyperpolarization. The resting membrane potential depends on two factors:

1. Leak ion channels open at rest with markedly different permeabilities to sodium and potassium, making the cell membrane a semipermeable membrane.
2. Energy-dependent pumps, particularly the sodium/potassium pump.

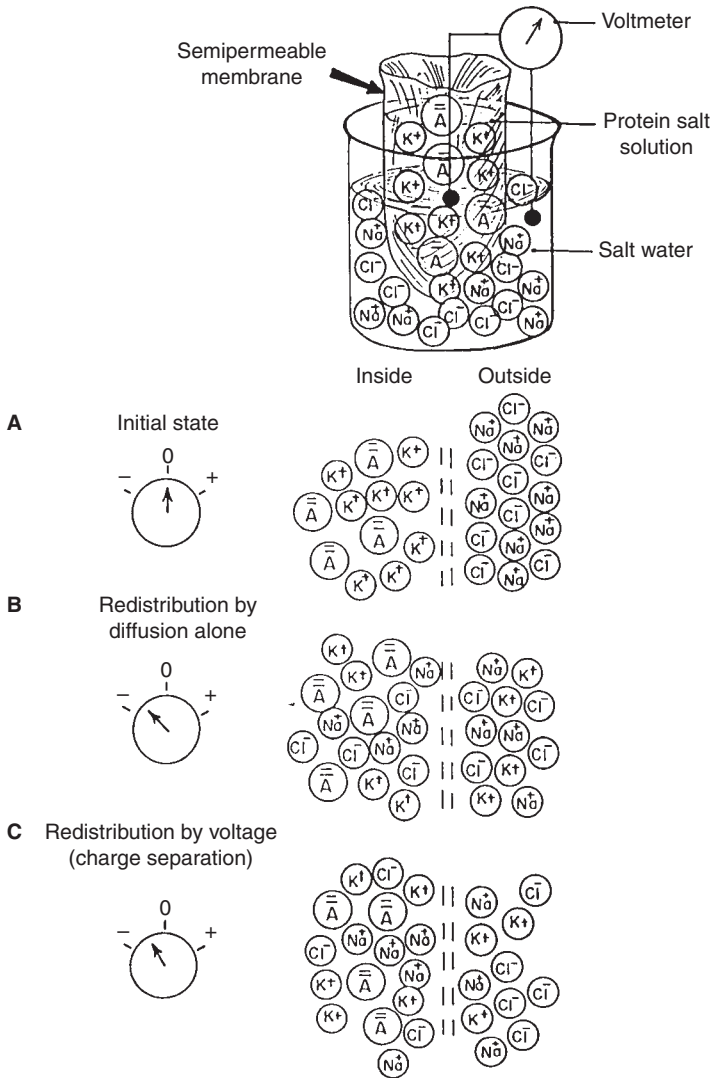
At rest, there is a continuous “leak” of potassium outward and of sodium inward across the membrane. Cells at rest have a permeability to sodium ions that ranges from 1% to 10% of their permeability to potassium. Thus, in the absence of synaptic activity, the membrane potential is dominated by its high permeability to potassium, and the membrane potential is drawn toward the equilibrium potential of this ion (90 mV). However, the membrane at rest is also permeable to sodium and chloride, so that the membrane potential is also pulled toward the equilibrium potential of these ions.

The resting potential varies among different types of neurons, but it is typically  $-60$  to  $-80$  mV. The continuous leaking of potassium outward and sodium inward is balanced by the activity of the sodium/potassium pump.

### Steady State

Potassium diffuses through the membrane most readily because potassium channels are

more open and potassium conductance is much higher than that of other ions. Therefore, potassium is the largest source of separation of positive and negative charges (voltage) as it diffuses out and leaves the large anions behind. This is illustrated schematically in Figure 5-4. Small amounts of sodium entering the cells, driven by both electrical and chemical forces, tend to depolarize the membrane. As a result, potassium is no longer in equilibrium and leaves the cell. Thus, the cell is not in



**Figure 5-4.** A theoretical model of the generation of a membrane potential by diffusion across a semipermeable membrane. *A*, Equal amounts of anions and cations are dissolved on each side of the membrane, producing no voltage gradient. The membrane is permeable to all ions except large anions ( $A^-$ ). *B*,  $K^+$ ,  $Na^+$ , and  $Cl^-$  redistribute themselves solely by diffusion; this results in a charge separation, with greater negativity inside. *C*, Electrical pressure due to charge separation and diffusion pressure due to concentration differences are balanced at the resting membrane potential.



equilibrium but in a steady state dependent on metabolic energy. In this steady state, the small outward potassium leak must be exactly equal in magnitude to the rate at which potassium is transported into the cell. The same is true also for sodium. In this condition, the net movement of each ion across the membrane is zero, an exact description of the resting membrane potential.

## Sodium Pump

The sodium pump (Na/K ATPase) maintains the intracellular concentrations of sodium and potassium despite their constant leaking through the membrane. The sodium/potassium pump transports three sodium ions out of the cell for every two potassium ions carried into the cell. Because the pump is not electrically neutral, it contributes directly to the resting potential; that is, it is electrogenic. The contribution of the sodium/potassium pump steady state to the resting potential is approximately 11 mV. The cell membrane at rest is permeable also to chloride ions. In most membranes, chloride reaches equilibrium simply by adjustment of its internal concentration to maintain electroneutrality, without affecting the steady state membrane potential.

## Role of Extracellular Calcium

The external surface of the cell membrane contains a high density of negative charges because of the presence of glycoprotein residues. This produces a local negative potential that contributes to the resting membrane potential. Divalent ions, such as extracellular calcium, alter the transmembrane potential by neutralizing this local, negative surface potential. Neutralizing the surface potential increases the contribution of the transmembrane potential to the resting potential, and this increases the threshold for opening voltage-gated sodium channels. This explains the stabilizing effect of extracellular calcium on membrane excitability and the presence of increased spontaneous activity (tetany) that occurs in patients with hypocalcemia or alkalosis.

## Role of Glial Cells

Astrocytes are important in controlling the extracellular concentration of potassium. Astrocytes are highly permeable to potassium and are interconnected with each other by gap junctions. When the extracellular concentration of potassium increases because of neuronal activity, astrocytes incorporate potassium and transfer it from one cell to another through gap junctions. This prevents the extracellular accumulation of potassium and maintains neuronal excitability. This is referred to as spatial buffering of extracellular potassium.

### Key Points

- At the resting potential there is no net flow of current between the inside and the outside of a cell.
- Hyperpolarization moves the resting potential away from zero; depolarization moves it toward zero.
- The high permeability of the membrane to potassium is the primary determinant of the resting potential.
- Outward leakage of potassium and inward leakage of sodium at rest are balanced by the reverse action of the sodium/potassium pump.
- Calcium stabilizes the membrane.
- Glial cells buffer the extracellular concentration of potassium.

## LOCAL POTENTIALS

In a normal nerve cell or muscle cell with adequate sources of oxygen and glucose, the resting potential is maintained at a stable, relatively unchanging level. However, the resting potential readily changes in response to stimuli. The membrane potential can change from the resting state in only two ways. It can become either more negative inside, hyperpolarization, or less negative inside, depolarization. Even if the membrane potential reverses, so that the inside becomes positive with respect to the outside, it is still referred to as depolarization, because the potential is less negative than the resting potential.

The changes in the membrane potential that occur with anoxia or a change in the concentration of the ions on either side of the membrane



are relatively long lasting (minutes to hours). In contrast, rapid changes (seconds or less) can occur in response to electrical, mechanical, or chemical stimuli. These changes occur as a result of current flow through the membrane. Transient currents in living tissues are due to the movement of charged ions and can flow through the membrane as a result of an applied voltage or of a change in membrane conductance. A local potential is a transient depolarizing or hyperpolarizing shift of the membrane potential in a localized area of the cell. Local potentials result from the current flow due to localized change in ion channels that alter the permeability to one or more ions. Ion channel opening or closing may result from:

1. Synaptic potential from a chemical agent acting on the channel.
2. Receptor potential from a stimulus acting on a sensory receptor channel.
3. Electrotonic potential from an eternally applied voltage.

Synaptic potentials are the response to information carried by a neurotransmitter released by an adjacent neuron. Receptor potentials are the response to external stimuli. Electrotonic potentials participate in the transfer of information throughout a cell by action potentials.

## Ionic Basis

Local potentials result from the flow of current through the membrane with a change in channels that are open or closed in response to a chemical agent, mechanical deformation, or an applied voltage. Neurotransmitters and neuromodulators produce synaptic potentials by one of six mechanisms:

1. Opening of potassium channels increases potassium conductance, resulting in hyperpolarization, a relatively slow process.
2. Opening of sodium channels increases sodium conductance, resulting in depolarization, a relatively fast process.
3. Opening of both potassium and sodium channels increases the conductance of both ions, resulting in a depolarization but to a lesser degree than in item 2 above.

4. Opening of chloride channels increases chloride conductance, resulting in rapid stabilization or hyperpolarization of the membrane voltage.
5. Closing of potassium channels, resulting in a slow depolarization.
6. Opening of calcium channels, resulting in a slow depolarization.

Generator potentials occur primarily by opening of both sodium and potassium channels and increasing conductance of both ions. This produces depolarization. Generator potentials also occur in response to specific molecules that activate olfactory receptors and to photic stimuli that activate photoreceptors in the retina of the eye. Electrotonic potentials occur in one of two ways:

1. Opening of sodium channels by a current arising from a voltage in an adjacent area of membrane. This produces depolarization.
2. Opening or closing of several different ion channels by an externally applied voltage. Application of a negative voltage to the outside of the membrane causes outward current flow and depolarization of the membrane. Application of a positive voltage to the outside of the membrane causes inward current flow and hyperpolarization of the membrane. When a voltage is applied to the outside of the axonal membrane, the negative pole is commonly referred to as the cathode and the positive pole as the anode. The current flow at the cathode depolarizes, whereas that at the anode hyperpolarizes a membrane. This is because the negative charge at the cathode is extracellular and hence *decreases* the transmembrane potential, conversely for the anode.

## Characteristics of Local Potentials

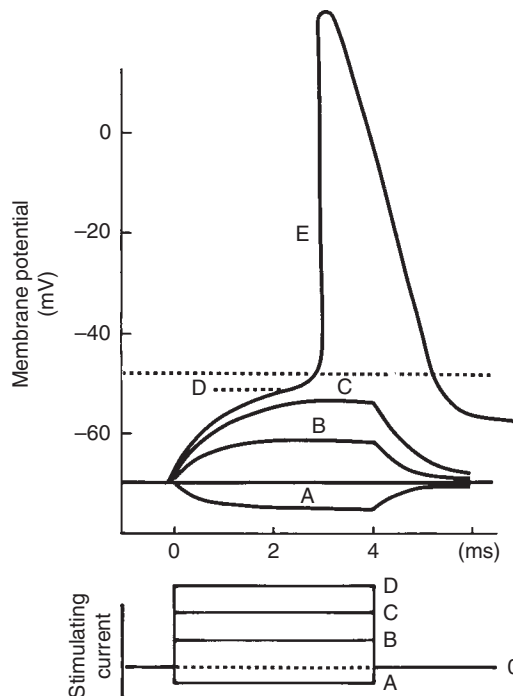
All local potentials have certain characteristics in common (Table 5–6). Importantly, the local potential is a graded potential; that is, its amplitude is proportional to the size of the stimulus (Fig. 5–5). Measurement of a local potential uses the resting potential as its baseline. If the membrane's resting potential is depolarized

Table 5-6 Comparison of Local Potentials and Action Potentials

Characteristic	Local potentials	Action potentials
Example	Generator Synaptic Electrotonic	Nerve impulse
Duration, ms	5-100	1-10
Amplitude, mV	0.1-10	70-110
Ionic mechanism	Local changes in permeability to $\text{Na}^+$ , $\text{K}^+$ , $\text{Ca}^{2+}$ , or $\text{Cl}^-$	Transient increase in permeability to $\text{Na}^+$ , followed by increase in permeability to $\text{K}^+$
Threshold	No	Yes
Spatial and temporal summation	Yes	No (all-or-none)
Refractory period	No	Yes
Propagation	Passive and decremental	Active and nondecremental

from  $-80$  to  $-70$  mV during the local potential, the local potential has an amplitude of 10 mV. This potential change is one of decreasing negativity (or of depolarization), but it could also be one of increasing negativity (or of

hyperpolarization). Because the local potential is a graded response proportional to the size of the stimulus, the occurrence of a second stimulus before the first one subsides results in a larger local potential. Therefore, local



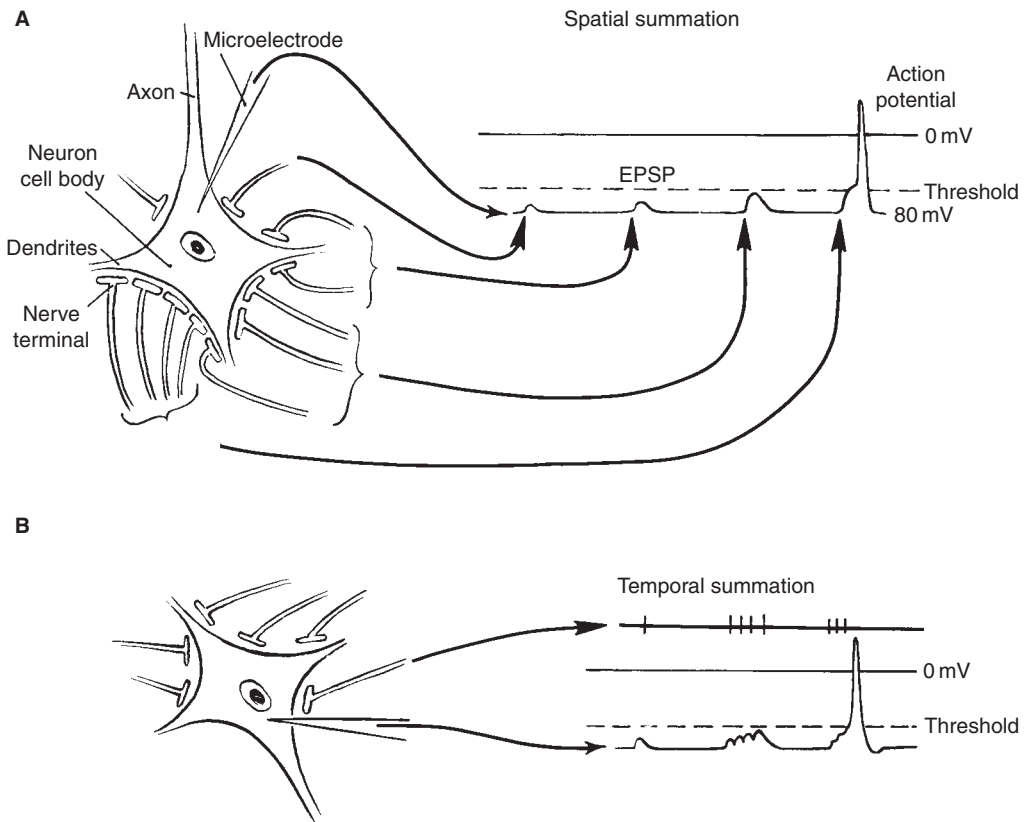
**Figure 5-5.** Local potentials. These potentials are shown as an upward deflection if they are a depolarization and as a downward deflection if they are a hyperpolarization. Resting potential is 70 mV. At time zero, electrical currents of varied polarities and voltages are applied to the membrane (*bottom*). A is an anodal current; B, C, and D are cathodal currents. A produces a transient hyperpolarization; B, C, and D produce a transient depolarization that is graded and proportional to the size of the stimulus. All of these are local potentials. D produces an action potential, E.

potentials can be summated. They are summated algebraically, so that similar potentials are additive and hyperpolarizing and depolarizing potentials tend to cancel out each other. Summated potentials may reach threshold and produce an action potential when single potentials individually are subthreshold. When a stimulus is applied in a localized area of the membrane, the change in membrane potential has both a temporal and a spatial distribution.

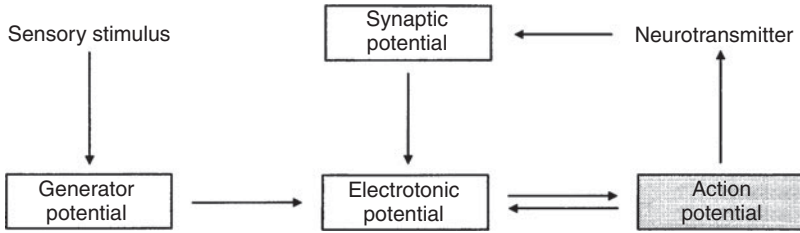
A study of the temporal course of the local potential (Fig. 5-6) shows that the increase in the potential is not instantaneous, but develops over a few milliseconds. After the stimulus ends, the potential subsides over a few milliseconds as well. Therefore, local potentials have a temporal course that outlasts the stimulus. The occurrence of a second stimulus at the same site shortly after the first produces another local potential, which summates with the residual of the earlier one that has not yet

subsided (Fig. 5-6). This summation of local potentials occurring near each other in time is called *temporal summation* (Fig. 5-6B). Different synaptic potentials have different time courses. Most synaptic potentials range from 10 to 15 ms in duration; however, some are very brief, lasting less than 1 ms, but others may last several seconds or several minutes. Longer duration synaptic potentials have a greater chance for temporal summation. By means of temporal summation, the cell can integrate signals that arrive at different times.

Study of the spatial distribution of local potentials reveals another of their characteristics. As their name implies, they remain localized in the region where the stimulus is applied; they do not spread throughout the entire cell. However, the locally applied stimulus, because of local current flow, has an effect on the nearby membrane. The potential change is not sharply confined to the area of



**Figure 5-6.** Summation of local potentials in a neuron. *A*, Spatial summation occurs when increasing numbers of nerve terminals release more neurotransmitter to produce larger EPSPs. *B*, Temporal summation occurs when a single terminal discharges repetitively more rapidly to produce larger EPSPs.



**Figure 5-7.** Local potentials and triggering of the action potential. Three types of local potentials are (1) receptor (or generator) potential, triggered by the action of a sensory stimulus on a sensory receptor; (2) synaptic potential, triggered by the action of a neurotransmitter; and (3) electrotonic potential, which consists of the passive movement of charges according to the cable properties of a membrane. Both the generator and synaptic potentials give rise to electrotonic potentials, which depolarize the membrane to threshold for triggering an action potential. The action potential is a regenerating depolarizing stimulus that, via electrotonic potentials, propagates over a distance without decrement in its amplitude.

the stimulus but falls off over a finite distance along the membrane, usually a few millimeters.

The application of a simultaneous second stimulus near the first (but not at the same site) results in summation of the potentials in the border zones; this is called *spatial summation* (Fig. 5-6A). Thus, the membrane of the cell can act as an integrator of stimuli that arrive from different sources and impinge on areas of membrane near one another. Spatial summation and temporal summation are important mechanisms in the processing of information by single neurons; when summated local potentials reach threshold, they initiate an action potential (Fig. 5-7). If a current or voltage is applied to a membrane for more than a few milliseconds, the ion channels revert to their resting state, changing ionic conductances of the membrane in a direction to restore the resting potential to baseline value. This phenomenon is known as *accommodation* (Fig. 5-8). Therefore, if an electrical stimulus is increased slowly, accommodation can occur and no change will be seen in the membrane potential. The changes in conductance during

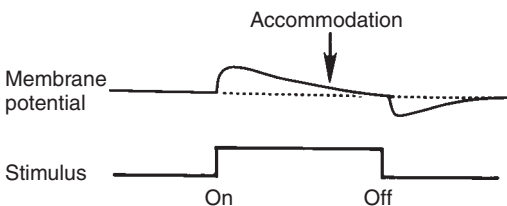
accommodation require several milliseconds, both to develop and to subside. As a result, if an electrical stimulus is applied gradually so that accommodation prevents a change in the membrane potential, no effect is observed.

### Key Points

- Amplitude of depolarizing and hyperpolarizing local potentials depend on stimulus intensity.
- Local changes in membrane potential can be triggered by synaptic transmitters, voltage changes, or sensory stimuli.
- Local potentials summate spatially and temporally.

## ACTION POTENTIALS

Action potentials have several advantages for the rapid transfer of information in the nervous system. Because action potentials are all-or-none (i.e., they are not graded responses; they either occur or do not occur), they can transfer information without loss over relatively long distances. Their all-or-none feature also allows coding of information as frequency rather than the less stable measure of amplitude. Also, their threshold eliminates the effects of small, random changes in membrane potential.



**Figure 5-8.** Accommodation of the membrane potential to applied stimulus of constant strength. Note the response to sudden cessation of the stimulus when the stimulus is turned off. The residual change in conductance produces a transient change in resting potential. Thus, accommodation can result in a cell responding to the cessation of a stimulus.

### Threshold

The membranes of neurons, axons, and muscle cells have another characteristic that is basic to their ability to transmit information from one

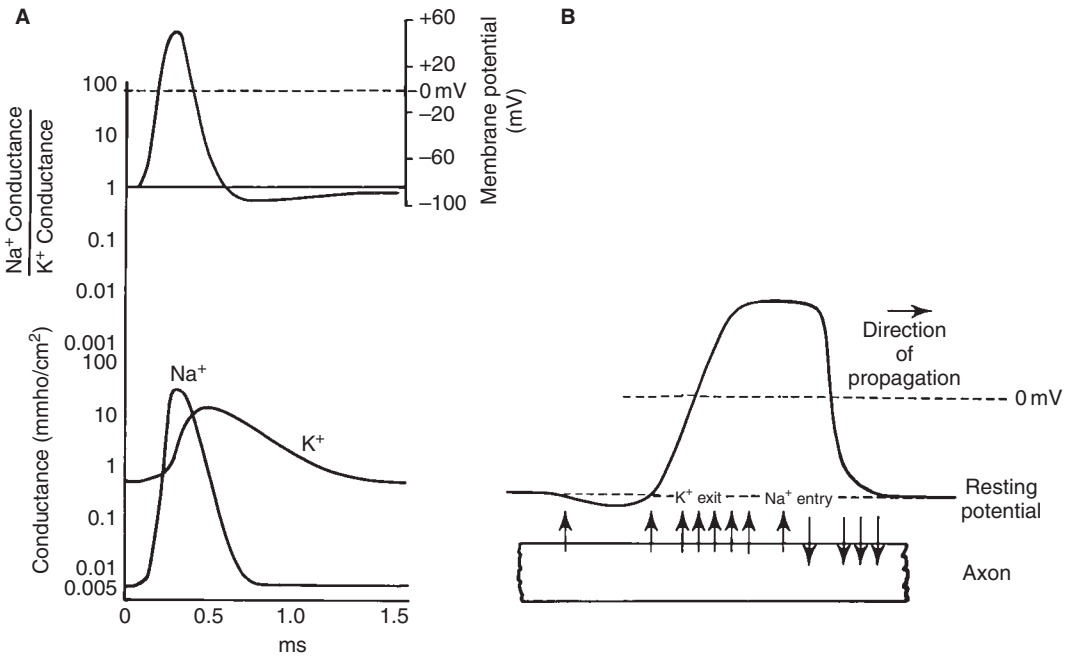
area to another—their excitability. If a membrane is depolarized by a stimulus, there is a point at which suddenly many sodium channels open. This point is known as the *threshold for excitation* (Fig. 5-5). If the depolarization does not reach threshold, the evoked activity is a local potential. Threshold may be reached by a single local potential or by summated local potentials. When threshold is reached, there is a sudden increase in the membrane's permeability to sodium. This change in conductance results in the action potential.

### Ionic Basis of Action Potentials

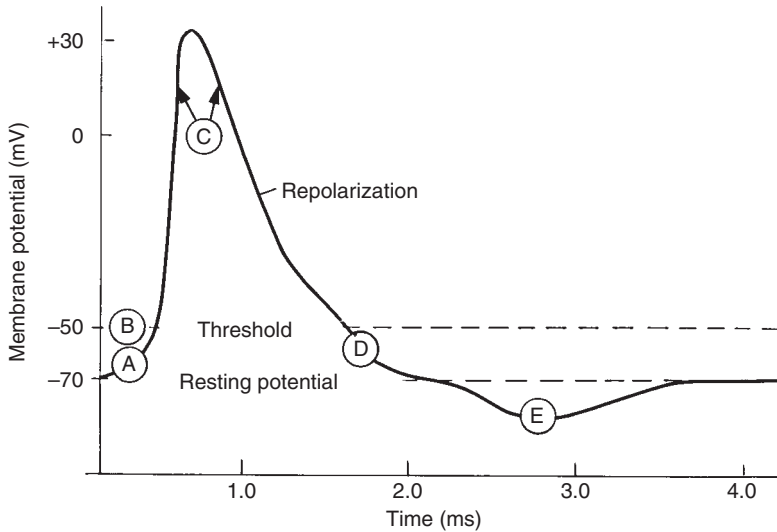
In the resting state, many more potassium channels are open, the conductance of sodium is much less than that of potassium, and the resting potential is near the equilibrium potential of potassium. At threshold, many sodium channels open so that the conductance of sodium suddenly becomes greater than that of potassium, and the membrane potential shifts toward the equilibrium potential of sodium,

which is approximately +60 mV. This depolarization locally reverses the polarity of the membrane, the inside becoming positive with respect to the outside. With the opening of the sodium channels and increased sodium conductance, there is a flow of current with the inward movement of sodium ions. The change in sodium conductance is usually transient, lasting only a few milliseconds, and is followed by the opening of potassium channels, an increase in the potassium conductance, and an outward movement of potassium ions. These three changes overlap, and the potential of the membrane during these changes is a function of the ratios of the conductances (Fig. 5-9).

Sodium conductance increases several thousand-fold early in the process, whereas potassium conductance increases less, does so later, and persists longer. The conductance changes for these two ions result in ionic shifts and current flows that are associated with a membrane potential change: the action potential (Fig. 5-9). The action potential is a sudden, short duration, all-or-none change in the



**Figure 5-9.** Conductance changes during action potential. *A*, Temporal sequence at a single site along an axon. Changes in conductances (permeabilities) of sodium and potassium are plotted against time as they change with associated changes in membrane potential. Note that sodium conductance changes several thousand-fold early in the process, whereas potassium conductance changes only about 30-fold during later stages and persists longer than sodium conductance changes. *B*, Spatial distribution of an action potential over a length of axon at a single instant.



**Figure 5-10.** Components of an action potential with a resting potential of 70 mV. *A*, Local electrotonic potential. *B*, Threshold level. *C*, Spike. *D*, Negative (depolarizing) afterpotential. *E*, Positive (hyperpolarizing) afterpotential.

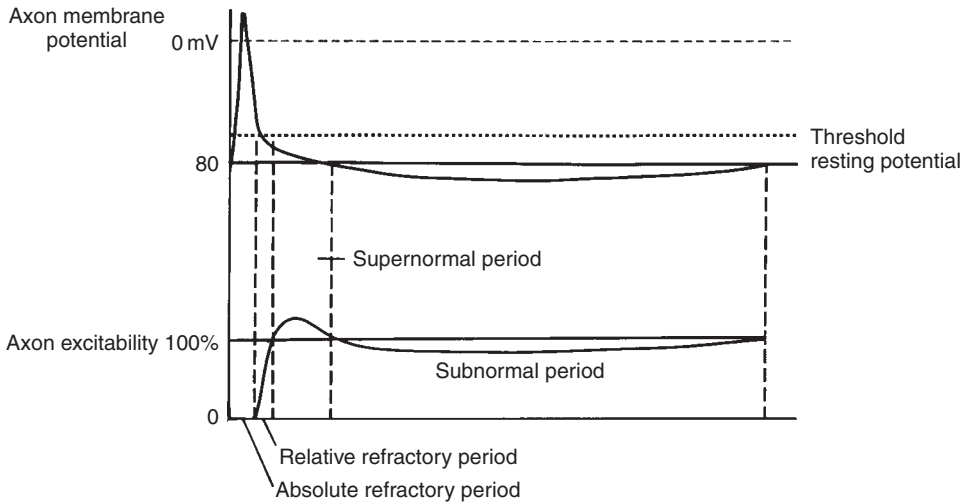
membrane potential that occurs if the membrane potential reaches threshold (Table 5-5). Its components are shown in Figure 5-10. The initial portion of the membrane potential change is the local potential. At threshold, the rising phase of the action potential suddenly changes because of the influx of positive ions. In most nerve cells and skeletal muscle cells, the inward current during the rising phase of the action potential is carried by sodium ions, because sodium conductance is markedly increased. The action potential also could be carried by calcium ions if the calcium conductance increased sufficiently, as occurs in some dendrites.

Repolarization begins as sodium conductance decreases or potassium conductance increases (usually both). The decreased flow of sodium ions is followed by an efflux of potassium ions. The rate of return of the membrane potential to the baseline slows after sodium conductance has returned to baseline, producing a small residual on the negative component of the action potential, which is called the *negative afterpotential*. In some myelinated axons, repolarization occurs by a decrease in sodium conductance with no change in potassium conductance. The afterpotential is positive when the membrane potential is recorded with a microelectrode within the cell, but it is called negative because it is negative when recorded with

an extracellular electrode. The increase in potassium conductance persists and results in a hyperpolarization after the spike component of the action potential—the after-hyperpolarization. The after-hyperpolarization is due to continued efflux of potassium ions, with a greater potential difference between the inside and the outside of the cell than the typical resting potential difference. The after-hyperpolarization is positive when measured with extracellular electrodes and therefore is called a *positive afterpotential*. During the positive afterpotential, the membrane potential is near the potassium equilibrium potential, and is increased with increased activity of the sodium pump. The amounts of sodium and potassium that move across the membrane during the action potential are small, buffered by surrounding astrocytes, and do not change the concentration enough to result in a change in the resting potential. In addition, the sodium that moves in during the action potential is continually removed by the sodium pump during the relatively long intervals between action potentials.

## Excitability

The excitability of a membrane is the ease with which an action potential can be generated and is usually measured in terms of the

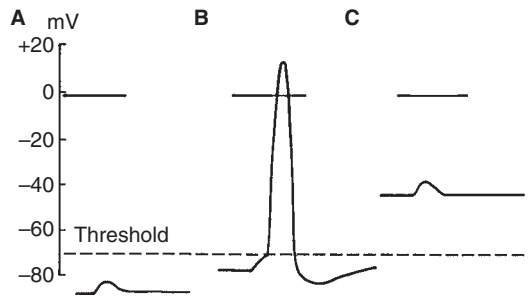


**Figure 5-11.** Excitability changes during an action potential. The lower portion of the illustration shows the ease with which another action potential can be elicited (change in threshold). During absolute and relative refractory periods, the amplitude of the action potential evoked is low. Subsequently, it is normal.

voltage required to initiate an action potential. During increased sodium conductance, the membrane cannot be stimulated to discharge again. A second stimulus at this time is without effect; therefore, action potentials, unlike local potentials, cannot summate. This period of unresponsiveness is the absolute refractory period (Fig. 5-11). As sodium conductance returns to normal, the membrane again becomes excitable, but for a short period, termed the *relative refractory period*, it requires a larger stimulus to produce an action potential. After the relative refractory period, while the negative afterpotential is subsiding, the membrane is partially depolarized, is closer to threshold, and has an increased excitability. This period is the supernormal period. Finally, during the positive afterpotential, the membrane is hyperpolarized, and stronger stimuli are required. This period is the subnormal period.

Up to now, the term threshold has been used to refer to the membrane potential at which sodium channels open and an action potential is generated. The threshold of a membrane remains relatively constant. If the membrane potential becomes hyperpolarized, it moves away from threshold, and the membrane is less excitable. If the membrane potential moves closer to threshold, the membrane becomes more excitable and will generate an action potential with a smaller stimulus. If

the membrane potential is very near threshold, the cell may fire spontaneously. If the membrane potential remains more depolarized than threshold, however, the membrane cannot be stimulated to fire another action potential (Fig. 5-12). The term threshold is also used to describe the voltage required to excite an action potential with an eternally applied stimulus. When threshold is used in this sense, an axon with an increased excitability due to partial depolarization may be said to have a lower threshold for stimulation, even though the actual threshold is unchanged. The



**Figure 5-12.** The effect of stimulation of a neuron at different resting potentials as recorded with a microelectrode. A, The membrane is hyperpolarized, and a stimulus produces a subthreshold local potential. B, The membrane is normally polarized at 65 mV, and a stimulus produces a local potential that reaches threshold and results in an action potential. C, The membrane is depolarized beyond threshold, and a stimulus produces only a small local potential.



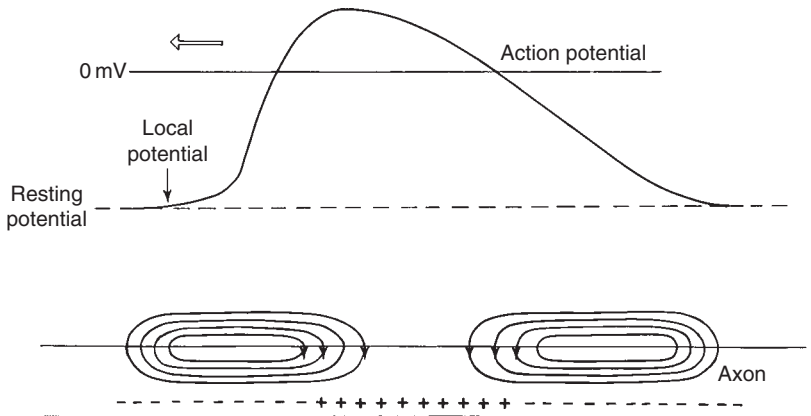
first meaning of threshold is used when intracellular recordings are considered, and the second is used in reference to extracellular stimulation and recording. The threshold of the nerve membrane differs in different parts of the neuron: it is high in the dendrite and soma and lowest at the initial segment. Thus, an action potential is usually generated in the area of the axon hillock.

## Propagation

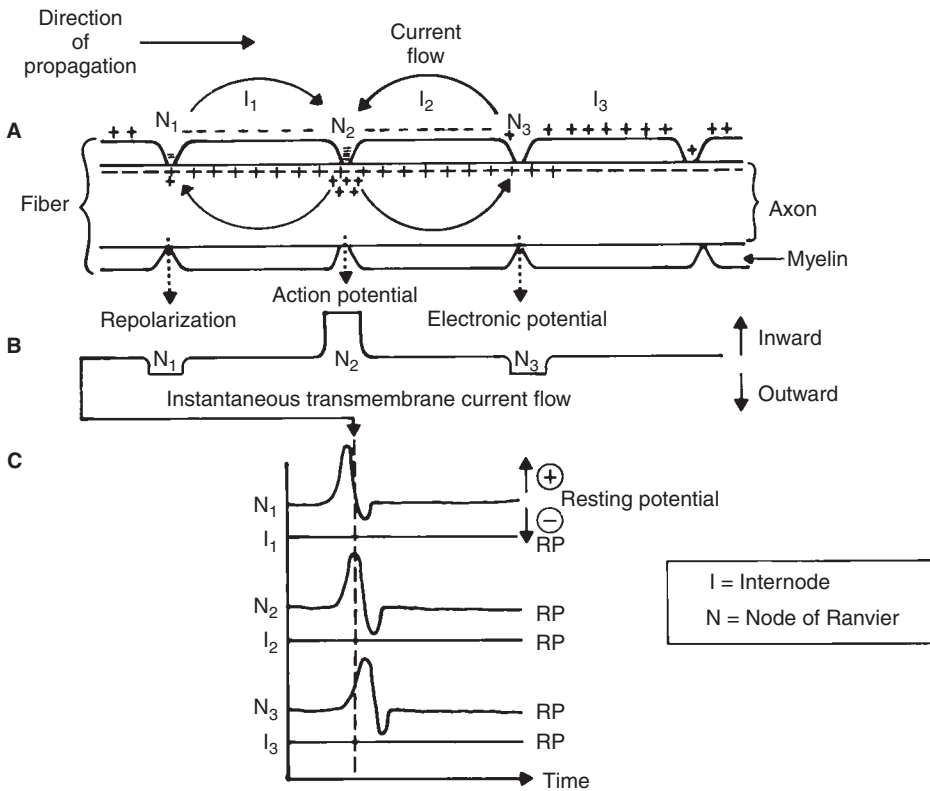
Another important characteristic of action potentials is their propagation. If an action potential is initiated in an axon in the tip of the finger, for instance, the potential spreads along the entire length of that axon to synapse on its second-order sensory neuron in the spinal cord. This characteristic permits the nervous system to transmit information from one area to another. When an area of membrane is depolarized during an action potential, ionic currents flow (Fig. 5-13). In the area of depolarization, sodium ions carry positive charges inward. There is also a longitudinal flow of current both inside and outside the membrane. This flow of positive charges (current) toward nondepolarized regions internally and toward depolarized regions externally tends to depolarize the membrane in the areas that surround the region of the action potential. This depolarization is an electrotonic potential. In normal tissue, this depolarization is sufficient

to shift the membrane potential to threshold and thereby generate an action potential in the immediately adjacent membrane. Thus, the action potential spreads away from its site of initiation along an axon or muscle fiber. Because of the refractory period, the potential cannot reverse and spread back into an area just depolarized.

The rate of conduction of the action potential along the membrane depends on the amount of longitudinal current flow and on the amount of current needed to produce depolarization in the adjacent membrane. The longitudinal current flow can be increased by increasing the diameter of an axon or muscle fiber, because this increase reduces the internal resistance, just as a larger electrical wire has a lower electrical resistance. However, many axons in the central and peripheral nervous systems have an increased conduction velocity because they are insulated with a myelin sheath. A myelinated axon has its membrane bared only at the nodes of Ranvier, so that transmembrane current flow occurs almost exclusively at the nodal area. When the current flow opens enough sodium channels to reach threshold in the nodal area, it results in many more sodium channels opening and an influx of sodium ions with a generation of an action potential. The nodal area in the mammalian nervous system is unique in that it consists almost exclusively of sodium channels, with an almost complete absence of potassium channels. The potassium channels are located at the paranodal regions (adjacent



**Figure 5-13.** Current flow and voltage changes in an axon in the region of an action potential. The voltage changes along the membrane are shown in the upper part of the figure and the spatial distribution of current flow is shown in the lower part as *arrows* through the axon membrane.



**Figure 5-14.** Saltatory conduction along an axon from left to right. A, The charge distribution along the axon is shown with an action potential (depolarization) at the second node of Ranvier (N<sub>2</sub>). Current flow spreads to the next node (N<sub>3</sub>). B, Membrane current flow along the axon. C, The portion of the action potential found at each node is indicated by dotted lines.

to the node), which are covered by myelin. The action potential generated at the node consists predominantly of inward sodium currents with little outward potassium currents, and repolarization is achieved by means of sodium inactivation and leakage currents. An action potential at one node of Ranvier produces sufficient longitudinal current flow to depolarize adjacent nodes to threshold, thereby propagating the action potential along the nerve in a skipping manner called *saltatory conduction* (Fig. 5-14).

- Excitability is the probability of triggering an action potential.
- The density of voltage-gated sodium potentials determines the threshold for triggering an action potential.
- Membrane depolarization (toward threshold) increases excitability.
- A refractory period occurs with membrane depolarization above threshold and inactivation of voltage-gated sodium channels.

**Key Points**

- An action potential consists of two components:
  - Rapid membrane depolarization due to opening of voltage-gated sodium channels.
  - Repolarization due to delayed opening of voltage-gated potassium channels.

**Patterns of Activity**

Information in the nervous system is coded by the number and type of axons that are active and by the firing pattern of action potentials. This activity is initiated in peripheral receptors or in neurons. Neuronal firing of action potentials may occur spontaneously or in response to external stimulation. Beating,

or pacing, neurons fire repetitively at a constant frequency; their intrinsic firing rate may be increased or decreased by external stimulation. Bursting neurons generate regular bursts of action potentials separated by hyperpolarization of the membrane. Such neurons are important for rhythmic behavior such as breathing, walking, and chewing. Neurons that fire in response to external stimulation may do so in one of three ways:

1. A sustained response neuron shows repeated action potentials with a constant firing frequency that reflects the strength of the stimulus.
2. A delayed response neuron fires action potentials only after stimulation of sufficient intensity.
3. An accommodation response neuron fires only a single potential at the onset of stimulation and remains silent thereafter.

Some neurons (e.g., in the thalamus) have the ability to discharge either in rhythmic bursts or with typical action potentials. The firing pattern depends on the level of the resting membrane potential. An important property of this type of neuron is the presence of a particular class of calcium channel, the *T channel*. This channel can be activated only if the membrane potential is relatively hyperpolarized (e.g.,  $-80$  mV). Under this condition, a stimulus opens the T channel and calcium enters the cell and produces a small, brief calcium-based depolarizing potential change called the *low-threshold calcium spike*. This calcium spike triggers the opening of sodium channels, which produces a burst of repetitive action potentials.

As calcium accumulates in the cell, it opens a calcium-activated potassium channel that allows the efflux of potassium. The resulting hyperpolarization (called *after-hyperpolarization*) allows reactivation of the T channel, entry of sodium, and recurrence of the cycle. This sequence generates rhythmic burst firing of the neuron. Thus, T channels are an exception to the general rule of neuronal excitability: hyperpolarization “deinactivates” T channels and increases the likelihood that the neuron will discharge in rhythmic bursts of activity. Rhythmic burst firing in thalamic neurons that project to the cerebral cortex impairs

the encoding of information by cortical neurons and interferes with the transmission of sensory information. Inactive states of the cerebral cortex occur during deep sleep and in some types of seizures.

### Key Points

- The action potential is an all-or-none signal that is transmitted without decrement along an axon.
- The frequency of discharge of action potentials is determined by the amplitude of the stimulus.
- Action potential conduction velocity depends on axon diameter and the myelin sheath.
- Voltage-gated sodium channels are clustered at the nodes of Ranvier in a myelinated axon.
- Potassium channels are covered by the myelin sheath.

## SYNAPTIC TRANSMISSION

A synapse is a specialized contact zone where one neuron communicates with another neuron. The contact zone between a neuron and a nonneural effector element (e.g., a muscle fiber) is referred to as a neuron-effector junction. The two types of synapses are chemical and electrical. The most common form of communication in the nervous system is through chemical synapses. A chemical synapse consists of a presynaptic component (containing synaptic vesicles), a postsynaptic component (dendrite, soma, or axon), and an intervening space called the *synaptic cleft* (Fig. 5–15). Many of the drugs used in clinical medicine have their pharmacologic site of action at the synapse. The mechanism underlying chemical synaptic transmission should make it apparent that synaptic transmission has three unique characteristics:

1. First, conduction at a synapse is delayed because of the brief interval of time required for the chemical events to occur.
2. Second, because the two sides of the synapse are specialized to perform only one function, transmission can occur in only one direction across the synapse.

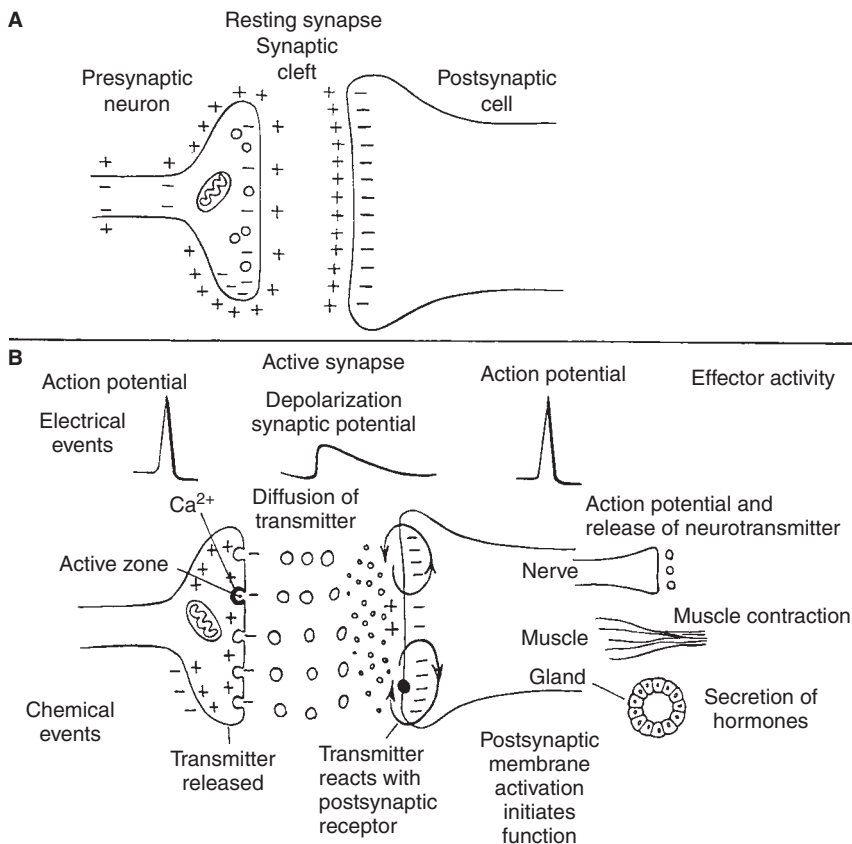
Thus, neurons are polarized in the direction of impulse transmission.

- Third, because nerve impulses from many sources impinge on single cells in the central and peripheral nervous systems, synaptic potentials summate both temporally and spatially.

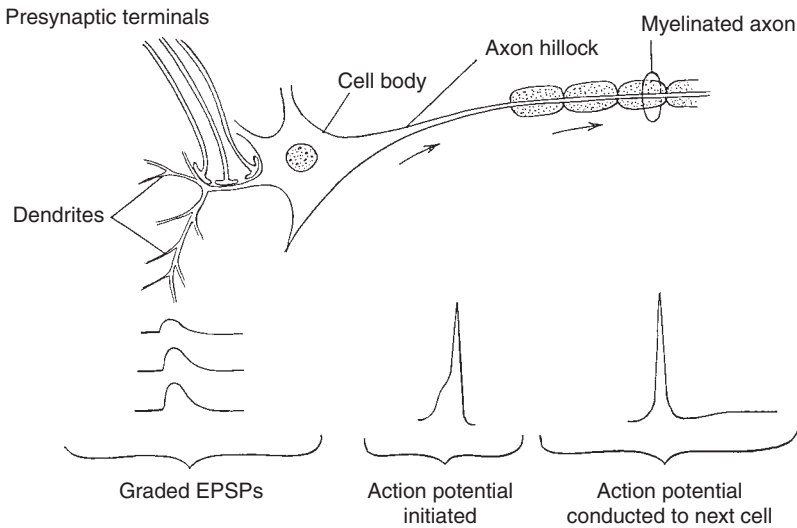
The membrane of a cell is continually bombarded with neuromodulators and neurotransmitters, which produce either excitatory postsynaptic potentials (EPSPs) or inhibitory postsynaptic potentials (IPSPs) of varying duration. When the membrane potential reaches threshold, an action potential is generated. Thus, a single neuron can integrate activity from many sources. A summary of the electrical events in a single cell underlying the transmission, integration, and conduction of information is shown in Figure 5–16.

## Biosynthesis, Storage, Release, and Reuptake of Neurochemical Transmitters

Neurochemical transmitters include amino acids, acetylcholine, monoamines (catecholamines, serotonin, and histamine), neuropeptides, and purines (ATP and adenosine). Amino acids include L-glutamate, the most abundant excitatory neurotransmitter in the central nervous system, and  $\gamma$ -aminobutyric acid (GABA), the most abundant inhibitory neurotransmitter. Both of these neurotransmitters are synthesized from intermediate metabolites of the Krebs cycle. Acetylcholine and monoamines are synthesized by specific enzymes from precursors that are actively taken up by the presynaptic terminal. Neuropeptides are synthesized from messenger RNA in the cell body and transported to the synaptic terminal.



**Figure 5–15.** Synaptic transmission. *A*, In a resting synapse, both the presynaptic axon terminal and the postsynaptic membrane are normally polarized. *B*, In an active synapse, an action potential invades the axon terminal (from left in the diagram) and depolarizes it. Depolarization of the axon terminal of a presynaptic neuron results in the release of neurotransmitter from the terminal. The neurotransmitter diffuses across the synaptic cleft and produces local current flow and a synaptic potential in the postsynaptic membrane, which initiates the effector activity (neuronal transmission, neurotransmitter release, hormonal secretion, or muscle contraction).



**Figure 5-16.** Neuronal electrical activity from its initiation by excitatory postsynaptic potentials (EPSPs) to its transmission as an action potential to another area.

Neurochemical transmitters are stored in special intracellular organelles called *synaptic vesicles*. Small clear synaptic vesicles store the classic neurotransmitters (amino acids, acetylcholine, monoamines), and large dense core secretory granules store neuropeptides.

Neurotransmitter release is triggered by the influx of calcium through voltage-gated channels that open in response to the arrival of an action potential in the presynaptic terminal. These channels are clustered in specific regions of the presynaptic membrane called *active zones* (Fig. 5-15B). The synaptic vesicles are mobilized in the presynaptic terminal and dock close to the active zones. In response to the influx of calcium, the vesicle membrane fuses with the presynaptic membrane, which allows the release of the neurotransmitter into the synaptic cleft; this process is called *exocytosis*. The mobilization, docking, and fusion of synaptic vesicles depend on the interactions of various synaptic vesicle proteins with other components of the presynaptic terminal.

A neuron can produce and release different neurotransmitters. Neurons frequently contain a classic neurotransmitter (an amino acid or acetylcholine) and one or more neuropeptides. The neuron can release a variable mixture of these neurotransmitters according to its firing pattern, a process referred to as frequency-dependent chemical coding. Classic neurotransmitters can be released after a single action potential; neuropeptides are released in response to rapid, burst firing of a neuron. Two

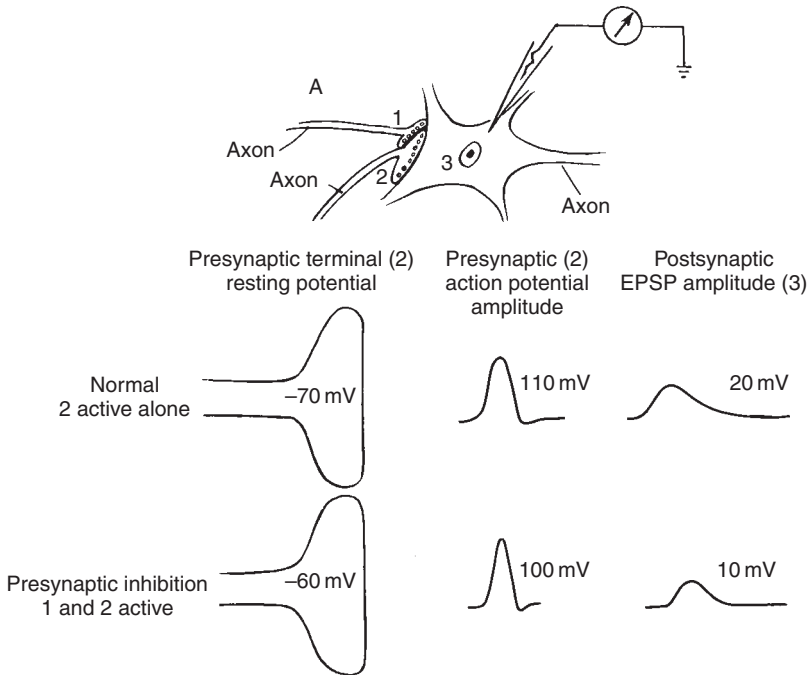
other presynaptic mechanisms also regulate neurotransmitter release:

1. The neurotransmitter inhibits its own release, acting via presynaptic inhibitory autoreceptors.
2. Inhibitory neurons (generally containing GABA) form axoaxonic synapses that inhibit the release of neurotransmitter from the postsynaptic axon, a process called *presynaptic inhibition* (Fig. 5-17).

The synaptic action of neurotransmitters is terminated by several mechanisms. Presynaptic reuptake, mediated by specific sodium-dependent and ATP-dependent neurotransmitter transporters, is the primary mechanism of inactivation of glutamate, GABA, and monoamines. Monoamines are metabolized after reuptake by monoamine oxidases and methyltransferases. Acetylcholine and neuropeptides do not undergo reuptake but are rapidly inactivated by enzymatic hydrolysis in the synaptic cleft.

## Postsynaptic Effects of Neurochemical Transmitters

Postsynaptic effects are mediated by two main classes of receptors: (1) Ligand-gated receptors or ion channels mediate rapid



**Figure 5-17.** A, Presynaptic inhibition of neuron 3 when axon 1 partially depolarizes axon 2. B, Response to axon 2 acting alone. C, Response to axon 2 after depolarization of axon 1. In the latter case, there is less neurotransmitter and a smaller excitatory postsynaptic potential (EPSP).

changes in ionic conductance (ionotropic effect) and (2) G-protein-coupled receptors produce slower changes in neuronal excitability and metabolism (metabotropic effect) (Table 5-7). These changes not only modify

the electrical behavior of the neuron but also may produce long-term effects, such as use-dependent modification of synaptic efficacy, cytoskeletal changes during development and repair, and control of genetic transcription.

**Table 5-7 Comparison of Classic Neurotransmission and Neuromodulation**

	Classic neurotransmission	Neuromodulation
Function	Rapid synaptic excitation or inhibition	Modulation of neural excitability
Receptor mechanism	Ion channel receptors	G-protein-coupled receptors
Ionic mechanism	Opening of either cation channel (fast EPSP) or Cl <sup>-</sup> channel (fast IPSP)	Opening or closing of voltage-gated K <sup>+</sup> or Ca <sup>2+</sup> channels (slow IPSP and slow EPSP)
Example	L-Glutamate (ionotropic) GABA (GABA <sub>A</sub> ) Acetylcholine (nicotinic)	L-Glutamate (metabotropic) GABA (GABA <sub>A</sub> ) Acetylcholine (muscarinic) Monamines Neuropeptides
Systems	Relay systems, direct Sensory Motor	Diffuse systems, indirect Internal regulation Consciousness

Note: EPSP, excitatory postsynaptic potential; GABA,  $\gamma$ -aminobutyric acid; IPSP, inhibitory postsynaptic potential.

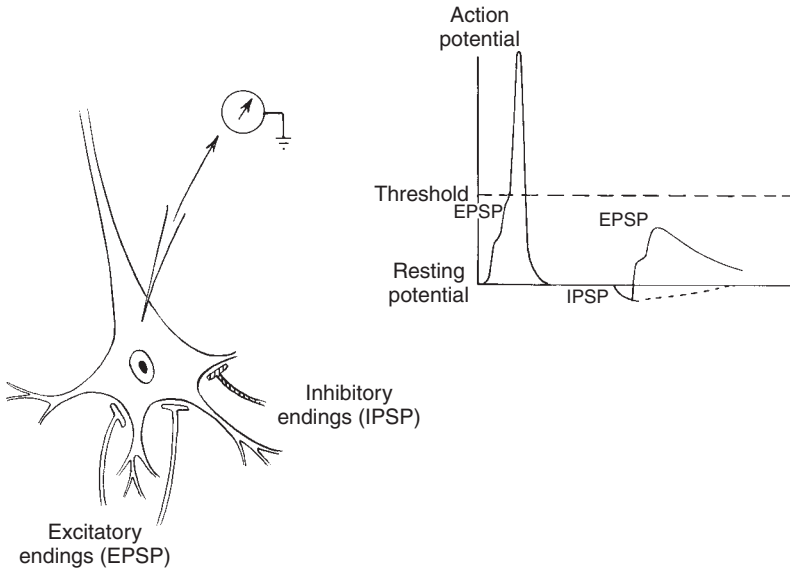
Table 5–8 Postsynaptic Potentials

Receptor	Ionic mechanism	Effect	Kinetics
Nicotinic Glutamate	Increased cation ( $\text{Na}^+$ , $\text{Ca}^{2+}$ ) conductance	Excitatory	Fast
GABA <sub>A</sub> Glycine	Increased $\text{Cl}^-$ conductance	Inhibitory	Fast
G-protein-coupled receptors	Decreased $\text{K}^+$ conductance Increased $\text{K}^+$ conductance	Excitatory Inhibitory	Slow Slow

**Classic Neurotransmission**

Classic neurotransmission is used for fast, precise, point-to-point transmission of excitatory or inhibitory signals. It involves rapid, brief opening of ligand-gated ion channel receptors. Neurotransmitters produce a transient increase or decrease in ion channel conductance to the passive flow of a specific ion current. These ionic currents produce local changes in the membrane potential called *postsynaptic potentials*. In most mammalian neurons, the resting membrane potential is approximately 60 to 80 mV. The threshold for opening voltage-gated sodium channels that trigger an action potential is reached when the postsynaptic potentials drive the membrane potential to a value that is about

10 mV less negative than the resting potential. Ion currents that increase the net positive charge of the membrane produce depolarization EPSPs because they bring the membrane potential toward the threshold for triggering an action potential. In classic neurotransmission, fast EPSPs result from the opening of cation channels (conducting sodium ions and, in some cases, calcium ions). Ligand-gated cation channel receptors that produce fast EPSPs include nicotinic acetylcholine receptors and several ionotropic glutamate receptors. Ion currents that increase the net negative charge of the membrane produce IPSPs. Fast IPSPs are produced by the opening of chloride channels. GABA (via GABA<sub>A</sub> receptors) and glycine act via this mechanism (Table 5–8 and Fig. 5–18).



**Figure 5–18.** Postsynaptic inhibition in the neuron on the left occurs when the inhibitory and excitatory endings are active simultaneously. On the right, a microelectrode recording shows two excitatory postsynaptic potentials (EPSPs) summing to initiate an action potential. When there is a simultaneous occurrence of an inhibitory postsynaptic potential (IPSP), depolarization is too low to reach threshold, and no action potential occurs.



## Neuromodulation

Neurotransmitters acting through G-protein-coupled receptors, second messengers, and protein phosphorylation cascades control the excitability and responsiveness of neurons to rapid synaptic signals, a process called *neuromodulation*. G-protein-coupled receptors include metabotropic glutamate receptors, GABA<sub>B</sub> receptor, and receptors for catecholamines, serotonin and histamine, neuropeptides, and adenosine. Potassium channels are an important target of neuromodulatory signals. Potassium currents determine the pattern of activity generated by neurons through control of the resting membrane potential, repolarization of the action potential, and probability of generation of repetitive action potentials. The opening of potassium channels brings the membrane potential toward the equilibrium potential of potassium (100 mV) and thus away from the threshold for triggering an action potential. Closure of the potassium channels moves the membrane potential away from the equilibrium potential of potassium and thus closer to the threshold.

Neuromodulation involves the production of slow potentials. Activation of G-protein receptors that lead to closure of potassium channels produces slow depolarization and increased neuronal excitability. G-protein receptor mechanisms that increase potassium permeability lead to membrane hyperpolarization and reduce neuronal excitability. The same neurotransmitter may act via different receptor subtypes, each coupled to a distinct transduction pathway. Also, different neurotransmitters, via their respective receptors, may activate a similar transduction pathway.

## Electrical Synapses

Although most synapses in the nervous system use chemical transmitters, neurons with junctions that contain channels extending from the cytoplasm of the presynaptic neuron to that of the postsynaptic neuron interact electrically. In these electrical synapses, the bridging channels mediate ionic current flow from one cell to the other. Transmission across the electrical synapse is very rapid, without the synaptic delay of chemical synapses. Electrical synapses are also bidirectional, in contrast to chemical

synapses, which transmit signals in only one direction.

### Key Points

- Presynaptic activities include
  - Synthesis and storage of neurotransmitters in synaptic vesicles
  - Vesicle mobilization
  - Exocytic release of neurotransmitter.
- Action potentials trigger the opening of presynaptic, voltage-gated calcium channels and exocytosis of neurotransmitter.
- Fast excitatory or inhibitory postsynaptic potentials are elicited by neurotransmitters acting on ligand-gated chloride or cation channels.
- Neuromodulation (changes in neuronal excitability due to permeability changes of voltage-gated potassium or calcium channels) is brought about by neurotransmitters acting on G-protein-coupled receptors.

## CLINICAL CORRELATIONS

### Pathophysiologic Mechanisms

The mechanisms responsible for neuronal excitability, impulse conduction, and synaptic transmission in the central and peripheral nervous system may be altered transiently to produce either loss of activity or overactivity of neurons. A loss of activity results in a clinical deficit of relatively short duration (seconds to hours), whereas overactivity results in extra movements or sensations. Both types of transient alteration are usually reversible. These transient disorders may be focal or generalized (Table 5–9) and may be due to different mechanisms (Table 5–10). Transient disorders reflect disturbances in neuronal excitability due to abnormalities in membrane potential.

### Energy Failure

Energy metabolism is necessary for maintenance of the membrane potential by the ATP-coupled sodium/potassium pump. Most of the ATP produced in the nervous system by aerobic metabolism of glucose is

Table 5–9 Transient Disorders of Neuronal Function

Neuronal excitability	Focal disorder	Generalized disorder
Increased	Focal seizure Tonic spasms Muscle cramp Paresthesia Paroxysmal pain	Generalized seizure Tetany
Decreased	Transient ischemic attack Migraine Transient mononeuropathy	Syncope Concussion Cataplexy Periodic paralysis

Table 5–10 Mechanisms of Transient Disorders

Energy failure
Hypoxia-ischemia
Hypoglycemia
Seizures
Spreading cortical depression
Trauma
Ion channel disorders
Mutation of channel protein (channelopathies)
Immune blockade
Drugs
Toxins
Electrolyte disorders
Demyelination

used to maintain the activity of the sodium pump. Conditions such as hypoxia, ischemia, hypoglycemia, or seizures affect the balance between energy production and energy consumption of neurons and cause energy failure and thus impaired activity of sodium/potassium ATPase.

If the active transport process stops, the cell accumulates sodium and loses potassium and the membrane potential progressively decreases. This depolarization has two consequences. First, there may be a transient increase in neuronal excitability as the membrane potential moves closer to threshold for opening voltage-gated sodium channels and triggering the action potential. This may produce a paroxysmal discharge of the neuron cell body or axon. Second, if depolarization persists, the sodium channel remains inactivated and the neuron becomes inexcitable. This is known as *depolarization blockade* and results in a focal deficit, such as focal paralysis or anesthesia, or a generalized deficit, such as

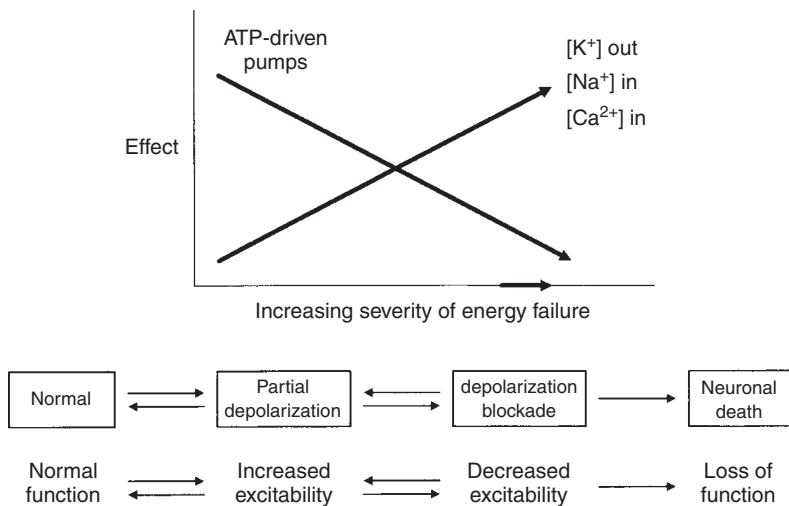
paralysis or loss of consciousness (Fig. 5–19). The neuron also uses ATP to maintain ion gradients that allow active presynaptic reuptake of neurotransmitters, such as the excitatory amino acid L-glutamate. Under conditions of energy failure, glutamate accumulates in the synapse and produces prolonged activation of its postsynaptic receptors, leading to neuronal depolarization and the accumulation of calcium in the cytosol. Because the lack of ATP also impairs active transport of calcium into the endoplasmic reticulum or toward the extracellular fluid, calcium accumulates. Essentially, all forms of neuronal injury involve to various extents

1. Accumulation of glutamate and activation of glutamate receptors
2. Accumulation of cytosolic calcium and activation of calcium-triggered cascades
3. Generation of free radicals
4. Mitochondrial failure

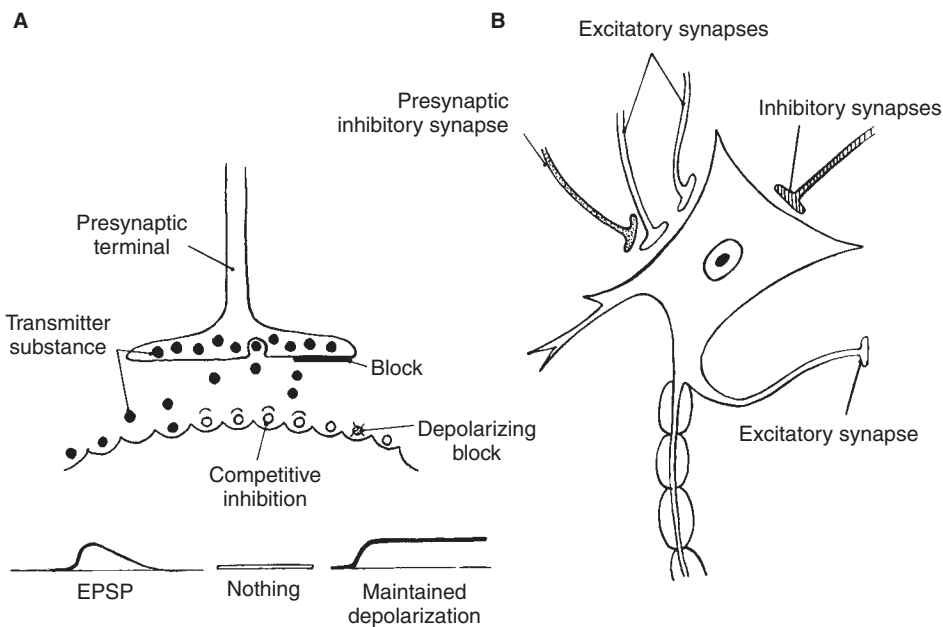
The consequences are functional and potentially reversible (e.g., cell depolarization, pump failure, and accumulation of intracellular sodium). If the cause is not corrected, calcium accumulates and triggers irreversible changes, including destruction of cellular and mitochondrial membranes, disorganization of the cytoskeleton, and degradation of DNA by nucleases, and these effects lead to cell death by necrosis or apoptosis.

## Ion Channel Blockade

Voltage-gated sodium channels mediate the initiation and conduction of action potentials.



**Figure 5-19.** Effects of increasing severity of energy failure (and ATP depletion) on activity of ATP-driven pumps, ionic concentrations in the intracellular and extracellular fluid, and neuronal electrical activity. With progressive failure of ATP-driven pumps, potassium accumulates in the extracellular fluid, and sodium and calcium accumulate inside the neuron. This produces progressive neuronal depolarization. With partial depolarization, the resting potential moves closer to the threshold for triggering an action potential; this results in a transient increase in neuronal excitability, which may be manifested by paresthesias or seizures. With further depolarization, the membrane potential is at a level that maintains inactivation of the sodium channel, preventing further generation of action potentials and, thus, reducing neuronal excitability. This constitutes a depolarization block, which manifests with transient and reversible deficits such as paralysis or loss of consciousness. If the energy failure is severe and prolonged, the excessive accumulation of intracellular calcium triggers various enzymatic cascades that lead eventually to neuronal death and irreversible loss of function.



**Figure 5-20.** Abnormalities of synaptic transmission may occur (A). Types of transmission block include block of transmitter release (block), block of transmitter binding to postsynaptic membrane (competitive inhibition), and binding of another depolarizing agent to the membrane (depolarizing block). B, These types of abnormalities may occur at each neuronal synapse shown.

Voltage-gated calcium channels mediate neurotransmitter release, and ligand-gated cation (sodium and calcium) channels mediate excitatory postsynaptic potentials. All these channels may be blocked by autoantibodies, drugs, or toxins. Examples of the types of transmission block are illustrated in Figure 5–20. There may be presynaptic block of transmitter release, or postsynaptic block by competitive or non-competitive inhibition of postsynaptic receptors, or by depolarizing substances. Blockade of sodium channels at the node of Ranvier slows conduction velocity or causes conduction block; this produces a reversible focal deficit (weakness or anesthesia). For example, the blockade of sodium channels in sensory axons by local anesthetic agents produces anesthesia, and antibodies against ganglioside GM1 (associated with sodium channels) in the nodes of Ranvier of motor axons produce focal paralysis. Autoantibodies may also block ion channels involved in neuromuscular transmission and produce reversible muscle fatigue or paralysis.

## SUMMARY

The transmission of information in the nervous system depends on the generation of a resting potential that acts as a reserve of energy poised for release when the valve is turned on. Ionic channels act as the valve, controlling the energy in the ionic concentration gradient. The release of energy is seen either as local graded potentials or as propagated action potentials that arise when local potentials reach

threshold. Information is moved from one area to another as action potentials conducted by single cells. The information is integrated in neurons by the interaction of local potentials generated in response to the neurotransmitters released from depolarized nerve terminals. In this system, information can be coded either as the rate of discharge in individual cells or axons or as the number and combination of active cells. Both of these are important mechanisms, for although the activity of the nervous system can be conveniently described in terms of the electrical activity of single cells, the combined activity of large numbers of cells and axons determines the behavior of the organism.

Each type of alteration in neuronal or muscle cell physiology can produce symptoms or signs of short duration, transient disorders. The particular findings in a patient depend on which cells are altered. If the changes are in neurons that subserve sensation, there may be a loss of sensation or an abnormal sensation such as tingling, loss of vision, or “seeing stars.” In other systems, there might be loss of strength, twitching in muscles, loss of intellect, or abnormal behavior. In all these cases, the physiologic alterations are not specific and may be the result of any one of a number of diseases. Transient disorders do not permit a pathologic or etiologic diagnosis. Any type of disease (vascular, neoplastic, inflammatory) may be associated with transient changes. Therefore, the pathology of a disorder cannot be deduced when its temporal profile is solely that of transient episodes.

# Electrophysiologic Generators in Clinical Neurophysiology

Terrence D. Lagerlund

## STRUCTURAL GENERATORS

Peripheral Nerves  
Muscles  
Sweat Glands  
Spinal Cord

Brain Stem  
Special Sensory Receptors  
Optic and Auditory Pathways  
Cerebral Cortex

## SUMMARY

## STRUCTURAL GENERATORS

The variety of clinical neurophysiologic studies corresponds to a variety of structural generators in the body, including muscles, sweat glands, peripheral nerves, and various components of the central nervous system. Each structural generator may have associated with it several different types of physiologic potential. In some cases, the activity resulting from different physiologic potentials can be easily distinguished, but in many cases (particularly sensory pathways in the central nervous system assessed by evoked potential studies), complete knowledge of the physiologic generator underlying any recorded waveform is lacking.

### Peripheral Nerves

Peripheral nerves consist of axons and supporting structures, including myelin-producing

Schwann cells, connective tissue, and blood vessels. They contain three types of axons. *Motor axons* originate from neurons in the spinal cord (spinal motor neurons) or brain stem (cranial nerve motor neurons) and synapse on muscle fibers. *Sensory axons* originate from neurons in the spinal dorsal root ganglia or cranial nerve ganglia; these axons terminate in skin, muscle, or other organs in specialized sensory receptors, for example, pacinian corpuscles or muscle spindles, or as “bare” nerve terminals. *Autonomic axons* originate either in neurons of the spinal cord or brain stem (preganglionic neurons) or in neurons in autonomic ganglia (postganglionic neurons located in the sympathetic trunk ganglia for many sympathetic neurons or in visceral ganglia near the end organ innervated for all parasympathetic and some sympathetic neurons). The sum of the propagating action potentials of all stimulated sensory axons in a motor or mixed nerve can be recorded as a sensory nerve action potential during sensory

nerve conduction studies (see Chapter 17). These primarily involve the large diameter, or IA and IB, sensory axons in the nerve, because only they are stimulated by conventional electrical stimuli. Generally, motor and autonomic axons are tested only indirectly by stimulating the nerve and observing the postsynaptic effects in muscle and sweat glands.

### Key Points

- Peripheral nerves contain motor axons, sensory axons, and autonomic axons.
- Sensory nerve action potentials are the sum of propagating action potentials of sensory axons, mainly IA and IB.

## Muscles

Muscles consist of muscle fibers and connective tissue; both motor and sensory axons traverse muscles. Contraction of muscle fibers is initiated by neuromuscular synaptic transmission (with acetylcholine as the neurotransmitter), which leads to a propagated muscle action potential. This in turn causes calcium to enter the muscle fibers. Calcium is the intracellular trigger for the contractile process.

*Muscle end plate potentials* are muscle fiber excitatory postsynaptic potentials (EPSPs) that originate at the end plate, or neuromuscular junction. Both sodium and potassium ions flow through the channel opened by acetylcholine receptor binding so that the reversal potential, that is, the membrane potential in a voltage clamp experiment at which the ionic current flow reverses from net inward to net outward, for this channel is near 0 V, intermediate between the Nernst potentials of sodium and potassium. Normal end plate potentials are caused by the simultaneous release of hundreds of quanta, or packets, of acetylcholine, which occurs when an action potential reaches the nerve terminal. However, *miniature end plate potentials* are much smaller and are caused by the spontaneous, random release of a single packet of acetylcholine from the nerve terminal. End plate noise recorded from needle electrodes in the vicinity of the muscle end plate is caused by miniature end plate potentials. *End plate spikes* are action potentials of muscle fibers caused by mechanical activation,

for example, by the electromyographic needle, of nerve terminals in the end plate region and are mediated by normal neuromuscular synaptic transmission.

Muscle action potentials are similar to nerve action potentials but have a generally slower propagation velocity. They propagate outward—often in two opposite directions simultaneously—from the vicinity of the neuromuscular junction to the ends of the muscle fiber. Muscle action potentials may occur spontaneously in individual muscle fibers (fibrillation potentials), simultaneously in all muscle fibers that are part of the same motor unit (e.g., voluntary motor units or involuntary fasciculation potentials), or nearly simultaneously in all muscle fibers supplied by one motor or mixed nerve (leading to the surface-recorded compound muscle action potential in motor nerve conduction studies) (see Chapters 23 and 26).

### Key Points

- Muscle end plate potentials are muscle fiber EPSPs that originate at the end plate.
- Miniature end plate potentials are caused by spontaneous, random release of a single packet of acetylcholine.
- End plate noise is caused by miniature end plate potentials.
- End plate spikes are action potentials of muscle fibers caused by mechanical activation.
- Fibrillation potentials are spontaneous muscle action potentials in individual muscle fibers.
- Voluntary motor units and fasciculation potentials are summed action potentials from all fibers in one motor unit.
- Compound muscle action potentials are summed action potentials from all simultaneously activated fibers.

## Sweat Glands

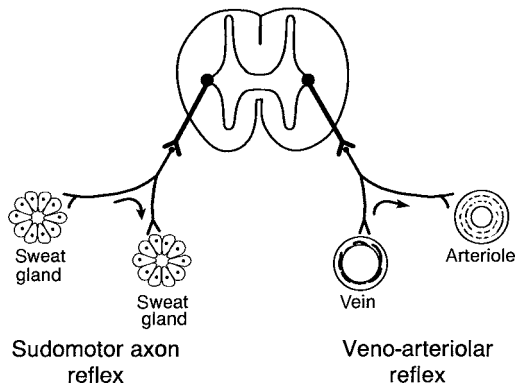
Sweat glands are end organs innervated by sympathetic postganglionic neurons that have acetylcholine as their neurotransmitter. Many of these axons have multiple branches in the skin, and a single axon may innervate many sweat glands. Release of acetylcholine by sympathetic nerve terminals in response to



various stimuli, for example, an electric stimulus applied to a contralateral limb, leads to a prolonged depolarization of sweat glands that can be recorded diffusely from the skin surface in certain areas. This recorded response is called the peripheral autonomic surface potential. Function of peripheral sympathetic axons and sweat glands is also assessed with the quantitative sudomotor axon reflex test (see Chapter 36). In this test, a controlled release of acetylcholine into one skin region leads to reflex depolarization of autonomic axons that propagate antidromically to a “Y” branch point and orthodromically from there to activate sweat glands synaptically in a nearby region of skin, thus producing sweat. Sweat gland activity (sweat production) is quantified by measuring the water output of the glands<sup>1</sup> (Fig. 6–1).

### Key Points

- Sweat glands are innervated by sympathetic postganglionic neurons that use acetylcholine as their neurotransmitter.
- Activation of sympathetic nerve terminals releases acetylcholine causing prolonged depolarization of sweat glands.
- The quantitative sudomotor axon reflex test provides a quantitative measure of distal sudomotor axon function.



**Figure 6–1.** Physiology of two postganglionic axon reflexes: The sudomotor axon reflex and the veno-arteriolar reflex. The former is the basis of the quantitative sudomotor axon reflex test, but the latter is not used in any clinical test. (From Low, P. A. 1993. Quantitation of autonomic function. In *Peripheral neuropathy*, ed. P. J. Dyck, P. K. Thomas, J. W. Griffin, P. A. Low, and J. F. Poduslo, 3rd ed., 731. Philadelphia: WB Saunders. By permission of the publisher.)

## Spinal Cord

The spinal cord contains cell bodies of motor, autonomic, and other neurons and axons of central and peripheral neurons arranged in various ascending and descending tracts. Many synapses occur on spinal cord neurons. Thus, potentials originating from generators in the spinal cord include EPSPs, IPSPs, and action potentials. Although the quantity and integrity of spinal motor neurons in the ventral horn can be assessed to some degree by standard electromyographic and nerve conduction studies, specific potentials produced by spinal motor neurons themselves are not routinely measured. During somatosensory evoked potential (SEP) studies, recordings from cervical or cervical–cranial derivations may demonstrate an N11 waveform that is thought to be generated primarily at the root entry zone in the dorsal horn at the level of spinal segments C5 and C6 (see Chapter 18). This waveform may be the propagated action potential in the sensory axons ascending in the dorsal column rather than a response recorded from the roots entering the cord, as indicated by the latency shift that occurs with recording at progressively higher levels in the cord.

### Key Points

- Generators in the spinal cord include EPSPs, IPSPs, and action potentials.
- The N11 peak in SEP studies is generated at the root entry zone in the dorsal horn of the C5–C6 spinal segments.

## Brain Stem

The brain stem somatosensory pathways include the dorsal column nuclei in the lower medulla and the medial lemniscus. Recordings during SEP studies demonstrate an N13 waveform thought to be generated by the upper cervical cord dorsal columns (presynaptic action potential) or by the dorsal column nuclei (post-synaptic potential) or by both. A P14 waveform may also be seen; it is thought to be generated by the medial lemniscus (action potential) (see Chapter 18).



**Key Points**

- The N13 peak in SEP studies is generated by the upper cervical cord dorsal columns or by the dorsal column nuclei or by both.
- The P14 peak in SEP studies is likely generated by action potentials in the medial lemniscus.

**Special Sensory Receptors**

Sensory receptors in the visual and auditory systems generate characteristic potentials that can be recorded with appropriate evoked potential studies.

The retina contains photoreceptors, the rods and cones, and other types of neurons, including bipolar, horizontal, amacrine, and ganglion cells. Retinal visual evoked potentials, the *electroretinogram*, can be recorded from electrodes placed near or on the eye and are thought to be caused by summed postsynaptic potential activity in retinal neurons.

Hair cells are sensory receptors in the cochlea. They release a neurotransmitter that activates the peripheral axons of the bipolar cells of the spiral ganglion, which in turn conduct action potentials to the central axons that make up the auditory nerve and synapse in the cochlear nucleus in the lower pons. Some components of the electrocochleogram, that is, the cochlear microphonic and the summing potential, are thought to be produced by sensory receptor potentials in the hair cells. Wave I of the brain stem auditory evoked potential (BAEP) is caused by the propagated action potentials in the auditory nerve (see Chapters 19 and 21).

**Key Points**

- Retinal visual evoked potentials (electroretinogram) can be recorded from electrodes on or near the eye.
- The cochlear microphonic and summing potential are summated sensory receptor potentials of cochlear hair cells.
- Wave I of the brain stem auditory evoked potential is caused by propagated action potentials in the auditory nerve.

**Optic and Auditory Pathways**

The optic and auditory pathways are generators of later components of the visual and auditory evoked potentials. Propagated action potentials in the optic tracts or optic radiations may contribute to some variable early components of diffuse light-flash visual evoked potentials, but these have little clinical usefulness (see Chapter 22). Wave II of the BAEP is thought to be generated either by propagated action potentials in the auditory nerve as it enters the brain stem or by postsynaptic potentials in the cochlear nucleus. Wave III may be generated by postsynaptic potentials in the superior olivary nucleus and waves IV and V by the lateral lemniscus (propagated action potentials) or the inferior colliculus (postsynaptic potentials).<sup>2</sup> Later waves (VI and VII) may arise from the medial geniculate body and the auditory radiations (see Chapter 19).

**Key Points**

- BAEP wave II is due to propagated auditory nerve action potentials entering brain stem or postsynaptic potentials in the cochlear nucleus.
- BAEP wave III may be due to postsynaptic potentials in the superior olivary nucleus.
- BAEP waves IV and V are due to propagated action potentials in the lateral lemniscus or postsynaptic potentials in the inferior colliculus.
- BAEPs waves VI and VII may arise from the medial geniculate body and the auditory radiations.

**Cerebral Cortex**

The cerebral cortex is the generator of essentially all electroencephalographic (EEG) activity recorded without averaging as well as the late components of evoked potentials, including the P100 component of the pattern-reversal visual evoked potential (see Chapters 8, 18, 19, and 22). Cortical neurons include both pyramidal cells (excitatory neurons that provide the major output of the cerebral cortex) and stellate cells (excitatory or inhibitory interneurons). The long apical dendrites of pyramidal cells are perpendicular to

the cortical surface. Each pyramidal cell has an extensive dendritic tree on which 1000–100,000 synapses may occur.

The neocortex consists of six cellular layers. Layer I is the most superficial and layer VI is the deepest layer. Layer I contains mainly glial cells and axonal and dendritic processes. Layer IV is the most developed in sensory areas of the cortex and receives much of the specific thalamocortical projections. Layer V is the most developed in motor areas of the cortex in which many of the pyramidal cells are exceptionally large and project particularly to distant sites, including the brain stem and spinal cord.

Brodman divided the cortex into 52 cortical areas on the basis of cell size, neuron density, myelinated axon density, and number of layers. The primary somatosensory cortex (areas 1, 2, and 3) is the likely generator of the scalp components of the SEP. Primary visual cortex (area 17) and visual association cortex (areas 18 and 19) are the likely generators of the P100 component of the visual evoked potential. Auditory cortex (areas 41 and 42) may be the generator of the late components of the long-latency auditory evoked potential.

It is known that postsynaptic potentials—not action potentials—in cortical neurons are responsible for all scalp-recorded electrical activity. This is because postsynaptic potentials are of long duration (tens to hundreds of milliseconds), involve large areas of membrane surface, occur nearly simultaneously in thousands of cortical pyramidal cells, and occur especially in pyramidal cell dendrites that are uniformly perpendicular to the cortical surface. These properties all allow postsynaptic potentials to summate effectively to produce a detectable scalp potential. In contrast, action potentials are brief (1 ms), involve small surface areas of membrane (axons), occur at random and widely spaced intervals in various neurons, and propagate along axons that are

oriented in many directions, all of which make effective summation impossible.

### Key Points

- Cerebral cortex generates essentially all EEG activity and late components of evoked potentials like the VEP P100.
- Neocortex has six cellular layers, with layer I most superficial and layer VI most deep.
- Primary visual cortex and visual association cortex (Brodmann areas 17, 18, and 19) are generators of the VEP P100.
- Postsynaptic potentials, not action potentials, in cortical neurons are responsible for all scalp-recorded electrical activity.

## SUMMARY

This chapter reviews the generators of electrophysiologic potentials in terms of basic cellular electrophysiology and the anatomical structures that generate electrophysiologic potentials of clinical interest. Knowledge of the generators of the potentials recorded in clinical neurophysiologic studies is helpful in understanding the characteristics and distribution of the recorded potentials and is the first step in correlating the alterations seen in disease states with the pathologic changes demonstrated in the underlying generators.

## REFERENCES

1. Dyck, P. J., P. K. Thomas, J. W. Griffin, P. A. Low, and J. F. Poduslo, eds. 1993. *Peripheral neuropathy*, 3rd ed. Philadelphia: WB Saunders.
2. Melcher, J. R., J. J. Guinan Jr., I. M. Knudson, and N. Y. Kiang. 1996. Generators of the brain stem auditory evoked potential in cat. II. Correlating lesion sites with waveform changes. *Hearing Research* 93: 28–51.

*This page intentionally left blank*

# Waveforms and Artifacts

Jasper R. Daube

## INTRODUCTION CONTINUOUS WAVEFORMS EVENT RECORDING

Frequency  
Configuration

## COMBINATIONS OF CONTINUOUS WAVEFORMS AND EVENTS WAVEFORM ALTERATIONS

## PHYSIOLOGIC ALTERATION OF WAVEFORMS

Single Potential  
Continuous Waves  
Signal Display

## ARTIFACTUAL WAVEFORMS

Physiologic Artifacts  
Nonphysiologic Artifacts

## SUMMARY

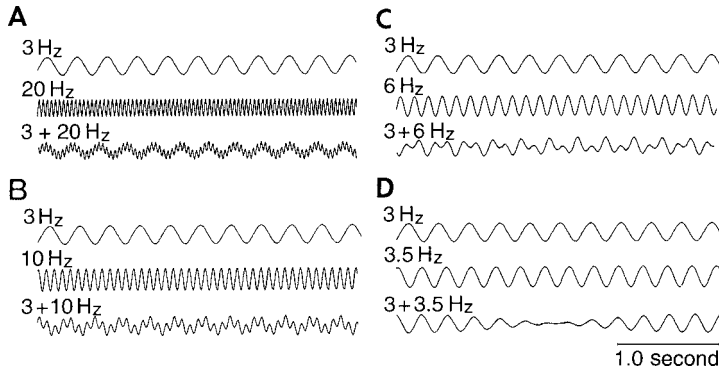
## INTRODUCTION

The waveforms that make up the electric signals generated by the central, peripheral, and autonomic nervous systems and muscle are classified according to the variables that characterize them. These variables identify the signals and demonstrate the abnormalities that occur in disease. Each waveform is a change over time in the potential difference between two recording points. If no change occurs in the potential difference, a flat line with no signal is recorded, even if there is a voltage difference between the points. Changes in potential difference are broadly classified as *continuous* and *intermittent*. Continuous waveforms are characterized by a relatively smooth, continuously varying appearance. These are most commonly seen in electroencephalogram (EEG) and related studies. Intermittent waveforms are single, discrete events on a flat background, especially motor unit potential. These are most

commonly seen in electromyogram (EMG). It must be noted that there is overlap in these patterns such that an EEG can have superimposed events, for example, the spike discharges in epilepsy, and an EMG can have a continuously varying pattern when multiple waveforms are superimposed.

## CONTINUOUS WAVEFORMS

A continuously varying signal is described by the rate of change of the signal (cycles per second), the signal amplitude (peak-to-peak), the shape of the waveform, and the consistency of the signal over time. Continuous waveforms recorded from living tissue are usually sinusoidal, as shown in Figure 7-1. The rate of change of a signal is known as its *frequency* and is measured in cycles per second. The term more commonly used to describe this rate of alteration is *hertz* (Hz). A 10-Hz signal is



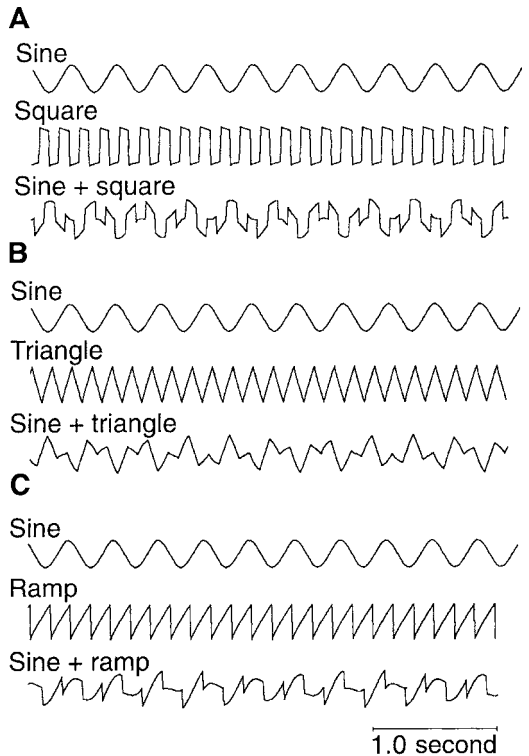
**Figure 7-1.** Simple, regular, sinusoidal waves of different frequencies combine to form complex waveforms. *A*, A 3-Hz and a 20-Hz waveform summate into a waveform in which both are still recognizable. *B*, A 3-Hz and a 10-Hz waveform summate to form a more complicated waveform in which the components are less recognizable. *C*, Summation of a 3-Hz and a 6-Hz waveform results in an apparently regular, more complex waveform. *D*, Summation of a 3-Hz and a 3.5-Hz waveform results in fluctuation of the waveform as the components go in and out of phase.

a waveform that has continuous variation 10 times per second. The traces in Figure 7-1 have waveforms varying at five basic rates (3, 3.5, 6, 10, and 20 Hz). The continuous waveforms generated by physiologic generators can be described by their component frequencies. The change of a continuous waveform from one frequency to another may occur because a single generator changes its rate of activity or because one generator working at 3 Hz becomes inactive while another working at 6 Hz becomes active.

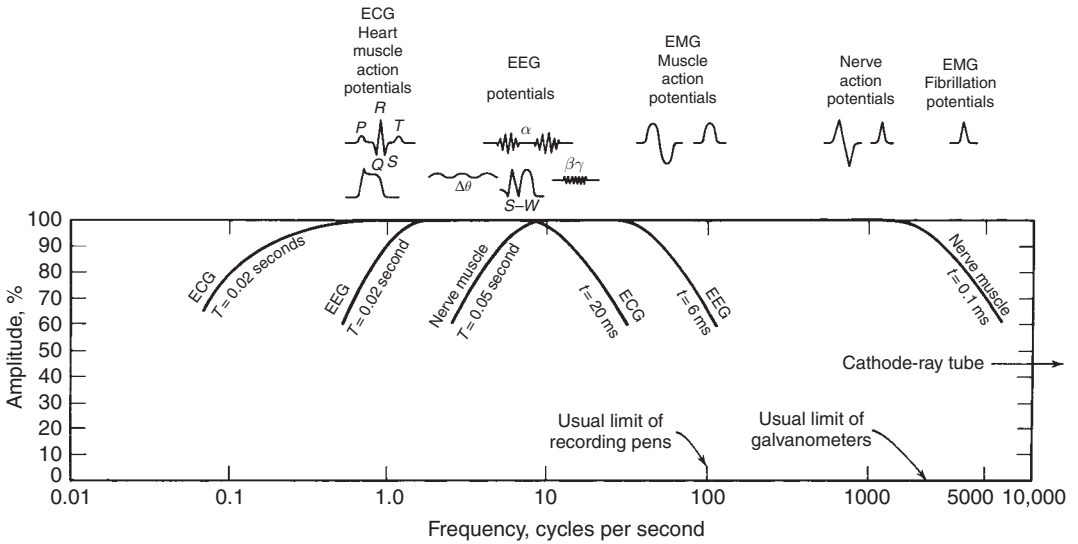
If the recording electrodes are located near two structures that simultaneously generate signals of different frequencies, a more complex signal is recorded. Signals illustrating the combination of two frequencies are shown in Figure 7-1. Note that the combination of signals of both frequencies is still recognized if the frequencies are widely different. Combinations of waveforms with similar frequencies result in less recognizable waveforms and even temporary obliteration of the signal (3 and 3.5 Hz). Such complex physiologic waveforms can still be described in terms of the component frequencies of the signal. Waveforms become even more complex when differently shaped waves of the same frequency summate, as shown in Figure 7-2.

Continuously varying signals in physiologic recordings are usually described in terms of their frequency components, as illustrated in Figure 7-3. Many of them, such as electroencephalographic waveforms, often have a predominant frequency that at any given

time characterizes the signal at a pair of electrodes. The ability to dissect a waveform into its component frequencies does not mean that distinct structures generate each of the frequencies. For example, a neuron with



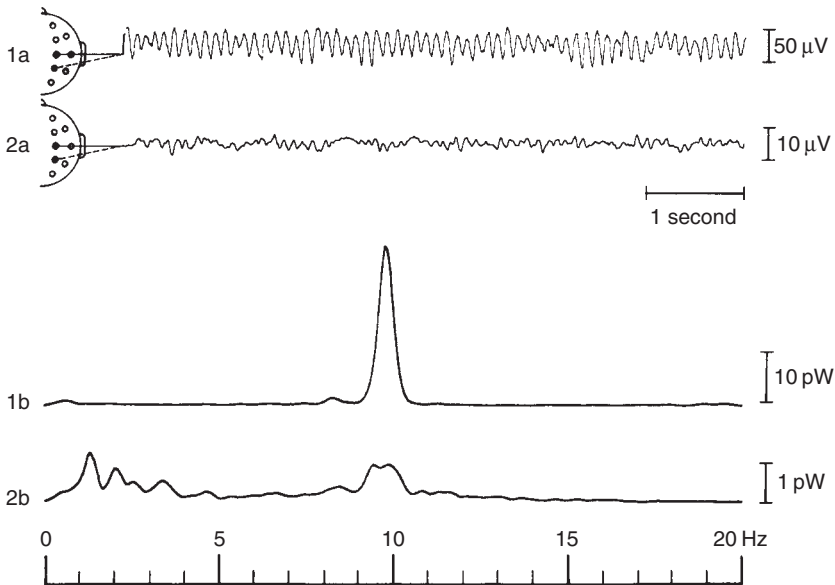
**Figure 7-2.** Summation of waveforms with different shapes but the same frequency (3 Hz) results in more complex waveforms. A sine wave is combined with (A) a square wave, (B) a triangular wave, and (C) a ramp wave.



**Figure 7-3.** The frequency components of electric activity recorded in clinical neurophysiology are shown on a logarithmic scale.  $T$  and  $t$  are the upper and lower time constants of each frequency cutoff. ECG, electrocardiogram; EEG, electroencephalogram; EMG, electromyogram. (From Geddes L. A., and L. E. Baker. 1968. *Principles of applied biomedical instrumentation*. 317. New York: John Wiley & Sons. By permission of the publisher.)

synaptic input from multiple sources displays postsynaptic potentials that summate at the cell body and produce a complex, varying intracellular potential. Many frequencies would be identified by frequency analysis, but no

single generator would be active at any of the component frequencies. Frequency analysis with automated electronic systems can define the frequency components of any signal as a histogram, as shown in Figure 7-4.



**Figure 7-4.** Frequency analysis of, 1a, normal and, 1b, abnormal electroencephalographic recordings. The frequency components of 1a are shown in 1b as a predominantly 10-Hz signal. Tracing 2a is a combination of the 10-Hz activity, with the abnormal 1-4 Hz activity shown in 2b. (From Fisch B. J. 1991. *Spehlmann's EEG primer*, 2nd ed. 132. Amsterdam: Elsevier Science Publishers. By permission of the publisher.)

Frequency analysis of either the first or the second trace in *A*, *B*, *C*, and *D* in Figure 7-1 would show only one frequency component, whereas frequency analysis of the third trace in each panel would show two frequency components. A frequency analysis of this type can be made on signals of different time duration.

Therefore, a continuously varying signal is described by its frequency components, their amplitudes, and the intervals of time over which they occur. This approach to describing signals is used most commonly with electroencephalographic potentials.<sup>1</sup> New methods of analysis of continuous potentials continue to be developed for signals from both EEG and EMG.<sup>2-4</sup>

A description of neurophysiologic signals always includes the location at which the signal is recorded. For example, the frontal region of the head may have a 30  $\mu$ V, 20 Hz signal occurring for 10 seconds of a 20-second recording, whereas the occipital region simultaneously has a 10 Hz signal throughout the 20-second recording epoch.

### Key Points

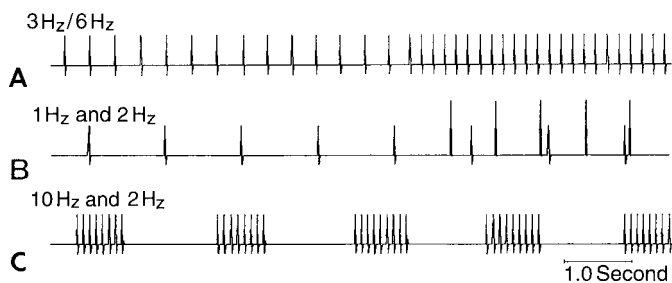
- Continuous waveforms are mixtures of smoothly changing sinusoidal waveforms.
- Continuous waveforms change appearance by
  - Change in the underlying generator's pattern
  - Addition of waveforms from other generators.
- Continuous waveforms are recorded primarily in electroencephalography, sleep studies, and autonomic studies.

## EVENT RECORDING

### Frequency

A second description of the waveforms seen in clinical neurophysiology is in recordings made up of a sequence of well-defined events, as shown in Figure 7-5. Recurrent, brief spikes in a recording that includes no other activity are shown in Figure 7-5A. The description and classification of events use terminology similar to that used for continuous recording, but with some differences in meaning. In Figure 7-5A, the spikes occurring in the first 5 seconds of the recording are described as occurring at a frequency of 3 per second; those in the next 4 seconds have a frequency of 6 per second. The entire recording of 37 events in 10 seconds could be described as spikes occurring 3.7 times per second. However, this is an average of their occurrences instead of the actual recurrence of 3 and 6 times per second. Therefore, events are better described as (1) the number per unit time, (2) the regularity of their occurrence in time, and (3) the pattern of recurrence. In Figure 7-5C, groups of eight spikes recur at 2-second intervals. This is described as a burst pattern of 10 per second spikes recurring regularly at 2-second intervals.

A recording from a pair of electrodes often includes the activity of multiple generators, each of which may be generating events in different patterns. A single generator may generate regularly recurring events that occur in a changing but definable pattern or events that recur in an unpredictable, or random, pattern. In Figure 7-5B, a second independent generator becomes active after 6 seconds. Such superposition gives a complex pattern of events that can be separated into the recurrence of



**Figure 7-5.** Single spikes occur as events at different rates. *A*, a spike changes from 3 per second to 6 per second. *B*, a spike occurring at 1 per second combines with another, independent spike occurring at 2 per second. *C*, a single spike occurs in bursts of eight spikes at 10 per second every 2 seconds.



distinct events coming from different generators. This distinction is made most accurately by analyzing the pattern of events.<sup>5</sup> Also, recognizing the unique appearance of the individual events can help to distinguish them, but this becomes unreliable when the individual waveforms are similar. New methods continue to be developed for identifying and characterizing intermittent events in both EEG and EMG recordings.<sup>6-9</sup>

In summary, characterizing the occurrence of events requires (1) identifying the patterns of individual events as bursting or nonbursting, (2) describing those that occur in bursts according to their rate of firing during a burst and the recurrence rate of the burst, and (3) describing those that are nonbursting by the rate and pattern of firing.

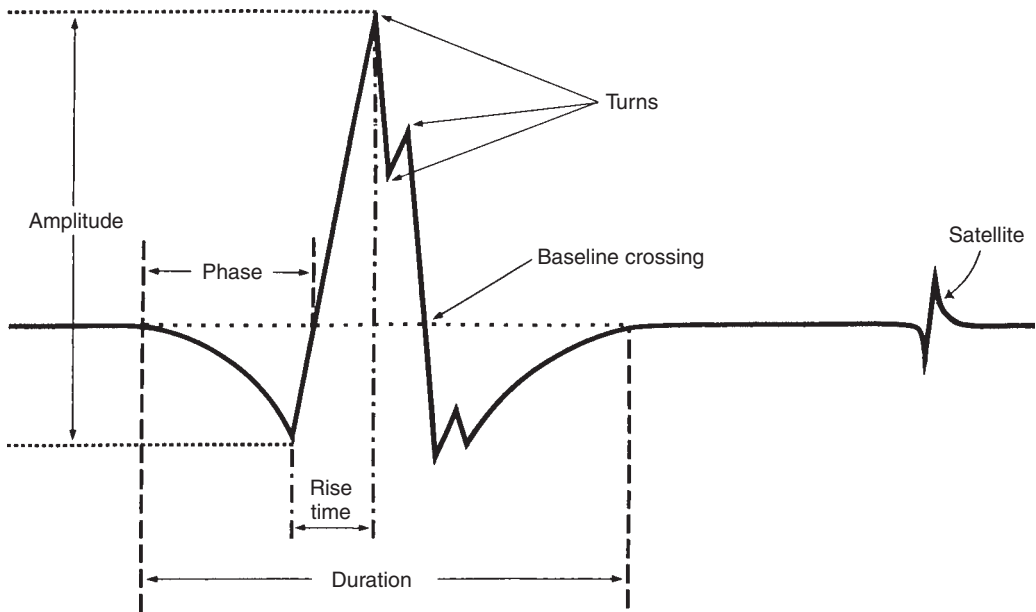
## Configuration

Each event is characterized further on the basis of its own variables.<sup>10</sup> The event, often called a *discharge* or *spike*, has an amplitude that is measured either from the baseline-to-peak or from peak-to-peak (Fig. 7-6). The discharge has a duration from onset to termination. Discharges have configurations that may be

monophasic, biphasic, triphasic, or more complex with multiple phases.<sup>11</sup> If there is more than one phase, each phase can be described according to its amplitude, duration, and configuration. Each component of a discharge has a *rise time*, or a *rate of rise*, from the positive peak to the negative peak. The rise time is a direct function of the distance of the recording electrodes from the generator and can be used to determine how close a generator is to the recording electrodes. Short duration or rapid rise times occur when the recording electrodes are close to the generator.

A typical discharge is triphasic when it is recorded from a nearby generator. If the waveform is moving, the initial positive portion of the discharge is recorded from the potential when the potential is distant from the recording electrode. A negative component is obtained when the potential is adjacent to the active electrode, and the late positive component when the potential leaves the electrode. The complexity of a discharge is a function of the number of generators that contribute to the discharge and the synchrony of their firing. Greater synchrony of firing produces a simpler waveform of larger size.

Individual events can also be characterized according to their frequency spectrum. The



**Figure 7-6.** Each single event, such as the spikes in Figure 7-5, can be described quantitatively by the variables illustrated here. The same event could also be analyzed into its component frequencies, which could range from fewer than 1 Hz to more than 10,000 Hz.

analysis of an event—regardless of its size, shape, or configuration—can break it down into a summation of the activity of different frequencies. Event recording is used in recording from single axons and single neurons and in clinical electromyography. In these settings, the measurements are generally those of the pattern of firing and the characteristics of the individual discharges. The frequency component of such potentials is not a useful measure.

### Key Points

- Intermittent waveforms are mixtures of discrete waveforms recurring in a defined pattern.
- Intermittent waveforms change in appearance by
  - Alteration in the configuration of individual events
  - Alteration in their rate and pattern of recurrence
  - Superimposition of multiple events.
- Intermittent waveforms are recorded primarily in electromyography.

## COMBINATIONS OF CONTINUOUS WAVEFORMS AND EVENTS

The division of electric activity into continuous waveforms and events is somewhat arbitrary, and they may be found together, such as spike discharges in a sinusoidal electroencephalographic waveform. Such spikes are intermittent and described using the criteria for intermittent events. The superimposition of multiple events in an EMG discharge gives rise to a continuous signal that can be measured in terms of its frequency components called an *interference pattern* since individual components are no longer recognizable. While an EMG pattern can be described by its frequency components, it has not been helpful in clinical diagnosis. In contrast, analysis of the amplitude and number of spike potential reversals per unit time in the interference pattern has provided useful clinical information.

Similar measurements can be made with either spikes or continuous waveforms. The frequency of a continuous waveform is the inverse of the duration of a cycle. For example, a 10-Hz signal has a 100-ms interval between recurrences. The broad sine wave of the 10-Hz

signal when repeated through one cycle could be considered an event and characterized as such. In contrast, the designation of events and their patterns of recurrence and complexity of appearance occasionally require characterizing them in terms of frequency, amplitude, and rate of recurrence.

### Key Points

- Continuous and intermittent patterns may be superimposed.
- An EEG with spike discharges is measured by both the underlying sinusoidal frequencies and the number, character, and distribution of the spikes.
- An EMG interference pattern is measured by extracting the basic features of the underlying events as turns (sudden reversal of potential) and amplitude.

## WAVEFORM ALTERATIONS

Abnormalities of the waveforms generated by the central nervous system, nerves, or muscles can be assessed only in terms of a change in the waveform of a specific generator. No waveform itself can be defined as abnormal without reference to the generator. Normal waveforms arising from one generator would be abnormal if they arose from a different generator. For example, the spike activity normally generated by muscle has features that are similar to those of an epileptic spike generated by the cerebral cortex. Therefore, alterations in waveform must be considered in relation to the categories described above. In contrast, electric artifacts often have distinct waveforms that do not arise from any physiologic generator. Artifacts are best defined as electric activity of no clinical significance originating from nonphysiologic sources. Artifacts are considered separately in the section Artifactual Waveforms.

## PHYSIOLOGIC ALTERATION OF WAVEFORMS

Changes in single potentials, such as a single well-defined electromyographic (EMG) spike, are described by the characteristics of the single event. In contrast, changes in continuously varying signals, such as electroencephalographic (EEG) waves, are described by

the characteristics of a series of waves. The distinction between a single event and continuous waves is not always clear, but usually can be readily separated. The alterations of single potentials and waves are considered separately below.

## Single Potential

Electric activity generated by nerve or muscle tissue often appears as a single, discrete event, a *single potential*, with no activity or only unrelated activity around it. Single potentials may be normal or abnormal. Changes in individual potentials are described by measuring the variables of the potentials to determine whether they are outside the normal range (Table 7–1). To describe single potentials, four sets of variables are measured.

The first set describes the size and includes amplitude (peak-to-peak or baseline-to-peak), area, and duration of the potential. The second set describes the waveform configuration and includes the rate of change of the components of the potential, the number and timing of changes in the direction of the current flow, and the components of the potential. The components include the phases and turns of the potential. The third set describes the pattern and frequency of occurrence of the potential. A spike might occur at a regular, low rate (e.g., a voluntary motor unit potential) or as high-frequency, short bursts (e.g., a myokymic discharge). The fourth set describes the distribution or field of occurrence. For example, an epileptic spike might occur in the frontal lobe or in the temporal lobe. A waveform may have different variables in different parts of its field. A potential may be described by its relationship to other events, such as the latency of a response. Disease can alter the variables of existing waveforms, eliminate a normal waveform, or initiate a new waveform.

If a single potential recurs over time, another set of variables is measured, including stability, rate, pattern, and the type of change that occurs with time. The alteration of waveforms with disease is defined by the variable which is outside the normal range. In disease, each variable should be considered for measurement. The methods for measuring these variables must be defined because the results can vary with the method of measurement.

### Key Points

- Single potentials (events) are described by their variation from normal in
  - Size (amplitude, area, and duration)
  - Configuration (phases and turns) and changes in configuration over time
  - Frequency and pattern of recurrence
  - Distribution of the potential and change in characteristics with location.

## Continuous Waves

Much of the electric activity that is generated by neural tissue occurs as continuously varying potentials that may persist over long periods. These potentials usually have a sinusoidal configuration. Recurrent, single events recorded at a considerable distance from the generator may also appear as continuously varying waves. Continuous waves are characterized by variables similar to—but different from—the variables that characterize single events (Table 7–2).

Variables that are used to measure the size of continuous waves include amplitude (peak-to-peak or base-to-peak), root mean square (square root of mean amplitude over time), and power (square of the amplitude). In most situations, the major variable to measure is the frequency, or the number of cycles of the wave per second. Frequency can be measured simply as baseline or zero crossings per second. More

Table 7–1 Measurable Variables of Single Potentials

Size	Amplitude, area, duration
Configuration	Rate of change, direction, number, and timing of reversal of direction
Recurrence	Rate, pattern, timing
Distribution	Field, area, location
Relationship to other waveforms or events	Time-locked, latency, order of interpotential interval
Stability	Pattern and type of change with recurrence over time

Table 7-2 Measurable Variables of Continuous Waves

Size	Peak-to-peak amplitude, root mean square, power
Frequency	Cycles per second, zero crossing
Appearance	Usually sinusoidal, frequency bands
Distribution	Field or area, symmetry
Relationship to other waves	Phase relation, synchrony

complex automated analyses of frequency spectra are the fast Fourier transforms and autoregressive modeling. Continuous waves may be simple, with a single frequency, or they may be complex, with more than one frequency contributing to the waveform. The addition of multiple frequencies changes the appearance of the wave from a simple sinusoidal pattern to a more complex, varying one. Continuous waves can be analyzed with regard to their frequency components and the power of each component. Polarity or direction is seldom described because the waves are continuous. Frequency analysis can provide a precise measurement of the waveform, but it requires defining the amount of each of the component frequencies. This is sometimes done with frequency bands (Table 7-3).

The distribution of continuous waves is another important variable to measure. It is usually described as broad areas, and comparisons are made between homologous areas of the body for symmetry. The relationship of continuous waves to other waves in the same or other areas is another important variable that is measured to identify alterations produced by disease. Waveforms may occur in synchrony for defined periods or may not be in synchrony but still have a definable time relationship, the

*phase relation*. Waves may be in phase or out of phase. Measurement of the timing, frequency, and spatial distribution of the waves can provide valuable information about the presence and the stage of disease.

### Key Points

- Continuous waves are described by their variation from normal in
  - Size (amplitude, root mean square, and power)
  - Frequency (cycles per second, frequency analysis, Fourier transform, and autoregression)
  - Distribution of the potential, phase relations among areas, and differences with location.

### Signal Display

The single potentials and continuous waves generated by neural and muscle tissues can be recorded as analog or digital signals. Modern equipment uses a digital format that allows the signals to be readily stored for subsequent review and analysis. This capability makes it possible to analyze signals without displaying

Table 7-3 Voltages, Display Times, and Frequency of Common Signals in Clinical Neurophysiology

	Voltage ( $\mu\text{V}$ )	Time (ms)	Frequency (Hz)
Electromyography	50–1000	20–1000	32–16,000
Nerve conduction studies	1–20,000	10–500	1–8000
Electroencephalography	1–2000	5000–200,000	0.1–1000
Brain stem auditory evoked potentials	0.1–2	5–20	–
Somatosensory evoked potentials	0.1–20	50–200	20–3000
Visual evoked potentials	1.0–200	100–200	20–3000
Skin potentials	100–5000	1000–10,000	0.1–100
Electrocardiography	1000–5000	10,000–50,000	0.5–100
Respiratory movements	50–2000	5000–200,000	32–10,000
Electronystagmography	1000–5000	5000–100,000	1–2000
Electroretinography	1000–5000	500–2000	1–500
Vascular reflexes	1000–5000	1000–5000	0.1–100

the raw data, showing only the processed data. Although this can improve the recording efficiency, it has the risk of recording and analyzing unwanted signals, such as the artifacts described in the following section. Thus, it is preferable to display the raw, unprocessed signal for review before proceeding to analyze the information. The human eye and ear are better than automated systems for recognizing artifact. For example, the raw signal recorded during evoked potential testing should be displayed along with the averaged potential during data collection.

Unprocessed signals are best displayed as a horizontal trace in which the horizontal axis (sweep) is time and the vertical axis is voltage change. The sweep speed and amplification vary widely with the many different forms of signals (Table 7-3). Multiple signals from different areas are often recorded simultaneously as vertically separated lines.

There are many formats for displaying processed data. The most common one is a line format, as used for averaged signals. Results may also be shown as histograms, bar graphs, numerical tables, topographic maps, or frequency plots (e.g., compressed spectral arrays). Statistical analysis of the data is used with many of these displays. The assumptions of any statistical analysis performed must be understood and appropriate for the problem to be solved.

### Key Points

- Clinical neurophysiologic recordings are virtually all digital rather than analog.
- Primary raw data needs to be reviewed along with processed data to assure its validity and recognize artifact.
- Waveforms are best displayed as linear time data in addition to any other modified formats.

## ARTIFACTUAL WAVEFORMS

*Artifacts* are unwanted signals generated by sources other than those of interest. They are not of clinical value. Artifacts can be classified as signals from living tissue, *physiologic artifact*, or as signals from other sources, *non-physiologic artifact*.

## Physiologic Artifacts

*Physiologic artifacts* are unwanted noise that are the signals of interest in other settings. These include (1) the electrocardiogram—a relatively high-amplitude, widely distributed potential generated by heart muscle that can interfere with any clinical neurophysiology recording; (2) EMG signals that accompany muscle contractions during EEG and evoked potential recordings; (3) potentials that occur with the movement of electrically charged structures (e.g., tongue movement, eye movement, or blink); and (4) autonomic nervous system potentials, such as those arising from changes in skin impedance with perspiration.<sup>12-14</sup> Common artifacts are listed in Table 7-4. Each of these signals and other waveforms that may be recorded to study a particular structure in one setting may be an artifact that interferes with the recording of a different signal in another setting (Fig. 7-7). Although physiologic artifacts are phenomena that cannot be dissociated from normal function, they must be circumvented as much as possible. For example, decreasing the level of muscle activity can help circumvent EMG artifact. Another method is to filter out unwanted frequencies. In some cases, physiologic artifacts need only to be recognized and mentally discounted or subtracted electronically, for example, eye movement artifact on EEG records.

### Key Points

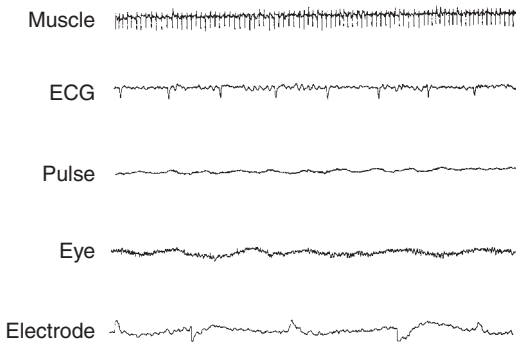
- Physiologic artifacts must be recognized and minimized in any recording, including
  - Muscle contraction EMG during EEG
  - High-voltage EEG during evoked potential recording
  - Electrocardiogram with any clinical neurophysiology measurement
  - Skin impedance changes.

## Nonphysiologic Artifacts

*Nonphysiologic artifacts* are from technical sources, for example, the recording electrodes, the electric amplification and display system, electric stimulation, and the external electric devices or wiring.<sup>15</sup> The most common source of such artifacts is movement of the wires that connect the electrodes to the equipment or movement of the electrodes on the

Table 7-4 Common Forms of Artifact and Interference

Source	Appearance
<i>Movement of charged structures</i>	
Eye movement	Slow positive, lateralized
Eye blink	V-shaped positive
Tongue movement	Slow positive
Eye flutter	Rapid, rhythmic, alternating
<i>Normal activation</i>	
Muscle potentials	Rapid, recurrent spikes
Perspiration	Very slow oscillation
Electrocardiogram	Sharp and slow, regular
Dental fillings touching	Short spikes
Transcutaneous stimulator	70–150 Hz spikes
Cardiac pacemaker	1-Hz spike
Paging and radio signals	Intermittent, recognizable sound
<i>Recording System</i>	
Electrode movement	Irregular, rapid spike
Wire movement	Irregular, slower waves
Poor electrode contact	Mixture of rapid spikes and 60 Hz
Rubbing materials, static	Sharp spikes
Display terminal	300 Hz, regular
White thermal noise	Random, high-frequency spikes
<i>Electromagnetic, external</i>	
Equipment 60 cycle	Regular, 60 Hz
Switch artifact	Rapid spikes
Diathermy	Complex, 120 Hz
Cautery	Dense, high-frequency spikes



**Figure 7-7.** Rhythmic physiologic artifacts in electroencephalographic (EEG) recordings. ECG, electrocardiogram.

skin. The interface between the metal electrode and the skin is complex; the epidermal skin layers are relatively nonconducting. Cleansing and abrading the skin and the application of electrode paste with sodium and chloride concentrations that readily carry ionic current between the skin act to reduce the skin impedance. Nonetheless the remaining

difference in the very low impedance of the metal and that of the skin result in the formation of ionic layers with capacitance and a junctional potential. Movement of the electrodes causes a change in the junctional potential and capacitance that exist at the interface of the electrode and the skin, resulting in an artifact due to a local voltage. Similar changes occur at the ground electrode. If the ground is not well applied, it can generate artifacts, or more commonly a 60-Hz artifact is recorded. A 60-cycle artifact always requires initial electrode removal for recleaning of the skin and application of electrode gel. In general, the impedance of metal or saline-moistened electrodes is lower than stick-on electrodes. Changing stick-on electrodes for metal will often eliminate 60-Hz artifact. If one of the electrodes is not well applied, the ground electrode becomes the reference with distortion of the evoked potential.

Wire leads also frequently produce artifacts, especially if near 60 cycle generators or near the stimulating electrode. Alteration in static



field or electromagnetic induction around the wire leads by movement can produce large, slow wave artifacts. Artifacts also can arise from the opening and closing of switches on equipment; from poor connections of the recording electrodes, with high resistance of the electrodes; and from the use of dissimilar metals. Spurious signals generated within the recording apparatus are usually a 60- or 300-Hz signal.

A shock artifact is virtually always seen if the recording electrodes are near the stimulating electrode, or if the leads to either of them are near or touching each other. In some cases, slow, gradual reorientation of the two stimulating electrodes to each other will reduce the artifact by changing the current flow paths on the skin.

Several external power sources generate specific artifacts. Examples include the 60-cycle signal caused by electromagnetic radiation from power lines; the modified 60-cycle signal of fluorescent lights; the high-frequency, complex discharges from cautery and diathermic equipment; and the irregular waveforms from radio sources, and magnetic resonance imaging power<sup>16</sup> (Fig. 7–8).

Artifacts sometimes are referred to as *interference* because they interfere with recording the activity of interest. By recognizing the nature and source of an artifact, clinical neurophysiologists can often reduce or eliminate it by changing the electrodes or by changing the

location of the equipment or its relationship to the power source. At times, averaging can reduce activity if it is not time-locked to the stimulus. Differential amplification that is used in all modern recording equipment markedly reduces external artifacts. Appropriate grounding can also help.<sup>17</sup>

Continuously occurring artifacts are sometimes referred to as *noise* and compared with the signal as a *signal-to-noise ratio*. This ratio determines the likelihood of eliminating the artifact by averaging the signal.

### Key Points

- Nonphysiologic artifacts require recognition and knowledge of methods to eliminate or reduce them.
- Nonphysiologic artifacts arise from innumerable sources:
  - Wires and electrode contact with skin
  - Equipment malfunction
  - Surrounding equipment.

## SUMMARY

Artifacts can alter all of the variables used to describe the continuous and discrete waveforms recorded in clinical neurophysiology. Changes in amplitude, frequency, and distribution of waveforms occur in continuous waveforms. Frequency change may include the addition of new, abnormal frequencies, the loss of normal frequencies, and either an increase or a decrease in amplitude. Discrete events themselves may be abnormal. The configuration, distribution, size, and pattern of normally occurring discrete events may be changed by disease.

The waveforms recorded in clinical neurophysiology are divided into continuous waveforms and discrete waveforms, or events. Continuous waveforms are described by their frequency components, amplitudes, and distributions. Discrete waveforms are described by their individual amplitudes, durations, and configurations as well as by their patterns of occurrence and distribution.

## REFERENCES

1. Samar, V. J., A. Bopardikar, R. Rao, and K. Swartz. 1999. Wavelet analysis of neuroelectric waveforms: A conceptual tutorial. *Brain and Language* 66:7–60.

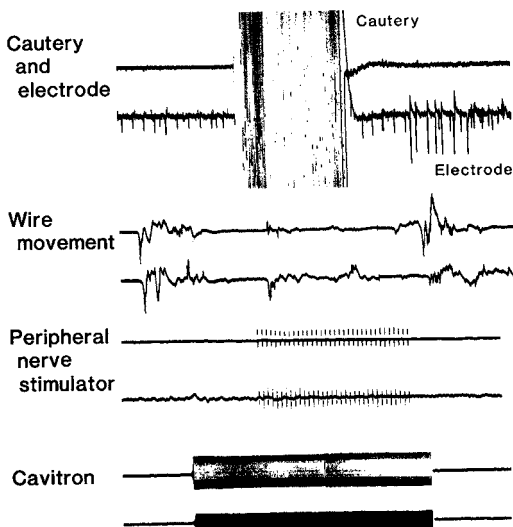


Figure 7–8. Nonphysiologic artifacts recorded during surgical monitoring of muscle activity.



2. Paramanathan, P., and R. Uthayakumar. 2008. Application of fractal theory in analysis of human electroencephalographic signals. *Computers in Biology & Medicine* 38(3):372–8.
3. Abel, E. W., H. Meng, A. Forster, and D. Holder. 2006. Singularity characteristics of needle EMG IP signals. *IEEE Transactions on Biomedical Engineering* 53(2):219–25.
4. Arikidis, N. S., E. W. Abel, and A. Forster. 2002. Interscale wavelet maximum—A fine to coarse algorithm for wavelet analysis of the EMG interference pattern. *IEEE Transactions on Biomedical Engineering* 49(4):337–44.
5. Kobayashi, K., C. J. James, T. Nakahori, T. Akiyama, and J. Gotman. 1999. Isolation of epileptiform discharges from unaveraged EEG by independent component analysis. *Clinical Neurophysiology* 110:1755–63.
6. De Lucia, M., J. Fritschy, P. Dayan, and D. S. Holder. 2008. A novel method for automated classification of epileptiform activity in the human electroencephalogram-based on independent component analysis. *Medical & Biological Engineering & Computing* 46(3):263–72.
7. Sugi, T., M. Nakamura, A. Ikeda, and H. Shibasaki. 2002. Adaptive EEG spike detection: Determination of threshold values based on conditional probability. *Frontiers of Medical & Biological Engineering* 11(4):261–77.
8. Rasheed, S., D. Stashuk, and M. Kamel. 2006. Adaptive certainty-based classification for decomposition of EMG signals. *Medical & Biological Engineering & Computing* 44(4):298–310.
9. Rasheed, S., D. Stashuk, and M. Kamel. 2006. Adaptive fuzzy k-NN classifier for EMG signal decomposition. *Medical Engineering & Physics* 28(7):694–709.
10. Dumitru, D. 2000. Physiologic basis of potentials recorded in electromyography. *Muscle & Nerve* 23:1667–85.
11. Dumitru, D., J. C. King, and D. F. Stegeman. 1998. Normal needle electromyographic insertional activity morphology: A clinical and simulation study. *Muscle & Nerve* 21:910–20.
12. Croft, R. J., and R. J. Barry. Removal of ocular artifact from the EEG: A review. *Neurophysiologie Clinique* 30:5–19.
13. Picton, T. W., P. van Roon, M. L. Armilio, P. Berg, N. Ille, and M. Scherg. 2000. The correction of ocular artifacts: A topographic perspective. *Clinical Neurophysiology* 111:53–65.
14. Jung, T. P., S. Makeig, C. Humphries, et al. 2000. Removing electroencephalographic artifacts by blind source separation. *Psychophysiology* 37:163–78.
15. Wichmann, T. 2000. A digital averaging method for removal of stimulus artifacts in neurophysiologic experiments. *Journal of Neuroscience Methods* 98: 57–62.
16. Allen, P. J., O. Josephs, and R. Turner. 2000. A method for removing imaging artifact from continuous EEG recorded during functional MRI. *Neuroimage* 12:230–9.
17. Tenke, C. E., and J. Kayser. 2001. A convenient method for detecting electrolyte bridges in multichannel electroencephalogram and event-related potential recordings. *Clinical Neurophysiology* 112: 545–50.

SECTION 2

**ELECTROPHYSIOLOGIC  
ASSESSMENT OF NEURAL  
FUNCTION**

---

*This page intentionally left blank*

# Assessment of Cortical Function

---

In clinical neurophysiology, neural function is assessed by measuring the electric potentials generated by neural tissue and the changes in these potentials and waveforms produced by disease. The characteristics of the waveforms and their alteration with disease are a function of the neural generators producing the waveform. A particular modality of recording in clinical neurophysiology reflects only the alteration in the area of the nervous system generating the activity. For example, routine electroencephalography (EEG) records the waveforms arising from cerebral cortex using electrodes applied to the scalp. The EEG recordings described in Chapters 8–11 reflect the normal and abnormal EEG findings and the disease processes that directly involve the cerebral cortex. The EEG records the ongoing spontaneous electric activities of the cerebral cortex and the cortical response to external stimuli. These patterns of responses can provide important clues to the underlying disease process.

Variations of standard EEG recordings that provide unique information for specific situations have been developed. Longer recordings are needed to document infrequent

episodes and to define their nature, character, and spread. Some abnormalities may not be detected with a standard 30- to 60-minute EEG recording. For abnormal electric activity that occurs only in an outpatient setting or under specific circumstances, ambulatory recordings from a few scalp electrodes are made continuously during activities at home or work (Chapter 12) to obtain a full picture of their nature. To help define the nature and origin of frequent seizures, a patient undergoes prolonged EEG recording with multiple electrodes left in place for several days (Chapter 13). Electroencephalograms can also be recorded in other specialized situations, such as in the intensive care unit or operating room, or with computerized quantitation, as described in Chapter 14. This chapter also reviews additional information that can now be obtained from magneto-EEG. Patients being considered for epilepsy surgery require highly specialized recordings, including new correlations with magnetic resonance imaging (Chapter 15). Cortical function can also be assessed with potentials that occur before a planned movement or in response to external stimulation (Chapter 16).

*This page intentionally left blank*

# Electroencephalography: Adult, Normal, and Benign Variants

Barbara F. Westmoreland

## INTRODUCTION RECORDING THE ELECTROENCEPHALOGRAM DISPLAY OF EEG ACTIVITY ACTIVATION PROCEDURES

Hyperventilation  
Photic Stimulation  
Sleep  
Other Activating Procedures

## ARTIFACTS

## INTRODUCTION

Electroencephalography is a dynamic electrophysiologic procedure that evaluates the function or disturbance of function of the brain by recording the electrical activity of the brain.

### *Purpose and Role of the EEG in the Normal Adult*

- To evaluate the function of the brain.
- To describe normal EEG and benign variants.

## RECORDING THE ELECTROENCEPHALOGRAM

The electroencephalogram (EEG) records the electrical activity and waveforms generated by

## NORMAL EEG ACTIVITY OF ADULTS

Awake State  
The EEG in Older Adults  
Drowsiness  
Sleep State

## BENIGN VARIANTS

Variants During Wakefulness  
Benign Variants During Drowsiness  
and Sleep

## SUMMARY

cortical neurons. The EEG is performed by attaching small disc electrodes on the scalp of the head or utilizing an electrode cap. The electrodes are connected to the EEG instrument which amplifies the brain wave potentials and activity by a million times and then displays it on a moving strip of paper or on a computer reader station if a digital system is used.

## DISPLAY OF EEG ACTIVITY

The EEG activity is displayed using a variety of combinations of electrode pairs or montages. The American Clinical Neurophysiology Society has recommended that all EEG laboratories include a minimum number of standard montages for routine EEG recording.<sup>1</sup> The

minimum recommendations are longitudinal bipolar (Fig. 8-1A), transverse bipolar (Fig. 8-1B), and referential displays (Fig. 8-1C). Since one type of montage may be insufficient for the problem, it is advisable to use a combination of montages and to emphasize whatever array is most useful for the problem<sup>1-3</sup> (Fig. 8-1D). One should be able to select the most advantageous montage to best display the type of activity or abnormality in the EEG. The advent of digital EEG recording has proved to be very helpful for the electroencephalographer to reformat and select any of several different montages for the most appropriate display of a particular segment of the EEG<sup>2</sup> (see Chapter 4).

**Key Points**

- Various combinations of electrode pairs constitute montages.
- The minimum number of standard montages for an EEG recording should include longitudinal, transverse, and referential montages.

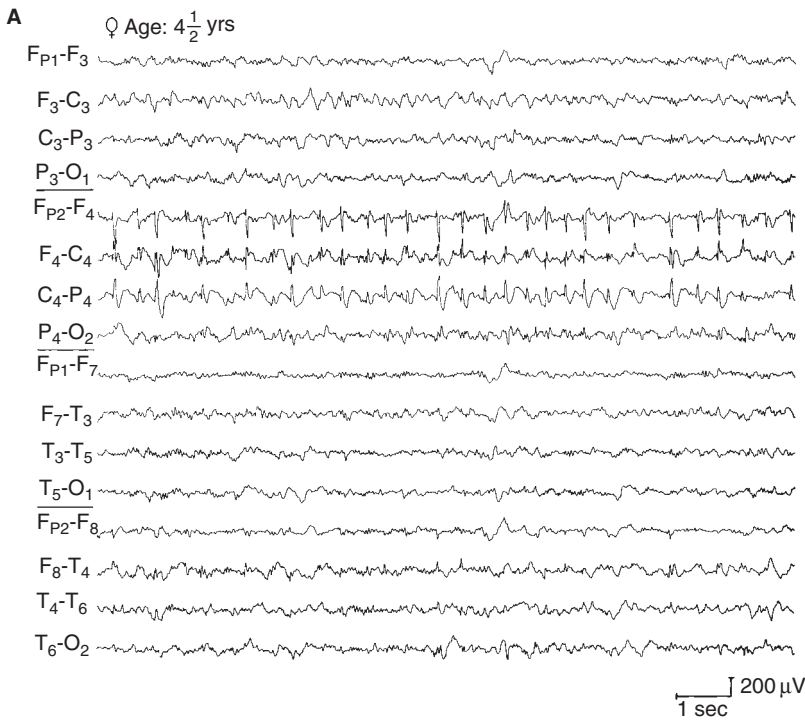
- A combination of different montages may be needed to best display the finding or abnormality in the EEG.
- Digital EEG recording has been helpful in selecting various montages.

**ACTIVATION PROCEDURES**

Activation procedures are commonly used to help bring out abnormal activity such as epileptiform discharges when the resting record is noncontributory. The activating procedures consist of hyperventilation, photic stimulation, and sleep recordings.<sup>2,3</sup>

**Hyperventilation**

Hyperventilation is performed for 3-5 minutes. In adults, this usually produces little change in the EEG. If there is a change, this usually consists of generalized slowing or bursts of slow waves, which is sometimes



**Figure 8-1.** EEG from a 4½-year-old girl showing the appearance of focal right frontocentral (F4,C4) spikes in, A, a longitudinal (anteroposterior) bipolar montage, B, a transverse bipolar montage, C, a referential montage, and, D, a montage combining bipolar and referential recording.



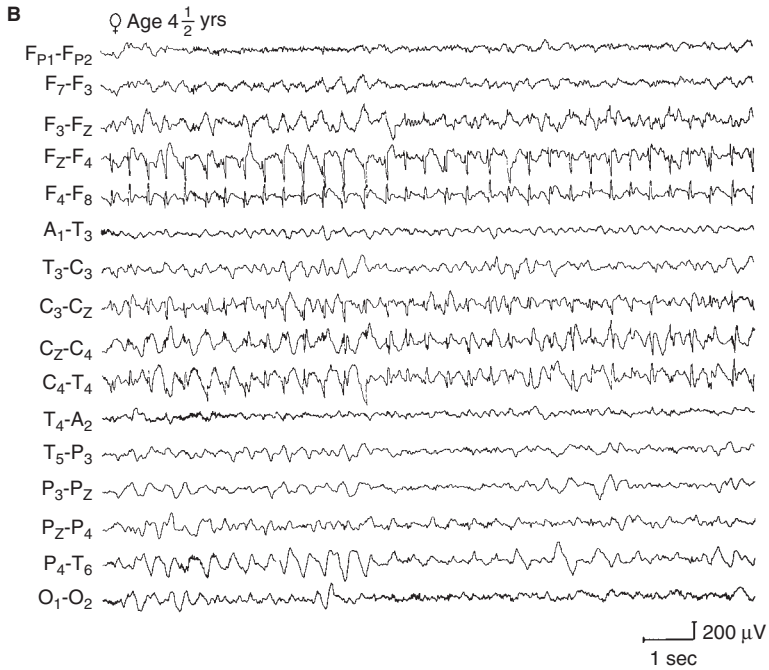
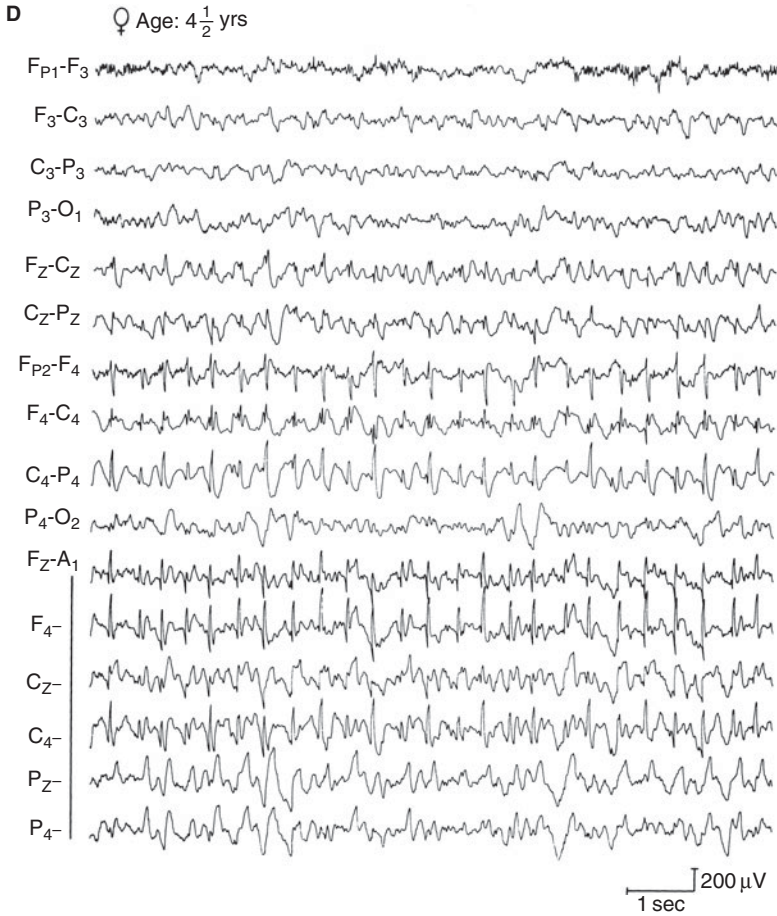


Figure 8-1. (Continued).



**Figure 8-1.** (Continued).

referred to as a *buildup*. Slowing is usually more prominent in children when compared to adults (Fig. 8-2). The degree of the slowing depends on age, the vigor of hyperventilation, whether the patient is hypoglycemic, and posture. The response may be potentiated by hypoglycemia. Abnormal responses to hyperventilation include epileptiform discharges, the most common being 3-Hz generalized spike-and-wave discharge that is usually seen with typical absence seizures. Focal or lateralized slowing or asymmetry of activity that is brought on by hyperventilation is also an abnormal finding.

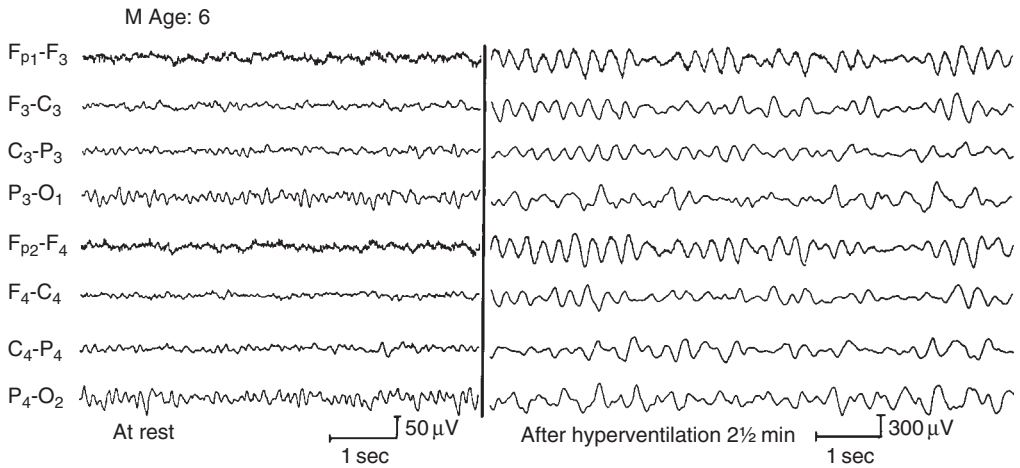
**Key Points**

- Hyperventilation may produce generalized slowing.

- The slowing may be more prominent in children.
- The degree of slowing depends on age, vigor of hyperventilation, and hypoglycemia.
- Hypoglycemia can potentiate the degree of slowing with hyperventilation.
- Hyperventilation can activate epileptiform activity, with the most common being 3-Hz generalized spike-and-wave discharges.

**Photic Stimulation**

Intermittent photic stimulation is another activating procedure. Stimulation usually includes frequencies ranging from 1 to 30 Hz and is usually done with the eyes open and then



**Figure 8-2.** EEG from a 6-year-old boy awake and at rest (segment on *left*) and normal response to hyperventilation (segment on *right*).

closed. The normal response consists of flash-evoked responses over the posterior head regions, termed *photic driving*. An abnormal response is a consistent asymmetric photic driving response or activation of epileptiform discharges. One characteristic response is termed the *photoparoxysmal response* and is an abnormal response, which consists of generalized and bilaterally synchronous spike-and-wave discharges evoked by the photic stimulus.<sup>2-4</sup> This is usually seen in patients with a generalized seizure disorder. The other response is the *photomyogenic response*, which consists of myogenic twitching of the forehead or eyelids in association with the photic stimulus.<sup>2-4</sup>

### Key Points

- Photic stimulation evokes flash-evoked responses over the posterior head regions, termed photic driving.
- An abnormal response consists of activation of epileptiform activity or an asymmetric driving response.
- A photoparoxysmal response, which consists of generalized spike-and-wave discharges, is an abnormal response that is seen in patients with a generalized seizure disorder.
- A photomyogenic response consists of myogenic twitching of the forehead or eyelids.

## Sleep

Sleep recordings can be an important way of bringing out focal or generalized epileptiform activity. In particular, discharges arising from the temporal region are frequently activated during drowsiness and sleep. Partial sleep deprivation the night prior to the recording may increase the chance of detecting epileptiform activity.

### Key Points

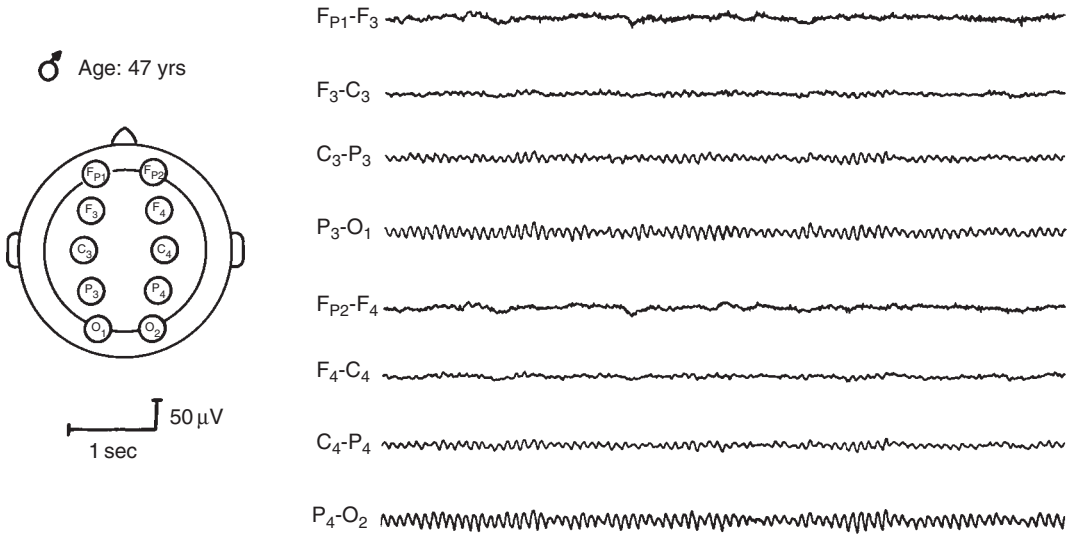
- Sleep recordings are an important way to activate epileptiform discharges.
- Discharges arising from the temporal region are frequently activated during drowsiness and sleep.
- Partial sleep deprivation may increase the chance of detecting epileptiform activity.

## Other Activating Procedures

Other activating procedures can be used to evoke the patient's symptoms if the patient is sensitive to a certain stimulus such as light, sound, music, or somatosensory stimulation.<sup>3,5</sup>

## ARTIFACTS

An artifact is a potential or waveform that is not due to cerebral activity. Artifacts are often



**Figure 8-3.** Normal EEG from a 47-year-old man showing symmetric alpha rhythm predominantly in the occipital regions (O<sub>1</sub> and O<sub>2</sub>).

seen in the EEG. Artifacts can take a variety of forms and shapes, including those resembling cerebral EEG activity. It is important to recognize the artifacts and not misinterpret them as cerebral activity.<sup>2,3,6</sup> At times muscle and movement artifacts can obscure the EEG recording.

### Key Points

- Artifacts are potentials that are not due to cerebral activity.
- Artifacts can take any shape or form.

## NORMAL EEG ACTIVITY OF ADULTS

### Awake State

The activity seen in the EEGs of awake adults consists of frequencies in the *alpha* and *beta* range, with the alpha rhythm constituting the predominant background activity.

### ALPHA RHYTHM

*Alpha activity* refers to any activity in the range between 8 and 13 Hz, whereas the *alpha rhythm* is a specific rhythm consisting of alpha activity occurring over the posterior

head regions when the person is awake and relaxed and has the eyes closed (Fig. 8-3); it is attenuated by eye opening, alerting stimuli, or attention.<sup>7,8</sup> The usual alpha amplitude in an adult is 15–50 μV. The maximal amplitude occurs over the occipital region, with variable spread to the parietal, temporal, and, at times, central leads. The alpha activity may be of higher voltage and wider distribution over the right hemisphere.

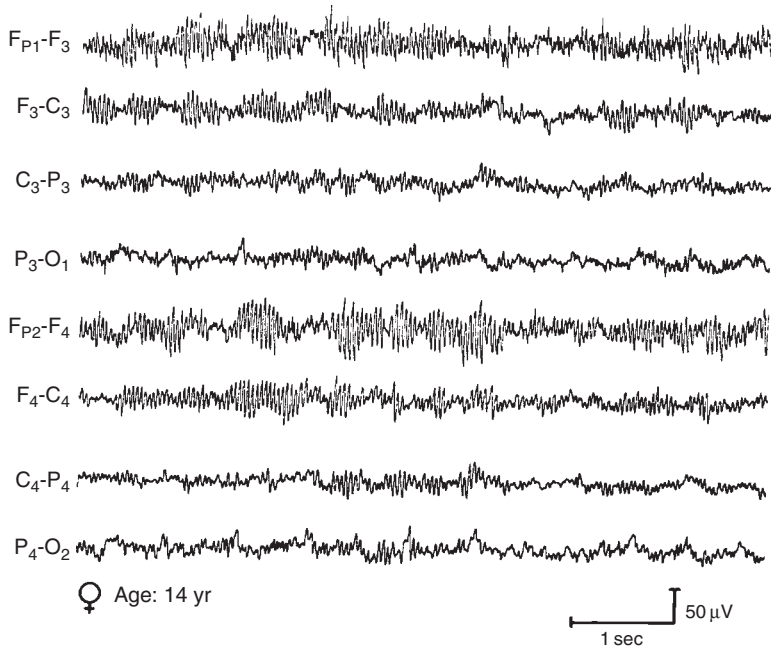
The alpha rhythm should attenuate bilaterally with eye opening, alerting stimuli, or mental concentration. Failure of the alpha rhythm to attenuate on one side with either eye opening or mental alerting indicates an abnormality on the side that fails to attenuate.<sup>9</sup>

### Key Points

- Alpha activity is any activity between 8 and 13 Hz.
- The alpha rhythm is present over the posterior head regions.
- The alpha rhythm occurs in the awake state with the eyes closed.
- The alpha rhythm is attenuated by eye opening, alerting stimuli, or attention.

### BETA ACTIVITY

*Beta activity* has a frequency greater than 13 Hz.<sup>2</sup> The average voltage is between 10 and



**Figure 8-4.** EEG containing beta activity which is maximal over the anterior head regions in a 14-year-old girl receiving diazepam.

$20 \mu\text{V}$ <sup>7,8</sup> (Fig. 8-4). The three main types of beta activity, based on distribution, are the following: (1) the precentral type occurs predominantly over the frontal and central regions, which is increased with drowsiness, and may attenuate with bodily movement; (2) posterior dominant beta activity can be seen in children up to 1–2 years old; it is also enhanced by drowsiness; and (3) generalized beta activity which is induced or enhanced by certain drugs, such as benzodiazepines and barbiturates. Focal accentuation of beta activity can result from a lesion or defect in the skull.

### Key Points

- Beta activity is greater than 13 Hz.
- There are three main types of beta activity:
  - Precentral beta
  - Posterior beta in children
  - Generalized beta which is seen with drugs.

### THETA ACTIVITY

*Theta activity* (4–7 Hz) constitutes part of the background activity in children.<sup>7</sup> Theta activity

can be seen in adults during drowsiness, occurring in a generalized distribution or over the posterior head regions. In older patients, theta components can occur as single transients or as part of a mixed alpha–theta burst over the temporal regions.<sup>7</sup>

### Key Points

- Theta activity is in the range of 4–7 Hz.
- It is part of the background activity in young children.
- It is seen in adults during drowsiness.
- Theta activity can be seen over the temporal regions in older adults.

### DELTA ACTIVITY

*Delta activity* (<4 Hz) is the predominant background frequency seen in infants.<sup>3,7</sup> Delta slowing can be seen in adults as a normal finding in deeper levels of sleep.<sup>7</sup>

### Key Points

- Delta activity is less than 4 Hz.
- Delta activity is seen in infants.
- Delta activity can be seen in adults during deeper levels of sleep.

## MU RHYTHM

The *Mu rhythm* consists of arciform waveforms with a frequency of 7–11 Hz, which occurs independently over the central head regions.<sup>7,8</sup> Mu activity is functionally related to the sensorimotor cortex and is attenuated by touch, active or passive movement of the extremities, or thought of movement (Fig. 8–5). It can occur in an asymmetrical fashion or predominate over one hemisphere. Mu rhythm can be quite prominent if there is an overlying skull defect (*breach rhythm*).

### Key Points

- Mu activity has a frequency range of 7–11 Hz.
- Mu activity is attenuated by touch, movement of the extremities, or thought of movement.
- Mu activity can be quite prominent with an overlying skull defect.

## LAMBDA WAVES

The *lambda wave* has a configuration resembling the Greek letter  $\lambda$  and occurs over the occipital regions when the subject actively scans a picture.<sup>7</sup> Lambda waves appear to represent an evoked cerebral response to visual stimuli produced by scanning movements of the eyes when looking at a picture. The waveforms are monophasic or diphasic, with the

most prominent component usually surface-positive (Fig. 8–6). The amplitude is usually between 20 and 50  $\mu$ V, and the duration is approximately 100–250 ms. Lambda waves are bilateral and synchronous but may be asymmetrical.

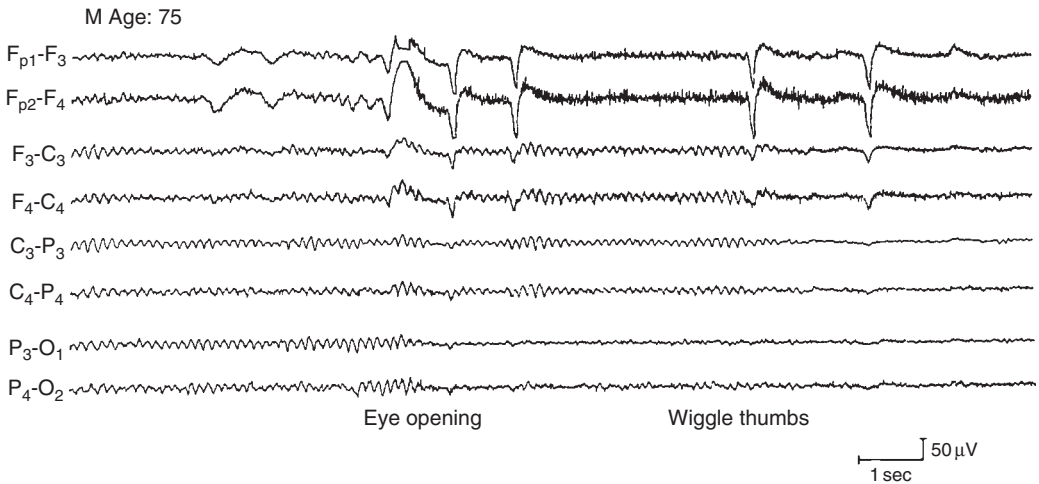
### Key Points

- Lambda waves resemble the Greek letter  $\lambda$ .
- They are present over the occipital regions when the person is scanning a picture.
- The lambda waves represent an evoked response to visual stimuli in association with eye movements.

## The EEG in Older Adults

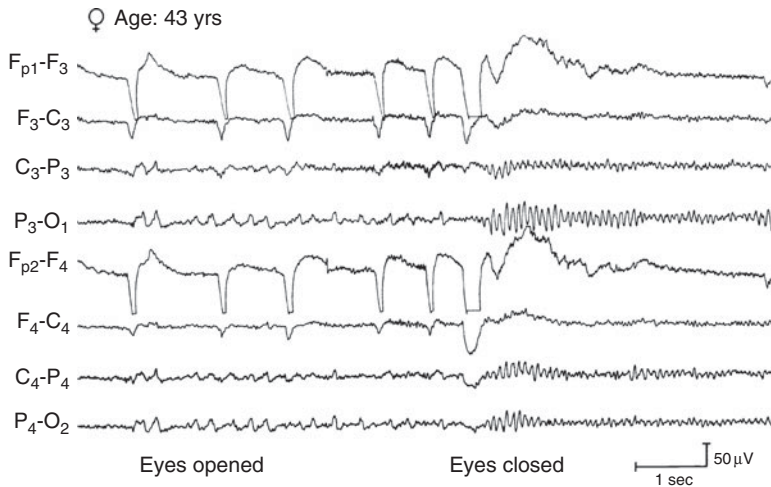
In older adults, there may be a shift to slower background frequencies. However, it has been shown that the alpha frequency can continue to be greater than 8 Hz in normal elderly subjects.<sup>7,10,11</sup> There is a tendency, however, for the alpha rhythm to be of lower voltage in older subjects and perhaps to show less reactivity.<sup>10</sup>

*Benign temporal slow wave transients* consist of sporadic delta and theta slow waves that occur over the temporal regions in older adults, usually after the age of 60 years.<sup>10</sup> The temporal slow waves usually have a left-sided preponderance and appear to be related to



**Figure 8–5.** Normal EEG showing bilateral mu rhythm in the central regions; the rhythm persists when the eyes are opened and attenuates with movement of the thumbs. This is in contrast to the alpha rhythm (O<sub>1</sub> and O<sub>2</sub>), which is attenuated by eye opening.





**Figure 8-6.** EEG showing normal lambda waves maximal in O<sub>1</sub> and O<sub>2</sub> when the patient's eyes are open and looking around the room.

a normal aging process.<sup>2,10,11</sup> Hyperventilation and drowsiness facilitate the appearance of temporal slow waves.

### Key Points

- In older adults, the EEG may shift to a slower background frequency.
- The EEG may show lower voltage activity.
- Temporal slow wave transients may be present in older adults.
- Hyperventilation and drowsiness can facilitate temporal slow wave transients.

## Drowsiness

In adults, drowsiness is typically associated with slow eye movements, slowing of the background frequency, a disappearance of alpha activity, and enhancement of beta activity. At times, rhythmic 5–7 Hz theta activity can be present, occurring in a generalized fashion or over the anterior or posterior head regions. In older subjects, there may be an enhancement of theta and delta waves over the temporal regions. Sharply contoured waveforms, called *wicket spikes* or *wicket waves*, may also be present over the temporal regions, maximal over the left temporal region.<sup>5,12</sup> The beta activity over the frontocentral regions often increases in prominence during drowsiness. This usually has a frequency of 16–20 Hz, but occasional bursts of faster frequencies may

occur. Mu activity may also be seen during drowsiness and may persist after the alpha rhythm disappears.

### Key Points

- Drowsiness is associated with slowing, disappearance of alpha activity, and enhancement of theta and beta activity.
- Wicket waves may be present during drowsiness.
- Mu activity can persist during drowsiness.

## Sleep State

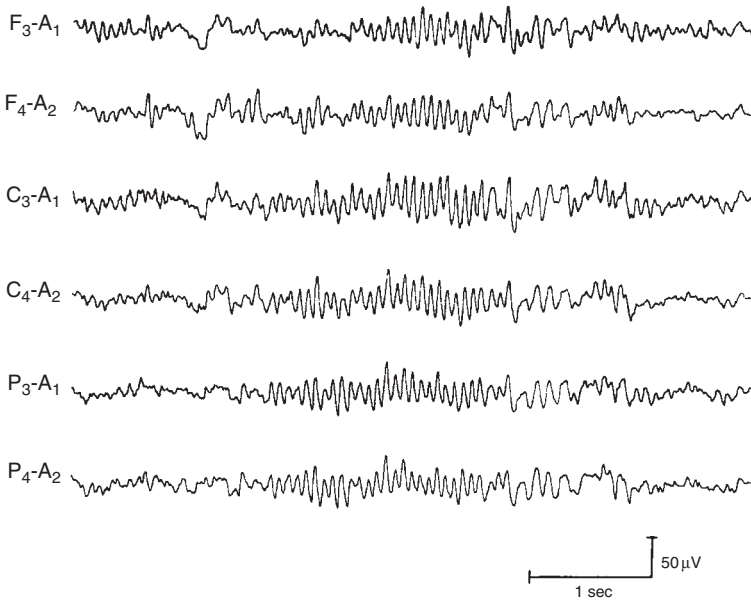
Sleep activity consists of slow waves, spindles, V waves, K complexes, and positive occipital sharp transients of sleep (POSTS).

### SLEEP SPINDLES

In adults, the sleep spindles of NREM sleep usually have a frequency of 14 Hz and occur in a symmetrical and synchronous fashion over the two hemispheres in the frontocentral regions (Fig. 8-7). In deeper levels of sleep, the spindle frequency decreases to approximately 12 Hz and maximal amplitude is located more anteriorly. More continuous spindle activity may be seen in some patients who are receiving drug therapy, particularly benzodiazepines.



♀ Age: 20 yrs



**Figure 8-7.** EEG from a 20-year-old woman during sleep showing normal 14-Hz sleep spindles.

### Key Points

- Sleep spindles have a frequency of 12–14 Hz.
- Spindles occur maximally over the fronto-central regions.
- More continuous spindle activity can be seen with certain drugs.

### VERTEX SHARP TRANSIENTS

*Vertex sharp transients (V waves)* are sharp-contoured transients that occur maximally over the central vertex region during sleep (Fig. 8-8). In children and young adults, V waves may have a sharp or spiky appearance and attain high voltages. They are typically symmetrical in the central leads but may show transient asymmetries at the time of sleep onset. F waves, or frontally dominant V waves, are often broader than the centrally dominant V waves and may extend asymmetrically into the lateral frontal regions.

### Key Points

- Vertex waves are sharp-contoured transients that occur maximally over the central vertex region.
- F waves are frontally dominant V waves.

### K-COMPLEX

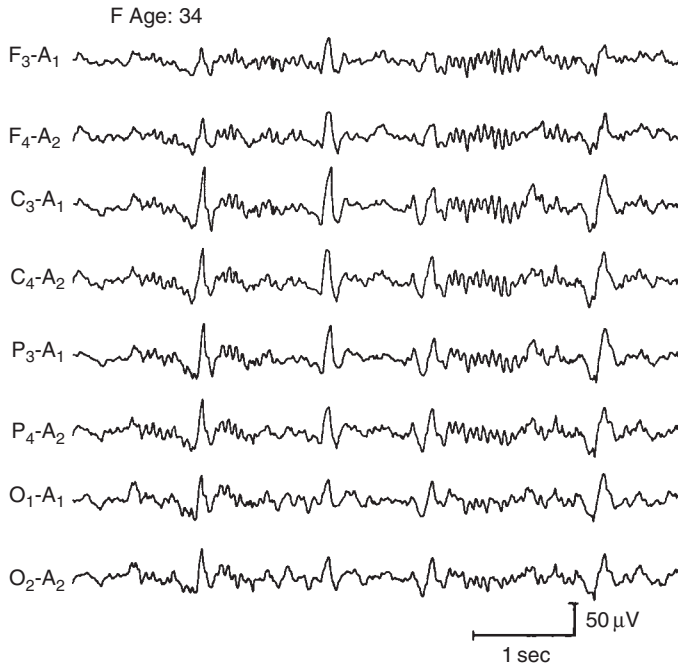
The *K-complex* is a diphasic or polyphasic wave that is maximal at the vertex and is usually longer than 500 ms. It is frequently associated with spindle activity. The K-complex represents a nonspecific response to afferent stimulation and is generally linked to the arousal mechanism.<sup>7</sup>

### Key Points

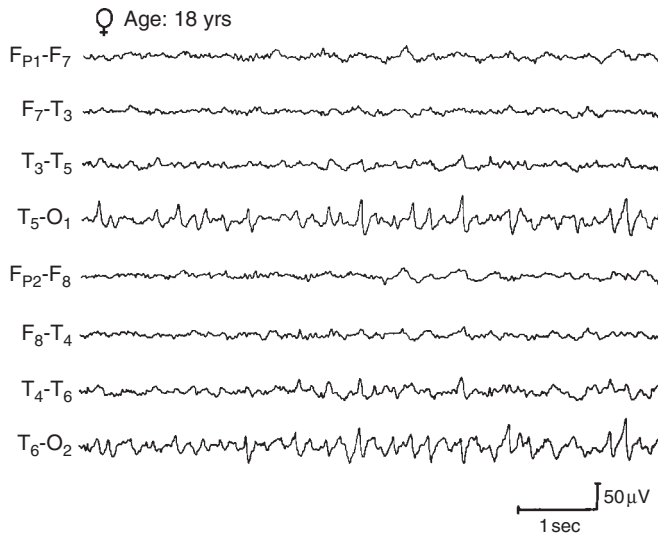
- K-complexes are broad diphasic waveforms that are maximal at the vertex region.
- K-complexes are usually longer than 500 ms.
- K-complexes represent a nonspecific arousal response.

### POSTS

*Positive Occipital Sharp Transients of Sleep (POSTS)* are sharp-contoured, surface-positive transients that occur singly or in clusters over the occipital regions (Fig. 8-9). They are usually bilaterally synchronous but may be somewhat asymmetrical. They are predominantly seen during light-to-moderate levels of sleep



**Figure 8-8.** EEG from a 34-year-old woman during sleep showing normal V waves maximal in C<sub>3</sub> and C<sub>4</sub> and P<sub>3</sub> and P<sub>4</sub>.



**Figure 8-9.** EEG during sleep showing prominent normal POSTS maximal in O<sub>1</sub> and O<sub>2</sub>.

and should not be mistaken for abnormal sharp waves.

### Key Points

- POSTS are sharp-contoured, surface-positive waves that are seen over the occipital regions during sleep.

### OLDER ADULTS

Changes during drowsiness and sleep occur in normal elderly subjects.<sup>10,11</sup> During drowsiness, rhythmic trains of high-amplitude delta activity may occur in older adults and are often maximal over the anterior head regions. This drowsy pattern of older subjects needs

to be carefully distinguished from abnormal frontal intermittent rhythmic delta activity.<sup>2,3,10,11</sup> During NREM sleep, the V waves and K-complexes are lower in amplitude and less sharp in appearance than in young adults, and sleep spindles are less prominent. Delta activity is lower in voltage and less abundant in older subjects than in young adults during deeper stages of NREM sleep.

### RAPID EYE MOVEMENT SLEEP

During rapid eye movement (REM) sleep, the EEG shows a low-voltage pattern that has some similarities to an awake pattern when the eyes are open. The EEG also shows intermittent rapid eye movements. In addition, rhythmic groups of saw-toothed waves may occur intermittently over the frontal and central leads and may precede or occur in association with the rapid eye movements.

#### Key Points

- REM sleep is associated with a low-voltage pattern.
- Saw-toothed waves may be seen in association with rapid eye movements.

## BENIGN VARIANTS

### Variants During Wakefulness

#### ALPHA VARIANTS

The alpha-variant patterns consist of activity over the posterior head regions.<sup>13</sup> This activity has a harmonic relationship to the alpha rhythm and shows reactivity and a distribution similar to those of the alpha rhythm. The *slow alpha variant* appears as dicrotic or notched waveforms that result from a subharmonic component of the alpha rhythm, usually in the range of 4–5 Hz. The *fast alpha variant* contains a frequency twice that of the resting alpha activity, usually between 18 and 20 Hz.

#### Key Points

- Alpha-variant patterns have a harmonic relation to the alpha rhythm.
- The slow alpha variant is a subharmonic of the alpha rhythm with a frequency of 4–5 Hz.

- The fast alpha variant has a frequency twice the rest alpha frequency.

### PHOTIC RESPONSES

Complex waveforms may be induced by photic stimulation when harmonics or subharmonic components are admixed with the fundamental frequency of the driving response. Occasionally, the resultant mixture of frequencies can produce waveforms that simulate epileptiform spikes or spike-wave complexes.

#### Key Points

- Complex waveforms may be induced by photic stimulation and can produce waveforms that simulate spike-wave complexes.

### SUBCLINICAL RHYTHMIC ELECTROGRAPHIC DISCHARGE OF ADULTS

*Subclinical rhythmic electrographic discharge of adults* (SREDA) is an uncommon phenomenon that occurs mainly in the older patient.<sup>13,14</sup> The pattern consists of a mixture of theta and delta frequencies, but most often predominating in the theta frequency range. It resembles an epileptiform seizure discharge but is not accompanied by any clinical symptoms and has no significance for the diagnosis of epileptic seizures (Fig. 8–10). The characteristics of SREDA are listed in Table 8–1.

### BREACH RHYTHM

Various normal rhythms are more prominent when recorded over a skull defect. The term *breach rhythm* has been used to refer to a focal increase in the amplitude of sharp-contoured EEG activity over or near the area of a skull defect.<sup>15,16</sup> When mu and beta rhythms are present, the activity can resemble epileptiform spikes (Fig. 8–11).

#### Key Points

- Breach rhythm refers to a focal increase in the amplitude of EEG activity over the area of a skull defect.
- Benign variants seen in the awake EEG consist of
  - Slow and fast alpha variants

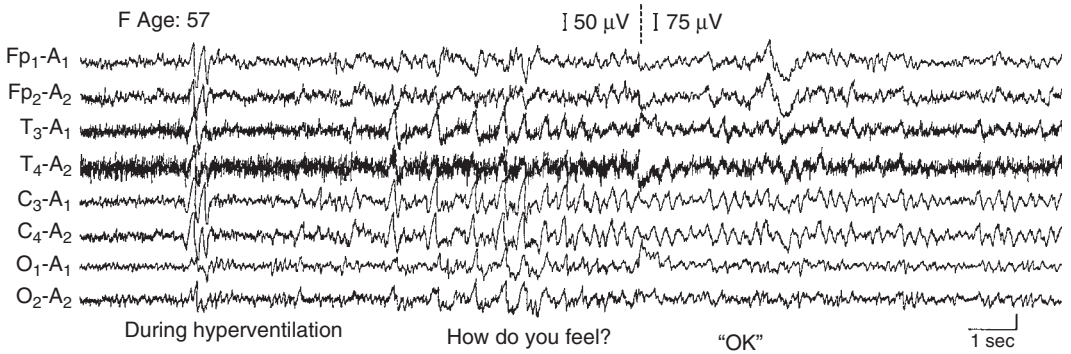


Figure 8–10. Onset of SREDA in a 57-year-old woman.

Table 8–1 Characteristics of Subclinical Rhythmic Electrographic Discharge of Adults (SREDA)

Feature	Characteristic
Onset	Segmented or abrupt
Repetition rate	Theta
Duration	Average 1 minute
Distribution	Maximal parietal–posterior temporal
Laterality	Symmetrical or asymmetrical
State	Awake at rest or during hyperventilation
Background activity	Often visible during the discharge
Delta aftermath	None
Clinical accompaniment	None
Patient age	Mainly older adults

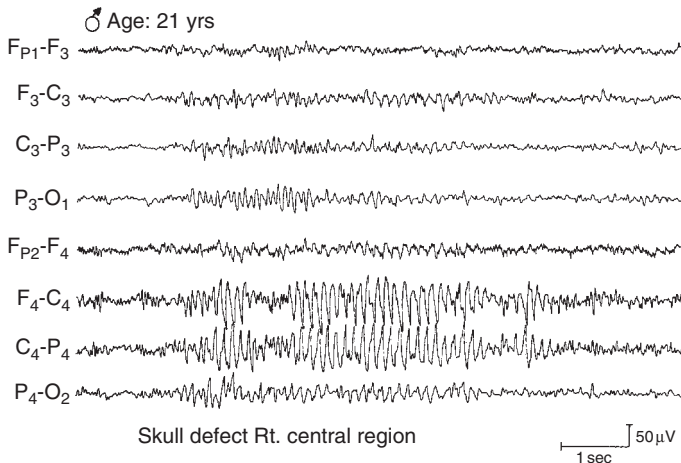


Figure 8–11. EEG from a 21-year-old man showing breach rhythm (C4) over the area of a skull defect.

- Spike-like photic responses
- Subclinical rhythmic electrographic discharge of adults (SREDA)
- Breach rhythm where there is an enhancement of activity over the area of a skull defect.

## Benign Variants During Drowsiness and Sleep

There are several benign variants that occur mainly during drowsiness or light sleep.<sup>2,13</sup> Some of these have an appearance suggestive of epileptiform abnormality, but are of little or no clinical significance and have no importance for the diagnosis of seizures or cerebral lesions.

### RHYTHMIC TEMPORAL THETA BURSTS OF DROWSINESS

The *rhythmic temporal theta bursts of drowsiness* (previously known as the *psychomotor-variant pattern*) frequently have a flat-topped or notched appearance because of the harmonics of the fundamental theta frequency. The bursts may occur bilaterally or independently over the two temporal regions, with a shifting emphasis from side to side (Fig. 8–12). This pattern differs from a true seizure discharge in that it does not evolve into other frequencies or waveforms.<sup>13</sup> It occurs predominantly in young or middle-aged adults.

#### Key Points

- Rhythm temporal theta bursts of drowsiness have a notched appearance and occur independently or bilaterally over the temporal regions.

### 14 AND 6 HZ POSITIVE BURSTS

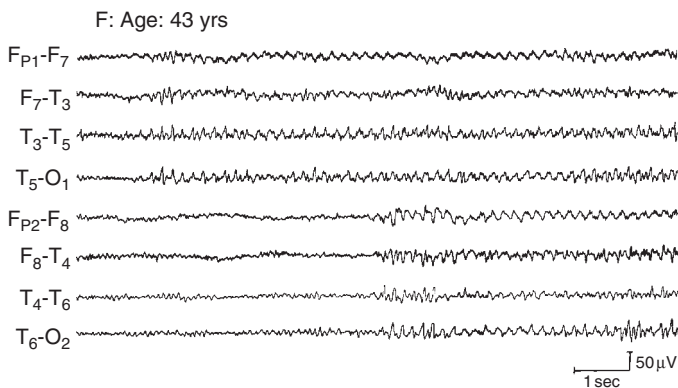
The *14 and 6 Hz positive bursts* (previously known as *14 and 6 per second positive spikes*) are displayed best on long interelectrode distance referential montages and are most prominent over the posterior temporal region during light sleep. As the name implies, the bursts occur at a rate of 14 Hz (Fig. 8–13A) or between 6 and 7 Hz (Fig. 8–13B) and are from 0.5 to 1 second in duration. The 14 and 6 Hz positive bursts usually occur independently over the two hemispheres and vary from side to side in occurrence. They are most frequently seen in subjects between 12 and 20 years old.<sup>2,13</sup>

#### Key Points

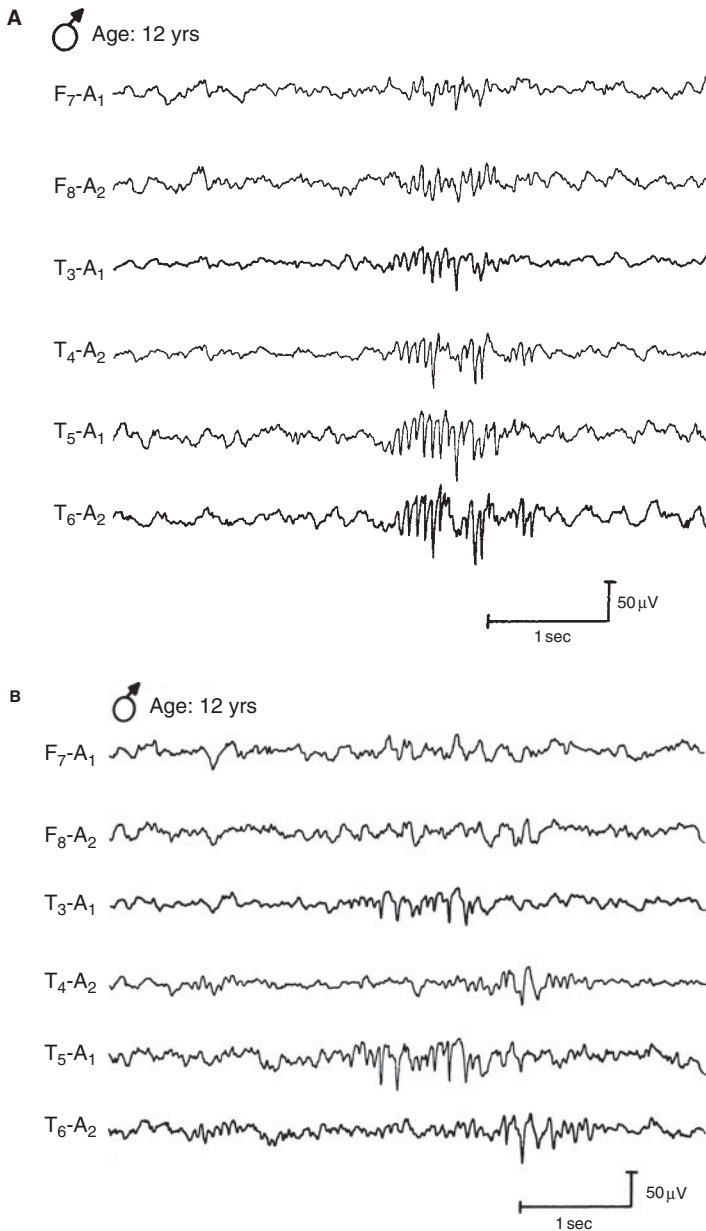
- 14 and 6 Hz positive bursts are most prominent over the posterior head regions.
- 14 and 6 Hz positive bursts are seen most frequently in teenagers.

### BENIGN SPORADIC SLEEP SPIKES

*Benign sporadic sleep spikes* (BSSS), also known as *small sharp spikes* (SSS) or *benign epileptiform transients of sleep* (BETS), occur mainly in adults during drowsiness and light levels of sleep<sup>2,13</sup> (Fig. 8–14). They are usually low-voltage, short-duration diphasic spikes with a steep descending limb. The BSSS occur typically as single spikes, rarely as doublets, and never in repetitive trains. The BSSS may have a single low-voltage aftercoming slow-wave component, but they do not distort the background and are not associated with slow-wave activity, as temporal sharp waves are.



**Figure 8–12.** EEG from a 43-year-old woman showing rhythmic temporal theta activity during drowsiness.



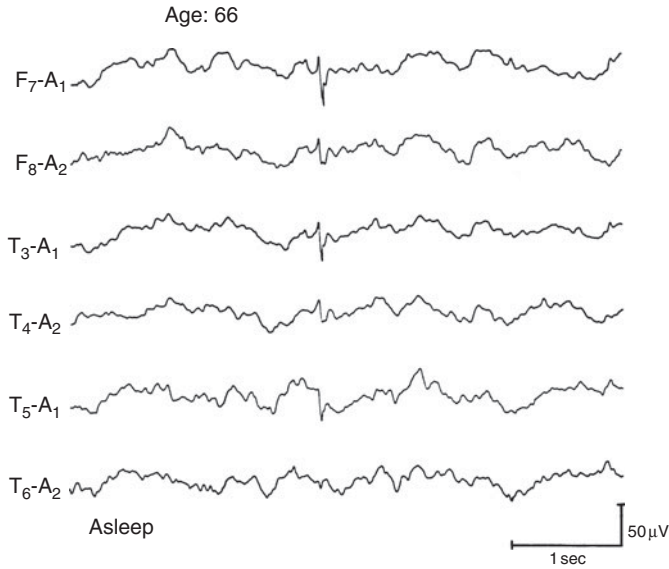
**Figure 8-13.** EEG from a 12-year-old boy during sleep. *A*, A 14-Hz positive burst (maximal in T<sub>5</sub> and T<sub>6</sub>) and, *B*, 6-Hz positive bursts (maximal in T<sub>5</sub> and T<sub>6</sub>).

They are best seen with long interelectrode distance derivations, including the temporal and ear leads. Provided a long enough recording is obtained, they almost always have a bilateral representation, occurring either independently or synchronously over the two hemispheres. Their characteristics are summarized in Table 8-2. They need to be carefully distinguished from more important types of spikes

because the BSSs have no significance for the diagnosis of epileptic seizures.<sup>2,13</sup>

#### 6-HZ SPIKE-AND-WAVE

The 6-Hz *spike-and-wave* pattern has also been called the *fast spike-and-wave*, because of its repetition rate, or the *phantom spike-and-wave*, because of its usual low-amplitude spike



**Figure 8-14.** A typical BSSS in a 66-year-old patient.

component. It occurs mainly during drowsiness and disappears during deeper levels of sleep (Fig. 8-15). It has no associated clinical manifestations and has no correlation with clinical seizures or other symptoms.<sup>2,13</sup> Its typical characteristics are listed in Table 8-3.

**WICKET SPIKES**

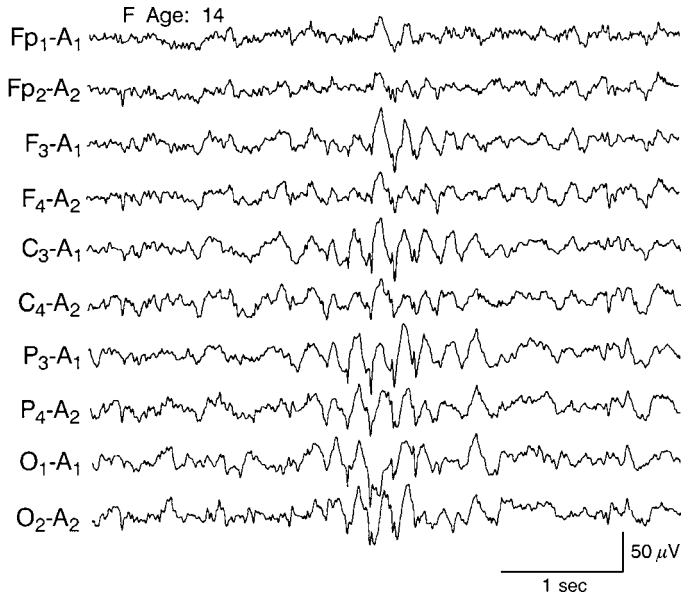
*Wicket spikes*<sup>12,13</sup> consist of single spike-like waveforms and appear as a monophasic fragment of a mu-like rhythm (Fig. 8-16). Wicket spikes, or wicket waves, have a frequency of

6-11 Hz and an amplitude ranging from 60 to 200  $\mu$ V and are seen mainly in adults. They occur during drowsiness and light sleep and become apparent when the alpha and other awake patterns drop out. Wicket spikes are present over the temporal regions, occurring bilaterally or independently over the two temporal regions, and they may occur more frequently on one side, usually the left. When wicket spikes occur as a single waveform, they may be mistaken for a temporal spike discharge; however, they are not accompanied by aftercoming slow waves or a distortion or

**Table 8-2 Characteristics of Benign Sporadic Sleep Spikes**

Feature	Characteristic
Amplitude	Low
Duration	Short
Morphology	Sharp, diphasic (steep descent)
Associated slow wave	None or minimal
Background activity	No disruption
Distribution	Widespread
Laterality	
Single	Maximal unilateral
Multiple	Bilateral
Occurrence	Mainly adults
Event	Sporadic
State	Drowsiness or light sleep
Patient age	Adult
Clinical accompaniment	None

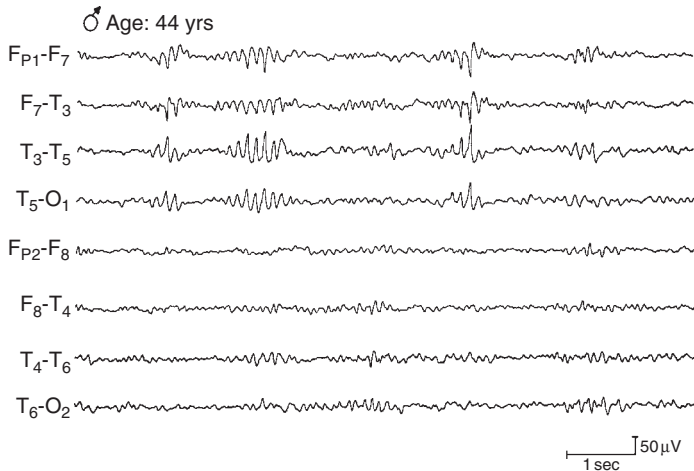




**Figure 8-15.** A 6-Hz spike-and-wave burst during drowsiness in a 14-year-old girl with headaches but no seizures.

**Table 8-3 Characteristics of 6-Hz Spike-and-Wave**

Feature	Characteristic
Frequency	6±1 Hz
Repetition rate	Regular
Burst duration	Brief, 1-2 seconds
Spike duration	Brief
Amplitude	Low
Distribution	Diffuse, maximal anterior or posterior
Laterality	Bisynchronous, symmetrical
Clinical state	Drowsiness
Clinical accompaniment	None
Patient age	Young adult



**Figure 8-16.** Wicket spikes in the left temporal region of a 44-year-old man.

slowing of the background that occurs with a true epileptogenic temporal spike.

### Key Points

- Wicket spikes have a spike or mu-like configuration and can occur as a single wave-form or in a train with a frequency of 6–11 Hz.
- Wicket spikes occur over the temporal regions during drowsiness or sleep.
- Wicket spikes should not be mistaken for a true epileptogenic spike discharge.

### MITTEN PATTERNS

*Mitten patterns* are seen during sleep and consist of fast-wave and slow-wave components that resemble a mitten, with the thumb of the mitten formed by the last wave of a spindle and the hand portion by the slower wave component. Mittens are a variant of a V wave or K-complex and should not be mistaken for a spike-and-wave discharge.

### Key Point

- Mitten V-wave variants should not be mistaken for spike-and-wave discharges

### BENIGN VARIANTS DURING DROWSINESS AND SLEEP

#### Summary Key Points

- Rhythmic temporal theta bursts of drowsiness
- 14 and 6 Hz positive bursts
- Benign sporadic sleep spikes
- 6-Hz spike and wave
- Wicket spikes
- Mitten V-wave variants

### SUMMARY

In conclusion, this chapter provides an overview of the different types of normal EEG activity and benign variants that are seen in the EEG. One needs to be aware of the normal variability at different ages and different states of wakefulness, drowsiness, and sleep. Dr. Klass has stated that the “detection and interpretation of the EEG data derived from visual analysis involve matters of judgment and experience,

which render clinical EEG an art as much as a science.”<sup>5</sup>

### REFERENCES

1. American Electroencephalography Society. 2006. Guideline 6: A proposal for standard montages to be used in clinical EEG. *Journal of Clinical Neurophysiology* 23:111–17.
2. Fisch, B. J. 1999. *Spehlmann's EEG primer: Principles of digital and analog EEG*. 3rd ed. Amsterdam: Elsevier Science Publishers.
3. Ebersole, J. S., and T. A. Pedley, eds. 2003. *Current practice of clinical electroencephalography*. 3rd ed. Philadelphia: Lippincott Williams & Wilkins.
4. Kasteleijn-Nolst Trenite, D. G., R. Guerrini, C. D. Binne, and P. Genton. 2001. Visual sensitivity and epilepsy: A proposed terminology and classification for clinical and EEG phenomenology. *Epilepsia* 42:692–701.
5. Klass, D. W., and B. F. Westmoreland. 2001. Electroencephalography: General principles and adult EEGs. In *Clinical neurophysiology*, ed. J. R. Daube, 2nd ed., 77–107. London: Oxford University Press.
6. Klass, D. W. 1995. The continuing challenge of artifacts in the EEG. *The American Journal of EEG Technology* 35:239–69.
7. Kellaway, P. 2003. Orderly approach to visual analysis: Characteristics of the normal EEG of adults and children. In *Current practice of clinical electroencephalography*, ed. J. S. Ebersole, and T. A. Pedley, 2nd ed., 100–59. Philadelphia: Lippincott Williams & Wilkins.
8. Tatum IV, W. O., A. M. Husain, S. R. Benbadis, and P. W. Kaplan. 2006. Normal adult EEG and patterns of uncertain significance. *Journal of Clinical Neurophysiology* 23:194–207.
9. Westmoreland, B. F., and D. W. Klass. 1998. Defective alpha reactivity with mental concentration. *Journal of Clinical Neurophysiology* 15:424–28.
10. Klass, D. W., and R. P. Brenner. 1995. Electroencephalography of the elderly. *Journal of Clinical Neurophysiology* 12:116–31.
11. Van Cott, A. C. 2002. Epilepsy and EEG in the elderly. *Epilepsia* 43(Suppl 3):94–102.
12. Reiher, J., and M. Lebel. 1977. Wicket spikes: Clinical correlates of a previously undescribed EEG pattern. *The Canadian Journal of Neurological Sciences* 4:39–47.
13. Westmoreland, B. F. 2003. Benign electroencephalographic variants and patterns of uncertain clinical significance. In *Current practice of clinical electroencephalography*, ed. J. S. Ebersole, and T. A. Pedley, 3rd ed., 235–45. Philadelphia: Lippincott Williams & Wilkins.
14. Westmoreland, B. F., and D. W. Klass. 1981. A distinctive rhythmic EEG discharge of adults. *Electroencephalography and Clinical Neurophysiology* 51:186–91.
15. Cobb, W. A., R. J. Guiloff, and J. Cast. 1979. Breach rhythm. The EEG related to skull defects. *Electroencephalography and Clinical Neurophysiology* 47:251–71.
16. Radhakrishnan, K., D. Chandy, G. Menon, and S. Sarma. 1999. Clinical and electroencephalographic correlates of breach activity. *American Journal of Electroneurodiagnostic Technology* 39:138–47.

# Epileptiform Activity

Joseph F. Dratzkowski

## INTRODUCTION AND OVERVIEW OF EPILEPTIFORM ACTIVITY

### SPECIFIC FOCAL INTERICTAL DISCHARGES

Anterior Temporal and Frontal Spikes  
Occipital Spikes  
Central-Temporal Spikes  
Periodic Lateralized Epileptiform Discharges

### GENERALIZED EPILEPTIFORM PATTERNS

3-Hz Spike and Wave  
Slow Spike and Wave Discharges

Atypical Spike and Wave  
Paroxysmal Rhythmic Fast Activity  
Hypsarrhythmia  
Photoparoxysmal Response  
Temporal Intermittent Rhythmic Delta Activity

### ICTAL DISCHARGES EPILEPTIFORM ACTIVITY WITH A POTENTIAL SEIZURE ASSOCIATION

Stimulus-Induced Rhythmic, Periodic, or Ictal Discharges (SIRPIDS)  
Burst Suppression

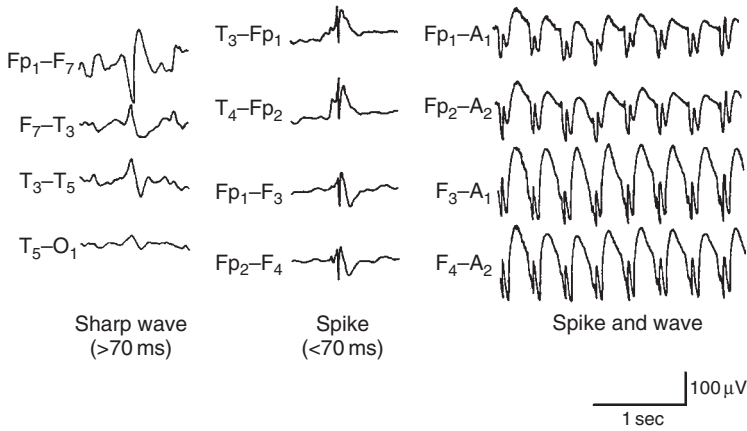
### SUMMARY

## INTRODUCTION AND OVERVIEW OF EPILEPTIFORM ACTIVITY

The concept of defining specific epileptiform abnormalities on routine electroencephalogram (EEG) began decades ago. Epileptiform discharges are paroxysmal waveforms with distinctive morphology that stand out from the ongoing background activity, and typically are recorded from patients with epileptic seizures. Epileptiform activity refers to spike discharges and sharp waves with after-coming slow waves. A *spike discharge* is a waveform that has a duration of less than 70 ms and pointed or sharp morphology with steep ascending and descending limbs. A *sharp wave* is a broader

waveform, which has a pointed peak or sharp morphology but is less sharp than a spike discharge and has a duration of 70–200 ms (Fig. 9–1). A *spike and slow wave complex* consists of a spike followed by an after-coming slow wave.

The routine EEG, performed with the usual activation procedures of sleep, hyperventilation, sleep deprivation, and photic stimulation, is used to assess people with spells or potential seizures, where epilepsy is considered in the differential diagnosis. In patients with epilepsy, interictal epileptiform discharges may be focal, more diffuse, or generalized. While not all abnormal epileptiform discharges have specific clinical correlations, some provide important



**Figure 9-1.** Sharp waves, spike with after-coming slow waves, and generalized spikes and waves.

clues about specific epilepsy or seizure syndromes. However, not all epileptiform activity is necessarily associated with the presence of seizures; and routine EEGs containing unequivocal sharp waves or spikes with after-coming slow waves are present in a small number of people with no history of seizures or epilepsy.<sup>1</sup> Many waveforms have these specific epileptiform features but do not predict seizures or are even considered abnormal.<sup>1,2</sup> The converse situation, where the routine EEG is normal in people with suspected or definite epilepsy despite performing multiple recordings, is more common.<sup>3</sup> Therefore, a normal routine EEG does not rule out the possible presence of epilepsy. Since EEG waveforms having epileptiform characteristics may be normal or abnormal, the electroencephalographer should be aware of both normal variants with epileptiform features and abnormal epileptiform waveforms. Electroencephalographers should be proficient in distinguishing between normal and abnormal recordings and avoid “over interpretation” of normal variants or other epileptiform-like activity as abnormal.<sup>4</sup>

### Key Points

- Epileptiform discharges are paroxysmal waveforms with distinctive morphology that stand out from the ongoing background activity.
- A spike discharge is a waveform with a duration of less than 70 ms and pointed or sharp morphology with steep ascending and descending limbs.

- A sharp wave has a pointed peak or sharp morphology and has a duration of 70–200 ms.
- Epileptiform activity can occur without a seizure disorder, and not all patients with seizures have epileptiform activity between seizures.
- Epileptiform discharges are important clues to specific epilepsy or seizure syndromes.

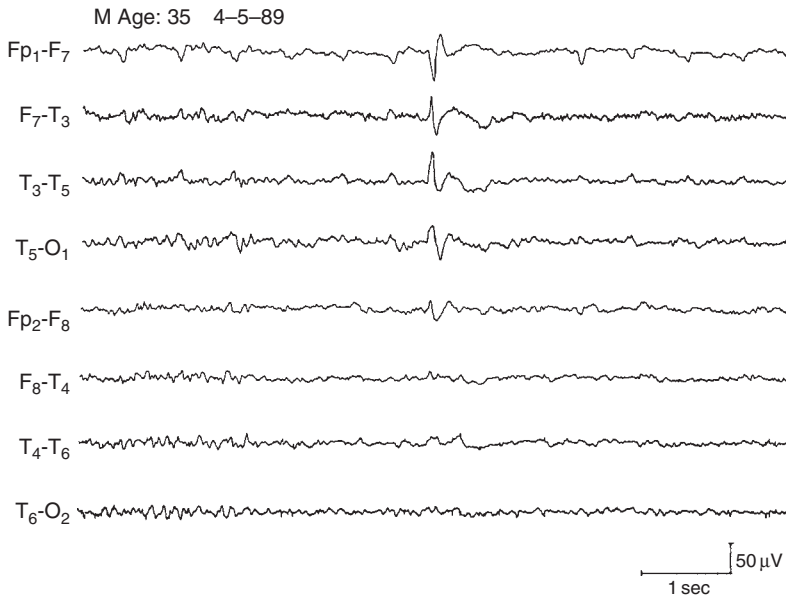
## SPECIFIC FOCAL INTERICTAL DISCHARGES

### Anterior Temporal and Frontal Spikes

Temporal and frontal spike and sharp wave discharges represent an important finding if found in a patient being evaluated for seizures and are highly correlated with seizures. Over 90% of patients with anterior temporal spikes and over 70% of patients with frontal spikes have seizures (Fig. 9-2). During the routine EEG, temporal spikes are activated by slow wave sleep, with a 40%–60% increase in spike occurrence during sleep.<sup>5</sup>

### Key Points

- Temporal and frontal spike and sharp wave discharges are highly correlated with seizures.
- Temporal spikes are activated during slow wave sleep.



**Figure 9-2.** Left temporal spike.

## Occipital Spikes

Occipital spikes are most commonly seen in children. The presence of occipital spikes is associated with seizures in approximately 30%–50% of children between 3 and 6 years of age. The presence of occipital spikes may be associated with a history of visual deprivation, and many children with this finding experience visual abnormalities. If this entity is seen in older children it may be associated with benign occipital epilepsy where the spikes attenuate with eye opening.<sup>6,7</sup> As with other spikes, occipital spikes may be associated with underlying structural lesions.

### Key Points

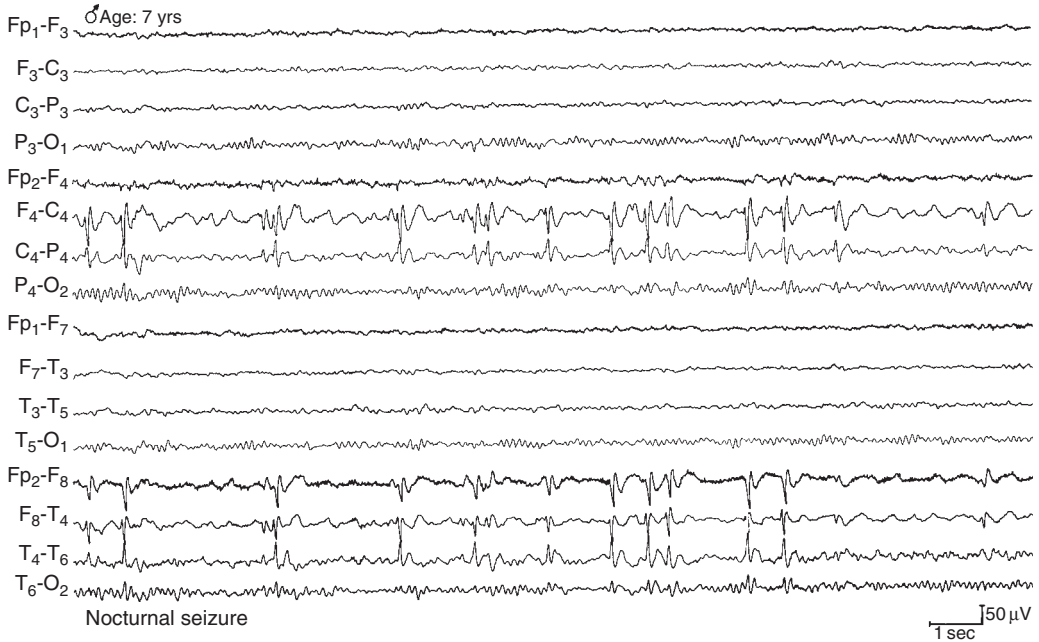
- In 30%–50% of children between 3 and 6 years of age, occipital spikes are associated with seizures.
- In older children, occipital spikes are associated with benign occipital epilepsy and attenuate with eye opening.

## Central-Temporal Spikes

Central-temporal spikes represent important epileptiform discharges, typically occurring in children aged 4–12 years, which are associated with seizures in up to 80% of them.<sup>8</sup> The morphology of these discharges is unique

compared to other epileptiform discharges, as central-temporal spikes have a horizontal dipole in which both ends of the dipole are recorded with standard surface leads. The surface positive end of the dipole is oriented toward the frontal lobe and the negative end of the dipole is mostly oriented toward the central (rolandic) or temporal areas (Fig. 9-3). They are usually of high amplitude and diphasic, with a high amplitude after-coming slow wave. The spikes may be unilateral or bilateral often shifting from one side to another.<sup>9</sup> Their occurrence is often frequent, appearing in trains or short clusters that shift from one hemisphere to the other. The background activity of the EEG is otherwise normal. Like anterior-temporal spikes, central-temporal spikes may be activated by sleep.

The presence of these central-temporal spikes is associated with the clinical condition of benign rolandic epilepsy of childhood (BREC). This disorder is primarily seen in children aged 4–12 years and is characterized by frequent nocturnal seizures, although daytime seizures may also occur. The typical seizure is of focal onset with symptoms referable to the Sylvian area, and includes facial or hand twitching, motor speech arrest, or sensory symptoms involving the upper extremity or face. These discharges are usually not associated with structural lesions. The syndrome, and



**Figure 9-3.** Central-temporal (rolandic) spikes.

EEG abnormalities, often resolves during the second decade of life.

### Key Points

- Central-temporal spikes typically occur in children aged 4–12 years, which are associated with seizures in up to 80% of them.
- Central-temporal spikes have a horizontal dipole in which both ends of the dipole are recorded with standard surface leads.
- The surface positive end of the dipole is oriented toward the frontal lobe and the negative end of the dipole is mostly oriented toward the central (rolandic) or temporal areas.
- The presence of central-temporal spikes is associated with the clinical condition of benign rolandic epilepsy of childhood.

## Periodic Lateralized Epileptiform Discharges

Periodic lateralized epileptiform discharges (PLEDs) are recurring sharp waves that recur with a regular periodicity (Fig. 9-4). The rate of occurrence of the discharges is typically about one every second, but they may be less frequent.<sup>10-12</sup> PLEDs are usually continuous and may be acute or subacute in nature. While

PLEDs often occur in the absence of seizures, occasionally the presence of PLED may be seen with ongoing partial seizures. Correlative motor activity or an evolving ictal pattern on the EEG along with the PLED is suggestive of seizure activity. Distinguishing the presence of seizures is important for therapeutic intervention.<sup>11</sup>

PLEDs are usually indicative of a unilateral hemispheric lesion. The most common and classical etiology is acute ischemic stroke. However, infectious etiologies such as herpes simplex encephalitis can also be an etiology. The term PLED implies laterality, but on occasion independent bilateral PLEDs (BiPLEDs) may be seen in similar patients. The presence of BiPLEDs is associated with infections and epileptic seizures.<sup>12</sup>

### Key Points

- PLEDs are recurring sharp waves that recur with a regular periodicity.
- The rate of occurrence of the discharges is typically about one every second.
- PLEDs are usually indicative of a unilateral hemispheric lesion. The most common and classical etiology is acute ischemic stroke.





**Figure 9-4.** Left periodic lateralized epileptiform discharges (15  $\mu$ V/mm, low-frequency filter 1.0 Hz, high-frequency filter 70 Hz).

## GENERALIZED EPILEPTIFORM PATTERNS

In contrast to focal epileptiform discharges, some epileptiform activity occurs in a generalized distribution. These generalized epileptiform patterns are highly associated with specific epilepsy syndromes.

### 3-Hz Spike and Wave

The 3-Hz spike and wave discharge is seen most commonly in childhood, between the ages of 4 and 14, but may persist later in life. This pattern is characterized by generalized, paroxysmal, high amplitude spike and slow wave complexes recurring at a frequency of 3 Hz (Fig. 9-5). The maximum amplitude of the pattern is seen in the frontal regions. The 3-Hz spike and wave pattern is classically enhanced by hyperventilation and is more prominent during hypoglycemia. The morphology of the discharges changes with sleep, when they become less well formed and more fragmented with shorter bursts during early sleep, with increased occurrence with deeper stages of NREM sleep.<sup>13</sup> Interictal background

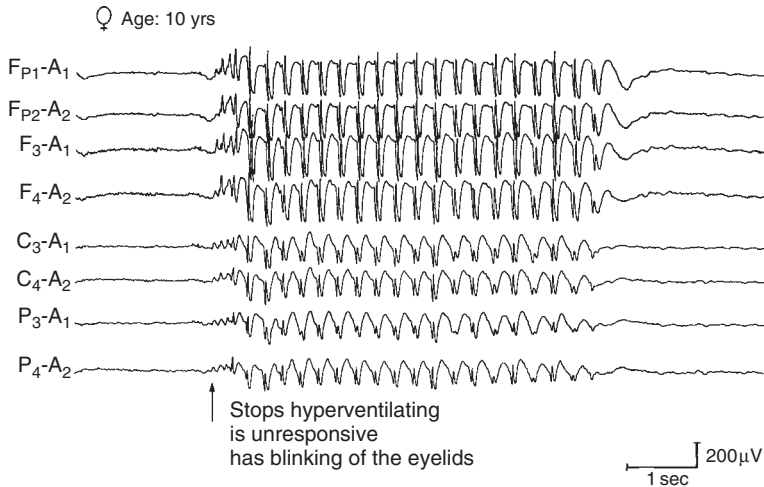
activity is usually normal, no matter the age of the patient.

The 3-Hz spike and wave discharges are associated with *absence seizures*. The duration of these discharges on the routine EEG varies from fractions of a second to many seconds. During brief discharges, clinical accompaniments may not be witnessed. However, when the activity lasts for more than a few seconds, consciousness may be impaired. With longer discharges, other minor clinical signs may be seen and noted by the technologist performing the EEG, including eye blinks or minor motor activity of the face or limbs that may correlate with the 3-Hz spike and wave activity. Ambulatory EEG may help quantify the frequency of the discharges.

#### Key Points

- The 3-Hz spike and wave discharge is seen most commonly in childhood, between the ages of 4 and 14 years
- The 3-Hz spike and wave discharge is characterized by generalized, paroxysmal, high amplitude spike and slow wave complexes recurring at a frequency of 3 Hz.
- The maximum amplitude of the pattern is seen in the frontal regions.





**Figure 9-5.** Generalized 3-Hz spike and wave pattern with frontal predominance.

- The 3-Hz spike and wave pattern is enhanced by hyperventilation and hypoglycemia.
- The morphology of the discharges changes with sleep when they become less well formed and more fragmented with shorter bursts during early sleep.
- The 3-Hz spike and wave discharges are associated with absence seizures.

## Slow Spike and Wave Discharges

The slow spike and wave pattern has important clinical correlations. With this pattern, recurring sharp and slow wave discharges fire repetitively at a frequency of 1.5–2.5 Hz, which is distinctly slower than the more classic 3-Hz spike and slow wave activity. The spike has a slightly longer duration than typical 3-Hz spike and wave complexes and has more of a sharp wave morphology<sup>14</sup> (Fig. 9–6). In contrast to the normal inter-burst background activity with 3-Hz spike and wave discharges, the background activity of slow spike and wave discharges is usually abnormal with diffuse slowing.

Slow spike and wave pattern is seen mostly in children between the ages of 2 and 6, but may persist into adolescence.<sup>14–16</sup> Multiple generalized seizure types are associated with this discharge, including tonic–clonic, akinetic, and myoclonic. This epileptiform pattern typically

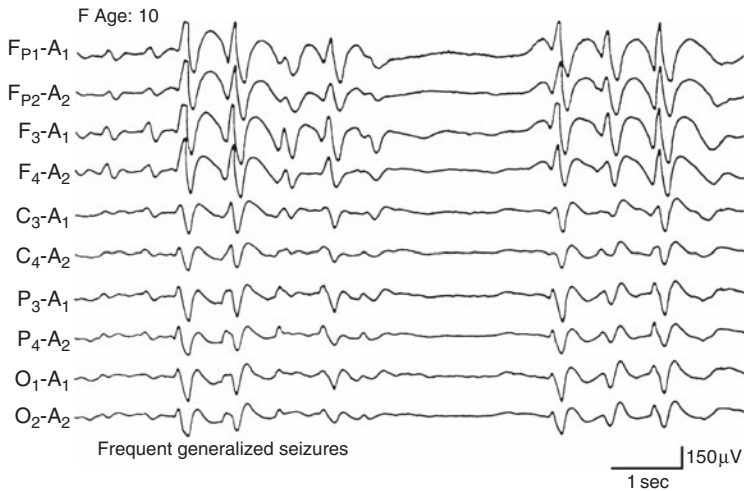
occurs in patients with a variety of underlying pathologies. In young children it is associated with the Lennox–Gastaut syndrome—a syndrome of intractable seizures, developmental delay with motor dysfunction, and poor response to anti-seizure medications.<sup>15,17</sup>

### Key Points

- The slow spike and wave pattern has characteristic recurring sharp and slow wave discharges firing repetitively at a frequency of 1.5–2.5 Hz.
- The background activity of slow spike and wave discharges is usually abnormal with diffuse slowing.
- Multiple generalized seizure types are associated with this discharge, including tonic–clonic, akinetic, and myoclonic.
- In young children it is associated with the Lennox–Gastaut syndrome.

## Atypical Spike and Wave

The so-called *atypical spike and wave discharges* are another example of a generalized epileptiform discharge. The spike and wave discharges occur in a more irregular nonrhythmic interval as compared to the classic 3-Hz spike and wave activity. Atypical spike and wave bursts may consist of both spike or polyspike and slow waves with frequencies in the 2–5 Hz



**Figure 9-6.** Slow spike and wave pattern.

range. These discharges may occur in relatively short bursts (1–3 seconds) when they occur between seizures or may be a part of an ictal pattern associated with various types of generalized seizures, especially tonic–clonic and myoclonic seizures. Like most forms of generalized spike and wave discharges, atypical spike and wave activity may be activated by sleep or photic stimulation. The pattern may be seen in both children and adults.

### Key Points

- Atypical spike and wave discharges have an irregular interval and vary from 2 to 5 Hz.
- The atypical spike and wave pattern is associated with various forms of generalized seizures.

### Paroxysmal Rhythmic Fast Activity

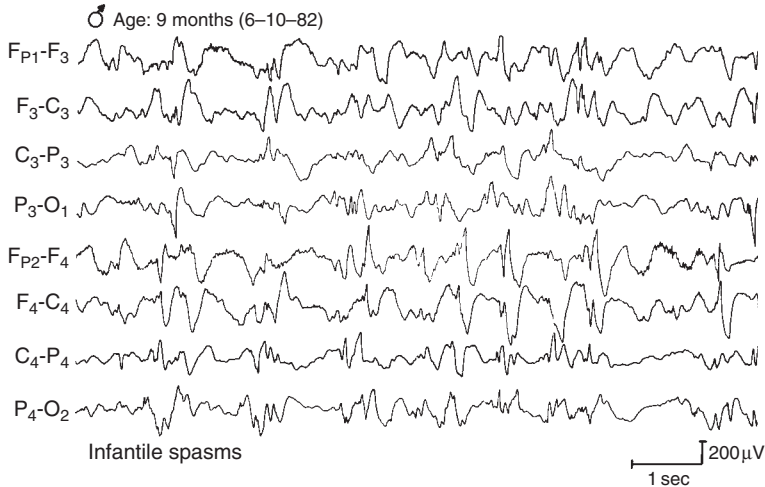
This unique activity consists of repetitive spike discharges ranging from 12 to 20 Hz and occurs in the parasagittal regions. It may appear synchronous but may be asymmetrical as well and is often seen during sleep. Toward the end of the discharge, which may be brief in duration, one or more slow waves may be seen. The occurrence of these waveforms has been associated with tonic or tonic–clonic seizures.<sup>15</sup>

### Key Points

- Paroxysmal rhythmic fast activity is a 12–20 Hz repetitive spike discharge that occurs in the parasagittal region, usually during sleep that is associated with tonic or tonic–clonic seizures.

### Hypsarrhythmia

Hypsarrhythmia is an epileptiform pattern with features of high amplitude, virtually continuous mix of arrhythmic slowing, and multifocal sharp waves and spikes (Fig. 9-7). This activity is usually seen in epilepsy patients aged between 4 months and 4 years, who often have infantile spasms.<sup>19</sup> If the EEG is performed during the infantile spasms, the clinical seizure is associated with an *electrodecremental* pattern in which there is a sudden suppression of virtually all activity on the EEG.<sup>20</sup> The combination of infantile spasm, developmental delay, and hypsarrhythmia is West syndrome. No one specific disease causes the syndrome and the pattern is felt to be the result of significant cerebral insult that usually occurred before the age of one year. Tuberous sclerosis is one of the more common causes of the disorder and is often associated with very difficult to control seizures. Other metabolic or infectious etiologies account for one third of the cases, and in approximately one third of the cases a cause is never found.



**Figure 9-7.** Hypsarrhythmia with high amplitude discharges.

### Key Points

- Hypsarrhythmia is an epileptiform pattern with features of high amplitude, virtually continuous mix of arrhythmic slowing, and multifocal sharp waves and spikes.
- Hypsarrhythmia is seen in patients aged between 4 months and 4 years, who often have infantile spasms.
- If the EEG is performed during the infantile spasms, the clinical seizure is associated with an electrodecremental pattern on EEG.
- The combination of infantile spasm, developmental delay, and hypsarrhythmia is West syndrome.

### Photoparoxysmal Response

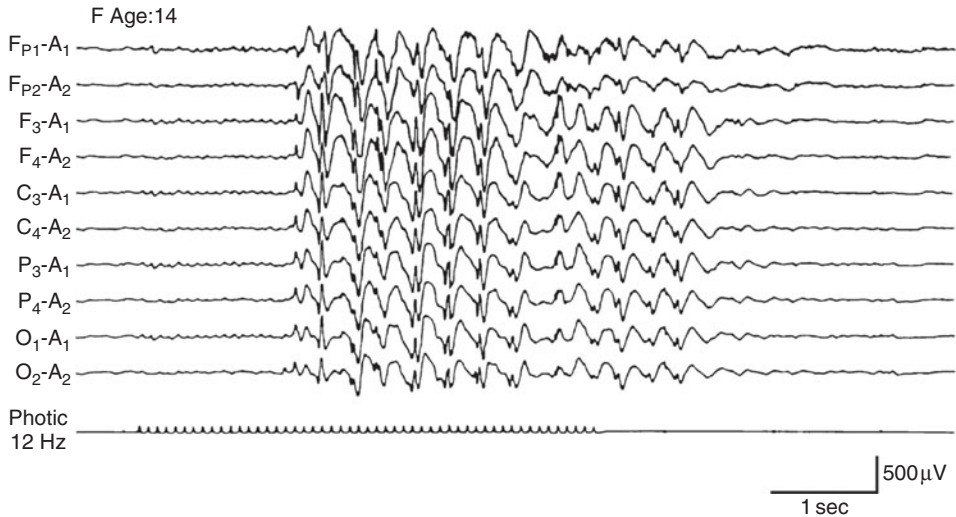
Abnormal epileptiform activity in response to strobe light stimulation is a well-known entity. The light is typically flashed at frequencies of 1–30 Hz, with abnormal activity mostly seen at stimulus rates between 15 and 25 Hz. The activity is usually seen as a bilateral generalized synchronous spike (frontal predominant) or polyspike (posterior predominant) and slow wave discharges or rarely as a focal occipital discharge (Fig. 9-8).<sup>21</sup> The discharges may be self-limited and end with discontinuation of the stimulus or may persist after the strobe is turned off (*photoconvulsive response*). If the strobe light is not turned off when the epileptiform activity is present, a seizure may be

precipitated. These discharges should not be confused with the photomyogenic response in which repetitive contractions of facial or other muscles are time-locked to the frequency of the strobe light.

Photoparoxysmal discharges are often associated with clinical seizures, most commonly the generalized epilepsies, including juvenile myoclonic epilepsy, childhood absence epilepsy, and the West and Lennox–Gastaut syndromes. There is a slight female predominance for the photoparoxysmal abnormality.<sup>22</sup> Although poorly understood, there appears to be a hereditary photosensitivity that may appear in asymptomatic siblings of affected individuals, especially females.<sup>22–24</sup>

### Key Points

- Photoparoxysmal activity is abnormal epileptiform activity that occurs in response to strobe light stimulation.
- The activity is usually seen as a bilateral generalized synchronous spike (frontal predominant) or polyspike (posterior predominant) and slow wave discharges or rarely as a focal occipital discharge.
- Photoparoxysmal activity is mostly seen at stimulus rates between 15 and 25 Hz.
- The discharges may be self-limited and end with discontinuation of the stimulus or may persist after the strobe is turned off (*photoconvulsive response*).
- Photoparoxysmal discharges are often associated with clinical seizures.



**Figure 9-8.** Photoparoxysmal response with discharges that persist beyond stimulus termination.

## Temporal Intermittent Rhythmic Delta Activity

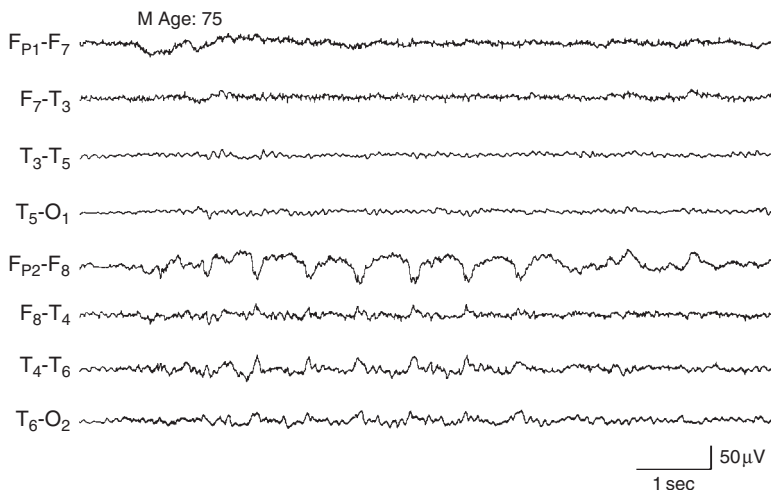
Temporal intermittent rhythmic delta activity (TIRDA) is an uncommon finding that is seen in approximately 0.3% of all EEGs. TIRDA usually occurs during drowsiness and light sleep. The presence of this activity is often seen in patients being evaluated for temporal lobe resection and has a high predictive value for temporal lobe epilepsy.<sup>25,26</sup> The lack of spike or sharp activity is likely a reflection of a deep focus in the temporal lobe that is seen slowing in a routine EEG using scalp electrodes (Fig. 9-9).

### Key Points

- TIRDA is a pattern that occurs during drowsiness or light sleep and likely reflects a deep focus in the temporal lobe.

## ICTAL DISCHARGES

It is uncommon to record ictal activity during routine EEGs utilizing surface electrodes in the EEG lab or at the bedside. Seizures recorded on an EEG are more typically captured with extended recordings, such as ambulatory devices or in an epilepsy monitoring unit.



**Figure 9-9.** Temporal intermittent rhythmic delta activity.

Ictal discharges have many frequencies, locations, and morphologies. Ictal discharges may occur at any EEG waveform frequency (beta, alpha, theta, or delta) and the morphology can range from sharp waves to spike and slow wave or any combination of morphologies. Ictal abnormalities may also be focal or generalized.

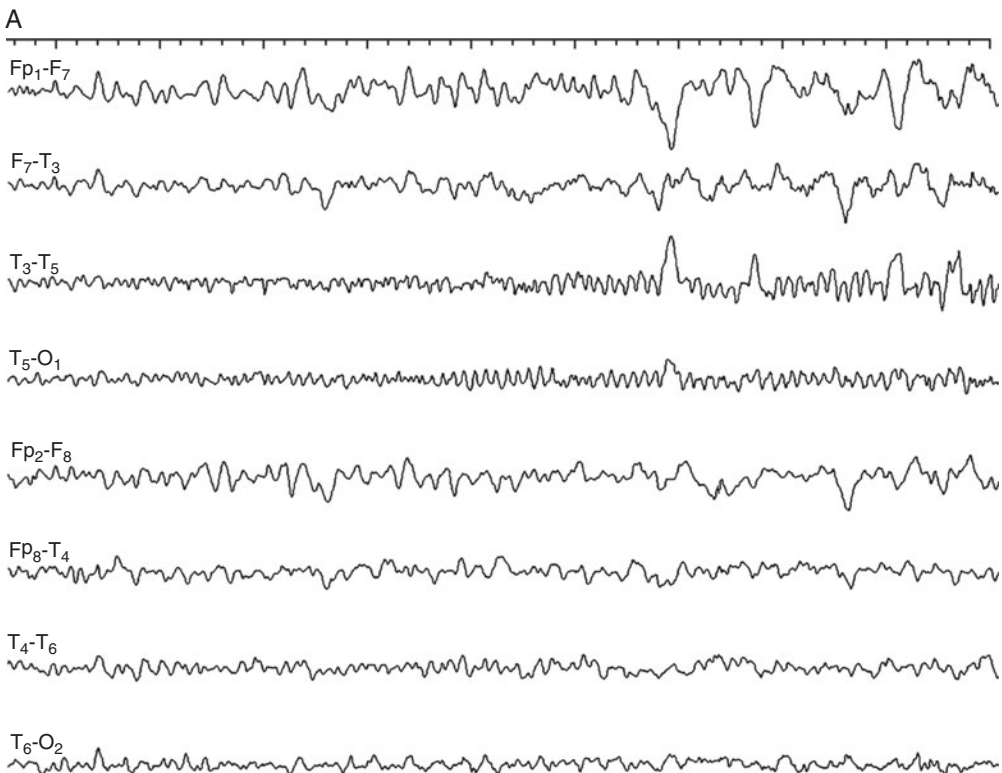
The ictal activity may begin as a certain pattern and remain constant or more likely evolve as the seizure progresses. The changing or evolving pattern may be manifest by changing amplitudes (increased or decreased), frequencies, or both. Partial seizures begin focally and either stay localized or spread to become generalized. Post-ictal slowing and suppression is common and may be focal in a partial seizure or generalized in a primary or secondary generalized seizure. Focal post-ictal slowing may have localizing value. Figure 9–10 depicts a partial seizure that evolves and spreads to other regions. Although the EEG is very good in recording epileptiform activity during a clinical seizure, 5% or less of all complex partial seizures show no ictal activity on EEGs utilizing scalp recording electrodes.<sup>27</sup> This lack

of activity using scalp electrodes during a partial seizure is particularly common when seizure foci are located in the midline or deep within the frontal lobe.

Status epilepticus is defined as continuous or frequently recurring seizures that may be partial or generalized and convulsive or non-convulsive. Figure 9–11 shows a continuous, generalized spike discharge in a patient with nonconvulsive status. The discharges would be the same with an ongoing clinical seizure.

### Key Points

- Seizures recorded on an EEG are more typically captured with extended recordings, such as ambulatory devices or in an epilepsy monitoring unit.
- Ictal discharges have many frequencies, locations, and morphologies.
- Ictal abnormalities may also be focal or generalized.
- The ictal activity may begin as a certain pattern and remain constant, or more likely evolve as the seizure progresses.



**Figure 9–10.** Evolving left central seizure. A. Initiation at T5–O1 (left posterior temporal). B. Spread of rhythmic, ictal activity to entire left temporal region with head turning.



B

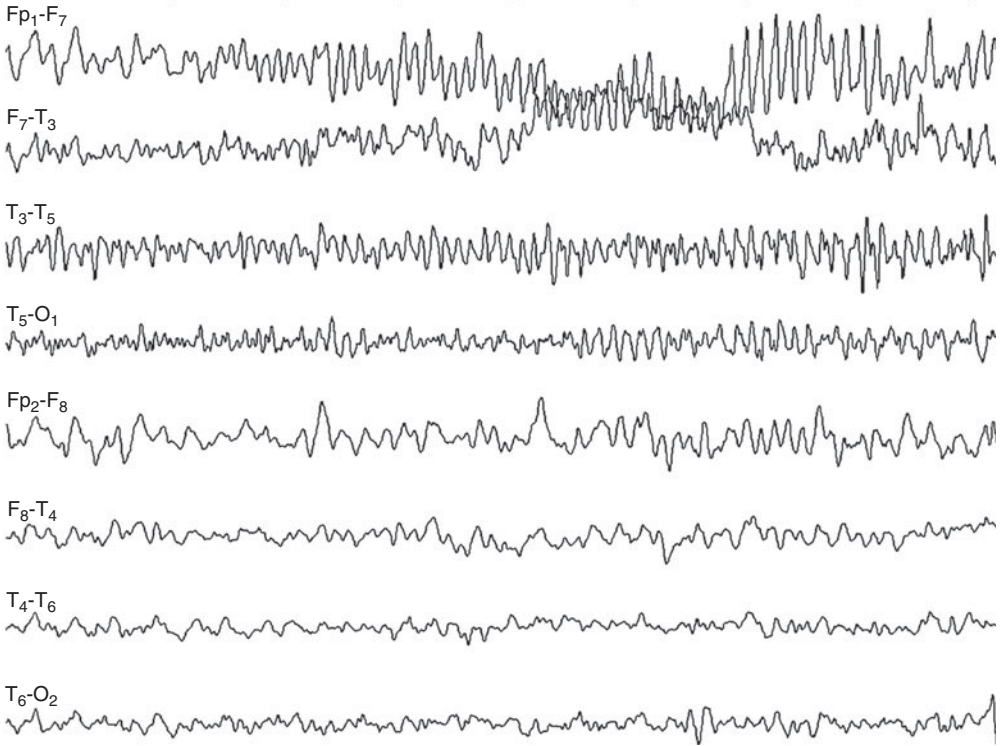


Figure 9-10. (Continued).

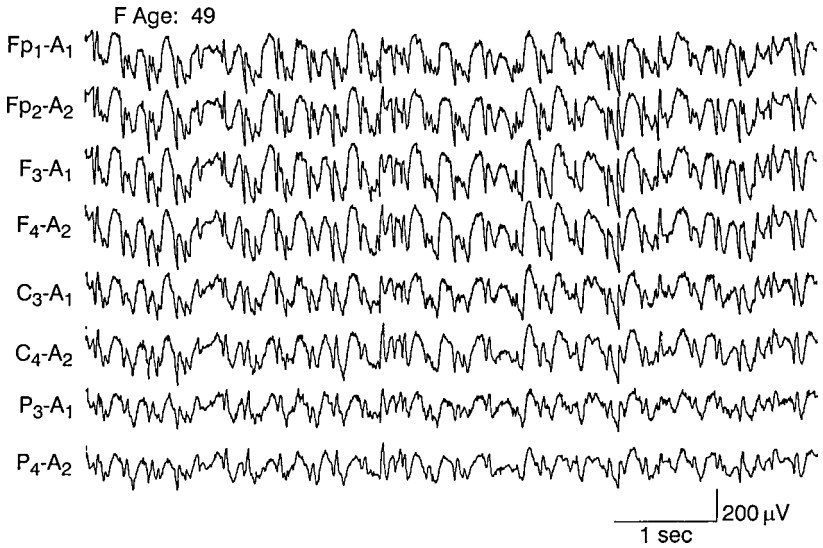


Figure 9-11. Continuous spike and wave activity in generalized status epilepticus.

## EPILEPTIFORM ACTIVITY WITH A POTENTIAL SEIZURE ASSOCIATION

### Stimulus-Induced Rhythmic, Periodic, or Ictal Discharges (SIRPIDS)

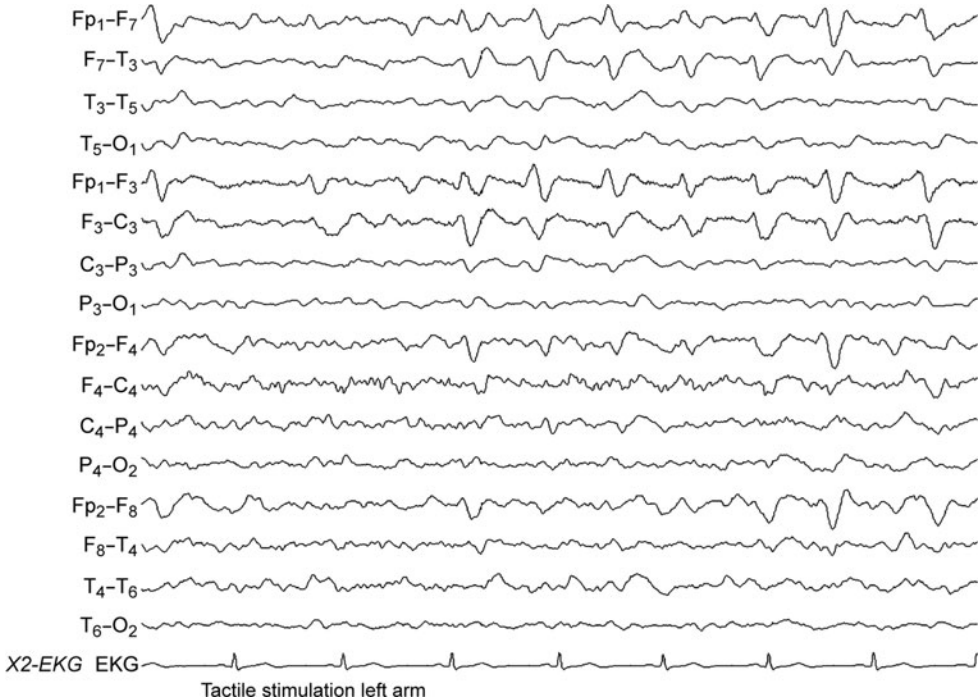
Stimulus-induced rhythmic, periodic, or ictal discharges (SIRPIDS) are discharges that are typically seen during long-term trending in the intensive care unit setting. This pattern is comprised of rhythmic, periodic, or ictal appearing discharges that are consistently induced by some type of alerting stimuli (Fig. 9–12). The pattern has been associated with status epilepticus. The observation of these waveforms is largely a product of the advances in equipment and recording capabilities that have permitted long-term recordings. The study of this type of epileptiform activity and its potential clinical correlation is ongoing.<sup>28</sup>

### Key Points

- SIRPIDS are discharges that are typically seen during long-term trending in the intensive care unit setting.
- This pattern is comprised of rhythmic, periodic, or ictal appearing discharges that are consistently induced by some type of alerting stimuli and is associated with status epilepticus.

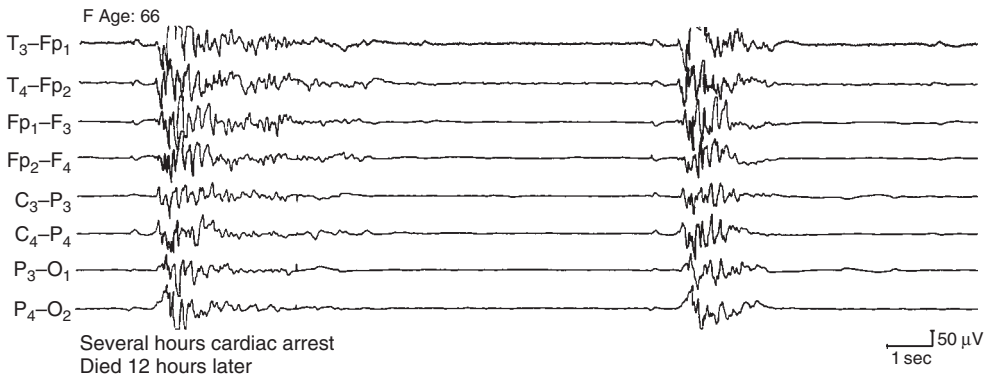
### Burst Suppression

The burst suppression pattern is characterized by intermittent bursts of paroxysmal sharp and slow activity or an admixture of various frequencies separated by periods of absent or relatively quiescent EEG activity (Fig. 9–13). The bursts generally last from less than a second to several seconds with relative quiescent periods lasting variable lengths of time, usually 4–10 seconds in length. Etiologies that produce this pattern include ongoing end-stage seizures, hypothermia, medication effect (particularly



**Figure 9–12.** SIRPIDS activated by a noxious sternal rub. (From Hirsch, L. J., J. Claassen, S. A. Mayer, and R. G. Emerson. 2004. Stimulus-induced rhythmic, periodic, or ictal discharges (SIRPIDS): A common EEG phenomenon in the critically ill. *Epilepsia* 45:109–23. By permission of Blackwell Publishing.)





**Figure 9-13.** Burst suppression pattern  $7\ \mu\text{V}/\text{mm}$ ; LFF, low-frequency filter 1.0 Hz; HFF, high-frequency filter 70 Hz, 10 mm/sec.

during anesthesia or drug overdose), and post anoxic/hypoxic insult.<sup>29-33</sup> The usefulness of using ongoing monitoring of the burst suppression pattern during surgery for depth of anesthesia has recently been questioned.<sup>34</sup>

### Key Points

- Burst suppression pattern is characterized by intermittent bursts of paroxysmal sharp and slow activity or an admixture of various frequencies separated by periods of absent or relatively quiescent EEG activity.
- Etiologies that produce burst suppression pattern include ongoing end-stage seizures, hypothermia, anesthesia, or drug overdose, and post anoxic/hypoxic insult.

### SUMMARY

EEG continues to be an important test to functionally evaluate people with suspected seizures. Although few specific EEG patterns exist for specific diseases, the presence of epileptiform discharges and patterns on the EEG may help identify certain syndromes. Clinicians using EEG in the evaluation and management of people with suspected epilepsy should be familiar with the different epileptiform discharges and their associated clinical significance.

### REFERENCES

1. Petersén, I., O. Eeg-Olofsson, and U. Sellén. 1968. Paroxysmal activity in EEG of normal children. In *Clinical electroencephalography of children*, ed. P. Kelaway, and I. Petersén, 167-88. New York: Grune & Stratton.
2. Eeg-Olofsson, O., I. Petersén, and U. Sellén. 1971. The development of the electroencephalogram in normal children from the age of one through fifteen years. Paroxysmal activity. *Neuropädiatrie* 4:375-404.
3. Draskowski, J., and D. Blum. 1998. Electroencephalography and evoked potential studies. In *Adult neurology*, ed. J. Corey-Bloom, 2nd ed., 15-33. Mosby, St. Louis, MO: Blackwell.
4. Benbadis, S. R., and W. O. Tatum. 2003. Overinterpretation of EEGs and misdiagnosis of epilepsy. *Journal of Clinical Neurophysiology* 20:42-4.
5. Klass, D. W. 1975. Electroencephalographic manifestations of complex partial seizures. *Advances in Neurology* 11:113-40.
6. Kivity, S., T. Ephraim, R. Weitz, and A. Tamir. 2000. Childhood epilepsy with occipital paroxysms: Clinical variants in 134 patients. *Epilepsia* 41:1522-33.
7. Niedermeyer, E., and F. Lopes da Silva, eds. 1999. *Electroencephalography: Basic principles, clinical applications, and related fields*, 4th ed. Baltimore: Williams & Wilkins.
8. Lombroso, C. T. 1967. Sylvian seizures and midtemporal spike foci in children. *Archives of Neurology* 17:52-9.
9. Kellaway, P. 2000. The electroencephalographic features of benign centrotemporal (rolandic) epilepsy of childhood. *Epilepsia* 41:1503-6.
10. Chatrian, G. E., C. M. Shaw, and C. N. Luttrell. 1965. Focal electroencephalographic seizure discharges in acute cerebral infarction. Electrographic, clinical, and pathological observations. *Neurology* 15:123-31.
11. Chatrian, G. E., C. M. Shaw, and F. Plum. 1964. Focal periodic slow transients in epilepsy partialis continua: Clinical and pathological correlations in two cases. *Electroencephalography and Clinical Neurophysiology* 16:387-93.
12. Chatrian, G. E., C. M. Shaw, and H. Leffman. 1964. The significance of periodic lateralized epileptiform discharges in EEG: An electrographic, clinical and pathological study. *Electroencephalography and Clinical Neurophysiology* 17:177-93.
13. Dalby, M. A. 1969. Epilepsy and 3 per second spike and wave rhythms. A clinical, electroencephalographic

- and prognostic analysis of 346 patients. *Acta Neurologica Scandinavica* 40(Suppl):3.
14. Blume, W. T., R. B. David, and M. R. Gomez. 1973. Generalized sharp and slow wave complexes. Associated clinical features and long-term follow-up. *Brain* 96:289–306.
  15. Markand, O. N. 1977. Slow spike-wave activity in EEG and associated clinical features: Often called “Lennox” or “Lennox–Gastaut” syndrome. *Neurology* 27:746–57.
  16. Daly, D. D. 1979. Use of the EEG for diagnosis and evaluation of epileptic seizures and nonepileptic episodic disorders. In *Current practices of clinical electroencephalography*, ed. D. W. Klass, and D. D. Daly, 221–68. New York: Raven Press.
  17. Gastaut, H., J. Roger, R. Soulayrol, et al. 1966. Childhood epileptic encephalopathy with diffuse slow spike-waves (otherwise known as “petit mal variant”) or Lennox syndrome. *Epilepsia* 7:139–79.
  18. Westmoreland, B. F., and D. W. Klass. 1990. Unusual EEG patterns. *Journal of Clinical Neurophysiology* 7:209–28.
  19. Jeavons, P. M., and B. D. Bower. 1974. Infantile spasms. In *Handbook of clinical neurology: The epilepsies*, ed. P. J. Vinken, and G. W. Bruyn, Vol. 15, 219–34. Amsterdam: North-Holland Publishing Company.
  20. Bickford, R. G., and D. Klass. 1969. Scalp and depth electrographic studies of electro-decremental seizures (abstract). *Electroencephalography and Clinical Neurophysiology* 12:638.
  21. Sunku, A. J., M. R. Gomez, and D. W. Klass. 1998. Epileptic seizures, EEG abnormalities, and neuronal heterotopia in the Dubowitz syndrome. *American Journal of Electroencephalographic Technology* 38:156–63.
  22. Wolf, P., and R. Goosses. 1986. Relation of photosensitivity to epileptic syndromes. *Journal of Neurology, Neurosurgery, and Psychiatry* 49:1386–91.
  23. Doose, H. 1982. Photosensitivity: Genetics and significance in the pathogenesis of epilepsy. In *Genetic basis of the epilepsies*, ed. V. E. Anderson, W. A. Hauser, J. K. Penry, and C. R. Sing, 113–21. New York: Raven Press.
  24. Newmark, M. E., and J. K. Penry. 1979. *Photosensitivity and epilepsy: A review*. New York: Raven Press.
  25. Geyer, J. D., E. Bilir, R. E. Faught, R. Kuzniecky, and F. Gilliam. 1999. Significance of interictal temporal lobe delta activity for localization of the primary epileptogenic region. *Neurology* 52:202–5.
  26. Normand, M. M., Z. K. Wszolek, and D.W. Klass. 1995. Temporal intermittent rhythmic delta activity in electroencephalograms. *Journal of Clinical Neurophysiology* 12:280–4.
  27. Gastaut, H., and R. Broughton. 1972. *Epileptic seizures*. Springfield, Illinois: Thomas.
  28. Hirsch, L. J., J. Claassen, S. A. Mayer, and R.G. Emerson. 2004. Stimulus-induced rhythmic, periodic, or ictal discharges (SIRPIDs): A common EEG phenomenon in the critically ill. *Epilepsia* 45: 109–23.
  29. Treiman, D. M. 1995. Electroclinical features of status epilepticus. *Journal of Clinical Neurophysiology* 12:343–62.
  30. Bird, T. D., and F. Plum. 1968. Recovery from barbiturate overdose coma with a prolonged isoelectric electroencephalogram. *Neurology* 18:456–60.
  31. Haider, I., H. Matthew, and I. Oswald. 1971. Electroencephalographic changes in acute drug poisoning. *Electroencephalography and Clinical Neurophysiology* 30:23–31.
  32. Silverman, D. 1975. The electroencephalogram in anoxic coma. In *Altered states of consciousness, coma and cerebral death*. *Handbook of electroencephalography*, ed. A. Rémond, Vol. 12, 81–94. Amsterdam: Elsevier.
  33. Martin, J. T., A. Faulconer, Jr., and R. G. Bickford. 1959. Electroencephalography in anesthesiology. *Anesthesiology* 20:359–76.
  34. Fabregas, N., and C. Gomar. 2001. Monitoring in neuroanaesthesia: Update of clinical usefulness. *European Journal of Anaesthesiology* 18(7):423–39.

# Adult EEG: Abnormal Nonepileptiform Activity

Barbara F. Westmoreland

## INTRODUCTION

### TYPES OF EEG ABNORMALITIES

Slow-Wave Abnormalities

Asymmetry

Asymmetric or Altered Reactivity

Suppression

Epileptiform Activity

Periodic Patterns

### FOCAL INTRACRANIAL

#### PROCESSES CAUSING EEG ABNORMALITIES

The EEG in Focal Intracranial Lesions

Cerebral Infarction

Intracerebral Hemorrhage

Arteriovenous Malformations

Tumors

Head Trauma

Subdural Hematoma

Inflammatory Disorders

Herpes Simplex Encephalitis

Other Focal Cerebral Lesions

Transient Disorders

### ELECTROENCEPHALOGRAPHIC MANIFESTATIONS OF DIFFUSE DISORDERS

Slow-Wave Abnormalities

Specific Patterns

Generalized Periodic Patterns

Coma Patterns

### EVALUATION FOR SUSPECTED BRAIN DEATH CONCLUSION

## INTRODUCTION

Electroencephalography (EEG) is a clinical neurophysiology test that assesses the function of the brain. Neuroimaging studies look at the structure of the brain, but the EEG can give evidence of normal or altered function of the brain and evolution of a disease process that may not be apparent on neuroimaging studies. The EEG is useful for evaluation of cerebral function and can help determine whether there is a focal vs. diffuse process, the site and extent of the

lesion or disease process, and the degree of the disturbance of function. In a patient with altered consciousness, the EEG can confirm an organic disturbance of function, help make the diagnosis, and help determine the prognosis.

The most common referrals for EEGs are seizure disorders (discussed in Chapter 9), focal lesions, encephalopathies, and alteration of consciousness.

This chapter will review the types of EEG abnormalities in focal lesions, diffuse disorders, and brain death.

## TYPES OF EEG ABNORMALITIES

The EEG is one measure or parameter of brain function or dysfunction, and anything causing a disturbance of cerebral function can cause changes in the EEG. There are certain common ways in which lesions or disease processes can affect the EEG, and the main types of abnormalities that are seen with cerebral lesions are slowing, asymmetry, altered reactivity, suppression, epileptiform activity, and periodic patterns.

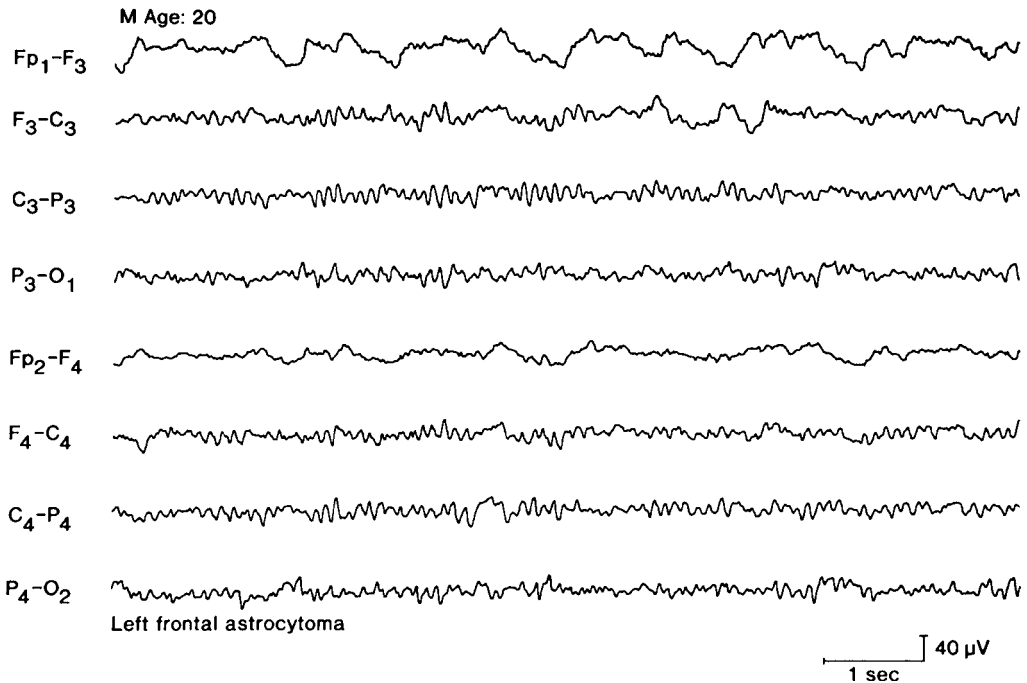
### Slow-Wave Abnormalities

The slower the frequency, the more severe the abnormality. A slowing of the alpha frequency reflects a mild abnormality, theta slowing reflects a moderate abnormality, and delta slowing a more severe abnormality.

Polymorphic and arrhythmic delta slowing, which persists throughout the tracing and shows little or no reactivity to afferent stimulation, usually indicates a disturbance of cerebral function (Fig. 10-1). Lesions primarily

involving the subcortical white matter usually cause the delta slowing seen on the EEG.<sup>1-4</sup>

Another type of slowing consists of intermittent rhythmic and bilaterally synchronous slow-wave activity which shows reactivity or is attenuated to eye opening or alerting stimuli. When present or maximal over the frontal head regions, this is referred to as FIRDA (*Frontal Intermittent Rhythmic Delta Activity*). When present over the posterior head regions, this is referred to as OIRDA (*Occipital Intermittent Rhythmic Delta Activity*). This type of slowing is often seen with diffuse encephalopathies, particularly in metabolic or toxic encephalopathies.<sup>5,6</sup> FIRDA or OIRDA can also be seen as a disturbance of function arising at a distance from more deep-seated structures such as the diencephalon and periventricular structures. Since this is projected to the surface, this has been referred to as a *projected rhythm*. The projected rhythm can occur as a result of a primary lesion affecting midline structures, a shift or distortion of midline structures from a mass lesion, increased intraventricular pressure, or obstruction of ventricular flow.<sup>1-3,5</sup>



**Figure 10-1.** Electroencephalogram from a 20-year-old man with a left frontal astrocytoma showing persistent polymorphic delta activity predominantly in the left frontal region (Fp1).

**Key Points**

- Slower frequencies are seen with more severe abnormalities.
- Polymorphic delta slowing reflects a disturbance of cerebral function.
- Intermittent rhythmic delta slowing is seen with encephalopathies, more deep-seated lesions, and increased intraventricular pressure.

**Asymmetry**

Asymmetry refers to an amplitude difference in similar activity which may be increased or decreased on the side of the lesion as compared to homologous regions on the opposite side. An additional abnormality such as slowing, in addition to the asymmetry, is helpful in lateralizing the side of the abnormality. A skull defect may be associated with a focal increase in the amplitude of activity in the region of the skull defect. This has been termed a *breach rhythm*.<sup>7,8</sup> An amplitude difference between sides due to suppression is not referred to as an asymmetry.

**Key Points**

- Asymmetry is an increase or decrease in the amplitude of activity on one side.
- A breach rhythm is a focal increase in the amplitude of activity over a skull defect.

**Asymmetric or Altered Reactivity**

There may be a focal or lateralized alteration in the reactivity of EEG activity on one side. This can be seen with the alpha rhythm, photic driving, and hyperventilation. If there is a failure of alpha activity or rhythm to attenuate on one side, the side that fails to attenuate is the abnormal side. This may occur with eye opening or mental alerting procedures.<sup>9</sup> An altered or asymmetric photic driving response is most commonly seen with lesions affecting the occipital lobe and in which the photic driving is usually decreased or absent on the side of the lesion. On rare occasions, it may be increased on the side of the lesion. Hyperventilation may elicit or accentuate focal or lateralized slowing or an asymmetry of background activity. The changes may persist on the

abnormal side following cessation of hyperventilation.<sup>3</sup>

**Key Points**

- Asymmetric reactivity can occur with failure of alpha activity to attenuate on one side.
- An asymmetric driving response is seen with occipital lesions.
- Hyperventilation may accentuate or elicit focal slowing or an asymmetry on one side.

**Suppression**

Suppression refers to both a decrease in amplitude and amount, or an absence of activity. While often generalized, it may occur in a focal or lateralized distribution. Suppression is graded mild, moderate or severe with the latter showing essentially no activity.

**Key Point**

- Suppression refers to a decrease in amplitude and amount of activity.

**Epileptiform Activity**

Epileptiform activity can be present with spikes, sharp waves, periodic lateralized epileptiform discharges (PLEDs), or seizure discharges, which can occur focally in the vicinity of the lesion or in a more generalized distribution.<sup>3-5</sup> The most epileptogenic areas of the brain are the temporal and frontal lobes, and lesions involving these regions are more likely to be accompanied by epileptiform abnormalities and seizures.

**Key Points**

- Epileptiform activity may be focal or generalized.
- The most epileptogenic areas of the brain are the temporal and frontal regions.

**Periodic Patterns**

Generalized periodic patterns or waveforms consisting of triphasic waves, sharp waves, slow-wave complexes, and epileptiform discharges may be seen with various disorders

of cerebral function.<sup>3-5,10</sup> More focal periodic waveforms can occur as with PLEDs.<sup>3,10,11</sup>

### Key Points

- Generalized periodic patterns may be seen with disorders of cerebral dysfunction
- Periodic patterns include triphasic waves, sharp waves, slow-wave complexes, and epileptiform discharges

## FOCAL INTRACRANIAL PROCESSES CAUSING EEG ABNORMALITIES

### The EEG in Focal Intracranial Lesions

The EEG is one measure or parameter of brain function or dysfunction, and lesions causing a disturbance of cerebral function can cause changes in the EEG. The degree and severity of the EEG abnormalities depend on a number of factors, which include location, size, and type of lesion. Also, the stage of evolution and rapidity of evolution of the lesion determine the severity of the abnormal findings in the EEG. Other factors that play a role in the degree of EEG findings include medications, seizures, postictal state, skull defect, and other systemic processes. The state of the patient, whether awake or asleep, level of consciousness, and the age (child or adult) are also factors determining the degree of EEG abnormalities.<sup>12</sup>

### Purpose and Role of EEG in Focal Intracranial Processes

- Indicating the presence of a focal lesion.
- Indicating the presence of focal epileptiform activity.
- Following the patient's clinical course.
- Determining whether the lesion is resolving, static, or progressing.

The most common cerebral lesions are vascular lesions and tumors. Other lesions include head trauma, infectious lesions, and other types of focal pathology involving the cerebral hemispheres.<sup>3-5</sup>

### Key Points

- The most common focal cerebral lesions are vascular lesions and tumors.
- The degree of the EEG abnormality depends on various factors including location, type, and evolution of lesion, the presence of clinical seizures, the presence of skull defect, the state and age of the patient, and other concomitant systemic processes.

## Cerebral Infarction

During the acute phase, the EEG often shows focal delta slowing over the involved area and a decrease in background activity.<sup>3-5</sup> During the first few days, the EEG abnormalities may become worse secondary to the effects of local edema and vasospasm. At times more widespread slowing can also be seen in addition to the more focal abnormalities. After a few days, the EEG usually improves with a return of faster frequencies and more normal background components. In some patients, the EEG will become normal after an infarct even though there may be a persistence of a neurologic deficit. In other cases, there may be some persistence of slow-wave abnormalities or asymmetry of activity. If the infarct involves more deep-seated structures such as the internal capsule, the EEG shows minimal or little change even though the patient may have a severe neurologic deficit.

On occasion, an acute epileptic focus develops within a few hours or days after an acute cerebral infarct. This usually consists of PLEDs on the EEG, which are frequently associated with seizures, a neurologic deficit, and obtundation of the patient. The clinical manifestations and PLEDs usually improve or resolve after a few days to a couple of weeks after the acute onset.<sup>3,11,13</sup>

### Key Points

- During an acute infarction, the EEG shows focal slowing and a decrease in the background activity.
- The EEG usually improves after a few days.
- There may be little change in the EEG with more deep-seated infarcts.
- On occasions, PLEDs and seizures may be seen following an acute vascular insult.



## Intracerebral Hemorrhage

Marked focal slowing and attenuation of background activity occur with an intracerebral hemorrhage. If there is a shift across the midline or compromise of the midline structures, intermittent rhythmic delta activity may also be present.

### Key Point

- Intracerebral hemorrhage is associated with more severe slow-wave abnormalities.

## Arteriovenous Malformations

The most frequent finding in arteriovenous malformations is focal epileptiform activity. Other types of findings that may be present are focal slowing or asymmetry of activity.<sup>3,5</sup>

### Key Point

- Arteriovenous malformations are usually associated with focal epileptiform abnormalities.

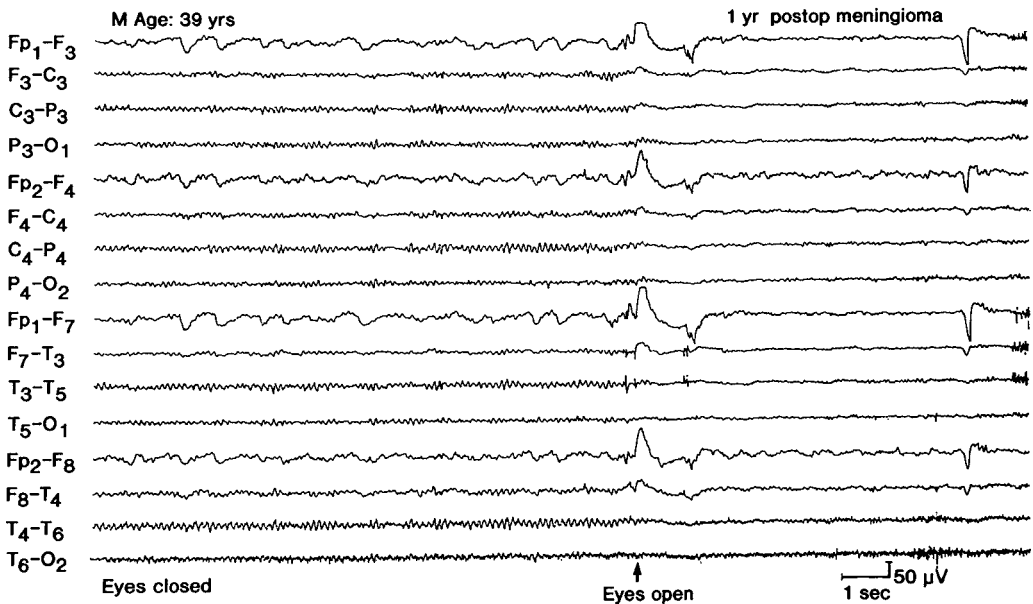
## Tumors

The most common finding overlying the site of the tumor is the presence of persistent,

polymorphic delta activity (Fig. 10-1). Usually the slowest frequency components and the most persistent slowing occur over the site of the tumor.<sup>3,4,12</sup> Slow-wave activity may also be reflected to the areas adjacent to the tumor. Sometimes the more focal slow-wave abnormality may be masked by other EEG activity, muscle, or eye movement artifact (Fig. 10-2).<sup>12</sup> At times more widespread bursts of intermittent rhythmic slow waves are present.

Asymmetry of background activity may also be present. Usually the background activity is decreased on the side of the tumor. On occasion the background activity may be increased, particularly if a skull defect is present.<sup>7,8</sup>

Slower growing tumors are more likely to produce epileptiform abnormalities than faster growing tumors. Thus, the oligodendroglioma, a slow growing tumor, has the highest incidence of associated epileptiform abnormalities followed by astrocytomas, meningiomas, metastatic carcinomas, and glioblastomas. Certain areas of the brain are more epileptogenic or have a lower threshold for developing epileptiform abnormalities than other areas of the brain, and tumors involving the temporal lobe, the rolandic strip, and the frontal lobe are more likely to produce epileptiform abnormalities than tumors affecting the parietal and occipital lobes.



**Figure 10-2.** Focal polymorphic delta activity in the right frontal region (Fp2) that is clearly evident when the patient's eyes are open but masked by eye movement when the eyes are closed.

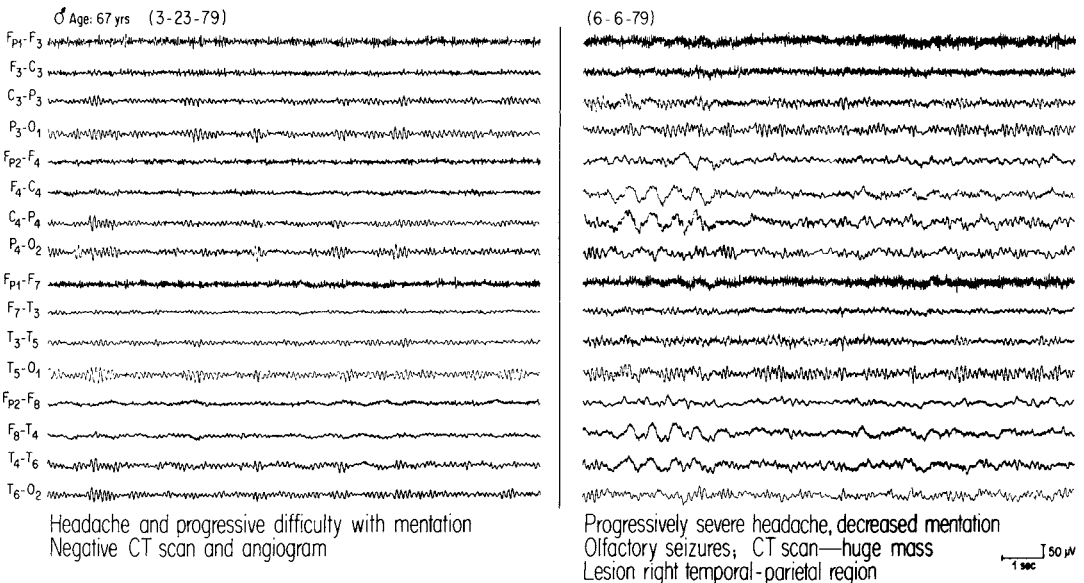


The type and degree of EEG abnormality depend on various factors. Focal abnormalities are more likely to occur with a lesion near the surface of the brain as compared to a more deeply situated lesion.<sup>3,12</sup> The extent and degree of slowing are related to the size of the tumor. The more rapidly growing and malignant the tumor, the more severe the slow-wave abnormalities. The stage of evolution at which the EEG was recorded determines the degree of abnormality. If the EEG is recorded at an early stage, there may be little abnormality reflected in the EEG as compared to a later stage (Fig. 10-3).<sup>12</sup> The state of the patient and level of consciousness can affect the degree of the EEG abnormalities. Another factor is the age of the patient. Children tend to show more severe abnormalities than adults. Medications can cause diffuse slowing of the EEG and/or accentuate more focal slow-wave abnormalities. The presence of a skull defect can enhance slowing or spike or sharp wave-like activity. Seizures and a postictal effect can also affect the EEG, particularly if the EEG is recorded shortly after a seizure. Interictal activity, such as temporal intermittent rhythmic delta activity (TIRDA), can also affect the EEG (Fig. 10-4).

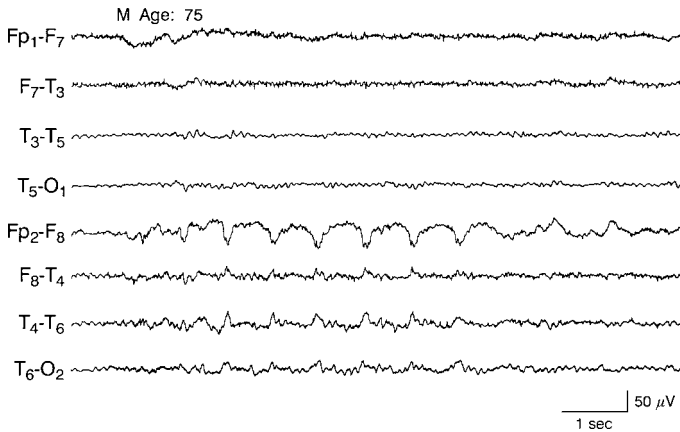
Complications, such as vascular compromise, infarct, hemorrhage, edema, pressure effects, and increased intraventricular pressure, can also contribute to the degree of EEG abnormalities.

**Key Points**

- The EEG in patients with cerebral tumors may show focal slowing, asymmetry, or epileptiform activity.
- The slowest frequency and most persistent slowing are seen over the site of the tumor.
- An asymmetry of activity may be seen with a decrease on the side of the tumor.
- An increased amplitude of activity can be seen with a skull defect.
- Epileptiform activity is more likely to occur with slow growing tumors.
- Tumors involving the temporal and frontal regions are more likely to be associated with epileptiform activity.
- The location, size, state of evolution, medication and seizures all play a role in determining the degree of EEG findings.



**Figure 10-3.** Electroencephalograms from a 67-year-old man showing focal persistent polymorphic delta activity in the right temporal region (F8 and T4) (segment on left), and the addition 2½ months later (segment on right) of intermittent rhythmic delta activity caused by a rapidly progressive brain tumor.

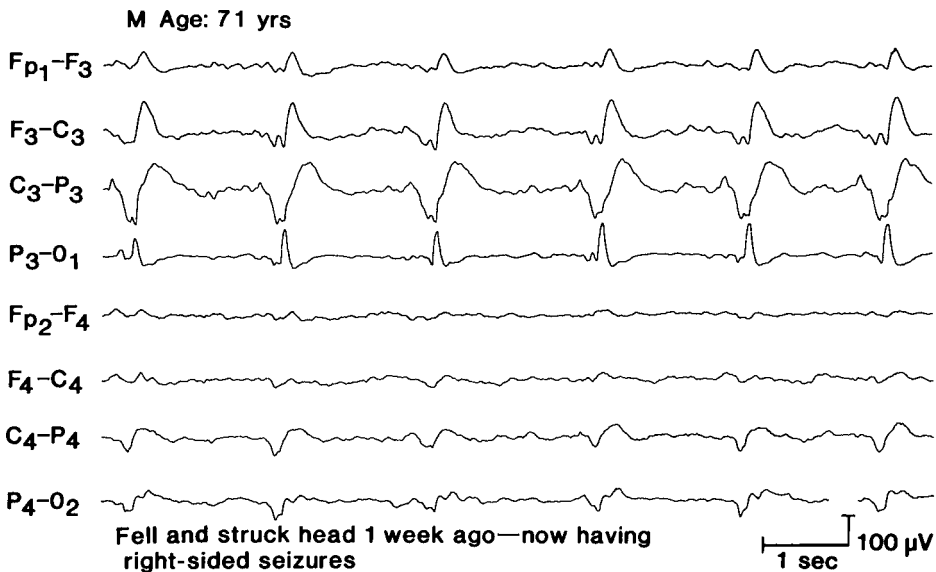


**Figure 10-4.** TIRDA over right temporal region in a 75-year-old man with complex partial seizures.

### Head Trauma

Head trauma may be associated with a variety of EEG abnormalities.<sup>3-5</sup> Mild head trauma may be associated with a transient asymmetry or mild slowing on the side of the head injury. Severe head injuries may be associated with significant slowing, an asymmetry or suppression, and/or epileptiform activity. The degree of slowing often parallels the degree of head injury and level of consciousness. An asymmetry or suppression of activity may also be present over an area or side of the brain that has received more significant trauma.

Epileptiform abnormalities are usually uncommon during the acute period following head trauma, but if present, usually indicate a significant brain injury. The patients may have associated focal seizures in association with focal epileptiform discharges on their EEG (Fig. 10-5). Generalized spike-and-wave discharges are uncommon following head injury and usually reflect a preexisting seizure disorder. Patients who are most likely to have epileptiform abnormalities on their EEG and seizures are those with penetrating head injuries, depressed skull fractures, prolonged periods of altered consciousness, and long periods of retrograde amnesia.<sup>3,5,12</sup>



**Figure 10-5.** Electroencephalogram from a 71-year-old man with recent head trauma showing left-sided PLEDs.

**Key Points**

- Mild head trauma is associated with transient slowing and/or asymmetry
- Severe head injuries are associated with slowing, asymmetry, and suppression of activity
- Epileptiform abnormalities may be present in patients with severe head trauma
- Epileptiform abnormalities are more likely to be seen in patients with penetrating head injuries, skull fractures, prolonged periods of unconsciousness, and amnesia.

**Subdural Hematoma**

A subdural hematoma is one of the common complications of head injury. The most common findings produced by a subdural hematoma are asymmetry—with decreased amplitude on the side of the subdural—and focal or lateralized slowing. Intermittent rhythmic delta slowing may also be present.<sup>3,4</sup> It is often difficult to distinguish on a single recording the effects produced by a subdural hematoma versus that of a cerebral contusion during the first 1 or 2 weeks following a severe head injury. A subdural hematoma should be considered, however, if a later EEG shows increased focal or generalized slowing or the combination of a focal abnormality, either slowing or asymmetry, in association with intermittent rhythmic delta activity.<sup>12</sup>

In summary, the EEG can be helpful in following the patients with head trauma in determining or confirming the presence of seizures, seeing if patients develop focal complications such as intracerebral or subdural hematoma, or diffuse disorders, including metabolic, toxic, or inflammatory encephalopathies.

**Key Point**

- Subdural hematomas are associated with asymmetry of activity and slowing.

**Inflammatory Disorders**

Focal abscess or cerebritis can be associated with focal EEG abnormalities. This can consist of focal polymorphic delta activity and/or associated epileptiform activity.<sup>3,4,14</sup> The EEG can be helpful in determining whether there is a focal, lateralized, or more diffuse process

in evaluation of patients with inflammatory disorders.

Brain abscesses may occur as a result of meningitis, septicemia, septic emboli, or as an extension of an infectious process involving the ears, mastoids, and sinuses. Focal polymorphic delta slowing can develop overlying the site of the abscess, particularly if the lesion is located close to the surface of the brain. On infrequent occasions, focal or lateralized periodic sharp- or slow-wave complexes and PLEDs may be present over the involved area of the brain.<sup>3,11,13,14</sup> Infratentorial abscesses produce less severe slow-wave abnormalities, and at times there may be little or no change on the EEG.

After treatment, the slow-wave abnormalities improve. There is a decrease in the degree of slow-wave abnormalities within the first few days after the surgery; however, some slowing and asymmetry of activity can continue to be present over the involved area.<sup>3</sup> Epileptiform abnormalities are not very common in the acute stages of the abscess; however, patients with cerebral abscess can subsequently develop seizures and epileptiform activity in their EEG.

**Key Points**

- Brain abscess is associated with focal slowing.
- PLEDs and epileptiform discharges may be seen with an acute abscess.
- Epileptiform abnormalities may occur later following treatment of an abscess.

**Herpes Simplex Encephalitis**

The EEG often shows a characteristic pattern of PLEDs, which can be of great value in the diagnosis of herpes simplex encephalitis. The periodic pattern is usually seen between 2 and 5 days after the onset of the illness, but on occasion has been observed several days later. Usually the complexes occur in a unilateral fashion; however, if there is bilateral involvement of the brain, bilateral PLEDs can occur synchronously or independently over the two hemispheres.<sup>3,13,14</sup> Focal or lateralized electrographic seizure discharges may be present over the involved area or hemisphere. The discharges may or may not be associated with clinical seizures. In nonfatal herpes simplex encephalitis, the PLEDs disappear as the

disease process resolves. The EEG, however, frequently continues to show subsequent slow-wave abnormalities, loss of background activity, or focal epileptiform activity over the involved area.

### Key Points

- The characteristic finding in herpes simplex encephalitis is PLEDs.
- PLEDs may be unilateral or bilateral.
- In nonfatal herpes simplex encephalitis, the EEG improves but continues to show slowing, loss of background activity, and epileptiform activity.

## Other Focal Cerebral Lesions

Other types of focal cerebral lesions such as a cyst or congenital defects can also cause focal slowing, asymmetry, suppression, or epileptiform abnormalities on the EEG.<sup>3-5</sup>

## Transient Disorders

Transient disorders that can cause transient changes in the EEG include migraine headaches, transient ischemic episodes, and postictal effects.

Migraine headaches can be accompanied by focal or lateralized slowing and/or asymmetry on the side of the migraine headache. These changes can occur during the migrainous episode and persist for 1 to 2 days in adults. Hemiplegic migraine is associated with hemispheric slowing and loss of background activity on the side of the migrainous episode and may persist for several days before resolving.<sup>3</sup>

If a recording is performed during a transient ischemic attack, the EEG can show focal delta slowing and/or decreased amplitude of activity over the involved area.<sup>3,4</sup> Usually the EEG abnormality resolves in association with resolution of the patient's symptoms. If the abnormality persists beyond 24 hours, then this would indicate that an infarct has occurred.

Focal or lateralized slowing and/or an asymmetry of activity may occur as a postictal effect following a seizure discharge. This can be helpful in indicating or confirming the focal or lateralized onset of a seizure discharge. The

postictal changes may be present from several minutes to hours after the seizure.

### Key Points

- Transient disorders such as migraine headaches, transient ischemic attacks, and postictal states may cause transient changes in the EEG.
- The EEG during or following a migraine headache may show slowing and an asymmetry of activity.
- The EEG during a transient ischemic episode shows slowing and/or decreased amplitude of activity over the involved area.
- Focal or lateralized slowing or asymmetry can be seen following a focal or lateralized seizure discharge.

In summary, different types of focal cerebral lesions can cause similar types of EEG abnormalities and although the EEG findings are not specific for a single lesion, they do give evidence of a focal disturbance of cerebral function. Sequential recordings may be necessary to distinguish a resolving or static lesion from a more progressive lesion. Although neuroimaging studies are now used to evaluate patients with suspected focal lesions, the EEG is still very useful as it reflects function or dysfunction of the brain and can indicate the presence of focal or lateralized pathophysiological processes that may not be detectable on neuroimaging studies.<sup>12</sup>

## ELECTROENCEPHALOGRAPHIC MANIFESTATIONS OF DIFFUSE DISORDERS

The EEG is helpful in the evaluation of diffuse disorders of cerebral function and serves as a measurement of the severity of the disturbance.<sup>3,5,15</sup> Diffuse encephalopathies can be caused by various conditions, including metabolic, toxic, inflammatory, posttraumatic, hypoxic, and degenerative disorders.<sup>16</sup>

The type of diffuse disorder and whether it involves white or gray matter influence the EEG pattern.<sup>1,2</sup> Processes that predominantly affect superficial white matter usually cause polymorphic delta slowing in the EEG, whereas diffuse processes that involve both

cortical and subcortical gray matter are more likely to cause intermittent bilaterally synchronous paroxysmal slow-wave activity.<sup>1,2,5,6</sup> Epileptiform abnormalities are seen more commonly in gray matter disease than in white matter disease. Other factors that influence the degree and type of EEG abnormalities include the state of the patient, the type and stage of the disease process, contributing factors such as infectious processes, metabolic derangements, drug effects, and/or other systemic processes.

### Key Points

- Processes affecting white matter usually cause delta slowing.
- Diffuse processes involving cortical and subcortical structures often cause intermittent slow-wave activity.
- Epileptiform abnormalities are seen with gray matter disease.
- Factors influencing the degree and type of EEG abnormality include state of the patient, type of disease process, and systemic disorders.

## Slow-Wave Abnormalities

The most common type of EEG finding in diffuse disorders, or encephalopathies, consists of slowing of varying degrees (Fig. 10-6).<sup>3-5,16</sup> This may involve slowing of the background activity, slowing in the theta frequency range, or generalized polymorphic delta slowing.<sup>16</sup> Intermittent bursts of bilaterally synchronous

rhythmic slow waves can occur in a generalized fashion or have a maximal expression over the anterior or posterior head regions. Usually the degree of slowing parallels the degree of disturbance of function or alteration in level of consciousness (or both). These findings can be caused by various diffuse disorders and, therefore, are considered nonspecific changes in that they are not diagnostic of any single condition.

### Key Points

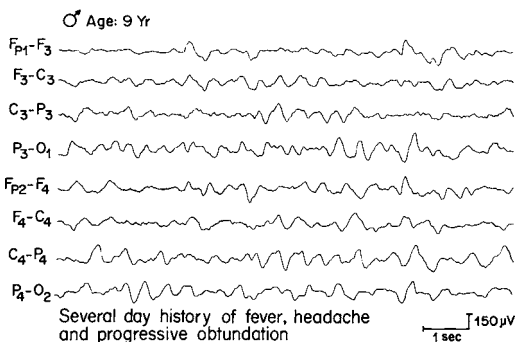
- The most common EEG finding in diffuse disorders is slowing.
- The slowing may consist of slowing of the background, theta and/or delta slowing, or intermittent rhythmic bisynchronous slow waves.
- The degree of slowing reflects the degree of disturbance of function and altered consciousness.

## Specific Patterns

At times, however, the EEG may show a more specific pattern, such as periodic patterns or the various distinctive coma patterns. The generalized periodic patterns include those associated with Creutzfeldt-Jakob disease, subacute sclerosing panencephalitis, and hepatic coma.<sup>3,4,10</sup> The distinctive coma patterns include alpha, beta, spindle coma, and burst-suppression patterns.

## Generalized Periodic Patterns

*Creutzfeldt-Jakob disease* is a diffuse, subacute, and progressive disorder of the central nervous system that occurs predominantly in middle-aged patients. It is characterized by dementia, motor dysfunction, myoclonus, and, when the disease is fully developed, a characteristic periodic EEG pattern consisting of generalized, bisynchronous, and periodic sharp waves recurring at intervals of 0.5–1 second, with a duration of 200–400 ms (Fig. 10-7).<sup>3,10,14</sup> Myoclonic jerks are often associated with the periodic sharp waves; however, there is not always a constant relationship between the two. Although occasionally other degenerative or toxic disorders may be associated



**Figure 10-6.** Severe diffuse slow-wave (delta) abnormality in a 9-year-old boy with encephalitis.



Figure 10-7. Diffuse periodic sharp waves in a 71-year-old man with Creutzfeldt-Jakob disease.

with a quasiperiodic sharp-wave pattern, the presence of periodic sharp waves, progressive dementia, and myoclonus is strongly suggestive of Creutzfeldt-Jakob disease.

*Subacute sclerosing panencephalitis* (SSPE) is a degenerative disorder that occurs in children and adolescents and is believed to be caused by the measles virus. This degenerative disorder is characterized by abnormal movements, intellectual deterioration, and a diagnostic, periodic EEG pattern. This consists of repetitive stereotyped high-voltage sharp- and slow-wave complexes recurring every 4–15 seconds (Fig. 10-8).<sup>3,10,14</sup> This pattern is usually

present during the intermediate stages of the disease. In a single recording from a single patient, the morphology of the complexes is stereotyped; however, the shape of the complexes can vary in different patients and change from time to time in the same patient at different stages of the disease. The complexes are usually generalized and bisynchronous, but at times they may be asymmetrical or more lateralized. Stereotyped motor jerks or spasms are often associated with the periodic complexes.

In hepatic coma, the EEG often shows a *triphasic wave pattern* consisting of medium- to high-voltage broad triphasic waves that



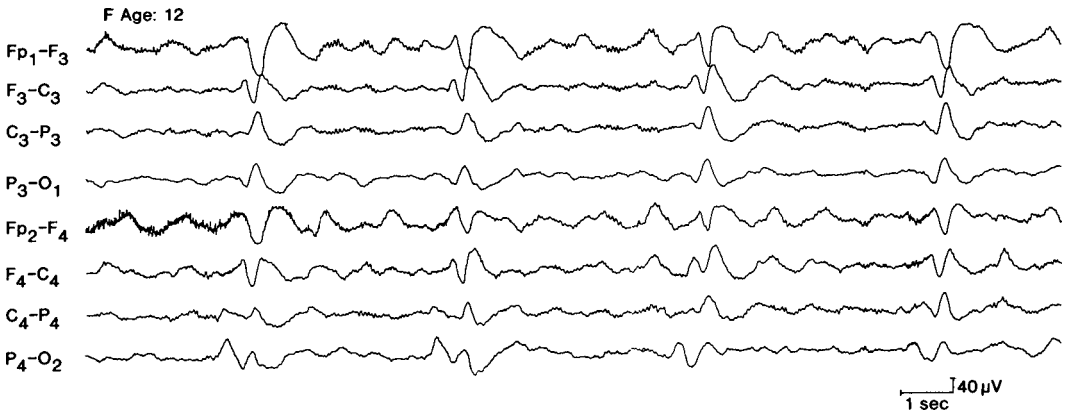


Figure 10-8. Diffuse periodic complexes in a 12-year-old girl with subacute sclerosing panencephalitis.

occur rhythmically or in periodic serial trains at a rate of 1–2 Hz in a bilaterally synchronous and symmetrical fashion over the two hemispheres with a fronto-occipital or occipitofrontal time lag. The triphasic waves usually have a frontal predominance and consist of a short-duration, low-voltage surface-negative component followed by a prominent positive sharp-contoured wave and then a longer duration surface-negative slow wave (Fig. 10-9).<sup>17</sup> Although triphasic waves are often associated with liver dysfunction, atypical triphasic waves can be seen in other conditions, including metabolic derangements, electrolyte disturbances, toxic states, degenerative processes, or after a hypoxic episode. The triphasic wave pattern needs to be carefully distinguished from epileptiform activity.<sup>3,17</sup>

**Key Points**

- Creutzfeldt–Jakob disease is associated with generalized periodic sharp waves.
- SSPE is associated with generalized periodic slow-wave complexes.
- Hepatic coma is associated with triphasic waves.

**Coma Patterns**

Comatose patients often show generalized slow waves or abnormalities; however, more specific coma patterns may be present in the EEG. The specific coma patterns include alpha- and beta-frequency coma, spindle coma, and burst-suppression patterns.

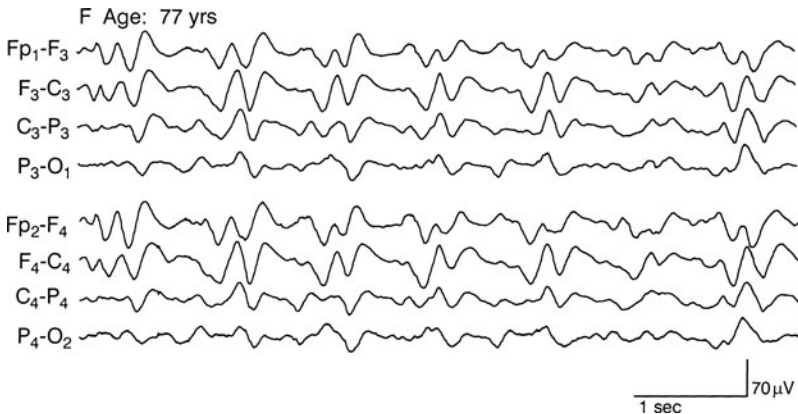


Figure 10-9. Triphasic waves in a 77-year-old woman in hepatic coma.



The *alpha-frequency coma pattern* consists of diffusely distributed invariant alpha activity that shows little or no reactivity or variability. This type of pattern has been seen after cardiac arrest or hypoxic insult to the brain and with significant brain stem lesions.<sup>3,18</sup> When the alpha-frequency coma pattern is seen in the context of a hypoxic insult, it usually indicates a poor prognosis. A reversible alpha-frequency coma pattern, on the other hand, can be seen with medications, anesthetic agents, or overdose of drugs.<sup>18</sup>

The *beta-frequency coma pattern* consists of generalized beta activity superimposed on underlying delta slowing. This pattern is usually associated with drug toxicity or anesthesia.

The *spindle coma pattern* resembles a sleep EEG and consists predominantly of spindle activity with some V waves, but it shows little or no reactivity.<sup>3-5</sup> This type of pattern can result from various causes, including head trauma, hypoxic insults, or brain stem lesions. Depending on the type of underlying cause and severity of damage to the central nervous system, the pattern indicates that the potential for improvement exists. In many types of coma, spontaneous variability of EEG activity, including the sleep-like pattern, indicates a better prognosis than a prolonged invariant pattern.

The *burst-suppression pattern* consists of periodic or episodic bursts of activity, usually irregular mixtures of sharp waves or spikes, alternating with intervals of suppression (Fig. 10-10). The bursts may be accompanied by myoclonic jerks. This pattern is often seen after a severe insult to the brain, such as a hypoxic or anoxic insult, in which case the

pattern usually indicates a poor prognosis.<sup>3,15</sup> However, the burst-suppression pattern can also be seen with potentially reversible conditions, such as anesthesia, drug intoxication, and hypothermia.

With regard to the EEG in coma and prognosis, favorable findings in EEG include variability, reactivity, variable wake-and-sleep patterns, and a progressive increase in background frequencies. Patterns that indicate a poor prognosis for return of useful neurologic function include an invariant monorhythmic pattern with little or no reactivity, a burst-suppression pattern, and generalized suppression of activity.

### Key Points

- Patients in coma often show generalized slow-wave abnormalities.
- The alpha-frequency coma pattern is seen following cardiac arrest or with a brain stem lesion.
- A reversible alpha-frequency coma pattern can be seen with overdose of drugs or anesthesia.
- A beta-frequency coma pattern is seen with drug toxicity or anesthesia.
- The spindle coma pattern can be seen with head trauma, hypoxic insults, or brain stem lesions.
- The burst-suppression pattern can be seen following anoxic insult to the brain and usually indicates a poor prognosis.
- Burst suppression can also be seen with potentially reversible conditions such as drug overdose, anesthesia, or hypothermia.

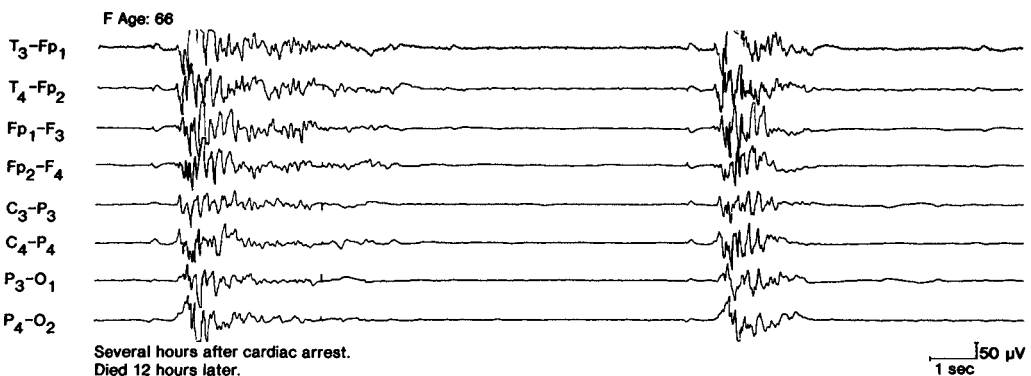


Figure 10-10. Diffuse burst-suppression pattern after cardiac arrest.

- EEG variability, reactivity, variable wake and sleep patterns and a progressive increase in background frequencies indicate a favorable prognosis in coma.
- EEG patterns that indicate a poor prognosis in coma include an invariant monorhythmic pattern with little or no reactivity, a burst-suppression pattern, and a generalized suppression of activity.

In summary, in patients with diffuse disorders, the EEG is useful in documenting a disturbance of cerebral function, in determining the degree of disturbance, in monitoring changes and trends in the course of the disease process, and in helping to establish the diagnosis in certain conditions in which a characteristic EEG pattern is present. Also, the EEG sometimes helps to detect the presence of an additional, more focal cerebral process.

### EVALUATION FOR SUSPECTED BRAIN DEATH

The EEG can provide confirmatory evidence of brain death, which is manifested by an absence of spontaneous or induced electric activity of cerebral origin (Fig. 10–11). *Electrocerebral inactivity* (ECI) is defined as “no EEG activity over 2 microvolts/mm.”<sup>19</sup> There are important minimal technical criteria for

recording in patients with suspected cerebral death. These criteria include the following:<sup>19</sup>

1. A minimum of eight scalp electrodes should be used.
2. Interelectrode impedances should be less than 10,000 V but more than 100 V.
3. The integrity of the entire recording system must be verified.
4. Interelectrode distances should be at least 10 cm.
5. The sensitivity should be at least 2  $\mu$ V/mm for at least 30 minutes of recording.
6. Appropriate filter settings should be used.
7. Additional monitoring techniques should be used when necessary.
8. There should be no EEG reactivity to afferent stimulation.
9. The recording should be made by a qualified technologist.
10. A repeat EEG should be performed if there is doubt about the presence of electrocerebral silence.

Because temporary and reversible ECI can be caused by drug overdose and hypothermia, these conditions should be excluded before reaching a conclusion of brain death.<sup>3</sup> In young infants, because of uncertainties about the significance of ECI, one should exercise caution in the interpretation of this finding.<sup>3</sup> The

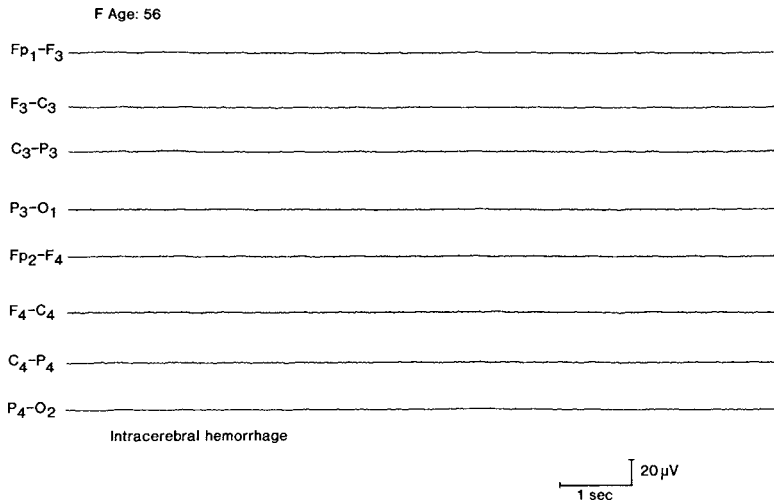


Figure 10–11. Electrocerebral inactivity.

Guidelines of the Task Force for the Determination of Brain Death in Children<sup>20</sup> recommend that for infants between 7 days and 2 months old, two EEGs demonstrating ECI be performed at least 48 hours apart, and that for infants between 2 months and 1 year old, two records showing ECI be done at least 24 hours apart.

### Key Points

- Electrocerebral inactivity is defined as no EEG activity over 2  $\mu$ V/mm.
- EEG in suspected brain death must meet specific performance criteria.
- Drug overdose and hypothermia should be excluded as potentially reversible causes of cerebral inactivity.

## CONCLUSION

Since the EEG reflects altered function or pathophysiology of the brain, the EEG can be very helpful in evaluating patients with focal or diffuse disorders, altered consciousness, or who are comatose. In evaluation of patients, the EEG should also be interpreted in association with other factors including state of consciousness, reactivity, neurologic function or dysfunction, drugs or medications, underlying metabolic, cardiovascular, pulmonary, or other systemic medical problems, and age of the patient. The EEG can be particularly helpful in patients who are comatose, on respirators, are paralyzed, or when the neurologic status cannot be evaluated.

The occurrence of certain patterns and the presence of variability and reactivity of the EEG can help ascertain the prognosis or potential for improvement. Sequential recordings are very helpful in determining whether the patient is improving or deteriorating or developing other complications such as seizures, metabolic encephalopathies, or toxic or medication effect. Specific EEG patterns, when present, can indicate or give a clue as to what the underlying process is.

In summary, the EEG can:

1. Document a disturbance of cerebral functioning.
2. Determine the degree of disturbance of cerebral functioning.

3. Monitor changes in the course of a disease process and help determine whether the patient is improving or deteriorating.
4. Rule out the possibility of a more focal cerebral process such as an expanding mass lesion.
5. Make the diagnosis in certain conditions when a characteristic EEG pattern is present.
6. Help in the evaluation of suspected brain death.

In conclusion, this chapter provides an overview of nonepileptiform abnormalities in the EEG. The EEG findings can be seen with a number of different focal lesions or diffuse disorders. As Dr. Donald Klass has stated “the usefulness of the EEG depends on an enlightened interpretation of the findings with regard to the specific clinical problem that the EEG is being used to solve.”<sup>12</sup>

## REFERENCES

1. Gloor, P., O. Kalabay, and N. Giard. 1968. The electroencephalogram in diffuse encephalopathies. Electroencephalographic correlates of grey and white matter lesion. *Brain* 91:779–802.
2. Gloor, P., G. Ball, and N. Schaul. 1977. Brain lesions that produce delta waves in the EEG. *Neurology* 27:326–33.
3. Ebersole, J. S., and T. A. Pedley, eds. 2003. *Current practice of clinical electroencephalography*, 3rd ed. Philadelphia: Lippincott Williams & Wilkins.
4. Fisch, B. J. 1999. *Spehlmann's EEG primer: principles of digital and analog EEG*, 3rd ed. Amsterdam: Elsevier Science Publishers.
5. Niedermeyer, E., and F. Lopes da Silva, eds. 2005. *Electroencephalography: Basic principles, clinical applications, and related fields*, 5th ed. Philadelphia: Lippincott Williams & Wilkins.
6. Watemberg, N., F. Alehan, R. Dabby, T. Lerman-Sagie, P. Pavot, and A. Towne. 2002. Clinical and radiological correlates of frontal intermittent rhythmic delta activity. *Journal of Clinical Neurophysiology* 19:535–9.
7. Cobb, W. A., R. J. Guiloff, and J. Cast. 1979. Breach Rhythm. The EEG related to skull defects. *Electroencephalography and Clinical Neurophysiology* 47:251–71.
8. Radhakrishnan, K., D. Chandy, G. Menon, and S. Sarma. 1999. Clinical and electroencephalographic correlates of breach activity. *American Journal of Electroencephalography and Technology* 39:138–47.
9. Westmoreland, B. F., and D. W. Klass. 1998. Defective alpha reactivity with mental concentration. *Journal of Clinical Neurophysiology* 15:424–28.

10. Brenner, R. P., and N. Schaul. 1990. Periodic EEG patterns: Classification, clinical correlations, and pathophysiology. *Journal of Clinical Neurophysiology* 7:249–67.
11. Chatrian, G. E., C.-M. Shaw, and H. Leffman. 1964. The significance of periodic lateralized epileptiform discharges in EEG: An electrographic, clinical and pathological study. *Electroencephalography and Clinical Neurophysiology* 17:177–93.
12. Klass, D. W., and B. F. Westmoreland. 2001. Electroencephalography: General principles and adult EEGs. In *Clinical neurophysiology*, ed. J. R. Daube, 2nd ed., 77–107. Oxford University Press: New York.
13. Pohlman-Eden, B., D. B. Hoch, J. I. Cochiuș, and K. H. Chiappa. 1996. Periodic lateralized epileptiform discharges—A critical review. *Journal of Clinical Neurophysiology* 13:519–30.
14. Westmoreland, B. F. 2005. EEG in cerebral inflammatory processes. In *Electroencephalography*, ed. E. Niedermeyer, and F. Lopes da Silva, 5th ed., 323–37. Philadelphia: Lippincott Williams & Wilkins.
15. Young, G. B. 2000. The EEG in coma. *Journal of Clinical Neurophysiology* 17:473–85.
16. Kaplan, P. W. 2004. The EEG in metabolic encephalopathy and coma. *Journal of Clinical Neurophysiology* 21:307–18.
17. Fisch, B. J., and D. W. Klass. 1988. The diagnostic specificity of triphasic wave patterns. *Electroencephalography and Clinical Neurophysiology* 70:1–8.
18. Kaplan, P. W., D. Geroud, T. W. Ho, and P. Jallon. 1999. Etiology, neurologic correlations, and prognosis in alpha coma. *Clinical Neurophysiology* 110: 205–13.
19. American Electroencephalography Society. 2006. Guideline 3: Minimal technical requirements for recording in suspected cerebral death. *Journal of Clinical Neurophysiology* 23:97–104.
20. Task force for the determination of brain death in children. Guidelines for the determination of brain death in children. 1987. *Neurology* 37: 1077–78.

# Electroencephalography: Electroencephalograms of Infants and Children

*Barbara F. Westmoreland*

## **INTRODUCTION**

### **NEONATAL EEG PATTERNS**

Normal EEGs

Abnormal EEGs

### **DEVELOPMENTAL CHANGES**

#### **DURING INFANCY,**

#### **CHILDHOOD, AND ADOLESCENCE**

Hyperventilation

Photic Responses

Drowsiness

Sleep

### **BENIGN VARIANTS IN CHILDREN**

Posterior Slow Waves Associated  
with Eye Blinks or Slow Lambdas  
of Youth

O Waves or Cone-Shaped Waves

Posterior Slow Waves of Youth

14 and 6 Hz Positive Spike Bursts

### **ABNORMALITIES**

Epileptiform Abnormalities

Slow-Wave Abnormalities

Conditions Giving Rise to

Abnormal EEG Patterns in Children

Transient Abnormalities

### **SUMMARY**

## **INTRODUCTION**

Electroencephalography (EEG) is an important part of the evaluation of many disorders in infants and children, including seizures, spells, transient central nervous system (CNS) symptoms, behavioral disorders, altered states of consciousness, and lesions or conditions resulting in a disturbance of cerebral function. The most common referral for EEG is for evaluation of seizures, because the EEG can show the presence of epileptiform abnormalities and, often, indicate the type of seizure

disorder. The EEG is helpful in the evaluation of nonepileptic spells and transient CNS symptoms by indicating whether there is an associated EEG change and, if so, the degree, location, and type of change. Ambulatory and prolonged video EEG monitoring can be of additional help in the evaluation of seizures, spells, and transient symptom. Another common referral is for evaluation of children who have altered consciousness or are comatose. The EEG can help determine the degree and extent of the disturbance and, if specific patterns are present (as described in

Chapter 10), help indicate the diagnosis or prognosis (or both).

The EEG is also helpful in evaluating conditions or lesions causing a disturbance of cerebral function, in determining whether the process is focal or generalized, and in identifying the extent of the disturbance. The EEG reflects the degree and extent of the disturbance and, if certain diagnostic EEG patterns are present, helps to make the diagnosis.

Children with behavioral disturbances, attention deficits, or learning disorders are also referred for EEGs to rule out an underlying organic process.

### **Purpose of EEG Studies in Infants and Children**

- Evaluate seizures, transient spells, and altered states of consciousness.
- Evaluate conditions and lesions causing a disturbance of cerebral function.
- Determine whether the condition or lesion is focal or generalized.
- Help make the diagnosis if certain diagnostic EEG patterns are present.

## **NEONATAL EEG PATTERNS**

### **Normal EEGs**

Recordings in newborn infants usually require monitoring of physiologic variables such as the electrocardiogram (ECG), respirations, eye movements, and chin myogram in addition to EEG recording to help determine the state of the infant.<sup>1</sup>

In infants of less than 32 weeks' conceptional age, which is the age since the first day of the mother's last menses, the EEG consists of an intermittent or discontinuous pattern, with bursts of activity alternating with long quiescent periods. There is little distinction between the EEG of the awake and sleep states.<sup>2-6</sup> Between 32 and 37 weeks' conceptional age, there is an EEG distinction between the awake state and the two types of sleep states, active and quiet sleep.<sup>2-6</sup> *Active sleep*, which is similar to rapid eye movement (REM) sleep in adults, manifests eye movements, body twitches, grimaces, reduction in muscle tone, and irregular respirations. During this state, the EEG shows a more continuous pattern, similar to that of the awake state. *Quiet sleep* has reduced

eye and body movements, increased muscle tone, regular respirations, and a regular ECG. During this state, the EEG shows a discontinuous pattern, with bursts of mixed sharp- and slow-wave activity alternating with periods of flattening of the background. This is referred to as the *tracé alternant* pattern.

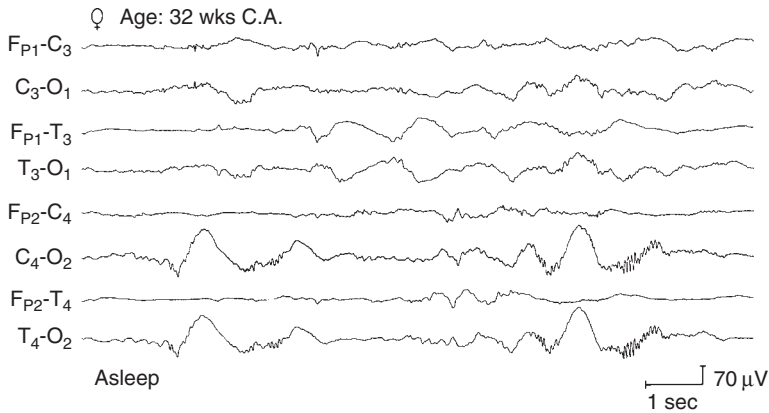
### **Key Points**

- Active sleep is similar to REM sleep in adults.
- Active sleep in infants consists of eye movement, body twitches, reduction in muscle tone, irregular respirations, and a continuous low amplitude EEG pattern.
- Quiet sleep is similar to non-REM sleep in adults.
- Quiet sleep consists of reduced eye and body movements, increased muscle tone, regular respirations and ECG, and a discontinuous pattern called the *tracé alternant pattern*.

Other types of activity that are present at this age include<sup>2-6</sup>

1. Occipital dominant slow waves, which are broad, high-amplitude slow waves over the occipital head regions, shifting from side to side in prominence.
2. The spindle delta brush pattern, which consists of moderate-to-high-amplitude delta waves with superimposed 8- to 20-Hz activity; it is seen over the rolandic, temporal, and occipital head regions (Fig. 11-1).
3. Random multifocal sharp transients or focal sharp waveforms occurring in multiple locations but most frequently over the frontal head regions (frontal sharp transients) (Fig. 11-2).
4. Anterior slow waves, which consist of rhythmic delta slow waves over the anterior head regions; they are usually associated with frontal sharp transients.
5. Bursts or trains of sharp-contoured theta waves over the temporal and central vertex regions. In the younger, premature infant, these patterns are seen in both the awake and sleep states.

As the child matures, these patterns are seen primarily during sleep and then disappear after about 44 weeks' conceptional age.



**Figure 11-1.** EEG from a normal premature infant at 32 weeks' conceptual age (C. A.) during sleep, showing the delta brush pattern.

Infants 38–42 weeks old show four basic patterns:<sup>2-6</sup>

1. A low-voltage irregular pattern that is present during wakefulness and active sleep.
2. A high-voltage slow-wave pattern that is seen during quiet sleep.
3. A tracé alternant pattern that is also seen during quiet sleep.
4. A mixed pattern of theta and delta waves seen during drowsiness and active sleep and as a transitional pattern between the various states.

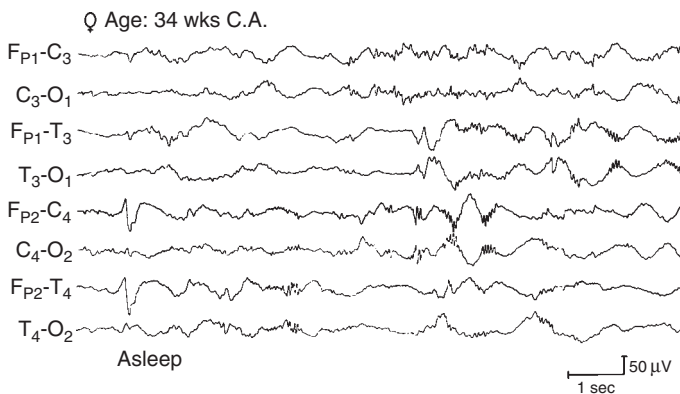
### Key Points

- Specific patterns and waveforms in premature and neonatal infants consist of
  - Tracé alternant pattern
  - Occipital dominant slow waves

- Spindle delta brush pattern
- Anterior slow waves
- Sharp-contoured theta waves in the temporal and central regions

### Abnormal EEGs

The EEG in premature and newborn infants should be interpreted with care. The age of the infant is important because the EEG activity changes with maturation, and what might be normal at one age may be abnormal for a more mature infant. The background rhythms are the most significant EEG finding.<sup>2-7</sup> If these are appropriate for the infant's age, the infant usually has a fairly good prognosis; if abnormal, then the degree of abnormality usually reflects the degree of disturbance and the ultimate



**Figure 11-2.** EEG from a normal premature infant at 34 weeks' conceptual age (C.A.) during sleep, showing a frontal sharp transient (Fp2). Less prominent sharp transients also occur in T3 and T4.



outcome of the infant. Abnormalities may be divided into mild and significant types.

### MILD ABNORMALITIES

Mild abnormalities, such as excessive multifocal sharp transients or immature and dysmature patterns, can be seen in stressed premature or term infants. These findings are nonspecific and rarely suggest a specific diagnosis.<sup>2,4</sup> They often are transient and usually disappear within a few days. Mild and transient focal abnormalities in the EEG usually are not associated with any obvious focal pathologic condition. However, persistent focal EEG abnormalities are often associated with structural lesions such as intracranial hemorrhage or congenital defects.<sup>2-7</sup>

### SIGNIFICANT ABNORMALITIES

Significant abnormalities in the EEG are usually associated with an important disturbance of brain function and often indicate a poor prognosis or poor neurologic outcome. The more abnormal the pattern, the more severe the underlying encephalopathy or disturbance of brain function.<sup>2-7</sup> The following patterns are significantly abnormal.

#### *Isoelectric EEG*

An *isoelectric EEG* is a flat record that meets the criteria for electrocerebral inactivity. Infants with a single flat EEG may survive the neonatal period but usually suffer severe long-term neurologic sequelae.<sup>2-7</sup>

#### *Burst-Suppression Pattern*

A *burst-suppression pattern* consists of diffuse bursts of abnormal activity superimposed on an isoelectric or very low-amplitude background. This is an invariant pattern that does not change with state of sleep-wakefulness or in response to stimuli. It, too, is associated with severe encephalopathy and poor long-term prognosis.<sup>2-7</sup>

#### *Persistent Low Voltage*

*Persistent low voltage* can occur in a generalized fashion in association with a diffuse

disturbance of function or, in a more focal fashion, in association with focal lesions such as porencephaly, subdural collection of fluids, or congenital abnormalities.

#### *Epileptiform Activity*

Epileptiform activity is one of the most frequent types of abnormalities seen in EEGs of neonates and consists of focal or multifocal interictal and ictal discharges.<sup>2-9</sup> The interictal discharges usually take the form of spikes, sharp waves, and broad slow waves. The ictal discharges consist of rhythmic activity that may take the form of spikes, sharp waves, slow waves, or rhythmic activity in the alpha, beta, theta, or delta range and may evolve and persist for relatively long periods. Ictal electrographic discharges often occur in association with clinical seizures but may be present without any clinical accompaniment (Fig. 11-3). If associated with seizures, the seizures usually take the form of clonic or tonic movements, but there may be diverse and subtle manifestations that may not be easily recognizable as epileptic.<sup>2-9</sup>

#### *Positive Rolandic Sharp Waves*

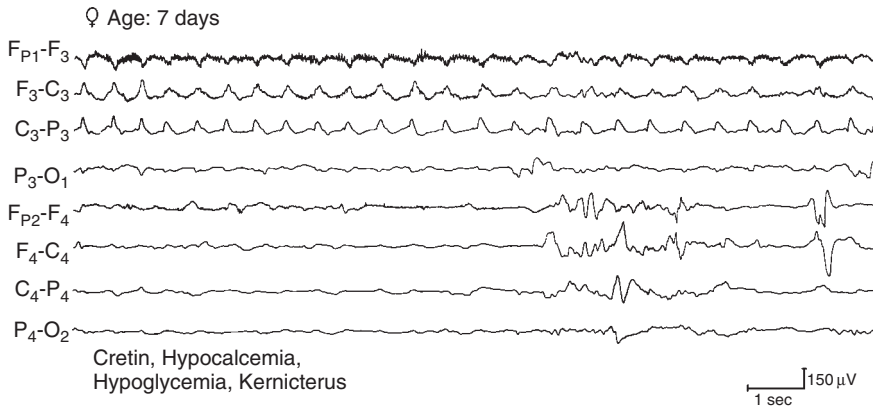
*Positive rolandic sharp waves* occur unilaterally or bilaterally and are most common in the rolandic and midline areas.<sup>2-6</sup> They were described initially in infants with intraventricular hemorrhage; however, they also occur in patients who have periventricular leukomalacia and deep white matter lesions.<sup>2-6</sup>

#### *Asymmetry*

An excessive and persistent asymmetry of the activity during both the wake and sleep states, occurring focally or lateralized to one hemisphere, is a significant abnormal finding in an infant's EEG.<sup>2-7</sup> This can occur with congenital lesions, porencephalic cysts, vascular insults, or subdural collections of fluid.

#### *Periodic Discharges*

*Periodic lateralized epileptiform discharges* (PLEDs) can occur with an acute or subacute process, most often caused by an ischemic, hypoxic, or vascular insult, or neonatal herpes simplex encephalitis.<sup>10,11</sup>



**Figure 11-3.** Focal subclinical EEG-seizure discharge arising from the left frontal region (F3) in a 7-day-old girl with neonatal seizures.

### Persistent Slowing

Persistent focal or generalized slowing in the delta and theta range with decreased reactivity can occur with a focal lesion or a diffuse process.<sup>2-6</sup>

### Key Points

- Mild abnormalities consist of excessive multifocal sharp transients or immature and dysmature patterns.
- Significant abnormalities consist of
  - Isoelectric EEG
  - Burst-suppression pattern
  - Persistent low-voltage pattern
  - Epileptiform activity
  - Positive Rolandic sharp waves
  - Excessive asymmetry
  - Periodic discharges
  - Persistent slowing

### CONDITIONS GIVING RISE TO ABNORMAL EEG PATTERNS IN INFANTS

#### Hypoxic-Ischemic Insult

This gives rise to severe EEG abnormalities and is the most common cause of neonatal seizures.<sup>2-9</sup>

#### Intraventricular Hemorrhage

Intraventricular hemorrhage, which can occur in premature infants who have a hypoxic-ischemic insult, is associated with rolandic positive sharp waves in the EEG.<sup>2-7</sup>

### Metabolic Disorders

The most common metabolic disorders that produce abnormal EEG patterns are hypoglycemia and hypocalcemia, which previously were the most frequent causes of neonatal seizures. Metabolic disorders can be associated with focal or multifocal epileptiform abnormalities in the EEG; the EEG usually improves after the metabolic disorder has been corrected.<sup>2-9</sup>

### Drugs and Drug Withdrawal

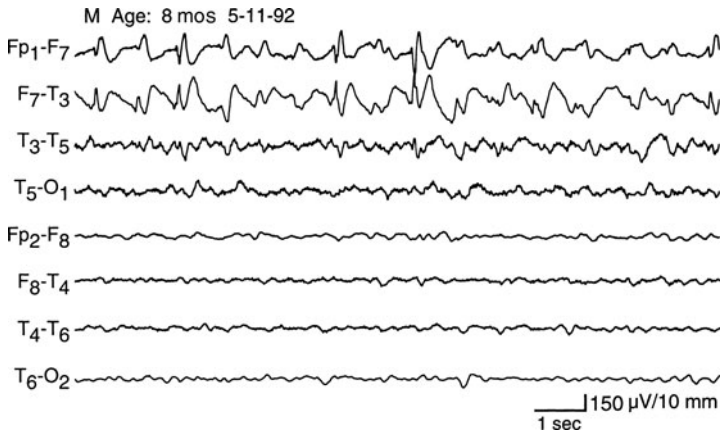
Drug withdrawal is becoming a more frequent cause of seizures in newborn infants. The EEG in these infants often shows evidence of cortical irritability, as manifested by focal or multifocal epileptiform activity and seizure discharges. Drugs such as anticonvulsants can also cause changes in an infant's EEG, including a burst-suppression pattern or generalized suppression of activity.<sup>2,5-7</sup>

### Infectious Diseases

Infectious diseases involving the CNS are frequently associated with abnormalities in the EEG. The most characteristic finding is seen in neonatal herpes simplex encephalitis and consists of PLEDs.<sup>10</sup> Other findings associated with infectious processes include significant asymmetries, interhemispheric asynchronies, multifocal sharp waves, and seizure discharges.

### Inborn Errors of Metabolism

Inborn errors of metabolism, biochemical disorders, and aminoacidurias can be associated



**Figure 11-4.** Focal spikes in an 8-month-old boy with focal right-sided motor seizures caused by tuberous sclerosis complex.

with abnormal EEG patterns. Phenylketonuria previously was a common cause, but other types of aminoacidurias and inborn errors of metabolism can present with neonatal seizures and epileptiform discharges.<sup>2-9</sup>

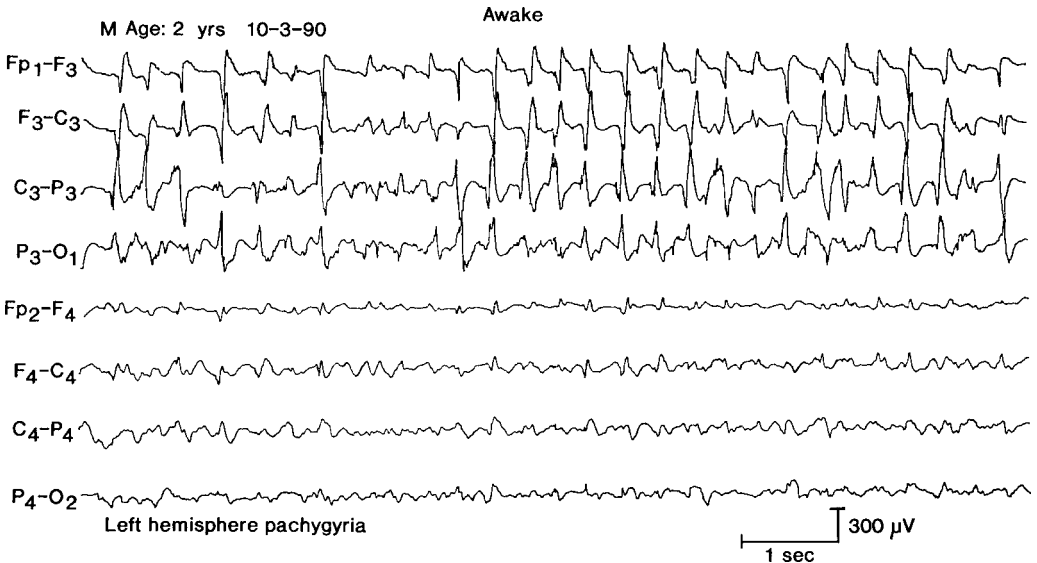
***Dysgenetic Disorders or Neurocutaneous Disorders***

Tuberous sclerosis complex presenting in infancy may be associated with a hypersarhythmic pattern or focal or multifocal EEG abnormalities that may or may not be related to the

location of the tubers<sup>2,11,12</sup> (Fig. 11-4). Sturge-Weber syndrome is associated with an asymmetry of background activity and epileptiform activity on the side of the facial nevus.<sup>2,11,13,14</sup>

***Cortical Malformations***

Cortical malformations, particularly cortical dysplasia, may be highly epileptogenic and can result in focal or multifocal epileptiform abnormalities with frequent interictal and ictal discharges. At times almost continuous trains of spike discharges or rhythmic epileptiform discharges may be present<sup>14-17</sup> (Fig. 11-5).



**Figure 11-5.** Repetitive spike discharges over the left hemisphere in a 2-year-old boy with left hemisphere pachygyria.

### **Congenital Abnormalities**

These may be associated with various types and combinations of abnormal patterns reflecting the abnormality of patients with congenital abnormalities.<sup>2-5,14</sup>

#### **Key Points**

- Many different conditions may be associated with abnormal EEG patterns in infants, including hypoxic insults, metabolic disorders, infectious diseases, inborn errors of metabolism, dysgenesis, and congenital anomalies.

## **DEVELOPMENTAL CHANGES DURING INFANCY, CHILDHOOD, AND ADOLESCENCE**

In the first 3 months of life, a transition occurs from the neonatal to the infant EEG pattern.<sup>2,6</sup> The background consists of irregular low-amplitude delta activity.

Rhythmic activity in the range of 5–6 Hz is present in the central regions and is probably a precursor of the mu rhythm. At 3 months of age, rhythmic occipital activity in the range of 3–4 Hz is present. This activity can be attenuated with eye opening and represents a precursor of the alpha rhythm. Between 4 and 6 months of age, the central rhythm becomes better developed and shows a frequency of 5–8 Hz; a better defined occipital rhythm in the range of 5–6 Hz is present when the eyes are closed. Between 6 months and 2 years of age, the central rhythm is well developed at a frequency of 5–8 Hz. After 6 months, the occipital rhythms become more prominent, and there is a gradual shift to higher amplitude and faster frequency activity, ranging from 6 to 8 Hz. In patients between 2 and 5 years of age, the central and occipital rhythms are further differentiated. By 3 years of age, the occipital alpha rhythms range from 6 to 8 Hz, and the amplitude of this activity gradually increases.<sup>2,5,18,19</sup> Between 6 and 16 years of age, there is a progressive increase in the alpha frequencies, and the typical adult frequency range of 9–10 Hz is usually reached by 10–12 years of age. Some interspersed theta activity may still be present, predominantly over the anterior head regions.

During the first decade of life, there is considerable variability among children of the same age with regard to the amount of alpha, theta, and delta activity present.<sup>2,5,18,19</sup>

#### **Key Points**

- Developmental changes in infants and children consist of evolution of rhythmic activity over the central and posterior head regions.
- The central rhythm evolves to a mu rhythm.
- The posterior rhythm evolves to alpha rhythm.
- As the infant and child matures, the central and posterior rhythms increase in frequency with the adult frequency range being reached by 10–12 years of age.

## **Hyperventilation**

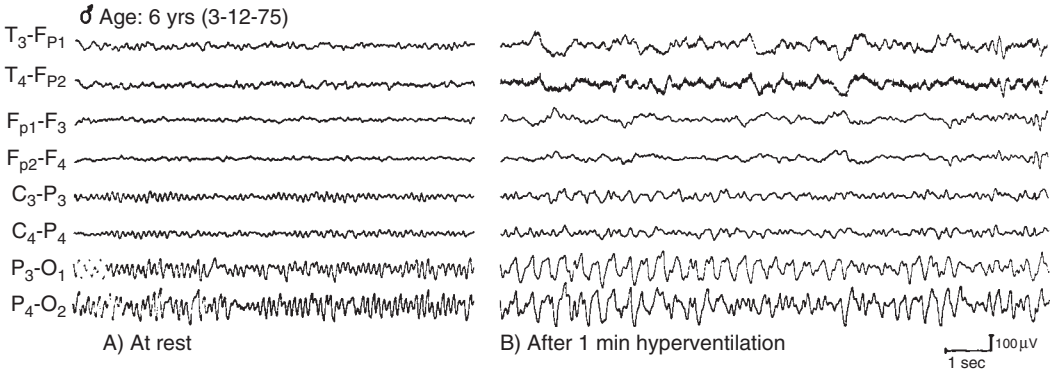
In younger children, the slowing produced by hyperventilation is often maximal over the posterior head regions (Fig. 11–6), whereas in older children, the buildup response is usually maximal over the anterior head regions.<sup>18,19</sup>

## **Photic Responses**

Young children show responses in the occipital regions predominantly at slower flash frequencies. In older children, driving can be seen at faster flash frequencies.

## **Drowsiness**

Drowsiness in young children is characterized by high-amplitude sinusoidal 4–5 Hz theta activity that is maximal over the frontal, central, and parietal regions. These slow waves initially occur in prolonged rhythmic trains and, in children between 1 and 9 years old, in bursts.<sup>2,5,18,19</sup> (Fig. 11–7). Sometimes the slow waves may have a notched or sharp appearance because of superimposed faster frequencies.<sup>19</sup> During adolescence, characteristic trains of monorhythmic sinusoidal theta activity occur over the frontal regions and may precede the disappearance of the alpha rhythm.



**Figure 11-6.** Normal EEG from a 6-year-old boy, A, during resting wakefulness and, B, during hyperventilation.

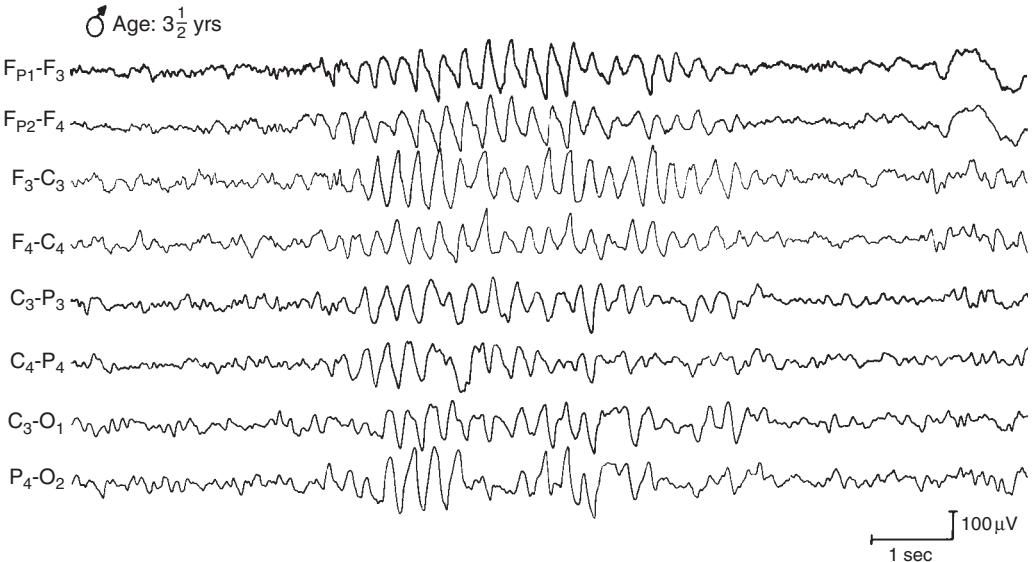
**Key Points**

- Drowsiness in children may be associated with a high amplitude 4–5 Hz rhythm over the frontal, central, and parietal regions.
- In adolescents, the drowsy rhythm may consist of theta activity over the frontal regions.

**Sleep**

During the first few months of life, the trace alternant pattern of newborns (see the section on Normal EEGs) is replaced by generalized

slow-wave activity during quiet sleep, and the percentage of time spent in non-rapid eye movement (NREM) sleep is increased. Spindles become apparent by 1–3 months of age and are well developed and bisynchronous by 1–2 years of age. The spindles in the patient's first year of life may have a characteristic arciform or comb-like appearance and occur in prolonged and asynchronous trains. V waves are apparent by 3–5 months of age. In children from 2 to 5 years old, V waves have a high amplitude and a sharp or spiky appearance and occur in groups. O waves are large, broad, bioccipital delta waves that are present over the occipital regions during drowsiness



**Figure 11-7.** Normal burst of rhythmic slow waves during drowsiness in a 3½-year-old boy.

and sleep.<sup>18</sup> Occasionally they may have a somewhat sharply contoured monophasic or diphasic waveform.<sup>19</sup> Occipital slow waves are most prominent at 1–2 years of age but may persist to at least 6 years of age.

### Key Points

- During the first few months of life, the tracé alternant pattern is replaced by a generalized slow-wave pattern.
- Spindles become apparent by 1–3 months of age.
- Spindles may occur in prolonged and asynchronous trains.
- V waves become apparent by 3–5 months of age.
- Occipital slow waves (O waves) are most prominent at 1–2 years of age but can persist up to 5–6 years of age.

## BENIGN VARIANTS IN CHILDREN

Several benign variants can be seen in the EEGs of children and adolescents. These include the slow lambdas of youth, O waves, posterior slow waves of youth, and 14 and 6 Hz positive bursts.

### Posterior Slow Waves Associated with Eye Blinks or Slow Lambdas of Youth

A phenomenon similar to that of the lambda waves is the posterior slow waves associated with eye blinks in some children (*slow lambdas of childhood* or *shut-eye waves*). They are single, broad, and monophasic or diphasic waveforms that occur bilaterally over the occipital head regions after eye blinks or eye movements.<sup>20</sup> The amplitude is often 100–200  $\mu$ V, and the duration is approximately 200–400 ms. The predominant polarity is surface-negative. The waveform may have a sharp-contoured appearance, but it should not be misinterpreted as abnormal epileptiform activity. These waveforms can be seen in children who are between 6 months and 10 years old and are most prominent in those 2–3 years old.

## O Waves or Cone-Shaped Waves

In young children, high-voltage slow-wave transients, *O waves*, varying from a cone-shaped appearance to diphasic slow-wave transients may be present over the occipital head regions and interspersed with occipital dominant slow delta waves of sleep.<sup>19</sup> This activity should not be mistaken for abnormal sharp-wave or slow-wave activity.

## Posterior Slow Waves of Youth

Single delta frequency waves, referred to as *posterior slow waves of youth* or *slow fused transients*, are common over the posterior head regions in children and adolescents.<sup>18,19</sup> The posterior slow waves of youth occur sporadically rather than in consecutive trains, do not protrude much above the average amplitude of the alpha rhythm, and attenuate together with the alpha rhythm when the eyes are opened.

## 14 and 6 Hz Positive Spike Bursts

The *14 and 6 Hz positive spike bursts* consist of brief bursts or trains of positive spikes that occur during drowsiness at a rate of 14 and 6 Hz, mainly over the posterior temporal regions. They can be seen in children but are seen most often in adolescents<sup>5,21</sup> (see Fig. 8–13).

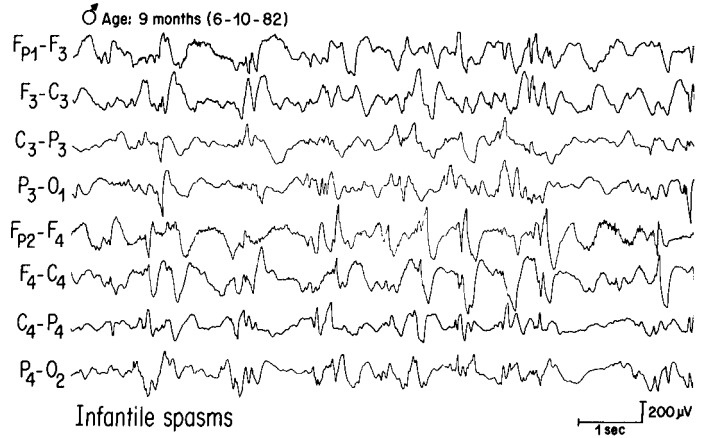
### Key Points

- Benign variants in children consist of
  - Posterior slow waves associated with eye blinks
  - O waves
  - Posterior slow waves of youth
  - 14 and 6 Hz positive spike bursts

## ABNORMALITIES

Electroencephalograms in children can show a wide variety of abnormalities. The most common are epileptiform abnormalities and slowing.



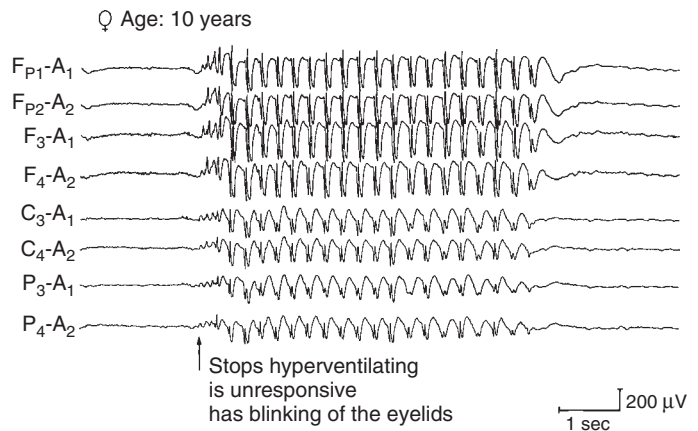


**Figure 11-8.** Hypsarrhythmia in a 9-month-old boy with infantile spasms.

### Epileptiform Abnormalities

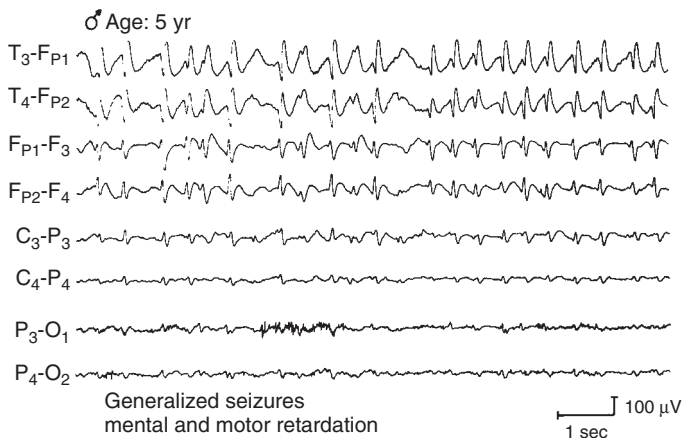
Almost any type of epileptiform abnormality can be seen in children. Some types of epileptiform abnormalities and associated seizure disorders are unique or seen more commonly in children.<sup>13,14,18,22</sup> The types of epileptiform abnormalities most common in children include the following:

1. *Hypsarrhythmia*—a pattern seen in children aged 4 months to 4 years. It consists of high-amplitude multifocal spikes, sharp waves, and slow waves. This type of epileptiform activity is often seen in association with infantile spasms<sup>11,14,21,23</sup> (Fig. 11-8). The combination of the hypsarrhythmia pattern and infantile spasms is referred to as the West Syndrome.
2. *3-Hz generalized spike-and-wave*—a pattern usually seen in children between 3 and 15 years old. It is associated with absence seizures<sup>11,21,24</sup> (Fig. 11-9).
3. *Generalized slow spike-and-wave*—a pattern consisting of generalized sharp- and slow-wave discharges seen in young children with frequent seizures and mental retardation and which constitutes the Lennox-Gastaut syndrome<sup>11,18,21,25</sup> (Fig. 11-10).
4. *Central-temporal spikes*—a pattern seen in children 4–12 years old. The spikes have a blunt spike-and-wave appearance. This pattern occurs in children with benign rolandic epilepsy of childhood (BREC)<sup>18,22,26</sup> (Fig. 11-11). The above epileptiform patterns are described more fully in Chapter 9.
5. *Occipital spikes and seizures*—a pattern seen in children with occipital lesions



**Figure 11-9.** Absence seizure accompanied by typical paroxysm of 3-Hz spike and slow-wave complexes during hyperventilation in a 10-year-old girl.



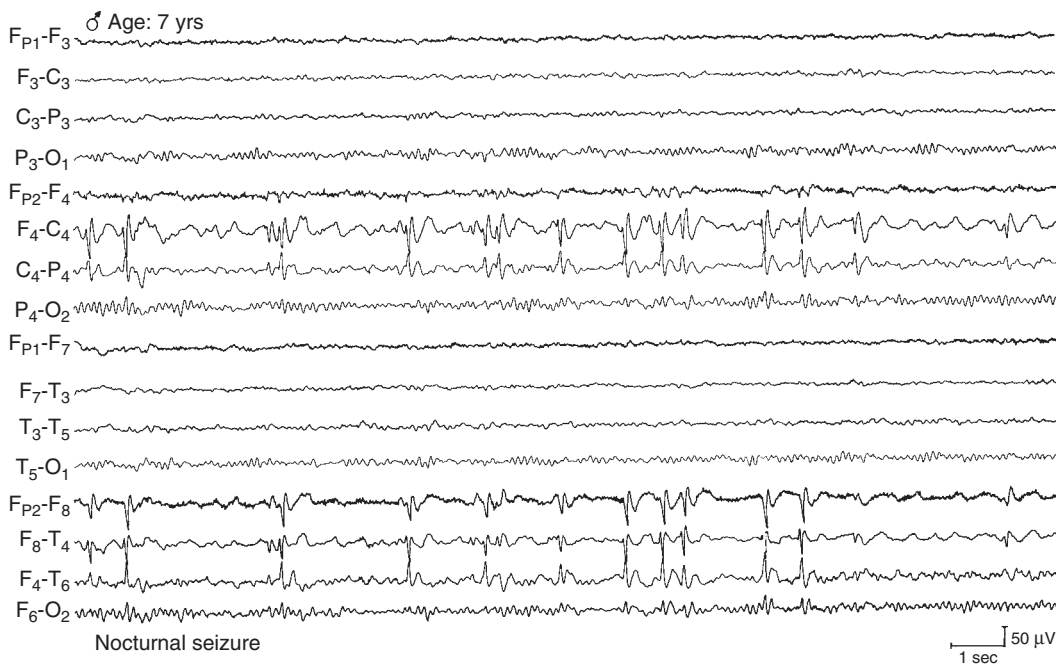


**Figure 11-10.** Slow spike-and-wave pattern (sharp- and slow-wave complexes) in a 5-year-old boy with seizures and mental retardation (Lennox-Gastaut syndrome).

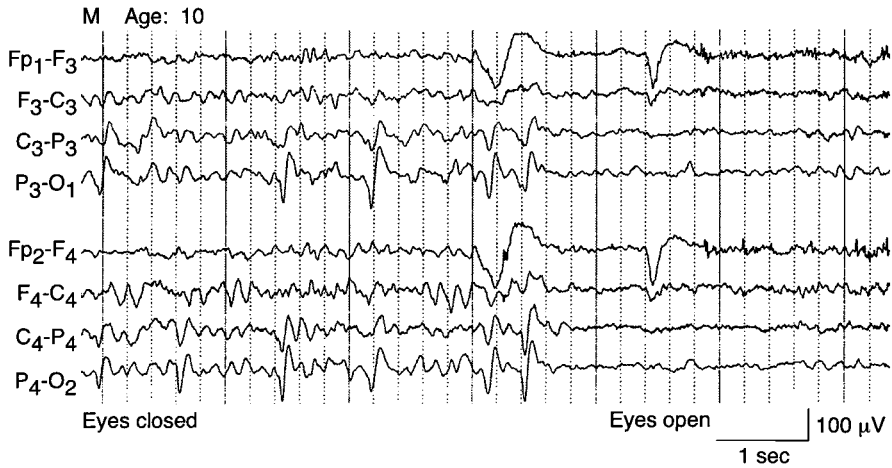
because of birth injury, vascular lesions, congenital malformations, cortical dysgenesis, Sturge-Weber syndrome, tuberous sclerosis, tumors, or trauma.<sup>11, 13, 14, 18, 22, 27, 28</sup>

Occipital spikes are also seen in the benign epilepsies of children with occipital paroxysms<sup>27, 28</sup> (Fig. 11-12). This is a seizure disorder associated with elementary visual phenomena; it may progress to secondarily generalized tonic-clonic seizures. The child may also

have nocturnal seizures with head and eye deviation, nausea, and vomiting. The seizures sometimes are followed by migraine headaches. The interictal EEG shows spike-and-wave discharges over the occipital head regions. These discharges occur in a unilateral, bilaterally independent, or bilaterally synchronous manner, are attenuated with eye opening, and reoccur with eye closure. Ictal discharges consist of low-voltage fast activity



**Figure 11-11.** Central-temporal spikes (maximal in C4 and T4) in a 7-year-old boy with a history of a single nocturnal seizure.



**Figure 11-12.** Occipital spike discharges attenuated with eye opening in a 10-year-old boy with benign occipital seizures of childhood.

over the occipital head regions, but it can spread more widely. The child often outgrows the seizures and the spike discharges.<sup>21,22,27,28</sup>

The Panayiotopoulos variant or syndrome consists of benign focal seizures of childhood associated with vomiting and other autonomic symptoms and multifocal spike discharges which are often maximal over the occipital or posterior head regions.<sup>27</sup>

Focal occipital spike discharges can also be seen in young children with amblyopia, without associated seizures.<sup>21,27,28</sup>

### Key Points

- Hypsarrhythmia occurs in infants with infantile spasms (West Syndrome).
- 3-Hz generalized spike-and-wave is seen in children with absence seizures.
- Generalized slow spike-and-wave is seen in children with frequent seizures and mental retardation (Lennox–Gastaut syndrome).
- Central-temporal spikes is seen in children with benign rolandic epilepsy of childhood.
- Occipital spikes can be seen in infants and children with occipital lesions, with benign epilepsy of childhood, or young children with amblyopia.

### Slow-Wave Abnormalities

Slow-wave abnormalities may be focal or diffuse and are often more prominent and take longer to resolve in children than in adults. Slow-wave abnormalities in children also tend to have maximal expression over the posterior head region.<sup>11,21</sup>

Occipital intermittent rhythmic delta activity (OIRDA) is also seen in children. This consists of intermittent rhythmic delta activity over the posterior head region which can be seen with a variety of conditions including epilepsy; metabolic, toxic, degenerative disorders; encephalopathies; posterior fossa tumors; and following head trauma.<sup>29</sup>

### Key Points

- Slow-wave abnormalities may consist of focal or generalized slowing or OIRDA.
- The slowing is often more prominent than seen in adults.
- The slowing is often maximal over the posterior head regions.

### Conditions Giving Rise to Abnormal EEG Patterns in Children

Electroencephalographic abnormalities can be seen in many disorders, including degenerative

disorders, inflammatory diseases, tumors, vascular insults, head trauma, and various types of encephalopathies. Transient abnormalities also occur with migraine headaches and postictal states.

## DEGENERATIVE DISORDERS

Degenerative disorders, various aminoacidurias, and inborn errors of metabolism may be associated with slowing and multifocal epileptiform abnormalities in the EEG, particularly if the child has seizures.<sup>2-11,13</sup>

The type of degenerative process and whether it involves the white or gray matter influences the EEG pattern. Processes that affect predominantly the white matter usually cause polymorphic delta slowing in the EEG. Epileptiform abnormalities are more common in gray matter disease but also can occur in white matter disease. Other factors influencing the degree and type of EEG abnormalities include the age of onset of the disease process, the age and state of the patient at the time of the EEG, the stage of the disease process, and other complicating factors, including infectious, metabolic, and drug effects.

### Gray Matter Disease

Gray matter disease such as the progressive myoclonic epilepsies is associated with generalized epileptiform abnormalities and slowing

in the EEG of patients following the onset of seizures.<sup>2,11,13,14,21</sup>

### White Matter Disease

White matter disease, including the various leukodystrophies, is associated with the loss of background activity and moderate- to high-amplitude delta slowing, which is often maximal over the posterior head regions<sup>2,11,18,21</sup> (Fig. 11-13).

#### Key Points

- Gray matter disorders are often associated with epileptiform activity.
- White matter disorders are associated with delta slowing.

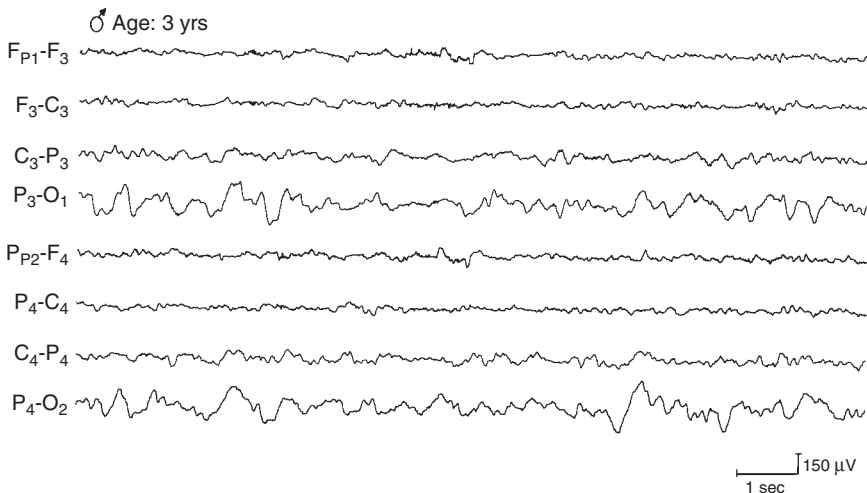
## INFLAMMATORY DISORDERS

### Meningitis

This is associated with differing degrees of slowing in the EEG depending on the type of meningitis and the degree of involvement of the CNS. Purulent meningitis is often associated with moderate-to-severe generalized slow-wave abnormalities, and epileptiform discharges may be present in patients who have seizures.<sup>18,30</sup>

### Encephalitis

The EEG abnormalities in encephalitis often are more severe than those in meningitis, with



**Figure 11-13.** Delta slowing over the posterior head regions in a 3-year-old boy with metachromatic leukodystrophy.

the EEG showing high-voltage arrhythmic or rhythmic delta slowing (see Fig. 10–6). Focal or multifocal epileptiform abnormalities may occur in patients who have seizures.<sup>30</sup>

*Herpes simplex encephalitis* can occur in infants and children. As in adults, PLEDs are a prominent feature in the EEG.<sup>10</sup> After resolution of the infection, the EEG may show localized areas of attenuation overlying cystic areas of the brain or multifocal epileptiform abnormalities or both.

*Rasmussen encephalitis*—a syndrome of chronic smoldering encephalitis, is characterized by progressive neurologic and intellectual deterioration and recurrent seizures.<sup>31,32</sup> The patients have varying types of seizures, which may progress to *epilepsia partialis continua*. The EEG shows various types of epileptiform and slow-wave abnormalities that occur in different locations during the different stages of the disease process. Often, Rasmussen encephalitis initially involves one hemisphere and then may spread more widely.

*Subacute sclerosing panencephalitis (SSPE)*—a slow virus disorder believed to be caused by the measles virus that occurs in children and adolescents, is associated with repetitive stereotyped high-voltage sharp- and slow-wave complexes that recur every 4 or 5 seconds and are associated with stereotyped motor jerks or spasms<sup>2,11,21,30</sup> (see Fig. 10–8).

### Brain Abscess

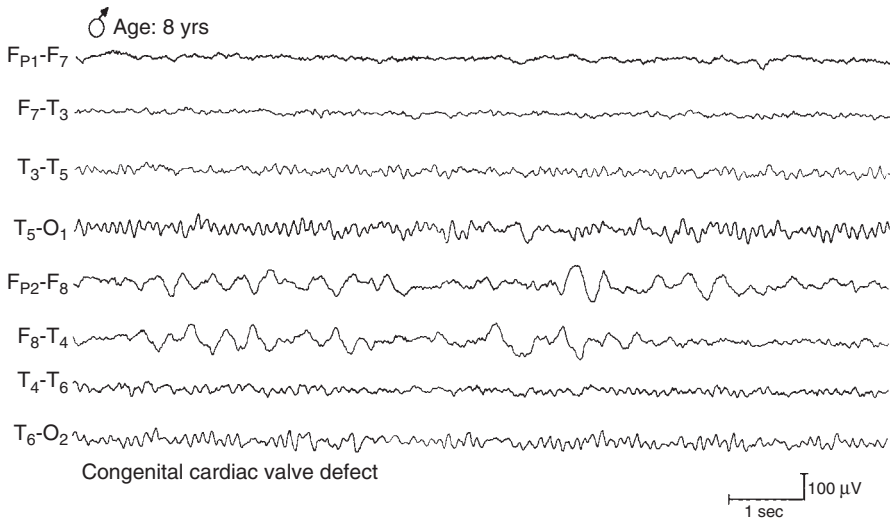
Focal polymorphic delta slowing is often present over the site of the abscess if the lesion is located close to the surface of the brain (Fig. 11–14). Although epileptiform abnormalities are not usually seen in acute stages, they may develop in the later stages of resolution of the abscess.<sup>30</sup>

### Key Points

- Meningitis and encephalitis are associated with generalized slowing in the EEG.
- Focal epileptiform abnormalities may be present in meningitis and encephalitis.
- Herpes simplex encephalitis is associated with PLEDs.
- Rasmussen encephalitis is associated with lateralized epileptiform abnormalities and slowing.
- SSPE is associated with periodic sharp- and slow-wave complexes.
- Brain abscesses are often associated with focal delta slowing, and epileptiform abnormalities may develop at a later stage.

### SUBDURAL EFFUSION AND EMPYEMA

Subdural effusions, hygromas, and empyemas act like subdural hematomas and cause an attenuation or decreased amplitude of activity and slowing over the involved hemisphere.<sup>30</sup>



**Figure 11–14.** Focal delta slowing over the right frontal region in an 8-year-old boy with a right frontal abscess.

## HEMICONVULSIONS, HEMIPLEGIA, AND EPILEPSY

In the *hemiconvulsions, hemiplegia, and epilepsy syndrome (HHE)*, the infant or child has a series of seizures or hemiconvulsive status epilepticus during an acute febrile illness. Following the acute episode of seizures the child has hemiparesis, and later, chronic epilepsy develops. In the acute stage of the syndrome, the EEG shows frequent or continuous spike discharges or spike-and-wave discharges over the involved side. After the acute stage, there is persistent attenuation of the EEG activity and slowing over the affected side. The child usually develops epilepsy after the acute event with focal, unilateral, or multifocal epileptiform discharges being present over the affected side.

### Key Points

- In HHE, the child has hemiconvulsive status during a febrile illness.
- The EEG shows frequent or continuous epileptiform activity over the involved hemisphere during the acute seizures.
- Later epileptiform activity, attenuation of activity, and slowing are seen over the affected side.

## TUMORS

The EEGs of children with tumors show a greater predominance of slow-wave abnormalities over the posterior head regions than those of adults with tumors. This may partly reflect two things: (1) children have a greater incidence of posterior fossa tumors than adults and (2) the predominance of slow-wave abnormalities over the posterior head region in children is an age-related phenomenon. In supratentorial tumors, the EEG shows focal or lateralized slow-wave abnormalities, asymmetry, or epileptiform activity over the involved area.<sup>11</sup>

### Key Points

- Tumors are associated with focal slow-wave abnormalities.
- Because of the frequency of posterior fossa tumors, the slowing may predominate over the posterior head regions.

## VASCULAR LESIONS

Vascular insults, including infarcts and hemorrhage, are less common in children than adults, but when present, they are associated with focal slowing and loss of background activity. PLEDs may be seen in the acute stage and focal epileptiform abnormalities in the chronic stage.<sup>11,21</sup>

### Key Points

- The EEG in vascular lesions may show slowing, loss of background activity, and epileptiform discharges.

## HEAD TRAUMA

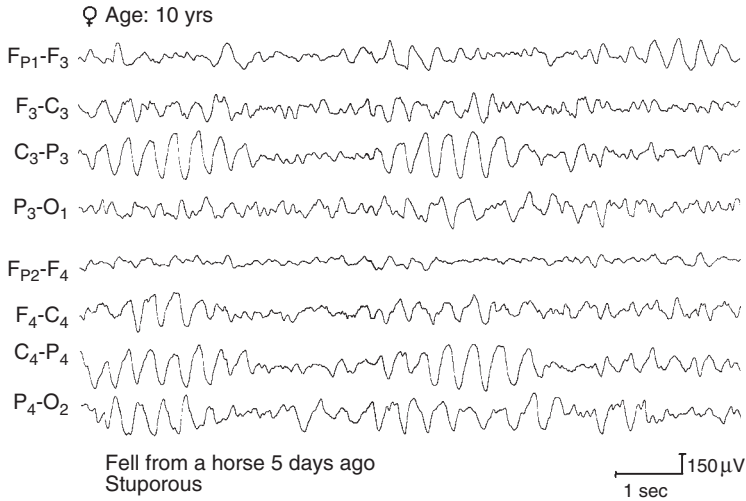
The EEG may show focal, lateralized, or generalized slow-wave abnormalities or an asymmetry of activity (or both slow-wave abnormalities and asymmetry) depending on the extent of the head injury (Fig. 11–15). The slow-wave abnormalities often are maximal over the posterior head regions. A moderate degree of slowing is not uncommon after relatively minor head injury, and slowing may be out of proportion to the degree of head injury.<sup>11,21</sup>

### Key Points

- The EEG in head trauma can show focal, lateralized, or generalized slow-wave abnormalities or asymmetry of activity.
- The slowing may be out of proportion to the degree of head trauma.

## HYDROCEPHALUS

The EEG abnormalities in patients with hydrocephalus may consist of focal or generalized slow-wave abnormalities, epileptiform abnormalities, asynchronous sleep activity, or asymmetry of the background activity. There may be an increase in the slow-wave and epileptiform abnormalities with obstructive hydrocephalus because of malfunction of the shunt (Fig. 11–16). The incidence of EEG abnormalities is higher in children who have had a ventricular shunt, and focal abnormalities are often present in the area of the shunt.



**Figure 11-15.** Moderate diffuse slow-wave abnormalities after head trauma in a 10-year-old girl.

**Key Points**

- Hydrocephalus may be associated with focal or generalized slow-wave abnormalities, asymmetry, and epileptiform discharges.
- Focal EEG abnormalities may be present in the area of the shunt.

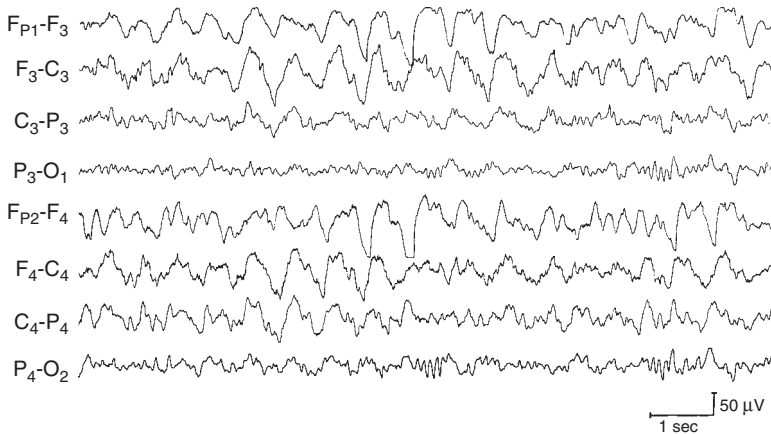
frequent spikes or sharp-wave discharges occurring focally or bilaterally and which are often maximal over the temporal or parietal occipital head regions (Fig. 11-17). There is a marked increase in the spike discharges during sleep. The discharges can become more widespread and continuous during slow-wave sleep.<sup>2,5,13,14,33</sup>

**LANDAU-KLEFFNER SYNDROME**

This is a disorder seen in children who develop acquired aphasia with loss of spontaneous speech, seizures, and epileptiform abnormalities on the EEG. The EEG typically shows

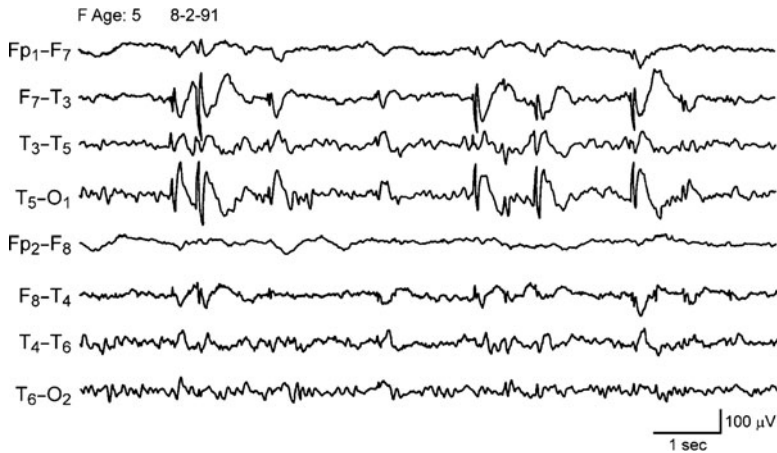
**Key Points**

- Landau-Kleffner syndrome consists of acquired aphasia and frequent epileptiform abnormalities on the EEG.



**Figure 11-16.** Intermittent rhythmic slow-wave abnormalities in a 12-year-old child with obstructive hydrocephalus with a blocked shunt.





**Figure 11-17.** Left temporal spike discharges in a 5-year-old child with Landau-Kleffner syndrome.

## Transient Abnormalities

### MIGRAINE HEADACHE

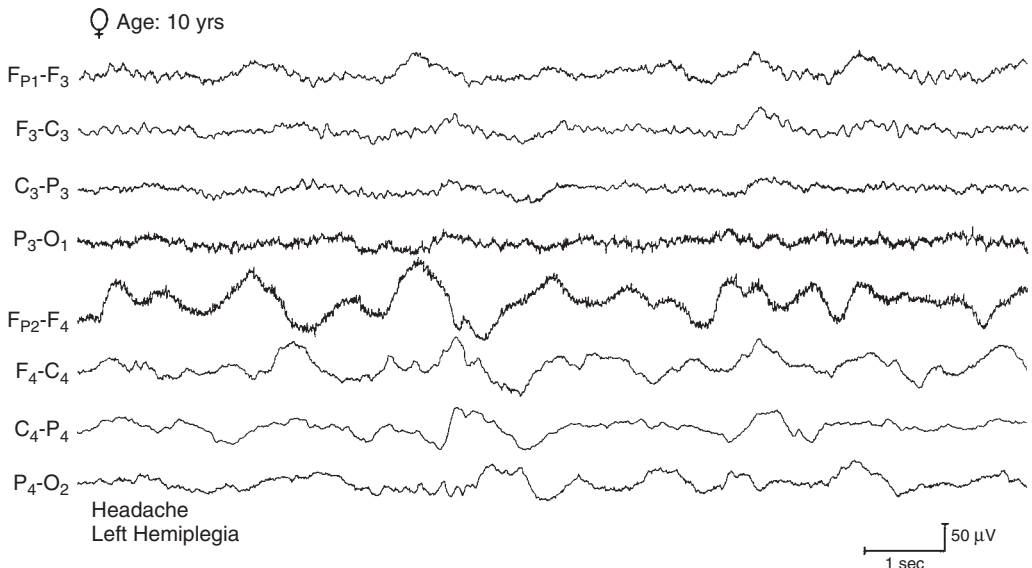
In between migrainous attacks, the EEG may show nonspecific abnormalities. During and after a migraine episode, asymmetry and focal, lateralized, or generalized slowing may be present. Slow-wave abnormalities are usually more prominent and widespread in children than in adults<sup>11,21</sup> (Fig. 11-18). The abnormalities may persist longer in children than in adults and may take up to a week to resolve.

### POSTICTAL SLOWING

Postictal slowing and attenuation of the background may be more prominent and persist longer in children than in adults.

#### Key Points

- The EEG in transient disorders such as migraine headache and in postictal states can show focal, lateralized, or generalized slowing and asymmetry of activity.
- Postictal slowing may persist longer and be more prominent in children than in adults.



**Figure 11-18.** Prominent delta slowing over the right hemisphere during a hemiplegic migrainous episode in a 10-year-old girl.



## SUMMARY

This chapter discusses the normal and abnormal EEG patterns in neonates, infants, and children. Because the EEG is a neurophysiologic test that reflects a disturbance of cerebral function, it is an important tool in evaluating infants and children. The EEG helps determine whether there is an underlying organic disorder, indicates the degree and extent of cerebral dysfunction, confirms or helps make the diagnosis of a specific disorder such as seizures, indicates whether there is a focal or generalized process, and, in certain instances, aids in determining the prognosis.

## REFERENCES

- American Electroencephalographic Society. 2006. Guideline two: Minimum technical standards for pediatric electroencephalography. *Journal of Clinical Neurophysiology* 23:92–6.
- Hahn, J. S., and B. R. Tharp. 2005. Neonatal and pediatric electroencephalography. In *Electrodiagnosis in clinical neurology*, ed. M. J. Aminoff, 5th ed., 85–129. New York: Elsevier Churchill Livingstone.
- Mizrahi, E. 2004. *Atlas of neonatal electroencephalography*. Philadelphia: Lippincott Williams & Wilkins.
- Scher, M. S. 2005. Electroencephalography of the newborn: Normal and abnormal features. In *Electroencephalography: Basic principles, clinical applications, and related fields*, ed. E. Niedermeyer, and F. Lopes da Silva, 5th ed., 937–90. Philadelphia: Lippincott Williams & Wilkins.
- Holmes, G. L., S. L. Moshé, and H. R. Jones. 2006. *Clinical neurophysiology of infancy, childhood, and adolescence*, 3–129. Philadelphia: Butterworth-Heinemann/Elsevier.
- Clancy, R. R., A. G. C. Bergqvist, and D. J. Dlugos. 2003. Neonatal electroencephalography. In *Current practice of clinical electroencephalography*, ed. J. S. Ebersole, and T. A. Pedley, 3rd ed., 160–234. Philadelphia: Lippincott Williams & Wilkins.
- Shewmon, D. A. 2000. Coma prognosis in children. Part II: Clinical application. *Journal of Clinical Neurophysiology* 17:467–72.
- Mizrahi, E. M., and P. Kellaway. 1998. *Diagnosis and management of neonatal seizures*. Philadelphia: Lippincott-Raven.
- Tharp, B. R. 2002. Neonatal seizures and syndromes. *Epilepsia* 43:2–10.
- Mizrahi, E. M., and B. R. Tharp. 1982. A characteristic EEG pattern in neonatal herpes simplex encephalitis. *Neurology* 32:1215–20.
- Niedermeyer, E., and F. Lopes da Silva, eds. 2005. *Electroencephalography: Basic principles, clinical applications, and related fields*, 5th ed. Philadelphia: Lippincott Williams & Wilkins.
- Westmoreland, B. F. 1999. The electroencephalogram in tuberous sclerosis. In *Tuberous sclerosis complex*, ed. M. R. Gómez, 3rd ed., 63–74. New York: Oxford University Press.
- Pellock, J. M., W. E. Dodson, and B. F. D. Bourgeois, eds. 2001. *Pediatric epilepsy. Diagnosis and therapy*, 2nd ed. New York: Demos.
- Wyllie, E., ed. 2006. *The treatment of epilepsy: Principles & practice*, 4th ed. Lippincott Williams & Wilkins.
- Kuzniecky, R. I. 2006. Malformations of cortical development and epilepsy, part 1: Diagnosis and classification scheme. *Reviews in Neurological Diseases* 3(4):151–62.
- Palmini, A. N. I., G. Avanzini, T. Babb, et al. 2004. Terminology and classification of the cortical dysplasias. *Neurology* 62:S2–8.
- Raymond, A. A., and D. R. Fish. 1996. EEG features of focal malformations of cortical development. *Journal of Clinical Neurophysiology* 13: 495–506.
- Blume, W. T., and M. Kaibara, eds. 1999. *Atlas of pediatric electroencephalography*. 2nd ed. Philadelphia: Lippincott-Raven.
- Kellaway, P. 2003. Orderly approach to visual analysis: Characteristics of the normal EEG of adults and children. In *Current practice of clinical electroencephalography*, ed. J. S. Ebersole, and T. A. Pedley, 3rd ed., 100–59. Philadelphia: Lippincott Williams & Wilkins.
- Westmoreland, B. F., and D. W. Klass. 1990. Unusual EEG patterns. *Journal of Clinical Neurophysiology* 7:209–28.
- Ebersole, J. S., and T. A. Pedley, eds. 2003. *Current practice of clinical electroencephalography*, 3rd ed. Philadelphia: Lippincott Williams & Wilkins.
- Loiseau, P. 2001. Benign focal epilepsies of childhood. In *The treatment of epilepsy: Principles and practice*, ed. E. Wyllie, 3rd ed., 475–84. Philadelphia: Lippincott Williams & Wilkins.
- Frost, J. D. Jr., and R. A. Hrachovy. 2003. *Infantile spasms*. Boston: Kluwer Academic Publishers.
- Hrachovy, R. A., and J. D. Frost Jr. 2006. The EEG in selected generalized seizures. *Journal of Clinical Neurophysiology* 23:312–32.
- Markand, O. N. 2003. Lennox–Gastaut syndrome childhood epileptic encephalopathy. *Journal of Clinical Neurophysiology* 20:426–41.
- Kellaway, P. 2000. The electroencephalographic features of benign centrotemporal (rolandic) epilepsy of childhood. *Epilepsia* 41:1053–6.
- Panayiotopoulos, C. P. 2005. *The epilepsies: Seizures, syndromes and management*. Oxfordshire, UK: Bladon Medical Publishing.
- Kivity, S., T. Ephraim, R. Weitz, and A. Tamir. 2000. Childhood epilepsy with occipital paroxysms: Clinical variants in 134 patients. *Epilepsia* 41: 1522–33.
- Watemberg, N., I. Linder, R. Dabby, L. Blumkin, and T. Lerman-Sagie. 2007. Clinical correlates of occipital intermittent rhythmic delta activity (OIRDA) in children. *Epilepsia* 48(2):330–4.
- Westmoreland, B. F. 2005. The EEG in cerebral inflammatory processes. In *Electroencephalography: Basic principles, clinical applications, and related fields*, ed. E. Niedermeyer, and F. Lopes

- da Silva, 5th ed., 323–37. Baltimore: Williams & Wilkins.
31. Andermann, F. ed. 1991. *Chronic encephalitis and epilepsy: Rasmussen's syndrome*. Boston: Butterworth-Heinemann.
32. Dubeau, F. 2006. Rasmussen's encephalitis (chronic focal encephalitis). In *The treatment of epilepsy: Principles & practice*, editor-in-chief E. Wyllie, 4th ed., 441–54. Philadelphia: Lippincott Williams & Wilkins.
33. Neville, B., and J. H. Cross. 2006. Continuous spike wave of slow sleep and Landau-Kleffner syndrome. In *The treatment of epilepsy: Principles & practice*, editor-in-chief E. Wyllie, 4th ed., 455–62. Philadelphia: Lippincott Williams & Wilkins.

*This page intentionally left blank*

# Ambulatory Electroencephalography

Jeffrey R. Buchhalter

## INTRODUCTION INDICATIONS TECHNOLOGY

### INTRODUCTION

Ambulatory electroencephalography (AEEG) is a clinical neurophysiology tool that is most useful when a diagnosis cannot be made on the basis of the clinical history, neurologic examination, and routine outpatient awake and sleep electroencephalographic (EEG) studies. Recently, AEEG has been used to define the frequency of epileptiform discharges in a nonepileptic population.<sup>1</sup> The advantages of AEEG include the ability to perform prolonged recording in the patient's natural environment and to record multiple cycles of sleep that have not been induced with medication. Also, the cost saving compared with the cost of inpatient evaluation is substantial. The utility of the specific type of study performed will be determined by the question being asked.<sup>2</sup> The technology has evolved from cassette tapes with limited memory capacity to digital systems with remounting capability, spike and seizure detection and extracerebral channels for recording heart rate, eye movements, oxygen saturation, respiratory excursion and video.

## CLINICAL APPLICATIONS SUMMARY

### *Purpose and Role of AEEG*

- AEEG provides a means of recording brain activity in a continuous fashion for a prolonged period of time in the outpatient setting in a cost-efficient manner.
- AEEG can define the etiology of an epileptic event, seizure classification, and localization.
- AEEG can have a high yield if patients are carefully selected for recording.

### INDICATIONS

Typically, the questions being asked relate to the potential epileptic etiology of an event (spell classification) in a patient with or without known seizures, the number of seizures that are occurring in the awake and sleep states (seizure quantification), determination of partial vs. generalized onset (seizure classification), and determining the precise region of seizure onset (ictal localization). The likelihood

of recording useful information depends on the clinical scenario that prompted the routine EEG and the frequency of the event. The following are situations in which AEEG may be indicated:

Clinical Scenario 1: Parents report that their 9-month-old child intermittently stiffens and stops breathing for 10 seconds within 2 or 3 hours after the onset of sleep each night. Routine EEG with sleep recording for 15 minutes is normal.

Clinical Scenario 2: Teachers report that a 6-year-old boy stares one or two times a day during school. A routine awake and sleep EEG is normal.

Clinical Scenario 3: A 27-year-old woman describes a numb feeling in her left arm and states that she "blanks out" three or four times a week. A routine awake and sleep EEG is normal.

Clinical Scenario 1 poses the problem of an infant who may have nocturnal seizures, intermittent aspiration, or respiratory obstructive disease. AEEG could clarify the event by demonstrating epileptiform abnormalities associated with the event or by recording the lack of chest wall movement and nasal airflow, with the use of additional polysomnogram channels, or by showing no abnormalities at all.

Clinical Scenario 2 describes the frequent problem of the "staring child." The differential diagnoses that could be refined by recording the event with AEEG in the classroom setting include normal daydreaming, complex partial seizures, and absence seizures. If the event is a seizure, precise quantitation is possible, as is the detection of subclinical (electrographic) seizures.

Clinical Scenario 3 could be caused by a complex partial seizure, a pseudoseizure, or cardiovascular or migraine phenomena. Recording the event with AEEG could demonstrate epileptiform abnormalities consistent with a seizure or suggest vascular insufficiency as indicated by focal or generalized slowing. If each event has onset in a discrete brain region (e.g., a temporal lobe), then this individual could be considered for further surgical evaluation if the seizures are refractory to antiepileptic medications.

## TECHNOLOGY

Although single-channel ambulatory cardiac monitoring was reported in 1949, it was not until the 1970s that the miniaturization of cassette recording allowed AEEG to become a reality. Devices capable of recording four channels of physiologic data were modified to record EEGs. The addition of preamplifiers reduced the noise level from 30 to 50  $\mu\text{V}$  to 5  $\mu\text{V}$ , so that EEG background activity and higher amplitude epileptiform transients could be distinguished from background noise.<sup>3</sup> The problem of prolonged playback times caused by the limited response time of mechanical pens was solved by adaptation of an inkjet printer that allowed playback of a 24-hour recording in 24 minutes. Thus, by 1980, it was possible to record four channels for 24 hours on a lightweight, analog cassette recorder. This system was used to quantify 3-Hz spike-wave discharges in children with childhood absence epilepsy, to lateralize EEG abnormalities, and to distinguish pseudoseizures from epileptic seizures.

However, substantial technical problems included limited spatial resolution and difficulty with artifact detection because of the limited number of channels, inability to reformat montages, and inferior recording characteristics when compared with those of standard hardwired systems. To estimate the effect of limited channels, a series of rigorous studies were performed in epilepsy patients undergoing standard inpatient EEG monitoring. The distribution of epileptiform discharges was determined,<sup>4</sup> the montage of the 4-channel AEEG was accordingly optimized,<sup>5</sup> and the detection of epileptiform abnormalities by the two techniques was compared.<sup>6</sup> It was found that even a limited number of recording channels could detect approximately 75% of the abnormalities. The subsequent introduction of an 8-channel system markedly improved the ability to identify artifacts and improved localization.<sup>7</sup> This was enhanced by the introduction of computerized, off-line analysis of the analog data. These algorithms were demonstrated to provide excellent detection of epileptiform rhythmic activity.<sup>8</sup>

Analog recording on cassettes was replaced by the application of digital, computer-based technology that has rendered the recording quality of AEEG comparable to that of

in-laboratory EEG. Since the initial report of this type of system,<sup>9</sup> an impressive array of commercially available products with various modifications have become available. All systems use digital recording that allows computer-based reformatting of the montage at the time of review. Basic recording features vary slightly between systems with regard to the number of recording channels (16–32), sampling rate (1–500 Hz), analog-to-digital conversion (12–22 bit), frequency bandwidth (DC–70 Hz), and common mode rejection of greater than 100 dB. Continuous recording can be performed from 24 to 60 hours depending on the battery life and data compression techniques used. Seventy-two hours of recording is possible if events or samples are stored in an intermittent rather than a continuous mode. Most systems incorporate epileptiform transient and seizure detection algorithms. Systems vary significantly with regard to the availability of pulse oximetry, specific channels for polysomnography, and simultaneous video recording. Clinical events are recorded in an event calendar and indicated by pushing an event marker button. One system provides an audio channel for the patient or attendant to indicate the time and nature of the event. The data are downloaded from the AEEG storage medium to a standard desktop personal computer (PC) on which proprietary software allows review with montage reformatting, ability to alter the filter and sensitivity settings, and analysis of detected events.

Simultaneous video to accompany the AEEG recording is not available on the majority of most commercially available systems. However, one manufacturer (Digitrace) has marketed a system with video for several years and another video option has recently become available (Lifelines Neurodiagnostic Systems, Inc.). In order for the video component to be useful, the patient must remain within the relatively small field of view of the portable camera. In an authoritative review of long-term monitoring in epilepsy, it was noted that no technology assessment exists for the use of video with AEEG.<sup>10</sup>

Despite the significant technical advances, several limitations of AEEG remain. Electrode stability cannot be assured in the home setting as it can be in the EEG laboratory or epilepsy monitoring unit. A trained EEG technologist or nurse can test the patient's response to the

external environment in a manner not feasible with AEEG. Also, the reduction or discontinuation of antiepileptic medication to facilitate seizure recording in the inpatient setting would not be safe in the home.

### **Key Points**

- Basic recording features of AEEG equipment vary with regard to the number of recording channels (16–32), sampling rate (1–500 Hz), analog-to-digital conversion (12–22 bit), frequency bandwidth (DC–70 Hz), and common mode rejection of greater than 100 dB.
- Despite the significant technical advances, several limitations of AEEG remain, such as electrode stability, which cannot be assured in the home setting as it can be in the EEG laboratory or epilepsy monitoring unit.

## **CLINICAL APPLICATIONS**

There are two fundamental types of clinical applications of AEEG. The first type is determining whether an event is of epileptic etiology (including persons with known seizures). Common examples include loss or impairment of consciousness, behavioral disturbances, motor phenomena, and sensory experiences.<sup>11</sup> The second type is in persons with known seizure disorders in which the AEEG may clarify partial vs. generalized onset, quantification of electrographic seizures, and localization of ictal onset for possible epilepsy surgery. The utility of AEEG is best demonstrated when comparison can be made with the same population previously (or simultaneously) studied with either routine awake and sleep EEG or inpatient, video-EEG recording. The following review highlights the applications noted above.

An early study with the 4-channel cassette recorder of 100 children and adults with temporal lobe epilepsy indicated that AEEG was at least three times more effective in recording a seizure than routine EEG.<sup>12</sup> Laterality, but not precise localization of the seizure focus, could be determined in many of the patients. Applications of AEEG in the pediatric population have included distinguishing epileptic from nonepileptic spells, predicting outcome after neonatal seizures, quantifying absence

seizures, and characterizing infantile spasms. An 8-channel system was used to study 95 infants and children who had clinically likely ( $n = 40$ ) or unlikely ( $n = 55$ ) seizures.<sup>13</sup> In the known seizure group, recorded seizures aided in the quantitation of seizure frequency. Ambulatory recordings captured events in 24 of the suspected pseudoseizure group and demonstrated no ictal EEG changes. A study of infants who had neonatal seizures demonstrated that a combination of findings on the routine EEG performed at the time of the seizure followed by subsequent AEEG predicted the risk of seizure recurrence at 4 months of age in 92% of infants.<sup>14</sup> This study showed how routine EEG and AEEG might complement each other.

To compare the utility of recording techniques in typical absence epilepsy, 25 children with this epilepsy syndrome had a routine awake EEG, followed by an 8-hour AEEG in the awake state.<sup>15</sup> These studies were repeated 1 month after the initiation of treatment. Although the initial prolonged study did not add to diagnostic accuracy, at 1 month, only four children had spike-wave abnormalities on the routine EEG and 10 children had epileptiform discharges on the AEEG despite having valproic acid levels in the therapeutic range. It appears that in this syndrome AEEG is very useful when the clinician and parents believe that seizures have been eliminated.

AEEG has been shown to provide diagnostic and prognostic information in children with infantile spasms. This severe symptomatic epilepsy syndrome of childhood is characterized by frequent clinical and electrographic seizures. In a cohort of 74 infants with infantile spasms, AEEG detected partial seizures in 51% in addition to the generalized spasms, and the partial seizures were associated with an unfavorable outcome.<sup>16</sup> This study contributed to the recognition that a generalized seizure disorder can be associated with focal seizures that indicate a relatively poor outcome. More recently, the utility of the computerized, 16-channel, digital AEEG with a seizure detection algorithm was demonstrated in a population of children to differentiate epileptic from nonepileptic events.<sup>17</sup> The seizure was detected by the computer only and not by clinical observation in 5 of 26 recordings.

One issue that remains unclear is how long ambulatory monitoring should be performed to

clarify the epileptic etiology of an event. This question was approached in a large study of 2221 patients (most of them adults).<sup>18</sup> AEEG recorded typical clinical events in approximately one-third of the study population. Of these patients, one-third had EEG findings that correlated with the ictus. The recording duration ranged from 1 to 8 days, with 90% of patients having an event within 2 days. This is the only study that provides information about the likely yield of AEEG monitoring with time, although interpretation is limited because of the lack of clinical information about the patients, thereby limiting the ability to predict who may benefit from more prolonged study. A related question is how the frequency of events relates to the likelihood of recording one using AEEG. Some insight is gained by a study of 157 children who reported having discrete events at least 3 days per week.<sup>19</sup> In this population, 89% of the patients had typical events during 1–4 days of study of which 76% were nonepileptic.

Relatively few recent investigations have directly compared routine EEG and AEEG. In a study of 344 patients, 16-channel, computer-assisted AEEG proved “clinically useful” (defined as detecting an epileptiform abnormality or recording clinical event that did not have an epileptiform EEG correlate) in 74% of the study population.<sup>20</sup> A similar proportion (67%) of AEEG studies was useful in 191 patients who had normal or nonspecific routine EEG recordings. A subsequent investigation revealed that management was affected directly by the results of the 16-channel AEEG recording in approximately 80% of the patients referred.<sup>21</sup>

The utility of AEEG in quantifying seizures was demonstrated by a study that analyzed 595 recordings of which 47 demonstrated partial seizures.<sup>22</sup> Sixty-two percent of the seizures were noted by the patients as indicated by push buttons and/or diary entries. However, 11 seizures (23%) were not noted or recorded by the patient. These findings provide a clear indication of how frequently patients underestimate seizure occurrence. The implication is that if the clinical suspicion is high, the clinician may wish to request an AEEG even if the reported event frequency may appear to make the likelihood of recording an event low.

A potential application of AEEG is the detection of abnormalities that occur during



sleep. A recent study compared the detection of abnormalities in routine sleep-deprived EEGs vs. AEEG in patients with normal or nonspecific awake recordings.<sup>23</sup> Approximately the same percentage of interictal epileptiform transients was found by both techniques during sleep. However, whereas the sleep-deprived EEG recorded no seizures, the AEEG recorded seizures in 15% of patients. Furthermore, for approximately half of the seizures, patients did not indicate awareness of their seizures by activating a push button. This study highlights the value of prolonged recording and seizure detection algorithms.

The role of AEEG in the selection of candidates for epilepsy surgery is evolving. As noted above, the early 4-channel system did not provide the necessary localizing information.<sup>6</sup> Similar results were found in a study in which an 8-channel AEEG recording with sphenoidal electrodes was compared directly with a standard 16-channel recording in an inpatient population undergoing study for epilepsy surgery.<sup>24</sup> The AEEG system was comparable to the standard system for hemispheric lateralization, but it was not as reliable for precise localization of seizure onset. However, it has been suggested that the use of AEEG systems with at least 16 channels in a carefully selected population of patients may provide the necessary information to proceed directly to epilepsy surgery without inpatient electrophysiologic evaluation.<sup>25</sup> A report of seven patients who had nonlesional temporal lobe epilepsy, resection based upon only AEEG recording and excellent outcome is supportive of this approach.<sup>26</sup> The authors were careful to note the small number of patients involved in this retrospective study and that AEEG cannot be used in circumstances that would compromise the safety of the patient, for example, when the dose of an antiepileptic drug is decreased to facilitate the recording of seizures or when intracranial electrodes are required.

In the future, the technology developed for AEEG may be utilized for seizure intervention.<sup>27</sup> This presumes a “closed loop” system in which the detection or anticipation of an ictal onset in the near or immediate future will lead to an intervention such as direct stimulation of the brain to depolarize the susceptible cortex or local infusion of an immediate acting antiepileptic compound.

### Key Points

- AEEG is an effective tool for determining the possible epileptic etiology of events involving alterations in conscious, behavioral, sensory, and motor activity when sufficient information has not been obtained from routine awake and sleep EEG.
- AEEG is also useful in the classification, quantification, and localization of seizures.
- Technical barriers to high-quality recording have been eliminated by computer-assisted digital systems with seizure detection algorithms.
- Out-of-hospital AEEG should not be used when the dose of medication is decreased or intracranial electrode implantation is required.
- AEEG is likely to provide substantial cost savings compared with the cost of misdiagnosis of nonepileptic events, inappropriate medication use, physician utilization, and inpatient EEG evaluation, but these have not been evaluated formally.

### SUMMARY

Ambulatory EEG (AEEG) can provide a cost-efficient means of recording prolonged, continuous EEG in the outpatient setting. The quality of digital systems is comparable to in-lab recording—number of available channels, sampling rate, frequency bandwidth, sharp transient/seizure detection algorithms, and the ability to reformat studies. AEEG is an effective technology to distinguish epileptic from non-epileptic events in addition to classification, quantification, and localization of seizures. Limitations of the technique are the inability to immediately secure loose electrodes and to decrease antiepileptic drugs without direct observation by EEG technologists and nursing personnel.

### REFERENCES

1. Schachter, S. C., M. Ito, and B. B. Wannamaker, et al. 1998. Incidence of spikes and paroxysmal rhythmic events in overnight ambulatory computer-assisted EEGs of normal subjects: A multicenter study. *Journal of Clinical Neurophysiology* 15:251–5.

2. Schomer, D. L. 2006. Ambulatory EEG telemetry: How good is it? *Journal of Clinical Neurophysiology* 23:294–305.
3. Ives, J. R. 1975. 4-Channel 24 hour cassette recorder for long-term EEG monitoring of ambulatory patients. *Electroencephalography and Clinical Neurophysiology* 39:88–92.
4. Leroy, R. F. and J. S. Ebersole. 1983. An evaluation of ambulatory, cassette EEG monitoring: I. Montage design. *Neurology* 33:1–7.
5. Ebersole, J. S. and R. F. Leroy. 1983. An evaluation of ambulatory, cassette EEG monitoring: II. Detection of interictal abnormalities. *Neurology* 33:8–18.
6. Ebersole, J. S., and R. F. Leroy. 1983. Evaluation of ambulatory cassette EEG monitoring: III. Diagnostic accuracy compared to intensive inpatient EEG monitoring. *Neurology* 33:853–60.
7. Ebersole, J. S., and S. L. Bridgers. 1985. Direct comparison of 3- and 8-channel ambulatory cassette EEG with intensive inpatient monitoring. *Neurology* 35:846–54.
8. Koffler, D. J., and J. Gotman. 1985. Automatic detection of spike-and-wave bursts in ambulatory EEG recordings. *Electroencephalography and Clinical Neurophysiology* 61:165–80.
9. Ives, J. R., N. R. Mainwaring, and D. L. Schomer. 1992. An 18-channel solid-state ambulatory EEG event recorder for use in the home and hospital environment (abstract). *Epilepsia* 33(Suppl. 3):63.
10. Velis, D., P. Plouin, J. Gotman, and F. L. da Silva. 2007. Neurophysiology IDSo. Recommendations regarding the requirements and applications for long-term recordings in epilepsy. *Epilepsia* 48:379–84.
11. Gilliam F., R. Kuzniecky, and E. Faught. 1999. Ambulatory EEG monitoring. *Journal of Clinical Neurophysiology* 16:111–15.
12. Ives J. R., and J. F. Woods. 1979. A study of 100 patients with focal epilepsy using a 4-channel ambulatory cassette recorder, ISAM 1979: Proceedings of the third international symposium on ambulatory monitoring. London: Academic Press.
13. Aminoff, M. J., D. S. Goodin, B. O. Berg, and M. N. Compton. 1988. Ambulatory EEG recordings in epileptic and nonepileptic children. *Neurology* 38:558–62.
14. Kerr, S. L., D. W. Shucard, M. H. Kohrman, and M. E. Cohen. 1990. Sequential use of standard and ambulatory EEG in neonatal seizures. *Pediatric Neurology* 6:159–62.
15. de Feo, M. R., O. Mecarelli, G. Ricci, and M. F. Rina. 1991. The utility of ambulatory EEG monitoring in typical absence seizures. *Brain & Development* 13:223–7.
16. Plouin, P., O. Dulac, C. Jalin, and C. Chiron. 1993. Twenty-four-hour ambulatory EEG monitoring in infantile spasms. *Epilepsia* 34:686–91.
17. Foley, C. M., D. K. Miles, A. Legido, and W. Grover. 1993. Diagnostic value of computerized outpatient long-term EEG monitoring in children and adolescents (abstract). *Epilepsia* 34(Suppl. 6):139.
18. Tuunainen, A., U. Nousiainen, E. Mervaala, and P. Riekkinen. 1990. Efficacy of a 1- to 3-day ambulatory electroencephalogram in recording epileptic seizures. *Archives of Neurology* 47:799–800.
19. Olson, D. M. 2001. Success of ambulatory EEG in children. *Journal of Clinical Neurophysiology* 18:158–61.
20. Morris, G. L. III, J. Galezowska, R. Leroy, and R. North. 1994. The results of computer-assisted ambulatory 16-channel EEG. *Electroencephalography and Clinical Neurophysiology* 91:229–31.
21. Morris, G. L. 1997. The clinical utility of computer-assisted ambulatory 16 channel EEG. *Journal of Medical Engineering & Technology* 21:47–52.
22. Tatum, W. O. T., L. Winters, and M. Gieron, et al. 2001. Outpatient seizure identification: Results of 502 patients using computer-assisted ambulatory EEG. *Journal of Clinical Neurophysiology* 18:14–9.
23. Liporace, J., W. T. Tatum, G. L. Morris III, and J. French. 1998. Clinical utility of sleep-deprived versus computer-assisted ambulatory 16-channel EEG in epilepsy patients: A multi-center study. *Epilepsy Research* 32:357–62.
24. Tuunainen, A., and U. Nousiainen. 1993. Ictal recordings of ambulatory cassette EEG with sphenoidal electrodes in temporal lobe epilepsy: Comparison with intensive videomonitoring. *Acta Neurologica Scandinavica* 88:21–5.
25. Schomer, D. L., J. R. Ives, and S. C. Schachter. 1999. The role of ambulatory EEG in the evaluation of patients for epilepsy surgery. *Journal of Clinical Neurophysiology* 16:116–29.
26. Chang, B. S., J. R. Ives, D. L. Schomer, and F. W. Drislane. 2002. Outpatient EEG monitoring in the presurgical evaluation of patients with refractory temporal lobe epilepsy. *Journal of Clinical Neurophysiology* 19:152–6.
27. Waterhouse, E. 2003. New horizons in ambulatory electroencephalography. *IEEE Engineering in Medicine & Biology Magazine* 22:74–80.

# Prolonged Video Electroencephalography

*Cheolsu Shin*

## INTRODUCTION

## EQUIPMENT

## CLINICAL APPLICATION

Epileptic Vs. Nonepileptic Events

Psychogenic Seizures or

Nonepileptic Behavioral Events

Classification of Seizure Type

PVEEG and Surgical Evaluation

## SUMMARY

## INTRODUCTION

Prolonged video electroencephalography (PVEEG) has become an essential tool in the evaluation of patients with epilepsy and other paroxysmal or episodic events.<sup>1-3</sup> Often, the clinical history alone is not adequate for making an accurate diagnosis, partly because of inadequate observer history—the patients frequently are unaware and have to report a second-hand history that usually is sketchy at best. Even with activation procedures such as sleep, sleep deprivation, hyperventilation, and photic stimulation, epileptiform abnormalities may not appear on routine electroencephalographic (EEG) recordings, which may last an hour at most. Accurate diagnosis often requires capturing the clinical spell in conjunction with simultaneous electrophysiologic and behavioral monitoring. PVEEG allows behavioral correlation of the patient's clinical spells with the EEG. The most experienced examiners may miss subtle or even obvious clinical

manifestations of seizures when they view the event only once. Capturing the seizure on video allows repeated review of the event and comparison with subsequent events. PVEEG provides physicians and allied health staff an extended period of observation that is often helpful in searching out psychosocial issues that may contribute to the patient's condition.

PVEEG can be used to differentiate epileptic from nonepileptic events, and it can help classify seizure type. PVEEG is also important in localizing the epileptogenic region in patients being considered for epilepsy surgery. With modifications of this technique, neonates, infants and children, patients in intensive care units, and patients with other episodic events such as sleep disorders can be evaluated. This chapter describes various techniques of PVEEG and discusses its clinical applications.

In 1949, Hunter and Jasper,<sup>4</sup> Schwab et al.,<sup>5</sup> and Stewart et al.<sup>6</sup> described systems for cinematographic and EEG recordings. The early split-screen systems used mirrors to record

simultaneously the patient's behavioral manifestations and the EEG. They were bulky and could record only 1 hour of cinema before the film reel had to be changed, making the systems quite impractical. The development of the videotape player and more compact camera units led to greater acceptance of the procedure. Even today, a simple prolonged EEG can be obtained using a video camcorder and a standard EEG. An obvious disadvantage of this technique is that paper must be printed for the entire monitoring session. Currently, video EEG units with digitally encoded EEG stored on a computer system or the videotape itself are commercially available from many sources. Most systems use telemetered EEG with either cable or radio telemetry and remote control video cameras, allowing relatively free movement of patients in the monitoring unit.

### **Purpose and Role of Prolonged Video EEG**

- Video and EEG correlation of the paroxysmal events for diagnosis of epileptic vs. nonepileptic conditions.
- Classification of seizure types.
- Localization of seizure onset zone for epilepsy surgery.

## **EQUIPMENT**

The variability among the PVEEG systems used in laboratories throughout the world is considerable because of the different manufacturers.<sup>7</sup> Each manufacturer uses custom-designed hardware and software to encode and decode the EEG signal during acquisition and analysis. This makes it difficult to exchange the raw EEG data between different systems. Miniaturization of electronics and computer equipment allows PVEEG on an outpatient basis because the patient and family can easily transport the system. This can be used for patients with frequent events that may not require detailed testing by medical personnel.<sup>8</sup> However, in most patients, PVEEG is performed in an inpatient epilepsy unit where trained medical personnel provide continuous surveillance along with video and EEG monitoring.

Currently, several systems are available commercially for PVEEG. Older versions used a VHS video system with either multiplexed

EEG recorded on one of the audio channels or a system that records the EEG digitally on the videotape or a computer with time synchronization. Most new systems utilize all digital formats for both video and EEG signals. However, there are pitfalls to be aware of even with digital signal processing.<sup>9</sup> All digital does not always mean all correct. Although the digitization may be accurate, display of the EEG tracing is on the computer monitor that has limited resolution. Sometimes, it is necessary to review 5-second epochs instead of the usual 10-second epochs to allow for correct representation of higher frequency signals on the monitor. There may also be artifacts of digitization such as aliasing of the signal. This can be dealt with through the use of the antialiasing filter, but manufacturers may differ in some of these details. In cases of intracranial monitoring, the simultaneous display of large number of channels up to 128 make it difficult to see the low-amplitude, fast-frequency signals. In those circumstances, reviewing select number of channels in different subgroups is necessary.

Infrared cameras are used at night to achieve reasonable quality video recording even in a darkened room. The patient may be connected to the recording equipment with a long EEG cable or the EEG data may be sent through a radio transmitter. With cable telemetry, patients have limited mobility. However, the technical quality of cable or hardwired systems is usually superior to that of radiotelemetered systems. With radiotelemetry, patients have greater mobility, which may or may not be an advantage given the circumstances of a patient's seizures, seizure frequency, and severity.

With rapidly advancing computer and networking technology, both in hardware and in software, most systems now use digital technology at least for EEG signal processing. EEG data can be stored on optical disks or other computer storage devices. The cost of these digital PVEEG systems can be high, but because of their superior recording, data processing, and analysis capabilities, they are gaining wider acceptance as an industry standard. Digital PVEEG allows online processing of EEG activity, with automatic detection of seizures and interictal epileptiform activity.<sup>10,11</sup> Many software programs are available for this online detection, but all of them require verification off-line because movement artifacts or rhythmic or sharp sleep transients can

trigger the detection paradigm.<sup>12,13</sup> Montage reformatting, filtering, frequency analysis, timing analysis, and correlation studies can be performed off-line with these systems. The ability to analyze a single seizure carefully in many ways and to view it with several different montages has decreased the number of actual seizures that need to be recorded. Because of the risks involved in recording seizures and in tapering seizure medications and the expense of the procedure, it is important to obtain as much information from as few seizures as possible.

Video signals are also being digitized for network transmission as well as for digital storage. This enables remote monitoring of patients, for example, from an intensive care unit, and the monitoring includes both video and EEG. However, because video signals are such large data sets, a larger and faster capacity network system is necessary for online access and the quality of the video may be inferior to that of an analog video system. One could also monitor digital EEG data online through the internet access as long as the hospital information technology system insures security of the network access. Video signal online again requires very high capacity network and therefore is of poor quality through the internet. These problems are likely to be overcome with rapidly advancing technology.

Portable PVEEG systems can also be used in intensive care units, neonatal units, and psychiatric facilities. These portable systems can be helpful in capturing events that are too infrequent to be seen on routine EEG but do not need online monitoring. The systems can include a video camera and recorder synchronized to the EEG. The data are analyzed off-line later, as in PVEEG monitoring of outpatients.

Most of these systems are designed so that continuous video EEG monitoring can proceed without the continuous attendance of technical personnel. However, most inpatient PVEEG monitoring units have technical personnel dedicated to monitoring several patients continuously around the clock. The personnel perform essential functions such as testing and examining patients during and after the seizure or spell and operating remote control cameras to focus or zoom in on the patient, and they ensure high-quality EEG recordings by repairing faulty electrodes or connections. Also, the technical personnel can recognize

subtle or subclinical electrographic seizures and test the patient during the seizure and alert the treatment team to possible status epilepticus when overt clinical activity may not be obvious. Competent technical personnel are essential for conducting specialized tests such as ictal single-photon emission computed tomography (SPECT), in which it is vital to recognize the seizure rapidly, either by behavior or by EEG.

### **Key Points**

- Progress in digital equipments and data processing has led to a major improvement in PVEEG, but there are pitfalls in digital analysis to be aware of.
- Competent technical personnel in attendance for inpatient PVEEG is essential for high-quality data acquisition as well as testing of patients during the paroxysmal events.

## **CLINICAL APPLICATION**

### **Epileptic Vs. Nonepileptic Events**

PVEEG often can help answer the fundamental question of whether a spell is an epileptic event.<sup>14</sup> Many different paroxysmal events can mimic seizures clinically. Distinguishing epileptic and nonepileptic events is critical for determining effective therapy, because anti-seizure medications are rarely beneficial for conditions other than seizures and have potentially significant risks.

Recurrent episodes of loss of consciousness can result from various nonepileptic causes, including syncopal attacks from aortic stenosis, cardiac arrhythmias, vasovagal depression, orthostatic hypotension, and hyperventilation. Vertigo and nonspecific dizzy spells may also be difficult to differentiate from seizures clinically. PVEEG with simultaneous electrocardiography (ECG) and blood pressure monitoring may help to delineate the nonepileptic nature of these events. Rarely, cardiac arrhythmias can be triggered by an epileptic discharge (ictal syncope); this can be documented by PVEEG.

Various movement disorders can be confused with seizures. Simultaneous surface electromyographic (EMG) recording of agonist and antagonist muscles with continuous EEG



recording can be helpful in diagnosing movement disorders and ruling out an epileptic cause.

Sleep disorders and seizures may be confused with one another. PVEEG allows behavior to be correlated with the EEG and other variables such as respiration, eye movements, surface EMG, ECG, and oxygen saturation. PVEEG may also help differentiate transient ischemic attacks, hypoglycemic attacks, and migraine attacks from seizures. Blood glucose monitoring can be performed at the time of the attacks to rule out hypoglycemia.

PVEEG can be especially helpful in differentiating types of childhood spells. Daydreaming, breathholding, migraines, night terrors, and other parasomnias can be confused with seizures. Occasionally, nocturnal epileptic seizures are misdiagnosed clinically as physiologic parasomnias. Although outpatient monitoring under the supervision of parents may be adequate for classifying these types of spells, inpatient setting usually yields more reliable data.<sup>15</sup>

Repetitive motor activities are common in patients with altered mental status in intensive care units. Many of these movements are manifestations of underlying cerebral or spinal lesions or reflections of toxic and metabolic derangement. However, some of these movements may represent epileptic events, possibly subtle status epilepticus, which would explain the altered mental status. Because untreated generalized status epilepticus can cause permanent neuronal damage, this possibility needs to be kept in mind and pursued for appropriate diagnosis and treatment with antiseizure medications. PVEEG with a portable system or online remote monitoring can be helpful in diagnosing these movements.

### Key Points

- There are nonepileptic and nonpsychogenic causes to many paroxysmal events that can be diagnosed with PVEEG.

## Psychogenic Seizures or Nonepileptic Behavioral Events

Psychogenic seizures are a difficult diagnostic problem.<sup>16,17</sup> Accurate diagnosis of psychogenic seizures can lead to appropriate

psychiatric treatment and discontinuation of unnecessary and potentially dangerous medical therapy. PVEEG may be advantageous economically in the diagnosis and treatment of psychogenic seizures, because patients with such a condition consume a significant amount of medical resources, including the costs of repeated visits to the emergency department.<sup>18</sup> In most cases, psychogenic seizures are not under conscious control. Factitious disorders, such as Munchausen's syndrome or actual willful malingering, are rare. Gates and colleagues<sup>19</sup> compared the clinical manifestations of psychogenic generalized tonic-clonic events with those of true generalized tonic-clonic seizures and found that out-of-phase clonic movements of the extremities, pelvic thrusting, lack of eye manifestations, side-to-side head movements, and early vocalizations were more common in the psychogenic group. Psychogenic seizures also tend to last longer than 2 minutes; patients with psychogenic seizures often have long attacks, with frequent rest periods during attacks. Also, these patients often respond to some degree to verbal or noxious stimulation during the generalized movements. However, caution is needed in making a clinical judgment on the basis of the history alone, because many of these ictal features can occur in epileptic seizures, especially ones with an extratemporal focus.<sup>20</sup>

Although a spectrum of psychiatric diagnoses are represented in patients with psychogenic seizures and as many as one-third of them have a history of sexual or physical abuse or assault, some may not have any easily identifiable psychiatric or psychologic problem. In addition, these psychiatric and psychologic factors are also associated with patients with epilepsy. To complicate matters further, some epileptic patients also have psychogenic seizures, and in some series, 10%–40% of patients with psychogenic seizures also had epileptic seizures.<sup>21</sup> Therefore, the correlation of each type of ictal event with the EEG is essential to exclude epilepsy as a cause.

PVEEG allows careful analysis of behavioral and EEG manifestations in patients with psychogenic seizures. Muscle and movement artifacts are usually prominent, but there is no ictal EEG change. After the movement stops, the normal background EEG usually returns immediately. Postictal slowing and suppression

of the EEG, which are typically present after a true generalized tonic-clonic seizure, do not occur after a psychogenic seizure. A caveat is that the patient needs to be tested during the ictal events to assess the responsiveness and memory processing. If there is no alteration of consciousness, the possibility of a simple partial seizure cannot be ruled out. Surface EEG changes may not be seen with the simple partial seizures, and this may be true of the majority of cases.<sup>22</sup>

The timing of the spells is also helpful information because psychogenic seizures are more likely to occur during the day. If they occur at night, it is during wakefulness. Although some patients may claim that the spells occur out of sleep, they invariably wake up first (as shown by the change in EEG pattern from sleep to wakefulness) and then have the spell.<sup>23</sup> Epileptic seizures during sleep tend to occur directly out of sleep, without intervening wakefulness. Laboratory studies on changes in the serum levels of prolactin or neuron-specific enolase can corroborate the PVEEG studies.<sup>24,25</sup> Epileptic generalized tonic-clonic seizures or complex partial seizures—but not psychogenic seizures—are associated with a significant increase in the levels of these substances above the baseline values for that patient.

Induction or provocation of psychogenic seizures is a matter of controversy.<sup>26</sup> Certain triggering situations can be used if the historical information about the reliable triggering factors is clear. Some clinicians have used saline injections or a tuning fork with a strong suggestion that a seizure will occur. However, to interpret the results, it has to be verified that the induced spell is the same type as the noninduced spell.

### Key Points

- PVEEG is necessary for the accurate diagnosis of nonepileptic behavioral spells.
- In many patients, nonepileptic behavioral spells coexist with epileptic seizures, making it important to analyze all different spell types.
- Correct diagnosis of nonepileptic behavioral spells using PVEEG allows for more efficient and appropriate care of these conditions.

## Classification of Seizure Type

PVEEG may lead to a reclassification of the seizure type in many patients with uncontrolled seizures, especially if the diagnosis is in question, thus improving medical management.

Distinguishing primary generalized from secondary generalized seizures is often difficult only on the basis of the clinical history and routine EEG. Some patients have rapid secondary spread and may have an interictal EEG that shows generalized spike-and-wave discharges (secondary bilateral synchrony). However, ictal recording may demonstrate that seizure onset is focal. Other patients with true absence or true generalized tonic-clonic seizures may mistakenly be thought to have focal epilepsy, because of the asymmetrical manifestation of generalized discharges. By clinical history alone, absence seizures may be indistinguishable from complex partial seizures. In virtually all patients with untreated absence seizures, hyperventilation will activate 3-Hz spike-and-wave discharges. The diagnosis may be more difficult to make in patients with infrequent spells or those taking medication and may benefit from PVEEG. Medications can be tapered when the patient is in the hospital and being carefully observed.

Monitoring can also help to differentiate temporal from extratemporal seizures.<sup>27-29</sup> Many patients with simple partial seizures have no EEG accompaniment. However, most patients with complex partial seizures have an ictal EEG change. Temporal lobe seizures often begin with an attenuation of scalp activity, followed by a rhythmic discharge, usually in the theta range that increases in amplitude and becomes more widespread. Postictally, a focal slowing often occurs over the temporal region where the seizure began. Tachycardia is observed in most patients with complex partial seizures of temporal lobe origin, even before any significant motor activity is apparent. Lateralized ictal posturing of the upper extremity contralateral to the ictal onset is observed with many seizures of temporal onset.<sup>30</sup> Also, there is forced turning of the head away from the ictal focus just before secondary generalization.<sup>31</sup> Postictally, there may be paresis or neglect on the side contralateral to the seizure focus.



Frontal lobe seizures tend to be shorter and to cause less postictal confusion than temporal lobe seizures. Frontal lobe seizures are associated with frequent falls, because of the rapid bilateral spread. Focal tonic, or fencing, postures may be seen and may suggest a focus in the supplementary motor area. Certain frontal lobe seizures may mimic absence seizures and, at times, have been referred to as *pseudoabsences*. Frontal lobe seizures often begin with low-amplitude fast activity but can be associated with some frontal sharp waves or spikes. PVEEG can often help identify these frontal lobe seizures, although at times the movement artifacts from hypermotor behavior may make the identification of ictal discharge difficult. In that situation, other factors should be considered, such as stereotypic behavior, onset during sleep, or postictal slowing of EEG.

Inpatient PVEEG can be helpful in distinguishing various spells and multiple seizure types in patients with Lennox–Gastaut syndrome.<sup>32</sup> Patients with this syndrome can have different types of epileptic seizures as well as stereotyped mannerisms, tics, and other movements that are not epileptic. Because these phenomena tend to occur almost daily in this patient population, only a relatively short session of inpatient PVEEG monitoring is needed. After the various spells and seizures have been classified, outpatient management is simpler because antiepileptic drug adjustments are not necessary for recurrent nonepileptic spells. Through education and reassurance of parents and caretakers, emergency department visits or unnecessary rectal administration of diazepam can be avoided.

### Key Points

- Correct seizure classification through PVEEG makes possible more rational pharmacological treatment of the epileptic condition.

## PVEEG and Surgical Evaluation

Surgical treatment frequently eliminates or decreases the frequency and severity of seizures in many partial epilepsies.<sup>33,34</sup> Seizures arising from the temporal lobe are especially amenable to surgical treatment.<sup>35</sup> A comprehensive evaluation is performed on patients

who are being considered for epilepsy surgery.<sup>36</sup> The most important part of the presurgical evaluation probably is the recording of the patient's typical seizures on continuous EEG with video monitoring.<sup>37</sup> This serves two purposes at the outset: first, to establish that the refractory habitual seizures are indeed epileptic and not a nonepileptic behavioral spell and, second, to establish the localization of the epileptic focus electrophysiologically. Because seizures occur sporadically and unpredictably, treatment with antiepileptic medications is usually withdrawn rather rapidly to expedite the recording of seizures.<sup>38</sup> Some concern exists about whether seizures recorded during acute withdrawal of medication faithfully represent the patient's habitual seizure pattern. An additional risk is the possibility of a secondarily generalized tonic–clonic seizure in patients who had only complex partial seizures and the possibility of a generalized tonic–clonic or complex partial status epilepticus. The PVEEG monitoring unit should be well equipped and the personnel should be expertly trained in the management of these neurologic emergencies. Ready intravenous access must be maintained by way of a heparin-lock system, and intravenous formulations of benzodiazepines (lorazepam) or fosphenytoin should be immediately available. Patients and families need to be well informed about these issues before or at the time of admission to the monitoring unit.

PVEEG allows careful analysis of clinical and EEG changes and can be used with scalp, sphenoidal, foramen ovale, or implanted depth or subdural strip or grid electrodes. With computer-assisted recordings, montage reformatting, and off-time analysis of seizures, there may be less need for invasive EEG recordings. For surgical monitoring, digital video EEG systems with 64–128 channels are commonly used. One important caveat is that computer monitor does not allow adequate resolution of each channel activity when all the recording channels are displayed. Low-amplitude fast beta or gamma activity, frequently indicative of cortical seizure focus, may be ignored, leading to misplaced seizure onset localization. One needs to view subgroups of channels with manageable numbers (e.g., 20) with higher sensitivity to detect low-amplitude signals of seizure onset zones. For focal cortical resection, typical seizures must be shown to arise from a single

region of the brain. An adequate number of seizures must be recorded so that the seizure can be localized confidently. If the patient has multiple seizure types, then all of them need to be captured and analyzed to determine whether the seizures have multifocal onset or a single focus with different propagation paths.

When intracranial electrodes are implanted and the identified epileptogenic zone is near a functional cortical region (e.g., motor, sensory, language, or visual cortex), the determination of cortical function is necessary. A train of electric pulses (usually biphasic rectangular pulses at 60 Hz from a stimulation isolation unit) can be applied through pairs of electrodes through the special interface device coupled to the PVEEG input stage. During the delivery of the stimulation, positive motor, sensory, or visual phenomena can be observed or reported by the patient. For the language area, stimulation causes the arrest of language function, such as a pause in reading a sentence aloud or naming objects. EEG recording must be performed to verify that the stimulation did not cause an after-discharge (electrographic seizure), because that would suggest a propagated effect away from the stimulated electrodes. This can be done in the PVEEG monitoring unit outside the operating room and obviate intraoperative cortical mapping with the patient awake.

In evaluating medically refractory partial epilepsy, PVEEG from the scalp electrodes alone is not always adequate for localizing seizure onset. Subtraction ictal-interictal SPECT coregistered on magnetic resonance images (SISCOM) can be useful for either avoiding further invasive intracranial monitoring or guiding the placement of intracranial electrodes.<sup>39,40</sup> The ictal SPECT scan needs to be performed with exquisite temporal urgency. The sooner the tracer is injected after the onset of the seizure (usually within tens of seconds), the more likely the scan will reflect the foci of ictal increase in blood flow. Therefore, it is critical to monitor the patient closely for signs of seizure onset, either by behavior or by EEG. This is possible only in the setting of inpatient PVEEG with appropriately trained monitoring personnel and ready access to and availability of the radioactive tracer from the nuclear medicine department.

### Key Points

- PVEEG is an essential first step in the evaluation of medically intractable epileptic syndromes toward surgical solution and is necessary for intracranial electrocorticographic monitoring.
- Personnel, both technical and nursing, should be well versed in dealing with the more severe motor seizures and status epilepticus that may occur during medication withdrawal.
- Intracranial electrodes can be used for functional mapping of areas surrounding the epileptic focus to be resected during presurgical PVEEG.

### SUMMARY

PVEEG has become an essential diagnostic tool in the management of epileptic seizures, psychogenic seizures, and other paroxysmal events. Various monitoring systems are available, mostly all digital systems. PVEEG monitoring allows psychogenic seizures and other nonepileptic paroxysmal events to be differentiated from epileptic seizures. It also enables accurate classification of most seizure types and is a necessary part of the evaluation of patients being considered for surgical treatment of epilepsy. Also, this type of monitoring allows extended observation of patients and can lead to a better understanding of their medical problems and any superimposed psychosocial issues. All these factors contribute to improved quality of life for patients and their families and more efficient delivery of appropriate medical care in these often very complex situations.

### REFERENCES

1. Engel, J. Jr, J. Burchfiel, and J. Ebersole, et al. 1993. Long-term monitoring for epilepsy. Report of an IFCN committee. *Electroencephalography and Clinical Neurophysiology* 87:437–58.
2. Kaplan, P. W., and R. P. Lesser. 1990. Long-term monitoring. In *Current practice of clinical electroencephalography*, ed. D. D. Daly, and T. A. Pedley, 2nd ed. 513–34. New York: Raven Press.
3. Mizrahi, E. M. 1999. Pediatric electroencephalographic video monitoring. *Journal of Clinical Neurophysiology* 16:100–10.

4. Hunter, J., and H. H. Jasper. 1949. A method of analysis of seizure pattern and electroencephalogram: A cinematographic technique. *Electroencephalography and Clinical Neurophysiology* 1:113–14.
5. Schwab, R. S., M. W. Schwab, D. Withee, and Y. C. Chock. 1954. Synchronized moving pictures of patient and EEG. *Electroencephalography and Clinical Neurophysiology* 6:684–6.
6. Stewart, L. F., H. H. Jasper, and C. Hodge. 1956. Another simple method for simultaneous cinematographic recording of the patient and his electroencephalogram during seizures. *Electroencephalography and Clinical Neurophysiology* 8:688–91.
7. Lagerlund, T. D., G. D. Cascino, K. M. Cicora, and F. W. Sharbrough. 1996. Long-term electroencephalographic monitoring for diagnosis and management of seizures. *Mayo Clinic Proceedings* 71:1000–6.
8. Gilliam, F., R. Kuzniecky, and E. Faught. 1999. Ambulatory EEG monitoring. *Journal of Clinical Neurophysiology* 16:111–15.
9. Epstein, C. M. 2006. Digital EEG: Trouble in paradise? *Journal of Clinical Neurophysiology* 23:190–3.
10. Gotman, J. 1982. Automatic recognition of epileptic seizures in the EEG. *Electroencephalography and Clinical Neurophysiology* 54:530–40.
11. Gotman, J. 1985. Seizure recognition and analysis. *Electroencephalography and Clinical Neurophysiology Supplement* 37:133–45.
12. Salinsky, M. C. 1997. A practical analysis of computer based seizure detection during continuous video-EEG monitoring. *Electroencephalography and Clinical Neurophysiology* 103:445–9.
13. Spatt, J., G. Pelzl, and B. Mamoli. 1997. Reliability of automatic and visual analysis of interictal spikes in lateralising an epileptic focus during video-EEG monitoring. *Electroencephalography and Clinical Neurophysiology* 103:421–5.
14. Mohan, K. K., O. N. Markand, and V. Salanova. 1996. Diagnostic utility of video EEG monitoring in paroxysmal events. *Acta Neurologica Scandinavica* 94:320–5.
15. Connolly, M. B., P. K. Wong, Y. Karim, S. Smith, and K. Farrell. 1994. Outpatient video-EEG monitoring in children. *Epilepsia* 35:477–81.
16. Krumholz, A. 1999. Nonepileptic seizures: Diagnosis and management. *Neurology* 53:S76–83.
17. Scott, D. F. 1982. Recognition and diagnostic aspects of nonepileptic seizures. In *Pseudoseizures*, ed. T. L. Riley, and A. Roy. 21–33. Baltimore: Williams & Wilkins.
18. Martin, R. C., F. G. Gilliam, M. Kilgore, E. Faught, and R. Kuzniecky. 1998. Improved health care resource utilization following video-EEG-confirmed diagnosis of nonepileptic psychogenic seizures. *Seizure* 7:385–90.
19. Gates, J. R., V. Ramani, S. Whalen, and R. Loewenson. 1985. Ictal characteristics of pseudoseizures. *Archives of Neurology* 42:1183–7.
20. Geyer, J. D., T. A. Payne, and I. Drury. 2000. The value of pelvic thrusting in the diagnosis of seizures and pseudoseizures. *Neurology* 54:227–9.
21. Ramani, S. V., L. F. Quesney, D. Olson, and R. J. Gummit. 1980. Diagnosis of hysterical seizures in epileptic patients. *The American Journal of Psychiatry* 137:705–9.
22. Bare, M. A., T. H. Burnstine, R. S. Fisher, and R. P. Lesser. 1994. Electroencephalographic changes during simple partial seizures. *Epilepsia* 35:715–20.
23. Bazil, C. W., and T. S. Walczak. 1997. Effects of sleep and sleep stage on epileptic and nonepileptic seizures. *Epilepsia* 38:56–62.
24. Rabinowicz, A. L., J. Correale, R. B. Boutros, W. T. Couldwell, C. W. Henderson, and C. M. DeGiorgio. 1996. Neuron-specific enolase is increased after single seizures during inpatient video/EEG monitoring. *Epilepsia* 37:122–5.
25. Tumani, H., M. Otto, and O. Gefeller, et al. 1999. Kinetics of serum neuron-specific enolase and prolactin in patients after single epileptic seizures. *Epilepsia* 40:713–18.
26. Dericioglu, N., S. Saygi, and A. Ciger. 1999. The value of provocation methods in patients suspected of having nonepileptic seizures. *Seizure* 8:152–6.
27. Marks, W. J. Jr, and K. D. Laxer. 1998. Semiology of temporal lobe seizures: Value in lateralizing the seizure focus. *Epilepsia* 39:721–6.
28. Williamson, P. D., V. M. Thadani, and J. A. French, et al. 1998. Medial temporal lobe epilepsy: Videotape analysis of objective clinical seizure characteristics. *Epilepsia* 39:1182–8.
29. Geyer, J. D., T. A. Payne, E. Faught, and I. Drury. 1999. Postictal nose-rubbing in the diagnosis, lateralization, and localization of seizures. *Neurology* 52:743–5.
30. Kotagal, P. A. Bleasel, E. Geller, P. Kankirawatana, B. I. Moorjani, and L. Rybicki. 2000. Lateralizing value of asymmetric tonic limb posturing observed in secondarily generalized tonic-clonic seizures. *Epilepsia* 41:457–62.
31. Theodore, W. H., R. J. Porter, and P. Albert, et al. 1994. The secondarily generalized tonic-clonic seizure: A videotape analysis. *Neurology* 44:1403–7.
32. Bare, M. A., T. A. Glauser, and R. H. Strawsburg. 1998. Need for electroencephalogram video confirmation of atypical absence seizures in children with Lennox–Gastaut syndrome. *Journal of Child Neurology* 13:498–500.
33. Engel, J., ed. 1993. *Surgical treatment of the epilepsies*, 2nd ed. New York: Raven Press.
34. Penry, J. K., and R. J. Porter. 1977. Intensive monitoring of patients with intractable seizures. In *Epilepsy: The 8th international symposium*, ed. J. K. Penry, 95–101. New York: Raven Press.
35. Kilpatrick, C., M. Cook, A. Kaye, M. Murphy, and Z. Matkovic. 1997. Non-invasive investigations successfully select patients for temporal lobe surgery. *Journal of Neurology, Neurosurgery, and Psychiatry* 63:327–33.
36. Sutula, T. P., J. C. Sackellares, J. Q. Miller, and F. E. Dreifuss. 1981. Intensive monitoring in refractory epilepsy. *Neurology* 31:243–7.
37. Serles, W., Z. Caramanos, G. Lindinger, E. Pataraia, and C. Baumgartner. 2000. Combining ictal surface-electroencephalography and seizure semiology improves patient lateralization in temporal lobe epilepsy. *Epilepsia* 41:1567–73.

38. Quiroga, R. C., L. Pirra, C. Podesta, R. C. Leiguarda, and A. L. Rabinowicz. 1997. Time distribution of epileptic seizures during video-EEG monitoring. Implications for health insurance systems in developing countries. *Seizure* 6:475-7.
39. O'Brien, T. J., E. L. So, and B. P. Mullan, et al. 2000. Subtraction peri-ictal SPECT is predictive of extratemporal epilepsy surgery outcome. *Neurology* 55:1668-77.
40. So, E. L., T. J. O'Brien, B. H. Brinkmann, and B. P. Mullan. 2000. The EEG evaluation of single photon emission computed tomography abnormalities in epilepsy. *Journal of Clinical Neurophysiology* 17:10-28.

*This page intentionally left blank*

# Electroencephalographic Special Studies

Gregory A. Worrell and Terrence D. Lagerlund

## INTRODUCTION QUANTITATIVE METHODS OF ELECTROENCEPHALOGRAPHIC ANALYSIS

Fourier (Spectral) Analysis  
Spike, Sharp-Wave,  
High-Frequency Oscillation and  
Seizure Detection  
Montage Reformatting  
Cross-Correlation Analysis

## INTRODUCTION

Digital computers can aid in extracting information from electroencephalographic (EEG) waveforms that is not readily obtainable with visual analysis alone. These computers may also be used for quantitation of key features of waveforms, which may be useful in accurate EEG interpretation and also in making serial comparisons between EEGs performed on the same subject at different times or between two subject groups in scientific investigations. Digital computers may also partially automate the interpretation of EEGs, particularly in prolonged monitoring for epilepsy. This chapter discusses some of the uses of computers in EEG.

### *Purpose and Role of EEG Special Studies*

- Allows for quantitation of key features of waveforms to assist in accurate EEG interpretations.

Cross-Spectral Analysis  
Interpolation Techniques  
Topographic Displays (Mapping)  
Multivariate Statistical Methods  
and Topographic Analysis  
Cortical Projection Techniques  
Source Dipole Localization

## MAGNETOENCEPHALOGRAPHY SUMMARY

- Assists in making serial comparisons between EEGs performed on the same subject at different times or between two subject groups.

## QUANTITATIVE METHODS OF ELECTROENCEPHALOGRAPHIC ANALYSIS

### Fourier (Spectral) Analysis

The technique of spectral analysis is described in Chapter 4. Electroencephalographic spectral analysis has been used to assess the dominant background frequencies in normal and disease states, including dementia, cerebral infarction, cerebral neoplasms, and various toxic and metabolic disorders. Most abnormal

conditions increase the amount of slow-wave activity in an EEG and may decrease the amount of faster frequency activity. Quantitative measures that may be used include (1) the percentage power in the delta, theta, or delta + theta bands; (2) the percentage power in the alpha, beta, or alpha + beta bands; (3) various other power ratios (e.g., alpha to delta); (4) the mean frequency in the entire spectrum or in a portion of the spectrum, such as the alpha band; and (5) the spectral edge frequency, which is often taken to be the frequency below which 95% of the power in the entire spectrum occurs. Spectral analysis has also been used in intraoperative monitoring to assess changes in depth of anesthesia or cerebral ischemia. Although spectral analysis per se can be applied only to one channel at a time, useful comparisons can be made between the spectra of recordings in different regions of the head. As expected, focal brain lesions tend to produce focal changes in power spectra, whereas diffuse processes produce generalized changes. Quantitative measures of asymmetry can be calculated, such as the left-to-right ratio of power in the entire spectrum or in individual frequency bands, such as alpha, delta, and so forth. Some studies of power spectra during transient cerebral events, such as epileptic seizures, have also been conducted. The power spectra of a partial complex seizure of temporal lobe origin, for example, tend to be complex, with several frequency components (often a fundamental with one or more harmonics, that is, integral multiples of the fundamental frequency) whose amplitudes in various regions of the head may differ. The spectra also evolve over time during the course of the seizure.

### Key Points

- Spectral analysis is the decomposition of an EEG time series into a sum of sinusoidal functions of different frequencies.
- Quantitative measures can be determined for EEGs in different disease states using spectral analysis.
- Spectral analysis can be used in intraoperative monitoring to assess changes in depth of anesthesia or cerebral ischemia.

## Spike, Sharp-Wave, High-Frequency Oscillation and Seizure Detection

The detection of interictal and ictal epileptic discharges in an EEG by computer algorithms has received much attention because of the increasing use of prolonged EEG monitoring for epilepsy. In prolonged EEG monitoring, many EEG channels (21 or more in most cases for scalp, and often more than 100 for intracranial recordings) are recorded over many hours, days, or weeks, generating huge amounts of data that must be reviewed to assess the frequency, nature, and localization of epileptic discharges. Computer algorithms may be used to locate candidate interictal or ictal discharges for further study by an electroencephalographer and, thus, the need to scan many pages of EEG tracings manually may be avoided. The techniques of pattern recognition are discussed in Chapter 4. Spike and sharp-wave detection generally relies on the *sharpness* criteria applied to individual waveforms on a channel-by-channel basis, although more advanced algorithms may use context information and multichannel correlation to improve specificity. High-frequency oscillation and seizure detection algorithms are more complex, because of the great variability in types of ictal discharges, and generally are based on detecting a sudden change in rhythmicity and amplitude of background activity simultaneously in several channels.

Current state-of-the-art commercially available software has a reasonably good overall sensitivity, although the sensitivity may be inadequate for the seizures of certain patients. Consequently, prolonged monitoring systems usually do not rely exclusively on computer detection of seizures but also make use of trained observers or patient and family members to recognize and log seizure occurrence. The specificity of currently used algorithms is also fairly good; however, in many prolonged monitoring situations, a large variety of artifacts arising from patient's activities and various waveforms of cerebral origin, for example, V waves in sleep, cause false detections that may outnumber true epileptic discharges by an order of magnitude for some patients. Thus, a physician or technician must review all discharges detected by the computer, but the



ability to markedly decrease the amount of data to be reviewed still makes automated detection algorithms of great practical value.

There has been considerable interest recently in interictal and ictal high-frequency oscillations (80–1000 Hz) recorded from intracranial subdural and depth electrodes. Because these oscillations are of very low amplitude they are largely obscured by lower frequency activity. Studies using automated detection of high-frequency oscillations have demonstrated a strong correlation of high-frequency oscillations with epileptogenic brain.<sup>1</sup>

**Key Points**

- Spike and sharp waves are recognized as EEG signatures of epileptogenic brain and are strongly associated with seizure disorders.
- High-frequency oscillations (80–1000 Hz) are oscillatory local field potentials from intracranial EEG recordings.
- Seizures are an abnormal brain activity characterized by excessively synchronized rhythmic discharges of a population of neurons.
- Computer algorithms have been developed for automated detection of epileptiform spikes, sharp waves, high-frequency oscillations, and seizures. These algorithms make possible the data mining of large EEG data sets.

**Montage Reformatting**

Montage reformatting allows EEG montages to be selected when the data are reviewed independently of the montage used to acquire and to store the data. The same EEG segment can be viewed using a variety of different montages. To generate a derivation such as  $X_1 - X_2$ , which does not exist in the EEG as recorded, the computer looks for two existing channels one of which records  $X_1$  against a reference electrode and another which records  $X_2$  against the same reference, and then subtracts the two. That is,  $X_1 - X_2 = (X_1 - R) - (X_2 - R)$ , where  $R$  is the reference. This allows new referential and bipolar montages to be formed.<sup>2</sup> For example,

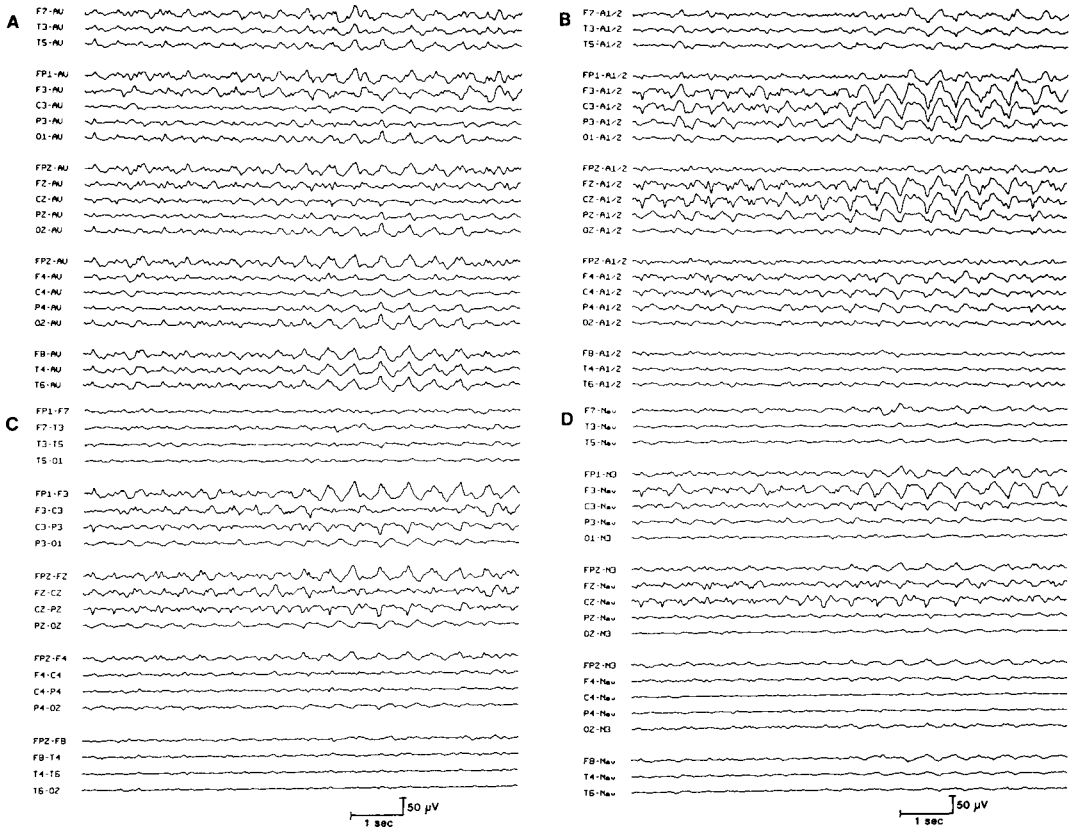
suppose that recorded EEG data include the following channels:

Channel	Derivation
1	$F_{p1} - C_z$
2	$F_{p2} - C_z$
3	$F_3 - C_z$
4	$F_4 - C_z$
5	$C_3 - C_z$
6	$C_4 - C_z$
7	$P_3 - C_z$
8	$P_4 - C_z$
9	$O_1 - C_z$
10	$O_2 - C_z$
11	$A_1 - C_z$
12	$A_2 - C_z$

Then, a new referential montage with ipsilateral ear reference can be created by subtracting pairs of channels as follows:

Channels	Derivation
1–11	$F_{p1} - A_1$
2–12	$F_{p2} - A_2$
3–11	$F_3 - A_1$
4–12	$F_4 - A_2$
5–11	$C_3 - A_1$
6–12	$C_4 - A_2$
7–11	$P_3 - A_1$
8–12	$P_4 - A_2$
9–11	$O_1 - A_1$
10–12	$O_2 - A_2$

New reference electrodes can also be created by averaging data from two or more existing electrodes. For example, suppose an EEG is recorded with a  $C_z$  reference. A new derivation such as  $O_1 - A_{1/2}$ , where  $A_{1/2}$  represents the average of the ear electrodes, can be calculated as follows:  $O_1 - A_{1/2} = (O_1 - C_z) - 0.5(A_1 - C_z) - 0.5(A_2 - C_z)$ . Other types of montages, such as a common average reference montage (in which the reference for each electrode is the average potential of all recorded electrodes) or a laplacian (source) montage<sup>3,4</sup> (in which the reference for each electrode is the average of the four nearest neighbors to that electrode), may also be generated easily by the computer. The same ictal discharge viewed with various montages (one as recorded, three after reformatting) is shown in Figure 14–1.



**Figure 14–1.** An EEG recorded during a seizure. *A*, As recorded from a C<sub>3</sub>/C<sub>4</sub> average reference (AV on figure) that is active. *B*, Reformatted to average ear reference (A<sub>1/2</sub> in figure). *C*, Reformatted to longitudinal bipolar montage. *D*, Reformatted to longitudinal laplacian montage (Nav, 4-neighbor average; N3, 3-neighbor average). (From Lagerlund, T. D. 1991. Montage reformatting and digital filtering. In *Epilepsy surgery*, ed. H. Luders, 318–22. New York: Raven Press. By permission of Lippincott Williams & Wilkins.)

**Key Points**

- Digital EEG makes montage reformatting fast and efficient.

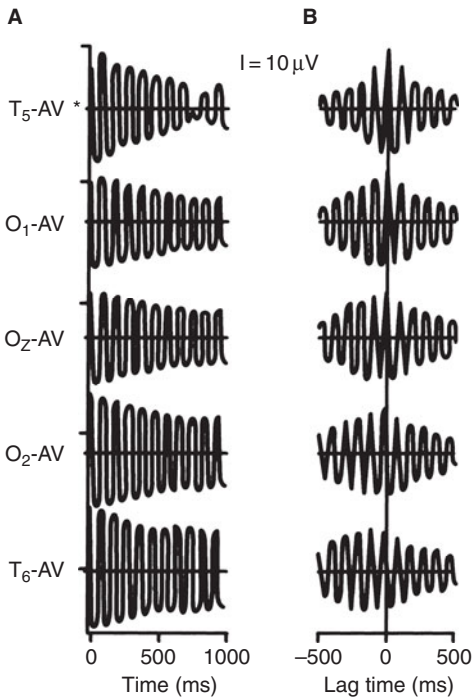
**Cross-Correlation Analysis**

Cross-correlation analysis quantifies the relationship between EEG signals recorded from different derivations. The cross-correlation function is the correlation between EEG signal number 1 and EEG signal number 2 delayed by time *t*, expressed as a function of *t*. If EEG signal number 2 is identical to number 1, the cross-correlation function is the same as the autocorrelation function described in Chapter 4. If signal number 2 is similar to

number 1 but delayed by time *T*, then the cross-correlation function is a maximum at *t* = *T*, and periodically thereafter if both signals are periodic. Thus, examination of cross-correlation functions may be used as a means to assess small interchannel time differences (Fig. 14–2); one possible use of this is in determining whether a bilateral epileptic discharge in fact represents secondary bilateral synchrony or is generalized from onset.

**Key Points**

- Cross-correlation analysis quantifies the relationship between EEG signals recorded from different derivations.
- Examination of cross-correlation functions may be used as a means to assess small interchannel time differences.



**Figure 14-2.** A, Autocorrelation functions and, B, cross-correlation functions for a 1-second epoch of alpha activity recorded using a  $C_3/C_4$  average reference (AV on figure). The autocorrelations demonstrate the rhythmicity of the signal but cannot be used to assess interchannel time differences. The cross correlations demonstrate a systematically increasing time delay between channels as one goes from right,  $T_6$ , to left,  $T_5$ , across the head.

## Cross-Spectral Analysis

The cross-power spectrum between EEG signal number 1 and number 2 is the Fourier transform of the cross-correlation function. From the cross-power spectrum, one can calculate two additional functions:

1. Coherence function—a normalized function that takes on values between 0 and 1. It is defined as the absolute square of the cross-power spectrum of signal numbers 1 and 2, divided by the product of the power spectrum of signal number 1 and that of signal number 2. It is a convenient measure of the degree of correlation between similar frequency components in the two signals (0%–100%), expressed as a function of the frequency.

2. Phase spectrum—the relative phase angle ( $0^\circ$ – $360^\circ$ ) between corresponding frequency components of signal number 1 and those of signal number 2, expressed as a function of the frequency.

The phase angle, in turn, is related to timing differences between the two signals. Because the phase angle between two sine or cosine waves delayed by a fixed time  $T$  equals  $360^\circ$  multiplied by the product of the time delay  $T$  and the frequency  $f$ , the time delay between two signals can be calculated from the phase spectrum  $\phi$  by the formula<sup>5</sup>

$$T = \frac{\phi}{360^\circ \times f}$$

Thus, if a plot of phase angle vs. frequency is linear over some range of frequencies, the time difference between the signals can be derived by taking the slope of the plot divided by  $360^\circ$  (Fig. 14-3).

## Interpolation Techniques

Interpolation techniques are used to estimate the electric potential at intermediate scalp positions from its known value at each electrode position. This procedure is necessary when constructing maps of scalp potential, and it may form a preliminary step in the application of various techniques of spatial, or topographic, analysis of EEG, such as calculating accurate estimates of the laplacian of the scalp potential, multivariate statistical analyses, cortical projection techniques, and source dipole localization. Some interpolation methods that are commonly used include the following:

1. Nearest neighbor inverse distance weighted.<sup>6,7</sup>
2. All-electrode inverse distance weighted.<sup>8</sup>
3. Rectangular two-dimensional splines, which conceptually minimize the *bending energy* of an infinite, elastic plate constrained to pass through known points.<sup>9,10</sup>
4. Rectangular three-dimensional splines, which interpolate potentials in three dimensions, after which results may be projected as needed onto spherical or ellipsoidal surfaces.<sup>11,12</sup>

5. Spherical surface splines, which are applied to a spherical surface instead of a rectangular one.<sup>6,9,13</sup>
6. Spherical harmonic expansion, the equivalent of a Fourier series in spherical instead of rectangular coordinates.<sup>14,15</sup>
7. Single or multidipole source models, which localize source dipoles and then predict the scalp potential these sources would generate.

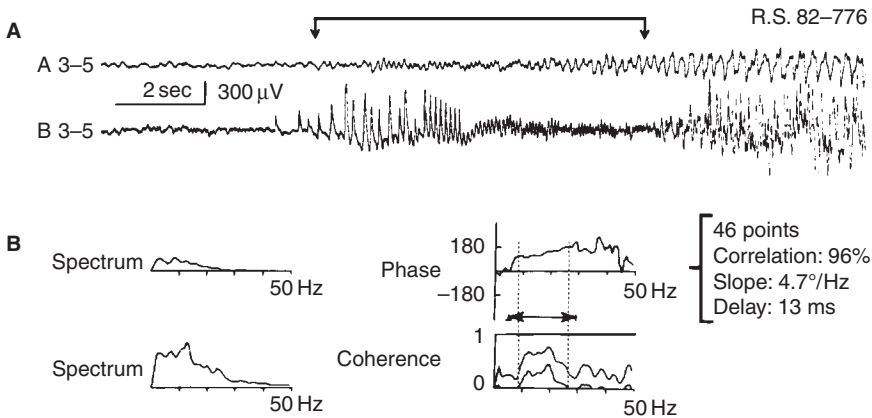
Note that methods 1–3 are based on a rectangular planar model of the scalp surface, and methods 5 and 6 assume a spherical head and should be more accurate. Only method 1 (the simplest and least accurate) has been used widely in commercial EEG systems.

### Topographic Displays (Mapping)

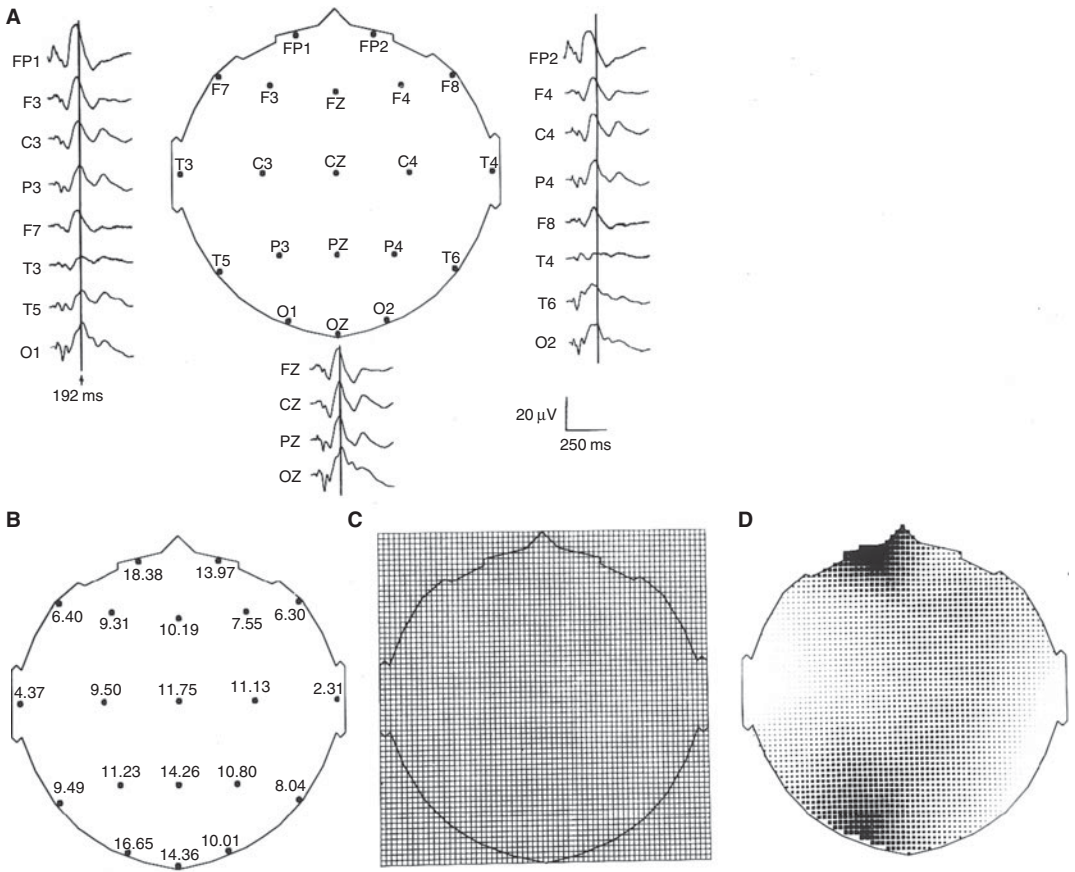
Electroencephalographic topographic, or spatial, maps are a way of displaying EEG data that differ significantly from the conventional multichannel amplitude-vs.-time plots (montages). However, topographic mapping is not in itself a method of EEG analysis, because it only displays the *raw* data in a different way. In its simplest form, a topographic map of scalp potential is a *snapshot* of the EEG

at one instant in time; it shows the distribution of potentials on the head surface at that time and may facilitate localization of EEG abnormalities (while making it more difficult to appreciate their variation in time). Because potentials are actually measured at only a few points on the head (that is, at the electrode locations), an interpolation technique must be used to estimate potentials at all other scalp points;<sup>7</sup> thus, the information conveyed by a topographic display is only as accurate as the interpolation technique used (Fig. 14–4). Various methods of topographic display include three-dimensional plots (potential on *z* axis vs. *x* and *y* coordinates), contour plots (connecting all points on the head with the same value of potential), gray scale intensity plots (degree of darkness at each point on a head map corresponds to the potential at that point), and color plots (color at each point on a head map corresponds to the potential at that point). As a general rule, topographic maps should be used only as an adjunct to ordinary time series EEG displays and not as a replacement for them, because 75% or more of the information derived from an EEG depends on the temporal rather than the spatial characteristics of waveforms.

In addition to maps of unprocessed EEG, topographic mapping has been used to display the spatial distribution of the results of



**Figure 14–3.** A, Onset of a seizure discharge recorded with a bipolar montage from intracerebral electrodes in a patient with epilepsy: A, A 3–5 are in amygdala and B 3–5 are in hippocampus. B, Power spectra of each channel (*left*) and phase angle and coherence spectra (*right*); the upper coherence graph is the coherence itself, the lower graph is the lower boundary of the 99% confidence interval of the coherence. For the range of frequencies indicated by the arrows, the phase is linearly related to frequency with slope 4.7° per Hz, corresponding to a delay of 13 ms between channels. Positive slope indicates that the first channel is leading. (From Gotman, J. 1983. Measurement of small time differences between EEG channels: Method and application to epileptic seizure propagation. *Electroencephalography and Clinical Neurophysiology* 56:501–14. By permission of Elsevier Scientific Publishers.)



**Figure 14-4.** Example of topographic map construction for visual evoked potential signals recorded referentially from 20 scalp electrodes. Each evoked potential is divided into 128 intervals of 4 ms. **A**, Individual evoked potentials for the indicated electrode locations. **B**, Mean voltage values at each electrode location for the 4-ms interval beginning 192 ms after the stimulus (corresponding to the vertical line in **A**). **C**, The grid of interpolation points ( $64 \times 64$ ) used; each of the 4096 points is assigned a voltage value by linear interpolation from the three nearest known points. **D**, The topographic map of this evoked potential, using an equal interval intensity scale to represent voltage at each location. (From Duffy, F. H., J. L. Burchfiel, and C. T. Lombroso. 1979. Brain electrical activity mapping (BEAM): A method for extending the clinical utility of EEG and evoked potential data. *Annals of Neurology* 5:309–21. By permission of the American Neurological Association.)

various techniques of multichannel EEG analysis. For example, maps of power spectra—power within a specific frequency band at various scalp locations—can be generated. Similarly, maps of the laplacian of the scalp potential, of principal components of the scalp potential (from multivariate statistical analysis), or of estimated cortical potentials (from a cortical projection technique) can also be produced.

**Key Points**

- Visualization of EEG potentials and sources on topographic maps and patient-specific MRI aids in analysis of EEG data.

- Various methods of topographic display include three-dimensional plots, contour plots, gray scale intensity plots, and color plots.
- Topographic maps should be used only as an adjunct to ordinary time series EEG displays and not as a replacement for them.

**Multivariate Statistical Methods and Topographic Analysis**

The purpose of multivariate statistical methods of EEG topographic analysis is to achieve data



reduction from many simultaneously recorded EEG signals. This is possible because of the redundancy of multichannel EEG data—many activities or waveforms appear simultaneously in many different channels. Mathematical techniques such as factor analysis, principal component analysis, eigenvector analysis, and independent component analysis are used to reduce the observed EEG signals in multiple channels to a minimum number of independent, or orthogonal, component signals. Individual components may be displayed spatially as topographic maps or temporally as derived EEG channels. Although these methods may provide data reduction, their major drawback is that the resultant independent signals are not always recognizable as traditional pure EEG activities such as alpha or mu, and comparison between analyses made on the same EEG at different times or on different subjects is difficult. Also, these methods generally do not provide information on the nature and location of physiologic generators of EEG. However, principal component analysis and independent component analysis may be used to create a type of spatial filter that can aid in the removal of certain types of artifact, such as ocular movement and electrocardiographic artifact, from an EEG recording.<sup>16,17</sup>

### Key Points

- The purpose of multivariate statistical methods of EEG topographic analysis is to achieve data reduction from many simultaneously recorded EEG signals.

## Cortical Projection Techniques

Cortical projection techniques such as spatial deconvolution<sup>18</sup> and deblurring<sup>19</sup> are designed to reverse the smearing effect of the skull on scalp EEG by using a model of volume conduction in the head (such as a three-sphere model of brain, skull, and scalp or an anatomically based boundary element or finite element model constructed from magnetic resonance scans of the patient's head). The electric potential at selected points on the brain surface is calculated from the electric potential at the scalp surface, thus noninvasively providing a distribution of electrical activity at the cortical surface. Cortical potentials may be displayed as

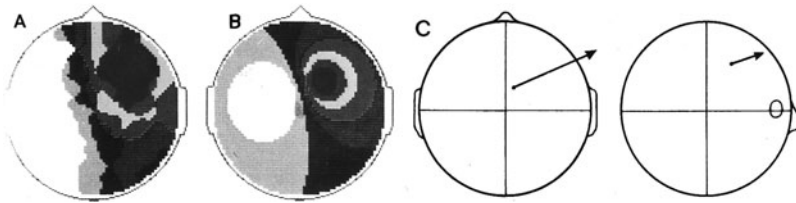
a time series (montage format) or as a topographic display (map format). This technique has proved capable of resolving two adjacent dipole sources in the cerebral cortex that could not be resolved by inspection of the scalp EEG signals and has been used successfully to localize median nerve somatosensory evoked potentials and interictal epileptic discharges on the cortical surface, with confirmation by recordings from subdural electrode grids.

### Key Points

- Cortical projection techniques such as spatial deconvolution and deblurring are designed to reverse the smearing effect of the skull on scalp EEG by using a model of volume conduction in the head.
- This technique has proved capable of resolving two adjacent dipole sources in the cerebral cortex that could not be resolved by inspection of the scalp EEG signals.

## Source Dipole Localization

The ultimate goal of localization of abnormal activity, such as epileptic discharges, from EEG is to find the intracranial sources generating a given distribution of scalp potentials. This is sometimes called the *inverse problem* (the forward problem refers to finding the distribution of scalp potentials resulting from a known distribution of intracranial sources). Although the forward problem has a unique solution, the inverse problem does not; that is, there are an infinite number of different sets of intracranial generators that could produce any given distribution of scalp activity. To constrain the problem, certain physiologically based assumptions must be made about the number and approximate location of generators. Most approaches to solving the inverse problem have concentrated on finding the location, orientation, and strength of a single dipole generator whose potential field best matches actual data. This is done with a least-squares minimization algorithm, which varies the dipole coordinates and direction to minimize the sum of squares of the differences between the predicted and the actual potentials at each electrode location on the head.<sup>20,21</sup> The assumption of a single



**Figure 14-5.** Dipole modelling of a spike discharge recorded with a sternoclavicular reference from a patient with epilepsy. *A*, Map of measured spike discharge distribution. *B*, Map of distribution of potential based on fitted dipole. *C*, Fitted dipole located in right frontocentral region (*long arrow*), with *short arrow* indicating orientation of dipole negativity. (From Thickbroom, G. W., H. D. Davies, W. M. Carroll, and F. L. Mastaglia. 1986. Averaging, spatio-temporal mapping and dipole modelling of focal epileptic spikes. *Electroencephalography and Clinical Neurophysiology* 64:274-7. By permission of Elsevier Scientific Publishers.)

dipole generator is most useful for small generators, such as the generators of certain evoked potential peaks or of some epileptic spikes (Fig. 14-5). More recently, distributed source models such as low resolution electromagnetic tomography (LORETA) have been proposed and have been used to estimate the location of generators of some EEG waveforms.<sup>22</sup> LORETA utilizes a distributed grid of dipole sources, with considerably more dipole sources than recording electrodes, as opposed to single dipole models.<sup>22</sup> In addition, because of the reduced complexity of linear source methods it is now common to use realistic, patient specific, models of the head and brain based on MRI.<sup>23,24</sup> With source localization methods it is now possible to combine the temporal resolution of EEG with the spatial resolution of other imaging modalities, such as MRI and SPECT. The integration of these imaging modalities has shown promise as a clinical tool for localization of epileptogenic brain.<sup>25,26</sup>

### Key Points

- With source localization methods it is now possible to combine the temporal resolution of EEG with the spatial resolution of other imaging modalities, such as MRI and SPECT.
- The integration of these imaging modalities has shown promise as a clinical tool for localization of epileptogenic brain.

## MAGNETOENCEPHALOGRAPHY

Magnetoencephalography (MEG) is the recording of the small magnetic fields produced by the electric activity of neurons in the brain.

These magnetic fields are generated by current flowing in neurons, with a small contribution from extracellular current flow in the volume-conducting medium around the brain (generally less than the contribution of intracellular currents). These magnetic fields are extremely small, typically in the femtoTesla or picotesla range ( $10^{-15}$  to  $10^{-12}$  T). They must be detected by a magnetic gradiometer connected to a special type of extremely sensitive amplifier called a *superconducting quantum interference device* (SQUID), which must be cooled by liquid helium. To eliminate noise signals caused by the much larger magnetic fields associated with electrical equipment, power lines, and the earth's magnetic field, a special magnetically shielded room is required. For all of these reasons, MEG is a very expensive tool. Another disadvantage of MEG, compared with EEG, is that it cannot be used readily for the long-term recordings needed to capture and localize an epileptic seizure, because the subject's head must be kept immobilized near the magnetic gradiometer array during the entire recording. Until recently, the number of channels available in commercial MEG instruments was relatively small, although some systems now available have more than 100 channels; the spatial resolution of these devices is quite good. Because magnetic fields created by a current source are always oriented along a tangent to a circle around the line of current flow, MEG is insensitive to radially oriented currents in cerebral cortex and is sensitive only to tangential currents, in contrast to EEG, which is sensitive to both (although more sensitive to radial than to tangential currents). Thus, in practice, MEG recordings are often combined with simultaneous conventional EEG recordings.



The major advantage of MEG is in source localization. The accuracy of localization of intracranial sources by MEG is not limited by the smearing effects of the volume-conducting medium, especially the poorly conducting skull, on electric potentials, as occurs in EEG, because all the tissues between the sources and the magnetic field detectors are transparent to magnetic fields. Thus, when a dipole localization algorithm is used with MEG data, a simple homogeneous sphere model of the volume conductor is usually sufficient to obtain accurate localization of the source dipole.<sup>27</sup> In addition to recording the spontaneous MEG, one can record evoked magnetic fields in response to visual, auditory, and somatosensory stimuli, and these may also be submitted to dipole localization algorithms to determine the location of visual, auditory, and somatosensory cortical areas. This may be used as part of the surgical planning process in patients with tumors or vascular malformations, in whom the sensory cortical areas may be significantly displaced from their usual or expected location. MEG has been used for localization of an epileptic spike focus before performing resective surgery for intractable partial epilepsy.<sup>28</sup>

### Key Points

- MEG is the recording of the small magnetic fields produced by the electric activity of neurons in the brain.
- The major advantage of MEG is in source localization.
- MEG has been used for localization of an epileptic spike focus before performing resective surgery for intractable partial epilepsy.

### SUMMARY

This chapter reviews several quantitative analysis techniques that may be applied to digitized EEG data. The technique of MEG is also discussed. Many of these techniques were primarily used as research tools; but as they have become more widely available, they are having an increasing effect on EEG interpretation and diagnosis.

### REFERENCES

1. Gardner, A. B., G. A. Worrell, E. Marsh, D. Dlugos, and B. Litt. 2007. Human and automated detection of high-frequency oscillations in clinical intracranial EEG recordings. *Clinical Neurophysiology* 118(5):1134–43.
2. Lagerlund, T. D. 1991. Montage reformatting and digital filtering. In *Epilepsy surgery*, ed. H. Luders, 318–22. New York: Raven Press.
3. Hjorth, B. 1975. An on-line transformation of EEG scalp potentials into orthogonal source derivations. *Electroencephalography and Clinical Neurophysiology* 39:526–30.
4. Wallin, G., and E. Stalberg. 1980. Source derivation in clinical routine EEG. *Electroencephalography and Clinical Neurophysiology* 50:282–92.
5. Gotman, J. 1983. Measurement of small time differences between EEG channels: Method and application to epileptic seizure propagation. *Electroencephalography and Clinical Neurophysiology* 56:501–14.
6. Babiloni, F., C. Babiloni, L. Fattorini, F. Carducci, P. Onorati, and A. Urbano. 1995. Performances of surface Laplacian estimators: A study of simulated and real scalp potential distributions. *Brain Topography* 8:35–45.
7. Duffy, F. H., J. L. Burchfiel, and C. T. Lombroso. 1979. Brain electrical activity mapping (BEAM): A method for extending the clinical utility of EEG and evoked potential data. *Annals of Neurology* 5:309–21.
8. Lemos, M. S., and B. J. Fisch. 1991. The weighted average reference montage. *Electroencephalography and Clinical Neurophysiology* 79:361–70.
9. Nunez, P. L. 1989. Estimation of large scale neocortical source activity with EEG surface Laplacians. *Brain Topography* 2:141–54.
10. Perrin, F., J. Pernier, O. Bertrand, M. H. Giard, and J. F. Echallier. 1987. Mapping of scalp potentials by surface spline interpolation. *Electroencephalography and Clinical Neurophysiology* 66:75–81.
11. Law, S. K., P. L. Nunez, and R. S. Wijesinghe. 1993. High-resolution EEG using spline generated surface Laplacians on spherical and ellipsoidal surfaces. *IEEE Transactions on Bio-medical Engineering* 40:145–53.
12. Srinivasan, R., P. L. Nunez, D. M. Tucker, R. B. Silberstein, and P. J. Cadusch. 1996. Spatial sampling and filtering of EEG with spline laplacians to estimate cortical potentials. *Brain Topography* 8:355–66.
13. Perrin, F., J. Pernier, O. Bertrand, and J. F. Echallier. 1989. Spherical splines for scalp potential and current density mapping. *Electroencephalography and Clinical Neurophysiology* 72:184–7.
14. Lagerlund, T. D., F. W. Sharbrough, N. E. Busacker, and K. M. Cicora. 1995. Interelectrode coherences from nearest-neighbor and spherical harmonic expansion computation of laplacian of scalp potential. *Electroencephalography and Clinical Neurophysiology* 95:178–88.
15. Pascual-Marqui, R. D., S. L. Gonzalez-Andino, P. A. Valdes-Sosa, and R. Biscay-Lirio. 1988. Current source density estimation and interpolation based on the spherical harmonic Fourier expansion. *The International Journal of Neuroscience* 43: 237–49.

16. Lagerlund, T. D., F. W. Sharbrough, and N. E. Busacker. 1997. Spatial filtering of multi-channel electroencephalographic recordings through principal component analysis by singular value decomposition. *Journal of Clinical Neurophysiology* 14: 73–82.
17. Hu, S., M. Stead, and G. A. Worrell. 2007. Automatic identification and removal of scalp reference signal for intracranial EEGs based on independent component analysis. *IEEE Transactions on Bio-medical Engineering* 54(9):1560–72.
18. Nunez, P. L. 1988. Methods to estimate spatial properties of dynamic cortical source activity. In *Functional brain imaging*, ed. G. Pfurtscheller, and F. H. Lopes da Silva, 3–9. Toronto: Hans Huber Publishers.
19. Gevins, A., J. Le, P. Brickett, B. Reutter, and J. Desmond. 1991. Seeing through the skull: Advanced EEGs use MRIs to accurately measure cortical activity from the scalp. *Brain Topography* 4: 125–31.
20. Salu, Y., L. G. Cohen, D. Rose, S. Sato, C. Kufta, and M. Hallett. 1990. An improved method for localizing electric brain dipoles. *IEEE Transactions on Bio-medical Engineering* 37: 699–705.
21. Thickbroom, G. W., H. D. Davies, W. M. Carroll, and F. L. Mastaglia. 1986. Averaging, spatio-temporal mapping and dipole modelling of focal epileptic spikes. *Electroencephalography and Clinical Neurophysiology* 64:274–7.
22. Pascual-Marqui, R. D., C. M. Michel, and D. Lehmann. 1994. Low resolution electromagnetic tomography: A new method for localizing electrical activity in the brain. *International Journal of Psychophysiology* 18:49–65.
23. Ebersole, J. S. 1999. Non-invasive pre-surgical evaluation with EEG/MEG source analysis. *Electroencephalography and Clinical Neurophysiology. Supplement*, 50:167–74.
24. Phillips, C., M. D. Rugg, and K. J. Friston. 2002. Anatomically informed basis functions for EEG source localization: Combining functional and anatomical constraints. *Neuroimage* 16(3 Pt 1):678–95.
25. Worrell, G. A., T. D. Lagerlund, F. W. Sharbrough, et al. 2000. Localization of the epileptic focus by low-resolution electromagnetic tomography in patients with a lesion demonstrated by MRI. *Brain Topography* 12(4):273–82.
26. Ding, L., G. A. Worrell, T. D. Lagerlund, and B. He. 2007. Ictal source analysis: Localization and imaging of causal interactions in humans. *Neuroimage* 34(2):575–86.
27. Hari, R. 1994. Comment: MEG in the study of epilepsy. *Acta Neurologica Scandinavica Supplementum* 152:89–90.
28. Minassian, B. A., H. Otsubo, S. Weiss, I. Elliott, J. T. Rutka, and O. C. Snead III. 1999. MEG localization in pediatric epilepsy surgery: Comparison with invasive intracranial electroencephalography. *Annals of Neurology* 46:627–33.

*This page intentionally left blank*

# Electroencephalography in the Surgical Evaluation of Epilepsy

*Joseph F. Drazkowski*

## **BACKGROUND PRESURGICAL SELECTION AND EVALUATION**

Clinical Evaluation  
Imaging Studies  
Intracarotid Amobarbital

## **ROUTINE EEG IN THE SURGICAL EVALUATION OF PATIENTS WITH SEIZURES PREOPERATIVE VIDEO-EEG MONITORING**

## **PRESURGICAL EVALUATION WITH CONTINUOUS OR CHRONIC INTRACRANIAL MONITORING**

Depth Wire Electrodes  
Subdural Electrode  
Monitoring

## **INTRAOPERATIVE ELECTROCORTICOGRAPHY SUMMARY**

## **BACKGROUND**

Epilepsy is a relatively common neurological condition with an estimate of more than 1 million citizens of the United States suffering from partial epilepsy. Unfortunately more than 40% of individuals with partial epilepsy are thought to be medically refractory to antiepileptic drugs (AEDs) and are considered to have intractable epilepsy.<sup>1,2</sup> In people with epilepsy (PWE), disabling and intractable complex, partial, and secondarily generalized major motor seizures significantly impair their quality of life (QOL).<sup>3</sup> For example, the ability to legally drive has been identified as an important indicator for QOL and should be

considered when treating epilepsy patients<sup>4</sup> as even rare seizures impair the ability to operate a motor vehicle.<sup>5</sup> As a result of the impact on QOL, elimination of all disabling seizures should be the goal of any therapy.

Historically, resective epilepsy surgery for the person with intractable epilepsy has sometimes been considered a treatment of last resort. The time for the PWE to ultimately be considered for epilepsy surgery has sometimes been measured in decades. A randomized prospective study comparing surgery for intractable temporal lobe epilepsy with medical therapy concluded that resective temporal lobe surgery is significantly superior to medical therapy alone.<sup>6</sup> The American Academy

of Neurology practice parameter concerning surgery for temporal lobe epilepsy endorses the benefits of anterior-mesial temporal lobe resection over continued medical treatment with AEDs in patients with intractable temporal lobe epilepsy.<sup>7</sup> The most common type of surgery for epilepsy is the focal resection of the suspected seizure focus, with the majority being temporal lobectomy. Studies have shown additional benefits of temporal lobectomy including the postoperative improvement of behavioral and cognitive functions.<sup>8,9</sup> Long-term outcomes have been reported to be favorable for anterior temporal lobectomy with approximately two-thirds of patients remaining seizure-free after surgery.<sup>10</sup> Selecting favorable temporal lobe epilepsy patients prior to surgery can improve postoperative outcome.<sup>11–13</sup> Health-related QOL after epilepsy surgery may worsen if the patient has continued postoperative seizures and suffered from an associated memory decline due to the surgery. If seizures are well controlled postoperatively, the patients' QOL improved despite any associated memory difficulties.<sup>14</sup> Temporal lobe epilepsy surgery has also been shown to reduce overall health care costs,<sup>15</sup> and improve the employment status.<sup>16</sup> When seizures are controlled after surgery, outcomes are perceived by the patients as being improved.<sup>17,18</sup> The preoperative electroencephalographic (EEG) evaluation is done to localize and characterize seizures and is essential in the preoperative planning process.

### ***Purpose and Role of Electroencephalography in the Surgical Evaluation of Epilepsy***

- To assist in further localization of epileptogenic zones using continuous intracranial monitoring with depth and grid leads.

## **PRESURGICAL SELECTION AND EVALUATION**

### **Clinical Evaluation**

Determining the appropriate epilepsy surgical candidate requires a team approach and generally occurs at a comprehensive epilepsy center that is able to provide a multidisciplinary approach to the evaluation. The evaluation includes specialized imaging studies,

neuropsychological and possibly psychiatric evaluations, and frequently intracarotid amobarbital (ICA) testing.<sup>19–23</sup> The surgical evaluation is focused on identifying and resecting the epileptic zone, with the ultimate goal of seizure freedom. Seizure surgery is most efficacious for patients with temporal lobe epilepsy from mesial temporal sclerosis.<sup>10,22</sup> Determining that a patient has medically refractory seizures usually occurs after 6–12 months' time or after failing several AEDs.<sup>24</sup> Unfortunately, not all people with partial epilepsy are appropriate surgical candidates. Major medical or psychiatric illnesses may preclude resective surgery, or even a safe presurgical evaluation.<sup>1</sup> In reality, the majority of surgical candidates are traditionally young adults and children, but surgery may be efficacious and indicated in healthy, older individuals.<sup>1</sup>

### **Key Points**

- Surgical evaluation of patients with epilepsy is focused on identifying and resecting the epileptic zone.
- Seizure surgery is most efficacious for patients with temporal lobe epilepsy from mesial temporal sclerosis.

### **Imaging Studies**

Imaging studies, such as specialized MRI with temporal lobe volumes or high-resolution cuts through the temporal lobes, are useful for identifying lesions that may be associated with epileptogenic brain tissue.<sup>11,12,25,26</sup> Identifying a lesion that is concordant with the epileptic zone on EEG is a predictor of good surgical outcome.<sup>12,13</sup> Brain lesions that are typically associated with good epilepsy surgical outcomes include mesial temporal sclerosis, cortical maldevelopment or dysgenesis, vascular malformations, and neoplasms.

Ictal single photon emission computed tomography (SPECT) scan is performed during a seizure when the nuclear material is injected intravenously and the SPECT is performed within a few hours to look for an area of increased blood flow corresponding with the ictal zones. The sensitivity of the SPECT can be enhanced by performing an interictal study and then subtracting the interictal from the ictal study. Subtraction of the background activity during this process may reveal the

ictal onset zone. After subtraction, the resulting signal is coregistered on the MRI, and has been named SISCOM. A positive test has been shown to be helpful in the localization process.<sup>27-32</sup>

Positron emission tomography (PET) scan may also be useful during the presurgical evaluation. PET typically utilizes fluoro-deoxyglucose (FDG) and is performed interictally. A positive test reveals areas of hypometabolism that may correspond with the ictal zone. An ambulatory EEG is often done during the PET scan to verify that the study is performed during the interictal state.

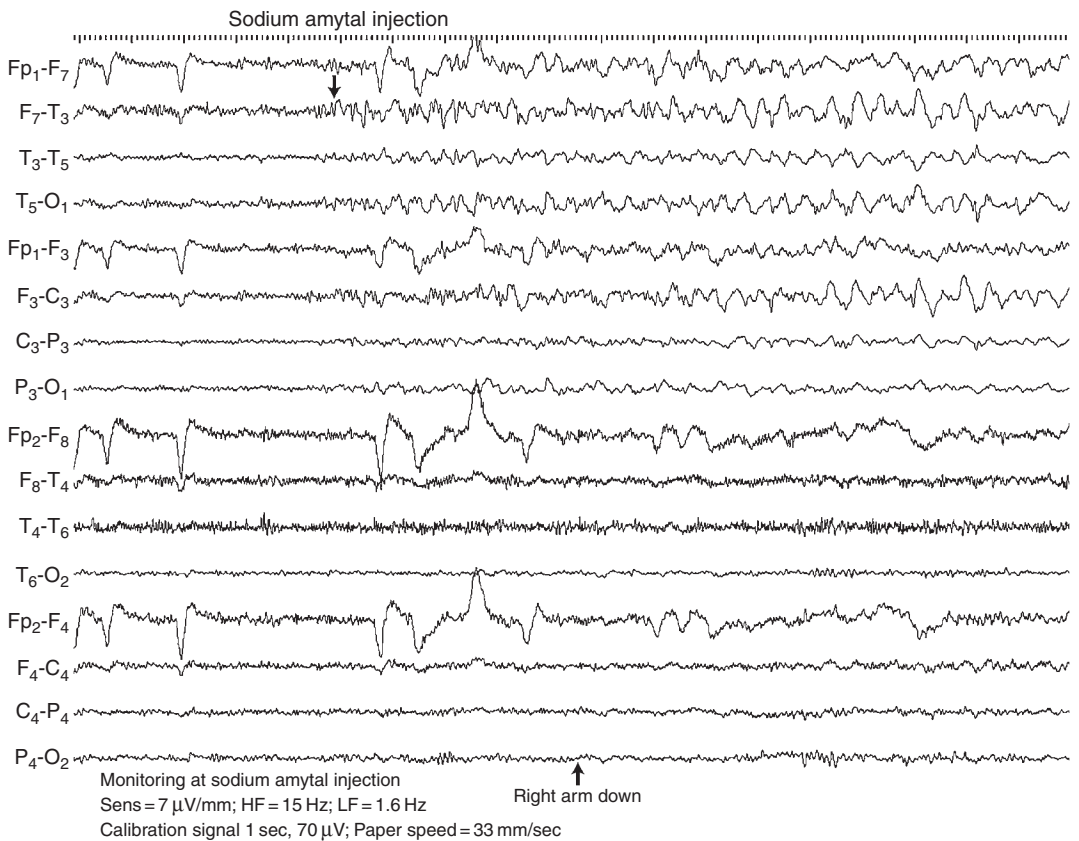
**Key Points**

- Identifying a lesion on imaging studies that is concordant with the epileptic zone on EEG is a predictor of good surgical outcome.

- Ictal SPECT scan is a nuclear study performed during a seizure to assess for an area of increased blood flow corresponding with the ictal zones.
- PET scan utilizes FDG and may reveal areas of hypometabolism that may correspond with the ictal zone.

**Intracarotid Amobarbital**

Intracarotid amobarbital (ICA) or Wada testing is sometimes performed in the assessment of epilepsy patients being considered for surgery.<sup>33,34</sup> The test is performed by selectively injecting each carotid artery with sodium amobarbital to anesthetize areas served by the particular carotid artery. The basic premise of the test is that after the injection, the areas that are anesthetized have their normal function impaired. During this brief period of anesthesia, the patients' language and memory are



**Figure 15-1.** Selective injection of the left carotid artery with sodium Amytal. Amytal injection corresponds with left hemisphere slowing, and concurrent weakness in the right arm is clinically observed. HFF = 35 Hz, LFF = 1.0 Hz, Sensitivity = 7 μV/mm.

evaluated.<sup>35–40</sup> Data gathered during this time is used to help determine language lateralization and memory support. The test may predict language and memory function after temporal lobectomy, which is particularly important in dominant hemisphere resective surgery.

During the ICA procedure, the EEG is used to ensure that no subtle seizures have occurred during the test, verify that the EEG changes are limited to the side of the injection, and ensure that the electrical activity returns to baseline postinjection. Figure 15–1 shows typical EEG changes during a left-sided carotid injection.<sup>36</sup> Limitations of the ICA test include accurate ability in predicting postoperative memory function.<sup>38,39,41</sup> Functional MRI testing (fMRI) may be a potential alternative to ICA, especially in determining language lateralization.<sup>42,43</sup> The utility of alternative testing to the ICA test, including fMRI, is currently unclear.<sup>44</sup>

### Key Points

- ICA or Wada testing is used to help determine language lateralization and memory support.
- During the ICA procedure, the EEG is used to ensure that no subtle seizures have occurred during the test, verify that the EEG changes are limited to the side of the injection, and ensure that the electrical activity returns to baseline postinjection.

## ROUTINE EEG IN THE SURGICAL EVALUATION OF PATIENTS WITH SEIZURES

The use of routine EEG is the first step in the evaluation of the person with suspected seizures and intractable partial epilepsy.<sup>21,25,45</sup> The routine, interictal EEG may provide clues to localization and seizure type. Utilizing standard activation procedures such as photic stimulation, hyperventilation, and sleep deprivation may improve the diagnostic yield of the routine interictal EEG.<sup>45–47</sup> Normal interictal EEGs may be recorded in patients with epilepsy and, therefore, performing multiple routine EEGs may be helpful in increasing the likelihood of recording abnormalities with each subsequent test. Epileptiform activity may not be recorded on routine EEG since the epileptic source may

be distant from the scalp-recording site, the recording time may be limited, and technical issues of signal attenuation by scalp bone and dura may occur.<sup>46,48,49</sup>

### Key Points

- Routine EEG is the first step in the evaluation of the person with suspected seizures and intractable partial epilepsy.
- Standard activation procedures such as photic stimulation, hyperventilation, and sleep deprivation may improve the diagnostic yield of the routine interictal EEG.
- Epileptiform activity may not be recorded on routine EEG since the epileptic source may be distant from the scalp-recording site, the recording time may be limited, and technical issues of signal attenuation by scalp bone and dura may occur.

## PREOPERATIVE VIDEO-EEG MONITORING

Video-EEG monitoring in an epilepsy monitoring unit (EMU) is used to characterize and localize the onset of typical events. The ictal scalp recordings can help to localize the epileptiform focus, but also may lead to false localization of the ictal zone, especially when seizures begin in the amygdala, which is at a relatively long distance from the scalp-recording electrodes.<sup>21,48–50</sup> Seizures beginning in the temporal lobe have the highest sensitivity and specificity for localization using scalp recordings. Another misleading false negative result may occur when recording simple partial seizures, in which ictal scalp recordings may show no discernable ictal change.<sup>51</sup> Foci in the frontal lobe may also not be recorded, since many of its cortical generators of EEG are located at considerable distances for the scalp-recording electrodes.<sup>51</sup>

The placement of supplementary electrodes may provide a means of improving the yield of surface recordings. The use of inferior lateral temporal leads and so-called 10% (additional closer spaced) electrodes may help to further localize ictal and interictal discharges.<sup>21,49,50</sup> Sphenoidal electrodes have also been widely used in the past during the surgical evaluation. These thin electrodes are placed near the base



of the sphenoid bones bilaterally with a guidance insertion needle. The utility of sphenoidal electrodes has been questioned, especially with their invasive nature being less well tolerated than comparable surface leads.<sup>50</sup> Nasopharyngeal leads inserted in each nostril and left in place for extended periods were felt to help record discharges from the medial temporal structures. The use of these electrodes has been shown to be of no more benefit than additional lateral low temporal leads in the presurgical evaluation.<sup>52</sup> The use of computerized aids such as seizure- and spike-detection programs in the evaluation process may be useful in analyzing the vast amounts of data gathered in the long-term video-monitoring unit. Various strategies are employed by these programs to detect epileptiform activity but their use is an adjunct to the interpretative process.

### Key Points

- Video-EEG monitoring in an epilepsy monitoring unit is used to characterize and localize the onset of typical events.
- Seizures beginning in the temporal lobe have the highest sensitivity and specificity for localization using scalp recordings.
- The placement of supplementary electrodes, such as inferior lateral temporal leads or sphenoidal electrodes, may provide a means of improving the yield of surface recordings.

## PRESURGICAL EVALUATION WITH CONTINUOUS OR CHRONIC INTRACRANIAL MONITORING

Even after the initial evaluation in patients with epilepsy, some of the patients may not immediately qualify for resective surgery due to inadequate lesion localization. When this occurs, if the patient is still considered a surgical candidate intracranial electrodes may be required. The location of the indwelling electrodes is predetermined and is tailored to the individual patient based on data collected during initial studies, including scalp recordings, ICA testing, and specialized imaging studies. Once the electrodes are placed, the patient is transferred

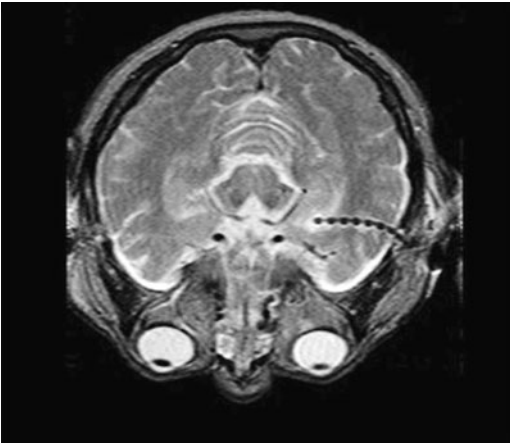
to the EMU or the ICU and monitored in a continuous manner until typical seizures are recorded.<sup>53-56</sup> The length of time that monitoring occurs may vary from a few days to weeks, and is mostly based on the number and nature of seizures recorded. The type of electrodes utilized is determined by the suspected location of the ictal zone and if brain mapping is needed.

The main potential complications of intracranial monitoring include hemorrhage and infection, which occur at a frequency of approximately 3%. Certain variables have been shown to be important in determining the rate of complications. The complication rate increases with increasing numbers of electrodes inserted; using more than 60 electrodes leads to more frequent complications.<sup>57</sup>

The two most common types of electrodes used for chronic intracranial monitoring are depth wire electrodes and grid electrodes. The usefulness of intracranial EEG in the surgery evaluation process was recently confirmed, especially in patients when there is a lack of congruence between EEG and MRI findings.<sup>58</sup>

## Depth Wire Electrodes

Depth wire electrodes are thin, flexible electrodes that are inserted in the parenchyma of the brain in areas of interest. These electrodes are commonly used when there is ambiguity as to lateralization of the seizure onset, typically when there is a concern about possible bitemporal seizures. When comparing scalp vs. depth leads, discordance is found in only 13% of cases when considering all available information from the results of the initial comprehensive epilepsy evaluation utilizing imaging and neuropsychological data. When scalp recordings produce ambiguous results, the use of depth electrodes may demonstrate that the patient indeed is a surgical candidate.<sup>53-55</sup> Depth wire recordings have distinct advantages over scalp leads as there is no movement or muscle artifact when utilizing depth leads.<sup>55</sup> Typical placement of a left temporal depth lead is depicted in Figure 15-2. The use of depth wires may be combined with the use of grid electrodes in an attempt to improve localization of the ictal zone. Interictal spiking recorded with the depth leads cannot be

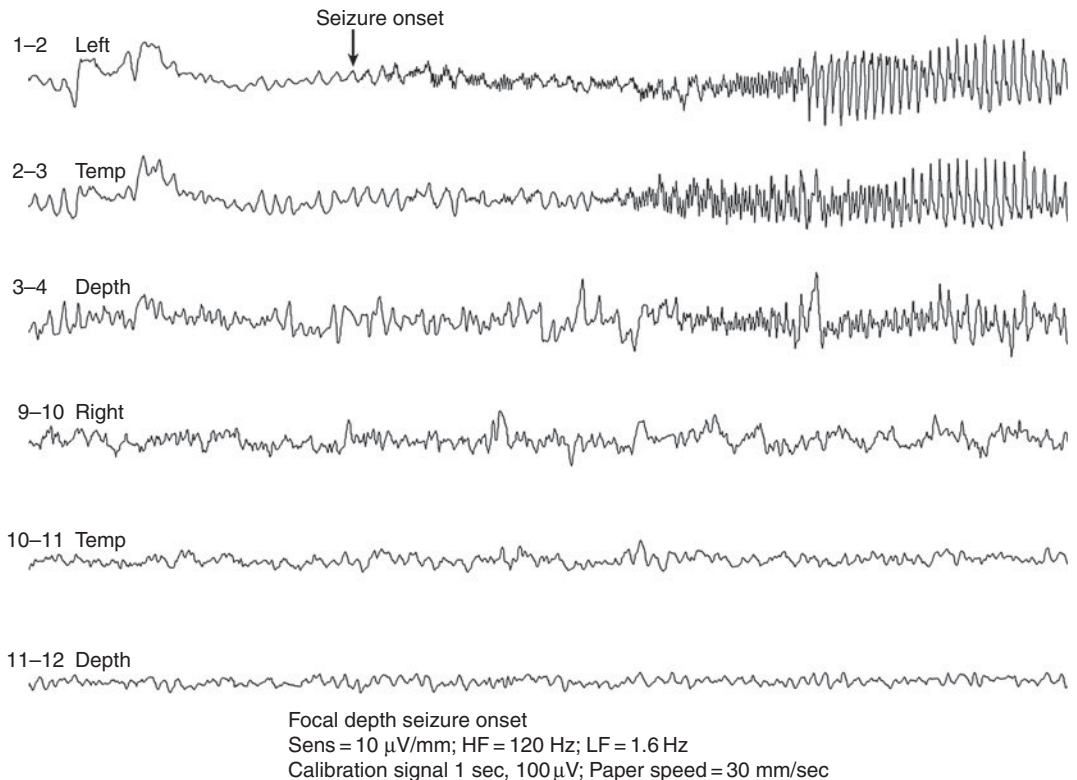


**Figure 15-2.** MRI scan highlighting left temporal depth lead placement used in recording the ictal activity depicted in Figure 15-3. (Note: Depth leads in the opposite temporal lobes and bilateral frontal lobes are not depicted in this image).

may be more frequent from the contralateral hemisphere. Frequent contralateral interictal spiking does not necessarily predict a poor outcome in temporal lobectomy.<sup>26,55,56</sup> Recording the patient's typical seizure with depth leads in place is often the ultimate determining factor for localization of the site of seizure onset irrespective of seizure onset.<sup>26</sup> If seizures occur in an independent manner from opposite hemispheres, the patient is likely not a good resection candidate. The number of typical seizures needed to be recorded utilizing depth electrodes to adequately determine if a patient is a good surgical candidate ranges from five to ten.<sup>25</sup>

When considering the electrographic seizure onset, the type of discharge is important in prognostic value. The outcome after surgery is more favorable if the onset is more focal and precise, as recorded from a single electrode and then spreading, compared to a seizure onset that is more regional.<sup>59</sup> Figure 15-3 shows a localized onset seizure beginning in

relied upon totally to help determine the ictal zone as up to 20% of cases interictal spikes



**Figure 15-3.** Typical ictal activity in the deepest contact in the left temporal depth lead (fast activity in trace 1). Ictal activity evolves rapidly to adjacent leads as the seizure progresses. HFF = 120 Hz, LFF = 1.0 Hz, Sensitivity = 75  $\mu$ V/mm.

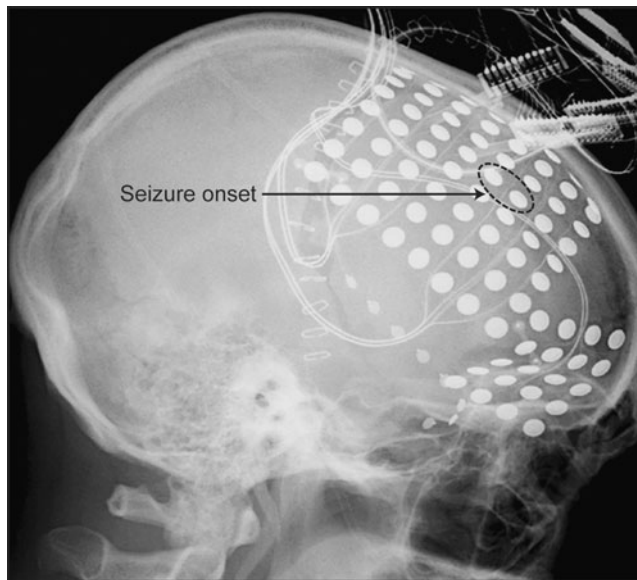
a temporal depth lead. The amount of time that it takes the electrographic seizure activity to spread has also been shown to predict outcome. If the electrographic seizure activity propagates more slowly to the opposite hemisphere, the surgical outcomes are better.<sup>25</sup>

## Subdural Electrode Monitoring

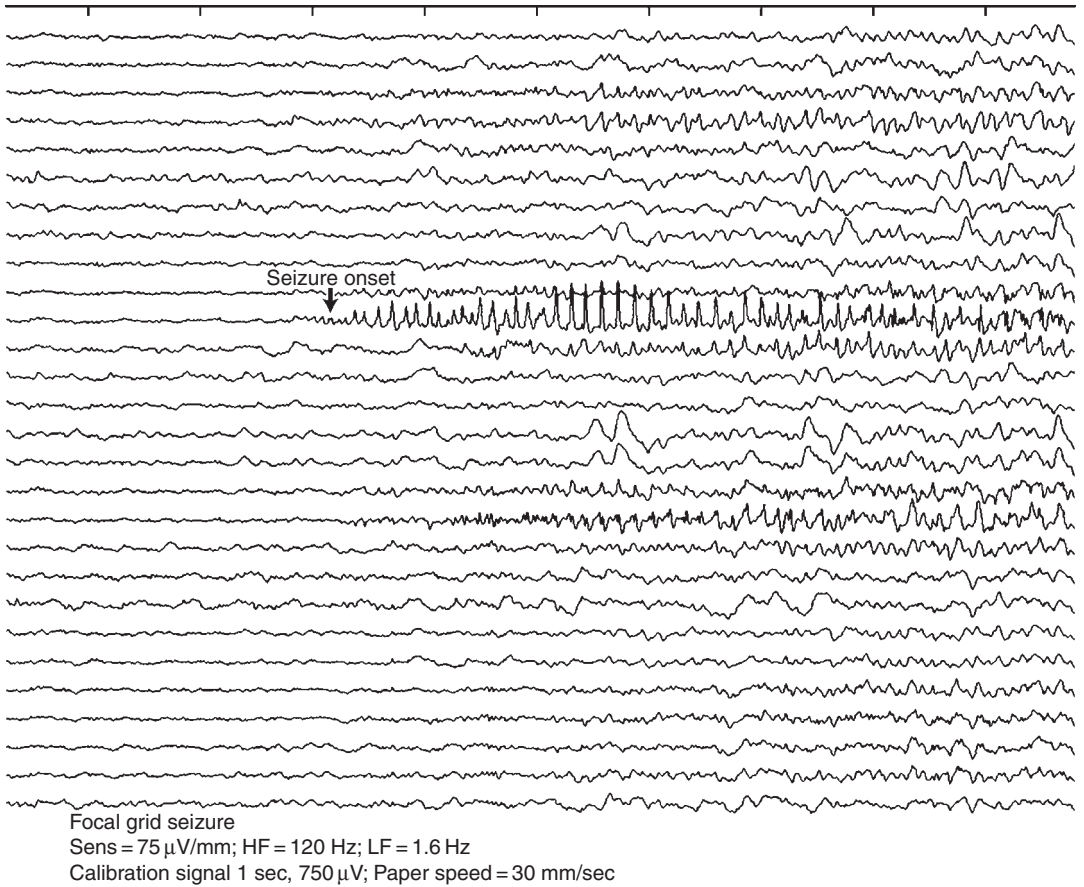
Multiple subdural electrodes embedded at fixed distances in a flat flexible plastic background material (grid) are utilized for neocortical recordings. Similar to the use of depth leads, subdural grid monitoring is accomplished after the initial scalp EEG and other tests have identified a preliminary target for resection. Grid placement is performed under general anesthesia, following which the patient is monitored in the EMU. The number of electrodes and their location is determined by the preliminary results of the initial studies and the anatomical location of the suspected ictal zone. When evaluating the mesiotemporal lobe structures, depth electrodes placed in the temporal lobes may be more sensitive in detecting epileptiform activity.<sup>50</sup> Figure 15-4 depicts a typical grid placement and Figure 15-5 shows a well-localized seizure onset.

As with depth wire electrodes, the number of electrodes implanted impacts the complication rate.<sup>57</sup> The appropriate grid or depth wire candidate must be able to tolerate the intracranial electrodes being in place for a period of days to a couple of weeks.

Subdural grid electrodes provide a unique opportunity to perform cortical mapping to determine the presence and location of eloquent cortex prior to surgical resection of the ictal zone. This localization is accomplished by using the individual electrodes of the grid that are resting upon neocortex to electrically stimulate the ictal and periictal cortex looking for vital functions, including language, vision, and motor and sensory function. These studies are relatively easily evaluated with the grid in place during the monitoring session in the EMU. Stimulation is accomplished with the use of an external stimulator that applies a small electrical stimulus in either a bipolar or a unipolar strategy utilizing the recording electrodes. Electrodes overlying the suspected ictal zone or eloquent cortex are particularly important. During the stimulation procedure, the patient performs specific and appropriate tasks for the area in question. With each stimulation, the patient is observed or self-reports changes in the ability to perform those specific tasks during the stimulation. If the ictal zone overlaps



**Figure 15-4.** Skull X-Ray showing a combination of frontal grid electrodes and temporal strip electrodes used to localize the ictal zone.



**Figure 15-5.** EEG utilizing neocortical grid in the frontal lobe showing a well-localized seizure onset (*arrow*). Note the rapid spread to adjacent electrodes.

with eloquent cortex, resection may not be possible.<sup>60</sup>

Surgical outcomes for people undergoing chronic intracranial monitoring are good, with an approximately 80% seizure-free rate if there is an associated MRI lesion that is concordant with the ictal zone. Poorer outcomes are noted in nonlesional cases with less than 25% being seizure-free after surgery.<sup>26</sup>

### Key Points

- Depth wire electrodes inserted in the parenchyma of the brain in areas of interest may be used when there is ambiguity as to lateralization of the seizure onset, typically when there is a concern about possible bitemporal seizures.
- The use of depth wires may be combined with the use of grid electrodes in an attempt to improve localization of the ictal zone.
- The outcome after surgery is more favorable if the seizure onset is more focal and precise, as recorded from a single electrode and then spreading, compared to a seizure onset that is more regional.
- Multiple subdural electrodes embedded at fixed distances in a flat flexible plastic background material (grid) are utilized for neocortical recordings.
- Subdural grid electrodes provide a unique opportunity to perform cortical mapping to determine the presence and location of eloquent cortex prior to surgical resection of the ictal zone.

## INTRAOPERATIVE ELECTROCORTICOGRAPHY

Intraoperative electrocorticography (ECoG) is a technique that involves a multidisciplinary epilepsy team, including the epileptologist, neurosurgeon, EEG technologist, anesthesiologist and possibly neuropsychologist assembling in the operating room (OR) during the resective procedure. The need for ECoG depends on the results of the presurgical evaluation, the localization of the epileptogenic zone, and the type(s) of extraoperative EEG monitoring. If the epileptogenic zone has been localized with continuous intracranial monitoring, ECoG may be less important in determining the region of cortical resection. Patients in whom depth electrode studies show a mesiobasal limbic origin of seizures may subsequently have en bloc resection of the temporal lobe without ECoG. Traditional focal corticectomies have used a *tailored resection*, with ECoG localizing the site of seizure onset.

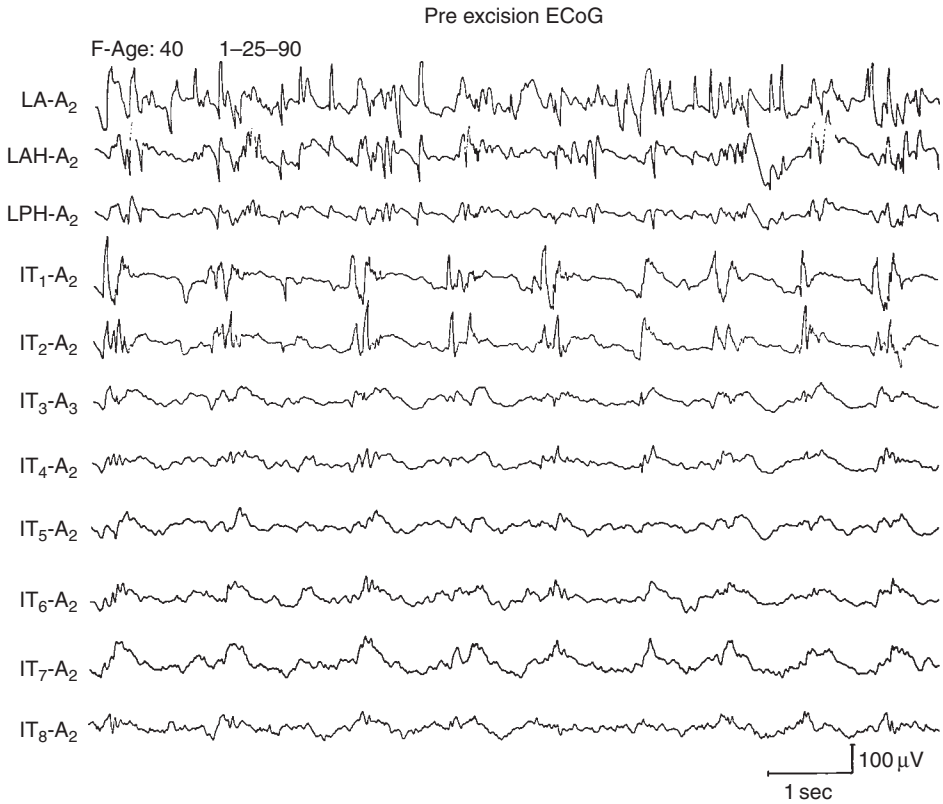
When performed at Mayo Clinic, ECoG is performed with the patient under general anesthesia. The anesthetic agents used include nitrous oxide, fentanyl, or a low-volume percentage of isoflurane. A 16- or 32-channel EEG recording is made. Methohexital given intravenously may be used to enhance or to activate epileptiform activity in the preexcision recordings. The strategy for intraoperative EEG monitoring is discussed with the surgical team, the anesthesiologist, and the EEG technologist. The electroencephalographer is present in the OR for immediate interpretation of the EEG data.

Several techniques for ECoG are available that include the use of subdural strip electrodes or a rigid electrode holder with graphite tip or cotton wick electrodes.<sup>61</sup> After craniotomy, electrodes are placed on the cortex and ECoG is recorded while the patient is under light general anesthesia. Subdural strip electrodes are particularly useful in recordings obtained from the inferior temporal lobe and the mesiofrontal region.<sup>61</sup> The preexcision ECoG at Mayo Clinic uses three subdural strips (each with eight electrode contacts) placed on the superior and inferior temporal lobe gyri and in the suprasylvian region. Three depth electrodes are also placed by hand in the region of the amygdala and hippocampus.

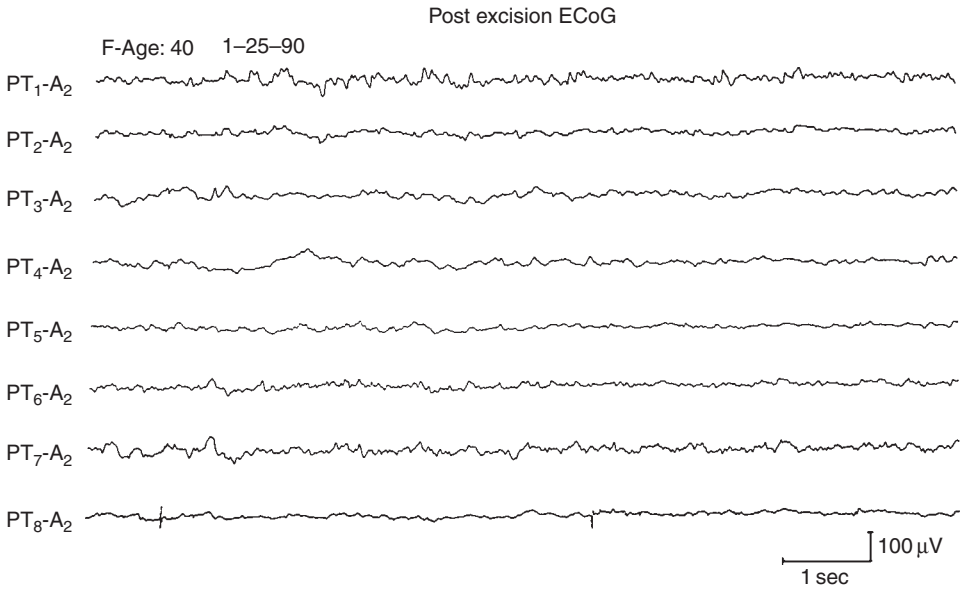
A baseline extracranial EEG recording is performed before the surgical resection with the patient awake, and a contralateral ear reference is used for the intracranial recordings. Electrical stimulation is used intraoperatively to assist in localizing the epileptogenic zone and functional anatomy. Samples of EEG activity are obtained before and after cortical resection and interictal epileptiform activity is recorded and localized (Fig. 15-6). The cortex producing epileptiform activity is then resected and the electrodes are reinserted along the margin of the resection. The extent of the focal corticectomy is based on the ECoG and the presurgical evaluation. The relationship between the localization of the epileptogenic zone and the eloquent cortex is considered at the time of the operation. A postexcision recording is made, with a subdural strip electrode placed posterior to the margin of the surgical resection (Fig. 15-7). If further epileptiform activity is noted further resection is attempted. The limit of the resection may depend on functional cortical mapping that is also accomplished in the OR.

Electrocorticography has several important limitations that must be recognized for appropriate interpretation of these studies. Information about the localization and lateralization of the epileptogenic zone must be determined prior to the ECoG study. Electrocorticography has been used mainly to assess neocortical epileptiform activity, and it may be restricted in sampling from the orbitofrontal, mesiofrontal, and mesiotemporal regions, which may not correlate with the region of seizure onset. Other potential disadvantages of ECoG include the sampling of predominant interictal EEG activity, the restricted spatial distribution of the EEG recording, and usually the brief duration of the monitoring. The neurosurgical team must delay the cortical resection until ECoG is performed and the studies are interpreted. In addition, general anesthesia used during the surgical procedure may suppress epileptiform activity. High concentrations of certain anesthetic drugs, such as isoflurane, may make it difficult to document the neocortical extent of the epileptogenic zone. Enflurane may activate or increase interictal epileptiform activity; however, this may be nonspecific and may not correlate with the site of seizure onset. The false positivity of methohexital-activated





**Figure 15-6.** Electrocorticography performed at the time of left anterior temporal lobectomy. The three upper channels represent recording from the mesiotemporal region with depth electrodes. Prominent spiking is noted in the mesiotemporal region and the lateral temporal cortex.



**Figure 15-7.** Postexcision ECoG performed with a subdural strip placed posterior to the margin of the resection. No definite residual spiking is noted.

ECoG has also been observed. Certain ECoG-recorded postexcision spike discharges are not prognostically important.<sup>62</sup>

The use of intraoperative ECoG has been found to be of little predictive value for a good outcome after resective surgery.<sup>11,63</sup> The presence of residual spiking may be associated statistically with unfavorable seizure outcome. However, the presence of residual spiking may not preclude a successful surgical outcome after focal corticectomy.<sup>64</sup>

### Key Points

- During electrocorticography, electrodes are placed on the cortex and the activity is recorded while the patient is under light general anesthesia.
- The cortex producing epileptiform activity is surgically resected and the electrodes are reinserted along the margin of the resection.

### SUMMARY

As technology advances, the availability and use of minute microprocessors may change the way we evaluate the patient with epilepsy. Currently trials are ongoing using permanently implanted electronic devices that are capable of recording limited but chronic EEG from depth or grid leads.<sup>65</sup> The device has been shown to be able to analyze ongoing EEG and detect the onset of seizures by various algorithms and in response provide a small electrical shock in an attempt to abort the ictal activity, while other permanent devices stimulate at scheduled intervals.<sup>66</sup> Trending data, brief samples, and seizures may be easily downloaded for analysis via the Internet. The ability to safely record and detect seizures on a chronic basis may change future treatment strategies. The current study and use of such devices is limited to patients felt not to be resective surgical candidates and are able to be participants in ongoing clinical studies.

The use of EEG in the evaluation of people with refractory partial epilepsy for possible resective surgery remains integral to the comprehensive epilepsy evaluation. Surgery remains a potentially curative procedure for people with intractable epilepsy. Using a multidisciplinary team to evaluate the PWE requires

that essential elements of the evaluation are in agreement before surgery is offered. The use of specialized tests and sometimes invasive EEG recording techniques can assist in localizing the ictal zone for possible surgical resection when standard monitoring techniques are not conclusively localizing. Epilepsy surgery has been shown to be effective in the treatment of intractable epilepsy, especially in patients with temporal lobe epilepsy. Future technology is currently being studied that may dramatically change how we manage and evaluate people with intractable epilepsy.

### REFERENCES

1. Kwan, P., and M. J. Brodie. 2000. Early identification of refractory epilepsy. *The New England Journal of Medicine* 342:314–19.
2. French, J. A., and S. Schachter. 2002. A workshop on antiepileptic drug monotherapy indications. *Epilepsia* 43(Suppl 10):3–27.
3. Fisher, R. S. 2000. Epilepsy from the patient's perspective: Review of results of a community-based survey. *Epilepsy & Behavior* 1:S9–14.
4. Gilliam, F., R. Kuzniecky, E. Faught, L. Black, G. Carpenter, and R. Schrodt. 1997. Patient-validated content of epilepsy-specific quality-of-life measurement. *Epilepsia* 38:233–6.
5. Drazkowski, J. F., R. S. Fisher, J. I. Sirven, et al. 2003. Seizure-related motor vehicle crashes in Arizona before and after reducing the driving restriction from 12 to 3 months. *Mayo Clinic Proceedings* 78:819–25.
6. Wiebe, S., W. T. Blume, J. P. Girvin, and M. Eliasziw. 2001. Effectiveness and efficiency of surgery for temporal lobe epilepsy study group. A randomized, controlled trial of surgery for temporal-lobe epilepsy. *The New England Journal of Medicine* 345:311–8.
7. Engel, J. Jr., S. Wiebe, J. French, et al. 2003. Quality Standards Subcommittee of the American Academy of Neurology; American Epilepsy Society; American Association of Neurological Surgeons. Practice parameter: Temporal lobe and localized neocortical resections for epilepsy: Report of the Quality Standards Subcommittee of the American Academy of Neurology, in association with the American Epilepsy Society and the American Association of Neurological Surgeons. *Neurology* 60:538–47.
8. Radhakrishnan, K., E. L. So, P. L. Silbert, et al. 1998. Predictors of outcome of anterior temporal lobectomy for intractable epilepsy: A multivariate study. *Neurology* 51:465–71.
9. National Institutes of Health Consensus Conference. 1990. Surgery for epilepsy. *JAMA* 264:729–33.
10. Walczak, T. S., R. A. Radtke, J. O. McNamara, et al. 1990. Anterior temporal lobectomy for complex partial seizures: Evaluation, results, and long-term follow-up in 100 cases. *Neurology* 40:413–18.
11. Cascino, G. D., M. R. Trenerry, C. R. Jace Jr., et al. 1995. Electrocorticography and temporal lobe



- epilepsy: Relationship to quantitative MRI and operative outcome. *Epilepsia* 36:692–6.
12. Cascino, G. D., M. R. Trenery, E. L. So, et al. 1996. Routine EEG and temporal lobe epilepsy: Relation to long-term EEG monitoring, quantitative MRI, and operative outcome. *Epilepsia* 37:651–6.
  13. Cascino, G. D. 1998. Neuroimaging in partial epilepsy: Structural magnetic resonance imaging. *Journal of Epilepsy* 11:121–9.
  14. Langfitt, J. T., M. Westerveld, M. J. Hamberger, et al. 2007. Worsening of quality of life after epilepsy surgery: Effect of seizures and memory decline. *Neurology* 68:1988–94.
  15. Langfitt, J. T., R. G. Holloway, M. P. McDermott, et al. 2007. Healthcare costs decline after successful epilepsy surgery. *Neurology* 68:1290–8.
  16. Chin, P. S., A. T. Berg, S. S. Spencer, et al. 2007. Employment outcomes following resective epilepsy surgery. *Epilepsia* 48(12):2253–7.
  17. Spencer, S. S., A. T. Berg, B. G. Vickrey, et al. 2007. Multicenter study of epilepsy surgery. Health-related quality of life over time since resective epilepsy surgery. *Annals of Neurology* 62(4):327–34.
  18. Gilliam, F., R. Kuzniecky, K. Meador, et al. 1999. Patient-oriented outcome assessment after temporal lobectomy for refractory epilepsy. *Neurology* 53:687–94.
  19. Salinsky, M., R. Kanter, and R. M. Dasheiff. 1987. Effectiveness of multiple EEGs in supporting the diagnosis of epilepsy: An operational curve. *Epilepsia* 28:331–4.
  20. Jack, C. R. Jr., W. H. Theodore, M. Cook, and G. McCarthy. 1995. MRI-based hippocampal volumetrics: Data acquisition, normal ranges, and optimal protocol. *Magnetic Resonance Imaging* 13:1057–64.
  21. Quency, L. F., M. W. Risinger, and D. A. Shewmon. 1993. Extracranial EEG evaluation. In *Surgical treatment of the epilepsies*, ed. J. Engel Jr., 2nd ed., 173–95. New York: Raven Press.
  22. O'Brien, T. J., E. L. So, B. P. Mullan, et al. 2000. Subtraction peri-ictal SPECT is predictive of extratemporal epilepsy surgery outcome. *Neurology* 55:1668–77.
  23. Theodore, W. H., S. Sato, C. V. Kufta, W. D. Gaillard, and K. Kelley. 1997. FDG-positron emission tomography and invasive EEG: Seizure focus detection and surgical outcome. *Epilepsia* 38:81–6.
  24. Engel, J., Jr., and G. A. Ojemann. 1993. The next step. In *Surgical treatment of the epilepsies*, ed. J. Engel Jr., 2nd ed., 319–29. New York: Raven Press.
  25. Gates, J. R. 1987. Epilepsy presurgical evaluation in the era of intensive neurodiagnostic monitoring. *Advances in Neurology* 46:227–47.
  26. Schiller, Y., G. D. Cascino, and F. W. Sharbrough. 1998. Chronic intracranial EEG monitoring for localizing the epileptogenic zone: An electroclinical correlation. *Epilepsia* 39:1302–8.
  27. O'Brien, T. J., E. L. So, B. P. Mullan, et al. 1998. Subtraction ictal SPECT co-registered to MRI improves clinical usefulness of SPECT in localizing the surgical seizure focus. *Neurology* 50:445–54.
  28. O'Brien, T. J., E. L. So, B. P. Mullan, et al. 1999. Subtraction SPECT co-registered to MRI improves postictal SPECT localization of seizure foci. *Neurology* 52:137–46.
  29. So, E. L. 2000. Integration of EEG, MRI, and SPECT in localizing the seizure focus for epilepsy surgery. *Epilepsia* 41(Suppl 3):S48–54.
  30. Boullieret, V., M. P. Valenti, E. Hirsch, F. Semah, and I. J. Namer. 2000. Correlation between PET and SISCOM in temporal lobe epilepsy. *Journal of Nuclear Medicine* 48:991–8.
  31. Wiest, R., J. Kassubek, K. Schindler, et al. 2005. Comparison of voxel-based 3-D MRI analysis and subtraction ictal SPECT coregistered to MRI in focal epilepsy. *Epilepsy Research* 65:125–33.
  32. Whiting, P., R. Gupta, J. Burch, et al. 2006. A systemic review of the effectiveness and cost-effectiveness of neuroimaging assessments used to visualize the seizure focus in people with refractory epilepsy being considered for surgery. *Health Technology Assessment* 10:iii–iv, 1–250.
  33. Gardner, W. J. 1941. Injection of procaine into the brain to relocate speech area in left-handed persons. *Archives of Neurology and Psychiatry* 46:1035–8.
  34. Wada, J. 1949. A new method for determination of the site of cerebral speech dominance: A preliminary report on the intracarotid injection of sodium Amytal [in Japanese]. *Igaku to Seitbutsumgaki* (Medicine and Biology) 14:221–2.
  35. Wyllie, E., H. Lüders, D. Murphy, et al. 1990. Intracarotid amobarbital (Wada) test for language dominance: Correlation with results of cortical stimulation. *Epilepsia* 31:156–61.
  36. Morrell, M. J., C. A. Phillips, M. J. O'Connor, and M. R. Sperling. 1991. Speech during partial seizures: Intracranial EEG correlates. *Epilepsia* 32:886–9.
  37. Wada, J., and T. Rasmussen. 1960. Intracarotid injection of sodium Amytal for the lateralization of cerebral speech dominance: Experimental and clinical observations. *Journal of Neurosurgery* 17:266–82.
  38. Kneebone, A. C., G. J. Chelene, D. S. Dinner, R. I. Naugle, and I. A. Awad. 1995. Intracarotid amobarbital procedure as a predictor of material-specific memory change after anterior temporal lobectomy. *Epilepsia* 36:857–65.
  39. Loring, D. W., K. J. Meador, G. P. Lee, et al. 1995. Wada memory asymmetries predict verbal memory decline after anterior temporal lobectomy. *Neurology* 45:1329–33.
  40. Loring, D. W., B. P. Hermann, K. J. Meador, et al. 1994. Amnesia after unilateral temporal lobectomy: A case report. *Epilepsia* 35:757–63.
  41. Loring, D. W., G. P. Lee, K. J. Meador, et al. 1990. The intracarotid amobarbital procedure as a predictor of memory failure following unilateral temporal lobectomy. *Neurology* 40:605–10.
  42. Klöppel, S., and C. Büchel. 2005. Alternatives to the Wada test: A critical view of functional magnetic resonance imaging in preoperative use. *Current Opinion in Neurology* 18:418–23.
  43. Grote, C. L., and K. Meador. 2005. Has amobarbital expired? Considering the future of the Wada. *Neurology* 65:1692–3.
  44. Abou-Khalil, B. 2007. An update on determination of language dominance in screening for epilepsy surgery: The Wada test and newer noninvasive alternatives. *Epilepsia* 48:442–55.

45. Niedermeyer, E., and F. Lopes da Silva, eds. 1987. *Electroencephalography: Basic principles, clinical applications, and related fields*, 2nd ed. Baltimore: Urban & Schwarzenberg.
46. Daly, D. D. 1990. Epilepsy and syncope. In *Current practice of clinical electroencephalography*, ed. D. D. Daly, and T. A. Pedley, 2nd ed., 269–334. New York: Raven Press.
47. Blum, D. 1994. Prevalence of bilateral partial seizure foci and implication for electroencephalographic telemetry monitoring and epilepsy surgery. *Electroencephalography and Clinical Neurophysiology* 91:329–36.
48. Quesney, L. F., M. Constain, D. R. Fish, and T. Rasmussen. 1990. Frontal lobe epilepsy—A field of recent emphasis. *American Journal of EEG Technology* 30:177–93.
49. Quesney, L. F., and P. Gloor. 1985. Localization of epileptic foci. *Electroencephalography and Clinical Neurophysiology*. 37(Suppl):165–200.
50. Sharbrough, F. W. 1990. Electrical fields and recording techniques. In *Current practice of clinical electroencephalography*, ed. D. D. Daly, and T. A. Pedley, 2nd ed., 29–49. New York: Raven Press.
51. Devinsky, O., S. Sato, C. V. Kufta, et al. 1989. Electroencephalographic studies of simple partial seizures with subdural electrode recordings. *Neurology* 34:527–33.
52. Sperling, M. R., and J. Engel Jr., 1985. Electroencephalographic recording from the temporal lobes: A comparison of ear, anterior temporal, and nasopharyngeal electrodes. *Annals of Neurology* 17:510–13.
53. So, N., P. Gloor, L. F. Quesney, M. Jones-Gotman, A. Olivier, and F. Andermann. 1989. Depth electrodes investigations in patients with bitemporal epileptiform abnormalities. *Annals of Neurology* 25:423–31.
54. So, N., A. Olivier, F. Andermann, P. Gloor, and L. F. Quesney. 1989. Results of surgical treatment in patients with bitemporal epileptiform abnormalities. *Annals of Neurology* 25:432–9.
55. Spencer, S. S., D. D. Spencer, P. D. Williamson, and R. H. Mattson. 1982. The localizing value of depth electroencephalography in 32 patients with refractory epilepsy. *Annals of Neurology* 12:248–53.
56. Schiller, Y., G. D. Cascino, N. E. Busacker, and F. W. Sharbrough. 1998. Characterization and comparison of local onset and remote propagated electrographic seizures recorded with intracranial electrodes. *Epilepsia* 39:380–8.
57. Hamer, H. M., H. H. Morris, E. J. Mascha, et al. 2002. Complications of invasive video-EEG monitoring with subdural grid electrodes. *Neurology* 58:97–103.
58. Pondal-Sordo, M., D. Diosy, E. E. Téllez-Zenteno, R. Sahjapaul, and S. Wiebe. 2007. Usefulness of intracranial EEG in the decision process for epilepsy surgery. *Epilepsy Research* 74:176–82.
59. Engel, J. Jr., and P. H. Crandall. 1987. Intensive neurodiagnostic monitoring with intracranial electrodes. *Advances in Neurology* 46:85–106.
60. Lesser, R. P., H. Lüders, H. H. Morris, et al. 1986. Electrical stimulation of Wernicke's area interferes with comprehension. *Neurology* 36:658–63.
61. Lesser, R. P., and B. Gordon. 2000. Methodologic considerations in cortical electrical stimulation in adults. In *Epileptic seizures: Pathophysiology and clinical semiology*, ed. H. O. Lüders, and S. Noachtar, 153–65. New York: Churchill Livingstone.
62. Engel, J. Jr., and G. A. Ojemann. 1993. The next step. In *Surgical treatment of the epilepsies*, ed. J. Engel Jr., 2nd ed., 319–29. New York: Raven Press.
63. Cascino, G. D., M. R. Trenerry, C. R. Jack Jr., et al. 1995. Electrocorticography and temporal lobe epilepsy: Relationship to quantitative MRI and operative outcome. *Epilepsia* 36:692–6.
64. Fiol, M. E., J. R. Gates, F. Torres, and R. E. Maxwell. 1991. The prognostic value of residual spikes in the postexcision electrocorticogram after temporal lobectomy. *Neurology* 41:512–16.
65. Duckrow, R. B., and T. K. Tcheng. 2007. Daily variation in an intracranial EEG features in humans detected by a responsive neurostimulator system. *Epilepsia* 48(8):1614–20.
66. Morrell, M. 2006. Brain stimulation for epilepsy: Can scheduled or responsive neurostimulation stop seizures? *Current Opinion in Neurology* 19(2):164–8.

*This page intentionally left blank*

# Movement-Related Cortical Potentials and Event-Related Potentials

*Virgilio Gerald H. Evidente and John N. Caviness*

## MOVEMENT-RELATED CORTICAL POTENTIALS

Introduction  
Technique  
Normal Waveforms  
Individual Variation

Abnormalities in Disease  
Contingent Negative Variation

## EVENT-RELATED POTENTIALS

The P300

## SUMMARY

## MOVEMENT-RELATED CORTICAL POTENTIALS

### Introduction

Movement-related cortical potentials (MRCPs) are electroencephalographic (EEG) potentials that occur around the time of movement and are recorded using surface scalp electrodes. Slow negative EEG waveforms preceding self-initiated movements were first described by Kornhuber and Deecke in 1965.<sup>1</sup> They recorded EEG and electromyogram (EMG) simultaneously while making subjects do self-paced repetitive movements and stored the data on magnetic tape. Using this technique, they identified two premovement components: the Bereitschaftspotential (BP) and reafferente potenziale (RP). Later on,

they found two more components occurring right before movement onset: premovement positivity (PMP) and motor potential (MP).<sup>2</sup> As for post-movement MRCP components associated with hand movements, Shibasaki et al. in 1980 identified four different peaks: the N50, P90, N160, and P300.<sup>3</sup> Microcomputers and software programs are now available that facilitate the back-averaging of cortical activity preceding a marked event.

### *Purpose and Role of MRCPs*

- These potentials have been important in understanding the cortical activity underlying normal and abnormal movements; their clinical application is limited.
- The BP may help identify some functional movement disorders.

## Technique

One of the most challenging tasks in clinical neurophysiology is to obtain MRCPs. A technique termed *jerk-locked averaging* is used to obtain and study MRCP. The minimal scalp electrode montage should include at least one to two vertex electrodes (Cz and Fz) and a pair of lateral electrodes around the area of the motor cortex (C3 and C4). The recordings are typically referenced to linked ear electrodes. It is critical that the electro-oculographic activity also be recorded. By applying additional electrodes in grids over sensorimotor cortex, the potentials can be mapped topographically. A low-frequency filter with a cutoff in the range of approximately 0.05 Hz or less must be used to record the slow premovement negative wave.

A brisk voluntary movement, usually of a digit or distal limb, acts as the timing event, but the character of the movement must be defined. The subject is instructed to keep eyes open (to minimize alpha activity) and fixate on a single point (to minimize eye movement artifacts). The subject makes self-paced, repetitive movements every 3–10 seconds. The initial rise of rectified EMG activity from the movement triggers data collection. The computer buffer is configured to collect the data for 2–3 seconds before and for 0.5–1 second after the trigger. Data from 100 to 200 such artifact-free movements are collected and stored for later analysis.

Averaging must be performed off-line to ensure proper artifact rejection. Each trace is reevaluated to detect any contamination by eye movement artifact. The tracing must also display a clear EMG takeoff point. If acceptable, the tracing is aligned at the EMG onset and computed into the ongoing averaging process.

## Normal Waveforms

The earliest recordable MRCP is the Bereitschaftspotential or readiness potential, which is a slowly rising negativity beginning 1.0–2.0 seconds before the onset of movement.<sup>1</sup> It is maximal at the vertex (particularly at the midline centro-parietal area), and is symmetrically and widely distributed over the scalp regardless of the site of movement. The onset of the BP can vary depending on the amount

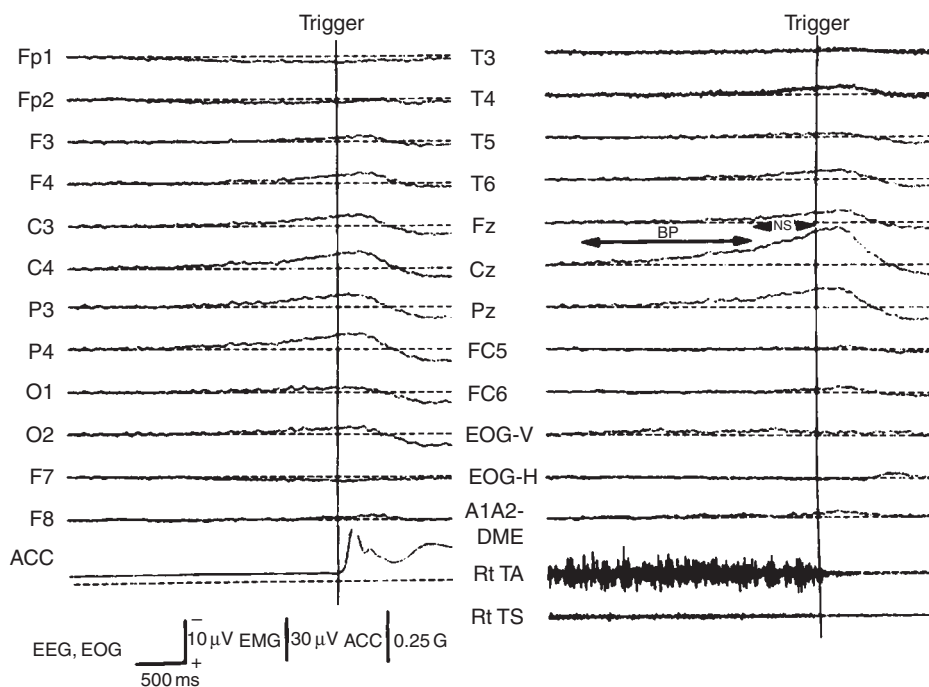
of time the subject has in order to prepare for the movement. Approximately 400–650 ms before movement onset, the slope of the negativity turns more sharply upward. This later steeper slope of the BP was differentiated by Shibasaki et al. from the early slower shift and was designated the *Negative Slope (NS')*; it terminates approximately 90–100 ms before movement onset.<sup>3</sup> The other terms used to refer to the NS' include NS2 and contralateral preponderance of negativity (CPN).

The early component of the BP with a shallower slope is also referred to as *early BP*, while the later segment with a steeper slope as *late BP* (Fig. 16–1).<sup>4</sup> The precise identity of neural generators of each of the movement-related potentials is a subject of controversy. The early BP is thought to reflect activity associated with processes of movement preparation and most likely originates from the supplementary motor area (SMA), the pre-supplementary motor area (pre-SMA), and lateral premotor cortex bilaterally. The late BP is theorized to represent activity related to movement execution at the primary motor cortex (PMC) and lateral premotor cortex. The late BP is maximal over the contralateral central area (approximately C1 or C2) for hand movements, and at the midline (approximately Cz) for foot movements.

The premovement positivity or P50 is predominant over the ipsilateral hemisphere to the moving hand.<sup>2,3</sup> It was initially proposed to be related to suppression of movements of the opposite hand in voluntary unilateral hand movements based on observations that the PMP is not seen with bilateral simultaneous hand movements.<sup>5</sup> However, the PMP is currently thought to represent a trough between two successive negative peaks, and that it may actually have no physiological significance.<sup>4</sup>

The MP occurs right before the onset of movement and is localized to a small area in the contralateral central scalp region corresponding to the movement site. The MP was also named *N10* as it occurs on an average of about 10 ms prior to the rectified EMG. This negative peak most likely represents activity of pyramidal tract neurons in the PMC.<sup>4</sup>

Shibasaki named four post-movement peaks based on the time interval from the peak of the averaged, rectified EMG to the peak of the post-movement potential.<sup>3</sup> The first post-movement peak called *N50* is a negative peak localized to the frontal region. The P90 is a



**Figure 16-1.** Movement-related potential recorded from multiple scalp locations, with right anterior tibial muscle (TA) relaxation in a normal subject with no soleus movement (TS). ACC is a simultaneous accelerometer recording. The initial slow negative phase of the Bereitschaftspotential (early BP) begins 1.7 seconds before movement and is followed by the steeper negative slope (late BP) 650 ms before movement. Later positivity represents the reafferent potential. Electrooculogram (EOG) shows that no eye movement occurred. (From Terada, K., A. Ikeda, S. Yazawa, T. Nagamine, and H. Shibasaki. 1999. Movement-related cortical potentials associated with voluntary relaxation of foot muscles. *Clinical Neurophysiology* 110:397–403. By permission of Elsevier Science.)

surface-positive waveform that occurs over the parietal region and is larger over the contralateral hemisphere. The N160 is a negative potential localized to the contralateral parietal area, and forms a positive-negative complex with P90. The P300 is a positive waveform that corresponds to the RP referred to by Kornhuber and Deecke.<sup>1</sup>

### Individual Variation

The BP may be absent in some subjects, possibly reflecting differences in cortical anatomy. Age-related variations in the premovement potentials are minor.<sup>5</sup> Although older individuals consistently show slower motor reaction times to the onset of motion compared to younger subjects, the bulk of slowed response appears to arise from slowed motor processes rather than from slowness in perceptual processing or in the readiness potential.<sup>6</sup> Evidente

et al. noted that in normal subjects, the most reproducible part of the BP was the late component; thus, the late BP would be most useful in studies quantifying MRCP changes before and after an intervention.<sup>7</sup>

### Abnormalities in Disease

Early small studies reported that the movement-related potentials in Parkinson's disease (PD) were normal.<sup>8</sup> Subsequent larger studies revealed that the amplitude of the early BP component was reduced in PD patients.<sup>9,10</sup> Similarly, the BP associated with gait showed decreased activation in PD.<sup>11</sup> Dick et al pointed out that levodopa modifies BP amplitude.<sup>12</sup> It causes an increase in the amplitude of the early part of the BP and of the negative peak just before the EMG onset. Limousin et al., as well as Gironell and colleagues, described the effects of pallidotomy



on MRCP in PD patients.<sup>13,14</sup> Post pallidotomy, there was an increase in the NS' of the late component of the BP, and no change in the early component. It was thus suggested that pallidotomy improves mainly the later stages of movement preparation.

Patients with cerebellar lesions may have abnormalities in MRCP. In Ramsay Hunt cerebellar degeneration or in some patients with Benedikt's syndrome, no premovement potential is noted.<sup>15</sup> Those with cortical cerebellar degeneration, however, usually have normal waveforms. Individuals who suffer from acute cerebellar infarction may have a reduction in the late BP phase, consistent with the known cerebellar projection to the motor cortex.<sup>16</sup>

Studies of MRCP in stroke showed variable findings related to the locations and sizes of the lesions, particularly whether or not the motor cortex is involved, and the duration. Most of these studies have found changes in the late BP as well as the MP, which usually resolve on recovery.<sup>17</sup>

Patients suffering from primary dystonia or from symptomatic dystonia due to lesions of the basal ganglia or their output pathways exhibit with smaller early and late BP components.<sup>18,19</sup> Patients with focal hand dystonia have abnormalities in the distribution and amplitude of the BP that indicate impaired cortical activation during voluntary movement and relaxation.<sup>20,21</sup> In tardive dyskinesia, the BP is increased in amplitude.<sup>22</sup>

Early studies on tics by Obeso et al. showed that such movements were not preceded by a premovement potential, whereas mimicked voluntary jerks were.<sup>23</sup> Later studies done by Karp et al. showed that tics are preceded by MRCPs, albeit shorter than normal.<sup>24</sup>

Chorea may be technically difficult to do MRCP studies on because of the randomness and unpredictability of the movements. Shibasaki et al. nevertheless reported that the chorea in chorea-acanthocytosis was preceded by a slow negative potential resembling the BP, whereas the chorea in Huntington's disease was not.<sup>25</sup>

In patients suffering from Restless Legs Syndrome, no BP could be elicited before the restless limb movements, whereas a BP precedes voluntary leg movements in the same subjects.<sup>26</sup>

Propriospinal myoclonus is not preceded by the BP.<sup>27</sup> Psychogenic jerks, on the other hand,

may be distinguished by the presence of a BP before an apparently involuntary muscle jerk.<sup>28</sup> Caution is advised when using the BP to support the diagnosis of a psychogenic jerk, since its absence may be due to a difficult recording situation. Moreover, its absence does not rule out pathology.

## Contingent Negative Variation

In the contingent negative variation testing paradigm, a stimulus such as a click warns the subject to prepare to move. After 1–2 seconds, a second stimulus, such as a flash of light, signals the patient to begin moving. Contingent negative variation is a slow negative potential that appears in the interval between the warning stimulus and the second stimulus. The distribution of this wave is predominately bilateral and frontal, but it may shift with variations in the testing procedure. The neural generators of contingent negative variation appear to be different from those of the BP.<sup>29</sup>

### Key Points

- The BP and contingent negative variation are two movement-related cortical potentials, each of which is generated by a specific paradigm.
- Abnormalities in the BP have been seen in a variety of disorders but are not specific.
- Caution is advised when using the BP to support the diagnosis of a psychogenic jerk.

## EVENT-RELATED POTENTIALS

Whereas standard somatosensory or visual-evoked potentials map the cortical response to a simple sensory stimulus, event-related potentials record the cortical activity evoked by a stimulus charged with cognitive significance. As such, event-related potentials are more sensitive to the *endogenous* reaction to a stimulus than to the physical nature of the stimulus. Sutton et al.<sup>30</sup> were among the first to note a large late cortical positivity in reaction to stimuli to which the subject attached importance. Since that time, numerous techniques have been devised to record the cortical activity surrounding processes such as



selective attention,<sup>31</sup> memory,<sup>32</sup> olfaction,<sup>33</sup> and facial recognition.<sup>34</sup> A comprehensive review of this topic—spanning the disciplines of physiology, psychology, psychiatry, and neurology—is beyond the scope of this book.

## The P300

The P300 is the most commonly recorded event-related potential.<sup>35</sup> Generally, an *oddball technique* of auditory stimulation is used, in which a *standard stimulus*, also called *frequent stimulus*, is replaced at infrequent intervals by a stimulus of different tone, termed the *oddball stimulus* or *rare stimulus*. The subject is instructed to attend to or to count the oddball stimuli. Only trials triggered by this rare event are averaged.

At times, the P300 is visible on a single raw tracing. Averaging clearly defines a wave with a peak latency of approximately 300 ms and an amplitude of approximately 10  $\mu$ V. The amplitude of the wave is increased by many factors, including the subject's attentiveness and the unpredictability of the oddball stimulus. The P300 has a bilateral, mid-parietal distribution. However, a single generator for the potential cannot be defined; the wave likely reflects activity in several areas of the brain.<sup>36</sup> The role of the wave in cognition is also debated. It may be the electrophysiologic correlate of selected attention.

The P300 is abnormal in many diseases in which cortical processing is impaired. The amplitude is decreased and the latency is prolonged in all types of dementia.<sup>37</sup> Prolongation of the P300 latency may also be a pre-clinical finding in those at risk of developing Alzheimer's disease.<sup>38</sup> Abnormalities have also been reported in PD,<sup>39</sup> mild metabolic encephalopathies, drug intoxications, multiple sclerosis, autism, and schizophrenia.<sup>39</sup>

## Key Points

- Event-related potentials record the cortical activity evoked by a stimulus charged with cognitive significance.
- The P300 is the most commonly recorded event-related potential.
- The P300 is abnormal in many diseases in which cortical processing is impaired; the

amplitude is decreased and the latency is prolonged in all types of dementia.

## SUMMARY

Special EEG averaging techniques may be used to study the cortical processes underlying movement and cognition. Movement-related potentials and contingent negative variation are observed before a voluntary movement occurs. The P300 and other event-related potentials provide electrophysiologic correlates of perception and cognition.

## REFERENCES

1. Kornhuber, H. H., and L. Deecke. 1965. Hirnpotentialänderungen bei Willkürbewegungen und passiven Bewegungen des Menschen: Bereitschaftspotential und reafferente Potentiale. *Pflügers Archive* 284:1–17.
2. Deecke, L., P. Scheid, and H. H. Kornhuber. 1969. Distribution of readiness potential, pre-motion positivity and motor potential of the human cerebral cortex preceding voluntary finger movement. *Experimental Brain Research* 7:158–68.
3. Shibasaki, H., G. Barrett, E. Halliday, and A. M. Halliday. 1980. Components of the movement-related cortical potential and their scalp topography. *Electroencephalography and Clinical Neurophysiology* 49: 213–16.
4. Shibasaki, H., and M. Hallett. 2006. What is the Bereitschaftspotential? *Clinical Neurophysiology* 117:2341–2356.
5. Singh, J., R. T. Knight, D. L. Woods, D. J. Beckley, and C. Clayworth. 1987. Lack of age effect on human brain potentials preceding voluntary movements. *Neuroscience Letters* 119:27–31.
6. Roggeveen, A. B., D. J. Prime, and L. M. Ward. 2007. Lateralized readiness potentials reveal motor slowing in the aging brain. *The Journals of Gerontology. Series B, Psychological Sciences and Social Sciences* 62: P78–84.
7. Evidente, V. G. H., J. N. Caviness, B. Jamieson, A. Weaver, and N. Joshi. 1999. Intersubject variability and intrasubject reproducibility of the Bereitschaftspotential. *Movement Disorders* 14:313–19.
8. Barrett, G., H. Shibasaki, and R. Neshige. 1986. Cortical potential shifts preceding voluntary movement are normal in parkinsonism. *Electroencephalography and Clinical Neurophysiology* 63:340–8.
9. Jahanshahi, M., I. H. Jenkins, R. G. Brown, C. D. Marsden, R. E. Passingham, and D. K. Brooks. 1995. Self-initiated versus externally triggered movements. I. An investigation using measurement of regional cerebral blood flow with PET and movement-related potentials in normal and Parkinson's disease subjects. *Brain* 118:913–33.

10. Dick, J. P. R., J. X. Rothwell, B. L. Day, et al. 1989. The Bereitschaftspotential is abnormal in Parkinson's disease. *Brain* 112:233–44.
11. Vidailhet, M., F. Stocchi, J. C. Rothwell, et al. 1993. The Bereitschaftspotential preceding simple foot movement and initiation of gait in Parkinson's disease. *Neurology* 43:1784–8.
12. Dick, J. P. R., R. Cantello, O. Buruma, et al. 1987. The Bereitschaftspotential, L-dopa and Parkinson's disease. *Electroencephalography and Clinical Neurophysiology* 66:263–74.
13. Limousin, P., R. G. Brown, M. Jahanshahi, et al. 1999. The effects of posteroventral pallidotomy on the preparation and execution of voluntary hand and arm movements in Parkinson's disease. *Brain* 122:315–27.
14. Gironell, A., A. Rodriguez-Fornells, J. Kulisevsky, B. Pascual, M. Barbanjo, and P. Otermin. 2002. Motor circuitry re-organization after pallidotomy in Parkinson disease. A neurophysiological study of the Bereitschaftspotential, contingent negative variation, and N30. *Journal of Clinical Neurophysiology* 19:553–61.
15. Shibasaki, H., F. Shima, and Y. Kuroiwa. 1978. Clinical studies of the movement-related cortical potential (MP) and the relationship between the dentatorubrothalamic pathway and readiness potential (RP). *Journal of Neurology* 219:15–25.
16. Gerloff, C., E. Altenmuller, and J. Dichgans. 1996. Disintegration and reorganization of cortical motor processing in two patients with cerebellar stroke. *Electroencephalography and Clinical Neurophysiology* 98:59–68.
17. Jankelewitz, S. K., and J. G. Colebatch. 2005. Movement related potentials in acutely induced weakness and stroke. *Experimental Brain Research* 161:104–13.
18. Feve, A., N. Bathien, and P. Rondot. 1994. Abnormal movement related potentials in patients with lesions of basal ganglia and anterior thalamus. *Journal of Neurology, Neurosurgery, and Psychiatry* 57:100–4.
19. van der Kamp, W., J. C. Rothwell, P. D. Thompson, B. L. Day, and C. D. Marsden. 1995. The movement related cortical potential is abnormal in patients with torsion dystonia. *Movement Disorders* 10:630–3.
20. Deuschl, G., C. Toro, J. Matsumoto, and M. Hallett. 1995. Movement-related cortical potentials in writer's cramp. *Annals of Neurology* 38:862–8.
21. Yazawa, S., A. Ikeda, R. Kaji, et al. 1999. Abnormal cortical processing of voluntary muscle relaxation in patients with focal hand dystonia studied by movement-related potentials. *Brain* 122:1357–66.
22. Adler, L. E., M. Pecevich, and H. Nagamoto. 1989. Bereitschaftspotential in tardive dyskinesia. *Movement Disorders* 4:105–12.
23. Obeso, J. A., J. C. Rothwell, and C. D. Marsden. 1981. Simple tics in Gilles de la Tourette's syndrome are not prefaced by a normal premovement EEG potential. *Journal of Neurology, Neurosurgery, and Psychiatry* 44:735–8.
24. Karp, B. I., S. Porter, C. Toro, and M. Hallett. 1996. Simple motor tics may be preceded by a premotor potential. *Journal of Neurology, Neurosurgery, and Psychiatry* 61:103–6.
25. Shibasaki, H., T. Sakai, H. Nishimura, Y. Sato, I. Goto, and Y. Kuroiwa. 1982. Involuntary movements in chorea-acanthocytosis: A comparison with Huntington's chorea. *Annals of Neurology* 12:311–14.
26. Trenkwalder, C., S. F. Bucher, W. H. Oertel, D. Proeckl, H. Plendl, and W. Paulus. 1993. Bereitschaftspotential in idiopathic and symptomatic restless legs syndrome. *Electroencephalography and Clinical Neurophysiology* 89:95–103.
27. Brown, P., P. D. Thompson, J. C. Rothwell, B. L. Day, and C. D. Marsden. 1991. Axial myoclonus of propriospinal origin. *Brain* 114:197–214.
28. Terada, K., A. Ikeda, P. C. Van Ness, et al. 1995. Presence of Bereitschaftspotential preceding psychogenic myoclonus: Clinical application of jerk-locked back averaging. *Journal of Neurology, Neurosurgery, and Psychiatry* 58:745–7.
29. Ikeda, A., H. Shibasaki, T. Nagamine, et al. 1994. Dissociation between contingent negative variation and Bereitschaftspotential in a patient with cerebellar efferent lesion. *Electroencephalography and Clinical Neurophysiology* 90:359–64.
30. Sutton, S., M. Braren, J. Zubin, and E. R. John. 1965. Evoked-potential correlates of stimulus uncertainty. *Science* 150:1187–8.
31. Heinze, H. J., G. R. Mangun, W. Burchert, et al. 1994. Combined spatial and temporal imaging of brain activity during visual selective attention in humans. *Nature* 372:543–6.
32. Begleiter, H., B. Porjesz, and W. Wang. 1993. A neurophysiologic correlate of visual short-term memory in humans. *Electroencephalography and Clinical Neurophysiology* 87:46–53.
33. Evans, W. J., L. Cui, and A. Starr. 1995. Olfactory event-related potentials in normal human subjects: Effects of age and gender. *Electroencephalography and Clinical Neurophysiology* 95:293–301.
34. Hertz, S., B. Porjesz, H. Begleiter, and D. Chorlian. 1994. Event-related potentials to faces: The effects of priming and recognition. *Electroencephalography and Clinical Neurophysiology* 92:342–51.
35. Picton, T. W. 1992. The P300 wave of the human event-related potential. *Journal of Clinical Neurophysiology* 9:456–79.
36. Neshige, R., and H. Luders. 1992. Recording of event-related potentials (P300) from human cortex. *Journal of Clinical Neurophysiology* 9:294–8.
37. Goodin, D. S., K. C. Squires, and A. Starr. 1978. Long latency event-related components of the auditory evoked potential in dementia. *Brain* 101:635–48.
38. Green, J., and A. I. Levey. 1999. Event-related potential changes in groups at increased risk for Alzheimer disease. *Archives of Neurology* 56:1398–403.
39. Rumbach, L., C. Tranchant, J. F. Viel, and J. M. Warter. 1993. Event-related potentials in Parkinson's disease: A 12-month follow-up study. *Journal of Neurology Science* 116:148–51.

SECTION 2

**ELECTROPHYSIOLOGIC  
ASSESSMENT OF NEURAL  
FUNCTION**

---

*This page intentionally left blank*

## PART B

# Sensory Pathways

---

The sensory axons conduct information from the periphery to the central nervous system as action potentials traveling from peripheral sensory receptors centrally to the spinal cord and cortex. Primary sensory neurons located in the dorsal root and cranial ganglia send a peripheral axon out to the limb or cranial receptors, and a central axon to the brain stem. Sensory axons are therefore among the longest in the body traveling as far as from the foot to the neck. The sensory axons make reflex connections in the brain stem and spinal cord, as well as to the cerebellum and cerebral hemispheres.

Because the signals from single axons are difficult to record, most electrophysiologic recordings from nerves being tested for possible neurologic or neuromuscular disease are summated responses made from specific generators in response to controlled external stimulation. Somatic sensory and somatic motor axons can be tested by stimulating along the length of a nerve while recording the sensory or motor responses from peripheral nerve or muscle. Sensory axons can be isolated for testing by selective stimulation of sensory structures or by selective recording from generators that are purely sensory. The potentials recorded

from sensory structures in response to specific stimulation are called *sensory evoked potentials*. Sensory evoked potentials are classified as *nerve conduction studies* that test peripheral nerves (Chapter 17), *somatosensory evoked potentials* that test central somatic sensory pathways (Chapter 18), *brain stem auditory evoked potentials* that test peripheral and central auditory pathways (Chapters 19–21), and *visual evoked potentials* that test peripheral and central visual pathways (Chapter 22).

Combinations of these sensory potential recordings help to determine localization of damage at different levels of the nervous system and, in some cases, help to define the type of underlying lesion. Advances in the method of stimulation and recording have extended the applications of some of these techniques.

Mechanical components of peripheral auditory function can be tested separately with audiography, acoustic reflexes, and evoked otoacoustic emissions (Chapter 20). Movement-related potentials and event-related potentials (see Chapter 16 in Part A) are also sometimes referred to as *evoked potentials*. Evoked potentials obtained with stimulation of motor axons are considered in Part C.

*This page intentionally left blank*

# Sensory Nerve Action Potentials

*Eric J. Sorenson*

## **INTRODUCTION**

### **PATHOPHYSIOLOGY OF SNAPs**

Normal SNAPs

Abnormal SNAPs

Clinical Importance of SNAPs

### **METHODS OF STUDY OF SNAPs**

Nerve Stimulation

Recording the Potential

Averaging

### **MEASUREMENTS**

#### **TECHNICAL FACTORS**

Noise and Shock Artifact

Submaximal Stimulation

Recording and Stimulating Distance

Temperature

Distance Between Recording

Electrode and Nerve

Measurement

Interelectrode Distance

### **PLANNING THE STUDY AND FINDINGS IN DISEASES**

Radiculopathy

Plexopathy

Common Mononeuropathies

Myopathy

Disorders of the Neuromuscular  
Junction

Motor Neuron Diseases

### **SUMMARY**

## **INTRODUCTION**

This chapter reviews the electrical principles relevant to sensory nerve action potential (SNAP) studies, including the neurophysiology intrinsic to the axon and extrinsic ambient electrical interference and their effects on these studies, the clinical relevance of SNAPs, and strategies for planning appropriate sensory testing to maximize diagnostic yield. Also, the recording of SNAPs is frequently complicated by unique technical difficulties and common human errors, which are discussed along with a strategy for troubleshooting such problems. Finally, the chapter explains how SNAPs are measured and how the function of a nerve is quantified.

The main indication for assessing peripheral SNAPs is in studying sensory nerves. Sensory nerve action potentials remain the most reliable means of testing peripheral sensory nerves.<sup>1</sup> Sensory nerve action potentials are very sensitive to pathologic conditions in a nerve. Often, alterations in the amplitudes, terminal latencies, and conduction velocities of evoked responses are the earliest abnormalities detected in a peripheral neuropathic process.<sup>2</sup> The studies provide invaluable data for the localization and classification of a peripheral neuropathy, and the study results may indicate a specific pathologic condition. While most of the peripheral nerves that are studied are mixed nerves with both motor and sensory axons, sensory components can be isolated



by stimulating or recording from pure sensory branches. Studying a pure population of fibers provides information that is more meaningful for interpretation. For practical purposes, this is only possible for the sensory axons.

### **Purpose and Role of SNAPs**

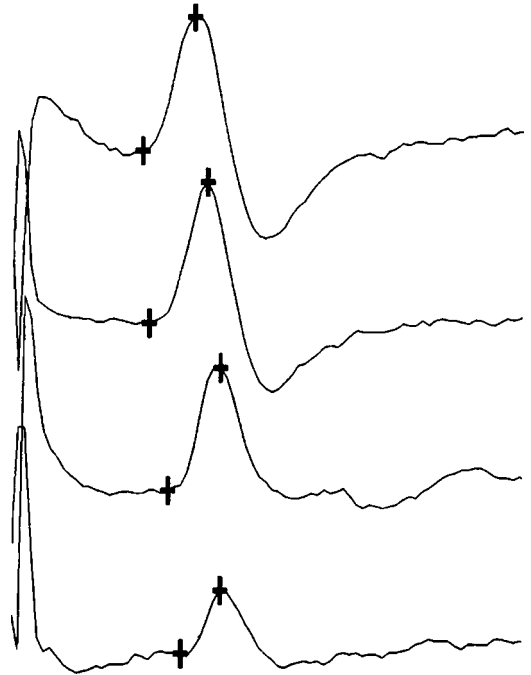
- Provide objective evidence of the integrity of the peripheral sensory nerves.
- Assist in identifying and localizing mono-neuropathies.
- Used to assess sensory involvement in generalized peripheral neuropathies.
- Helps to distinguish lesions of the spinal roots (preganglionic) from lesions of the plexus (postganglionic).

### **PATHOPHYSIOLOGY OF SNAPs**

Electrically evoked nerve action potentials are the only way clinically to directly study the function of peripheral nerves. Unlike compound muscle action potentials, these potentials are not affected by secondary factors such as transmission at the neuromuscular junction or the electrical excitability of the muscle. Except perhaps for sympathetic sweat gland skin potentials,<sup>3</sup> the electrical excitability of sensory nerve target receptors cannot be measured reliably. Although somatosensory evoked potentials provide information about the proximal peripheral sensory pathways (see Chapter 18), SNAPs are the only practical way to assess sensory peripheral nerves reliably. Because of these factors, the measurement of electrically evoked peripheral SNAPs provides invaluable information about the physiology and pathology of the peripheral nervous system, particularly about sensory nerves.

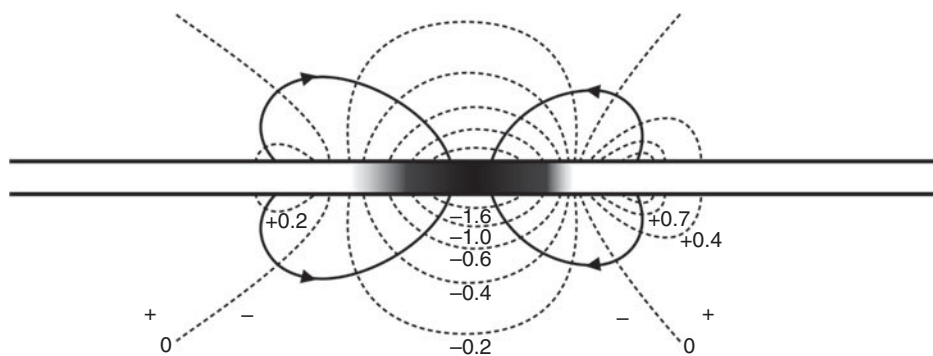
### **Normal SNAPs**

Sensory nerve action potentials are recorded using two recording electrodes grounded to a common ground. The active electrode, commonly referred to as the G1 electrode, is placed upon the skin superficial to the nerve being tested. The reference electrode, G2, is placed along the length of the nerve, typically 3–5 cm distal to the G1 electrode. This distance is

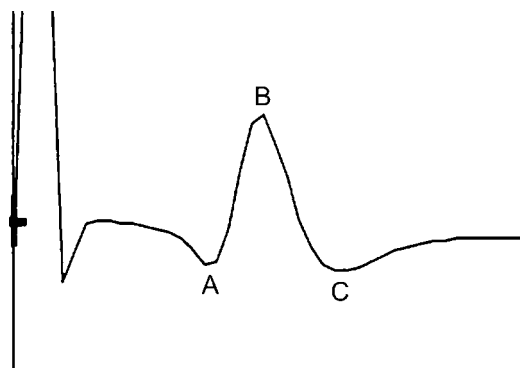


**Figure 17-1.** Effect of decreasing the interelectrode distance on the amplitude of the response. As the distance decreases, the amplitude diminishes.

sufficient to prevent the G2 electrode from distorting the waveform as it is recorded at the G1 electrode (Fig. 17-1). Distances greater than 5 cm or placement of the G2 electrode somewhere beyond the distal nerve segment introduces the possibility of volume conducted responses from distant electrical generators. The nerve action potential is induced by an electrical stimulus to the nerve sufficient to generate an action potential in all axons simultaneously. This nerve action potential creates an electrical field that propagates along the length of the nerve (Fig. 17-2). The initial portion of the electrical field is positive, which, as it approaches the G1 electrode, results in the initial downward (positive) phase of the nerve action potential waveform. As the nerve action potential continues to propagate, the large negative portion of the electrical field (the region of depolarization) passes beneath the G1 electrode resulting in the large upward (negative) phase of the nerve action potential waveform. Finally, as the nerve action potential travels away from the G1 electrode the final positive portion of the electrical field



**Figure 17-2.** Example of the electrical field generated at the axon during the action potential.



**Figure 17-3.** Triphasic appearance of a nerve action potential. Note initial positivity (A), followed by the dominant negative peak (B), and ending with a final positive phase (C).

passes beneath the G1 electrode resulting in the last downward (positive) phase of the nerve action potential waveform. The net effect is the characteristic triphasic appearance to the SNAP waveform (Fig. 17-3). The magnitude of the electrical field diminishes with the square of the distance from the electrical generator (i.e., the axon membrane). As a result of this diminution with increasing distance, the appearance of the SNAP changes with a reduction in amplitude and a less apparent triphasic appearance with increased distance.

### Key Points

- The normal waveform configuration of an SNAP is triphasic.
- Recording the SNAP with a 3–5 cm separation between G1 and G2 maximizes the amplitude and reduces the possibility of

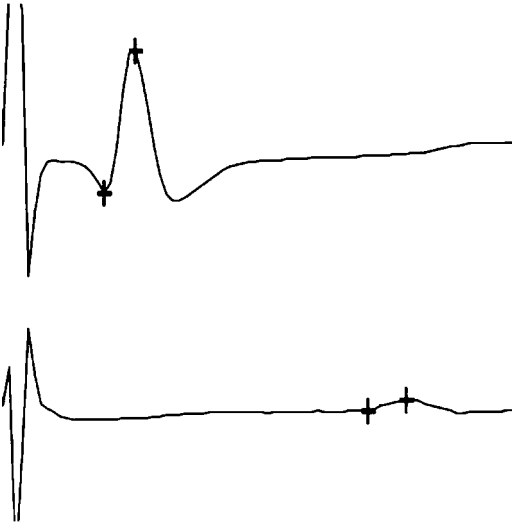
volume conducted responses from distant electrical generators.

- The amplitude of the SNAP response is reduced with increasing recording distance from the nerve.

### Abnormal SNAPs

A major advantage of studying SNAPs is their sensitivity for detecting an underlying abnormality. Frequently, sensory potential abnormalities are the earliest findings in a peripheral nerve disorders and SNAPs are often more sensitive in detecting peripheral nerve abnormalities since they are unaffected by reinnervation. To interpret the findings of SNAP responses accurately, the temporal profile and evolution of the changes in SNAPs must be understood. With acute nerve injuries characterized by injury to the axons, the SNAP remains normal immediately following the injury. Over the ensuing days, Wallerian degeneration begins and the degenerating axons lose their electrical excitability. As a result, the amplitude of the SNAP begins to decrease, reaching its nadir 5–10 days after the injury.

In contrast to lesions producing axonal loss, if the lesion affects only the myelin sheath and causes a focal area of demyelination, the SNAPs distal to the lesion may remain normal. Stimulating and recording across the area of demyelination, however, may show a delay in the conduction velocity across the site; the delay will be seen as either a prolonged latency or slowed conduction velocity. Focal conduction block, as defined by a discrete loss of



**Figure 17-4.** Phase cancellation of a normal SNAP with a larger amplitude and area with distal stimulation (*top tracing*) when compared to proximal stimulation (*bottom tracing*).

amplitude across a focal segment usually cannot be established with SNAPs, since, in normal nerves, nerve action potentials demonstrate an unpredictable reduction in amplitude with increasing distance between the stimulating and recording electrodes (Fig. 17-4). This is caused by *phase cancellation*, which results from sensory fibers having a wide range of conduction velocities even within the same nerve.

Understanding how the pathology affects SNAPs is necessary to classify the neuropathic process. This classification has important implications for the differential diagnosis of neuropathy.<sup>1</sup> The usual finding in axonal neuropathy is a decrease in amplitude. Because the neuropathic process preferentially can affect the largest fibers and, hence, the fastest conducting ones, the conduction velocity may be slightly below the limit of normal. Generally, axonal loss alone should not decrease conduction velocity less than approximately 70% of the lower limit of normal.<sup>4</sup> Similarly, the terminal distal latency of the response may be slightly prolonged.

If the nerve has a focal area of demyelination, the findings depend on the sites of stimulation. If the stimulation sites are proximal and distal to the area of demyelination, the conduction velocity usually is decreased

substantially. However, the distal latency is normal. If the area of demyelination causes pronounced conduction block or dispersion, no proximal response may be obtained. However, true conduction block, defined as loss of amplitude over a discrete segment, cannot be determined reliably by sensory nerve conduction studies alone.

If the focal demyelinating lesion occurs only in the terminal segment of the nerve, the distal latency is prolonged. The amplitudes are frequently reduced if the lesion is associated with conduction block or phase cancellation. A conduction velocity obtained by stimulating or recording at two sites proximal to the lesion in a terminal segment may be slightly decreased because the largest, fastest conducting fibers in the area of demyelination are affected. If there is an area of demyelination proximal to both stimulation sites, the nerve action potential responses may be entirely normal.

In diffuse demyelination, in which the nerve is affected all along its course, distal latencies are prolonged, conduction velocities are slowed, and amplitudes are reduced. However, the electrophysiologic features that are used to differentiate an acquired demyelinating process from an inherited process, that is, conduction block and dispersion, cannot be assessed accurately with SNAPs.

In cases of diffuse demyelination, testing SNAPs over long segments will be more sensitive; because the effects of subtle slowing will be additive, the changes become more apparent as a longer segment of nerve is tested. Conversely, in the case of focal demyelination, testing over the shortest segment of nerve possible provides the greatest sensitivity, because subtle areas of focal conduction slowing are not *averaged* with the normally conducting segments. The difference between focal and diffuse disorders becomes important when selecting the SNAPs to sample in response to a specific clinical situation. For example, if focal median mononeuropathy at the wrist is suspected, sampling the SNAP across a short distance, as in the palmar (orthodromic) stimulation technique, provides the greatest sensitivity. However, if a diffuse disorder is suspected, a median antidromic technique with proximal and distal stimulation is preferred because the amplitude is more reproducible and the conduction velocity is sampled over a long segment of nerve.

### Key Points

- SNAPs are often more sensitive in detecting peripheral nerve abnormalities than compound muscle action potentials.
- SNAP may remain normal for the first several days following an acute injury.
- The SNAP amplitude is decreased following axonal injuries, reaching its nadir 5–10 day after the injury.
- Processes producing demyelination may produce slowing of conduction velocity or prolongation of terminal latencies in SNAPs.
- Conduction block cannot be reliably identified with SNAPs due to the phase cancellation that normally occurs in sensory nerves.

### Clinical Importance of SNAPs

Since SNAPs are sensitive to peripheral neuropathic lesions, they can provide important information for localization. The distribution of abnormalities can suggest a focal lesion, a multifocal process, or a diffuse disease. Also, because of the unique anatomy of sensory neurons, SNAPs are extremely helpful in differentiating an intraspinal process from a more peripheral one. The cell bodies of the sensory neurons form dorsal root ganglia, which lie within the intervertebral foramina, where the spinal roots exit from the spinal canal. Thus, a process that is localized within the spinal canal is described as preganglionic. In a preganglionic lesion, the distal sensory axon remains intact and connected with the cell body. The SNAPs remain normal, even if the sensory loss is severe. Conversely, any lesion that affects the nerve by interrupting its axons distal to the intervertebral canal causes a loss of amplitude in SNAPs. This provides invaluable information for differentiating a preganglionic lesion such as a radiculopathy from a postganglionic lesion such as a plexopathy or mononeuropathy. However, a postganglionic lesion that does not affect the axons but produces a pure conduction block will not affect the amplitude of SNAPs if the stimulation and recording sites are distal to the lesion.

### Key Points

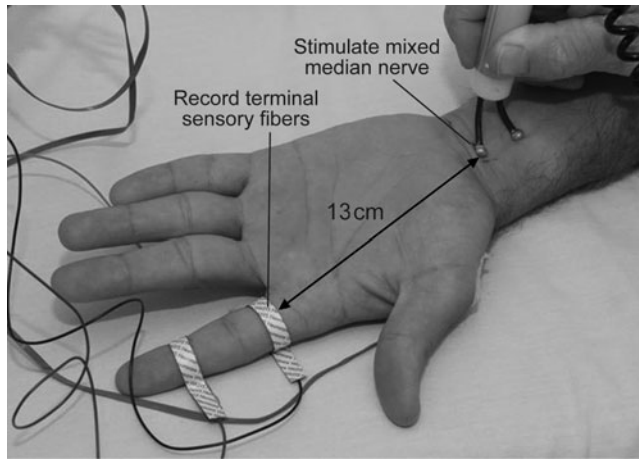
- SNAPs are very effective at distinguishing lesions central to the dorsal root ganglia (preganglionic) from lesion peripheral to the dorsal root ganglia (postganglionic).
- SNAP amplitudes remain normal distal to a conduction block.

### METHODS OF STUDY OF SNAPs

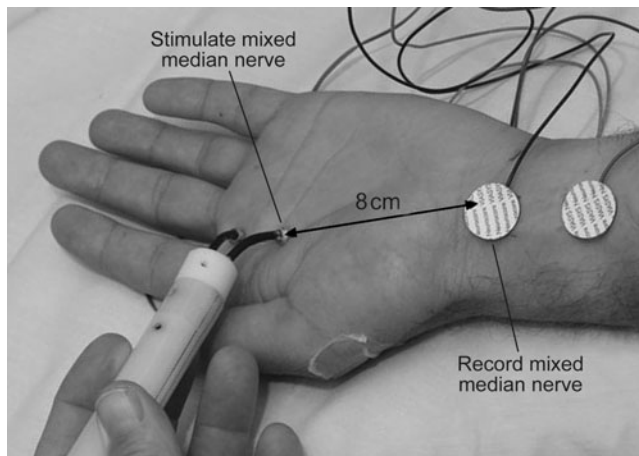
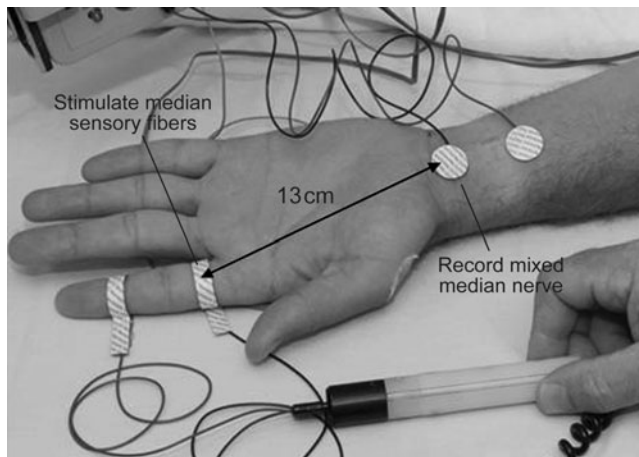
Two main strategies have been developed for studying sensory axons. The first strategy is to stimulate the mixed motor and sensory nerve and to record the SNAP from a terminal sensory branch at a site that is distal to where the nerve splits into motor and sensory components. This is called the *antidromic technique*, because the direction of the action potential is opposite (anti-) that of the physiologic action potential (Fig. 17–5). The advantage of the antidromic technique is that it ensures adequate supramaximal stimulation of the nerve and, thus, larger amplitudes.<sup>5,6</sup> However, this technique also activates the motor fibers and generates a muscle action potential that, through volume conduction, may interfere with the SNAP that is being recorded.

The second strategy for isolating sensory fibers in a mixed nerve is to stimulate the nerve distal to the point where it splits into sensory and motor components and to record proximally over the mixed nerve. This is called the *orthodromic technique*, because the direction of the action potential is the same as that of the physiologic action potential (Fig. 17–6). However, the number of fibers activated and the amplitude of the responses are more variable than with the antidromic technique. The main advantage of the orthodromic technique is that it eliminates volume conduction from muscle action potentials because no motor fibers are activated.

Another, and less optimal technique, is to stimulate a mixed nerve and to record at a fixed distance over the nerve where it contains both motor and sensory fibers. With this technique, it is assumed that because the nerve has a small number of motor axons and the amplitude of the SNAP is directly proportional to the total number of axons activated, the contribution



**Figure 17-5.** Median antidromic sensory technique. Stimulation of the median nerve at the wrist will activate both motor and sensory fibers; however, recording from the digit will isolate the sensory fibers to generate an SNAP. Amplitudes are higher than classic orthodromic and more reliable than palmar, but there is a volume conducted motor artifact of slower rise time and longer duration that may need to be minimized by moving recording electrodes distally.



**Figure 17-6.** Median orthodromic sensory technique. *A*, Classic digital stimulation of the median nerve activates only cutaneous sensory fibers allowing for a low amplitude SNAP to be recorded from the mixed motor and sensory median nerve at the wrist. *B*, Palmar stimulation gives higher amplitude mixed motor and sensory potential, but is technically difficult.



of the motor fibers to the SNAP is negligible. Because of the variation from subject to subject in the motor and sensory components of mixed nerves, normal data obtained with this technique are more variable than comparable data obtained with the antidromic and orthodromic techniques.

Some of the peripheral nerves that are available for testing are pure sensory nerves. For these nerves, it is necessary only to stimulate the nerve and to record at a fixed distance along it, using either the antidromic or orthodromic technique. Examples of pure sensory nerves are the sural, superficial peroneal, saphenous, and medial and lateral antebrachial sensory nerves. Although superficially the technique for studying these nerves appears straightforward, technical factors may make it difficult, as discussed below.

Some laboratories have utilized magnetic stimulation to activate the peripheral nerves. This technique was developed because of the perception that a magnetic stimulus would be less painful than electrically elicited responses. However magnetic stimulation does not allow for a precise localization of the initiation site of the elicited nerve action potential. This makes latencies and conduction velocities unreliable. Because of this poor reliability, magnetic stimulation has fallen out of favor.

### Key Points

- Orthodromic techniques minimize motor artifact but SNAP amplitudes are more variable.
- Antidromic techniques produce more reliable SNAP amplitudes but motor artifact may interfere with the waveforms.
- Pure sensory nerves, such as the sural, superficial peroneal, saphenous, and medial and lateral antebrachial nerves can be studied with orthodromic or antidromic techniques.

## Nerve Stimulation

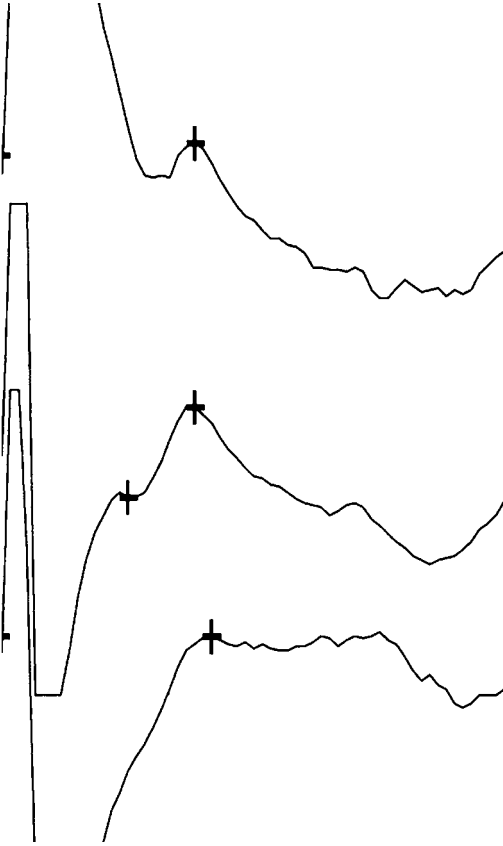
The sensory nerve should be stimulated with a current that is sufficient to activate all the sensory axons in the nerve but not to cause overstimulation. This balance requires that the

stimulator be as close to the nerve as possible. To initiate the study, the stimulator is placed over the approximate location of the nerve, with the cathode pointed towards the recording electrodes (distal in antidromic studies and proximal in orthodromic studies). The nerve should be depolarized with the cathode, not the anode. Depolarization with the anode distally can cause an electrical conduction block, called *anodal block*, of some of the axons and result in a submaximal response. The action potential is generated at the cathode, if the anode is placed distally, the distance measurements will not be accurate. As the current is increased gradually, an SNAP becomes apparent. At this stage, the stimulator is moved laterally (*sliding*) to identify the site at which the response is maximal. At the site of the maximal response, the current is gradually increased until the amplitude reaches its maximum.

If stimulation creates a large shock artifact, several methods can be used to reduce the artifact. Rotating the anode off the nerve while stimulating it often decreases the shock artifact (Fig. 17-7). If this is ineffective, confirm that the ground is in the appropriate location. Check the impedance of the recording and stimulating electrodes, and if necessary, apply conduction paste to improve the impedance values. After this has been done, if an acceptable response cannot be obtained in large limbs, consider near-nerve stimulation with a monopolar needle electrode. With near-needle stimulation, the monopolar needle serves as the cathode and the surface electrode, as the anode. Near-nerve stimulation has several advantages. The largest amount of impedance arises from transcutaneous stimulation. Thus, placing the needle within the subcutaneous tissue eliminates the transcutaneous resistance. Also, placing the needle much closer to the nerve allows supramaximal stimulation at a lower level of current.

### Key Points

- Nerve stimulation is performed with the cathode pointed toward the recording electrodes. Anode block, due to the anode pointed towards the recording electrodes, may result in a submaximal response.



**Figure 17-7.** Effect of rotation of the anode during stimulation. Note the large shock artifact in the *upper* and *lower* tracings obscuring the onset and amplitude of the waveform. Rotation of the anode will minimize the shock artifact resulting in an acceptable recording (*middle trace*).

- Rotating the anode off the nerve can reduce shock artifact.
- Near nerve stimulation using a monopolar needle can be used when a large shock artifact cannot be reduced with other methods.

## Recording the Potential

SNAPs are recorded using disc or ring electrodes. Standard 5 mm–1 cm plate electrodes are typically used in the limb. When recording over the digits, ring electrodes are used that record the electrical potentials circumferentially from the digit. Recording SNAPs requires appropriate placement of the G1 and G2 electrodes. An interelectrode

distance of 3.5–4.0 cm maximizes the sensory response and minimizes the amount of electrical interference. If the electrical background noise is excessive, assess the impedance of the electrodes. Any impedance mismatch in the electrodes causes problems with the common-mode rejection, and the signals generated by background noise will be amplified. If no satisfactory response can be obtained, confirm that the location of the electrodes is correct.

Occasionally, the motor artifact may distort the SNAP waveform recording and, if the SNAP is absent, the motor artifact may be mistaken for a sensory potential. Motor artifact primarily occurs when applying the antidromic technique, such as during the ulnar antidromic study recording from the fifth digit, where motor and sensory fibers are co-stimulated. Motor artifact should be recognized by the longer latency, slower rise time and longer duration, broader response compared to sensory responses. If motor artifact is present stimulation of the nerve should be repeated at a lower stimulus to determine if a supra-maximal SNAP can be elicited without the motor activation. If this is unsuccessful then the G1 and G2 recording electrodes should be moved slightly more distal on the digit to separate the motor artifact from the SNAP waveform.

## Key Points

- SNAPs are recorded using G1 and G2 disc or ring electrodes, placed 3.5–4.0 cm apart.
- Motor artifact may occur with antidromic studies, and can be recognized by the longer latency, slower rise time and longer duration, broader response compared to sensory responses.
- If motor artifact is present stimulation of the nerve should be repeated at a lower stimulus or the G1 and G2 recording electrodes should be moved slightly more distal on the digit to separate the motor artifact from the SNAP waveform.

## Averaging

Sensory potentials have much lower amplitudes than motor responses; thus, the signal-to-noise



ratio is much lower. Because of this, the sensory responses are much more affected by background ambient electrical noise, even with good testing technique. The low signal-to-noise ratio can be improved by averaging, which can reduce or eliminate random background noise. The improvement in the signal-to-noise ratio is directly proportional to the square root of the number of responses averaged. This means that improvement is greatest with the first few responses that are averaged and little more is gained after averaging the first four or five responses. Sensory nerve action potentials should routinely be averaged 4–5 times to maximize the quality of the waveform while minimizing the distortion from the background noise.

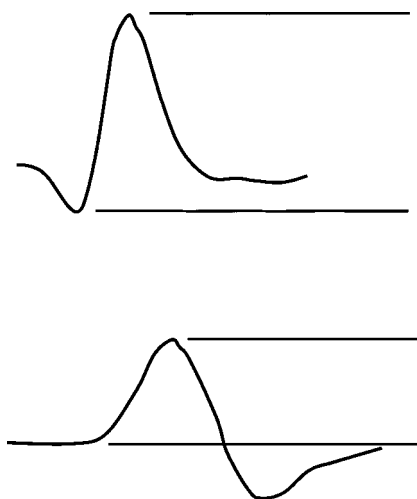
### Key Points

- Averaging is useful to maximize the signal-to-noise ratio of the recorded SNAP responses.
- Four or five SNAP responses should be routinely averaged during a standard sensory nerve conduction study.

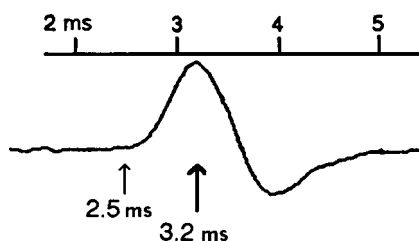
## MEASUREMENTS

Clinically, the most relevant measurements are amplitude, distal latency, and conduction velocity. Amplitude is measured as a peak-to-peak amplitude, from the nadir of the initial positivity to the peak negativity (Fig. 17–8). Because amplitude decreases substantially with increasing length of the segment, the amplitude that is recorded and compared is the distal amplitude.

The distal latency that is recorded and compared is the *peak latency*, not the *onset latency* of the response. *Peak latency* is the time from the stimulus to the peak negative deflection. Onset latencies are more variable and difficult to measure (Fig. 17–9). The distances for the distal response should be kept fixed so that the latencies can be compared directly with normal values. If the distance is variable, then the latency must be divided by the distance (generating a figure analogous to a conduction velocity) to allow for comparisons. This is not optimal, because it introduces a source of human error.



**Figure 17–8.** Amplitude measurement of a potential, with, *top*, and without, *bottom*, an initial positive peak.

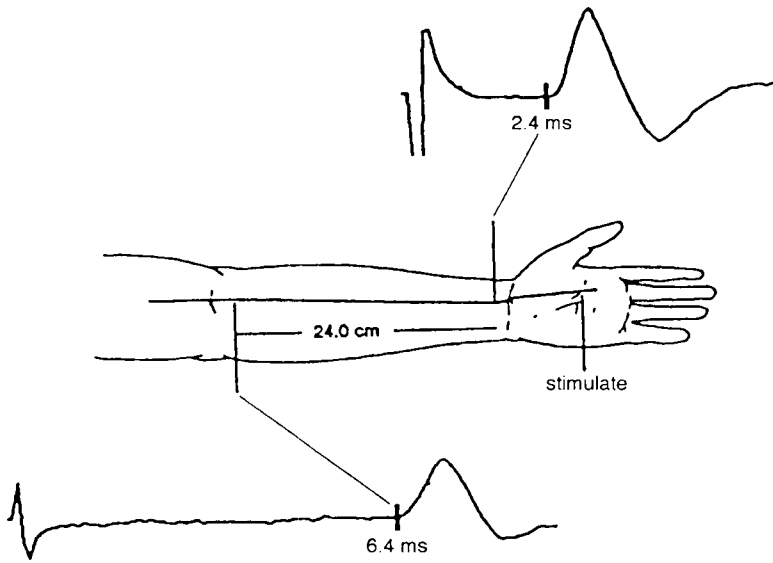


**Figure 17–9.** Onset latency at 2.5 ms and peak latency at 3.2 ms.

Conduction velocity is the last variable that is assessed clinically. Conduction velocity is obtained by dividing the distance between two stimulus sites by the conduction time. The onset latencies are measured and subtracted to obtain conduction time (Fig. 17–10). The resulting time represents conduction time. In this instance, the onset latencies are chosen because they represent the fastest conducting fibers, and the calculated conduction velocity reflects the speed of conduction in these fibers.

### Key Points

- The SNAP parameters of interest include the amplitude (measured from the maximal positive deflection to the maximal negative deflection), distal latency (measure from the stimulus to the peak latency), and conduction velocity (measured from the SNAP onset latency).



**Figure 17-10.** Measurement of conduction velocity in a proximal nerve segment. The difference in latencies between the proximal and distal stimulation sites is divided by the distance between the two sites. Latencies are measured to the initial negative deflection (onset latency).

- The peak latency is the time from the stimulus to the peak negative deflection, and is the most reliable and easy to measure latency parameter.
- Onset latencies between two waveforms recorded or stimulated at different sites are used in determining the conduction velocity since they represent the fastest conducting fibers.

and, fourth, the distance between the electrodes and the nerve affect the amplitude. To obtain reproducible and comparable results, the stimulation distance, nerve temperature, and recording distance must be controlled and standardized for each sensory nerve tested. Each of these factors is discussed below.

## TECHNICAL FACTORS

The SNAPs measured in the electrophysiology laboratory represent a summation of individual action potentials of all the large myelinated sensory axons in the stimulated nerve. Because the responses are recorded from the nerve and not from the muscle, the amplitudes are much lower than those of compound muscle action potentials. This causes several problems that are not usually encountered in motor conduction studies. The amplitude of SNAPs depends on several factors. First, the amplitude is directly proportional to the number of axons that are depolarized. Second, the distance between the recording and stimulation sites affects the amplitude. Third, the temperature of the nerve at the time of the study

## Noise and Shock Artifact

A main difficulty in recording well-defined SNAP responses is background electrical noise. Since the sensory amplitudes are low, the background noise appears proportionally larger; this is referred to as a *lower signal-to-noise ratio*. Thus, it is imperative that background electrical activity be minimized. This includes proper impedance of the electrodes to avoid any impedance mismatch that would distort the common-mode rejection between the electrodes. Electrode impedance can be minimized by applying contact paste to the electrodes. If disposable electrodes are used, repeated use of the electrodes will reduce the effectiveness of the contact gel increasing the electrode impedance. Disposable electrodes with increasing impedance should be replaced with a new set. Dry desiccated skin has a very high impedance that cannot be overcome with

conducting paste. This is most common in calloused hand and feet. This impedance can be markedly improved by gently abrading the skin with an abrasion board or tape to remove the dry and desiccated skin. In addition to ensuring proper impedance, background voluntary muscle activity that interferes with the baseline must be minimized.

The stimulus should be delivered so that shock artifact is minimized. This requires proper ground placement, and it often requires rotating the stimulator to minimize the effects of shock artifact. It is important to place the stimulator as near the nerve as possible to allow supramaximal depolarization with the minimal amount of current. This will benefit the study by minimizing shock artifact and by reducing the risk of overstimulation and creating muscle artifact. Occasionally, a needle cathode needs to be placed near the nerve to provide the appropriate amount of stimulation. Sources of external electrical activity need to be eliminated, including any electrical equipment within the vicinity of the study, particularly fluorescent lighting. Incandescent lighting does not produce the same electrical interference and, thus, is preferred to fluorescent lighting for rooms in which nerve conduction studies are performed.

## Submaximal Stimulation

The primary variable of interest when recording SNAPs is the number of axons depolarized. The fact that the amplitude of the response is directly proportional to the number of axons stimulated allows one to estimate clinically if the number of sensory axons is normal or reduced. In order to accurately assess the number and integrity of all of the sensory axons within a nerve, all fibers must be depolarized. Providing adequate stimulus intensity is necessary to ensure accurate assessment of the response.

## Recording and Stimulating Distance

Because the conduction velocity of sensory axons varies markedly, the longer the conducting segment the more the responses tend to

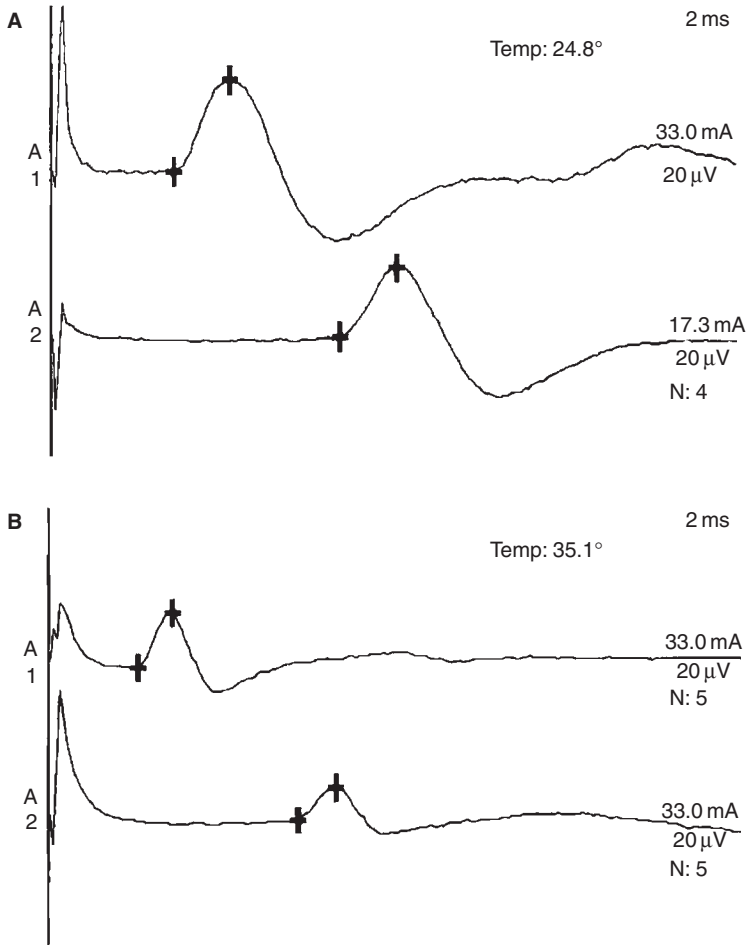
disperse. Thus, the closer a stimulus is applied to the recording site, the less the dispersion and the larger the amplitude. The longer the distance, the greater the dispersion and the lower the amplitude. Because this diminution in amplitude with increasing distance is unpredictable, it is preferable to record and to compare the distal amplitudes of the responses instead of the proximal ones.

## Temperature

Cool limb temperature prolongs the duration of the depolarization of the axon membrane, thus prolonging the action potential. This in turn increases the amplitude of the response. This effect is significant, and limb temperature cannot be ignored when performing nerve conduction studies. SNAPs are more susceptible to temperature effects than the motor compound muscle action potentials. A cool limb also has the effect of slowing conduction, which is apparent in the prolonged distal latency and slowed conduction velocity (Fig. 17–11). A temperature correction algorithm is used in some electrophysiology laboratories to correct for differences in limb temperature. These algorithms tend to be inaccurate. Although time-consuming, it is preferable to sufficiently warm a cool limb before performing the studies.

## Distance Between Recording Electrode and Nerve

The magnitude of an electrical field will decrease proportional to the square of the distance from the electrical generator. As the G1 electrode is merely recording the strength of the electrical field at that location, the further the electrode is from the nerve (the generator) the lower the amplitude of the waveform recorded. For most standard sensory studies, this is not a critical factor. However, in some obese patients or those with exceptionally large hands or digits, the increased distance between electrode and nerve may affect the amplitude of the response. In less commonly performed sensory conduction studies, for example, lateral and medial antebrachial cutaneous nerves and the saphenous nerve, careful attention to



**Figure 17-11.** Effect of limb temperature on the sensory nerve action potentials. Note the higher amplitude, larger area responses with longer latencies in the cool limb (A) when compared to the warm limb (B).

anatomical landmarks is required to ensure that the recording is made from the same location each time, because even the slightest movement can affect the distance between the electrode and the nerve and, thus, affect the amplitude.

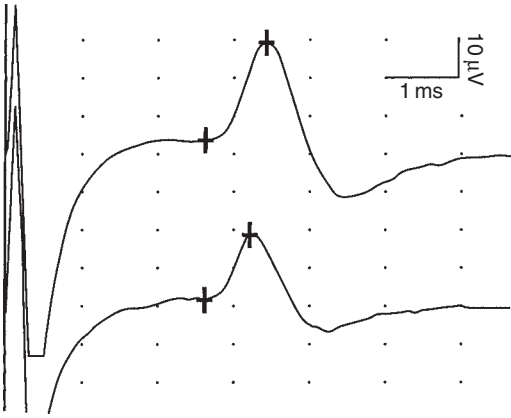
**Measurement**

Human error can affect accurate recording of SNAP parameters. These are perhaps the easiest factors to correct and to control. Measuring distance is a source of human error. The distances that are chosen affect the amplitude, latency, and conduction velocity, and careful attention has to be paid to measuring distances because an error of even a few millimeters

can change the conduction velocity calculation. Recall that relatively short distances are used to calculate conduction velocity. Therefore, standard positioning of the limb and standard anatomical landmarks need to be used in every study.

**Interelectrode Distance**

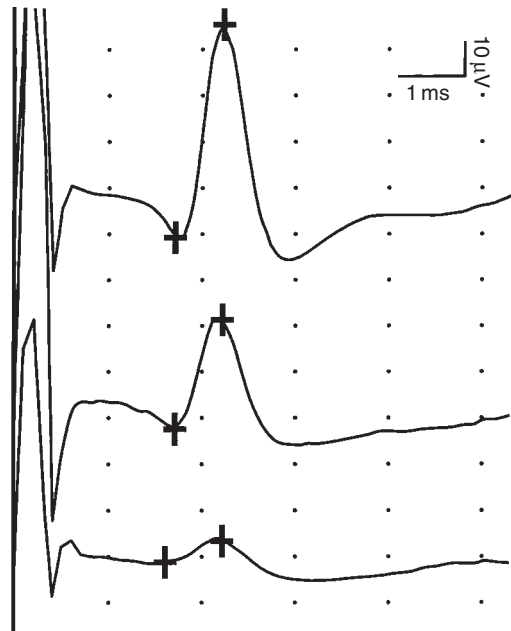
The interelectrode distance is important when performing SNAP studies. The G1 and G2 electrodes need to be far enough apart to prevent phase cancellation and a reduction in the amplitude of the SNAP<sup>7</sup> (Fig. 17-12). However, placing the electrodes too far apart increases the problem with electrical interference by reducing the effectiveness of the



**Figure 17-12.** Sensory nerve action potential with G1 and G2 separated by, *top*, 3.5 cm, and, *bottom*, 1 cm. Note the decrease in amplitude. Bar markers indicate measurements for latency and amplitude.

common-mode rejection. The interelectrode distance must be kept constant.

Placement of the recording and stimulating electrodes needs to be standardized. In most nerve conduction studies, specific landmarks are used for placing the stimulating and the



**Figure 17-13.** Sensory nerve action potential with, *top* to *bottom*, G1 and G2 moved away from the nerve at 5-mm increments. Note the decrease in amplitude and prolongation of the rise time. Bar markers indicate measurements for latency and amplitude.

recording electrodes, and any deviation from these locations with the recording electrodes will alter the response amplitudes noticeably. Because the amplitude of the response is inversely proportional to the square of the distance between G1 and the nerve, an error of even a few millimeters will alter the amplitude markedly (Fig. 17-13). Also, stimulating the nerve from a distance requires excessive current, which can cause excessive shock artifact, nonspecific excitation of other nerves, or direct muscle stimulation, leading to problems with volume conduction.

### Key Points

- Shock artifact can be reduced by maintaining proper impedance with conducting paste and gentle skin abrasion, or by rotating the stimulator.
- Submaximal nerve stimulation may lead to a falsely low SNAP amplitude.
- Cool limb temperatures have the effect of prolonging the distal latencies, slowing the conduction velocity, and increasing the amplitudes.
- Standard electrode placement and G1–G2 separation should be used to record the maximal SNAP.
- Careful limb measurements are necessary for accurate interpretation of the SNAP parameters.

## PLANNING THE STUDY AND FINDINGS IN DISEASES

The specific sensory nerves to be tested in a patient must be selected on the basis of the clinical findings and the differential diagnosis of the presenting complaints. In general it is advisable to test nerves supplying the sensory distribution that are clinically affected. Although this seems intuitive, often electromyographers are tempted to restrict testing to the more common nerves because these nerves are more familiar and less complicated. For example, in a patient who complains of numbness in the dorsum of the foot, selecting the superficial peroneal sensory nerve, rather than the sural, would be more appropriate. The temptation of only studying the most common sensory nerves should be avoided because testing these less familiar nerves can provide

invaluable localizing information that often cannot be obtained otherwise. This requires knowledge of the techniques unique to these nerves and the technical problems that tend to occur with these studies. The importance of maintaining skill in this area cannot be overemphasized. Retaining these skills requires that these less familiar sensory nerves be tested regularly, not only once or twice a year. Some examples of these less familiar sensory nerves are the superficial peroneal sensory nerve and the medial and lateral plantar nerves in the lower extremities, the lateral and medial antebrachial nerves, and the dorsal ulnar cutaneous nerve in the upper extremity. Testing of each of these nerves in the appropriate clinical setting can add substantially to the quality of the study.

## Radiculopathy

Cervical and lumbar radiculopathies are among the most common diagnoses of patients referred to the electrophysiology laboratory. SNAPs are most useful in confirming that the lesion is preganglionic (i.e., intraspinal). The most common lumbar radiculopathies are at the L5 and S1 levels, followed by the L4 and L3 levels. Because a peroneal neuropathy may mimic an L5 radiculopathy, one should consider studying the superficial peroneal sensory nerve. As previously mentioned, the dorsal root ganglia lay within the intervertebral foramina, and an intraspinal lesion in general does not disrupt the continuity between the cell body and its axon leaving the SNAPs intact. However, the location of the dorsal root ganglia can vary. The dorsal root ganglia of lower lumbar and upper sacral roots may actually be located within the spinal canal in 40% of patients.<sup>8</sup> Thus, in these patients, radiculopathy caused by lateral herniation of an intervertebral disk may cause axonal damage peripheral to the dorsal root ganglion, reducing the amplitude of SNAPs. This has been demonstrated in the superficial peroneal sensory nerve in L5 radiculopathies.<sup>8</sup> In an S1 radiculopathy, the sural sensory nerve should be selected for testing because it is located within the dermatomal distribution of the S1 nerve root. Because a femoral neuropathy may mimic an L3 or L4 radiculopathy, the saphenous sensory nerve could be considered to exclude a postganglionic lesion. Unfortunately the saphenous

sensory nerve conduction studies are not reliable and there is no good sensory study to exclude a preganglionic lesion of the L3 or L4 roots from a postganglionic lesion of the lumbar plexus.

The superficial peroneal sensory, sural sensory, and saphenous sensory nerves are pure sensory nerves, and anatomical landmarks have been established for several techniques for stimulating and recording from these nerves. However, the anatomical location of these nerves varies, and amplitudes vary significantly from person to person. Also, for each of these nerves, the normal amplitude values diminish with age, and the amplitudes become increasingly difficult to obtain. Because of this, it is important to compare the responses with those of the opposite side in any case in which responses cannot be obtainable or the amplitude is equivocal for a person of that age. Normally, the side-to-side asymmetry may be as much as 50%.<sup>9</sup> These less common SNAP studies should be conducted for the common referral diagnoses in order to maintain the skill needed to perform such tests with confidence and to obtain valid and reliable results.

## Plexopathy

The selection of nerves to be tested in a person with suspected plexopathy should be based on the most likely localization determined on routine neurologic examination. In cases of brachial plexopathy, the specific site of involvement often cannot be localized on the basis of clinical findings alone. Tailoring the study to the areas of suspected involvement increases substantially the yield of the nerve conduction studies. Although brachial plexus lesions can be patchy in distribution, a clinical examination often suggests one of three patterns: upper trunk/lateral cord, middle trunk/posterior cord, or lower trunk/medial cord. In the upper trunk/lateral cord distribution, the lateral antebrachial cutaneous sensory nerve needs to be studied in addition to the median nerve. The lateral antebrachial cutaneous sensory nerve represents the termination of the musculocutaneous nerve and, in all cases, is a branch from the upper trunk and lateral cord. If a middle trunk/posterior cord lesion is suspected, a superficial radial sensory response in addition to the median sensory response will enable a



more complete assessment of the cutaneous distribution from this segment of the brachial plexus. If a lower trunk/medial cord lesion is suspected, a medial antebrachial cutaneous nerve study in addition to an ulnar sensory nerve study is necessary to adequately assess the cutaneous distribution of the lesion. As with some sensory nerves in the lower extremity, these uncommon nerve studies become increasingly difficult to perform the older the patient is, and side-to-side comparisons should be made for any responses that cannot be obtained or have an equivocal amplitude.

Using the median SNAP recorded from the index finger is unreliable in localizing a lesion of the brachial plexus.<sup>10</sup> The median SNAP from the index finger is subject to frequent anatomical variation. In approximately 80% of cases it is derived from the middle trunk of the brachial plexus and in the remaining 20% from the upper trunk.<sup>11</sup> More reliable localization can be performed by studying the lateral antebrachial cutaneous nerve (which arises from the upper trunk and lateral cord in all cases); medial antebrachial cutaneous nerve (which arises from the lower trunk and medial cord in all cases); and the superficial radial sensory nerve (which arises from the posterior cord in all cases).<sup>11</sup> Unfortunately there is no reliable sensory nerve in the distribution of the middle trunk. Distinguishing between an upper trunk and lateral cord or the lower trunk and medial cord cannot be reliably done with SNAPs and must rely upon the needle electromyography findings. Interestingly, the SNAPs may not be helpful in cases of idiopathic inflammatory brachial neuritis.<sup>12</sup> This syndrome most commonly affects multiple mononeuropathies rather than discrete sections of the brachial plexus. It has a predilection to affect motor predominate nerves such as the anterior interosseous, long thoracic, suprascapular, and phrenic nerves.<sup>13</sup>

In lumbosacral plexopathy, the anatomical patterns are not as discrete as they are in the upper limb. Clinically, lumbosacral plexopathies often can be divided into two distribution patterns: lumbar plexus and sacral plexus. In most cases, the sacral plexus can be sampled with the sural and superficial peroneal sensory nerves. Reliable techniques have not been developed to sample the cutaneous branches in the lumbar plexus. Techniques for dermatomal somatosensory evoked potentials

have been developed<sup>14</sup> and are described in Chapter 18. In some normal subjects over the age of 60 the lower extremity SNAPs may not be elicitable. In older subjects with a low-amplitude or absent lower extremity SNAP, the response should be compared to that of the contralateral limb.

Asymmetry of the amplitudes of greater than 50% should be considered abnormal. If the SNAP is absent bilaterally then no conclusions can be drawn. Localization of a lumbar plexopathy often relies on the findings of needle electromyography.

## Common Mononeuropathies

Median and ulnar neuropathies are among the most common diagnoses referred to the electrophysiology laboratory. A median mononeuropathy at the wrist (carpal tunnel syndrome) can be easily identified via a prolongation of the median SNAP distal latency across the carpal tunnel. This is the most commonly identified abnormality of the median nerve. Several techniques have been described that assess slowing of conduction in the median nerve at the wrist. Two techniques are used almost exclusively in clinical practice: the median sensory antidromic technique (stimulating at the wrist and recording from the index finger) and median sensory orthodromic technique (stimulating the median nerve in the palm and recording over the wrist).

In the antidromic technique, the recording site is over one of the digits supplied by the median nerve, commonly the second digit (index finger), and the stimulation sites are proximal at the wrist and at the elbow. The advantage of this technique is that the amplitudes are more reliable. However, because the antidromic technique involves a longer distance, it is less sensitive to subtle slowing of conduction across the wrist and therefore less sensitive to mild cases of carpal tunnel syndrome. This antidromic technique is usually applied to more severe cases of carpal tunnel syndrome where the median motor responses are already abnormal.

In milder cases of carpal tunnel syndrome, the orthostatic or palmar technique is preferred. In the palmar (orthodromic) technique, the stimulation site is the palm and the recording sites are proximal to the wrist and



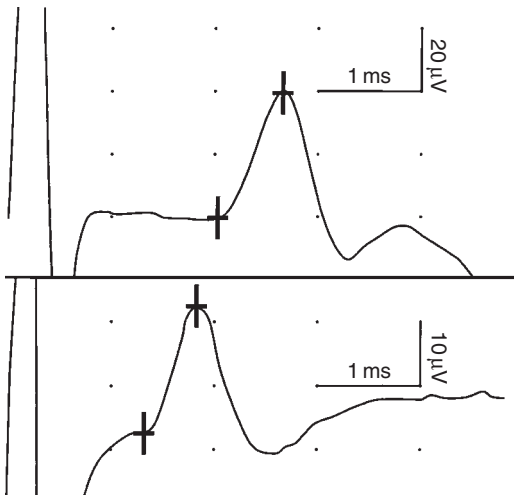
at the elbow. This technique is more sensitive for focal slowing because the distal distance is shorter. The sensitivity can be further improved by comparing the median palmar sensory distal latency to the analogous palmar sensory study of the ulnar nerve. If stimulated and recorded over the same distance (typically 8 cm) then the difference in the distal latencies between these two nerves should be 0.3 ms or less. Differences in latencies larger than this indicate focal slowing in the median nerve and in the proper setting diagnostic of a median mononeuropathy at the wrist (i.e., carpal tunnel syndrome). One additional advantage is that the proximal and distal recordings can be obtained with one set of electrical stimulations, decreasing the number of shocks compared with that of the antidromic technique. However, with the orthodromic technique, the distribution of axons activated at supramaximal stimulation is more variable, resulting in a less reliable amplitude response. In these mild cases of carpal tunnel syndrome the distal latency is more relevant than the amplitude (Fig. 17-14).

When a case of carpal tunnel syndrome is suspected, the median motor nerve is often tested first, which helps guide the decision of which median sensory conduction would be most useful to perform. If the motor responses

show slowing across the wrist, the carpal tunnel syndrome will be more severe and the antidromic technique, which is easier to perform and more reliable than palmar orthodromic studies, should be performed. If there is no slowing of conduction across the wrist in the motor studies then the carpal tunnel syndrome will be mild and the more sensitive palmar orthodromic technique should be used. Various grading scales have been developed to quantify severity of the median mononeuropathy at the wrist using nerve conduction studies.<sup>15</sup>

Ulnar neuropathies occur most commonly at the elbow; however, definitive localization of the lesion often can be difficult, especially the more chronic the condition. The most common technique for studying the ulnar sensory nerve is the antidromic method, with the recording site over the 5th digit and the stimulation sites proximal at the wrist and above the elbow. The palmar orthodromic technique used in studying median SNAPs is not often used to assess ulnar neuropathy, because it does not appreciably increase the sensitivity of the ulnar studies.

Conduction block in the ulnar nerve across the elbow cannot be proven reliably with sensory studies, but if conduction block is present, the proximal sensory amplitudes may be much reduced or even unobtainable. In the case of pure conduction block, the responses elicited with distal stimulation may demonstrate normal amplitudes and latencies. Stimulation above and below the elbow may be helpful in demonstrating focal slowing of conduction across the elbow by isolating the slowing across a much shorter segment. This may be further refined using inching techniques. If there is no demyelination and only axonal injury, the only finding on an ulnar antidromic sensory study may be a reduction in amplitude, a finding that is not helpful in localization. If this is the case, additional sensory studies can be used to further localize the lesion. For example, a lesion can be localized to a site above the wrist if the dorsal ulnar cutaneous nerve is abnormal, since it branches from the main ulnar nerve in the forearm. However, the reliability of dorsal ulnar cutaneous responses is less than that of other nerves more commonly tested and this nerve should be compared with that on the contralateral side.<sup>16</sup> Occasionally, a lower trunk or medial cord



**Figure 17-14.** Example of median (*upper tracing*) and ulnar (*lower tracing*) palmar sensory studies in mild median mononeuropathy at the wrist. Note that the difference in the peak latencies between the two studies is nearly 1 ms.

brachial plexopathy may appear clinically similar to an ulnar neuropathy. If both the ulnar antidromic study and the dorsal ulnar cutaneous sensory nerves are abnormal, the medial antebrachial cutaneous nerve should be tested. Abnormal findings in this nerve suggest a more proximal lesion of the medial cord or lower trunk of the brachial plexus. As with the dorsal ulnar cutaneous nerve, the lateral antebrachial cutaneous nerve should be compared with that of the contralateral side.

Peroneal, sciatic, and femoral neuropathies are common diagnoses referred to the electrophysiology laboratory. The sensory nerves to be tested for each of these mononeuropathies are the superficial peroneal, sural, and saphenous nerves, respectively. The antidromic technique is typically used. If the lesion causes a pure conduction block above the level of stimulation, the SNAP may be normal. This is not uncommon in a peroneal neuropathy at the head of the fibula. If the amplitude in any of these sensory studies is abnormal or borderline, the contralateral side should be tested.

## Myopathy

Sensory nerve action potentials are typically unaffected in most myopathies. Exceptions to this include disorders with multisystem involvement where the peripheral nerves, muscle, and often other organ systems are involved simultaneously. This may be seen in systemic inflammatory disorders such as the mixed connective tissue disorders and vasculitis. Other disorders than can affect the peripheral sensory nerves (and therefore the SNAPs) in addition to muscle include some congenital metabolic disorders, such as mitochondrial diseases, systemic hematological disorders such as amyloidosis, and certain environmental toxins and medications (e.g., hydroxychloroquine).

## Disorders of the Neuromuscular Junction

Most disorders of neuromuscular junction transmission (autoimmune myasthenia gravis, Lambert–Eaton myasthenic syndrome and the congenital myasthenic syndromes) do not affect the SNAP. Botulism can present with

sensory involvement in addition to its primary manifestation as a presynaptic defect of neuromuscular transmission. Botulism primarily affects the bulbar region and may demonstrate alteration of the blink reflexes. Whether this is due to involvement of the afferent sensory trigeminal nerve or the efferent facial motor nerve is not clear.<sup>17</sup> Abnormalities within the limb SNAPs have not been well described.

## Motor Neuron Diseases

The most common motor neuron disease encountered in clinical practice is amyotrophic lateral sclerosis (ALS). The primary defect in ALS is degeneration of the motor neurons in the motor cortex and the anterior horn of the spinal cord. The SNAP amplitudes remain normal in most cases of ALS. There have been recent reports suggesting that the sural SNAPs may be mildly reduced in a minority of cases.<sup>18</sup> Like ALS, spinal muscular atrophy also results in progressive loss of the motor neurons in the anterior horn of the spinal cord. As in ALS, the SNAP remain normal. Spinal and bulbar muscular atrophy (SBMA), also known as Kennedy's syndrome, clinically presents as a progressive lower motor neuron syndrome which may strongly resemble ALS. SBMA is an X-linked disorder, occurring only in men, caused by a trinucleotide repeat in the androgen receptor gene. In addition to the pathology in the lower motor neurons, SBMA also affects the sensory neurons within the dorsal root ganglia. While the lower motor neuron findings dominate the clinical presentation of SBMA the involvement of the dorsal root ganglia neurons is known to reduce the SNAP amplitude in a majority of those affected.<sup>19,20</sup> This involvement of the SNAPs may be the only neurophysiological feature to distinguish SBMA from ALS.

### Key Points

- SNAP testing needs to be performed in the distribution of the sensory deficits.
- The SNAP remains preserved in radiculopathies.
- The SNAP is abnormal in clinically affected distributions in plexopathies.
- SNAPs are very sensitive at detecting mononeuropathies.

- SNAPs are normal in common myopathies and disorders of the neuromuscular junction.
- SNAPs are normal in ALS and spinal muscular atrophy; abnormal SNAP in a male patient with motor neuron disease should raise suspicion for SBMA.

## SUMMARY

Nerve conduction studies are an invaluable addition to clinical electrophysiology testing. SNAPs are a sensitive and specific measure of function in the peripheral sensory pathways. These studies confirm whether large myelinated axons are affected by an underlying abnormality. When an area that is affected is clinically tested, nerve conduction studies can help to distinguish between a preganglionic (i.e., root level or higher) and a postganglionic (i.e., peripheral) process.

SNAPs are small and technically difficult to record; therefore close attention has to be given to proper technique, including minimizing electrical interference and using proper stimulating and recording methods. When stimulating a nerve, stimulate as close to the nerve as possible to allow a supramaximal response but to minimize the electrical artifacts. When recording, adhere to fixed anatomical landmarks, maintain proper interelectrode distance, and be attentive in measuring stimulating and recording distances. If satisfactory responses cannot be obtained with transcutaneous stimulation, consider near-needle stimulation in the appropriate setting. Because the amplitudes are low, averaging responses enhances the signal and eliminates the random ambient electrical activity. The measurements that are most relevant clinically and should be noted on all studies are the distal amplitude, distal peak latency, and conduction velocity of the nerve. It must be emphasized that appropriate technique is needed to produce reliable and valid results. The interpretations drawn from the results of a study can be only as good as the information on which they are based.

## REFERENCES

1. Donofrio, P. D., and J. W. Albers. 1990. AAEM minimonograph #34: Polyneuropathy: Classification by nerve conduction studies and electromyography. *Muscle & Nerve* 13:889–903.
2. Buchthal, F., and A. Rosenfalck. 1971. Sensory potentials in polyneuropathy. *Brain* 94:241–62.
3. Handwerker, H. Ö. 1996. Sixty years of C-fiber recordings from animal and human skin nerves: Historical notes. *Progress in Brain Research* 113:39–51.
4. Albers, J. W. 1993. Clinical neurophysiology of generalized polyneuropathy. *Journal of Clinical Neurophysiology* 10:149–66.
5. Melendrez, J. L., L. J. MacMillan, and J. Vajsar. 1998. Amplitudes of sural and radial sensory nerve action potentials in orthodromic and antidromic studies in children. *Electromyography and Clinical Neurophysiology* 38:47–50.
6. Wilbourn, A. J. 1994. Sensory nerve conduction studies. *Journal of Clinical Neurophysiology* 11:584–601.
7. Wee, A. S., and R. A. Ashley. 1990. Effect of inter-electrode recording distance on morphology of the antidromic sensory nerve action potentials at the finger. *Electromyography and Clinical Neurophysiology* 30:93–6.
8. Levin, K. H. 1998. L5 radiculopathy with reduced superficial peroneal sensory responses: Intraspinal and extraspinal causes. *Muscle & Nerve* 21:3–7.
9. Bromberg, M. B., and L. Jaros. 1998. Symmetry of normal motor and sensory nerve conduction measurements. *Muscle & Nerve* 21:498–503.
10. Moran, S. L., S. P. Steinmann, and A. Y. Shin. 2005. Adult brachial plexus injuries: Mechanism, patterns of injury and physical diagnosis. *Hand Clinics* 21: 13–24.
11. Ferrante, M. A., and A. J. Wilbourn. 2002. Electrodiagnostic approach to the patient with suspected brachial plexopathy. *Neurological Clinics of North America* 20: 423–50.
12. Puri, V., N. Chaudhry, K. K. Jain, D. Chowdhury, and R. Nehru. 2004. Brachial plexopathy: A clinical and electrophysiological study. *Electromyography and Clinical Neurophysiology* 44:229–35.
13. Jillapalli, D., and J. M. Shefner. 2005. Electrodiagnosis in common mononeuropathies and plexopathies. *Seminars in Neurology* 25(2):196–203.
14. Dumitru, D., and P. Dreyfuss. 1996. Dermatomal/segmental somatosensory evoked potential evaluation of L5/S1 unilateral/unilevel radiculopathies. *Muscle & Nerve* 19:442–9.
15. Bland, J. D. 2000. A neurophysiological grading scale for carpal tunnel syndrome. *Muscle & Nerve* 23:1280–3.
16. Dutra de Oliveira, A. L., A. A. Barreira, and W. Marques Jr. 2000. Limitations on the clinical utility of the ulnar dorsal cutaneous sensory nerve action potential. *Clinical Neurophysiology* 111:1208–10.
17. Hatanaka, T., K. Owa, M. Yasunaga, et al. 2000. Electrophysiological studies of a child with presumed botulism. *Childs Nervous System* 16(2):84–6.
18. Hammad, M., A. Silva, J. Glass, J. T. Sladky, and M. Benatar. 2007. Clinical, electrophysiologic, and pathologic evidence for sensory abnormalities in ALS. *Neurology* 69:2236–42.
19. Polo, A., F. Teatini, S. D'Anna, et al. 1996. Sensory involvement in X-linked spino-bulbar muscular atrophy (Kennedy's syndrome): An electrophysiological study. *Journal of Neurology* 243(5):388–92.
20. Antoni, G., F. Gragnani, A. Romaniello, et al. 2000. Sensory involvement in spinal-bulbar muscular atrophy (Kennedy's disease). *Muscle & Nerve* 23(2): 252–8.

# Somatosensory Evoked Potentials

*Jonathan L. Carter and J. Clarke Stevens*

## **INTRODUCTION**

### **GENERATORS AND ORIGIN OF SEPs**

Neuroanatomic Sites of Origin of Potentials

### **METHODS**

Nerve Stimulation Variables

### **RECORDING**

Methods and Montages

Volume Conduction and

Near-Field and Far-Field Potentials

Averaging

Peak Nomenclature

SEP Interpretation

Factors That Affect the Amplitude

and Latencies of the Evoked Response

### **LOCALIZATION**

Latency Prolongation

Amplitude Reduction

### **CLINICAL APPLICATIONS**

Disorders of the Peripheral

Nervous System

Disorders of the CNS

SEP Findings in Brain Death

SEPs Recorded in the Intensive

Care Unit

### **SUMMARY**

## **INTRODUCTION**

Somatosensory evoked potentials (SEPs) are presynaptic and postsynaptic responses recorded over the limbs, spine, and scalp following the stimulation of peripheral mixed motor and sensory nerves or cutaneous sensory nerves. SEPs are analogous to standard peripheral sensory nerve conduction studies, although they assess both the peripheral and the central somatosensory conduction pathways. Since routine sensory nerve conduction studies are easier to perform and are more reliably recorded than SEPs, the main value of SEPs is to provide a measurement of sensory conduction in proximal peripheral nerves, the spinal cord, and the brain.

Although evoked potentials can be elicited by physiologic stimuli such as a finger tap or tendon stretch, electric stimulation produces consistently higher amplitude evoked potentials and is the only type of stimulus useful for clinical application.

SEPs are used to evaluate the central somatosensory pathway. One of the most frequent applications is in the evaluation of patients with suspected multiple sclerosis, to obtain evidence for a clinically or subclinically evident lesion. They also provide objective evidence of central nervous system (CNS) dysfunction when sensory symptoms are vague and the findings on neurologic examination are normal or of uncertain significance. Spinal cord dysfunction due to causes other than multiple

sclerosis is another common indication for recording SEPs. The localization of sensory symptoms to a proximal peripheral nerve, the spinal cord, or a cerebral site is helpful in diagnosis and can suggest where an imaging study may show abnormality. SEPs are normal if sensory complaints are caused by a conversion reaction. Magnetic resonance imaging (MRI) of supratentorial structural lesions is so sensitive and reliable that SEPs are rarely indicated for investigation of this area of the CNS.

### **Purpose and Role of SEPs**

- To assess the integrity of the peripheral and central somatosensory pathways.
- To identify abnormalities in the spinal cord, brain stem, or cortex in diseases such as multiple sclerosis or cervical stenosis.
- To provide objective evidence of CNS dysfunction when sensory symptoms are vague and the neurologic examination is normal.
- To assist in localization of sensory symptoms to proximal peripheral nerve (roots), spinal cord, or cerebral site.

## **GENERATORS AND ORIGIN OF SEPs**

### **Neuroanatomic Sites of Origin of Potentials**

The neuroanatomy of the sensory pathways is well known; however, the exact origin of many of the SEP waveforms is still not clear and it is evident that some have overlapping generator sources.<sup>1</sup> The potentials recorded with low-current stimulation of a mixed nerve represent activity in the proprioceptive system, conducted peripherally by large-diameter, myelinated, fast-conducting cutaneous and muscle afferents and conducted centrally by the dorsal column-medial lemniscus and the spinocerebellar pathways. There are numerous collaterals to the gray matter at all levels. The first-order axons contain the fibers within the peripheral nerves with the cell bodies lying in the dorsal root ganglion, as well as axons extending centrally within the spinal cord to the cuneate or gracile nuclei in the medulla. The second-order axons travel from

the medulla through the brain stem to the ventral posterolateral nucleus of the thalamus. The axons of third-order neurons go from the ventral posterolateral nucleus of the thalamus to the primary somatosensory cortex. The traveling volley of the action potentials propagating along these pathways, or the responses generated at the sites of the synapses or within the sensory pathway nuclei may be recorded at different sites in the limb, spine, and scalp.

Stimulation of cutaneous sensory nerves or dermatomes activates large cutaneous afferents with similar anatomic origins as mixed nerve stimulation, but the SEPs have a lower amplitude than those produced by stimulation of mixed nerves because fewer fibers are excited. Also, the peak latencies obtained with the stimulation of sensory nerves are slightly longer than those obtained when a mixed nerve is stimulated, because fast-conducting group Ia muscle afferents are not present in a sensory nerve. Lesions affecting sensory modalities transmitted by small-diameter sensory fibers or by central pathways in the ventral half of the spinal cord usually do not produce SEP abnormalities. Pain-related SEPs have been recorded by stimulation of small-diameter A $\delta$  pain fibers with a carbon dioxide laser and thermal stimulation, but the acceptance of these techniques has been limited.<sup>2,3</sup>

### **Key Points**

- The potentials recorded during SEP studies represent activity in the proprioceptive sensory system.
- The responses are conducted by large diameter, myelinated, fast-conducting fibers in the periphery and by the dorsal column-medial lemniscus and spinocerebellar pathways in the CNS.
- Responses obtained with stimulation of cutaneous sensory nerves or dermatomes have a lower amplitude than those with mixed nerve stimulation.

## **METHODS**

### **Nerve Stimulation Variables**

Somatosensory evoked responses are typically obtained with electrical stimulation of a peripheral nerve, such as at the wrist or ankle.



Stimulating electrodes are fixed in place with an elastic strap. The stimulus applied should be of sufficient intensity to produce a small visible twitch of the muscle. Stimulus intensities higher than this are painful (making it difficult for the patient to relax) and do not increase the amplitude of the SEP. Intensities twice the motor threshold are sometimes necessary to achieve maximal central responses. If the small foot muscles are atrophied, a twitch may not be visible except at high stimulus intensities. In this case, use a stimulus that is 2–2.5 times sensory threshold. If sensory loss is marked, higher stimulus intensities can be used without causing patient discomfort and may be needed to exceed threshold. In the upper limb, stimulus rates of 2–5 Hz are well tolerated by most patients, but rates of 1–2 Hz are used in the lower limb. A slower rate of 0.5 Hz may be required to avoid a flexor withdrawal reflex in a spastic limb. Rates greater than 10 Hz may cause an increase in the latency and a decrease in the amplitude of some components.

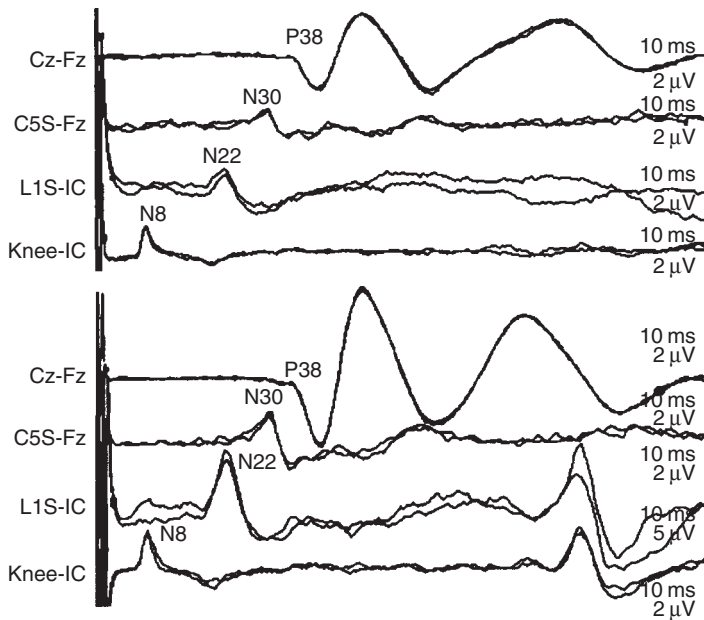
### NERVE STIMULATED

In the upper limb, the highest amplitude SEPs are obtained with stimulation of the ulnar and

median nerves. In the lower limb, stimulation of the tibial nerve produces more reliable SEPs than stimulation of the peroneal nerve. The lowest amplitudes are obtained with stimulation of cutaneous or dermatomal nerves. After cutaneous nerve stimulation, spinal potentials usually are absent in normal subjects; thus, disease in the CNS cannot be distinguished from that in the peripheral nervous system.

### UNILATERAL AND BILATERAL STIMULATION

Tibial spinal, brain stem, and cerebral evoked potentials increase in amplitude with bilateral nerve stimulation (Fig. 18–1). Therefore, bilateral stimulation is helpful when the tibial scalp SEPs are absent or poorly formed or when spine potentials are absent. In this case, bilateral stimulation may produce adequate subcortical potentials and allow central conduction time or at least the absolute scalp latencies to be estimated. The response to bilateral stimulation may not be enhanced if the peripheral and central nerve conduction velocities are not similar on the two sides. A limitation of bilateral tibial nerve stimulation is that a unilateral lesion may be more difficult to identify, since



**Figure 18–1.** Tibial nerve stimulation. *Top*, unilateral and *bottom*, bilateral stimulation at the same amplification in the same patient. Note that bilateral stimulation enhances the amplitudes of N22, N30, and P38.

the conduction along the bilateral somatosensory pathway may mask a unilateral lesion. Bilateral median nerve stimulation is rarely necessary.

### Key Points

- Stimulation is performed with a cutaneous stimulator, fixed over the nerve with an elastic strap.
- The stimulus intensity should produce a small twitch of the muscle or be 2–2.5 times the sensory threshold.
- Stimulus rates of 2–5 Hz are used in the upper limb and 1–2 Hz in the lower limb.
- The highest amplitude SEPs are obtained with ulnar, median, or tibial nerve stimulation.
- Bilateral tibial nerve stimulation may enhance the identification of subcortical peaks.

## RECORDING

### Methods and Montages

SEPs are typically recorded using 5-mm tin disc electrodes taped or pasted on to the skin surface at the different recording sites. Scalp electrodes are fixed with collodion, and spinal and Erb's point electrodes are taped in place. Responses are recorded over the peripheral nerve (median, ulnar, or tibial nerve and Erb's point), lumbar or cervical spine, and scalp. Bipolar electrodes have a fixed interelectrode distance of 35 mm. Electrolyte gel is applied to all electrodes, and impedance is maintained less than 5 k $\Omega$ . The montages used in Mayo neurophysiology laboratories to study SEPs are listed in Table 18–1. Different montages are used in different electrophysiology laboratories. Despite differences between electrophysiology laboratories in the number of channels

Table 18–1 Standard Methods for Recording SEPs

	Median or Ulnar Nerve	Tibial Nerve
Stimulation	Bipolar at wrist, cathode proximal	Bipolar at ankle, cathode proximal
Standard recording, montage: potential	Bipolar at elbow: N5 EPi–EPc: N9 C5S–Fz: N11, N13, N14 C3' (C4')–Fz: N20/P25 Ground: arm	Bipolar at knee: N8 L1–ICc: N22 C5S–Fz: N30 Cz–Fz: N33/P38 Ground: leg
Optional recording	Anterior neck–C5S: P13 C3' (C4')–noncephalic: P9, P13, P14 far-field N20/P25 parietal F3' (F4')–noncephalic: N22/P30 frontal	C3'–C4': N33/P38
Machine settings	Stimulus rate, 1–5 Hz Stimulus intensity, slight muscle twitch Amplifier sensitivity 10 $\mu$ V spine and scalp 20 $\mu$ V peripheral Analysis time, 50 ms Filter, 30–3000 Hz Number averaged, 500	Stimulus rate, 0.5–2 Hz Stimulus intensity, slight muscle twitch Amplifier sensitivity 10 $\mu$ V spine and scalp 20 $\mu$ V peripheral Analysis time, 80 ms Filter, 30–3000 Hz Number averaged, 500
Measurement	Height and F-distance Limb temperature Waveform amplitude N5, N9, N13: onset-peak N20: N20–P25 P25: P25–N35	Height and F-distance Limb temperature Waveform amplitude N8, N22, N30: onset-peak N33: N33–P38 P38: P38–N46

EPi–EPc, Erb's point ipsilateral to contralateral; C5S, spine of C5 vertebra; L1–ICc, spine of L1 vertebra to contralateral iliac crest.



and recording montages used, the major recognized potentials are consistent. Helpful guidelines for conducting SEP studies are available from the American Association of Neuromuscular and Electrodiagnostic Medicine.<sup>4</sup>

## Volume Conduction and Near-Field and Far-Field Potentials

Volume conduction principles have important implications to the recorded somatosensory responses. The principles of volume conduction are discussed in Chapter 3. In a volume conductor, the amplitude of the potential is related inversely to the square of the distance between the generator and the recording point. If the recording electrode is close to the generator, a second electrode that is a long distance away will act as an indifferent electrode and a high amplitude potential will be obtained. If the recording electrode is far from the source, another electrode at a similar distance will be almost as active as the recording electrode itself, in which case the potentials of the two electrodes will cancel in a differential amplifier so that little or no potential will be recorded.

All electrodes—regardless of where they are placed on the body—are relatively active. Therefore, responses generated anywhere along the somatosensory conduction pathway could be recorded by distant electrodes. This is analogous to the electric activity of the heart, which can also be recorded anywhere on the body. Ideally, one electrode should be as close to the generator as possible and the other electrode as far away as possible to obtain the maximal potential difference between the electrodes. However, increasing electrode distance also increases noise, especially muscle artifact, and may introduce additional generators. Therefore, it is necessary to compromise between the cancellation effect of closely spaced electrodes and the noise introduced by long distance between recording electrodes. If the generator is proximal to the shoulder or hip, moving the reference electrode distally along a limb does not improve the signal.

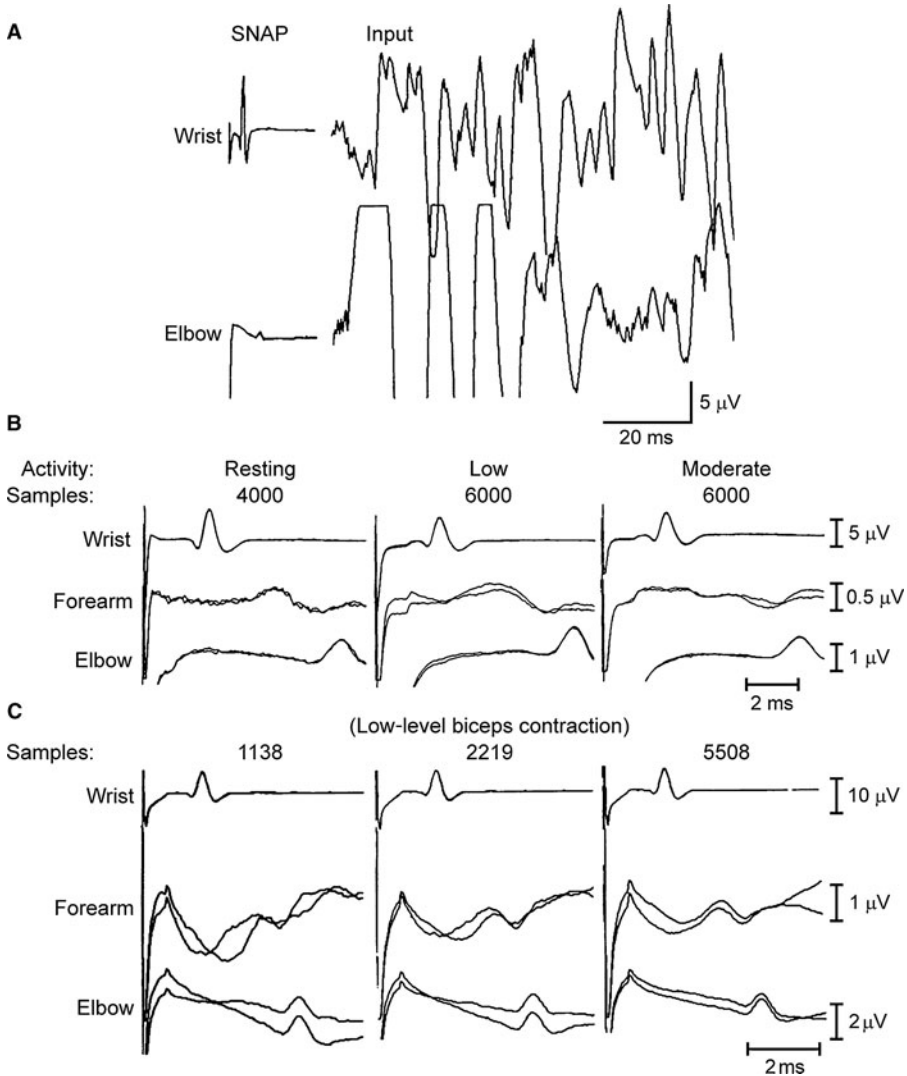
As in peripheral nerve conduction studies, a bipolar electrode montage that detects an approaching or departing depolarization records a positive waveform, a positivity, and the electrode overlying the depolarization records a negative waveform, a negativity.

Nerve action potentials that travel along nerves or fiber tracts are called *traveling waves*. Potentials that remain localized in areas of nuclei or synapses are called *stationary waves*.

Near-field potentials (NFPs) represent a propagating nerve action potential that is recorded as it passes under the recording electrodes. The recording electrodes 3 cm apart that are used in routine nerve conduction studies primarily record NFPs. The term *far-field potential* (FFP) refers to stationary potentials generated by nerve action potentials distant to the recording site.<sup>5</sup> A referential montage, such as the scalp to Erb's point, preferentially detects FFPs. The advantage of using far-field recordings is that information from many different levels of the nervous system can be obtained from a single recording montage. The disadvantage is the excess noise introduced by long interelectrode distances, which makes it difficult to obtain accurate latency measurements.

## Averaging

The main technical limitation to recording SEPs is that their amplitude is low compared with the noise of motor activity, movement artifacts, the electrocardiogram, the electromagnetic activity in the environment, and the electroencephalogram (EEG). Generally, 500–2000 stimuli are necessary to display well-defined, reproducible waveforms of 1–10  $\mu\text{V}$ . Averaging summates activity that is time-locked to the stimulus trigger, while gradually subtracting random background noise. If the noise is excessive, increasing the number of stimuli averaged does not help to extract a better signal because the signal-to-noise ratio is too small. For example, artifact in the form of large quasirandom triphasic motor unit potentials may produce continuous variation in the averaged waveform that does not improve with continued averaging (Fig. 18–2). If the noise becomes time-locked with the signal, it will be enhanced and may be mistaken for a physiologic signal. Sixty-cycle electrical artifact can be reduced by using a stimulation rate that is not a factor of 60 (e.g., 2.1 Hz). Averagers deal with intermittent artifacts by rejecting sweeps that contain waveforms exceeding the fixed maximal amplitude. This helps to decrease or to eliminate most artifacts. In addition, inspection



**Figure 18–2.** Averaged median sensory nerve action potential (SNAP) at three levels with increasing sample number (note comparison of input signals with actual potential). *A*, Input signal to be averaged and the averaged SNAPs at the wrist and elbow. *B*, Increasing level of contraction obscures the forearm waveform with low level contraction and makes it unrecognizable at moderate levels, despite 6000 averages. Even larger numbers of averages at moderate contraction, did not bring out the forearm waveform. *C*, The patient is flexing the elbow at a low level of activation showing improvement in averages in the forearm and elbow with increasing numbers of averages.

of the signal being averaged allows the technician to interrupt averaging if excessive artifact occurs. Averaging is resumed after the technical problem has been corrected.

**Key Points**

- The amplitude of the SEP responses is inversely proportional to the square of the distance between the recording electrode and the generator of the response.
- Potentials that travel along nerve fibers or tracts are called traveling waves, while those generated in nuclei or synapses are called stationary waves.
- NFPs represent a propagating action potential recorded as it passes under the recording electrodes. FFPs represent stationary potentials generated by action potentials distant to the recording site.
- SEP amplitudes are very low compared to other electrical generators in

the body; hence, large number of stimuli must be averaged to obtain reproducible responses. Muscle artifact is a major technical challenge in recording SEPs.

## Peak Nomenclature

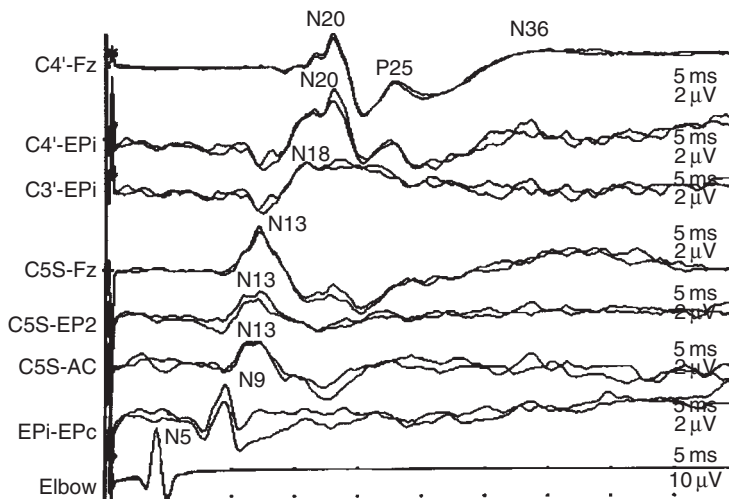
The SEP responses are named according to the direction of peak deflection (P = positive or N = negative) and the latencies of the peak response. By standard convention, upward deflections are labeled as N (negative) and downward deflections as P (positive). The number following the N or P refers to the average latency at which the particular potential is recorded in normal subjects. Thus, with a bipolar montage, the negative potential that is recorded over the brachial plexus approximately 9 ms after the median nerve is stimulated at the wrist is termed N9 (Table 18-1). However, peak nomenclature has not been standardized, and slightly different numbering systems are used to identify the same evoked potential. Evoked potentials are measured only when two superimposed averages reveal consistent responses. If it is clear that reproducible waveforms are present when looking at the two averages, viewing a single combined average may make it easier to identify and to measure the waveforms.

## MEDIAN AND ULNAR MIXED NERVE SEPs

Following stimulation of the median or ulnar nerve at the wrist, activity can be recorded at the elbow, Erb's point, cervical spine, and scalp (Figs. 18-3 and 18-4). Several different peaks are identified with standard recording montages: N5, N9, N11, N13, N14, and N20.

**N5.** The N5 potential recorded with a bipolar electrode at the elbow represents the propagating nerve action potential in the median or ulnar nerve. The presence of this potential helps to indicate that the stimulation is adequate and provides an estimate of peripheral conduction velocity. When SEP latencies are prolonged, a motor conduction study in the arm or leg (or both) is performed to check for slowing of peripheral nerve conduction.

**N9.** The N9 potential recorded with an electrode at Erb's point (2 cm superior to the midpoint of the clavicle) referred to an electrode in the same location contralaterally represents orthodromic activity in sensory fibers and antidromic activity in motor fibers passing through the brachial plexus. Stimulation of the median nerve activates cutaneous sensory fibers that enter the spinal cord through the upper and middle trunks and posterior roots of C6 and C7. Antidromic median motor and spindle afferent potentials pass through the medial cord and lower trunk of the plexus to enter the spinal cord through the anterior



**Figure 18-3.** Normal 8-channel median SEPs in a 13-year-old child. AC, anterior cervical electrode placed just above the thyroid cartilage.

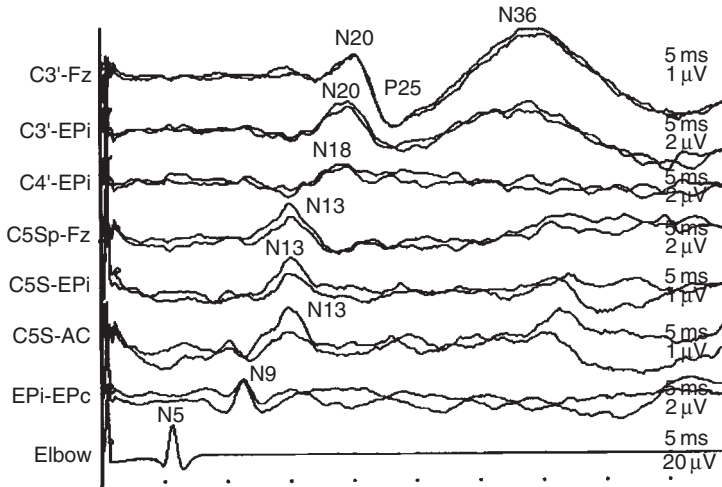


Figure 18-4. Normal 8-channel ulnar SEPs.

and posterior roots of C8 and T1. With ulnar nerve stimulation, activity is confined to the C8 and T1 segments. Occasionally, the ulnar N9 potential is difficult to record in normal subjects older than 60 years. Most of the potential is generated in sensory fibers because the N9 potential is prominent in patients with avulsion of the roots of the brachial plexus. Conversely, if a peripheral sensory deficit is substantial, the N9 peak may represent antidromic activity in motor, not sensory, fibers.

*N11, N13, and N14.* An electrode placed over the spine of C5 or C7 referred to Fz is the most common montage for recording activity arising from the cervical spine and brain stem. This montage records three negative potentials: N11, N13, and N14. The N11 potential is likely a presynaptic traveling wave that arises from activity near the root entry zone of C6 and C7 and action potentials ascending in the dorsal columns. N11 is also referred to as the *dorsal column volley* (DCV). The evidence is convincing that N13 is a standing dipole that is negative when recorded over the posterior neck and positive when recorded prevertebrally.<sup>6-9</sup> N13/P13 is a dorsal horn postsynaptic potential that is elicited by collaterals of the primary afferent fibers in the lower cervical cord. A second potential with the same latency occurs at the level of the cervicomedullary junction; it possibly arises from the cuneate nucleus.<sup>10-12</sup> The C5S-Fz montage records a large N13 potential that is likely an average of the standing dorsal cord potential and the P13/P14 FFP recorded by the scalp electrode.

The N13 potential can be recorded in all normal subjects, whereas the N11 peak is recorded in approximately 75% of normal subjects and N14 in approximately 15%–20%. Separation of the spinal N13/P13 dorsal horn potential from P14 can be facilitated by recording from the anterior neck at the superior border of the thyroid cartilage with a contralateral elbow reference or with a C5S-anterior neck montage. Loss of N13/P13, but not P14 and N20, may occur when lesions interrupt collateral axons to dorsal horn neurons without affecting fibers ascending in the dorsal columns.

In the C5S-Fz montage, N14 is sometimes seen as a small negative potential on the falling phase of N13. N14/P15 potentials probably arise in the caudal medial lemniscus because they are preserved in cases of thalamic lesion and tend to be abnormal in cases of brain stem dysfunction.<sup>13,14</sup> The N13–P14 interpeak latency assesses cervical cord–brain stem conduction time.

*N18.* N18 is a broad, subcortically generated FFP best recorded in an ipsilateral scalp-to-noncephalic montage. Evidence points to this potential being postsynaptic activity arising from several generator sources in the brain stem.<sup>13,15</sup> Studies of patients with brain stem lesions suggest that N18 reflects excitatory postsynaptic potentials evoked by dorsal column axons in the cuneate nucleus or accessory inferior olive (or both) or, possibly, presynaptic afferent depolarization in the cuneate nucleus.<sup>16-18</sup>

N20. Scalp potentials with a latency of 20 ms and longer reflect the postsynaptic potentials generated by neurons in the hand area of the primary somatosensory cortex in response to the afferent thalamocortical volley. There is disagreement about the exact identity of cortical generators. Whether the N20/P25 peaks are mediated by separate thalamocortical projections or by sequential activity in one pathway is uncertain. SEPs may occur with selective involvement of early or late cortical peaks. This phenomenon has led to the speculation that the N20 peak is related to vibration and position sense (large myelinated fibers), while the N35 peak is attributed to pain and temperature sense (small myelinated fibers).<sup>19</sup> The N20/P25 complex, as recorded with the bipolar C3' or C4'-Fz montage, may be an average of independent posterior frontal (P22/N30) and parietal (N20/P30) generators, or may represent a single generator with electrodes recording opposite ends of the dipole generator source.

### Key Points

- SEP waveform nomenclature is derived from the direction of the peak deflection (P = positive or downward deflection, N = negative or upward deflection) and the average latency of the response.
- The major clinically important waveforms with median nerve stimulation are N5, N9, N11, N13, N14, and N20.

- N5 represents the propagating nerve action potential from the median or ulnar nerve at the elbow.
- N9 represents the propagating nerve action potential passing through the brachial plexus.
- N11, N13, and N14 represent activity in the nerve root entry zone and dorsal columns in the cervical spinal cord.
- N20 represents potentials generated over the primary somatosensory cortex.

### TIBIAL MIXED NERVE SEPs

Following stimulation of the tibial nerve at the ankle, potentials are recorded from the leg, lumbar and cervical spine, and scalp.

N8. The peripheral nerve action potential recorded at the popliteal fossa is labeled N8 (Fig. 18-5).

N22. An electrode over vertebra L1 referred to the iliac crest records a negative, sometimes bifid, potential designated N22. The N22 represents postsynaptic potentials generated in the dorsal horn of the spinal cord, analogous to the stationary N13/P13 potential recorded over the neck with stimulation of the median nerve. An initial, small, rarely recorded negative peak, N18, is a traveling wave that represents conduction through the cauda equina and root.<sup>20</sup> It

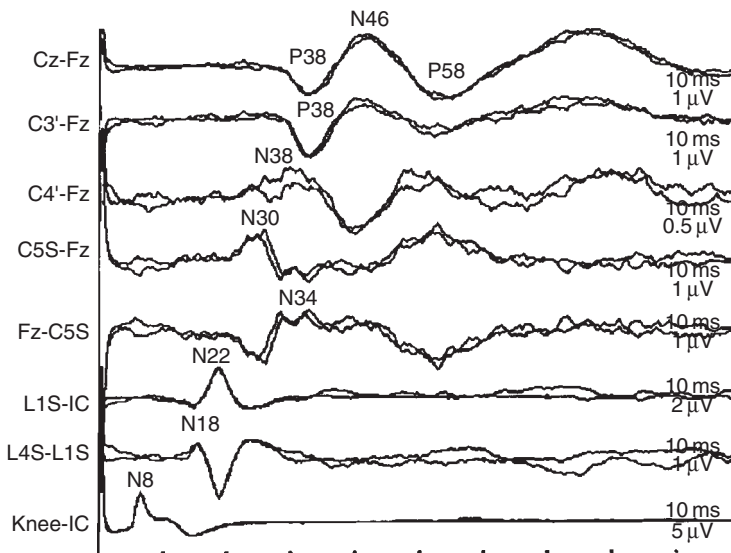


Figure 18-5. Normal 8-channel left tibial SEPs in a 27-year-old woman.



is best displayed with an L1S-to-L4S montage; however, because its amplitude is small, the potential cannot be recorded in many patients.

**N30.** The N30 potential recorded over the cervical spine (C5S–Fz montage) represents activity in the fasciculus gracilis, the spinocerebellar pathways, and possibly the gracile nucleus.<sup>21,22</sup> It is difficult to record in many subjects because of muscle artifact and progressive dispersion of the ascending volley. Stimulation of the posterior tibial nerve bilaterally is frequently helpful in eliciting the tibial lumbar and cervical responses (Fig. 18–5).

**N34.** The N34 (Fz–C5S montage) is a subcortically generated FFP analogous to N18 following stimulation of the median nerve. It may reflect postsynaptic activity from many generator sources in the brain stem and, perhaps, thalamus.

**P38.** The activity of the foot area in primary somatosensory cortex is ascribed to P38 (also known as *P37*).<sup>23</sup> This potential is usually maximal somewhere between the midline and the centroparietal scalp locations, contralateral to the simulated leg. The primary component may consist of at least two dipoles.<sup>24</sup> Because the orientation of the dipole inside the longitudinal fissure is variable, P38 is sometimes maximal over the ipsilateral scalp. This is known as *paradoxical localization*. To be certain that P38 is absent, record from the ipsilateral scalp as well as from the usual midline location.

### Key Points

- The major clinically important potentials with tibial nerve stimulation are the N8, N22, N30, and P38 potentials.
- The N8 potential represents the peripheral nerve action potential recorded at the popliteal fossa.
- The N22 potential represents the postsynaptic potentials generated in the dorsal horn of the spinal cord in the cauda equina.
- The N30 potential represents activity recorded in the dorsal columns in the cervical spinal cord.
- The P38 potential represents activity recorded over the primary somatosensory cortex.

## CUTANEOUS NERVE STIMULATION SEPs

Stimulation of cutaneous nerves such as the sural, superficial peroneal, and lateral femoral cutaneous nerves in the lower extremity and the digital, superficial radial, and other nerves in the upper extremity readily elicits a scalp SEP in normal subjects. However, the amplitude of the potentials is much smaller than those obtained with mixed nerve stimulation, and responses are not obtained over the spine. Cutaneous nerve stimulation is used (1) to assess the integrity of specific cutaneous nerves that are not readily studied with conventional nerve conduction study techniques, (2) to evaluate isolated root function, and (3) to assess patchy numbness for medical–legal reasons.<sup>25</sup>

## DERMATOMAL SEPs

Dermatome stimulation is used occasionally to assess function of the lumbosacral and cervical nerve roots. Stimulation sites are the thumb (C6), adjacent sides of the index and middle fingers (C7), little finger (C8), the dorsal surface of the foot between the first and second toes (L5), and the lateral side of the foot (S1). Stimulation sites and normal values are available for the cervical, thoracic, and lumbosacral levels.<sup>26</sup>

## SEP Interpretation

The first important step in interpreting SEP studies is close examination of the recording to determine whether all the normally appearing components are present. The absence of a main ulnar or median SEP component almost always indicates an abnormality. Similarly, the absence of a waveform that is easily recorded on the contralateral side also indicates an abnormality. Occasionally, the lumbar and cervical responses following tibial nerve stimulation are absent in normal subjects and frequently absent in older and obese subjects, particularly if they have difficulty relaxing. Stimulation of the nerve is performed twice to assess for reproducibility of the recorded responses, which helps to assess technical reliability. The lack of superimposable tracings at the lumbar and cervical levels often represents a technical limitation rather than an abnormality. Subcortical or peripheral

potentials may be low in amplitude or absent, but because of central amplification and several parallel central pathways, a relatively normal scalp response may still be obtained. Avoid making statements about pathologic conditions, because disease-specific changes are not observed with SEP studies.

## Factors That Affect the Amplitude and Latencies of the Evoked Response

A number of physiologic and technical factors can affect the amplitude and latencies of the evoked responses, and are important to consider in the interpretation of the study.

### AGE

SEP latencies and amplitudes are affected by age. Values in children do not reach those of adults until the age of 8 years. In older age groups, there is a small decrease of peripheral sensory nerve conduction and amplitude, which is most marked distally. According to one study, median nerve central conduction time (N13–N20) was constant between the ages of 10 and 49 years, increased by 0.3 ms between the 5th and 6th decades, and then remained stable in normal subjects up to 79 years old.<sup>27</sup> Mild prolongation of N9–N13 and N11–N13 transit times has been found in comparing subjects 15–39 years old with those 40–60 years old.<sup>28</sup>

### BODY HEIGHT AND LIMB LENGTH

The latencies of central SEPs are a function of body height and limb length. Therefore, the use of absolute latencies has major limitations. The use of interpeak latencies that are not related to body size eliminates the effect of height. However, when interpeak latencies cannot be measured because all peripheral or subcortical evoked potentials are absent, absolute latencies must be relied upon for interpretation even though the abnormalities are nonlocalizing.

### TEMPERATURE

Low limb temperature decreases peripheral nerve conduction velocity and prolongs the

latency of spinal and cortical evoked potentials. Therefore, it is necessary to monitor limb temperature to avoid errors. If the temperature of the arm is less than 32 °C and that of the leg less than 30 °C, the limbs should be warmed. However, central conduction velocity is affected only if hypothermia is profound. To assist with interpretation, median and tibial nerve conduction studies are performed if the SEPs are abnormal. For example, a peripheral neuropathy can markedly affect the absolute latencies and morphology of evoked potentials.

### SEDATIVE MEDICATIONS

Sedation given to reduce muscle artifact may allow the patient to sleep during the test, but it can mildly prolong the scalp latencies. Sedative medications do not have any effect on the latencies of the potentials recorded from the peripheral nerve or spine.

### MUSCLE ARTIFACT

Muscle artifact can be controlled by having the patient relax in a reclining chair or bed. Because evoked responses recorded at the elbow, Erb's point, or the knee have a high amplitude, muscle activity is not usually a problem at these locations. However, recording over the lumbar or cervical spine is difficult because of the motor unit activity of the paraspinal muscles and the distance from the generators. Audio monitoring of all channels is essential; however, the spine derivations are most important because they are usually the noisiest channels. Muscle artifact in the scalp leads is rarely a problem. Sedation of the patient is helpful, especially patients who are tense or spastic; diazepam is routinely given for sedation unless it is contraindicated.

### ELECTRIC ARTIFACT

The two main sources of electric artifact in recordings of SEPs are stimulus artifact and 60-Hz alternating current transmitted to the amplifier by the machine used to record the evoked potential or through electromagnetic radiation. Stimulus artifact can be decreased by using a stimulus-isolation device and a fast-recovery amplifier, by maintaining proper orientation and contact of the stimulating electrodes, and by avoiding higher than necessary stimulus intensity.



Maintaining recording electrode impedance less than 5000  $\Omega$  by cleaning the skin and proper grounding eliminates most 60-Hz noise from the SEP. If different types of electrodes, for example, surface and needle electrodes, are used at recording and reference sites, an impedance mismatch is created, thus amplifying 60-Hz interference.

### FILTER SETTINGS

Correct filter settings decrease noise without reducing the waveforms of interest. A low-frequency filter setting of 30 Hz and a high-frequency setting of 3 kHz are usually satisfactory. Restricting low frequencies with a filter setting of 150 Hz reduces 60-cycle artifact and may be useful in some situations. It also allows better visualization of certain peaks (e.g., N11). However, the 150 Hz setting has the disadvantage of reducing the amplitude of most peaks (e.g., N13) and slightly shortening peak latencies. Use of a 60-Hz “notch” filter is not recommended because SEPs in this range contain important physiologic information.

### Key Points

- Absence of any waveform with median or ulnar nerve stimulation is abnormal.
- Absence of lumbar or cervical potentials with tibial nerve stimulation is commonly seen due to muscle artifact, especially in older individuals.
- Sedation or bilateral tibial nerve stimulation may help with detection of subcortical peaks when recording tibial SEPs.
- Body height, limb length, temperature, and other technical factors are important in recording SEPs and may affect interpretation of the SEP.

## LOCALIZATION

### Latency Prolongation

For purposes of clinical interpretation, SEP waveforms are assumed to represent the sequential activation of ascending levels of the somatosensory pathway. Interpeak latency prolongations indicate a defect between the generators of the two peaks involved. Interpeak latency determinations are most desirable

because the effects of height, limb length, and temperature are eliminated.

With the stimulation of the median or ulnar nerve, the absence or delay of N13, with a normal N9, suggests a lesion central to the brachial plexus and caudal to the foramen magnum. The loss of N13 is also consistent with a lesion of the low-to-mid cervical cord. Because collaterals from the main pathway generate the N13 dorsal horn potential, it is not uncommon for a lesion of the dorsal horn to eliminate N13, while dorsal column function and the N14 and N20 potentials are preserved. If N13 is normal but N20 is delayed or absent, a lesion rostral to the midcervical cord is indicated and is either a cortical lesion or a subcortical lesion of the ascending somatosensory pathways.

For tibial nerve SEPs, the absence of a lumbar potential (N22) following tibial nerve stimulation suggests a lesion at or distal to this level. The presence of the lumbar N22 potential, with delay of the cervical N30 potential, suggests a lesion within the spinal cord between these two areas. In the absence of a cervical potential, the presence of a lumbar potential with a delayed or absent scalp component suggests a nonlocalized lesion rostral to the lumbar spinal cord.

Side-to-side interpeak latency differences are also sensitive indicators of abnormality. Dispersion of SEPs suggests desynchronization of the nerve action potential analogous to that found in demyelinating disease of peripheral nerves; however, this is difficult to quantify and should be interpreted cautiously. Morphological peculiarities of waveforms, unaccompanied by latency prolongation, should not be interpreted as an abnormality but rather as an atypical feature of uncertain clinical significance.

### Amplitude Reduction

A decrease in the amplitude of SEP waveforms is helpful; however, the range of normal values is broad, making this measurement less useful than latency measurements. Also, a general attenuation of cortical SEP amplitude may be encountered with a lesion at any level of the somatosensory pathway from the periphery to the cerebral cortex. It has been suggested that a 50% or greater side-to-side difference indicates a substantial central conduction block or axonal loss or both.

### Key Points

- Interpeak latency determinations are desirable because they eliminate the effects of height, limb length, and temperature.
- Amplitude of the SEP waveforms is less useful than latency prolongation because of the broad range of normal values for amplitude. A 50% or greater asymmetry in amplitude between sides may be clinically important.
- Interpeak latency prolongations imply a lesion between the generators of the two peaks involved.
- Absence of subcortical peaks, which is more common with tibial nerve SEPs, may point to a nonlocalized lesion of central pathways especially if a lumbar N22 response can be recorded.

### CLINICAL APPLICATIONS

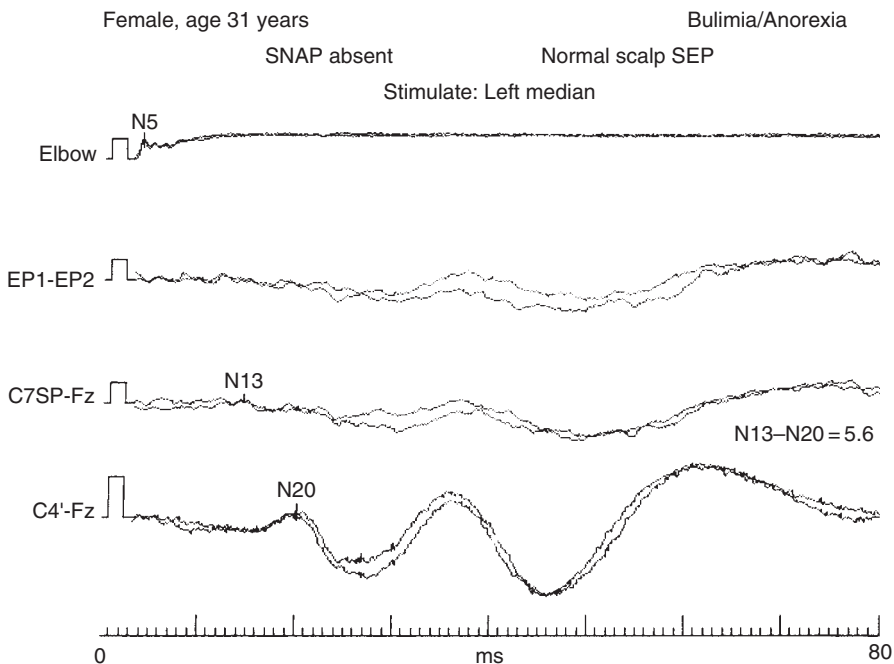
The usefulness of SEPs in disorders of the central and peripheral nervous system has been reviewed recently.<sup>25</sup>

### Disorders of the Peripheral Nervous System

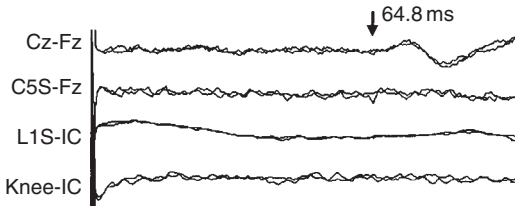
#### PERIPHERAL NEUROPATHY

Peripheral neuropathies generally cause prolongation of the absolute latencies of brachial plexus, neck, and scalp evoked potentials, but central conduction time is normal. When the neuropathy is marked, only low-amplitude and poorly formed scalp potentials are obtained, and other components are absent (Fig. 18–6). In some cases, no response is obtained at any level, particularly with stimulation of the posterior tibial nerve. Routine nerve conduction studies are sufficient for the evaluation of most neuropathies. SEPs are useful for evaluating the proximal segments of nerve if slowing of conduction through the plexus or roots is suspected. Occasionally, patients with chronic inflammatory demyelinating neuropathy may have slowing primarily at the root level, with relatively normal peripheral nerve conduction.

In neuropathy associated with sclerosing myeloma, prolonged interpeak latencies of

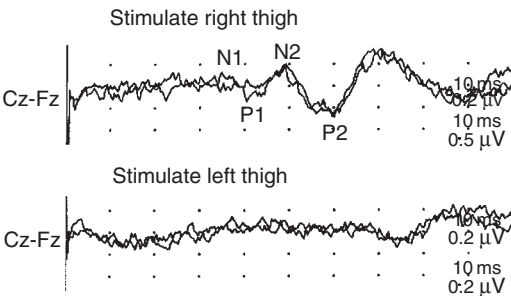


**Figure 18–6.** Median SEPs in a patient with a severe axonal peripheral neuropathy from prolonged ingestion of 2 g of vitamin B6 daily. N5 has a very low amplitude and N9 is absent. The N13 amplitude is very small, but N20 is normal because of central amplification of the signal. Central conduction (N13–N20) is normal. The antidromic median sensory nerve action potential (SNAP) recorded from the index finger was absent.



**Figure 18-7.** Guillain-Barré syndrome in a 69-year-old woman. Note markedly prolonged scalp response after sural nerve stimulation. Subcortical evoked potentials are absent. Sural nerve action potential at the ankle was normal (amplitude 9.8  $\mu$ V, latency 4.1 ms at 14 cm).

N9-N13 have been found and correlated with demyelination in the dorsal root. Similar changes have been reported in Guillain-Barré syndrome, but only occasionally in the absence of changes in F-wave latencies (Fig. 18-7).<sup>29</sup> In patients with severe sensory neuropathies, a relatively normal scalp SEP can often be obtained because of *central amplification* of the peripheral afferent volley, even when the peripheral sensory nerve action potential is absent. If the scalp latencies are within normal limits, it can be inferred that peripheral sensory nerve conduction velocities probably are not markedly slowed. Central conduction times in hereditary motor and sensory neuropathy type I are usually normal.<sup>30</sup> Slowing of spinal sensory conduction occurs in some patients with diabetes mellitus. Dermatomal SEP can be used to evaluate for some cutaneous neuropathies, where standard nerve conduction studies are less reliable, such as lateral femoral cutaneous neuropathy (meralgia paresthetica) (Fig. 18-8).

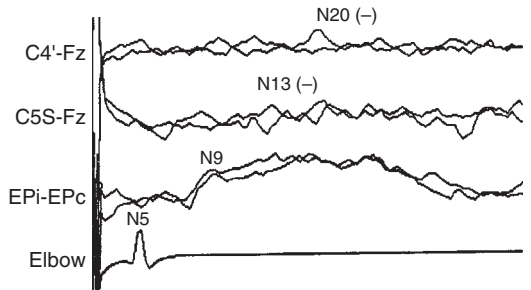


**Figure 18-8.** Left meralgia paresthetica. Stimulation of the skin of the right and left anterolateral thigh. The scalp response after stimulation on the left is absent.

### TRAUMATIC BRACHIAL PLEXOPATHY

Following traumatic plexopathy, recordable scalp SEPs and the attenuation or absence of sensory nerve action potentials indicate continuity between peripheral and central structures. Conversely, the presence of a normal Erb's point potential and the absence of cervical and scalp responses suggest avulsion of the roots of the plexus (Fig. 18-9). However, localization often is not possible for severe lesions that involve both preganglionic and postganglionic elements of the plexus. The absence of responses without paraspinal denervation may suggest the need for surgical exploration of the plexus. Complete SEP study of an extensive brachial plexus injury may require stimulation of several nerves, including the ulnar, median, and radial nerves.

With more restricted injuries, it is possible to be more selective in planning the study. The nerve chosen should have roots near the site of injury, as determined clinically and electromyographically. If only one or two roots or trunks are involved, stimulation of the median nerve can give normal results, because median nerve afferents enter the spinal cord through several roots (C6, C7, C8, and T1). Stimulation of the musculocutaneous nerve has been advocated for the study of upper trunk lesions, but this nerve is difficult to stimulate selectively without activating the radial nerve. If avulsion of C7 is suspected, stimulate the radial nerve, and for C8 and T1 lesions, stimulate the ulnar nerve. A more precise but time-consuming alternative to stimulation of mixed nerve trunks



**Figure 18-9.** The median SEP in a 34-year-old man injured in a motorcycle accident shows a normal N5, a poorly formed N9, and absence of N13 and N20 components, consistent with root avulsion. The median antidromic sensory amplitude was 15.6  $\mu$ V. The thenar compound muscle action potential was absent. The ulnar SEP showed the same pattern.

is stimulation of “segmental” cutaneous nerves. Stimulation of the lateral cutaneous nerve of the forearm and digital nerve afferents permits evaluation of nerve fibers confined to nerve roots C5–C8.

### THORACIC OUTLET SYNDROME

Ulnar SEPs have limited usefulness in the diagnosis of neurogenic thoracic outlet syndrome.<sup>31–33</sup> Several patterns have been described, including a low-amplitude N9, with a prolonged N9–N13 interpeak latency, and a low-amplitude N13, with or without attenuation of the N9 potential. The ulnar nerve should be stimulated because stimulation of the median nerve usually gives normal results. SEPs are usually normal in patients with vascular or symptomatic thoracic outlet syndrome.

### RADICULOPATHY

Radiculopathies are evaluated most easily and reliably by needle electromyography. SEPs evoked by stimulation of a mixed nerve are usually normal in the case of a single root lesion, because major nerve trunks are formed from several roots. Segmental sensory stimulation, stimulation of individual digits, or stimulation of peripheral nerve branches innervated by a single nerve root are potentially useful for the evaluation of patients with disk disease. Some investigators have reported a good correlation between lumbosacral dermatomal SEP abnormalities and findings on electromyography, myelography, and at surgery; but others have found the method less useful.<sup>34–36</sup> Dermatome SEP studies are time-consuming and difficult to interpret because the responses can be small and poorly formed. Because of these limitations, SEP studies are not performed routinely in the evaluation of radiculopathies.

### Key Points

- Peripheral neuropathies and other peripheral nerve lesions typically produce prolonged absolute latencies, but normal interpeak latencies unless there is a separate additional lesion of the CNS.
- SEPs may be recorded from the scalp even with severe peripheral neuropathies, a phenomenon known as *central amplification* of the response.

- SEP may help in localization of brachial plexus lesions, but often must be interpreted along with results of conventional needle EMG.
- SEP is rarely useful in routine evaluation of radiculopathies.

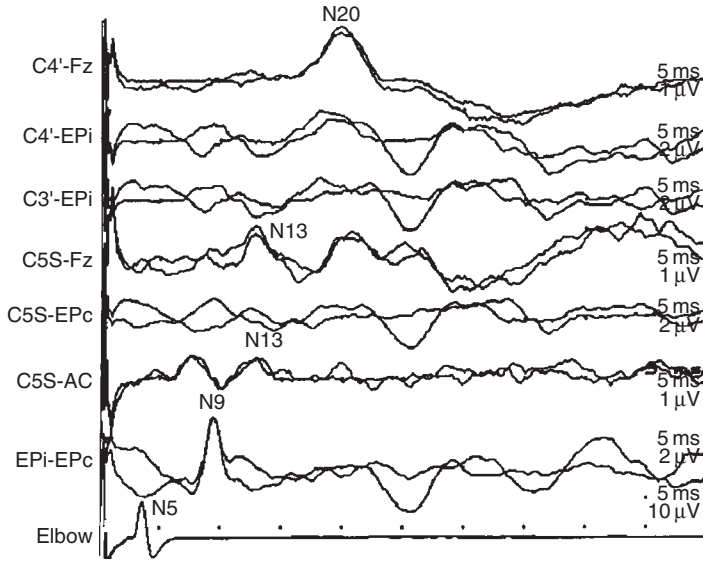
### Disorders of the CNS

Abnormalities of SEPs have been described in many diseases of the CNS. However, SEPs are most helpful in detecting CNS lesions when the results of the clinical examination are normal or equivocal. Diseases of myelin tend to produce prominent changes in latency, whereas diseases of axons preferentially affect the amplitude of central potentials. The overlap is so marked that pathologic conditions cannot be predicted reliably by changes in SEPs. The following discussion is limited to disorders in which SEPs appear to aid in diagnosis or management.

#### CERVICAL SPONDYLITIC MYELOPATHY

Tibial SEPs are abnormal in approximately 75% of cases of cervical spondylitic myelopathies, while ulnar SEPs are abnormal in 60%, and median SEPs are abnormal in 25% of cases.<sup>37–39</sup> The abnormalities consist of loss of amplitude, degradation of waveforms, or slight interpeak delays (Figs. 18–10 and 18–11). The low-amplitude N9 potentials that are found occasionally may be caused by disease of the dorsal root ganglia. The median N13 potential is more likely to be abnormal when compression occurs at several spinal cord levels rather than at either the C4–5 or the C5–6 level alone.<sup>40</sup> The absence of the cervical peak (N30) after tibial nerve stimulation is common in cervical myelopathy, but it may also be absent in normal older persons, making interpretation a problem. Therefore, the most reliable measurement is prolongation of the tibial N22–P38 interpeak latency.

SEP testing repeated a year after successful surgical treatment shows persisting abnormalities, and the results are of little value in assessing the adequacy of the decompression.<sup>41</sup> Somewhat surprisingly, the severity of MRI abnormalities, clinical examination findings, and SEP abnormalities show no clear



**Figure 18-10.** Left median SEPs in a 63-year-old man with a slowly progressive quadriplegia caused by cervical spondylotic myelopathy. The N13–N20 interpeak latency is mildly prolonged at 7.0 ms (normal, 6.7 ms). See MRI in Figure 18-11.



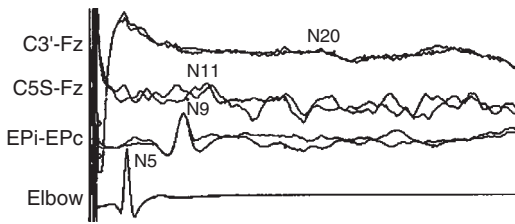
**Figure 18-11.** MRI of the cervical spine of the same patient as in Figure 18-10. Note cervical spondylosis with myelomalacia and spinal cord atrophy at C3–C4. The patient had a history of previous C3–C4 anterior cervical fusion.

correlation. However, severe MRI abnormalities are usually associated with abnormal SEPs. Conversely, some patients with normal imaging studies may have abnormal SEPs.<sup>42</sup>

### DEMYELINATING DISEASE

Most frequently SEPs are used to evaluate suspected multiple sclerosis (Fig. 18-12), especially in documenting a second clinically silent lesion, for example, in a patient with optic neuritis. SEP testing is also helpful if symptoms are suggestive of myelopathy when no definite abnormalities are found on physical examination. Median SEPs are abnormal in 56%–59% and tibial SEPs are abnormal in 77%–82% of all patients with multiple sclerosis. The rates of abnormality are somewhat higher for lower limb SEPs because of the greater length of white matter traversed. The sensitivity of SEPs in detecting “clinically unsuspected lesions” ranges from 37% to 41%. The most frequent finding is prolongation of SEP interpeak latencies, but low-amplitude and dispersed scalp responses are also common. It may be difficult to determine whether the early scalp responses are markedly prolonged or are absent and only late potentials are present. The N13 potential recorded after median nerve stimulation is often absent or attenuated, whereas the scalp response is still present. Lesions of the cervical





**Figure 18-12.** Right median SEPs in a patient with multiple sclerosis. N13 is absent. The N9–N20 interpeak latency is quite prolonged at 14.1 ms (normal, 6.8 ms). The scalp response has a low amplitude and is dispersed. These findings are consistent with demyelination.

cord seen on MRI usually result in an abnormal SEP.<sup>43</sup> Although the overall sensitivity of SEPs is lower than that of MRI in multiple sclerosis (MS), SEPs may be better for detecting spinal cord lesions that are below the resolution of MRI.<sup>44</sup>

While SEPs are clearly useful in the diagnosis of MS, their use as a prognostic marker in MS is more controversial. Recent studies have demonstrated a good correlation ( $R = 0.60$ , Spearman correlation coefficient) between SEP abnormality “score” and increased disability on the Kurtzke EDSS (Expanded Disability Status Scale) as well as the relevant functional system score in patients at baseline evaluation.<sup>45</sup> In a cohort of patients followed longitudinally for a mean of 30.5 months, there was a significant worsening of SEP scores overall. However, the correlation of worsening SEP scores with worsening EDSS scores was not statistically significant. Patients with more severe global evoked potential scores at baseline had a significantly greater risk of progressing over the follow-up period, with a positive predictive value of 72.5% and a negative predictive value of 63.6%. Hence, evoked potential “scores” may be a useful tool in prognostication especially since they represent physiological measures of impairment that may be more clinically meaningful than many MRI parameters that are currently being used as outcome measures in MS clinical trials.<sup>45,46</sup>

Evoked potentials have been used as an outcome measure in a limited number of MS clinical trials, with some reports of a positive correlation evoked potential parameters and a therapeutic response to the drug being studied.<sup>47,48</sup> Other studies have failed to find such associations.<sup>49,50</sup> Significant challenges

remain, including the fact that SEPs are more variable in MS patients than in normal controls due to instability of conduction in partially demyelinated axons, or conduction block or loss of potentials due to axonal damage. Additionally, SEPs are more difficult to record in MS patients who may have significant spasticity or other factors that introduce technical difficulties.<sup>51</sup> The test–retest variability of evoked potentials in MS patients over time is not well known. All of these factors currently limit the utility of SEPs as outcome measures for MS clinical trials.

### SYRINGOMYELIA

In syringomyelia, ulnar and median SEPs are usually normal if there is dissociated sensory loss and usually abnormal if all sensory modalities are impaired. The absence of N13 suggests involvement of the central gray matter of the cervical cord.<sup>52</sup> Because of conduction directly up the dorsal columns, P14 and N20 may still be recorded when spinal N13 is absent. Tibial SEPs most frequently are abnormal, showing an absence of the neck response (N30), delayed low-amplitude or absent scalp potentials, or prolongation of the N22–P38 latency.<sup>32</sup>

### SPINAL CORD TUMORS

Various types of spinal cord tumor commonly have associated SEP abnormalities. An absent or reduced N13 response indicates involvement of dorsal horn gray matter and is correlated with disturbed pain and temperature sensation and reduced reflexes in the upper limbs. P14 abnormalities are correlated with impaired joint and touch sensation. Involvement of the lumbar cord is associated with an abnormal N22 potential. Prolongation of interpeak latencies is also common.<sup>53</sup> SEPs may be normal in slow-growing astrocytomas that infiltrate but do not destroy sensory pathways.

### MISCELLANEOUS SPINAL CORD LESIONS

Markedly prolonged conduction times are seen in patients with adrenomyeloneuropathy and are caused by involvement of distal and proximal peripheral nerves and the

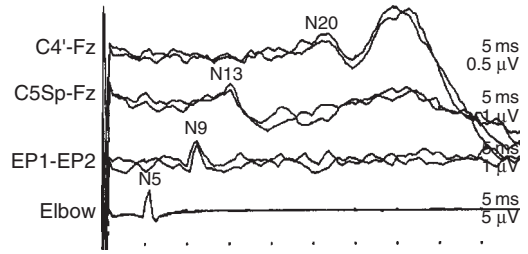
CNS.<sup>54</sup> Slowing is also found in the majority of adrenoleukodystrophy carriers.<sup>55</sup> In vitamin B12 deficiency, changes in central conduction usually appear before peripheral slowing, suggesting that the central process of a dorsal root ganglion cell is affected earlier than the distal process.<sup>56</sup> Early treatment lessens the abnormalities of SEPs. SEPs may also be abnormal in the myeloneuropathy due to copper deficiency, where they help document central slowing of conduction in addition to the severe axonal sensorimotor peripheral neuropathy that usually accompanies this condition. This slowing of central conduction has been reported to correlate with MRI T2 signal changes in the dorsal columns of the spinal cord.<sup>57-59</sup>

### Key Points

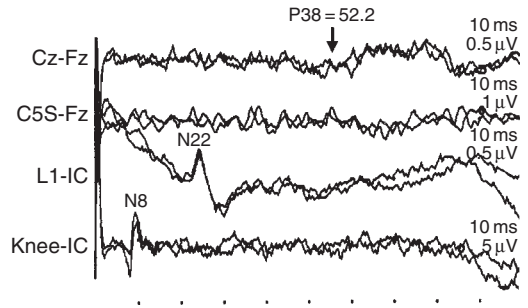
- SEPs are most useful clinically in evaluation of suspected MS, where they are highly sensitive for clinically undetected spinal cord lesions.
- Tibial SEPs are more likely to be abnormal in MS than median SEPs, due to the greater length of the pathways involved from the lower extremities.
- The usual SEP abnormality in MS is prolongation of interpeak latencies but preserved waveforms with normal amplitudes.
- Other spinal cord lesions may produce absent or reduced amplitude SEP responses, with variable effects on interpeak latencies.

### BRAIN STEM AND SUPRATENTORIAL LESIONS

Central conduction times may be prolonged with lesions of the lemniscal pathway in the brain stem or the thalamocortical radiation. SEPs are normal in the Wallenberg and Weber syndromes, because the medial lemniscus is unaffected. Central conduction times in hereditary motor and sensory neuropathy type I are usually normal.<sup>37</sup> In Friedreich's ataxia, SEPs typically show absent or low-amplitude N9–N13 potentials of normal or near normal latency, whereas the latency of cortical responses is increased, often with broadening of N20<sup>60</sup> (Figs. 18–13 and 18–14). Abnormal median and tibial SEPs are also seen in patients



**Figure 18–13.** Left median SEPs in a 17-year-old man with Friedreich's ataxia. The N13–N20 interpeak latency is prolonged at 11.3 ms (normal, 6.7 ms). The N9–N13 interpeak latency is normal.



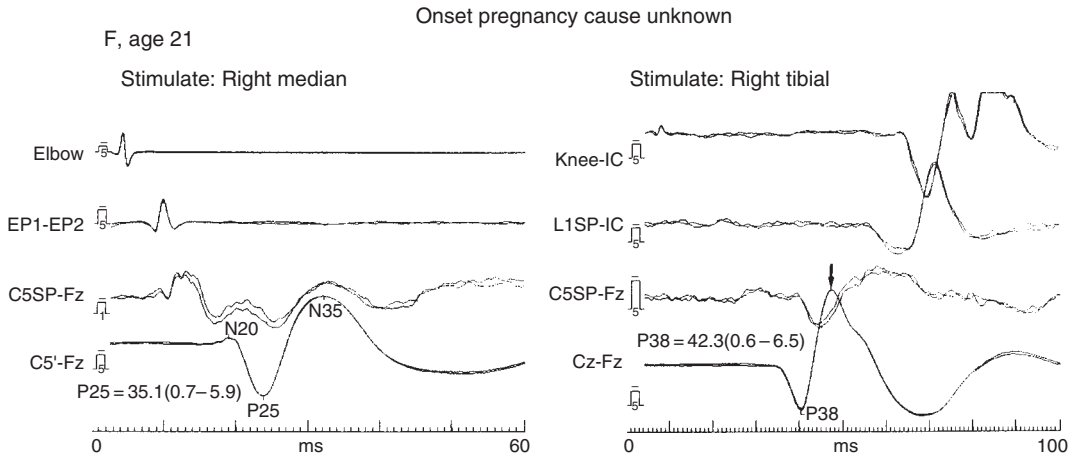
**Figure 18–14.** Tibial scalp potentials, in the same patient as in Figure 18–13, are low amplitude, and the P38 latency is approximately 52.2 ms. The N22–P38 interpeak latency is quite prolonged at 28 ms (normal, 20 ms).

with other autosomal dominant cerebellar ataxias.<sup>61,62</sup> In thalamocortical lesions with no sensory loss, SEPs are normal; but if the sensory loss is complete, the patient will have no N20 or subsequent potentials. Patients with minimal cortical sensory loss may have asymmetrical cortical potentials. Evoked potentials in patients with nonorganic sensory loss should be normal.

### MYOCLONUS

Myoclonus occasionally is associated with very high-amplitude cortical evoked responses (Fig. 18–15). The giant SEPs are separable into three types that reflect hyperexcitability in the afferent or efferent system (or both) of the somatosensory cortex.<sup>63</sup> The amplitude may be increased up to 10 times normal in patients with cortical reflex myoclonus, including progressive myoclonus epilepsy and epilepsy partialis continua.<sup>64</sup> The cortical SEPs are not exaggerated in patients with myoclonus of brain stem or spinal cord origin.

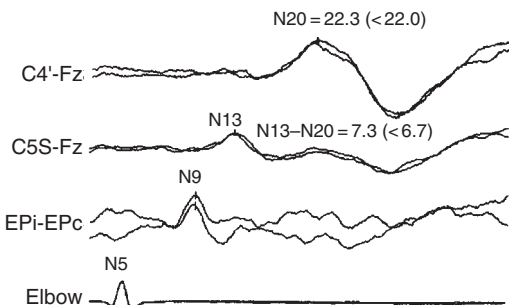




**Figure 18–15.** Upper and lower extremity SEPs in a patient with stimulus-sensitive myoclonus, illustrating the characteristic pattern of very high-amplitude cortical potentials recorded from the scalp electrodes.

## MOTOR NEURON DISEASE

Patients with amyotrophic lateral sclerosis may have minor abnormalities of central conduction, delay, or absence of cortical responses and increased mean values of all potential latencies with median nerve stimulation and stimulation of lower extremity motor and sensory nerves<sup>65,66</sup> (Fig. 18–16). Severe abnormalities in patients with suspected motor neuron disease should raise suspicion of other conditions that may mimic amyotrophic lateral sclerosis, for example, cervical spondylosis. An exception to this generalization is X-linked spinobulbar muscular atrophy (Kennedy's syndrome), in which the scalp evoked potentials after median and tibial nerve stimulation are poorly formed or absent, whereas the peripheral and spinal potentials are relatively preserved.<sup>67</sup>



**Figure 18–16.** Left median SEPs in a 57-year-old man with amyotrophic lateral sclerosis. There is mild slowing of central conduction (N13–N20 interpeak latency).

## PROGNOSIS IN COMA

### Head Injury

SEPs are helpful in defining the functional reversibility of cerebral injuries of any cause.<sup>68</sup>

In 78% of patients, SEPs can predict outcome within 3.5 days.<sup>69</sup> Surviving patients with persistent asymmetries of cerebral evoked potentials remain hemiplegic, whereas those with absence of evoked potentials over both cerebral hemispheres die. In most patients who have a good recovery, conduction times return to normal before day 10, but in those who remain disabled or who die, conduction times are persistently abnormal or scalp potentials are absent. When cortical evoked potentials are absent, it generally is futile to use heroic measures such as barbiturate coma or decompressive craniectomy to control refractory increased intracranial pressure.

However, SEPs are not perfect indicators of recovery. A few patients with poor recovery can have normal SEPs. Serial studies have shown that both conduction time and amplitude recover gradually, with differences persisting between patients who make a good recovery and those who remain disabled. SEPs are superior to EEG in determining prognosis of severe head injury, by allowing prediction of favorable and unfavorable outcomes in a much larger number of patients.<sup>70,71</sup>

A battery of auditory evoked potentials, visual evoked potentials, and SEPs is also an accurate and reliable prognostic indicator after

severe head injury, with an overall accuracy of approximately 91%.<sup>72-74</sup> Patients are assigned to multimodality evoked potential (MMEP) groups according to the most abnormal study obtained in any modality. The scale ranges from grade 1 (normal) to grade 4 (absence of activity). As the severity of MMEP abnormality increases, so does mortality. Of patients with mildly abnormal MMEP scores, 81% have a return to normal life or have only moderate disability, and 76% of those with severely abnormal MMEP scores have a poor outcome. A good outcome is realized by 76% of patients with a grade 1 MMEP, 61% with grade 2, 35% with grade 3, and 0% with grade 4. Overall, 87% of patients with a grade 1 MMEP have a good-to-moderate outcome at 1 year.

### ***Anoxia, Cerebral Hemorrhage, and Stroke***

Outcome has been examined in a series of patients with anoxic coma caused by cardiopulmonary arrest or severe hypotension whose prognoses were uncertain on the basis of clinical findings on day 1.<sup>75</sup> Patients with an obviously good or bad prognosis clinically were excluded. All 18 patients with absent or low-amplitude responses had no recovery. It was found that some patients with initially unfavorable appearing EEGs and normal SEPs may recover and should be supported until the prognosis is more definitive. The combination of SEPs and brain stem auditory evoked response is useful in assessing the prognosis of patients with subarachnoid or hypertensive hemorrhage and cerebral infarction.<sup>76,77</sup>

### ***Infants and Children***

SEP results similar to those in adults have been found in children comatose from hypoxic-ischemic encephalopathy, head injury, or other conditions.<sup>78</sup> In a study of 127 children who were comatose because of severe head injury, all 32 who had an absence of brain stem auditory evoked responses and SEPs died. Of children with normal evoked potential studies, 78% had a good prognosis.<sup>79</sup> SEPs recorded in the first week after admission correlate highly with outcome assessed 1 and 5 years after severe brain injury.<sup>80</sup> SEPs are also accurate prognostic tools for newborns with asphyxia. The absence of scalp potentials is a very poor prognostic sign, and delayed latencies are

associated with deficits in most patients. SEPs also have long-term predictive value for deficits that become apparent at school age.<sup>81</sup>

### **SEP Findings in Brain Death**

All patients with brain death have bilateral loss of median SEP N20 components, but cervical N13 potentials can still be elicited. The presence of SEP N13 is helpful because it establishes that the input signal has reached the CNS. However, this finding does not prove brain death, because rare patients who have severe bilateral supratentorial lesions, drug intoxication, or severe cerebral edema but no clear clinical signs of brain death may also have a loss of the N20 potential.<sup>82</sup>

Recent research has suggested that N18 is a useful indicator of brain stem function. This potential has the advantage of being generated by the cuneate nucleus in caudal medulla, close to the respiratory center. N18 is almost always lost in brain death and preserved in recordings from patients who are comatose but not brain dead. In contrast, auditory brain stem evoked responses reflect pontine and midbrain function rather than medullary function and can fail to detect remaining brain stem function.<sup>83</sup>

### **SEPs Recorded in the Intensive Care Unit**

Recording SEPs in the intensive care unit presents technical challenges, usually in the form of high-amplitude 60-Hz artifact, not encountered in the outpatient laboratory. Suggestions for reducing the artifact include shutting off all nonessential electric equipment such as lights, cardiac monitor, cooling blanket, feeding pumps, and blood warmers to ascertain if one of these is causing the artifact. The impedance of the electrodes should be checked and, if necessary, the electrodes reapplied or new electrodes substituted. If artifact is present in all channels, replace the ground.

In an unconscious patient or in one under anesthesia, subcutaneous needle electrodes may be applied; this not only saves time but also reduces artifact. If muscle artifact is a problem in a patient who had a head injury and is decerebrate or decorticate and on a respirator, a single dose of a neuromuscular blocking agent can be given safely. If a paralyzing agent

cannot be given, increasing the gain to 20  $\mu\text{V}$  or 50  $\mu\text{V}$  per division on channels recording from the elbow, Erb's point, or neck may eliminate blocking of the amplifier and still result in recognizable peaks, which can be amplified after the recording has been completed.

Patients with severe head injury often require neurosurgical procedures for evacuation of intracerebral hematomas and frequently have intracranial pressure monitors placed. The location of the incisions and drains may require placement of recording electrodes slightly anterior or posterior to the usual locations. Generally, this does not result in a marked change in the morphology of the cortical evoked potentials, and they are still diagnostically useful. The rate of stimulation may also have an effect in patients with head injury or significant spasticity. Recording at 5 per second occasionally causes a reflexive increase in decerebrate posturing or extensor spasms, which can be eliminated by reducing the rate of stimulation to 1 or 2 per second and by using the lowest voltage possible to elicit a muscle twitch.

### Key Points

- SEP latencies may be prolonged in a variety of brain stem or supratentorial processes, including ALS, spinocerebellar ataxias, Freidrich's ataxia, and other disorders.
- Giant cortical SEPs may be seen with various forms of cortical myoclonus.
- Absence of cortical SEP responses or significant asymmetries in coma may predict a poor prognosis for recovery.
- Absence of cortical SEP responses may provide confirmatory evidence for brain death.

### SUMMARY

SEPs recorded with surface electrodes represent volume-conducted activity arising from myelinated peripheral and central axons, synapses in central gray matter, and changes in the size and shape of the volume conductor. They provide an objective measure of function in large-diameter myelinated sensory afferents peripherally and in proprioceptive pathways centrally. Changes in amplitude and latency can be used to localize lesions in the

nervous system, to identify objectively abnormalities in patients with few sensory manifestations or none at all, and to monitor function over time.

### REFERENCES

1. Lee, E. K., and M. Seyal. 1998. Generators of short latency human somatosensory-evoked potentials recorded over the spine and scalp. *Journal of Clinical Neurophysiology* 15:227-34.
2. Kakigi, R., H. Shibasaki, K. Tanaka, et al. 1991. CO<sub>2</sub> laser-induced pain-related somatosensory evoked potentials in peripheral neuropathies: Correlation between electrophysiological and histopathological findings. *Muscle & Nerve* 14:441-50.
3. Kakigi, R., S. Watanabe, and H. Yamasaki. 2000. Pain-related somatosensory evoked potentials. *Journal of Clinical Neurophysiology* 17:295-308.
4. Guidelines for somatosensory evoked potentials. 1999. *Muscle & Nerve* 22(Suppl 8):S123-38.
5. Dumitru, D., and D. L. Jewett. 1993. Far-field potentials. *Muscle & Nerve* 16:237-54.
6. Desmedt, J. E., and G. Cheron. 1981. Prevertebral (oesophageal) recording of subcortical somatosensory evoked potentials in man: The spinal P13 component and the dual nature of the spinal generators. *Electroencephalography and Clinical Neurophysiology* 52:257-75.
7. Emerson, R. G., M. Seyal, and T. A. Pedley. 1984. Somatosensory evoked potentials following median nerve stimulation. I. The cervical components. *Brain* 107:169-82.
8. Jeanmonod, D., M. Sindou, and F. Manguiere. 1989. Three transverse dipolar generators in the human cervical and lumbo-sacral dorsal horn: Evidence from direct intraoperative recordings on the spinal cord surface. *Electroencephalography and Clinical Neurophysiology* 74:236-40.
9. Manguiere, F. 2000. Anatomic origin of the cervical N13 potential evoked by upper extremity stimulation. *Journal of Clinical Neurophysiology* 17:236-45.
10. Lesser, R. P., H. Lueders, J. Hahn, and G. Klem. 1981. Early somatosensory potentials evoked by median nerve stimulation: Intraoperative monitoring. *Neurology* 31:1519-23.
11. Sonoo, M., T. Shimpo, K. Genba, M. Kunimoto, and T. Mannen. 1990. Posterior cervical N13 in median nerve SEP has two components. *Electroencephalography and Clinical Neurophysiology* 77:28-38.
12. Zanette, G., M. Tinazzi, P. Manganotti, C. Bonato, and A. Polo. 1995. Two distinct cervical N13 potentials are evoked by ulnar nerve stimulation. *Electroencephalography and Clinical Neurophysiology* 96:114-20.
13. Tomberg, C., J. E. Desmedt, I. Ozaki, and P. Noël. 1991. Nasopharyngeal recordings of somatosensory evoked potentials document the medullary origin of the N18 far-field. *Electroencephalography and Clinical Neurophysiology* 80:496-503.
14. Restuccia, D. 2000. Anatomic origin of P13 and P14 scalp far-field potentials. *Journal of Clinical Neurophysiology* 17:246-57.
15. Urasaki, E., S. Uematsu, and R. P. Lesser. 1993. Short latency somatosensory evoked potentials recorded

- around the human upper brain-stem. *Electroencephalography and Clinical Neurophysiology* 88:92–104.
16. Noël, P., I. Ozaki, and J. E. Desmedt. 1996. Origin of N18 and P14 far-fields of median nerve somatosensory evoked potentials studied in patients with a brain-stem lesion. *Electroencephalography and Clinical Neurophysiology* 98:167–70.
  17. Sonoo, M., M. Kobayashi, K. Genba-Shimizu, T. Mannen, and T. Shimizu. 1996. Detailed analysis of the latencies of median nerve somatosensory evoked potential components, I: Selection of the best standard parameters and the establishment of normal values. *Electroencephalography and Clinical Neurophysiology* 100:319–31.
  18. Sonoo, M. 2000. Anatomic origin and clinical application of the widespread N18 potential in median nerve somatosensory evoked potentials. *Journal of Clinical Neurophysiology* 17:258–68.
  19. Yamada, T., T. Muroga, and J. Kimura. 1981. Tourniquet-induced ischemia and somatosensory evoked potentials. *Neurology* 31:1524–9.
  20. Seyal, M., and A. J. Gabor. 1985. The human posterior tibial somatosensory evoked potential: Synapse dependent and synapse independent spinal components. *Electroencephalography and Clinical Neurophysiology* 62:323–31.
  21. Halonen, J. P., S. J. Jones, M. A. Edgar, and A. O. Ransford. 1989. Conduction properties of epidurally recorded spinal cord potentials following lower limb stimulation in man. *Electroencephalography and Clinical Neurophysiology* 74:161–74.
  22. Seyal, M., L. W. Kraft, and A. J. Gabor. 1987. Cervical synapse-dependent somatosensory evoked potential following posterior tibial nerve stimulation. *Neurology* 37:1417–21.
  23. Yamada, T. 2000. Neuroanatomic substrates of lower extremity somatosensory evoked potentials. *Journal of Clinical Neurophysiology* 17:269–79.
  24. Baumgärtner, U., H. Vogel, J. Ellrich, J. Gawehn, P. Stoeter, and R. D. Treede. 1998. Brain electrical source analysis of primary cortical components of the tibial nerve somatosensory evoked potential using regional sources. *Electroencephalography and Clinical Neurophysiology* 108:588–99.
  25. Aminoff, M. J., and A. A. Eisen. 1998. AAEM minimonograph #19: Somatosensory evoked potentials. *Muscle & Nerve* 21:277–90.
  26. Slimp, J. C., D. E. Rubner, M. L. Snowden, and W. C. Stolov. 1992. Dermatome somatosensory evoked potentials: Cervical, thoracic, and lumbosacral levels. *Electroencephalography and Clinical Neurophysiology* 84:55–70.
  27. Hume, A. L., B. R. Cant, N. A. Shaw, and J. C. Cowan. 1982. Central somatosensory conduction time from 10 to 79 years. *Electroencephalography and Clinical Neurophysiology* 54:49–54.
  28. Strengé, H., and J. Hedderich. 1982. Age-dependent changes in central somatosensory conduction time. *European Neurology* 21:270–6.
  29. Yiannikas, C. 1990. Short-latency somatosensory evoked potentials in peripheral nerve lesions, plexopathies, radiculopathies, and spinal cord trauma. In *Evoked potentials in clinical medicine*, ed. K. H. Chiappa, 2nd ed., 439–69. New York: Raven Press.
  30. Aramideh, M., J. E. Hoogendijk, C. M. Aalfs, et al. 1992. Somatosensory evoked potentials, sensory nerve potentials and sensory nerve conduction in hereditary motor and sensory neuropathy type I. *Journal of Neurology* 239:277–83.
  31. Yiannikas, C., and J. C. Walsh. 1983. Somatosensory evoked responses in the diagnosis of thoracic outlet syndrome. *Journal of Neurology, Neurosurgery, and Psychiatry* 46:234–40.
  32. Veilleux, M., and J. C. Stevens. 1987. Syringomyelia: Electrophysiologic aspects. *Muscle & Nerve* 10: 449–58.
  33. Komanetsky, R. M., C. B. Novak, S. E. Mackinnon, M. H. Russo, A. M. Padberg, and S. Louis. 1996. Somatosensory evoked potentials fail to diagnose thoracic outlet syndrome. *The Journal of Hand Surgery [American Volume]* 21: 662–6.
  34. Aminoff, M. J., D. S. Goodin, G. J. Parry, N. M. Barbaro, P. R. Weinstein, and M. L. Rosenblum. 1985. Electrophysiologic evaluation of lumbosacral radiculopathies: Electromyography, late responses, and somatosensory evoked potentials. *Neurology* 35: 1514–18.
  35. Rodriguez, A. A., L. Kanis, A. A. Rodriguez, and D. Lane. 1987. Somatosensory evoked potentials from dermatome stimulation as an indicator of L5 and S1 radiculopathy. *Archives of Physical Medicine and Rehabilitation* 68:366–8.
  36. Walk, D., M. A. Fisher, S. H. Doundoulakis, and M. Hemmati. 1992. Somatosensory evoked potentials in the evaluation of lumbosacral radiculopathy. *Neurology* 42:1197–202.
  37. Veilleux, M., and J. R. Daube. 1987. The value of ulnar somatosensory evoked potentials (SEPs) in cervical myelopathy. *Electroencephalography and Clinical Neurophysiology* 68:415–23.
  38. Yiannikas, C., B. T. Shahani, and R. R. Young. 1986. Short-latency somatosensory-evoked potentials from radial, median, ulnar, and peroneal nerve stimulation in the assessment of cervical spondylosis. Comparison with conventional electromyography. *Archives of Neurology* 43:1264–71.
  39. Yu, Y. L., and S. J. Jones. 1985. Somatosensory evoked potentials in cervical spondylosis. Correlation of median, ulnar and posterior tibial nerve responses with clinical and radiological findings. *Brain* 108: 273–300.
  40. Kaneko, K., S. Kawai, T. Taguchi, Y. Fuchigami, T. Ito, and H. Morita. 1998. Correlation between spinal cord compression and abnormal patterns of median nerve somatosensory evoked potentials in compressive cervical myelopathy: Comparison of surface and epidurally recorded responses. *Journal of the Neurological Sciences* 158:193–202.
  41. de Noordhout, A. M., S. Myressiotis, V. Delvaux, J. D. Born, and P. J. Delvaide. 1998. Motor and somatosensory evoked potentials in cervical spondylotic myelopathy. *Electroencephalography and Clinical Neurophysiology* 108:24–31.
  42. Berthier, E., F. Turjman, and F. Mauguier. 1996. Diagnostic utility of somatosensory evoked potentials (SEPs) in presurgical assessment of cervical spondylotic myelopathy. *Neurophysiologie Clinique* 26: 300–10.



43. Turano, G., S. J. Jones, D. H. Miller, G. H. Du Boulay, R. Kakigi, and W. I. McDonald. 1991. Correlation of SEP abnormalities with brain and cervical cord MRI in multiple sclerosis. *Brain* 114:663–81.
44. Guérit, J. M., and A. Monje Argiles. 1988. The sensitivity of multimodal evoked potentials in multiple sclerosis. A comparison with magnetic resonance imaging and cerebrospinal fluid analysis. *Electroencephalography and Clinical Neurophysiology* 70:230–8.
45. Leocani, L., M. Rovaris, F. M. Boneschi, et al. 2006. Multimodal evoked potentials to assess the evolution of multiple sclerosis: A longitudinal study. *Journal of Neurology, Neurosurgery, and Psychiatry* 77:1030–5.
46. O'Connor, P., P. Marchetti, L. Liesly, and M. Perera. 1998. Evoked potential abnormality scores are a useful measure of disease burden in relapsing–remitting multiple sclerosis. *Annals of Neurology* 44:404–7.
47. Nuwer, M. R., J. W. Packwood, L. W. Myers, and G. W. Ellison. 1987. Evoked potentials predict the clinical changes in a multiple sclerosis drug study. *Neurology* 37:1754–61.
48. Khatri, B. O., M. P. McQuillen, G. J. Harrington, et al. 1984. Chronic progressive multiple sclerosis: Double blind controlled study of plasmapheresis in patients taking immunosuppressant drugs. *Neurology* 34:1273–9.
49. Anderson D. C., G. E. Slater, R. Shearman, et al. 1987. Evoked potentials to test the treatment of chronic multiple sclerosis. *Archives of Neurology* 44:1232–6.
50. Smith, P., I. Zeeberg, and O. Sjo. 1986. Evoked potentials in multiple sclerosis before and after high dose methylprednisolone infusion. *European Neurology* 23:67–73.
51. Leocani, L., S. Medaglini, and G. Comi. 2000. Evoked potentials in monitoring multiple sclerosis. *Neurological Sciences* 21:S889–91.
52. Urasaki, E., S. Wada, C. Kadoya, H. Matsuzaki, A. Yokata, and S. Matsuoaka. 1988. Absence of spinal N13-P13 and normal scalp far-field P14 in a patient with syringomyelia. *Electroencephalography and Clinical Neurophysiology* 71:400–4.
53. Restuccia, D., V. Di Lazzaro, M. Valeriani, C. Colosimo, and P. Tonali. 1996. Spinal responses to median and tibial nerve stimulation and magnetic resonance imaging in intramedullary cord lesions. *Neurology* 46:1706–14.
54. Kaplan, P. W., R. J. Tusa, J. Rignani, and H. W. Moser. 1997. Somatosensory evoked potentials in adrenomyeloneuropathy. *Neurology* 48:1662–7.
55. Restuccia, D., V. Di Lazzaro, M. Valeriani, et al. 1997. Neurophysiological abnormalities in adrenoleukodystrophy carriers. Evidence of different degrees of central nervous system involvement. *Brain* 120:1139–48.
56. Jones, S. J., Y. L. Yu, P. Rudge, et al. 1987. Central and peripheral SEP defects in neurologically symptomatic and asymptomatic subjects with low vitamin B12 levels. *Journal of the Neurological Sciences* 82:55–65.
57. Kumar, N. 2006. Copper deficiency myelopathy (human swayback). *Mayo Clinic Proceedings* 81:1371–84.
58. Kumar, N., J. B. Gross, and J. E. Ahlskog. 2004. Copper deficiency myelopathy produces a clinical picture like subacute combined degeneration. *Neurology* 63:33–9.
59. Goodman, B. P., B. W. Chong, A. C. Patel, G. P. Fletcher, and B. E. Smith. 2006. Copper deficiency myelopathy resembling B12 deficiency: Partial resolution of MR imaging findings with copper substitution. *American Journal of Neuroradiology* 27:2112–14.
60. Jones, S. J., M. Baraitser, and A. M. Halliday. 1980. Peripheral and central somatosensory nerve conduction defects in Friedreich's ataxia. *Journal of Neurology, Neurosurgery, and Psychiatry* 43:495–503.
61. Abele, M., K. Burk, F. Andres, et al. 1997. Autosomal dominant cerebellar ataxia type I. Nerve conduction and evoked potential studies in families with SCA1, SCA2 and SCA3. *Brain* 120:2141–8.
62. Perretti, A., L. Santoro, B. Lanzillo, et al. 1996. Autosomal dominant cerebellar ataxia type I: Multimodal electrophysiological study and comparison between SCA1 and SCA2 patients. *Journal of the Neurological Sciences* 142:45–53.
63. Shibasaki, H., Y. Yamashita, R. Neshige, S. Tobimatsu, and R. Fukui. 1985. Pathogenesis of giant somatosensory evoked potentials in progressive myoclonic epilepsy. *Brain* 108:225–40.
64. Kakigi, R., and H. Shibasaki. 1987. Generator mechanisms of giant somatosensory evoked potentials in cortical reflex myoclonus. *Brain* 110:1359–73.
65. Georgesco, M., A. Salerno, and W. Camu. 1997. Somatosensory evoked potentials elicited by stimulation of lower-limb nerves in amyotrophic lateral sclerosis. *Electroencephalography and Clinical Neurophysiology* 104:333–42.
66. Zakrzewska-Pniewska, B., R. Gasik, A. Kostera-Pruszczyk, and B. Emeryk-Szajewska. 1999. Reconsiderations about the abnormalities of somatosensory evoked potentials in motor neuron disease. *Electroencephalography and Clinical Neurophysiology* 39:107–12.
67. Polo, A., F. Teatini, S. D'Anna, et al. 1996. Sensory involvement in X-linked spino-bulbar muscular atrophy (Kennedy's syndrome): An electrophysiological study. *Journal of Neurology* 243:388–92.
68. Carter, B. G., and W. Butt. 2001. Review of the use of somatosensory evoked potentials in the prediction of outcome after severe brain injury. *Critical Care Medicine* 29:178–86.
69. Hume, A. L., and B. R. Cant. 1981. Central somatosensory conduction after head injury. *Annals of Neurology* 10:411–19.
70. Hutchinson, D. O., R. W. Frith, N. A. Shaw, J. A. Judson, and B. R. Cant. 1991. A comparison between electroencephalography and somatosensory evoked potentials for outcome prediction following severe head injury. *Electroencephalography and Clinical Neurophysiology* 78:228–33.
71. Moulton, R. J., J. I. Brown, and S. J. Konasiewicz. 1998. Monitoring severe head injury: A comparison of EEG and somatosensory evoked potentials. *The Canadian Journal of Neurological Sciences* 25:S7–11.
72. Greenberg, R. P., P. G. Newlon, M. S. Hyatt, R. K. Narayan, and D. P. Becker. 1981. Prognostic implications of early multimodality evoked potentials in severely head-injured patients. A prospective study. *Journal of Neurosurgery* 55:227–36.
73. Narayan, R. K., R. P. Greenberg, J. D. Miller, et al. 1981. Improved confidence of outcome prediction in severe head injury. A comparative analysis of the

- clinical examination, multimodality evoked potentials, CT scanning, and intracranial pressure. *Journal of Neurosurgery* 54:751–62.
74. Newlon, P. G., R. P. Greenberg, M. S. Hyatt, G. G. Enas, and D. P. Becker. 1982. The dynamics of neuronal dysfunction and recovery following severe head injury assessed with serial multimodality evoked potentials. *Journal of Neurosurgery* 57:168–77.
  75. Chen, R., C. F. Bolton, and B. Young. 1996. Prediction of outcome in patients with anoxic coma: A clinical and electrophysiologic study. *Critical Care Medicine* 24:672–8.
  76. Facco, E., A. U. Behr, M. Munari, et al. 1998. Auditory and somatosensory evoked potentials in coma following spontaneous cerebral hemorrhage: Early prognosis and outcome. *Electroencephalography and Clinical Neurophysiology* 107:332–8.
  77. Haupt, W. F., and G. Pawlik. 1998. Contribution of initial median-nerve somatosensory evoked potentials and brain stem auditory evoked potentials to prediction of clinical outcome in cerebrovascular critical care patients: A statistical evaluation. *Journal of Clinical Neurophysiology* 15:154–8.
  78. Ruiz-López, M. J., A. Martínez de Azagra, A. Serrano, and J. Casado-Flores. 1999. Brain death and evoked potentials in pediatric patients. *Critical Care Medicine* 27:412–16.
  79. Butinar, D., and A. Gostisa. 1996. Brain stem auditory evoked potentials and somatosensory evoked potentials in prediction of posttraumatic coma in children. *Pflugers Archive* 431:R289–90.
  80. Carter, B. G., A. Taylor, and W. Butt. 1999. Severe brain injury in children: Long-term outcome and its prediction using somatosensory evoked potentials (SEPs). *Intensive Care Medicine* 25:722–8.
  81. Schwarz, S., S. Schwab, A. Aschoff, and W. Hacke. 1999. Favorable recovery from bilateral loss of somatosensory evoked potentials. *Critical Care Medicine* 27:182–7.
  82. Sonoo, M., Y. Tsai-Shozawa, M. Aoki, et al. 1999. N18 in median somatosensory evoked potentials: A new indicator of medullary function useful for the diagnosis of brain death. *Journal of Neurology, Neurosurgery, and Psychiatry* 67:374–8.
  83. Sonoo, M., H. Hagiwara, Y. Motoyoshi, and T. Shimizu. 1996. Preserved widespread N18 and progressive loss of P13/14 of median nerve SEPs in a patient with unilateral medial medullary syndrome. *Electroencephalography and Clinical Neurophysiology* 100:488–92.



# Brain Stem Auditory Evoked Potentials in Central Disorders

Jonathan L. Carter

**INTRODUCTION**  
**AUDITORY ANATOMY AND  
PHYSIOLOGY**  
**GENERATORS OF THE BRAIN  
STEM AUDITORY EVOKED  
POTENTIALS**  
**BRAIN STEM AUDITORY EVOKED  
POTENTIALS: METHODS**  
Stimulation  
Recording  
**FACTORS AFFECTING THE BAEP  
RESPONSE**  
Age and Gender

Auditory Acuity  
Stimulus Rate  
Stimulus Intensity  
Stimulus Polarity

**INTERPRETATION OF BAEPs**  
**CLINICAL APPLICATIONS**  
Acoustic Neuroma  
Demyelinating Disease  
Intrinsic Brain Stem Lesions  
Coma and Brain Death  
Intraoperative Monitoring

**SUMMARY**

## INTRODUCTION

*Brain stem auditory evoked potentials* (BAEPs) are electrophysiologic studies that assess the peripheral and central auditory conduction pathways. BAEPs may be used to assess peripheral auditory nerve function, such as during the assessment for hearing loss in infants (see Chapter 21). BAEPs are also used to assess for lesions or disorders in the central nervous system (CNS), and they are usually abnormal in patients with lesions involving the auditory portion of cranial nerve VIII (CN VIII), the auditory pathways in the brain stem, or both. BAEPs may be performed in awake and cooperative patients or those with an altered mental status (e.g., sedation, general anesthesia, or coma). The rationale

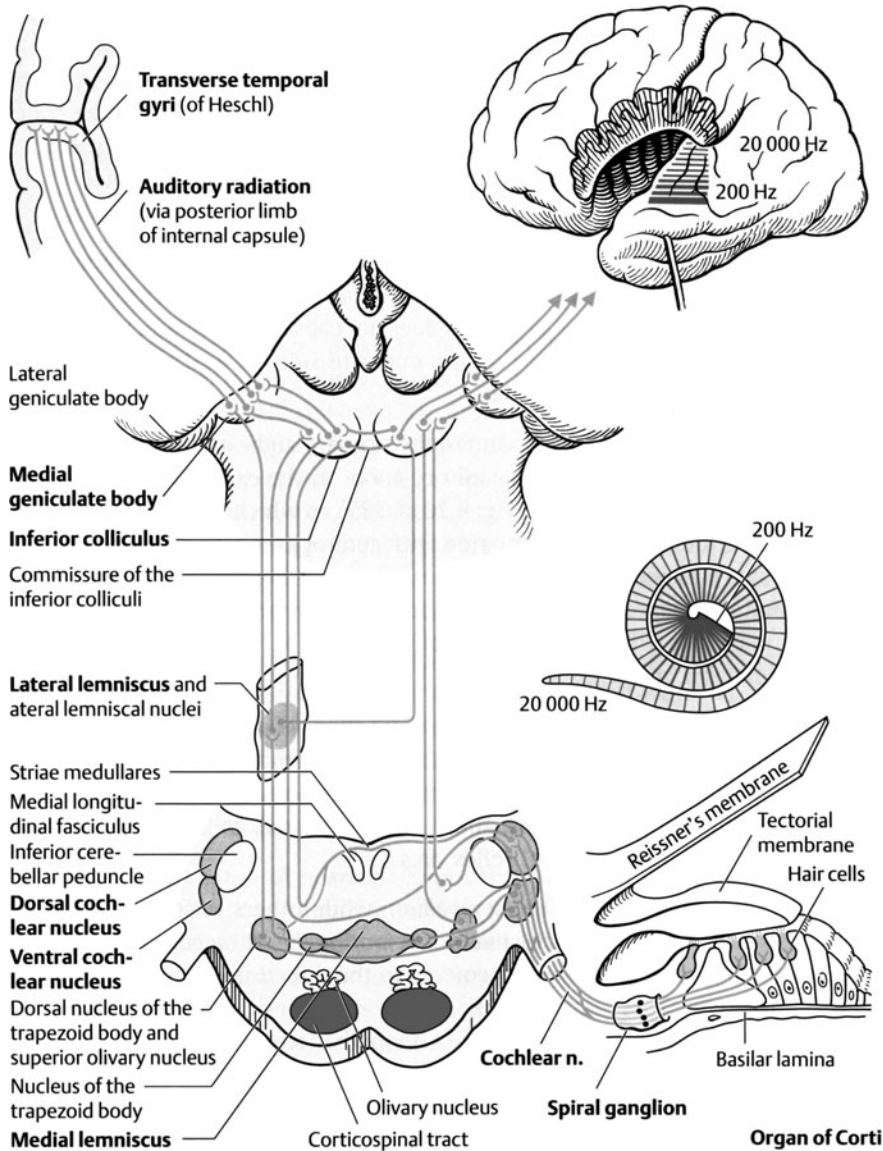
for performing these studies in patients with neurologic disease is the close correlation between specific auditory waveforms and structures in the brain stem.

BAEPs are usually performed with a click stimulus that is delivered monaurally and that activates the peripheral and central auditory pathways. Auditory stimuli cause sequential activity in CN VIII, the cochlear nucleus, the superior olivary nucleus, the lateral lemniscus, and the inferior colliculus. Five prominent vertex positive waveforms, numbered I through V, are invariably present in normal subjects after peripheral auditory stimulation. The common BAEP alterations in patients with brain stem lesions include increased I–V interpeak latency, a low-amplitude or absent wave V, and an absence of all waveforms.

Results of BAEP studies are useful not only in evaluating hearing and specific neurologic disorders but also in evaluating the significance of certain symptoms and signs. BAEPs may be useful in evaluating patients with suspected acoustic neuroma, multiple sclerosis (MS), or intrinsic brain stem lesions. The studies also

provide prognostically important information about comatose patients. For BAEPs to assess peripheral auditory function, the method must be altered.

This chapter reviews the method, interpretation, and clinical applicability of BAEPs in patients with neurologic disease.



**Figure 19-1.** Neuroanatomy of the brain stem auditory pathways. (From Baehr, M., M. Frotscher, and P. Duus. 2005. *Topical diagnosis in neurology: Anatomy, physiology, signs, symptoms*, trans. E. Taub. Stuttgart: Thieme Medical Publishers, #81. By permission of the publisher.)

### Purpose and Role of BAEPs (in Central Disorders)

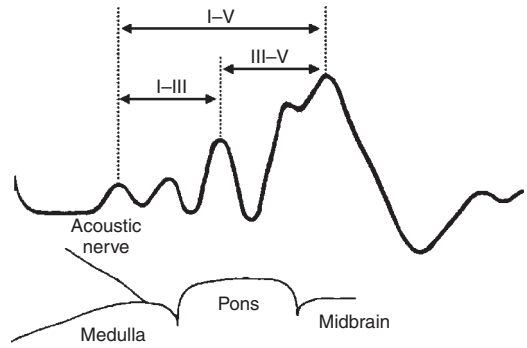
- To assess central auditory conduction pathways.
- To evaluate patients with suspected acoustic neuroma, MS, or intrinsic brain stem lesions.
- To assist in prognostication in comatose patients.

## AUDITORY ANATOMY AND PHYSIOLOGY

Knowledge of the neuroanatomy of the auditory system is essential to understand the structures that are sequentially activated during BAEPs<sup>1</sup> (Fig. 19-1, for color image, see color plates). The auditory system begins with the peripheral auditory apparatus. The cochlea and the spiral ganglion must be activated (with monaural stimulation) before the central auditory pathways can be assessed. The initial central structure that is activated is the auditory portion of CN VIII, which enters the brain stem at the pontomedullary junction. Sequential activation involves the cochlear nucleus in caudal pons, the superior olivary complex in caudal to mid-pons, the lateral lemniscus in mid-pons, and the inferior colliculus in caudal midbrain. In normal subjects, hearing is associated with bilateral activation of the auditory pathway, maximal contralateral to the ear stimulated. BAEPs may be associated with activation of the brain stem pathways that are involved with sound localization rather than with hearing.

## GENERATORS OF THE BRAIN STEM AUDITORY EVOKED POTENTIALS

Stimulation of the peripheral auditory apparatus in normal subjects produces seven vertex positive waveforms, conventionally labeled I-VII (Figs 19-2 and 19-3).<sup>1</sup> Since waves VI and VII are only variably present, they are not useful clinically. Although the specific generators of all the waveforms have not been completely clarified, the anatomical regions that are activated are known. These sites of waveform generation are based on limited data



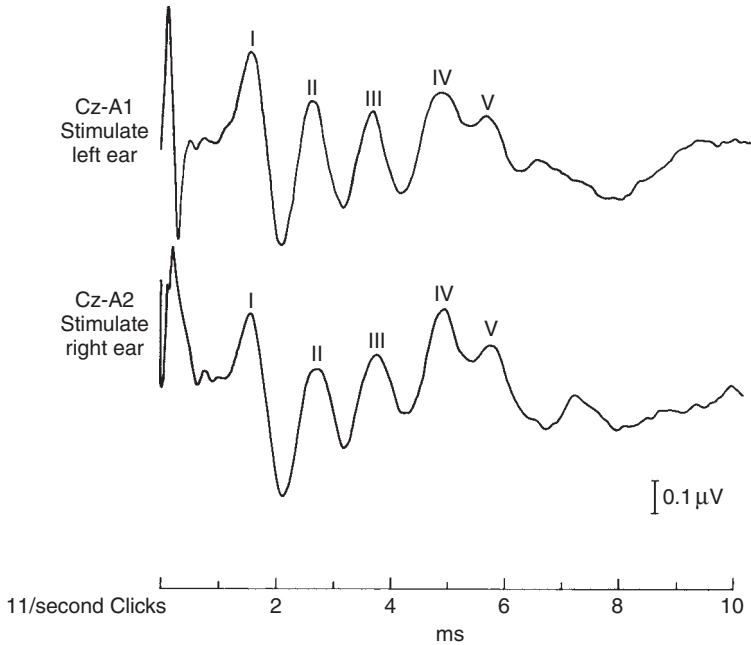
**Figure 19-2.** BAEP waveforms and anatomical localization. (From Misulis, K. E., and T. Fakhoury. 2001. *Spehlmann's evoked potential primer*, 3rd ed., 49. Boston: Butterworth-Heinemann. By permission of the publisher.)

from patients with brain stem lesions.<sup>1-3</sup> It is not known whether BAEPs are generated by nuclei, tracts, or a combination of the two. The following waves are routinely measured during BAEP testing:

- *Wave I* represents the distal action potential of CN VIII and appears as a negative potential at the ipsilateral ear electrode. If wave I is absent, central auditory conduction cannot be assessed reliably. Supplementary electrodes, for example a needle electrode in the external auditory canal, may help register this wave if it cannot be recorded with a conventional earlobe electrode.
- *Wave II* may be generated by either the ipsilateral proximal CN VIII or the cochlear nucleus.
- *Wave III* is likely related to activation of the ipsilateral superior olivary nucleus.
- *Wave IV* is produced by activation of the nucleus or axons of the lateral lemniscus.
- *Wave V* appears to result from activation of the inferior colliculus.
- *Waves VI and VII* are presumed to be generated by the medial geniculate body and the thalamocortical pathways, respectively.

### Key Points

- Seven vertex positive waves are produced during auditory nerve stimulation, although only waves I-V are consistently recorded in normal individuals.
- Wave I represents the action potential of CN VIII.
- Waves III-V are generated from pathways in the CNS (brain stem).



**Figure 19-3.** Normal BAEPs in a 26-year-old man. Waves I–V, characteristic vertex positive waveforms. (From Benarroch, E. E., et al. 1999. *Medical neurosciences: An approach to anatomy, pathology and physiology by systems and levels*, 4th ed., 513. Philadelphia: Lippincott Williams & Wilkins. By permission of Mayo Foundation for Medical Education and Research.)

## BRAIN STEM AUDITORY EVOKED POTENTIALS: METHODS

BAEPs are performed by stimulating the auditory nerve, typically with square wave clicks and recording the evoked response from the scalp. Every BAEP study should begin with an assessment of peripheral auditory function and a bedside test of auditory acuity should be conducted to determine the hearing threshold. After assessing peripheral auditory acuity, the BAEP study is performed. The time required to perform BAEPs depends on several clinical factors, but the study usually can be completed in 30–45 minutes.

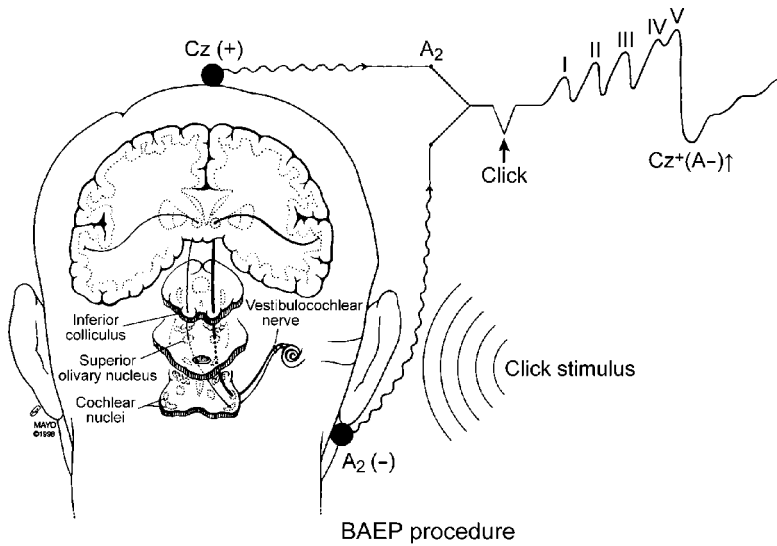
### Stimulation

Conventional audiometric earphones are used to deliver an electric square wave “click.” The stimulus that optimally activates the central auditory system is maximal to the click threshold for each ear. The preferred stimulus for waveform recognition is 65–70 dB above the click hearing threshold, the *click sensation*

*level*. The optimal stimulus repetition rate for identifying waveforms is approximately 10 per second. Since binaural stimulation may fail to reveal abnormality in a patient with a unilateral auditory lesion, its use should be avoided. Therefore, monaural stimulation is used with the contralateral ear masked by white noise.

### Recording

Surface electrodes are placed at the vertex (CZ) and on each earlobe (A1 and A2) to record the auditory waveforms (Fig. 19-4). Mastoid electrodes are not used routinely because of increased muscle artifact. The channel derivations include ipsilateral ear to vertex and contralateral ear to vertex. In some circumstances, an ipsilateral ear to contralateral ear derivation may assist in identifying wave I. Wave I is identified in the ipsilateral ear derivation as a negative peak (*near-field potential*) at the ear and as a positive peak (*far-field potential*) at the vertex. Wave II may be absent in normals, and wave IV may fuse with wave V. The contralateral ear channel may be useful in identifying wave II and for distinguishing wave IV from wave V (Fig. 19-5). At least two



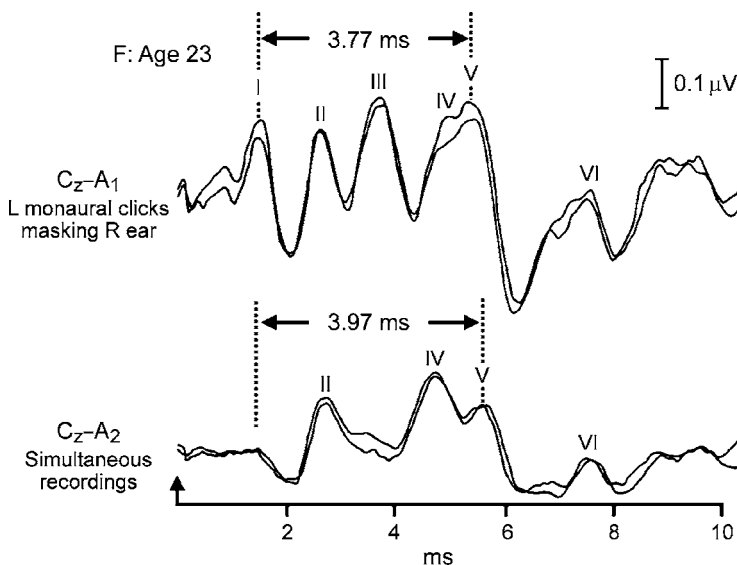
**Figure 19-4.** BAEP electrode placement and technique.

averages of 2000–4000 responses are obtained from each ear. Additional trials may be necessary to recognize waveforms. The optimal filter bandpass is 100–3000 Hz, and the bandpass should be held constant for clinical BAEP studies. Averaging is performed on 10 ms of data after auditory stimulation.

The presence of a discrete, reproducible wave I and the demonstration of reproducibility for all subsequent waveforms are critical for rational interpretation of the study. One of the major technical challenges in performing

BAEPs is interpreting the study when there is a poorly formed or absent wave I. Several maneuvers may help to elicit a wave I if it is not identified with the standard setup, including the following:

1. Increasing the stimulus intensity if waves are low amplitude and poorly defined.
2. Decreasing the stimulus intensity if there are too many or poorly defined waves.
3. Changing the click polarity from rarefaction to condensation.



**Figure 19-5.** Normal BAEP tracing, illustrating how the contralateral ear reference aids in identification of waves II, IV, and V.

4. Slowing the stimulus rate.
5. Using an external canal supplementary electrode (tiptrode).
6. Decreasing muscle artifact, using sedation with chloral hydrate or diazepam if patients are unable to relax or if excessive muscle artifact is present.

Recent advances in BAEPs have focused on improved methodology. The three main areas of emphasis have been (1) increasing wave definition, (2) decreasing recording time, and (3) increasing the objectivity of detecting and identifying waves. Methods that use non-conventional averaging formulas, steady state responses, improved signal-to-noise ratio calculations, and template correlation analysis have been developed.<sup>4</sup> These newer techniques may have application for studies involving patients whose cooperation is minimal, for example, in newborns and children. Probably, equipment in which some of these techniques are incorporated will become more available commercially.

### Key Points

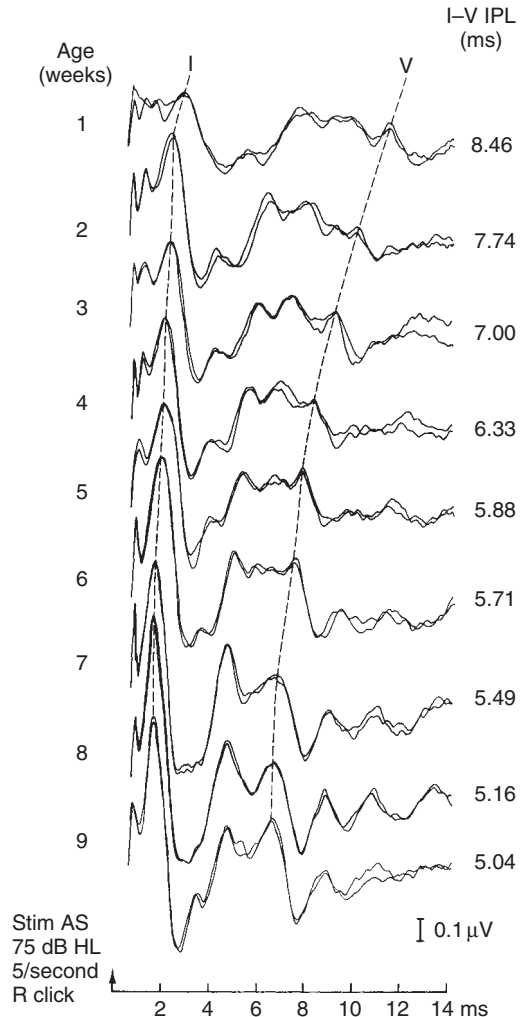
- BAEPs are evoked with electrical square wave clicks.
- Stimulus intensity should be 65–70 dB above the click hearing threshold for optimal waveform recognition.
- Monaural stimulation with contralateral masking noise provides optimal recognition of unilateral auditory pathway lesions.
- Failure to identify wave I can be improved with techniques such as changing stimulus intensity, changing click polarity from rarefaction to condensation clicks, slowing the stimulus rate, using tiptrodes, or decreasing muscle artifact.
- The contralateral ear channel recording may help in identification of wave II and in distinguishing wave IV from wave V.

## FACTORS AFFECTING THE BAEP RESPONSE

Several physiologic and technical variables that may alter BAEPs include age, sex, and auditory acuity.<sup>5</sup> Factors related to the stimulus, including stimulus repetition rate, intensity, and polarity, also may affect BAEPs.

## Age and Gender

The age of the patient may affect waveform morphology and latency. BAEPs can be recorded even in premature infants, but the absolute and interpeak latencies are longer than in older patients (Fig. 19–6).<sup>6</sup> By 2 years of age, the latencies are about the same as the normal values of adult subjects. Persons older than 60 years have a statistically significant increase



**Figure 19–6.** Effect of age (weeks) on wave I and wave V absolute latencies in an infant of 28-week gestation. IPL, interpeak latency; Stim AS, stimulation of left ear; HL, hearing level. (From Stockard, J. E., and B. F. Westmoreland. 1981. Technical considerations in the recording and interpretation of the brain stem auditory evoked potential for neonatal neurologic diagnosis. *The American Journal of EEG Technology* 21:31–54. By permission of the American Society of Electroneurodiagnostic Technologists.)



in BAEP latencies compared with those of younger subjects. The BAEP interpeak latencies are significantly shorter in women than in men.

## Auditory Acuity

For patients with hearing loss, a higher stimulus intensity is required to activate the central auditory pathways. Significant peripheral hearing loss may not allow brain stem auditory conduction to be assessed. The absence of waves II–V in patients with a normal wave I or an increased wave I–V interpeak latency cannot be explained on the basis of hearing loss alone. Common BAEP findings in patients with hearing loss include a delay in the absolute latencies of all waveforms, absence of only wave I with delayed waves II–V, or absence of all waveforms.<sup>2</sup>

## Stimulus Rate

Stimulation rates greater than 10 per second may be associated with a significant increase in absolute and interpeak latencies and a decrease in waveform amplitude.

## Stimulus Intensity

Decreasing stimulus intensity affects the BAEPs much like hearing loss does. Stimulus intensities less than 65–70 dB above the sensation level increase absolute and interpeak latencies, decrease waveform amplitude, and alter waveform morphology.

## Stimulus Polarity

The polarity of the click produces movement of the earphone diaphragm away from the tympanic membrane (*rarefaction*) or toward the tympanic membrane (*condensation*). The former polarity may be preferred because of an increase in wave I amplitude. Occasionally, condensation may produce a more obvious wave I. A mixture of the two polarities (*alternating*) is not used routinely because of alterations in waveform morphology and interpeak latencies.

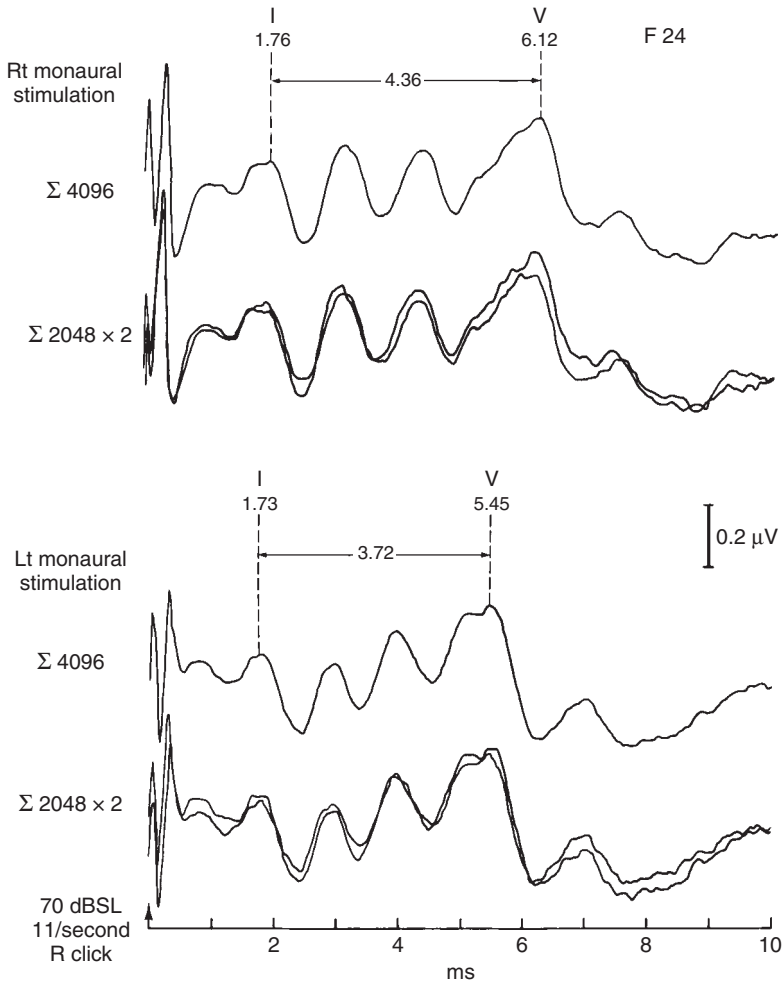
## Key Points

- BAEP latencies are longer in infants under the age of 2 and in adults over 60, and are longer in men than women.
- Peripheral hearing loss may cause absence of wave I, delayed absolute latencies of all waveforms, or distorted or absent waveforms beyond wave I.
- Stimulus rates greater than 10 Hz may increase the BAEP latencies and decrease amplitudes.
- Stimulus intensities less than 65–70 dB above hearing threshold may increase absolute and interpeak latencies, decrease amplitude, and alter waveform morphology.
- Changing polarity of the click may affect the amplitude and morphology of wave I.

## INTERPRETATION OF BAEPs

BAEP variables evaluated in patients with suspected neurologic disease include measurement of absolute waveform latencies and interpeak latencies (I–III, III–V, and I–V) and determination of wave V/I amplitude ratio.<sup>7</sup> Normative data obtained by similar methods, preferably within the same laboratory, should be available to determine latency and amplitude criteria for abnormal BAEPs. Right and left ear evoked potential studies should be compared only by using identical stimulus variables.

The most common BAEP abnormality in patients with CNS disease is a prolonged I–V interpeak latency (Fig. 19–7). Other alterations include the absence of all waveforms, a decreased V/I amplitude ratio, and preservation of wave I with poorly formed waves II–V (Figs. 19–8, 19–9, and 19–10). The I–III and III–V interpeak latencies may be useful in determining the anatomical localization of auditory dysfunction. In patients with a prolonged I–III interpeak latency and a normal III–V interpeak latency, the auditory dysfunction is assumed to be located between the distal part of CN VIII (near the cochlea) and the superior olivary nucleus, ipsilateral to the ear stimulated. In patients with a prolonged III–V interpeak latency and a normal I–III interpeak latency, the auditory conduction defect likely



**Figure 19-7.** BAEPs in a patient with MS are abnormal because of prolonged I-V interpeak latency. The patient had no symptoms or signs of brain stem disease, and the neurologic examination findings were unremarkable.

is located between the superior olivary nucleus and the inferior colliculus, ipsilateral to the ear stimulated (Fig. 19-11).

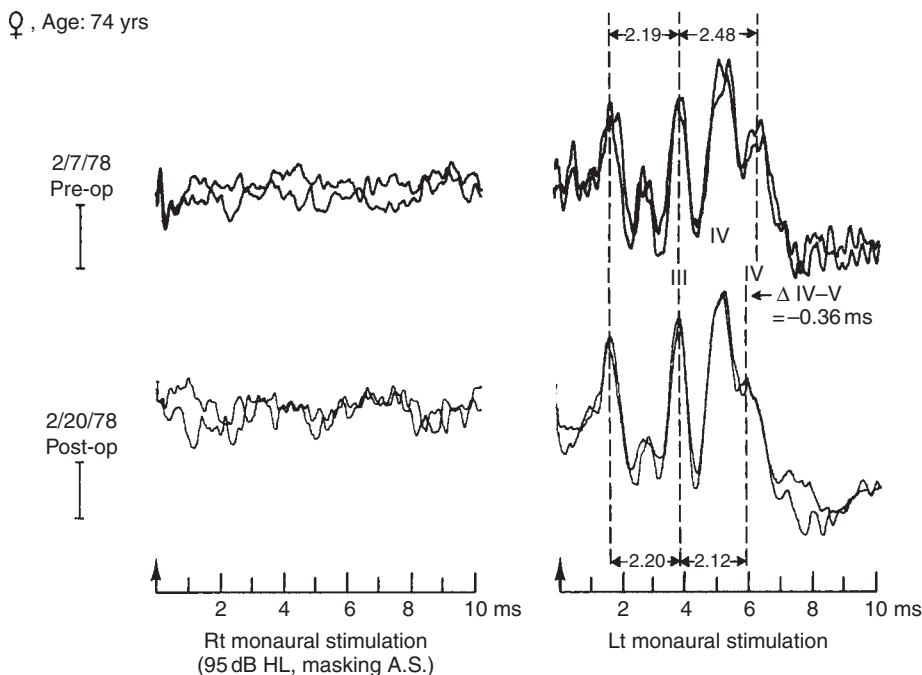
**Key Points**

- Absolute and interpeak latencies (waves I-III, III-V, and I-V) are used in the interpretation of the BAEP study.
- The most common abnormality with CNS disease is a prolonged I-V interpeak latency.
- Determination of the region of prolongation using the I-III and III-V interpeak latencies assists in determining anatomical localization of the lesion.

**CLINICAL APPLICATIONS**

The use of the BAEPs provides an objective physiologic measure that complements the findings of the clinical history and examination and neuroimaging. Categories of clinical problems for which BAEPs can be used include the following:

1. Confirmation of brain stem abnormality if the symptoms and signs of brain stem dysfunction are equivocal.
2. Confirmation of brain stem abnormality in patients known to have diffuse or multifocal CNS disease.
3. Screening for brain stem dysfunction in patients who have symptoms that



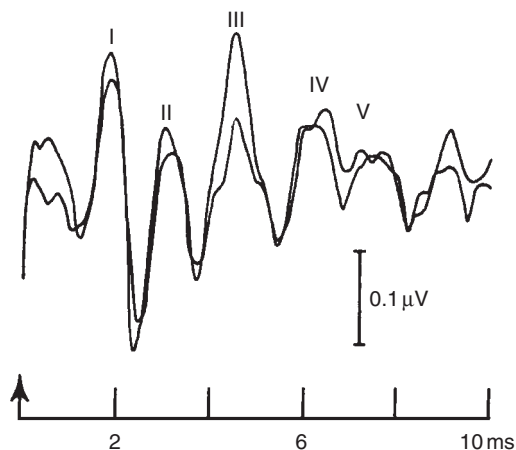
**Figure 19-8.** Preoperative and postoperative BAEPs in a 74-year-old woman with a right acoustic neuroma associated with brain stem compression. The tumor was resected. No response was observed after stimulation of the right (Rt) ear, either preoperatively or postoperatively. Postoperatively, stimulation of the left (Lt) ear showed significant shortening of the III-V interpeak latency related to resection of the lesion. (From Stockard, J. J., and F. W. Sharbrough. 1980. Unique contributions of short-latency auditory and somatosensory evoked potentials to neurologic diagnosis. *Progress in Clinical Neurophysiology* 7:231-63. By permission of S. Karger, AG.)

usually refer to a peripheral cranial nerve or sensory organ, for example hearing loss, dizziness, peripheral facial weakness, diplopia, and peripheral jaw weakness.

The potential advantages of BAEPs over neuroimaging studies are lower cost, less discomfort for patients, and the ability to perform the studies in patients who have a contraindication to magnetic resonance imaging (MRI). Also, sequential BAEP studies are easier to perform. A disadvantage of BAEPs is the lack of specificity and sensitivity if the brain stem lesion does not involve the central auditory pathways. Clinical studies have indicated that BAEPs are complementary to MRI studies for certain central auditory abnormalities, for example acoustic neuromas.<sup>2</sup>

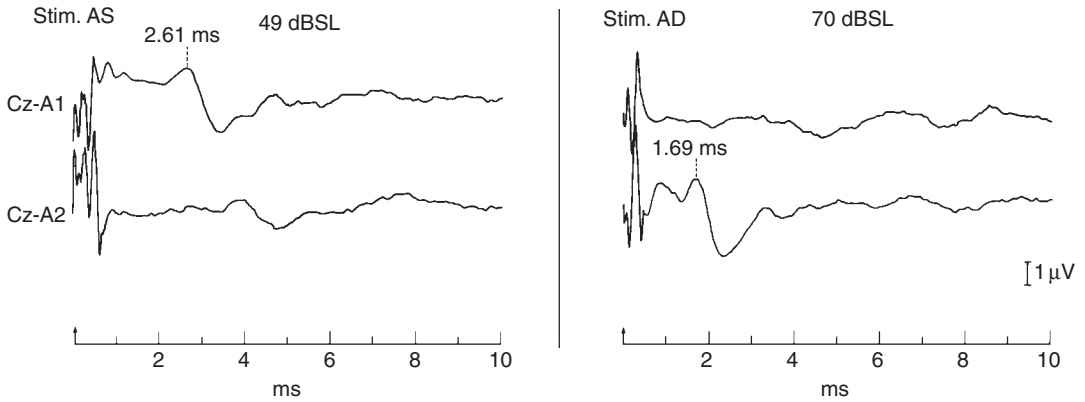
BAEP abnormalities have been observed in several specific neurologic disorders, including cerebellopontine angle tumors, demyelinating disease, brain stem tumors, brain stem infarcts and hemorrhages, coma, and leukodystrophies.<sup>5</sup> The sensitivity and specificity of BAEPs for these neurologic diseases have

been determined. The most common neurologic indication for BAEPs is evaluation for



♀ : Age 39—unsteady gait

**Figure 19-9.** BAEPs in a 39-year-old woman with MS show the combined abnormalities of prolonged I-V interpeak latency and decreased V/I amplitude ratio.



**Figure 19-10.** BAEPs in a 30-year-old woman with MS reveal only wave I bilaterally. Waves II–V are absent. Stim. AS, stimulation of left ear; Stim. AD, stimulation of right ear.

suspected acoustic neuroma or MS. The rationale for BAEP studies in these suspected disorders is to demonstrate an electrophysiologic alteration indicative of a CNS abnormality and to provide information about the anatomical localization of the lesion. BAEPs may be useful as a prognostic indicator in patients with coma.<sup>5</sup> Also, BAEPs have been used to monitor response to therapy.<sup>9</sup>

## Acoustic Neuroma

BAEPs are a reliable indicator of the presence of cerebellopontine angle tumors affecting CN VIII (see Fig. 19-8).<sup>10</sup> Auditory conduction abnormalities almost invariably are found in patients with acoustic neuroma, even in those who are asymptomatic.<sup>11</sup> BAEPs may be abnormal when the findings of other audiometric studies and even neuroimaging studies are normal. According to Chiappa,<sup>2</sup> “BAEPs are the most sensitive screening test when an acoustic neuroma is suspected.” The characteristic BAEP changes are prolonged I–V and I–III interpeak latencies ipsilateral to the tumor. The absolute or asymmetrical prolongation of the I–III interpeak latency may be the most sensitive BAEP variable. Patients with autosomal dominant neurofibromatosis in whom bilateral acoustic neuromas develop may have normal BAEPs if the tumors are asymptomatic, small, and confined to the intracanalicular region. Normal BAEP results in a patient with symptoms suggestive of acoustic neuroma, such as dizziness and hearing loss, argue strongly against the diagnosis. MRI has a low

diagnostic yield in patients with normal BAEPs and suspected acoustic neuroma. Chiappa<sup>2</sup> has suggested that neuroimaging studies are unnecessary in most patients with suspected acoustic neuroma and normal BAEPs (if the studies are performed correctly). Other cerebellopontine angle tumors, for example meningiomas, may not produce BAEP abnormalities until the tumor is large and involves CN VIII. Thus, the diagnostic yield of BAEPs for these tumors early in the course of disease is low, and neuroimaging is a more important neurodiagnostic technique.

## Key Points

- BAEPs are useful in the diagnosis of acoustic neuromas. The most sensitive abnormalities are an absolute or asymmetric prolongation of the wave I–III interpeak latency.
- The characteristic BAEP changes are prolonged I–V and I–III interpeak latencies ipsilateral to the tumor.
- BAEPs may be abnormal when the findings of other audiometric studies and even neuroimaging studies are normal.
- Normal BAEP results in a patient with symptoms suggestive of acoustic neuroma, such as dizziness and hearing loss, argue strongly against the diagnosis.

## Demyelinating Disease

The frequency of BAEP abnormalities in patients with suspected MS is related directly

to the likelihood the person has the disorder and the presence of clinical evidence for brain stem disease.<sup>12</sup> Abnormal BAEP results are common in patients with clinically definite MS (Figs. 19-7, 19-9, and 19-10). In a study of 60 patients with clinically definite MS and symptoms or signs of brain stem lesions, 34 (57%) had abnormal BAEPs. Of 33 patients with brain stem disease and possible MS, 7 (21%) had central auditory conduction defects.<sup>2</sup> Importantly, BAEPs may be abnormal in patients with suspected MS who do not have evidence of brain stem lesions. Of patients without symptoms or signs of brain stem disease related to MS, 20%–50% may have abnormal BAEPs. However, the diagnostic yield of BAEPs in MS is much lower than with visual evoked potentials (VEPs) or somatosensory evoked potentials (SEPs).

BAEP results in patients with demyelinating disease include a unilateral or bilateral prolonged I–V interpeak latency and a decreased V/I amplitude ratio (Figs. 19-7, 19-9, and 19-10).<sup>5</sup> Characteristically, patients with bilateral central auditory conduction defects do not have auditory symptoms or abnormal click thresholds. The usefulness of BAEPs in these cases includes identifying unsuspected brain stem lesions in patients with an anatomically unrelated disorder such as optic neuritis.

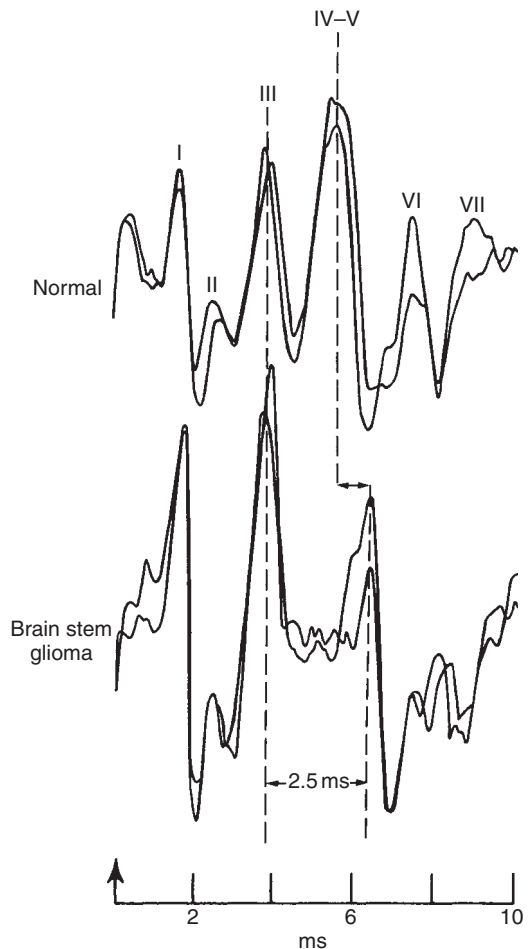
BAEPs may also provide confirmatory evidence of a CNS alteration when neurologic evaluation does not suggest the diagnosis of demyelinating disease. BAEPs may implicate brain stem disease in patients with vague, ill-defined, nonspecific symptoms. Potentially, BAEPs may be used to monitor the response to treatment of patients with MS. Ultimately, MS is a clinical diagnosis, and the results of BAEP studies must be interpreted carefully in conjunction with the rest of the neurologic evaluation.

### Key Points

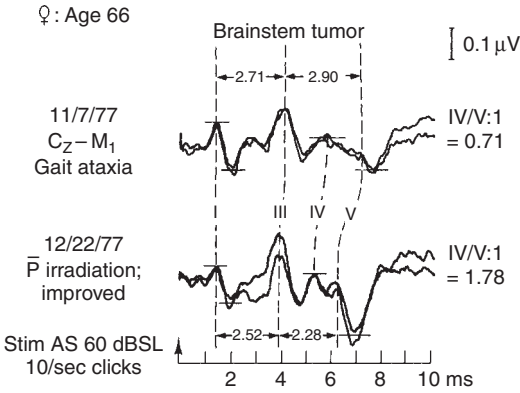
- Abnormal BAEP results are common in patients with clinically definite MS.
- BAEPs may be abnormal in patients with suspected MS who do not have evidence of brain stem lesions.
- BAEP results in patients with demyelinating disease include a unilateral or bilateral prolonged I–V interpeak latency and a decreased V/I amplitude ratio.

## Intrinsic Brain Stem Lesions

BAEPs are abnormal in most patients with brain stem tumors, for example pontine glioma (Figs 19-11 and 19-12).<sup>5</sup> The findings are similar to those in patients with other central auditory conduction defects. Brain stem tumors are often associated with bilateral BAEP abnormalities (maximal ipsilateral to the lesion). Extra-axial tumors may not be associated with BAEP abnormalities unless there is direct compression on and disruption of the brain stem. Ependymomas of the fourth ventricle and cerebellar tumors may also be associated with central auditory conduction defects.

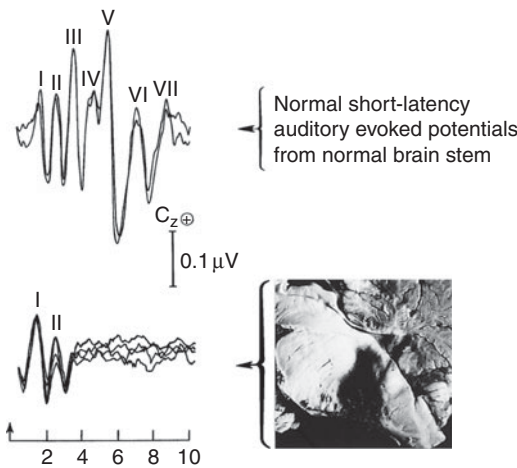


**Figure 19-11.** BAEPs from a normal subject and a patient with a brain stem glioma. The latter study shows prolonged III–V interpeak latency, indicating a central auditory conduction defect between the caudal pons and caudal midbrain.



**Figure 19-12.** BAEPs in a 66-year-old woman before and after (p-) radiation therapy for a brain stem tumor. Note the significant shortening of III-V interpeak latency after treatment. (From Stockard J. J., J. E. Pope-Stockard, and F. W. Sharbrough. 1992. Brainstem auditory evoked potentials in neurology: Methodology, interpretation, and clinical application. In *Electrodiagnosis in clinical neurology*, ed. M. J. Aminoff, 3rd ed., 402. New York: Churchill Livingstone. By permission of the publisher.)

The results of BAEP studies are variable in brain stem strokes, that is infarcts and hemorrhages (Fig. 19-13). Although abnormal BAEPs are found in these patients, BAEPs are normal if the stroke spares the brain stem auditory pathways, for example infarction of the posterior inferior cerebellar artery (lateral medullary syndrome). Brain stem transient ischemic attacks usually do not produce abnormal BAEPs.<sup>2</sup>



**Figure 19-13.** Top, BAEPs in a normal subject and, bottom, in a patient who died of brain stem hemorrhage. Note the absence of waves III-V in the latter study.

**Key Points**

- BAEPs are abnormal in most patients with brain stem tumors.
- Extra-axial tumors may not be associated with BAEP abnormalities unless there is direct compression on and disruption of the brain stem.

**Coma and Brain Death**

BAEPs may be normal or abnormal in a comatose patient, depending on the underlying cause and the presence of a brain stem lesion. BAEPs may provide prognostically important information about the outcome.<sup>5</sup> Patients in whom BAEPs are absent (if peripheral auditory dysfunction can be excluded) are unlikely to survive. Lesions confined to the cerebral hemispheres are not associated with abnormal BAEPs unless the upper brain stem is functionally disrupted. BAEPs may be useful in assessing the integrity of brain stem structures when the findings on neurologic examination are unreliable; for example, after treatment with a high dose of barbiturates or with the patient under general anesthesia. The brain-dead person invariably has abnormal BAEPs, with the characteristic findings of the bilateral absence of all waveforms or the presence of wave I and the absence of waves II-V bilaterally.

**Key Points**

- BAEPs may provide prognostically important information about outcome in comatose patients; patients with absent BAEPs are unlikely to survive.
- The brain-dead person invariably has abnormal BAEPs, with the characteristic findings of the bilateral absence of all waveforms or the presence of wave I and the absence of waves II-V bilaterally.

**Intraoperative Monitoring**

BAEPs are useful for monitoring auditory pathway integrity during neurosurgical procedures, since they are resistant to the effects of drugs or anesthesia. Compression or vascular insult to the eighth nerve or brain stem during surgery will alter the response.<sup>13-15</sup>



## SUMMARY

BAEPs are performed primarily in patients with suspected neurologic disorders to determine whether there is evidence of a brain stem lesion. BAEPs are highly sensitive to auditory conduction defects, but the findings are not pathologically specific. BAEPs provide data that are highly reproducible and objective and lend themselves to sequential studies for comparison. BAEPs are noninvasive and can be performed not only in the clinical neurophysiology laboratory but also in a hospital room or the intensive care unit. Patient cooperation is not critical, and BAEP waveforms are resistant to the effects of drugs or anesthesia. Important factors that need to be considered for accurate interpretation of BAEPs include the patient's age, sex, and auditory acuity. The diagnostic yield of BAEPs has been confirmed in patients with acoustic neuromas, MS, or intraxial brain stem lesions involving the auditory pathways. BAEPs appear to be complementary to structural neuroimaging studies such as MRI.

## REFERENCES

1. Moller, A. R. 1994. Auditory neurophysiology. *Journal of Clinical Neurophysiology* 11:284–308.
2. Chiappa, K. H. 1997. *Evoked potentials in clinical medicine*, 3rd ed. Philadelphia: Lippincott-Raven, 31–130.
3. Nuwer, M. R. 1998. Fundamentals of evoked potentials and common clinical applications today. *Electroencephalography and Clinical Neurophysiology* 106:142–8.
4. Hwang, J. H., J. C. Chao, H. C. Ho, and S. H. Hsiao. 2008. Effects of sex, age, and hearing asymmetry on the interaural differences of auditory brainstem responses. *Audiology & Neuro-Otology* 13(1):29–33.
5. Markand, O. N. 1994. Brain stem auditory evoked potentials. *Journal of Clinical Neurophysiology* 11:319–42.
6. Boettcher, F. A. 2002. Presbycusis and the auditory brainstem response. *Journal of Speech Language & Hearing Research* 45(6):1249–61.
7. Hall, J. W. III, and K. A. Rupp. 1997. Auditory brain stem response: Recent developments in recording and analysis. *Advances in Oto-rhino-laryngology* 53:21–45.
8. Guerit, J. M. 1992. Evoked potentials: A safe brain-death confirmatory tool? *The European Journal of Medicine* 1:233–43.
9. Nuwer, M. R., J. W. Packwood, L. W. Myers, and G. W. Ellison. 1987. Evoked potentials predict the clinical changes in a multiple sclerosis drug study. *Neurology* 37:1754–61.
10. Matthies, C., and M. Samii. 1997. Management of vestibular schwannomas (acoustic neuromas): The value of neurophysiology for evaluation and prediction of auditory function in 420 cases. *Neurosurgery* 40:919–29.
11. Tandon, O. P. 1998. Average evoked potentials—Clinical applications of short latency responses. *Indian Journal of Physiology and Pharmacology* 42:172–88.
12. Drislane, F. W. 1994. Use of evoked potentials in the diagnosis and follow-up of multiple sclerosis. *Clinical Neuroscience* 2:196–201.
13. Kumar, A., A. Bhattacharya, and N. Makhija. 2000. Evoked potential monitoring in anaesthesia and analgesia. *Anaesthesia* 55:225–41.
14. Bischoff, B., J. Romstock, R. Fahlbusch, M. Buchfelder, and C. Strauss. 2008. Intraoperative brainstem auditory evoked potential pattern and perioperative vasoactive treatment for hearing preservation in vestibular schwannoma surgery. *Journal of Neurology, Neurosurgery, & Psychiatry* 79(2): 170–5.
15. Raftopoulos, C., B. Abu Serieh, T. Duprez, M. A. Docquier, and J. M. Guerit. 2005. Microsurgical results with large vestibular schwannomas with preservation of facial and cochlear nerve function as the primary aim. *Acta Neurochirurgica* 147(7):697–706.

*This page intentionally left blank*

# Audiogram, Acoustic Reflexes, and Evoked Otoacoustic Emissions

Christopher D. Bauch and Wayne O. Olsen

## INTRODUCTION

### AUDIOGRAM

Speech-Recognition Thresholds  
Word Recognition

### ACOUSTIC REFLEX

CN VIII vs. Cochlear Findings  
Disorders of CN VII  
Disorders of Brain Stem

## EVOKED OTOACOUSTIC EMISSIONS

Neonatal Screening  
Auditory Neuropathy/  
Dys-synchrony  
Pseudohypacusis

## APPLICATIONS SUMMARY

## INTRODUCTION

The auditory system can be assessed with a variety of acoustic stimuli presented via standardized procedures, and these are routinely used in the evaluation of patients for whom there is concern about hearing or balance. Hearing tests performed with pure-tone and speech stimuli are used to assess hearing function in patients for whom there is concern about hearing or balance. These tests can help determine whether there are related balance and hearing problems, can document difficulties in communication attributable to hearing disorders, and can help establish a diagnosis. On the basis of the patterns of results from these tests, hearing loss can be categorized as follows:

1. Conductive—abnormality of the ear canal, tympanic membrane, or middle ear ossicles, or a combination of these.
2. Sensorineural—disorder of the cochlea or cranial nerve (CN) VIII.
3. Mixed—a combination of conductive and sensorineural disorders.

*Acoustic reflex tests* assess contraction of the stapedius muscle and require no voluntary behavioral response from the patient. They are used primarily to help differentiate sensory (cochlear) lesions from neural (CN VIII) lesions and to evaluate a portion of CN VII.

*Evoked otoacoustic emissions* (EOAEs) require no voluntary behavioral response, assess preneural function in the cochlea, and are useful screening tests for hearing in

newborn infants, for diagnosis of auditory neuropathy/dys-synchrony, and for documenting pseudohypacusis, that is, feigned or exaggerated hearing loss.

*Pure-tone and speech audiometric testing* constitute the basic hearing evaluation of persons who have a balance or hearing problem or both. Acoustic reflex tests often are administered to patients who have tinnitus, unilateral or asymmetric sensorineural hearing loss, vestibular disorders, or facial paralysis (or a combination of these) to help determine whether the lesion involves the end organ or the acoustic nerve portion of CN VIII or to help define the site of involvement of CN VII. EOAEs are used to test cochlear function in newborn infants, young children undergoing hearing evaluations, and older children or adults suspected of feigning or exaggerating hearing loss during routine pure-tone and speech testing.

### **Purpose and Role of Audiogram, Acoustic Reflexes, and EOAEs**

- Audiologic tests can help determine whether there are related balance and hearing problems, can document difficulties in communication attributable to hearing disorders, and can help establish a diagnosis.
- The audiogram establishes the site of pathology as conductive, sensorineural, or mixed.
- Acoustic reflexes assess middle ear function and CN VII function, help differentiate cochlear vs. CN VIII lesions, and, in some instances, the integrity of the lower brain stem.
- EOAEs assess preneural function in the cochlea, require no behavioral response, and are useful hearing screening tests for newborn infants, young children undergoing hearing evaluations, and for documenting pseudohypacusis for older children and adults suspected of feigning or exaggerating hearing loss during routine pure-tone and speech testing.

## **AUDIOGRAM**

Basic audiologic tests use pure tones delivered by standard earphones and bone vibrators to

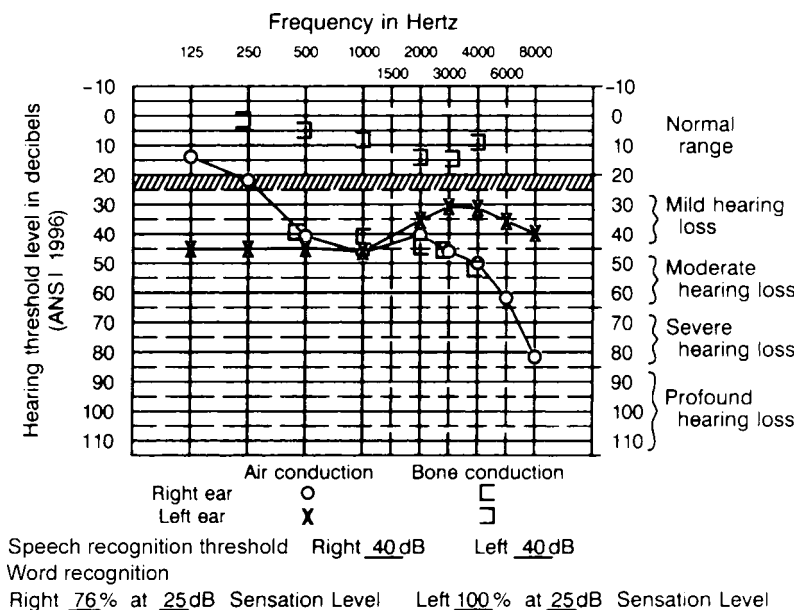
assess thresholds of hearing (just barely audible) for air-conducted and bone-conducted stimuli. These tests are akin to the Schwabach and Rinne tuning fork tests. However, the presentation of electronically generated signals through standard transducers allows testing over a greater frequency and intensity range and with far greater precision than is possible with tuning forks. Children as young as 6 months can be conditioned to respond to pure-tone stimuli at or near threshold levels. School-age and older children and adults need only to be instructed to provide a behavioral response on hearing the designated signals. The responses of the patient are plotted on a standardized chart called an *audiogram* and compared with internationally established reference levels for normal hearing.

A conventional audiogram format is shown in Figure 20-1, with intensity in decibels of hearing level (HL) (the American National Standards Institute<sup>1</sup>) on the ordinate and frequency (125–8000 Hz) on the abscissa. The “0 decibel HL” line is an internationally accepted reference representing the average hearing sensitivity for young people with normal hearing. The normal range indicated on the right side of the audiogram extends to 25 dB HL, because persons with hearing thresholds in this range, at least for frequencies of 500–4000 Hz, generally do not report difficulty hearing and understanding conversational speech in quiet surroundings. People whose hearing thresholds are

1. In the 26–45 dB HL range have mild hearing loss and difficulty hearing soft or distant speech.
2. In the 46–65 dB HL range have difficulty hearing speech at normal conversational levels and are considered to have moderate hearing loss.
3. In the 66–85 dB HL range have severe hearing loss, indicating difficulty hearing even loud speech.
4. Greater than 85 dB HL have profound hearing loss.

The term *deaf* is reserved for people in group 4, and *hearing impaired* and *hard of hearing* are used for those in groups 1–3.

The threshold data shown in Figure 20-1 reveal mild hearing loss in the left ear (marked by “X” in Fig. 20-1), and in the right ear



**Figure 20-1.** Audiogram showing pure-tone and speech test results for sensorineural hearing loss (*right ear*) and conductive hearing loss (*left ear*). Degree of hearing loss on right ordinate. ANSI, American National Standards Institute.

(marked by “O”), hearing sensitivity that ranges from normal for the lower frequencies (125–250 Hz) to mild hearing loss for the middle frequencies (500–3000 Hz), and moderate to severe hearing loss for the higher frequencies. The hearing loss for the right ear is *sensorineural*, as shown by the interweaving air-conduction and bone-conduction thresholds (marked by “O” and “[” respectively in Fig. 20-1). The hearing loss in the left ear is *conductive*, as indicated by the separation of the air-conduction and bone-conduction thresholds (marked by “X” and “[” respectively in Fig. 20-1).

## Speech-Recognition Thresholds

The audiogram in Figure 20-1 also shows speech-recognition thresholds that are based on correct responses to 50% of spondaic words (*spondees* are words with two syllables of equal stress when spoken, such as “airplane” and “baseball”) at the hearing levels indicated (40 dB HL). This measurement reflects the level at which approximately 50% of spoken meaningful sentences would be understood. The levels in Figure 20-1 indicate mild hearing loss for speech, as do pure-tone thresholds in the 500–2000 Hz frequency range.

## Word Recognition

The ability to understand lists of monosyllables (one-syllable words such as “thin,” “sack,” and “vote,” presented singly) at clearly audible levels is shown by the percentage correct word recognition score. In the example shown in Figure 20-1, lists of monosyllables were presented at a sensation level of 25 dB, that is, 25 dB above the speech-recognition thresholds. The score of 76% reveals less than perfect understanding of the test items through the right ear. The score for the left ear is perfect (100%), as expected for conductive hearing loss. These results demonstrate that speech loud enough to be heard easily was understood perfectly by the left ear (*conductive hearing loss*) but not by the right ear (*sensorineural hearing loss*). Scores of 90%–100% indicate that people should have little difficulty understanding speech loud enough to be heard easily in quiet environments. Correct responses to 70%–88% of the monosyllables in a given list suggest occasional difficulty; 60%–68%, definite difficulty; 40%–58%, marked difficulty; and less than 40%, extreme difficulty in understanding speech. Persons who have CN VIII lesions often have considerable difficulty comprehending speech in the affected ear.<sup>2</sup>

**Key Points**

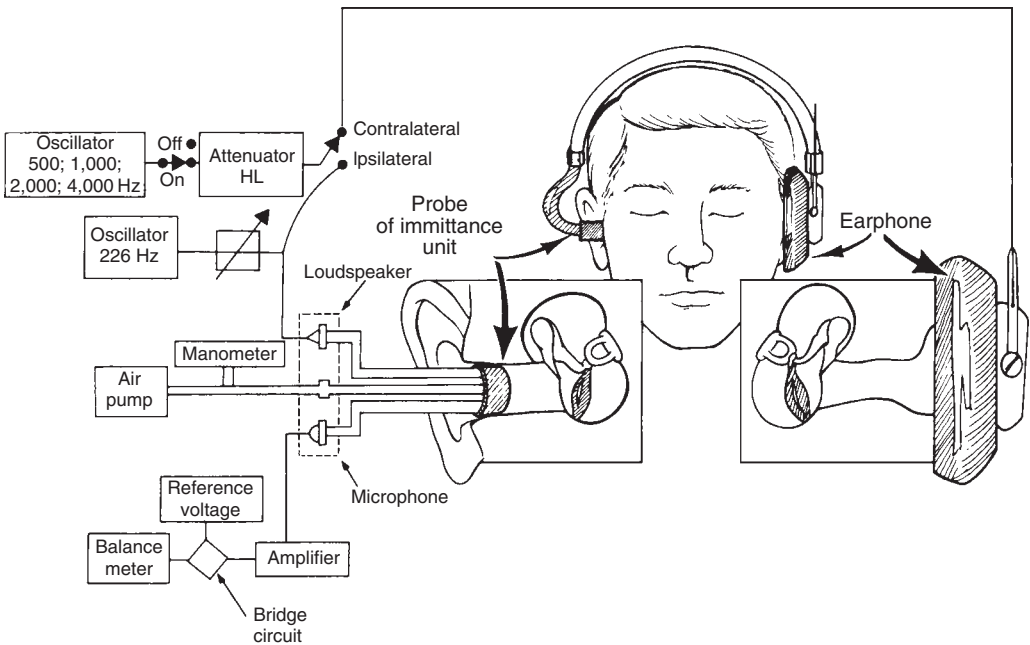
- Basic audiologic tests use pure tones delivered by standard earphones and bone vibrators to assess thresholds of hearing (just barely audible) for air-conducted and bone-conducted stimuli.
- Pure-tone test results plotted on a standardized audiogram format provide data regarding the patient's hearing status relative to international standards and also delineate whether the hearing is conductive, sensorineural, or mixed.
- Persons with hearing thresholds up to 25 dB HL, at least for frequencies of 500–4000 Hz, generally do not report difficulty hearing and understanding conversational speech in quiet surroundings.
- Persons whose hearing thresholds are in the 46–65 dB HL range have difficulty hearing speech at normal conversational levels and are considered to have moderate hearing loss.
- Persons with hearing thresholds greater than 85 dB HL are considered deaf.
- Speech-recognition thresholds reveal the intensity level necessary for the patient

to understand 50% of two-syllable words, and reflect the level at which approximately 50% of meaningful sentences would be understood.

- Word recognition results indicate how well the patient understands speech at clearly audible levels.
- Persons who have CN VIII lesions often have difficulty comprehending speech in the affected ear.

**ACOUSTIC REFLEX**

Intense stimulation of either ear causes contraction of the stapedius muscle in both ears. This protective response, called the *acoustic reflex*, is measured easily and quickly with a device called an *immittance unit* (Fig. 20–2). The system microphone monitors the level of a low-frequency tone (226 Hz) maintained in the space between the probe tip sealed in the ear canal and the tympanic membrane, while intense tones (500, 1000, 2000, or 4000 Hz) are presented to the opposite ear or, in some situations, to the same ear as the 226-Hz probe tone. Contraction of the stapedius muscle,



**Figure 20–2.** Block diagram of immittance unit showing the setting for eliciting contralateral acoustic reflexes (stimulus presented through earphone). HL, hearing level.



which is attached to the neck of the stapes, stiffens the middle ear system, thereby altering the level of the 226-Hz tone maintained between the probe tip and the tympanic membrane. This change is the acoustic reflex response measured by the immittance unit.

Measurement of acoustic reflexes requires an intact tympanic membrane, mobile middle ear ossicles (no conductive hearing loss), hearing adequate to allow sufficient stimulation of the ear with at least one of the above-mentioned tones, intact CN VII and CN VIII, intact reflex arc in the brain stem, and stapedius muscle attachment to the stapes. Because of the complexity of this system, various response patterns emerge (Table 20-1). In conjunction with the case history and other audiologic test results, acoustic reflex testing provides valuable diagnostic information.

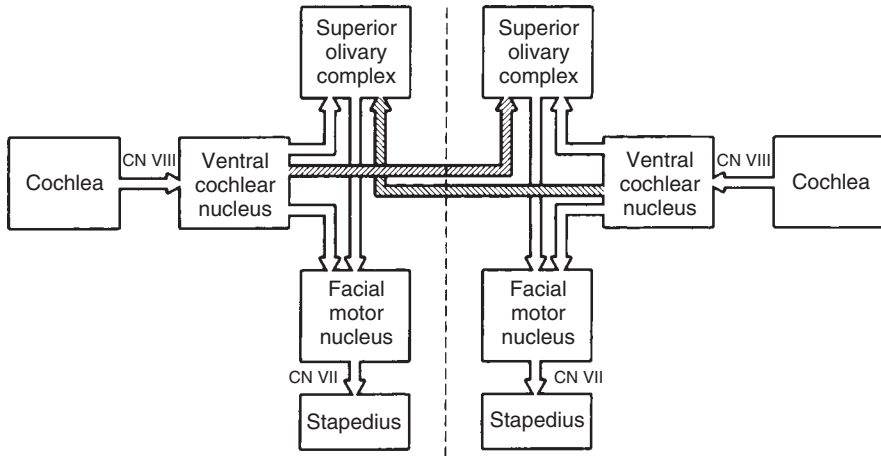
## CN VIII vs. Cochlear Findings

The absence of acoustic reflexes or response only to very intense tones in an ear with sensorineural hearing loss no worse than severe in degree makes one suspect neural (CN VIII) involvement on the side of the stimulated ear.<sup>3</sup> Similarly, *acoustic reflex decay*—that is, diminished amplitude of the acoustic reflex response to less than half within 5 seconds to a 500-Hz or 1000-Hz tone delivered 10 dB above the acoustic reflex threshold—suggests a lesion of CN VIII. Elicitation of the acoustic reflexes by normal levels of stimulation and the absence of reflex decay indicate that the middle and inner ears are normal or, in the case of sensorineural hearing loss, indicate sensory (cochlear) abnormality (Table 20-1). The sensitivity and specificity of acoustic reflex and reflex decay tests for identification of CN VIII lesions are 85%;

Table 20-1 **Audiogram and Acoustic Reflex Findings for Various Conditions**

Condition	Audiogram			Acoustic Reflexes	
	Normal hearing	Conductive hearing loss	Sensorineural hearing loss	Normal response	Abnormal response
<b>Normal</b>	X			X	
<b>Conductive disorders</b>					
Cerumen plug		X			X
Thickened tympanic membrane	X			X	
Perforated tympanic membrane		X			X
Otitis media fluid		X			X
Ossicular discontinuity		X			X
Otosclerosis stapes fixation		X			X
<b>Sensorineural loss</b>					
Cochlea			X	X	
CN VIII			X		X
<b>Facial paralysis</b>					
Proximal to stapedial branch CN VII	X				X
Distal to stapedial branch CN VII	X			X	

CN, cranial nerve. (Modified from Keating, L. W., and W. O. Olsen. 1978. Practical considerations and applications of middle-ear impedance measurements. In *Audiological assessment*, ed. D. E. Rose, 2nd ed., 336-67. Englewood Cliffs, NJ: Prentice-Hall. By permission of the author.)



**Figure 20-3.** Contralateral and ipsilateral acoustic reflex arcs. Crossing tracts for contralateral reflexes are shaded. CN, cranial nerve. (From Wiley, T. L., and M. G. Block. 1984. Acoustic and nonacoustic reflex patterns in audiologic diagnosis. In *The acoustic reflex: Basic principles and clinical applications*, ed. S. Silman, 387–411. Orlando, FL: Academic Press. By permission of the publisher.)

that is, this test combination correctly identifies lesions of CN VIII and correctly rules out such lesions 85% of the time.

### Disorders of CN VII

The presence of a normal stapedius muscle contraction on the same side as facial paralysis reveals that the CN VII lesion is distal to the branch that innervates the stapedius muscle. In contrast, the absence of a reflex response on the same side as facial paralysis indicates that the involvement of CN VII is proximal to the stapedius branch of the nerve (Table 20-1).

### Disorders of Brain Stem

The absence of acoustic reflexes with contralateral stimulation (e.g., stimulating the right ear and measuring the acoustic reflex in the left ear and vice versa) but their occurrence with ipsilateral stimulation (i.e., stimulating and measuring the response in the same ear) indicates a brain stem lesion that interrupts the crossing acoustic reflex tracts (Fig. 20-3).

#### Key Points

- Acoustic reflex tests measure involuntary contraction of the stapedius muscle in response to intense stimulation and yield

information regarding the mobility of the middle ear system.

- Measurement of acoustic reflexes requires an intact tympanic membrane, mobile middle ear ossicles, hearing adequate to allow sufficient stimulation of the ear with at least one of the above-mentioned tones, intact CN VII and CN VIII, reflex arc in the brain stem, and stapedius muscle attachment to the stapes.
- Acoustic reflexes require intact CNs VIII and VII and lower brain stem, and help differentiate cochlear vs. CN VIII lesions.
- Acoustic reflexes can assist in localizing the site of involvement in instances of CN VII or lower brain stem pathology.
- The absence of acoustic reflexes or response only to very intense tones in an ear with sensorineural hearing loss no worse than severe in degree makes one suspect neural (CN VIII) involvement on the side of the stimulated ear.
- Elicitation of the acoustic reflexes by normal levels of stimulation and the absence of reflex decay indicate that the middle and inner ears are normal or, in the case of sensorineural hearing loss, indicate sensory (cochlear) abnormality.
- The presence of a normal stapedius muscle contraction on the same side as facial paralysis reveals that the CN VII lesion

is distal to the branch that innervates the stapedius muscle.

- The absence of acoustic reflexes with contralateral stimulation but their presence with ipsilateral stimulation indicates a brain stem lesion that interrupts the crossing acoustic reflex tracts.

## EVOKED OTOACOUSTIC EMISSIONS

EOAEs reflect the response of electromotile activity within the cochlea in response to external sound stimuli.<sup>4</sup> This minuscule activity can be measured in the ear canal with a sensitive microphone sealed in the ear canal. The output of the microphone is averaged to reduce the inherent physiologic and environmental noise in the ear canal. Transient evoked otoacoustic emissions (TEOAEs) are measurements of the active cochlear response to clicks. Distortion product otoacoustic emissions (DPOAEs) reflect the interaction within the cochlea to stimulation with two pure tones simultaneously. Displays of normal TEOAEs and DPOAEs are shown in Figures 20-4 and 20-5, respectively. The different segments in Figure 20-4 show the waveform, stability, level, and spectrum of the click stimulus as well as the waveform, reproducibility, level, and spectrum of the response from the cochlea, signal-to-noise ratio of the response, the noise

level in the ear canal, test time, and other variables. The graph in Figure 20-5 shows the amplitude of the distortion products generated within the cochlea (line graph near center on left) in response to two tones presented simultaneously, the noise level in the ear canal, frequency separation, level of the stimulus tones, and test time.

Robust EOAEs, such as those shown in Figures 20-4 and 20-5, indicate good function of the cochlear outer hair cells and are generally associated with normal hearing sensitivity, 25 dB HL or better for frequencies of 1000-6000 Hz.<sup>4,5</sup> Low-frequency physiologic noise in the ear canal, and occasionally low-frequency environmental noise, precludes measurement of otoacoustic emissions for frequencies less than 1000 Hz.<sup>6</sup> Nevertheless, observation of EOAEs for the 1000-4000 Hz range provides important information, because it suggests normal or near-normal hearing sensitivity for the frequencies most important for hearing and understanding speech. EOAEs are rarely observed at a given test frequency when sensorineural hearing loss is 30 dB HL or greater at that frequency or when conductive hearing loss blocks transmission of the low-level otoacoustic emissions from the cochlea back to the microphone in the ear canal.<sup>4</sup>

## Neonatal Screening

Because EOAE tests can be completed quickly and do not require a voluntary response and

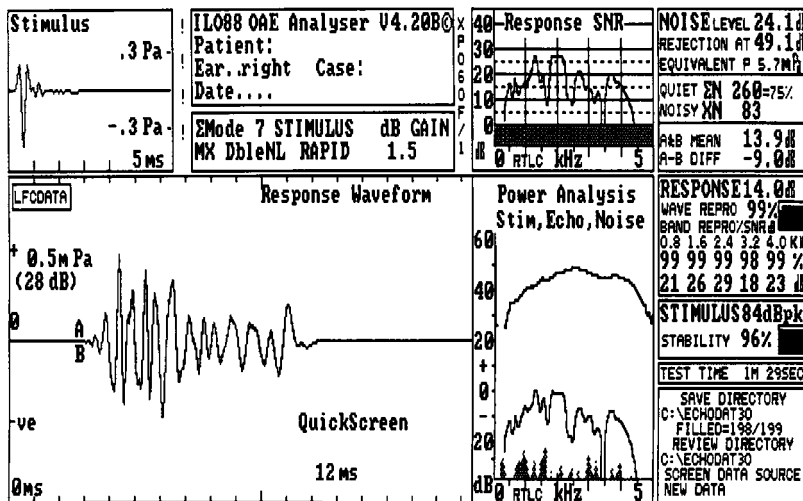


Figure 20-4. Display of TEOAE measurement showing test variables and response.

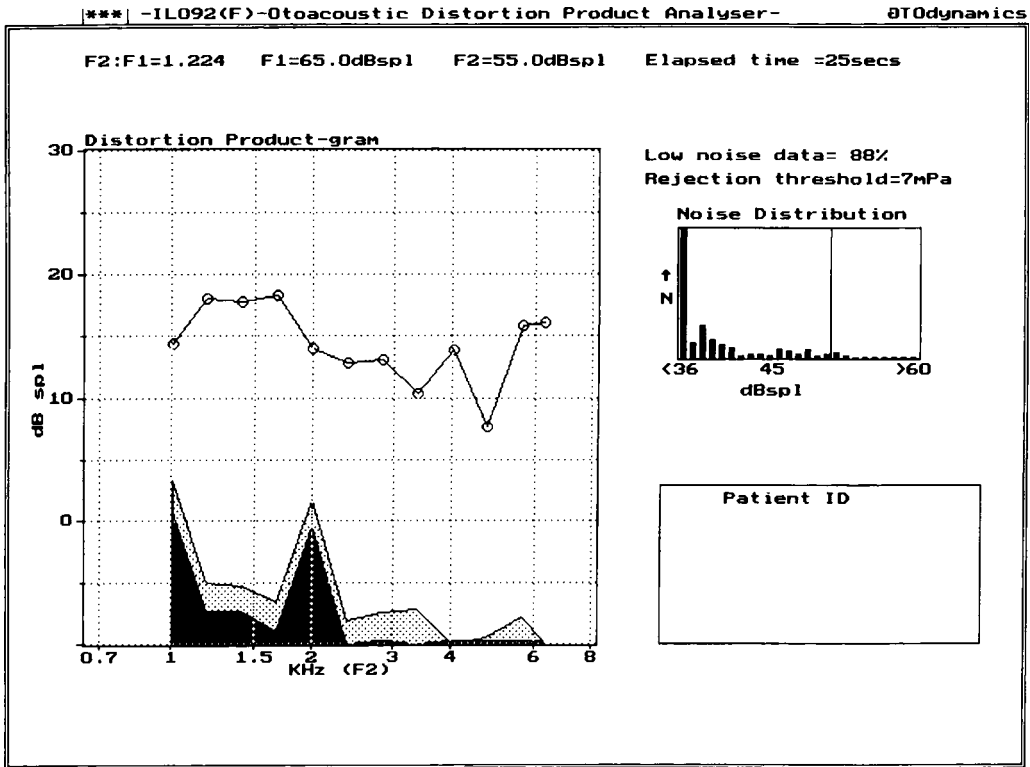


Figure 20-5. Display of DPOAE showing test variables and response.

because elicitation of a response suggests normal middle ear and cochlear function, they have been used as hearing screening tests in neonatal intensive care units and well-baby nurseries. The absence of a response raises the possibility of a significant hearing loss that warrants further audiologic and medical evaluation. EOAEs are often used to help confirm behavioral observations made during an audiologic evaluation of a young child.

### Auditory Neuropathy/ Dys-synchrony

An unusual auditory disorder, termed *auditory neuropathy/dys-synchrony*, has been reported in patients ranging in age from infancy to adulthood.<sup>7,8</sup> The hallmark audiologic findings of this disorder are normal EOAEs in the presence of absent acoustic reflexes and absent or severely abnormal brain stem auditory evoked potentials (BAEPs) (see Chapter 21).<sup>9</sup> Additional test findings may include poor or inconsistent responses to pure tones

with varying degrees and configuration of hearing loss, and often very poor speech or word recognition, particularly in background noise.<sup>5</sup> The normal electromotile activity of the outer hair cells is revealed by the EOAE responses, but the poor behavioral, acoustic reflex, and BAEP responses indicate abnormal neural connections at the inner hair cells of the cochlea, a defective synaptic juncture between inner hair cells and the cochlear branch of CN VIII, or a defective CN VIII itself.<sup>8</sup> This entity was delineated only recently with the discovery of EOAEs.

### Pseudohypacusis

For patients who are not cooperative or who are suspected of feigning or exaggerating a hearing loss greater than 30 dB HL, EOAE tests provide a fast and objective assessment of the peripheral portion of the auditory system. If behavioral responses indicate a hearing loss that is mild or greater in degree for frequencies between 1000 and 6000 Hz (or

no behavioral responses are obtained), but EOAEs are observed at various test frequencies, there is reason to suspect pseudohypacusis and the need for additional testing to establish hearing sensitivity more precisely.

### Key Points

- EOAEs measure electromotile activity of the outer hair cells in the cochlea in response to sound stimulation.
- These emissions most often are obtained only when the middle ear mobility is normal and when hearing sensitivity is within normal or near-normal limits (approximately 30 dB HL).
- Otoacoustic emissions require no voluntary response and as such are useful for hearing screening in newborn infants, for assessment of hearing in young children, for evaluation of auditory neuropathy/dys-synchrony, and for evaluation of persons suspected of feigning or exaggerating their hearing loss (pseudohypacusis).
- Auditory neuropathy/dys-synchrony is a rare disorder due to either abnormal neural connections at the inner hair cells of the cochlea, a defective synaptic juncture between inner hair cells and the cochlear branch of CN VIII, or a defective CN VIII, and is characterized by normal EOAEs in the presence of absent acoustic reflexes and absent or severely abnormal BAEPs.

### APPLICATIONS

Patients referred for audiologic evaluations are routinely queried regarding their concerns about hearing and balance and history of such problems. Such information assists in the selection of subsequent appropriate audiologic tests. The audiologic evaluation usually begins with pure-tone threshold tests (air conduction and bone conduction) followed by speech-recognition and word-recognition testing. These results yield basic information about the patient's hearing and communication status as well as the type of hearing loss (conductive, sensorineural, or mixed). Depending on the specific diagnostic concerns and patterns of findings on routine audiologic testing, other studies, such as acoustic reflex tests, may be

administered to assist in determining whether the localization of a sensorineural hearing loss is cochlear or involving CN VIII. If the audiologist questions the accuracy or validity of the pure-tone and speech test results, otoacoustic emissions tests may help identify pseudohypacusis, or possibly auditory neuropathy/dys-synchrony. The patterns of abnormalities in different disorders are shown in Table 20-1.

### SUMMARY

Audiologic testing in the form of pure-tone air-conduction and bone-conduction audiograms provides diagnostic information about the type of hearing loss (conductive, sensorineural, or mixed) and the degree of hearing loss and attendant communication difficulties. The addition of speech tests that use specific types of speech stimuli directly assesses the patient's ability to hear and to understand speech. Acoustic reflex and reflex decay tests are used to evaluate the integrity of a complicated neural network involving not only the auditory tracts to and through the brain stem but also decussating pathways in the brain stem and the course of CN VII to the innervation of the stapedius muscle. EOAE tests provide an objective measurement of the peripheral hearing system from the external ear through the cochlear outer hair cells. They are useful screening tests for hearing in infants, in patients suspected of auditory neuropathy/dys-synchrony, and in patients suspected to have pseudohypacusis, that is, feigned or exaggerated hearing loss.

### REFERENCES

1. American National Standards Institute. 1996. *American National Standard Specification for Audiometers (ANSI S3.6-1996)*. New York: The Society.
2. Van Dijk, J. E., J. Duijndam, and K. Graamans. 2000. Acoustic neuroma: Deterioration of speech discrimination related to thresholds in pure-tone audiometry. *Acta Oto-Laryngologica* 120:627-32.
3. Bauch, C. D., W. O. Olsen, and S. G. Harner. 1990. Preoperative and postoperative auditory brain-stem response results for patients with eighth-nerve tumors. *Archives of Otolaryngology—Head & Neck Surgery* 116:1026-9.
4. Robinette, M. S., and T. J. Glatke, eds. 2002. *Otoacoustic emissions: Clinical applications*, 2nd ed. New York: Thieme.

5. Lonsbury-Martin, B. L., and G. K. Martin. 2007. Otoacoustic emissions. In *Auditory evoked potentials: Basic principles and clinical application*, ed. R. F. Burkhard, M. Don, and J. J. Eggermont. Baltimore: Lippincott Williams & Wilkins.
6. Headley, G. M., D. E. Campbell, and J. S. Gravel. 2000. Effect of neonatal test environment on recording transient-evoked otoacoustic emissions. *Pediatrics* 105:1279–85.
7. Starr, A., T. W. Picton, and Y. Sininger. 1996. Auditory neuropathy. *Brain* 119:741–53.
8. Hood, L. J. 2007. Auditory neuropathy and dys-synchrony. In *Auditory evoked potentials: Basic principles and clinical application*, ed. R. F. Burkhard, M. Don, and J. J. Eggermont. Baltimore: Lippincott Williams and Wilkins.
9. Berlin, C. I., L. J. Hood, T. Morlet, et al. 2005. Absent or elevated middle ear muscle reflexes in the presence of normal otoacoustic emissions: A universal finding in 136 cases of auditory neuropathy/dys-synchrony. *Journal of the American Academy of Audiology* 16: 546–53.



# Brain Stem Auditory Evoked Potentials in Peripheral Acoustic Disorders

Christopher D. Bauch

**INTRODUCTION**  
**STIMULI**  
**ELECTRODES**  
**INTERPRETATION**  
Absolute Latencies

Interaural Latency  
Differences  
Interpeak Intervals

**APPLICATIONS**  
**SUMMARY**

## INTRODUCTION

Brain stem auditory evoked potentials (BAEPs) testing (also called *brain stem auditory evoked response* [BAER]) is a useful technique for the otoneurologic assessment of patients with complaints of dizziness, hearing loss, or tinnitus. The BAEP evaluation records neuroelectric potentials from cranial nerve (CN) VIII and the ascending brain stem pathways that are elicited as a response to click stimuli. When evaluating patients with complaints of dizziness, hearing loss, or tinnitus, concomitant audiology testing may be necessary when considering BAEP evaluation since *conductive hearing losses* resulting from abnormalities of the ear canal, tympanic membrane, or middle ear as well as *sensorineural disorders* (lesions of the cochlea or CN VIII) can affect BAEP waveform morphology and latencies. Therefore, the potential effects of hearing losses must be considered in the interpretation of

BAEP findings. The utility of BAEPs in the evaluation of central nervous system disorders is discussed in Chapter 19. However, of particular interest here is the very small wave I, the whole nerve action potential, generated in CN VIII. Wave I is a critical component for neurodiagnostic assessment, which often requires interpeak interval determination. Other waves, especially waves III and V, are typically more robust and may be observed even though wave I often cannot be identified.

### ***Purpose and Role of BAEPs in Peripheral Acoustic Disorders***

- BAEPs can be used to evaluate CN VIII and ascending brain stem pathways.
- The test helps to differentiate cochlear from retrocochlear pathology in patients with complaints of hearing loss, tinnitus, dizziness, unsteadiness, or facial weakness.

## STIMULI

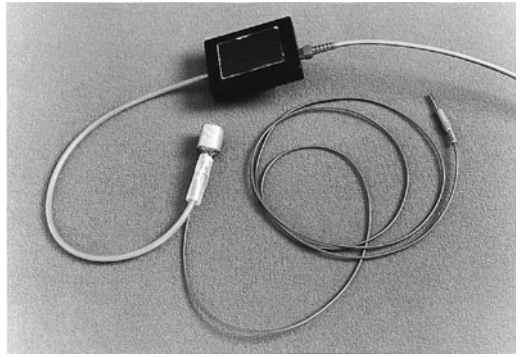
Clicks are the most effective stimuli in BAEP assessment since their short duration (50–100  $\mu$ s) and abrupt onset disperse acoustic energy and provide good synchronization of neural discharges across a broad frequency range. However, the importance of high-frequency hearing sensitivity is accentuated by the spectral characteristics of the earphone and by the response characteristics of the ear canal and middle ear, resulting in greater excitation in the frequencies above 1000 Hz, that is, 2000–4000 Hz range. Because this region is stimulated maximally by clicks, routine pure-tone assessment is recommended before BAEP evaluation. Hearing losses, particularly in the 2000–4000 Hz frequency range, can affect BAEP results.<sup>1,2</sup> Behavioral thresholds for clicks are not an adequate screen for hearing, because the click's spectral spread of energy across low- and high-frequency regions can yield relatively good thresholds despite significant hearing loss in the 2000–4000 Hz range.

### Key Points

- Stimuli are usually brief (50–100  $\mu$ s) clicks that disperse acoustic energy and provide good synchronization of neural discharges.
- Because hearing losses can affect BAEP results, pure-tone audiometry is recommended prior to BAEP evaluation.

## ELECTRODES

BAEPs are recorded with surface electrodes, typically placed at or near the vertex and the ears. Although conventional mastoid or earlobe electrodes usually allow recording of waves I, III, and V from patients with normal hearing sensitivity, wave I is difficult or impossible to identify in patients with mild, moderate, or severe cochlear hearing loss. An ear canal electrode can enhance wave-I amplitude. The electrode is a disposable, soft, foam plug wrapped in a thin layer of conducting foil. It couples to a transducer through flexible silicon tubing. Such an electrode serves dual roles as a recording electrode and a stimulus delivery system (Fig. 21–1).



**Figure 21–1.** Etymotic ER-3A transducer, sound tube, ear canal electrode (TIPtrode), and electrode lead. (From Nicolet Biomedical Instruments, Inc., Madison, WI.)

In direct comparison with mastoid electrodes, the ear canal electrode improves wave-I amplitude by nearly 100% for patients with normal hearing and 41%–127% for those with mild-to-severe hearing losses. In a large sample of hearing-impaired patients, wave I was identified easily 96% of the time with the ear canal electrode, compared with 70% of the time with mastoid electrodes.<sup>3</sup> The primary advantages of the ear canal electrode are that wave-I amplitude is improved for all degrees of hearing loss and the foam material is compressible, fits comfortably, and prevents collapse of the ear canals. Its disadvantage is that it can be used only once.

### Key Points

- Ear canal electrodes enhance wave-I amplitude and thereby allow additional analyses of BAEP measurements.

## INTERPRETATION

Three basic measurements are often made in the typical evaluation of BAEP waveforms: (1) absolute latencies, (2) wave-V interaural latency differences, and (3) interpeak intervals. BAEP waveform amplitude may be an unreliable criterion for clinical testing because of marked variations among normal subjects and are therefore not routinely used in interpretation.<sup>1,4,5</sup>

## Absolute Latencies

Absolute latencies of the BAEP waves may be influenced by peripheral conductive or cochlear hearing loss. Conductive hearing loss reduces the effective stimulus reaching the cochlea and causes absolute latency delays dependent on the degree of conductive impairment. On average, a 0.4-ms shift can be expected for each 10 dB of conductive hearing loss.

For cochlear disorders, the hearing thresholds for 2000, 3000, and 4000 Hz are important. As hearing thresholds for these frequencies become poorer, the latencies of waves I, III, and V increase systematically. Presumably, this is because of the time delay of the traveling wave in the cochlea reaching more responsive apical (lower frequency) areas and also because of the decrease in effective intensity stimulating the defective cochlea. These factors, and the fact that the cochlea produces more synchronous responses at its high-frequency basal end, lead to latencies that depend on the integrity of high-frequency hearing. Clinical experience has shown that when the average hearing thresholds for 2000, 3000, and 4000 Hz are equal to or greater than a 60-dB hearing loss, at least 60% of the absolute latencies for waves I, III, and V are abnormal. Although absolute latencies may be delayed slightly for elderly patients, such delays are quite variable and age is usually not considered in the interpretation of these results. Further, while body temperature can be a factor in BAEP latencies for seriously ill patients with hyperthermia or hypothermia, it is usually not necessary to document temperature for otherwise healthy patients. Sedative effects on the BAEP are minimal, with the response never being totally eliminated by anesthetics. Knowledge of these tendencies is important in the interpretation of absolute wave-V latencies for patients with a suspected CN VIII abnormality. Wave latency delays for patients with similar cochlear hearing losses are often indistinguishable from those of patients with lesions of CN VIII.

### Key Points

- Latencies of all BAEP waves may be delayed by both conductive and sensorineural hearing losses.

- A 0.4-ms shift can be expected for each 10 dB of conductive hearing loss.
- Age and temperature usually do not affect the interpretation of these results.
- Sedative effects on the BAEP are minimal with the response never being totally eliminated by anesthetics.

## Interaural Latency Differences

Another measure, *interaural latency differences*, compares wave-V latencies at the two ears of the patient. The advantage of this measure is that the patient serves as his or her own control. Normal variability for interaural latency differences is 0.4 ms. Larger wave-V latency differences between ears are considered indicative of CN VIII involvement. However, the degree of hearing loss in the 2000–4000 Hz range can also influence the validity of such comparisons.<sup>6</sup> When wave-V latency differences between ears exceed the predetermined criterion, the examiner must determine what influence, if any, the hearing loss has on the results. Adjustments in wave-V latency based on various levels of high-frequency hearing loss have been advocated, but the application of these corrections is often misleading and confusing.

### Key Points

- Interaural latency differences are an important BAEP measurement.
- Wave-V latency differences between ears can be influenced by hearing loss.
- Normal variability for interaural latency differences is 0.4 ms.

## Interpeak Intervals

*Interpeak intervals* reflect the time interval from one neural generator to another. The primary interpeak intervals (I–III, III–V, and I–V) separate a delayed wave-V absolute latency into its peripheral (I–III) and central (III–V) components. Normal I–III and III–V intervals are each approximately 2 ms, which provide an overall I–V interval of approximately 4 ms. An advantage of measuring the interpeak intervals is that they usually are not affected by moderate-to-severe levels of

cochlear or conductive hearing loss. A prolonged I–V interval (longer than 4.54 ms) suggests a retrocochlear lesion, whereas conductive and cochlear hearing losses usually have normal intervals (4.54 ms or less). The main disadvantage to using the interpeak intervals is that wave I cannot always be identified if peripheral hearing loss is mild, moderate, or severe. In these cases, the examiner must rely on the absolute latencies or interaural latency difference measures for interpretation. When all three measures—absolute latency, interaural latency difference, and interpeak intervals—are used collectively, the sensitivity of BAEP for CN VIII lesions is more than 90%,<sup>7–10</sup> and the specificity for cochlear hearing loss is nearly 90%.<sup>7</sup>

### Key Points

- Interpretation of results is based on absolute latencies, interaural latency differences, and interpeak intervals.
- Absolute latencies are often influenced by peripheral (conductive, cochlear) disorders, that is, the greater the degree of hearing loss, the greater the latency delay.
- Interaural latency differences for wave V allow for the patient to serve as his or her own control.
- Interaural latency differences greater than 0.4 ms are often considered suggestive of CN VIII disorders.
- Interpeak intervals are increased by lesions of CN VIII, the pons, and medulla.
- Interpeak intervals are not affected by moderate-to-severe levels of cochlear or conductive hearing loss.

### APPLICATIONS

Absolute latencies of waves I, III, and V have been compared between patients with CN VIII tumors (tumor group) and patients with cochlear hearing loss (nontumor group) matched for pure-tone audiometric configurations. Mean wave-I absolute latencies are usually similar between tumor and nontumor groups, but mean latencies for waves III and V are prolonged by as much as 1 ms for the tumor group. The range of latencies for waves I, III, and V is also considerably larger for patients in the tumor group than for patients in the

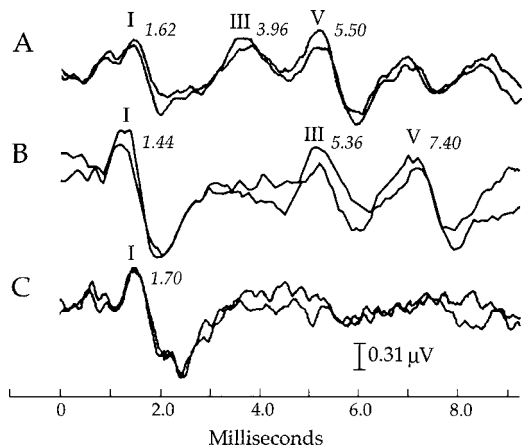
nontumor group who have a similar degree of cochlear hearing loss.

Interaural latency differences that exceed the 0.4-ms criterion identify more than 90% of the patients with CN VIII tumors. If the criterion is decreased to 0.3 ms, the rate of tumor detection increases only slightly and the number of patients with cochlear hearing loss that exceeds the 0.3-ms criterion is substantial. The 0.4-ms criterion for interaural latency differences appears to be a reasonable compromise.<sup>6</sup>

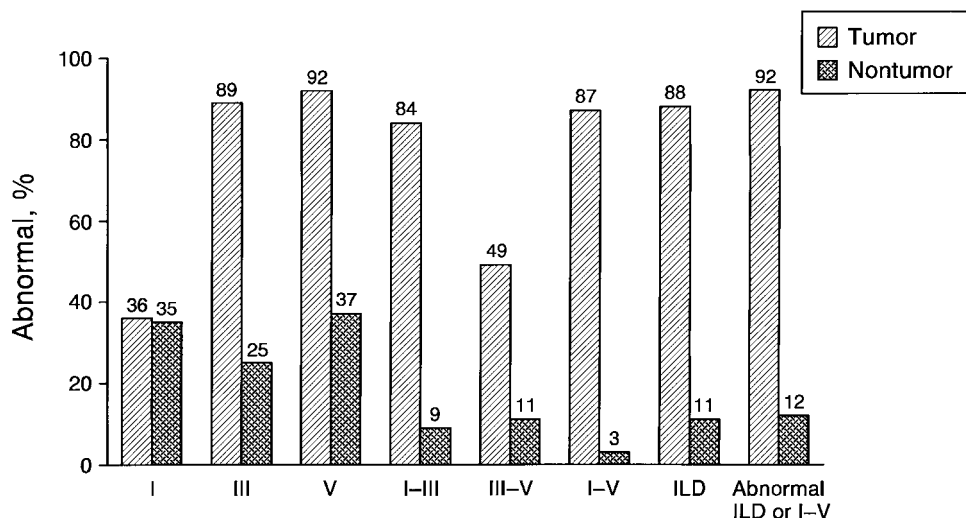
Interpeak intervals have also been compared between tumor and nontumor groups matched for hearing loss. The mean I–III interval for the tumor group exceeds that of the nontumor group by approximately 0.6 ms, whereas the mean III–V interval is similar for both groups. The mean overall I–V interval is larger by nearly a whole millisecond for the tumor group. Only rarely does the I–V interpeak interval for patients in the nontumor group exceed 4.54 ms.

BAEP waveforms for a person with normal hearing (A) and for patients with a tumor of CN VIII (B and C) are shown in Figure 21–2. The normal tracing (A) is well defined and depicts waves I, III, and V at the appropriate latencies. The lower tracings show abnormal I–III and I–V interpeak intervals (B) or the absence of waves following wave I (C).

Various BAEP latency indices and their sensitivity and specificity for CN VIII lesions are shown in Figure 21–3. These results were



**Figure 21–2.** BAEP recordings showing, A, normal waveforms (I, III, V) and, B and C, abnormal waveforms of patients with a CN VIII tumor.



**Figure 21-3.** Percentage of abnormal (delayed or absent) BAEPs for 75 patients without tumor (nontumor) and 75 patients with CN VIII tumor (tumor) matched for hearing loss. I, III, V, BAEP waves; I-III, III-V, I-V, interpeak intervals; ILD, wave-V interaural latency difference. (From Bauch, C. D., W. O. Olsen, and A. F. Pool. 1996. ABR indices: Sensitivity, specificity, and tumor size. *American Journal of Audiology* 5:97-104. By permission of the American Speech-Language-Hearing Association.)

obtained from 75 patients with confirmed CN VIII tumors who were matched audiometrically with 75 patients with cochlear hearing loss.<sup>7</sup> The highest sensitivity for this group of CN VIII tumors was 92% when using abnormal wave-V interaural latency difference (greater than 0.4 ms) or abnormal I-V interpeak interval. The specificity with these same criteria was 88% (false-positive rate of 12%). Absolute latency measures for waves III and V are also sensitive for retrocochlear disorders, but they have an unacceptably high false-positive rate (25% and 37%, respectively) because of the influence of cochlear hearing loss.

Tumor size influences the sensitivity of traditional BAEP latency measurement for patients in the tumor and nontumor groups (Fig. 21-4). In a study that compared tumor size, five BAEP indices had a sensitivity of 100% if the tumor was larger than 2 cm. However, if the tumor was 1 cm or smaller, the best sensitivity was 82%.

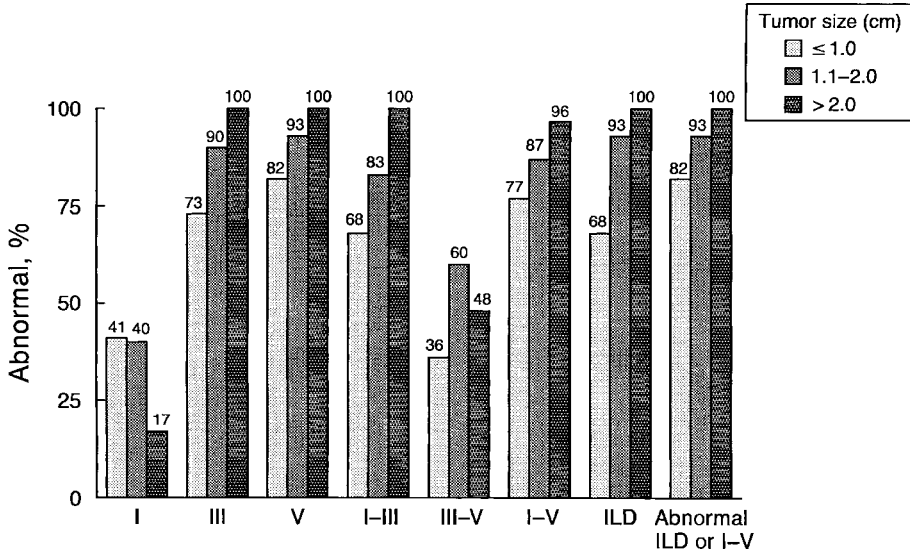
A recent BAEP method having potentially higher sensitivity to smaller tumors (<1 cm) is referred to as the *stacked ABR* (auditory brain stem response).<sup>11</sup> Rather than relying on various latency measurements obtained with standard BAEP testing, the stacked ABR procedure uses special amplitude measurements. The underlying theory is that any reduction in

synchronous neural activity due to a tumor will result in a reduction of the BAEP amplitude. Although very time-consuming, preliminary studies with the stacked ABR amplitude technique have reported high sensitivity (95%) for small tumors.<sup>2,11</sup> Further studies with the stacked ABR are underway.

### Key Points

- Applications of latency measures help separate cochlear from retrocochlear disorders.
- Overall sensitivity of BAEP is 92% for patients with a CN VIII tumor.
- Interaural latency differences >0.4 ms identify approximately 90% of patients with CN VIII tumors without an excessively high false-positive rate for cochlear hearing losses.
- Interpeak intervals >4.54 ms for waves I-V strongly suggest retrocochlear involvement.
- Absolute latency measures often indicate retrocochlear pathology for patients having cochlear hearing losses.
- Traditional BAEP measurements successfully identify CN VIII tumors larger than 2.0 cm, but are less sensitive for CN VIII tumors that are 1 cm or smaller.





**Figure 21-4.** Percentage of abnormal (delayed or absent) BAEPs for 75 patients with CN VIII tumor as a function of tumor size. I, III, V, BAEP waves; I-III, III-V, I-V, interpeak intervals; ILD, wave-V interaural latency difference. (From Bauch, C. D., W. O. Olsen, and A. F. Pool. 1996. ABR indices: Sensitivity, specificity, and tumor size. *American Journal of Audiology* 5:97-104. By permission of the American Speech-Language-Hearing Association.)

**SUMMARY**

Hearing sensitivity in the 2000-4000 Hz range is important to BAEP assessment. Absolute latencies and interaural latency differences are often affected by increasing degrees of hearing loss in this frequency range, whereas interpeak intervals are relatively stable measures, even for patients with moderate-to-severe degrees of peripheral hearing loss. However, the reduction in amplitude or the absence of a measurable wave I associated with peripheral hearing losses often makes it difficult or impossible to measure I-III or I-V intervals. Overall sensitivity of BAEP is 92% for patients with a CN VIII tumor. The false-positive rate for patients with cochlear hearing loss is 12%. Tumor size influences BAEP test results: the sensitivity is 100% for CN VIII tumors larger than 2 cm, but it is only 82% for CN VIII tumors 1 cm or smaller.

**REFERENCES**

1. Hall, J. W. 1992. *Handbook of auditory evoked responses*. Boston: Allyn and Bacon.
2. Musiek, F. E., J. B. Shinn, and R. E. Jirsa. 2007. The auditory brainstem response in auditory nerve and brainstem dysfunction. In *Auditory evoked potentials: Basic principles and clinical application*, ed. R. F. Burkard, M. Don, and J. J. Eggermont. Baltimore: Lippincott Williams and Wilkins.

3. Bauch, C. D., and W. O. Olsen. 1990. Comparison of ABR amplitudes with TIPtrode and mastoid electrodes. *Ear and Hearing* 11:463-7.
4. Jiang, Z. D., L. Zhang, Y. Y. Wu, and X. Y. Liu. 1993. Brain stem auditory evoked responses from birth to adulthood: Development of wave amplitude. *Hearing Research* 68:35-41.
5. Burkard, R. F., and M. Don. 2007. The auditory brainstem response. In *Auditory evoked potentials, basic principles and clinical application*, ed. R. F. Burkard, M. Don, and J. J. Eggermont. Baltimore: Lippincott Williams and Wilkins.
6. Bauch, C. D., and W. O. Olsen. 1989. Wave V interaural latency differences as a function of asymmetry in 2,000-4,000 Hz hearing sensitivity. *American Journal of Otolaryngology* 10:389-92.
7. Bauch, C. D., W. O. Olsen, and A. F. Pool. 1996. ABR indices: Sensitivity, specificity, and tumor size. *American Journal of Audiology* 5:97-104.
8. El-Kashlan, H. K., D. Eisenmann, and P. R. Kileny. 2000. Auditory brain stem response in small acoustic neuromas. *Ear and Hearing* 21:257-62.
9. Haapaniemi, J. J., E. T. Laurikainen, R. Johansson, T. Rinne, and M. Varpula. 2000. Audiovestibular findings and location of an acoustic neuroma. *European Archives of Oto-Rhino-Laryngology* 257: 237-41.
10. Schmidt, R. J., R. T. Sataloff, J. Newman, J. R. Spiegel, and D. L. Myers. 2001. The sensitivity of auditory brain stem response testing for the diagnosis of acoustic neuromas. *Archives of Otolaryngology Head & Neck Surgery* 127:19-22.
11. Don, M., B. Kwong, C. Tanaka, D. Brackmann, and R. Nelson. 2005. The Stacked ABR: A sensitive and specific screening tool for detecting small acoustic tumors. *Audiology and Neurotology* 10(5):274-90.



# Visual Evoked Potentials

Jonathan L. Carter

## INTRODUCTION VISUAL SYSTEM ANATOMY AND PHYSIOLOGY VISUAL EVOKED POTENTIALS: METHODS

Stimulation  
Recording

## FACTORS AFFECTING THE VEP RESPONSE

Visual acuity  
Pupillary size  
Age and gender

Patient cooperation  
Sedation and anesthesia

## INTERPRETATION OF VEPs LOCALIZATION OF VISUAL SYSTEM LESIONS

Anterior Visual Pathway  
(Prechiasmatic or Chiasmatic) Lesions  
Visual Evoked Potentials in  
Multiple Sclerosis  
Other Anterior Visual Pathway Lesions  
Posterior Visual Pathway  
(Retrochiasmatic) Lesions

## SUMMARY

## INTRODUCTION

*Visual evoked potentials* (VEPs) are noninvasive studies that measure the evoked responses to visual stimuli and assess the visual conduction pathways through the optic nerves and brain. VEPs allow a quantitative determination of visual function and are highly sensitive to lesions of the optic nerve and anterior chiasm but relatively insensitive to ophthalmologic disorders. They are usually performed in cooperative patients with good visual acuity.

Pattern-reversal VEPs are performed by using a shift of a checkerboard pattern without changing luminance. Monocular visual stimulation is always preferred. In normal subjects, the visual stimulus evokes a prominent waveform with positive polarity in the posterior head region at a mean latency of approximately 100 ms. This potential, the *P1*

or *P100* wave, is generated by striate and peristriate occipital cortex after visual stimulation. The most common transient VEP abnormality in patients with anterior visual pathway lesions is prolonged latency of the *P100* wave.

Monocular *P100*-wave alterations in latency have a higher diagnostic yield than physical examination findings in patients with optic neuritis. Full-field visual stimulation usually does not demonstrate abnormality in patients with unilateral retrochiasmatic lesions. The results of VEP studies in cases of bilateral optic nerve lesions may be indistinguishable from those of bilateral retrochiasmatic lesions. Alterations in test methods can assist with delineating retrochiasmatic lesions.

This chapter reviews the method, interpretation, and clinical applicability of transient full-field pattern-reversal VEPs in patients with neurologic disease.

### **Purpose and Role of VEPs**

- To provide a quantitative determination of visual function through the visual conduction pathways.
- To assess for clinical or subclinical lesions in the optic nerve or anterior chiasm, such as when evaluating a patient with multiple sclerosis (MS).

## **VISUAL SYSTEM ANATOMY AND PHYSIOLOGY**

The visual system functions at several levels, beginning with the retina and terminating in several regions of the cerebral cortex<sup>1</sup> (Fig. 22–1, for color image, see color plates). Each eye projects to both occipital lobes through the decussation of the axons from the nasal half of each retina. Important structures involved in visual conduction include the macula, optic nerve, optic chiasm, optic tract, lateral geniculate body in the thalamus, and thalamocortical pathways. The macula at the posterior pole of the retina is specialized for high-acuity central vision. The primary visual system projects to striate and peristriate areas of the occipital cortex (Brodmann areas 17, 18, and 19). The occipital cortex projects to the midtemporal cortex and the posterior parietal cortex. Cells in the visual cortex are most sensitive to movement and to edges. The retina topographically transmits visual information to the occipital cortex. The macula projects to the occipital poles, and more peripheral regions of the retina project to medial calcarine cortex. Different features of a visual stimulus activate specific neurons in the visual system. For example, certain neuronal groups in the retina and lateral geniculate body are involved primarily in detecting visual motion or color. Neurons in the visual cortex also appear to demonstrate these unique electrophysiologic properties.

### **Key Points**

- The macula is specialized for high-acuity central vision and projects to the occipital poles.
- The visual system projects to the striate and peristriate areas of the occipital cortex.
- Cells in the visual cortex are most sensitive to movement and edges.

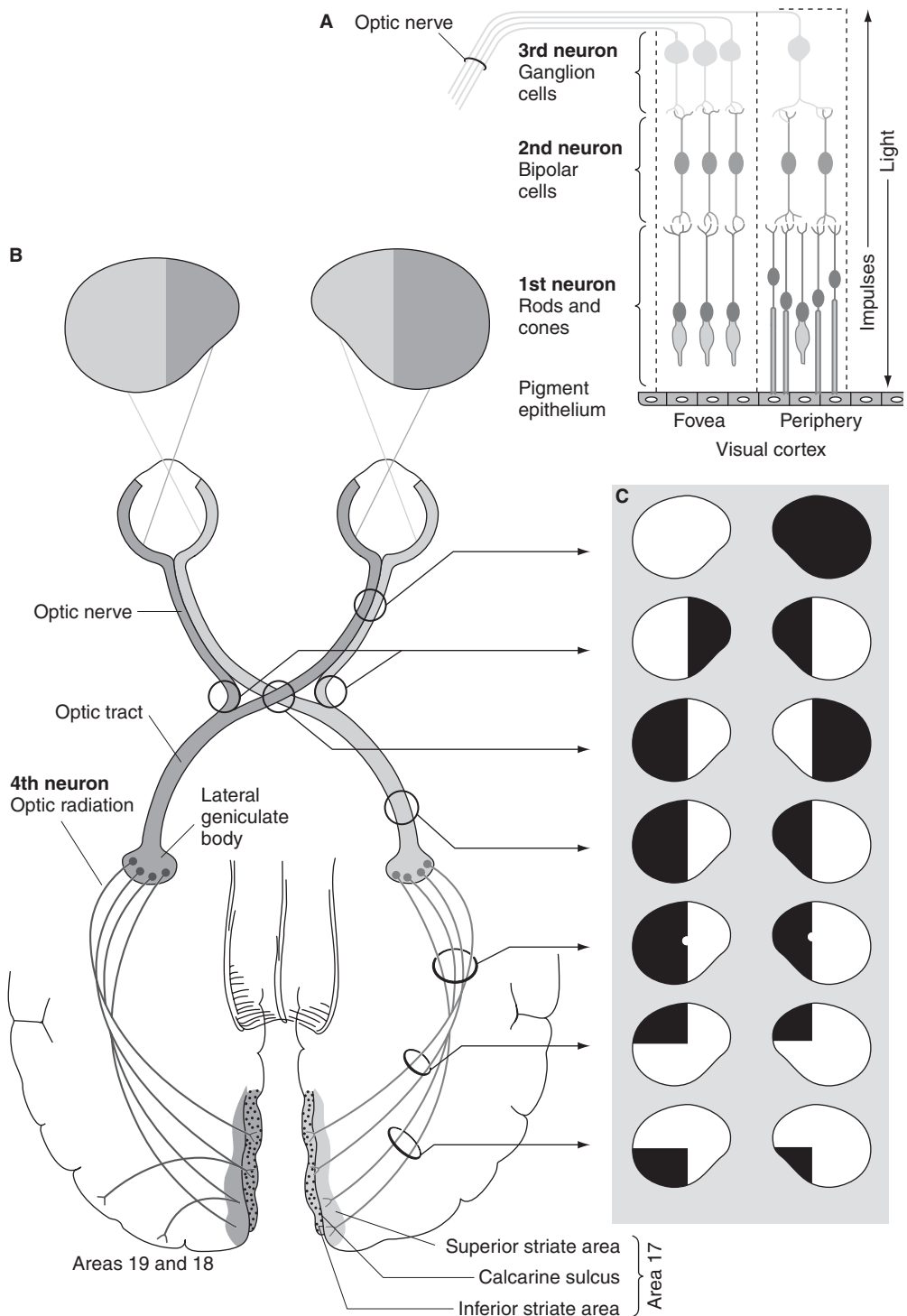
## **VISUAL EVOKED POTENTIALS: METHODS**

Visual evoked potentials are performed by stimulating the visual fields, usually with a checkerboard visual stimulus, and recording the evoked response using surface recording electrodes over the occipital lobe.

### **Stimulation**

Pattern-reversal VEP studies generally are performed with a shift of a checkerboard pattern (black and white). No change in luminance (total light output) occurs with this form of stimulation.<sup>2</sup> Studies that change luminance, for example pattern-flash or strobe light, produce more variable results in normal subjects and are not as sensitive for detecting abnormalities in visual conduction. Flash VEPs may be appropriate for intraoperative monitoring of visual function.<sup>3</sup> Monocular testing is preferred because binocular stimulation may mask a unilateral visual conduction abnormality. The patient is seated at a fixed distance, 70–100 cm, from the screen (usually a television monitor) and is asked to focus on the center of the screen. In certain situations, the technician may need to verify that the patient is looking at the screen. The patient should not be sedated before being examined.

The size of the checks used in the checkerboard pattern may affect the amplitude and latency of the P100 wave.<sup>4</sup> The checks are measured by the degree of visual angle (minutes of arc [']). Checks that are between 28' and 31' are associated with stimulation of the central retina and are usually satisfactory.<sup>5</sup> Larger check sizes may be necessary in patients with decreased visual acuity. A decrease in check size to 10' in people with normal acuity is associated with an increase in the amplitude and latency of the P100 wave. The fovea is most sensitive to smaller checks and makes the largest contribution to the P100 amplitude.<sup>6</sup> However, smaller check sizes are inherently sensitive to ophthalmologic disorders, including poor visual acuity, and are not used routinely in performing VEPs. VEPs are routinely performed with full-field stimulation. Hemifield stimulation can be performed in an attempt to localize retrochiasmatic lesions. A normal response to



**Figure 22-1.** Neuroanatomy of central visual pathways. (From Baehr, M., M. Frotscher, and P. Duus. 2005. *Topical diagnosis in neurology: Anatomy, physiology, signs, symptoms*, trans. E. Taub. Stuttgart: Thieme Medical Publishers. #81. By permission of the publisher.)

hemifield stimulation shows *paradoxical localization*, which refers to an ipsilateral distribution of the P100 wave to the hemifield being stimulated.

The checkerboard pattern is reversed (black to white to black) at a rate of 1 or 2 per second. An increase of the stimulus rate to 4 per second or greater may prolong the P100 latency. Steady-state VEPs obtained with stimulus rates of 8–10 per second are technically more difficult to perform and are not commonly used to evaluate patients with suspected neurologic disease.<sup>5</sup>

## Recording

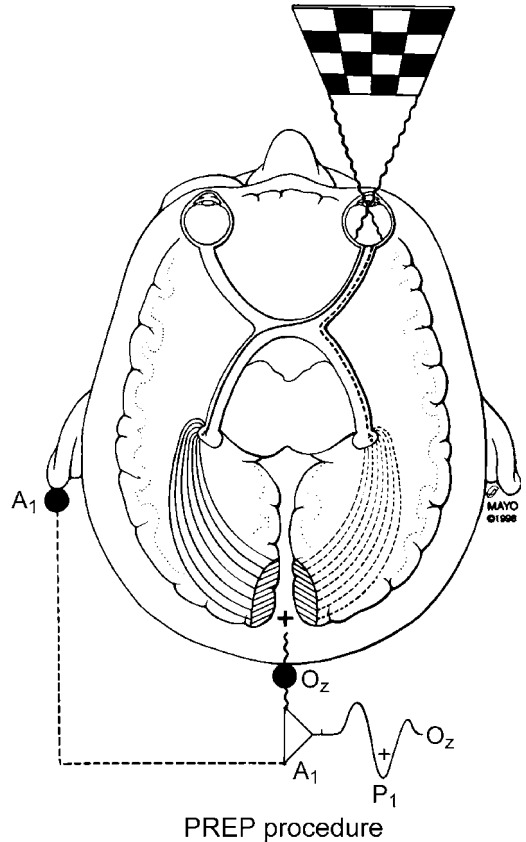
Electrodes are placed at Cz, Oz, A1, and Fz (Fig. 22–2). Other acceptable electrode positions include midoccipital (5 cm above the inion), right and left occipital (5 cm lateral to the midoccipital electrode), and midfrontal (12 cm above the nasion) regions. With full-field stimulation, the P100 waveform is maximal in the midoccipital region but may be well recorded between the inion and the vertex of the head.

The low-frequency filter may range between 0.2 and 1.0 Hz; the high-frequency filter should be 200–300 Hz. A sweep length of 200–250 ms is used, and 100–200 responses are averaged. Increasing the number of responses may produce a more favorable signal-to-noise ratio, but the subject may find it difficult to maintain fixation for a longer time. At least two trials should be performed before the P100 latency is identified. The trials should be reproducible. The American Electroencephalographic Society guidelines recommend a check size of approximately 30'.<sup>7</sup>

The procedure for performing a VEP test should be explained to the patient before the study is initiated. Visual acuity and pupillary size should be determined in each eye of the patient before the study is performed. If appropriate, the patient should wear his or her eyeglasses or contact lenses for the study. Mydriatic drops should not be used before the procedure.

### Key Points

- Pattern-reversal VEP studies are performed with a shift of a checkerboard pattern at a rate of 1–2 Hz.



**Figure 22–2.** Electrode placement for visual evoked potential recordings.

- Faster stimulus rates (>4 Hz) may prolong the P100 latency.
- The size of the checks used in the checkerboard pattern may affect the amplitude and latency of the P100 wave.
- Larger check sizes may be needed in patients with decreased visual acuity.
- A decrease in check size is associated with an increase in the amplitude and latency of the P100 wave.
- Monocular testing is preferred because binocular stimulation may mask a unilateral visual conduction abnormality.

## FACTORS AFFECTING THE VEP RESPONSE

A normal transient VEP to a pattern-reversal checkerboard is a positive midoccipital peak that occurs at a mean latency of 100 ms (Fig. 22–3).<sup>8</sup> The waveform consists of three

separate phases: an initial negative deflection ( $N_1$  or  $N_{75}$ ), a prominent positive deflection ( $P_1$  or  $P_{100}$ ), and a later negative deflection ( $N_2$  or  $N_{145}$ ). The numbers used for the waveform designation refer to the approximate latency (in milliseconds) in the normal population. The amplitude and latency of the  $N_1$  and  $N_2$  waveforms are too variable in normal subjects to be useful in interpreting VEPs in patients with neurologic diseases.

A number of physiological and technical factors may affect the response recorded with VEPs. Visual acuity, pupillary size, age, and sex may alter the  $P_{100}$  waveform in normal subjects.<sup>5</sup>

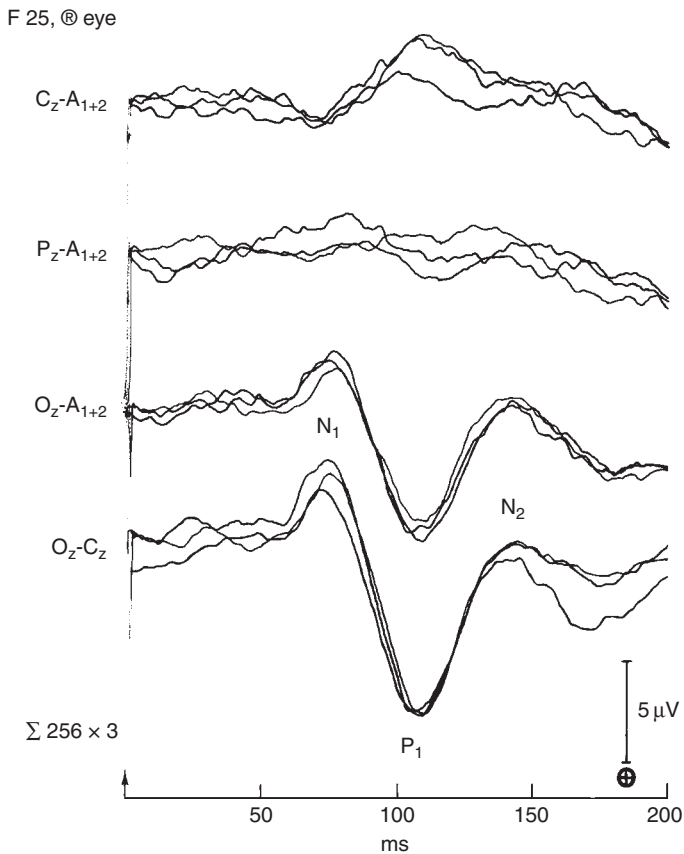
### Visual acuity

In the absence of an alteration in luminance, visual acuity must be decreased to 20/200

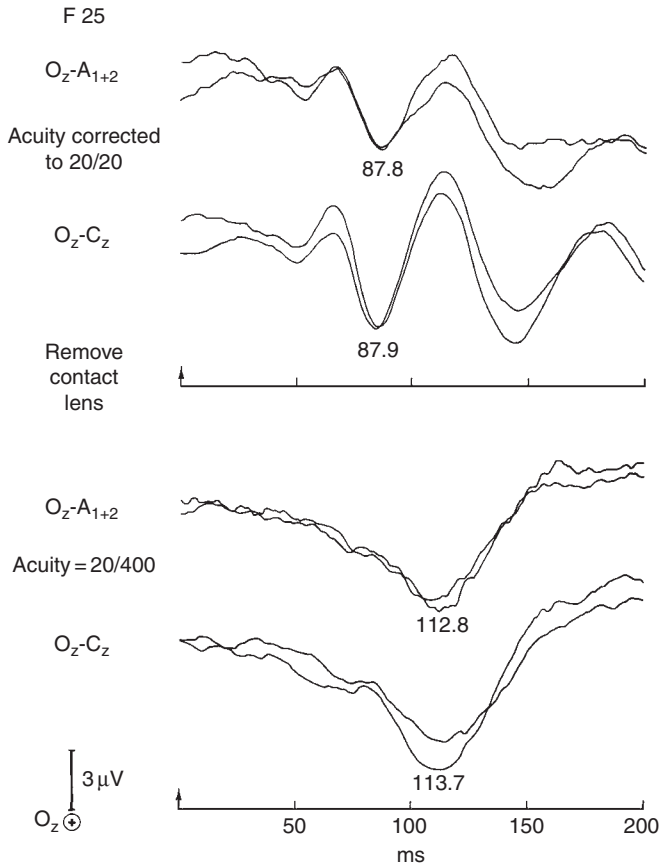
before the  $P_{100}$  latency becomes abnormal (Fig. 22-4).  $P_{100}$  latency is not prolonged with visual acuity of 20/200 or worse if large checks (greater than  $35'$ ) are used. Therefore, subtle changes in visual acuity, for example 20/40, do not explain significant prolongations of  $P_{100}$  latency.

### Pupillary size

Patients who have an asymmetry in pupillary diameter may have interocular differences in  $P_{100}$  latency. Therefore, patients should not have their pupils dilated before undergoing VEP studies. A miotic pupil may reduce luminance and prolong the latency and decrease the amplitude of  $P_{100}$ . A pharmacologically dilated pupil may increase the luminance and produce distorted waveforms.



**Figure 22-3.** Full-field visual evoked potential after stimulation of the right eye of a 25-year-old woman.  $P_1$  waveform is maximal in the posterior head region ( $O_z$  electrode);  $P_1$  amplitude and latency are normal. (From Stockard, J. J., J. F. Hughes, and F. W. Sharbrough. 1979. Visual evoked potentials to electronic pattern reversal: Latency variations with gender, age, and technical factors. *American Journal of EEG Technology* 19:171-204. By permission of the American Society of Electroneurodiagnostic Technologists.)



**Figure 22-4.** Full-field VEP obtained with and without a contact lens. *Top*, P1 amplitude and latency are normal. *Bottom*, With reduction of visual acuity to 20/400, P1 morphology is distorted and latency is prolonged.

**Age and gender**

Age is a significant variable in determining normal P100 latency. The latency increases with age and may be more marked in those older than 60 years. Also, women have a shorter P100 latency than men. This factor has to be considered when deciding on normative data for P100 latency.

**Patient cooperation**

If a normal subject chooses not to look directly at the screen used for visual stimulation, the P100 waveform may be distorted. Patient cooperation may be extremely important in a person with psychiatric disease and in very young and old people. Patients with oculomotor disorders (i.e., pendular nystagmus) may not be able to voluntarily fixate on the screen.

**Sedation and anesthesia**

Because sedation and anesthesia abolish VEPs, these studies are not useful for intraoperative neurophysiologic monitoring. Flash VEPs can be used in such situations, but the information gathered is more qualitative than quantitative.<sup>3,5</sup>

**Key Points**

- Technical parameters must be standardized and normal values adjusted for both age and gender before interpreting VEPs.
- Factors such as visual acuity, pupillary size, patient inattention, or failure to fixate on the screen may produce erroneous VEP results.
- Visual acuity must be decreased to 20/200 before the P100 latency becomes abnormal.



- Patients with an asymmetry in pupillary diameter may have interocular differences in P100 latency.
- The VEP may be altered in patients with oculomotor disorders or in those who are unable to cooperate and cannot voluntarily fixate on the screen.
- Sedation and anesthesia can abolish VEPs.

## INTERPRETATION OF VEPs

The interpretation of VEPs in patients with suspected neurologic disease begins with the identification of the amplitude and latency of the P100 wave. The results of VEP studies in normal subjects should be available in the laboratory to determine whether an absolute P100 latency and the interocular difference in latency are abnormal (Table 22–1). Each evoked potential laboratory preferably should have its own normative data. An acceptable alternative is to use published normal values obtained at a reference laboratory. Before VEP studies are performed, however, at least 20 normal subjects should be examined with methods similar to those of the reference laboratory. P100 latencies and interocular differences in latencies greater than the mean plus three standard deviations are often used to identify abnormal studies. Absolute amplitude determinations are not particularly useful when interpreting a VEP study. An interocular difference in amplitude greater than 50% may be considered abnormal if the asymmetry cannot be explained by technical factors.<sup>6</sup> However, amplitude abnormalities usually occur with latency abnormalities as well. Certain lesions in the visual pathway may distort amplitude more than latency. In reporting VEP studies, the anatomical localization (or the lack thereof) of the lesion in the visual

pathway and the lack of specificity must be emphasized.

VEP studies provide an objective physiologic measure that complements the results obtained for the clinical history and examination and from neuroimaging. Categories of clinical problems to which VEP studies can be applied include the following:

1. Confirmation of a visual system abnormality in the presence of current equivocal visual symptoms and signs.
2. Confirmation of a visual system abnormality in the presence of known or suspected diffuse or multifocal central nervous system disease.
3. Confirmation of a visual system abnormality when functional recovery has occurred after a past visual system insult. The classic example is finding a P100 latency delay after a patient has recovered from an episode of optic neuritis in the past.
4. Producing evidence for the nature of the pathologic process.<sup>9</sup> Demyelinating disease (e.g., multiple sclerosis) usually produces significant P100 latency delays, with relative preservation of amplitude. Compressive or ischemic lesions often show amplitude loss, with relative preservation of latency. VEP changes in degenerative disease are more nonspecific, and small changes in latency and amplitude are seen.
5. Localization of visual system lesions (this is considered below under the section Localization of Visual System Lesions).

### Key Points

- The P1 or P100 wave is the most reproducible and clinically useful waveform in normal subjects or in those with neurologic disease.
- Abnormalities in VEP latencies are much more important diagnostically than abnormalities of VEP amplitude.
- VEPs may provide objective evidence of a current or previous lesion in visual pathways.
- While VEP changes are nonspecific, the finding of prolonged latencies suggests a demyelinating process.

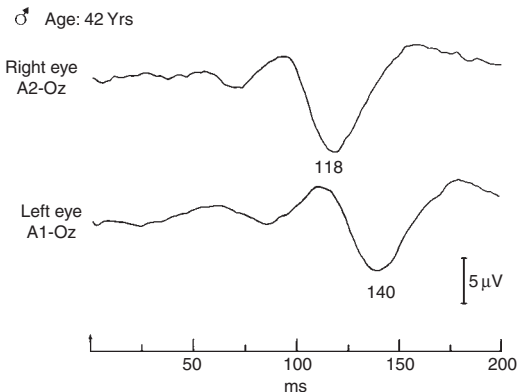
Table 22–1 Normative P1 Latency Values Used at Mayo Clinic

Age, year	LATENCY (ms)	
	Females	Males
Less than 60	<115	<120
60 or older	<120	<125

## LOCALIZATION OF VISUAL SYSTEM LESIONS

### Anterior Visual Pathway (Prechiasmatic or Chiasmatic) Lesions

Transient full-field VEPs are highly sensitive to anterior visual conduction lesions. Unilateral P100 abnormalities indicate a visual conduction defect anterior to the optic chiasm (Fig. 22–5). An abnormal interocular difference in P100 latency when both P100 values are normal suggests an optic nerve lesion on the side of the increased value. Bilateral increased P100 latency values can be found with bilateral optic nerve lesions, a chiasmatic lesion, or bilateral retrochiasmatic lesions (Fig. 22–6). However, if the interocular difference is abnormal when both P100 latencies are prolonged, bilateral retrochiasmatic lesions are less likely. It should be emphasized that VEP abnormalities are nonspecific, and do not identify the pathology underlying these changes.

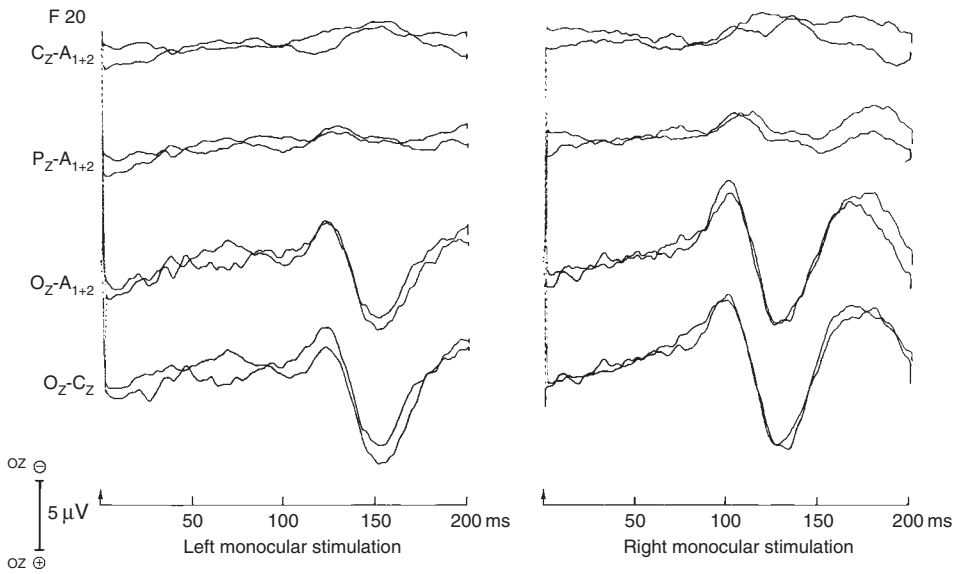


**Figure 22–5.** Full-field VEP in a 42-year-old man with MS and optic neuritis in the left eye. P1 latency and amplitude are normal with stimulation of the unaffected right eye. Absolute P1 latency is prolonged and the interocular difference is abnormal with stimulation of the left eye. Note that the amplitude in the lower tracing is preserved. This study suggests an anterior conduction defect on the left. (From Benarroch E. E., B. F. Westmoreland, J. R. Daube, T. J. Reagan, and B. A. Sandok. 1999. *Medical neurosciences: An approach to anatomy, pathology, and physiology by systems and levels*, 4th ed., 592. Philadelphia: Lippincott Williams & Wilkins. By permission of Mayo Foundation for Medical Education and Research.)

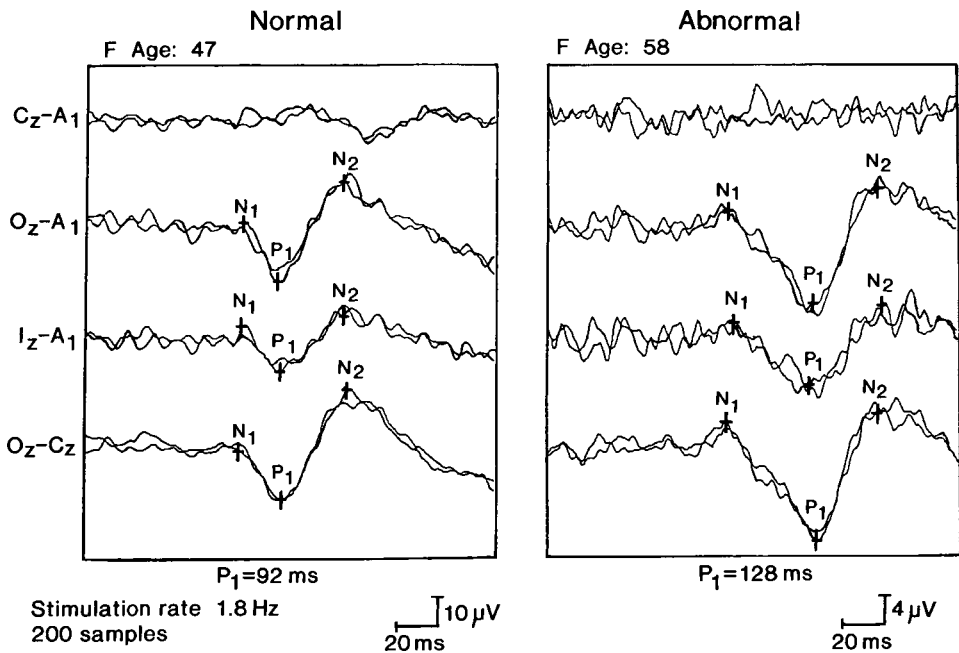
### Visual Evoked Potentials in Multiple Sclerosis

The most common neurologic disease associated with a unilateral P100 abnormality is demyelinating disease. An alteration of VEPs may be identified in patients with a history of optic neuritis who characteristically have no abnormality on physical examination. The sensitivity of VEPs may be superior to that of magnetic resonance imaging (MRI) of the optic nerves in patients with optic nerve lesions due to demyelinating disease, even when triple-dose gadolinium with delayed imaging is used to image the optic nerve.<sup>10</sup> VEPs should be used to complement other neurodiagnostic studies and should be correlated with the clinical presentation before the diagnosis of demyelinating disease is made. VEPs may be useful diagnostically in demonstrating a lesion in the optic nerve in patients with suspected MS, who have disease localized to the cerebral hemispheres or spinal cord. VEPs are abnormal in 85% of patients with *clinically definite* MS, 58% of those with *probable* MS, and 37% of those with *possible* MS.<sup>3</sup> VEPs will detect clinically unsuspected lesions in approximately 37%–41% of patients with MS. The most common VEP abnormality in patients with optic neuritis is an ipsilateral P100 latency prolongation (Figs. 22–5 and 22–7). This may be shown by an abnormality in the absolute P100 latency or with a prolonged interocular difference. The amplitude of the P100 wave may be normal even when the latency is markedly prolonged, especially after recovery from acute optic neuritis. Virtually all patients with clinically demonstrated optic neuritis have unilateral or bilateral abnormalities in VEPs.

In acute optic neuritis with severe alteration in visual acuity, a P100 wave may not be recorded. VEP amplitudes usually recover within 3 months after an episode of acute optic neuritis and parallel the recovery in visual acuity. The VEP may remain abnormal even years after the optic neuritis has resolved; however, improvement may also occur over time. One series found that 17 out of 60 eyes “improved” by at least 10 ms in latency with serial VEPs over 2 years.<sup>11</sup> Another series found normal P100 latencies in only 3% of patients 3 months after an episode of acute optic neuritis. After 2 years, however, the P100 latencies were normal in 10% of affected



**Figure 22-6.** P1 latencies are prolonged bilaterally, maximal on the left, in a patient who subsequently was shown to have demyelinating disease. (From Stockard, J. J., J. F. Hughes, and F. W. Sharbrough. 1979. Visual evoked potentials to electronic pattern reversal: Latency variations with gender, age, and technical factors. *American Journal of EEG Technology* 19:171-204. By permission of the American Society of Electroneurodiagnostic Technologists.)



**Figure 22-7.** Full-field VEP in a normal subject (*left*) and in a patient with an anterior visual conduction defect (*right*). Note that the P1 latency is prolonged in the patient, with preservation of P1 amplitude.

eyes.<sup>12</sup> Possible mechanisms for this improvement in latency include ion channel redistribution in the demyelinated optic nerve, partial remyelination of the optic nerve, or cortical reorganization in the occipital cortex.

Patients may also experience gradual prolongation of P100 latencies over time in the absence of new clinical attacks of optic neuritis.<sup>13</sup> This situation is suggestive of a chronic progressive optic neuropathy and resembles the

progressive worsening in other functional systems that occurs during the progressive phases of MS. Patients with optic neuritis may have a “bifid” P100 waveform, also known as a “W” waveform, where there is a small negative peak in the middle of the large positive deflection. While this finding can be seen in normal individuals, it appears to be more common in MS according to some authors.<sup>14</sup>

VEPs have been incorporated into the McDonald Criteria for the diagnosis of MS (2001) and the revised McDonald Criteria (2005).<sup>15,16</sup> A “positive” VEP is defined as a “delayed but well-preserved” waveform. VEPs are most useful in the McDonald Criteria in the diagnosis of primary progressive MS, where they form one of the criteria for dissemination of lesions in space, providing evidence for a second objective lesion in the central nervous system (Fig. 22–8).

### Key Points

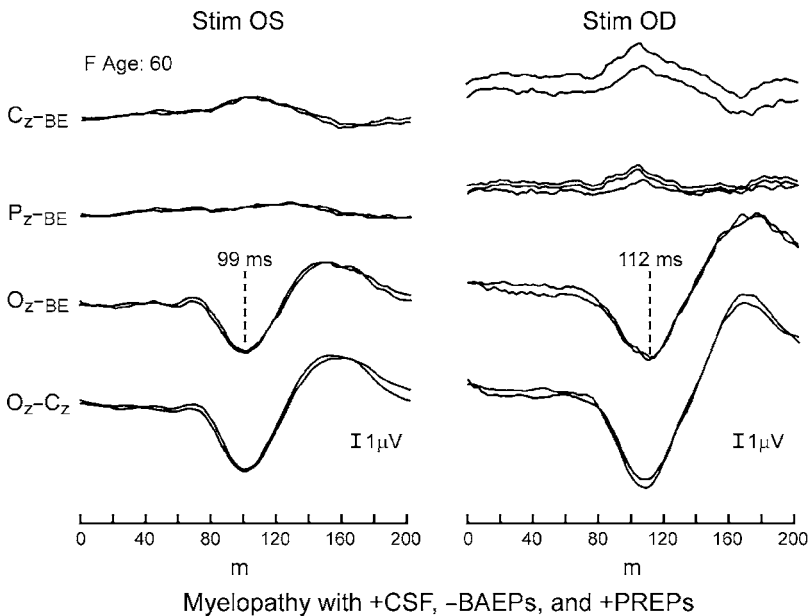
- Optic neuritis due to MS is the most common cause of VEP abnormalities, usually prolonged P100 latency.
- VEP latencies may remain abnormal for years after an episode of optic neuritis, or may “improve” or “worsen” over time without further clinical attacks of optic neuritis.

- A “delayed but well-preserved” P100 waveform is defined as a “positive” VEP in the McDonald Criteria for diagnosis of MS, and may be particularly useful in the diagnosis of primary progressive MS.

### Other Anterior Visual Pathway Lesions

Tumors compressing the optic nerve and optic chiasm or occurring within the optic nerve may be associated with a unilateral P100 abnormality.<sup>3,17</sup> P100 latency may be prolonged; but more commonly, the amplitude is decreased disproportionately to the change in latency. The morphology of the VEP may be markedly distorted, and occasionally the P100 wave may not be recorded. Neoplasms associated with optic nerve compression include optic nerve gliomas, meningiomas, craniopharyngiomas, and pituitary tumors. Giant aneurysms may produce a similar optic nerve lesion. Improvement in P100 waveforms may occur after surgical removal of the tumor.

Other anterior visual pathway lesions that may be associated with an abnormality in full-field VEPs include anterior ischemic optic neuropathy, toxic (drug-induced) amblyopia, glaucoma, and Leber’s optic atrophy.<sup>2</sup> The results



**Figure 22–8.** VEPs in a 60-year-old female who presented with a slowly progressive myelopathy over the preceding 2 years. Unilateral prolongation of P100 latency on the right gave evidence for dissemination of lesions in space, confirming a diagnosis of primary progressive MS.

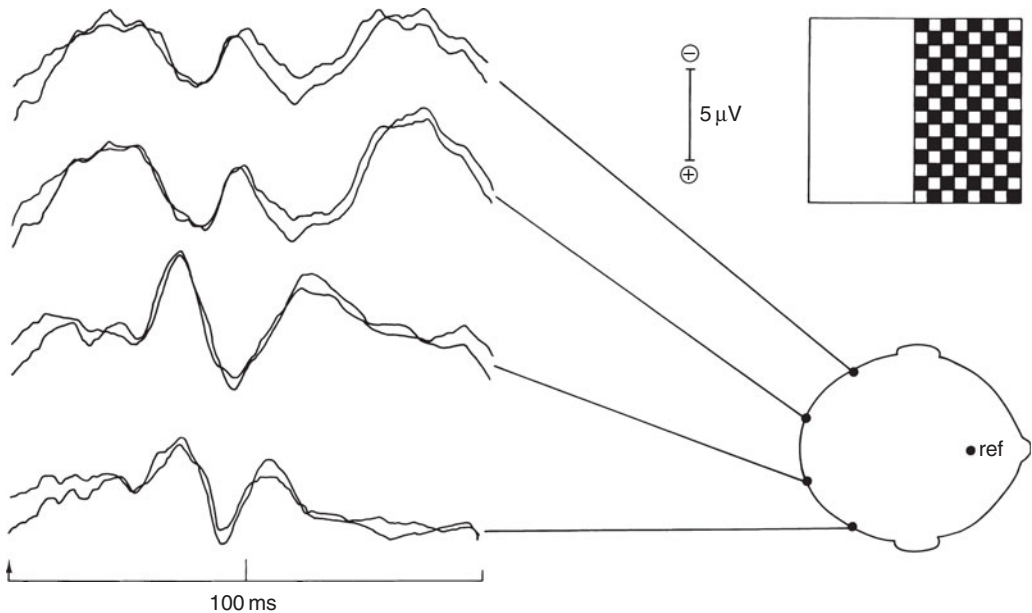
of the electrophysiologic studies must be correlated with the clinical presentation to confirm these diagnoses.

### Posterior Visual Pathway (Retrochiasmatic) Lesions

The recording of full-field VEPs from the midoccipital region usually does not show any P100 abnormality in patients with unilateral posterior visual conduction defects. Bilateral P100 abnormalities are seen in retrochiasmatic lesions, but this VEP result is nonlocalizing and nonspecific. MRI has been shown to be more useful than full-field transient VEPs in evaluating patients with retrochiasmatic lesions.<sup>18</sup> Full-field VEPs may be normal even in patients with abnormal neuroimaging findings retrochiasmatically or visual field defects or both. The diagnostic yield of VEPs is increased with partial-field stimulation in patients with posterior visual conduction defects.<sup>5</sup> Partial-field studies are not commonly performed and require a modified method. They require the additional placement of lateral temporal electrodes (Fig. 22-9) (see Chiappa<sup>5</sup> for a more complete discussion of the method

and interpretation of partial-field studies). The clinical applicability of partial-field VEPs is uncertain because of developments in quantitative visual perimetry and neuroimaging.

Patients with cortical blindness associated with various pathologic processes have been studied with transient VEPs.<sup>19</sup> Importantly, full-field VEPs have been reported to be normal in patients with blindness and with neuroimaging and pathologic changes confined to the visual cortex.<sup>4</sup> The sensitivity of VEPs in patients with cortical blindness depends on the anatomy of the cortical lesion and the method of the study. Lesions involving only Brodmann area 17 (bilaterally) may be associated with visual loss and normal VEPs. The use of smaller check sizes is important to identify changes in VEPs. Patients evaluated with *normal size* checks, for example 27', may have normal VEPs, but checks less than 20' usually reveal an alteration.<sup>4</sup> Normal VEPs obtained with large checks in patients with suspected cortical blindness should not be considered evidence for functional visual loss. A normal P100 latency and amplitude in a blind person are highly unusual except for those with visual cortex disease. Normal findings on a VEP study virtually exclude an optic nerve or anterior



**Figure 22-9.** Partial-field VEP after stimulation of the right hemifield. A P1 waveform maximal on the right is present in the posterior head region. (From Stockard, J. J., J. F. Hughes, and F. W. Sharbrough. 1979. Visual evoked potentials to electronic pattern reversal: Latency variations with gender, age, and technical factors. *American Journal of EEG Technology* 19:171-204. By permission of the American Society of Electroneurodiagnostic Technologists.)



chiasm lesion as the cause of visual loss.<sup>6</sup> As noted above, with small checks, a significant percentage of patients with retrochiasmatic lesions have changes in VEPs. However, in most patients with cortical blindness, the neuroimaging findings indicate the anatomy and pathology of the lesion.

### Key Points

- VEPs do not show abnormalities in patients with unilateral posterior visual conduction defects.
- Bilateral P100 abnormalities are nonlocalizing and can be seen in retrochiasmatic lesions or bilateral prechiasmatic lesions.
- VEPs may be normal in patients with cortical blindness, especially in lesions involving Brodmann area 17 bilaterally.

### SUMMARY

The role of VEPs in evaluating patients with neurologic disease has evolved in an era of advanced neuroimaging techniques. MRI is clearly superior in sensitivity and specificity to VEPs in detecting retrochiasmatic lesions. However, in patients with lesions involving the optic nerve and anterior chiasm, VEPs have several important advantages: (1) VEPs are objective and reproducible and may demonstrate a functional abnormality that is not evident on physical examination or with neuroimaging studies; (2) VEP abnormalities may persist over time even when there is clinical resolution of visual symptoms; (3) VEPs may be a more reliable indicator of disease than MRI (MRI may reveal nonspecific abnormalities that do not represent a pathologic process, such as nonspecific white matter signal changes in the cerebral hemispheres); (4) VEPs may be more sensitive than MRI for detecting abnormalities in optic nerves; and (5) VEP studies are less expensive than MRI studies and can be used in situations where MRI studies are contraindicated (i.e., pacemakers, aneurysm clips, etc).

### REFERENCES

1. Celesia, G. G., N. S. Peachey, M. Brigell, and P. J. DeMarco Jr. 1996. Visual evoked potentials: Recent advances. *Electroencephalography and Clinical Neurophysiology* 46(Suppl):3–14.

2. Tandon, O. P. 1998. Average evoked potentials—Clinical applications of short latency responses. *Indian Journal of Physiology and Pharmacology* 42: 172–88.
3. Jones, N. S. 1997. Visual evoked potentials in endoscopic and anterior skull base surgery: A review. *Journal of Laryngology Otolaryngology* 111:513–6.
4. Celesia, G. G. 1993. Visual evoked potentials and electroretinograms. In *Electroencephalography: Basic principles, clinical applications, and related fields*, ed. E. Niedermeyer, and F. Lopes da Silva, 3rd ed., 911–36. Baltimore: Lippincott Williams & Wilkins.
5. Chiappa, K. H., ed. 1997. *Evoked potentials in clinical medicine*, 3rd ed. Philadelphia: Lippincott-Raven.
6. Epstein, C. M. 1990. Visual evoked potentials. In *Current practice of clinical electroencephalography*, ed. D. D. Daly, and T. A. Pedley, 2nd ed., 593–623. New York: Raven Press.
7. American Electroencephalographic Society. 1994. Guideline nine: Guidelines on evoked potentials. *Journal of Clinical Neurophysiology* 11:40–73.
8. Aminoff, M. J., and D. S. Goodin. 1994. Visual evoked potentials. *Journal of Clinical Neurophysiology* 11:493–9.
9. Nuwer, M. R. 1998. Fundamentals of evoked potentials and common clinical applications today. *Electroencephalography and Clinical Neurophysiology* 106:142–8.
10. Acar, G., S. Ozajbas, H. Cakmakci, et al. 2004. Visual evoked potential is superior to triple dose magnetic resonance imaging in the diagnosis of optic nerve involvement. *International Journal of Neuroscience* 114:1025–33.
11. Fuhr, P., A. Borggrefe-Chappuis, C. Schindler, and L. Kappos. 2001. Visual and motor evoked potentials in the course of multiple sclerosis. *Brain* 124: 2162–8.
12. Brusa, A., S. J. Jones, and G. T. Plant. 2001. Long-term remyelination after optic neuritis: A 2-year visual evoked potential and psychophysical serial study. *Brain* 124:468–79.
13. Jones, S. J., and A. Brusa. 2003. Neurophysiological evidence for long-term repair of MS lesions: Implications for axon protection. *Journal of the Neurological Sciences* 2006:193–8.
14. Rousseff, R. T., P. Tzvetanov, and M. A. Rousseva. 2005. The bifid visual evoked potential—normal variant or a sign of demyelination? *Clinical Neurology and Neurosurgery* 107:113–16.
15. McDonald, W. I., A. Compston, G. Edan, et al. 2001. Recommended diagnostic criteria for multiple sclerosis: Guidelines from the International Panel on the Diagnosis of Multiple Sclerosis. *Annals of Neurology* 50:121–7.
16. Polman, C. H., S. C. Reingold, G. Edan, et al. 2005. Diagnostic criteria for multiple sclerosis: 2005 revisions to the “McDonald Criteria”. *Annals of Neurology* 58:840–6.
17. Ng, Y. T., and K. N. North. 2001. Visual-evoked potentials in the assessment of optic gliomas. *Pediatric Neurology* 24:44–8.
18. Drislane, F. W. 1994. Use of evoked potentials in the diagnosis and follow-up of multiple sclerosis. *Clinical Neuroscience* 2:196–201.
19. Stockard, J. J., J. F. Hughes, and F. W. Sharbrough. 1979. Visual evoked potentials to electronic pattern reversal: Latency variations with gender, age, and technical factors. *American Journal of EEG Technology* 19:171–204.



SECTION 2

**ELECTROPHYSIOLOGIC  
ASSESSMENT OF NEURAL  
FUNCTION**

---

*This page intentionally left blank*

## PART C

# Motor Pathways

---

Weakness, fatigue, loss of strength, and loss of power are among the major symptoms of neurologic disease that can be assessed with neurophysiologic testing. Strength and movement are under the control of the motor system, which includes the central mechanisms for integrating motor activity and the output pathways. Reflexes and other central motor control systems are discussed in Part E of this section. The electrophysiologic assessment of peripheral motor pathways is reviewed in this part and Part D. As with the sensory pathways, the most direct assessment of the motor pathways can be obtained with stimulation along the motor pathway and measurement of the response evoked by the stimulation. These measurements can include the threshold for activation, the conduction time or velocity (or both) between the points of stimulation and recording, and the size and shape of the evoked response.

Compound muscle action potentials recorded directly from a muscle are measured for each assessment of the motor pathways whether activated centrally or peripherally. The method of application, the strength, and the type of stimulus vary with the site along the motor pathway being stimulated. Stimulation at the cortical level requires high-intensity electric or magnetic stimuli to produce useful responses. Deep-lying motor nerves, such as the spinal nerves, may require needle

electrodes for stimulation. Surface electrical stimulation is adequate for stimulation of most peripheral motor nerves.

The recording of compound muscle action potentials described in Chapter 23 assesses motor nerve function in peripheral neuromuscular disorders. Repetitive activation of compound muscle action potentials, described in Chapter 24, assesses the function of the neuromuscular junction. Central stimulation of motor pathways at the spinal cord or cortical level evokes compound muscle action potentials, called *motor evoked potentials*, which is described in Chapter 25. The distinction between the terms *compound muscle action potential* and *motor evoked potential* is made on the basis of the site of stimulation. Stimulation of motor nerve fibers anywhere along their course after they leave the spinal cord produces a response in the muscle called a *compound muscle action potential*. Stimulation along the motor pathways in the spinal cord or at the cortical level produces an identical muscle response called a *motor evoked potential*.

The use of motor evoked potentials for monitoring central motor function during surgery has been expanded recently. Compound muscle action potentials continue to be the mainstay for providing insight into peripheral neuromuscular disease involving motor fibers.

*This page intentionally left blank*

# Compound Muscle Action Potentials

James C. Watson and Jasper R. Daube

## INTRODUCTION

### GENERAL CLINICAL APPLICATIONS

#### RECORDING CMAPs

Type of Recording Electrode

Location of Recording Electrode

#### STIMULATION

Type of Stimulating Electrode

Position of Stimulating Electrode

#### CMAP MEASUREMENTS

Amplitude and Area

Duration

Latency

Conduction Velocity

Potential Errors in CMAP Measurements

Normal Values in CMAP Recordings

#### F WAVES

Methods

#### AXON REFLEXES (A WAVES)

#### PHYSIOLOGIC VARIABLES

##### AFFECTING THE CMAP

Temperature

Age

#### CMAP CHANGES IN DISEASE

Pathophysiology

Mechanisms of Conduction in

Myelinated Fibers

Mechanisms of Slow Conduction  
in Disease

#### FINDINGS IN PERIPHERAL NERVE DISORDERS

Findings in Focal Lesions

Findings in Diffuse Peripheral

Nerve Damage and Peripheral  
Neuropathies

Findings in Specific Focal

Mononeuropathies

Brachial Plexus Lesions

Radiculopathies

#### SUMMARY

## INTRODUCTION

A *compound muscle action potential* (CMAP) is the action potential recorded from muscle when stimulation anywhere along the motor

pathway is sufficient to activate some or all the muscle fibers in that muscle. The CMAP is the summated activity of the synchronously activated muscle fibers in the muscle innervated by the axons and motor units represented in

that muscle. Therefore, a CMAP provides a physiologic assessment of (1) the descending motor axons in the pathway below the level of stimulation, (2) the neuromuscular junction, and (3) the muscle fibers activated by the stimulus. Because disease of the axons, neuromuscular junctions, or muscle fibers can alter the CMAP, CMAP recording can be used to assess disease at each of these locations. CMAP recordings are least useful for assessing muscle disease because the potentials are not altered until the disease is either severe or late in its course, when marked atrophy and loss of muscle tissue occur. CMAP assessment for disease of the neuromuscular junction is discussed in Chapter 24. CMAPs are also recorded with motor evoked potentials to assess central motor pathways (see Chapter 25). The major application of CMAP recording is in motor nerve conduction studies (NCS).

Motor NCS and CMAP recordings are equivalent. This chapter focuses on several aspects of CMAP recording as part of motor NCS and their applications. The chapter begins with a review of the techniques of stimulation and recording, including technical problems. The next section discusses modifications of the techniques of stimulation and recording to obtain F-wave latencies and is followed by a general discussion of the approach to selecting motor NCS and CMAP recording for different clinical entities.

## GENERAL CLINICAL APPLICATIONS

Recording of CMAPs in motor NCS is used for several purposes in assessing neuromuscular disease. CMAPs are particularly useful in providing objective measurements of the extent and type of weakness. If the weakness is caused by a peripheral neuromuscular disease, motor NCS can identify and localize the sites of damage, whether from compression, ischemia, or other focal lesion. These studies can also characterize the type of abnormality as a conduction block with neurapraxia or as slowing of conduction at a localized area. They can identify the changes associated with Wallerian degeneration and regeneration in the motor nerve. Measurement of CMAPs can assist in distinguishing peripheral nerve disease from

lower motor neuron disease, neuromuscular junction disease, and myopathies. NCS can also assist when the weakness may be caused by hysteria, malingering, or upper motor neuron disease. In these situations, the CMAP is normal.

CMAP recordings can go beyond confirming the presence of disease and the definition of severity by identifying disease that may not be apparent clinically. For example, in patients with clinical evidence of a mononeuropathy, CMAP recording may show signs of multiple mononeuropathies or widespread peripheral nerve damage that may not be apparent clinically. In patients with inherited neuropathies, motor NCS can identify the process early in the disease or when there is mild involvement and no clinical evidence of neuropathy. Motor NCS can also identify disease early in its evolution, for example, diabetes mellitus, when a mild peripheral neuropathy may not yet be apparent clinically.<sup>1</sup> In patients with an atypical distribution of deficits, the presence of anomalous innervation can be traced. This is particularly useful for Martin-Gruber anastomosis (median to ulnar) in the forearm, Riche-Cannieu anastomosis (ulnar to median) in the hand, the accessory branch of the superficial peroneal nerve in the leg, and crossed innervation after reinnervation.

A less common application of CMAP recording is to identify and measure transient loss of function in primary muscle disease such as periodic paralysis. The recordings can also be used to study abnormal reflex responses in upper motor neuron lesions. In selected patients who have primary muscle disease, a study of the mechanical twitch and its relationship to electric events may be useful as part of a CMAP recording. A recent report has suggested that measurement of CMAP with sequential incrementing stimulus intensities can identify multiple different neuromuscular disorders.<sup>2</sup>

### *Purpose and Role of Motor NCS*

- Provides objective assessment of the motor nerve, neuromuscular junction, and muscle fiber without patient participation.
- Identifies subclinical disease.
- Defines pathophysiologic process (e.g., demyelinating vs. axonal).
- Localizes focal disease.



- Assesses proximal conduction (e.g., F waves).
- Defines severity of a peripheral disease.
- Defines the extent of a neurogenic injury (e.g., length-dependent peripheral neuropathy vs. mononeuritis multiplex).
- Provides prognostic information (e.g., facial CMAP amplitude in Bell's palsy).
- Follows a disease to assess progression or response to treatment.
- Estimates the number of axons in a nerve.

## RECORDING CMAPs

### Type of Recording Electrode

The electrodes that record CMAPs can alter the size, shape, and, to a lesser extent, the latency of the response.<sup>3</sup> Large surface electrodes, small surface electrodes, subcutaneous

electrodes, and intramuscular electrodes each have advantages and disadvantages. Metal electrodes, stick-on electrodes, and saline electrodes also have different electrical characteristics. These are summarized in Table 23–1.

Normal values for CMAP recording depend in part on the type of electrode used for recording; therefore, these values are most reliable when the electrodes are identical. Most commonly, a 5–10 mm small surface electrode is used because of the ease of application and the availability of well-defined normal values. Larger electrodes provide a better depiction of CMAPs obtained from large muscles or multiple muscles with a common innervation; they also have better reproducibility.<sup>4</sup> Generally, the use of these larger electrodes is limited to laboratories in which normal values have been developed specifically for them. Also, in some laboratories, large electrodes are used to measure the number of motor units in a muscle (see Chapter 29).

Table 23–1 Types of CMAP Recording Electrodes

Electrode size/type	Uses	Advantages	Disadvantages
<b>Small (5–10 mm) surface electrode</b>	Most muscles	Ease of use	
	Routine motor NCS	Well-defined normal values	
<b>Large surface electrode</b>	Large muscles (anterior tibialis, biceps)	Ease of use	
	Closely approximated muscles of similar innervation	Better reproducibility	
<b>Subcutaneous electrode</b>	Intraoperative monitoring (can be placed, secured as surgical field defined preoperatively)	Larger CMAP amplitude	Discomfort Infection, bleeding risk Higher impedance, noise
<b>Intramuscular electrode</b>	Intraoperative monitoring	Precision	Discomfort Infection, bleeding risk
	Deep muscles		Irregular waveform (see text) with variable amplitude and area makes unsuitable for comparison with normal controls
	Confirming surface CMAP response is from muscle of interest and not volume-conducted		

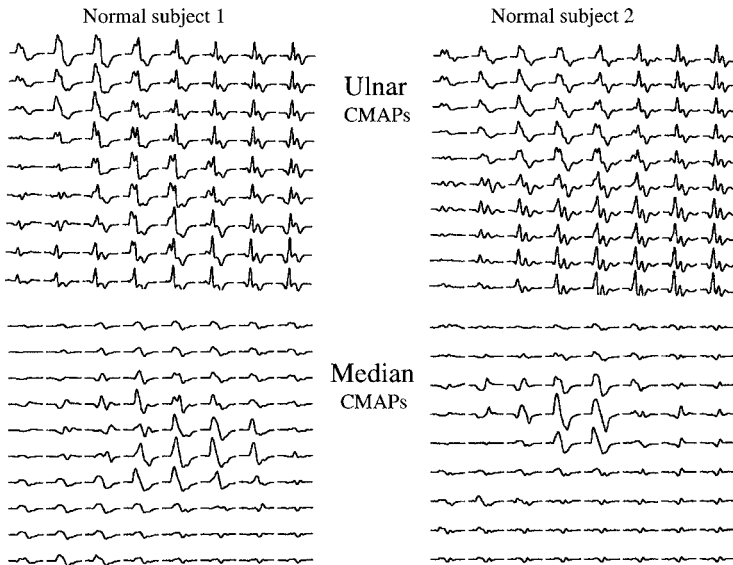
Subcutaneous needle electrodes have the advantage of being placed closer to muscle tissue; therefore, they sometimes record higher amplitude CMAPs. For some muscles, these electrodes are easier to apply. The disadvantages are those of any invasive technique, including greater discomfort for the patient and the (extremely low) risk of infection or bleeding. The subcutaneous needle recording electrode occasionally has higher impedance, resulting in greater noise, shock artifact, or both.

Intramuscular needle or wire electrodes have the advantage of recording from well-defined small areas of muscle, thereby better isolating the CMAP of individual muscles. Intramuscular recordings are able to record small potentials, particularly of deep muscles that may not be recordable on the skin surface. However, the configuration of the potential varies markedly with the precise location of the recording electrode, which may shift during the movement produced by the stimulation. Thus, amplitude and area measurements with intramuscular recordings are not sufficiently reliable to be useful clinically. Latencies may

be difficult to measure because of irregular initiation of the CMAP.

## Location of Recording Electrode

CMAP recording is made with an active electrode (G1) and a reference electrode (G2) whose locations are critical for the size, shape, and latency of the CMAP. Normal values must be determined with specific recording electrode locations. The amplitude and area of the CMAP decrease with the distance of the active electrode from the muscle.<sup>4</sup> The size and configuration of the CMAP vary with placement of the active recording electrode over a muscle, as shown in Figure 23–1.<sup>5</sup> The active electrode (G1) is optimally placed over the end plate region of the muscle, where the potential recorded is a well-defined waveform with an initial negativity, a sharp inflection, and maximal amplitude. If multiple muscles are activated or the end plate region is not well localized, as in some disease, the CMAPs are more complex. Large electrodes will average the differences between electrode locations



**Figure 23–1.** Amplitude and configuration changes in ulnar (*upper*) and median (*lower*) CMAPs in two normal subjects. CMAPs were recorded from small electrodes in multiple locations in 839 grids over the thenar and hypothenar muscles to show the variation in size and shape with electrode location. Note the double peaks, marked changes in potential over short distances, and the differences between subjects. These variations make CMAPs highly susceptible to small differences in electrode placement, especially with small recording electrodes. Note also the difference in pattern of distribution between normal subjects. (From van Dijk, J. G., I. van Benton, C. G. Kramer, and D. F. Stegeman. 1999. CMAP amplitude cartography of muscles innervated by the median, ulnar, peroneal, and tibial nerves. *Muscle & Nerve* 22:378–89. By permission of John Wiley & Sons.)

to reduce the variation that can occur with different placements of small electrodes, and hence have better reproducibility than small electrodes.<sup>4</sup> However, large electrodes are too large and impractical for the most common motor nerve conduction study recording sites (intrinsic hand and foot muscles).

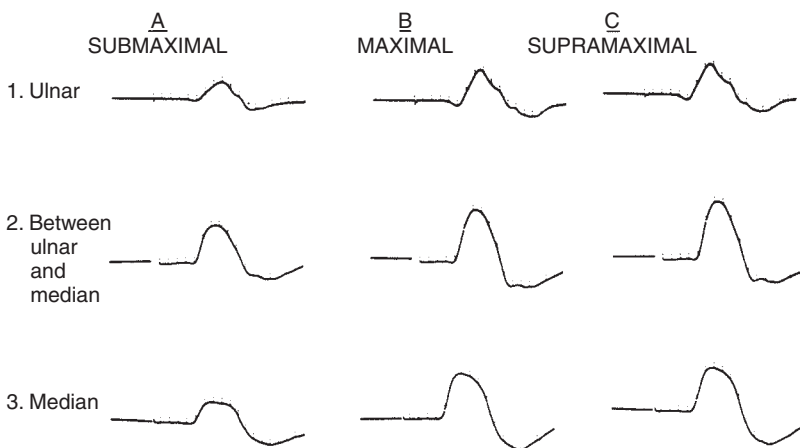
A CMAP can be recorded with the active electrode far from the muscle, but it is maximal when located directly over the muscle generating it. If the electrode is either off the motor end plate or located at some distance from the muscle that is generating the CMAP, the potential is predominantly or initially positive in polarity and much smaller, with a significantly slower rise time to the negative peak. (Fig. 23–2). The presence of an initial positivity on a CMAP at all sites of stimulation is, therefore, evidence that the active electrode is not over the end plate region of the muscle generating the CMAP and may be entirely off the muscle. The slope or rate of rise of the positive-to-negative peak of the CMAP is a rough gauge of the distance between the active recording electrode and the muscle generating the CMAP.

The location of the reference electrode, sometimes referred to as the *inactive, G2, or terminal-two electrode*, also has an effect on the amplitude and configuration, as well as on the onset latency of the CMAP (i.e., the G2 electrode is not in reality “inactive”

or electrically silent).<sup>6–8</sup> The contribution from the G2 electrode to CMAP morphology appears to influence the ulnar and tibial CMAPs most significantly.<sup>9</sup> The bifid appearance of the ulnar CMAP can be explained by the contributions of the large negative peaks from the G1 and an active G2 electrode. Because of this, it is particularly important that the placement of both the G1 and the G2 electrodes be placed at the same location with the same protocols that were used when the normal values were obtained. In CMAPs with a large contribution from the G2 electrode (ulnar and tibial), the CMAP is less sensitive to precise positioning of the active G1 electrode.<sup>9</sup> Maximal amplitude is generally obtained with the reference electrode over the tendon of the muscle being recorded, optimally at the junction of the tendon with the muscle. Because muscles vary in size, in motor NCS, the reference electrode should *not* be at a fixed distance from the active electrode (an important difference from sensory NCS). CMAPs recorded with fixed interelectrode distances often have a shorter duration, lower amplitude, and smaller area, and, occasionally, a different configuration; therefore, they should not be used.<sup>10</sup>

### Key Points

- Recording electrode type and location in a laboratory should be consistent and have well-defined normal values. Different



**Figure 23–2.** Summation of CMAPs recorded from thenar muscles with stimulation of the median and ulnar nerves. Rows 1 and 3 show the CMAPs obtained with isolated stimulation of each of the two nerves. Note the initial positivity with ulnar stimulation that results from recording CMAPs from ulnar-innervated thenar muscles at a distance from the thenar recording electrode (placed over the median-innervated abductor pollicis brevis). Row 2 shows the effect of simultaneous stimulation of both median and ulnar nerves, with summation of the potentials recorded in rows 1 and 3.

types of recording electrodes should have normal values and should be used only for defined clinical purposes.

- Active recording electrodes (G1) should be placed at the site of maximal amplitude with no positivity.
- G1 electrode is mispositioned off the muscle end plate if there is an initial positivity.
- Inactive electrodes (G2) should be placed over the tendon (G1–G2 fixed distance placements are not reliable).

## STIMULATION

CMAP recording requires stimulating a nerve at site(s) along its length. Stimuli can be applied in several ways. The stimulation technique used to activate a nerve affects the values obtained.<sup>11</sup>

### Type of Stimulating Electrode

Electrical stimulation is applied through a cathode (negative) and an anode (positive) that may vary in size and shape. Electrodes over and in parallel with the nerve evoke the most reproducible responses with the lowest stimulus intensity. The advantages and disadvantages of different types of stimulating electrodes must be understood to select the optimal electrode for each motor nerve.

*Handheld electrical surface stimulator.* The commonly used handheld surface stimulator allows the electrodes to be moved easily in search of the nerve. Smooth, rounded, 5–10 cm electrodes mounted on the end of curved, removable stimulating poles permit rapid change of the anode and cathode positions. This stimulator is more convenient for stimulating nerves that may require pressing on the overlying skin so the electrode is closer to the nerve and for rotating the position of the anode to reduce shock artifact. This type of electrode is optimal for standard motor NCS.

*Flat disc electrodes.* When stimuli have to be applied for longer periods, as in testing periodic paralysis and measuring motor unit number estimates, flat disk electrodes taped on the skin over the nerve or a pair of electrodes mounted in a bar with the electrode protruding from the bar allows more stable positioning of the electrode.

*Needle electrodes.* Needle electrodes, 1–2 cm, that are entirely uninsulated or a longer needle that is insulated except for 1–2 mm at its tip can also be used to stimulate motor nerves. These electrodes are particularly useful for stimulating deep nerves such as the median and ulnar nerves in the forearm and the tibial and sciatic nerves in the leg. This type of stimulus is often less painful, despite the needle stick, than surface stimulation that requires higher currents or excessive surface pressure to elicit a supramaximal response (i.e., obese patients or in tender areas such as the femoral triangle). However, needle electrodes are more difficult to move when attempting to find the optimal location for nerve stimulation. A stimulating needle for long periods (e.g., repetitive stimulation) may be displaced with limb movement and loss of the supramaximal response.

*Magnetic stimulation.* Magnetic stimulation can activate some but not all peripheral nerves and is seldom used for neuromuscular electrodiagnosis. The site of onset of the initiation of the action potential cannot be precisely defined with magnetic stimulation. Despite the advantage of minimal discomfort with magnetic stimulation, especially with deep nerves, the inability to assure maximal stimulation and to accurately calculate velocities precludes its use for routine NCS.

### Position of Stimulating Electrode

*Cathode–anode relationship.* Depolarization of motor axons occurs at the cathode. The anode hyperpolarizes the nerve and may block conduction of an action potential through the area of hyperpolarization (“anodal block”). Activation of a motor axon requires areas of both depolarization and hyperpolarization along the length of the axon, with current flow through the axon between the two locations.<sup>11</sup> Therefore, the optimal position of stimulating electrodes is for the cathode to be as close as possible to the nerve between the anode and the recording site so that the activated action potential does not traverse the area of hyperpolarization at the anode. The optimal location of the anode is longitudinally along the course of the axon away from the recording electrode. Ideally, the anode and cathode are adjacent to the nerve and only a few millimeters apart so that all current flow is directed through the

nerve being tested and not into surrounding muscle, another nerve, or other tissue.

The ideal position of surface stimulating electrodes is along the length of the nerve, with the cathode closest to the recording electrode. The anode and cathode must be farther apart than for needle electrode stimulation. If the anode and cathode are too close, current flow passes directly between them without entering the tissue to the depth of the nerve. Thus, activation of all motor axons may not occur despite the use of high voltage and the passage of a large current. For most motor nerves, a distance of 3–5 cm between the anode and the cathode is sufficient for adequate current to penetrate the tissues to the depth of the motor axons. For nerves that are very deep in the tissue, a greater distance between the anode and the cathode may be necessary. This increases the depth and diameter of the depolarizing stimuli, increasing the risk of inadvertent stimulation of other nerves and muscles and of stimulating the nerve of interest at some distance from the intended site of depolarization at the cathode (making measurements for distal latencies and conduction velocities prone to error). This is known as the *virtual cathode* effect.

*Shock artifact from stimulator location.* The anode may also be placed perpendicular to the course of the nerve and lateral from it. The anode may need to be on the opposite side of the limb, for example, to activate the tibial nerve in an obese patient. A perpendicular location requires a higher current intensity to obtain depolarization, increasing the possibility that adjacent nerves will be stimulated. The most common need for the lateral position is when the stimulating and recording electrodes are placed so close that a prominent shock artifact occurs in the recording. The shock artifact occurs because the current flow from the stimulating electrode spreads through the tissue directly to the recording electrode and charges the capacitance of the intervening tissue, which then discharges over 2–20 ms, with a waveform superimposed on the CMAP (or sensory nerve action potential, SNAP). This occurs especially when the distance between the stimulating and recording electrodes is short, such as the tibial or sural nerve stimulation at the ankle, mixed motor and sensory median and ulnar palmar responses, and the facial nerve at the angle of the mandible. In these situations, it may

become necessary to locate the anode perpendicularly to the nerve as the anode is rotated to find a position of minimal shock artifact. Occasionally, the anode may need to be rotated excessively to a position where it sits closer to the G1-recording electrode than the cathode to eliminate the shock artifact.

*Localizing the nerve with stimulator (sliding).* The location of most nerves can be identified reasonably well from anatomical landmarks for each nerve. However, it must always be remembered that the exact location of a nerve can vary significantly among normal subjects. The most striking example is the peroneal nerve at the ankle; its position can vary from 0.5 to 4 cm lateral to the tibia. Therefore, when attempting to stimulate a motor nerve, the nerve must be localized to minimize stimulus intensity for lessened patient discomfort and to decrease the likelihood of current spread to other nerves. Placing the stimulating electrodes at the location judged to be over the nerve and then obtaining an initial low-amplitude CMAP best accomplishes this. The stimulating electrode is then moved medially or laterally perpendicularly to the nerve without changing the stimulus intensity. If the subsequent CMAPs have increasing amplitude, the electrode is being moved closer to the nerve. However, if the amplitude decreases, the electrode is being moved away from the nerve. The electrode continues to be moved until the maximal amplitude is obtained with the original stimulus intensity. This is known as *sliding*. The voltage is then increased until the CMAP does not increase further with a 25%–30% increase in applied voltage or current.

*Needle stimulator position.* Needle electrodes can be placed immediately adjacent to the nerve, but this may require considerable probing in the tissue. The optimal location of a needle electrode can be obtained by repeated stimulation to identify the region of minimum threshold. When the anode and cathode are both immediately adjacent to the nerve, stimuli of less than 2 mA are adequate for activating all the motor axons. An anode at some distance from the nerve, either on the surface or elsewhere in the tissue, may be used with the needle cathode near the nerve. A distant anode can result in a somewhat higher threshold for activation, a greater risk of current spreading to



the surrounding nerves, and a less accurate site of stimulation. These disadvantages are generally outweighed by the advantage of not having to probe the tissue with the anode to find the optimal location near the nerve. The invasive nature of needle stimulation and the time it takes to achieve optimal location of the stimulating electrode have made it less accepted than surface stimulation, unless a deep, focal conduction block is likely.

In normal subjects, these techniques allow supramaximal or full amplitude CMAPs to be obtained with stimulus intensities less than 20 mA (100 V) in the arm and less than 40 mA (200 V) in the leg. In obese subjects or in cases of particularly deep nerves and in patients with peripheral nerve disease, a greater intensity of current may be needed to activate motor nerves. The intensity of a stimulus applied to a motor nerve is defined by total current flow, which is a function of the intensity of the applied voltage, the resistance to current flow, and the duration of the stimulus. Pulses of 0.1–0.2 ms are usually adequate for stimulation of motor nerves, but longer durations of up to 1 ms may be necessary for deep or diseased nerves.

### Key Points

- Depolarization of the nerve occurs at the cathode.
- Optimal stimulation occurs with cathode and anode over and parallel to the nerve with the cathode closest to the G1-recording electrode.
- Cathode and anode should be kept as close together as possible to prevent stimulation distally along the nerve or of nearby nerves.
- Shock artifact is best eliminated by rotating the anode around the cathode as much as needed while watching the artifact configuration change.
- “Sliding” the stimulating electrode perpendicular to the nerve localizes a nerve medial to lateral.

## CMAP MEASUREMENTS

The CMAP recorded over any muscle in response to nerve stimulation is called the *M*

*wave* (*M* for motor). It is characterized by several specific measurements, each of which reflects the physiologic activity occurring in the muscle or nerve.

### Amplitude and Area

The most valuable measurement is the size of the CMAP, measured as either the amplitude or area. Both of these variables reflect the total number of muscle fibers that contribute to the potential. In most laboratories, amplitude is measured from the baseline to the peak. Recall that for CMAPs, an initial positivity generally indicates that the G1 electrode is not placed appropriately over the muscle end plate and that the G1 electrode should be moved. However, with certain disease states, anomalous innervation (Martin-Gruber Anastomosis), or excessive stimulation stimulating adjacent nerves and adding a volume conducted distal response to the CMAP waveform, one may not be able to eliminate this initial positivity and in that situation the CMAP is measured from the positive peak to the negative peak. The area of the CMAP is related most directly to the number of muscle fibers or motor units that contribute to the CMAP. Changes in the CMAP amplitude and area are also measured as part of repetitive stimulation during assessment of neuromuscular junction disorders or in disorders such as periodic paralysis.

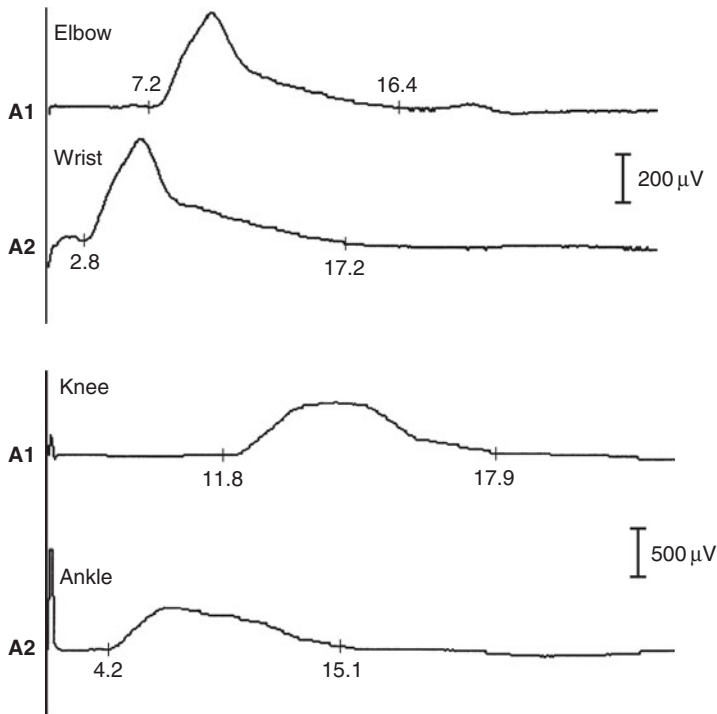
### Duration

The duration of the response of the CMAP is a function of the duration of the action potential of individual muscle fibers within the muscle as well as the synchrony of firing of the muscle fibers contributing to the potential. A loss of synchrony results in longer duration and lower amplitude. Prolongation of the action potentials of individual muscle fibers, as occurs in critical illness myopathy, will also result in longer duration CMAPs (Fig. 23–3).

### Latency

The latency of the CMAP is best measured from the time of stimulation to the onset of





**Figure 23-3.** Ulnar (*upper two traces*) and peroneal (*lower two traces*) motor nerve conduction studies in severe critical illness myopathy. A1, stimulation at elbow (ulnar) and knee (peroneal); A2, stimulation at wrist (ulnar) and ankle (peroneal). Conduction velocities are normal. CMAP durations are markedly prolonged with the typical configuration of critical illness myopathy without dispersion of the type seen in demyelinating neuropathies.

the initial negativity. The latency defines the time it takes the action potential to travel from the stimulation site to the recording site and depends mainly on the conduction time in the peripheral axons. A small amount of time is needed to traverse the neuromuscular junction. If the electrodes are not over the end plates, latency also includes the time for conduction along the muscle fiber to the recording electrode. In this case, the CMAP initially is positive rather than negative, with the elapsed time to reach the end plate being the latency of the initial positive deflection (Figs. 23-1 and 23-2). Initial positive deflections may also be caused by the recording of a CMAP of a distant muscle, for example, a contribution from the anterior compartment muscles with stimulation of the peroneal nerve at the knee when recording from the extensor digitorum brevis (EDB). This initial positivity should not be measured.

*Distal latency* is the onset of a CMAP at the most distal site of stimulation and is best measured as an absolute value. Distal latency measurements should be made from the CMAP at the distal stimulation site and

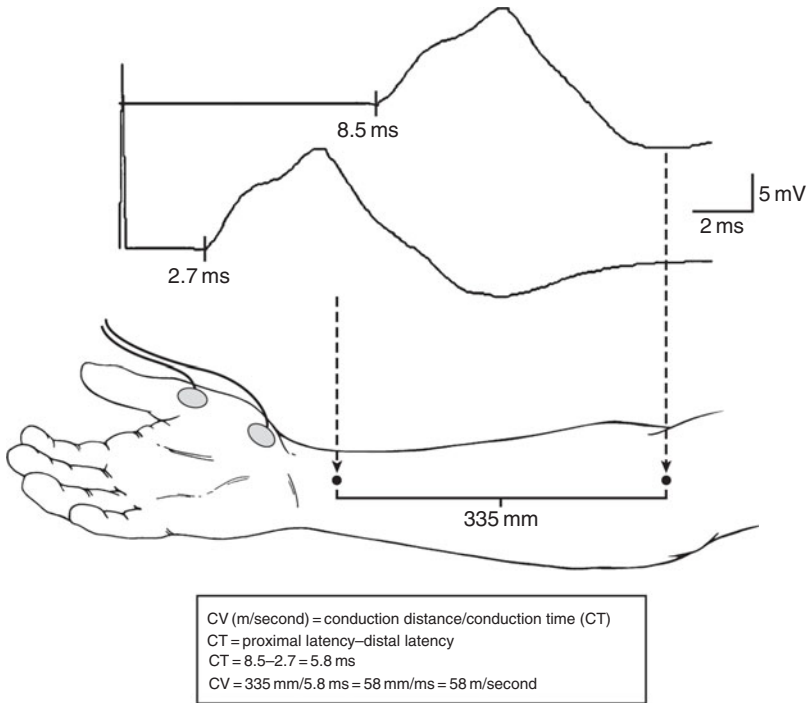
represent the time (milliseconds) from the stimulus to the onset point of the negative wave of the CMAP. The reproducibility of latency measurements can be enhanced by automated measurement at a fixed voltage above baseline ( $200 \mu\text{V}/\text{cm}$  is often recommended).<sup>11</sup> Attempts have been made to correct for slowing in the nerve terminal and at the neuromuscular junction, a measurement called *residual latency*. This method has been reported to be of value in diagnosing early carpal tunnel syndrome (CTS). Residual latency is calculated with the formula:

$$\text{RL} = \text{DML} - (\text{distal distance} / \text{conduction velocity}),$$

where RL is residual latency and DML is distal motor latency.

## Conduction Velocity

The difference in CMAP latency with stimulation at two points along a nerve is a function of the distance between the two points and



**Figure 23-4.** Calculation of conduction velocity from latency and distance measurements on standard motor NCS. The upper waveform is the response from stimulation at the elbow and the lower waveform from stimulation at the wrist. The calculation for the CV is demonstrated in the box.

the rate of conduction of the action potentials in that nerve between the two points. Dividing the distance between the two points by the difference in CMAP latencies measures the *conduction velocity* (CV) of the nerve fibers. Because the latency measurements are made to the initial negativity, the conduction velocity measurement is that of the fastest conducting fibers. Paired stimulation techniques, in which the action potentials in the fast conducting fibers are obliterated by collision, have been used to measure conduction velocity in slower conducting axons. However, the additional clinical data provided by paired stimulation are not sufficiently useful clinically to make it a standard procedure.<sup>12</sup>

The conduction velocity is measured using the following formula:

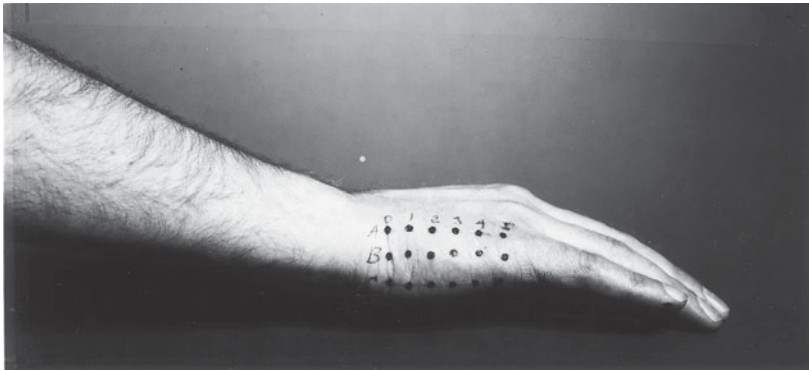
$$CV \text{ (meters/second)} = \frac{\text{conduction distance (millimeters)}}{\text{conduction time (milliseconds)}}$$

where the conduction distance is the distance between the two stimulation sites along the nerve (in millimeters) and the conduction time

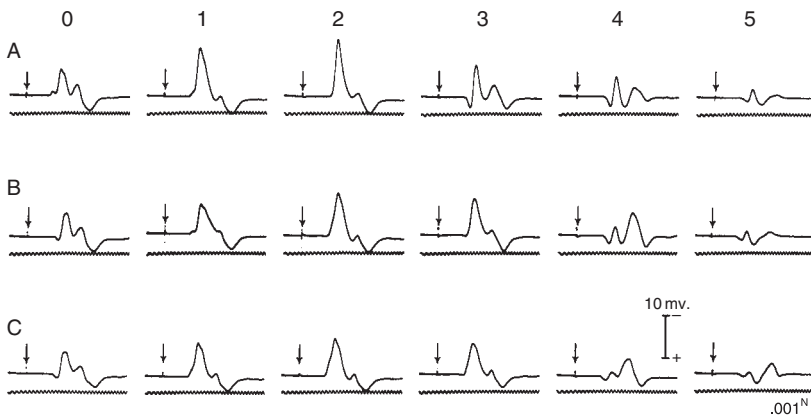
is the latency of the proximal stimulation site minus the latency of the distal stimulation site (in milliseconds) (Fig. 23-4).

### Potential Errors in CMAP Measurements

Several potential sources of error must be kept in mind in measuring CMAPs during NCS. The most common one is incorrect measurement of the distance between the two points of stimulation, which may be caused by (1) distortion of the skin when applying the stimulating electrodes or when making the measurement, (2) nonstandard position of the body during the measurement, such as having the elbow extended rather than flexed during ulnar NCS, (3) erroneous polarity of the stimulating electrode, and (4) simultaneous stimulation of adjacent nerves (Fig. 23-2). Sources of error in latency measurements include (1) failure to note the sweep speed correctly, (2) a poorly defined shock artifact that interferes with the take-off of the CMAP, (3) incorrect electrode



Action potentials from hypothenar muscles following stimulation of right ulnar nerve at elbow



**Figure 23-5.** The size and configuration of CMAPs evoked by ulnar nerve stimulation vary with location of the hypothenar recording electrodes. *Top*, Location of the active recording electrode with the reference electrode on the fifth digit. *Bottom*, The corresponding CMAPs. (From Carpendale, M. T. F. 1956. Conduction Time in the Terminal Portion of the Motor Fibers of the Ulnar, Median and Peroneal Nerves in Healthy Subjects and in Patients With Neuropathy. Thesis, Mayo Graduate School of Medicine [University of Minnesota], Rochester. By permission of Mayo Foundation.)

location, resulting in an initial positivity or a poorly defined onset of the negative CMAP (Fig. 23-5A and 23-5B), and (4) failure to select the same point on the inflection of the CMAP for the measurement at two points of stimulation. When a CMAP is recorded at two sites unless disease or anomalous innervation is present. If the two responses are not similar, technical or physiologic errors must be excluded before the difference is attributed to localized disease. Technical errors can be caused by submaximal stimulation at one location or excessive stimulation with activation of an adjacent nerve in another location. Also, excessive stimulation at one site may shorten the latency because of current spread along the nerve.

### Normal Values in CMAP Recordings

For clinical reports, values in CMAP recordings should include the actual value measured and the appropriate associated normal values. Ideally, normal values are those collected in the same laboratory using the same techniques, including careful attention to sources of error.<sup>13</sup> This is not always possible, and values collected in large studies can serve if the techniques are similar to those of the user.<sup>14,15</sup> First, normal values are corrected as needed for the physiologic variables described below. The resulting normal values have been presented in various ways, but often without a full understanding of their complexity and possible errors resulting from their skewed distribution.<sup>16,17</sup> Because

no single value can truly identify a conduction value as normal or abnormal, it is best to use normal deviates or percentile values. *Normal deviates* define the value's extent of deviation from normal, and *percentiles* define the proportion of a normal population that has this value.<sup>18</sup> Composite NCS scores appear to be more reproducible and, in some neuropathies, more sensitive and better correlated with neurologic impairment than individual NCS attributes.<sup>19</sup>

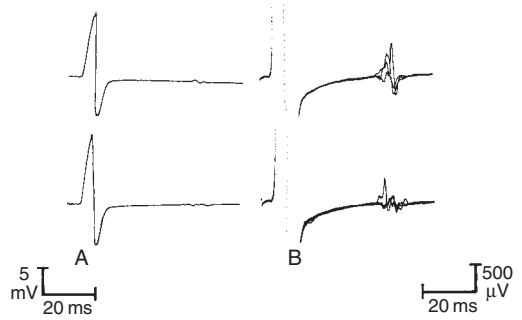
### Key Points

- CMAP amplitude depends on the number and synchrony of firing of axons.
- CMAP area depends on the number of active axons.
- Distal latency is the time from the stimulus artifact to the onset of the CMAP.
- Measurement errors and low temperatures are the most common causes of unexpected conduction velocity abnormalities.

## F WAVES

*F waves* are small CMAPs recorded from the muscle fibers of a single or small number of motor units which are activated by antidromic action potentials that travel centrally along motor axons to anterior horn cells. Thus, the criteria for identifying F waves are responses that are variable in latency, amplitude, and configuration, but occur grouped within a consistent range of latencies. However, in disorders in which there is a loss of significant numbers of motor units and only a small number of motor units remain, elicited F waves may have the same morphology and be mistaken as A waves. Consequently, the latency of an F wave includes the time required for the action potential to travel antidromically from the site of stimulation to the spinal cord and the time to travel orthodromically from the spinal cord to the muscle. Because F waves travel over long segments of nerve, they are among the most sensitive measures of diffuse nerve disease, as well as a measure of proximal conduction.<sup>20</sup>

In most muscles, only a small proportion of the motor units are activated antidromically by any one supramaximal stimulus. Therefore, F waves are much lower in amplitude than

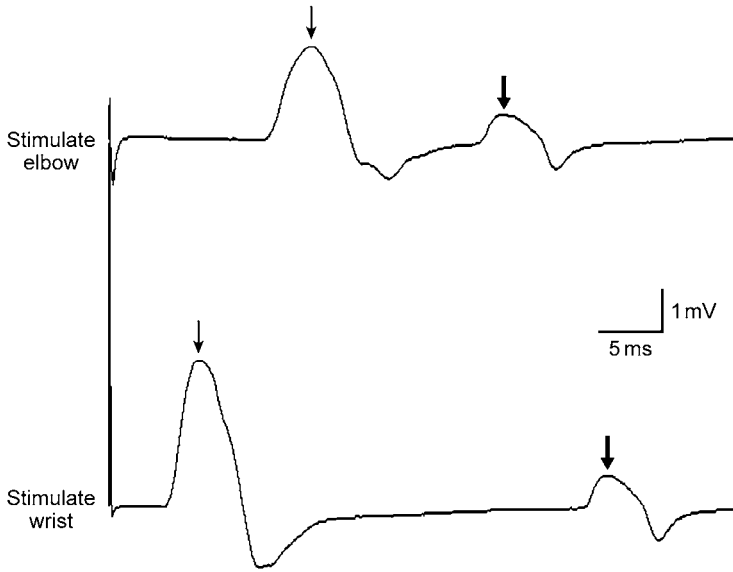


**Figure 23-6.** CMAP recorded from abductor hallucis muscle with tibial nerve stimulation at A, low and B, high amplification. F waves are depicted much better for measurement at higher amplification. (From Daube, J. R. 1992. Nerve conduction studies. In *Electrodiagnosis in Clinical Neurology*, ed. M. J. Aminoff, 3rd ed., 293. New York: Churchill Livingstone. By permission of WB Saunders Company.)

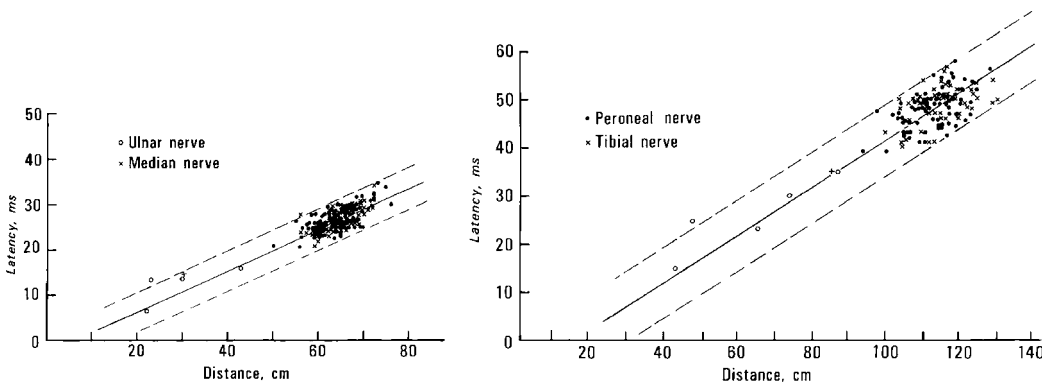
the directly evoked CMAP (Fig. 23-6). Additionally, which motor units are activated varies from stimulus to stimulus, so each F wave may have a different morphology (representing the summated response of the myofibers activated by whichever motor unit(s) was activated). F-wave latencies vary with each stimulus, because axons with different conduction velocities are activated from stimulus to stimulus. As the site of stimulation is moved proximally on a limb, F-wave latency decreases (because the distance the action potential travels decreases) and M-wave latency increases until the two potentials merge, usually with stimulation at the elbow or just proximal to it (Fig. 23-7). Hence, F waves are routinely elicited at the distal stimulation site so that they are clearly distinguishable from the M wave. The decrease in latency of F waves with more proximal stimulation is an important test to ensure that the responses are in fact late responses, if there is a question. The F-wave latency varies with the distance from the spinal cord to the site of stimulation, with the distance to the muscle, and with the conduction velocity of the motor fibers<sup>21</sup> (Fig. 23-8).

## Methods

**Recording.** F waves can be elicited by stimulating any nerve, but they are more prominent in some nerves, for example, in the tibial nerve



**Figure 23-7.** CMAP (M waves) (*thin arrows*) and F waves (*thick arrows*) recorded from hypothenar muscles with ulnar nerve stimulation at elbow and wrist. With proximal stimulation (at the elbow), the M-wave latency increases, whereas the F-wave latency decreases.

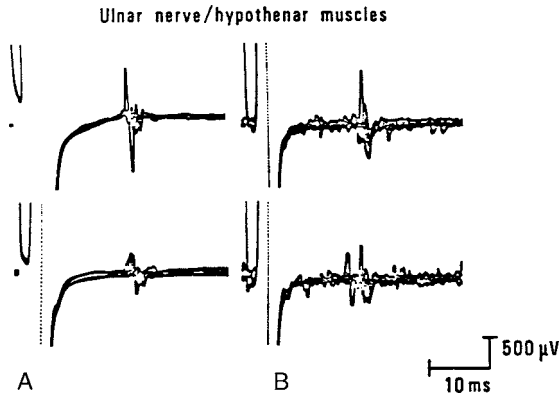


**Figure 23-8.** Variation of F-wave latency with distance in normal subjects for, *A*, arm conduction studies and, *B*, leg conduction studies.

when recording from foot muscles (hence, *F* for foot). Recording electrodes for F waves are placed over the muscle in the standard locations used for motor NCS.

**Stimulation.** Stimulation applied to the median, ulnar, tibial, or peroneal nerve at the wrist or ankle evokes an F wave that is separated clearly from the M wave. The cathode should be *proximal* to the anode, and the stimulus should be supramaximal to ensure antidromic activation of all the axons.<sup>22</sup> This is most easily accomplished after obtaining the supramaximal CMAP response at the distal stimulation site

for the routine motor NCS and then immediately rotating the anode perpendicular to the nerve so that there is no anodal block of the antidromic volley necessary to elicit the F waves. F waves should be recorded with only supramaximal stimulation; otherwise, they may be confused with H reflexes. Higher amplification is needed than for standard NCS; gains of 200 or 500 mV/cm are usually adequate. The longer latencies of F waves require slower sweep speeds than needed for standard NCS. The rate of stimulation does not affect the F waves, but minimal muscle contraction may enhance them. However, such contraction can



**Figure 23-9.** F-wave recordings made, *A*, with the muscle at rest and, *B*, with muscle contraction. Reliable measurements are not possible with poor relaxation.

make it more difficult to recognize F waves (Fig. 23-9). Jendrassik or other distracting maneuvers such as contraction and relaxation of muscles in another limb or in the jaw may enhance F waves without obscuring them.

A series of stimuli is applied until a minimum of eight to ten F waves have been obtained.<sup>23</sup> Too few F waves will result in an inadequate sample for reliable measurement of the variables. In some nerves, particularly the peroneal, F waves may be too infrequent for an adequate number to be obtained for reliable measurements. Therefore, for the peroneal nerve, no elicitable F waves may be a normal variant.

**Measurements.** The F-wave latency is measured to the earliest reproducible potential in the series recorded. The latency of each of the F waves can be measured and the values plotted as a histogram that gives the dispersion (*chrono-dispersion*) of the F latencies, but this is time-consuming and adds little additional value clinically<sup>24</sup> (Fig. 23-10). Different laboratories use different distance measurements. Normal values must be recorded using the same techniques. In the Mayo EMG laboratory, we have found that arm measurements made from the site of stimulation at the wrist (cathode) to the sternoclavicular joint and leg measurements from the cathode to the xiphoid process are most useful.

Several methods have been suggested for assessing F waves, including comparing the latency with normal values corrected for age and distance, calculating the conduction velocity in the central segment, and calculating a central latency and comparing it with an estimated latency based on known conduction

velocity (Fig. 23-10). The most convenient and readily applied method is to compare F-wave latency with normal values corrected for distance. However, because F-wave latency varies with distance, the absolute latencies depend on limb length. Measurements of limb length should be made as described for each nerve whenever F waves are recorded.

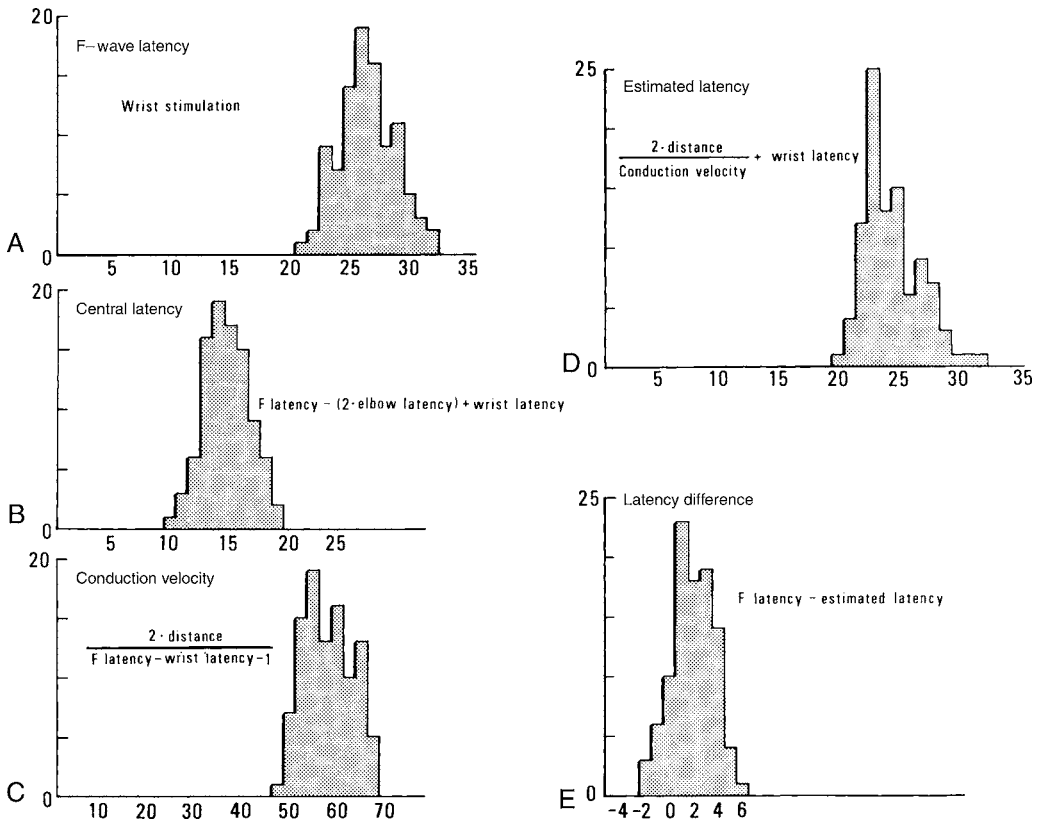
Another method is to compare the actual F-wave latencies with an estimated F-wave latency, *F estimate* ( $F_{est}$ ), based on the distance and conduction velocity in the distal segment using the following formula (Fig. 23-10D):

$$F_{est} = [(2 \times \text{distance}) / \text{conduction velocity}] + \text{distal latency}$$

F-wave latencies should be within the normal range of F-wave estimates. If they are shorter, proximal conduction is faster than distal conduction. If they are longer, proximal conduction is slower than distal conduction. Thus, F waves can distinguish diffuse peripheral nerve disorders from those that are primarily distal and those that are primarily proximal. F-wave latencies obtained in normal subjects 18-88 years old are listed in Table 23-2.

In measuring F-wave latencies, it is particularly important to pay attention to potential errors.<sup>25</sup> A poorly relaxed muscle may produce deflections throughout the sweep, making it difficult to identify F waves (Fig. 23-9). Late components or satellite potentials of a dispersed compound action potential may be identified incorrectly as F waves. Satellite potentials can be recognized by their constant location and configuration, in contrast to the variable F waves. Also, the latency of satellite





**Figure 23-10.** Calculated values for ulnar F-wave latency based on recordings from 96 normal subjects. *A*, All values are derived from the F-wave latencies, by the calculations shown with each histogram. *B*, Central latency estimates the time from elbow stimulation to return of the F-wave response to the elbow location. *C*, Conduction velocity is the velocity of the F waves over the length of the nerve from the wrist to the spinal cord. *D*, Estimated latency for the F wave is based on peripheral conduction and the distance from the wrist to the sternal notch. *E*, Latency difference compares estimated latency with measured F-wave latency. Proximal slowing alone results in positive differences; distal slowing alone results in negative differences.

**Table 23-2 F-Wave Latency in Normal Subjects 18-88 Years Old**

	Mean (ms)	Range (ms)	Distance (cm)	Contralateral Difference
Ulnar/ADM	26.6	21-32	50-76	0-3
Median/APB	26.4	22-31	57-73	0-3
Tibial/AHB	48.6	41-57	106-125	0-4
Peroneal/EDB	47.4	38-57	102-128	0-4

ADM, abductor digiti minimi; AHB, abductor hallucis brevis; APB, abductor pollicis brevis; EDB, extensor digitorum brevis.

potentials increases with more proximal stimulation, whereas F-wave latencies decrease.

**Key Points**

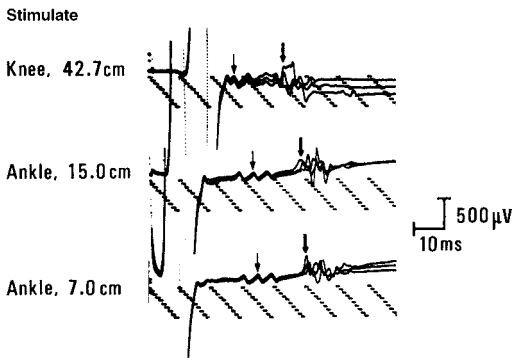
- F waves are of lower amplitude than the CMAP and vary in latency and morphology because

- Only about 1% of motor axons are activated with a supramaximal stimulus.
- Different axons are activated with sequential stimuli.
- Both F-wave and A-wave latencies are shorter with more proximal stimulation.

- F waves vary in configuration with sequential stimuli (unless there are too few present, that the same one recurs).
- A waves have a constant configuration and occur with each stimulus (unless the stimulus is near threshold for A-wave activation).
- F-wave recording varies with a number of factors:
  - May be absent with a normal peroneal nerve.
  - Distracting maneuvers like the Jendrassik enhance F-wave occurrence.
  - F-wave measurements are not possible with poor relaxation.
- Comparison of F-wave latency to the F estimate localizes the slowing in a nerve:
  - F-wave latency (the same)—conduction is the same along the length of the nerve.
  - F-wave latency (longer)—slowing is greater in the proximal segment of the nerve.
  - F-wave latency (shorter)—slowing is greater in the distal segment of the nerve.

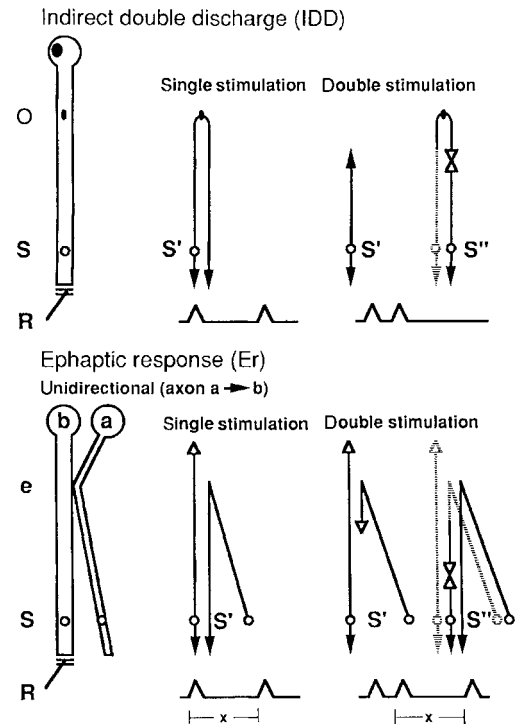
**AXON REFLEXES (A WAVES)**

Other late responses, A waves, can resemble F waves, but they are more persistent at



**Figure 23-11.** Superimposed abductor hallucis CMAPs recorded in response to tibial nerve stimulation. Late responses are (1) F waves (*thick, second arrow*) that are variable in latency, amplitude, and configuration and (2) stable axon reflexes (*thin, first arrow*). Both have shorter latency with more proximal stimulation. (From Daube, J. R. 1992. Nerve conduction studies. In *Electrodiagnosis in clinical neurology*, ed. M. J. Aminoff, 3rd ed., 294. New York: Churchill Livingstone. By permission of WB Saunders Company.)

a single stimulus intensity. The two types of A waves are axon reflexes and indirect discharges.<sup>26</sup> Both decrease in latency with more proximal stimulation (Fig. 23-11, *small arrow*). *Indirect discharges* are the identical backfiring activation at a proximal location on an axon that can be blocked by paired stimuli, as can F waves (Fig. 23-12). *Axon reflexes* are potentials that invade a proximal branch of an axon and can become more or less frequent with a change in stimulus intensity. The morphology of an axon reflex does not change with repeat stimulation. In contrast, F waves are responses



**Figure 23-12.** Diagram showing the effects of antidromic action potentials on two forms of A waves (late responses). *Top*, A single axon with proximal hyperexcitability is reactivated by an antidromic action potential to give a late response; the reactivated late response is blocked by a paired stimulus. *Bottom*, Theoretical outcome if the late responses were activated ephaptically. None of the patients with these late responses showed the pattern of ephaptic activation. e, point of ephaptic activation; O, point of action potential backfiring; S', single stimulus; S'', second of a pair of stimuli. (From Magistris, M. R., and G. Roth. 1992. Motor axon reflex and indirect double discharge: Ephaptic transmission? A reappraisal. *Electroencephalography and Clinical Neurophysiology* 85:124-30. By permission of Elsevier Scientific Publishers.)

that are variable in latency, amplitude, and configuration but occur grouped within a consistent range of latencies. However, in disorders in which there is a loss of significant numbers of motor units and only a small number of motor units remain, elicited F waves may have the same morphology and be mistaken as A waves.

### Key Points

- Axon reflexes are potentials that invade a proximal branch of an axon and can become more or less frequent with a change in stimulus intensity.
- The two types of A waves are axon reflexes and indirect discharges.

## PHYSIOLOGIC VARIABLES AFFECTING THE CMAP

### Temperature

In normal subjects, CMAPs vary with several factors, which need to be controlled. The temperature of the limb is the most significant factor; a temperature decrease produces a 2.0 m/second slowing per degree centigrade and increases both amplitude and area.<sup>27</sup> Temperature is a greater cause of variation in measurements of conduction velocity than errors in measurements of latency or distance. Between 22°C and 38°C, conduction velocity is related approximately linearly to the temperature, increasing about 50% when the temperature is increased 10°C ( $Q_{10} = 1.5$ ). Thus, a nerve with a conduction velocity of 60 m/second at 36°C conducts at 40 m/second at 26°C (i.e., a decrease of 2 m/second per degree centigrade). The change per degree centigrade is proportionally less for nerves that have a lower conduction velocity. Calculations can be made to correct for a cool limb, but it is more reliable and effective to warm a cool limb before doing the nerve conduction study. Immersing the limb in a water bath at 40°C for 5 minutes is best. The temperature of the arm measured on the surface over the hand should be at least 32°C; the temperature of the leg measured anterior to the lateral malleolus should be at least 30°C. More distal sites have lower temperatures. CMAP measurements in

patients should always be performed in the same temperature range in which the normal values were determined.

Similar to the worsening of conduction and, hence, worsening of neurologic function in central demyelinating disorders, such as multiple sclerosis, with increasing temperature (Uhthoff's phenomenon), increasing temperature has been shown to be important in the function of peripheral nerves and the electrophysiologic assessment of them. This is particularly important in demyelinating neuropathies. In normal nerves, increasing temperature lowers the amplitude, increases conduction velocity, and reduces temporal dispersion. Increasing temperature increases how quickly sodium channels open (and close) which shortens the action potential rise time and thus decreases the internodal conduction time (increasing conduction velocity). This phenomenon decreases the sodium influx. Coupled with increased current leak about the areas of demyelination and hence decreasing available sodium current at the next node, in demyelinating states at higher temperatures there may not be enough sodium current to propagate an action potential. This results in conduction block.<sup>28</sup> Hence, increasing temperature for NCS increases the degree of demonstrable conduction block (while decreasing temporal dispersion) in demyelinating neuropathies<sup>28,29</sup> and compressive mononeuropathies (median neuropathy at the wrist<sup>30</sup> and ulnar neuropathy at the elbow<sup>31</sup>). Therefore, conduction block may be missed when the limb being examined is too cool (e.g., this may be problematic and confounding when assessing for possible acute inflammatory demyelinating polyradiculoneuropathy (AIDP; Guillain-Barré Syndrome) in a patient in the intensive care unit). Focal cooling has been shown to decrease the demonstrable conduction block and (interestingly from a clinical implication standpoint) improve clinical function in patients with peroneal neuropathy at the fibular head.<sup>32</sup>

### Age

Age must also be considered in determining the significance of prolonged latencies, slow conduction velocities, and low amplitudes of compound action potentials. Conduction

velocity slows progressively between 20 and 30 years of age, and by age 80, it is approximately 10 m/second slower.<sup>33</sup> Conduction velocities are slower in children younger than 3 years and in people older than 65 years. CMAP recordings show no significant differences between men and women. Height and body size, for example, finger circumference for median sensory values, are also contributing factors to normal values. Conduction velocity slows with axonal length. The effect is particularly noteworthy in persons taller than 6 ft in whom normal values are significantly slower than in shorter subjects.<sup>34</sup> Ideally, the normal value for a patient should be adjusted for temperature, age, and height.

The range of normal values is wide, making the measurement of a single value less reliable in identifying mild disease. For example, the range of normal peroneal/EDB CMAP amplitudes from 2 to 12 mV means that a patient who has a baseline amplitude of 10 mV may lose 80% of the response before the value is outside the normal range. It is thus critical to compare to the other side (recognizing some potential pitfalls—see below) for unilateral processes where there is a high clinical suspicion, but NCS are still in the normal range. This is particularly true in younger patients. Generally, a greater than 50% side-to-side difference in amplitude is considered a significant asymmetry. The range of normal values for conduction velocity, latency, and F-wave latency is narrower and, thus, somewhat better for identifying mild changes in disease. However, in each case, percentile or normal deviation measurements are better for detecting mild disease.<sup>18</sup> Combinations of variables may improve the recognition scores.<sup>35</sup>

There are also significant differences in the normal values for amplitudes and rates of conduction between different nerves, particularly between the upper and lower extremities. In unilateral disorders, comparisons of values obtained in the affected limb with those obtained in the opposite limb can be helpful, but there may be large side-to-side differences in normals (amplitude, 20%–70%; latency, 30%–40%; conduction velocity, 20%–30%; F-wave latency, 10%).<sup>36</sup> Therefore, the significance of any value is best evaluated by comparing it with values obtained in the same nerve in a limb at the same temperature of subjects of the same age who participated in the

study in which the normal values were determined, using the same methods and making a percentile comparison.

The reproducibility of CMAP recordings must also be considered both in identifying abnormality and in comparing values over time when a patient's condition is being monitored. These range from 5% for F-wave latencies in the arm to 15% for CMAP amplitudes in the foot.<sup>11</sup> Reliable motor NCS require vigilance in recognizing the many pitfalls possible.<sup>37</sup>

### Key Points

- Lower temperature slows conduction velocity and increases CMAP amplitude and area.
- Increasing temperature increases the degree of demonstrable conduction block.
- Conduction velocities are slower in
  - Children <3 years old and adults >65 years old.
  - Longer axons and hence in adults >6 ft tall.
- There is no significant difference in CMAP responses between men and women.
- Side-to-side CMAP amplitude differences of greater than 50% identify pathology with “normal” amplitude responses.

## CMAP CHANGES IN DISEASE

### Pathophysiology

The techniques routinely used to study nerve conduction test large-diameter afferent fibers and alpha motor fibers. The nerve action potential from a mixed nerve is predominantly from large afferent fibers. Components resulting from activation of small myelinated (delta) fibers and C fibers cannot be identified. Hence, normal NCS and electromyography do not exclude a small fiber neuropathy or process. Special techniques of measuring distribution of conduction in the activated axons have generally not been accepted.<sup>38–40</sup>

The CMAP recorded from peripheral nerves is the action potential that results from activation of these large myelinated motor fibers. Changes in the motor fibers, as occurs in certain diseases, may affect the conduction time along the fibers.

## Mechanisms of Conduction in Myelinated Fibers

Conduction in myelinated fibers is saltatory. The action potential jumps from one node of Ranvier to the next, with the action potential of one node providing the current that excites the subsequent node. Conduction velocity is determined by the time required for one node to excite the next. Thus, if the distance between two nodes (internodal distance) is 1 mm and the nodal conduction time is 20  $\mu$ s, the conduction velocity is 50 m/second. The time required for one node to excite the next node is determined by several factors:

1. The faster the rate of rise of the action potential at node 1, the more rapidly node 2 will be activated.
2. The smaller the amount of current required to neutralize the charge held by the membrane capacitance of node 2 and to depolarize the nodal membrane to threshold, the more rapidly an action potential will appear at node 2. Large myelinated fibers have a lower membrane capacitance than unmyelinated fibers and hence have a faster conduction velocity.
3. The more current that is lost in neutralizing the charge across the axonal membrane in the internode and by leakage through the myelin, the longer it will take to activate the next node. Large myelinated fibers lose less charge and hence have a faster conduction velocity.
4. The higher the resistance to current flow in the axoplasm from node 1 to node 2, the longer it will take to activate node 2. Large myelinated fibers have lower resistance than unmyelinated fibers and hence have faster conduction velocity.

## Mechanisms of Slow Conduction in Disease

Paranodal demyelination increases the capacitance of the internodal membrane. More current is needed to neutralize the charge across the internodal membrane and less is available to discharge node 2. Thus, it takes longer to initiate an action potential at node 2. Segmental demyelination results

in a more profound increase in capacitance and decrease of resistance across the internodal membrane. In large-diameter fibers, conduction may be blocked. In smaller diameter fibers, conduction may become continuous, as in unmyelinated fibers, instead of saltatory.<sup>41</sup>

A decrease in the diameter of fibers occurs with axonal atrophy or compression. This has been best demonstrated in ultrasound<sup>42-44</sup> and MRI studies<sup>45</sup> for CTS. It has been consistently shown that there are compressive signs and flattening at the site of compression distally in the carpal tunnel and swelling with an increased cross sectional area at the most proximal aspect of the carpal tunnel. It is the demonstration of the enlarged nerve proximal to the compression that is most reproducible in ultrasonography evaluation and hence is what is measured. (These ultrasound findings have been demonstrated to be of similar sensitivity (89%) and specificity (98%) to electrophysiologic diagnosis of CTS with emerging evidence that it may also correlate with electrophysiologic measures of severity.)<sup>42-44,46</sup> Decreased diameter increases the resistance to flow of current from node 1 to node 2. Reduction in current flow increases the time required to excite node 2. Simultaneous reduction in internodal membrane capacitance because of reduced membrane area does not compensate for the higher resistance.

With the loss of large-diameter fibers because of conduction block or degeneration, conduction measurements reflect conduction in smaller diameter, more slowly conducting fibers instead of the slowing of conduction in larger fibers. This may account for the slow conduction observed in segments proximal to a focal lesion instead of reflecting an extension of the lesion proximal to the site of compression.

With decreased myelin thickness, particularly during remyelination, the number of myelin lamellae is small in proportion to fiber diameter. The capacitance and conductance of the internodal membrane are high, the loss of current through the internode is more than normal, and a longer time is required to excite the next node. Other possible factors in the slowing of conduction are altered characteristics of the nodal membrane, which affect the generation of the action potential. No such factor has been identified in focal lesions.



Other effects of demyelination should also be kept in mind. Demyelination increases the refractory period, decreases the ability of the fiber to conduct impulses at high frequency, and increases the susceptibility to blocking of conduction with increasing temperature (see explanation in the section on Physiologic Variables Affecting the CMAP).

### Key Points

- NCS test large-diameter afferent fibers and alpha motor fibers.
- Normal NCS and EMG do not exclude a small fiber neuropathy.
- Saltatory conduction (“jumping”) of the action potential along a myelinated nerve provides faster conduction velocities without increased fiber diameter.
- Membrane capacitance (charge storage capacity) is inversely related to nerve fiber conduction velocity (e.g., high capacitance and slow conduction in unmyelinated fibers). Demyelination increases capacitance and thereby slows conduction.
- Axonal internal resistance is inversely related to fiber diameter, resulting in faster conduction in large fibers. Thus, nerve fiber narrowing or compression leads to slow conduction.
- High membrane resistance in myelinated fibers reduces current leakage and increases conduction velocities.

## FINDINGS IN PERIPHERAL NERVE DISORDERS

The electrophysiologic findings in peripheral nerve disorders are conduction slowing, conduction block, and reduced CMAPs or their absence. Each may have a focal or a diffuse distribution. *Conduction slowing* may be seen as prolonged distal latencies, slow conduction velocity, or prolonged F-wave latencies. Segmental demyelination and the narrowing of axons both slow conduction. *Conduction block* can result from a metabolic alteration in the axonal membrane, such as local anesthetic block, or structural changes in the myelin, such as telescoping or segmental demyelination. Reduced or absent responses are the result of total conduction block, Wallerian degeneration

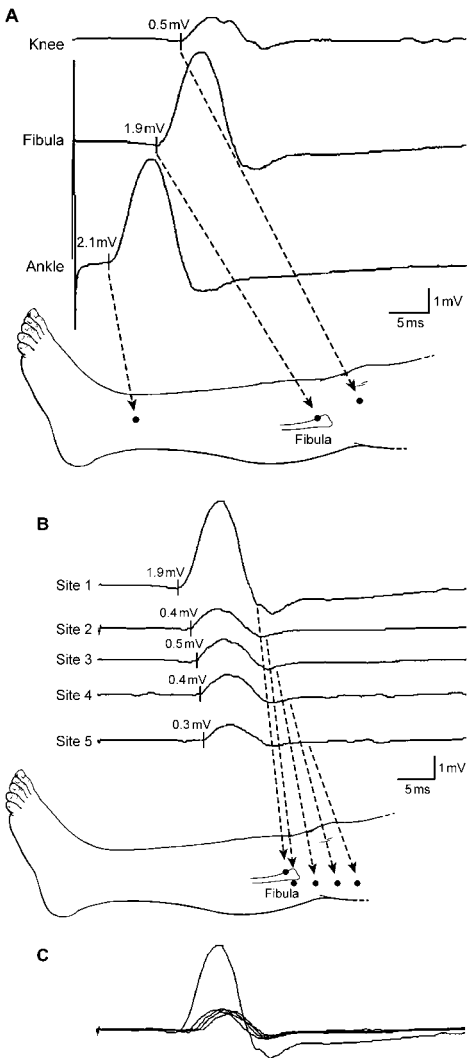
after axonal disruption, or axonal degeneration, as in *dying-back neuropathies*.

Large-diameter myelinated fibers are the nerve fibers that are most sensitive to damage by localized pressure. The largest ones are the afferent fibers that mediate touch pressure, vibration, and proprioception. In a mixed nerve, these fibers generally have larger diameters than alpha motor fibers, as evidenced by their 10%–15% faster conduction velocity. In a chronic compression lesion, measurement of conduction velocity in the sensory fibers often demonstrates an abnormality before it is evident in motor fibers.

*Conduction block.* Conduction block is identifiable most clearly in individual axons at a site where the action potential cannot be transmitted to the next segment. No response occurs with stimulation proximal to the block, and a full response is seen with stimulation distal to the block. Thus, conduction block in a whole nerve may be *total*, in which no axons transmit potentials across the site of damage, or *partial*, in which only a proportion transmit potentials across the block (Fig. 23–13A and 23–13B). In conduction block associated with a localized mononeuropathy, the CMAP area (or amplitude) obtained with stimulating just proximal to the site of the block is decreased compared with that just distal to the block. *Conduction block* generally means there are intact axons that are unable to transmit potentials across a local area of damage. However, an acute injury to a nerve that destroys all axons will have the appearance of a conduction block for a few days until Wallerian degeneration occurs.<sup>47</sup>

Because many other factors may result in changes that have the appearance of conduction block, explicit criteria are required for identifying conduction block.<sup>48,49</sup> Slowing in some of the axons with dispersion of the CMAP decreases the amplitude, but it increases the duration and area. Therefore, amplitude is less reliable in recognizing conduction block. Because of normal dispersion over longer segments of nerve, stimulation over short segments is more reliable for identifying conduction block.<sup>50</sup> With routine motor NCS, stimulating a distal and a proximal site, the Mayo Clinic EMG lab uses the following thresholds to define when the NCS should be extended to formally evaluate for possible conduction block





**Figure 23-13.** Example of partial conduction block in the peroneal nerve. *A*, Routine peroneal motor NCS demonstrating a partial conduction block between the fibular head and the knee [CMAP amplitudes of 2.1 mV at the ankle, 1.9 mV at fibular head, and 0.5 mV at the knee]. *B*, Inching study with stimulation below the fibular head (*top trace*) and making incremental steps proximal along the peroneal nerve (conduction block is identified between sites 1 and 2, at the fibular head). *C*, Traces shown in superimposed view.

(i.e., these do not define conduction block, but only cue one that it should be looked for such as stimulating below the elbow or fibular head): (1) for median nerve if proximal amplitude/area is less than 90% of distal; (2) for ulnar and peroneal nerves if proximal amplitude/area is less than 80% of distal; and (3) for tibial nerve if proximal amplitude/area is less than

50% of distal. Similar consensus criteria for conduction block have been published.<sup>48</sup> Dispersion of a CMAP can also be associated with decreased area because of *phase cancellation*, that is, the summation of positive and negative components of action potentials from different axons.<sup>12</sup> Thus, conduction block is more difficult to identify with low-amplitude potentials. Conduction block increases with temperature in a damaged nerve, providing another important reason for monitoring temperature.<sup>28</sup>

**Conduction slowing.** In contrast to conduction block, conduction slowing is seen as prolonged latency and slowed conduction velocity. Although conduction block and slowing may occur together, they often occur independently. Conduction block is more common in rapidly developing disorders, and conduction slowing is more common in chronic disorders. Loss of strength is quantified most accurately by reduction in CMAPs to stimulation at a proximal site. CMAP amplitude and area changes can help in categorizing nerve damage into broad groups. For instance, in traumatic injuries of a nerve, there is usually conduction block (with an area or amplitude change) or axonal disruption (with low amplitude at all stimulation points) or some combination of the two. The clinical deficit caused by either conduction block or axonal disruption may have variable duration (Table 23-3). The

**Table 23-3 Duration of Deficit after Peripheral Nerve Injury**

Injury	Duration of deficit
<i>Conduction block (amplitude change)</i>	
Metabolic	Seconds to minutes
Myelin loss	Days to weeks
Axonal distortion	Weeks to months
<i>Axonal disruption (fibrillation potentials)</i>	
Few axons	No deficit
Many axons	Weeks to months
All axons	Months to years

From Daube, J. R. 1992. Nerve conduction studies. In *Electrodiagnosis in clinical neurology*, ed. M. J. Aminoff, 3rd ed., 308. New York: Churchill Livingstone. By permission of WB Saunders Company.

Table 23–4 Patterns of Abnormality in NCS of Peripheral Neuromuscular Disorders

Disorder	Motor nerve studies			Sensory nerve studies			
	Action potential			F-wave latency	Action potential		
	Amplitude	Duration	Conduction velocity		Amplitude	Duration	Conduction velocity
Axonal neuropathy	↓	Normal	>70%	Mild ↑	↓↓	Normal	>70%
Demyelinating neuropathy	↓ Proximal	↑ Proximal	<50%	↑	↓	↑ Proximal	<50%
Mononeuropathy	↓	↑	↓	↑	↓↓	↑	↓
Regenerated nerve	↓	↑	↓	↑	↓	↓	↓
Motor neuron disease	↓↓	Normal	>70%	Mild ↑	Normal	Normal	Normal
Neuromuscular transmission defect	(↓)	Normal	Normal	Normal	Normal	Normal	Normal
Myopathy	(↓)	Normal	Normal	Normal	Normal	Normal	Normal

Symbols: ↑, increase; ↓, decrease; ↓↓, greater decrease; (↓), occasional decrease.

From Daube, J. R. 1992. Nerve conduction studies. In *Electrodiagnosis in clinical neurology*, ed. M. J. Aminoff, 3rd ed., 309. New York: Churchill Livingstone. By permission of WB Saunders Company.

results of NCS are a function of the underlying pathologic change, not the duration of the disorder. No single change in NCS is typical of the clinical phenomenon of neurapraxia, in which there is transient weakness without atrophy. If neurapraxia is caused by a metabolic alteration, it lasts only a few minutes; however, if it is caused by axonal distortion with telescoping of internodes, it may persist for weeks or months.<sup>51</sup> Some patterns of abnormality are summarized in Table 23–4. CMAP measurements cannot predict how long these abnormalities will last.

### Key Points

- NCS assess large-diameter myelinated fibers which are the most sensitive to damage by localized pressure.
- The following distal to proximal amplitude differences require short segment stimulation for *possible* conduction block:
  - Ulnar nerve >20%
  - Median nerve >10%
  - Peroneal nerve >20%
  - Tibial nerve >50%.

### Findings in Focal Lesions

A low-amplitude CMAP, slow conduction, or conduction block characterizes localized peripheral nerve damage. The amplitude of the CMAP may be low at all sites of stimulation if Wallerian degeneration has occurred. In conduction block, some axons are unable to transmit action potentials through the damaged segment but are functioning distal to it.<sup>52</sup> If all axons are blocked, no response is obtained proximal to the site of the lesion. A block in conduction must be distinguished from slowing in conduction, which may resemble it. In conduction block, there is an abrupt decrease in CMAP amplitude and area over a short segment. Slowing of nerve conduction in some axons is associated with a gradual decrease in amplitude as stimulation is moved proximally because of dispersion of the CMAP. The area of the evoked response remains constant with conduction slowing unless phase cancellation also occurs.

The CMAP findings in focal nerve damage evolve over time with the restoration of function. Local membrane changes, paranodal demyelination, segmental demyelination, and axonal telescoping are all followed by local

Table 23–5 Changes in Nerve Conduction Variables After Focal Nerve Injury\*

Variable	Changes			
	Acute (<7 days)	Subacute (weeks)	Progressive	Residual*
Compound muscle action potential	Normal	Low if severe	Low if severe	Low if severe
Motor conduction velocity	Normal	<30% slow if severe	<30% slow if severe	(<30% slow if severe)
Motor distal latency	Normal	<30% long if severe	<30% long if severe	(<30% long if severe)
F wave	Prolonged or absent	Absent or prolonged	Absent or prolonged	(Prolonged or absent)

\* Parentheses indicate changes that occur sometimes, but not always, at that stage.

repair within days to weeks. Wallerian degeneration of some axons in a nerve is followed by collateral sprouting of surrounding axons, resulting in reinnervation of the muscle and the restoration of CMAPs within a few weeks, depending on the amount of axonal loss. Axonal sprouting within the nerve and the reinnervation of the muscle after the loss of all the axons are much slower and less complete than collateral sprouting. The evolution of the nerve conduction changes is outlined in Table 23–5.

### EVALUATION OF FOCAL NEUROPATHIES

If a nerve is conducting slowly, it is important to identify whether the abnormality is localized or diffuse. Latencies and amplitudes obtained with stimulation (or recording) over short distances provide the best localization of focal nerve damage.<sup>55</sup> If there is slowing of conduction velocity over any length of nerve (e.g., the median and ulnar nerves in the forearm or the tibial and peroneal nerves in the leg), the severity of slowing must be compared with that of other nerves in the patient. If the slowing is out of proportion to the slowing elsewhere or the decrease in amplitude is more than the normal for that nerve, a localized abnormality must be sought. Stimulating proximally and distally to the suspected area of local abnormality (e.g., knee or elbow) can identify localized lesions. If conduction block or slowing is found between two points of stimulation, the method of short segmental stimulation (*inching*) should also be used. Inching begins with supramaximal stimulation in the

normal segment just distal to the area of abnormality.<sup>56</sup> The point of stimulation is noted, and stimulation is reapplied at 2-cm intervals proximally along the nerve. The responses are superimposed and compared along the length of the nerve. A localized area of abnormality is indicated by a greater decrease in amplitude or a greater increase in latency between two adjacent points of stimulation than between other sites. The anatomical location of this point is measured from a fixed landmark (e.g., the medial epicondyle or fibular head) (Fig. 23–13). In this way, a conduction block can be localized precisely along the nerve. Stimulation with near-nerve needle electrodes can be used for inching in nerves deep in the tissue, for example, the median nerve in the forearm.

In patients with hereditary neuropathy with liability to pressure palsies (HNPP), even slight traction or compression of a nerve may cause motor and sensory disturbances. Furthermore, the nerves of clinically unaffected relatives also may have EMG and histologic abnormalities. These patients typically have evidence of an underlying sensory and distal motor neuropathy.<sup>53</sup> An increased incidence of pressure palsies has been observed among patients with diabetes mellitus.<sup>54</sup>

Slowing of conduction in Guillain-Barré syndrome (AIDP) is often most marked at sites commonly affected by pressure lesions (e.g., the median nerve at the wrist, the ulnar nerve at the elbow, and the peroneal nerve at the knee). Other conditions, including renal failure, alcoholism, and malnutrition, have been reported to increase susceptibility to focal compression lesions.

**Key Points**

- Short segmental stimulation (inching) can precisely localize a conduction block along the nerve.

**Findings in Diffuse Peripheral Nerve Damage and Peripheral Neuropathies**

NCS can differentiate a disorder of primarily axonal loss from a disorder of primarily demyelination. A disorder associated primarily with axonal destruction, as in axonal dystrophies and dying-back neuropathies, is associated predominantly with low-amplitude CMAPs at all sites of stimulation, with no more than about 30% slowing in conduction velocity. Segmental demyelination is associated with pronounced slowing of conduction, usually to less than 50% of normal, and with a progressive decrease in the CMAP amplitude at proximal stimulation sites (Fig. 23–14). Slowing of conduction also occurs in severe, chronic axonal disorders with axonal narrowing.

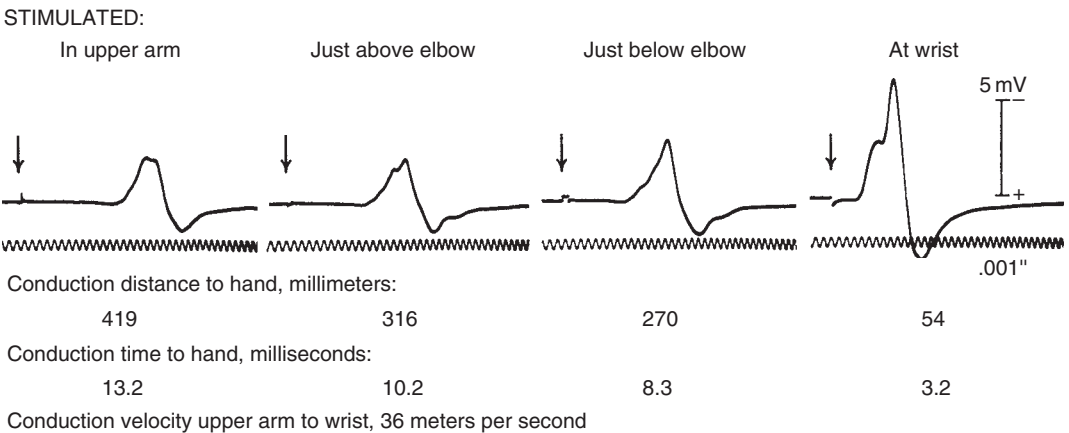
The severity of peripheral nerve damage can be well defined by NCS, but the pathologic alteration cannot be predicted for mixed patterns or mild changes. Diabetes mellitus, the most common cause of peripheral neuropathy, has a mixed pattern of abnormalities. In this condition, there commonly is a mild generalized distal neuropathy caused by multiple small additive lesions along the

nerves, often with features of a demyelinating neuropathy.<sup>57</sup> There may also be mononeuropathies of the median nerve at the wrist, the ulnar nerve at the elbow, or the peroneal nerve at the knee, with localized slowing or conduction block superimposed on a generalized decrease in the CMAP amplitude and mild generalized slowing of conduction. F-wave latencies and sural sensory nerve action potential amplitudes are the most sensitive motor and sensory nerve conduction variables, respectively, for identifying neuropathy.<sup>20,58</sup> Needle examination usually shows only mild changes distally. However, some patients with diabetes mellitus have a lumbosacral polyradiculopathy, with diffuse fibrillation potentials in lumbar paraspinal muscles. This pattern may be associated with prolongation of F-wave latencies caused by proximal slowing of conduction.

Although many patients with neuropathy have mixed findings on NCS, some patients may have a predominantly axonal or segmental demyelinating neuropathy (Table 23–6).

**AXONAL NEUROPATHIES**

Axonal neuropathies primarily affect the axon and produce either diffuse degeneration or dying-back of the distal portion of the axon. Axonal damage is particularly common with toxic and metabolic disorders. The major change on NCS is a decrease in the amplitude of the CMAP or the compound nerve action potential (or both). This decrease is



**Figure 23–14.** Hypothenar CMAP recorded with ulnar nerve stimulation in a patient with generalized peripheral neuropathy. Velocity is slow throughout (36 m/second), with gradual dispersion of the CMAP to produce lower amplitudes with proximal stimulation. Downward arrow indicates point of stimulation. (Courtesy of Dr. E. H. Lambert, Mayo Clinic).

**Table 23–6 Patterns of Electromyographic Abnormality in Conditions Associated with Peripheral Neuropathy**

**Predominant EMG/NCS Changes of Axonal Degeneration**

Diabetes mellitus (some patients)  
 Guillain-Barré syndrome (some patients)  
 Toxic—vincristine, acrylamide, others  
 Alcohol  
 Uremia  
 Acute intermittent porphyria  
 Collagen-vascular diseases  
 Carcinoma  
 Amyloidosis

**Predominant EMG/NCS Changes of Segmental Demyelination**

Diabetes mellitus (some patients)  
 Guillain-Barré syndrome (some patients)  
 Dejerine-Sottas disease  
 Diphtheritic neuropathy  
 Chronic inflammatory neuropathy  
 Refsum disease  
 Leukodystrophies  
 Neuropathy with monoclonal protein

EMG, electromyographic; NCS, nerve conduction studies.

From Daube, J. R. 1992. Nerve conduction studies. In *Electrodiagnosis in clinical neurology*, ed. M. J. Aminoff, 3rd ed., 312. New York: Churchill Livingstone. By permission of WB Saunders Company.

proportional to the severity of the disease. Some axonal neuropathies, such as those associated with vitamin B12 deficiency, carcinoma, and Friedreich's ataxia, chiefly affect sensory fibers; others, such as lead neuropathies, have a greater effect on motor fibers. Sensory axons commonly are involved earlier and more severely than motor axons. Occasionally, sensory potentials can be low amplitude and associated with only mild sensory symptoms. In contrast to the change in amplitude, there usually is little change in latency or conduction velocity in axonal neuropathies; conduction in individual axons is generally normal until the

axon has degenerated. Therefore, normal conduction velocities should not be considered evidence against the presence of neuropathy. Often, the only finding in a case of axonal neuropathy is fibrillation potentials on needle examination of distal muscles, especially intrinsic foot muscles.

If many large axons are lost because of axonal neuropathy, conduction velocity may be decreased but not to less than 70% of normal. Axonal neuropathies typically affect the longer axons earlier and are first identified in the lower extremities. Tables 23–7A and 23–7B compare the electrophysiologic findings in

**Table 23–7A Electrodiagnostic Features of Predominantly Axonal Neuropathies**

CMAP amplitude	Conduction velocity	Distal latency	Conduction block or temporal dispersion
50–100% NL	NL/minimally decreased	NL	No
<50% NL	>70% NL	<130%NL	No

**SNAPs**—low amplitude with mild slowing in milder cases to absent in severe cases

**EMG**—clear fibrillations suggesting axonal loss and uncompensated denervation. In length-dependent processes, this shows a distal gradation. In polyradiculopathy/neuropathy, fibrillations are seen proximally and distally.

**Table 23–7B Electrodiagnostic Features of Predominantly Demyelinating Neuropathies**

CMAP amplitude	Conduction velocity	Distal latency	Conduction block or temporal dispersion	F wave or blink reflex
50–100% NL	<70% NL	>130% NL	Yes*	Prolonged
<50% NL	<50% NL	>130% NL	Yes*	

**SNAPs**—lower amplitude, significant slowing; more likely absent than axonal

**EMG**—No fibrillations (or minimal if severe) in pure demyelinating process

Reduced recruitment out of proportion to fibrillations and neurogenic changes

In reality as these processes become chronic → mixed demyelinating/axonal

\*Conduction block and temporal dispersion are typical of acquired demyelinating neuropathies; occur rarely in hereditary demyelinating neuropathies.

demyelinating and axonal neuropathies based on the criteria used at the Mayo Clinic. Nerves that are more susceptible to local trauma because of their superficial location are also more sensitive to axonal damage; sometimes, axonal neuropathies are manifested first as peroneal neuropathies with low-amplitude or absent responses, while other motor nerves remain intact. Axonal neuropathies may be associated with a change in the refractory period of the nerve and with a relative resistance to ischemia. Amyotrophic lateral sclerosis, a disease of anterior horn cells, shows changes on motor conduction studies typical of axonal neuropathy<sup>59</sup> (Table 23–8) and is notable for large, *repeater* F waves resulting from collateral sprouting of axons.<sup>60</sup>

**SEGMENTAL DEMYELINATING NEUROPATHIES**

*Segmental demyelinating neuropathies* are usually subacute inflammatory disorders, the prototype being Guillain–Barré syndrome.

Similar patterns may be seen in the inherited chronic hypertrophic neuropathies, for example, hereditary demyelinating motor and sensory neuropathy type I (Charcot–Marie–Tooth (CMT) type I) and Dejerine–Sottas disease (CMT type III), as well as acquired disorders such as chronic inflammatory demyelinating polyradiculoneuropathy (CIDP) and variations of it (such as distal acquired demyelinating sensory polyneuropathy (DADS), multifocal motor neuropathy (MMN) with conduction block, and multifocal acquired demyelinating sensory and motor neuropathy (MADSAM)). Demyelinating neuropathies typically are associated with prolonged latencies and a pronounced slowing of conduction, often in the range of 10–20 ms.<sup>61</sup> Commonly, the amplitude is relatively preserved on distal stimulation but is decreased proximally because of dispersion of the CMAP on proximal stimulation. In some hereditary disorders, such as Dejerine–Sottas disease, the velocity may be only a few meters per second.

**Table 23–8 Changes in Nerve Conduction Variables in Amyotrophic Lateral Sclerosis**

Variable	Changes		
	Subacute/active	Chronic active	Inactive or residual
Compound muscle action potential	Normal unless severe	Low if severe	Low if severe
Motor conduction velocity/F wave	Normal	<30% slow if severe	<30% slow if severe
Motor distal latency	Normal	<30% long if severe	<30% long if severe
Repetitive stimulation	Decrement in some	Decrement in some	Normal



The electrophysiologic findings also vary among the inherited neuropathies, as shown in Table 23–9.<sup>62</sup> Acquired demyelinating neuropathies commonly affect sites of nerve compression early and produce asymmetrical neuropathies of the peroneal, ulnar, or median nerves at the knee, elbow, or wrist, respectively. The refractory period in demyelinating neuropathies is decreased, often to the extent that repetitive stimulation at rates as low as 5 Hz causes a decrement. The decrement usually does not appear, however, until rates of 10 or 20 Hz are used. Maximal voluntary contraction may increase the conduction block and weakness because of the axonal membrane changes in CIDP.<sup>63</sup>

### **Guillain–Barré Syndrome**

Guillain–Barré syndrome (AIDP), predominantly a multifocal demyelinating disorder, has a spectrum of electrophysiologic changes.<sup>64</sup> NCS may show no abnormalities or the abnormalities may be limited early in the disease course and the study should be repeated if there is a high clinical suspicion. The

most common early electrophysiologic abnormalities are prolongation of the F wave, H wave, blink reflex, or distal motor latencies and temporal dispersion.<sup>65–68</sup> Distal recording with stimulation at proximal sites, such as a spinal nerve or brachial plexus, also may show abnormalities correlating with proximal segmental demyelination and slowing.<sup>69</sup> More commonly, however, Guillain–Barré syndrome is associated with prolonged distal latencies of a mild-to-moderate degree, dispersion or partial conduction block of CMAPs with proximal stimulation, and symmetrical or asymmetrical slowing of conduction velocities. A waves are particularly prominent in Guillain–Barré syndrome and are often the earliest sign of the disease on conduction studies.<sup>64,70</sup> Sensory NCS demonstrate a unique pattern with, often marked, abnormalities of median and ulnar antidromic sensory responses, but sparing of the sural response. This is a function of the larger nerve fiber diameter and degree of myelination in the sural nerve (recorded behind the lateral malleolus) than the median or ulnar nerves (recorded antidromically over the digits) such that the median and ulnar nerves are more prone to

**Table 23–9 Electrophysiologic Findings of Inherited Demyelinating Neuropathies**

---

#### **Inherited disorders with uniform conduction slowing**

- Charcot–Marie–Tooth 1A
- Charcot–Marie–Tooth 1B
- Dejerine–Sottas disease
- Metachromatic leukodystrophy
- Cockayne’s disease
- Krabbe’s disease

#### **Inherited disorders with multifocal conduction slowing**

- Hereditary neuropathy with liability to pressure palsies
- Charcot–Marie–Tooth X
- Adrenomyeloneuropathy
- Pelizaeus–Merzbacher disease
- Refsum’s disease

#### **Inherited disorders with incompletely characterized electrophysiology**

- PM22 point mutations
- P0 point mutations
- Adult-onset leukodystrophies
- Merosin deficiency
- EGR 2 mutations

---

From Lewis, R. A., A. J. Sumner, and M. E. Shy. 2000. Electrophysiological features of inherited demyelinating neuropathies: A reappraisal in the era of molecular diagnosis. *Muscle & Nerve* 23:1472–87. By permission of John Wiley & Sons.

show electrodiagnostic abnormalities earlier in the disease process. Facial nerves or other cranial nerves may be involved, with abnormalities seen on blink reflex testing or facial nerve stimulation. Patients with mild nerve conduction abnormalities and only mild changes on needle examination have a good prognosis; others with low-amplitude CMAPs and prominent fibrillation potentials have severe axonal destruction and a poor prognosis for rapid recovery.<sup>71</sup> If the initial diagnostic study is done early in the disease process, before there has been adequate time for Wallerian degeneration and active signs of denervation on the needle examination, a repeat study several weeks into the illness may be useful for defining the relative degree of axonal loss (CMAP amplitude reduction and fibrillations) and hence prognosis.

Several electrodiagnostic criteria have been proposed for AIDP, although no definitive consensus has been reached. These criteria have been compared and it has been suggested that those originally proposed by Albers, et al.<sup>65</sup> may be the most sensitive.<sup>72</sup> However, sensitivities and specificities of the various criteria may vary depending on the AIDP subtype and patient population. The Albers criteria include one of the following in two or more nerves: conduction velocity <95% if amplitude >50% of normal or <85% if amplitude <50% of normal, distal latency >110% if the amplitude is normal or >120% if the amplitude is less than normal, evidence of temporal dispersion (proximal > distal duration by 30%), evidence of conduction block (proximal to distal ratio of <0.7), or F-wave latency >120% of normal.<sup>65,72</sup> Studies have shown, however, that in the majority of AIDP patients with conduction velocity slowing, it is <75% of the lower limit of normal<sup>73</sup> and similar findings have been reported for CIDP<sup>74</sup> and paraprotein-associated neuropathies.<sup>75</sup> As increasing sensitivity often sacrifices some specificity, at the Mayo Clinic we have used more conservative criteria for demyelinating disorders (Table 23-7BB). In addition, F waves can recognize focal slowing proximally in addition to peripheral slowing from demyelination by comparing F-wave latency with F estimate. A longer F estimate than F latency signifies greater slowing proximal than distal. It is not possible therefore, without comparing the F latency to the F estimate, to determine if there is a greater degree of slowing and prolongation

of the F-wave latency than would be expected from the degree of conduction velocity slowing. At the Mayo Clinic, we routinely compare F latencies to a calculated F estimate based on the distal conduction velocity.

### ***Chronic Inflammatory Demyelinating Polyradiculopathy***

There have been a number of proposed criteria (including electrophysiologic and clinical parameters) for the diagnosis of CIDP.<sup>76-78</sup> Importantly, these include clinical, laboratory, pathologic, and electrophysiologic parameters. The most widely cited is the American Academy of Neurology (AAN) consensus criteria which required three of four of the following to meet the electrophysiologic criteria for CIDP: (1) conduction block (>20% between the proximal and the distal sites) or temporal dispersion in one motor nerve, (2) abnormal conduction velocities in at least two motor nerves that are <80% of the lower limit of normal if the CMAP amplitude is >80% and <70% if the CMAP amplitude is <80%, (3) prolonged distal latency in at least two motor nerves (>125% if amplitude >80% of normal, >150% if amplitude <80% of normal), and (4) absent or prolonged F waves in at least two motor nerves (>125% of normal if amplitude >80% of normal and >150% if amplitude <80%).<sup>76</sup> These criteria were modified by Saperstein et al.<sup>77</sup> such that only two of the four electrodiagnostic criteria were required to make the diagnosis of CIDP and using the more stringent conduction block consensus criteria.<sup>48</sup> These modified criteria as well as those proposed by the European Federation of Neurological Societies/Peripheral Nerve Society<sup>78</sup> have been shown to be more sensitive, without a significant loss of specificity to the original AAN criteria.<sup>79</sup> More recent diagnostic criteria for CIDP have tried to take into account its varying clinical patterns (symmetric CIDP, DADS, MADSAM). These criteria, particularly those of revised AAN and the European Federation of Neurological Societies/Peripheral Nerve Society, are improvements in our strict research criteria for defining CIDP. However, it is important to recognize that a number of patients with CIDP may not meet the strict electrophysiologic criteria, yet based on clinical, laboratory, and pathologic

data may still meet criteria for possible or probable CIDP and deserve a treatment trial in the appropriate clinical context.<sup>77</sup> Electrodiagnostic criteria proposed for the identification of CIDP are not as sensitive as histologic criteria in identifying patients who may respond to immune suppressive therapy.<sup>76,80</sup>

### **Multifocal Motor Neuropathy With Conduction Block**

One form of demyelinating neuropathy is *multifocal motor neuropathy with conduction block*, which may superficially resemble amyotrophic lateral sclerosis. Although it may have other features of a generalized demyelinating neuropathy, the classic finding is that of conduction block, especially in the median nerve in the forearm. The conduction block can increase with activity<sup>81</sup> and is hyperexcitable with fasciculation potentials. The conduction block may persist for years.<sup>82</sup> Consensus criteria for the diagnosis of MMN with conduction block have been published.<sup>83</sup> To summarize, the diagnosis requires clinical weakness without objective sensory loss or upper motor neuron signs in the distribution of two or more named nerves that is due to conduction block outside of common entrapment sites and with normal sensory NCS over these same segments (and throughout the remainder of the study).

At times, the pattern of abnormality in demyelinating neuropathies helps differentiate an acquired process from a hereditary one.<sup>84</sup> An acquired demyelinating neuropathy has scattered areas of slowing, with some areas being much more abnormal than others; hereditary disorders generally have a symmetrical pattern. Conduction block suggests an acquired process. Acquired demyelinating disorders often show more dispersion with proximal stimulation than hereditary disorders do. This distinction is not always reliable because some patients who have a hereditary demyelinating neuropathy with a low-amplitude CMAP may have pronounced dispersion at proximal sites of stimulation.

### **Key Points**

- Diabetes can produce any of the variety of types of neuropathy:

- Length-dependent, axonal sensorimotor, large fiber, peripheral
- Mixed axonal and demyelinating, peripheral
- Polyradiculoneuropathy
- Lumbosacral radiculoplexus neuropathy
- Single or multiple mononeuropathies.
- AIDP (Guillain–Barré Syndrome) has multiple
  - Prolonged F wave and distal latencies early
  - Conduction block, temporal dispersion, marked velocity slowing
  - Prolonged blink reflexes
  - Sural sensory sparing with median and ulnar loss or slowing.
- Conduction block and/or temporal dispersion and side-to-side conduction asymmetry favor acquired over inherited demyelinating neuropathy.
- Toxic and metabolic disorders are typically axonal neuropathies with greater sensory than motor involvement.
- CV >70% of the lower limit of normal is seen in axonal neuropathies, even with CMAP amplitude reduction.
- Comparison of F latency with F estimate defines relative proximal to distal slowing even with marked distal slowing.
- Clinical, laboratory, and pathologic findings are important supplements to NCS in the several diagnosis of CIDP.

### **Findings in Specific Focal Mononeuropathies**

On NCS, changes in mononeuropathies vary with the rapidity of development, the duration of damage, and the severity of damage as well as with the underlying disorder.<sup>85</sup> With a chronic compressive lesion, localized narrowing or paranodal or internodal demyelination produces localized slowing of conduction. Narrowing of axons distal to a chronic compression slows conduction along the entire length of the nerve. Telescoping of axons with intussusception of one internode into another distorts and obliterates the nodes of Ranvier and thus blocks conduction. Moderate segmental demyelination and local metabolic alterations are often also associated with conduction block. The segment of nerve with disruption of the

axons distal to an acute lesion may continue to function normally for as long as 5 days; then, as the axons undergo Wallerian degeneration, conduction ceases and the amplitude of the evoked response diminishes and finally disappears. One week after an acute injury, the amplitude of the evoked response can be used as an approximation of the number of intact, viable axons (Table 23–10).

The evolution of electrophysiologic changes after peripheral nerve injury is also seen on needle examination and is an aid in characterizing mononeuropathies (Table 23–11). Therefore, an adequate assessment of a peripheral nerve injury should include both needle examination and NCS. The significance of changes with time after injury is outlined in Table 23–12. The sequence of changes shows that NCS can be important in assessing localized nerve injury within the first few days of injury.

### Key Points

- Distal CMAP amplitude is decreased by 7 days after acute axonal disruption while it remains normal with conduction block.
- Needle/EMG findings after nerve injury are dependent on the type of injury and time since injury:
  - Reduced recruitment occurs immediately and remains present indefinitely after any injury.
  - Fibrillation potentials and motor unit potential changes begin after two weeks with axonal disruption.
  - All findings except reduced recruitment and large motor unit potentials subside over two years after acute nerve injury.
  - Both NCS and EMG are necessary for full evaluation of an acute nerve injury.

**Table 23–10 Compound Action Potential Amplitude after Peripheral Nerve Injury\***

Injury	Amplitude		
	0–5 Days	After 5 Days	Recovery
Conduction block			
Proximal stimulation	Low	Low	Increases
Distal stimulation	Normal	Normal	Normal
Axonal disruption			
Proximal stimulation	Low	Low	Increases
Distal stimulation	Normal	Low	Increases

\* Supramaximal stimulation.

From Daube J. R. 1992. Nerve conduction studies. In *Electrodiagnosis in clinical neurology*, ed. M. J. Aminoff, 3rd ed., 314. New York: Churchill Livingstone. By permission of WB Saunders Company.

**Table 23–11 Findings on Needle Examination after Peripheral Nerve Injury**

	0–15 Days	After 15 days	Recovery
Conduction block			
Fibrillation potentials	None	None	None
Motor unit potentials	↓ Recruitment	↓ Recruitment	↓ Recruitment
Axonal disruption			
Fibrillation potentials	None	Present	Reduced
Motor unit potentials	↓ Recruitment	↓ Recruitment	Nascent

↓, decrease.

From Daube J. R. 1992. Nerve conduction studies. In *Electrodiagnosis in clinical neurology*, ed. M. J. Aminoff, 3rd ed., 314. New York: Churchill Livingstone. By permission of WB Saunders Company.

Table 23–12 **Electromyographic Interpretations after Peripheral Nerve Injury**

<b>Finding</b>	<b>Interpretation</b>
<b>0–5 days</b>	
Motor unit potentials present	Nerve intact, functioning axons
Fibrillations present	Old lesion
Low compound action potential	Old lesion
<b>5–15 days</b>	
Compound action potential distal only	Conduction block
Low compound action potential	Amount of axonal disruption
Motor unit potentials present	Nerve intact
<b>After 15 days</b>	
Compound action potential distal only	Conduction block
Motor unit potentials present	Nerve intact
Fibrillation potentials	Amount of axonal disruption Distribution of damage
<b>Recovery</b>	
Increasing compound action potential	Block clearing
Increasing number of motor unit potentials	Block clearing
Decreasing number of fibrillation potentials	Reinnervation
“Nascent” motor unit potentials	Reinnervation

From Daube J. R. 1992. Nerve conduction studies. In *Electrodiagnosis in clinical neurology*, ed. M. J. Aminoff, 3rd ed., 315. New York: Churchill Livingstone. By permission of WB Saunders Company.

## MEDIAN NEUROPATHIES

The most common focal mononeuropathy is carpal tunnel syndrome, in which the median nerve is compressed in the space formed by the wrist bones and the carpal ligament. Many different approaches have been suggested for the electrodiagnosis of this condition.<sup>86–88</sup> Early or mild compression of the median nerve in the carpal tunnel may not show any electrophysiologic abnormalities, especially of CMAPs. However, more than 90% of symptomatic patients have localized slowing of conduction in sensory fibers. The sensory latency through the carpal tunnel is the most sensitive single measurement for identifying the earliest abnormality. This so-called *palmar latency* may be compared with normal values but is more reliable when compared with the latency in ulnar sensory fibers over the same distance for a relative prolongation. Improved sensitivity, specificity, and reliability in the diagnosis of CTS have been reported with a *combined sensory index* (CSI). The CSI adds the relative difference between the latencies of median and radial antidromic sensory

responses recorded at the thumb over the same distance (10 cm), median and ulnar antidromic sensory responses to the ring finger over the same distance (14 cm), and median and ulnar palmar latencies (both over 8 cm).<sup>35,89,90</sup> The sensitivity of comparing median to ulnar palmar (a mixed sensorimotor nerve response) is approximately 70%–75%, with a specificity of 97%.<sup>35,91</sup> When there is a high clinical suspicion, with symptoms preferentially affecting the thumb or fourth digit, and routine NCS and palmars do not show median slowing across the carpal tunnel, it can be useful to compare median to radial antidromic latencies (recording over the thumb) or ulnar (recording over the fourth digit) latencies over the same distance.<sup>91</sup> If these are nondiagnostic, performing the full CSI will increase the sensitivity to 83% with similar specificity for the diagnosis of CTS.<sup>35</sup>

Moderate nerve compression decreases the amplitude of the sensory nerve action potential and prolongs the latency to a greater extent. Severe median neuropathy at the wrist also increases the distal motor latency to the thenar

muscles and decreases the thenar CMAP. Very severe median neuropathies at the wrist, which have no elicitable routine motor or sensory NCS, can be assessed with a comparison of median to ulnar nerve distal motor latencies recording over the lumbricals and second dorsal interosseous.<sup>92</sup> It has only 56% sensitivity for CTS in all patients, but it has a high specificity (98%) and is generally still elicitable when other routine responses are not.<sup>91</sup> Table 23–13 summarizes the electrophysiologic grading of the severity of median neuropathies at the wrist. It should be noted that some patients with electrophysiologically mild changes may have severe, limiting symptoms and patients with electrophysiologically severe changes may have little as far as symptoms are concerned. The electrophysiologic severity correlates with the degree of sensory and motor axonal loss. This becomes an important factor in how soon one should strongly consider surgical treatment options. Mild electrophysiologic abnormalities mean treatment options from wrist splints, to corticosteroid injections, to surgical options can be considered based on the severity of clinical symptoms, whereas more severe electrophysiologic findings may push toward earlier surgical interventions. Clinical features cannot predict NCS findings (or severity).<sup>93</sup>

A decrease in the CMAP is often associated with mild slowing of motor conduction velocity in the forearm and fibrillation potentials in the thenar muscles. CTS of moderate severity is often associated with anomalous innervation of the thenar muscles, with the amplitude of the response being higher on elbow stimulation than on wrist stimulation with an initial positivity before the M wave.<sup>94</sup> This positivity represents the median to ulnar crossover fibers

which are not slowed traversing the carpal tunnel, but innervate the thenar eminence traveling along the ulnar nerve. These crossing fibers reach the nearby ulnar hand muscles before the uncrossed median fibers that traverse the carpal tunnel (Fig. 23–15).

Many patients with CTS have bilateral abnormalities on NCS, even though the symptoms may be unilateral. Therefore, the conduction in the opposite extremity should be measured if a median neuropathy at the wrist is identified. Several other considerations must be kept in mind when testing for CTS. A few patients have a normal sensory response and a prolonged distal motor latency. Chronic neurogenic atrophy from a proximal lesion, such as damage to a spinal nerve or anterior horn cells, can result in distal motor slowing and a normal sensory response. A radial sensory response may be evoked inadvertently by high-voltage stimulation of the median nerve and recorded as an apparent median sensory potential. Occasionally, patients have sensory branches that innervate one or more fingers, which are anatomically separated from the motor fibers and relatively spared. Also, the severity of compression may not be the same for all the fascicles of the median nerve, which would result in greater slowing in the axons to some digital nerves than to others. This variation in involvement is the likely reason for the added value of the CSI. A median neuropathy may be an early finding in patients with more diffuse neuropathies. To exclude this possibility, it is necessary to assess other nerves.

Median neuropathies in the forearm are much less common and only rarely show abnormality on NCS, other than slightly low-amplitude sensory or motor responses (or

Table 23–13 Defining the Severity of CTS with NCS

---

**Mild CTS**

Prolonged sensory or palmar (mixed) distal latency with or without amplitude reduction

**Moderate CTS**

Prolonged sensory or mixed palmar distal latency with low amplitude and prolonged median motor distal latency

**Severe CTS**

Absent sensory or mixed palmar and prolonged motor latency OR

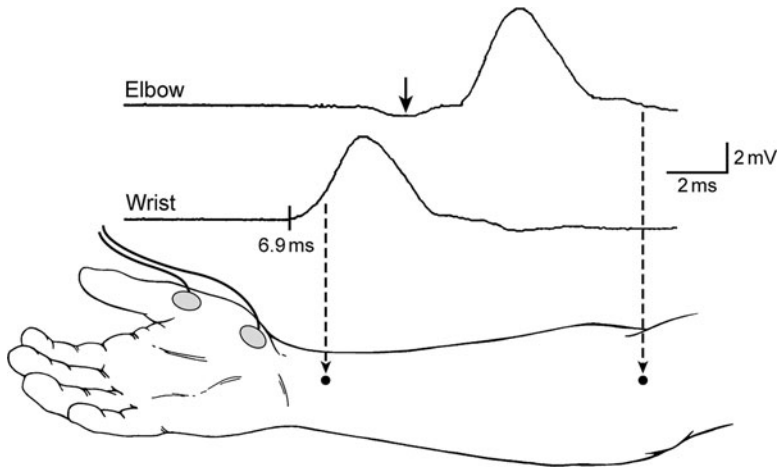
Prolonged sensory or mixed palmar with low amplitude and prolonged motor with low amplitude

**Very severe CTS**

Absent sensory or mixed palmar and absent routine median motor response

---





**Figure 23-15.** An example of a median neuropathy at the wrist with a Martin-Gruber anastomosis. The response from median nerve stimulation at the wrist with a prolonged distal latency 6.9 ms (normal <4.5 ms). The response from stimulation at the elbow shows a large positive wave (arrow) preceding the M wave and a higher amplitude than at the wrist. The preceding positive wave represents median to ulnar crossover fibers innervating the thenar eminence that do not traverse the impinged carpal tunnel and hence arrive at the thenar eminence prior to the median fibers that must traverse the carpal tunnel.

both).<sup>95</sup> Anterior interosseous neuropathy and pronator syndrome are usually manifested electrophysiologically by fibrillation potentials in the appropriate muscles. Infrequently, patients have localized slowing of conduction in the damaged segment of nerve.

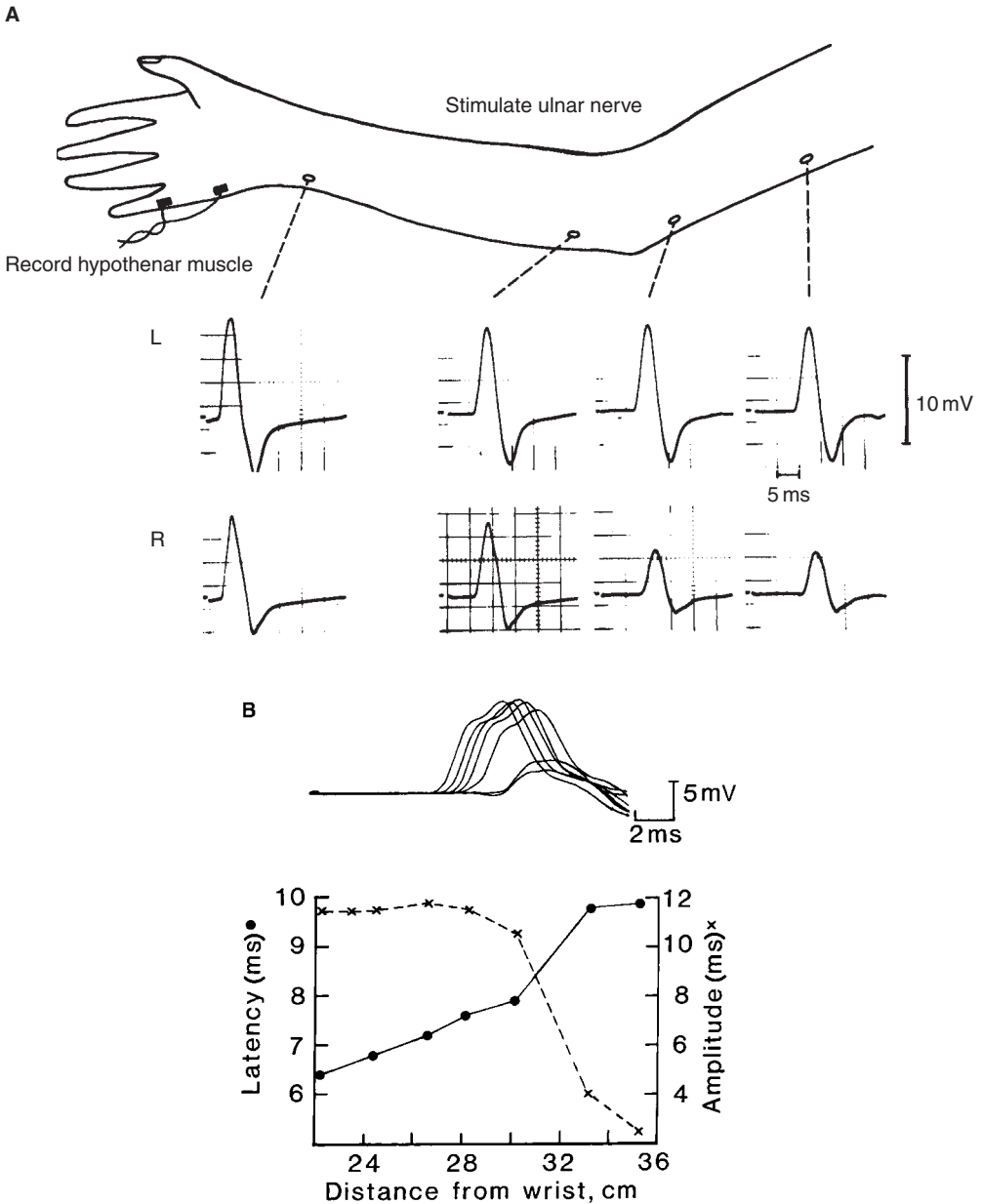
### Key Points

- CTS is a clinical diagnosis that may have no electrophysiologic correlates.
- Difference between median and ulnar palmar distal latencies is the most sensitive single study for identifying median slowing through the carpal tunnel.
- Other comparisons can supplement identification of focal slowing:
  - Median/thumb and radial/thumb antidromic latency differences.
  - Median/digit-IV and ulnar/digit-IV antidromic latency differences.
- EMG and NCS abnormalities
  - May not correlate with the severity of clinical symptoms.
  - Define the degree of axonal damage or loss.
  - Help the clinician determine the urgency or timing of surgery.
  - Comparison of median/lumbrical to ulnar/dorsal interosseous II latencies

can identify slowing in the carpal tunnel when standard studies show no responses.

### ULNAR NEUROPATHIES

Findings in ulnar neuropathy vary with the severity and location of the lesion.<sup>96</sup> In most patients, the abnormality is at the elbow (Fig. 23-16). Various methods have been suggested for electrodiagnostic evaluation of ulnar neuropathy.<sup>88</sup> As in CTS, sensory fibers are more likely to be damaged than motor fibers so that the sensory nerve action potential is commonly lost early. In some patients, focal slowing can be demonstrated in ulnar sensory fibers across the elbow. Thus, direct measurement of the orthodromic compound nerve action potential may be an efficient and accurate method for recognizing mild ulnar neuropathy.<sup>96</sup> Motor involvement often occurs later and may involve different fascicles selectively; thus, motor recordings from the first dorsal interosseous as well as the hypothenar muscles may increase the sensitivity.<sup>97</sup> Although there may be slowing of conduction to the flexor carpi ulnaris, this muscle usually shows little or no change on NCS and needle examination. Measurements are more accurate with the arm extended laterally and the elbow flexed

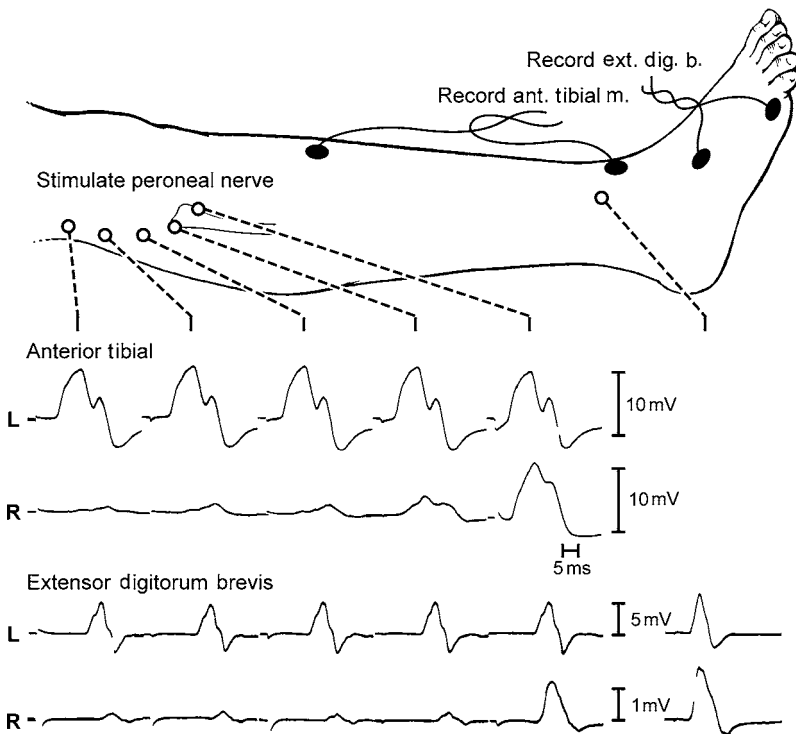


**Figure 23-16.** Ulnar neuropathy at the elbow. *A*, Stimulation sites (from left to right: wrist, below elbow, above elbow, and upper arm) are demonstrated on the arm schematic. Responses from the normal left upper extremity (*L*) follow on the next line and from the affected right ulnar nerve (*R*) on the next line. A drop in amplitude is seen at the above elbow and upper arm levels. *B*, Superimposed responses from inching across the elbow. The sixth response has a marked drop in amplitude compared with the fifth response and despite the stimulator being moved the same distance between inching stimuli (i.e., approximately an inch between stimuli, hence inching) there is an evidence of focal slowing (larger than expected increase in latency for distance stimulator was moved) from the fifth to sixth stimuli. By looking at the distance of the stimulator between stimuli 5 and 6 and comparing it to the distance to the medial epicondyle, the focal partial conduction block and focal slowing can be precisely localized relative to the medial epicondyle for the surgeon. (Courtesy of Dr. E. H. Lambert, Mayo Clinic.)

to 45°, because of better access to and measurement of the ulnar nerve at the elbow.<sup>98</sup> The most common localized finding in ulnar neuropathy of recent onset is conduction block at the elbow that can be localized precisely by using the inching procedure<sup>99</sup> (Fig. 23-16). This conduction block may be associated with local slowing. Occasionally, focal slowing is seen without conduction block. Chronic ulnar neuropathy usually results in slowing of conduction. If there has been significant axonal loss with low-amplitude motor responses, the associated axonal atrophy results in slowing in the forearm. Occasionally, a lesion proximal to the elbow requires that stimulation be applied in the upper arm as well.<sup>100</sup> In ulnar and median neuropathies, F-wave latency is prolonged proportional to the slowing in the peripheral segments. Ulnar neuropathies are commonly bilateral; if an ulnar neuropathy is evident on one side, the opposite extremity should also be tested.

### Key Points

- Ulnar neuropathy at the elbow may show
  - Localized conduction block
  - Localized slowing
  - Both localized conduction block and slowing.
- Ulnar/first dorsal interosseous conduction studies may be abnormal while ulnar/hypothenar are not, if there is fascicular involvement of that segment of the ulnar nerve.
- Acute compression often shows more focal motor changes than sensory.
- Chronic compression results in greater sensory NCS changes.
- If standard NCS are normal and there is a high clinical suspicion, side-to-side comparison should be performed.
- Chronic nerve focal compression results in slowing along the entire length of the nerve distal to the damage.



**Figure 23-17.** Right and left peroneal NCS with a compressive peroneal neuropathy with partial conduction block localizing to the fibular head. Top image, Sites of stimulation and recording. Bottom images, Compound muscle action potentials. Note the decrease in amplitude (conduction block) with stimulation at the fibula on the right with a normal amplitude elicited below the level of the fibula. Ant. Tibial M., anterior tibialis muscle; Ext. Dig. B, extensor digitorum brevis muscle. (Courtesy of Dr. E. H. Lambert, Mayo Clinic.)

## PERONEAL NEUROPATHIES

Neuropathy of the peroneal nerve at the head of the fibula is another common focal lesion. Peroneal neuropathy of recent onset caused by compression is typically associated with a conduction block that can be localized precisely using the inching procedure to identify the area where the evoked response decreases (Fig. 23–17). Conduction across this segment usually is not slowed, although in lesions of longer standing the slowing becomes prominent.<sup>101</sup>

NCS of the superficial peroneal nerve may be of value in differentiating a peroneal neuropathy from an L5 radiculopathy. If the superficial peroneal sensory nerve is normal, it is more likely that the damage is at the root level rather than the peripheral level.<sup>102</sup> However, the superficial peroneal sensory response has been shown to be abnormal in lumbar radiculopathies when the dorsal root ganglion (DRG) sits more proximally within the neural foramen (estimated to occur in 10%–40% of L5 DRG) and there is a laterally placed disc compressing the dorsal root ganglion as well as the root.<sup>102</sup> It should also be noted that in almost 50% of common peroneal neuropathies (including those with clinical sensory involvement), the superficial peroneal sensory response is spared (presumably secondary to fascicular sparing, anatomical variation where this branch comes off above the level of compression, or normal sensory nerve function below a purely demyelinating block without axonal loss).<sup>103</sup>

Patients with a moderately severe peroneal neuropathy often do not have a CMAP response from the EDB. Recordings from the anterior tibial muscle with stimulation at the head of the fibula and the knee may still demonstrate a block or slowing of conduction in the nerve. Anomalous innervation of the EDB muscle by a deep accessory branch of the superficial peroneal nerve may make it more difficult to recognize a peroneal neuropathy. In an apparent peroneal neuropathy without localized slowing of conduction, the short head of the biceps femoris muscle should be tested on needle examination for fibrillation potentials to exclude a sciatic nerve lesion, as it is the most proximal peroneal innervated muscle and the only one above the popliteal fossa. Sciatic nerve lesions may present with only peroneal deficit secondary to preferential

fascicular involvement and may require deep needle electrode stimulation for sciatic NCS.

### Key Points

- Knee/ankle amplitude difference >20% requires stimulation at the fibular head in search of focal conduction block.
- Peroneal/anterior tibial testing is required if no EDB response is recorded.
- Focal peroneal neuropathy at the knee without known nerve injury requires ultrasound of the region for ganglion cyst invading the peroneal nerve, especially deep branch.
- Superficial peroneal sensory response
  - Most often reduced by postganglionic damage
  - May be spared in common peroneal neuropathies
  - May be abnormal in lumbar radiculopathies.

## OTHER MONONEUROPATHIES

Most other neuropathies are traumatic in origin and may be localized by motor conduction studies.<sup>104</sup> Neuropathies of the radial, tibial, or phrenic nerves may similarly be localized by NCS but technically are more difficult.<sup>105,106</sup> Evaluation of most other nerves is not aided by NCS because these neuropathies do not show localized slowing. Reports of localized slowing of such nerves generally have not taken into account the distal slowing that occurs with a long-standing proximal lesion.<sup>107,108</sup> In facial neuropathies such as Bell's palsy, stimulation cannot be applied proximal to the site of the lesion. The usual findings in Bell's palsy with neurapraxia are normal amplitudes and latencies; in axonal degeneration, the amplitude of the evoked response is decreased in proportion to the axonal destruction.<sup>109</sup> Blink reflexes can be used to measure conduction across the involved segment, but they are commonly absent in Bell's palsy. Conduction studies can help differentiate hemifacial spasm from other facial movements by demonstrating ephaptic activation of lower facial muscles during periods of spasm, called the *lateral spread response*.

## Brachial Plexus Lesions

Most brachial plexus lesions are traumatic, and motor NCS are of limited value. Generally, the amplitude of the CMAP is reduced. Given predictable sensory pathways, sensory NCS can be extremely useful in brachial plexus lesions in localizing to the brachial plexus vs. the root level (the latter has normal sensory NCS) and to localizing within the brachial plexus.<sup>110</sup> In patients with lower trunk lesions, the ulnar and medial antebrachial sensory responses are reduced or absent, and in those with upper trunk lesions, the median sensory response to the thumb and sometimes to the index finger, as well as the lateral antebrachial sensory response, is reduced or absent. In patients with slowly evolving or compressive lesions of the plexus, such as tumors, a localized slowing of conduction of motor fibers and occasionally conduction block may be identified on stimulation at the supraclavicular or nerve root level. *Neuralgic amyotrophy* (Parsonage–Turner syndrome) has been reported to show proximal conduction block with root stimulation.<sup>111,112</sup> *Thoracic outlet syndrome*, which has been reported to show abnormalities on NCS, is usually a vascular syndrome with a change, if any, only in sensory potential amplitudes that traverse the lower trunk (ulnar antidromic and medial antebrachial sensory responses) and little or no slowing of nerve conduction.

## Radiculopathies

Cervical and lumbosacral radiculopathies are not usually associated with changes in motor NCS; however, if there is sufficient destruction of axons and Wallerian degeneration in the distribution of the nerve being tested, the amplitude of the CMAP may be decreased.<sup>113</sup> For example, in an L5 radiculopathy with weakness, the response of the EDB muscle on peroneal nerve stimulation is often of low amplitude or absent. In the presence of atrophy and a low CMAP, there may be mild slowing of conduction in the motor axons innervating the atrophic muscle. In a few patients with lumbosacral radiculopathy, measurements of F-wave or H-reflex latencies in mild lesions have been valuable in identifying proximal slowing of conduction.<sup>113</sup> Because most lesions

of the spinal nerve and nerve root are proximal to the dorsal root ganglion, the sensory potentials usually are normal, even in the distribution of a sensory deficit. This phenomenon is valuable in identifying avulsion of a nerve root in which there is total anesthesia and loss of motor function with normal sensory potentials. No evidence has been found of *double crush*, a peripheral mononeuropathy related to a radiculopathy.<sup>114</sup>

## SUMMARY

CMAPs are among the most helpful recordings in the electrophysiologic assessment of peripheral neuromuscular disease. Compound muscle action potentials are the recordings made for all motor conduction studies, both of the directly recorded M wave used for peripheral conduction and the F-wave late response used for testing proximal conduction. Reliable CMAP recordings require the use of standard stimulating and recording electrode types and locations and standard measurement criteria.<sup>115</sup> The sensitivity and specificity of motor conduction studies depend on comparing the results obtained in a patient with the normal values obtained by using exactly the same methods. The normal values of motor conduction studies vary with physiologic factors such as age and temperature, which must be controlled and adjusted.

Motor NCS with CMAPs localize focal lesions in a nerve by identifying either localized conduction block or localized slowing of conduction. Conduction block is a change in size of the CMAP when stimulating at two points near each other along the nerve. Both conduction block and slowing of conduction represent pathophysiologic changes in the nerve, which can sometimes be predicted by the changes found on NCS. These changes can be helpful in defining prognosis for improvement after nerve damage.

## REFERENCES

1. Dyck, P. J., J. L. Karnes, P. C. O'Brien, W. J. Litchy, P. A. Low, and L. J. Melton. 1992. The rochester diabetic neuropathy study: Reassessment of tests and criteria for diagnosis and staged severity. *Neurology* 42:1164–70.

2. Blok, J. H., A. Ruitenberg, E. M. Maathuis, and G. H. Visser. 2007. The electrophysiological muscle scan. *Muscle & Nerve* 36(4):436–46.
3. Barkhaus, P. E., M. I. Periquet, and S. D. Nandedkar. 2006. Influence of the surface EMG electrode on the compound muscle action potential. *Electromyography and Clinical Neurophysiology* 46: 235–9.
4. Tjon, A. T. A. M., H. H. Lemkes, A. J. van der Kamp-Huyts, and J. G. van Dijk. 1996. Large electrodes improve nerve conduction repeatability in controls as well as in patients with diabetic neuropathy. *Muscle & Nerve* 19:689–95.
5. van Dijk, J. G., I. van Benton, C. G. Kramer, and D. F. Stegeman. 1999. CMAP amplitude cartography of muscles innervated by the median, ulnar, peroneal, and tibial nerves. *Muscle & Nerve* 22:378–89.
6. Kincaid, J. C., A. Brashear, and O. N. Markand. 1993. The influence of the reference electrode on CMAP configuration. *Muscle & Nerve* 16: 392–6.
7. Brashear, A., and J. C. Kincaid. 1996. The influence of the reference electrode on CMAP configuration: Leg nerve observations and an alternative reference site. *Muscle & Nerve* 19: 63–7.
8. Phongsamart, G., J. J. Wertsch, M. Ferdjallah, J. C. King, and D. T. Foster. 2002. Effect of reference electrode position on the compound muscle action potential (CMAP) onset latency. *Muscle & Nerve* 25: 816–21.
9. Nandedkar, S. D., and P. E. Barkhaus. 2007. Contribution of reference electrode to the compound muscle action potential. *Muscle & Nerve* 36: 87–92.
10. Jonas, D., C. Bischoff, and B. Conrad. 1999. Influence of different types of surface electrodes on amplitude, area and duration of the compound muscle action potential. *Clinical Neurophysiology* 110:2171–5.
11. Falck, B., and E. Stalberg. 1995. Motor nerve conduction studies: Measurement principles and interpretation of findings. *Journal of Clinical Neurophysiology* 12:254–79.
12. Kimura, J. 1998. Kugelberg lecture: Principles and pitfalls of nerve conduction studies. *Electroencephalography and Clinical Neurophysiology* 106:470–6.
13. Brill, V., R. Ellison, M. Ngo, B. Bergstrom, D. Raymond, and H. Gin. 1998. Electrophysiological monitoring in clinical trials. Roche neuropathy study group. *Muscle & Nerve* 21:1368–73.
14. Buschbacher, R. M. 1999. Median nerve motor conduction to the abductor pollicis brevis. *American Journal of Physical Medicine and Rehabilitation* 78(Suppl):S1–31.
15. Daube, J. R. 1996. Compound muscle action potentials. In *Clinical neurophysiology*, ed. J. R. Daube, 199–234. Philadelphia: FA Davis Company.
16. Rivner, M. H. 1994. Statistical errors and their effect on electrodiagnostic medicine. *Muscle & Nerve* 17:811–14.
17. Wang, S. H., and L. R. Robinson. 1998. Considerations in reference values for nerve conduction studies. *Physical Medicine and Rehabilitation Clinics of North America* 9:907–23.
18. Dyck, P. J., P. C. O'Brien, W. J. Litchy, C. M. Harper, J. R. Daube, and P. J. Dyck. 2001. Use of percentiles and normal deviates to express nerve conduction and other test abnormalities. *Muscle & Nerve* 24: 307–10.
19. Dyck, P. J., W. J. Litchy, J. R. Daube, et al. 2003. Individual attributes versus composite scores of nerve conduction abnormality sensitivity, reproducibility, and concordance with impairment. *Muscle & Nerve* 27:202–10.
20. Andersen, H., E. Stalberg, and B. Falck. 1997. F-wave latency, the most sensitive nerve conduction parameter in patients with diabetes mellitus. *Muscle & Nerve* 20:1296–302.
21. Guiloff, R. J., and H. Modarres-Sadeghi. 1991. Preferential generation of recurrent responses by groups of motor neurons in man. Conventional and single unit F wave studies. *Brain* 114:1771–801.
22. Young, M. S., and W. J. Triggs. 1998. Effect of stimulator orientation on F-wave persistence. *Muscle & Nerve* 21:1324–6.
23. Nobrega, J. A., G. M. Manzano, N. F. Novo, and P. T. Monteagudo. 1999. Sample size and the study of F waves. *Muscle & Nerve* 22:1275–8.
24. Weber, F. 1998. The diagnostic sensitivity of different F wave parameters. *Journal of Neurology, Neurosurgery and Psychiatry* 65:535–40.
25. Rivner, M. H. 1998. The contemporary role of F-wave studies. F-wave studies: Limitations. *Muscle & Nerve* 21:1101–4.
26. Magistris, M. R., and G. Roth. 1992. Motor axon reflex and indirect double discharge: Ephaptic transmission? A reappraisal. *Electroencephalography and Clinical Neurophysiology* 85:124–30.
27. Dioszeghy, P., and E. Stalberg. 1992. Changes in motor and sensory nerve conduction parameters with temperature in normal and diseased nerve. *Electroencephalography and Clinical Neurophysiology* 85:229–35.
28. Franssen, H., G. H. Wieneke, and J. H. J. Wokke. 1999. The influence of temperature on conduction block. *Muscle & Nerve* 22:166–73.
29. Chaudhry, V., T. O. Crawford, and S. E. Derosssett. 1993. Thermal sensitivity in demyelinating neuropathy. *Muscle & Nerve* 16:301–6.
30. Wang, A. K., E. M. Raynor, A. S. Blum, and S. B. Rutkove. 1999. Heat sensitivity of sensory fibers in carpal tunnel syndrome. *Muscle & Nerve* 22: 37–42.
31. Rutkove, S. B., M. A. Geffroy, and S. H. Lichtenstein. 2001. Heat-sensitive conduction block in ulnar neuropathy at the elbow. *Clinical Neurophysiology* 112:280–5.
32. Rutkove, S. B. 2001. Focal cooling improves neuronal conduction in peroneal neuropathy at the fibular neck. *Muscle & Nerve* 24:1622–6.
33. Garcia, A., J. Calleja, F. M. Antolin, and J. Berciano. 2000. Peripheral motor and sensory nerve conduction studies in normal infants and children. *Clinical Neurophysiology* 111:513–20.
34. Stetson, D. S., J. W. Albers, B. A. Silverstein, and R. A. Wolfe. 1992. Effects of age, sex, and anthropometric factors on nerve conduction measures. *Muscle & Nerve* 15:1095–104.
35. Robinson, L. R., P. J. Micklesen, and L. Wang. 1998. Strategies for analyzing nerve conduction data: Superiority of a summary index over single tests. *Muscle & Nerve* 21:1166–71.



36. Bromberg, M. B., and L. Jaros. 1998. Symmetry of normal motor and sensory nerve conduction measurements. *Muscle & Nerve* 21:498–503.
37. Krarup C. 1999. Pitfalls in electrodiagnosis. *Journals of Neurology* 246:1115–26.
38. Wells, M. D., and S. N. Gozani. 1999. A method to improve the estimation of conduction velocity distributions over a short segment of nerve. *IEEE Transactions on Biomedical Engineering* 46: 1107–20.
39. Tu, Y., S. Honda, and Y. Tomita. 1999. Estimation of the conduction velocity distribution of peripheral nerve trunks. *Frontiers of Medical Biological Engineering* 9:189–97.
40. Schulte-Mattler, W. J., M. Jakob, and S. Zierz. 1999. Assessment of temporal dispersion in motor nerves with normal conduction velocity. *Clinical Neurophysiology* 110:740–7.
41. Bostock, H., and T. A. Sears. 1976. Continuous conduction in demyelinated mammalian nerve fibers. *Nature* 263:786–7.
42. Nakamichi, K., and S. Tachibana. 2002. Ultrasonographic measurement of median nerve cross-sectional area in idiopathic carpal tunnel syndrome: Diagnostic accuracy. *Muscle & Nerve* 26: 798–803.
43. Kele, H., R. Verheggen, H. J. Bittermann, and C. D. Reimers. 2003. The potential value of ultrasonography in the evaluation of carpal tunnel syndrome. *Neurology* 61:389–91.
44. Beekman, R., and L. H. Visser. 2003. Sonography in the diagnosis of carpal tunnel syndrome: A critical review of the literature. *Muscle & Nerve* 27:26–33.
45. Mesgarzadeh, M., C. D. Schneck, A. Bonakdarpour, A. Mitra, and D. Conaway. 1989. Carpal tunnel: MR imaging. Part II. Carpal tunnel syndrome. *Radiology* 171:749–54.
46. Bayrak, I. K., A. O. Bayrak, H. E. Tilki, M. S. Nural, and T. Sunter. 2007. Ultrasonography in carpal tunnel syndrome: Comparison with electrophysiological stage and motor unit number estimate. *Muscle & Nerve* 35:344–8.
47. McCluskey, L., D. Feinberg, C. Cantor, and S. Bird. 1999. “Pseudo-conduction block” in vasculitic neuropathy. *Muscle & Nerve* 22:1361–6.
48. Olney, R. K. 1999. Consensus criteria for the diagnosis of partial conduction block. *Muscle & Nerve* 8(Suppl):S225–9.
49. Pfeiffer, G., E. M. Wicklein, and K. Wittig. 2000. Sensitivity and specificity of different conduction block criteria. *Clinical Neurophysiology* 111:1388–94.
50. Schulte-Mattler, W. J., T. Muller, D. Georgiadis, M. E. Kornhuber, and S. Zierz. 2001. Length dependence of variables associated with temporal dispersion in human motor nerves. *Muscle & Nerve* 24:527–33.
51. Ochoa, J., T. J. Fowler, and R. W. Gilliatt. 1972. Anatomical changes in peripheral nerves compressed by a pneumatic tourniquet. *Journal of Anatomy* 113:433–55.
52. Brown, W. F., and S. K. Yates. 1982. Percutaneous localization of conduction abnormalities in human entrapment neuropathies. *Canadian Journal of Neurological Science* 9:391–400.
53. Andersson, P. B., E. Yuen, K. Parko, and Y. T. So. 2000. Electrodiagnostic features of hereditary neuropathy with liability to pressure palsies. *Neurology* 54:40–4.
54. Mulder, D. W., E. H. Lambert, J. A. Bastron, and R. G. Sprague. 1961. The neuropathies associated with diabetes mellitus: A clinical and electromyographic study of 103 unselected diabetic patients. *Neurology* 11:275–84.
55. van Dijk, J. G., J. Meulstee, M. J. Zwarts, and F. Spaans. 2001. What is the best way to assess focal slowing of the ulnar nerve? *Clinical Neurophysiology* 112:286–93.
56. Campbell, W. W. 1998. The value of inching techniques in the diagnosis of focal nerve lesions. Inching is a useful technique. *Muscle & Nerve* 21: 1554–6.
57. Wilson, J. R., J. D. Stittsworth, A. Kadir, and M. A. Fisher. 1998. Conduction velocity versus amplitude analysis: Evidence for demyelination in diabetic neuropathy. *Muscle & Nerve* 21:1228–30.
58. Shin, J. B., Y. J. Seong, H. J. Lee, S. H. Kim, H. Suk, and Y. J. Lee. 2000. The usefulness of minimal F-wave latency and sural/radial amplitude ratio in diabetic polyneuropathy. *Yonsei Medical Journal* 41:393–7.
59. Feinberg, D. M., D. C. Preston, J. M. Shefner, and E. L. Logigian. 1999. Amplitude-dependent slowing of conduction in amyotrophic lateral sclerosis and polyneuropathy. *Muscle & Nerve* 22:937–40.
60. Ibrahim, I. K., and M. A. el-Abd. 1997. Giant repeater F-wave in patients with anterior horn cell disorders. Role of motor unit size. *American Journal of Physics Medicine Rehabilitation* 76:281–7.
61. Gutmann, L., A. Fakadej, and J. E. Riggs. 1983. Evolution of nerve conduction abnormalities in children with dominant hypertrophic neuropathy of the Charcot-Marie-Tooth type. *Muscle & Nerve* 6:515–9.
62. Lewis, R. A., A. J. Sumner, and M. E. Shy. 2000. Electrophysiological features of inherited demyelinating neuropathies: A reappraisal in the era of molecular diagnosis. *Muscle & Nerve* 23:1472–87.
63. Cappellet-Smith, C., S. Kuwabara, C. S. Lin, I. Mogyoros, and D. Burke. 2000. Activity-dependent hyperpolarization and conduction block in chronic inflammatory demyelinating polyneuropathy. *Annals of Neurology* 48:826–32.
64. Roth, G., and M. R. Magistris. 1999. Indirect discharges as an early nerve conduction abnormality in the Guillain-Barré syndrome. *European Neurology* 42:83–9.
65. Albers, J. W., P. D. Donofrio, and T. K. McGonagle. 1985. Sequential electrodiagnostic abnormalities in acute inflammatory demyelinating polyradiculoneuropathies. *Muscle & Nerve* 8: 528–39.
66. Ropper, A. H., E. F. M. Wijdicks, and B. T. Shahani. 1990. Electrodiagnostic changes in early Guillain-Barré: A prospective study in 113 patients. *Archives of Neurology* 47: 881–7.
67. Vucic, S., K. D. Cairns, K. R. Black, P. S. Chong, and D. Cros. 2004. Neurophysiologic findings in early acute inflammatory demyelinating polyradiculoneuropathy. *Clinical Neurophysiology* 115:2329–35.
68. Cleland, J. C., K. Malik, P. Thaisetthawatkul, D. N. Herrmann, and E. L. Logigian. 2006. Acute inflammatory demyelinating polyneuropathy: Contribution

- of a dispersed distal compound muscle action potential to electrodiagnosis. *Muscle & Nerve* 33:771-7.
69. Menkes, D. L., D. C. Hood, R. A. Ballesteros, and D. A. Williams. 1998. Root stimulation improves the detection of acquired demyelinating polyneuropathies. *Muscle & Nerve* 21:298-308.
  70. Rowin, J., and M. N. Meriggioli. 2000. Electrodiagnostic significance of supramaximally stimulated A-waves. *Muscle & Nerve* 23:1117-20.
  71. Chiò, A., D. Cocito, M. Leone, et al. 2003. Register for Guillain-Barré Syndrome. Guillain-Barré syndrome: A prospective, population-based incidence and outcome survey. *Neurology* 60:1146-50.
  72. Alam, T. A., V. Chaudhry, and D. R. Cornblath. 1998. Electrophysiological studies in the Guillain-Barré syndrome: Distinguishing subtypes by published criteria. *Muscle & Nerve* 21(10):1275-9.
  73. Albers, J. W., and J. J. Kelly. 1989. Acquired inflammatory demyelinating polyneuropathies: Clinical and electrodiagnostic features. *Muscle & Nerve* 12: 435-51.
  74. Barohn, R. J., J. T. Kissel, J. R. Warmolts, and J. R. Mendell. 1989. Chronic inflammatory demyelinating polyneuropathy. Clinical characteristics, course, and recommendation for diagnostic criteria. *Archives of Neurology* 46: 878-84.
  75. Kelly, J. J. 1983. The Electrodiagnostic findings in polyneuropathy associated with monoclonal gammopathy. *Muscle & Nerve* 6: 504-9.
  76. Report from an Ad Hoc Subcommittee of the American Academy of Neurology AIDS Task Force: Research criteria for diagnosis of chronic inflammatory demyelinating polyneuropathy (CIDP). 1991. *Neurology* 41:617-18.
  77. Saperstein, D. S., J. S. Katz, A. A. Amato, and R. J. Barohn. 2001. Clinical spectrum of chronic acquired demyelinating polyneuropathies. *Muscle & Nerve* 24:311-24.
  78. Hughes, R. A., P. Bouche, D. R. Cornblath, et al. 2006. European Federation of Neurological Societies/Peripheral Nerve Society guideline on management of chronic inflammatory demyelinating polyradiculoneuropathy: Report of a joint task force of the European Federation of Neurological Societies and the Peripheral Nerve Society. *European Journal of Neurology* 13(4):326-32.
  79. Tackenberg, B., J. D. Lünemann, A. Steinbrecher, et al. 2007. Classifications and treatment responses in chronic immune-mediated demyelinating polyneuropathy. *Neurology* 68:1622-9.
  80. Haq, R. U., T. J. Fries, W. W. Pendlebury, M. J. Kenny, G. J. Badger, and R. Tandan. 2000. Chronic inflammatory demyelinating polyradiculoneuropathy: A study of proposed electrodiagnostic and histologic criteria. *Archives of Neurology* 57: 1745-50.
  81. Kaji, R., H. Bostock, N. Kohara, N. Murase, J. Kimura, and H. Shibasaki. 2000. Activity-dependent conduction block in multifocal motor neuropathy. *Brain* 123:1602-11.
  82. Taylor, B. V., R. A. Wright, C. M. Harper, and P. J. Dyck. 2000. Natural history of 46 patients with multifocal motor neuropathy with conduction block. *Muscle & Nerve* 23:900-8.
  83. Olney, R. K., R. A. Lewis, T. D. Putnam, and J. V. Campellone Jr. 2003. Consensus criteria for the diagnosis of multifocal motor neuropathy. *Muscle & Nerve* 27:117-21.
  84. Lewis, R. A., and A. J. Sumner. 1982. The electrodiagnostic distinctions between chronic familial and acquired demyelinating neuropathies. *Neurology* 32:592-6.
  85. Fowler, T. J., G. Danta, and R. W. Gilliatt. 1972. Recovery of nerve conduction after a pneumatic tourniquet: Observations on the hind-limb of the baboon. *Journal of Neurology, Neurosurgery and Psychiatry* 35:638-47.
  86. Giralda, P., A. Quartarone, S. Sinicropi, et al. 1998. Electrophysiological studies in mild idiopathic carpal tunnel syndrome. *Electroencephalography and Clinical Neurophysiology* 109:44-9.
  87. Stevens, J. C. 1997. AAEM minimonograph #26: The electrodiagnosis of carpal tunnel syndrome. American Association of Electrodiagnostic Medicine. *Muscle & Nerve* 20:1477-86.
  88. American Association of Electrodiagnostic Medicine: Practice parameter for electrodiagnostic studies in carpal tunnel syndrome: Summary statement. 1999. *Muscle & Nerve* 8(Suppl):S141-3.
  89. Lew, H. L., L. Wang, and L. R. Robinson. 2000. Test-retest reliability of combined sensory index: Implications for diagnosing carpal tunnel syndrome. *Muscle & Nerve* 23:1261-4.
  90. Kaul, M. P., K. J. Pagel, and J. D. Dryden. 2001. When to use the combined sensory index. *Muscle & Nerve* 24:1078-82.
  91. AAEM. 2002. Practice parameter for electrodiagnostic studies in carpal tunnel syndrome: Summary statement. *Muscle & Nerve* 25:918-22.
  92. Preston, D. C., and E. L. Logigian. 1992. Lumbrical and interossei recording with carpal tunnel syndrome. *Muscle & Nerve* 15: 1253-7.
  93. Witt, J. C., J. G. Hentz, and J. C. Stevens. 2004. Carpal tunnel syndrome with normal nerve conduction studies. *Muscle & Nerve* 29:515-22.
  94. van Dijk, J. G., and P. A. Bouma. 1997. Recognition of the Martin-Gruber anastomosis. *Muscle & Nerve* 20:887-9.
  95. Buchthal, F., A. Rosenfalck, and W. Trojaborg. 1974. Electrophysiological findings in entrapment of the median nerve at wrist and elbow. *Journal of Neurology, Neurosurgery and Psychiatry* 37:340-60.
  96. Merlevede, K., P. Theys, and J. van Hees. 2000. Diagnosis of ulnar neuropathy: A new approach. *Muscle & Nerve* 23:478-81.
  97. Kothari, M. J., M. Heistand, and S. B. Rutkove. 1998. Three ulnar nerve conduction studies in patients with ulnar neuropathy at the elbow. *Archives of Physical Medicine Rehabilitation* 79:87-9.
  98. Kincaid, J. C., L. H. Phillips, and J. R. Daube. 1986. The evaluation of suspected ulnar neuropathy at the elbow. Normal conduction study values. *Archives of Neurology* 43:44-7.
  99. Herrmann, D. N., D. C. Preston, K. A. McIntosh, and E. L. Logigian. 2001. Localization of ulnar neuropathy with conduction block across the elbow. *Muscle & Nerve* 24:698-700.
  100. Ochiai, N., J. Honmo, A. Tsujino, and Y. Nisiura. 2000. Electrodiagnosis in entrapment neuropathy by the arcade of Struthers. *Clinical Orthopaedics* 12:129-35.

101. Singh, N., F. Behse, and F. Buchthal. 1974. Electrophysiological study of peroneal palsy. *Journal of Neurology, Neurosurgery and Psychiatry* 37:1202–13.
102. Levin, K. H. 1998. L5 radiculopathy with reduced superficial peroneal sensory responses: Intraspinal and extraspinal causes. *Muscle & Nerve* 21:3–7.
103. Kang, P. B., D. C. Preston, and E. M. Raynor. 2005. Involvement of superficial peroneal sensory nerve in common peroneal neuropathy. *Muscle & Nerve* 31:725–9.
104. Robinson, L. R. 2000. Traumatic injury to peripheral nerves. *Muscle & Nerve* 23:863–73.
105. Trojaborg, W. 1970. Rate of recovery in motor and sensory fibres of the radial nerve: Clinical and electrophysiological aspects. *Journal of Neurology, Neurosurgery and Psychiatry* 33:625–38.
106. Cruz-Martinez, A., A. Armijo, A. Feroso, S. Moraleda, I. Mate, and M. Marin. 2000. Phrenic nerve conduction study in demyelinating neuropathies and open-heart surgery. *Clinical Neurophysiology* 111:821–5.
107. Post, M. 1999. Diagnosis and treatment of supracapular nerve entrapment. *Clinical Orthopaedics* 368:92–100.
108. Uludag, B., C. Ertekin, A. B. Turman, D. Demir, and N. Kiylioglu. 2000. Proximal and distal motor nerve conduction in obturator and femoral nerves. *Archives of Physical Medicine Rehabilitation* 81:1166–70.
109. Olsen, P. Z. 1975. Prediction of recovery in Bell's palsy. *Acta Neurologica Scandinavica* 61(Suppl):1–121.
110. Ferrante, M. A., and A. Wilbourn. 1995. The utility of various sensory nerve conduction responses in assessing brachial plexopathies. *Muscle & Nerve* 18:879–89.
111. Lo, Y. L., and K. R. Mills. 1999. Motor root conduction in neuralgic amyotrophy: Evidence of proximal conduction block. *Journal of Neurology, Neurosurgery and Psychiatry* 66:586–90.
112. Watson, B. V., M. W. Nicolle, and J. D. Brown. 2001. Conduction block in neuralgic amyotrophy. *Muscle & Nerve* 24:559–63.
113. Wilbourn, A. J., and M. J. Aminoff. 1998. AAEM minimonograph #32: The electrodiagnostic examination in patients with radiculopathies. American Association of Electrodiagnostic Medicine. *Muscle & Nerve* 21:1612–31.
114. Richardson, J. K., and G. M. Forman, B. Riley. 1999. An electrophysiological exploration of the double crush hypothesis. *Muscle & Nerve* 22:71–7.
115. Stalberg, E., B. Falck, A. Gilai, J. Jabre, M. Sonoo, and K. Todnem. 1999. Standards for quantification of EMG and neurography. The International Federation of Clinical Neurophysiology. *Electroencephalography Clinical Neurophysiology* 52 (Suppl): 213–20.

*This page intentionally left blank*

# Assessing The Neuromuscular Junction With Repetitive Stimulation Studies

Andrea J. Boon

INTRODUCTION  
ANATOMY AND PHYSIOLOGY  
OF THE NEUROMUSCULAR  
JUNCTION  
TECHNIQUE  
CRITERIA OF ABNORMALITY

RAPID RATES OF  
STIMULATION  
SELECTION OF NERVE–MUSCLE  
COMBINATIONS  
CLINICAL CORRELATIONS  
SUMMARY

## INTRODUCTION

*Repetitive stimulation* is a clinical neurophysiologic technique designed and used to evaluate the function of the neuromuscular junction. The neuromuscular junction is the anatomical site where the motor nerve axon connects functionally with a striated (voluntary) muscle fiber. The function of the neuromuscular junction is disturbed and the test results are abnormal in a group of rare diseases that includes myasthenia gravis, Lambert–Eaton myasthenic syndrome, botulism, and several rare congenital myasthenic syndromes. Repetitive stimulation is important not only in the detection, clarification, and follow-up of these unusual diseases, but also in excluding these disorders in patients presenting with symptoms of fatigue, vague weakness, diplopia, ptosis, and malaise, or with objective weakness of uncertain origin.

This chapter includes a brief review of the anatomy and physiology of the neuromuscular junction as it applies to repetitive stimulation, a detailed discussion of the technique involved, the pitfalls that can occur if not carried out correctly, criteria used to classify the results as normal or abnormal, the patterns of abnormalities that can be seen, and the clinical correlation of those abnormalities with the various different disorders of neuromuscular transmission.

Techniques that will be reviewed include

- Slow-frequency repetitive stimulation of proximal and distal muscle/nerve combinations to evaluate for decrement (reduction in amplitude or area with repetitive stimulation) seen in myasthenia gravis, Lambert–Eaton myasthenic syndrome,

botulism, and congenital myasthenic syndromes.

- The use of brief exercise to evaluate for postexercise facilitation seen in Lambert–Eaton myasthenic syndrome.
- The use of more prolonged exercise to evaluate for repair and postexercise exhaustion seen in myasthenia gravis.
- The use of rapid rates of stimulation to bring out postexercise facilitation in patients who are too weak to exercise, or to bring out decrement in some rare congenital myasthenic syndromes.

**Purpose and Role of Repetitive Stimulation Studies**

- To evaluate the function of the neuromuscular junction.
- To assess for disorders such as myasthenia gravis and Lambert–Eaton myasthenic syndrome.
- To evaluate for neuromuscular disorders in patients with symptoms of fatigue or weakness.

**ANATOMY AND PHYSIOLOGY OF THE NEUROMUSCULAR JUNCTION**

Knowledge of the anatomy and function of the neuromuscular junction is important in

understanding the indications for, techniques of, and results of repetitive stimulation.<sup>1</sup>

Each muscle fiber is innervated by the terminal branch of a motor neuron. The myelinated axon of the motor neuron divides into numerous branches (collaterals), each of which loses its myelin sheath near the muscle fiber and joins the muscle fiber midway along its length. As the axonal branch nears the muscle fiber, it expands into a presynaptic *terminal bouton* that lies within a depression in the muscle cell membrane. The muscle cell membrane (postsynaptic membrane) beneath the nerve terminal has a highly specialized structure, with numerous *junctional folds*. These specialized presynaptic neural and postsynaptic muscle cell membrane structures constitute the *neuromuscular junction*, that is, the synapse between nerve and muscle (Fig. 24–1).

The presynaptic nerve terminal has specialized anatomical and metabolic features for the formation, storage, release, and reuptake of acetylcholine. Acetylcholine is required for chemical synaptic transmission and is stored in synaptic vesicles that release their contents into the synaptic cleft under appropriate conditions (Fig. 24–1). The amount of acetylcholine contained in a single vesicle is called a *quantum*.

The postsynaptic membrane contains acetylcholine receptor protein molecules concentrated on the crest of the junctional folds (Fig. 24–1). When acetylcholine binds to the postsynaptic acetylcholine receptor protein

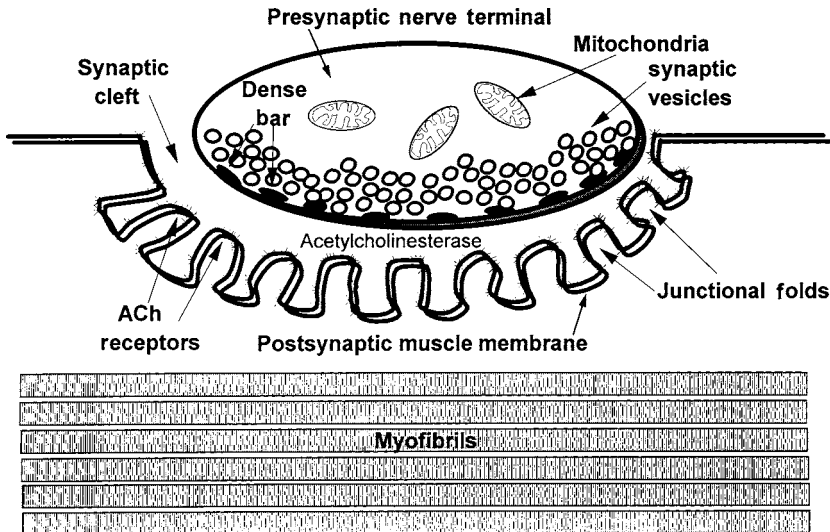


Figure 24–1. Functional anatomy of the neuromuscular junction.



molecules, it causes a change in configuration of the receptor, opening a pore or channel in the membrane, resulting in sodium influx and depolarization of the muscle cell membrane.

Randomly, presynaptic vesicles containing acetylcholine join the presynaptic membrane and release their quantal contents into the neuromuscular junction. The acetylcholine joins with the acetylcholine receptor and produces a small depolarization of the muscle membrane in the area around the neuromuscular junction. This local change is called a *miniature end plate potential* (MEPP).

When an action potential reaches the nerve terminal, voltage-gated channels in the nerve terminal open, allowing influx of calcium. This triggers the release of a large number of vesicles (quanta) of acetylcholine in a short time. The acetylcholine binds with the postsynaptic receptors to produce a depolarization that is much larger than an MEPP. This larger depolarization is termed an *end plate potential* (EPP). An EPP is large enough to depolarize the muscle membrane around the end plate sufficiently to generate a muscle fiber action potential, which then spreads in an all-or-none fashion over the membrane of the entire muscle fiber, releasing large quantities of stored calcium into the sarcoplasm. The calcium causes a change in configuration of the muscle fiber filaments and leads to excitation–contraction coupling. Thus, through excitation–contraction coupling, the action potential results in contraction of the muscle fiber. In normal individuals, the EPP is much greater in amplitude than necessary for the muscle cell membrane to reach threshold, and each EPP results in contraction of the muscle fiber. The size of the EPP is determined by the amount of acetylcholine in each vesicle, the number of vesicles released, and the number and function of the acetylcholine receptors stimulated.

The amount of acetylcholine released at the neuromuscular junction varies under different conditions. The mechanisms involved in the release of acetylcholine by an action potential are such that if another action potential occurs within 200 ms after the first one, the amount of acetylcholine released is greater with the second action potential (Fig. 24–2), but if a second action potential arrives later than 200 ms after the first, less acetylcholine is released with the second action potential.

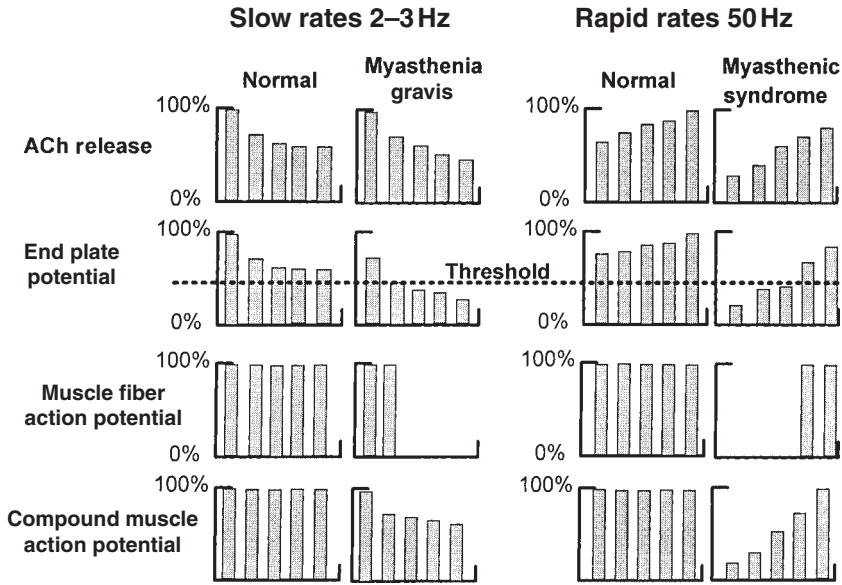
Thus, if a nerve is stimulated repetitively, the amount of acetylcholine released with each stimulus varies depending on the rate of stimulation. At fast rates of repetition, that is, more than 10 per second (short interval between successive stimuli), the amount of acetylcholine released increases or is potentiated. After a series of rapid stimuli (called *tetanic stimulation*), the potentiation of acetylcholine release may persist for 30–60 seconds. With slow rates of repetitive stimulation, that is, less than 5 per second (long interval between stimuli), the amount of acetylcholine released is less with each of the first four stimuli. This decrease is more pronounced for 2–5 minutes after a period of exercise or after repetitive, or tetanic, stimulation.

In normal subjects, the amplitude of the EPP is so much greater than that required to reach threshold (known as the *safety factor*), such that small decreases or increases in amplitude of the EPP with repetitive firing have no effect and each nerve action potential will produce contraction of the muscle fiber.

However, in disorders in which the size of the EPP is decreased to the point where the amplitude falls just above or just below threshold, minor physiologic fluctuations in the amplitude of the EPP may assume major importance. If the EPP is marginally above threshold, repetitive stimulation at slow rates results in a lower amplitude EPP that may not reach threshold and neuromuscular transmission may fail, causing a decrease in the number of muscle fibers that contract. If the EPP is just below threshold for generating an action potential, repetitive stimulation at rapid rates may result in an increased release of acetylcholine, producing an increased EPP amplitude that may exceed threshold and result in facilitation of neuromuscular transmission, with an increment in the number of muscle fibers responding.

### Key Points

- The neuromuscular junction is composed of a synapse where an axonal branch of a motor neuron joins with a muscle fiber.
- The presynaptic membrane contains synaptic vesicles, each of which contains one quantum of acetylcholine.
- The postsynaptic membrane has numerous junctional folds with acetylcholine



**Figure 24-2.** The effects of repetitive stimulation at slow and fast rates on the release of acetylcholine (ACh), end plate potential, individual muscle fiber action potentials, and compound muscle action potential in normal subjects, patients with myasthenia gravis, and patients with myasthenic syndrome.

receptors concentrated on the ends of those folds.

- When one quantum of acetylcholine binds to a receptor, a channel opens in the muscle membrane, resulting in a small depolarization of the muscle membrane (an MEPP).
- An action potential arriving at the nerve terminal causes release of many quanta of acetylcholine, resulting in an EPP that depolarizes the muscle membrane sufficiently to generate a muscle fiber action potential.
- The muscle fiber action potential spreads in an all-or-none fashion and leads to contraction of the muscle fiber.
- The amount of acetylcholine released with each action potential depends on the frequency of nerve stimulation.
- In normal subjects, the EPP is much greater than needed to ensure reliable neuromuscular transmission (this is known as a *high safety factor*).
- In diseases where the EPP is just above threshold, there will be less release of acetylcholine with successive stimuli at low rates of stimulation, resulting in a

reduction in the number of fibers that contract and a decrement in the compound muscle action potential.

## TECHNIQUE

Repetitive stimulation testing demands an unusual degree of experience, attention to detail, and technical expertise to avoid misleading results. Technique is very important because, on the one hand, poor technique can result in “abnormal” findings in patients with normal neuromuscular transmission, leading to an erroneous diagnosis of a disorder of neuromuscular transmission.<sup>2-4</sup> On the other hand, poor technique may result in “normal” findings in patients with abnormal neuromuscular transmission, producing a falsely negative result and a missed diagnosis.

The basic techniques required are those used for routine motor nerve conduction studies (see Chapter 23). These basic techniques must be mastered before repetitive stimulation is attempted. Attention to these basic technical details results in reliable and rapid testing.

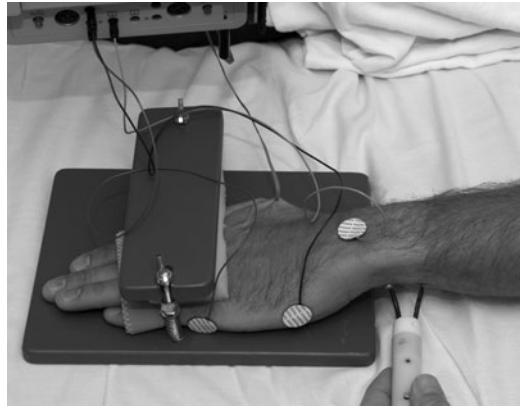
Ignoring these technical details can produce unreliable results, requiring repetition of the procedure and causing great expenditure of time and unnecessary patient discomfort.

Recording electrode placement is the same as for routine motor nerve conduction studies, with the active, or G1, electrode over the end plate or motor point and the G2 electrode over the tendon. Repetitive stimulation requires that the G1 electrode be positioned so that the initial upward, or *negative*, deflection is very sharp and there is no initial downward (positivity at G1) deflection. The recording electrodes and wires must be attached securely so that no movement or loosening occurs during the study. The ground electrode should be positioned to minimize stimulus artifact.

Patient cooperation is critical for a technically satisfactory study. The patient has to understand the purpose and importance of the study. Patient cooperation results in a shorter, less painful study and produces more reliable results. Instruct patients about the purpose of the study and the importance of remaining as relaxed as possible. The patient should let the movement produced by the stimulation occur but avoid the contraction of other muscles, especially between stimuli.

Immobilization is very important in repetitive stimulation studies. Movement can result in broken connectors and wires, loose electrodes, alterations in the relationship between the recording electrode and the muscles, introduction of unwanted activity from neighboring muscles, and shifts in the location of the stimulator. Some form of physical restraint should be used when possible to minimize movement. Immobilization devices may include clamps, boards, straps, sheets, and towels (Fig. 24-3). Basically, any device that limits shifts between the electrodes and recording or stimulating sites without harming the patient or recording setup can be used.

The stimulation technique is based on the usual techniques of supramaximal stimulation with the smallest stimulus possible in terms of duration and intensity. Therefore, the stimulating cathode and anode must be as close to the nerve as possible. The longer the duration and the greater the intensity of the stimulus, the more uncomfortable the patient will be, the more movement that will occur, the more stimulus artifact that will be created, and the



**Figure 24-3.** Example of a simple immobilization device for ulnar motor repetitive stimulation studies. Two boards are connected by adjustable clamps and padded for patient comfort. The fingers are immobilized with a Velcro strap. The hand is immobilized in this fashion after the recording electrodes have been attached securely.

greater the chance of stimulating unwanted nearby nerves. For these reasons, the nerve must be carefully localized. In repetitive stimulation, the stimulus site must be stable. This is a challenge because movements produced by the stimulation and the reaction of patients tend to cause movement of the stimulating electrode in relation to the nerve. Stimulation of the nerve distally limits the contraction of unwanted muscles and results in less artifact. Stimulation with a near-nerve needle electrode results in shorter duration, lower intensity, and more localized stimulation. This may produce less stimulus artifact, less patient discomfort, and more reliable results. The needle can be taped firmly to the skin, to avoid the sliding of the stimulator during the train of stimuli or between series of stimuli. This is particularly helpful if prolonged testing is necessary, such as when evaluating for periodic paralysis, or some congenital myasthenic syndromes.

The stimulus must be strong enough to excite all the motor axons, and the intensity must be increased 10%–25% above the level that produced a maximal response. This supramaximal stimulus cancels the effect of small degrees of movement of the stimulating electrode away from the nerve. Watch the response carefully for any change in amplitude or configuration. If any such change is noted, the adequacy of the stimulus intensity should be checked immediately.

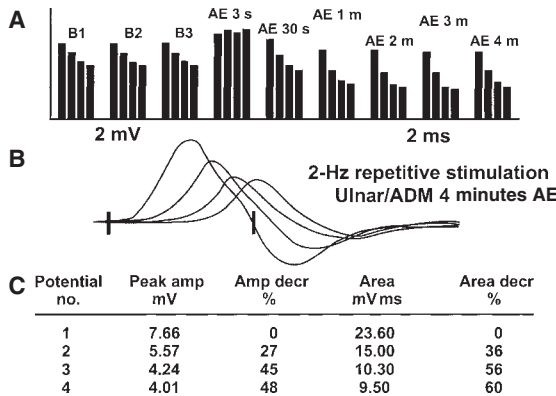
The stimulus rate and the number of stimuli vary depending on the clinical problem. In most situations, slow rates of stimulation of 2 Hz, with an interstimulus interval of 500 ms, will maximize any potential decrement. The greatest decrease in acetylcholine release at slow rates of stimulation occurs during the first four stimuli. For these reasons, the best standard approach is four or five stimuli at 2 Hz. The slower the rate and the fewer the number of stimuli given, the better the patient is able to tolerate the procedure.

The train of four stimuli should be repeated, with at least 15–30 seconds of rest between trains (Fig. 24–4). The trains are repeated to check for reproducible amplitudes, areas, and configurations as well as the stability of the baseline, the presence of stimulus artifact, patient relaxation or movement, and the stability of the recording and stimulating electrodes. If any abnormalities are found, it is important to exclude any potential source of artifact that could result in such an abnormality before proceeding with further testing. After excluding any such artifact, three reproducible and technically satisfactory sets of four stimuli at 2 Hz with 15–30 seconds between sets should be obtained as a baseline.

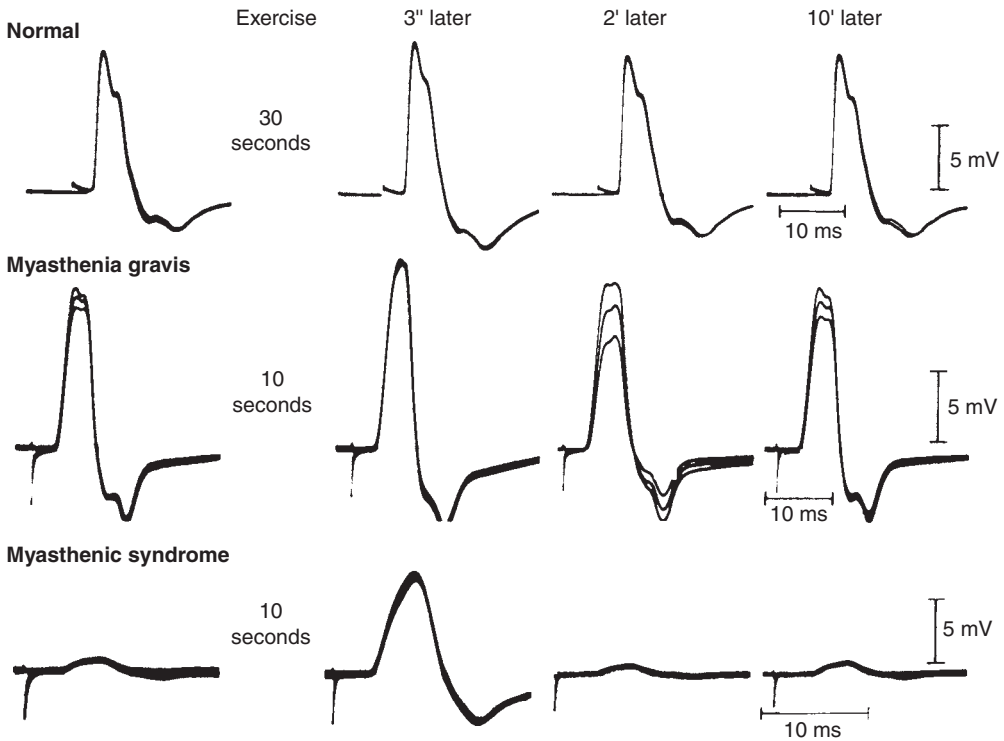
Depending on the clinical problem and the results of the baseline 2-Hz repetitive stimulation, a decision must be made about the usefulness of further testing of neuromuscular transmission with repetitive stimulation after exercise or tetanic stimulation (Fig. 24–5). In general, exercise is done for a brief period (10 seconds) or an intermediate period (1 minute).

Brief (10 seconds) periods of exercise in a cooperative patient have almost the same effect as rapid stimulation at 20–50 Hz for 10 seconds, but are not nearly as uncomfortable. After 10 seconds of exercise, the release of acetylcholine with each action potential is potentiated for 30–60 seconds. During this period of postactivation, or posttetanic, potentiation, the amplitude of the EPP is increased, and the amplitude of the evoked potential may be markedly increased in Lambert-Eaton myasthenic syndrome or in botulism; this phenomenon is known as *postactivation facilitation*. In myasthenia gravis, the decrement at baseline may be decreased or *repaired* during this period (Figs. 24–4 and 24–5).

If there is no decrement or only a very questionable decrement on baseline testing and the



**Figure 24–4.** Example of a repetitive stimulation study in a patient with myasthenia gravis, with stimulation of the ulnar nerve and recording of the CMAP from the ADM muscle of the hand. A train of four stimuli were given at 2/second (s) with the muscle rested on three occasions, separated by 30 seconds of rest for the three baseline studies (B1, B2, B3). Next, the muscle was exercised voluntarily for 1 minute (m). The train of four stimuli at 2 Hz was repeated 3 seconds, 30 seconds, 1 minute, 2 minutes, 3 minutes, and 4 minutes after exercise (AE). *Top*, Histogram of the amplitudes of the four responses of each train. This histogram is a good example of the pattern of abnormality that can be expected in disorders of neuromuscular transmission. In each train of four, the greatest decrement is between the first and second response, with less decrement between the second and third and the third and fourth responses. Immediately after exercise, the decrement has repaired and there is some postactivation facilitation of the amplitude of the CMAP compared to baseline. At 4 minutes after exercise (AE 4 m), the decrement is greater than it was at baseline (postexercise exhaustion). *Middle*, The four responses to 2-Hz stimulation 4 minutes after exercise are displayed in the x-shifted fashion. *Bottom*, Numerical display of the amplitudes and areas of each of the responses (Potential [pot] 1–4) and the percentage decrements (decr) in amplitude (amp) and area 4 minutes after exercise.



**Figure 24-5.** Examples of supramaximal repetitive stimulation at 3 Hz of the ulnar nerve at the wrist while recording over the hypothenar muscle at rest and at 3 seconds, 2 minutes, and 10 minutes after exercise. Each waveform consists of three superimposed CMAPs in a normal subject, in a patient with myasthenia gravis, and in another patient with myasthenic syndrome. In the patient who has myasthenia gravis, the decrease in amplitude from the first to third response repairs after 10 seconds of exercise and then becomes more pronounced 2 minutes after exercise. In a patient with Lambert-Eaton myasthenic syndrome, the CMAP at rest is very low in amplitude; there is a decrement that is not appreciable at this sensitivity. After brief exercise, there is a transient facilitation in amplitude of the CMAP. (From Lambert, E. H., E. D. Rooke, L. M. Eaton, and C. H. Hodgson. 1961. Myasthenic syndrome occasionally associated with bronchial neoplasm: Neurophysiologic studies. In *Myasthenia gravis* [The Second International Symposium Proceedings], ed. H. R. Viets, 362–410. Springfield, IL: Charles C. Thomas. By permission of the publisher.)

purpose of the electrophysiologic examination is to unmask a borderline or mild defect of neuromuscular transmission, the patient should be exercised for 1 minute. The 1-minute period of exercise should be performed in three sets of 20 seconds of exercise interspersed with 2–5 seconds of rest between each set, to simulate prolonged stimulation. For 2–5 minutes after exercise, the amount of acetylcholine released with each stimulus should be minimal, providing the greatest chance for detecting any defect of neuromuscular transmission (Fig. 24-5). Usually, after the patient completes 1 minute of exercise, four stimuli are given at 2 Hz immediately after exercise, and at 30, 60, 120, 180, and 240 seconds after exercise. As emphasized above, any change in amplitude, configuration, or area should initially be considered a technical problem, and

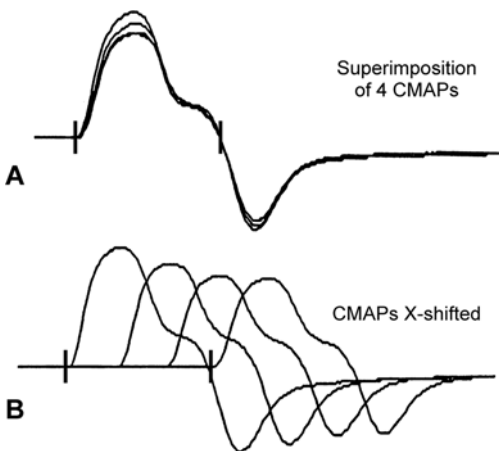
technical factors, including strength of stimulation, should be checked.

The display of the results varies with the machine, hardware, software, and display devices. In general, the sensitivity should be adjusted to display the potentials as large as possible without overflowing or blocking. The sweep speed should be slow enough to spread the potential out so that it can be analyzed visually and fast enough such that the entire potential is displayed, including any late components. The repetitive potentials should be displayed in an *x-shifted* fashion. This means that the onset of the sweep for each successive stimulus is shifted to the right on the horizontal, or *x*-axis, or delayed so that every potential can be analyzed individually. Thus, if there are changes, it is possible to determine which potential in the sequence of four changed and



what the order of change was. Superimposition of successive stimuli may allow closer inspection and detection of changes in amplitude, area, or configuration but does not allow the determination of the sequence of changes (Fig. 24-6). Results should be either printed immediately or stored for later review and printing.

The measurements of interest for repetitive nerve stimulation studies are primarily the amplitude, duration, and area of the waveform of the compound muscle action potential (CMAP) (Fig. 24-4), assuming that the standard nerve conduction studies for that nerve/muscle combination have already been completed. Measurements of amplitude can be made either with manual or automated markers. Measurements of area are quickly and reliably made on digital electromyography (EMG) machines provided that the markers are placed at the initial negative deviation from baseline, and the return of the negative M-wave to baseline. Digital EMG machines can quickly measure changes in amplitude and area between the first and subsequent responses. An increase in size occurs with facilitation and is measured as the percent increment (increase) in the response; a decrease in size occurs with post activation exhaustion and is measured as percent decrement (decrease).



**Figure 24-6.** A, Superimposition and, B, staggering of four CMAPs. The potentials evoked by repetitive stimulation can be displayed in a staggered, or x-shifted, fashion to allow inspection of each potential and determination of the sequence of any changes. Superimposition of the potentials allows easier visual identification of small decrements.

Increments and decrements in responses are measured by dividing the change in size by the baseline size. For example, a baseline amplitude of 10 mV with:

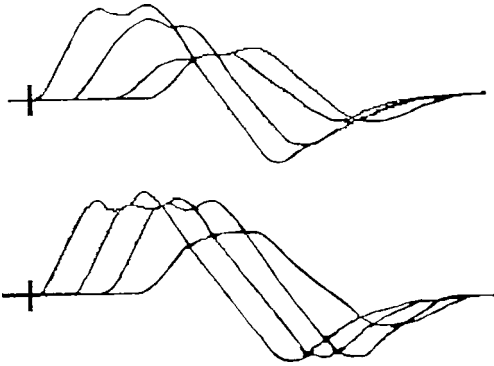
- with a postexercise amplitude of 8 or 12 mV equates to 20% decrement and 20% increment, respectively,
- with postexercise amplitudes of 1 and 19 mV equates to 90% decrement and 90% increment, respectively,
- with postexercise amplitudes of 20, 25, and 30 mV equates to 100%, 150%, and 250% increments, respectively.

Small apparent decrements (<10%) may occur for technical reasons in normal individuals. Decrements greater than 10% make it more likely that it is not a technical error. Small increments in amplitude (usually <20%) may be seen in normal individuals. Such an increment is usually accompanied by a decrease in duration with little or no change in area and is known as *pseudofacilitation*. This is due to an increased synchronization of the firing of motor units rather than an increase in the number of units or the amplitude of the response of individual fibers.

There are several possible causes for abnormal results in the absence of disease (false positives) which should always be considered before making the diagnosis of a disorder of neuromuscular transmission. If there is movement of the stimulating electrode in relation to the nerve, this can produce a random variation in amplitude or, less frequently, a sequential decrement. This is more common immediately after exercise and is more likely to occur when the stimulus is not supramaximal. Submaximal stimulation is suggested by a loss of amplitude of the initial response in the train in comparison to the amplitude obtained during the baseline testing (Fig. 24-7).

Movement of the recording electrode relative to the underlying muscle can produce a change in configuration and amplitude that is usually random but occasionally may show a decrement or increment. A shift in the baseline or visible muscle activity between the stimuli is suggestive of such movement. If technical factors cannot be excluded and are suspected to be the cause of the abnormality, the study should be considered technically inadequate





**Figure 24-7.** Technical problems such as poor relaxation or movement during repetitive stimulation can produce apparent decrements in normal subjects, as seen in these examples.

and nondiagnostic. This is preferable to making a serious diagnosis on the basis of questionable data. Repeating the study at a later date or under other circumstances may be helpful.

False-negative results or normal results in a patient with a disorder of neuromuscular transmission can be caused by low temperature, which will mask a mild defect of neuromuscular transmission, or continuation of pyridostigmine or neostigmine during the testing. Therefore, it is imperative that the patient discontinue such medications before the study and is warm before and during the study. Temperatures should be monitored with the hand skin temperature greater than 32°C and the foot skin temperature greater than 30.5°C. If the temperatures are cool, the patient should be warmed before further studies are performed. When possible, treatment with acetylcholinesterase inhibitors such as pyridostigmine or neostigmine should be discontinued for at least 4–6 hours before the test and preferably overnight. The risk to the patient from discontinuing treatment must be weighed against the importance of the test.

False-negative results may also occur if treatment with immunosuppressants, intravenous immunoglobulin, or plasma exchange is successful. Ideally, the test should be conducted when the patient is most symptomatic—usually late in the day when fatigued. Patients for whom the diagnosis is in question should preferably be tested when the effects of treatments such as plasma exchange, intravenous gamma globulin, and corticosteroids are minimal.

### Key Points

- Educate patients as to what to expect, and how best to relax.
- If there is no risk, ensure that patients have discontinued anticholinesterases at least 6 hours before the test, and preferably overnight.
- Immobilize the limb and attach recording wires and electrodes securely to prevent movement.
- Keep the stimulator as still as possible (consider using near-nerve needle stimulation, with needle taped in place).
- Ensure that the stimulus is supramaximal (20% above that which gives a maximal response).
- Ensure temperature is adequate; a cold limb can lead to false-negative results.
- Begin with a train of four stimuli at a slow rate of stimulus (2 Hz), and record three separate baseline trains with 15–30 seconds of rest in between.
- Consider repeating low-frequency train of four stimuli after brief (10 seconds) exercise to evaluate for facilitation, especially if CMAP is low at baseline.
- Consider repeating low-frequency train of four stimuli after 1 minute of exercise, to bring out a mild decrement not seen at rest or postexercise exhaustion.
- Technical factors should be suspected if (1) the results are not reproducible; (2) the pattern of decrement, increment, postexercise potentiation, or exhaustion is unusual; (3) there are baseline shifts or changes in configuration; or (4) there is evidence of muscle activity or movement between stimuli.

### CRITERIA OF ABNORMALITY

In normal subjects, no decrement should occur with 2-Hz stimulation; however, technical problems will often result in small decrements. Therefore, a conservative criterion of abnormality is to require a decrement in both area and amplitude of at least 10% in two different muscle/nerve combinations.

An abnormal test should meet the following criteria:

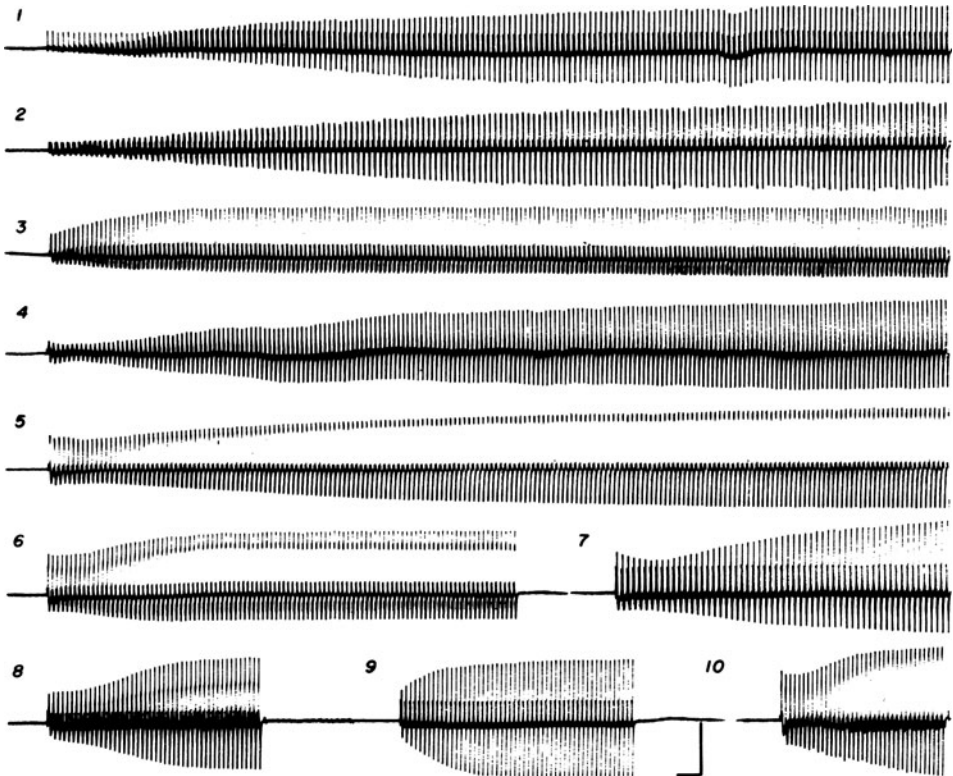
- Reproducible results should be obtained on repeated testing (three baseline trains of four stimuli are recommended).
- The pattern of decrement should be consistent with that seen in neuromuscular disorders, with the greatest decrement in both amplitude and area occurring between the first and second stimuli in the train of four (Fig. 24-4).
- The changes induced by exercise with potentiation and exhaustion should be compatible with what is seen in the disease under question (Fig. 24-5).
- Edrophonium (Tensilon) or neostigmine should decrease or correct the abnormalities seen in myasthenia gravis.

## RAPID RATES OF STIMULATION

Rapid rates of stimulation of 10–50 Hz are helpful in some disorders such as Lambert–

Eaton myasthenic syndrome and botulism in which there may be a marked increment with rapid rates of stimulation (Fig. 24-8). Rapid repetitive stimulation is painful. Brief exercise with voluntary, strong contraction produces the same effect without pain; however, some patients are unable to produce a strong contraction because of extreme weakness, lack of understanding, or inability to cooperate.

If a disorder is suspected such as Lambert–Eaton myasthenic syndrome, rapid rates of stimulation may be necessary. Explain the details of the test to the patient before proceeding. Stress the importance of remaining as still and relaxed as possible so that the results of the test will be reliable. Before beginning, check the machine and electrode setup to prevent any technical errors. If a large facilitation is expected, the gain or sensitivity should be set so that a much larger response can be recorded without blocking. Stimulate at 20–50 Hz for 2–10 seconds, depending on the situation. An



**Figure 24-8.** 1–10, Examples of facilitation of CMAPs of the hypothenar muscle during 40–50 Hz repetitive nerve stimulation in 10 patients with Lambert–Eaton myasthenic syndrome. The potentials are shown at slow sweep speeds. The facilitation ranges from 160%–1400%. Note the variety of patterns of facilitation that occur. In some recordings, a constant amplitude shock artifact is seen with each CMAP (traces 1, 2, 3, 5, 7, and 9). (Courtesy of Dr. E. H. Lambert, Mayo Clinic.)

increment greater than 40% in adults or 20% in infants after 3 seconds of stimulation is considered abnormal.

### SELECTION OF NERVE–MUSCLE COMBINATIONS

Most of the diseases that are studied tend to affect certain muscles more than others. Proximal muscles are usually more involved than distal muscles. There are a number of different nerve–muscle combinations that can be studied to search for defects of neuromuscular

transmission (Table 24–1), depending on the individual patient’s clinical presentation. Clinically weak muscles are more likely to show a decrement on repetitive stimulation, and therefore those nerve–muscle combinations should always be checked; however, it is often more reliable to start with a distal muscle since there is less movement and less pain. It also allows the patient to get used to the technique before moving on to proximal muscles of more interest. Furthermore, in Lambert–Eaton myasthenic syndrome, distal muscles have actually been shown to be more sensitive than the biceps or trapezius in detecting significant postexercise facilitation.<sup>5</sup>

Table 24–1 Specific Nerve–Muscle Combinations

Nerve	Muscle	Stimulation Site	Advantages	Disadvantages	Immobilization
Ulnar	Abductor digiti minimi	Wrist	Reliably immobilized, well tolerated	Distal muscle may be spared	Velcro strap, clamp
Median	Abductor pollicis brevis	Wrist	Well tolerated	Distal muscle may be spared, difficult to immobilize	Thumb restrained with towel
Radial	Extensor indicis proprius	Spinal groove	Reliable, well tolerated, more sensitive than ADM	Distal muscle may be spared, may be difficult to reliably stimulate the nerve	Restrain fingers manually
Musculocutaneous	Biceps	Lower edge axilla	Proximal muscle	Unstable stimulus, difficult to immobilize, painful	Board
Axillary	Deltoid	Supraclavicular	Proximal muscle	Unstable stimulus, difficult to immobilize, painful	Large Velcro strap or sheet
Spinal accessory	Trapezius	Posterior border upper sternocleidomastoid	Proximal muscle, well tolerated	Difficult to immobilize	Strap or hands under chair
Facial	Nasalis	Between mastoid and tragus	Proximal muscle	Painful, unstable stimulation, shock artifact, cannot immobilize. Masseter contraction	None
Trigeminal	Masseter	Mandibular notch	Reliable, well tolerated proximal muscle	Not quite as sensitive as the facial nerve in myasthenia	None (gauze pads between teeth to prevent tooth trauma)
Peroneal	Tibialis anterior	Knee	Leg muscle	Distal muscle may be spared	Board
Femoral	Rectus femoris	Femoral triangle	Proximal leg muscle	Painful, difficult to immobilize	Restrained manually

The most common nerve muscle combinations studied are the ulnar nerve/abductor digiti minimi (ADM), spinal accessory nerve/trapezius, and facial nerve/nasalis. Other combinations should be considered based on the reliability and results of the initial testing. The peroneal/anterior tibial, musculocutaneous/biceps, and femoral/quadriceps may show abnormalities not detected with other nerves. A recent study demonstrated the utility of the trigeminal nerve/masseter technique, which is reliable, well tolerated, and almost as sensitive as the facial nerve/nasalis combination.<sup>6</sup> For distal muscles, techniques utilizing stimulation of the radial nerve with recording over either the extensor indicis proprius or the anconeus muscle have been found to be reliable and more sensitive than the ulnar nerve/ADM combination.<sup>7,8</sup> Even unusual combinations such as stimulation of the phrenic nerve while recording from the diaphragm are feasible.<sup>9</sup>

### Key Points

- Begin with a distal muscle in the most affected limb (hypotenar and thenar).
- Move to more proximal muscles that are clinically involved (trapezius, masseter, and nasalis).
- Consider unusual nerve/muscle combinations in situations where weakness is very focal.

## CLINICAL CORRELATIONS

*Myasthenia gravis* is the classic disease of the neuromuscular junction.<sup>10</sup> It usually is the result of an autoimmune-mediated attack on the acetylcholine receptor on the muscle (postsynaptic) cell membrane. This results in fewer functional receptors and fluctuating, fatigable weakness involving proximal muscles more than distal ones, particularly the bulbar muscles and often the extraocular muscles. Experimentally, the amplitudes of MEPPs and EPPs are low (Fig. 24-2). The resting CMAP is normal or minimally abnormal except in more severe cases. With repetitive stimulation at 2 Hz, there is a decrement, with the greatest decrease in amplitude occurring between the first and second response and lesser decreases after that (Figs. 24-4 and 24-5). By the fifth

response, the decrement levels off. After 10 seconds of exercise, the decrement is partially or completely repaired and there may be a small increment in the amplitude of the CMAP compared to baseline. In severe cases in which the amplitude of the CMAP at baseline is low, there may be a marked increment in this amplitude after brief exercise, as is typically seen in Lambert–Eaton myasthenic syndrome.<sup>4</sup> At 2–4 minutes after 1 minute of exercise, the decrement may be larger than at rest (termed *postexercise exhaustion*). Similar findings are seen in myasthenia gravis associated with the use of the drug D-penicillamine.

*Lambert–Eaton myasthenic syndrome* is a rare entity, which is associated with systemic malignancies such as small cell carcinoma of the lung in about 40% of cases.<sup>11</sup> This syndrome is an autoimmune disorder resulting from an antibody that alters the function of the voltage-gated calcium channels in the axon terminal of the neuromuscular junction. The result is decreased release of acetylcholine with each action potential. The amount of acetylcholine released increases rapidly with rapid rates of activation or stimulation. The weakness is more generalized than in myasthenia gravis but involves proximal muscles more than distal muscles and leg muscles more than arm muscles. The bulbar muscles are not involved as prominently as they are in myasthenia gravis. Some patients have autonomic symptoms such as dry mouth, impotence, and constipation.

Baseline nerve conduction studies usually demonstrate low-amplitude CMAPs at rest. Repetitive stimulation at 2 Hz produces decrements similar to but often more prominent than those seen in myasthenia gravis. However, unlike myasthenia where the decrement levels off after four or five stimuli, in Lambert–Eaton myasthenic syndrome, the decrement usually continues to increase with each stimulus, for up to nine stimuli.<sup>12</sup> Brief (10 seconds) exercise or rapid stimulation at 50 Hz produces a marked increment or facilitation of the amplitude of the CMAP to more than 100% increase from the baseline amplitude (Figs. 24-5 and 24-8). This effect is transient and must be looked for in a well-rested, warm muscle immediately after brief exercise. After 60–120 seconds, the amplitude returns to baseline and the decrement resumes and may be more prominent 3–4 minutes after exercise (*postexercise exhaustion*). If the patient is too weak to exercise,

2–3 seconds of 50 Hz stimulation will induce the same effect. Lo Monaco et al. have reported a similar facilitation in very weak patients by combining voluntary exercise with 3-Hz stimulation applied while exercising.<sup>13</sup> Although an increment of 100% or more has been used as the gold standard in diagnosing Lambert–Eaton myasthenic syndrome, Oh et al. recently showed that an increment of 60% after exercise is highly specific for this disorder, and increases the sensitivity of the test, particularly in seronegative cases.<sup>14,15</sup>

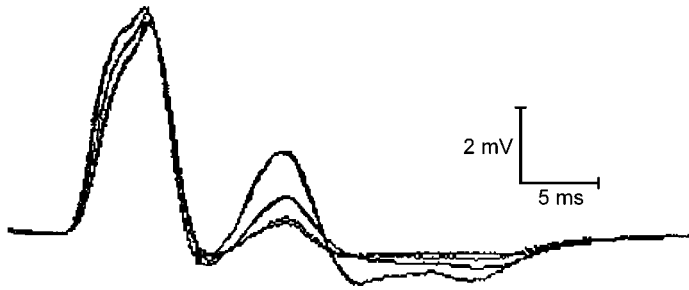
*Botulism*, another rare disorder, is caused by exposure to one of the seven types of toxin produced by *Clostridium botulinum*. In adults, the toxin is ingested in inadequately preserved or prepared food. In infants, botulism is caused by ingestion of spores that germinate into bacteria that produce botulinum toxin in the gut. From 12 to 36 hours after the toxin is ingested, blurred vision, dysarthria, dysphagia, dry mouth, dyspnea, and generalized weakness develop. The toxin markedly decreases the number of quanta of acetylcholine released by an action potential, thus reducing the amplitude of the EPP. Routine nerve conduction studies are normal except for low-amplitude CMAPs. Rapid repetitive stimulation at 50 Hz or brief exercise produces an increment in most cases (in 62% of adults and 92% of infants). This may not be found in very severe cases but, when present, is in the range of 30%–200%. In general, the degree of facilitation seen in botulism is in the 130%–150% range as opposed to Lambert–Eaton myasthenic syndrome where facilitation is typically greater than 200%. A small decrement at slow rates of repetitive stimulation is rarely seen in adults, but is present in more than 50% of cases in infants; more severe cases tend to have less decrement and less facilitation. Postexercise exhaustion is not seen.<sup>16–19</sup>

*Congenital myasthenia* is the general term applied to a group of rare inherited disorders of neuromuscular transmission caused by various structural or functional alterations of the neuromuscular junction, such as decreased filling of the synaptic vesicles with acetylcholine, decreased number of synaptic vesicles available for release, absence of one form of acetylcholinesterase, decreased number of acetylcholine receptors on the junctional folds, or kinetic defects in the acetylcholine receptor that increase or decrease the response to

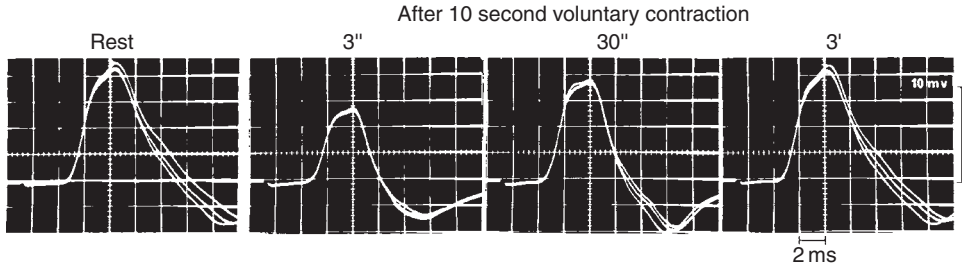
acetylcholine.<sup>20–22</sup> Results of repetitive stimulation are abnormal, but the pattern of abnormality varies among the different disorders. Special techniques are required in patients with a defect of acetylcholine resynthesis or packaging, formerly named *familial infantile myasthenia*, as routine repetitive stimulation may be normal, but prolonged exercise or prolonged repetitive stimulation at 10 Hz for 5–10 minutes may be required to bring out the decrement. On routine nerve conduction studies in these cases, it is also important to look for repetitive CMAPs, which follow the main CMAP by about 3–6  $\mu$ s, and may be seen in slow-channel congenital myasthenic syndrome or acetylcholinesterase deficiency.<sup>21</sup> Such repetitive CMAPs are easily missed on routine nerve conduction studies as they decrease in amplitude rapidly and may disappear with stimulus rates as low as 0.5 Hz; they are best detected after delivery of a single supramaximal stimulus in a nerve/muscle combination with a short duration CMAP such as the ulnar nerve/ADM (Fig. 24–9).

In myotonic disorders, repetitive stimulation may produce a small decrement at rest that may become more prominent as the rate of stimulation is increased. The decrement in myotonic disorders is quite variable, in regards to pattern, severity, and the stimulus rate at which it occurs, depending on the specific genetic mutation involved, temperature, relationship to exertion, and several other variables.<sup>23</sup> The decrement can even vary from one stimulus to the next within a train of stimuli. Usually the decrement increases with increasing rates of stimulus or with prolonged exercise. In most myotonic disorders, there is a drop in amplitude of the CMAP after exercise (and the decrement between the first and fourth stimuli may repair to some degree for several minutes after exercise) (Fig. 24–10); however, in proximal myotonic myopathy (myotonic dystrophy type 2), there is no loss in amplitude of the CMAP after brief exercise, and this finding may help distinguish the two disorders.<sup>24</sup> In paramyotonia, exercise or repetitive stimulation may fail to bring out a decrement of the CMAP amplitude when the muscle is warm; however, a significant decrement may be brought out by cooling the muscle, which may be more pronounced after exercise or repetitive stimulation during cooling, and may even progress to complete





**Figure 24-9.** Repetitive stimulation of the ulnar nerve at 2 Hz, recording from surface electrodes over the ADM muscle in a patient with slow-channel congenital myasthenic syndrome. Note the repetitive CMAPs that follow the main CMAP by about 6 ms, but are smaller and decrement to a greater degree than the main CMAP.

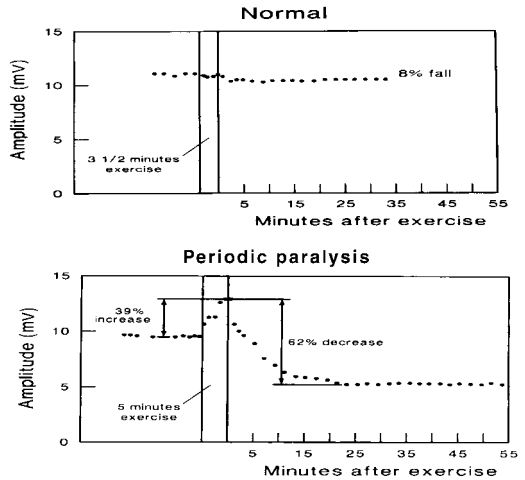


**Figure 24-10.** Example of repetitive stimulation study of the ulnar nerve while recording from hypothenar muscles in a patient with myotonia. There is a very small reproducible decrement at baseline. The decrement and the amplitude of the CMAP are decreased after 10 seconds of exercise, but 3 minutes after exercise the amplitude and the decrement have increased again.

electrical silence.<sup>23</sup> Recessive myotonia congenita may show decrements of 60%–80% after a short exercise test, and even more so with a train of 10-Hz stimulation.<sup>23</sup> Changes of this magnitude are strongly suggestive of recessive myotonia congenita.

Periodic paralysis may reveal a gradual reduction in amplitude of the CMAP for 20–30 minutes after exercising the muscle for 3–5 minutes (Fig. 24-11), therefore the usual protocol is to leave the electrodes in place, and record a single CMAP every 5 minutes for 30 minutes to demonstrate this loss of amplitude.<sup>25</sup> There usually is no decrement at slow rates of repetitive stimulation.

In progressing neurogenic disorders such as amyotrophic lateral sclerosis, a decrement at slow rates of stimulation may be found that is less prominent after brief exercise and increased after prolonged exercise. Such abnormalities are seen more frequently when the disease is rapidly progressive, and there can be a decrement as high as 30%–40% in such cases. Disorders of neuromuscular transmission are rarely found in peripheral neuropathies and inflammatory myopathies.<sup>26</sup>



**Figure 24-11.** Results of the prolonged exercise test in a normal subject (*top*) and a patient with hypokalemic periodic paralysis (*bottom*). The subject is studied by recording the CMAP amplitude with single stimuli at 1-minute intervals while the patient is at rest, during 3–5 minutes of exercise, and for 20–40 minutes after exercise. In this patient with hypokalemic periodic paralysis, the amplitude increases 39% during exercise and then decreases dramatically by 62% after exercise.



## Key Points

- The usual pattern seen in myasthenia gravis is a decrement at rest, in proximal muscles, that repairs after brief exercise, and then recurs and sometimes increases after one minute of exercise (postexercise exhaustion).
- The usual pattern seen in Lambert–Eaton myasthenic syndrome is a low-amplitude CMAP, with a decrement present at rest, and significant facilitation (>60%) after brief exercise. Both proximal and distal muscles are usually affected.
- The usual pattern seen in botulism is a low-amplitude CMAP on routine nerve conduction studies, often with minimal or no decrement present on repetitive stimulation, but marked facilitation after brief exercise or 50-Hz stimulation.
- Congenital myasthenic syndromes have variable presentation; in some cases routine repetitive stimulation may be normal and a decrement may only be brought out after prolonged repetitive stimulation at 10 Hz for 5–10 minutes.
- No decrement is present in periodic paralysis, but the CMAP amplitude may gradually decrease over 20–30 minutes following 5 minutes of exercise.
- Recessive myotonia congenita may show decrements of over 40% with trains of 10-Hz stimulation.
- A small decrement may be seen in disorders such as amyotrophic lateral sclerosis, other myotonic disorders, and rarely in inflammatory myopathies. For this reason, it is important to document a decrement of at least 10% in two or more nerve/muscle combinations.

## SUMMARY

The electrophysiologic technique of repetitive stimulation is an important component of the evaluation of patients with fatigue, weakness, ptosis, diplopia, dysphagia, or dysarthria. The technique requires a knowledge of the physiology and pathophysiology of neuromuscular transmission and the basic techniques of nerve conduction studies for proper application and interpretation. Errors in technique can produce falsely positive or negative results. The

test must be individualized for each case, with the proper selection of nerve and muscle combinations, rates of stimulation, and types of exercise. The examiner must be aware of the varied abnormalities that occur with different disease entities.

## REFERENCES

1. Engel, A. G. 1999. Anatomy and molecular architecture of the neuromuscular junction. In *Myasthenia gravis and myasthenic disorders*, ed. A. G. Engel, 3–39. New York: Oxford University Press.
2. Keeseey, J. C. 1989. AAEE minimonograph #33: Electrodiagnostic approach to defects of neuromuscular transmission. *Muscle & Nerve* 12:613–26.
3. Sanders, D. B. 1992. Electrophysiologic study of disorders of neuromuscular transmission. In *Electrodiagnosis in clinical neurology*, ed. M. J. Aminoff, 3rd ed., 327–54. New York: Churchill Livingstone.
4. Harper, C., Jr. 1999. Electrodiagnosis of endplate disease. In *Myasthenia gravis and myasthenic disorders*, ed. A. G. Engel, 65–84. New York: Oxford University Press.
5. Maddison, P., J. Newsom-Davis, and K. R. Mills. 1998. Distribution of electrophysiologic abnormality in Lambert–Eaton myasthenic syndrome. *Journal of Neurology, Neurosurgery, and Psychiatry* 65:213–17.
6. Rubin, D. I., C. M. Harper, and R. G. Auger. 2005. Trigeminal nerve repetitive stimulation in myasthenia gravis. *Muscle & Nerve* 29(4):591–6.
7. Petertska, A., R. Jarrar, and D. I. Rubin. 2006. Radial nerve repetitive stimulation in myasthenia gravis. *Muscle & Nerve* 33(6):817–19.
8. Kennett, R. P., and R. W. Fawcett. 1993. Repetitive nerve stimulation of anconeus in the assessment of neuromuscular transmission disorders. *Electroencephalography and Clinical Neurophysiology* 89:170–6.
9. Zifko, U. A., M. W. Nicolle, W. Grisold, and C. F. Bolton. 1999. Repetitive phrenic nerve stimulation in myasthenia gravis. *Neurology* 53:1083–7.
10. Sanders, D. B., ed. 1994. Myasthenia gravis and myasthenic syndromes. *Neurologic Clinics* 12:231–442.
11. Newsom-Davis, J., and B. Lang. 1999. The Lambert–Eaton myasthenic syndrome. In *Myasthenia gravis and myasthenic disorders*, ed. A. G. Engel, 205–28. New York: Oxford University Press.
12. Baslo, M. B., F. Deymeer, P. Serdaroglu, Y. Parman, C. Ozdemir, and M. Cattini. 2006. Decrement pattern in Lambert–Eaton myasthenic syndrome is different from myasthenia gravis. *Neuromuscular Disorders* 16: 454–8.
13. Monaco, M., M. Milone, L. Padua, and P. Tonaco. 1997. Combined low rate nerve stimulation and maximal voluntary contraction in the detection of compound muscle action potential facilitation in Lambert–Eaton myasthenic syndrome. *Muscle & Nerve* 20(9):1207–8.
14. Oh, S. J., K. Kurokawa, G. C. Claussen, and H. F. Ryan. 2005. Electrophysiological diagnostic criteria of Lambert–Eaton myasthenic syndrome. *Muscle & Nerve* 32(4):515–20.

15. Oh, S. J., Y. Hatanaka, G. C. Claussen, and E. Sher. 2007. Electrophysiological differences in seropositive and seronegative Lambert–Eaton myasthenic syndrome. *Muscle & Nerve* 35(2):178–83.
16. Pickett, J. B. III. 1988. AAEM case report #16: Botulism. *Muscle & Nerve* 11:1201–5.
17. Sheth, R. D., B. P. Lotz, K. E. Hecox, and A. J. Waclawik. 1999. Infantile botulism: Pitfalls in electrodiagnosis. *Journal of Child Neurology* 14:156–8.
18. Chaudhry, V., and T. O. Crawford. 1999. Stimulation single-fiber EMG in infant botulism. *Muscle & Nerve* 22:1698–703.
19. Hatanaka, T., K. Owa, M. Yasunaga, et al. 2000. Electrophysiological studies of a child with presumed botulism. *Childs Nervous System* 16: 84–6.
20. Engel, A. G., K. Ohno, and S. M. Sine. 1999. Congenital myasthenic syndromes. In *Myasthenia gravis and myasthenic disorders*, ed. A. G. Engel, 251–97. New York: Oxford University Press.
21. Jones, H. R., C. F. Bolton, and C. M. Harper Jr. 1996. *Pediatric clinical electromyography*, 353–85. Philadelphia: Lippincott-Raven.
22. Vedanarayanan, V. V. 2000. Congenital myasthenic syndromes. *Neurologist* 6:186–96.
23. Michel, P., D. Sternberg, P. Jeannet, et al. 2007. Comparative efficacy of repetitive nerve stimulation, exercise, and cold in differentiating myotonic disorders. *Muscle & Nerve* 36:643–50.
24. Sander, H. W., S. N. Scelsa, M. F. Conigliari, and S. Chokroverty. 2000. The short exercise test is normal in proximal myotonic myopathy. *Clinical Neurophysiology* 111:362–6.
25. McManis, P. G., E. H. Lambert, and J. R. Daube. 1984. The exercise test in periodic paralysis (abstract). *Muscle & Nerve* 7:579.
26. Rubin, D. I., and R. C. Hermann. 1999. Electrophysiologic findings in amyloid myopathy. *Muscle & Nerve* 22:355–9.

# Motor Evoked Potentials

Jeffrey A. Strommen

## INTRODUCTION TECHNIQUE

MEP Stimulation  
Technical Aspects of Electrical  
Stimulation  
Technical Aspects of Magnetic  
Stimulation  
MEP Recording  
MEP Measurements

## MEP PHARMACOLOGY APPLICATIONS

Demyelinating Disease  
Stroke  
Spinal Cord Injury  
Other Disorders

## CONTRAINDICATIONS AND RISKS SUMMARY

## INTRODUCTION

*Motor evoked potential* (MEP) recording are being increasingly utilized as a means to monitor the central motor pathways during surgical procedures at which time these structures, particularly the spinal cord, are at risk. Several studies have also evaluated the diagnostic yield in various conditions including demyelinating disease, spondylotic myelopathy, amyotrophic lateral sclerosis (ALS), and peripheral nerve disorders. The ability of MEP to predict recovery, for prognostication, following central nervous system insults, such as stroke or spinal cord injury, is being developed. Some authors have used MEP to predict disability in multiple sclerosis. Although the term *motor evoked potentials* has been used to describe potentials from muscle or nerve elicited by several

methods of stimulation, in this chapter this will refer to potentials recorded after stimulation of motor structures in the central nervous system. Although technically, stimulation of a peripheral nerve with recording over the muscle is an MEP, this will be referred to as a compound muscle action potential (CMAP) which was discussed in Chapter 23. MEPs are the response elicited distally along the spinal cord, peripheral nerve, or muscle with stimulation of the central motor pathways (spinal cord or cerebral hemispheres) using either transcranial magnetic stimulation (TMS) or transcranial electric stimulation (TES). In intraoperative monitoring, the goal is to stimulate rostral to the structure at risk and record the potentials at a distal site, in order to identify potentially reversible damage. In the diagnostic realm, central conduction time (CCT) and

the size of an MEP are measured to identify focal slowing in the central motor pathways or loss of amplitude due to axonal loss. Clinical and experimental studies of the efficacy and safety of TES and TMS have been performed extensively in most countries and clinical applications of transcranial electrical MEP are now permitted in all countries. TMS is permitted in all countries except the United States where the method is still considered experimental.

### **Purpose and Role of MEPs**

- Primary use is to monitor central motor pathways that are at risk during surgical procedures.
- May have predictive value in central nervous system injuries such as stroke and spinal cord injury.
- May provide additional diagnostic information in processes that lead to slowing of the central motor pathways such as multiple sclerosis.

## **TECHNIQUE**

### **MEP Stimulation**

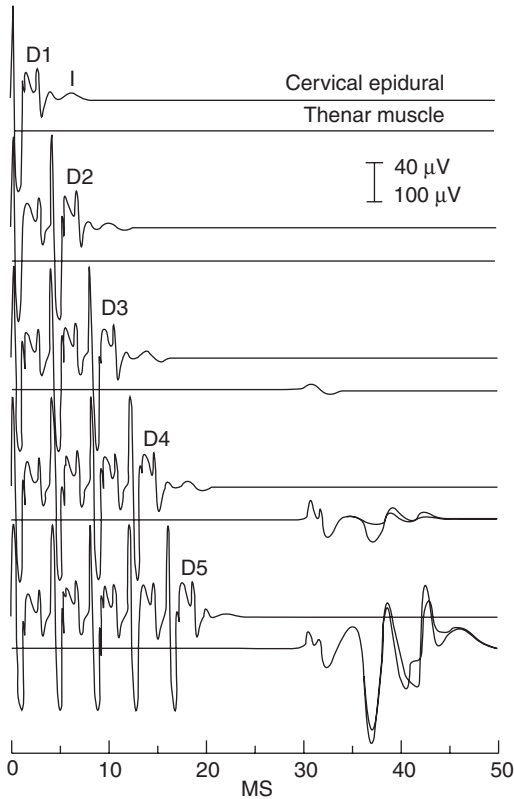
Theoretically, MEP can be obtained with stimulation anywhere along the peripheral or central motor axis. For clinical purposes, stimulation is generally performed in the central nervous system, either at the cerebral cortex or at the cervical spinal cord.<sup>1</sup> At each location, motor pathways can be activated by either electric or magnetic stimulation. Although the technical aspects of electric and magnetic stimulation differ, the physiology of MEP activation is similar for both forms of stimulation.

Direct electrical activation of the motor pathways at the level of the cerebral cortex has been used in experimental animals for many years to study the motor pathways. Penfield conducted the first extensive study of stimulation of the motor cortex in humans more than 50 years ago during surgical procedures for epilepsy.<sup>2</sup> He noted that the responses were attenuated substantially by anesthesia and so conducted many of his operations with patients under local or light anesthesia. He also recognized that the cerebral cortex was activated more readily with rapid repetitive stimulation,

ranging from 20 to 50 Hz and that optimal activation occurred with the anode, rather than the cathode, placed over the motor area. Thus, stimulation of the motor cortex differs from that of peripheral nerves or motor fiber tracts in the spinal cord in both the polarity of stimulation and the importance of rate of repetitive stimulation.

Direct stimulation of the cerebral cortex may activate the dendrites, cell bodies, or the axon hillocks of the motor neurons in the precentral gyrus. MEPs depend on activation at the axon hillocks in the depths of the cerebral cortex. With TES the anode is placed over the area of the cortex to be stimulated. In contrast to peripheral stimulation, the anode more effectively stimulates the pyramidal cells of the cortex because of its ability to induce hyperpolarization of the apical dendrite and depolarization of the axon hillock. This orientation enhances hyperpolarization at the cortical surface and depolarization in the deep layers of the cortical gray matter. With magnetic stimulation, an intense current in an external coil induces local depolarizing electric currents that flow through the neuron and axon hillock. Both depolarizations initiate descending action potentials in the corticospinal pathway.

Cortical stimulation produces a series of descending action potentials in the corticospinal tracts. The *D* (direct) wave results from depolarization of the axon hillocks of the large motor neurons. These are followed by a series of *I* (indirect) waves that reflect activation of the cortical interneurons. The *D* and *I* waves can be recorded directly from the spinal cord but with single pulse stimulation they generally will not depolarize the anterior horn cell. MEPs are augmented with repetitive stimulation at both the cortical and the spinal cord levels. Trains of action potential summate and facilitate depolarization of the anterior horn cell above threshold for firing. Figure 25–1 shows temporal summation at the anterior horn cell.<sup>3</sup> Anterior horn cell activation propagates axonal action potentials and muscle depolarization that can be recorded as nerve and muscle action potentials. For clinical purposes, a series of 3–10 stimuli to the brain generally produces optimal activation of MEP. Newly designed transcranial, electric and magnetic, stimulators provide repetitive stimulation that enhances MEP. Comparable enhancement of MEP also can be obtained



**Figure 25-1.** TES epidural and muscle responses during C2 to C3 meningioma surgery under propofol and fentanyl anesthesia omitting neuromuscular blockade. Epidural recording (bandwidth 500–10,000 Hz) used a bipolar electrode inserted caudal to the lesion after opening. Muscle recording (bandwidth 20–3000 Hz) used intramuscular needle pairs. Traces consist of two superimposed averages of five trials. D1 through D5 are sequential D-wave corticospinal volleys following one to five pulses (Nicolet Viking, 0.5-ms pulse duration, 250-Hz train frequency, 250 V) through 9-mm cup electrodes collodion fixed 1 cm anterior to C1/C2. A small I wave follows each. Temporal summation produced progressive motor unit recruitment with three through five-pulse trains. The brain stimulation, epidural electrode, and induced movement raise safety concerns discussed in this chapter. Single-pulse epidural and five-pulse train muscle MEP monitoring were successful without adverse effects in this patient. (From MacDonald, D. B. 2002. Safety of intraoperative transcranial electrical stimulation motor evoked potential monitoring. *Journal of Clinical Neurophysiology* 19(5): 416–29. By permission of Lippincott Williams & Wilkins.)

by low-level voluntary activation, which partially depolarizes the cell body and axon hillock before the stimulus is applied<sup>4</sup> (Fig. 25-2). On electromyographic (EMG) recordings from the muscles used to record MEP, 15% activation has been found to give optimal facilitation of MEP. Other methods including vibration of

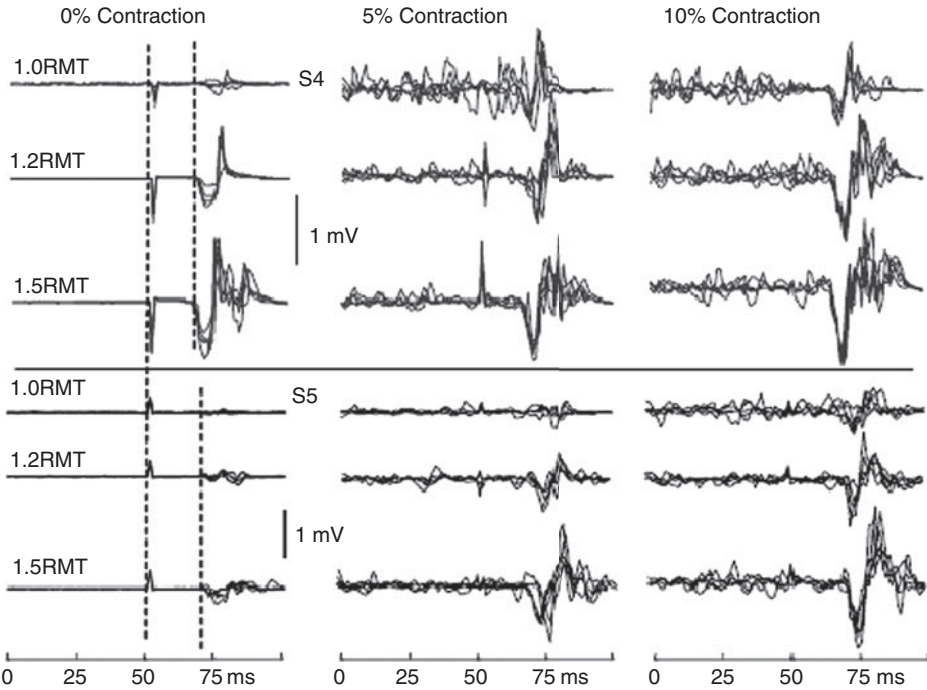
the examined muscles, prestimulation of the appropriate mixed nerve, and mental simulation of movement have been suggested to facilitate MEP in disorders in which the patient is unable to voluntarily contract the muscle.<sup>5-7</sup>

### Key Points

- Cortical stimulation can be performed with either electrical or magnetic stimulation.
- Electrical stimulation is utilized routinely for intraoperative monitoring whereas magnetic stimulation is generally used for diagnostic studies as it is better tolerated.
- Transcortical electrical stimulation uses anodal activation which differs from stimulation of the peripheral nervous system where cathode activation occurs.
- Motor neurons are activated by the summation of the initial direct wave (D) and series of indirect waves (I) arising from the pyramidal axons and cortical interneurons respectively.
- Responses are facilitated with paired stimulation (3–10) and interstimulus interval of 1–4 ms. These are most commonly facilitated with slight voluntary activation.

### Technical Aspects of Electrical Stimulation

Transcranial electric MEPs of the motor cortex through the intact bony skull or percutaneous stimulation of the spinal cord are used for most intraoperative monitoring. Direct stimulation of the exposed cortex is used occasionally for location of the motor cortex during tumor surgery and epilepsy surgery, and even less commonly for clinical diagnostic purposes. The high resistance of bone to electric current requires much higher applied voltages to drive the few milliamps of current to the cerebral cortex needed for cortical stimulation. TES in normal adults often requires stimuli up to 1000 V which can be quite painful as there is considerable contraction of the cranial musculature. By using brief, high voltage shocks from a stimulator with a low output impedance, the resistance of the scalp and calvarium can be overcome. Although there has not been consistent standardization of stimulation parameters, a recent study by Szelenyi et al. evaluated



**Figure 25–2.** Variability of motor potentials evoked by TMS depends on muscle activation. TMS induced MEPs recorded from the extensor digitorum communis (EDC). Each panel shows five superimposed MEPs at a single stimulus intensity at one activation level. (From Darling, W. G., S. L. Wold, and A. J. Butler. 2006. Variability of motor potentials evoked by transcranial magnetic stimulation depends on muscle activation. *Experimental Brain Research* 174:376–85. By permission of Springer-Verlag.)

various parameters during intraoperative monitoring and recommended the following when recording over a limb muscle:<sup>8</sup>

1. The lowest stimulus intensity to elicit MEP in the tibialis anterior (TA) and abductor pollicis longus (APB) is achieved with a train of individual 0.5-ms duration electric pulses (many commercial machines have shorter duration pulses to reduce pain).
2. An interpulse interval of 4 ms gave the lowest motor thresholds but did not differ significantly from 3 ms.
3. Stimulating electrode locations of C3/C4 or C4/C3 (international 10–20 EEG system) gave the lowest stimulation thresholds.

MEP stimulation protocols vary among institutions, but anodal stimulation, with 0.05 ms rapid rise time pulses to subcutaneously placed electroencephalographic (EEG) electrodes at C3 and C4 is commonly used. Two to five

stimuli with an interstimulus interval of 1–4 ms are given at intensities of 200–500 V (MultiPulse Cortical Stimulator D185, Digitimer Ltd, Welwyn Garden City, Hertfordshire, UK). These parameters are varied until a reproducible response can be recorded in all the muscles examined. The polarity of the stimulation is also switched to assure maximal anodal stimulation. Electric activation of the motor pathways in the spinal cord occurs by depolarization of the axons in the corticospinal tract by the cathode, with hyperpolarization at the anode, similar to that of a peripheral nerve. This can be obtained by surface electrodes with stimuli greater than 1000 V, similar to the electric stimuli used in transcranial stimulation. However, in the operating room, activation is possible with lower intensity stimuli by a flat plate cathode directly on the dura mater in the surgical field or by a needle electrode cathode placed either in the interspinous ligament or over the vertebral lamina. Anode placement for activation of the spinal cord may be epidural, laminar, esophageal, subcutaneous, or on the



surface of the skin at some distance from the cathode. Stimulation of the spinal cord is also enhanced by repetitive stimulation at intervals of 3–5 ms. In surgical settings, activation of motor pathways in the cervical spinal cord is easier than cortical stimulation because anesthetics have less effect on the spinal cord than on the cerebral cortex. However, spinal cord stimulation produces retrograde dorsal column activation as well as anterograde activation of the motor pathways. Thus, a descending potential recorded from the spinal cord or individual peripheral nerve will be from both motor and sensory fibers.<sup>9</sup> Such sensory responses are not seen when recording from muscle because of their relatively smaller size. With the technological development of modern stimulating equipment, TES has become the preferred method with an overall success rate of obtaining TES MEP of 94.8% in the upper extremities and 66.6% in the lower extremities.<sup>10</sup> However, the ability to record MEP is significantly reduced in patients under 7 years of age, those over 64 years, and in patients with more pronounced, preexisting clinical neurologic deficits.

### Key Points

- TES is the preferred method for eliciting MEP in the intraoperative setting.
- MEP is most readily elicited with stimulation at C3–C4 for both the APB and the TA (better responses occur in a few patients from CZ–FZ.)
- Maximal MEP is obtained with 3–5 pulses, an interstimulus interval of 3–4 ms, and pulse duration of 0.5 ms.
- Most responses will be obtained with intensity of 200–500 V.
- MEP is more difficult to obtain in those under 7 or over 64 years of age and those with more severe preexisting neurologic deficits.

### Technical Aspects of Magnetic Stimulation

In awake subjects, TMS is the preferred technique since the magnetic pulse is painless while the high voltage electric shock is quite painful. TMS produces some contraction of

cranial muscles that requires only a gauze pad between the teeth; it is not reliable for intraoperative monitoring because of smaller responses, marked suppression with anesthetic agents, and difficulty with stabilization of the magnetic coil. Activation of the axons in the cervical corticospinal tract and the neurons in the motor cortex depends on the same mechanism. In both cases, an intense pulse of current in an external coil induces a magnetic field that traverses the skin and bone without effect. In TMS, the electrically induced pulse of the magnetic field induces current flow in the underlying tissue of the brain or spinal cord.<sup>11</sup> At threshold the local current flow causes neuronal or axonal depolarization; this depolarization initiates descending action potentials in the corticospinal pathway. Magnetic stimulation differs from electric stimulation in that no current flow occurs in the superficial levels of the skin, muscle, or bone. All current flow is induced intracranially by the rapid change in current in the stimulating coil. With optimal recording and no interference, TMS MEP can initiate supramaximal or nearly supramaximal CMAP.

TMS is performed with coils of different sizes and shapes for different clinical applications. In TMS an increase or decrease of current or a change in direction of current in the coil induces comparable changes in the intracranial or intraspinal local currents. Thus it is necessary to vary the orientation of the coil and direction of current flow to induce the current needed for activation of the neural tissue. In general, for lower limb MEP the coil is centered around Cz whereas for upper extremity TMS the coil is placed just laterally. Single or paired stimuli of increasing intensity are applied until a stable MEP is recorded or the maximal output (100%) is reached. The coil can then be adjusted by rotation and lateral movement to obtain a maximal response.

### Key Points

- TMS is less painful and preferred for clinical diagnostic testing.
- A magnetic field applied through the skull induces current flow in underlying brain tissue with little current in the skin or subcutaneous tissue.

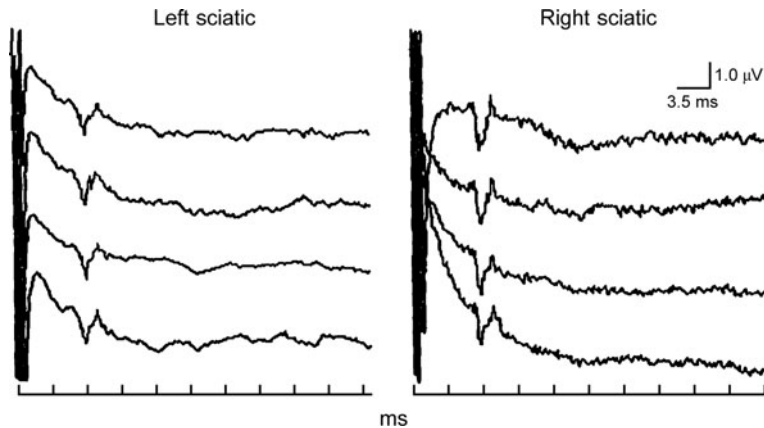
- For lower extremity MEP, the coil is centered in the region of Cz and for the upper limb it is just lateral.
- TMS is less useful of the intraoperative applications due to the marked sensitivity to anesthetic agents.

## MEP Recording

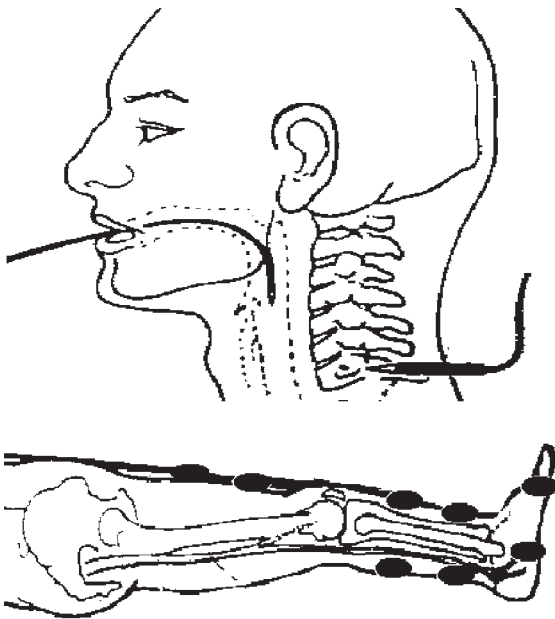
While magnetic coil positioning can focus stimulation more on one than another area of the brain, stimulation of the motor pathways at either the cortical or the spinal cord level activates multiple descending pathways with contraction of many muscles. Recording electrodes can thus be placed anywhere along the descending pathway. In the spinal cord, the motor volley can be recorded with electrodes placed directly on the cord or in the epidural space. With the technique one can relatively easily record the D and I waves during surgical procedures with single pulses at a relatively low intensity (Fig. 25-1). As cord MEPs are not affected by neuromuscular blocking agents, they can be recorded with complete neuromuscular block. Disadvantages of cord MEP include possible hematoma from catheter placement as well as inability to recognize unilateral loss of responses masking a persistent contralateral response.<sup>12</sup> The motor response can also be recorded over peripheral nerves with spinal cord stimulation and has been referred to as *neurogenic* MEP<sup>13</sup>

(Fig. 25-3). Although this has the potential advantage of allowing complete neuromuscular block, it is a small response that is more likely arising from small responses of surrounding, paralyzed muscles. This response may not be a pure motor response since it likely includes retrograde somatosensory potential, which could lead to a false-positive response.<sup>14</sup>

MEPs recorded from muscle have become the recording of choice in most laboratories. With either cortical or spinal cord stimulation, CMAP can be recorded from the muscle with surface, subdermal, or intramuscular electrodes (Fig. 25-4). MEP elicited by stimulation of the cerebral cortex or the cervical spinal cord may be recorded relatively easily from most limb muscles with selection of the muscles for recording determined by the clinical problem (Fig 25-5). Typically, the potentials are recorded with surface electrodes, but subcutaneous electrodes, intramuscular wires, or other electrodes can be used. Intramuscular recording are used with caution as they lead to less quantifiable CMAP. These potentials are reduced by the neuromuscular blocking agents usually required during surgical procedures, but with controlled blockade they can usually be recorded with paired stimulation. The standard gains, filter settings, with longer sweep speeds than used for peripheral motor conduction studies are usually satisfactory. Some MEPs during surgery are small enough to require averaging. Typically, the ankle extensor and flexor muscles and the quadriceps muscles are tested in the lower extremity, while the

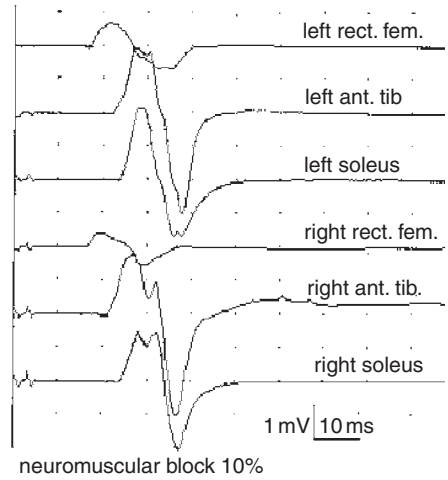


**Figure 25-3.** Neurogenic MEPs recorded from the right and left sciatic nerves during spinal deformity surgery. (From Owen, L. H., J. Laschinger, K. Bridwell, et al. 1988. Sensitivity and specificity of somatosensory evoked and neurogenic MEPs in animals and humans. *Spine* 13:1111-18. By permission of Lippincott Williams & Wilkins.)

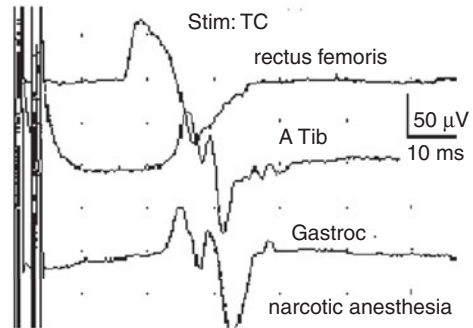
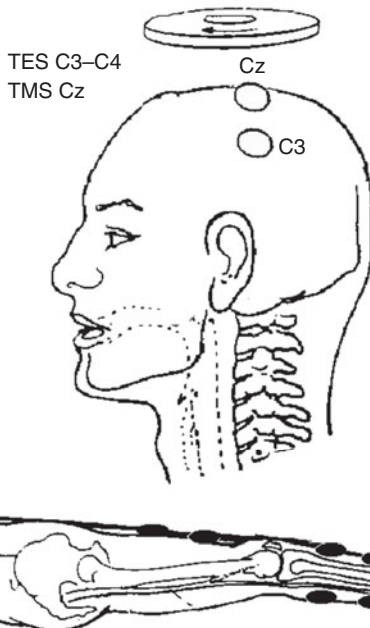


MEP during scoliosis surgery

Spinal stimulation: Paired ISI 3 ms, 80 mA, dur 1 ms  
Esophageal-left cervical



**Figure 25-4.** Spinal stimulation with recording of CMAPs by surface electrodes over selected lower extremity muscles. Stimulation in this case was with an anode-cathode set up from an esophageal to percutaneous laminar needle.



**Figure 25-5.** Transcortical stimulation with recording of CMAPs by surface electrodes over selected lower extremity muscles. These responses were recorded with electrical stimulation at C3-C4 during spine surgery with partial neuromuscular blockade. Magnetic stimulation will also elicit lower extremity CMAPs when the magnet is centered over Cz but these are generally not used during surgery.

intrinsic hand muscles, forearm extensors, and arm flexors are tested in the upper extremities. The thenar muscle in the hand and the anterior tibial muscle in the leg are the sites most frequently used and provide the most definitive normal data. MEP can also be recorded from facial innervated muscles during cranial base surgeries.<sup>15</sup>

### Key Points

- Motor evoked recordings directly over the spinal cord or peripheral nerve are easily obtainable and are less affected by anesthesia but have other drawbacks.
- MEPs recorded over the muscle are easily recorded but requires either no or controlled neuromuscular blockade.
- Recording locations vary based on the clinical problem but are most reliable when obtained in the TA and thenar muscles.
- Surface or subdermal needle electrodes provide the most quantifiable CMAP response.

### MEP Measurements

With peripheral recordings, three measurements of MEP have been used: latency, amplitude, and threshold. MEP amplitude is more variable in size and configuration than CMAP evoked with peripheral stimulation. They can vary with the attention and level of relaxation in an awake patient. Thus, amplitude measures are of limited clinical diagnostic value. However, major changes in amplitude can be used to detect motor pathway damage during surgical monitoring. In general, a 50% reduction in amplitude from an average baseline value at a critical time during surgery is considered significant. Given the significant variability, some centers have used only a loss of the response as significant (see Chapter 44).

The latency of responses from the time of stimulation to recording is the most reliable measurement. The most direct method of measuring MEP latency is by direct measurements that are compared with those of normal subjects matched for age, height, and sex; however, absolute latencies may not be sufficiently

sensitive to identify mild involvement by disease. Because MEPs are designed primarily to detect disease of the central motor pathway, several methods have been developed to subtract the latency of the peripheral segment of the motor pathway from the total latency, and thereby distinguish conduction over the central portion of the motor pathways. *Central conduction time* is the most commonly used measure to identify central disorders.<sup>16</sup> CCT is calculated by subtracting the time needed for the signal to travel over the peripheral segment (spinal cord to the muscle) from the total latency (site of stimulation to the muscle). The latency of the peripheral segment is measured in one of two ways. The latency of a lumbar spine MEP is the most direct. Peripheral latency can also be obtained indirectly from F-wave measurements made during standard nerve conduction studies. F-wave traverses the peripheral motor pathway from the distal limb to the anterior horn cell and back to the muscle; thus, F-wave latency minus the distal M-wave latency divided by two plus the distal latency. The direct or F-wave calculated spinal MEP latency subtracted from the latency obtained with cortical stimulation gives the CCT. Thresholds for activation of an MEP have been used widely in physiologic studies of cortical function, but they have not proved of value in clinical assessment.

### Key Points

- Amplitude of MEP is highly variable and is thus of limited clinical utility.
- An MEP amplitude reduction of >50% at critical periods during intraoperative monitoring is generally considered significant.
- CCT is the most useful clinical diagnostic measurement in various diseases but has limited utility in intraoperative monitoring.
- CCT is most commonly measured using calculated peripheral segment latencies based on F-waves subtracted by the total conduction time from cortical stimulation.

### MEP PHARMACOLOGY

The effect of drugs on the MEP of the awake patient is minimal. Minimal changes have

been reported with sedating agents such as lorazepam, diazepam, and midazolam. These are not sufficient to preclude MEP testing in patients on these medications.

The primary factor affecting the MEPs in the operating room is anesthesia. Anesthetic agents can suppress the response at multiple sites, particularly at central synapses in the cortex, anterior horn cell, and less so at the neuromuscular junction. Halogenated inhalation agents easily abolish MEPs by blockade at the cortex and anterior horn cell.<sup>17</sup> If used at all, the concentration of these agents need to remain very low (<0.5%). While not universally the case, nitrous oxide can also suppress MEP dramatically. Since MEPs are recorded from muscle, neuromuscular blocking agents will also suppress or eliminate them. MEP can still be reliably recorded with neuromuscular blockade up to 50%. Continuous monitoring of the level of neuromuscular junction block is valuable in assuring stable MEP. The remaining movement with MEP requires that the surgeon be warned before each stimulus. Unless core body temperature is quite low, temperature produces only a mild, gradual increase in stimulation threshold.<sup>17</sup>

### Key Points

- Inhalation of anesthetic agents plays a major role in suppressing MEP during intraoperative monitoring.
- In the awake patient there is little suppression from oral anxiolytic, or sedative agents.
- Neuromuscular blocking agents should be minimized and closely monitored but are acceptable with blockade up to 50%.

## APPLICATIONS

MEPs are used for two major purposes: clinical diagnosis and operative monitoring of neural function. TMS are widely used for diagnostic purposes outside the United States, but are not approved for this use in this country because of the time and effort that would be required by the manufacturers. TMS in the United States is limited to studies conducted under research protocols. In contrast, TES is

approved in the United States, and is therefore much more heavily used but only in monitoring for surgery. In developed countries outside the United States, TES is as commonly used in surgical monitoring.

Normal data have been obtained in only a few laboratories (and for specific stimulation and recording methods that have not been widely adopted).<sup>18</sup> Furthermore, variability of the responses has raised concern about the reliability of the responses for clinical interpretation.<sup>6,19</sup> Although some reports include normative data, most do not. Consequently, generally accepted values for MEP amplitude and latencies do not exist. For clinical studies, amplitude measures generally are not used because of the marked differences among normal subjects. Latency measures can show marked slowing or dispersion of the response. Such a finding is strong evidence for a demyelinating process, as in multiple sclerosis. Finally, although MEPs have been shown to have clinical value in patients with central motor process, clinical examination, magnetic resonance imaging, and other laboratory testing are often more specific. Despite this, a large study in Italy using TMS revealed that this technique can be highly accurate as a diagnostic test in many conditions.<sup>20</sup> In this study the overall agreement between clinical and electrophysiologic abnormalities was 87% with higher sensitivities in spinal cord pathology (0.85), hereditary spastic paraplegia (0.8), and motor neuron disease (0.74). MEPs have been tested and reported on as a diagnostic aid in many neurologic disorders, including cerebral infarcts, Parkinson's disease, other movement disorders, motor neuron disease, cervical spondylosis, and less common disorders. More recent reports have attempted to use MEP to predict prognosis in injuries to the central nervous system such as in stroke or spinal cord injury.

MEP recordings are commonly used in monitoring neural function during surgery in major medical centers, but have not otherwise been widely adopted. In the operative setting the goal is to protect central motor pathways which may be at risk at a time when clinical examination is not possible. More recently, they have become a valuable tool in brachial plexus exploration and reconstruction, in assessing whether the motor root is



avulsed. These applications will be discussed in Chapters 43–45.

## Demyelinating Disease

In clinical diagnostic neurology, the most common use of MEP is the search for evidence of demyelinating disease.<sup>21</sup> MEPs show marked slowing and dispersion in the presence of demyelinating disease in the spinal cord or brain stem, particularly in transverse myelitis<sup>22,23</sup> (Fig. 25–6). Such changes may be present even in the absence of any major or clear-cut neurologic deficit. Therefore, MEP can be used to identify subclinical lesions in patients with multiple sclerosis and help define the significance of fatigue.<sup>24</sup> Many reports have shown the sensitivity of MEP in detecting and characterizing slowing of conduction in the motor pathways that may not produce a measurable motor deficit. Virtually all patients with multiple sclerosis who have weakness in a limb also have abnormal MEP in that limb. Recent studies have attempted to use MEP as an objective measure to document functional consequences of multiple sclerosis, thus providing an outcome measure to estimate prognosis and document treatment effects and assist with interpretation of clinical treatment trials. Kalkers et al. analyzed TMS as a valid measure of evaluating neurologic dysfunction and found that the degree of abnormality did correlate with standard multiple sclerosis.<sup>25</sup>

## Key Points

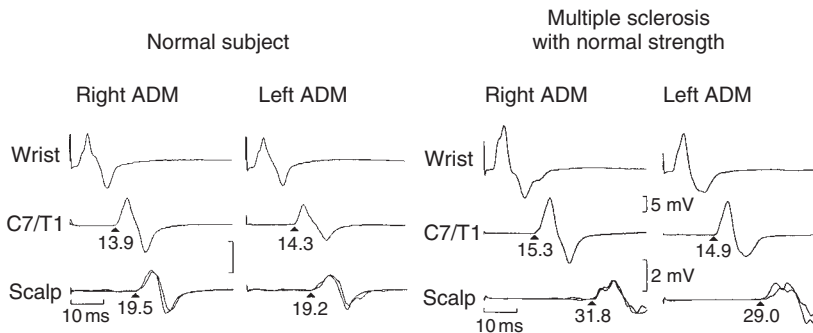
- MEP is frequently abnormal and may serve as a valuable diagnostic tool in the assessment of central demyelinating disease.
- CCT and motor dispersion may be evident in central demyelinating diseases.

## Stroke

MEPs have been studied as a predictor of outcome in stroke. Many variations in MEP methods have been used to evaluate different stroke populations, but there still does not appear to be a clear consensus on the predictive value of functional return after stroke.<sup>26,27</sup> MEP testing has been applied in studies of recovery after severe traumatic injury to the brain and in acute brain stem lesions and may be helpful in predicting the outcome.<sup>28,29</sup>

## Spinal Cord Injury

MEPs are frequently abnormal in patients with cervical or lumbar spondylosis.<sup>30</sup> The changes may be a prolongation of absolute latency at a single site or a change in latency and configuration between two sites of recording. In cervical spondylosis, abnormality on MEP testing may be caused by bony compression of the spinal cord or the spinal nerves in the intervertebral foramina. The abnormalities are increased latency and decreased amplitude.<sup>31,32</sup> A recent



**Figure 25–6.** Hand MEPs in a normal subject (*left*) and in a patient with documented multiple sclerosis (*right*). Function and clinical testing were normal in the hand and arm. ADM, abductor digiti minimi of the hand. Black triangles, MEP latencies. (From Hess, C. W., K. R. Mills, N. M. Murray, and T. N. Schriefer. 1987. Magnetic brain stimulation: Central motor conduction studies in multiple sclerosis. *Annals of Neurology* 22:744–52. By permission of John Wiley & Sons.)



study has also found significant correlation with MRI abnormalities and suggests MEP as a screening tool to detect cervical spondylotic myelopathy.<sup>33</sup> Generally, a change in latency is more prominent than a reduction in amplitude. Amplitude reduction is particularly difficult to assess in MEP as it may be difficult to obtain a supramaximal response in many normal subjects, particularly in the lower extremities.

Assessing functional preservation of the motor tracts and predicting recovery in spinal cord injury has become a major topic of research with the increasing number of treatment trials addressing spinal cord repair with growth factors, stem cells, and bridging grafts. MEP recording has been used in this setting to determine level of injury, completeness of injury, and to monitor recovery after injury. In a study by Curt et al., it was shown that an absence of a recordable abductor digiti minimi (ADM) MEP with TMS was very highly predictive of poor recovery of intrinsic hand function. In addition, ambulatory capacity could be predicted in that those with normal MEP recorded in the TA regained full ambulatory ability whereas if this response was absent 78% showed no or only minimal ambulatory capacity.<sup>34</sup> Lack of facilitation of MEP amplitudes has been utilized as a measure of motor tract involvement in incomplete spinal cord injuries but requires more study to determine the clinical and prognostic significance.<sup>35</sup>

### Key Points

- The value of MEP after strokes remains to be determined.
- Latency abnormalities correspond well to structural damage to roots or cord in cervical spondylosis.
- MEP may well become important for following the course of recovery with new treatments for spinal cord injury.

### Other Disorders

Reports in a small number of patients with other disorders who have had MEP testing are available, but their clinical significance is difficult to determine. In ALS, MEP testing is reported to show abnormalities of latency and threshold, but these are difficult to distinguish from the changes that would be expected solely

from loss of amplitude and loss of facilitation and, thus, MEP testing is unlikely to add to the standard EMG evaluation despite some reported abnormalities.<sup>36,37</sup> Cortical hyperexcitability has been shown with MEP testing as an early feature of motor neuron disease establishing the presence of both upper and lower motor neuron but without clear evidence of diagnostic value.<sup>38</sup> MEP testing also has been applied extensively in analyzing in Parkinson's disease. One unconfirmed TMS study reported early diagnosis of central motor changes and difference in compensational capacity based on the type of disease.<sup>39</sup> In completely paralyzed patients with an apparent psychogenic paralysis, MEP can be useful if the motor pathway from cortex to muscle is intact. MEP should be markedly abnormal or absent in a structural disorder that produces complete paralysis, in contrast to the normal MEP seen in psychogenic disorders.<sup>40</sup>

### CONTRAINDICATIONS AND RISKS

Reports of complications of MEP testing are few. The most extensive safety review reported remarkably few adverse events.<sup>3</sup> In over 15,000 patients the most common adverse event was tongue or lip lacerations which could be prevented by placement of a bite block. Seizures were very rare occurring in only five reported cases, usually with underlying epilepsy, cardiac arrhythmia in five patients and intraoperative awareness in one. There were no recognized adverse neuropsychologic effects, headaches, or endocrine disturbances. Based on these findings the relative contraindications include epilepsy, cortical lesions, convexity skull defects, raised intracranial pressure, cardiac disease, being on medication for epilepsy testing under anesthesia, intracranial electrodes, vascular clips or shunts, and cardiac pacemakers or other implantable biomedical devices. Additional exclusion criteria provided by the manufacturer of the D185 MultiPulse Cortical Stimulator (Digitimer, Welwyn Garden City, Hertfordshire, UK) include history of stroke or psychiatric disorder. Few studies have assessed MEP in children,<sup>41</sup> but current age ranges as per Digitimer's operator manual report no other risks in ages from 3 to 99 years.

## SUMMARY

MEP recordings are a safe and effective means of assessing conduction along the central and peripheral motor pathways in a variety of clinical settings. MEP is proven to be effective in monitoring central motor pathways that are at risk during surgical procedures and is finding usefulness in the diagnosis and prognosis of several central nervous system disorders such as multiple sclerosis, stroke, and spinal cord injury. The responses can be elicited by a variety of stimulation techniques using either magnetic or electrical stimulation to the cortex, spinal cord, or peripheral nerve. Recordings can be obtained from several structures including the spinal cord, peripheral nerve, or muscle dependent on the clinical application. The clinical neurophysiologist should have a basic understanding of the techniques as well as the potential physiologic and technical factors that need to be accounted for in the interpretation of these studies.

## REFERENCES

- Rossini, P. M. 1990. Methodological and physiological aspects of motor evoked potentials. *Electroencephalography Clinical Neurophysiology* 41(Suppl):124-33.
- Penfield, W., and H. Jasper. 1954. *Epilepsy and the functional anatomy of the human brain*. Boston: Little, Brown.
- MacDonald, D. B. 2002. Safety of intraoperative transcranial electrical stimulation motor evoked potential monitoring. *Journal of Clinical Neurophysiology* 19(5): 416-29.
- Darling, W. G., S. L. Wold, and A. J. Butler. 2006. Variability of motor potentials evoked by transcranial magnetic stimulation depends on muscle activation. *Experimental Brain Research* 174:376-85.
- Rossini, P. M., and S. Rossi. 1998. Clinical applications of motor evoked potentials. *Electroencephalography and Clinical Neurophysiology* 106:180-94.
- Magistris, M. R., K. M. Rosler, A. Truffert, and J. P. Myers. 1998. Transcranial stimulation excites virtually all motor neurons supplying the target muscle. A demonstration and a method improving the study of motor evoked potentials. *Brain* 121:437-50.
- Han, T. R., J. H. Kim, and J. Y. Lim. 2001. Optimization of facilitation related to threshold in transcranial magnetic stimulation. *Clinical Neurophysiology* 112:593-9.
- Szelenyi, A., K. F. Kothbauer, and V. Deletis. 2007. Transcranial electrical stimulation for intraoperative motor evoked potential monitoring: Stimulation parameters and electrode montages. *Clinical Neurophysiology* 118: 1586-95.
- Machida, M., S. L. Weinstein, T. Yamada, J. Kimura, T. Itagaki, and T. Usui. 1988. Monitoring of motor action potentials after stimulation of the spinal cord. *Journal of Bone and Joint Surgery (American Volume)* 70:911-18.
- Chen, X., D. Sterio, X. Ming, et al. 2007. Success rate of motor evoked potentials for intraoperative neurophysiologic monitoring: Effects of age, lesion location and preoperative neurologic deficits. *Journal of Clinical Neurophysiology* 24(3):281-5.
- Counter, S. A., and E. Borg. 1992. Analysis of the coil generated impulse noise in extracranial magnetic stimulation. *Electroencephalography and Clinical Neurophysiology* 85:280-8.
- Burke, D., and R. G. Hicks. 1998. Surgical monitoring of motor pathways. *Journal of Clinical Neurophysiology* 15(3):194-205.
- Owen, L. H., J. Laschinger, K. Bridwell, et al. 1988. Sensitivity and specificity of somatosensory evoked and neurogenic-motor evoked potentials in animals and humans. *Spine* 13:1111-18.
- Toleikis, J. R., J. P. Skelly, A. O. Carlvn, and J. K. Burkus. 2000. Spinally elicited peripheral nerve responses are sensory rather than motor. *Clinical Neurophysiology* 111:736-42.
- Akagami, R., C. Dong, and B. D. Westerberg. 2005. Localized transcranial electrical motor evoked potentials for monitoring cranial nerves in cranial base surgery. *Neurosurgery* 57:ONS-78-85.
- Claus D. 1990. Central motor conduction: Method and normal results. *Muscle & Nerve* 13:1125-232.
- Sloan, T. B., and E. J. Heyer. 2002. Anesthesia for intraoperative neurophysiologic monitoring of the spinal cord. *Journal of Clinical Neurophysiology* 19(5):430-43.
- Eisen, A., S. Siejka, M. Schulzer, and D. Calne. 1991. Age-dependent decline in motor evoked potential (MEP) amplitude: With a comment on changes in Parkinson's disease. *Electroencephalography and Clinical Neurophysiology* 81:209-15.
- Triggs, W. J., L. Kiers, D. Cros, J. Fang, and K. H. Chiappa. 1993. Facilitation of magnetic motor evoked potentials during the cortical stimulation silent period. *Neurology* 43:2615-20.
- Di Lazzaro, V., A. Oliviero, P. Profice, et al. 1999. The diagnostic value of motor evoked potentials. *Clinical Neurophysiology* 110:1297-307.
- Jones, S. M., L. J. Streletz, V. E. Raab, R. L. Knobler, and F. D. Lublin. 1991. Lower extremity motor evoked potentials in multiple sclerosis. *Archives of Neurology* 48:944-8.
- Ho, K. H., M. Lee, K. Nithi, J. Palace, and K. Mills. 1999. Changes in motor evoked potentials to short-interval paired transcranial magnetic stimuli in multiple sclerosis. *Clinical Neurophysiology* 110:712-19.
- Kalita, J., and U. K. Misra. 2000. Neurophysiological studies in acute transverse myelitis. *Journal of Neurology* 247:943-8.
- Colombo, B., F. Martinelli Boneschi, P. Rossi, et al. 2000. MRI and motor evoked potential findings in nondisabled multiple sclerosis patients with and without symptoms of fatigue. *Journal of Neurology* 247:506-9.
- Kalkers, N. F., R. L. M. Strijers, M. M. S. Jaspersse, et al. 2007. Motor evoked potential: A reliable and objective

- measure to document the functional consequences of multiple sclerosis? Relation to disability and MRI. *Clinical Neurophysiology* 118:1332–40.
26. Pennisi, G., G. Rapisarda, R. Bella, et al. 1999. Absence of response to early transcranial magnetic stimulation in ischemic stroke patients: Prognostic value for hand motor recovery. *Stroke* 30:2666–70.
  27. Feys, H., J. van Hees, F. Bruyninckx, R. Mercelis, and W. De Weerd. 2000. Value of somatosensory and motor evoked potentials in predicting arm recovery after a stroke. *Journal of Neurology, Neurosurgery and Psychiatry* 68:323–31.
  28. Moosavi, S. H., P. H. Ellaway, M. Catley, M. J. Stokes, and N. Haque. 1999. Corticospinal function in severe brain injury assessed using magnetic stimulation of the motor cortex in man. *Journal of Neurological Sciences* 164:179–86.
  29. Schwarz, S., W. Hacke, and S. Schwab. 2000. Magnetic evoked potentials in neurocritical care patients with acute brain stem lesions. *Journal of Neurological Sciences* 172:30–7.
  30. Travlos, A., B. Pant, and A. Eisen. 1992. Transcranial magnetic stimulation for detection of preclinical cervical spondylotic myelopathy. *Archives of Physics Medicine and Rehabilitation* 73:442–6.
  31. Tavy, D. L., H. Franssen, R. W. Keunen, A. R. Watterdorff, R. E. Hekster, and A. C. van Huffelen. 1999. Motor and somatosensory evoked potentials in asymptomatic spondylotic cord compression. *Muscle & Nerve* 22:628–34.
  32. Nakanishi, K., N. Tanaka, N. Kamei, et al. 2007. Significant correlation between corticospinal tract conduction block and prolongation of central motor conduction time in compressive cervical myelopathy. *Journal of Neurological Sciences* 256(1–2):71–4.
  33. Lo, Y. L., L. L. Chan, W. Lim, et al. 2006. Transcranial magnetic stimulation screening for cord compression in cervical spondylosis. *Journal of Neurological Sciences* 244:17–21.
  34. Curt, A., M. E. Keck, and V. Dietz. 1998. Functional outcome following spinal cord injury: Significance of motor-evoked potentials and ASIA scores. *Archives of Physics Medicine and Rehabilitation* 79:81–6.
  35. Diehl, P., U. Kliesch, V. Dietz, and A. Curt. 2006. Impaired facilitation of motor evoked potentials in incomplete spinal cord injury. *Journal of Neurology* 253:51–7.
  36. Kohara, N., R. Kaji, Y. Kojima, et al. 1996. Abnormal excitability of the corticospinal pathway in patients with amyotrophic lateral sclerosis: A single motor unit study using transcranial magnetic stimulation. *Electroencephalography and Clinical Neurophysiology* 101:32–41.
  37. Truffert, A., K. M. Rosler, and M. R. Magistris. 2000. Amyotrophic lateral sclerosis versus cervical spondylotic myelopathy: A study using transcranial magnetic stimulation with recordings from the trapezius and limb muscles. *Clinical Neurophysiology* 111:1031–8.
  38. Vucic, S., and M. C. Kiernan. 2006. Novel threshold tracking techniques suggest that cortical hyperexcitability is an early feature of motor neuron disease. *Brain* 129:2436–46.
  39. Guekht, A., M. Selikhova, M. Serkin, and E. Gusev. 2005. Implementation of the TMS in the early stages of Parkinson's disease. *Electromyography and Clinical Neurophysiology* 45(5):291–7.
  40. Pillai, J. J., S. Markind, L. J. Streletz, H. L. Field, and G. Herbison. 1992. Motor evoked potentials in psychogenic paralysis. *Neurology* 42:935–6.
  41. Nezu, A., S. Kimura, S. Uehara, T. Kobayashi, M. Tanaka, and K. Saito. 1997. Magnetic stimulation of motor cortex in children: Maturity of corticospinal pathway and problem of clinical application. *Brain Development* 19:176–80.

*This page intentionally left blank*

SECTION 2

**ELECTROPHYSIOLOGIC  
ASSESSMENT OF NEURAL  
FUNCTION**

---

*This page intentionally left blank*



# Assessing the Motor Unit

---

Contraction of somatic muscles underlies all human movement. Central and peripheral motor pathways that control movement ultimately act on muscle to produce contraction. The lower motor neuron forms the connection between motor pathways in the central nervous system and the muscles, and may be considered the “final common pathway” of motor function. The lower motor neuron is made up of *motor units*, each of which consists of a cell body, an axon, and all of the muscle fibers innervated by that axon. The cell body of a motor neuron is located in a cranial nerve motor nucleus within the brain stem or the anterior horn of the spinal cord. The peripheral motor axon is a myelinated fiber that travels in a cranial nerve or peripheral nerve to the muscle, where it branches into multiple nerve terminals. Each terminal branch innervates a number of muscle fibers, and the number of terminal branches in the muscle determines the innervation ratio (the number of muscle fibers in a motor unit). Innervation ratios may be as small as 50 (in extraocular muscles and other small muscles requiring fine control) or as large as 2000 (in large, powerful muscles such as the gastrocnemius).

Most peripheral neuromuscular diseases involve one or more components of a motor unit. Motor neuron diseases, such as amyotrophic lateral sclerosis, involve the anterior

horn cells; radiculopathies, mononeuropathies, and peripheral neuropathies involve the peripheral axons; and primary myopathies and disorders such as myasthenia gravis affect the muscles and neuromuscular junctions.

Several electrophysiologic techniques may be used to test the integrity of the motor units. Motor nerve conduction studies measure alterations in function of the peripheral motor axons, neuromuscular junction, or muscle, but only indirectly measure the extent of axonal destruction or anterior horn cell loss. The electrophysiologic assessments described in the chapters in this section complement nerve conduction studies in defining the character, severity, and distribution of neuromuscular disease. Distinguishing among primary muscle diseases, disorders of the neuromuscular junction, and neurogenic disorders depends on needle electromyography (Chapter 26). In addition, needle electromyography helps characterize the defects of neuromuscular transmission and the number of functioning axons or anterior horn cells. These two aspects of neuromuscular disease can be quantified more precisely with the special techniques of quantitative EMG (Chapter 27), single fiber electromyography (Chapter 28), and motor unit number estimate (MUNE) (Chapter 29)—techniques that are discussed in this section.

*This page intentionally left blank*

# Assessing the Motor Unit with Needle Electromyography

*Devon I. Rubin*

## **INTRODUCTION**

### **KNOWLEDGE BASE OF NEEDLE EMG**

#### **TECHNIQUE OF NEEDLE EXAMINATION**

Clinical Evaluation

#### **CONDUCTING THE NEEDLE EXAMINATION**

Preparing the Patient

Muscle Selection

Needle Insertion

Needle Movement

Recording Display During Needle Examination

Data Collection of a Resting Muscle

Data Collection from a Contracting Muscle

Measurement of MUPs

#### **POTENTIAL COMPLICATIONS DURING NEEDLE EXAMINATION**

Anticoagulation or Bleeding Disorders

Lymphedema and Skin Problems

Infection Precautions

Examining Peri-Pleural Muscles

Examination of Patients with Pacemaker

Obese Patients

Low Pain Tolerance

#### **EMG SIGNAL ANALYSIS**

##### **NEEDLE ELECTRODE**

###### **CHARACTERISTICS**

Standard Concentric Electrodes

Monopolar Electrodes

Single Fiber Electrodes

Macroelectrodes

#### **SKILLS OF EMG WAVEFORM RECOGNITION**

Pattern Recognition

Semiquantitative EMG

#### **ORIGIN OF EMG POTENTIALS NORMAL EMG ACTIVITY**

Normal Spontaneous Activity (End plate Activity)

Normal Voluntary Activity (Normal MUPs)

Firing Rate and Recruitment of MUPs

MUP Configuration

Rise Time

Duration and Amplitude

Phases

Stability

#### **ABNORMAL SPONTANEOUS ELECTRIC ACTIVITY**

Insertional Activity

Fibrillation Potentials

Myotonic Discharges

Complex Repetitive Discharges

Fasciculation Potentials

Myokymic Discharges

Neuromyotonic Discharges (Neuromyotonia)

Cramp Potentials (Cramp Discharge)

Synkinesis

#### **ABNORMAL ELECTRICAL ACTIVITY—VOLUNTARY MUPs**

Abnormal Recruitment

Long-Duration MUPs  
 Short-Duration MUPs  
 Polyphasic MUPs  
 Mixed Patterns: Long-Duration  
 and Short-Duration  
 MUPs  
 Varying or Unstable  
 MUPs  
 Doublets (Multiplets)

## ABNORMAL ELECTRICAL ACTIVITY—DISORDERS OF CENTRAL CONTROL

Tremor  
 Dystonia, Rigidity, Spasticity,  
 Stiff-man syndrome

## PATTERNS OF ABNORMALITIES SUMMARY

## INTRODUCTION

Needle electromyography (EMG) is one of the major diagnostic tools for identifying and characterizing disorders of the motor unit, including anterior horn cells, peripheral nerves, neuromuscular junctions, and muscles. Most electrodiagnostic studies require needle EMG evaluation as a complement to the nerve conduction studies to adequately assess for neuromuscular disorders. Similar to nerve conduction studies, needle EMG requires a unique combination of knowledge and skills. Specialized knowledge of peripheral nervous system anatomy, physiology, pathophysiology, diseases, techniques, electricity, and patient interaction is necessary. The knowledge is familiar to practicing clinicians but requires a detail beyond that of the general neurologist. Successful, high-quality, reproducible EMG depends on the skills of a clinician practiced in physically inserting, moving, and recording with a needle electrode, assessing clinical problems, and on the unique art and skills of analyzing electric signals recorded from muscle using auditory pattern recognition and semiquantitation.<sup>1,2</sup> Many of these facets of needle EMG depend on the unique analysis and processing capabilities of the human brain and have precluded the replacement of skilled physician electromyographers by automated equipment. This chapter will review the steps and techniques of needle EMG and waveform analysis, and will describe the types of EMG waveforms recorded during the needle examination.

### *Purpose and Role of Needle EMG*

- Method used to assess the integrity of the motor unit, including lower motor neuron, neuromuscular junction, and muscle.

- Complements nerve conduction studies in the localization of neuromuscular disorders.
- Assists in the assessment of the temporal profile and activity of neuromuscular diseases.
- Identification of specific spontaneous discharges may help to identify a specific etiology or narrow the differential diagnosis.

## KNOWLEDGE BASE OF NEEDLE EMG

An initial step in learning EMG is to understand the range of information that EMG can provide to extend the clinical evaluation of patients with suspected neuromuscular diseases.<sup>1</sup> Information provided by electrodiagnostic testing includes

- Confirming a clinically suspected diagnosis
- Excluding other potential mimicking diseases
- Identifying unrecognized or subclinical disease
- Localizing abnormality or lesion within a specific region of the peripheral nervous system
- Defining the severity of a disease
- Defining the pathophysiologic mechanism of a disease
- Defining the evolution, stage, and prognosis of a disease

The expert clinical electromyographer understands how EMG can provide each of these types of information and keeps each one in mind when interpreting and reporting the

results of EMG testing. Several steps are necessary throughout the EMG evaluation for the electromyographer to efficiently and accurately provide the appropriate information. These steps include

- Performing a thorough clinical evaluation.
- Conducting the needle examination, including:
  - Preparing the patient for the study
  - Selecting the appropriate muscles to test
  - Inserting and moving the needle electrode
  - Collecting the data
  - Recognizing special situations related to the ability to examine muscles.
- Analyzing the recorded activity.

Special attention to aspects of each of these steps is necessary during an EMG examination to ensure a comfortable, comprehensive, and reliable study.

## TECHNIQUE OF NEEDLE EXAMINATION

### Clinical Evaluation

A clinical electromyographer's approach to the evaluation of a patient referred for an EMG study is an extension of the type of hypothesis generation and testing that is commonly used in clinical neurology. The electromyographer must review all of the clinical data, confirm and obtain additional history as needed, and perform a focused neuromuscular examination to define the clinical deficits. On the basis of this information, a set of hypotheses listing the possible localizations and causes of the clinical problem can be generated and prioritized. These hypotheses determine which electrophysiologic tests, including nerve conduction studies and needle EMG, are required to test the hypotheses and distinguish among the potential disorders.

*Case Example.* A 52-year-old man presents with a 6-month history of left leg pain, foot weakness, and foot numbness. The clinical examination demonstrates weakness in foot dorsiflexion, inversion, eversion, and

hip abduction. There is decreased pinprick sensation over the dorsum of the foot and a reduced left Achilles reflex. On the basis of the clinic examination, the primary hypothesis is an L5 radiculopathy and possible S1 radiculopathy. Alternate hypotheses include peroneal mononeuropathy, sciatic neuropathy, or sacral plexopathy.

On the basis of these hypothesis, nerve conduction studies selected were the left peroneal motor, tibial motor, superficial peroneal sensory, and sural sensory. Abnormal conduction studies were compared with the conduction studies on the right leg. Decision regarding muscles to examine during needle EMG are discussed below.

## CONDUCTING THE NEEDLE EXAMINATION

The ability to efficiently and effectively record the electric activity from muscle depends considerably on an electromyographer's skills of patient interaction and using a needle recording electrode. These skills are learned by experience. Special attention to each aspect of the needle examination will help to ensure a more comfortable and reliable study. In addition, careful attention to several special problems—skin infection or other cutaneous conditions, bleeding disorder, cardiac valvular disease, obesity—presented by a few patients must be considered before a needle examination is performed.

### Preparing the Patient

Prior to the study, most patients will have received information about the needle examination and may have a few questions. It is helpful to explain briefly that a needle will be inserted into several muscles and may cause some discomfort. The patient will appreciate knowing approximately how long the study will take and approximately how many muscles will be examined.

### Muscle Selection

The muscles to be tested are selected initially on the basis of the clinical hypotheses. In

evaluating certain diseases, the distribution of findings will often vary between muscles as well as in different regions of the same muscle. For example, in many myopathies needle EMG abnormalities are more commonly seen in proximal muscles, but in some etiologies, such as with inflammatory myopathies, the superficial layers of the muscle may show more prominent changes than deeper portions. Motor neuron disease may show widely distributed findings and therefore multiple distal and proximal limb muscles supplied by different roots and nerves may be necessary to demonstrate a widespread disease of motor neurons. Some types of motor neuron diseases, such as Kennedy's disease, may demonstrate findings more prominently in cranial muscles. In contrast to generalized disorders, in a patient with a suspected radiculopathy or single mononeuropathy, the needle examination will be more focused on a single limb.

Regardless of the distribution of muscles being examined, the individual muscles selected should ideally be superficial, easily palpated, and readily identified. They should be located away from major blood vessels, nerve trunks, and viscera and should be those that cause the least discomfort for the patient. For example, testing the thenar or small foot muscles often makes patients more uncomfortable than testing other muscles. Hence, these muscles should be tested only when the information is not available from other muscles. Since the location and method of activation of muscles and the appearance of motor unit potentials (MUPs) can vary greatly among different muscles, the examiner should become familiar with how to test each muscle and the range of normal findings within the muscle.

*Case Example.* In the case described earlier, the muscles initially planned to be examined with needle EMG in the patient with leg pain, foot weakness, and foot numbness include anterior tibialis, posterior tibialis, medial gastrocnemius, vastus medialis, tensor fascia lata, gluteus maximus, and lumbar paraspinals.

## Needle Insertion

Once the appropriate muscle to be examined is identified, the skin is wiped over each puncture site with alcohol prior to needle insertion.

The muscle should be palpated during intermittent contraction to localize its borders. The skin is pulled taut to decrease the pain that occurs during insertion of the needle through the skin, and pulled a short distance over the muscle to reduce bleeding following removal of the needle after the study. The needle electrode should be held firmly in the fingers and, after alerting the patient to an imminent *stick*, the needle is then inserted smoothly and quickly through the skin into the subcutaneous tissue or superficial layers of the muscle.

## Needle Movement

During needle EMG, three types of activity are recorded: insertional activity, spontaneous activity, and voluntary activity. Since the needle electrode primarily records activity from a small area in a muscle, the electrode must be moved to record the activity in several different regions of the muscle in order to obtain a more complete assessment of the underlying changes that may have occurred in the motor units. The movement of the needle through the muscle is the predominant generator of the discomfort experienced during the examination. To reduce this discomfort, the muscle should be examined by moving the needle along a straight line into the muscle in short steps (0.5–1 mm). Large movements are more painful.<sup>3</sup> The pace of needle movement should not be rushed. A brief pause (2 seconds or longer) between each step is needed to listen and watch for slow firing abnormal activity, such as fibrillation potentials or fasciculation potentials. The needle is advanced in 5–30 such steps depending on muscle diameter. After the diameter of the muscle has been traversed, the needle is withdrawn from the muscle—but not from the skin—and reinserted from a different angle at the same location. Two to four such passes through the muscle are made until an adequate number of sites in the muscle have been examined. Adequate control during needle manipulation can only be obtained manually with small advances of the needle. The examiner's hand should be resting on the patient and the needle should be held firmly and steadily in the hand without release throughout the examination.



## Recording Display During Needle Examination

Each electromyographer develops a preference for how to display the electric activity; however, certain variables should be familiar to all examiners because of their common use and advantages in certain situations. Oscilloscope sweep speeds of 5–10 ms/cm are best for characterizing the appearance of motor units, but slower speeds of 50 or 100 ms/cm are helpful to characterize firing patterns and assess firing rates during recruitment analysis. Amplification settings of 50  $\mu\text{V}/\text{cm}$  and 200  $\mu\text{V}/\text{cm}$  are most useful for examining spontaneous and voluntary activity, respectively. Filter settings of approximately 30 and 10,000 Hz or more should be used for routine studies. If formal quantitation of MUPs is to be performed with comparison of results to those published by Buchthal, measurements of the duration of MUPs should be made with a gain of 100  $\mu\text{V}/\text{cm}$  at a sweep speed of 5 ms/cm (10 ms/cm if long duration) and with a low filter frequency of 2–3 Hz. The convention of displaying negative potentials at the active electrode as upward deflections is used in clinical EMG.

## Data Collection of a Resting Muscle

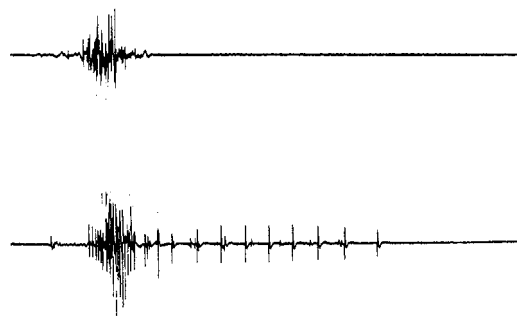
Examination of the muscle at rest is performed to assess for abnormal spontaneous discharges that may be indicators of an underlying disease (see Abnormal Spontaneous EMG Waveforms). The resting muscle is tested for spontaneous activity at a gain of 50  $\mu\text{V}/\text{div}$ . When the needle is well within the muscle, it should not be moved for several seconds so the examiner can listen for fasciculations or slowly firing fibrillation potentials. In some cases, obtaining complete muscle relaxation may be difficult or impossible, such as in patients experiencing pain, patients with spasticity or tremor, in children, or in muscles such as the diaphragm or anal sphincter. In tense patients or during a painful examination, relaxation can be enhanced by certain techniques, such as positioning the muscle in neutral or relaxed position, passively manipulating the limb, activating an antagonist

muscle, distracting the patient with conversation, and providing continuous verbal feedback and reassurance.

Several types of electrical signals normally occur in a resting muscle. *Insertional activity* is the electric response of the muscle to the mechanical damage by a small movement of the needle (Fig. 26–1). Evaluation of insertional activity requires a pause of 0.5–1 second or more following cessation of needle movement to see any repetitive potentials that may be activated. Insertional activity may be increased, decreased, or show specific waveforms, such as myotonic discharges. *End plate activity* is made up of many, individual, miniature end plate potentials (MEPPs) (*end plate noise*) or action potentials of individual muscles fibers due to discharge from terminal nerve irritation from the examining needle tip (see Normal Spontaneous EMG Activity).

## Data Collection from a Contracting Muscle

The majority of the time spent during the needle examination occurs during the assessment of MUPs in a contracting muscle. The contracting muscle is best examined with the muscle at a level of contraction that activates only a few motor units (low to moderate effort). Selective activation of the muscle of interest may be needed to determine needle position when examining deep muscles, muscles that are difficult to palpate, or small muscles. The



**Figure 26–1.** *Top*, Normal short burst of insertional activity with needle movement. *Bottom*, Increased insertional activity with a train of repetitive firing potentials after the insertional burst.

steps in testing contracting muscle include the following:

- Withdraw the needle to a subcutaneous position prior to voluntary muscle contraction to reduce bending of the needle and discomfort.
- Position the joint across which the muscle acts to limit the activity of synergistic and adjacent muscles.
- Prior to moving the needle into the muscle, ask the patient to hold the limb in a position that requires activation only of the muscle being examined.
- Palpate the contracting muscle as a guide to needle movement.
- Advance the needle until encountering MUPs with a rapid rise time (identified by a sharp *clicking* sound).

The MUPs recorded from muscle can be analyzed in several different ways.<sup>4-6</sup> The usual method in clinical studies is to display and measure isolated potentials (described below under Measurement of Motor Unit Potentials); however, other approaches that analyze the entire sequence of waveforms in an interference pattern when multiple motor units are firing have also been used. Such analyses are applied almost exclusively to motor unit activity, but not to spontaneous activity.

## Measurement of MUPs

The recruitment and appearance of MUPs are examined during voluntary activity. Multiple, different MUPs (a minimum of 20) in different areas of the muscle must be assessed to obtain a complete assessment of the integrity of the motor units composing that muscle.

Measurements may be made in two ways: by isolation and measurement of a single MUP (*quantitative EMG*) and by *interference pattern analysis*. Quantitative EMG is the classic method of measuring an MUP by isolating and recording at least 20 single potentials and then manually measuring the duration, number of phases, and amplitude. These measurements must be compared with the values recorded from the same muscle in normal subjects of the same age. This method provides no quantitative assessment of recruitment and makes the measurements

only at minimal-to-moderate levels of contraction while the needle is advanced through different areas of the muscle. Currently, digital EMG machines have automated the measurements. Two other quantitative EMG programs use computer algorithmic template matching, called *multiple motor unit potential (multi-MUP)* and *decomposition quantitative EMG (DQEMG)*, allow for assessment of individual MUPs during a stronger contraction where 3–5 MUPs are firing at one time. Quantitative EMG is reliable and often needed in questionable cases to increase the certainty of a diagnosis. Objective measurements may be a necessity in recognizing mild diseases, such as an early neurogenic process or mild myopathies.

Details of individual characteristics of MUPs cannot be measured reliably during a strong voluntary contraction, which normally produces a dense pattern of multiple superimposed potentials called an *interference pattern*. *Interference pattern analysis* summates the effect of recruitment with the duration and amplitude of the potentials and records the number of turns and total amplitude of the electric activity during a fixed time with an automatic counting device.<sup>7</sup> With examination at these stronger levels of contraction, less dense patterns may occur if there is a loss of motor units, poor effort, an upper motor lesion, or if the muscle is powerful. The latter three conditions can be distinguished from a loss of motor units only by estimates of firing rates. This method varies with patient effort, which must be accounted for in measurements.

Recording EMG by isolation of single MUPs and by interference pattern provides reliable estimates of the electric activity in a muscle. Because of the number and variety of normal MUPs, both of these methods require multiple measurements and a statistical description of the results obtained from different areas of a muscle. The results of these two methods correlate well with each other and with muscle histology and neither method has been shown to be superior to the other.

## Key Points

- A thorough clinical evaluation and examination by the physician performing the electromyogram prior to the study is necessary to define the hypotheses and determine which muscles should be examined.

- The technique used during needle insertion and movement through the muscle should consist of small needle movements with pauses to minimize discomfort.
- Brief pauses of one second or longer are necessary during spontaneous activity assessment to observe for slowly firing potentials.
- Sensitivities of  $50 \mu\text{V}/\text{cm}$  are optimal for assessment of spontaneous discharges and  $200 \mu\text{V}/\text{cm}$  are optimal for assessment of voluntary MUPs.
- Assessment of a resting and mildly contracting muscle is necessary to assess for abnormal spontaneous activity and changes in MUPs.
- Assessment of at least 20 different MUPs is necessary to adequately assess the changes that may be occurring in the muscle.
- Single MUP (quantitative EMG) and interference pattern analysis are both complementary techniques used to assess the motor units.

## POTENTIAL COMPLICATIONS DURING NEEDLE EXAMINATION

Needle EMG is a safe procedure; however, potential complications related to needle insertion and movement through a muscle may rarely occur.<sup>8</sup> In special circumstances, limitations in the needle examination or adjustments in the examination technique may need to be considered to reduce potential risks.

### Anticoagulation or Bleeding Disorders

Needle examination can generally be performed without complications in patients on anticoagulants, antiplatelet agents, or with bleeding complications, although adjustments in technique and limitations may apply. The risk of performance of the needle examination in patients on anticoagulation is excessive bleeding or hematoma formation. If this were to occur in a closed compartment, there is the potential for development of compartment syndrome and tissue necrosis. Despite this theoretical risk, the magnitude of the risk is likely

extremely low. There are only a few reports of paraspinal hematoma, calf hematoma, and calf artery pseudoaneurysm development following needle examination in patients on anticoagulation.<sup>9–11</sup> In a recent study using ultrasound to identify hematoma formation in the anterior tibialis muscle following needle EMG in patients on anticoagulants and antiplatelets, only 2 of 100 patients on Coumadin (with INRs up to 4.0 assessed) and one of 60 patients on antiplatelet agents developed small (2–3 mm wide by 2–3 cm long), subclinical hematomas.<sup>12</sup>

In a survey of 47 EMG laboratories in the United States, 9% of laboratories reported experiencing at least one episode of bleeding complication requiring medical or surgical intervention due to needle EMG.<sup>9</sup> However, in this same survey, 66% of laboratories indicated that they were willing to perform EMG on all limb muscles in anticoagulated patients, while the other laboratories indicated that they would limit the needle examination. Furthermore, half of the laboratories limited needle examination of cranial muscles and 28% limited paraspinal muscle examination.

At this time, there is no standard of practice in electrodiagnostic medicine regarding the highest level of anticoagulation at which a needle examination can safely be performed without additional risk and no consensus statement by the American Association of Neuromuscular and Electrodiagnostic Medicine (AANEM) related to the performance of needle EMG in anticoagulated patients. Nonetheless, each case must be examined individually and the necessity and benefits of the study must be weighed with the potential risks. In the ideal situation, anticoagulants should be discontinued prior to the study, although in most cases, this increases the risk of potential thrombotic complications. Most electromyographers prefer to know the level of anticoagulation (INR) before the study to determine the level of risk. If the prothrombin time is in the therapeutic range (especially low range), the study can be performed safely in most instances. If it is above therapeutic range, all or part of the needle examination may need to be deferred. If the needle examination is performed on patients on anticoagulation, special attention and adjustment in the technique of the study should be made and the physician should

1. Examine the minimal number of muscles necessary to answer the referring physician's question.
2. Avoid deep muscles, for example, paraspinals and diaphragm.
3. Avoid tight fascial spaces, for example, tibialis anterior.
4. Avoid muscles in close proximity to arteries, for example, iliopsoas, flexor pollicis longus.
5. Place pressure on the puncture site for 1–2 minutes following the examination.

Similar precautions should be considered in patients with thrombocytopenia. If the platelet count is above 30,000/mm<sup>2</sup> the study can usually be performed safely. For hemophilia and uncommon bleeding disorders, the patient's hematologist should be consulted prior to performance of the needle examination.

## Lymphedema and Skin Problems

Several dermatologic conditions should lead to avoidance or limitation of the needle examination. The needle electrode should not be inserted into an infected area of skin (such as one with cellulitis) or in an area of prominent vasculature (such as varicose veins). Additionally, patients with thin skin, such as those on corticosteroids, may be more prone to bleeding or tearing of the skin and extra caution should be taken during the examination.

Examining a limb with lymphedema poses the risk of persistent leaking of serous fluid, potentially increasing the risk of the development of cellulitis. Despite the absence of studies assessing this risk, a position statement by the AANEM suggested that “reasonable caution should be exercised in performing needle examinations in lymphedematous regions.”<sup>13</sup>

## Infection Precautions

Universal precautions should be taken with every study. In patients with dementia (with possible Creutzfeldt–Jakob disease), HIV infection, viral hepatitis, or other transmissible disease, added precautions to avoid inadvertent needle stick should be made. The risk of needle EMG in patients with rheumatic or other

type of valvular heart disease or with prosthetic valves is similar to that of repeated venipuncture and prophylactic antibiotics are not necessary.

## Examining Peri-Pleural Muscles

Examination of muscles adjacent to or near the lungs produces a risk of puncturing the pleura and inducing pneumothorax. This may occur with examination of the diaphragm, rhomboids, serratus anterior, trapezius, supraspinatus, and cervical paraspinals. Experience in examining these muscles and precise knowledge of the location and anatomy of these muscles is crucial to prevent this complication. Techniques used to reduce the risk of pneumothorax when examining these muscles have been reviewed.<sup>8</sup> In all cases, when any of these muscles are examined, the needle electrode should be advanced very slowly and smoothly, listening for the sharp, *clicky* sound of the MUPs (indicating close proximity). When the sound of the potentials becomes more dulled with needle advancement, the needle is likely nearing the distant portion of the muscle and should be withdrawn. Listening for a respiratory pattern of MUP firing, indicating the approach to the peri-pleural muscles, should prompt discontinuation of forward movement of the needle. When the needle is close to MUPs with this pattern of firing in deeper muscles, caution should be made against further advancement of the needle.

## Examination of Patients with Pacemaker

There is no contraindication to performing the needle examination in patients with a pacemaker or other automated defibrillator. Recognition of pacemaker artifact is important, in order to avoid misinterpretation of the artifact as a fibrillation potential.

## Obese Patients

Examination of certain muscles may be difficult in obese patients. Positioning the needle electrode at a steeper angle allows for deeper

Table 26–1 Guidelines for Needle Size According to BMI

lb	kg	Needle size for hip girdle muscles by BMI													
353	160														
342	155														
331	150														
320	145														
308	140														
297	135														
286	130														
275	125														
264	120				120										
253	115														
242	110														
231	105						90								
220	100														
209	95							75							
198	90														
187	85														
176	80														
165	75														
154	70														
143	65														
132	60														
	cm	145	150	155	160	165	170	175	180	185	190	195	200	205	
	in	57	59	61	63	65	67	69	71	73	75	77	79	81	

	BMI < 30: use 50 mm needle
	BMI > 30: use 75 mm needle
	BMI > 35: use 90 mm needle
	BMI > 40: use 120 mm needle

penetration through the tissue into the muscle. Deep muscles, such as hip girdle muscles, may require a 75-, 90-, or 120-mm needle. The patient's body mass index (BMI) can be used to guide the electromyographer in the selection of the appropriate needle length (Table 26–1). Some muscles, such as the deep paraspinal muscles, may be difficult to reach, even in average-sized patients, without a long needle. Needles up to 120 mm long should be available. Caution should be taken when examining peri-pleural muscles or muscles neighboring risky structures. Selective activation of muscles may be necessary to ensure correct muscle localization.

## Low Pain Tolerance

Most patients are able to tolerate the discomfort of the needle examination without difficulty, but a few need a special approach.

Pain minimization requires attention to all interactions with the patient, in particular the techniques of the needle examination itself. Techniques such as distraction, continued reassurance, and an empathetic approach to the patient during the study may improve the patient tolerance of the study. The technique of needle movement has a significant impact in pain reduction. Studies have demonstrated that needle movements of less than 1 mm when using concentric needle electrodes are significantly less painful than needle movements of approximately 1 cm.<sup>13</sup>

## Key Points

- Needle examination can be carried out safely in most patients on therapeutic anticoagulation or antiplatelet agents.
- In anticoagulated patients, bleeding complications can be reduced by minimizing



the number of muscles examined, avoiding deep muscles or tight fascial compartments, and placing extra pressure on puncture sites.

- In patients with thrombocytopenia with platelet counts of less than 30,000/mm<sup>2</sup> or in patients with hemophilia, consultation with a hematologist should be considered prior to needle EMG.
- Caution should be used when examining patients with lymphedema or peripleural muscles to avoid complications, such as the development of cellulitis or pneumothorax.
- There is no contraindication to needle EMG in patients with pacemaker; pacemaker artifact should not be misinterpreted as a fibrillation potential.

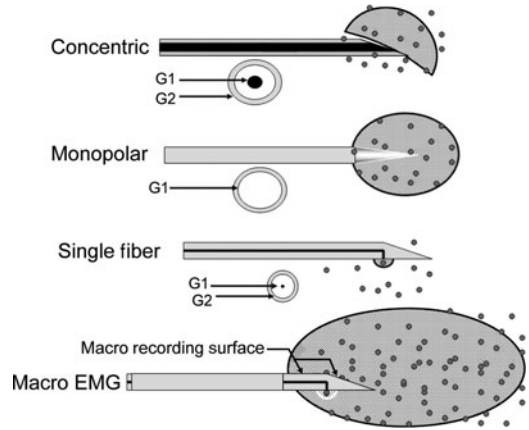
## EMG SIGNAL ANALYSIS

The ultimate goal of the needle examination is to obtain data that reflects the underlying morphology of the muscle fibers and motor units, and identify the changes that occur with different diseases. The electrical signals that are recorded are dependent on a number of factors, including the electrode type that is used during the examination and characteristics of the muscles.

## NEEDLE ELECTRODE CHARACTERISTICS

The selection of the type of needle electrode used in EMG depends on a number of patient-related and examiner considerations. Needle electrodes must be sterile, sharp, and straight and the recording surface must be absolutely clean. A thin, poorly conducting film on the electrode surface can cause a low-voltage, irregular, positive waveform, popping artifact that can be mistaken for end plate noise or positive waves. Electric impedance should be checked if a break or short is suspected (correct impedance at 60 Hz is 5–20 Ω).

Different types of electrodes have been used to record the electric activity of normal and diseased muscles. Surface electrodes can depict the extent of EMG activity and measure the conduction velocity in muscle fibers, but the



**Figure 26–2.** Electrode types used in recording EMG signals. The recording areas of each electrode type are shown by the hashed regions.

electric signals are distorted by intervening skin, subcutaneous tissue, and other muscles. Needle electrodes inserted into the muscle can depict the electric signals accurately, but depending on needle type, these electrodes record from different numbers of muscle fibers and from muscle fibers in different locations<sup>14</sup> (Fig. 26–2, for color image, see color plates). Standard concentric and monopolar electrodes are the ones most commonly used for diagnostic clinical EMG.

## Standard Concentric Electrodes

A bare, 24- to 26-gauge hollow needle with a fine wire down the center is beveled at the tip to expose an active, oval recording surface of 125 μm by 580 μm. The electrode is referenced to the shaft of the needle, thereby canceling unwanted activity from distant, surrounding muscle. Although these electrodes were expensive, inexpensive disposable models are now available. The common sizes available are 25 mm (26 gauge), 50 mm (26 gauge), and 75 mm (20 gauge). The needle is a detachable electrode connected to the preamplifier by a cable. Because of the narrow gauge, electrodes are particularly delicate and need to be handled carefully. They are most fragile at the junction of the shaft and hub and may bend or break at this location. This electrode type has several advantages: (1) its ability to record EMG activity with a minimum of interference from surrounding muscles, (2) its fixed-size



recording surface, (3) the absence of a separate reference electrode, and (4) the extensively defined quantitation of the sizes of normal MUPs for ages and muscles.

## Monopolar Electrodes

A Teflon-coated fine needle electrode, usually made of stainless steel, can have a very fine gauge and an extremely sharp point. Monopolar electrodes consist of a solid 22-gauge to 30-gauge needle with a bare tip approximately 500  $\mu\text{m}$  in diameter. These electrodes record essentially the same activity as recorded with standard concentric electrodes, but MUPs are slightly longer in duration and have a higher amplitude.<sup>15</sup> Monopolar electrodes are preferred by some electromyographers because they are less expensive and, depending on the technique of needle movement, may be less uncomfortable for patients.<sup>16</sup>

## Single Fiber Electrodes

Recordings made with electrodes with small (25  $\mu\text{m}$ ) recording surfaces referenced to the shaft of the needle with filtering of the low-frequency components focus on a small number of muscle fibers in the immediate vicinity of the electrode (see Chapter 28). Single fiber EMG needles record from small areas of muscle and cannot be used to characterize the size of MUPs. This method has been used primarily in studying disorders of neuromuscular transmission because it can detect variation in motor units (jitter between single fiber potentials) not seen with other needle electrodes. Single fiber EMG can also be used to quantify the density of muscle fibers in a motor unit (*fiber density*), a measurement closely related to the percentage of MUPs that are polyphasic and the number of turns on the MUP.

## Macroelectrodes

A larger needle electrode is the *macro needle*, or *macroelectrode*.<sup>17</sup> A macroelectrode recording is made from 15 mm of the shaft of a needle electrode referenced to a surface electrode. The macroelectrode records from a large number of muscle fibers of multiple motor units

in a cylinder along the shaft of the needle. This recording summates the activity of many MUPs, which cannot be differentiated from one another.<sup>18</sup> The potential from a single motor unit is isolated with the help of simultaneous recording of potentials from single muscle fibers with a 25- $\mu\text{m}$  diameter electrode halfway along the shaft of the macroelectrode on a second channel. The second channel is used to identify the firing pattern of a single motor unit. The electric activity recorded from the macroelectrode at the time of the firing of a single fiber potential on the small electrode is averaged over multiple discharges. This results in an averaged potential from all muscle fibers along the macroelectrode, which are innervated by the same motor unit as the single muscle fiber. Thus, the averaged potential gives an estimate of the activity in a larger portion of the muscle fibers of the motor unit. Occasionally, macroelectrode recordings are able to identify changes in the whole motor unit that are not apparent with smaller electrodes.<sup>19</sup>

## Key Points

- Several different types of needle electrodes may be used for needle examination.
- Concentric needle electrodes record less noise and with a more stable baseline than monopolar electrodes.
- The MUPs recorded with a monopolar electrode are of higher amplitude and slightly longer duration than those recorded with a concentric needle electrode.
- Single fiber needles are used predominantly to assess for disorders of neuromuscular transmission and the density of fibers in a motor unit.
- Macroelectrodes record from a larger surface area of the electrode and summate activity of several motor units.

## SKILLS OF EMG WAVEFORM RECOGNITION

EMG waveform analysis requires measurement of multiple different types and parameters of waveforms. It would be ideal to have formal, quantitative measures of each of the variables of the potentials that are assessed

during needle EMG, such as are available for nerve conduction studies. The limitations of current EMG equipment and the time required to accomplish such measurements preclude this for routine EMG. However, a skilled electromyographer can achieve accurate and reliable waveform recognition and analysis by applying the well-defined skills of *pattern recognition* and *semiquantitation*. Pattern recognition is used to identify and name a waveform while semiquantitation is the skill used to analyze the changes that occur in MUPs with diseases. Both of these skills rely heavily on auditory recognition and analysis. Similar to learning the technique of the needle examination, the skills of pattern recognition and semiquantitation are learned by experience but can be continually improved and enhanced throughout the electromyographer's career. (*The accompanying CD is a useful tool to assist with learning pattern recognition and semiquantitation of EMG waveforms.*)

### Pattern Recognition

A major component of EMG is *auditory pattern recognition*, a skill that most persons have that allows them to recognize the voice of a friend and to recognize and name the enormous range of sounds in the environment. Only a limited number of automated systems have been able to make these distinctions.<sup>20</sup>

Auditory pattern recognition, like visual pattern recognition, is so intrinsic to cortical function that once learned it occurs essentially instantaneously. The skills of auditory pattern recognition form the basis of learning the major distinct patterns of firing of EMG discharges. EMG waveforms fire with distinct patterns, and these patterns help to identify and define the waveform. The patterns of firing of EMG waveforms are defined by the manner of change of the interpotential interval of successively firing potentials. These patterns can also be considered as the predictability of when the next potential of a repetitively firing waveform will occur (Fig. 26–3). The different firing patterns of EMG waveforms are

- *Semirhythmic*—recurring in orderly, but not precise, intervals. The variation in the change of interpotential interval is approximately 10%. Potentials that fire in a semirhythmic pattern are voluntary MUPs.
- *Regular (no change or linear change)*—recurring at precisely defined intervals that may be identical, may be changing slowly or rapidly, or may be changing in a linear manner. Regular firing potentials include fibrillation potentials and complex repetitive discharges (CRDs).
- *Regular (exponential change)*—recurring at precisely defined intervals that change slowly or rapidly in an exponential

### Firing patterns of EMG potentials

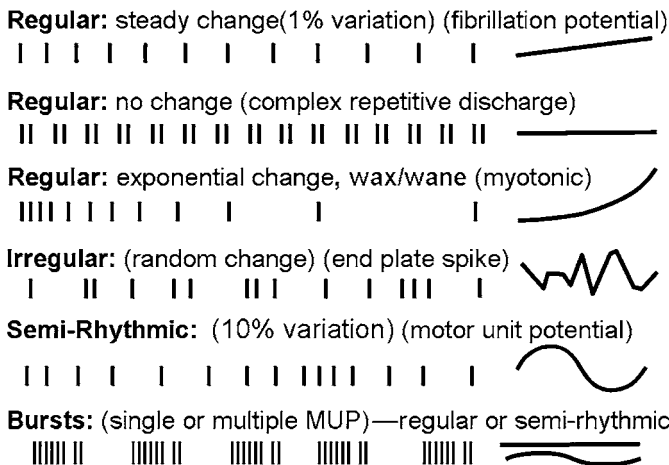


Figure 26–3. Firing patterns of EMG potentials.

manner. Potentials firing with this pattern include myotonic discharges.

- *Irregular*—recurring in random intervals with no predictability. Potentials that fire in an irregular pattern include end plate spikes, fasciculation potentials, and cramp discharges.
- *Burst*—groups of discharges firing at one interval in the burst, with the burst recurring at slower intervals. Potentials that fire in this pattern include myokymic discharges, hemifacial spasm, and tremor.

## Semiquantitative EMG

Reliable estimates of numerical values for the duration, phases, rise time, firing rate and number of active motor unit potentials can be obtained by estimates based auditory recognition. This skill of semiquantitative EMG (also called rapid quantitation) requires taking the time to learn the methods and then applying them consistently to each recording until the techniques are mastered. Semiquantitation (rapid quantitation) takes less time than formal quantitative EMG. Semiquantitative EMG includes the following steps:

- Patient contracts the muscle to activate only a few (1–4) MUPs from a single area of muscle. The MUPs are recorded and displayed.
- The number of individual MUPs and their individual rates of firing are determined by auditory recognition.
- The variables of MUPs (rise time, duration, amplitude, phases, turns, stability) are determined by auditory recognition for each of the potentials.
- The stored potentials are visually reviewed to assess accuracy in the determination of the parameters.
- With no change in activation, the steps above are repeated in additional areas of muscle (using 0.5-mm movements).
- Recordings in different areas are repeated until a minimum of 30 potentials are recorded. The findings at each location are averaged mentally.

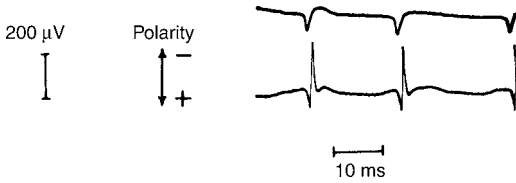
With mastery of semiquantitation, the electromyographer will be able to estimate each of the parameters with more than 90% accuracy.

## Key Points

- Auditory pattern recognition is the skill used to identify and name EMG potentials.
- Assessment of the firing pattern of a discharge helps to identify the discharge.
- Firing pattern is defined by the manner in which the interpotential interval of successively firing potentials change.
- Potentials with a regular firing pattern have a defined change in the interpotential interval, which may be a fixed interval or one that changes linearly or exponentially.
- Fibrillation potentials fire in a regular pattern with a fixed or linear change in firing rate.
- Myotonic discharges fire in a regular pattern with an exponential change in firing rate.
- CRDs fire in a regular firing pattern with a fixed firing rate.
- Fasciculation potentials and end plate spikes fire in an irregular firing pattern.
- MUPs fire in a semirhythmic firing pattern.
- Semiquantitation allows for rapid assessment of the parameters of MUPs.

## ORIGIN OF EMG POTENTIALS

The electric activity of all of the EMG potentials recorded with a needle electrode in a muscle is derived from the action potentials of the muscle fibers that are firing singly or in groups near the electrode.<sup>21,22</sup> The muscle fiber action potentials, and MUPs, normally have a triphasic configuration, since the action potentials typically propagate toward and then away from the recording electrode. If a potential is recorded from a region of a muscle fiber that is unable to generate a negative component of the potential (e.g., if the membrane of the muscle fiber is damaged), the potential will be recorded as a large positivity followed by a long low negativity.<sup>23</sup> For example, fibrillation potentials recorded from damaged areas of muscle fibers are recorded as positive waves (Fig. 26–4). The amplitude of the externally recorded action potential and the rate of rise of the positive–negative inflection (*rise time*) is proportional to the distance between the muscle fiber and the recording electrode



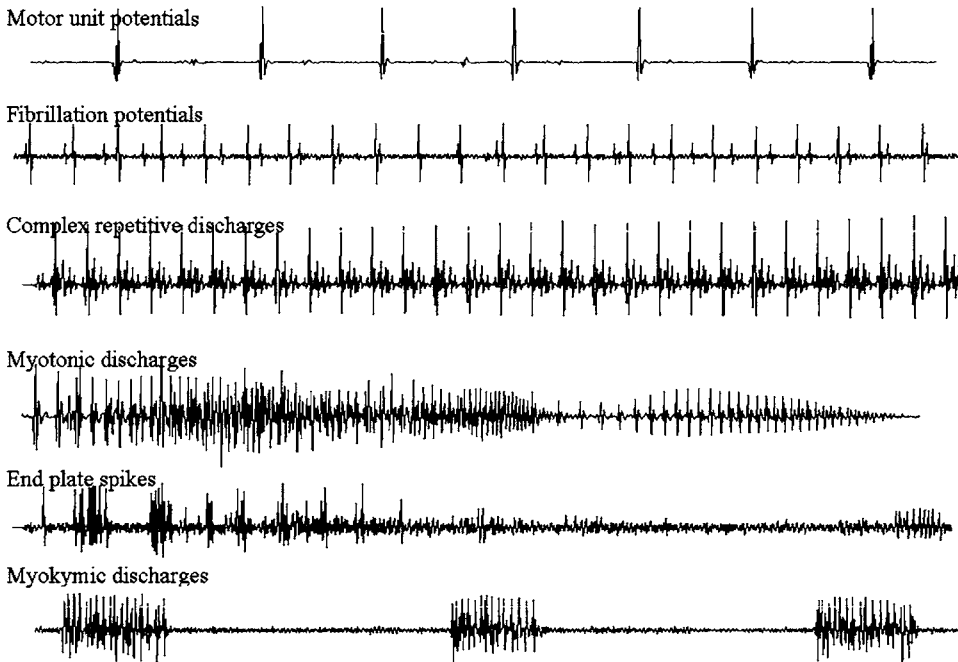
**Figure 26-4.** Simultaneous recording of a single muscle fiber potential from one needle electrode that mechanically initiates the potentials and from another electrode, a few millimeters distant, recording from the same muscle fiber. (From Daube, J. R. 1991. AAEM minimonography #11: Needle examination in clinical electromyography. *Muscle & Nerve* 14:685-700. By permission of John Wiley & Sons.)

and both fall off exponentially as the distance increases.<sup>24</sup> Therefore, in order to accurately assess the potentials, only those with a rapid rise time should be analyzed. The size of single fiber action potentials is also related directly to the diameter of the muscle fiber and can partially be used clinically to judge the duration of denervation.<sup>25</sup> Normally, the size and shape of the potentials are constant each time they fire.

Action potentials of individual muscle fibers may occur spontaneously or may be initiated by external excitation. Muscle fiber action

potentials occur involuntarily at the end plate zone or in diseased states. For example, muscle fibers that are not innervated by an axon have an unstable muscle fiber membrane potential and fire individually without external stimulation, usually with a regular rhythm. These are *fibrillation potentials*. Normally, muscle fibers are under neural control and fire only in response to an end plate potential that reaches threshold. This usually occurs after voluntary activation and is mediated by central neural control. These potentials are *motor unit potentials*.

A variety of normal and abnormal EMG waveforms may be recorded from the muscle (Fig. 26-5). EMG waveforms generated from single muscle fiber action potentials firing individually include end plate spikes, fibrillation potentials, and myotonic discharges. Waveforms generated by groups of muscle fiber action potentials include CRDs, fasciculation potentials, myokymic discharges, and neuromyotonic discharges. Voluntary MUPs are groups of muscle fibers firing together, linked as part of the same motor unit firing under voluntary control (Table 26-2).



**Figure 26-5.** Examples of EMG waveforms recorded from muscle fibers. (From Daube JR. AAEM minimonography #11: needle examination in clinical electromyography. *Muscle & Nerve*. 1991;14:685-700. Used with permission of the publisher.)

Table 26–2 Origin of EMG Waveforms

Single fibers		MUPs		
Firing alone	Firing in groups (adjacent fibers)	Firing spontaneously (individual)	Firing spontaneously (in bursts)	Firing voluntarily (individual)
End plate spikes	Insertional activity	Fasciculation potentials	Myokymic discharges	MUPs
Fibrillation potentials	CRDs	Neurotomyotonic discharges	Synkinesis	
Myotonic discharges		Myoclonus	Tremor	
		Dystonia	Hemifacial spasm	
		Stiff-man syndrome		

CRDs, complex repetitive discharges.

### Key Points

- All of the EMG potentials recorded during needle EMG are generated from the action potentials of single muscle fibers.
- Single muscle fibers action potentials may fire spontaneously and individually, spontaneously in groups, or under voluntary control.
- Individual muscle fiber action potentials are typically triphasic.
- When recorded from a region of muscle that cannot generate a negative component, such as a damaged muscle fiber, they have a predominantly positive configuration.
- The amplitude and rise time of a muscle fiber action potential is proportional to the distance between the muscle fiber and the electrode.
- The size of a single fiber action potential is directly related to the diameter of the muscle fiber.
- MUPs occur under central neural control.

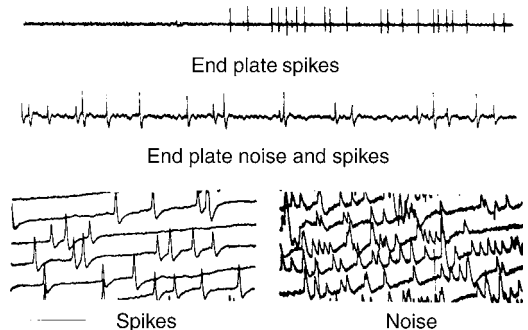
## NORMAL EMG ACTIVITY

### Normal Spontaneous Activity (End plate Activity)

Normal muscle fibers show no spontaneous electric activity outside of the end plate region. In the end plate region, MEPPs occur randomly due to spontaneous release of individual quanta of acetylcholine. These MEPPs may be

recorded with needle electrodes as monophasic negative waves that have amplitudes less than  $10\ \mu\text{V}$  and durations of 1–3 ms or less. Individual potentials occur irregularly but usually cannot be distinguished. This activity is usually seen as an irregular baseline called *end plate noise* and has a typical *seashell sound* (Fig. 26–6).

The action potentials of some individual muscle fibers may be recorded in the end plate region as brief spike discharges called *end plate spikes*.<sup>26</sup> End plate spikes are caused by mechanical activation of a nerve terminal with secondary discharge of a muscle fiber. They have a rapid irregular firing pattern, often with interspike intervals of less than 50 ms. Although usually initially negative, end plate



**Figure 26–6.** *Top*, Spike form of normal spontaneous activity in the end plate region. *Middle*, End plate noise is seen as an irregularity in the baseline at a low amplification in addition to the spike form. *Bottom*, End plate spikes and noise are seen as small triphasic potentials at a fast sweep speed and high amplification.



spikes may be triphasic or, if the needle electrode has damaged the muscle fibers, may also be recorded as rapid, irregularly firing positive waves. End plate spikes sound like *sputtering fat in a frying pan* or *slowly ripping Velcro*.

End plate activity is normal, occurs in every individual, and has no clinical significance. However, since recording from the end plate region is usually uncomfortable, identification of end plate should prompt repositioning of the needle electrode. Additionally, end plate spikes should not be confused with fibrillation potentials or short-duration MUPs, both of which fire in a different pattern.

### Key Points

- End plate spikes and noise are normal spontaneous discharges.
- End plate noise is the recording of the MEPPs.
- End plate spikes are the action potentials of muscle fibers that occur with release of several quanta of acetylcholine due to irritation of a nerve terminal branch.
- End plate spikes and noise fire in an irregular pattern and have no clinical significance.

## Normal Voluntary Activity (Normal MUPs)

All voluntary muscle activity is mediated by lower motor neurons and the muscle fibers they innervate (motor units) and is recorded electrically as *motor unit potentials*. All MUPs under voluntary control fire in a *semirhythmic* pattern and at a relatively constant frequency, although this frequency continuously changes as the voluntary activation increases or decreases. The MUP is the sum of the potentials of the individual muscle fibers innervated by a single anterior horn cell. Since the muscle fibers in the region of the needle electrode discharge in near synchrony and as a result of factors such as proximity of the fibers to the electrode, length of the innervating terminal axon, and conduction time along the muscle fiber, the MUP has a more complex configuration of higher amplitude and longer duration than a single fiber action potential. MUPs may

be characterized by their firing pattern, firing rates (recruitment), and configuration or appearance.

### Key Points

- Voluntary MUPs are the sum of the potentials of the individual muscle fibers innervated by a single anterior horn cell that occur in the region of the needle electrode.
- MUPs are characterized by their firing pattern, firing rates (recruitment), and configuration or appearance.
- MUPs fire in a semirhythmic pattern.

## Firing Rate and Recruitment of MUPs

Clinical EMG judges the number of motor units present in a muscle. The number of motor units in a muscle may be considered in two ways. The first is the total number of motor units that *could* be fired if the anterior horn cell pool received adequate central nervous system input. This refers to the actual number of motor units within an individual muscle. The second is the *actual* number of motor units that are activated when a patient attempts a voluntary contraction. Both of these are used to assess the presence or absence of disease involving the lower motor neuron although the second is quite variable and changes with the patient's cooperation, the strength of the muscle, pain, and the presence or absence of disease of the upper motor neuron.

Judgment of the number of motor units within a muscle can be performed by assessing MUP *recruitment*—which is defined as the initiation of the firing of additional motor units as the rate of discharge of the active MUP increases. Recruitment can be assessed by comparing the rate of firing of single units with the total number of motor units that are firing. In most normal muscles, motor units initiate firing rates at approximately 5–8 Hz and gradually increase up to 20–40 Hz as the effort exerted by the patient increases.<sup>27</sup> The *rate* of firing is used as a gauge of the intensity of excitation of the anterior horn cell by the central nervous system. As the firing rates increase, additional motor units begin to fire



(are recruited). The determination of the rate of firing is one of the more difficult steps to master in standard EMG because of difficulty in obtaining sufficient control by the patient of motor units to isolate one or two units. *Slow firing* is a term referring to individual MUPs that fire at rates slower than 10 Hz and *rapid firing* refers to individual MUPs firing faster than 12 Hz. When possible, the rate of firing of the motor unit initially activated is measured at the time the second unit begins to fire. In most muscles, this occurs at 6–8 Hz. Normally, recruitment of additional MUPs occurs at low levels of effort and at slow rates of firing (Fig. 26–7).

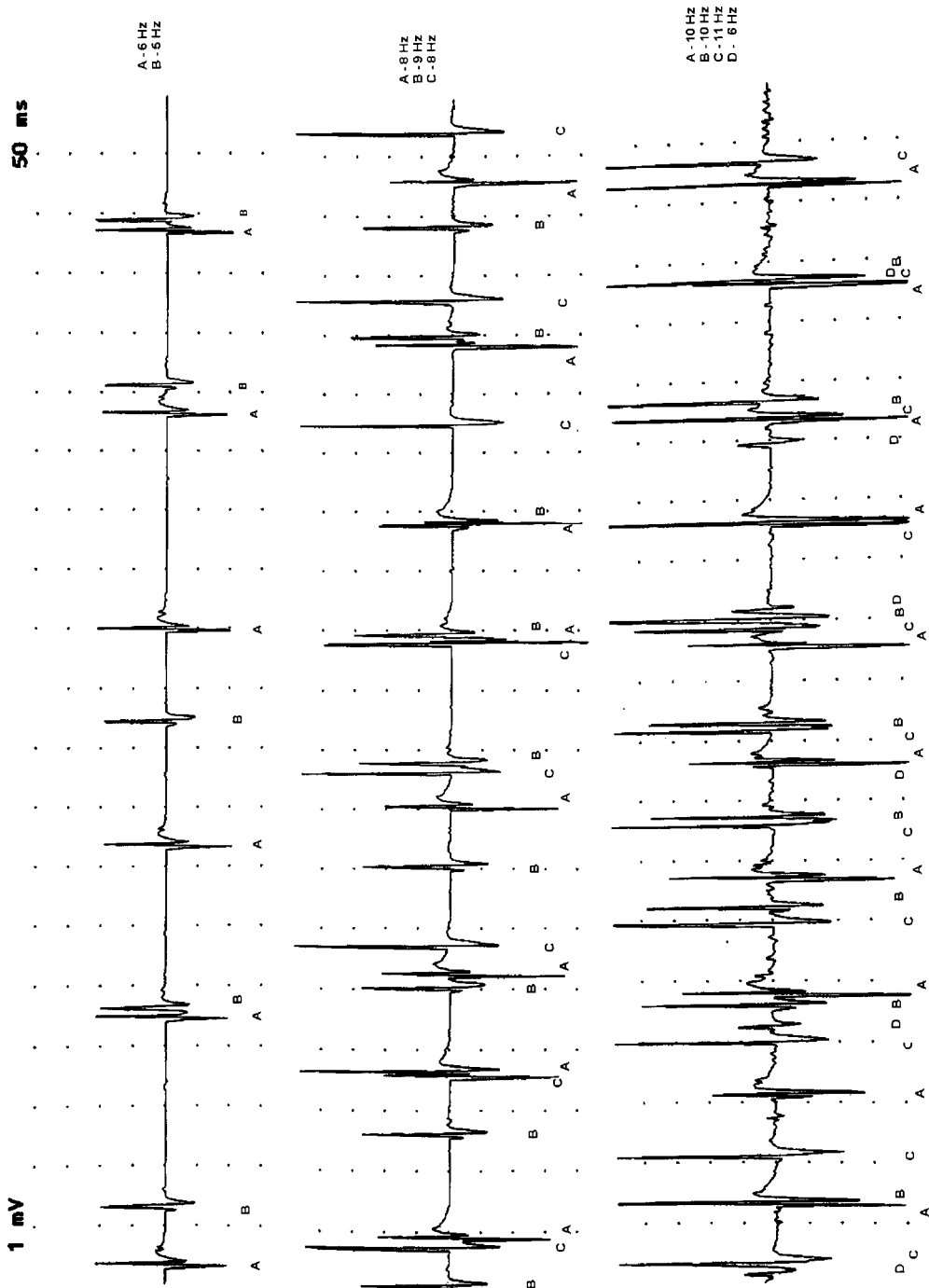
Recruitment can be characterized by recruitment frequency, which is the frequency of firing of a unit when the next unit is recruited (begins to discharge). This is a function of the number of units capable of firing and is usually between 7 and 10 Hz for motor units in normal limb muscles and up to 16 Hz for motor units in cranial muscles during mild contraction.<sup>28</sup> Recruitment frequencies vary in different muscles and for different types of motor units. Recruitment may also be characterized by the ratio of the rate of firing of the individual motor units to the number that are active. For most normal limb muscles, this ratio averages less than 5 and therefore there will be two MUPs firing if one of them is firing at 10 Hz, three at 15 Hz, and four at 20 Hz. Therefore, the ratio of the number of units firing to the rate of firing can provide a rough gauge of the number of motor units.

In the presence of lower motor neuron diseases, where the number of motor units in a muscle is decreased from axonal loss, or in disorders characterized by conduction block, recruitment frequency increases and, therefore, MUPs fire more rapidly before additional motor units are recruited. Conversely, the rate of firing of those MUPs already firing will be unduly fast for the number of MUPs that have been activated. Or, less commonly, the first unit begins firing at a higher rate than normal (more than 10 Hz). If the ratio is greater than 5 (e.g., 2 units firing at 16 Hz), there is virtually always some decrease in the number of motor units. Thus, firing rate of MUPs is an important measure of the loss of axons.<sup>29</sup> This semiquantitative method of determining reduced recruitment provides a more accurate and reproducible estimate of the number of

motor units than full interference pattern analysis. However, since there may be selective loss of higher threshold motor units, recruitment analysis should include levels of effort associated with firing rates in the range of 15 Hz.

Recruitment may be defined as normal, reduced (sometimes referred to *reduced numbers* or *discrete firing*), rapid (sometimes referred to as *full recruitment*), or poor activation.

- *Normal recruitment*—the pattern of recruitment is normal for that muscle, with an adequate number of MUPs being recruited for the frequency of firing present. If maximal effort can be obtained, a full interference pattern is seen, but individual motor unit firing rates of 15 Hz are sufficient for recruitment analysis.
- *Reduced recruitment*—a higher recruitment frequency or a smaller number of MUPs recruited for firing rates in the range of 15 Hz than expected for that muscle. Reduced recruitment is characteristic of neurogenic disorders in which axonal loss or conduction block is the pathophysiologic mechanism. In patients with severe or end-stage myopathic disorders, reduced recruitment may also occur due to the loss of all muscle fibers within a motor unit. This term should not be used to describe the condition of patients in whom relatively few MUPs fire because of pain, strong muscles, upper motor neuron lesions, or poor cooperation. In these situations, few potentials are fired although they fire slowly with a normal pattern of recruitment (i.e., poor activation).
- *Poor activation*—a normal recruitment pattern and normal recruitment frequency, but with relatively few motor potentials firing. These potentials fire slowly, but recruitment of additional potentials is normal. This occurs with upper motor neuron disorders, poor cooperation by the patient, pain, excessively strong muscle, or two-joint muscles, such as the gastrocnemius. It is not evidence of lower motor neuron disease.
- *Rapid recruitment*—increased number of motor units relative to the force of contraction. With this type of recruitment, the occurrence of large numbers of MUPs with normal recruitment frequencies and



**Figure 26-7.** MUP firing under voluntary control showing minimal reduction in recruitment in an extensor carpi radialis muscle with normal strength. *Top*, Two motor units (A and B) initially fire at 5 and 6 Hz. *Middle*, With increased voluntary effort, firing rate of A and B increases to 8 and 9 Hz, with recruitment of a third unit (C). *Bottom*, With greater effort, the rates increase to 10 and 11 Hz, with no additional nearby units recruited. Only a small, distant unit begins firing at 7 Hz (D). (From Daube, J. R. 2000. Electrodiagnostic studies in amyotrophic lateral sclerosis and other motor neuron disorders. *Muscle & Nerve* 23:1488–502. By permission of John Wiley & Sons.) (From Daube JR. AAEM minimonography #11: needle examination in clinical electromyography. *Muscle & Nerve*. 1991;14:685–700. Used with permission of the publisher.)

normal patterns of recruitment occur with minimal patient effort. This must be graded in proportion to the force exerted, because the patterns of firing are entirely normal. It is the only estimate described that requires consideration of the force exerted by the muscle. It is evidence of disease involving the muscle directly.

Although recruitment analysis is reasonably reproducible and clinically reliable, it is usually a subjective judgment made by electromyographers on the basis of experience. It requires taking into account differences in recruitment in different areas of individual muscles and the even greater differences among different muscles. Automated methods for formally quantitating the recruitment pattern have been developed.<sup>30</sup> In automated studies, individual MUPs were isolated in human muscles under voluntary control in an experimental setting. The interpotential interval (the inverse of frequency of firing) was determined for a population of normal subjects and for patients with ALS. The normal onset frequency in the biceps muscle ranged from 6 to 8 Hz, with the recruitment frequency of the second motor unit at 7–12 Hz. In patients with ALS, the onset frequency was from 8 to 20 Hz, with recruitment frequencies of 12–50 Hz. These studies provided quantitative measures of *motor unit number estimate*. Formal quantitative measures can provide evidence of the reliability of the clinical methods; however, they are so time consuming and complex that they have not been applied clinically (see Chapter 27). Further studies and technical developments may eventually allow recruitment analysis to provide more accurate estimates of the number of motor units in a muscle.

### Key Points

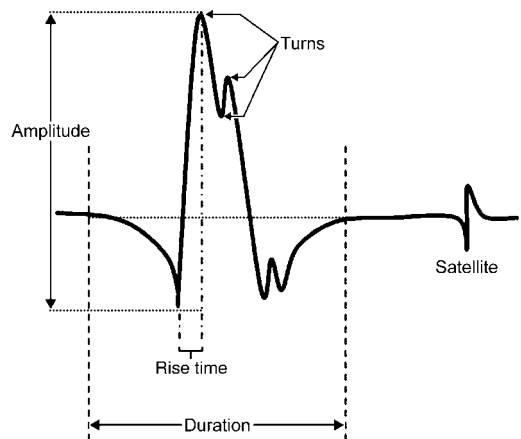
- MUP recruitment judges the number of motor units in the muscle, and is defined by the ratio of the rate of firing of the potentials to the number of potentials firing.
- In most normal muscles, motor units initiate firing rates at approximately 5–8 Hz and gradually increase up to 20–40 Hz as the effort exerted by the patient increases.
- Recruitment can be assessed by comparing the rate of firing of single units with

the total number of motor units that are firing; for most normal limb muscles, this ratio averages less than 5.

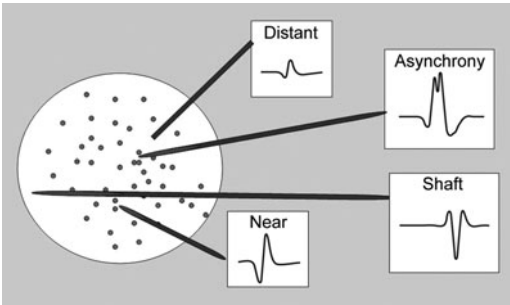
- Loss of motor units leads to reduced recruitment (few MUPs firing at fast rates) and is most commonly seen in neurogenic disorders.
- Identification of rapid recruitment requires consideration of the force exerted by the patient.
- Poor activation is seen as a normal recruitment pattern and frequency, but with relatively few MUPs firing. This occurs with upper motor neuron disorders, poor cooperation by the patient, pain, or an excessively strong or two-joint muscle, such as the gastrocnemius.

## MUP Configuration

An MUP is also characterized by its appearance, including duration, amplitude, number of turns, area, and rate of rise of the fast component (rise time) (Fig. 26–8). Each of these characteristics has multiple determinants, including technical, physiologic, and pathologic factors. Technical factors that have a major influence on the appearance of MUPs include the type of needle electrode used to record the potentials, the area of exposed surface of the active leads of the electrode, the characteristics of the metal recording surfaces, and the electric characteristics of the cables,



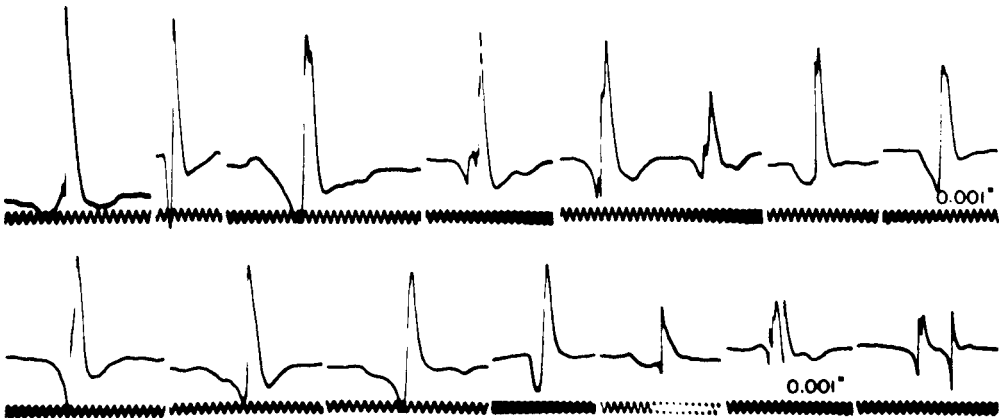
**Figure 26–8.** Schema of MUP showing characteristics that can be measured.



**Figure 26-9.** Schema of variation of MUP morphology with electrode position.

preamplifier, and amplifier. The appearance of an MUP from one motor unit also varies with electrode position, since only a small proportion of the fibers in a motor unit are near the electrode and those at a distance contribute little to the recorded MUP (Fig. 26-9, for color image, see color plates). Thus, no single MUP characterizes a motor unit but rather the characteristics of multiple MUP recorded from different sites allow for the optimal assessment of the morphology of the motor unit (Fig. 26-10). The appearance of MUPs also changes with several normal physiologic variables, including the subject's age, the muscle being studied, the location of the needle in the muscle, the manner of activation of the potentials (minimal voluntary contraction, maximal voluntary contraction, reflex activation, or electric stimulation), and the temperature of the muscle.<sup>31,32</sup>

If these technical and physiologic factors are controlled, the normal anatomical and histologic features of the motor unit and any pathologic changes that may affect these features will determine the characteristics of the MUPs. The anatomical and histologic features include *innervation ratio* (number of muscle fibers in the motor unit), *fiber density* (number of muscle fibers per given cross-sectional area), the distance of the needle tip from the muscle fibers and from the end plate region, and the direction of the axis of the muscle fiber. The characteristics of the action potentials generated by individual muscle fibers depend on muscle fiber membrane resistance and capacitance (which may be affected by the amount of connective tissue, blood vessels, and fat between the electrode and muscle fibers), intracellular and extracellular ionic concentrations, muscle fiber diameter, and conduction velocity. The synchrony of firing of the muscle fibers in a motor unit depends on the length, diameter, and conduction velocity of the nerve terminals, the diameter of the muscle fibers, and the relative location of the end plates on the muscle fibers. The firing characteristics of the motor unit depend on the amount of overlap with other motor units, the number of motor units in the muscle (or per given area), the differential response to sources of activation (monosynaptic, local spinal cord, higher centers), and the rates and patterns of discharge of the anterior horn cell.



**Figure 26-10.** Normal MUPs in the biceps muscle showing the variety of configurations that can be seen. (From Daube, J. R. 1991. AAEM minimonography #11: Needle examination in clinical electromyography. *Muscle & Nerve* 14:685-700. By permission of John Wiley & Sons.)

## Rise Time

The *rise time* is the duration of the rapid positive–negative inflection and is a function of the distance of the muscle fibers from the electrode (Fig. 26–8). It is less than 500  $\mu$ s if the electrode is near muscle fibers in the active motor unit. When the needle electrode is more distant to the muscle fibers in the motor unit, the rise time will increase and the amplitude and duration of the motor unit may decrease. As a result, only MUPs that are near the electrode, with a rise time of 0.5 ms or less, should be analyzed.

## Duration and Amplitude

The *duration* of the MUP is the time from the initial deflection away from baseline to the final return to baseline (Fig. 26–8). It varies with the muscle, muscle temperature, and the patient's age. The duration is the parameter which most accurately reflects the area of the motor unit. The *amplitude* of the potential is the maximal peak-to-peak amplitude of the main spike of the potential and varies with the size and density of the muscle fibers in the region of the recording electrode and with their synchrony of firing. The amplitude typically consists of the action potentials of a few muscle fibers within the motor unit that are closest to the recording tip of the electrode. It also differs with the muscle, muscle temperature, and the patient's age. Decreased muscle temperature produces higher amplitude and longer duration MUPs.

The polarity of all potentials recorded on needle EMG depends on recording the potential with the active (G1 amplifier input) electrode. In most cases, where the potential is recorded by the active central recording wire at the tip of the electrode, MUPs will appear predominantly negative. However, if an MUP is recorded with the shaft of a standard concentric electrode or with the reference of a *monopolar* electrode, it will be displayed as an inverted triphasic potential (apparently negative–positive–negative).

## Phases

A phase of an MUP can be defined as the number of times the potential crosses the baseline

plus one (Fig. 26–8). The configuration of an MUP may be monophasic, biphasic, or triphasic or it may have multiple phases. The configuration depends on the synchrony of firing of the muscle fibers in the region of the electrode. Usually, only a small proportion of MUPs have more than four phases; those that do are called *polyphasic potentials*. The percentage varies with the muscle being tested and the age of the patient, but is usually no more than 15% of MUPs in most muscles. A late spike, distinct from the main potential, that is time locked to the main potential is called a *satellite potential* (Fig. 26–8). The satellite potential is generated by a muscle fiber in a motor unit that has a long nerve terminal, narrow diameter, or distant end plate region. If an MUP is recorded from damaged muscle fibers or from the end of the muscle fibers it may have the configuration of a positive wave with low, long, late negativity phases.

## Stability

Variability of an MUP is any change in its configuration, amplitude, or both in the absence of movement of the recording electrode as the motor unit fires repetitively. Normally, MUPs are stable and appear identical each time they fire. In disorders affecting neuromuscular transmission, variation of the potential may occur.

## Key Points

- Motor unit configurational changes occur when there has been loss or remodeling of the motor unit, in myopathic or neurogenic disorders.
- Duration and amplitude of the MUPs are the parameters which best reflect the area of the MUP.
- Motor unit variation indicates unstable neuromuscular transmission and can occur in neuromuscular junction disorders as well as in progressing neurogenic and myopathic diseases.
- Technical factors that have an influence on the appearance of MUPs include the type of needle electrode used, the area of exposed surface of the active leads of the electrode, the characteristics of the metal

recording surfaces, and the electric characteristics of the cables, preamplifier, and amplifier.

- Several normal physiologic variables affect the configuration of the MUPs, including the subject's age, the muscle being studied, the location of the needle in the muscle, the degree of activation of the potentials, and the temperature of the muscle.
- A short rise time (typically less than 500  $\mu$ s) indicates recording close to the muscle fibers in the motor unit.
- MUP duration is measured from initial baseline deflection to final return to baseline, and varies with muscle, temperature, and age.
- MUP amplitude consists of the action potentials of a few muscle fibers within the MUP.
- Only up to 15% of normal MUPs in a muscle should be polyphasic (>4 phases).
- Normal MUPs have a stable configuration each time they fire.

## ABNORMAL SPONTANEOUS ELECTRIC ACTIVITY

Neuromuscular diseases are best described by a combination of clinical findings, histologic changes, and the pattern of abnormal findings on needle EMG. Needle EMG findings are combinations of different specific types of abnormal electric waveforms described in the following sections. The clinical electromyographer must recognize specific discharges and know what diseases are associated with them. In most cases, a specific discharge may be associated with several different diseases. The following discussion describes the types of abnormal electrical activity recorded with a needle electrode and the diseases associated with them. Neuromuscular diseases may show abnormal spontaneous discharges, abnormal voluntary MUPs, or both. Abnormal spontaneous activity includes fibrillation potentials, fasciculation potentials, myotonic discharges, CRDs, myokymic discharges, cramps, and neuromyotonic discharges. MUPs may have an abnormal duration and amplitude, abnormal number of phases, or vary in morphology. The recruitment pattern of the potentials may also

be altered or there may be abnormal patterns of activation, as in tremor and synkinesis. All of these abnormal EMG discharges are recognized most accurately and reliably by auditory pattern recognition and semiquantitation. The trained ear of an electromyographer can define the discharge frequency, rise time, duration, and number of turns/phases of EMG potentials. The techniques of pattern recognition and semiquantitation have been described previously (see Skills of EMG Waveform Recognition).

## Insertional Activity

Insertional activity is the electrical activity that occurs with mechanical depolarization of the muscle fibers due to needle insertion and movement through the muscle. Insertional activity is generated by single muscle fiber action potentials and is composed of combinations of positive and negative spikes depending on the site of origin of the generated action potential.<sup>33</sup> In a normal muscle, the burst of insertional activity reflects the number of muscle fibers that depolarize due to mechanical irritation; with larger needle movements, the length of the bursts of insertional activity is longer, and with smaller needle movements the length is shorter. Regardless of the length of the insertional bursts, the activity ceases almost immediately following cessation of needle movement.

Insertional activity may be increased (Fig. 26–11) or reduced from the brief burst that occurs in normal subjects. Increased insertional activity may occur as two types of normal variants, as a result of denervated muscle, or associated with myotonic discharges. The normal variants are recognized by their widespread distribution, most often occurring in younger, muscular persons, especially in their calf muscles. One normal variant is composed of short trains of regularly firing positive waves. Some patients with this type of diffuse increased insertional activity have been found to have mutations in the *CLCN1* gene associated with myotonia congenita.<sup>34</sup> The second type is characterized by short recurrent bursts of irregularly firing potentials, sometimes termed *snap*, *crackle*, *pop*.

Increased insertional activity may be the initial early sign, within the first 2–3 weeks,





**Figure 26-11.** Increased insertional activity. (From Daube JR. AAEM minimonography #11: needle examination in clinical electromyography. *Muscle & Nerve*. 1991;14:685-700. Used with permission of the publisher.)

of denervation following an acute neurogenic disorder, such as an early radiculopathy or mononeuropathy. This often occurs prior to the development of more sustained fibrillation potentials. In addition, since needle movement often leads to the generation of fibrillation potentials in denervated muscle, most muscles that demonstrate more sustained fibrillation potentials have increased insertional activity.

In rare cases, decreased insertional activity may occur when the muscle fibers are unable to produce action potentials in response to membrane irritation. This most commonly occurs in severe or end-stage neurogenic or myopathic disorders where the muscle is completely atrophic or has been replaced by connective tissue or fat. Additionally, disorders of muscle membrane dysfunction, such as periodic paralysis (during paralysis) or myophosphorylase deficiency myopathy (McArdle's) (during a contracture), may demonstrate decreased insertional activity or electrical silence during needle movement through the muscle.

### Key Points

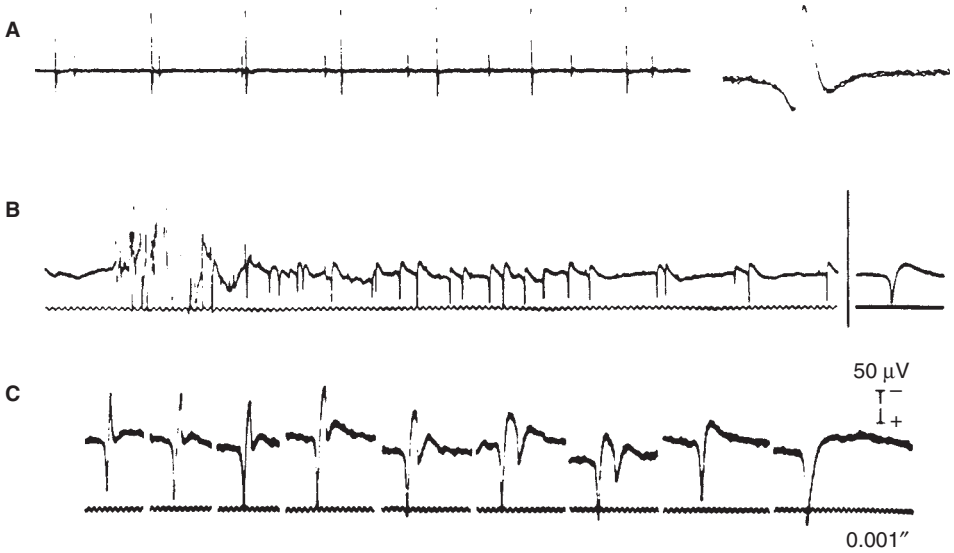
- Insertional activity is the electrical activity that occurs with mechanical depolarization of the muscle fibers due to needle movement through the muscle.
- Insertional activity reflects the number of muscle fibers that depolarize due to mechanical irritation; with larger needle movements, the length of the bursts of insertional activity is longer, and with smaller needle movements the length is shorter.
- Increased insertional activity may be the initial early sign of denervation from an

acute neurogenic disorder, such as an early radiculopathy or mononeuropathy.

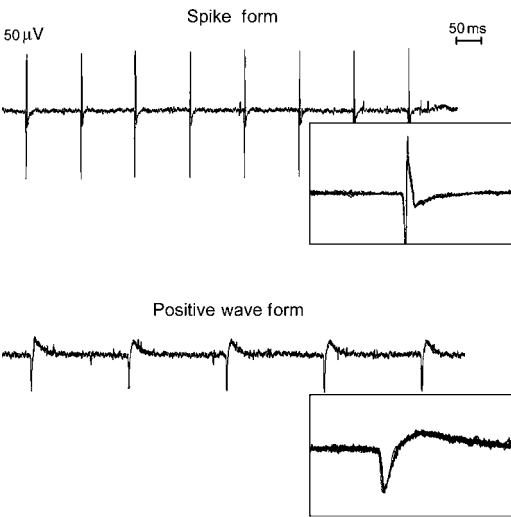
- Rarely, benign forms of insertional activity, such as *snap*, *crackle*, *pop*, may be seen in young, muscular patients.
- Diffuse increased insertional activity of the positive waveform type may be seen in patients with the *CLCN1* gene associated with myotonia congenita.
- Decreased insertional activity may occur when muscle fibers are unable to produce action potentials, such as with end-stage neuromuscular diseases where the muscle is replaced by connective tissue or fat or with disorders such as periodic paralysis or metabolic myopathies.

### Fibrillation Potentials

*Fibrillation potentials* are the action potentials of single muscle fibers that are twitching spontaneously in the absence of innervation. These potentials typically fire in a regular pattern at rates of 0.5–15 Hz (Fig. 26-12). Infrequently, they may be intermittent or irregular, particularly early after a denervating process; in these cases, the interspike interval is longer than 70 ms, distinguishing them from end plate spikes. Fibrillation potentials have one of two forms, either a brief spike or a positive wave.<sup>35,36</sup> (Fig. 26-13) Fibrillation potentials that occur as brief spikes (*spike form*) may be triphasic or biphasic, 1–5 ms in duration, and 20–200  $\mu\text{V}$  in amplitude, with an initial positivity or negativity (when recorded at the site of origin). Fibrillation potentials that occur as positive waves (*positive waveform*) are often of longer duration (10–30 ms) and biphasic, with



**Figure 26-12.** Fibrillation potentials. A, Spike form. B, Positive waveform. C, Development of a positive waveform from a spike form (serial photographs taken after insertion of needle electrode). (From Daube, J. R. 1991. AAEM minimonography #11: Needle examination in clinical electromyography. *Muscle & Nerve* 14:685-700. By permission of John Wiley & Sons.)



**Figure 26-13.** Spike form and positive waveform fibrillation potentials. (From Daube JR. AAEM minimonography #11: needle examination in clinical electromyography. *Muscle & Nerve*. 1991;14:685-700. Used with permission of the publisher.)

the action potential cannot propagate along the muscle fiber past the recording electrode. Rarely, fibrillation potentials are observed to transform from a spike to a positive waveform or vice versa; even less frequently, two fibrillation potentials are time-locked.<sup>37</sup> The amplitude of a fibrillation potential is variable and is proportional to the muscle fiber diameter. In diseases with muscle fiber atrophy, fibrillation potentials may have a low amplitude whereas in hypertrophic muscle fibers, the amplitude may be high.<sup>38</sup> As a result of the range of sizes of fibrillation potentials, the configuration alone cannot be used to identify them. Both spike and positive waveform fibrillation potentials are recognized as fibrillation potentials by their slow, regular firing pattern, which sounds like the “ticking or tocking of a clock.” Both forms have the same significance, indicating a denervated muscle fiber.

Fibrillation potentials occur in any muscle fiber that is not innervated, due to neurogenic or myopathic processes (Table 26-3). These potentials may occur in muscle fibers that (1) have lost their innervation, (2) have been sectioned transversely or divided longitudinally, (3) are regenerating, and (4) have never been innervated. In neurogenic disorders, such as radiculopathies, mononeuropathies, or motor neuron disease, loss or degeneration of axons leads to denervated muscle fibers. In contrast, in myopathic diseases that produce

an initial sharp positivity followed by a long-duration negative phase. The morphologic difference of the two forms reflects the site of the initiation of the fibrillation potential along the muscle fiber relative to the site of the needle electrode. The positive waveforms are muscle fiber action potentials recorded from an injured portion of the muscle fiber, when

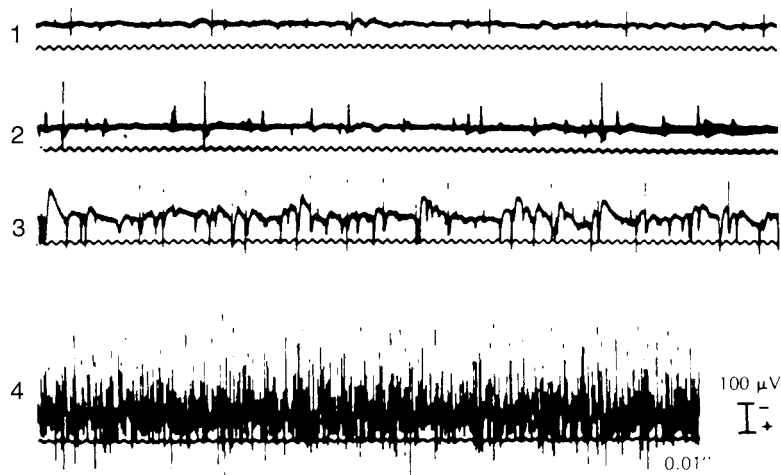
Table 26–3 Diseases Associated with Fibrillation Potentials

Lower motor neuron diseases	Anterior horn cell diseases (e.g., ALS) Polyradiculopathies Radiculopathies Plexopathies Peripheral neuropathies, especially axonal Mononeuropathies
Neuromuscular junction diseases	Myasthenia gravis, severe Botulinum intoxication Lambert–Eaton myasthenic syndrome, severe
Myopathies	Inflammatory (e.g., polymyositis, dermatomyositis, inclusion body myositis) Infiltrative (e.g., sarcoidosis, amyloid) Muscular dystrophies (e.g., Duchenne, Becker, limb-girdle) Myotonic dystrophy Toxic myopathies (e.g., lipid-lowering agents, chloroquine) Metabolic myopathies (e.g., acid maltase) Congenital myopathies (e.g., myotubular, late onset rod myopathy) Infectious myopathy (e.g., viral myositis, trichinosis)
Other	Muscle trauma and rhabdomyolysis

pathologic changes of muscle fiber necrosis, fiber splitting, functional denervation of individual or segments of muscle fibers occurs as the fiber becomes separated from the end plate zone. In myopathies, fibrillation potentials are often of low amplitude and have a slow firing rate (e.g., 0.5 Hz). The density of fibrillation potentials is a rough estimate of the number of denervated muscle fibers and is commonly

graded from 1+ (few fibrillation potentials in most areas of the muscle) to 4+ (profuse fibrillations filling the free-running baseline in all areas) (Fig. 26–14).

Other forms of electric activity could potentially be mistaken for fibrillation potentials. These include the spontaneous activity in the region of the end plate (end plate noise and end plate spikes), short-duration MUPs, and



**Figure 26–14.** Fibrillation potentials in denervated muscle. Grades of activity: 1, fibrillation potentials persistent in at least two areas; 2, moderate number of persistent fibrillation potentials in three or more areas; 3, large number of persistent discharges in all areas; and 4, profuse, widespread, persistent discharges that fill the baseline. (From Daube, J. R. 1991. AAEM minimonography #11: Needle examination in clinical electromyography. *Muscle & Nerve* 14:685–700. By permission of John Wiley & Sons.)

MUPs with a positive configuration. While the configuration of these waveforms may be identical to fibrillation potentials, all of them are distinguished from fibrillation potentials by their firing patterns, none of which fire in a regular pattern like a fibrillation potential.

### Key Points

- Fibrillation potentials are the action potentials of single muscle fibers that are twitching spontaneously in the absence of innervation.
- Fibrillation potentials fire in a regular pattern at rates of 0.5–15 Hz.
- There are two forms of fibrillation potentials: spike form and positive waveform. Both forms have the same significance.
- Fibrillation potentials occur in neurogenic disorders and myopathies, in which the muscle fibers have lost their innervation, have been sectioned transversely or divided longitudinally, are regenerating, or have never been innervated.
- The density of fibrillation potentials reflects the number of denervated muscle fibers.

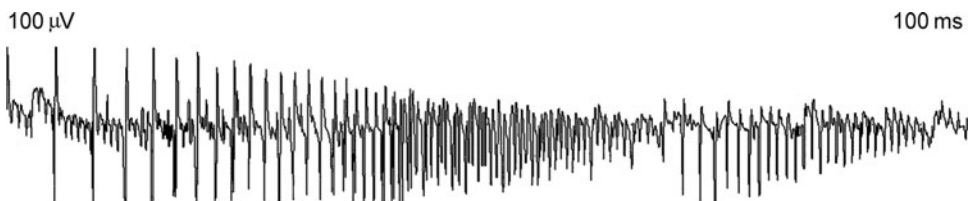
## Myotonic Discharges

*Myotonic discharges* are the action potentials of single muscle fibers that are firing spontaneously in a prolonged fashion after external excitation. The potentials wax and wane in amplitude and frequency because of an abnormality in the membrane of the muscle fiber. Myotonic discharges are regular in rhythm, but the firing rates vary exponentially in frequency between 40 and 100 Hz, which makes them sound like a *dive-bomber*. Slowly firing myotonic discharges, which bear some resemblance to fibrillation potentials but

demonstrate a more rapid rate of change in firing frequency and amplitude, may also occur.<sup>39</sup>

Myotonic discharges occur as brief spikes or positive waveforms, depending on the relation of the recording electrode to the muscle fiber. When initiated by insertion of the needle, myotonic potentials have the configuration of a positive wave, with an initial sharp positivity followed by a long-duration negative component. Both amplitude and frequency may increase or decrease as the discharge continues (Fig. 26–15). Myotonic discharges that occur after a voluntary contraction are brief, biphasic or triphasic, initially positive spikes of 20–300  $\mu\text{V}$  that resemble the spikes of fibrillation potentials. They wax and wane, similar to mechanically induced myotonic discharges. This afterdischarge corresponds to the clinically evident poor relaxation. The degree of waxing and waning has been shown to differ between different forms of myotonic dystrophy (DM1 and DM2). In DM1, myotonic discharges typically wax and wane (increase and then decrease in firing rate), whereas in DM2 (previously known as *proximal myotonic myopathy* or PROMM), the discharges more commonly wane in frequency.<sup>40</sup>

Disorders associated with myotonic discharges are listed in Table 26–4. Myotonic discharges may occur in disorders with or without associated clinical myotonia. In those with clinical myotonia, the myotonic discharges are often prominent and frequent. Most commonly, these occur in myotonic dystrophy types 1 and 2 (DM1 and DM2) or myotonia congenita. The severity of myotonic discharges and the presence of waxing and waning discharges have been shown to be correlated with muscle weakness in DM1, but not in DM2.<sup>40</sup> In a study comparing the abundance of myotonic discharges in patients with sodium and chloride channelopathies, including myotonia congenita,



**Figure 26–15.** Myotonic discharge. (From Daube JR. AAEM minimonography #11: needle examination in clinical electromyography. *Muscle & Nerve*. 1991;14:685–700. Used with permission of the publisher.)

Table 26–4 Diseases Associated with Myotonic Discharges

Myopathies with clinical myotonia	Myotonic dystrophy type 1 and 2 (DM1, DM2) Myotonia congenita Paramyotonia congenita
Myopathies without clinical myotonia	Hyperkalemic periodic paralysis Polymyositis Acid maltase deficiency Statin-associated myopathy Toxic myopathies (e.g., colchicine myopathy) Potassium sensitive myotonia Centronuclear myopathy Hypothyroid myopathy Amyloid
Neurogenic disorders	Severe axonal disorders (e.g., peripheral neuropathies, radiculopathies)

paramyotonia congenita, and hyperkalemic periodic paralysis, no difference in the degree of myotonic discharges was found between the diseases.<sup>41</sup> Rarely, briefer and less prominent myotonic discharges may occur with fibrillation potentials in chronic denervating disorders and with some medications. They are less readily elicited in a muscle that has just been active than a resting muscle, which is equivalent to the *warm-up phenomenon* that occurs in patients with myotonic myopathies.

### Key Points

- Myotonic discharges are the action potentials of single muscle fibers that are firing spontaneously in a prolonged fashion after external excitation.
- Myotonic discharges fire in a regular pattern with exponentially varying firing rates of 40 and 100 Hz, which makes them sound like a *dive-bomber*.
- Myotonic discharges are most commonly seen in myotonic myopathies, such as myotonic dystrophy or myotonia congenita, but can also be seen less prominently in chronic neurogenic disorders.
- In DM1, myotonic discharges typically wax and wane (increase and then decrease in firing rate), whereas in DM2 the discharges more commonly wane in frequency.

## Complex Repetitive Discharges

*Complex repetitive discharge* (CRD), previously referred to as *bizarre repetitive potentials*,

*high-frequency potentials*, or *pseudomyotonic discharges*, is the action potential of groups of muscle fibers discharging spontaneously in near synchrony in a regular, repetitive fashion. The groups of muscle fibers arise from several different neighboring motor units rather than from the same motor unit. Standard and single fiber EMG recordings suggest that they are the result of ephaptic activation of groups of adjacent muscle fibers.<sup>42</sup> A CRD is initiated by the spontaneous firing of a single muscle fiber action potential; however, that action potential ephaptically spreads and depolarizes a neighboring muscle fiber. Subsequently, a variable number of neighboring muscle fibers may be depolarized in sequence until the *circuit* is complete, whereby the initial muscle fiber discharges again. Therefore, each spike within a group in a CRD is composed of individual muscle fibers action potentials from fibers that may be part of a different motor unit, but lie adjacent to one another.

CRDs fire in a regular pattern, characteristically with an abrupt onset and cessation. During the discharge, they may have sudden changes in their configuration or firing rates. The frequency is uniform, ranging from as slow as 3 to up to 40 Hz (Fig. 26–16). Although their form is variable, it typically is polyphasic, with 3–10 spike components with amplitudes from 50 to 500  $\mu$ V and durations of up to 50 ms. CRDs sound like a *motor boat that misfires* or a *jackhammer*.

CRDs are nonspecific in significance but occur in neurogenic and myopathic disorders that are chronic or longstanding in nature (Table 26–5). Commonly, these include



**Figure 26-16.** Two examples of CRDs recurring at 30–40 per second. (From Daube, J. R. 1991. AAEM minimonography #11: Needle examination in clinical electromyography. *Muscle & Nerve* 14:685–700. By permission of John Wiley & Sons.)

**Table 26-5 Disorders Associated with Complex Repetitive Discharges**

Neurogenic disorders	Chronic anterior horn cell diseases (e.g., ALS, spinal muscular atrophy, polio) Chronic radiculopathies Chronic axonal neuropathies (e.g., CMT)
Myopathies	Chronic inflammatory myopathies (e.g., polymyositis, inclusion body myositis) Muscular dystrophies Hypothyroid myopathy Schwartz–Jampel syndrome
Normal muscles	Iliopsoas Biceps

old or chronic radiculopathies, peripheral neuropathies, or slowly progressive myopathies. In rare cases of patients with chronic S1 radiculopathies associated with pain and calf hypertrophy, CRDs are seen in the gastrocnemius in approximately 50%, raising the possibility that CRDs may contribute to neurogenic hypertrophy in these cases.<sup>43</sup> Rarely, CRDs occur in otherwise normal muscles, such as the iliopsoas or biceps.

CRDs may be confused with other repetitive discharges, such as myokymic discharges, cramps, neuromyotonia, tremor, and synkinesis. However, each of these has a characteristic pattern of firing best recognized by its sound and distinct from that of CRDs.

### Key Points

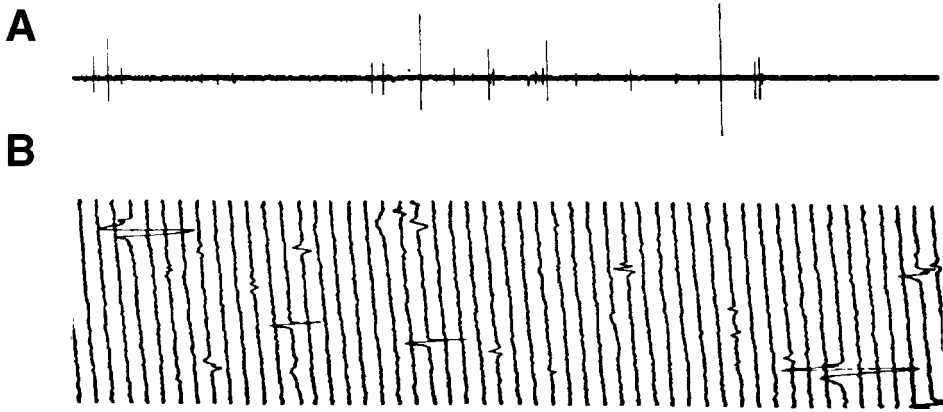
- CRDs are the action potentials of groups of adjacent muscle fibers discharging spontaneously in near synchrony in a regular, repetitive fashion.
- CRDs occur as a result of ephaptic spread of single muscle fiber action potentials along a circuit of neighboring muscle fibers.

- CRDs fire in a regular pattern with an abrupt onset and cessation, at rates of 3–40 Hz.
- CRDs occur in chronic neurogenic or myopathic disorders.

### Fasciculation Potentials

*Fasciculation potentials* are randomly discharging action potentials of a group of muscle fibers innervated by the same anterior horn cell (motor unit) (Fig. 26-17). These spontaneously firing MUPs may be generated anywhere along the lower motor neuron, from the anterior horn cell to the nerve terminal, but usually from spontaneous firing of the nerve terminal. The rates of discharge of an individual potential may vary from a few per second to fewer than 1 per minute. The sum of all fasciculations in a muscle may reach 500 per minute. These potentials may be of any size and shape, depending on the character of the motor unit from which they arise and their relation with the recording electrode, and they may have the appearance of normal or abnormal MUPs. They are identified by their irregular firing





**Figure 26-17.** Fasciculation potentials recurring in an irregular pattern. *A*, Slow sweep speed, continuous. *B*, Fast sweep speed, raster. (From Daube, J. R. 1991. AAEM minimonography #11: Needle examination in clinical electromyography. *Muscle & Nerve* 14:685-700. By permission of John Wiley & Sons.) (From Daube JR. AAEM minimonography #11: needle examination in clinical electromyography. *Muscle & Nerve*. 1991;14:685-700. Used with permission of the publisher.)

pattern and may sound like “large raindrops on a tin roof.”

Fasciculation potentials may occur in normal individuals as well as in individuals with many different neuromuscular diseases. They are especially common in chronic neurogenic disorders but have been found in all neuromuscular disorders (Table 26-6). Fasciculations usually occur in an overworked muscle, especially if there is underlying neurogenic disease. Fasciculation potentials have not been shown to occur more often in patients with myopathy than in normal persons.

Electrodiagnostic testing, using surface EMG, detects fasciculations more frequently than clinical observation or muscle palpation, and therefore EMG is useful in assessing for fasciculations and other changes in patients with suspected amyotrophic lateral sclerosis (ALS).<sup>44</sup> However, neither surface nor needle EMG can reliably distinguish between benign fasciculations and those associated with specific

diseases. In normal persons, fasciculations occur more rapidly, on the average, and are more stable.<sup>45</sup> The presence of fasciculations alone on EMG, without fibrillation potentials or changes in voluntary MUPs, is not sufficient to make a diagnosis of progressive motor neuron disease, such as ALS.

Patients who have large motor units caused by chronic neurogenic diseases may have visible twitching during voluntary contractions. Such *contraction fasciculations* must be differentiated from true fasciculations by the pattern of firing.

### Key Points

- Fasciculation potentials are spontaneously firing MUPs, which are generated anywhere along the lower motor neuron.
- Fasciculation potentials fire in an irregular pattern, at fast or slow rates.

**Table 26-6 Disorders Associated with Fasciculation Potentials**

Normal	Benign fasciculation syndrome
Peripheral nerve hyperexcitability syndrome	Cramp fasciculation syndrome
Neurogenic disorders	Anterior horn cell diseases (e.g., ALS, Kennedy disease, spinal muscular atrophy) Peripheral neuropathies, axonal Radiculopathies
Metabolic disorders	Hyperthyroidism
Medications	Anticholinesterase agents

- Fasciculation potentials may be of any size or shape, and the configuration reflects the motor units from which they arise.
- Fasciculations are nonspecific in significance; they may be a benign phenomenon or seen with neurogenic disorders.

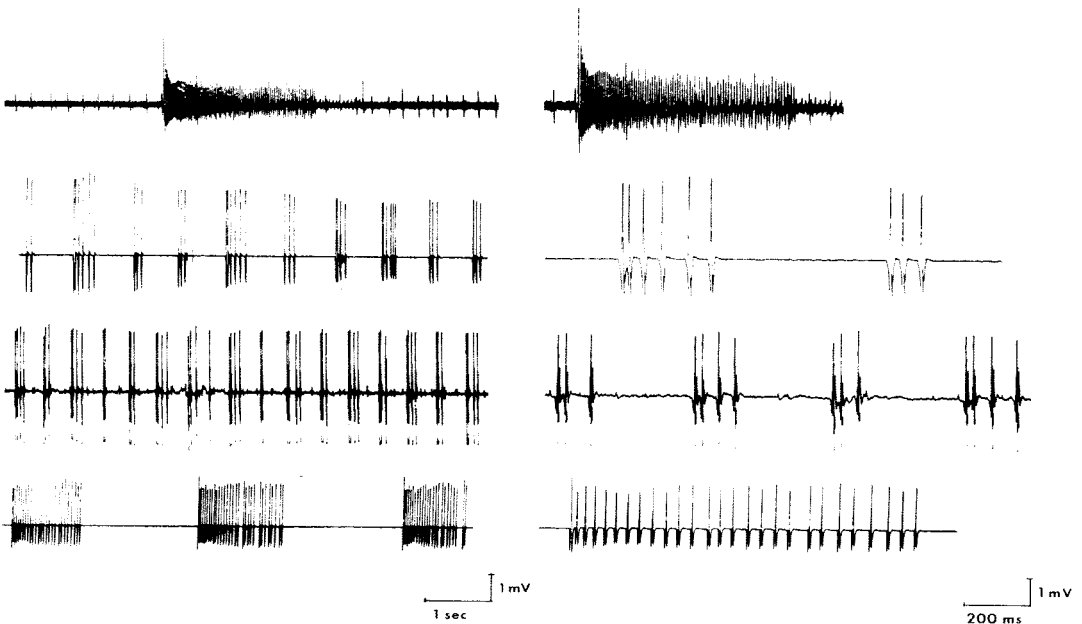
## Myokymic Discharges

*Myokymic discharges* are groups of recurring, spontaneously firing MUPs that fire in a repetitive burst pattern. The individual potentials within each burst often have the appearance of normal MUPs, although they may also be of long duration and high amplitude. Each burst may be composed of few or many potentials (2–10) and the rate of firing of potentials within each burst is typically 40–60 Hz. Each burst fires with a regular or semirhythmic pattern at intervals of 0.1–10 seconds (Fig. 26–18). The firing pattern is unaffected by voluntary activity, and simultaneously occurring myokymic discharges may vary in burst duration or firing rates. Some myokymic discharges sound similar to groups of *marching soldiers*.

Although discharges that have regular patterns of recurrence but fire at different rates

or with a regularly changing rate of discharge may have similar mechanisms, they are better classified with the broad group of *iterative discharges*. Some investigators consider iterative discharges and myokymic discharges to be forms of fasciculation because they arise in the lower motor neuron or axon. However, it is best to separate these discharges from fasciculation potentials because of their distinct patterns and different clinical significance.

Myokymic discharges may or may not be associated with clinical myokymia, which appears as fine, worm-like quivering of the muscles. Although myokymic discharges are more commonly found in limb muscles, clinical myokymia is more often observed in facial muscles, probably due to the smaller degree of overlying subcutaneous tissue, than in limb muscles. Diseases associated with myokymic discharges are listed in Table 26–7. Most commonly, myokymic discharges are found with radiation-induced nerve injury, chronic compressive neuropathies, or polyradiculopathies. The myokymic discharges seen in chronic compressive neuropathies, such as carpal tunnel syndrome, are often composed of a single or few potentials.



**Figure 26–18.** Examples of recurrent bursts of myokymic discharges at a slow (*left*) and fast (*right*) sweep speed. Firing rate is 20–30 per second within bursts, with variable recurrence rates of the bursts. (From Daube JR. AAEM minimonography #11: needle examination in clinical electromyography. Muscle & Nerve. 1991;14:685–700. Used with permission of the publisher.)

Table 26–7 Disorders Associated with Myokymic Discharges

Facial muscles	Multiple sclerosis Brain stem neoplasms Polyradiculopathy (e.g., acute inflammatory demyelinating polyneuropathy) Facial neuropathy (e.g., Bell's palsy) Radiation to head and neck
Extremity muscles	Radiation (plexopathy, mononeuropathy) Chronic nerve compression (e.g., chronic carpal tunnel syndrome) Syndrome of peripheral nerve hyperexcitability (Isaac's syndrome) Morvan's syndrome

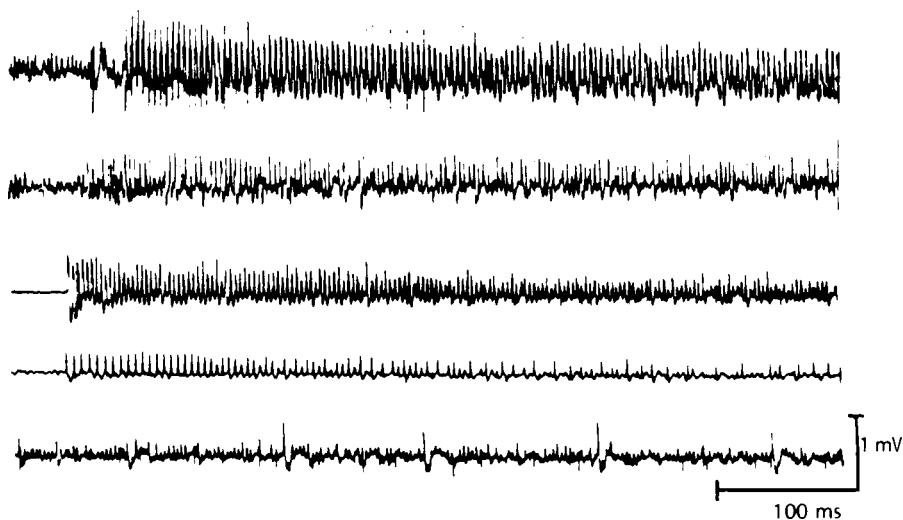
**Key Points**

- Myokymic discharges are groups of recurring, spontaneously firing MUPs that fire in a repetitive burst pattern.
- Each burst may be composed of few or many potentials (2–10) and the rate of firing of potentials within each burst is typically 40–60 Hz.
- Each burst fires with a regular or semirhythmic pattern at intervals of 0.1–10 seconds.
- The firing pattern is not affected by voluntary activity.
- Myokymic discharges may or may not be associated with clinical myokymia, which is seen more often in facial than limb muscles.

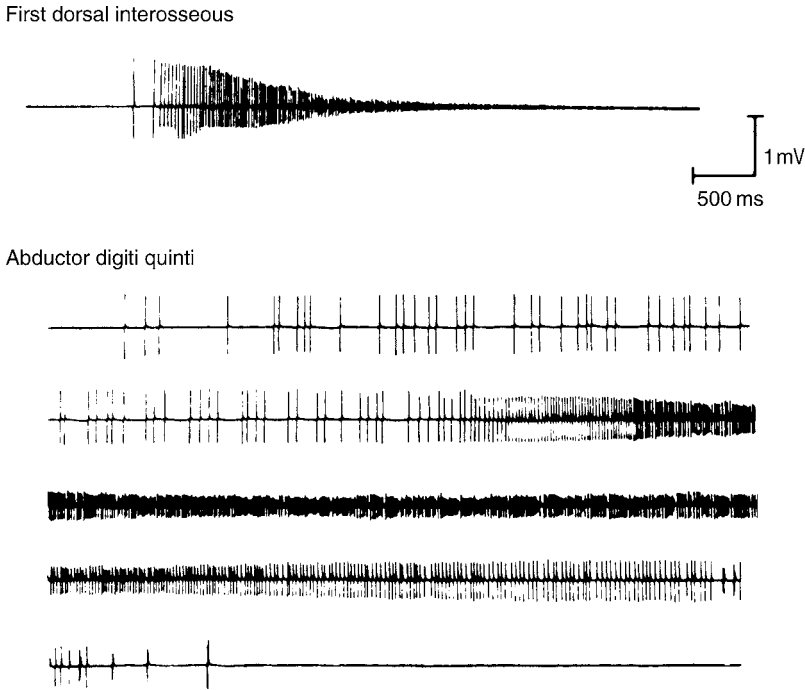
- Myokymic discharges are most commonly seen with radiation-induced nerve injury, but can occur in other disorders such as chronic nerve compression or polyradiculopathies.

**Neuromyotonic Discharges (Neuromyotonia)**

*Neuromyotonic discharges*, or *neuromyotonia*, are rare, spontaneously firing MUPs that are associated with some forms of continuous muscle fiber activity (Isaac's syndrome). Neuromyotonic discharges fire at very high frequencies of 100–300 Hz (Figs. 26–19 and 26–20). These potentials may decrease in



**Figure 26–19.** Examples of neuromyotonic (neurotonic) discharges in Isaac's syndrome. (From Daube, J. R. 1991. AAEM minimonography #11: Needle examination in clinical electromyography. *Muscle & Nerve* 14:685–700. By permission of John Wiley & Sons.)



**Figure 26–20.** Two examples of neuromyotonic discharges in spinal muscular atrophy firing at over 200 per second. (From Daube, J. R. 1991. AAEM minimonography #11: Needle examination in clinical electromyography. *Muscle & Nerve* 14:685–700. By permission of John Wiley & Sons.) (From Daube JR. AAEM minimonography #11: needle examination in clinical electromyography. *Muscle & Nerve*. 1991;14:685–700. Used with permission of the publisher.)

**Table 26–8 Disorders Associated with Neuromyotonic Discharges**

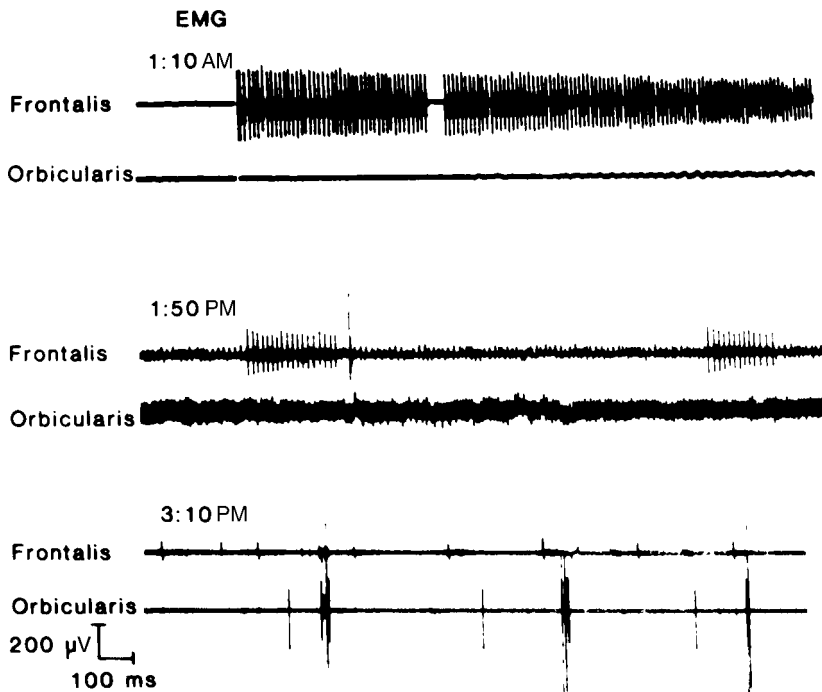
Hyperexcitable nerve syndromes	Syndrome of peripheral nerve hyperexcitability (Isaac’s syndrome) Tetany Morvan’s syndrome
Neurogenic	Chronic spinal muscular atrophy Hereditary motor neuropathy
Other	Anticholinesterase poisoning Intraoperative nerve irritation

amplitude because of the inability of muscle fibers to maintain discharges at rates greater than 100 Hz. The discharges may be continuous for long intervals or recur in bursts. They are unaffected by voluntary activity.

Neuromyotonic discharges are seen in disorders of peripheral nerve hyperexcitability, such as Isaac’s syndrome, and may occur as a result of a defect in potassium channels in the nerve membrane (Table 26–8).<sup>46</sup> Some forms of syndromes of peripheral nerve hyperexcitability are associated with bursts of doublet, triplet, or multiplet discharges, with intraburst

frequencies often ranging from 40–350 Hz, which may appear similar to myokymic discharges.<sup>47,48</sup> Neuromyotonia may also occur with tetany, where they may be precipitated by or augmented with ischemia, and Morvan’s syndrome.<sup>49</sup>

A form of neuromyotonic discharges called *neurotonic discharges* occur intraoperatively with the mechanical irritation of cranial or peripheral nerves. These discharges are brief bursts of MUPs discharging at very high rates, similar to the rates of spontaneously occurring neuromyotonic discharges. The identification of neurotonic discharges intraoperatively is



**Figure 26-21.** Neurotonic discharges in facial muscles during acoustic neuroma surgery. The times of recordings were at 1:10 PM, 1:50 PM, and 3:10 PM. (From Daube, J. R. 1991. AAEM minimonography #11: Needle examination in clinical electromyography. *Muscle & Nerve* 14:685-700. By permission of John Wiley & Sons.) (From Daube JR. AAEM minimonography #11: needle examination in clinical electromyography. *Muscle & Nerve*. 1991;14:685-700. Used with permission of the publisher.)

valuable in alerting surgeons to possible nerve damage (Fig. 26-21).

### Key Points

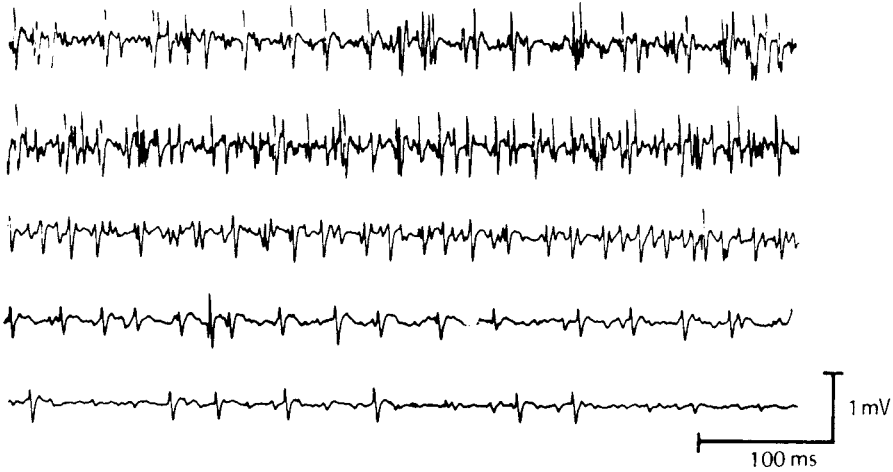
- Neuromyotonic discharges are rare, spontaneously occurring MUPs that fire at rates of 100–300 Hz.
- Neuromyotonic discharges may fire as long continuous discharges or brief bursts.
- They are often seen in disorders of peripheral nerve hyperexcitability, such as Isaac's syndrome, as well as tetany or other neurogenic disorders.
- A form of neuromyotonic discharges called *neurotonic discharges* occur intraoperatively with the mechanical irritation of cranial or peripheral nerves.

### Cramp Potentials (Cramp Discharge)

Cramps are painful, involuntary contractions of muscle. The discharges associated with a muscle cramp (*cramp discharges*) are composed

of MUPs that fire in a unique firing pattern, which distinguishes them from other spontaneous activity and normal strong voluntary activation. The configuration of the individual potentials resembles MUPs. However, in contrast to the pattern of activation that occurs with voluntary contraction, potentials in cramp discharges usually have an abrupt onset, rapid buildup and addition of subsequent potentials, and a rapid or *sputtering* cessation. The potentials fire rapidly (40–60 Hz) and during their discharge they may fire irregularly in a sputtering fashion, especially just before termination (Fig. 26-22). Typically, an increasing number of potentials that fire at similar rates are recruited as the cramp develops and these potentials stop firing as the cramp subsides.

Cramps are a common phenomenon in normal persons, usually when a muscle is activated strongly in a shortened position. In addition, cramps may occur with any chronic neurogenic disorder, in metabolic or electrolyte disorders, or in disorders of peripheral nerve hyperexcitability (such as *cramp fasciculation syndrome*) (Table 26-9).



**Figure 26-22.** Muscle cramp with MUPs firing at 30–50 per second. (From Daube, J. R. 1991. AAEM minimonography #11: Needle examination in clinical electromyography. *Muscle & Nerve* 14:685–700. By permission of John Wiley & Sons.) (From Daube JR. AAEM minimonography #11: needle examination in clinical electromyography. *Muscle & Nerve*. 1991;14:685–700. Used with permission of the publisher.)

**Table 26-9 Disorders Associated with Cramp Discharges**

Neurogenic disorders	Chronic radiculopathies Peripheral neuropathy Motor neuron disorders
Metabolic or electrolyte disorders	Salt depletion Pregnancy Hypothyroidism Uremia (dialysis)
Peripheral nerve hyperexcitability disorders	Cramp fasciculation syndrome
Other	Benign nocturnal cramps

**Key Points**

- Cramp discharges are composed of MUPs that fire with an abrupt onset, rapid buildup and addition of subsequent potentials, and a rapid or *sputtering* cessation.
- Cramp discharges can be identified by the rapid recruitment and irregular firing pattern of MUPs, often associated with the patient’s experience of a painful muscle cramp.
- The potentials fire rapidly (40–60 Hz) and during their discharge they may fire irregularly in a sputtering fashion, especially just before termination.
- Cramp discharges may occur in normal individuals, in chronic neurogenic

disorders, metabolic or electrolyte disturbances, or in peripheral nerve hyperexcitability syndromes.

**Synkinesis**

The aberrant regeneration of axons after nerve injury may result in two different muscles being innervated by the same axon called *synkinesis*. In such cases, voluntary potentials may be mistaken for spontaneous activity. Groups of MUPs fire in bursts in response to voluntary activation of a distant muscle. With synkinesis, MUPs may be normal or abnormal and, when abnormal, they are





**Figure 26–23.** Respiratory synkinesis. Spontaneously firing MUPs in the deltoid with long breaths. The rate and number of potentials increase and then decrease with each inspiration. (From Daube JR. AAEM minimonography #11: needle examination in clinical electromyography. *Muscle & Nerve*. 1991;14:685–700. Used with permission of the publisher.)

typically of long duration due to reinnervation from a neurogenic lesion. A common example of this is *facial synkinesis*, in which facial muscles such as the orbicularis oris spontaneously fire MUPs in association with blinking after facial reinnervation from facial neuropathy (Bells' palsy). Another less common example is *arm–diaphragm synkinesis* (also referred to as *the breathing arm or hand*) in which potentials in shoulder girdle or hand muscles fire in association with respiration as a result of aberrant regeneration of the phrenic nerve following brachial plexus injuries (Fig. 26–23).<sup>50–52</sup>

### Key Points

- Synkinesis is the aberrant regeneration of axons after nerve injury which may result in two different muscles being innervated by the same axon.
- Synkinesis is seen as groups of normal or abnormal MUPs that fire in bursts in response to voluntary activation of a distant muscle.
- Synkinesis may occur in facial muscles following facial nerve palsy or arm muscles following brachial plexus injuries.

## ABNORMAL ELECTRICAL ACTIVITY—VOLUNTARY MUPs

The characteristic features of normal voluntary MUPs have been detailed in the Normal Motor Unit Potentials section of this chapter. The majority of normal MUPs in limb muscles are triphasic with durations of 8–10 ms, stable appearing, and initially fire at rates of 6–8 Hz with an orderly increase in firing rate associated with the firing of additional units (normal recruitment). In neuromuscular

diseases, both MUP firing rates and configurations may be altered. The types of these alterations, in conjunction with the identification of spontaneous discharges, help to identify the underlying type, temporal profile of disease duration, and severity of neuromuscular disorder.

## Abnormal Recruitment

In a normal muscle, increasing voluntary effort causes an increase in the rate of firing of individual MUPs and initiates the discharge of additional MUPs. The relationship between the rate of firing of individual potentials to the number of potentials firing is constant for a particular muscle and is called the *recruitment pattern*.

In disorders in which there is a loss of MUPs, the rate of firing of the remaining individual potentials will be disproportionately high compared to the number of potentials firing; this is referred to as *reduced recruitment*. Reduced recruitment may be found in any disease process that destroys or blocks conduction in the axons innervating the muscle or destroys a sufficient proportion of the muscle so that muscle fibers of entire motor units are lost. This pattern occurs in association with all neurogenic disorders associated with axonal loss and may be the only finding in a neuropathic lesion in which the sole abnormality is a focal conduction block. Reduced recruitment may be the earliest finding in an acute axonal lesion in which fibrillation potentials or other MUP changes have not yet developed. Although a hallmark of neurogenic disorders, reduced recruitment may also be seen in severe or end-stage myopathies, where entire motor units are lost due to primary muscle fiber degeneration, such as in muscular dystrophies.

*Rapid recruitment* of MUPs occurs in disorders in which the force that a single motor unit can generate is decreased due to loss of muscle fibers within the motor unit. As a result, more motor units are activated than would be expected for the force exerted by the patient. The recruitment frequency and rate of firing in relation to number are normal with rapid recruitment; however, the number of motor units that fire is increased relative to force. Rapid recruitment occurs primarily in myopathies. While in many cases, abnormalities in MUP configuration will occur along with abnormal recruitment, this is not always the case and rapid recruitment may be the only abnormality identified on needle examination, particularly in early or mild myopathies.

### Key Points

- Recruitment refers to the relationship between the rate of firing of individual potentials and the number of potentials firing which is constant for a particular muscle.
- Reduced recruitment occurs when the rate of firing of MUPs is increased relative to the number of potentials firing.
- Reduced recruitment is a hallmark of neurogenic disorders and occurs with axonal loss or conduction block.
- Reduced recruitment can be seen in severe or end-stage myopathies.
- Rapid recruitment occurs in disorders in which the force that a single motor unit

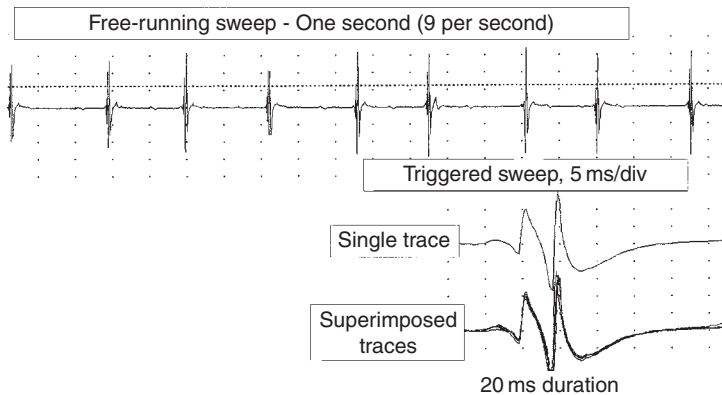
can generate is decreased due to loss of muscle fibers within the motor unit.

- Identification of rapid recruitment requires assessment of patient effort.

### Long-Duration MUPs

MUP duration is measured as the time from the initial baseline deflection to the time of the return to baseline, and reflects the density and area of fibers within a motor unit, as well as the synchrony of firing of those fibers. The size of MUPs in a muscle is dependent on the level of activation, with larger MUPs becoming active at a stronger force.<sup>53</sup> Normal values for MUP duration have been published.<sup>54</sup>

Individual MUPs that are longer than the normal range for a particular muscle or groups of MUPs that have a mean duration greater than the normal range for the same muscle in a patient of the same age are called *long-duration MUPs* (Fig. 26–24). These occur in diseases in which there is increased fiber density in a motor unit, an increased number of fibers in a motor unit, or loss of synchronous firing of fibers in a motor unit, typically due to collateral sprouting and reinnervation of a motor unit. Long-duration MUPs generally have high amplitude and show reduced recruitment, but since the spike amplitude reflects only the few muscle fibers closest to the needle recording tip they may have normal or low amplitude. When assessing MUP duration, those MUPs recorded from damaged muscle



**Figure 26–24.** Single long-duration voluntary MUP displayed on a free-running and triggered sweep. Semirhythmic firing rate of 9 per second without recruitment of other potentials is abnormal for this muscle.

Table 26–10 Disorders Associated with Long-Duration MUPs

Neurogenic disorders	Motor neuron diseases (e.g., ALS, poliomyelitis, spinal muscular atrophy) Chronic axonal neuropathies (e.g., hereditary motor sensory neuropathy type 2, diabetic neuropathy) Chronic radiculopathies or the residua of an old radiculopathy Chronic mononeuropathies or the residua of an old mononeuropathy
Myopathies	Chronic myopathies (e.g., inclusion body myositis)

fibers that are preponderantly positive with a long late negativity, which is a recording artifact, should not be measured or interpreted as long duration.

MUP duration is an important parameter used to distinguish neurogenic disorders from primary muscle diseases.<sup>55</sup> Long-duration MUPs typically occur in chronic neurogenic disorders. Following an acute nerve injury, long-duration MUPs may be seen within several weeks or months after reinnervation has begun. Long-duration MUPs may also be seen in conjunction with short-duration MUPs in chronic myopathies, such as inclusion body myositis or long-standing polymyositis (Table 26–10).

### Key Points

- Long-duration MUPs occur in diseases in which there is increased fiber density in a motor unit, an increased number of fibers in a motor unit, or loss of synchronous firing of fibers in a motor unit, typically due to collateral sprouting and reinnervation of a motor unit.
- Long-duration MUPs typically occur in chronic neurogenic disorders.
- Long-duration MUPs may also be seen in conjunction with short-duration MUPs in chronic myopathies, such as inclusion body myositis or long-standing polymyositis.

### Short-Duration MUPs

Single MUPs that are shorter than the normal range or groups of MUPs that have a mean duration less than the normal range for the same muscle in a patient of the same

age are called *short-duration MUPs*. Short-duration MUPs occur in diseases in which there is (1) physiologic or anatomical loss of muscle fibers from the motor unit or (2) atrophy of component muscle fibers. In these situations the number of innervated muscle fibers within the recording region of the electrode is decreased, thereby leading to a decrease in the area of that motor unit. Commonly, these potentials also have low amplitude and show rapid recruitment with minimal effort, but they may have normal or reduced recruitment and normal amplitudes. The actual duration that identifies a potential as short duration varies with the muscle and age of the patient. Some short-duration MUPs may be as short as 1–3 ms if only a single muscle fiber is in the recording area. This may appear identical to a fibrillation potential or end plate spike, and only the semirhythmic firing pattern may allow for correct identification.

Short-duration MUPs are most characteristic and are often seen in primary muscle diseases in which loss of muscle fibers from necrosis or degeneration occurs (Table 26–11).<sup>56</sup> Some myopathies, such as metabolic and endocrine disorders, show no or few short-duration MUPs. In rare circumstances, short-duration MUPs can occur due to technical problems, such as incorrect filter settings (e.g., low-frequency filter increased from 20 to 500 Hz) or an electrical short in the recording electrode or connecting cables. When short-duration MUPs occur when not expected, these technical problems should be considered and checked.

In addition to myopathies, short-duration MUPs may occur in severe neuromuscular junction disorders or in newly reinnervated motor units following severe nerve injury. These *nascent MUPs* are composed of only a

Table 26–11 Disorders Associated with Short-Duration MUPs

Myopathies	Muscular dystrophies Inflammatory myopathies (e.g., polymyositis, inclusion body myositis) Infiltrative myopathies (e.g., sarcoidosis, amyloid) Toxic myopathies (e.g., lipid-lowering agents, chloroquine) Congenital myopathies Endocrine myopathies (e.g., hypothyroid)
Neuromuscular junction disorders	Myasthenia gravis Lambert–Eaton myasthenic syndrome Botulinum intoxication
Neurogenic disorders	Early reinnervation after nerve damage (“nascent MUP”) Late-stage neurogenic atrophy
Disorders of muscle membrane	Periodic paralysis

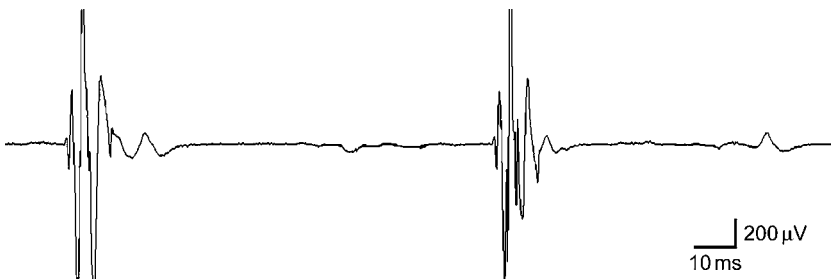
few muscle fiber action potentials, are typically polyphasic, and fire at a very high rate with reduced recruitment.

### Key Points

- Short-duration MUPs occur in diseases in which there is physiologic or anatomical loss of muscle fibers from the motor unit or atrophy of component muscle fibers.
- Short-duration MUPs are most characteristic of primary muscle diseases in which loss of muscle fibers from necrosis or degeneration occurs.
- Short-duration MUPs may also be seen in severe neuromuscular junction disorders.
- Nascent MUPs are short-duration, low-amplitude, polyphasic MUPs that fire with reduced recruitment, and are signs of early reinnervation following a severe nerve lesion.

### Polyphasic MUPs

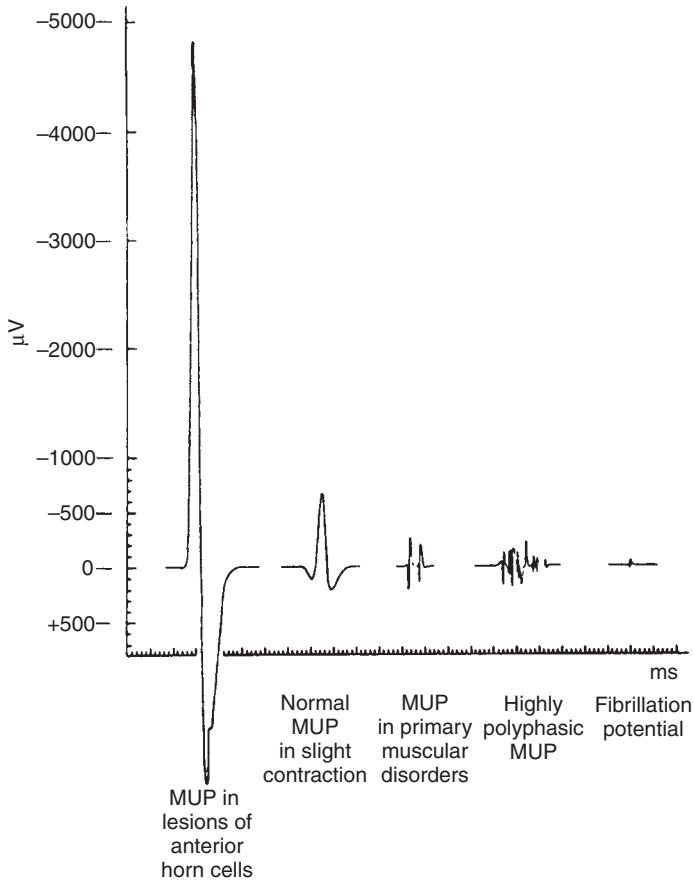
A *phase* of an MUP is defined as the area of a potential on either side of the baseline and is equal to the number of baseline crossings plus one. Most normal MUPs contain three or four phases, and less than 15% will have over four phases. When an MUP consists of five or more phases, it is called a *polyphasic MUP* (Figs. 26–25 and 26–26). The individual components of a polyphasic potential are action potentials recorded from a single or a few muscle fibers. The degree of phases reflects the synchrony of firing of the action potentials of muscle fibers within the MUP and when the fibers fire asynchronously, the number of phases (or turns) increases. This may occur as a result of collateral sprouting, reinnervation, and an increase in fiber density (in neurogenic disorders) or due to relative asynchrony from drop-out of muscle fibers or differences in muscle fiber conduction velocities in the motor unit (in myopathies).



**Figure 26–25.** Polyphasic, long-duration MUP displayed on a free-running sweep at 10 ms per division. (From Daube JR. AAEM minimonography #11: needle examination in clinical electromyography. *Muscle & Nerve*. 1991;14:685–700. Used with permission of the publisher.)

Polyphasic potentials may be of any duration—normal, long, or short. Some may have late, satellite components, sometimes called *linked potentials* or *satellite potentials*, which give the total unit a long duration<sup>57</sup>

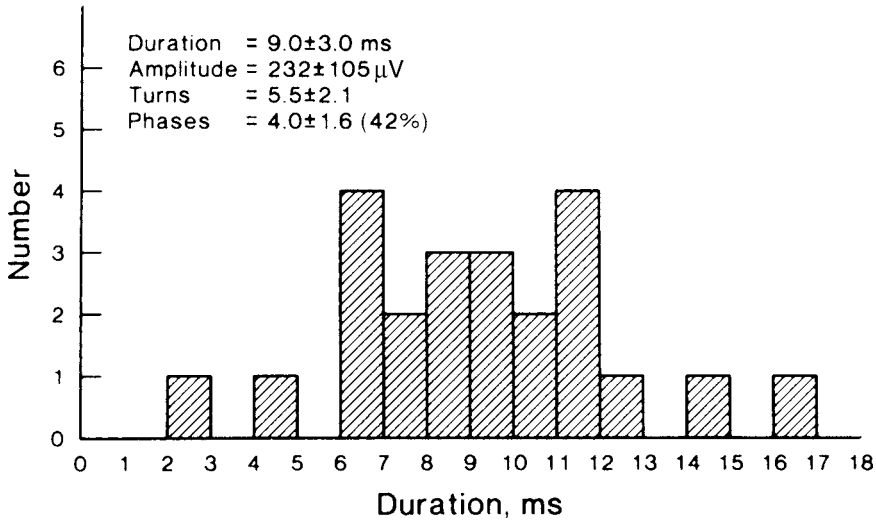
(Figs. 26–26 and 26–27). However, isolated satellite potentials should not be included in the duration measurement of the MUPs when comparing to normative data. Polyphasic MUPs may occur in any of the myopathies



**Figure 26–26.** Relative average durations and amplitudes of some electric potentials observed in EMG of human muscle. (From Daube, J.R. 1991. AAEM minimonography #11: Needle examination in clinical electromyography. *Muscle & Nerve* 14:685–700. By permission of John Wiley & Sons.)



**Figure 26–27.** Long-duration polyphasic MUP with satellite potential. (From Daube JR. AAEM minimonography #11: needle examination in clinical electromyography. *Muscle & Nerve*. 1991;14:685–700. Used with permission of the publisher.)



**Figure 26-28.** Patient with inclusion body myositis. Quantitation of MUPs shows a bimodal distribution. (From Daube, J. R. 1991. AAEM minimonography #11: Needle examination in clinical electromyography. *Muscle & Nerve* 14:685-700. By permission of John Wiley & Sons.) (From Daube JR. AAEM minimonography #11: needle examination in clinical electromyography. *Muscle & Nerve*. 1991;14:685-700. Used with permission of the publisher.)

or the neurogenic disorders and are graded by the percentage of MUPs in the muscle that are polyphasic.

### Key Points

- A *phase* of an MUP is defined as the area of a potential on either side of the baseline and is equal to the number of baseline crossings plus one.
- When an MUP consists of five or more phases, it is called a *polyphasic MUP*.
- In a normal muscle, no more than 15% of MUPs are polyphasic.
- The degree of phases reflects the synchrony of firing of the action potentials of muscle fibers.
- Polyphasic MUPs may be seen in myopathies or in neurogenic disorders.

### Mixed Patterns: Long-Duration and Short-Duration MUPs

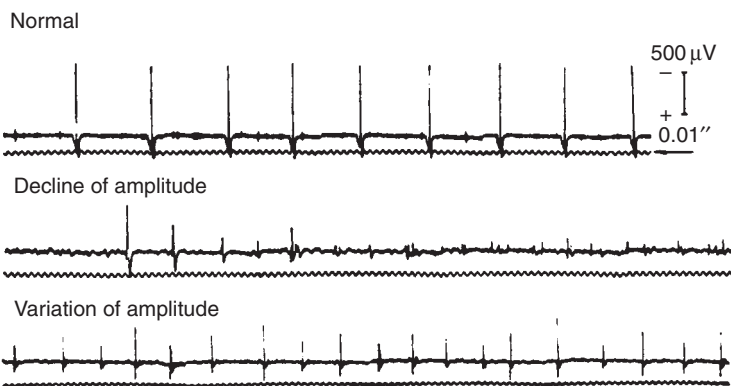
Occasionally, patients have a combination of the abnormalities described for short, long, and polyphasic MUPs, but instead of having the usual pattern of an excess of either long-duration or short-duration potentials, both types occur. The quantitative distribution becomes broad rather than shifting to long

or short. Rarely, the distribution of durations may be bimodal (Fig. 26-28). These combinations commonly occur in chronic myositis or in rapidly progressing motor neuron disease.

### Varying or Unstable MUPs

MUPs fire repetitively under voluntary control, and they normally have the same amplitude, duration, and configuration each time they fire. Fluctuation of any of these variables during repeated discharge of an MUP is abnormal and produces *varying* or *unstable MUPs*. Varying MUPs are caused by blocking of the discharge of action potentials of one or a few of the individual muscle fibers comprising the motor unit. The disorders in which MUPs fluctuate from moment to moment (Fig. 26-29) are listed in Table 26-12. Varying MUPs are classically seen in disorders of neuromuscular transmission, such as myasthenia gravis (MG) or Lambert-Eaton myasthenic syndrome (LEMS), but may also be seen in reinnervating neurogenic disorders and occasionally in myopathies. In disorders of muscle membrane, such as myotonia, there may be a slower progressive decrease or increase in an MUP (Fig. 26-30). In MG or in cases of active reinnervation, the amplitude initially may decline, but in the myasthenic syndrome, it may increase (Fig. 26-31).

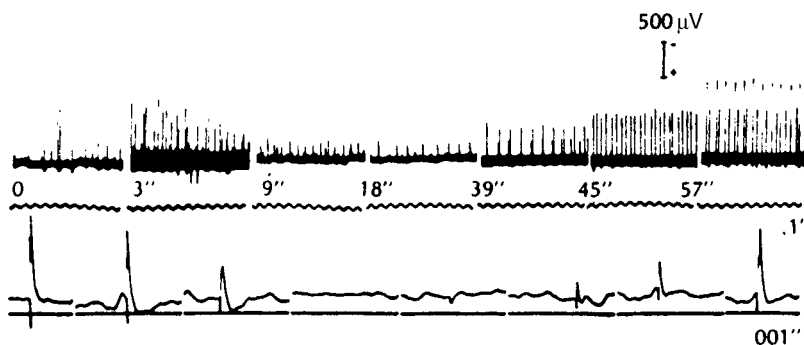




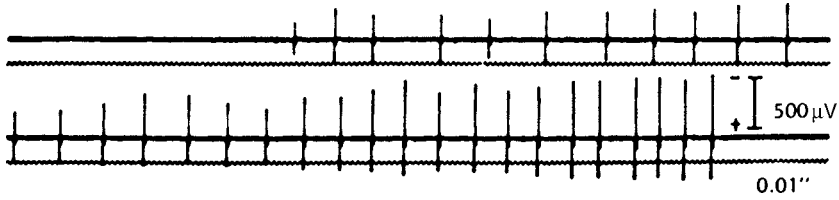
**Figure 26–29.** *Top*, Normal voluntary MUPs. *Middle and bottom*, Motor unit instability in MG. (From Daube, J. R. 1991. AAEM minimonography #11: Needle examination in clinical electromyography. *Muscle & Nerve* 14:685–700. By permission of John Wiley & Sons.) (From Daube JR. AAEM minimonography #11: needle examination in clinical electromyography. *Muscle & Nerve*. 1991;14:685–700. Used with permission of the publisher.)

**Table 26–12 Disorders Associated with Varying (Unstable) MUPs**

Neuromuscular junction disorders	Myasthenia gravis Lambert–Eaton myasthenic syndrome Botulism Congenital myasthenic syndromes
Neurogenic disorders	Reinnervation after nerve injury Progressing neurogenic disorders (e.g., ALS)
Myopathies	Inflammatory myopathies



**Figure 26–30.** Schema of motor unit potential showing characteristics that can be measured. Rise time defines the distance from the generator. Spikes and turns reflect the number of fibers; duration is determined by fiber size and synchrony. Stability changes with disorders of the neuromuscular junction or nerve terminal. (From Daube, J. R. 1991. AAEM minimonography #11: Needle examination in clinical electromyography. *Muscle & Nerve* 14:685–700. By permission of John Wiley & Sons.) (From Daube JR. AAEM minimonography #11: needle examination in clinical electromyography. *Muscle & Nerve*. 1991;14:685–700. Used with permission of the publisher.)



**Figure 26-31.** MUP variation with gradual increase in amplitude in the LEMS. (From Daube, J. R. 1991. AAEM minimonography #11: Needle examination in clinical electromyography. *Muscle & Nerve* 14:685-700. By permission of John Wiley & Sons.) (From Daube JR. AAEM minimonography #11: needle examination in clinical electromyography. *Muscle & Nerve*. 1991;14:685-700. Used with permission of the publisher.)

**Key Points**

- Varying MUPs occur when there is blocking of the discharge of action potentials of one or a few of the muscle fibers within the motor unit.
- MUP variation may occur in disorders of neuromuscular transmission or reinnervating neurogenic disorders.

**Doublets (Multiplets)**

Motor units under voluntary control normally discharge as single potentials in a semirhythmic fashion. In some disorders or occasionally in otherwise normal individuals, they fire two or more times at short intervals of 10-30 ms (Table 26-13) (Fig. 26-32). These are called *doublets*, *triplets*, or *multiplets*. The bursts of two or more potentials recur in a semirhythmic pattern under voluntary control. They are often increased by hyperventilation, hypocalcemia, or ischemia. Additionally, doublets or multiplets may be seen in patients with disorders of peripheral nerve hyperexcitability, often associated with voltage-gated potassium

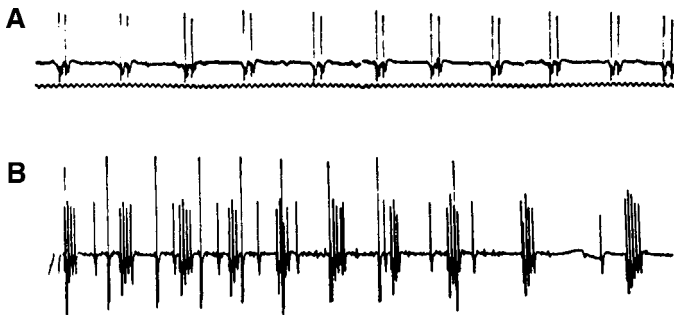
channel antibodies.<sup>47</sup> In these patients, the doublets and multiplets have been reported to occur more commonly in distal muscles and the intraburst frequency ranges from 40 to 350 Hz.<sup>47</sup>

**Key Points**

- Doublets or multiplets are the repetitive firing of the same MUP two or more times at short intervals (10-30 ms) in a semirhythmic pattern.
- Doublets or multiplets may be seen with hyperventilation, hypocalcemia, ischemia, or hyperexcitable nerve syndromes.

**Table 26-13 Disorders Associated with Doublets or Multiplets**

Hyperventilation
Tetany
Motor neuron disease (infrequent)
Syndrome of peripheral nerve hyperexcitability (Isaac's syndrome)
Other metabolic diseases



**Figure 26-32.** Voluntary MUPs. A, Doublets. B, Multiplets. (From Daube, J. R. 1991. AAEM minimonography #11: Needle examination in clinical electromyography. *Muscle & Nerve* 14:685-700. By permission of John Wiley & Sons.)

## ABNORMAL ELECTRICAL ACTIVITY—DISORDERS OF CENTRAL CONTROL

Normal MUPs may fire spontaneously in different patterns as a result of central nervous system motor disorders. When this occurs, the MUP configuration is normal, since there is no dysfunction of the motor unit.

### Tremor

Tremor is the most common pattern of motor unit firing that is caused by disorders of the central nervous system. Tremor must be recognized because the discharge may be confused with the changes seen with lower motor neuron disease, such as polyphasic MUPs or myokymic discharges. While the electrical discharge in tremor is often associated with a clinical tremor, this is not always the case. In muscle tremor, MUPs fire in groups but not in a fixed relation. The potentials of these motor units are superimposed and may resemble polyphasic, complex, or long-duration MUPs (Fig. 26–33). They are recognized by their rhythmic (often regular) pattern and changing appearance. Minimal activation, with slightly increasing and decreasing effort, often allows single MUPs to be resolved and characterized.

### Dystonia, Rigidity, Spasticity, Stiff-man syndrome

MUP firing patterns in dystonia, rigidity, spasticity, and stiff-man syndrome are normal and resemble normal patterns with less

voluntary control. In upper motor neuron weakness, patients cannot maintain motor unit firing.

### Key Points

- Tremor is characterized by MUPs firing in groups but not in a fixed relation; the potentials of these motor units are superimposed and may resemble polyphasic, complex, or long-duration MUPs.
- MUP firing patterns in dystonia, rigidity, spasticity, and stiff-man syndrome are normal MUP and resemble normal patterns but with loss of voluntary control.

## PATTERNS OF ABNORMALITIES

The types of needle EMG abnormalities described above may occur in different combinations. Only through knowledge of these combinations can reliable interpretations be made. No single finding allows the identification of a specific disease. The combinations of particular forms of spontaneous activity and changes in MUPs in neuromuscular diseases are too varied to be included in this review, but some general comments about patterns of abnormality of MUPs can be made. MUP changes have been divided broadly into neuropathic and myopathic.<sup>58</sup> The concept that MUP changes must be either one or the other of these two types is incorrect and can lead to misinterpretations.

Each of the variables—recruitment, duration, amplitude, configuration, and stability—of MUPs may be altered separately or in

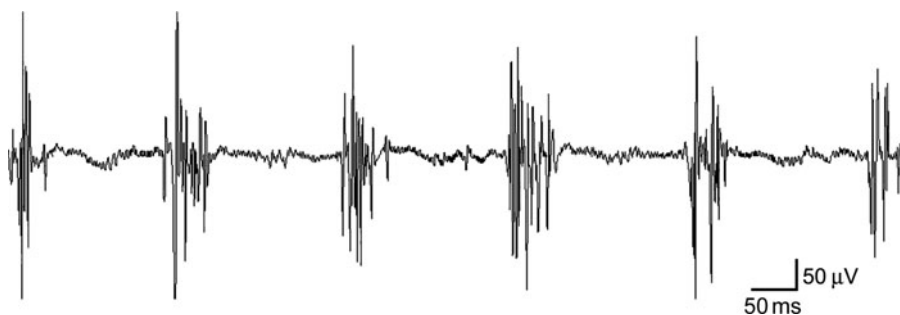
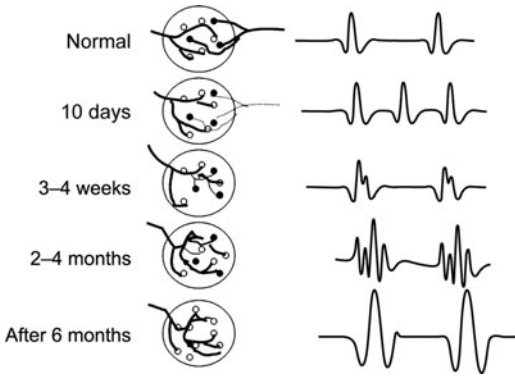


Figure 26–33. Superimposed MUPs with tremor that resemble polyphasic potentials.



**Figure 26-34.** Temporal profile of MUPs changes in neurogenic diseases.

judged individually, quantified if necessary, and compared with normal values. The result should then be interpreted on the basis of known pathophysiologic mechanisms or by common association with known disorders. Recruitment, duration, and stability are the important features of MUPs in determining the underlying pathologic factors. With these three criteria, it is possible to distinguish most patterns of MUP abnormality. Each pattern of abnormality changes with the severity and duration of the disease (Fig. 26-34). Careful attention to the independent changes of the variables of MUPs can allow an electromyographer to comment on the severity, duration, and prognosis of a disease.<sup>60</sup> Because of the various patterns that may be found, a description of the abnormalities should always

combination with one or more of the others in different disorders.<sup>59</sup> Each must be

**Table 26-14 Patterns of Abnormalities Seen With Needle EMG**

Recruitment	MUP appearance	Variation	Disorder
Normal	Normal	No	Normal
		Yes	Some metabolic or endocrine myopathies
	Short duration, polyphasic	No	Neuromuscular junction disorders (e.g., MG, LEMS)
		Yes	Primary myopathies
		Yes	Severe neuromuscular junction disorders (e.g., MG, LEMS, botulism)
		Yes	Primary myopathies (occasionally)
Mixed short and long duration	No or Yes	Chronic myopathies (e.g., inclusion body myositis)	
Reduced	Normal	No	Acute neurogenic lesion
		Yes	Subacute neurogenic lesion
	Long duration, polyphasic	No	Chronic neurogenic lesion
		Yes	Chronic, progressing neurogenic lesion
	Short duration, polyphasic	No	Severe myopathy
		No	End-stage neurogenic disorder
		Yes	Early reinnervation after severe nerve damage
		Yes	Severe, reinnervating neurogenic disorders
Mixed short and long duration	No or Yes	Rapidly progressing neurogenic disorders (e.g., ALS)	
Rapid	Normal	No	Mild myopathies
		Yes	—
	Short duration	No	Myopathies
		Yes	Myopathies
	Long duration	No	Chronic myopathies
		Yes	Chronic myopathies (occasionally)

include comments about each of the variables. The findings then can be interpreted most reliably by listing the disorders that may be seen with the pattern of abnormality found (Table 26–14).

## SUMMARY

Virtually all primary neuromuscular diseases result in changes in the electric activity recorded from muscle fibers. These changes can best be depicted using fine needle electrodes inserted into the muscle to record spontaneous and voluntary EMG. Thus, EMG can be used to distinguish among lower motor neuron, peripheral nerve, neuromuscular junction, and muscle disease with great sensitivity and some specificity. The sensitivity is usually greater than clinical measures; specificity in identifying the cause of the disease often requires muscle biopsy or other clinical measures. Although EMG is somewhat uncomfortable for patients because needles need to be inserted into the muscles, it generally is well tolerated by patients and provides a rapid, efficient means of testing the motor unit.

The application of techniques of clinical neurophysiology in the evaluation of peripheral neuromuscular disorders relies heavily on needle EMG. It was the first of the electrophysiologic techniques to be applied in this way, and it has remained a mainstay of electrodiagnosis. The collection of data with needle EMG and the interpretation for clinical purposes require a firm understanding of the physiology of muscle fibers and motor units. It is heavily dependent on controlling technical factors, mastering the skills of data collection, and understanding the changes that occur with the many disorders that may affect peripheral nerves, neuromuscular junctions, and muscle.

The essence of quality needle EMG rests with the ability to isolate, recognize, and interpret the wide range of specific waveforms and their variation that occur in normal and diseased muscle. The nature and meaning of fibrillation potentials and the alteration in appearance and firing pattern of MUPs in each muscle tested are the data on which a clinical interpretation is based. The extent and distribution of these abnormalities allow conclusions to be drawn about the type and severity of

disease, its duration or stage of evolution, and the likely anatomical location of the pathologic process.

## REFERENCES

- Caruso, G., A. Eisen, E. Stålberg, et al. 1999. Clinical EMG and glossary of terms most commonly used by clinical electromyographers. The International Federation of Clinical Neurophysiology. *Electroencephalography and Clinical Neurophysiology* 52(Suppl):189–98.
- Stålberg, E., B. Falck, A. Gilai, J. Jabre, M. Sonoo, and K. Todnem. 1999. Standards for quantification of EMG and neurography. The International Federation of Clinical Neurophysiology. *Electroencephalography and Clinical Neurophysiology* 52(Suppl): 213–20.
- Strommen, J. A., and J. R. Daube. 2001. Determinants of pain in needle electromyography. *Clinical Neurophysiology* 112:1414–18.
- Fuglsang-Frederiksen, A. 1987. Quantitative electromyography. I. Comparison of different methods. *Electromyography and Clinical Neurophysiology* 27:327–33.
- Fuglsang-Frederiksen, A. 1987. Quantitative electromyography. II. Modifications of the turns analysis. *Electromyography and Clinical Neurophysiology* 27:335–8.
- Fuglsang-Frederiksen, A., and J. Ronager. 1990. EMG power spectrum, turns-amplitude analysis and motor unit potential duration in neuromuscular disorders. *Journal of the Neurological Sciences* 97:81–91.
- Pfeiffer, G., and K. Kunze. 1992. Turn and phase counts of individual motor unit potentials: Correlation and reliability. *Electromyography and Clinical Neurophysiology* 85:161–5.
- Al-Shekhlee, A., B. E. Shapiro, and D. C. Preston. 2003. Iatrogenic complications and risks of nerve conduction studies and needle electromyography. *Muscle & Nerve* 27:517–26.
- Gruis, K. L., A. A. Little, V. A. Zebarah, and J. W. Albers. 2006. Survey of electrodiagnostic laboratories regarding hemorrhagic complications from needle electromyography. *Muscle & Nerve* 34:356–8.
- Rosioreanu, A., A. Dickson, S. Lypen, and D. S. Katz. 2005. Pseudoaneurysm of the calf after electromyography: Sonographic and CT angiographic diagnosis. *American Journal of Roentgenology* 185:282–3.
- Butler, M. L., and R. W. Dewan. 1984. Subcutaneous hemorrhage in a patient receiving anticoagulant therapy: An unusual EMG complication. *Archives of Physical Medicine and Rehabilitation* 65:733–4.
- Lynch, S., A. Boon, J. Smith, and C. Harper. 2008. Complications of needle electromyography: Hematoma risk and correlation with anticoagulation and antiplatelet therapy. *Muscle & Nerve*, 38:1225–30.
- AANEM Position Statement. 2005. Needle EMG in certain uncommon clinical contexts. *Muscle & Nerve* 31:398–9.
- Dumitru, D., J. C. King, and S. D. Nandedkar. 1997. Motor unit action potential duration recorded by

- monopolar and concentric needle electrodes. Physiological implications. *American Journal of Physical Medicine & Rehabilitation* 76:488-93.
15. Chan, R. C., and T. C. Hsu. 1991. Quantitative comparison of motor unit potential parameters between monopolar and concentric needles. *Muscle & Nerve* 14:1028-32.
  16. Walker, W. C., L. A. Keyser-Marcus, J. S. Johns, and R. T. Seel. 2001. Relation of electromyography-induced pain to type of recording electrodes. *Muscle & Nerve* 24: 417-20.
  17. Stålberg, E. 1980. Macro EMG, a new recording technique. *Journal of Neurology, Neurosurgery, and Psychiatry* 43:475-82.
  18. Finsterer, J., and A. Fuglsang-Frederiksen. 2000. Concentric needle EMG versus macro EMG I. Relation in healthy subjects. *Clinical Neurophysiology* 111:1211-15.
  19. Gan, R., and J. F. Jabre. 1992. The spectrum of concentric macro EMG correlations. Part II. Patients with diseases of muscle and nerve. *Muscle & Nerve* 15:1085-8.
  20. Schulte-Mattler, W. J., D. Georgiadis, and S. Zierz. 2001. Discharge patterns of spontaneous activity and motor units on concentric needle electromyography. *Muscle & Nerve* 24:123-6.
  21. Stålberg, E., and L. Karlsson. 2001. Simulation of the normal concentric needle electromyogram by using a muscle model. *Clinical Neurophysiology* 112: 464-71.
  22. Stålberg, E., and L. Karlsson. 2001. Simulation of EMG in pathological situations. *Clinical Neurophysiology* 112:869-78.
  23. Lorente de Nó, R. 1947. *A Study of Nerve Physiology. Studies from the Rockefeller Institute for Medical Research*, Vol. 132, 466-70. New York: The Rockefeller Institute for Medical Research.
  24. Okajima, Y., Y. Tomita, R. Ushijima, and N. Chino. 2000. Motor unit sound in needle electromyography: Assessing normal and neuropathic units. *Muscle & Nerve* 23:1076-83.
  25. Jiang, G. L., L. Y. Zhang, L. Y. Shen, J. G. Xu, and Y. D. Gu. 2000. Fibrillation potential amplitude to quantitatively assess denervation muscle atrophy. *Neuromuscular Disorders* 10:85-91.
  26. Dumitru, D., King J. C., and D. F. Stegeman. 1998. Endplate spike morphology: A clinical and simulation study. *Archives of Physical Medicine and Rehabilitation* 79:634-40.
  27. Conwit, R. A., B. Tracy, A. Cowl, et al. 1998. Firing rate analysis using decomposition-enhanced spike triggered averaging in the quadriceps femoris. *Muscle & Nerve* 21:1338-40.
  28. Gunreben, G., and W. Schulte-Mattler. 1992. Evaluation of motor unit firing rates by standard concentric needle electromyography. *Electromyography and Clinical Neurophysiology* 32:103-11.
  29. Schulte-Mattler, W. J., D. Georgiadis, K. Tietze, and S. Zierz. 2000. Relation between maximum discharge rates on electromyography and motor unit number estimates. *Muscle & Nerve* 23:231-8.
  30. Sun, T. Y., J. J. Chen, and T. S. Lin. 2000. Analysis of motor unit firing patterns in patients with central or peripheral lesions using singular-value decomposition. *Muscle & Nerve* 23:1057-68.
  31. Bischoff, C., J. Machetanz, and B. Conrad. 1991. Is there an age-dependent continuous increase in the duration of the motor unit action potential? *Electromyography and Clinical Neurophysiology* 81:304-11.
  32. Buchthal, F., P. Pinelli, and P. Rosenfalck. 1954. Action potential parameters in normal human muscle and their physiological determinants. *Acta Physiologica Scandinavica* 32:219-29.
  33. Dumitru, D., J. C. King, and D. F. Stegman. 1998. Normal needle electromyographic insertional activity morphology: A clinical and simulation study. *Muscle & Nerve* 21:910-20.
  34. Mitchell, C. W., and T. E. Bertorini. 2007. Diffusely increased insertional activity: "EMG Disease" or asymptomatic myotonia congenita? A report of 2 cases. *Archives of Physical Medicine and Rehabilitation* 88:1212-13.
  35. Dumitru, D. 2000. Configuration of normal and abnormal non-volitional single muscle fiber discharges. *Clinical Neurophysiology* 111:1400-10.
  36. Dumitru, D., and J. C. King. 2000. Hybrid fibrillation potentials and positive sharp waves. *Muscle & Nerve* 23:1234-42.
  37. Nandedkar, S. D., P. E. Barkhaus, D. B. Sanders, and E. V. Stålberg. 2000. Some observations on fibrillations and positive sharp waves. *Muscle & Nerve* 23: 888-94.
  38. Kraft, G. H. 1990. Fibrillation potential amplitude and muscle atrophy following peripheral nerve injury. *Muscle & Nerve* 13:814-21.
  39. Barkhaus, P. E., and S. D. Nandedkar. 2006. "Slow" myotonic discharges. *Muscle & Nerve* 34:799-800.
  40. Logigian, E. L., E. Ciafaloni, C. Quinn, et al. 2007. Severity, type, and distribution of myotonic discharges are different in type 1 and type 2 myotonic dystrophy. *Muscle & Nerve* 35:479-85.
  41. Fournier, E., M. Arzel, D. Sternberg, et al. 2004. Electromyography guides toward subgroups of mutations in muscle channelopathies. *Annals of Neurology* 56:650-61.
  42. Roth, G. 1994. Repetitive discharge due to self-efferent excitation of a motor unit. *Electroencephalography and Clinical Neurophysiology* 93:1-6.
  43. Costa, J., P. Graca, T. Evangelista, and M. de Carvalho. 2005. Pain and calf hypertrophy associated with spontaneous repetitive discharges treated with botulinum toxin. *Clinical Neurophysiology* 116:2847-52.
  44. Mateen, F. J., E. J. Sorenson, and J. R. Daube. 2007. Comparison of clinical methods for fasciculation detection in amyotrophic lateral sclerosis. *Muscle & Nerve* 36:404-5.
  45. de Carvalho, M., and M. Swash. 1998. Fasciculation potentials: A study of amyotrophic lateral sclerosis and other neurogenic disorders. *Muscle & Nerve* 21:336-44.
  46. Hart, I. K. 2000. Acquired neuromyotonia: A new autoantibody-mediated neuronal potassium channelopathy. *American Journal of Medicine and Sciences* 319:209-16.
  47. Maddison, P., K. R. Mills, and J. Newsom-Davis. 2006. Clinical electrophysiological characterization of the acquired neuromyotonia phenotype of autoimmune peripheral nerve hyperexcitability. *Muscle & Nerve* 33:801-8.



48. Hart, I. K., P. Maddison, J. Newsom-Davis, A. Vincent, and K. R. Mills. 2002. Phenotypic variants of autoimmune peripheral nerve hyperexcitability. *Brain* 125:1887–95.
49. Loscher, W. N., J. Wanschitz, K. Reiners, and S. Quasthoff. 2004. Morvan's syndrome: Clinical, laboratory, and in vitro electrophysiological studies. *Muscle & Nerve* 30:157–63.
50. Friedenberg, S. M., and R. C. Hermann. 2004. The breathing hand: Obstetric brachial plexopathy reinnervation from thoracic roots? *Journal of Neurology, Neurosurgery, and Psychiatry* 75:158–60.
51. Swift, T. R. 1994. The breathing arm. *Muscle & Nerve* 17:125–9.
52. Swift, T. R., R. T. Leshner, and J. A. Gross. 1980. Arm-diaphragm synkinesis: Electrodiagnostic studies of aberrant regeneration of phrenic motor neurons. *Neurology* 30:339–44.
53. Akaboshi, K., Y. Masakado, and N. Chino. 2000. Quantitative EMG and motor unit recruitment threshold using a concentric needle with quadrifilar electrode. *Muscle & Nerve* 23:361–7.
54. Buchthal, F. 1991. Electromyography in the evaluation of muscle diseases. In *Methods in clinical neurophysiology*, ed. A. Fuglsang-Frederiksen, Vol. 2, Number 2. Skovlunde, Denmark: DANTEC Elektronik.
55. Pfeiffer, G. 1999. The diagnostic power of motor unit potential analysis: An objective bayesian approach. *Muscle & Nerve* 22:584–91.
56. Liguori, R., A. Fuglsang-Frederiksen, W. Nix, P. R. Fawcett, and K. Andersen. 1997. Electromyography in myopathy. *Neurophysiologie Clinique* 27: 200–3.
57. Lang, A. H., and V. S. Partanen. 1976. "Satellite potentials" and the duration of motor unit potentials in normal, neuropathic and myopathic muscles. *Journal of Neurological Sciences* 27:513–24.
58. Buchthal, F. 1977. Electrophysiological signs of myopathy as related with muscle biopsy. *Acta Neurol (Napoli)* 32:1–29.
59. Sonoo, M., and E. Stålberg. 1993. The ability of MUP parameters to discriminate between normal and neurogenic MUPs in concentric EMG: Analysis of the MUP "thickness" and the proposal of "size index." *Electroencephalography and Clinical Neurophysiology* 89:291–303.
60. Johnston, S. C. 2000. Prognostication matters. *Muscle & Nerve* 23:839–42.

*This page intentionally left blank*

# Quantitative Electromyography

*Benn E. Smith*

**INTRODUCTION**  
**CHARACTERISTICS OF THE**  
**MOTOR UNIT POTENTIAL**  
**CHARACTERISTICS OF THE**  
**RECORDING EQUIPMENT**  
**PROPERTIES OF MUPs**  
**EVALUATED USING**  
**STANDARD ELECTRODES**

Duration  
Area  
Amplitude  
Rise Time  
Spike Duration  
Phases and Turns  
Stability and Variation

**PROPERTIES OF MUPs**  
**MEASURABLE ONLY WITH**  
**SPECIAL ELECTRODES**  
**QUANTITATIVE ANALYSIS OF**  
**SINGLE MUPs**

Manual Analysis  
Computer-Assisted Quantitative  
Analysis of User Selected MUP

Automated Analysis of Single MUPs  
Automated Decomposition  
EMG  
Multiple Motor Unit Action Potential  
Decomposition-based  
quantitative EMG

**PROPERTIES OF INTERFERENCE**  
**PATTERN AND METHODS OF**  
**INTERFERENCE PATTERN**  
**ANALYSIS**

Method  
Analysis  
Utility

**TURNS AND AMPLITUDE**  
**ANALYSIS OF THE**  
**INTERFERENCE PATTERN**  
**POWER-SPECTRUM**  
**ANALYSIS**

**AUTOMATED METHODS OF**  
**ANALYSIS OF SPONTANEOUS**  
**ACTIVITY**  
**SUMMARY**

## INTRODUCTION

In most clinical electromyography (EMG) laboratories motor unit potential (MUP) activity is analyzed subjectively or at most by semi-quantitative EMG methods (see Chapter 26).

This approach is fast, efficient, and reasonably accurate if the electromyographer has a solid foundation in quantitative EMG and is experienced from studying large numbers of patients across the spectrum of age and disease. Inexperienced electromyographers are more prone to

error than their seasoned counterparts. What are the principal types of error in this situation? Examiner bias toward a particular diagnosis is easily introduced during subjective MUP analysis. A number of cases encountered regularly in the practice of EMG are not readily solved by the strategy of semiquantitative analysis. For instance, it is common to encounter challenging cases with mild or equivocal disease in which the examiner, after the usual subjective analysis of MUP data, is in doubt about whether the findings are minimally abnormal or normal. Another frequent situation faced by the electromyographer is borderline results in patients who may have mild myopathy or possible radiculopathy and questionably abnormal MUPs in a few muscles. In addition, in some neuromuscular diseases EMG findings are mixed, with both large and small MUPs. In these kinds of cases, more objective measures of MUP variables might help to resolve the uncertainties the examiner may have regarding the EMG findings.

These issues have led to efforts to use quantitation to analyze electrophysiologic results. The quantitative approach focuses on measuring electric activity from muscle fibers and motor units as accurately as possible and to record numerical values derived from these precise measurements. These numerical data can be statistically analyzed and graphed to illustrate findings. Data from groups of normal subjects can be collected and compared with data from patients suspected of having disease.

The advantages that quantitation holds over subjective or semiquantitative EMG methods are many. The main aim of quantitation is to enable separation of patients into major diagnostic categories; for example, those with neuromuscular disease and those without neuromuscular disease, and patients with myopathies from those with neurogenic disorders or defects of neuromuscular transmission. Similarly quantitation should markedly reduce examiner bias, and therefore false-negative and false-positive EMG studies resulting from this systematically faulty approach. By virtue of the ease of sorting and comparing sets of numerical data, quantitation should allow distinctions to be made regarding severity of disease in different patients with the same disorder or in a single patient at different times during the course of the disease and its treatment. In terms of reliability, quantitative EMG should

produce reproducible results when performed by the same examiner at different times and by different examiners in the same or different institutions. Provided that the same techniques are used, comparisons of the results from different laboratories should be more robust, and reporting of normal and abnormal results in the literature should be more amenable to statistical analysis and critical assessment by others in the field. What would be the characteristics of an ideal method of quantitative EMG? Compared to conventional subjective or semiquantitative EMG, such a technique would be less time-consuming, be relatively easy to perform, be available on all existing EMG platforms (without the need to acquire additional hardware), be inexpensive, improve accuracy and reliability, be applicable to all muscles, and come with rigorously collected normal control values across a broad range of ages and muscles in males and females. In addition, the technique should sample a large number of motor units in the muscle being studied. Ideally, it would be helpful to the profession to have access to a variety of such techniques which would assess EMG activity in different ways and allow the extraction of data that have not been available with previous methods.

Although quantitative EMG methods have brought the field closer to many of these aspirations, a number of disadvantages remain to be solved. These include increased costs for software and hardware, in some cases the need for special equipment, and, depending on the technique, extra time to learn and perform the examinations. The introduction of any new techniques, including quantitative EMG methods, requires the establishment of new normal control data, a process requiring considerable time and expense. Also, novel techniques must be shown to be superior to the best methods currently available for routine clinical practice and be convincingly demonstrated to be applicable even in difficult cases with subtle abnormalities. Signals acquired from nerve conduction studies, evoked potential testing, and needle examination recordings have all been quantified. Spontaneous activity and voluntary activity on needle EMG are among the most difficult to quantify due to the complexity and rapid firing rates of the constituent waveforms. The development of analog-to-digital conversion of needle examination data and the availability of low-cost, fast digital processors

are leading to the development of automated techniques of evaluating MUPs and the interference pattern. This chapter considers only quantitative analysis of the findings on needle EMG.

### **Purpose and Role of Quantitative EMG**

- Quantitative EMG measurements of MUPs record numerical values derived from precise measurements.
- Quantitative EMG generates normative data and compares with data from patients with suspected neuromuscular diseases.
- Quantitative EMG allows for reproducible results that can be compared at different times by different examiners and in different labs.
- Quantitative EMG allows accurate assessment of improvement or deterioration in disease severity over time.

## **CHARACTERISTICS OF THE MOTOR UNIT POTENTIAL**

The MUP, sometimes referred to as the *motor unit action potential*, is the sum of individual potentials from muscle fibers within the recording area of the electrode which are innervated by a single anterior horn cell. The distinguishing features of the MUP are the result of several complex factors which reflect the characteristics of the motor unit. The number of motor units in a given muscle varies by the anatomic site and size of the muscle. Estimates range from 100–500 motor units in a typical muscle in a human extremity. Different types of lower motor neurons (LMNs) (types I and II) comprise the 100–500 motor units. In general, type I LMNs are activated at low levels of force, have smaller nerve cell bodies and motor axons, and generate smaller MUPs. Type II LMNs are larger, have larger axons, produce larger MUPs, and are activated at higher levels of force.<sup>1,2</sup>

The number of muscle fibers innervated by each LMN is termed the *innervation ratio*. This value varies by the LMN pool. In the extraocular muscles, there are as few as 9 muscle fibers per motor unit, compared with 1900 muscle fibers per motor unit in the gastrocnemius muscle.<sup>3</sup> The muscle fibers of one motor unit are distributed over 5–10 mm

volume of the cross-sectional diameter of the muscle. This is called the *motor unit territory*. The number of muscle fibers per given cross-sectional area in the motor unit territory is the *fiber density*. In a given muscle, motor unit territories from different motor neurons overlap and interdigitate, meaning that directly adjacent muscle fibers may belong to separate motor units.

The synchrony of firing of muscle fibers in a motor unit influences how the MUP appears on the EMG screen. The synchrony of firing is determined by the (1) length, diameter, and conduction velocity of the motor nerve terminals; (2) the location and function of the neuromuscular junctions; (3) the diameter, conduction velocity, and membrane characteristics of the muscle fibers; (4) temperature; and (5) the physical arrangement of muscle fibers in the motor unit.

In most muscles, individual muscle fibers have only one neuromuscular junction, or end plate. Exceptions are the extraocular muscles and the extensor digitorum muscle in the forearm.<sup>4</sup> The location of the neuromuscular junction is termed the *end plate zone*; this varies from muscle to muscle. In the biceps brachii muscle, for example, the end plate zone is an irregular V-shaped band 5 mm wide, but in the deltoid muscle, it forms an irregular sinusoidal pattern across the muscle. In the anterior tibial muscle, the end plate zone is at the periphery and is cone-shaped.

The characteristics of the action potentials generated by individual muscle fibers are fundamental to the attributes of the MUP. Muscle cell diameter and conduction velocity (typically 1.5–6.5 m/second) affect the muscle-fiber action potentials that summate to form the MUP. The amount and properties of the tissue interposed between the measuring electrode and the discharging muscle fibers, including connective tissue, blood vessels, and fat, affect the MUP. These intervening tissues act as a high-frequency filter and as such diminish high-frequency signals and relatively enhance low-frequency activity.

### **Key Points**

- The MUP is the sum of potentials from the muscle fibers innervated by a single anterior horn cell (a single motor unit) within the recording area of the electrode.

- The number of motor units in a muscle ranges from 100 to 500.
- Type I LMNs generate smaller MUPs at lower force levels than type II LMNs.
- The innervation ratio (number of muscle fibers innervated by each LMN) varies from a few to over 1000.
- Motor unit territory is the cross section of muscle in which an MUP is recorded with a rise time of less than 1.0 ms (overlaps territories of other MUPs).
- The characteristics of the MUP are directly related to the electrical properties of tissues near the recording electrode surface.

**CHARACTERISTICS OF THE RECORDING EQUIPMENT**

The construction of the recording electrode determines many of the properties of the recorded activity. Several different types of recording electrodes are available (Fig. 27-1). Concentric and monopolar needle electrodes are used most commonly. The concentric needle electrode is a bare 20- to 30-gauge hollow needle electrode with a thin wire core of approximately 150 μm diameter inserted down the center of a hollow cannula, beveled at its tip to expose an active oval recording surface measuring 580 μm × 125 μm. The activity at

the exposed tip of the central wire is connected to the G1 input of the differential amplifier, and the recording surface of the cannula is connected to the G2 input. This has the effect of canceling out undesired electrical activity from the surrounding muscle and other tissues. The concentric needle recording volume is roughly hemispheric in shape. Commonly available sizes are 25 mm (30-26 gauge), 50 mm (26 gauge), and 75 mm (22-20 gauge). The wire is separated from the cannula by an insulator. The tip of the electrode is machined to a 15° angle, producing an exposed surface of the center wire that is a 150 μm × 580 μm ellipse. The 0.07 mm recording surface of the central wire provides a very stable recording surface. The recording area is smaller and directional compared with the monopolar electrode. MUP amplitudes are smaller and shorter in duration than those measured with a monopolar electrode. Because the recording territory is smaller, fewer fibrillations, fasciculations, and complex repetitive discharges are recorded. There is less recording noise and the recording electrode surface area is more constant than that of a monopolar needle electrode. MUPs recorded from deeper in the muscle appear larger than those recorded from near the surface.

This type of electrode holds a number of advantages: (1) recording EMG activity minimizing interference from surrounding

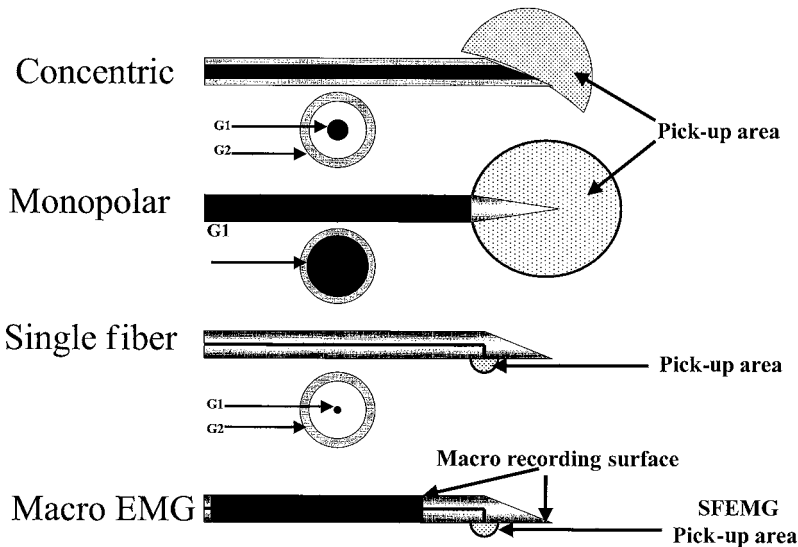


Figure 27-1. Various types of needle electrodes used in quantitative electromyography.



muscles, (2) the lack of need of a separate reference electrode, (3) the large number of muscles with well-defined MUP size data, and (4) widespread availability of inexpensive disposable versions of the electrode for most EMG systems.

The monopolar EMG electrode is a needle insulated down to its 0.56–0.80 mm<sup>2</sup> conical tip that serves as the recording surface and is connected to the G1 input of the differential amplifier of the EMG machine. The G2 electrode is supplied by a surface recording electrode. The active recording surface of the monopolar needle is larger than that of the concentric needle electrode, but this recording area may be more variable due to imprecise manufacturing or if the insulation is peeled back from use. The monopolar electrode's pick-up area is multidirectional and spherical, which is why MUPs recorded with a monopolar needle electrode have longer durations and higher amplitudes than the same potentials recorded with a concentric needle electrode. In addition, monopolar tracings also record more noise from distant motor units. Frequently, monopolar EMG recordings are contaminated by activity from the surface G2 electrode. Monopolar electrodes are less expensive and somewhat less painful for patients. Because of their larger pick-up area, monopolar electrodes may detect more fibrillation potentials, fasciculation potentials, and other spontaneous activity.

Single fiber EMG (SFEMG) electrodes are constructed of a very thin wire in a hollow cannula. The wire is insulated from the cannula and exposed through a hole in the shaft of the cannula. The recording surface is small (25 μm). The small recording area in combination with higher low-frequency filtering (500 Hz) allows individual muscle fibers of the motor unit to be recorded in relative isolation. Disposable concentric needle electrodes are increasingly being used for SFEMG, benefiting from yet a higher low-frequency filter setting (1 kHz) which is needed because of the larger recording volume of the concentric electrode, to diminish the effect of neighboring muscle fibers which are firing with the fibers of interest. Single fiber EMG is discussed in more detail in Chapter 28.

The filter settings of the recording device can alter the appearance of the MUP. EMG signals are contaminated by low-frequency

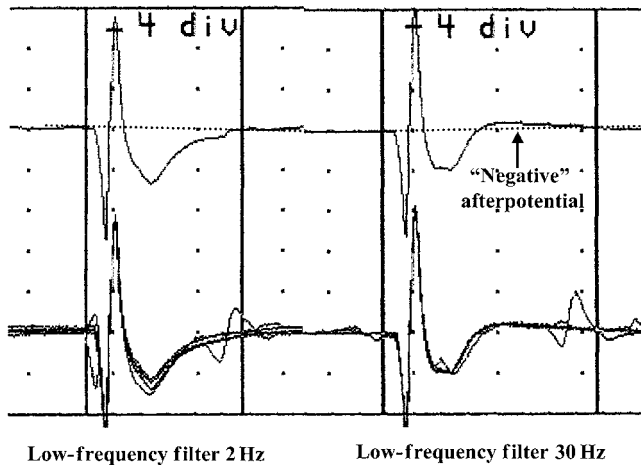
activity from motion and the surrounding distant MUP activity. This is particularly prominent with low-frequency filter settings as low as 2 Hz. Increasing the low-frequency filter setting to 30 Hz reduces much of this noise, and settings of 500 Hz eliminate almost all of it. However, increasing the low-frequency filter setting from 2 to 500 Hz drastically alters diagnostic MUP variables. Increasing the amount of low-frequency filtering may add extra components to the MUP such as the terminal *negative* afterpotential (Fig. 27–2). Stalberg et al.<sup>3</sup> noted that the *negative* afterwave that follows the return to baseline of the *positive* afterwave is an artifact generated by the capacitance of the low linear frequency filter, and that this artifact can be minimized using a low linear frequency filter setting of 2 Hz and should be ignored in measurements of MUP duration.

The sensitivity settings of the amplifier can also have a marked effect on MUP variables, and in particular on measurements of duration (Fig. 27–3). The greater the sensitivity, the longer the apparent duration of the MUP. This phenomenon secondarily affects other measures, such as area, thickness, and size index. If the sensitivity is too great, the MUP overloads the amplifier and the amplitude cannot be measured. If the sensitivity is set too low, the MUP may not be detected at all.

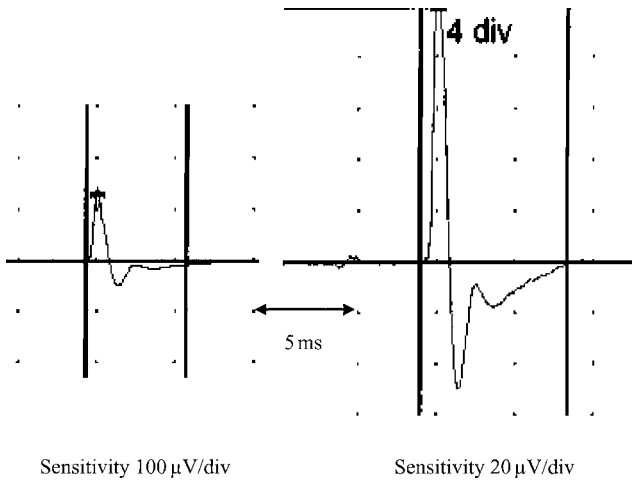
Amplifier characteristics such as input impedance, inherent noise level, amplifier recovery time, analog-to-digital sampling rate, signal-to-noise ratio, and common mode rejection affect the characteristics of the recorded EMG activity. Such variables limit the reliability, reproducibility, and ability to compare data obtained from different EMG equipment.<sup>5</sup>

### Key Points

- MUPs recorded with concentric needle electrodes are of shorter duration and lower amplitude than those recorded with a monopolar electrode.
- Isolated recordings of single muscle fibers in SFEMG are facilitated by a small (25 μm) recording surface and a low-frequency filter setting of 500 Hz.
- Increasing the low-frequency filter setting reduces the amplitude and duration of MUPs.
- Higher amplifier sensitivity settings increase the measured duration of an MUP.



**Figure 27-2.** Effects of varying low-frequency filter setting on recorded MUP morphology. The waveforms on the left are from a single MUP recorded with a low-frequency filter of 2 Hz. The top tracing is an average of the triggered superimposition of 5 recurrences of the same MUP in the lower half. The waveforms on the right are the same MUP recorded at the same position with a low-frequency filter setting of 30 Hz. Note changes in configuration, particularly the introduction of a new phase, the negative afterpotential.



**Figure 27-3.** Effects of different sensitivities on measured duration of the same MUP. At higher sensitivities, measured duration is longer.

## PROPERTIES OF MUPS EVALUATED USING STANDARD ELECTRODES

### Duration

The *duration* of the MUP is the time between the starting point and ending point of the slow component of the MUP. Duration is measured in milliseconds and includes the main spike and the initial and terminal parts (Fig. 27-4). The deviation of the initial and

terminal components from the baseline is often very gradual and difficult to define. In distal lower limb muscles, MUP duration, amplitude, and number of turns increase with age. In proximal muscles and distal upper limb muscles, MUP variables are affected less significantly by age. The greatest changes in duration occur after 60 years of age. Duration also increases by 5%–10% per degree centigrade decrease in temperature.

The duration of the MUP reflects the activity of muscle fibers of the motor unit that are within 2.5 mm of the recording electrode

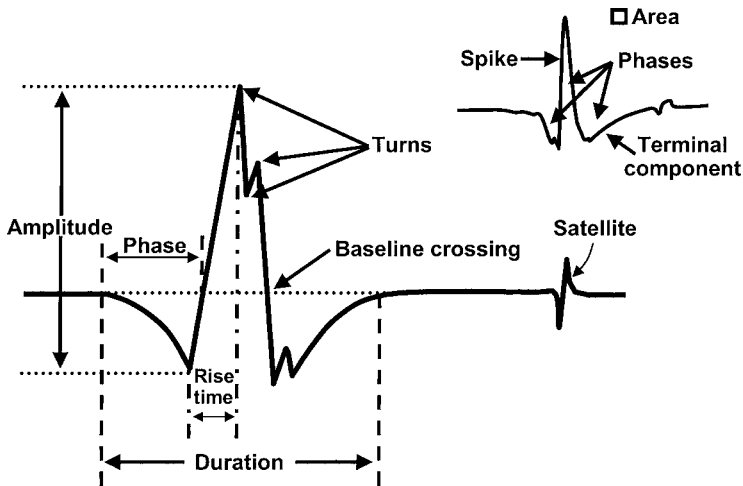


Figure 27-4. Commonly measured variables of the MUP.

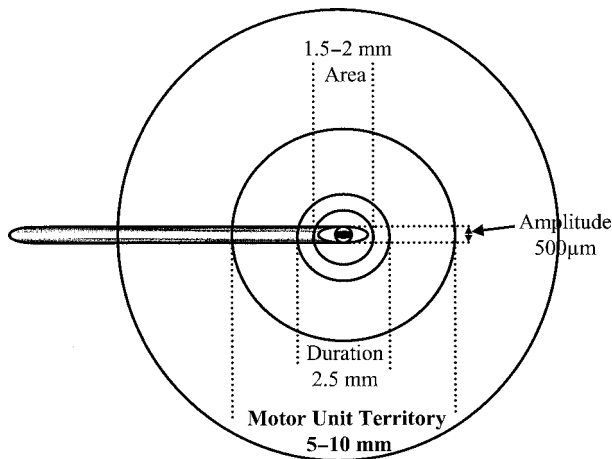


Figure 27-5. Relative size of the territory of muscle fibers of a single motor unit compared with the pick-up area of a concentric needle electrode. The amplitude of the MUP is determined by muscle fibers of the motor unit within 0.5 mm of the recording surface. The area is determined by muscle fibers within 1.5–2 mm and duration by muscle fibers of 2.5 mm.

(Fig. 27-5). If the muscle-fiber density or the territory of the motor unit changes, the duration of the MUP will change. In general, an increase in muscle-fiber density or territory of the motor unit will increase duration. Diminished muscle-fiber density or motor unit territory will decrease MUP duration. MUP duration rises if there is increased variation in the diameter, length, or conduction velocity of the nerve terminal or muscle fiber. A greater distance between the recording electrode and contributing neuromuscular junctions also increases MUP duration. The tissue intervening between the muscle fibers and recording electrodes functions as

a high-frequency filter with capacitance and resistance. Because slower frequency activity is transmitted further through connective tissue, muscle fibers at the periphery of the pick-up area of the recording electrode primarily generate the low-frequency, slow initial and terminal components of the MUP.

### Area

The *area* of the MUP is the two-dimensional territory under the curve of the waveform (Figs. 27-4 and 27-5). It reflects the amount of functioning muscle fibers near the electrode

better than does the amplitude or other variables. Digital analysis allows accurate measurement of the area. Simulation studies suggest that the activity of 15–20 muscle fibers (from a single motor unit) within a volume of radius 1.5–2 mm of the core of the concentric needle electrode contributes to the area of the MUP being measured.

## Amplitude

Amplitude is determined by the contributions of action potentials within 500  $\mu\text{m}$  of the electrode (Fig. 27–4). This is typically 2–12 muscle fibers, but sometimes only 1 or 2. Although the diameter of the muscle fibers and the fiber density affect amplitude, this attribute is more dependent on the proximity of the electrode to the muscle fibers than are duration or area. The *amplitude* is measured from the maximum positive peak to the maximum negative peak. *Thickness* is an MUP property derived by dividing the area by the amplitude. Some investigators have found that for the detection of myopathies, decreased thickness is one of the most sensitive variables of motor unit morphology.

## Rise Time

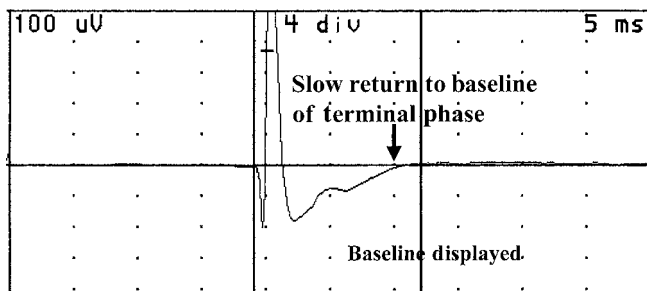
*Rise time* is the duration of the rising phase of the spike from the positive peak to the negative peak (Fig. 27–4). Rise time, or rise rate, is the best indicator of proximity of the source (generator) of the potential to the recording electrode.

## Spike Duration

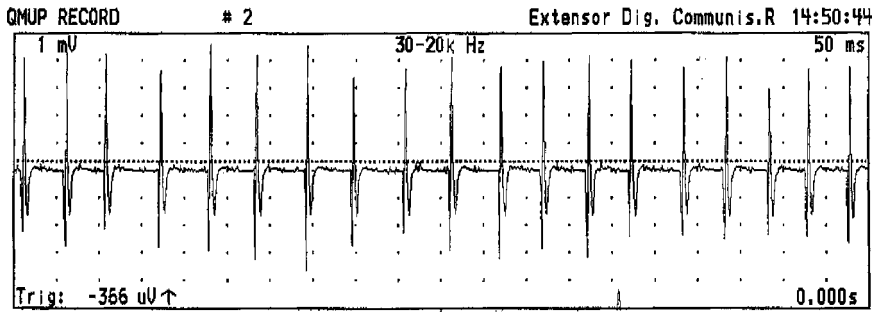
*Spike duration* is the time from the first positive peak to the last positive peak of the main component of the MUP. The *spike* is the sum of the action potentials, of usually fewer than 15 (and as few as 1–8) muscle fibers, closest to the recording electrode.<sup>2</sup> The spike may have linked or satellite potentials separate from the main spike. The *terminal component* of the MUP is measured from the end of the main spike to the return to baseline (Fig. 27–4). The terminal component is generated by action potentials traveling away from the recording electrode along muscle fibers. Marking the end of the slow return of the terminal component to the baseline is the most inconsistent measurement in semiquantitative and quantitative EMG (Fig. 27–6). The imprecision in marking the end of the terminal component results in major variations in quantitative analysis of MUP morphology. Large amounts of low-frequency filtering (10–30 Hz) may add an extra component to the MUP, called the *terminal negative afterpotential*, which follows the return to baseline of the positive afterwave (Fig. 27–2). This is an artifact generated by the capacitance of the low linear frequency filter which can be minimized using a low-frequency filter setting of 2 Hz and should be ignored in measuring MUP duration. If the terminal negative afterpotential is included in measurements, duration will be artificially prolonged.

## Phases and Turns

Most commonly, the overall shape of the MUP waveform is triphasic, with an initial slow downward deflection followed by a dominant,



**Figure 27–6.** Illustration of very gradual return to baseline of the terminal component of an MUP. The end is determined more easily when the baseline is displayed, as in this illustration.



**Figure 27-7.** Example of a single large-amplitude, long-duration MUP firing at very rapid rates and randomly varying in amplitude from one spike to the next.

rapid, upward deflection or spike, and then a slow downward deflection called the *terminal component* (Fig. 27-4). If the recording electrode is close to the end plate zone, the initial slow component is lost and the potential becomes biphasic, beginning with the upward spike component. Monophasic MUPs, with only a single upward or negative phase, are much less common. An MUP may have the configuration of a “positive” wave, with an initial large downward “positive” component followed by a low, long, late “negativity.” Such “positive” MUPs are recorded from damaged muscle fibers, from the ends of the fibers or the tendon, or from the cannula (G2 electrode) of the concentric needle electrode. Such positive potentials should be excluded from the analysis of MUP properties.

The number of components of the waveform above or below the baseline are considered *phases* (Fig. 27-4). If there are more than four phases, the MUP is considered *polyphasic*. The number of phases can be determined by counting the portions of the waveform above or below the baseline or by determining the number of baseline crossings and adding one. Normal muscles may have 5%–15% polyphasic motor units. An increase in the percentage of polyphasic motor units is not only a very sensitive indicator but also a very nonspecific indicator of neuromuscular disease.

A *turn* is defined as a peak in the waveform of the MUP (Fig. 27-4). The number of turns is determined by counting the number of positive and negative peaks separated from the preceding potential by some arbitrary amount, usually 50  $\mu\text{V}$  or more. If the MUP contains more than five turns, it is termed *complex*, or *serrated*. *Satellite potentials* are late components of the

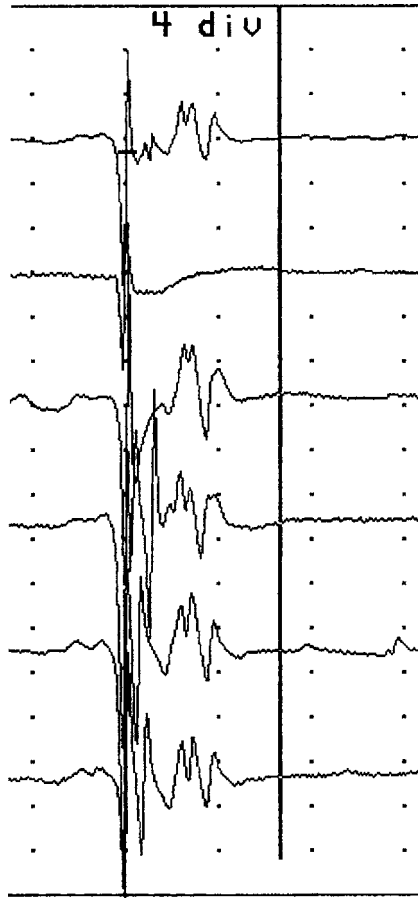
MUP, separated from the main component by a segment of flat baseline (Fig. 27-4). Many different terms have been used for satellite potentials, including *coupling discharges*, *parasite potentials*, and *linked potentials*. These usually follow the main component, but may also precede it. Such satellite potentials are typically excluded from measurements of MUP duration. Satellite potentials can be seen in 1%–3% of MUPs of normal muscles. These potentials occur in 10% of cases of normal muscles, 12% of cases of neuropathy, 60% of cases of old poliomyelitis, and 45% of cases of myopathy.

## Stability and Variation

*Motor unit potential variation* is a general term that refers to constantly fluctuating changes in amplitude or configuration of the MUP with successive discharges (Fig. 27-7). *Jiggle* refers to variation in the position of phases or turns in the MUP relative to each other from one discharge of the MUP to another (Fig. 27-8).<sup>6</sup> These two terms reflect an instability of conduction along nerve terminals, across the neuromuscular junction, or along muscle fibers. Although classically thought of as a feature of disordered neuromuscular transmission, MUP variation may be less specific. Firing rate and recruitment are important factors for measurement in quantitative analysis; these are discussed in detail in Chapter 26.

### Key Points

- MUP duration reflects the activity of muscle fibers that are within 2.5 mm of the recording electrode.



**Figure 27-8.** Multiple firings of a single large-amplitude, long-duration, polyphasic complex MUP. Some of the components block (*second trace down*) and others jiggle back and forth relative to each other.

- MUP amplitude is determined by the action potentials of 2–12 muscle fibers within 0.5 mm of the electrode.
- Area reflects the amount of functioning muscle near the electrode better than does the amplitude or other variables.
- Rise time is the best indicator of proximity of the recording electrode to the source of the potential.
- MUP duration, amplitude, and number of turns increase with age.
- An increase in polyphasic motor units is a sensitive but nonspecific indicator of neuromuscular disease.
- Satellite potentials are nonspecific findings seen in normal muscles and in neuromuscular disease.
- Unstable MUPs vary in amplitude or configuration with successive discharges,

usually because of a neuromuscular junction disorder.

**PROPERTIES OF MUPs  
MEASURABLE ONLY WITH  
SPECIAL ELECTRODES**

The size of the motor unit territory was measured in normal subjects and in patients with disease by Buchthal et al.<sup>7</sup> using a multilead electrode made with multiple recording sites along the length of a special needle electrode. The territory of motor units in limb muscles was found to be circular in cross section, with a diameter of 5.1 mm in the biceps brachii muscle and 10 mm in the rectus femoris muscle.



Motor unit territory diameter and fiber density tended to be reduced in patients with myopathy.

The distribution of electric activity of the motor unit can be mapped in a cross-sectional plane with the scanning EMG technique.<sup>8</sup> This technique uses a standard concentric needle electrode and a standard single fiber needle electrode. The activity from each of the two needles is recorded on a different channel of the EMG machine using different filter and sensitivity settings. The single fiber needle electrode is inserted into the muscle and manipulated to a point where the activity of one muscle fiber is recorded. The concentric needle electrode is then inserted at a nearby point, perpendicular to the course of the muscle fibers. The activity at the single fiber electrode triggers the sweep, and the MUP of the parent motor unit is recorded at the concentric needle. The concentric needle is then advanced through the muscle until no activity is recorded from the motor unit under consideration. Next, the concentric needle is connected to a mechanical motor drive that withdraws the concentric needle through the muscle in small uniform steps. The MUP is recorded and averaged at each site and the needle is withdrawn another step and the process is repeated until the concentric needle is withdrawn from the territory of the motor unit under study. Scanning EMG demonstrates that the shape of the MUP varies considerably across the motor unit territory. There may be one, two, or more distinct areas of activity, sometimes occurring with different latencies. These have been called *motor unit fractions*, and these are likely generated by groups of muscle fibers, each innervated by a major intramuscular axonal branch of the parent anterior horn cell. Scanning EMG allows measurement of the size of the motor unit and assessment of the density and distribution of muscle fibers within the motor unit territory.

Macro-EMG was developed in 1980 to record the activity of the majority of muscle fibers from a single motor unit. The concentric needle records activity from a 2–3 mm volume within the 5–10 mm diameter volume of the limb motor units. A macro-EMG needle is a modified SFEMG needle, with

the cannula insulated except for the terminal 15 mm (Fig. 27–1). This 15-mm length serves as the recording surface for the macro-EMG needle. In most limb muscles, the muscle fibers of a single motor unit are scattered over a cross-sectional area of 5–10 mm. The 15-mm recording area of the macro-EMG needle therefore encompasses the territory of most motor units in limb muscles. There is also a 25- $\mu$ m diameter wire electrode exposed on the shaft of the terminal part of the cannula, 7.5 mm from the tip that enables recording of single muscle-fiber activity. Recordings are made on two channels. The first channel records activity from the 15-mm bare shaft (G1 electrode) and a surface electrode (G2). The second channel records single fiber activity from the 25- $\mu$ m wire electrode (G1) and the shaft (G2). The needle is inserted into the muscle and manipulated during minimal levels of contraction to a position at which the action potential of a single muscle fiber is recorded from channel 2. The activity in channel 2 acts as a trigger, and the activity from channel 1 is then recorded and averaged over 60–80 ms. Next, the needle is moved to a different site in the muscle and the process is repeated. To obtain an adequate sample from the muscle being examined, 20 different potentials are recorded from 20 different sites. Normal values have been established.<sup>9</sup>

In neurogenic disorders characterized by denervation and reinnervation, the amplitudes of the macro-EMG potentials are generally increased. In disorders of muscle or myopathies, on the other hand, the amplitudes are often low, particularly in subacute myopathies. In chronic or long-standing myopathies, amplitudes may be increased.

Fiber density, blocking, and jitter are MUP attributes optimally evaluated with SFEMG. Other special recording techniques can measure muscle-fiber conduction velocity, contraction time, twitch time and tension, and the effects of fatigue, but these are not considered in this chapter.

Akaboshi et al.<sup>2</sup> have recently used a similar technique to decompose the interference pattern at forces of up to 50% of maximal voluntary contraction. They were able to determine the firing rates and recruitment frequencies of the motor units as well as isolate the units

for morphologic analysis. Unfortunately, this technique is too slow for routine clinical work.

### Key Points

- Scanning EMG measures the territory of a motor unit and assesses the density and distribution of muscle fibers within the territory.
- Macro-EMG records a larger proportion of the muscle fibers in a single motor unit than other needle recording electrodes.
- Fiber density can only be measured with an SFEMG electrode.

## QUANTITATIVE ANALYSIS OF SINGLE MUPs

### Manual Analysis

Historically, quantitative EMG began with the measurement of MUP attributes by manual analysis of paper tracings or photographs of MUPs.<sup>10-14</sup> This technique required minimal activation of preferably only one but at the most three MUPs at a time. This limited the evaluation to activity of type 1 muscle fibers and MUPs. The needle electrode was positioned to obtain fast rise times. Photographs were taken of several recurrences of the same potential and measurements were made. The amplitude was recorded as the maximal deflection on the screen possible to prevent the loss of low-amplitude components and to prevent blocking of the largest component of the MUP. MUPs less than 50  $\mu\text{V}$  in amplitude were excluded. The low-frequency filters were set at 2 Hz and high-frequency filters at 10,000 Hz. About 20-40 different recording sites per muscle were evaluated, with the sites separated by at least 3 mm. The technique was accurate but quite time-consuming. Normal values have been published for a large number of muscles. These data have been widely used for many years as the reference standard.

### Key Points

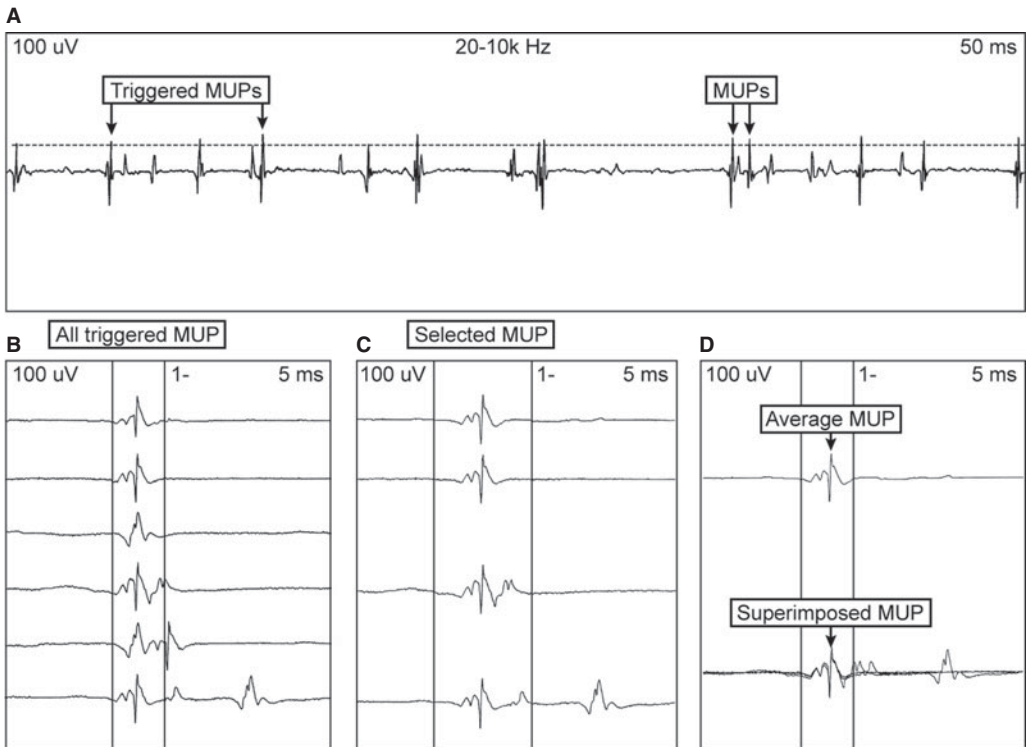
- Manual MUP analysis assesses individual MUPs at low levels of activation.
- Manual MUP analysis evaluates primarily type I MUPs.

- Low-frequency filter for manual MUP analysis is set at 2 Hz.
- Despite the high level of accuracy and reliable normal control data, manual MUP analysis is time-consuming.

## Computer-Assisted Quantitative Analysis of User Selected MUP

The introduction of triggering and delay techniques permitted the sampling of one MUP over and over, even if other motor units were active.<sup>15</sup> This allowed more rapid collection of data, with an improved signal-to-noise ratio. Digitized signals allowed computer averaging and storage of waveforms and the measurement of variables, such as area and thickness of the motor unit, not readily available with the previous techniques. Such analyses are not directly comparable to the results of the manual method of Buchthal et al.<sup>10-12,14</sup> and Petersen and Kugelberg.<sup>13</sup> The newer techniques give a sampling bias which favors larger MUPs.

A commonly used technique for automated analysis of single MUPs with computer-aided methods is the quantitative EMG (QEMG) program (Viasys) (Fig. 27-9). To use the original Buchthal normative data, 2-10 kHz filter settings, degree of minimal activation, and standard sensitivity settings should be employed. Ideally, MUPs should have rise times less than 500  $\mu\text{s}$ , although many experts think that a rise time of 1000  $\mu\text{s}$  is acceptable. The examiner must be able to hold the needle immobile during data collection. The patient must be able to activate only one to three MUPs at a time and maintain a very steady firing rate. The trigger must be adjusted to isolate individual motor units. Some bias is introduced by triggering with the largest unit, causing the selection of large-amplitude long-duration MUPs. This can be avoided by using minimal activation, employing a dual trigger line to select the smaller units, and intentionally collecting a representative sample of the MUP populations in the muscle being studied. The dual trigger uses two lines that can be adjusted together to select peaks between the two trigger lines, with sampling of the smaller MUPs. The MUP fires repetitively, and multiple traces are superimposed (5-15 iterations



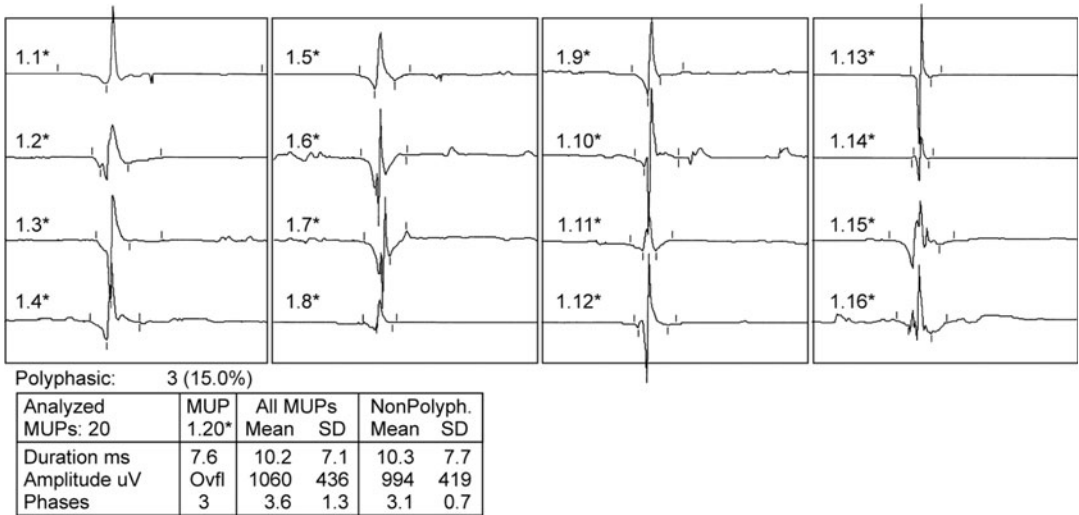
**Figure 27-9.** Computer-assisted quantitation of MUPs. A, Free running trace with four MUPs. Dashed line is trigger level that selects MUPs for individual display; B, Two different MUP isolated by trigger; C, Third and fifth MUP have been discarded manually; D, Remaining samples of a single MUP are superimposed to confirm their identity.

seem to work best). At least 20 MUPs are collected from different sites within the muscle. Different locations should be sampled so as to avoid recording repeatedly from the same MUP and to increase the likelihood of finding abnormalities localized to one part of the muscle which may occur in some multifocal diseases.

An important issue with these systems is how often the examiner must correct the measurements made by the automated system (Fig. 27-10). The examiner must always check the automated markers on every MUP collected. As remarkable as the pattern recognition capabilities of the QEMG software is, marking the gradual onset and termination of the MUP is frequently subject to variability and error (Fig. 27-6). The duration marked is usually greater at higher sensitivities, so the sensitivity should be close to the  $100\ \mu\text{V}/\text{division}$  setting that is generally accepted when marking duration (Fig. 27-3). Background noise and other artifacts must be minimized. Relaxation of neighboring muscles is particularly important.

The analysis generates a report of the properties of all recorded MUPs and a separate listing of the quantitative attributes of the simple and complex MUPs. These data include the duration, amplitude, turns, and percentage of polyphasic MUPs as well as their mean, median, mode, variation, minimal-maximal values, standard deviations, and confidence intervals.

Despite the methodological and statistical advantages of quantitative EMG, the evaluation of motor unit attributes is subject to bias even with this more rigorous technique. If a trigger line and delay are used, the single trigger tends to bias the examination toward larger potentials. An excessive number of units firing at excessive force levels biases the examination toward the larger units. Because MUPs appear larger when the needle is deeper in the muscle, the depth of needle insertion can also skew the results. The slow initial and terminal components of the MUP must be marked with special care. As mentioned previously, the negative afterpotential should be excluded from MUP measurements.



**Figure 27-10.** A, Display of sixteen of twenty MUPs that were isolated, selected and averaged as shown in Figure 27-9. B, Mean duration, amplitude, and phases calculated for all isolated MUPs (MUP 1.20\* column is not shown in the panel of 16).

**Key Points**

- Computer-assisted quantitative EMG programs focus on collecting a representative sample of the MUP populations in the muscle being studied.
- Digitized signals with triggering and delay allow for storage and efficient analysis of multiple single MUP.
- Computer-assisted quantitative EMG programs typically include descriptive statistics of duration, amplitude, turns, and percentage of polyphasic MUPs as well as their mean, median, mode, variation, minimal-maximal values, standard deviations, and confidence intervals.
- Comparison of quantitative EMG data with data collected by Buchthal requires 2-10 kHz filter settings and 100  $\mu$ V sensitivity.

**Automated Analysis of Single MUPs**

In recent years, a number of semiautomated and automated methods have been developed that select and measure MUPs with minimal human decision-making using standard needle EMG electrodes. Some of these methods are now in common clinical use, while others continue to be developed. The major methods are automated decomposition EMG

(ADEMG) of Dorfman and McGill,<sup>16</sup> multiple motor unit action potential (MMUAP) of Stalberg,<sup>17</sup> and decomposition-based quantitative EMG (DQEMG) of Stashuk.<sup>15</sup> Methods to further improve the QEMG continue to be developed.<sup>19</sup> Using a variety of approaches, such systems automatically detect events that may be MUPs. Comparisons among these methods have been reported.<sup>20-24</sup> All current methods suffer from inability to detect unstable MUPs and inability to identify reduced numbers of axons (reduced recruitment).

**Automated Decomposition EMG**

Dorfman and McGill<sup>16</sup> were the first to report a clinically applied, automated program using standard EMG needle electrodes called *automatic decomposition EMG* or ADEMG. It evaluates a single-channel interference pattern at steady isometric contraction with forces up to 30% of maximal voluntary contraction. The analysis is performed in nearly real time (less than 1 minute), but requires a good deal of operator time to assure the quality of the recording. The program can extract up to 15 simultaneously active MUPs at a single site (practically 4-8). Later recruited MUPs have different characteristics from the initially recruited MUPs. The mean MUP amplitudes are significantly greater and increase

with increasing force. The mean MUP duration is shorter and declines with increasing force. The number of turns increases with escalating force. The mean firing rates are linearly related to contractile force. The mean amplitude, duration, and number of turns increase with advancing age, but mean MUP firing rates decrease with age. The results are presented in numeric and graphic formats. The results cannot readily be compared with the manual quantitative normative data. In its current form, ADEMG is somewhat limited, in that MUPs smaller than 100  $\mu\text{V}$ , unstable MUPs, and MUPs with slow rise times cannot be recorded. Normative data are available for only a few muscles. Studies demonstrating the clinical usefulness of ADEMG are few and focus on small numbers of subjects. For practical purposes, ADEMG is being used in only a very limited number of laboratories.

### Key Points

- ADEMG evaluates an interference pattern at a steady isometric contraction and can extract up to 15 simultaneously active MUPs.
- Low amplitude and unstable MUPs are not recorded with ADEMG.

## Multiple Motor Unit Action Potential

Bischoff et al.<sup>17</sup> developed a technique of multi-motor unit action potential analysis (multi-MUAP analysis) that uses standard concentric needle or monopolar needle electrodes. It segments the record into epochs with and without MUPs usually on the basis of a predetermined amplitude threshold. Presumptive MUPs are then sorted and classified by comparing their wave shapes sequentially (template matching) using *a priori* match criteria. An MUP is accepted as an MUP when an arbitrary number of recurrences (2–10) are confirmed. The recurrences may be averaged to produce a potential less affected by random noise. The waveforms that do not recur are considered to represent either noise or superimposition of more than one MUP and therefore are not accepted. The properties of the identified MUP are then measured and accumulated. Several different MUPs can be

collected at each site. Graphs and reports of the data can be viewed or printed out. With patient cooperation, a sample of MUPs can be collected quickly. The examiner should review the individual MUPs accepted and their markings to ensure accuracy. The collection of data requires a quiet background and activation of only a few MUPs at a time.

The electrode is inserted into the middle part of the muscle at different depths through three separate skin insertions. No attempt is made to position the electrode to record maximal amplitude, but the electrode is positioned so that at least some MUPs are “sharp” or crisp, that is have short rise times. Force is varied from slight to moderate muscle contraction, but no special equipment is required to measure force. The baseline should be clearly discernible between signals. This analysis reportedly requires fewer than 4–8 minutes per muscle. Short segments (5 seconds) of activity are recorded. At least 20 MUPs are recorded from each muscle. MUPs are classified on the basis of shape variables by a multiple template matching technique. A minimum of five recurrences of each MUP is averaged. About 2–5 MUPs can be recorded at each site. MUPs must be larger than 50  $\mu\text{V}$  in amplitude and meet a rising phase criterion of less than 30  $\mu\text{V}/0.1$  ms. Duration markers can be adjusted manually and require manual correction in approximately 25% of the recorded MUPs. About 5%–15% of MUPs need to be rejected because of background noise.

The program automatically measures amplitude, duration, spike duration, thickness, phases, and turns, and calculates mean values and standard deviations for each parameter. Reference data for different age groups are available for the deltoid, biceps brachii, first dorsal interosseous, vastus lateralis, and anterior tibial muscles. A good correlation has been demonstrated between examinations performed by different examiners, repeat examinations by the same examiner, and side-to-side comparisons in the same subject. The multi-MUAP analysis program takes a different approach to defining the limits of normal by using outliers, based on the assumption that in mild or early disease, abnormalities may be limited to a few MUPs rather than the entire MUP population. Such changes may be lost when averaged in with other MUPs. The outlier limits were determined from the third



largest and third smallest value of a given variable in normal subjects. The highest and lowest values of these limits for the whole control group were chosen as the extreme outlier limits. The only outlier limit found to change with age was the amplitude of MUP in the anterior tibial muscle, but not other muscles. Using these criteria, none of the normal muscles had more than two values outside the defined limits.

Multi-MUAP analysis detected abnormalities in 25 of 31 cases of neuropathy.<sup>17</sup> The size index, amplitude, and duration were the most frequently abnormal variables. The method detected abnormalities in 6 of 8 cases of myopathy, with amplitude abnormalities more common than duration. Outliers were as sensitive as mean values in neuropathies and more sensitive than mean values in myopathies. Bischoff et al.<sup>17</sup> pointed out that determining mean values may miss mild abnormalities of a few MUPs. An increased number of outliers that indicate abnormality can be found only after evaluating a few MUPs, making it unnecessary to evaluate 20 or more units and, thus, saving time. Podnar in studying a cohort with fascioscapulohumeral muscular dystrophy pointed out the increased sensitivity of using outlier analysis in addition to traditional measures of MUP morphology.<sup>25</sup>

There appear to be advantages of multi-MUAP analysis. It allows sampling of a large number of MUPs in a short time, is reproducible, and allows MUP sampling at levels of contraction greater than threshold. It would reduce examiner bias. When editing time is included, the analysis usually takes longer than 5 minutes per muscle to perform. Multi-MUAP is available on a number of commercially available EMG machines, and is in widespread use, particularly in Europe.

### Key Points

- Multi-MUAP identifies MUPs on the basis of a predetermined amplitude threshold and sorts the waveforms according to their morphology (template matching).
- Multi-MUAP analysis is an automated technique that provides a relatively rapid and reliable method for analyzing MUPs which allows sampling of a large number of MUPs in a short time.

- Outlier analysis may provide another sensitive method to quantitate MUPs which requires fewer than 20 MUPs to assess whether the muscle in question is normal.

### Decomposition-based quantitative EMG

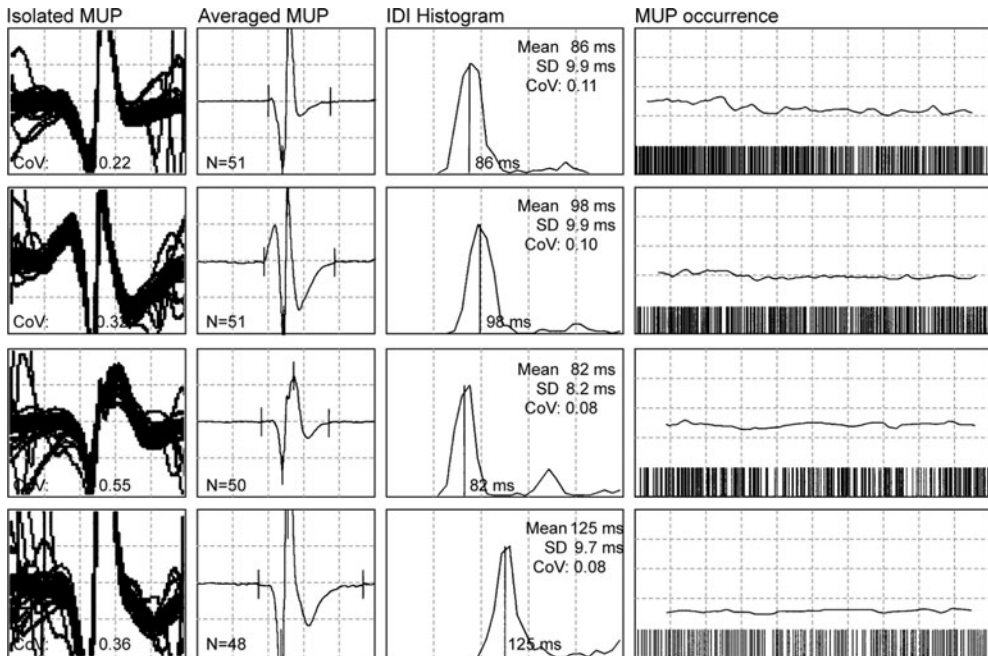
Stashuk et al.<sup>18</sup> have developed the most recent automated MUP selection and measurement method, which is coming into more common clinical use as it becomes available on EMG machines. Waveforms are isolated and selected by a multistep, mathematical algorithm from 20 seconds of data recorded with a needle electrode from a single site in the muscle. The user is provided ongoing measures of MUP rise time and MUP quality as the needle is moved to a new location. Up to eight simultaneously firing MUPs can be reliably recorded from a single site. The electrode is moved to as many distinct locations in the muscle to obtain a satisfactory sampling of MUP, typically more than 30. Measurements of the standard parameters of MUP are available within 10 seconds of completing the recording at a site. The user is given the opportunity to review and remark or delete any MUP deemed unsatisfactory after the primary data collection. Statistical parameters of the measurements are provided with the summary data.

Studies of the reliability, reproducibility, and normal values have been published.<sup>18,24,26,27</sup> They suggest that the method works as well or better than other existing MUP quantitation programs. The program takes longer than an EMG performed without formal quantitation by an experienced electromyographer.

### Key Points

- DQEMG rapidly and reliably isolates multiple MUP from a moderate level contraction.
- DQEMG provides live guidance to the electromyographer regarding the quality of the MUPs being recorded to allow optimal selection of the data to be recorded.
- Prompt data display after each 20-second recording allows quick assessment of the quality of MUP selection and measurement.





**Figure 27-11.** DQEMG data display from an anal sphincter in four columns named at the top of the figure. “Isolated MUP” (first column) displays all the isolated MUPs superimposed to confirm their validity. “Averaged MUP” (second column) is an average of all the isolated MUPs. “IDI Histogram” (third column) displays a histogram of the inter-discharge intervals of each successive MUP to further assure their identity. MUP occurrence (fourth column) displays the time of occurrence of each of the isolated MUP. The wiggly line plots the interdischarge intervals. Superimposed MUPs are not measured (blank spaces).

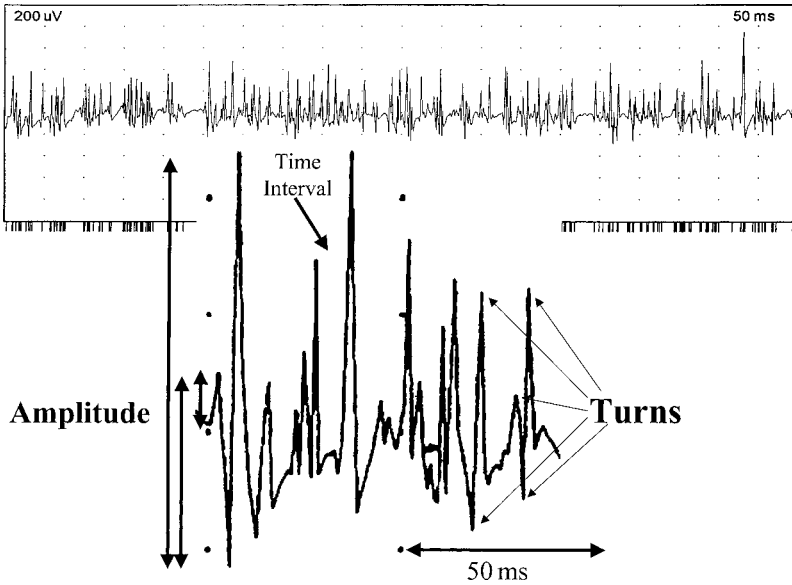
## PROPERTIES OF INTERFERENCE PATTERN AND METHODS OF INTERFERENCE PATTERN ANALYSIS

Individual MUPs can be identified and measured precisely at minimal levels of muscle contraction (Fig. 27-12). As the level of force produced increases to the maximal voluntary contraction (MVC) force, the number and firing rates of active motor units increase. At the same time, the size of the individual MUPs increases. As the number of MUPs increases, it becomes difficult and ultimately impossible for the unaided examiner to identify individual potentials using standard electrodes and manual quantitative methodologies. The observed activity in this situation is described as an *interference pattern* in which individual MUPs are superimposed on others, resulting in a complex profile of summated and canceled waveforms from the activity of multiple different contributing MUPs.<sup>28</sup> Automated techniques

have been developed as efforts to quantify the interference pattern.

## Method

The basic techniques of interference pattern analysis (IPA) are straightforward. A needle electrode or surface recording electrode can be used, but the surface electrode techniques are not clearly useful for diagnostic purposes.<sup>29</sup> The needle electrode is inserted into an area of the muscle where MUPs have short rise times. IPA is performed at different force levels in different systems. The test can be performed at variable or fixed percentages of MVC (usually in the range of 30% of MVC), but this requires special equipment. Analysis can be performed at fixed forces of 2–5 kg weights or at forces varying from minimal contraction to maximal contraction force. After the measurements have been made at one site, the needle is moved to another distinct site and another measurement is made. Ideally, a total of 20 to



**Figure 27-12.** The *top tracing* shows a partial interference pattern. The *bottom tracing*, an exploded view of a short segment of the top tracing, illustrates some of the properties measured in quantitation of the interference pattern.

30 sites are measured through three or more needle tracks.

## Analysis

Many different properties of the interference pattern have been measured. The number of turns is measured frequently (Fig. 27-12). Turns represent a change in signal direction of at least  $50\ \mu\text{V}$ . Turns indirectly reflect the number of active MUPs, the proportion of polyphasic MUPs, and the MUP firing rate. A turn may reflect an MUP peak, an interaction between overlapping MUPs, or noise. Baseline or zero crossings are the number of voltage crossings of the baseline per unit time. The time in milliseconds between turns or peaks can be measured as *time intervals* or *T's* (Fig. 27-12). Measurement of the number of short time intervals or comparing the number of turns with short time intervals of 0–1.5 ms to those with longer time intervals of 1.5–5 ms and 5–20 ms seems to have considerable clinical usefulness.<sup>30–32</sup>

Amplitude is measured as the potential difference between successive turns (Fig. 27-12). *Cumulative amplitude* is the total amplitude of turns over a certain time. Dividing the cumulative amplitude for a fixed time interval by the number of turns during that same interval defines *mean amplitude*. IPA data have also been expressed as a ratio called the *turns/amplitude ratio*, which is derived from

the number of turns for a certain time interval divided by the mean amplitude for that same interval. Others have measured the maximal value of the turns/amplitude ratio for all the sites tested and called this the *peak ratio*. Peak ratio appears to be a useful measurement for distinguishing between normal subjects and patients with neuromuscular disease.

## Utility

The advantages of IPA are that it incorporates signals from more of the muscle under study and samples activity from motor units that are activated at higher force levels, usually type II motor units. The technique samples a much larger amount of electric activity. Many of these techniques are available on commercial EMG machines. The evaluations are often rapid to perform. Most of the techniques are applicable to all muscles, and many can be applied to uncooperative patients, such as small children.

The disadvantages of IPA must be considered. The variables measured cannot be related in a simple and direct manner to the properties of the constituent MUPs. The effects of summation and cancellation of superimposed MUP activity are complex and difficult to understand. Large-amplitude potentials obscure activity from small MUPs, and a few long-duration polyphasic MUPs may

give results similar to many short-duration MUPs. Also, IPA systems often do not effectively measure activity less than 50–100  $\mu$ V. Technical factors such as system noise, filters, and analog-to-digital conversion rates can interfere. Normal values are available for a limited number of muscles, but their usefulness in mild or borderline cases has not been evaluated carefully. The problem of the examiner entering data that are not well-analyzed into a program that carries out complex analyses and provides data difficult to verify by other means introduces another element of uncertainty.

### Key Points

- IPA evaluates the properties of multiple, different, overlapping MUPs during a strong contraction.
- IPA incorporates and assesses both type I and type II motor units.
- Of the variety of automated techniques that have been developed, the turns/amplitude system has gained the most widespread use.
- IPA is rapid to perform, useful in uncooperative patients, and applicable to a number of muscles for which normal data has been determined by age group.
- Properties of the interference pattern which have been measured include number of turns, cumulative amplitude, and turns/amplitude ratio.
- IPA classifies EMG patterns into normal, myopathic, or neurogenic, but is unable to identify unstable MUPs, mixtures of large and small MUPs, or abnormalities in recruitment without other changes.

## TURNS AND AMPLITUDE ANALYSIS OF THE INTERFERENCE PATTERN

Probably the best-studied and most widely used method of automatic IPA was the turns analysis technique developed by Willison.<sup>25</sup> Initially, the number of turns and the mean amplitude of the turns were measured from photographs of the interference pattern. Later, Fitch and Willison developed an electronic analyzer that could extract the data from the raw EMG signal. It counted the number of turns per unit time. The amplitude was measured between the turns. This was done

at constant forces of 2 or 5 kg. In myopathies, these workers found that turns per second increased and amplitude per turn decreased. In neuronal or axonal loss and reinnervation, amplitude per turn increased and turns per second decreased.

Fuglsang-Frederiksen<sup>28</sup> obtained more consistent results using a fractional contractile force of 30% of the maximal voluntary force and found it necessary to record from multiple sites (10 for each muscle). The most sensitive variables were the ratio of the number of turns to the mean turn amplitude in myopathies and the decrease in the number of turns in neuropathic disorders. IPA did not replace evaluation of single MUPs but did increase the sensitivity and specificity of MUP analysis.

Hirose et al.<sup>33</sup> evaluated the interference pattern at maximal contraction levels and found that the frequency of short-duration turns of low amplitude was the most sensitive measure for differentiating myopathies from neuropathies.

Liguori et al.<sup>31</sup> measured mean amplitude (cumulative amplitude per time divided by number of turns per time), maximum ratio (peak ratio, which is the maximal value for the ratio of the number of turns per time to the mean amplitude), and the incidence of different time intervals between peaks (0 to 1.5 ms intervals, 1.5 to 5 ms intervals, and 5 to 20 ms intervals) in normal subjects and patients with myopathies or neuropathies. They used standard concentric needle electrodes inserted at three different sites (proximal, medial, and distal) in the muscle and recorded activity at a total of 10 different recording sites at least 5 mm apart. The force of contraction gradually increased from 0 to maximum voluntary contraction over 10 seconds, with the patient resting 1 or 2 minutes between each contraction. Of the patients with myopathy, 92% had abnormally high peak ratio values; the number of time intervals of short duration was increased in 84%. All patients were classified correctly by using the peak ratio and time intervals. In comparison, QEMG was diagnostic of myopathy in 72% of cases.

Of patients with neurogenic disorders, 86% had low peak ratio values. The number of short-time intervals was reduced in 48% while the number of long-time intervals was increased. In all patients, the diagnosis was made correctly using the combination of peak ratio and time intervals, whereas QEMG was

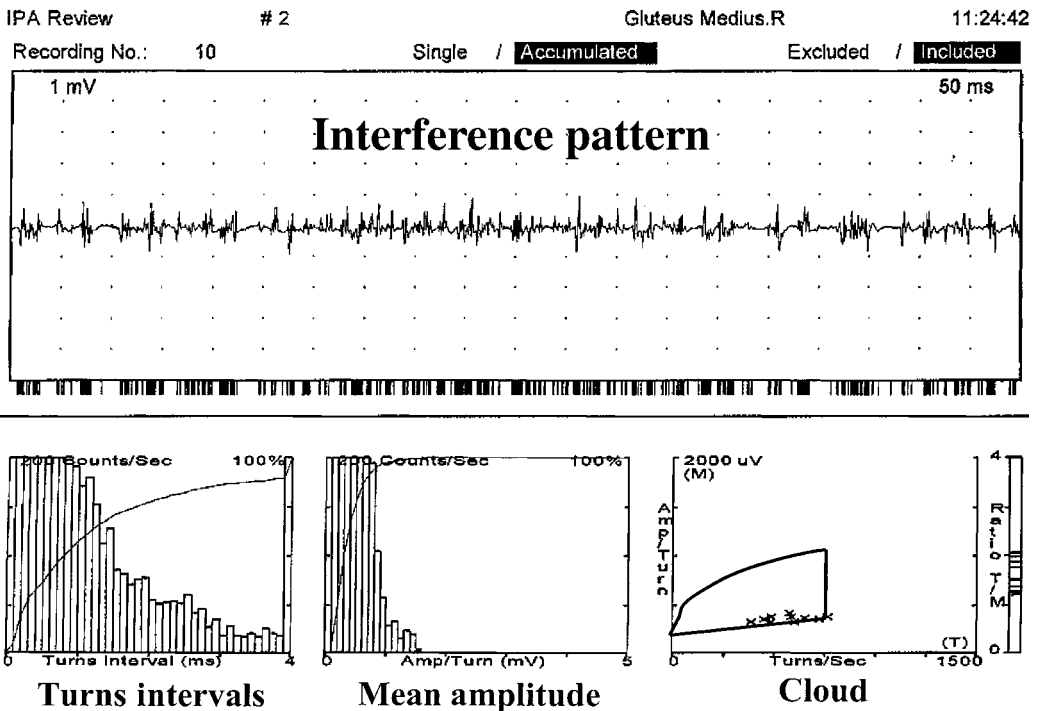
diagnostic in 95%. This technique appears to be objective, fast, and reliable, but it takes at least 20 minutes per muscle.

Stalberg et al.<sup>34</sup> depicted IPA graphically in a scatter plot (Fig. 27-13) without careful control of force. With a steady contraction for 1 second and rest for a few seconds between epochs, force was varied from slight to near-maximal. Standard concentric or monopolar needles were used. The needle was moved to a place in the muscle where a “spiky” pattern was obtained. The filters were set at a low linear frequency of 3.2 Hz and a high linear frequency of 8 kHz. The sensitivity was varied between 200 and 1000  $\mu\text{V}/\text{division}$  to allow adequate display of the activity without blocking. Twenty epochs were recorded in each muscle. Turns per second were plotted against mean amplitude per turn. Using this technique in normal muscles, the data points fall within a so-called *normal cloud*. In myopathies, the data points fall below the normal cloud, because of excessive turns and low amplitude (Fig. 27-11). In neuropathic disorders, the data points fall above the normal cloud because of increased amplitude and a low turn count. Nirkko et al.<sup>32</sup> prospectively evaluated

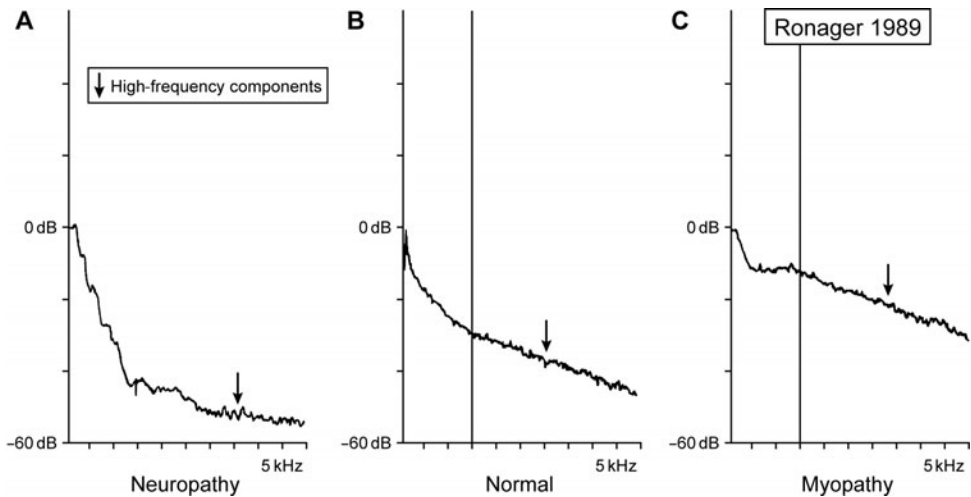
239 patients referred for quantitative MUP analysis. They found that for the detection of myopathies or neuropathies, IPA with the Stalberg technique was more sensitive and specific than quantitative measurement of MUPs at minimal effort (QEMG) or semiquantitative EMG. Other studies have shown that both IPA and single MUP analysis of EMG recordings provide complementary data.<sup>20,21</sup>

**Key Points**

- Turns and amplitude analysis of the interference pattern compares the number of turns per unit time with the amplitude of the activity between the turns.
- In myopathies, turns per second increases and amplitude per turn decreases; in neurogenic processes the turns per second decreases and the amplitude per turn increases.
- The parameters assessed with turns and amplitude analysis can be displayed graphically in a scatter plot, which eliminates the need to control for the force of contraction.



**Figure 27-13.** Quantitative interference pattern analysis in a mild myopathy. MUP interference pattern (top) using measurements of time intervals (bottom left), mean amplitude (middle), and the “cloud” (bottom right), note borderline low amplitude and excess turns per second.



**Figure 27-14.** Examples of differences in frequency analysis of normal, myopathy, and neuropathy subjects. Note the excess of high frequencies in myopathy and reduction of all frequencies in neuropathy (arrows).

## POWER-SPECTRUM ANALYSIS

Another less commonly used method is the application of fast Fourier transforms to the interference pattern to obtain the power of the interference pattern at different frequencies. This can be calculated and displayed across the entire frequency spectrum or given at specific frequencies (Fig 27-14).<sup>28,35</sup> Using fast Fourier transformation, the IPA can be described mathematically as a sum of sine waves of different frequencies. The interference pattern can be characterized according to the density of power it contains at various frequencies; this is referred to as the *power spectrum*.<sup>36</sup> The precise shape of the interference pattern power spectrum depends on the geometry of the recording electrodes and the characteristics of the instruments. The shape is generally an inverted “U,” with a broad peak or plateau between 100 and 500 Hz, and the power falling off toward 0 at approximately 800–2000 Hz. The lower frequency components (10–50 Hz) of the power spectrum tend to reflect the firing rates of MUPs. The higher frequency components are more closely related to MUP morphology.

In myopathies, the interference pattern power spectrum contains relatively more power in the higher frequencies, probably because of the short mean duration of the MUPs. Frequency peaks are above 400 Hz. In neuropathies, the interference pattern power spectrum contains relatively more power in

the lower frequencies, probably because of the long mean duration of the MUPs. Ronager et al.<sup>35</sup> examined power spectrum analysis in the biceps brachii muscle of normal subjects and patients with myopathies and neurogenic disorders. They determined the mean power frequency, the power at a variety of frequencies (140 Hz, 1400 Hz, 2800 Hz, and 4200 Hz) relative to the total power, and the high/low frequency ratio (1400/140). At a force of 30% of maximal voluntary contraction, power-spectrum analysis identified 55% of patients with myopathies and 64% of those with neurogenic diseases. In myopathies, the relative power at 1400 Hz was increased in 50%. In neurogenic disorders, there was a decrease in relative power at 1400 Hz and decrease in the high/low frequency ratio in 55% of patients.

Frequency analysis of the EMG signal has been used as a tool for measuring muscle fatigue.<sup>37</sup> The mean and median frequency of the power-density spectrum decay with fatigue as the result of changes in muscle-fiber conduction velocity and motor unit activation. The technique is, however, limited by poorly defined normal values and wide ranges of values among normal subjects.

### Key Points

- The power of the interference pattern can be expressed in component frequencies for power-spectrum analysis.



- In myopathies, the interference pattern power spectrum contains relatively more power in the higher frequencies while in neuropathies there is generally more power in the lower frequencies.

## AUTOMATED METHODS OF ANALYSIS OF SPONTANEOUS ACTIVITY

While quantitative methods for analyzing MUP activity have steadily advanced over the last several years, precise methods for assessing spontaneous activity are in their early stages. Drost et al. using multichannel high-density arrays of surface recording electrodes have developed a method of studying fasciculation potentials. They found that both spatial and temporal information about involuntary contractions of different segments of the motor unit can be acquired noninvasively, yielding new insights regarding the sources of individual fasciculation potentials.<sup>38</sup>

Methods for analyzing fibrillation potentials largely remain in the subjective realm. In considering what techniques being used in other fields might be considered for application in quantifying fibrillation potentials in EMG, two existing methodologies come to mind: (1) In electroencephalography, a number of algorithms have been developed for automated detection of seizure spikes.<sup>39</sup> Electrodes are placed either on the scalp, on the dura, in subdural arrays, or in the substance of the brain. When regularly recurring spikes meeting amplitude and rise-time criteria are identified, interventions can be instituted. (2) In cardiac electrophysiology, electrodes are placed on the chest wall or in proximity to the heart in order to detect, among other life threatening dysrhythmias, the regularly recurring narrow complex pattern of ventricular tachycardia.<sup>40</sup> When this is identified in a cardiac inpatient, alarms sound to summon critical care personnel. In the case of patients with implanted cardiac defibrillators, the identification of such a perilous rhythm sets in motion an automated direct current electrical impulse in an attempt to abort the dysrhythmia. Perhaps a variation of one of these algorithms might be found to have a diagnostic role in identifying and

quantitatively grading fibrillation potentials in resting skeletal muscle as an EMG technique.

### Key Points

- While different methods to quantitate MUP activity have been introduced at a steady rate over the last several years, rigorous approaches to quantitate fibrillation potentials are yet to be developed.
- Non-EMG fields of clinical physiology such as electroencephalography, which use spike detection algorithms, may hold promise for application in quantifying fibrillation potentials in denervated skeletal muscle.

## SUMMARY

The quantitative evaluation of individual MUPs, decomposition of the interference pattern, IPA of turns and amplitude, and frequency and power-spectrum analyses of the interference pattern are all useful techniques. They evaluate different features of the voluntary activity of skeletal muscle, with results probably reflecting different properties of the function and dysfunction of motor units. One method is not necessarily superior to the others. It is likely that the more methods used, the closer the examiner will come to understanding the functional structure of the muscle being studied and whether or not a neuromuscular disorder is present.

The most critical limiting variable in using these techniques is time. In a busy EMG practice, it is not possible to use all of these techniques in one patient. It is the author's practice to use semiquantitative EMG analysis first because this can be performed on any muscle and on a number of muscles relatively quickly. The clinical question is usually answered with this technique. If doubt still remains, quantitation of the MUP in the most suspect muscle is performed with the QEMG program or the multi-MUAP analysis program. Cloud IPA with the Stalberg method, interpotential intervals, and the peak ratio can provide supportive evidence.

The development of innovative methods of signal analysis, including wavelet domain analysis, and the use of artificial intelligence techniques, including neural networks that can



learn, suggest that improved methods of analysis of EMG signals will become available as the field advances. These new approaches in combination with the availability of faster and cheaper digital microprocessors will probably lead to significant improvements in QEMG over the next few years. Methods to quantitate fibrillation potential activity in skeletal muscle will likely remain beyond the horizon for some time.

## REFERENCES

- Conwit, R. A., D. Stashuk, B. Tracy, M. McHugh, W. F. Brown, and E. J. Metter. 1999. The relationship of motor unit size, firing rate and force. *Clinical Neurophysiology* 110:1270–5.
- Akaboshi, K., Y. Masakado, and N. Chino. 2000. Quantitative EMG and motor unit recruitment threshold using a concentric needle with quadrifilar electrode. *Muscle & Nerve* 23:361–7.
- Stalberg, E., S. D. Nandedkar, D. B. Sanders, and B. Falck. 1996. Quantitative motor unit potential analysis. *Journal of Clinical Neurophysiology* 13: 401–22.
- Trontelj, J. V., and E. V. Stalberg. 1995. Multiple innervation of muscle fibers in myasthenia gravis. *Muscle & Nerve* 18:224–8.
- Bromberg, M. B., A. G. Smith, and J. Bauerle. 1999. A comparison of two commercial quantitative electromyographic algorithms with manual analysis. *Muscle & Nerve* 22:1244–8.
- Stalberg, E. V., and M. Sonoo. 1994. Assessment of variability in the shape of the motor unit action potential, the “jiggle,” at consecutive discharges. *Muscle & Nerve* 17:1135–44.
- Buchthal, F., C. Guld, and F. Rosenfalck. 1957. Multielectrode study of the territory of a motor unit. *Acta Physiologica Scandinavica* 39:83–104.
- Stalberg, E., and P. Dioszeghy. 1991. Scanning EMG in normal muscle and in neuromuscular disorders. *Electroencephalography and Clinical Neurophysiology* 81:403–16.
- Stalberg, E., and P. R. Fawcett. 1982. Macro EMG in healthy subjects of different ages. *Journal of Neurology, Neurosurgery, and Psychiatry* 45:870–8.
- Buchthal, F., C. Guld, and P. Rosenfalck. 1954. Action potential parameters in normal human muscle and their dependence on physical variables. *Acta Physiologica Scandinavica* 32:200–18.
- Buchthal, F., P. Pinelli, and P. Rosenfalck. 1954. Action potential parameters in normal human muscle and their physiological determinants. *Acta Physiologica Scandinavica* 32:219–29.
- Buchthal, F., and P. Rosenfalck. 1955. Action potential parameters in different human muscles. *Acta Psychiatrica et Neurologica Scandinavica* 30:125–31.
- Petersen, I., and E. Kugelberg. 1949. Duration and form of action potential in normal human muscle. *Journal of Neurology, Neurosurgery, and Psychiatry* 12:124–8.
- Sacco, G., F. Buchthal, and P. Rosenfalck. 1962. Motor unit potentials at different ages. *Archives of Neurology (Chicago)* 6:366–73.
- Stalberg, E., S. Andreassen, B. Falck, H. Lang, A. Rosenfalck, and W. Trojaborg. 1986. Quantitative analysis of individual motor unit potentials: A proposition for standardized terminology and criteria for measurement. *Journal of Clinical Neurophysiology* 3: 313–48.
- Dorfman, L. J., and K. C. McGill. 1988. AAEE minimonograph #29: Automatic quantitative electromyography. *Muscle & Nerve* 11:804–18.
- Bischoff, C., E. Stalberg, B. Falck, and K. E. Eeg-Olofsson. 1994. Reference values of motor unit action potentials obtained with multi-MUAP analysis. *Muscle & Nerve* 17:842–51.
- Boe, S. G., D. W. Stashuk, W. F. Brown, and T. J. Doherty. 2005. Decomposition-based quantitative electromyography: Effect of force on motor unit potentials and motor unit number estimates. *Muscle & Nerve* 31(3):365–73.
- Pattichis, C. S., C. N. Schizas, and L. T. Middleton. 1995. Neural network models in EMG diagnosis. *IEEE Transactions on Bio-medical Engineering* 42:486–96.
- Podnar, S., E. Zaleska, and I. Hausmanowa-Petrusewicz. 2005. Evaluation of the complexity of motor unit potentials in anal sphincter electromyography. *Clinical Neurophysiology* 116(4):948–56.
- Fuglsang-Frederiksen, A. 2006. The role of different EMG methods in evaluating myopathy. *Clinical Neurophysiology* 117(6):1173–89.
- Brownell, A. A., O. Ni, and M. B. Bromberg. 2006. Comparison of three algorithms for multi-motor unit detection and waveform marking. *Muscle & Nerve* 33(4):538–45.
- Calder, K. M., M. J. Agnew, D. W. Stashuk, and L. McLean. 2008. Reliability of quantitative EMG analysis of the extensor carpi radialis muscle. *Journal of Neuroscience Methods* 168(2):483–93.
- Doherty, T. J., and D. W. Stashuk. 2003. Decomposition-based quantitative electromyography: Methods and initial normative data in five muscles. *Muscle & Nerve* 28(2):204–11.
- Podnar, S., and J. Zidar. 2006. Sensitivity of motor unit potential analysis in fascioscapulohumeral muscular dystrophy. *Muscle & Nerve* 34:451–6.
- Boe, S. G., D. W. Stashuk, and T. J. Doherty. 2007. Motor unit number estimates and quantitative motor unit analysis in healthy subjects and patients with amyotrophic lateral sclerosis. *Muscle & Nerve* 36(1): 62–70.
- Boe, S. G., D. W. Stashuk, and T. J. Doherty. 2006. Within-subject reliability of motor unit number estimate and quantitative motor unit analysis in a distal and proximal upper limb muscle. *Clinical Neurophysiology* 117(3):596–603.
- Fuglsang-Frederiksen, A. 2000. The utility of interference pattern analysis. *Muscle & Nerve* 23:18–36.
- Zwarts, M. J., G. Drost, and D. F. Stegeman. 2000. Recent progress in the diagnostic use of surface EMG for neurological diseases. *Journal of Electromyography and Kinesiology* 10:287–91.

30. Liguori, R., K. Dahl, and A. Fuglsang-Frederiksen. 1992. Turns-amplitude analysis of the electromyographic recruitment pattern disregarding force measurement. I. Method and reference values in healthy subjects. *Muscle & Nerve* 15:1314–18.
31. Liguori, R., K. Dahl, A. Fuglsang-Frederiksen, and W. Trojaborg. 1992. Turns-amplitude analysis of the electromyographic recruitment pattern disregarding force measurement. II. Findings in patients with neuromuscular disorders. *Muscle & Nerve* 15:1319–24.
32. Nirkko, A. C., K. M. Rosler, and C. W. Hess. 1995. Sensitivity and specificity of needle electromyography: A prospective study comparing automated interference pattern analysis with single motor unit potential analysis. *Electroencephalography and Clinical Neurophysiology* 97:1–10.
33. Hirose, K., M. Uono, I. Sobue, and M. Uono. 1975. Quantitative electromyography. Difference between myopathic findings and neuropathic ones. *Electromyography and Clinical Neurophysiology*. 15(5–6): 431–49.
34. Sanders, D. B., E. V. Stalberg, and S. D. Nandedkar. 1996. Analysis of the electromyographic interference pattern. *Journal of Clinical Neurophysiology* 13:385–400.
35. Ronager, J., H. Christensen, and A. Fuglsang-Frederiksen. 1989. Power spectrum analysis of the EMG pattern in normal and diseased muscles. *Journal of the Neurological Sciences* 94:283–94.
36. Kamen, G., and G. E. Caldwell. 1996. Physiology and interpretation of the electromyogram. *Journal of Clinical Neurophysiology* 13:366–84.
37. Krivickas, L. S., A. Taylor, R. M. Maniar, E. Mascha, and S. S. Reisman. 1998. Is spectral analysis of the surface electromyographic signal a clinically useful tool for evaluation of skeletal muscle fatigue? *Journal of Clinical Neurophysiology* 15:138–45.
38. Drost, G., B. U. Kleine, D. F. Stegeman, et al. 2007. Fasciculation potentials in high-density surface EMG. *Journal of Clinical Neurophysiology* 24: 301–7.
39. Gardner, A. B., G. A. Worrell, E. Marsh, et al. 2007. Human and automated detection of high-frequency oscillations in clinical intracranial EEG recordings. *Clinical Neurophysiology* 118:1134–43.
40. Singh, J. P., W. J. Hall, S. McNitt, et al. 2005. Factors influencing appropriate firing of the implanted defibrillator for ventricular tachycardia/fibrillation. *Journal of the American College of Cardiology* 46: 1712–20.

# Single Fiber Electromyography

C. Michel Harper, Jr.

## INTRODUCTION

### TECHNIQUE

Hardware  
Software  
Method of Activation  
Measurement

### PITFALLS OF SFEMG

General  
Unstable Trigger  
False Trigger  
Incorrect Measurement Position

Damaged Fiber  
Split Fiber or Ephaptic Activation  
Neurogenic Blocking  
Pitfalls Unique to Stimulated SFEMG

### CLINICAL APPLICATIONS OF SFEMG

Primary Disorders of  
Neuromuscular Transmission  
Primary Disorders of Muscle  
Primary Neurogenic Disorders

### SUMMARY

## INTRODUCTION

*Single fiber electromyography* (SFEMG) selectively evaluates individual components of the motor unit. SFEMG measurements that are useful clinically include fiber density, jitter, and blocking. Fiber density is increased in a nonspecific manner in most neurogenic and myopathic disorders, but it can be used in conjunction with jitter and blocking to make inferences about the time course and progression of disease. Jitter and blocking are quantitative and sensitive measures of neuromuscular transmission efficiency. These measures identify abnormalities early in the course of disease when standard electrodiagnostic studies are normal. Although SFEMG is highly sensitive, it is nonspecific because denervation and

reinnervation associated with muscle or nerve disease also impair neuromuscular transmission. Thus, SFEMG results should be interpreted carefully in the context of clinical and laboratory data as well as the results of nerve conduction studies and concentric needle electromyography (EMG).

### *Purpose and Role of SFEMG*

- Identify the presence of a disorder of neuromuscular transmission when other electrophysiologic assessments are normal.
- Follow the course of mild defects of neuromuscular transmission.
- Identify the presence of signs of regeneration in neurogenic and myopathic disorders.

SFEMG is the most selective technique available in clinical neurophysiology to study the motor unit. It is more selective than concentric needle EMG, which in turn is more selective than surface recordings. Selectivity refers to the ability to resolve individual generators of electrical activity within a volume conductor. In EMG, the generator is the action potential of a single muscle fiber. Selectivity depends on three main factors:

1. The size of the electrode in relation to the size of the action potential generator.
2. The filtering characteristics of the conducting medium.
3. The filter settings used in the recording process.

Surface electrodes record summated activity from many different motor units. A compound muscle action potential (CMAP) is recorded when motor units discharge synchronously after supramaximal electrical nerve stimulation. Assuming the electrodes are large enough, the amplitude and area of the CMAP reflect the summated activity of the entire muscle. When the muscle is activated voluntarily, surface electrodes record activity from a large number of motor units. These types of recordings provide information about firing patterns of large motor unit groups but do not permit selective recording of individual motor unit potentials. The lack of selectivity results from the large size of the electrode relative to the size of individual muscle fibers and the tendency of the intervening tissue of the volume conductor to act as a high-frequency filter.

The concentric needle EMG electrode, with a recording surface of  $150 \times 580 \mu\text{m}$ , is able to record selectively from individual motor unit potentials containing an average of several hundred muscle fibers. Due to the high-frequency filter characteristics of muscle tissue, most of the motor unit potential waveforms are generated from the 10 to 20 muscle fibers located within several millimeters of the electrode. The selectivity of concentric needle EMG is limited by the large electrode size relative to the diameter of a single muscle fiber (25–100  $\mu\text{m}$ ). This can be overcome to some extent by increasing the low-frequency filter to 500 Hz, which attenuates low-frequency activity from distant muscle fibers. This narrows the recording area of the concentric needle

EMG electrode to 500–1000  $\mu\text{m}$  and, in many cases, allows recording of potentials from single muscle fibers or potentials summated from two or three fibers. Thus, a reasonable estimation of jitter is obtained using a concentric needle EMG electrode by increasing the low-frequency filter to 500 Hz.<sup>1,2</sup>

The SFEMG electrode has a circular recording surface with a diameter of 25  $\mu\text{m}$ , about the same as individual muscle fibers. When used with a 500-Hz low-frequency filter, the effective recording distance is limited to 200  $\mu\text{m}$ . The combination of small electrode size, low-pass filter characteristics of muscle tissue, and use of a 500-Hz low-frequency filter provide the selectivity required to record single muscle fiber action potentials. The standard SFEMG needle has the recording electrode located along the shaft of the cannula 3 mm proximal to the nonbeveled side of the tip. This minimizes the chance of recording activity from muscle fibers that are damaged by the tip and further enhances selectivity by recording activity directly adjacent to the recording electrode.

SFEMG can be performed with minimal voluntary activation or electric stimulation. The single muscle fiber action potential recorded during SFEMG is typically biphasic, with an initial positive phase followed by a major negative spike. When the electrode is close to the muscle fiber (rise time, 500  $\mu\text{s}$ ), the amplitude ranges from 500  $\mu\text{V}$  to 10 mV with a duration of 1–1.5 ms. The amplitude varies greatly with minor changes in distance because of the small size of the recording electrode. The power spectrum of the single fiber action potential ranges from 100 to 5000 Hz, with a peak from 1 to 2 kHz. Four types of measurement can be made during SFEMG:

1. *Fiber density* reflects the packing density of muscle fibers within the recording area of the single fiber electrode. It correlates with the degree of motor unit potential polyphasia in concentric needle EMG recordings. Fiber density is increased in neurogenic and myopathic disease.
2. *Jitter* measures the latency variability of muscle fiber action potentials within the same motor unit. It reflects the variability in rise time of the end plate potential, providing a sensitive indicator of a mild defect of neuromuscular transmission. Jitter is increased in disorders associated

with denervation and reinnervation as well as primary neuromuscular junction diseases.

3. *Blocking* measures the intermittent loss of a regularly firing muscle fiber action potential within a motor unit. This typically reflects the failure of the end plate potential to reach threshold in disorders of neuromuscular transmission, but can also occur in neurogenic disorders when the impulse is blocked along a terminal branch of the motor axon. Blocking is present in moderate to severe disorders of neuromuscular transmission, in disorders associated with denervation and reinnervation of muscle, and in neuropathies associated with impulse blocking in the nerve terminal.
4. *Duration* measures the time between the first and the last muscle fiber action potentials in a motor unit within recording distance of the electrode. This reflects differences in conduction time along the terminal axonal branch and muscle fiber. Duration correlates with the duration of motor unit potentials recorded in concentric needle EMG and is increased in neurogenic disease and in some chronic myopathies.

### Key Points

- Selective isolation of a single muscle fiber action potential depends on
  - Recording electrode size down to 25  $\mu\text{m}$
  - Optimal signal filtering at 500 Hz low-frequency settings.
- SFEMG can be reasonably approximated with a standard concentric needle electrode using 500-Hz low-frequency settings.
- SFEMG is very sensitive but not specific for mild disorders of neuromuscular transmission.
- SFEMG is abnormal in myopathies, neuropathies, and anterior horn cell disorders.
- SFEMG assists in the assessment of the temporal profile and activity of neuromuscular diseases.
- SFEMG complements nerve conduction studies (repetitive stimulation) and concentric needle EMG in the evaluation of neuromuscular junction diseases, and

adds value only when routine nerve conduction studies and concentric needle EMG are normal.

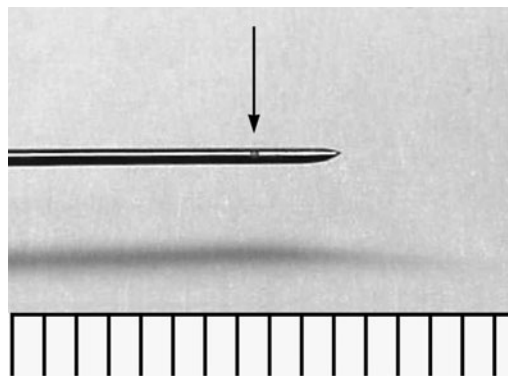
- SFEMG can be performed with voluntary activation or electric stimulation of motor units.
- The most clinically useful measure of SFEMG is *jitter*, the latency variability of muscle fiber action potentials within the same motor unit.

## TECHNIQUE

### Hardware

#### NEEDLE ELECTRODE

For standard SFEMG recordings, the needle consists of a stainless steel shaft (0.5 mm diameter), with a single platinum wire down the center, opening onto a side port opposite the beveled edge, and 3 mm proximal to the electrode tip (Fig. 28–1). The active recording surface is circular and 25  $\mu\text{m}$  in diameter. The shaft of the needle serves as the reference electrode. Single fiber electromyographic electrodes are expensive and, thus, are sterilized and reused. The electrode should be inspected under a dissecting microscope after being used every 5–10 times and sharpened as needed. Electrolyte treatment may be required if single fiber amplitudes are low or noise is excessive. Due to the high expense of SFEMG needles and safety concerns related to reusability, many



**Figure 28–1.** SFEMG electrode with active electrode (arrow) located along needle shaft proximal to tip of needle.

laboratories now use disposable concentric needle electrodes that have 5  $\mu$ sec shorter jitter MCD.<sup>1,2</sup>; but cannot measure fiber density.

### AMPLIFIER

The high impedance of the SFEMG electrode requires that the recording amplifier has high input impedance and low input capacitance, which maintains the frequency response and prevents distortion of the single fiber potential. Most standard clinical EMG preamplifiers and amplifiers are sufficient for SFEMG recording as long as the low-frequency filter can be set to 500 Hz.

### TRIGGER, DELAY, AND DISPLAY

An amplitude trigger placed on the negative phase of the single fiber action potential initiates the sweep, and an analog or digital delay allows the triggered potential and all potentials that are time-locked to the triggered potential to be displayed. The trigger can be used with voluntary, reflex, or electric activation. The potential should be displayed at a sweep speed of 0.2–1 ms and a sensitivity of 20  $\mu$ V–2 mV for accurate resolution of single fiber potentials and measurement of fiber density, jitter, blocking, and duration. When analog equipment and manual measurement are used, a counter and filming system that provide print-outs of five consecutive groups of 10 superimposed sweeps are required to measure and to quantitate jitter.

### Software

The majority of commercially available systems used to perform SFEMG are digital. Digital conversion of the signal affords the advantages of flexible display, automated measurement and calculation, storage, and reanalysis of data. Each system has features that differ with regard to ease of use, degree of automation, display, and price. Key features that are essential include automated jitter (mean consecutive difference, MCD) measurement of a minimum of 50 consecutive sweeps, storage capacity for at least 30 pairs, and the ability to review and reanalyze all the raw data.

## Method of Activation

### VOLUNTARY SFEMG

Muscle fiber action potentials are isolated with minimal voluntary muscle contraction. Approximately 60% of the time, a single potential is recorded. For the other 40%, from one to five potentials that are time-locked to the triggered potential are recorded on the same sweep. The level of activation should be adjusted to maintain the triggered potential at a firing rate of 10–15 Hz. When activation is too vigorous, various technical problems can arise, including overestimation of jitter (caused by unstable trigger and variation in amplitude of measured potential) and false blocking (caused by alternation of the trigger between a time-locked and a single potential). The position of the needle is adjusted to maximize the rise time of the triggered and time-locked potentials. Minor rotational movements of the needle help reduce noise from distant potentials and separate time-locked potentials that are fused with the triggered potential.

### STIMULATED SFEMG

Muscle fiber action potentials are recorded after electric stimulation in the study of disorders of neuromuscular transmission or investigation of certain reflexes (F waves, H reflex, blink reflex, etc.). Electric stimulation is useful when patients are unable to cooperate with voluntary SFEMG or when the effect of a change in firing rate on jitter and blocking needs to be quantitated. Stimulated SFEMG has several disadvantages. Fiber density cannot be measured accurately, and careful attention to technical problems is necessary to ensure accurate and reliable measurement of jitter and blocking. In particular, minor movements in the stimulating needle or “perithreshold” stimulus intensities can falsely elevate jitter while direct muscle stimulation can falsely depress jitter. In addition, different normal values are used for jitter in stimulated and voluntary SFEMG because jitter reflects neuromuscular transmission from a single end plate in stimulated SFEMG and from two end plates in voluntary SFEMG (i.e., both the triggered and the measured potentials). Finally, electric stimulation tends to selectively activate large diameter axons with low activation thresholds, unlike



voluntary SFEMG in which smaller diameter axons are recruited initially and recorded preferentially. The relative ease of obtaining data in stimulated SFEMG may lull the inexperienced examiner into a false sense of security, but the technical issues described above make stimulated SFEMG less accurate than voluntary SFEMG, even in the hands of experienced electromyographers.

Electric stimulation can be applied to a branch of the nerve located outside the muscle or to an intramuscular motor branch. A monopolar needle is used as a cathode with another needle or surface electrode as the anode. Very small currents (1–10 mA, 0.5 ms duration) are used to activate a small number of muscle fibers. The current and position of the SFEMG recording electrode are adjusted until a single muscle action potential with a rise time less than 500  $\mu$ s and time-locked to the stimulus is recorded. Jitter is measured as the latency variability of the muscle fiber action potential in relation to the stimulus. When increased jitter or blocking is observed, the stimulus is increased slightly. If the blocking disappears or the jitter lessens, the abnormalities likely were caused by slight variation in current strength above and below the threshold of activation. This is a technical problem unique to stimulated SFEMG. Reduced excitability resulting in latency prolongation, increased jitter, and blocking can also be seen with prolonged stimulation at rates of stimulation greater than 20 Hz. This can be avoided by keeping stimulation rates less than 20 Hz except for brief 5- to 10-second intervals of stimulation at higher rates. Very low jitter (MCD, 10  $\mu$ s) is related to direct muscle stimulation and should be ignored.

## Measurement

### FIBER DENSITY

*Fiber density* is defined as the average number or density of muscle fiber action potentials within the recording area of the single fiber needle electrode. The needle is adjusted until a single fiber action potential with an adequate rise time (i.e., 500  $\mu$ s) is isolated. The number of muscle fiber action potentials with an amplitude greater than 200  $\mu$ V time-locked to the triggered potential are counted. This

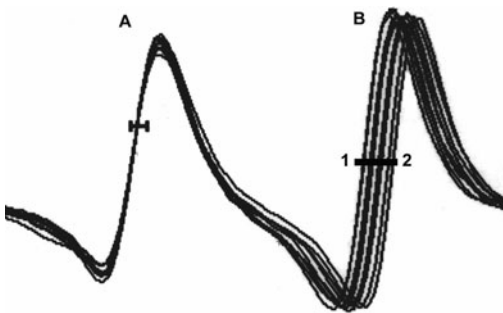
procedure is repeated for 30 separate triggered potentials to obtain an average fiber density for the entire muscle. In normal subjects, a single potential is isolated 60% of the time, two potentials 35%, and three or more potentials 5% of the time. Average fiber density ranges from 1.3 to 1.8 in normal persons younger than 70 years. Fiber density reflects the density of muscle fibers in one motor unit within the recording area and corresponds most directly to the number of turns seen on standard concentric needle EMG. This feature of the motor unit potential is sometimes called *complexity* because each of these turns typically represents a separate fiber that contributes to the motor unit potential. Fiber density has a less direct relationship to the percentage of polyphasic motor unit potentials because in a polyphasic potential a phase may include more than one turn. Satellite potentials seen in standard recordings are also recorded as separate single fiber potentials in SFEMG.

Fiber density is increased in disorders that produce denervation and reinnervation. Thus, increased fiber density is observed in most motor neuron diseases and peripheral neuropathies. The finding of increased fiber density is particularly striking and out of proportion to other changes on SFEMG early in the course of reinnervation, when differences in conduction along regenerating nerve terminals cause marked asynchrony of firing of newly reinnervated muscle fibers and dispersion of single muscle fiber action potentials. Chronic disorders with minimal active denervation but considerable compensated reinnervation have increased fiber density, with only minimal increase in jitter and blocking. In contrast, subacute progressive disorders associated with ongoing reinnervation have a marked increase in jitter and blocking and only a mild increase in fiber density. Fiber density is also increased in myopathies that are associated with fiber splitting, degeneration, and regeneration. Therefore, fiber density can be used to quantitate the severity and time course of some neuromuscular disorders, but it cannot distinguish between neurogenic and myopathic disorders.

### JITTER

In voluntary SFEMG, jitter is defined as variation in the interpotential interval between two

single muscle fiber action potentials recorded simultaneously from a single motor unit. Jitter typically results from variation in the rise time and amplitude of the end plate potential at the neuromuscular junction. Jitter can also result from variability of conduction along the muscle membrane, but these factors produce negligible jitter at regular firing rates and when the interpotential interval is less than 1 ms. In normal subjects, there are small variations in the size of the end plate potential caused by variations in the number of quanta of acetylcholine released from the nerve terminal. A smaller end plate potential has a slower rise time and reaches threshold later than a larger end plate potential, so that the time from the action potential in the nerve terminal to the action potential in the muscle fiber varies by as much as 50  $\mu$ s. The presence of this variation is evidence of a synapse between the activation site and the recording site. Two single fiber potentials with little or no jitter are either time-locked by ephaptic (electric) activation of each other or recorded from a single muscle fiber that has been split or otherwise distorted. The amplitude and the rise time of the end plate potential are a direct reflection of the safety margin of neuromuscular transmission. Any disorder of neuromuscular transmission that decreases the safety margin will increase jitter (Fig. 28–2). This includes primary disorders of neuromuscular transmission (e.g., congenital and autoimmune myasthenia gravis, Lambert–Eaton myasthenic syndrome, and botulism) or secondary disorders that reduce the safety margin by producing denervation and reinnervation with immature nerve terminals



**Figure 28–2.** SFEMG displaying multiple consecutive traces from a single pair superimposed. The sweep is triggered on potential “A.” The variability of the latency of potential “B” measured between “1” and “2” in microseconds represents jitter.

(e.g., amyotrophic lateral sclerosis, some peripheral neuropathies, and some myopathies).

Jitter can be measured as the standard deviation of the interpotential interval, but because of the occasional occurrence of a gradual change in the mean interpotential interval over time, it is more reliable to use the MCD:

$$\text{MCD} = (\text{IPI}_1 - \text{IPI}_2) + (\text{IPI}_2 - \text{IPI}_3) + \dots + \frac{\text{IPI}_{N-1} - \text{IPI}_N}{N-1}$$

where IPI is interpotential interval, and  $N$  is the number of intervals measured. For maximal reliability, the MCD should be calculated from 50 or more consecutive interpotential intervals. The MCD is calculated for each pair and then the mean of 20 pairs is calculated and compared with normal values for the muscle and the age of the patient.

When the firing interval is variable or the interpotential interval is large (i.e., 1 ms), the variation in the conduction velocity of the muscle fiber can affect jitter. This is described by the *velocity recovery function*, which demonstrates that when the preceding discharge interval is short the conduction velocity of the muscle fiber is faster on the subsequent discharge. If there is variability in the discharge frequency and the interpotential interval is long (i.e., if the velocity recovery function is beginning to affect jitter), then the mean sorted difference (MSD) is a better representation of jitter than the MCD. The MSD is calculated by first sorting the potentials in ascending order of size of the interpotential interval and then calculating the MCD. If the MCD:MSD ratio is greater than 1.25, the variability of the discharge frequency is affecting jitter and the MSD should be used.

The best point to measure jitter is on the steep rising phase of the potential close to the baseline crossing. Movement of the triggered potential (amplitude jitter) or contamination of the baseline with other potentials or one potential riding upon another will artificially increase jitter.

In stimulated SFEMG, jitter is measured as the MCD of the interpotential difference between the stimulus artifact and the single muscle fiber potential. The MCD reflects the jitter from a single end plate rather than the pair of end plates measured in voluntary SFEMG. The velocity recovery function of

muscle does not affect jitter measurement during stimulated SFEMG because there is no random variation in discharge frequency.

Several software applications are available to automate the measurement of jitter and blocking. Each program provides a graphic display of the calculated MCD for 50–100 consecutive sweeps and the ability to store, review, and reanalyze each individual sweep collected in order to ensure accuracy of the data collected. Manual calculation of MCD requires a counter that captures and displays 50 consecutive sweeps in five groups of 10 superimposed images. The variation of the interpotential difference can be measured directly from each of the five groups and the MCD calculated directly with a conversion factor.

Normal values for MCD vary with age and the muscle. In the Mayo EMG laboratory, the normal jitter in the extensor digitorum communis, the most commonly recorded limb muscle, is between 16 and 34  $\mu\text{s}$  (upper limit of normal for a single pair is 55  $\mu\text{s}$ ) for persons younger than 60 years. For persons older than 60 years, the upper limit for MCD increases to 43  $\mu\text{s}$ , and it is normal to have up to two pairs with an MCD greater than 55  $\mu\text{s}$ . The jitter is smaller in facial muscles than in limb muscles. Facial muscles are also less susceptible to local trauma, which can increase jitter indefinitely. The MCD for the frontalis muscle is 23–31  $\mu\text{s}$  in normal subjects younger than 60 years and 23–35  $\mu\text{s}$  for those 60 years and older. Similar normal values have been defined for these and other muscles.<sup>3</sup> Normal MCD values for stimulated SFEMG are approximately 80% of the value obtained with voluntary SFEMG of the same muscle in the same age group.

In normal muscle, jitter is not identifiable on standard concentric or monopolar needle EMG. However, if a motor unit potential is recorded with a standard concentric needle electrode at a low-frequency filter of 500 Hz and a sweep speed of 1 or 2 ms/cm, jitter can be identified. Quantitative measurements of jitter with a standard concentric needle electrode are somewhat larger than those recorded with a single fiber electrode, making the study less specific in the detection of mild defects of neuromuscular transmission.

Because jitter is the result of fluctuations in the amplitude of the end plate potential, any disorder that decreases the end

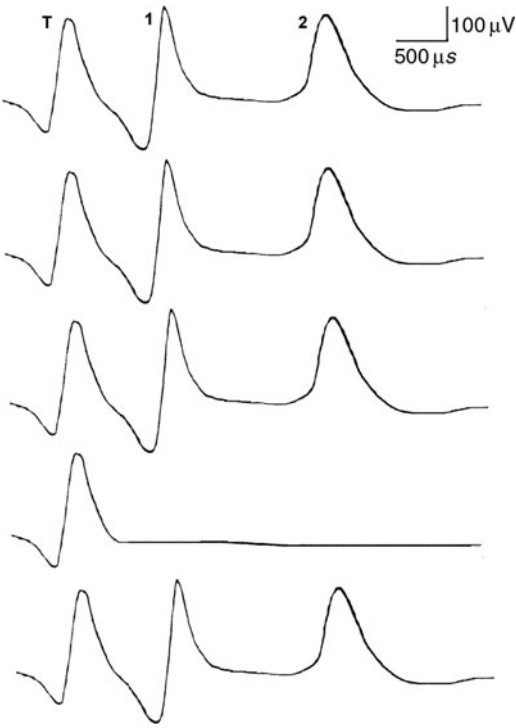
plate potential produces increased jitter. This occurs not only in disorders of neuromuscular transmission, such as myasthenia gravis, but also in disorders with ongoing reinnervation or regeneration of muscle fibers, such as amyotrophic lateral sclerosis and polymyositis. Thus, abnormalities of jitter are not diagnostic of a specific disease of the neuromuscular junction but must be considered in relation to findings obtained with standard electrophysiologic recordings. Abnormalities of jitter can occur without clinical weakness in the muscle.

Jitter is a function of the variation in synaptic potential size; therefore, it is present in recordings that include other synapses. F waves are a result of antidromic activation of the anterior horn without a central synapse so that F-wave jitter is approximately the same magnitude as with voluntary motor unit potentials. In contrast, H reflexes, which include a synapse in the spinal cord in addition to the neuromuscular junction, have normal jitter of two to three times that of voluntary motor unit potentials. Other more complex reflex phenomena, such as the blink and flexion reflexes, have correspondingly larger amounts of jitter.

Reliable jitter measurement depends on the presence of steep rising phases of both of the potentials from which to measure the interpotential interval. If the two single fibers have a short interpotential interval they will overlap, obscuring the steep rising phases. An alternative measure of the variation in the waveform resulting from the overlap of the two fiber potentials is called *jiggle*. Jiggle measures the change in shape of the summated fiber potentials that results from variation in their interpotential intervals. Amplitude measurements at each point in time of the potential are used to calculate consecutive amplitude differences and cross-correlation coefficient of consecutive discharges. Jiggle measurements are particularly useful for recordings from concentric needle electrodes where the single fiber potentials are less well distinguished than with SFEMG electrodes.<sup>4,5</sup>

## BLOCKING

In a normal muscle, the end plate potential always reaches threshold and initiates a single fiber action potential. Therefore, when multiple single fiber potentials are found, they



**Figure 28-3.** Five consecutive traces of three muscle fiber action potentials isolated during voluntary SFEMG recording. The sweep is triggered on the first potential (T). The later potentials (1 and 2) are in the same unit as the triggered potential. The latency of potentials 1 and 2 with respect to potential "T" vary slightly with each trace (jitter) until the fourth trace when potentials 1 and 2 disappear completely (blocking).

occur with each discharge of the motor unit potential. Blocking occurs when an end plate potential does not reach threshold or when conduction fails in the nerve terminal, resulting in a loss of a single fiber potential during one or more discharges of the motor unit (Fig. 28-3). Blocking is measured as the percentage of discharges of a motor unit in which a single fiber potential is missing. A motor unit in which a single fiber potential did not fire half the time would have 50% blocking. Blocking for a particular muscle is expressed either as the percentage of 20 fiber pairs that show any blocking or as the total percentage of discharges in the 20 pairs that displayed blocking. For example, if 20 potential pairs each discharge 50 times and blocking occurs a total of 20 times in two of the pairs, 10% of the pairs show blocking and 2% of all discharges have blocking.

Normal elderly subjects display occasional blocking in some muscles. In fact, in a study of 20 pairs of single fiber potentials, if a single pair exceeds the limit of normal jitter or displays blocking (or both), many electromyographers do not use those changes alone to interpret the study as abnormal. Blocking begins to occur when the jitter in a pair has increased to 80–100  $\mu$ s. In disorders of neuromuscular transmission, amplitude decrement of a CMAP with 2-Hz repetitive stimulation is caused by blocking, as is moment-to-moment variation observed on standard concentric or monopolar needle EMG.

Blocking is observed in disorders of neuromuscular transmission such as myasthenia gravis, and, when present, it provides evidence of a defect severe enough to produce weakness either at rest or with exertion. As with jitter, however, blocking can occur in other disorders in which neuromuscular transmission may be impaired, such as amyotrophic lateral sclerosis, polymyositis, and ongoing reinnervation. For blocking to be considered evidence of a disorder such as myasthenia gravis, it should be found in the absence of other electrophysiologic signs of neurogenic or myopathic disease.

## DURATION

The interval between the first and the last potential of multiple single fiber potentials recorded from a motor unit has been measured as *duration*. *Duration* is the total time from the first to the last potential averaged for all multiple potentials recorded. An alternative measure is *mean interspike interval*, which divides the duration by the number of single fiber potentials in each discharge. Mean interspike interval and duration increase when the activation of individual single fiber potentials is dispersed in time. Factors that may contribute to dispersion include reduced synchrony of firing, anatomical dispersion of end plates along muscle fibers, and differences in conduction along the terminal axon or muscle fiber. Duration is used less frequently than other SFEMG measurements because similar information is obtained from the duration of motor unit potentials and the examination for satellite potentials during standard concentric or monopolar needle EMG.

## Key Points

- A special needle electrode is used to record SFEMG although jitter can be accurately recorded with a concentric needle electrode with a shorter MCD.
- A high input impedance amplifier is required to obtain high-quality SFEMG recordings.
- SFEMG can be done with either voluntary activation or electrical stimulation of the target muscle.
- Fiber density can only be recorded with a single fiber needle and estimates the packing density of muscle fibers.
- Jitter represents time variation of the rise time of the end plate potential and represents a sensitive measure of neuromuscular transmission efficiency.
- Blocking occurs when end plate potentials intermittently fail to reach threshold for firing of a muscle action potential.
- Blocking reflects more severe neuromuscular transmission failure than increased jitter alone.

## PITFALLS OF SFEMG

### General

Most errors in SFEMG result from needle movement, excessive activation, or variability in the firing rate of the muscle action potential. The selectivity that affords the single fiber electrode the ability to focus the recording on one or two muscle fibers also renders SFEMG extremely sensitive to small movements of the needle electrode. Minor movement along the long axis as well as angulation or rotation of the cannula often produces marked changes in the amplitude or configuration of the muscle fiber action potential. Variation in amplitude and configuration leads to errors in jitter and blocking measurements. The ability to hold the electrode motionless is the greatest technical skill required to produce reliable SFEMG recordings. The second great technical challenge in voluntary SFEMG is to maintain minimal activation at relatively stable firing rates. Excessive noise produced by nearby muscle fiber action potentials may distort the baseline or the single fiber potentials of interest, which artificially

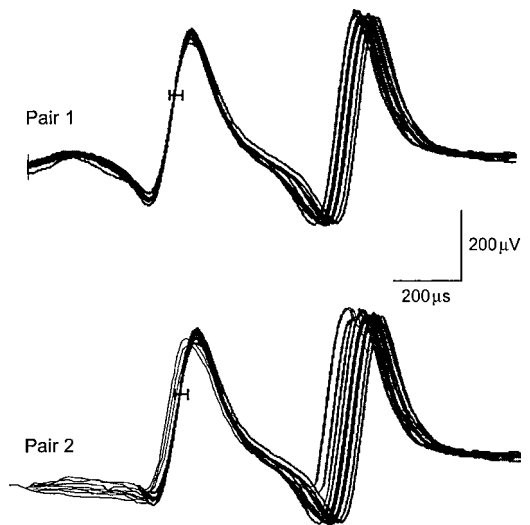
increases jitter. Changes in firing rates affect the velocity recovery function of the muscle fiber, which also increases jitter.

### Unstable Trigger

Because all measurements are taken in reference to the triggered potential, stability of this potential forms the cornerstone of voluntary SFEMG. Gross instability results in intermittent loss of the triggered potential and interruption of the SFEMG recording. When this occurs occasionally, the sweep can be deleted from analysis, but frequent loss of the triggered potential makes it impossible to record jitter or blocking accurately. Even minor fluctuation of the amplitude of the triggered potential can add as much as 10  $\mu$ s to the MCD. Superimposition of consecutive sweeps is an effective way to check for stability of the triggered potential (Fig. 28–4). Electrode movement, excessive activation, or variation in firing rates can produce an unstable trigger.

### False Trigger

Occasionally in voluntary SFEMG, two muscle fiber action potentials close to the electrode have similar firing thresholds, amplitude, and configuration. When this occurs, the trigger



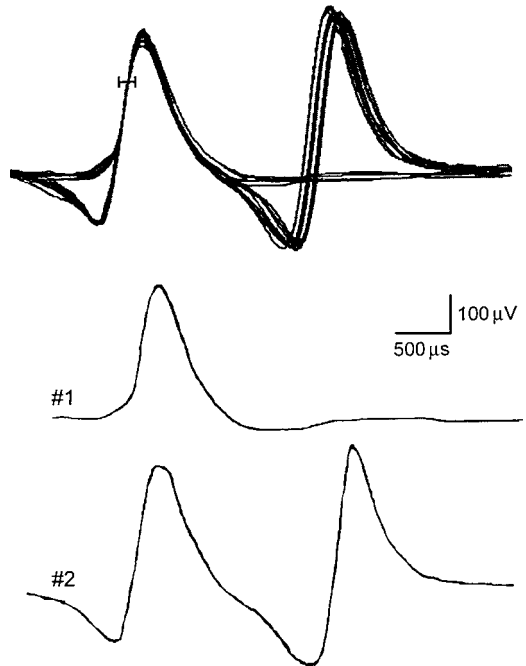
**Figure 28–4.** Superimposition of sweeps during SFEMG recordings. Poor superimposition traces in pair 2 demonstrates an unstable triggered potential.



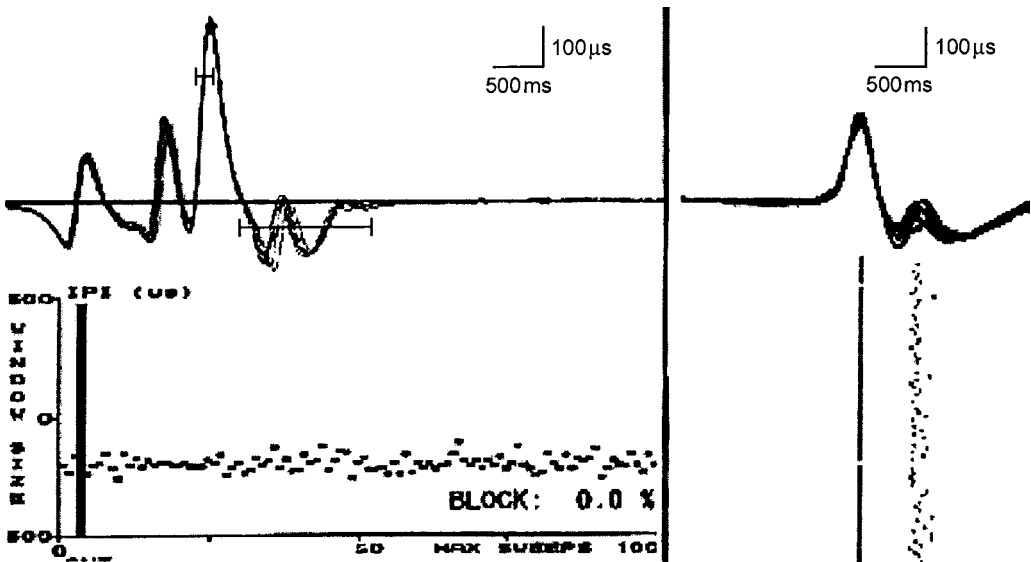
may “jump” from one potential to the other. If one of the potentials is a *double*—i.e., it has a second potential time-locked to the first—and the other potential is a *single*, alternation of the trigger between the two potentials gives the false impression of blocking (Fig. 28-5).

### Incorrect Measurement Position

Jitter is best measured from the inflection point of the second potential, which typically occurs as the rise time of the potential crosses the baseline. In voluntary SFEMG, this position requires minimal activation because any noise that moves the baseline will affect the measurement of jitter. The farther the measurement point is moved away from the inflection point, the more jitter is affected by changes in amplitude of the potential produced by needle movement. Some automatic algorithms measure jitter from the peak rather than the rising phase of the potential (Fig. 28-6). This method is also useful when multiple potentials are superimposed on one another. The accuracy of the peak jitter method depends on the ability of the examiner and the software to clearly define stable peaks of the waveforms.



**Figure 28-5.** False trigger. The trigger alternates between two potentials of similar size and shape. Potential #1 is a single potential, whereas potential #2 is time-locked to a second potential (i.e., part of a double). Alternation of the trigger between potentials #1 and #2 gives the false impression of blocking.



**Figure 28-6.** Jitter measurement. *Left*, Jitter measurement from the negative slope of the potential. *Right*, Jitter measurement from the peak of the potential.



## Damaged Fiber

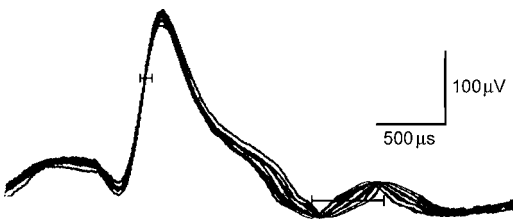
Recording from a damaged fiber often produces a broad positivity, followed by a negative phase of shorter duration and lower amplitude. The negative phase sometimes has the appearance of a second potential, which usually has low jitter with the parent potential (Fig. 28-7). This has been referred to as a *false double* and should not be included in jitter calculations.

## Split Fiber or Ephaptic Activation

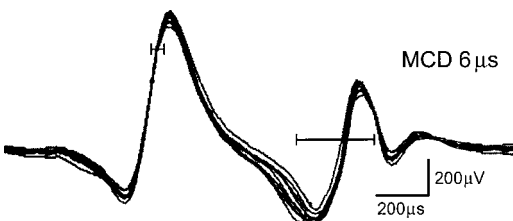
Jitter less than  $10\ \mu\text{s}$  generally indicates the absence of a neuromuscular junction between the two recorded potentials (Fig. 28-8). This occurs when the potentials are generated from the same muscle fiber that has split into two sections or when one fiber is activated by an adjacent fiber by ephaptic transmission. In stimulated SFEMG, low jitter occurs when direct muscle stimulation occurs. These values should be eliminated from jitter calculations.

## Neurogenic Blocking

There are two mechanisms by which blocking occurs in neurogenic disorders. The first,



**Figure 28-7.** Damaged fiber. Jitter from the second component should not be included in calculations of MCD.

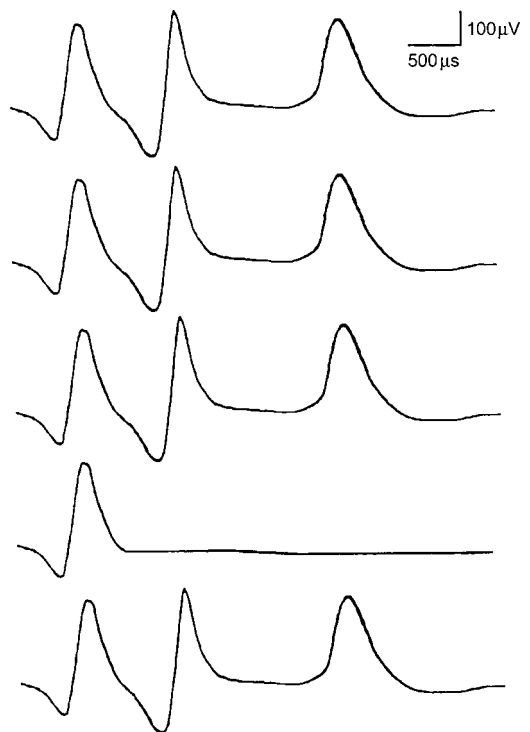


**Figure 28-8.** Low jitter indicates recording from a split fiber or one activated by ephaptic transmission. MCD, mean consecutive difference.

which occurs at the neuromuscular junction, is caused by immaturity of recently reinnervated end plates. The second, which occurs within the terminal branch of the motor axon, is caused by a prolonged refractory period related to branching and demyelination of the nerve terminals. Axonal blocking can be recognized when more than one muscle fiber action potential disappears or blocks simultaneously during either voluntary or stimulated SFEMG (Fig. 28-9). This phenomenon has also been referred to as *concomitant blocking*.

## Pitfalls Unique to Stimulated SFEMG

Stimulated SFEMG is useful when evaluating poorly cooperative patients or when it is important to measure the effect of discharge frequency on jitter and blocking. A disadvantage of stimulated SFEMG is the inability to measure fiber density. Other problems are technical in nature and must be accounted for to ensure accuracy of jitter and blocking



**Figure 28-9.** Neurogenic blocking. The second and third potentials block concomitantly.

measurements. The first technical pitfall is related to direct muscle stimulation. This is fairly easy to recognize because of the resulting small jitter. A more subtle but equally important technical problem is related to a false increase in jitter and blocking that occurs when the stimulus intensity is close to the axonal threshold of the single fiber potential being examined. Increasing the stimulus intensity slightly identifies this problem, which should eliminate blocking and reduce jitter if the problem is technical. The axonal threshold may also increase with prolonged stimulation or stimulation at rates in excess of 20 Hz. Thus, the effect of small increases in stimulus intensity should always be determined before jitter and blocking are measured during stimulated SFEMG.

### Key Points

- Most errors in SFEMG result from needle movement, excessive activation, or variability in the firing rate of the muscle action potential.
- Technical errors that result in falsely increased jitter or blocking include an unstable trigger, a false trigger, neurogenic blocking, and an incorrect position of measurement marker.
- Technical errors that produce a falsely reduced jitter include recording from a split fiber, a damaged fiber, or direct muscle stimulation (with stimulated SFEMG only).

## CLINICAL APPLICATIONS OF SFEMG

### Primary Disorders of Neuromuscular Transmission

SFEMG is so sensitive that abnormalities of neuromuscular transmission are recognized in the absence of clinical weakness or abnormalities on other physiologic tests.<sup>6-8</sup> The clinical usefulness of SFEMG in identifying and quantitating defects of neuromuscular transmission has been demonstrated repeatedly.<sup>7-11</sup> Although the method is more complicated and time-consuming than repetitive

stimulation studies, it can be learned readily and applied with a minimum of specialized equipment. However, in uncooperative or tremulous patients, reliable voluntary SFEMG can be time-consuming, so the selection of patients and muscles for SFEMG requires consideration.

### AUTOIMMUNE MYASTHENIA GRAVIS

The abnormalities found on SFEMG in patients with myasthenia gravis were demonstrated clearly in the early studies of Ekstedt and Stålberg and are reviewed in the textbook by Stålberg and Trontelj.<sup>12</sup> *Single Fiber Electromyography*. Both jitter and blocking are increased in proportion to the severity of clinical involvement, with greater abnormality in weaker muscles. However, in a given muscle, and even among the end plates of a single motor unit, there is marked variation in the amount of jitter in different fiber pairs. In a single muscle, some fiber pairs may be entirely normal and others may be grossly abnormal, with frequent blocking.

Most important among the features that Stålberg, Ekstedt, and Broman<sup>9</sup> noted was the presence of abnormal jitter even in clinically normal muscles. In their early experience with 70 patients with myasthenia gravis, jitter was always abnormal. They concluded that if jitter was normal in the presence of weakness, the weakness was not caused by myasthenia gravis. They also noted that jitter was increased with motor unit potential firing rate and muscle activity and decreased with rest or edrophonium. Frequent blocking in patients with severe myasthenia gravis made SFEMG recordings difficult to perform.

The work of Stålberg et al.<sup>9</sup> was confirmed and amplified by other investigators.<sup>6-8,13,14</sup> Even though the patient populations studied by these authors differed, all of them found that 77%–95% of patients with myasthenia gravis have abnormal SFEMG findings, with increased jitter or blocking (or both). Patients with generalized myasthenia gravis have a higher proportion (98%–100%) of abnormal jitter, and if there is weakness caused by myasthenia gravis in the muscle being tested, all authors agreed that the jitter in that muscle is abnormal.

The frequency of SFEMG abnormalities in patients with ocular myasthenia gravis was less consistent among the authors mentioned above, ranging from 20% to 70% abnormal in the extensor digitorum communis muscle and from 60% to 100% in proximal and facial muscles.<sup>7,8,15,16</sup> The presence of increased jitter in the extensor digitorum communis muscle in patients with clinical disease restricted to ocular muscles increases the risk of the development of clinically generalized myasthenia.<sup>17</sup>

Slight increases in fiber density have been reported for up to 25% of patients with myasthenia gravis; however, this usually is not found, and if it is present, it is minimal and of little clinical significance. SFEMG is often abnormal when myasthenia gravis is in clinical remission (66%–83%) and in patients with thymoma and no clinical weakness.

SFEMG findings have been compared with those of other diagnostic studies. All the comparisons have shown a much greater frequency of abnormality on SFEMG than on repetitive stimulation.<sup>18,19</sup> All the studies found a slightly higher percentage of abnormality for SFEMG than for acetylcholine receptor antibody levels. However, the studies of both Stålberg et al.<sup>10</sup> and Kelly et al.<sup>14</sup> demonstrated that SFEMG and acetylcholine receptor antibodies are complementary tests: one test identifies abnormality in some patients in whom the results of the other test are normal.

SFEMG has been used in the Mayo Clinic EMG Laboratory since 1976 as a useful adjunct to standard EMG and nerve conduction studies in patients thought to have a defect of neuromuscular transmission. Patients with other disorders have been evaluated with SFEMG only as part of special studies and not routinely. A large number of patients are evaluated, primarily for diagnostic purposes, in the Mayo Clinic laboratory, and the efficient evaluation of individual patients becomes a major determinant in the selection of studies. SFEMG is applied regularly only to patients in whom defects of neuromuscular transmission are suspected. Furthermore, it is limited to patients who have no evidence of disease on other electrophysiologic testing.

Each patient in whom myasthenia gravis or a similar disorder is suspected first undergoes repetitive stimulation of distal and proximal muscles before and after exercise. Repetitive

stimulation is a reliable, readily performed method of obtaining a quantitative measure of a defect of neuromuscular transmission. The presence of a reproducible decrement with slow rates of stimulation, which is partially repaired after exercise and is enhanced late after exercise, provides enough evidence of abnormality that SFEMG is not required unless further quantitation of the defect is needed. Moreover, most patients who have a decrement with repetitive stimulation have marked SFEMG abnormalities that make measurement of the jitter and blocking more difficult and less reliable.

In addition to repetitive stimulation, each patient undergoes standard needle EMG of the proximal and distal muscles, including clinically weak muscles, paraspinal muscles, and bulbar muscles. The needle examination can provide evidence of other diseases that may be associated with abnormal SFEMG, such as myopathies and anterior horn cell disease. These diseases must be identified before SFEMG is performed, to save the time and effort of performing SFEMG and to ensure that they are not mistaken for myasthenia gravis. Also, standard needle EMG can sample rapidly several muscles on which it may be difficult to perform SFEMG. In these muscles, single motor unit potentials are studied for the variation in size or shape that can provide clear evidence of a defect of neuromuscular transmission. The presence of abnormal motor unit potentials or motor unit potential variation on standard needle EMG makes SFEMG unnecessary unless further quantitation is needed.

Therefore, in our practice, SFEMG is limited to patients with normal findings on standard studies. SFEMG studies begin on the extensor digitorum communis muscle because it is easy to examine and is well defined, and age-controlled normal values are available. Twenty or more fiber pairs are measured for MCD, blocking, and mean duration of the total interpotential interval. This muscle is tested even with no symptoms or signs of weakness in the extremities because a high proportion of them show abnormalities. If the extensor digitorum communis muscle is normal, SFEMG is performed on other muscles selected on the basis of clinical weakness. The frontalis muscle is commonly used for patients with ocular or bulbar symptoms.<sup>20</sup>

**Key Points**

- In myasthenia gravis, both jitter and blocking are increased in proportion to the severity of clinical involvement, with greater abnormality in weaker muscles.
- There is marked variation in the amount of jitter in different fiber pairs in patients with myasthenia gravis.
- Abnormal jitter may be present in clinically normal muscles.
- The frequency of SFEMG abnormalities in patients with ocular myasthenia gravis ranges from 20% to 70% abnormal in the extensor digitorum communis muscle and from 60% to 100% in proximal and facial muscles.

**CONGENITAL MYASTHENIC SYNDROMES**

Use of voluntary SFEMG to study patients with congenital myasthenic syndromes is often limited by the difficulty in obtaining cooperation in young patients. Stimulated SFEMG provides a good alternative in these circumstances.<sup>21</sup> There are few reports of the use of stimulated SFEMG in congenital myasthenic syndromes. We have used this technique in selected patients but have yet to demonstrate that it provides additional information to repetitive stimulation and standard concentric needle EMG. Determination of the mechanism of the neuromuscular transmission defect in congenital myasthenic syndromes requires a combination of microelectrode and morphological studies performed on an intercostal or anconeus muscle biopsy specimen.<sup>22</sup>

**LAMBERT-EATON MYASTHENIC SYNDROME AND BOTULISM**

Presynaptic disorders of neuromuscular transmission have also been studied with single fiber techniques. Abnormalities, both with standard EMG and SFEMG, are readily seen in disorders such as the Lambert–Eaton myasthenic syndrome and botulism.<sup>23,24</sup> Increased jitter and blocking that decrease at higher innervation rates are characteristic of presynaptic disorders.<sup>25,26</sup>

Postsynaptic disorders typically demonstrate increased jitter and blocking at higher discharge rates.<sup>27</sup> With the possible exception of

the effect of firing rate on jitter and blocking, SFEMG has not been shown to add substantial information to repetitive stimulation and standard concentric needle EMG in patients with either Lambert–Eaton myasthenic syndrome or botulism.

**Key Points**

- Abnormalities on standard EMG and SFEMG are seen in disorders such as the Lambert–Eaton myasthenic syndrome and botulism.
- Increased jitter and blocking occur at higher discharge rates in Lambert–Eaton myasthenic syndrome and botulism.

**Primary Disorders of Muscle**

Most muscle disorders that cause abnormalities on SFEMG do so by causing muscle necrosis, with secondary regeneration and reinnervation. However, muscle fiber membrane abnormalities that cause electrophysiologic failure can also lead to changes. Decreased fiber density and blocking without much increase in jitter were observed during a paralytic attack in a patient with hypokalemic periodic paralysis.<sup>28</sup>

Muscular dystrophies and inflammatory myopathies are the muscle diseases that show the most marked abnormalities on SFEMG, but abnormalities have been noted in metabolic and congenital myopathies as well.<sup>29,30</sup> Foote et al.<sup>31</sup> found markedly increased jitter, blocking, duration of the single fiber complex, and fiber density in 18 patients with inflammatory myopathy. A significant negative correlation existed between the motor unit potential duration (measured with concentric needle electrode) and the degree of jitter and blocking. This was believed to provide evidence that the myopathic process was involved in the genesis of both electrophysiologic abnormalities. Duchenne muscular dystrophy causes increased fiber density and a markedly increased duration as well as moderately increased jitter and blocking. Limb girdle muscular dystrophy demonstrates quantitatively less marked changes.

SFEMG is not an effective method for primary diagnosis of myopathies. However, it adds complementary information to the concentric

needle examination about the degree and timing of associated reinnervation and may detect early mild abnormalities not recognized on standard EMG. The usefulness of SFEMG for serial study of myopathies during treatment trials and for investigation of membrane abnormalities has not been determined.

### Key Points

- Muscle disorders that cause abnormalities on SFEMG do so by causing muscle necrosis, with secondary regeneration and reinnervation.
- Muscular dystrophies and inflammatory myopathies are the muscle diseases that show the most marked abnormalities on SFEMG.
- SFEMG is *not* an effective method for primary diagnosis of myopathies.

## Primary Neurogenic Disorders

Because reinnervating nerve terminals have immature neuromuscular junctions, SFEMG demonstrates abnormalities. The specific type and degree of abnormality depend on the magnitude and rate of progression of the neurogenic process. Abnormalities on standard nerve conduction studies and EMG differentiate these from disorders of the neuromuscular junction.

### PERIPHERAL NEUROPATHY

In studies of severed nerves, increased fiber density is the first sign of reinnervation. Increases in fiber density are seen as early as 3–4 weeks after nerve injury, usually before changes can be detected on muscle biopsy. Fiber density increases rapidly for the first 3 months after injury and slowly thereafter. Increased jitter and blocking are seen for 3–6 months after the injury but rarely longer than that. Most clinical neuropathic disease presents with more complex findings because the process is progressive rather than a single insult and the disease may affect the ability to reinnervate.

Thiele and Stålberg<sup>32</sup> reported SFEMG findings in 54 patients with polyneuropathy associated with uremia, diabetes mellitus, or

alcohol abuse. Findings of increased fiber density, jitter, and blocking were seen in alcoholic patients who had only mildly slower nerve conduction velocities but evidence of denervation on concentric needle examination. Patients with diabetic or uremic polyneuropathies had slower nerve conduction velocities, relatively normal concentric needle examinations, and mild abnormalities on SFEMG; that is, mildly increased jitter without blocking and normal fiber density and duration. SFEMG corroborated standard EMG and pathologic data about the neuropathies of these patients. Similar findings have been demonstrated by other investigators in critical illness neuropathy<sup>33</sup> and length-dependent diabetic polyneuropathy.<sup>34</sup> SFEMG may also help detect conduction block in focal neuropathy.<sup>35</sup>

### Key Points

- Increases in fiber density are seen as early as 3–4 weeks after peripheral nerve injury.
- Increased jitter and blocking are seen for 3–6 months after the injury but rarely longer.

## ANTERIOR HORN CELL DISORDERS

Stålberg et al.<sup>36</sup> reported the SFEMG findings in 21 patients with anterior horn cell disease and in 3 with syringomyelia. All patients had increased fiber density. The increase was greatest in anterior horn cell disorders that were slowly progressive (fiber density, 5.4). The increase (fiber density, 3.3) was less in rapidly progressive amyotrophic lateral sclerosis. Increased jitter and blocking were observed in all these conditions: the largest increase was in amyotrophic lateral sclerosis, and the increase was less in the spinal muscular atrophies and syringomyelia. In the chronic conditions, the complexes (particularly the initial part) were more stable. Duration of single fiber potentials varied considerably. However, the longest durations were seen in the more chronic conditions. The authors concluded that the dual findings of moderately increased fiber density and the unstable complexes of varying configuration represent a rapidly progressive process with active reinnervation, such as amyotrophic lateral sclerosis. Markedly increased fiber density and relatively stable complexes



(particularly of the initial part) indicate a slowly progressive disease or burned-out process with long-standing reinnervation. The combination of markedly increased fiber density and unstable potentials was believed to reflect reactivation of a long-standing process.<sup>37</sup>

Schwartz et al.<sup>38</sup> reported similar conclusions in 10 patients with long-standing syringomyelia. SFEMG abnormalities (and clinical changes) were maximum in muscles innervated by spinal segments C8 and T1. In the first dorsal interosseous muscle, mean fiber density was 4.1, with 21% of potential pairs demonstrating increased jitter and 7% demonstrating blocking. The distribution of abnormalities, rather than the type, differentiated these patients from those with anterior horn cell disease. Patients with chronic non-progressive clinical conditions demonstrated complex, but stable, motor unit action potentials and increased fiber density. Patients with recent clinical progression demonstrated more blocking.

Daube and Mulder<sup>39</sup> reported mildly increased fiber density and more markedly increased jitter and blocking in 31 unselected patients with amyotrophic lateral sclerosis. The patient's age, clinical severity, CMAP amplitude, and presence of a decrement to slow repetitive stimulation were valuable in predicting longevity. However, SFEMG findings did not add to the prognostic accuracy. Single fiber study of spontaneously recorded fasciculations in patients with amyotrophic lateral sclerosis has documented increased jitter and blocking in those discharges.

In neurogenic disorders of all types, the abnormalities on SFEMG complement those seen during conventional needle EMG. The single fiber profile can delineate the rate of progression and longevity of the disease process. Whether SFEMG will become clinically useful in establishing prognosis in certain diseases, serially following diseases during clinical treatment trials, or evaluating for evidence of reinnervation in neurogenic diseases is not known.

### Key Points

- Increased jitter and blocking and fiber density are observed in amyotrophic lateral sclerosis.
- Markedly increased fiber density and relatively stable complexes (particularly of the

initial part) indicate a slowly progressive neurogenic disease or burned-out process with long-standing reinnervation.

- In neurogenic disorders of all types, the abnormalities on SFEMG complement those seen during conventional needle EMG.

## SUMMARY

SFEMG is a highly selective technique that permits recording of individual components of the motor unit. The selectivity of SFEMG depends on the use of a low-frequency filter of 500 Hz and a small electrode size. Voluntary activation or electric stimulation is used to activate the muscle fiber in SFEMG. Voluntary activation allows measurement of fiber density, whereas jitter and blocking are recorded with both voluntary and stimulated SFEMG.

SFEMG is technically demanding and requires specialized recording equipment. A variety of modern digital equipment is available that assists in the collection, display, analysis, reporting, and archiving of SFEMG data.

SFEMG is the most sensitive clinical electrophysiologic technique for the detection of a defect of neuromuscular transmission. The findings are not specific or diagnostic for individual diseases. SFEMG findings are also abnormal in disorders associated with denervation and reinnervation of muscle, such as certain myopathies, motor neuron diseases, and peripheral neuropathies. Correlation of fiber density and jitter and blocking analysis may help to determine disease chronicity and rate of progression.

## REFERENCES

1. Kouyoumdjian, J. A., E. V. Stalberg. 2008. Reference jitter values for concentric needle electrodes in voluntarily activated extensor digitorum communis and orbicularis oculi muscles. *Muscle & Nerve* 37(6):694–9.
2. Kouyoumdjian, J. A., E. V. Stalberg. 2008. Concentric needle single fiber electromyography: Comparative jitter on voluntary-activated and stimulated Extensor Digitorum Communis. *Clinical Neurophysiology* 119(7):1614–8.
3. Bromberg, M. B., and D. M. Scott. 1994. Single fiber EMG reference values: Reformatted in tabular form. AD HOC Committee of the AAEM Single Fiber Special Interest Group. *Muscle & Nerve* 17:820–1.



4. Stalberg, E. V., and M. Sonoo. 1994. Assessment of variability in the shape of the motor unit action potential, the "jiggle," at consecutive discharges. *Muscle & Nerve* 17(10):1135-44.
5. Campos, C., A. Malanda, L. Gila, V. Segura, I. Lasanta, and J. Artieda. 2000. Quantification of jiggle in real electromyographic signals. *Muscle & Nerve* 23(7):1022-34.
6. Sanders, D. B., J. F. Howard Jr., and T. R. Johns. 1979. Single-fiber electromyography in myasthenia gravis. *Neurology* 29:68-76.
7. Cui, L. Y., Y. Z. Guan, H. Wang, and X. F. Tang. 2004. Single fiber electromyography in the diagnosis of ocular myasthenia gravis: Report of 90 cases. *Chinese Medical Journal* 117:848-51.
8. Valls-Canals, J., M. Povedano, J. Montero, and J. Pradas. 2003. Stimulated single-fiber EMG of the frontalis and orbicularis oculi muscles in ocular myasthenia gravis. *Muscle & Nerve* 28:501-3.
9. Stålberg, E., J. Ekstedt, and A. Broman. 1971. The electromyographic jitter in normal human muscles. *Electroencephalography and Clinical Neurophysiology* 31:429-38.
10. Stålberg, E., J. V. Trontelj, and M. S. Schwartz. 1976. Single-muscle-fiber recording of the jitter phenomenon in patients with myasthenia gravis and in members of their families. *Annals of the New York Academy of Sciences* 274: 189-202.
11. Murga, L., F. Sanchez, C. Menendez, and J. M. Castilla. 1998. Diagnostic yield of stimulation and voluntary single-fiber electromyography in myasthenia gravis. *Muscle & Nerve* 21:1081-3.
12. Stålberg, E., and J. Trontelj, eds. 1994. *Single fiber electromyography: Studies in healthy and diseased muscle*. 2nd ed. New York: Raven Press.
13. Konishi, T., H. Nishitani, F. Matsubara, and M. Ohta. 1981. Myasthenia gravis: Relation between jitter in single-fiber EMG and antibody to acetylcholine receptor. *Neurology* 31:386-92.
14. Kelly, J. J. Jr., J. R. Daube, V. A. Lennon, F. M. Howard Jr., and B. R. Younge. 1982. The laboratory diagnosis of mild myasthenia gravis. *Annals of Neurology* 12:238-42.
15. Padua, L., E. Stålberg, M. Lo Monaco, A. Evoli, A. Batocchi, and P. Tonali. 2000. SFEMG in ocular myasthenia gravis diagnosis. *Clinical Neurophysiology* 111:1203-7.
16. Valls-Canals, J., J. Montero, and J. Pradas. 2000. Stimulated single fiber EMG of the frontalis muscle in the diagnosis of ocular myasthenia. *Muscle & Nerve* 23:779-83.
17. Weinberg, D. H., J. F. Rizzo III, M. T. Hayes, M. D. Kneeland, and J. J. Kelly Jr. 1999. Ocular myasthenia gravis: Predictive value of single-fiber electromyography. *Muscle & Nerve* 22:1222-7.
18. Sonoo, M., H. Uesugi, A. Mochizuki, Y. Hatanaka, and T. Shimizu. 2001. Single fiber EMG and repetitive nerve stimulation of the same extensor digitorum communis muscle in myasthenia gravis. *Clinical Neurophysiology* 112:300-3.
19. Srivastava, A., J. Kalita, and U. K. Misra. 2007. A comparative study of single fiber electromyography and repetitive nerve stimulation in consecutive patients with myasthenia gravis. *Electromyography and Clinical Neurophysiology* 47:93-6.
20. Ukachoke, C., P. Ashby, A. Basinski, and J. A. Sharpe. 1994. Usefulness of single fiber EMG for distinguishing neuromuscular from other causes of ocular muscle weakness. *The Canadian Journal of Neurological Sciences* 21:125-8.
21. Tidswell, T., and M. C. Pitt. 2007. A new analytical method to diagnose congenital myasthenia with stimulated single-fiber electromyography. *Muscle & Nerve* 35:107-10.
22. Engel, A. G., K. Ohno, M. Milone, and S. M. Sine. 1998. Congenital myasthenic syndromes. New insights from molecular genetic and patch-clamp studies. *Annals of New York Academy Sciences* 841: 140-56.
23. Chaudhry, V., and T. O. Crawford. 1999. Stimulation single-fiber EMG in infant botulism. *Muscle & Nerve* 22:1698-703.
24. Padua, L., I. Aprile, M. L. Monaco, et al. 1999. Neurophysiological assessment in the diagnosis of botulism: Usefulness of single-fiber EMG. *Muscle & Nerve* 22:1388-92.
25. Trontelj, J. V., E. Stålberg, M. Mihelin, and A. Khurabet. 1992. Jitter of the stimulated motor axon. *Muscle & Nerve* 15:449-54.
26. Mandler, R. N., and R. A. Maselli. 1996. Stimulated single-fiber electromyography in wound botulism. *Muscle & Nerve* 19:1171-3.
27. Lin, T. S., and H. C. Chiu. 1998. Motor end-plate jitter in myasthenia gravis at different firing rates. *Journal of Clinical Neurophysiology* 15:262-7.
28. De Grandis, D., A. Fiaschi, G. Tomelleri, and D. Orrico. 1978. Hypokalemic periodic paralysis. A single fiber electromyographic study. *Journal of Neurological Sciences* 37:107-12.
29. Ukachoke, C., P. Ashby, A. Basinski, and J. A. Sharpe. 1994. Usefulness of single fiber EMG for distinguishing neuromuscular from other causes of ocular muscle weakness. *The Canadian Journal of Neurological Sciences* 21:125-8.
30. Bertorini, T. E., E. Stålberg, C. P. Yuson, and W. K. Engel. 1994. Single-fiber electromyography in neuromuscular disorders: Correlation of muscle histochemistry, single-fiber electromyography, and clinical findings. *Muscle & Nerve* 17:345-53.
31. Foote, R. A., W. M. O'Fallon, and J. R. Daube. 1978. A comparison of single fiber and routine EMG in normal subjects and patients with inflammatory myopathy. *Bulletin of the Los Angeles Neurological Societies* 43:95-103.
32. Thiele, B., and E. Stålberg. 1975. Single fibre EMG findings in polyneuropathies of different aetiology. *Journal of Neurology, Neurosurgery, and Psychiatry* 38:881-7.
33. Schwarz, J., J. Planck, J. Briegel, and A. Straube. 1997. Single-fiber electromyography, nerve conduction studies, and conventional electromyography in patients with critical-illness polyneuropathy: Evidence for a lesion of terminal motor axons. *Muscle & Nerve* 20:696-701.
34. Brill, V., M. R. Werb, D. A. Greene, and A. A. Sima. 1996. Single-fiber electromyography in diabetic peripheral polyneuropathy. *Muscle & Nerve* 19:2-9.

35. Papua, L., I. Aprile, P. D'Amico, et al. 2001. A useful electrophysiological test for diagnosis of minimal conduction block. *Clinical Neurophysiology* 112: 1041–8.
36. Stålberg, E., M. S. Schwartz, and J. V. Trontelj. 1975. Single fibre electromyography in various processes affecting the anterior horn cell. *Journal of Neurological Sciences* 24:403–15.
37. Rodriguez, A. A., J. C. Agre, and T. M. Franke. 1997. Electromyographic and neuromuscular variables in unstable postpolio subjects, stable postpolio subjects, and control subjects. *Archives of Physical Medicine and Rehabilitation* 78:986–91.
38. Schwartz, M. S., E. Stålberg, and M. Swash. 1980. Pattern of segmental motor involvement in syringomyelia: A single fibre EMG study. *Journal of Neurology, Neurosurgery, and Psychiatry* 43:150–5.
39. Daube, J. R., and D. W. Mulder. 1982. Prognostic factors in amyotrophic lateral sclerosis (abstract). *Muscle & Nerve* 5(Suppl):S107.

# Quantitative Motor Unit Number Estimates

Jasper R. Daube

## INTRODUCTION

### MUNE BY STANDARD EMG

Interference Pattern  
Recruitment Analysis

### MUNE BY STANDARD MOTOR NCS QUANTITATIVE MUNE

Underlying Assumptions of  
Quantitative MUNE

Surface Averaging of Needle EMG MUPs

MUNE from All-or-None  
Increments in the CMAP  
Statistical (STAT) MUNE

## CLINICAL APPLICATIONS SUMMARY

## INTRODUCTION

Peripheral neuromuscular diseases are divided broadly into *neurogenic* and *myopathic* diseases, with diseases of the neuromuscular junction often being included with myopathic diseases. Neurogenic and myopathic diseases both result in the clinical problem of muscle weakness. The task of clinicians is, first, to distinguish between these two broad groups of diseases and, second, to identify the specific type.

### *Purpose and Role of Motor Unit Number Estimates*

- The major advantage of electrophysiologic testing of neuromuscular disease is the ability to measure changes caused by disease quantitatively.

- The hallmark of neurogenic diseases is damage or destruction to motor neurons and/or peripheral axons.
- None of the standard assessments are able to quantitatively and reproducibly directly measure the loss of motor units or axons.
- Motor unit number estimates (MUNEs) provide quantitative measures of the number of axons in peripheral neuromuscular diseases.
- MUNE can thereby provide direct confirmation of the severity of disease and its rate of progression.

The critical difference between neurogenic and myopathic diseases is that motor neurons or their axons are the primary site of damage in neurogenic diseases whereas muscle is the primary site of damage in myopathic diseases.

Damage to either the anterior horn cell or its peripheral axon is the essence of a neurogenic process, even though the associated change in muscle may be more apparent clinically. Neurogenic diseases may produce either histologic changes in nerve or muscle, or physiologic changes without histopathologic correlates. An example of a physiologic abnormality is fasciculation arising from axonal irritability, with spontaneous firing in the motor nerve. Physiologic disorders produce no loss of function (as in slowing of conduction) or loss of function (as in conduction block). Degenerative or destructive processes result in the loss of motor neurons or peripheral axons. Conduction block or loss of either motor axons or neurons is the basis of the weakness found in most patients with a neurogenic disease. The severity of the clinical deficit is related directly to the number of motor neurons or axons (or both) that are blocked or lost. Therefore, an important part of the assessment of neuromuscular disease is to determine the number of functioning motor units.<sup>1,2</sup> It would be ideal to have an actual measure of the number of motor units, but current methods—clinical, physiologic, histologic, and histopathologic—are not able to provide such a measure. Electrophysiologic methods are required to estimate the number of motor units in a muscle.<sup>3,4</sup>

This chapter describes the older, standard methods for estimating the number of motor units and their loss in neurogenic disease. Standard needle electromyography (EMG) and nerve conduction studies (NCS) provide non-quantitative information about the loss of motor units and motor axons. These are discussed in detail in other chapters, but will be reviewed briefly in this chapter to put them in perspective with the newer quantitative methods for determining the number of motor units in a muscle. One of the new quantitative methods uses needle electrode recordings in the muscle, while the other three new methods rely on stimulation of the peripheral nerve. These are as follows:

- Surface averaging of needle EMG motor unit potentials
- All-or-none increments in the compound muscle action potential
- F-wave measurements
- Statistical MUNE

Each of these MUNE methods is in active use in different EMG laboratories.

The important terms used in this chapter are defined as follows:

1. *Motor unit*—a single anterior horn cell or brain stem motor neuron, its peripheral axon (which travels in a cranial or peripheral nerve), and each of the muscle fibers the axon innervates.
2. *Motor unit potential (MUP)*—the electrical potential recorded from a motor unit by needle EMG electrode in the muscle.
3. *Surface-recorded motor unit potential (SMUP)*—the electrical potential recorded from a motor unit by a skin surface electrode over the muscle.
4. *Number of motor units*—the number of functioning motor neurons or functioning motor axons innervating a muscle or group of muscles.
5. *Motor unit number estimate (MUNE)*—a physiologic determination of the number of motor units in a muscle or group of muscles.

Physiologic estimates of the number of motor units have been hampered by the lack of a standard determination of the actual number of motor units in a muscle. At best, histopathologic and anatomical determinations are rough measures. Attempts have been made to measure the number of motor units in human fetal and newborn tissue.<sup>5</sup> In both types of studies, the individual muscles and the motor nerves innervating them were dissected and counted. The number of large myelinated axons in the motor nerve was counted and divided by two to estimate the proportion of these fibers that were motor rather than sensory. This proportion was based on animal studies in which degeneration of the peripheral sensory axons after section of the dorsal root indicated that approximately half of the axons in a motor nerve are sensory.<sup>6</sup> This proportion of large myelinated axons then served as the estimate for the number of motor units innervating the muscle. These studies also counted the number of muscle fibers in a muscle to determine the innervation ratio of muscle fibers to axons. Although the results of the two studies were similar, the values were sufficiently different to preclude the designation of a true standard

measurement of the number of motor units innervating individual human muscles. However, these studies do serve as baseline comparisons for the physiologic methods that have been developed for MUNE. The absence of a standard makes direct comparison of the values obtained by different methods an equally important part of the assessment of the validity of individual methods of MUNE.

### Key Points

- Weakness in neurogenic diseases is due to loss of axons or loss of motor neurons.
- MUNE defines the extent of loss of axons or motor neurons.
- Standard EMG and NCS provide non-quantitative information about the number of axons innervating a muscle.
- There are four categories of other electrophysiologic methods that estimate an actual number of motor units in a muscle or group of muscles.

## MUNE BY STANDARD EMG

Standard diagnostic clinical EMG has always included a subjective estimate of the number of motor units in a muscle (see Chapter 26). Electromyographers have used recruitment analysis or interference pattern analysis (or both) with voluntarily activated EMG recordings to judge the number of motor units in a muscle.<sup>7,8</sup> The EMG recorded with either surface or intramuscular electrodes during strong voluntary contractions summates the activity of the muscle fibers in the activated motor units to produce an interference pattern. The greater the number of motor units activated, the greater the density of the EMG pattern. The increased density with increased effort is the result of an increase in the number of motor units activated and an increase in the firing rate of individual motor units. The combination of the firing rate and the number of motor units reduces the reliability of density measures in determining the number of motor units. Density measures of the number of motor units are further beset by the problem of having to rely on the effort of the patient for obtaining activation. Clearly, the effort of the patient alters the number of motor units activated. Nonetheless, measures of density,

whether from subjective or automated methods, have been used to make judgments about the loss of motor units. When the loss is moderate to severe, these methods can identify a loss of motor units, for example, as in a reduced interference pattern or a single motor unit firing pattern.

### Key Points

- MUNE is reflected in the number of motor units activated during voluntary contraction.
- Assessment of voluntary EMG activity can provide a rough judgment of the number of motor units lost, but not a reproducible, quantitative value.

## Interference Pattern

The methods of interference pattern analysis can be classified into two approaches (see Chapter 27). The more common one is the measurement of the number of turns (i.e., reversals of potential per unit time) and the amplitude of the spikes in the EMG pattern. The other method analyzes the frequency components of the EMG pattern. Both methods provide some measure of density and, indirectly, of the number of motor units. Neither method is reliable enough to provide a quantitative measure of the number of motor units. Alterations in MUPs with disease further reduce the reliability of both methods. For example, in some disease processes, the potential generated by individual motor units becomes more complex with multiple phases. These additional phases contribute to both the high-frequency components and the number of turns, but they do not reflect a change in the number of motor units. Thus, interference pattern analysis is unsatisfactory for MUNE.

## Recruitment Analysis

The second method used by clinical electromyographers to judge the number of motor units in a muscle is recruitment analysis (see Chapter 27). *Recruitment* refers to the initiation of firing of additional motor units as the effort of voluntary contraction increases. The intrinsic anatomical and physiologic properties

of motor neurons result in a fixed pattern of activation in response to voluntary effort. During voluntary activation, low-threshold motor neurons begin firing at rates of 5–7 Hz and increase their firing frequency with increasing effort. As the effort increases, additional motor units are activated, and they, in turn, increase their frequency of firing with further increases in effort. The recruitment of motor units during activation is a fixed relationship between the number of activated motor units and their firing rates. In recruitment analysis, the number of MUPs activated at any given level of effort is compared with the rate of firing of individual motor units. This ratio provides an indirect measure of the number of motor units in the muscle.

Clinical EMG judgments about the number of motor units compare the rate of firing of single units with the total number of motor units. However, determining the rate of firing is one of the more difficult steps in standard EMG. The ratio of the number of units firing to the rate of firing can provide a rough gauge of the number of motor units. This semiquantitative method of determining reduced recruitment provides a more accurate and reproducible estimate of the number of motor units than does interference pattern analysis. Although recruitment analysis is reasonably reproducible and clinically reliable, it is usually a subjective judgment made by electromyographers on the basis of experience. It requires taking into account differences in recruitment in different areas of individual muscles and the even greater differences among different muscles. Automated methods for formally quantifying the recruitment pattern have been developed (see Chapter 27). These formal quantitative measures can provide evidence of the reliability of the clinical methods; however, they are time-consuming and complex and have not found clinical application. None of these methods provides an actual estimate of the number of motor units in a muscle.

### Key Points

- Interference pattern analysis of voluntary EMG activity cannot provide quantitative or even partially quantitative estimates of the number of axons lost in a neurogenic process.

- The ratio of the rate of firing of any single motor unit to the total number of active units provides a reproducible measure of the axons lost in a neurogenic process.
- Subjective assessment of recruitment requires years of EMG experience, which is not quantitative, and thus remains difficult to compare between examiners.

## MUNE BY STANDARD MOTOR NCS

Motor NCS are an important part of the electrophysiologic analysis of peripheral neuromuscular disease (see Chapter 23). The amplitudes of compound muscle action potentials (CMAPs) are related directly to the number and size of muscle fibers in a muscle group and indirectly to the number of motor units in the muscle group.<sup>9</sup> If a disease is known to be neurogenic and acute, the amplitude of a CMAP is a rough estimate of the number of motor units. Conduction block provides a quantitative measure of the *proportion* of motor units that are not functioning distal to the block, but not the actual number.

The value of CMAP amplitude is further limited by three other factors. First, the amplitude is decreased in myopathies with loss of muscle fiber tissue. Second, estimates of the number of motor units made on the basis of the amplitude of the CMAP are hampered further by the wide range of normal amplitudes. For example, even in the case of acute traumatic section of a peripheral nerve that disrupts half of the motor axons, the amplitude of the ulnar or hypothenar CMAP may decrease from 12 to 6  $\mu$ V and still be within normal limits. Third, the CMAP reduction that occurs with the destruction of axons can be compensated for partially or fully by reinnervation from collateral sprouting of intact axons. In the clinical setting in which the baseline amplitude is not known, the CMAP is only a rough guide to the number of motor units. Therefore, the amplitude of the CMAP cannot be used to obtain a reliable MUNE.

### Key Points

- CMAP amplitude measures can quantify the proportion of axons lost in disease in a disorder with conduction block, but



cannot define the specific number of axons remaining.

- CMAP amplitude measurement is an unreliable measure of the remaining axons because of
  - Reduction in CMAP amplitude by myopathies where there is no loss of axons.
  - Reinnervation of denervated muscle fibers by collateral sprouting from intact axons.
  - The wide range of normal amplitudes for all CMAPs.

## QUANTITATIVE MUNE

Needle EMG and nerve stimulation methods have been developed in the past twenty years to provide quantitative MUNE.<sup>10–15</sup> Both the needle EMG and the motor nerve stimulation approaches to MUNE make basic assumptions about the electric characteristics of MUPs that are important to understand to make use of quantitative MUNE. Six major methods of quantitative MUNE have been developed. Four of them record CMAPs in response to nerve stimulation, and two rely on needle EMG. Variations of each of these four basic techniques continue to evolve to improve on the accuracy and reliability of MUNE. Each method makes two basic measurements: (1) the average size of the potential generated by a single motor unit as recorded on the surface of the skin—*surface-recorded motor unit potential* (SMUP)—and (2) the size of the CMAP obtained with maximal stimulation of a motor nerve. MUNE is obtained by dividing the maximal CMAP by the average size of the SMUP. The techniques differ in the way that the average size of the SMUP is obtained.

### Key Points

- A number of quantitative MUP methods have been devised—four using nerve stimulation and two using voluntary EMG are of particular interest.
- All methods measure the size of the average single motor unit potential (SMUP) and the CMAP.
- MUNE is derived by dividing the CMAP by the SMUP.

## Underlying Assumptions of Quantitative MUNE

All MUNE techniques rely on several underlying assumptions that must be understood to appreciate fully the advantages and drawbacks of quantitative MUNE:

1. MUNE is assumed to be measurements from a single muscle, but maximal stimulation of any peripheral motor nerve activates all the muscles innervated by that nerve distal to the point of stimulation. Therefore, measurements of the CMAP are the summation of activity from multiple muscles. For example, the median or thenar CMAP is the summation of the activity of the opponens pollicis, abductor pollicis brevis, flexor pollicis brevis, and, to a lesser extent, the lumbrical muscles. The ulnar or hypothenar CMAP is the summation of all the other intrinsic muscles of the hand. Thus, MUNE is more accurately an estimate of the number of motor units in a group of muscles rather than in a single muscle. Moreover, the SMUP in more distant muscles contribute less to the CMAP than do SMUP in nearby muscles.
2. Each of the MUNE methods assumes that each SMUP has the same size each time it is activated. Thus, defects of neuromuscular transmission that result in varying sizes of the SMUP will cause inaccuracy. This is significant only if there is a large variation in SMUP size.
3. Although the assumption that all motor axons are activated by maximal stimulation is generally true, it may not be true of disease involving high-threshold axons (e.g., severe demyelination and regenerated axons). In these situations, the maximal CMAP may be difficult to obtain, thereby underestimating the number of intact axons.
4. Peripheral nerve stimulation methods assume a random activation of axons with differing thresholds and conduction velocities. Collision stimulation method studies of peripheral axons have shown that the first activated axons are not representative of the entire pool, thereby posing limitations on the reliability of

MUNE with threshold peripheral nerve stimulation.<sup>16</sup>

5. The most critical issue in determining the size of individual SMUPs is the adequacy of sampling of the many SMUPs in the muscle.<sup>17</sup> In patients with severe neurogenic disease, it is possible to identify each motor unit and to obtain a reliable, reproducible, direct count of up to 10 or 20 motor units. This is the practical maximum of such direct counts. With more motor units, none of the methods allows reliable measures of each motor unit, so it is uncertain whether an adequate sample has been obtained. If the number of motor units is greater than 20 or so, it is necessary to measure the size of a subset of the total population of motor units and then calculate an average size for that subgroup. If all the motor units are of nearly identical size, sampling a subset of them to obtain an average size of the SMUP is a valid approach. With greater variation in the size of SMUP, particularly if the size range is not a normal distribution, estimates of the true size become less reliable. Each of the methods for measuring the size of SMUP must address the adequacy of the sampling based on the variation of measured SMUP sizes to determine whether a reasonable representation of the total population of motor unit sizes has been obtained.

It had been assumed that there should be a lower limit of the size of SMUP used to calculate MUNE.<sup>18</sup> However, a more recent study<sup>19</sup> showed that there are significant numbers of small SMUP in normal subjects and those with a neurogenic disorder. Calculations that excluded small SMUP reduced the difference in MUNE between normal subjects and patients with a specific disease. These findings again illustrate the importance of correct sampling procedures.

Each of these assumptions is a possible source of error in each MUNE method. Nonetheless, the ease of measuring the small number of potentials in neurogenic disorders with moderate to marked loss of motor units minimizes these sources of error and makes MUNE highly reliable in those situations.

### Key Points

- Each of the methods of quantitative MUNE makes the same underlying assumptions that can reduce the reliability of the estimate. The most critical is
  - Reliable direct measurement of the number of SMUP can be made if there are fewer than 20.
  - Increasing number of samples are needed as the total number of SMUP increases in the muscle group.
  - Variation in the size of the sampled SMUP increases the number of samples needed.
- Stimulation must be high enough to activate all motor axons when recording the CMAP.
- Large defects of neuromuscular transmission resulting in different sizes of SMUP recorded with a sequence of stimuli to the same single axon are unreliable.
- MUNE is made from a group of muscles innervated by a single nerve rather than just the muscle under the recording electrode.

### Surface Averaging of Needle EMG MUPs

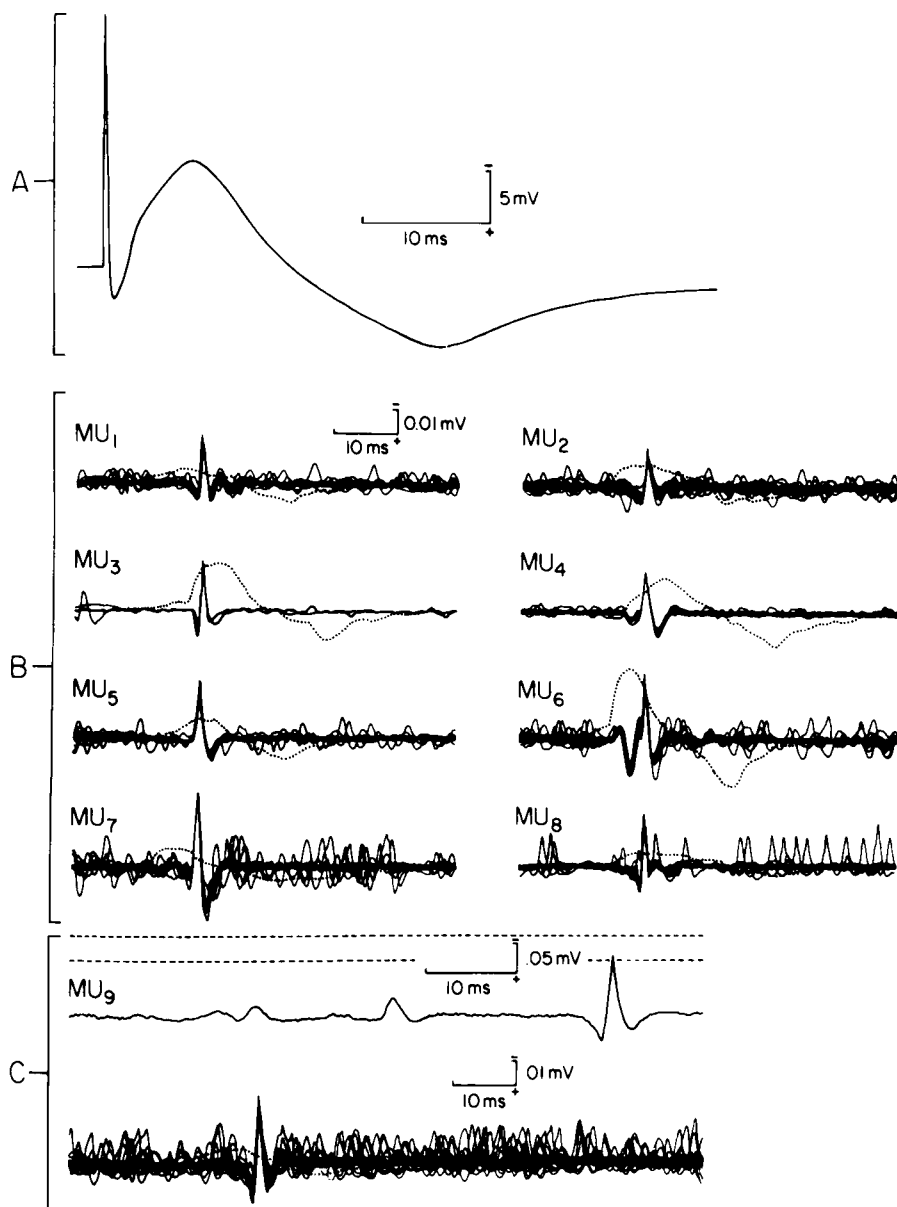
Both of the two methods for determining the average SMUP size rely on two channel recordings. One channel records the MUP recorded with a needle electrode in the muscle; the other records and averages the surface potentials generated by the MUP recorded with the needle electrode. The CMAP size is divided by the size of these surface-recorded SMUP to obtain the MUNE. Two methods have been described for needle EMG-based identification. Both can be used for MUNE in large proximal muscles such as the biceps.

#### SPIKE-TRIGGERED AVERAGING MUNE

The first of these methods selects a single MUP with an amplitude trigger, and is referred to as *spike-triggered averaging* (STA). STA relies on the ability to isolate MUP by voluntary activation on needle EMG with a two-channel EMG machine.<sup>20,21</sup> Intramuscular MUPs are recorded on one channel with any

one of several electrodes, including single fiber EMG, bipolar concentric, standard concentric, or fine-wire electrodes, but most often standard concentric. Individual MUPs are isolated on the first channel, by an amplitude trigger window that selects potentials on the basis of

peak amplitudes (Fig. 29-1). The triggered, surface-recorded MUPs are recorded simultaneously on a second channel triggered by the needle-recorded MUP on the first channel. The activity is averaged on the second channel from the same surface electrodes used to



**Figure 29-1.** Spike-triggered averaging for motor unit number estimate. A, Compound muscle action potential. B and C, Each line (MU<sub>1</sub>-MU<sub>9</sub>) shows the triggered motor unit (MU) potential recorded with a needle (solid lines) and the averaged surface CMAP (dotted line). (From Brown, W. F., M. J. Strong, and R. Snow. 1988. Methods for estimating numbers of motor units in biceps-brachialis muscles and losses of motor units with aging. *Muscle & Nerve* 11:423-32. By permission of John Wiley & Sons.)

record the CMAP. The technique requires the isolation of at least 10, and preferably 20, MUP whose spike-triggered average can be recorded on the surface. The amplitude or area of the surface-recorded potentials is used to calculate the average size of the MUP in the muscle. MUNE is then calculated by dividing the size (area or amplitude) of the maximal CMAP by the average size of the MUP.

Several of the assumptions made in using this technique are possible sources of error. First, the method assumes that all MUPs can be recorded at the surface. Studies by Brown and coworkers<sup>22</sup> suggest that this is true only in superficial muscles. Second, the technique assumes that voluntary activation recruits the full range of sizes of motor units. This likely is not true. Larger motor units probably are not activated with standard voluntary contraction. Despite these issues, the values obtained with the method are comparable to those expected on the basis of animal studies and those obtained with other methods of recording MUNE.

De Koning et al.<sup>23</sup> have modified the technique by using macro EMG needles to record the CMAP. It is assumed that a macro needle provides a better representation of the full range of motor units, particularly those deeper in the muscle. Milner-Brown and Brown<sup>24</sup> used the technique of microstimulation of nerve terminals in the end plate region to activate motor units recorded with a needle electrode. This reduces the bias in the selection of motor unit sizes that occurs with voluntary activation. Each of these methods gives comparable MUNE. Animal studies comparing the actual number of anterior horn cells with the MUNE using microstimulation of individual axons in the motor nerve<sup>25,26</sup> showed this method to be more accurate than standard STA.

The STA methods require specialized recording devices and programs not available on most commercial EMG machines. They are also generally more time-consuming and more complex to perform because of the need for two channels of recording: a MUP triggering channel and an SMUP averaging channel. The accuracy of the methods depends on the ability of the patient and electromyographer to activate, identify, and trigger individual MUPs for a period long enough to allow the size of the SMUP to be measured.

## DECOMPOSITION-BASED QUANTITATIVE EMG MUNE

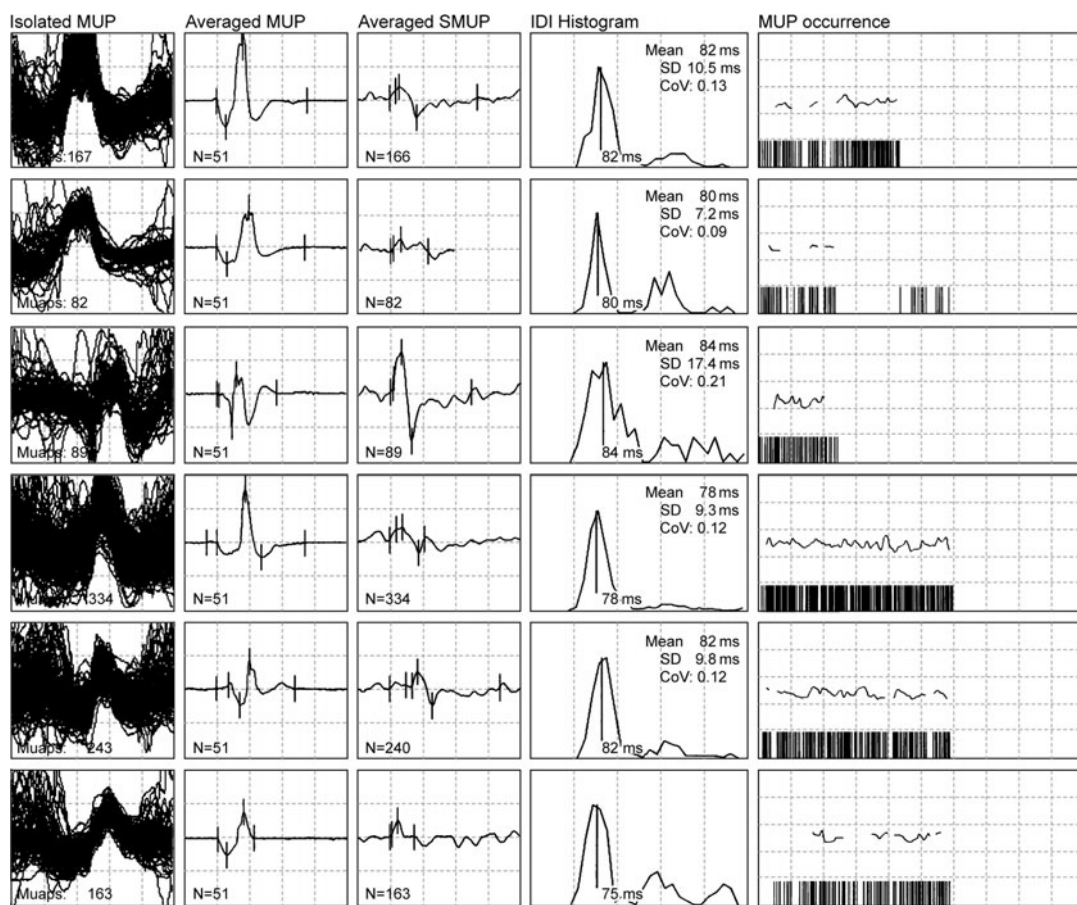
A more recently developed, simplified method of surface-averaged MUP MUNE selects MUP with a sophisticated, automated MUP identification—decomposition-based quantitative EMG (DQEMG). A 20-second train of needle-recorded MUP is recorded at the same time as a surface electrode over the muscle. The program isolates up to eight distinct MUPs and averages the simultaneous occurring SMUP. Studies have demonstrated the reliability of the programs and defined the differences in distal and proximal muscles, the effect of age, the effect of force of contraction, and the abnormalities in disease.<sup>27–30</sup> Figure 29–2 shows six averaged MUPs recorded from a single train of MUP in a normal anal sphincter with corresponding recordings of the simultaneous SMUP from that train.

### Key Points

- SMUP can be identified from MUP recorded from a needle electrode in the muscle.
- Two methods are based on recording MUP on needle EMG.
  - STA selects different MUPs by their amplitudes and then averages the surface-recorded potential occurring at the same time as the MUP.
  - DQEMG simultaneously isolates different MUPs with a specialized computer algorithm. The averaged surface potentials occurring with each of these is averaged to obtain SMUP.

## MUNE from All-or-None Increments in the CMAP

Axons have the special property of activation at a specific level of depolarization, called the *threshold*. Below that they are inactive, while above that they are fully activated and send an action potential down the axon. This property allows individual axons to be stimulated with very low stimulus intensities. An axonal action potential will travel down all branches of the axon to activate all the muscle fibers that it innervates. Activation will thus activate an



**Figure 29–2.** Example of DQEMG-MUNE recordings. DQEMG program identified six MUP from 15 seconds of ongoing EMG in a normal anal sphincter. Column 1, Superimposition of each of the MUPs identified as the same MUP confirms the quality selection process; column 2, Average of the MUP superimposed; column 3, Average surface electrode recording of the synchronous SMUP recorded with each MUP; column 4, Interdischarge interval between MUPs in that row to confirm the firing pattern; column 5, Vertical lines to depict the time of occurrence of each MUP selected in that row (gaps occur when superimposition of MUP prevents their isolation).

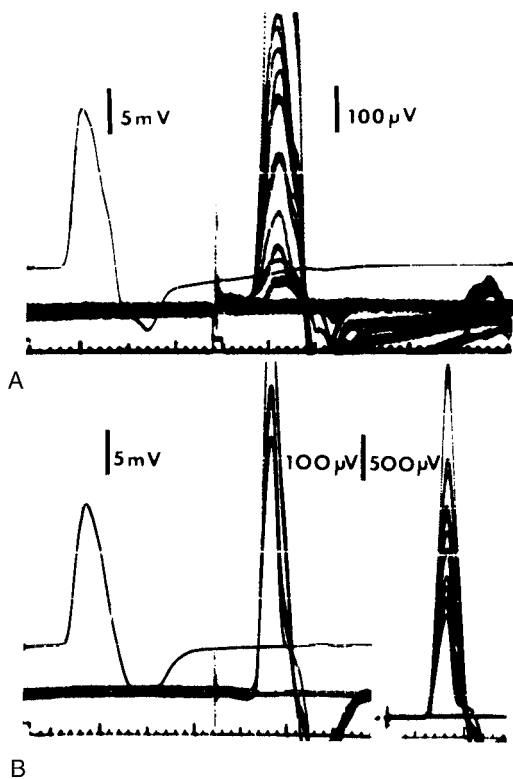
SMUP that can be recorded on the surface as an SMUP.

### MUNE FROM MULTIPLE ALL-OR-NONE INCREMENTS AT ONE STIMULATION POINT

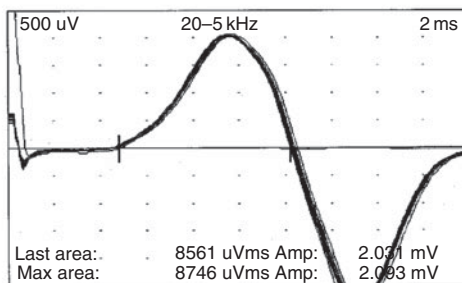
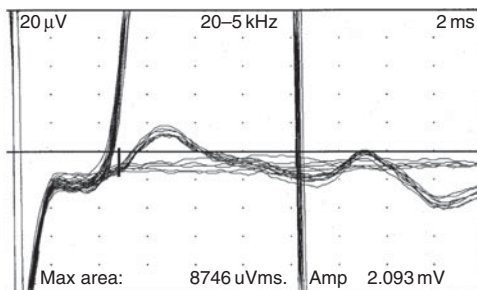
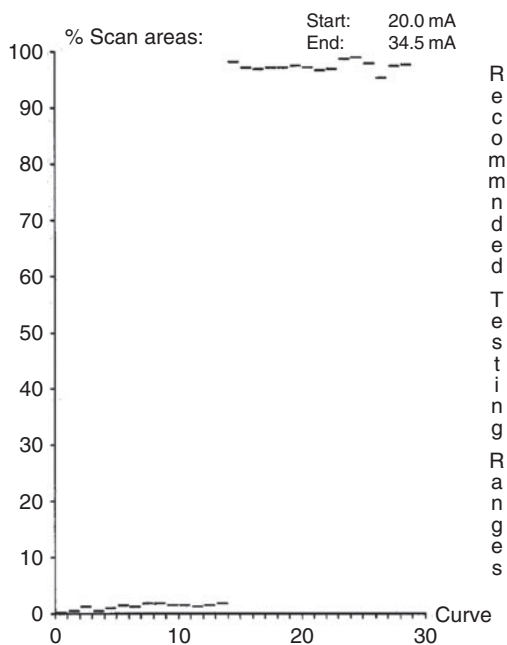
All-or-none increment measurement, introduced by McComas,<sup>31</sup> was the first method used for quantitative MUNE. The method is deceptively simple and provides the easiest and most direct and reliable method of obtaining MUNE if the number of axons or motor neurons is reduced.<sup>32,33</sup> It was based on the all-or-none characteristic of the motor axons activation. In the incremental method,

the stimulus current is finely controlled in very small steps designed to allow isolated stimulation of individual axons in a stepwise fashion (Fig. 29–3). For example, if a muscle contains only two motor units, the CMAP consists of the summed SMUP of these two potentials only. Incremental testing with slowly and gradually increasing current will show no response to a stimulus below the threshold of either axon of the two motor units. When the threshold of one of the axons is reached, that axon is fully activated and the CMAP suddenly changes from no response to the response of that SMUP. When the threshold of the second axon is reached, this axon also fires and the maximal CMAP is obtained (Fig. 29–4). Changing the





**Figure 29-3.** Incremental method of MUNE. A, Ten response increments in 500 μV give a MUNE of 100. B, Ten response increments in 2000 μV give a MUNE of 25. (From Brown, W. F., and T. E. Feasby. 1974. Estimates of functional motor axon loss in diabetics. *Journal of Neurological Sciences* 23:275-93. By permission of Elsevier Science.)



**Figure 29-4.** Left, Stimulation of the median nerve from threshold to maximal (20-34.5 mA) in 0.3 mA increments. Note that two SMUPs are elicited: (1) Top right at 20 μV sensitivity shows 11 superimposed, 30-μV SMUP with baseline noise. (2) Bottom right at 500 μV sensitivity shows 16 superimposed 2000-μV SMUP.



stimulus current above and below these thresholds produces stepwise activation of two steps; that is, the first SMUP and then the full CMAP. If there are three motor units in the muscle, three steps would be recorded, and similarly for a larger number of motor units.

With this technique, the size of the SMUP is estimated from the incremental change in the CMAP that occurs with control of the stimulus current to demonstrate the progressively increasing number of motor units. The more of these distinct steps of the total CMAP that can be measured, the more reliable MUNE becomes with incremental measurements. Normal nerves have so many motor axons that incremental steps becomes more difficult to separate. Thus, the incremental method is truly reliable only with markedly reduced numbers of axons.

Incremental MUNE using multiple current steps to selectively stimulate different axons has two major potential sources of error. First, there may be a selection bias for larger or smaller motor units. Second, and of greater concern, is that the occurrence of *alternation* that occurs when different axons have similar thresholds for activation. *Alternation* is best illustrated by the example of a muscle containing three axons of nearly the same threshold that result in seven rather than three apparent increments (Fig. 29-5). The threshold of

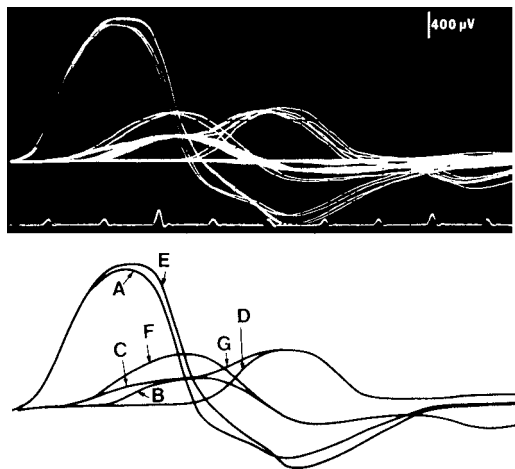
any axon varies within a small range so that for any given stimulus, an SMUP has a percentage likelihood of firing. Therefore, any one of the three axons with nearly identical thresholds might be activated for each stimulus. An axon that is activated first in one trial may be activated second or third in subsequent trials. Thus, the sizes of potentials that could be obtained when there are three motor units of different sizes—*A*, *B*, and *C*—are those generated by *A* alone, *B* alone, *C* alone; by *A* and *C*, *B* and *C*, *A* and *B*; and by *A*, *B*, and *C* together. Thus the three SMUPs might be recorded as three to seven steps.

A third problem with the incremental technique is the inability to separate very small potential, as occurs in severe myopathies, facial muscles, or with nascent MUPs. The inability to record the smallest steps results in underestimation of MUNE in myopathies.

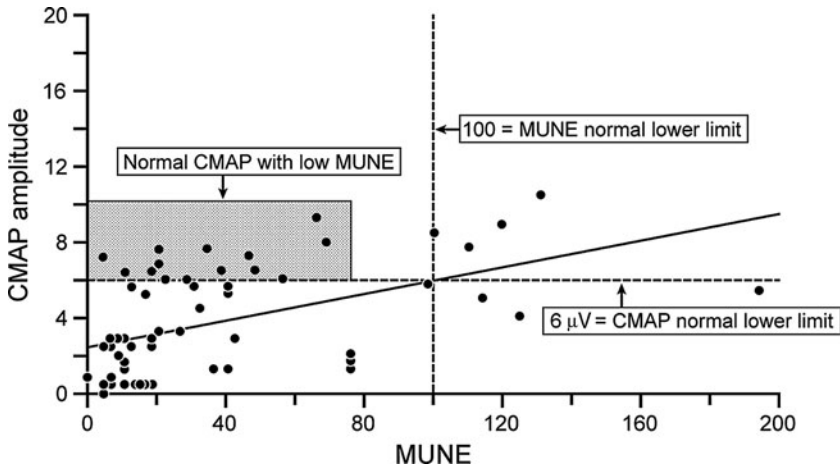
Several modifications have been developed to minimize some of these errors: (1) use of automated computer identification of the templates of different SMUPs allows recognition of different SMUPs and decreases the likelihood of measuring alternation, (2) use of recording electrodes of different sizes and shapes to selectively stimulate different axons, (3) automation of the incrementing stimulus size to allow finer control,<sup>34</sup> and (4) microstimulation of single nerve terminals at the end plate region.<sup>25,26</sup>

Each of the single point incremental CMAP techniques uses the average values of the size (amplitude or area) of all the SMUPs identified and compares them with the maximal size of the CMAP. Normal values determined by several authors have shown that the mean normal MUNE for median or thenar muscles is approximately 350 (range, 100–500) and for the peroneal or extensor digitorum brevis, the other well-studied muscle, 200 (range, 50–300).

Despite the problems, incremental CMAP is simple and direct enough that it should be learned by every electromyographer. Many patients with a neurogenic disease have low-amplitude CMAP providing a measure of the severity of axon loss. However, in some slowly progressing processes or with residuals of old processes, CMAP amplitude may be normal through collateral sprouting of intact axons despite the loss of axons. In such patients, recording the CMAP at a high sensitivity



**Figure 29-5.** Alternation of three SMUPs during F-wave recording to give seven F waves (A–G). (From Feasby, T. E., and W. F. Brown. 1974. Variation of motor unit size in the human extensor digitorum brevis and thenar muscles. *Journal of Neurology, Neurosurgery, and Psychiatry* 37:916–26. By permission of the publisher.)



**Figure 29-6.** Examples of maintenance of CMAP amplitude with marked loss of axons. Comparison of ulnar CMAP amplitude with MUNE in patients with ALS. The lower limit of normal MUNE is 100 and the lower limit of normal ulnar CMAP is  $6.0 \mu\text{V}$ . Note that 13 patients have low MUNE with normal CMAP, and some as low as eight motor units.

(100–200  $\mu\text{V}$ ) with fine stimulus control near threshold will demonstrate the presence of individual, high-amplitude SMUP. Some EMG machines provide automated stimulus control to make this even easier to do. This method can demonstrate as few as 3–10 remaining SMUPs with normal CMAP amplitude when there should be over 100 (Fig. 29-6).

### Key Points

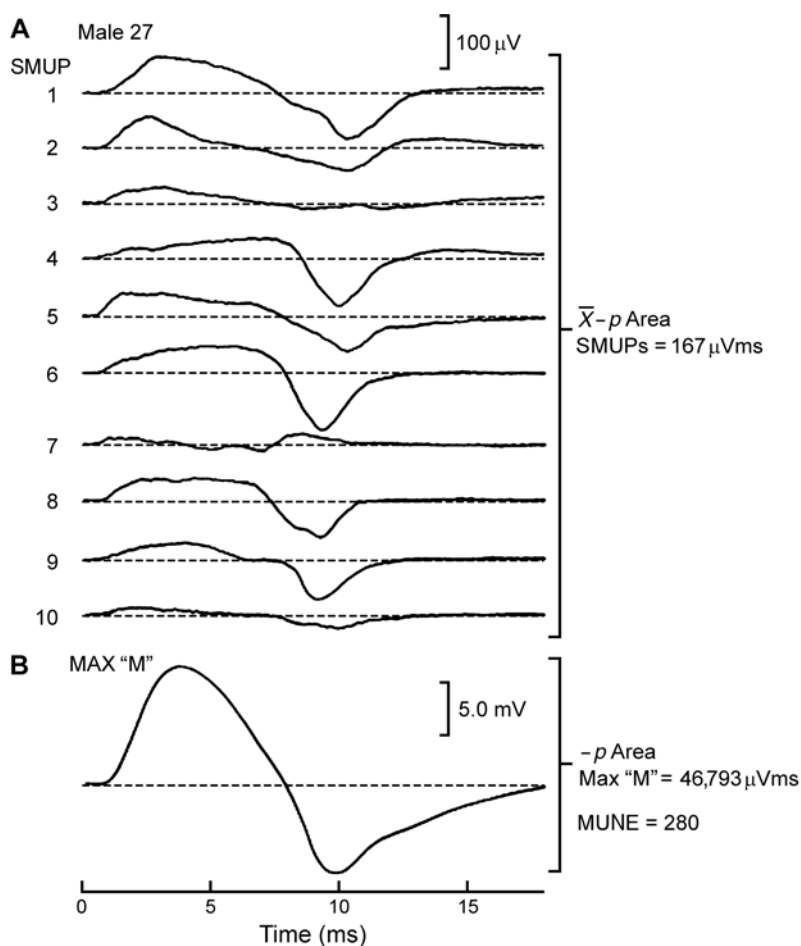
- Single point, incremental stimulation near threshold can sequentially isolate the SMUP from different nerves.
- Normal values for standardized incremental MUNE methods have been determined.
- Alternation of activation of axons with similar thresholds can erroneously significantly increase the MUNE with this method particularly if the number of axons is near normal.
- Alternation occurs from the summation of similar size SMUPs in what appear to be more SMUPs than are actually present.
- Averaging 10 or more such SMUPs provides a reasonable average size to divide into the maximal CMAP for MUNE.
- Other common technical problems of sample size, variation in SMUP size, and SMUP decrement can also decrease MUNE value and reproducibility.

- The incremental method is less commonly used than other methods because of technical problems.

### MULTIPOINT STIMULATION (MPS)

The second method of isolating SMUP by peripheral nerve stimulates axons at very low intensity to activate a single axon and record its SMUP. Stimulation applied at different points along the nerve (MPS) can isolate single SMUP at each point,<sup>14,35-37</sup> thereby eliminating the problem of alternation. MPS has become one of the two most commonly used MUNE methods. The method is conceptually simple, but requires the manual skills to maintain the position of the stimulator well enough to repeatedly activate the same SMUP with small stimulus variation at the axon threshold. Unique axons are identified by the recording of distinct, reproducible SMUP. Stimulation is applied at as many sites as possible at short intervals along the nerve to selectively activate different axons (Fig. 29-7). MUNE is calculated by dividing the maximal CMAP by the average size of the individual SMUP.

While MPS effectively eliminates the problem of alternation, the other problems remain. A nerve with normal numbers of axons requires fine control of the stimulus to reliably isolate individual axons. This can be enhanced by a

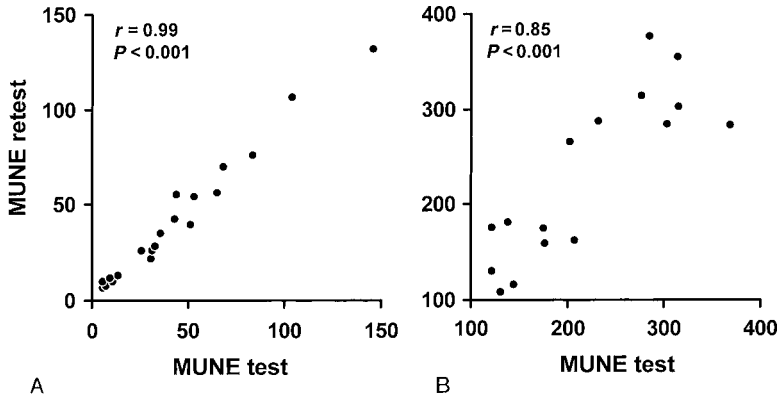


**Figure 29-7.** Example of data recorded for MPS. *A*, Traces 1–10 are single SMUP recorded over thenar muscles with threshold stimulation at ten different points along the median nerve. Their mean area is 167  $\mu$ Vms. *B*, Thenar CMAP recorded from the same thenar electrodes has an area of 46,793  $\mu$ Vms. Dividing CMAP area by average SMUP area gives a MUNE of 280 (normal). (From Doherty, T. J., and W. F. Brown. 1993. The estimated numbers and relative sizes of thenar motor units as selected by multiple point stimulation in young and older adults. *Muscle & Nerve* 16:355–66. By permission of the publisher.)

nonstandard stimulus control that allows stimulus gradation in 0.1 mA steps. Even so, it is often difficult to isolate more than 15–20 SMUPs. That number would be sufficient if the range of SMUP size was generally the same. However, in nerves with reduced numbers of axons and variation in collateral sprouting, the SMUP size can vary greatly. Sample size could then be insufficient to make a reproducible MUNE. Other possible problems include (1) defects of neuromuscular transmission that cause sufficient variation in SMUP size to make the recognition of individual SMUP less certain, (2) patient tremor or other movement when trying

to isolate an SMUP, (3) a myopathy with SMUP too small to distinguish, (4) SMUP selection bias by selective stimulation of low-threshold, large motor axons, and (5) depending on the other possible technical factors MPS MUNE for one nerve can take 5–10 minutes.

Despite these problems, MPS provides sufficient reliability for clinical use (Fig. 29-8). This figure also shows the marked improvement in reproducibility as the total number of axons in a nerve decreases.<sup>38</sup> A variation of MPS isolating only three SMUPs at each point makes the recording more efficient with similar values and reproducibility.<sup>39</sup>



**Figure 29-8.** Reproducibility of MUNE with MPS method. A, Subjects with decreased MUNE because of amyotrophic lateral sclerosis. B, Normal subjects. (From Felice, K. J. 1995. Thenar motor unit number estimates using the multiple point stimulation technique: Reproducibility studies in ALS patients and normal subjects. *Muscle & Nerve* 18:1412–16. By permission of John Wiley & Sons.)

### Key Points

- MPS records individual SMUP by selective stimulation of different low-threshold axons at different points along a nerve.
- Awareness of a limited number of technical problems can make this method clinically useful.
- MUNE values for different nerves in normal subjects are in the same range as those for single point incremental stimulation.

### F-WAVE MEASUREMENTS

F waves have been suggested as a method for determining the size of the SMUP.<sup>40,41</sup> Maximal activation of all the motor axons in a peripheral nerve is associated with antidromic activation of some of the anterior horn cells. The small proportion of anterior horn cells activated antidromically produces small late potentials, *F waves*. Repeated maximal stimuli activate different anterior horn cells and produce different F waves. Recording a range of sizes of F waves can be used to estimate the average size of the SMUP. This average size can be divided into the maximal CMAP to obtain MUNE. Simmons et al.<sup>42</sup> have shown that the drawbacks of this method are similar to those described in the preceding section for the incremental method and that multiple motor units are activated more commonly than single motor units. These drawbacks result in overestimating the average size of the SMUP and in underestimating the MUNE. Automated correction of these drawbacks by

submaximal stimulation and template matching may make the method useful clinically. Simmons et al.<sup>42</sup> have described an automated method of measuring only recurrent, identical F waves that are more likely to represent SMUP. This method has not been used widely because of the difficulty with implementing it.

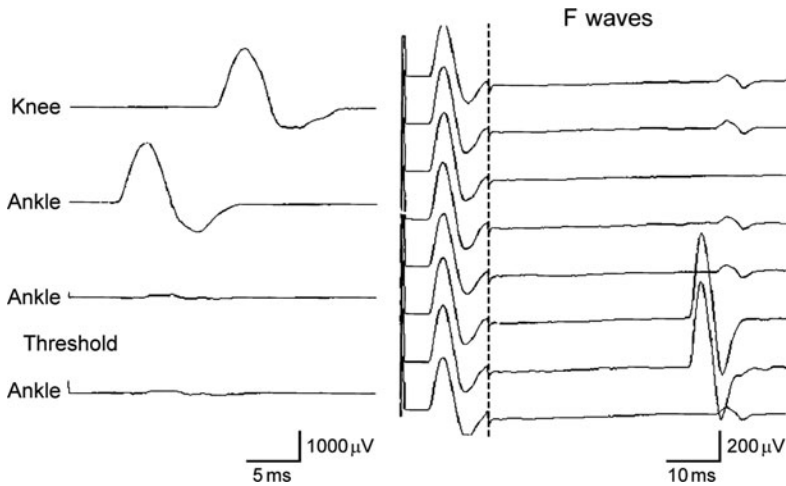
Nonetheless, F waves can be useful in judging the extent of collateral sprouting that results from loss of axons. The remaining individual motor units gain muscle fibers with an increase in size of the SMUP recorded as F waves. F waves from single SMUP can be recognized as large, identical F waves (Fig. 29-9). Their presence is confirmatory evidence of significant loss of axons, even if CMAP amplitude remains normal.

### Key Points

- F waves represent one or a combination of a few SMUPs.
- As axons are lost, F waves are more likely to represent single SMUP.
- Published reports of MUNE from F-wave sizes have not been sufficiently accurate or reproducible to provide clinically useful MUNE.
- Large reproducible F waves provide non-quantitative evidence of loss of axons.

### Statistical (STAT) MUNE

The fourth method of estimating the size of the SMUP uses direct stimulation of the motor nerve, similar to the all-or-none incremental



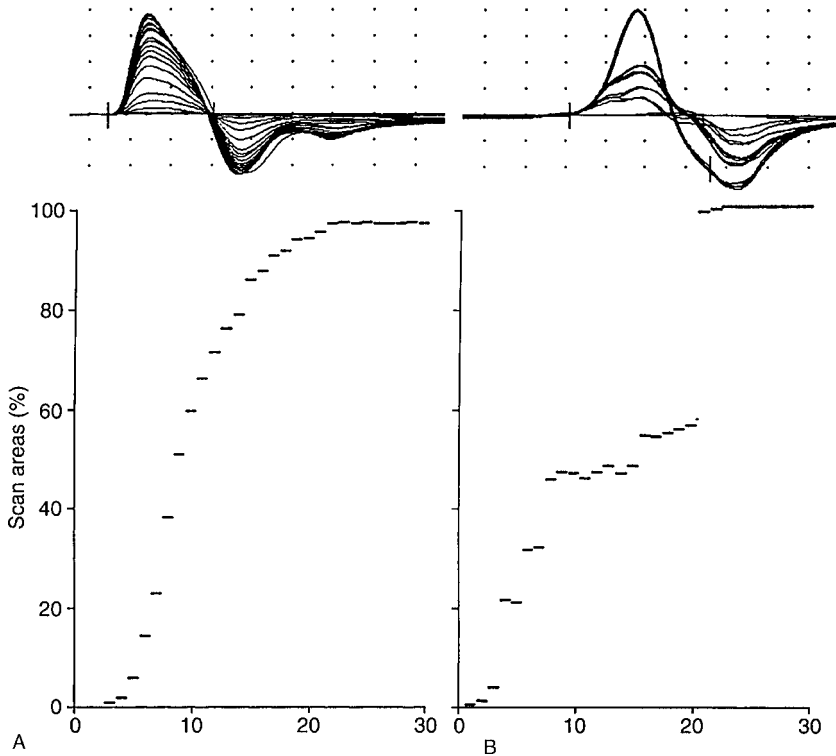
**Figure 29-9.** Peroneal motor conduction study. *Left*, Maximal and threshold recordings at 1000  $\mu\text{V}$  per division. *Right*, F-wave recordings at 200  $\mu\text{V}$  per division. Note that a 600- $\mu\text{V}$  SMUP was recorded twice as identical F waves. This large SMUP from collateral sprouting in a peripheral neuropathy makes up 40% of the 2.4- $\mu\text{V}$  M wave.

method, but it is conceptually different.<sup>11,43,44</sup> With the STAT MUNE, no attempt is made to identify the potentials associated with individual motor units. The method relies on the known relationship between the variance of multiple measures of step functions and the size of the individual steps when the steps have a Poisson distribution. Poisson statistics is used to calculate the number of quanta released from a nerve terminal at the neuromuscular junction when the individual quanta are too small to be distinguished, as in myasthenia gravis. In Poisson statistics, the sizes of a series of measurements are multiples of the size of a single component. Therefore, a Poisson distribution has discrete values at which responses are found. A Poisson distribution has decreasing numbers of responses with higher values. In a Poisson distribution, the variance of series of measurements is equal to the size of the individual components that make up each measurement. The STAT MUNE method measures the variance of the CMAP and does not require identification of individual components; it can be used when the sizes of SMUP are too small to be isolated, which is often the case in normal muscles and myopathies. Also, it can be used with high-amplitude CMAPs that require gains at which the SMUP cannot be isolated.

Although the STAT MUNE has advantages, it has the potential sources of error described above for the other methods. These include

the following assumptions: each motor unit has a similar size; it is the same size each time it is activated; the samples tested are unbiased; and all motor axons are activated. Two other issues must be considered for STAT MUNE. First, with a larger number of SMUP making up the CMAP, the distributions shift gradually from a Poisson to a normal distribution. This may produce an error of up to 10% in the STAT MUNE. Second, because all measurements are statistical, the results vary with each sample. Consequently, the number of samples must be increased to provide reproducibility comparable to that of the other methods.

In the STAT MUNE, recording electrodes are applied as they are for standard NCS, with the stimulating electrode taped firmly in place over the appropriate nerve. An initial "scan" of the responses of the nerve to 30 stimuli of equal increments between threshold and maximal CMAP identifies large increments that may result from a large SMUP (Fig. 29-10). Such large SMUPs do not need further statistical testing. A sequence of 30 or more submaximal stimuli is given at a fixed stimulus intensity in selected regions of small increments on the scan. The threshold of individual motor axons fluctuates so that at any given intensity the likelihood of firing ranges from 0% to 100%, with a finite range where the axon fires only some percentage of the time (Fig. 29-11). This inherent variability of the



**Figure 29-10.** MUNE scan from, *A*, normal subject and, *B*, patient with amyotrophic lateral sclerosis. Between the threshold and the maximal CMAP, 30 equal increments in stimulus intensity were applied to the nerve. The elicited CMAPs are superimposed above the histograms. The histograms depict the area of each of the 30 responses. In *A*, note the smooth curve with small increments. In *B*, the increments are larger, with a particularly large increment just before the maximal CMAP. The latter is caused by activation of a single large motor unit.

threshold of individual axons causes intermittent firing of axons and continuous variations in the size of the CMAP. Therefore, the problem of alternation with activation of different motor units described for the incremental and F-wave methods is not an issue with the STAT MUNE. Because the method is a statistical measurement, a somewhat different result is obtained each time, and multiple trials are needed to obtain the most accurate measurement. Experimental testing with trials of more than 300 stimuli has shown that repeated measurement of groups of 30 until the standard deviation of the repeated trials is less than 10% provides a close estimate of the number obtained with many more stimuli. Ongoing studies by different investigators have shown improvement in the reproducibility and reliability of the STAT MUNE.<sup>42,45-48</sup>

One recent study has raised questions about the validity of STAT MUNE when testing

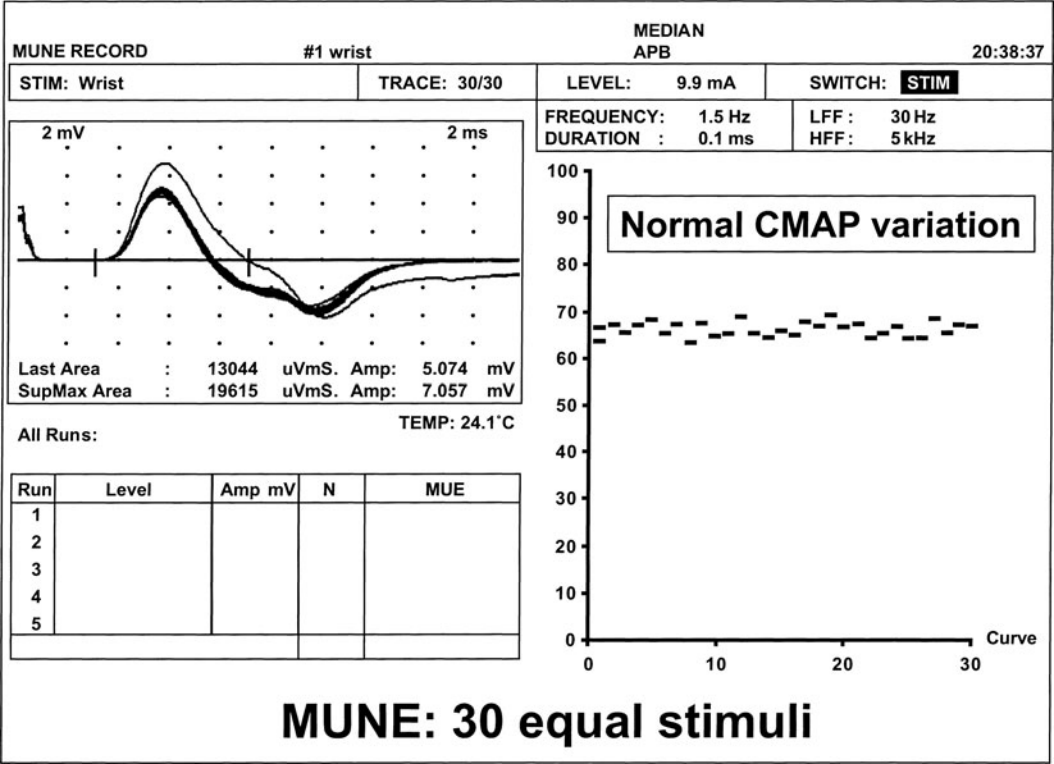
a muscle with unstable motor units such as amyotrophic lateral sclerosis (ALS);<sup>49</sup> but a number of technical issues that will not be reviewed here were not addressed in that publication. Another recent study reported further improvements in STAT MUNE.<sup>50</sup>

**Key Points**

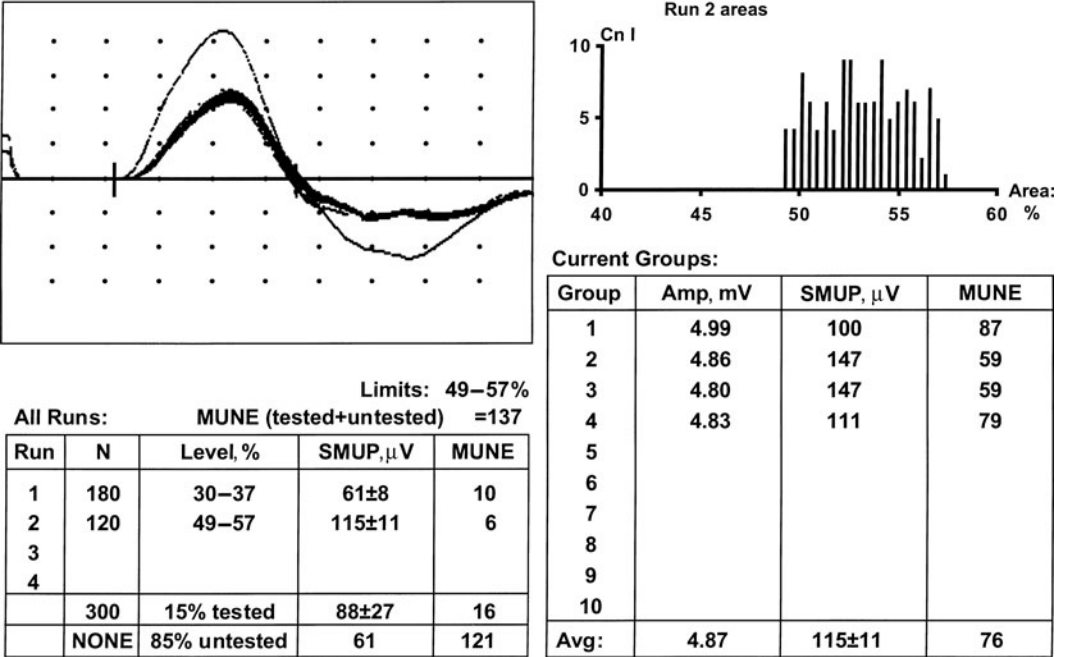
- STAT MUNE uses a distinctly different method of CMAP recording to determine the number of axons innervating a muscle group that provides a number of distinct advantages over other methods.
- The variance of the changes in the sizes of the CMAP due to intermittent firing of motor unit axons at threshold provides an estimate of the sizes of the SMUP that are firing.
- The CMAP variance is measured at four different levels of stimulation to sample the entire range of axons in the nerve.



A



B



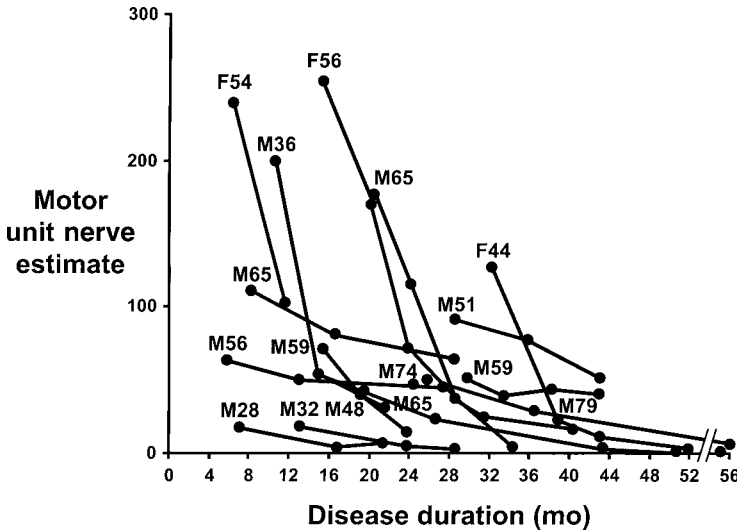
**Figure 29–11.** Statistical method of MUNE in a normal subject. A, Normal variation in CMAPs with 30 equal stimuli. B, Calculated SMUPs and MUNE for four groups of 30 stimuli (table on right) and two runs at different stimulus intensities (table on left). Superimposed CMAPs from the 30 stimuli are shown on top left in A and B.

**CLINICAL APPLICATIONS**

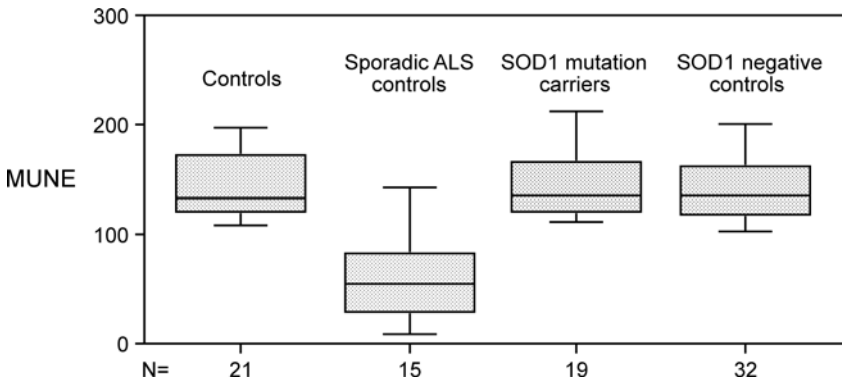
Applications of the methods of MUNE to diseases have shown the expected decrease in the number of motor units in peripheral nerve disease (carpal tunnel syndrome, lumbar radiculopathies, and peripheral neuropathies) and in motor neuron disease<sup>51-55</sup> (Fig. 27-12). MUNE is particularly helpful in chronic disorders in which collateral sprouting results in a CMAP of normal amplitude despite a loss of motor units such as residuals of old poliomyelitis,

spinal muscular atrophy, and ALS. Serial measurements of MUNE are helpful in following the course of a disease, especially in treatment trials or studies of the evolution of disease.<sup>59-62</sup>

MUNE has also been applied to assess the timing of axonal loss during the course of inherited (SOD1) motor neuron disease. Remarkably, in that disorder, axonal loss does not begin until only a few months before weakness appears, despite the lifelong presence of the genetic abnormality (Fig. 29-13).<sup>63</sup>



**Figure 29-12.** Decrease in thenar MUNE (STAT MUNE) in 16 patients with amyotrophic lateral sclerosis. Note the rapid decrease in MUNE over a few weeks in patients whose initial values were normal, but the decrease was slower after the initial reduction in MUNE. F, female; M, male. Numerals following F and M indicate the age of patients.



**Figure 29-13.** Statistical MUNE from thenar muscles in normal subjects (“controls”), patients with sporadic ALS, known carriers of the SOD1 ALS genetic defect, and SOD1 negative subjects in families with the genetic defect. Note that none of the carriers had manifested the disease at the time of testing, but did subsequently with a course similar to the ALS patients shown in Figure 29-12. (From Aggarwal, A., and G. Nicholson. 2009. Motor unit number estimates in patients with SOD1 positive and negative amyotrophic lateral sclerosis in motor unit number estimation. In *Motor Unit Number Estimation and Quantitative EMG*, 60, ed. M. B. Bromberg. *Proceedings of the Second International Symposium on MUNE and QEMG*, Snowbird, Utah, USA, August 19-20, 2006. Philadelphia: Elsevier. By permission of the publisher.)

## SUMMARY

The all-or-none increment, the STA, DQEMG, MPS, and the STAT MUNE methods of obtaining MUNE give similar values in each of the muscles compared in normal subjects. Alternative MUNE methods continue to be developed, but none have been used sufficiently in a clinical setting to assess them.<sup>64</sup> In addition, Felice has shown that MUNE is more reliable than other measurements in documenting the course of ALS.<sup>38</sup> Thus each of these methods can be used whenever and wherever it is most feasible and that different methods may be appropriate in different settings. For example, when each of the motor units can be identified with small increments of stimuli in a severe neurogenic process, MUNE is defined most rapidly and accurately by actually counting the total number of increments. When the number of motor units is too large to do this or their size is too small for them to be identified accurately in the CMAP, the STAT MUNE or multipoint methods are appropriate. In muscles in which CMAPs cannot be obtained reliably, as in proximal muscles that are difficult to immobilize during stimulation of the motor nerve, the STA and DQEMG methods are most appropriate. The value of other methods of MUNE remains to be determined.<sup>65-69</sup>

## REFERENCES

- Armon, C., and M. E. Brandstater. 1999. Motor unit number estimate-based rates of progression of ALS predict patient survival. *Muscle & Nerve* 22:1571-5.
- Johnston, S. C. 2000. Prognostication matters. *Muscle & Nerve* 23:839-42.
- Chan, K. M., and W. F. Brown. 1998. Quantitation in EMG. *Canadian Journal of Neurological Sciences* 25(1):S27-31.
- Daube, J. R. 2006. Motor unit number estimates—From A to Z. *Journal of Neurological Sciences* 242(1-2):23-35.
- Feinstein, B., B. Lindegård, E. Nyman, and G. Wohlfart. 1955. Morphologic studies of motor units in normal human muscles. *Acta Anatomica Scandinavica* 23:127-42.
- Azzouz, M., N. Leclerc, M. Gurney, J. M. Warter, P. Poindron, and J. Borg. 1997. Progressive motor neuron impairment in an animal model of familial amyotrophic lateral sclerosis. *Muscle & Nerve* 20:45-51.
- Erim, Z., C. J. De Luca, K. Mineo, and T. Aoki. 1996. Rank-ordered regulation of motor units. *Muscle & Nerve* 19:563-73.
- Schulte-Mattler, W. J., D. Georgiadis, K. Tietze, and S. Zierz. 2000. Relation between maximum discharge rates on electromyography and motor unit number estimates. *Muscle & Nerve* 23:231-8.
- Lateva, Z. C., K. C. McGill, and C. G. Burgar. 1996. Anatomical and electrophysiological determinants of the human thenar compound muscle action potential. *Muscle & Nerve* 19:1457-68.
- Armon, C., M. E. Brandstater, and G. W. Peterson. 1997. Motor unit number estimates and quantitative muscle strength measurements of distal muscles in patients with amyotrophic lateral sclerosis. *Muscle & Nerve* 20:499-501.
- Daube, J. R. 1995. Estimating the number of motor units in a muscle. *Journal of Clinical Neurophysiology* 12:585-94.
- Doherty, T. J., and W. F. Brown. 1993. The estimated numbers and relative sizes of thenar motor units as selected by multiple point stimulation in young and older adults. *Muscle & Nerve* 16:355-66.
- Doherty, T., Z. Simmons, B. O'Connell, et al. 1995. Methods for estimating the numbers of motor units in human muscles. *Journal of Clinical Neurophysiology* 12:565-84.
- Felice, K. J. 1995. Thenar motor unit number estimates using the multiple point stimulation technique: Reproducibility studies in ALS patients and normal subjects. *Muscle & Nerve* 18:1412-16.
- Roos, M. R., C. L. Rice, and A. A. Vandervoort. 1997. Age-related changes in motor unit function. *Muscle & Nerve* 20:679-90.
- Hennings, K., E. N. Kamavuako, and D. Farina. 2007. The recruitment order of electrically activated motor neurons investigated with a novel collision technique. *Clinical Neurophysiology* 118(2):283-91.
- Slawnych, M., C. Laszlo, and C. Hershler. 1997. Motor unit number estimation: Sample size considerations. *Muscle & Nerve* 20:22-8.
- Bromberg, M. B. 2007. Updating motor unit number estimation (MUNE). *Clinical Neurophysiology* 118:1-8.
- van Dijk, J. P., J. H. Blok, B. G. Lapatki, I. N. van Schaik, M. J. Zwarts, and D. F. Stegeman. 2008. Motor unit number estimation using high-density surface electromyography. *Clinical Neurophysiology* 119(1):33-42.
- Bromberg, M. B. 1993. Motor unit estimation: Reproducibility of the spike-triggered averaging technique in normal and ALS subjects. *Muscle & Nerve* 16:466-71.
- Bromberg, M. B., and J. L. Abrams. 1995. Sources of error in the spike-triggered averaging method of motor unit number estimation (MUNE). *Muscle & Nerve* 18:1139-46.
- Brown, W. F., T. J. Doherty, M. Chan, A. Andres, and S. M. Provost. 2000. Human motor units in health and disease. *Muscle & Nerve* 9(Suppl):S7-18.
- de Koning, P., G. H. Wieneke, D. van der Most van Spijk, A. C. van Huffelen, W. H. Gispen, and F. G. Jennekens. 1988. Estimation of the number of motor units based on macro-EMG. *Journal of Neurology, Neurosurgery, and Psychiatry* 51:403-11.
- Milner-Brown, H. S., and W. F. Brown. 1976. New methods of estimating the number of motor units in a muscle. *Journal of Neurology, Neurosurgery, and Psychiatry* 39:258-65.

25. Arasaki, K., M. Tamaki, Y. Hosoya, and N. Kudo. 1997. Validity of electromyograms and tension as a means of motor unit number estimation. *Muscle & Nerve* 20:552-60.
26. Arasaki, K., and M. Tamaki. 1998. A loss of functional spinal alpha motor neurons in amyotrophic lateral sclerosis. *Neurology* 51:603-5.
27. McNeil, C. J., T. J. Doherty, D. Stashuk, and C. L. Rice. 2005. Motor unit number estimates in the tibialis anterior muscles of young, old and very old men. *Muscle & Nerve* 31(4):461-7.
28. Boe, S. G., D. W. Stashuk, W. F. Brown, and T. J. Doherty. 2005. Decomposition-based quantitative electromyography: Effect of force on motor unit potentials and motor unit number estimates. *Muscle & Nerve* 31(3):365-73.
29. Boe, S. G., D. W. Stashuk, and T. J. Doherty. 2006. Within-subject reliability of motor unit number estimates and quantitative motor unit analysis in distal and proximal upper limb muscles. *Clinical Neurophysiology* 117(3):596-603.
30. Boe, S. G., D. W. Stashuk, and T. J. Doherty. 2007. Motor unit number estimates and quantitative motor unit analysis in healthy subjects and patients with amyotrophic lateral sclerosis. *Muscle & Nerve* 36(1):62-70.
31. McComas, A. J. 1995. Motor unit estimation: Anxieties and achievements. *Muscle & Nerve* 18:369-79.
32. Galea, V., H. de Bruin, R. Cavinis, and A. J. McComas. 1991. The numbers and relative sizes of motor units estimated by computer. *Muscle & Nerve* 14:1123-30.
33. Stein, R. B., and J. F. Yang. 1990. Methods for estimating the number of motor units in human muscles. *Annals of Neurology* 28:487-95.
34. Aoyagi, Y., F. J. Strohschein, and K. Ming Chan. 2000. Use of the collision technique to improve the accuracy of motor unit number estimation. *Clinical Neurophysiology* 111:1315-19.
35. Doherty, T. J., D. W. Stashuk, and W. F. Brown. 1993. Determinants of mean motor unit size: Impact on estimates of motor unit number. *Muscle & Nerve* 16:1326-31.
36. Doherty, T. J., and W. F. Brown. 1994. A method for the longitudinal study of human thenar motor units. *Muscle & Nerve* 17:1029-36.
37. Wang, F. C., and P. J. Delwaide. 1995. Number and relative size of thenar motor units estimated by an adapted multiple point stimulation method. *Muscle & Nerve* 18:969-79.
38. Felice, K. J. 1997. A longitudinal study comparing thenar motor unit number estimates to other quantitative tests in patients with amyotrophic lateral sclerosis. *Muscle & Nerve* 20:179-85.
39. Guiheneuc, P. 1987. Automatic detection and pattern recognition of motor unit potentials. *Electroencephalography and Clinical Neurophysiology* 39(Suppl):21-6.
40. Felice, K. J. 1998. Nerve conduction velocities of single thenar motor axons based on the automated analysis of F waves in amyotrophic lateral sclerosis. *Muscle & Nerve* 21:756-61.
41. Stashuk, D. W., T. J. Doherty, A. Kassam, and W. F. Brown. 1994. Motor unit number estimates based on the automated analysis of F-responses. *Muscle & Nerve* 17:881-90.
42. Simmons, Z., D. K. Epstein, B. Borg, D. T. Mauger, M. J. Kothari, and J. M. Shefner. 2001. Reproducibility of motor unit number estimation in individual subjects. *Muscle & Nerve* 24:467-73.
43. Olney, R. K., and C. Lomen-Hoerth. 2000. Motor unit number estimation (MUNE): How may it contribute to the diagnosis of ALS? *Amyotrophic Lateral Sclerosis & Other Motor Neuron Disorders* 1(Suppl 2):S41-4.
44. Yuen, E. C., and R. K. Olney. 1997. Longitudinal study of fiber density and motor unit number estimate in patients with amyotrophic lateral sclerosis. *Neurology* 49:573-8.
45. Aggarwal, A., and G. Nicholson. 1998. Motor unit number estimation in preclinical and amyotrophic lateral sclerosis subjects (abstract). *Muscle & Nerve* 7(Suppl):S203.
46. Lomen-Hoerth, C., and R. Olney. 1999. A comparison of multipoint and statistical motor unit number estimation (abstract). *Muscle & Nerve* 22:1304.
47. Olney, R. K., E. C. Yuen, and J. W. Engstrom. 2000. Statistical motor unit number estimation: Reproducibility and sources of error in patients with amyotrophic lateral sclerosis. *Muscle & Nerve* 23:193-7.
48. Shefner, J. M., D. Jillapalli, and D. Y. Bradshaw. 1999. Reducing intersubject variability in motor unit number estimation. *Muscle & Nerve* 22:1457-60.
49. Shefner, J. M., M. E. Cudkovicz, H. Zhang, D. Schoenfeld, and D. Jillapalli. 2007. Northeast ALS Consortium. Revised statistical motor unit number estimation in the Celecoxib/ALS trial. *Muscle & Nerve* 35(2):228-34.
50. Hong, Y. H., J. J. Sung, K. S. Park, O. Kwon, J. H. Min, and K. W. Lee. 2007. Statistical MUNE: A comparison of two methods of setting recording windows in healthy subjects and ALS patients. *Clinical Neurophysiology* 118(12):2605-11.
51. Bromberg, M. B., D. A. Forshew, K. L. Nau, J. Bromberg, Z. Simmons, and T. J. Fries. 1993. Motor unit number estimation, isometric strength, and electromyographic measures in amyotrophic lateral sclerosis. *Muscle & Nerve* 16:1213-19.
52. Bromberg, M. B., and W. L. Larson. 1996. Relationships between motor-unit number estimates and isometric strength in distal muscles in ALS/MND. *Journal of Neurological Sciences* 139(Suppl):38-42.
53. Brown, W. F., and T. E. Feasby. 1974. Estimates of functional motor axon loss in diabetics. *Journal of Neurological Sciences* 23:275-93.
54. Dantes, M., and A. McComas. 1991. The extent and time course of motoneuron involvement in amyotrophic lateral sclerosis. *Muscle & Nerve* 14:416-21.
55. Kuwabara, S., K. Mizobuchi, K. Ogawara, and T. Hattori. 1999. Dissociated small hand muscle involvement in amyotrophic lateral sclerosis detected by motor unit number estimates. *Muscle & Nerve* 22:870-3.
56. McComas, A. J., C. Quartly, and R. C. Griggs. 1997. Early and late losses of motor units after poliomyelitis. *Brain* 120:1415-21.
57. Smith, B. E., J. C. Stevens, W. J. Litchy, et al. 1995. Longitudinal electrodiagnostic studies in amyotrophic lateral sclerosis patients treated with recombinant human ciliary neurotrophic factor (abstract). *Neurology* 45(Suppl 4):A448.
58. Krajewski, K. M., R. A. Lewis, D. R. Fuerst, et al. 2000. Neurological dysfunction and axonal

- degeneration in Charcot-Marie-Tooth disease type 1A. *Brain* 123:1516–27.
59. Chan, K. M., D. W. Stashuk, and W. F. Brown. 1998. A longitudinal study of the pathophysiological changes in single human thenar motor units in amyotrophic lateral sclerosis. *Muscle & Nerve* 21: 1714–23.
  60. Gooch, C. L., M. Pleitez, and Y. Harati. 1999. MUNE and single motor unit tracking: Experience in a clinical ALS trial. *EEG and Clinical Neurophysiology* 107(Suppl 110):1001.
  61. Gooch, C. L. 1998. Repetitive axonal stimulation of the same single motor unit: A longitudinal tracking study. *Muscle & Nerve* 21:1537–9.
  62. Kuwabara, S., K. Ogawara, K. Mizobuchi, M. Mori, and T. Hattori. 2001. Mechanisms of early and late recovery in acute motor axonal neuropathy. *Muscle & Nerve* 24:288–91.
  63. Aggarwal, A., and G. Nicholson. 2009. Motor unit number estimates in patients with SOD1 positive and negative amyotrophic lateral sclerosis in motor unit number estimation. In *Motor Unit Number Estimation and Quantitative EMG, 60*, ed. M. B. Bromberg. *Proceedings of the Second International Symposium on MUNE and QEMG, Snowbird, Utah, USA, August 19–20, 2006*. Philadelphia: Elsevier.
  64. Nandedkar, S. D., D. S. Nandedkar, P. E. Barkhaus, and E. V. Stalberg. 2004. Motor unit number index (MUNIX). *IEEE Transactions on Biomedical Engineering* 51(12):2209–11.
  65. Fang, J., B. T. Shahani, and D. Graupe. 1997. Motor unit number estimation by spatial-temporal summation of single motor unit potentials. *Muscle & Nerve* 20:461–8.
  66. Roeleveld, K., A. Sandberg, E. V. Stalberg, and D. F. Stegeman. 1998. Motor unit size estimation of enlarged motor units with surface electromyography. *Muscle & Nerve* 21:878–86.
  67. Shahani, B. T., J. Fang, and U. K. Dhand. 1995. A new approach to motor unit estimation with surface EMG triggered averaging technique. *Muscle & Nerve* 18:1088–92.
  68. Slawnych, M., C. Laszlo, and C. Herschler. 1996. Motor unit estimates obtained using the new “MUESA” method. *Muscle & Nerve* 19: 626–36.
  69. Sun, T. Y., T. S. Lin, and J. J. Chen. 1999. Multi-electrode surface EMG for noninvasive estimation of motor unit size. *Muscle & Nerve* 22:1063–70.

*This page intentionally left blank*



SECTION 2

**ELECTROPHYSIOLOGIC  
ASSESSMENT OF NEURAL  
FUNCTION**

---

*This page intentionally left blank*

# Reflexes and Central Motor Control

---

Motor function is controlled by a complex combination of central nervous system circuits that involve all levels of the neuraxis. Local reflexes at the level of the spinal cord or brain stem mediate and integrate local sensory input and input from descending motor pathways to the motor unit. Descending motor pathways from the cerebral hemisphere to the spinal cord include the rapidly conducting direct corticospinal pathways and several indirect pathways that arise in the spinal cord and brain stem. Descending motor activity in these pathways is directed and controlled by motor areas in the cerebral cortex, basal ganglia, and cerebellum. The cerebellum and basal ganglia form feedback loops that extend through the thalamus to the cerebral cortex and control motor activities.

Many of these pathways and functions can be monitored electrically, as described in the chapters of this section. H reflexes (Chapter 30) and cranial nerve reflexes (Chapter 31) are localized responses of the motor neurons in the spinal cord and brain stem to localized sensory input. Both groups of reflexes can be used to assess peripheral sensory and motor function as well as their central connections in the spinal cord and brain stem. In contrast, long-loop reflexes and the silent period depend more on the descending motor pathways from the brain to the spinal cord (Chapter 32). Therefore, these reflexes are

useful primarily in elucidating central disorders of motor function or neuronal excitability. They have helped elucidate the central disorder in disorders with upper and lower motor neuron involvement, like amyotrophic lateral sclerosis.

Multichannel surface electromyographic recordings from agonist and antagonist muscles in the limbs and trunk can be used to characterize several motor disorders on the basis of the patterns of activation and the timing of activity in different muscles, either in one limb or longitudinally in the body (Chapter 33). New knowledge has allowed improvement in the analysis and classification of tremor.

Surface electromyographic recordings in posturography and electronystagmography are also used in measuring the motor control of posture and vestibular function. These measurements (Chapter 34) assess the long pathways that control motor function and their integration in the neuronal pools. Posturography and electronystagmography are useful in evaluating many disorders of both the vestibular pathways and the motor control pathways. Their applications have been expanded with new approaches to Dix-Hallpike, dynamic walking, and optokinetic rotary chair testing. These new approaches have helped increase the application of the tests in Parkinson's and Alzheimer's diseases, and in vestibular rehabilitation.

*This page intentionally left blank*

## H Reflexes

Ruple S. Laughlin

### INTRODUCTION PHYSIOLOGIC BASIS TECHNIQUE

Soleus Technique  
Gastrocnemius Technique  
Flexor Carpi Radialis Technique

### INTRODUCTION

In 1918, Hoffmann<sup>1</sup> recorded a late response from the soleus muscle that occurred with submaximal electric stimulation of the tibial nerve, similar to the response recorded as a result of a tendon tap. Magladery and McDougal<sup>2</sup> later termed this response the *Hoffmann reflex*, or *H reflex*. This reflex has been studied widely and has been found useful in assessing experimental and clinical aspects of disorders of the central and peripheral nervous systems. The H reflex may be obtained from other muscles, including the gastrocnemius and flexor carpi radialis.

Lachman et al.<sup>3</sup> later showed that the H reflex can be used to evaluate proximal nerve segments that are generally inaccessible by routine nerve conduction studies in cases of suspected radiculopathy, plexopathy, or sensory neuropathy, especially if routine nerve conduction studies do not detect an abnormality that is suspected clinically. These are the most practical and clinically applicable reasons

### PEDIATRIC H REFLEXES CLINICAL APPLICATIONS

Proximal Conduction  
Central Nervous System Excitability

### SUMMARY

for the H-reflex test. In the research literature, however, the H reflex is often discussed as a test of motor neuron excitability and used to assess conditions that may cause spasticity or rigidity, such as myelopathy, motor neuron disease, Parkinson's disease, and cerebellar disorders.

#### *Purpose and Role of H Reflex*

- To serve as the electrophysiologic correlate for the ankle jerk.
- To assess proximal nerve segments that are often inaccessible by routine nerve conduction studies.
- To serve as a tool in assessment of motor neuron excitability.

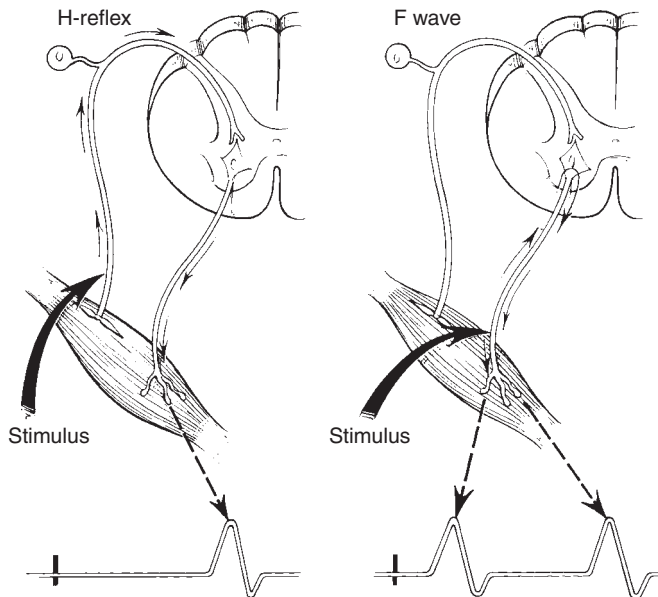
### PHYSIOLOGIC BASIS

Stimulation of the tibial nerve in the popliteal fossa at intensities less than needed to generate an early compound muscle action potential

(M response), from the soleus muscle elicits the H reflex. Magladery and McDougal<sup>2</sup> first demonstrated that the H reflex is a monosynaptic reflex response produced by activation of a small proportion of group Ia afferents traveling orthodromically to alpha motor neurons in the spinal cord (Fig. 30-1). Although similar to a tendon reflex, the H reflex is evoked by direct activation of the afferents bypassing the muscle spindle and the influence of sensory endings and gamma motor neuron activity on spindle sensitivity. In the spinal cord the Ia afferents make monosynaptic connections to the alpha motor neuron and initiates a volley of activation in the motor nerve traveling orthodromically from the cell body to the muscle. With gradually increasing stimulus intensities, the amplitude of the H reflex increases as more spindle afferents are activated. However, as stimulus intensity increases further causing motor axon activation, the H-reflex amplitude begins to decrease as more and more of the reflex volley is blocked in the motor axons by antidromically conducted motor impulses toward the spinal cord. A stimulus of long duration allows for more selective activation of afferent axons, whereas a stimulus of short duration increases the likelihood of motor axon activation.<sup>4</sup>

The latency of the H reflex depends on several factors. These include the time to activate the primary Ia afferents, conduction velocity of the primary afferents, central conduction delay, conduction velocity of motor axons and terminal conduction delay, neuromuscular transmission delay, distance from the site of stimulation to the spinal cord, and the time to detect a compound muscle action potential by the recording electrode.<sup>5,6</sup>

The amplitude of the H reflex, and hence the ability to record the reflex, is extremely variable. The value of measuring the amplitude of the H reflex in clinical settings is debated. Normal amplitude values of the tibial H reflex vary from 0.1 to 7 mV and also vary with recording electrode position, stimulus intensity, stimulus duration, posture, age, and temperature.<sup>7</sup> Additionally, H-reflex amplitude is sensitive to the degree of motor neuron excitability. Repeated recordings of the H reflex may demonstrate moment-to-moment amplitude variability by as much as 1.5 mV.<sup>8,9</sup> Activation of one group of motor units can inhibit motor units of other muscle groups, presumably through recurrent inhibition. Thus, agonist contraction can increase the amplitude of the H reflex and antagonist contraction can decrease it.<sup>10</sup> Furthermore,



**Figure 30-1.** Physiology of the H reflex: Selective activation of muscle spindle afferents and monosynaptic reflex response of soleus motor axons. The F wave represents recurrent discharge of motor neurons.



excitability can vary at different spinal cord segments. Studies of recovery of the H reflex have demonstrated that it is slower for the soleus H reflex than for the flexor carpi radialis H reflex, presumably because the motor neurons in the sacral segments have different characteristics from those in the cervical segments.<sup>11</sup> Thus, H-reflex amplitude alone may not be a reliable measure for clinical studies.<sup>8,9</sup>

Factors that affect the H reflex and that should be considered in performing this study are listed in Table 30–1. It is important to distinguish the H reflex from the F wave, which has a similar latency. The F wave is not a reflex but represents recurrent discharge of several motor neurons, with alpha motor neurons and axons serving as both the afferent and efferent pathways. This produces a smaller amplitude wave of varying latency and morphology obtained with supramaximal stimulation. The F wave can be recorded from many skeletal muscles (Table 30–2), and it can be distinguished from an H reflex by paired stimulation, which blocks the recurrent F wave but not the H reflex.

**Key Points**

- The H reflex is a monosynaptic reflex usually evoked with tibial nerve stimulation.
- The H reflex is evoked by direct activation of the afferents bypassing the muscle spindle and the influence of sensory endings and gamma motor neuron activity on spindle sensitivity.
- A stimulus of long duration is used when performing H reflexes, to allow for more selective activation of afferent axons.
- The amplitude of the H reflex, and hence the ability to record the reflex, is extremely variable and a less reliable measure than latency.

**TECHNIQUE**

The H reflex can be recorded from many muscles in normal neonates as well as in adults with upper motor neuron lesions. In normal adults, it is most reliably obtained from the soleus and flexor carpi radialis muscles and has

**Table 30–1 Factors That Affect the Presence or Amplitude of the H Reflex<sup>1,3,7,23</sup>**

Suppression	Facilitation
Contraction of antagonist muscles	Mild contraction of agonists
Strong contraction of agonists	Passive stretch
Passive shortening	Labyrinthine vestibular stimulation
Strong electric stimulus	Bite, grasp
Sleep	
Vibration	
Drugs (nicotine, pentobarbital, diazepam)	
Stimulation rate <1/second	
Tendon tap	
Strong flexion / extension of neck muscles	
Proximal ischemia	
Spinal anesthesia	

**Table 30–2 Comparison of the H Reflex and F Wave in Normal Subjects<sup>8,31,32</sup>**

H Reflex	F Wave
Suppressed by supramaximal stimulation	Maximal with supramaximal stimulation
Optimal with submaximal stimulation	Infrequent with submaximal stimulation
Amplitude 50%–100% of Mmax	Amplitude 10% of Mmax
Latency relatively constant	Latency variable
Morphology constant	Morphology variable
Recorded from forearm and leg	Recorded from hand and foot muscles

been reported in the gastrocnemius, palmaris longus, flexor carpi ulnaris, anterior tibialis, vastus medialis, masseter, extensor digitorum communis, and ulnar-innervated intrinsic hand muscles.<sup>9</sup> The H reflex is elicited most readily in the soleus muscle by stimulation of the tibial nerve. Although electric stimulation is used most commonly, an Achilles tendon tap or quick Achilles tendon stretch may also be used to elicit the reflex.<sup>9,12</sup>

## Soleus Technique

The H reflex can be easily elicited recording over the soleus muscle. Because the soleus muscle is the primary source of the reflex compound muscle action potential, recording over this muscle results in an initial negative deflection and a larger waveform as compared to recording over the gastrocnemius muscle. It has also been shown that there is a large separation between the stimulation thresholds of the H and M waves in the soleus muscle, making it easier to perform and interpret as compared to other muscles.

To perform the soleus technique, if necessary, the patient may be placed supine to avoid excessive lengthening or shortening of the soleus muscle and to allow adequate patient relaxation. The active recording electrode is placed medially over the soleus muscle approximately midway between the site of stimulation and the medial malleolus. The tibial nerve is stimulated immediately lateral to the popliteal artery at the level of the popliteal crease. To avoid stimulation of the peroneal nerve by current spread, the resultant plantar flexion muscle twitch of the gastrocnemius–soleus contraction without associated dorsiflexion of the anterior tibialis or peroneal muscles should be observed. The cathode is placed proximal to the anode. Square-wave pulses of 0.5–1.0-ms duration, with an intensity of 10–80 mA, are delivered at a rate of 0.5 Hz. Intensity should be increased by small increments from an initial low level until a response larger than the preceding M wave is elicited. With gradually increasing stimulus intensity, the H reflex usually appears before the M response or shortly thereafter. As the stimulus voltage is increased, the amplitude of the H reflex reaches a maximum before a maximal

M response is obtained (Fig. 30–2). With further increase in voltage, the H-reflex amplitude declines and eventually disappears as the M wave reaches maximal amplitude at supramaximal stimulus intensity.<sup>4,7,13</sup>

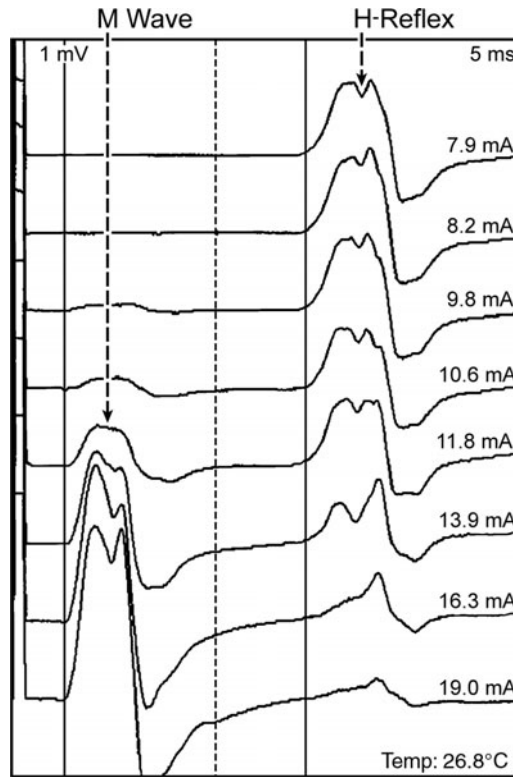
When recorded from the soleus muscle, the H reflex appears as a biphasic wave with a large negative deflection, which is normally 50%–100% of the maximal amplitude of the M wave (Fig. 30–2). Stimulus intensity should be increased and decreased as needed until a reproducible maximal H reflex is obtained.<sup>9,14</sup> This technique is important in differentiating the H reflex from the F wave (Table 30–2). Latency is measured to the initial deflection from baseline. In adults, the H reflex usually occurs at 28–35 ms and varies with leg length and age. Braddom and Johnson<sup>15</sup> developed a nomogram and formula that allow for age and leg-length differences. However, the side-to-side comparison of the latency of the H reflex is probably more widely used than the absolute value and should vary by no more than 3 ms<sup>9,14–17</sup> (Table 30–3). As previously noted, the reliability of amplitude measurements is not sufficient for clinical use.

## Gastrocnemius Technique

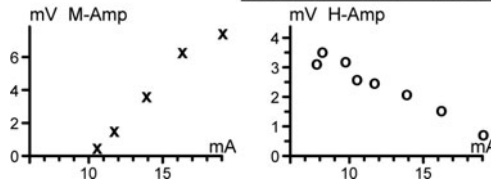
The H reflex can be elicited over the gastrocnemius muscle. Because the soleus muscle is the primary source of the reflex compound muscle action potential, recording over the gastrocnemius muscle results in a smaller waveform as compared to recording over the soleus muscle. For this reason, it should be noted that when the H reflex is recorded over the gastrocnemius muscle, an initial positivity may be present. To perform the study, the patient is placed supine as in the soleus technique described above. The recording electrodes are placed posteriorly between the two heads of the gastrocnemius muscle. Stimulation of the tibial nerve is applied in the same fashion as for soleus recordings. Latencies are similar for soleus and gastrocnemius recordings.

## Flexor Carpi Radialis Technique

The H reflex also can be recorded from the flexor carpi radialis muscle. According to



	Lat ms	Amp mV
M wave	5.1	7.399
H wave	28.5	3.498



**Figure 30-2.** *Top*, H reflex recorded from soleus muscle with increasing stimulus intensity (from *top* to *bottom*). Note maximal amplitude of the H reflex with submaximal stimulation and initial negativity of the waveform, allowing reliable latency measurement. *Bottom*, Graphical representation of stimulus intensity vs. amplitude depicting increasing M-wave amplitude with decreasing H-wave amplitude as stimulation intensity increases.

the method described by Jabre,<sup>18</sup> the active recording electrode is placed over the mid-portion of the flexor carpi radialis, approximately 10 cm distal to the elbow crease, with the reference electrode over the brachioradialis (Fig. 30-3). A flexor carpi radialis study usually is performed with the patient seated rather than supine to increase the likelihood of recording a response.<sup>19</sup> Normal values are listed in Table 30-3.

**Key Points**

- The H reflex can be reliably elicited over several muscles in adults, most commonly the soleus, gastrocnemius, and flexor carpi radialis.
- The soleus technique is the preferred method due to patient comfort and reproducibility.

Table 30–3 Normal Values for H-Reflex Latency

Reference	Muscle recorded	Latency, ms		
		Mean	Range	Side-to-side comparison
Braddom and Johnson <sup>15</sup>	Gastrocnemius	—	28–35	<1.2
Kimura <sup>8</sup>	Soleus	29.5	27–35	<1.4
Mayo Clinic	Soleus	—	25–35	<3
Shahani and Young <sup>33</sup>	Soleus	—	≤34	<2
Ongerboer de Visser, Schimsheimer, and Hart <sup>16</sup>	Flexor carpi radialis	16.8	15–20	<0.85
Jabre <sup>18</sup>	Flexor carpi radialis	15.9	11–21	<0.7
Buschbacher <sup>5</sup>	Gastrocnemius	30.3	30–38	<2

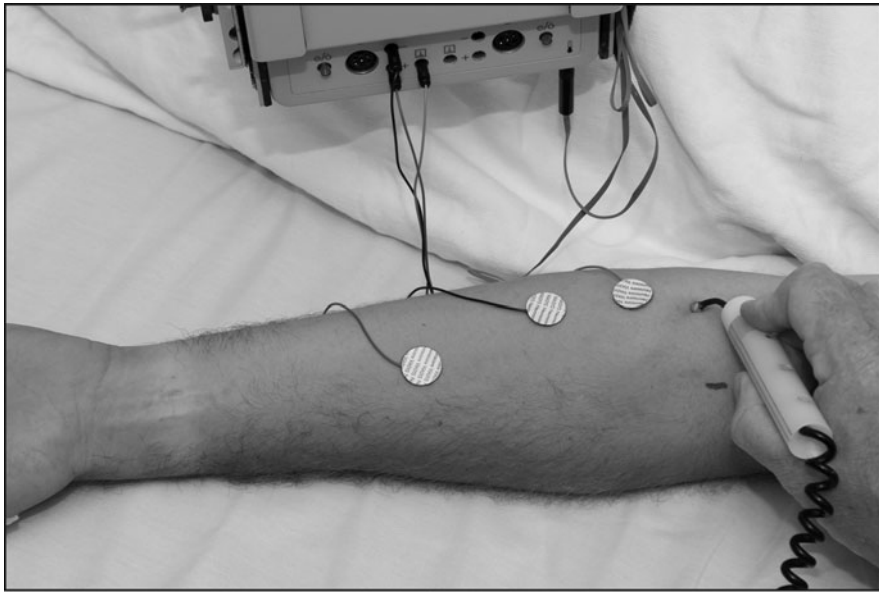


Figure 30–3. Technique of H reflex recording from flexor carpi radialis with median nerve stimulation.

## PEDIATRIC H REFLEXES

Cai and Zhang<sup>20</sup> demonstrated that the conduction velocities of the H reflex do not reach adult values until 6 years of age. Normal absolute latencies of the H reflex are correlated with body length until 1 year of age.<sup>21</sup> In infants, H reflexes are easily elicitable from calf and hand muscles. Mitsudome et al.<sup>22</sup> showed that although the evolution of motor velocities is the same for both premature and full-term infants, the evolution of the velocity of the H reflex may be slower in premature than in full-term infants. This factor should be considered when evaluating infants.

### Key Points

- Conduction velocities of the H reflex do not reach adult values until 6 years of age.
- In infants, H reflexes are easily elicitable from calf and hand muscles.

## CLINICAL APPLICATIONS

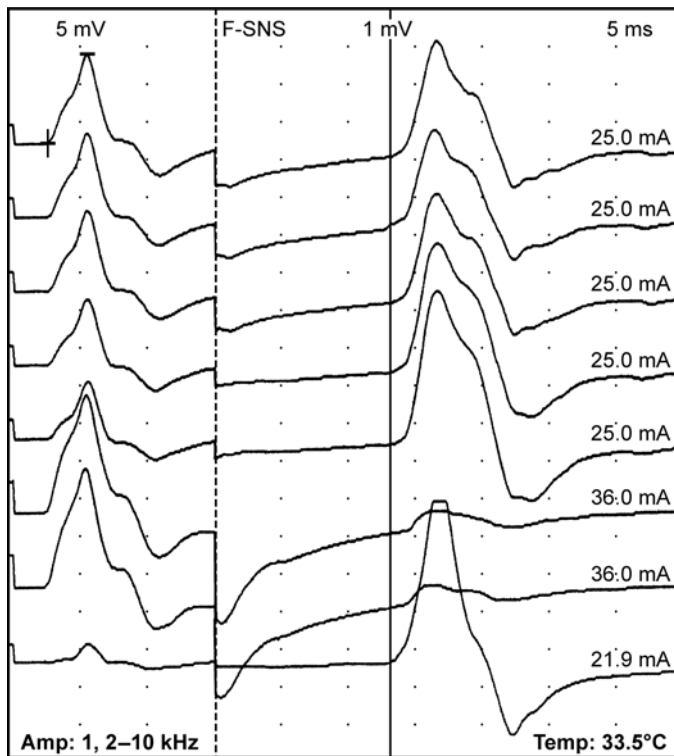
### Proximal Conduction

The H reflex is used best as a measure of proximal conduction. For instance, it is

most commonly used in assessing S1 radiculopathies. Braddom and Johnson<sup>15</sup> proposed that a side-to-side latency difference in the H reflex greater than 1.2 ms indicates a discrete lesion of the S1 nerve root, and may be the initial finding in acute radiculopathy or in cases of radiculopathy in which the only needle electromyographic findings are fibrillation potentials in paraspinal muscles.<sup>14</sup> The prolongation or absence of the H reflex correlates with clinically reduced or absent ankle jerk. Any lesion along the pathway of the H reflex may prolong its latency. Moreover, if the largest diameter axons are not affected by a root lesion, the H reflex may remain normal. Therefore, additional corroborating electrophysiologic evidence is needed to support the diagnosis of S1 radiculopathy.<sup>19,23</sup>

The latency of the H reflex also may be prolonged in some cases of peripheral neuropathy due to slowing of peripheral or proximal conduction. The H reflex may disappear before

the F wave in cases of peripheral neuropathy.<sup>3</sup> Prolonged latency of the H reflex has been demonstrated in diabetic, alcoholic, nutritional, paraneoplastic, cisplatin, and vasculitic neuropathies. In uremic neuropathy, this prolongation decreases after successful renal transplantation.<sup>24</sup> Prolonged latency also has been demonstrated in Guillain-Barré syndrome, chronic inflammatory polyradiculoneuropathies, and hereditary mixed motor and sensory neuropathy type I.<sup>25</sup> Because the H reflex may be absent in persons older than 60 years, a large number of whom also have lumbar stenosis, the usefulness of the H reflex in studying neuropathy in this age group is limited.<sup>23,26</sup> The latency of the H reflex in the flexor carpi radialis muscle has proved useful in assessing slowing of conduction through the proximal median nerve fibers in radiation-induced plexopathy.<sup>16,25</sup> This may be used to assess C7 radiculopathy, comparable to assessing S1 radiculopathy with recordings from the soleus muscle.



**Figure 30-4.** H reflex recorded from the abductor digiti minimi during ulnar nerve stimulation in a patient with cerebral palsy.

## Central Nervous System Excitability

If the H reflex is recorded from muscles other than the soleus during standard nerve conduction studies in adults, the possibility of a central nervous system disorder must be considered (Fig. 30–4). As the H reflex directly activates the Ia afferents, it can be used as a measure of the excitability of the neuronal components of the arc, without concerns for muscle spindle sense organ sensitivity.<sup>6, 8, 10, 27, 28</sup> However, both the latency and amplitude of the H reflex alone has been shown to have trial-to-trial variability as previously mentioned. This can not only occur between subjects but also within the same subject from day to day. In efforts to more reliably study the excitability of the motor neuron pool using the H reflex, two methods have been proposed.

The first way compares the ratio of maximal H-reflex amplitude with maximal M-response amplitude (Hmax/Mmax). By expressing the H reflex as a ratio relative to the M response, it is thought that the influence of many variables such as impedance and technical factors of size and electrode location is reduced.<sup>29</sup> This ratio may be 1 in normal subjects and increased in disorders causing spasticity, although it correlates poorly with the degree of spasticity noted clinically. The Hmax/Mmax ratio is normal in patients with rigidity.<sup>27</sup>

Many recent studies have extrapolated the Hmax/Mmax ratio not only as an indicator of an upper motor neuron lesion, but also as a means to assess clinical responsiveness in cases of spasticity. For instance, Stokie and Yablon recently employed this ratio as an adjunct for evaluating responsiveness to intrathecal baclofen in cases of spasticity.<sup>30</sup> In this study, the authors found that a decreasing Hmax/Mmax ratio is seen with increasing doses of baclofen. The most useful decline in the ratio was seen early at lower doses of baclofen, often before any clinical response was noted. They also found that the ratio would often nadir before any clinical benefit was seen with high doses of baclofen. In this study the Hmax/Mmax ratio was employed as a measure of spinal cord responsiveness to baclofen therapy rather than a direct reflection of spinal cord spasticity. They employed this ratio, therefore, as a pharmacological marker that would permit more aggressive dose escalation of medication in the absence of clinical responsiveness.

It should be noted, however, that many recent studies have questioned the stability of the M wave in various circumstances including degree of muscle contraction and time of day.<sup>29</sup> Therefore, it remains to be seen whether the Hmax/Mmax ratio is any more reliable from trial to trial as compared to the H-reflex amplitude as a clinical tool.

The second way the H reflex has been utilized as a measure of motor neuron excitability is to produce H-reflex recovery curves, first described by Magladery and McDougal.<sup>2</sup> The H reflex is elicited before, during, and after conditioning stimuli, usually electric stimuli, at a range of interstimulus intervals. It is important to keep the latency and amplitude of the M-response constant during these trials. These curves also have been used to study spasticity. However, the changes in the curves are rarely striking. The curve is influenced greatly by the position and comfort of the patient, the angle of lower extremity joints, relaxation, and the positioning of the head. Construction of these curves is time-consuming, and reproducibility is poor, making them impractical.<sup>10, 12</sup> The pathophysiologic basis of these curves is poorly understood and as a result, they are seldom used in clinical practice.

### Key Points

- Clinically, the H reflex is most utilized in assessing early S1 radiculopathies.
- The H reflex can be a useful adjunct to routine nerve conduction studies in assessing proximal peripheral nerve disorders.
- The H reflex and the Hmax/Mmax ratio may prove to be useful in assessment of upper motor neuron excitability and response to clinical therapy of upper motor neuron lesions.

### SUMMARY

Technically, the H-reflex test is relatively simple to perform in a clinical neurophysiology laboratory. A thorough understanding of the physiologic basis, sources of error, and clinical applications and limitations enhances the usefulness of the H reflex.



## REFERENCES

1. Hoffmann, P. 1918. Ueber die Beziehungen der Schenreflexe zur willkürlichen Bewegung und zum Tonus. *Zeitschrift für Biologie* 68:351-70.
2. Magladery, J. W., and D. B. McDougal Jr. 1950. Electrophysiological studies of nerve and reflex activity in normal man. I. Identification of certain reflexes in the electromyogram and the conduction velocity of peripheral nerve fibres. *Bulletin of the Johns Hopkins Hospital* 86:265-90.
3. Lachman, T., B. T. Shahani, and R. R. Young. 1980. Late responses as aids to diagnosis in peripheral neuropathy. *Journal of Neurology, Neurosurgery, and Psychiatry* 43:156-62.
4. Panizza, M., J. Nilsson, and M. Hallett. 1989. Optimal stimulus duration for the H reflex. *Muscle & Nerve* 12:576-9.
5. Buschbacher, R. M. 1999. Normal range for H-reflex recording from the calf muscles. *American Journal of Physical Medicine & Rehabilitation* 78(Suppl 6):S75-9.
6. Fisher, M. A. 1992. AAEM minimonograph #13: H reflexes and F waves: Physiology and clinical indications. *Muscle & Nerve* 15:1223-33.
7. Nishida, T., A. Kompoliti, I. Janssen, and K. F. Levin. 1996. H reflex in S-1 radiculopathy: Latency versus amplitude controversy revisited. *Muscle & Nerve* 19:915-17.
8. Funase, K., and T. S. Miles. 1999. Observations on the variability of the H reflex in human soleus. *Muscle & Nerve* 22:341-6.
9. Kimura, J. 1989. *Electrodiagnosis in diseases of nerve and muscle: Principles and practice*, 2nd ed., 359-61. Philadelphia: FA Davis Company.
10. Iles, J. F., and J. Pardoe. 1999. Changes in transmission in the pathway of heteronymous spinal recurrent inhibition from soleus to quadriceps motor neurons during movement in man. *Brain* 122:1757-64.
11. Rossi-Durand, C., K. E. Jones, S. Adams, and P. Bawa. 1999. Comparison of the depression of H-reflexes following previous activation in upper and lower limb muscles in human subjects. *Experimental Brain Research* 126:117-27.
12. Rico, R. E., and E. J. Jonkman. 1982. Measurement of the Achilles tendon reflex for the diagnosis of lumbosacral root compression syndromes. *Journal of Neurology, Neurosurgery, and Psychiatry* 45: 791-5.
13. Nishida, T., C. E. Levy, E. J. Lewit, and I. Janssen. 1999. Comparison of three methods for recording tibial H reflex: A clinical note. *American Journal of Physical Medicine & Rehabilitation* 78:474-6.
14. DeLisa, J. A., H. J. Lee, E. M. Baran, K-S. Lai, and N. Spielholz. 1994. *Manual of nerve conduction velocity and clinical neurophysiology*, 3rd ed., 168-75. New York: Raven Press.
15. Braddom, R. I., and E. W. Johnson. 1974. Standardization of H reflex and diagnostic use in S1 radiculopathy. *Archives of Physical Medicine and Rehabilitation* 55:161-6.
16. Ongerboer de Visser, B. W., R. J. Schimsheimer, and A. A. Hart. 1984. The H-reflex of the flexor carpi radialis muscle; a study in controls and radiation-induced brachial plexus lesions. *Journal of Neurology, Neurosurgery, and Psychiatry* 47:1098-101.
17. Falco, F. J., W. J. Hennessey, G. Goldberg, and R. L. Braddom. 1994. H reflex latency in the healthy elderly. *Muscle & Nerve* 17:161-7.
18. Jabre, J. F. 1981. Surface recording of the H-reflex of the flexor carpi radialis. *Muscle & Nerve* 4:435-8.
19. Sabbahi, M. A., and M. Khalil. 1990. Segmental H-reflex studies in upper and lower limbs of healthy subjects. *Archives of Physical Medicine and Rehabilitation* 71:216-22.
20. Cai, F., and J. Zhang. 1997. Study of nerve conduction and late responses in normal Chinese infants, children, and adults. *Journal of Child Neurology* 12:13-18.
21. Jones, H. R. Jr., R. L. Harmon, C. M. Harper Jr., and C. F. Bolton. 1996. An approach to pediatric electromyography. In *Pediatric clinical electromyography*, ed. H. R. Jones Jr., C. F. Bolton, and C. M. Harper Jr., 1-36. Philadelphia: Lippincott-Raven Publishers.
22. Mitsudome, A., S. Yasumoto, and H. Ogata. 1996. Late responses in full-term newborn infants. In *Recent Advances in Clinical Neurophysiology: Proceedings of the Xth International Congress of EMG and Clinical Neurophysiology*, ed. J. Kimura, and H. Shibasaki, 761-5. Kyoto, Japan, October 15-19, 1995. New York: Elsevier.
23. Wilbourne, A. J., and M. J. Aminoff. 1993. Radiculopathies. In *Clinical electromyography*, ed. W. F. Brown, and C. F. Bolton, 2nd ed., 177-209. Boston: Butterworth-Heinemann.
24. Bolton, C. F. 1993. Metabolic neuropathy. In *Clinical electromyography*, ed. W. F. Brown, and C. F. Bolton, 2nd ed., 561-98. Boston: Butterworth-Heinemann.
25. Schimsheimer, R. J., B. W. Ongerboer de Visser, B. Kemp, and L. J. Bour. 1987. The flexor carpi radialis H-reflex in polyneuropathy: Relations to conduction velocities of the median nerve and the soleus H-reflex latency. *Journal of Neurology, Neurosurgery, and Psychiatry* 50:447-52.
26. Wilbourn, A. J. 1993. Diabetic Neuropathies. In *Clinical electromyography*, ed. W. F. Brown, and C. F. Bolton, 2nd ed., 477-515. Boston: Butterworth-Heinemann.
27. Leonard, C. T., and T. Moritani. 1992. H-reflex testing to determine the neural basis of movement disorders of neurologically impaired individuals. *Electromyography and Clinical Neurophysiology* 32:341-9.
28. Misiaszek, J. E. 2003. The H-reflex as a tool in neurophysiology: Its limitations and uses in understanding nervous system function. *Muscle & Nerve* 28: 144-60.
29. Tucker, K. J., M. Tuncer, and K. S. Turker. 2005. A review of the H-reflex and M-wave in the human triceps surae. *Human Movement Science* 24: 667-88.
30. Stokic, D. S., and S. A. Yablon. 2007. Neurophysiological basis and clinical application of the H-reflex as an adjunct for evaluation response to intrathecal baclofen for spasticity. *Acta Neurochirurgica. Supplement* 97(Pt 1):231-41.
31. Liveson, J. A., and D. M. Ma. 1992. *Laboratory reference for clinical neurophysiology*. 238-46. Philadelphia: FA Davis.
32. Maryniak, O., and R. Yaworski. 1987. H-reflex: Optimum location of recording electrodes. *Archives of Physical Medicine and Rehabilitation* 68:798-802.
33. Shahani, B. T., and R. R. Young. 1980. Studies of reflex activity from a clinical viewpoint. In *Electrodiagnosis in clinical neurology*, ed. M. J. Aminoff, 209-304. New York: Churchill Livingstone.

*This page intentionally left blank*

# Cranial Reflexes and Related Techniques

*Benn E. Smith*

## INTRODUCTION

### BLINK REFLEX

Neuroanatomy  
Methods  
Applications

### LATERAL SPREAD OF THE FACIAL

#### NERVE RESPONSE:

#### ASSESSMENT OF FACIAL

#### SYNKINESIS AND HEMIFACIAL SPASM

### JAW JERK (MASSETER REFLEX)

Neuroanatomy  
Methods  
Applications

### MASSETER INHIBITORY REFLEX

Methods  
Applications

### GREAT AURICULAR SENSORY NERVE CONDUCTION STUDIES

Methods  
Applications

### TRIGEMINAL CONTACT HEAT EVOKED POTENTIAL STIMULATOR STUDIES

### SUMMARY

## INTRODUCTION

The integrity of the trigeminal and facial nerves and their central connections can be evaluated electrophysiologically by studying the reflex activity mediated by these nerves. For this reason, these reflexes are of greatest value in assessing cranial neuropathies. They can also provide useful information in some cases of polyradiculoneuropathy, peripheral neuropathy, and brain stem lesions. The reflexes discussed in this chapter are the electrically evoked blink reflex, the jaw jerk (or masseter reflex), and the masseter inhibitory reflex (MIR). In addition, two additional techniques—one to assess a sensory nerve

in the head which is not a cranial nerve of branchial arch origin, the great auricular sensory nerve, and the other to interrogate trigeminal sensory pathways from the sensory receptor level to the parietal cortex, contact heat evoked potential stimulator studies—will also be discussed.

### *Purpose and Role of Cranial Reflexes*

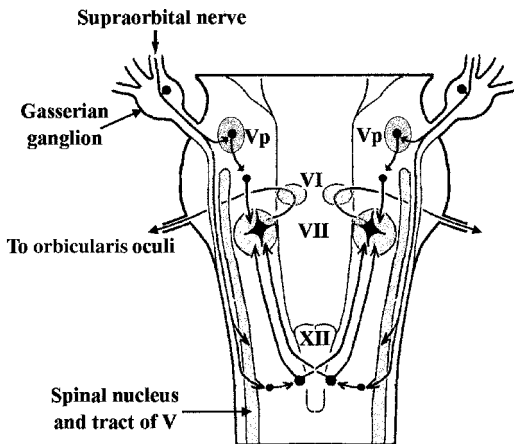
- To assess for cranial neuropathies.
- Used in the evaluation of polyradiculopathies or severe peripheral neuropathies.
- Assist in assessing brain stem lesions.
- To evaluate for facial movement disorders, such as hemifacial spasm or synkinesis.

## BLINK REFLEX

Overend<sup>1</sup> observed that a blink response occurs after a light tap on the forehead. Kugelberg<sup>2</sup> elicited the reflex with an electric stimulus and demonstrated two distinct responses: an early well-synchronized response occurring ipsilateral to the stimulus (R1) and poorly synchronized bilateral responses with a longer latency (R2). Rushworth<sup>3</sup> demonstrated that the afferent limb of the reflex is carried by the first division of the trigeminal nerve and the efferent component is transmitted by the facial nerve. Shahani<sup>4</sup> showed that the reflex was mediated by stimulation of cutaneous receptors rather than proprioceptive receptors, as previously thought.

## Neuroanatomy

The afferent limb of the reflex arc is transmitted in the ophthalmic division of the trigeminal nerve, with the afferent nerve cell body in the gasserian ganglion (Fig. 31-1). The efferent limb travels in the facial nerve. The

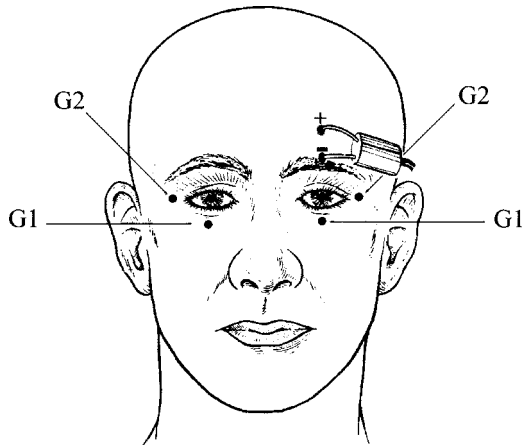


**Figure 31-1.** Neural pathways associated with the blink reflex. For the R1 response, afferent fibers from the trigeminal nerve synapse with the principal sensory nucleus in the pons (Vp). Connections are then made with the facial nucleus (VII) via one or two interneurons. For the R2 response, the trigeminal nerve fibers synapse with the spinal nucleus of the trigeminal nerve via a multisynaptic pathway. Connections are then relayed to the facial nuclei bilaterally. (From Ongerboer de Visser, V. W., and H. G. J. M. Kuypers. 1978. Late blink reflex changes in lateral medullary lesions: An electrophysiological and neuro-anatomical study of Wallenberg's syndrome. *Brain* 101:285-94. By permission of Oxford University Press.)

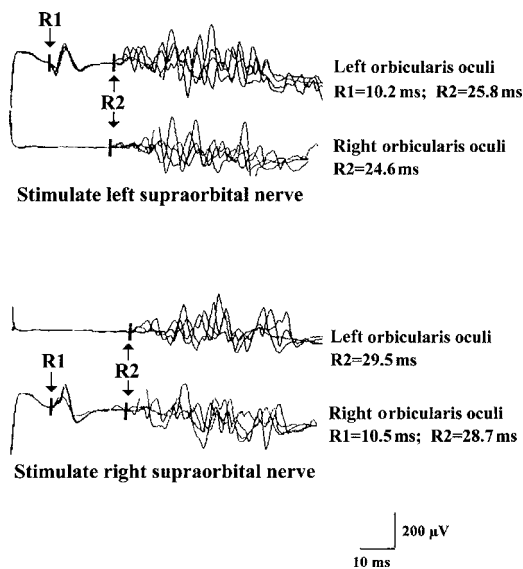
early response is relayed centrally through an oligosynaptic pathway involving the principal sensory nucleus of the trigeminal nerve in the pons.<sup>5</sup> The afferent fibers relaying the R2 response descend into the medulla and synapse in the spinal nucleus of the trigeminal nerve. Through polysynaptic pathways that pass ipsilaterally and contralaterally, the afferent limb is connected with the nucleus of the facial nerve, the efferent limb of the reflex.

## Methods

The *blink reflex* is elicited by mechanical or electric stimulation over the face with a graded threshold, with the lowest threshold being around the eye. The reflex is usually elicited by stimulating the supraorbital branch of the trigeminal nerve over the supraorbital notch, while recording simultaneously from both the left and the right orbicularis oculi muscles (Fig. 31-2). The stimuli are applied irregularly at least 5 seconds apart so as to minimize habituation. The stimulus current required to evoke the reflex is small and not generally considered painful. In normal subjects, an early (R1) response is obtained ipsilateral to the side of stimulus, and the late (R2) responses are obtained bilaterally (Fig. 31-3).

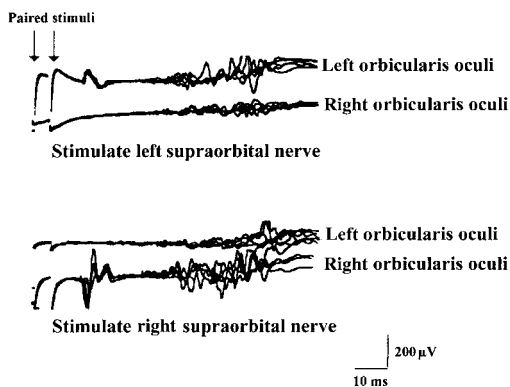


**Figure 31-2.** Electrode placement for blink reflex studies. The supraorbital nerve is stimulated with the cathode at the supraorbital notch. Responses are recorded ipsilaterally and contralaterally. G1, active electrode; G2, reference electrode. (From Auger, R. G. 1987. Brain stem disorders and cranial neuropathies. In *Clinical electromyography*, ed. W. F. Brown, and C. F. Bolton, 417-29. Boston: Butterworths. By permission of the publisher.)



**Figure 31-3.** Responses obtained with stimulation of the supraorbital nerve and simultaneously recording from both left and right orbicularis oculi muscles. R1, first response; R2, second response.

Later bilateral (R3) responses are also seen in normal subjects. With slowly increasing stimulation intensities, the R2 responses are usually elicited before R1. If an early response cannot be obtained, a paired stimulus can be used, with an interstimulus interval of 5 ms to take advantage of a period of facilitation that may last 1–9 ms after the initial conditioning stimulus (Fig. 31-4). Confusing results may be obtained if the stimulating electrode is too close to the midline, because a contralateral R1



**Figure 31-4.** In this patient, the R1 response could not be elicited with a single stimulus. A normal response was obtained with paired stimuli, with an interstimulus interval of 5 ms.

response may be obtained by stimulating the opposite trigeminal nerve. Amplitudes of the responses are not usually measured because differences in amplitude of up to 40% occur in normal subjects.<sup>6</sup>

Normal values, in milliseconds, are as follows:

- Ipsilateral R1 < 13
- Ipsilateral R2 < 41
- Contralateral R2 < 44

Ipsilateral vs. contralateral differences, in milliseconds, are as follows:

- R1 < 1.2
- R2 < 8

The R1 latency in young children reaches adult values by the age of 2 years. However, the R2 responses are sometimes absent in children younger than 2 years. The R2 waveforms attain adult values at age 5–6 years. Because of the variability of R2 responses, they are less useful in children younger than 6 years.<sup>7</sup>

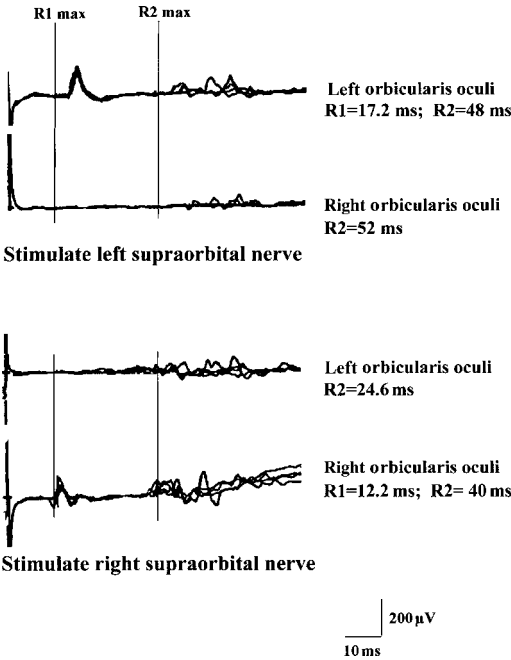
The R2 response correlates with contraction of the orbicularis oculi muscle and has the same latency as the corneal reflex. The physiologic significance of the R1 response remains unknown.

In patients with suspected lesions of the maxillary or mandibular division of the trigeminal nerve, the blink reflex obtained with supraorbital nerve stimulation may be normal. In this situation, the infraorbital branch (recording from the superior portion of the orbicularis oculi) can be stimulated to assess the function of the maxillary division. Stimulation of the infraorbital nerve consistently elicits R2 responses in normal subjects, but the R1 response is frequently absent. Stimulation of the mental nerve (the mandibular division) also elicits R2 responses, but the R1 response is never observed.<sup>8</sup>

## Applications

### TRIGEMINAL NERVE LESIONS

In lesions of the trigeminal nerve, blink reflex responses are usually delayed or absent—when recorded from either side—with stimulation of the involved side, but they are normal

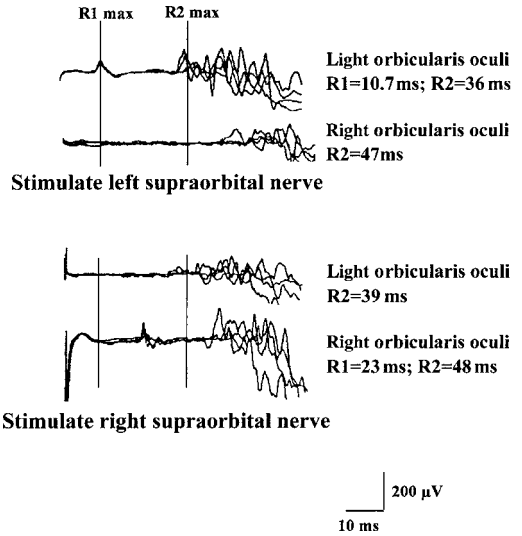


**Figure 31-5.** Blink reflex studies in a patient with a lesion of the left trigeminal nerve. R1 max, upper limit of normal for the onset of the R1 response; R2 max, upper limit of normal for the onset of the R2 response.

bilaterally with stimulation of the unaffected side (Fig. 31-5). In severe lesions of the trigeminal nerve, stimulation of the involved side may not elicit a response. In patients with trigeminal sensory neuropathy associated with connective tissue diseases, there may be abnormalities of R1 only or bilateral abnormalities of R1 and R2; it is uncommon for only R2 to be affected in isolation.<sup>9</sup> The blink reflex is also helpful in identifying lesions of the sensory root and gasserian ganglion, including tumors, vascular malformations, and postherpetic lesions. The blink reflex is usually normal in idiopathic trigeminal neuralgia and atypical facial pain.<sup>10</sup> Therefore, an abnormal blink response in a patient with suspected trigeminal neuralgia would suggest a structural lesion involving the trigeminal nerve or brain stem. Trichloroethylene, long known to produce trigeminal neuropathy, is associated with a prolonged mean latency of R1 in persons with occupational exposure or a contaminated water supply.<sup>11</sup>

**FACIAL NERVE LESIONS**

In lesions of the facial nerve, the R1 and R2 responses recorded from the affected



**Figure 31-6.** Blink reflex studies in a patient with a lesion of the right facial nerve. R1 max, upper limit of normal for the onset of the R1 response; R2 max, upper limit of normal for the onset of the R2 response.

facial-innervated muscles are delayed or absent with stimulation of the trigeminal nerve on either side. However, the R1 and R2 responses recorded from the unaffected facial muscles are normal if trigeminal nerve function is preserved (Fig. 31-6). As an illustrative example, in a patient with a right facial neuropathy, stimulation of the right supraorbital (trigeminal) nerve will produce abnormally prolonged or absent R1 and R2 responses from the right orbicularis oculi, but a normal contralateral R2 response is recorded from the left orbicularis oculi, since the right trigeminal and left facial nerves are intact. In the same patient, stimulation of the left supraorbital nerve will produce normal ipsilateral (left) R1 and R2 responses, but a prolonged or absent contralateral (right) R2 response. In severe lesions of the facial nerve, the R1 and R2 responses may be absent on the involved side.

In Bell's palsy, routine conduction studies of the facial nerve evaluate the segment of the nerve distal to the stylomastoid foramen, which is clinically helpful only when degeneration begins distally. The blink reflex, however, assesses the entire nerve, including the intraosseous portion. All the patients with Bell's palsy studied by Kimura, Giron, and Young<sup>12</sup> had a delayed or absent R1 response on the affected side of the face. On the weak side, the R2 response was also abnormal in all

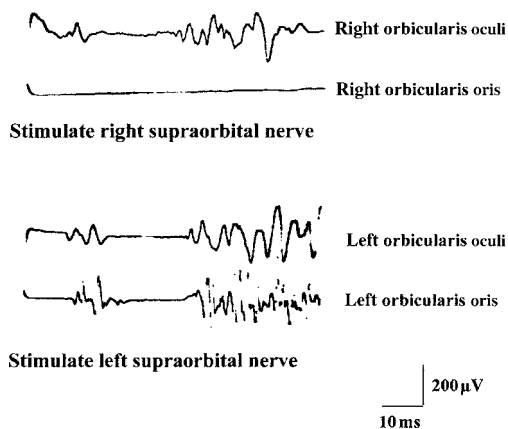


patients. Of 127 patients tested serially, 100 had return of the previously absent R1 and R2 responses, whereas responses with stimulation of the facial nerve at the mastoid process remained relatively normal. The R1 latency was increased by more than 2 ms initially, suggesting demyelination of facial nerve fibers. The latency of R1 decreased during the second month and returned to normal by the fourth month after onset. These patients generally had good return of function within a few months. The other 27 patients had smaller amplitudes with direct stimulation of the facial nerve, and the blink reflex responses did not return. These patients had degeneration of the facial nerve and poorer recoveries. More recent studies have reached similar conclusions—when the blink reflex is normal or R1 is only delayed, the prognosis is excellent. Absence of the blink reflex has been associated with a poor prognosis in 56% of cases.<sup>13,14</sup>

Delay or absence of only the R1 response indicates dysfunction of either the trigeminal or facial nerve or the corresponding central connections in the brain stem. Clinical findings, for example numbness of the face, may indicate which nerve is responsible. If both nerves are affected, as they may be in acoustic neuroma, it may be impossible to provide a more precise interpretation. If the R2 component is also affected, the examiner usually can clarify which of the nerves is involved. Abnormality of the R2 responses with a normal R1 response suggests a central lesion of the spinal tract and nucleus of the trigeminal nerve.

### ASSESSMENT OF FACIAL SYNKINESIS

In some instances, the location of facial recording electrodes during blink reflex studies can be modified to allow for objective assessment of facial synkinesis. This can be accomplished by recording simultaneously over the orbicularis oculi and another muscle on the same side of the face which is also supplied by the facial nerve, such as the mentalis or orbicularis oris. In normal subjects, stimulation of the supraorbital nerve produces reflex activation of only the orbicularis oculi muscle. In hemifacial spasm and aberrant regeneration of the facial nerve after injury, the second muscle often demonstrates a synkinetic response<sup>15</sup> (Fig. 31–7). This synkinetic response is not



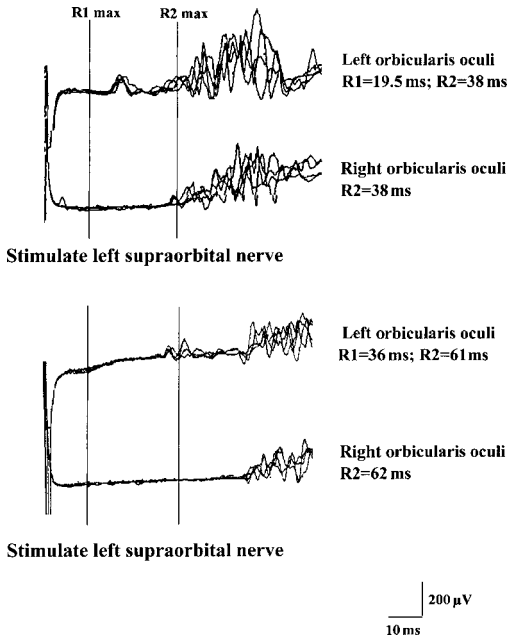
**Figure 31–7.** Assessment of facial synkinesis in a patient with left hemifacial spasm. A synkinetic response is present in the left orbicularis oris with stimulation of the left supraorbital nerve. On the right (normal) side, synkinesis is not present. (From Auger, R. G. 1979. Hemifacial spasm: Clinical and electrophysiologic observations. *Neurology* 29:1261–72. By permission of Lippincott Williams & Wilkins.)

present in other movement disorders involving the face, such as facial myokymia, blepharospasm, or Meige syndrome.

Rubin et al.<sup>16</sup> described a patient in whom an unusual movement disorder affecting the muscles of mastication developed after surgical removal of a tumor involving the trigeminal nerve. They used the blink reflex to demonstrate a synkinetic response in the masseter muscle with stimulation of the supraorbital nerve, thereby confirming that the masseter in their patient was innervated by aberrantly regenerated branches of the facial nerve.

### PERIPHERAL NEUROPATHY

Delayed responses to supraorbital nerve stimulation are found in hereditary motor and sensory neuropathy type I (Charcot–Marie–Tooth disease).<sup>17</sup> The delay is most marked in the distal segment of the facial nerve even though no facial weakness may be demonstrated. In contrast, the delayed latencies in Guillain–Barré syndrome are associated with facial muscle weakness. The blink reflexes also may be abnormal in acquired demyelinating neuropathies, including chronic inflammatory demyelinating polyradiculoneuropathy (CIDP) (Fig. 31–8). In most axonal sensorimotor peripheral neuropathies, including diabetic neuropathy,<sup>18</sup> the blink reflex is unaffected.



**Figure 31-8.** Blink reflex studies in a patient with chronic inflammatory demyelinating polyradiculoneuropathy. The R1 and R2 responses are significantly delayed. R1 max, upper limit of normal for the onset of the R1 response; R2 max, upper limit of normal for the onset of the R2 response.

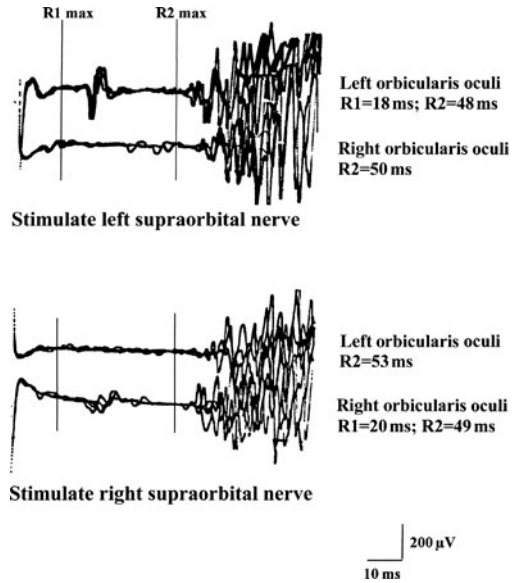
The blink reflex may be helpful in the evaluation of patients who present clinically with subacute sensory neuronopathy. In a study of patients who were evaluated in our laboratory, the blink reflex was normal in patients with paraneoplastic sensory neuronopathy (malignant inflammatory sensory polyganglionopathy), but frequently abnormal in those with Sjögren syndrome/sicca complex or idiopathic sensory neuronopathy (nonmalignant inflammatory sensory polyganglionopathy).<sup>19</sup>

**POSTERIOR FOSSA LESIONS**

In patients with cerebellopontine angle lesions, the blink reflex response latencies may be delayed. Previously, the blink reflex was used as a diagnostic test to screen for suspected tumors in the cerebellopontine angle. However, with the advent of sophisticated imaging techniques, the blink reflex has no place in the diagnostic evaluation when these lesions are suspected.

**MULTIPLE SCLEROSIS**

Before the advent of modern signal averaging and imaging techniques, the blink reflex



**Figure 31-9.** Blink reflex studies in a patient with multiple sclerosis and trigeminal neuralgia. The R1 and R2 responses are markedly delayed. R1 max, upper limit of normal for the onset of the R1 response; R2 max, upper limit of normal for the onset of the R2 response.

was used in some laboratories to search for evidence of clinically silent lesions that would provide further support for the diagnosis of multiple sclerosis (Fig. 31-9). Currently, it is rarely used for this purpose, but it may be helpful in documenting objective abnormalities in patients with vague facial paresthesias of uncertain significance.

In 260 patients with multiple sclerosis observed over a 7-year period, Kimura<sup>20</sup> found that the R1 response was delayed on one or both sides in 66% of those with definite multiple sclerosis, in 56% of those with probable multiple sclerosis, and in 29% of those with possible multiple sclerosis. R1 was abnormal in 78% of the patients with neurologic signs that suggested pontine involvement in 57% of those with signs of disease of the medulla or midbrain, and in 40% of those who had no brain stem signs. R2 was less diagnostic than R1 in detecting brain stem lesions and was most often abnormal in those with pontine signs. When R1 was normal and R2 was delayed, the patients had symptoms suggesting medullary involvement. As might be expected in patients with multiple sclerosis, the incidence of delayed R1 responses increases with time, although there may be improvement when the disease is in remission.

## EXTRAPYRAMIDAL DISEASE

In normal subjects, habituation of the R2 component of the reflex occurs with regularly applied electric stimuli, resulting in delayed or absent R2 responses. This is the basis for the glabellar tap sign elicited during neurologic examination. In patients with Parkinson disease or other disorders affecting the extrapyramidal system, habituation may be impaired.

## OTHER FACTORS AFFECTING BLINK REFLEX RESPONSES

Although the blink reflex pathways are confined to the brain stem, lesions rostral to the brain stem may affect latencies and thus diminish the localizing value of the reflex. In almost half of the patients with cerebral infarction associated with hemiparesis, the R1 response may be delayed for up to 1 week, and both direct and consensual R2 responses may be absent or diminished for several weeks.<sup>21</sup> Therefore, in the acute phase, whether facial paresis is caused by a central or a peripheral process cannot be determined solely on the basis of prolonged R1 latency. These effects may be the result of removal of crossed cortical facilitation in the brain stem.<sup>22</sup>

The R2 responses are attenuated with sleep and with the pharmacologic influence of sedative drugs.

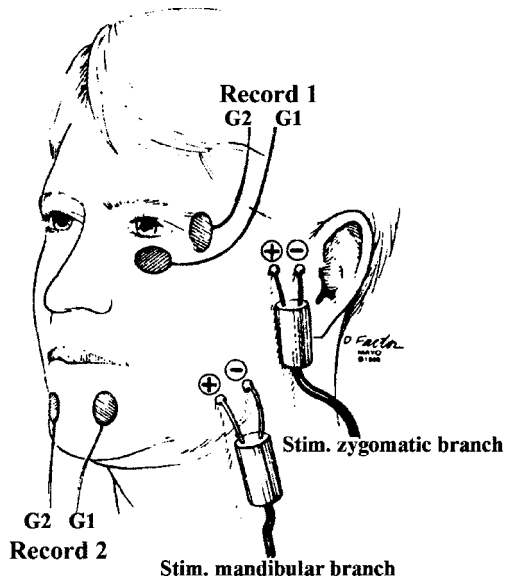
### Key Points

- The trigeminal blink reflex is mediated by the first division of the trigeminal nerve (afferent limb) and the facial nerve (efferent limb).
- In normal individuals, two responses (R1 and R2) are obtained when recording from the muscles ipsilateral to the stimulated nerve, and a single (R2) response is obtained from the contralateral muscles.
- Abnormalities in trigeminal blink reflex latencies can often be localized to specific segments of the peripheral and/or central neural pathways traversed by trigeminal and facial axons.
- For disorders affecting the ophthalmic division, the blink reflex is useful for identifying lesions of the sensory nerve, root, or gasserian ganglion.
- The blink reflex is less useful for disorders affecting the second or third divisions of the trigeminal nerve.
- The blink reflex is typically normal in trigeminal neuralgia and in cases of atypical face pain.
- The blink reflex and facial nerve conduction studies (NCS) can be used as predictive tools in determining the outcome of acute Bell's palsy.
- Facial synkinesis can be demonstrated by recording over the orbicularis oculi muscle and another facial nerve innervated muscle such as the mentalis muscle while stimulating the supraorbital nerve.
- In patients with cerebral infarction associated with hemiparesis, the R1 response may be delayed for up to 1 week, and both direct and consensual R2 responses may be absent or diminished for several weeks.

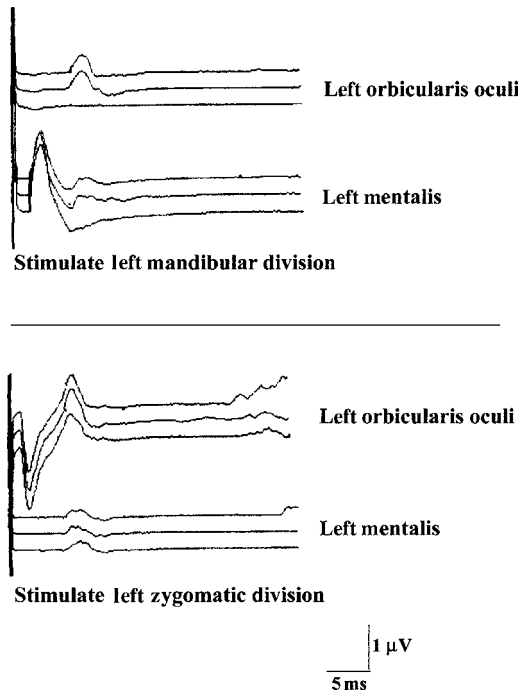
## LATERAL SPREAD OF THE FACIAL NERVE RESPONSE: ASSESSMENT OF FACIAL SYNKINESIS AND HEMIFACIAL SPASM

Hemifacial spasm is characterized by unilateral, involuntary twitching of periorbital muscles and muscles of the lower portion of the face. In most patients, the disorder is probably associated with compression of the nerve by a vascular loop near the brain stem. Rarely, a tumor, aneurysm, or vascular malformation may compress the facial nerve. Focal demyelination ensues, producing ectopic generation of action potentials or ephaptic transmission to other axons adjacent to the site of compression.<sup>23</sup> Recent evidence suggests that in hemifacial spasm the facial motor nucleus may become hyperactive, with spasms resulting from neuronal "backfiring" that is similar to an exaggerated F response.<sup>24,25</sup> These patients also have synkinesis, which appears similar to that seen in aberrant regeneration, but in distinction the synkinetic response is variable in early cases and may not be present between spasms.<sup>15</sup>

Abnormal communication between axons of the facial nerve, termed *lateral spread*, can be demonstrated by stimulating the mandibular branch of the facial nerve while recording over the orbicularis oculi muscle or by stimulating the zygomatic branch of the facial nerve



**Figure 31-10.** Electrode placement to assess the lateral spread response in a patient with hemifacial spasm. G1, active electrode; G2, reference electrode; Stim., stimulate. (From Harper, C. M. Jr. 1991. AAEM case report 21: Hemifacial spasm: Preoperative diagnosis and intra-operative management. *Muscle & Nerve* 14:213-18. By permission of Mayo Foundation for Medical Education and Research.)



**Figure 31-11.** Lateral spread response in a patient with hemifacial spasm. With stimulation of the mandibular branch of the facial nerve (*top*), a delayed response is recorded from the ipsilateral orbicularis oculi. With stimulation of the zygomatic branch of the facial nerve (*bottom*), a delayed response is recorded from the ipsilateral mentalis.

while recording over the mentalis muscle (Figs. 31-10 and 31-11). Surgical microvascular decompression of the facial nerve generally results in loss of lateral spread and synkinesis and relief of clinical hemifacial spasm.<sup>26,27</sup>

**Key Points**

- The lateral spread response can provide electrophysiological evidence of synkinetic activity in patients with hemifacial spasm.

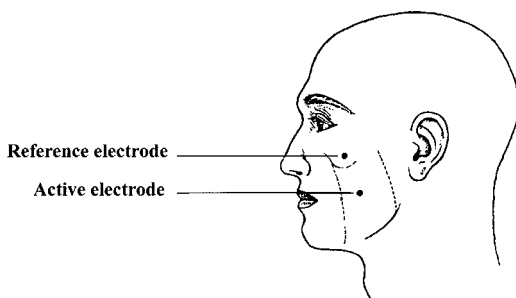
## JAW JERK (MASSETER REFLEX)

### Neuroanatomy

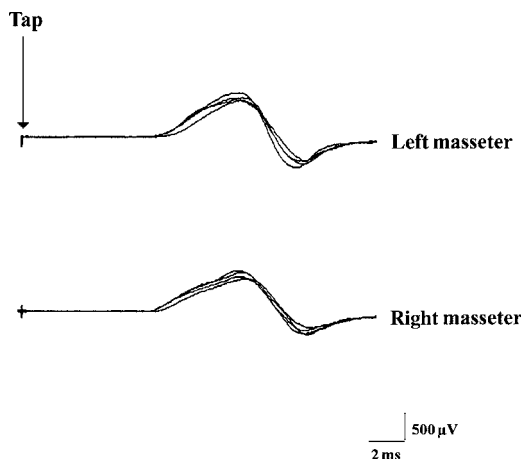
The *jaw jerk*, or *masseter reflex*, is a monosynaptic muscle stretch reflex elicited by a tap on the jaw. Afferent impulses from muscle spindles in the masseter muscle are conveyed via the motor root of the trigeminal nerve to the mesencephalic nucleus in the midbrain. Axons from this nucleus synapse in the motor nucleus of the trigeminal nerve to activate the efferent limb of the reflex arc. This reflex is unique among stretch reflexes in that the cell bodies of the afferent limb (i.e., the mesencephalic nucleus) lie intra-axially in the brain stem rather than in the gasserian ganglion, which is the brain stem counterpart of a spinal dorsal root ganglion. The afferent nerve cell bodies subserving all other stretch reflexes reside extra-axially in dorsal root ganglia.

### Methods

Recording electrodes are taped over the belly of the masseter muscle bilaterally, and the reference electrodes are placed over the zygoma (Fig. 31–12). The reflex hammer contains a microswitch that triggers a sweep across the monitor upon contact with the examiner's finger, which is held on the patient's chin. The latency is measured to the initial reproducible deflection from baseline (Fig. 31–13). The normal range of latencies is 6–10.5 ms. The maximal side-to-side difference in latency is 1.5 ms.



**Figure 31–12.** Electrode placement for study of the jaw jerk (masseter reflex). (From Auger, A. G. 1987. Brain stem disorders and cranial neuropathies. In *Clinical electromyography*, ed. W. F. Brown, and C. F. Bolton, 417–29. Boston: Butterworths. By permission of the publisher.)



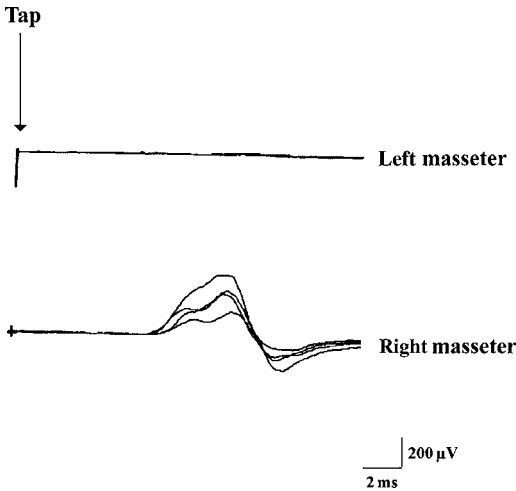
**Figure 31–13.** Superimposed responses recorded from the masseter muscles following four successive taps on the chin with a reflex hammer in a normal subject. The reflex hammer contains a microswitch that, upon contact, initiates a sweep across the monitor.

Wide variation in amplitude among normal subjects precludes the use of amplitude measurements in clinical studies. In normal subjects, particularly elderly and obese ones, the reflex is sometimes difficult to record using surface electrodes.

### Applications

The main indication for using the jaw jerk is to assess the function of the mandibular division of the trigeminal nerve. If a patient's symptoms are in the distribution of this division, the blink reflex may well be normal. In this situation, the jaw jerk may provide objective evidence of involvement of the mandibular division (Fig. 31–14). The most common abnormality is the absence of the jaw jerk rather than prolongation of its latency.

In patients with inflammatory polyganglionopathies presenting with pure sensory neuronopathy, the jaw jerk may be normal even though the patient is otherwise areflexic, has no sensory responses in the limbs, and may not have a blink reflex.<sup>28</sup> This likely occurs because the afferent nerve cell body involved with the jaw jerk is in the mesencephalic nucleus of the trigeminal nerve, which is in the brain stem and protected by the blood–brain barrier. Although neurons in the dorsal root ganglia and gasserian ganglion are protected by the blood–nerve



**Figure 31-14.** Superimposed responses recorded from the masseter muscles following four successive taps on the chin with a reflex hammer in a patient with a left acoustic neuroma. The response is normal on the right and absent on the left.

barrier, this is not as protective as the blood-brain barrier.

Ongerboer De Visser and Goor<sup>29</sup> studied jaw jerk and masseter electromyograms in patients with vascular or neoplastic disease of the midbrain and pons. Mesencephalic lesions were associated with abnormal jaw reflexes and normal masseter electromyograms. In the group with pontine lesions, both the masseter electromyograms and the jaw jerk were often abnormal. An abnormal jaw jerk suggests midbrain disease, whereas an abnormal R1 response, with or without an associated change in the jaw jerk, suggests a rostral pontine lesion.<sup>30,31</sup> The latency of the jaw jerk is not influenced by supratentorial or primary cerebellar disease.<sup>32</sup>

**Key Points**

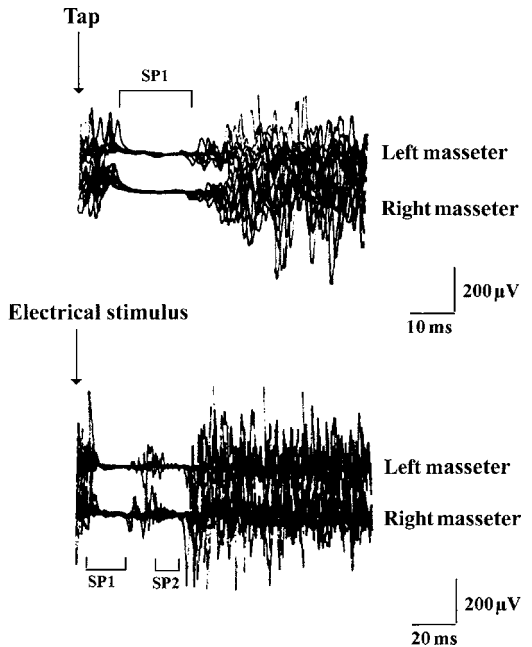
- The jaw jerk (masseter reflex) is mediated by the third division of the trigeminal nerve.
- The masseter reflex is unique among stretch reflexes in that the cell bodies of the afferent limb (in the mesencephalic nucleus) lie intra-axially in the brain stem rather than in the gasserian ganglion.
- Even though the jaw jerk can help to identify disease in the pons or midbrain, it has largely been supplanted by high-resolution neuroimaging techniques.

**MASSETER INHIBITORY REFLEX**

The *masseter inhibitory reflex* is important in the reflex control of biting and chewing. Its primary purpose is to protect intraoral structures against the powerful jaw-closing muscles. It is elicited by applying a mechanical or electric stimulus to the skin and mucous membrane supplied by the maxillary or mandibular division of the trigeminal nerve during voluntary contraction of the masseter muscle.

**Methods**

The recording electrodes are placed on the masseter muscle bilaterally, in the same manner as in the jaw jerk (Fig. 31-12). A mechanical tap usually produces only one silent period (SP), which begins between 11 and 15 ms after the tap and lasts for 14–30 ms (Fig. 31-15). With an electric stimulus, two silent periods typically occur: the first one (SP1) corresponds to the SP after a mechanical tap and the second



**Figure 31-15.** Superimposed responses recorded from the masseter muscles following four successive taps on the chin (*top*) and four successive electric stimuli to the mental nerve (*bottom*) while the subject clenched this teeth. SP1, first silent period; SP2, second silent period.



one (SP2) begins 30–60 ms after the stimulus (Fig. 31–15).

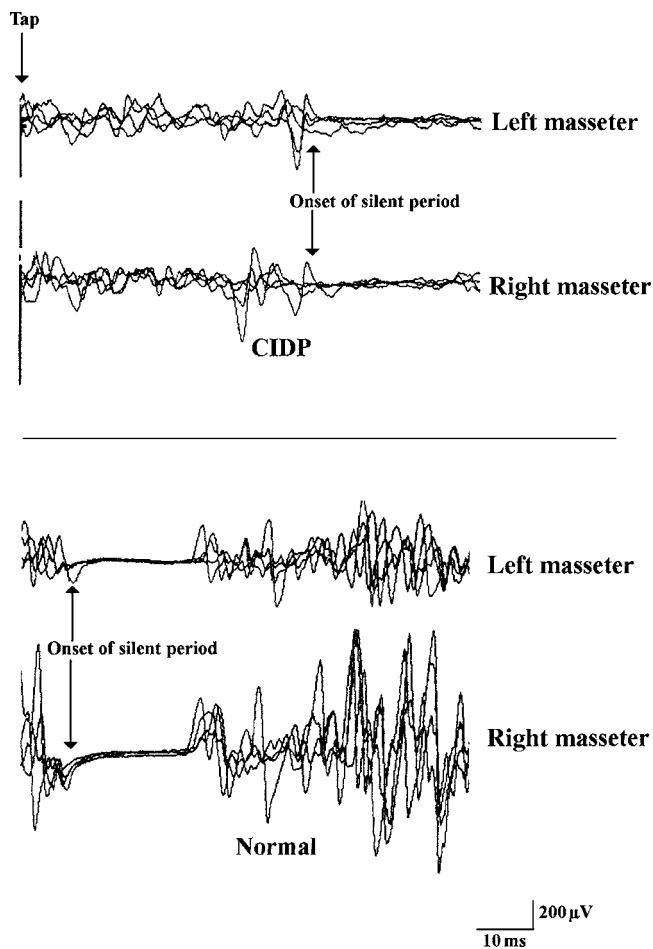
## Applications

The MIR is sometimes useful in the evaluation of peripheral neuropathies.<sup>33,34</sup> In severe demyelinating neuropathies in which no response occurs to stimuli in the limbs, the MIR can be used to assess conduction delay, because it can still be measured in neuropathies that are severe enough to abolish even the blink reflex (Fig. 31–16). In these situations, the latency of the onset of the MIR may be severely prolonged, thereby providing evidence for a demyelinating component. The reflex is normal in axonal neuropathies.

The MIR may be abolished in some forms of sensory neuropathy involving predominantly intraoral sensory nerves, giving rise to severe impairment in chewing and swallowing.<sup>35</sup>

In some laboratories, the MIR is used to assess function of the maxillary and mandibular divisions of the trigeminal nerve by applying an electric stimulus to the infraorbital and mental nerves, respectively, during voluntary contraction of the masseter. Abnormalities of conduction can be detected by comparing the latency of the onset of SP1 on the two sides.<sup>36</sup>

The MIR also has been used to assess central inhibition in some disease states. In trismus associated with tetanus, the MIR may be abolished. In the rare condition of hemimasticatory spasm, the MIR is attenuated on the side of the



**Figure 31–16.** MIR following a tap on the chin in a patient with CIDP compared with that in normal subject. The onset of the first silent period (SP1) is delayed in the patient with CIDP.

spasm, implying impaired inhibition during the period of spasm.<sup>37,38</sup>

### Key Points

- The MIR can be useful in demyelinating neuropathies when limb responses cannot be obtained.
- In situations which produce impaired central inhibition, such as tetanus, the MIR can be abolished.

## GREAT AURICULAR SENSORY NERVE CONDUCTION STUDIES

Nerve conduction studies (NCS) abound in clinical neurophysiology practice for assessing predominantly distal limb sensory nerves. In the lower extremity, the sural, plantar, and superficial fibular (peroneal) nerves may be studied, while in the upper extremity, the median, ulnar, radial, and antebrachial cutaneous nerves may be interrogated. Sensory NCS in proximal segments are limited to trigeminal “blink” reflexes and a few difficult-to-perform and less-than-reliable techniques to study such nerves as the saphenous, lateral femoral cutaneous, and posterior femoral cutaneous sensory nerves.

### Methods

The recording electrode is placed directly behind the earlobe, while the reference electrode is placed 2 cm away posterior to the helix. The stimulating electrode is placed on the posterior border of the sternocleidomastoid muscle 8 cm inferior to the recording electrode (Fig. 31–17). Amplitude values in normal subjects range from 8–48  $\mu$ V, while the distal latency falls between 1.4 and 2.4 ms.<sup>39,40</sup>

### Applications

The great auricular sensory nerve (C2,3) is a readily investigated proximal spinal sensory nerve that can be learned quickly, performed reliably, and studied in individuals suspected of having peripheral processes affecting proximal segments, ventral rami of the cervical plexus, or local disorders affecting the great auricular nerve in isolation.<sup>41</sup>



**Figure 31–17.** Greater auricular sensory nerve conduction study technique. (“Reprinted with the permission of The Cleveland Clinic Center for Medical Art & Photography © 2009. All Rights Reserved”.)

### Key Points

- The great auricular sensory response is useful in sensory neuropathies when limb sensory responses cannot be obtained.
- For focal disorders affecting sensation in the C2,3 dermatomes, the great auricular sensory response can provide evidence of the integrity of postganglionic sensory pathways.

## TRIGEMINAL CONTACT HEAT EVOKED POTENTIAL STIMULATOR STUDIES

The Contact Heat Evoked Potential Stimulator (CHEPS) method utilizes rapidly delivered pulses of heat to stimulate the differential warm or heat thresholds of receptors innervated by cutaneous A $\delta$  and C fibers. The resulting evoked potentials can be recorded and measured over the scalp with standard surface EEG electrodes. CHEPS has been used to excite preferentially cutaneous A $\delta$  and C fibers in human volunteers and correlate with subjectively reported scores of pain intensity.<sup>42–44</sup>

A marked similarity between CHEPS and laser evoked potentials has been noted;<sup>45</sup> CHEPS offers the advantages of being easier to administer, not requiring eye protection, and reducing risk of causing burns to the skin. The skin of the face can be stimulated in the first, second, or third division of the trigeminal nerve, eliciting responses over the midline scalp region between 5 and 30  $\mu\text{V}$  in amplitude and between 300 and 500 ms in latency.

In summary, CHEPS method offers an additional clinical tool for the assessment of small diameter somatic sensory nerve fiber function from the trigeminal territory (and other regions), complementing the assessment of autonomic small diameter fiber pathways by autonomic testing methods.<sup>46</sup>

### Key Points

- CHEPS studies assess somatic spinothalamic sensory function mediated by A $\delta$  and C fibers.
- Each of the three divisions of the trigeminal sensory territory can be investigated using CHEPS, stimulating the skin on the face and recording over the parietal scalp using standard EEG electrodes.

### SUMMARY

Although a certain level of expertise is necessary, electrophysiologic study of cranial reflexes is not technically demanding, time-consuming, or associated with substantial patient discomfort. The information obtained may document objective abnormality and assist with localization. The blink reflexes are useful for studying the function of the trigeminal and facial nerves and their central connections in the brain stem. When NCS in the limbs suggest a demyelinating peripheral neuropathy, the blink reflex can provide information about involvement of proximal nerve segments. Patterns of involvement of the facial and trigeminal nerves are often helpful in suggesting the type of neuropathy under investigation. The jaw jerk is useful in assessing the mandibular division of the trigeminal nerve, and it can aid in evaluating patients with suspected sensory ganglionopathies. The MIR is sometimes helpful in evaluating patients with demyelinating neuropathies and in assessing central inhibition.

The great auricular sensory NCS is a useful method to assess proximal somatic sensory function in the upper cervical dermatomes. The CHEPS technology provides a method to study somatic small fiber sensory pathways from the trigeminal dermatomes to the sensory cortex. Although not discussed in this chapter, needle electrode examination of muscles innervated by the trigeminal and facial cranial nerves are usually performed in combination with cranial nerve reflex studies.

### REFERENCES

1. Overend, W. 1896. Preliminary note on a new cranial reflex. *Lancet* 1:619.
2. Kugelberg, E. 1952. Facial reflexes. *Brain* 75:385–96.
3. Rushworth, G. 1962. Observations on blink reflexes. *Journal of Neurology, Neurosurgery, and Psychiatry* 25:93–108.
4. Shahani, B. 1970. The human blink reflex. *Journal of Neurology, Neurosurgery, and Psychiatry* 33:792–800.
5. Trontelj, M. A., and J. V. Trontelj. 1978. Reflex arc of the first component of the human blink reflex: A single motoneurone study. *Journal of Neurology, Neurosurgery, and Psychiatry* 41:538–47.
6. Stoehr, M., and F. Petrucci. 1978. The orbicularis oculi reflex: Diagnostic significance of the reflex amplitude. *Electromyography and Clinical Neurophysiology* 18:217–24.
7. Anday, E. K., M. E. Cohen, and H. S. Hoffman. 1990. The blink reflex: Maturation and modification in the neonate. *Developmental Medicine and Child Neurology* 32:142–50.
8. Jaaskelainen, S. K. 1995. Blink reflex with stimulation of the mental nerve. Methodology, reference values, and some clinical vignettes. *Acta Neurologica Scandinavica* 91:477–82.
9. Hagen, N. A., J. C. Stevens, and C. J. Michet Jr. 1990. Trigeminal sensory neuropathy associated with connective tissue diseases. *Neurology* 40:891–6.
10. Kimura, J., R. L. Rodnitzky, and M. W. Van Allen. 1970. Electrodiagnostic study of trigeminal nerve. Orbicularis oculi reflex and masseter reflex in trigeminal neuralgia, paratrigeminal syndrome, and other lesions of the trigeminal nerve. *Neurology* 20:574–83.
11. Feldman, R. G., C. Niles, S. P. Proctor, and J. Jabre. 1992. Blink reflex measurement of effects of trichloroethylene exposure on the trigeminal nerve. *Muscle & Nerve* 15:490–5.
12. Kimura, J., L. T. Giron, and S. M. Young. 1976. Electrophysiological study of Bell palsy: Electrically elicited blink reflex in assessment of prognosis. *Archives of Otolaryngology* 102:140–3.
13. Ghonim, M. R., and C. Gavilan. 1990. Blink reflex: Prognostic value in acute peripheral facial palsy. *ORL; Journal for Oto-Rhino-Laryngology and its Related Specialities* 52:75–9.
14. Heath, J. P., R. E. Cull, I. M. Smith, and J. A. Murray. 1988. The neurophysiological investigation of Bell's palsy and the predictive value of the blink reflex. *Clinical Otolaryngology* 13:85–92.

15. Auger, R. G. 1979. Hemifacial spasm: Clinical and electrophysiologic observations. *Neurology* 29:1261-72.
16. Rubin, D. I., J. Y. Matsumoto, G. A. Suarez, and R. G. Auger. 1999. Facial trigeminal synkinesis associated with a trigeminal schwannoma. *Neurology* 53:635-7.
17. Kimura, J. 1971. An evaluation of the facial and trigeminal nerves in polyneuropathy: Electrodiagnostic study in Charcot-Marie-Tooth disease, Guillain-Barré syndrome, and diabetic neuropathy. *Neurology* 21:745-52.
18. Kirk, V. H. Jr., W. J. Litchy, J. L. Karnes, and P. J. Dyck. 1991. Measurement of blink reflexes not useful in detection or characterization of diabetic polyneuropathy (abstract). *Muscle & Nerve* 14:910-11.
19. Auger, R. G., A. J. Windebank, C. F. Lucchinetti, and C. H. Chalk. 1999. Role of the blink reflex in the evaluation of sensory neuronopathy. *Neurology* 53:407-8.
20. Kimura, J. 1975. Electrically elicited blink reflex in diagnosis of multiple sclerosis. Review of 260 patients over a seven-year period. *Brain* 98:413-26.
21. Berardelli, A., N. Accornero, G. Cruccu, F. Fabiano, V. Guerrisi, and M. Manfredi. 1983. The orbicularis oculi response after hemispherical damage. *Journal of Neurology, Neurosurgery, and Psychiatry* 46:837-43.
22. Kimura, J., J. T. Wilkinson, H. Damasio, H. R. Adams Jr., E. Shivapour, and T. Yamada. 1985. Blink reflex in patients with hemispheric cerebrovascular accident (CVA). Blink reflex in CVA. *Journal of the Neurological Sciences* 67:15-28.
23. Nielsen, V. K. 1984. Pathophysiology of hemifacial spasm: I. Ephaptic transmission and ectopic excitation. *Neurology* 34:418-26.
24. Moller, A. R. 1991. Interaction between the blink reflex and the abnormal muscle response in patients with hemifacial spasm: Results of intraoperative recordings. *Journal of the Neurological Sciences* 101:114-23.
25. Valls-Sole, J., and E. S. Tolosa. 1989. Blink reflex excitability cycle in hemifacial spasm. *Neurology* 39:1061-6.
26. Auger, R. G., D. G. Piepgras, E. R. Laws Jr., and R. H. Miller. 1981. Microvascular decompression of the facial nerve for hemifacial spasm: Clinical and electrophysiologic observations. *Neurology* 31:346-50.
27. Moller, A. R., and P. J. Jannetta. 1987. Monitoring facial EMG responses during microvascular decompression operations for hemifacial spasm. *Journal of Neurosurgery* 66:681-5.
28. Auger, R. G. 1998. Role of the masseter reflex in the assessment of subacute sensory neuropathy. *Muscle & Nerve* 21:800-1.
29. Ongerboer De Visser, B. W., and C. Goor. 1976. Jaw reflexes and masseter electromyograms in mesencephalic and pontine lesions: An electrodiagnostic study. *Journal of Neurology, Neurosurgery, and Psychiatry* 39:90-2.
30. Hopf, H. C., F. Thomke, and L. Gutmann. 1991. Midbrain vs. pontine medial longitudinal fasciculus lesions: The utilization of masseter and blink reflexes. *Muscle & Nerve* 14:326-30.
31. Thomke, F. 1999. Isolated cranial nerve palsies due to brain stem lesions. *Muscle & Nerve* 22:1168-76.
32. Hopf, H. C., C. Hinrichs, P. Stoeter, P. P. Urban, J. Marx, and F. Thomke. 2000. Masseter reflex latencies and amplitudes are not influenced by supratentorial and cerebellar lesions. *Muscle & Nerve* 23:86-9.
33. Auger, R. G. 1996. Latency of onset of the masseter inhibitory reflex in peripheral neuropathies. *Muscle & Nerve* 19:910-11.
34. Cruccu, G., R. Agostino, M. Inghilleri, P. Innocenti, A. Romaniello, and M. Manfredi. 1998. Mandibular nerve involvement in diabetic polyneuropathy and chronic inflammatory demyelinating polyneuropathy. *Muscle & Nerve* 21:1673-9.
35. Auger, R. G., and P. G. McManis. 1990. Trigeminal sensory neuropathy associated with decreased oral sensation and impairment of the masseter inhibitory reflex. *Neurology* 40:759-63.
36. Ongerboer de Visser, B. W., and G. Cruccu. 1993. Neurophysiologic examination of the trigeminal, facial, hypoglossal, and spinal accessory nerves in cranial neuropathies and brain stem disorders. In *Clinical electromyography*, ed. W. F. Brown and C. F. Bolton, 2nd ed., 61-92. Boston: Butterworth-Heinemann.
37. Auger, R. G., W. J. Litchy, T. L. Cascino, and J. E. Ahlskog. 1992. Hemimasticatory spasm: Clinical and electrophysiologic observations. *Neurology* 42:2263-6.
38. Kim, H. J., B. S. Jeon, and K. W. Lee. 2000. Hemimasticatory spasm associated with localized scleroderma and facial hemiatrophy. *Archives of Neurology* 57:576-80.
39. Smith, B. E., and P. J. B. Dyck. 2004. Proximal spinal neurophysiological assessments: Greater auricular nerve conduction study (abstract 284). *Annals of Neurology* 56 (Suppl 8):S62.
40. Peuker, E. T., and T. J. Filler. 2002. The nerve supply of the human auricle. *Clinical Anatomy* 15:35-7.
41. Kimura, I., H. Seki, S. Sasao, and D. R. Ayyar. 1987. The great auricular nerve conduction study: A technique, normative data and clinical usefulness. *Electromyography and Clinical Neurophysiology* 27:39-43.
42. Granovsky, Y., D. Matre, A. Sokolik, J. Lorenz, and K. L. Casey. 2005. Thermoreceptive innervation of human glabrous and hairy skin: A contact heat evoked potential analysis. *Pain* 115(3):238-47.
43. Chen, A. C., D. M. Niddam, and L. Arendt-Nielsen. 2001. Contact heat evoked potentials as a valid means to study nociceptive pathways in human subjects. *Neuroscience Letters* 316(2):79-82.
44. Le Pera, D., M. Valeriani, D. Niddam, A. C. Chen, and L. Arendt-Nielsen. 2002. Contact heat evoked potentials to painful and non-painful stimuli: Effect of attention towards stimulus properties. *Brain Topography* 15(2):115-23.
45. Valeriani, M., D. Le Pera, D. Niddam, A. C. Chen, and L. Arendt-Nielsen. 2002. Dipolar modelling of the scalp evoked potentials to painful contact heat stimulation of the human skin. *Neuroscience Letters* 318(1):44-8.
46. Atherton, D. D., P. Facer, K. M. Roberts, et al. 2007. Use of the novel contact heat evoked potential stimulator (CHEPS) for the assessment of small fibre neuropathy: Correlations with skin flare responses and intra-epidermal nerve fibre counts. *BMC Neurology* 7:21-30.

# Long Latency Reflexes and the Silent Period

John N. Caviness

## INTRODUCTION

### LONG LATENCY REFLEXES

LLRs to Stretch

LLRs to Mixed Nerve Stimulation

Cutaneous Reflexes

The Flexor Reflex

### THE SILENT PERIOD

Cutaneous Silent Period

### SUMMARY

## INTRODUCTION

*Long latency reflexes* (LLRs) and the *silent period* are normal phenomena recorded from muscles that are highly dependent on the central nervous system connections. The clinical application of these phenomena is limited, but they can be helpful in selected situations. Some LLRs are abnormal in patients with myoclonus, and the silent period shows abnormalities with hyperexcitable motor neurons or peripheral nerves.

### *Purpose and Role of LLRs and the Silent Period*

- LLRs are useful in certain central nervous system disorders.
- The silent period is abnormal in disorders with hyperexcitable motor neurons.

## LONG LATENCY REFLEXES

There is no exact moment when the reflex response to a stimulus ends and the voluntary reaction begins. Rather, from the onset of a monosynaptic stretch reflex to the time of the first conscious voluntary reaction, the cortical influence over the spinal and brain stem reflex activity gradually increases. Unique electromyographic (EMG) phenomena called *long latency reflexes* arise during this transition period. Like spinal reflexes, LLRs have predictable latencies, but their amplitudes are modulated profoundly by context and volition. These characteristics make them important tools in the study of normal and abnormal motor control.<sup>1</sup>

Hammond<sup>2</sup> discovered the LLRs while studying the EMG responses evoked in the biceps muscle by sudden stretch. EMG activity

appeared at 70 ms, later than the monosynaptic stretch reflex and earlier than the voluntary reaction time of 113 ms. A command to “resist” the stretch augmented these long latency responses and the instruction to “let go” resulted in their virtual disappearance. Marsden et al.<sup>3</sup> studied similar stretch reflexes in the long flexor of the thumb during movement and theorized that LLRs served to reinforce volition or intent against unexpected perturbations. The reflexes were thought to emanate from a *transcortical loop*, with one arm of the loop ascending to the sensorimotor cortex in the dorsal column-medial lemniscus system and the other arm descending in the corticospinal tract.

Several lines of evidence support the concept of a transcortical reflex loop. They are as follows:

- LLRs are delayed or absent in patients with lesions of the dorsal columns or sensorimotor cortex.
- Cortical potentials precede LLRs by 30–50 ms and the two events correlate in amplitude.<sup>4</sup>
- LLRs occur bilaterally and nearly simultaneously in response to a unilateral stimulus in patients with congenital mirror movements.<sup>5</sup>
- Patients with cortical reflex myoclonus have hyperexcitable LLRs, which clearly are cortically mediated.<sup>6</sup>
- Modulation was also reflected in the amplitude of the sensorimotor cortex potentials just preceding the LLR.<sup>7</sup>

However, the persistence of LLRs in spinal animals forces one to consider other possible explanations. For example, repetitive firing of muscle spindles or transmission of sensory influences by slowly conducting fibers could explain the appearance of reflex activity at long latencies. It is likely that the neural circuits that generate LLRs depend on the type of stimulus.<sup>8,9</sup> Although the physiologic basis of LLRs is a matter of controversy, the weight of evidence strongly suggests that “loops” involving the motor cortex are involved in their generation.<sup>10</sup>

LLRs have been recorded by various techniques using stretch or different forms of electric stimulation. The precise character of the reflexes depends on the testing protocol, and

it is unlikely that all LLRs have an identical physiologic basis.<sup>11</sup>

LLRs are altered in disorders anywhere along their pathway from the periphery to the cortex. They may be absent, delayed, or enhanced.<sup>12</sup>

- Absent LLR II—lesions of the lemniscal pathways, cortex, corticospinal tracts,<sup>13</sup> and Huntington’s disease.
- Delayed LLR II—demyelinating lesions in multiple sclerosis and Friedreich’s disease.<sup>14</sup>
- Enhanced LLR I—cortical and subcortical myoclonus,<sup>15</sup> corticobasal degeneration, Parkinson’s disease, essential tremor, and dystonia.<sup>16</sup>

### Key Points

- LLRs arise during this transition period from the onset of a monosynaptic stretch reflex to the time of the first conscious voluntary reaction.
- The reflexes are thought to emanate from a transcortical loop, with one arm of the loop ascending to the sensorimotor cortex in the dorsal column-medial lemniscus system and the other arm descending in the corticospinal tract.

### LLRs to Stretch

All protocols for stretch reflex testing involve a computer-controlled torque motor that can be programmed to maintain a steady load or to introduce rapid perturbations. Generally, the torque is delivered through a manipulandum that the subject holds. The subject receives visual feedback about the position of the manipulandum and attempts to hold it stationary against a low constant torque. The computer delivers random torque pulses, and the surface EMG signals are recorded over the agonist and antagonist of the joint that is stretched. The EMG signal is rectified and averaged.

In a normal response, an M1 component occurs at 30 ms and corresponds to the monosynaptic stretch reflex. The M2 component, the most frequent long latency component, appears at 55–65 ms in the wrist. Occasionally, a later M3 component may be seen



individually or it may merge with the M2 component.

In Parkinson's disease, the M2 component is enlarged in the wrist flexors. This abnormality corresponds to the degree of the patient's rigidity. In contrast, a decrease in or absence of the M2 component distinguishes Huntington's disease.<sup>17</sup> M2 may be prolonged in dystonia. As noted above, lesions of the dorsal columns ipsilateral to the tested limbs or the contralateral sensorimotor cortex may delay or abolish M2.

### Key Points

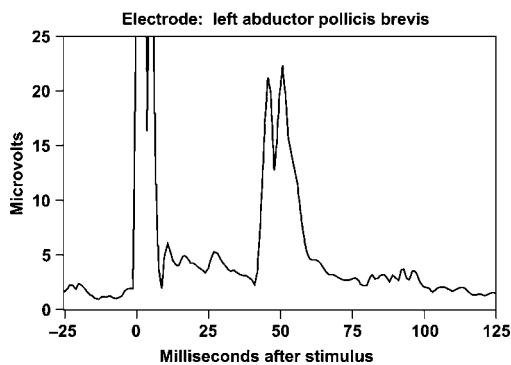
- In a normal LLR response to stretch, an M1 component occurs at 30 ms and corresponds to the monosynaptic stretch reflex.
- The M2 component, the most frequent long latency component, appears at 55–65 ms in the wrist.
- A later M3 component may be seen individually or it may merge with the M2 component.

### LLRs to Mixed Nerve Stimulation

Upton et al.<sup>18</sup> discovered a late response, termed V2, to the electric stimulation of a mixed nerve. Since that time, a series of LLRs in the hand muscles has been distinguished in response to median nerve stimulation.

The median nerve is stimulated at the wrist, with the cathode proximal. Surface EMG electrodes are placed over the abductor pollicis brevis. The stimulus duration is set to 1 ms, and the intensity is increased to the level that produces the first small twitch. Initially, recordings are made with the muscle at rest and single shocks are given. Next, the patient maintains a moderate contraction, and stimuli are given at a rate of 1–3 Hz. The signal must be rectified and then averaged. A total of 100–500 stimuli provide reproducible results.

In normal subjects with their hands at rest, no late response is seen after the F wave and before the voluntary reaction time. With contraction and averaging, a short latency reflex develops at approximately 28 ms and is identical with the H reflex. A late response named the *LLR II* appears in all normal subjects at 50 ms, and in one-third of them an additional *LLR I* may be recorded at 40 ms or an *LLR III* at 75 ms.



**Figure 32-1.** Abnormal presence of LLR II in a patient with cortical reflex myoclonus.

In myoclonic disorders, a late response that corresponds to a reflex myoclonic jerk is recorded at 40–60 ms in the hand at rest (Fig. 32-1). Sutton and Mayer<sup>19</sup> named this the *C reflex*, a distinct abnormality that may be seen in cortical reflex myoclonus, reticular reflex myoclonus, hyperekplexia, Alzheimer's disease, and other symptomatic myoclonic disorders. The pattern of an increased LLR I and LLR III with a normal LLR II may typify Parkinson's disease. The LLR II is absent in Huntington's disease but is unaffected in other choreatic movement disorders.<sup>17,20</sup> Patients with focal dystonia may display increased LLR I or reduced LLR II.<sup>21</sup> Possibly in a subgroup of patients with essential tremor, the LLR I is increased.<sup>22</sup> A delayed LLR II reflects slowing of central conduction in patients with multiple sclerosis.<sup>23</sup> LLR II disappears after thalamic infarction, corresponding to the clinical deficit and abnormalities on somatosensory evoked potential testing.<sup>24</sup> Deuschl provides useful normal values for LLRs of the hand muscles to median nerve stimulation.<sup>12</sup>

### Key Points

- LLRs in the hand muscles can occur in response to median nerve stimulation.
- In normal subjects with their hands at rest, no late response is seen after the F wave and before the voluntary reaction time. With contraction and averaging, a short latency reflex develops at approximately 28 ms and is identical with the H reflex.
- A late response named the *LLR II* appears in all normal subjects at 50 ms, and in one-third of them an additional *LLR I* may

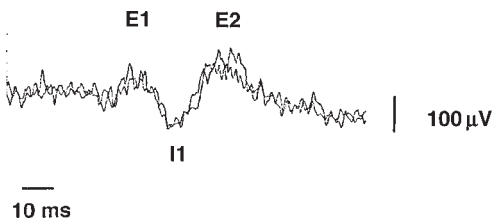
be recorded at 40 ms or an *LLR III* at 75 ms.

- In myoclonic disorders, a late response, called the *C reflex*, which corresponds to a reflex myoclonic jerk is recorded at 40–60 ms in the hand at rest.

## Cutaneous Reflexes

LLRs evoked by purely cutaneous nerve stimulation demonstrate well-defined inhibitory as well as excitatory periods.<sup>25</sup> Stimuli are delivered to the index finger by ring electrodes. The surface EMG is recorded with an electrode over the belly of the first dorsal interosseous and a reference electrode over the radial styloid process. The patient maintains a steady force at 20% of maximum. Stimulus intensity is adjusted to four times the sensory threshold, with a stimulus duration of 0.2 ms. With a stimulus rate of 3 Hz, 100–500 samples are collected, full-wave rectified, and then averaged.

A first excitatory period, E1, is present at approximately 40 ms, followed by inhibition, I1, at approximately 51 ms (Fig. 32–2). A final excitatory wave, E2, appears at approximately 66 ms.<sup>26,27</sup> I1 and E2 depend on the motor cortex and are absent with contralateral cortical lesions.<sup>26</sup> E2 may be delayed in multiple sclerosis. The depth of I1 is decreased in patients with Parkinson's disease as compared with control subjects.<sup>25</sup> E2 is increased in myoclonus associated with akinetic rigid disorders, and the latency of this component may separate Parkinson's disease and multiple systems atrophy from corticobasal degeneration.<sup>29</sup>



**Figure 32–2.** The cutaneous reflex. The index finger was stimulated electrically, and EMG activity was recorded from the flexor digitorum indicis. Two phases of excitation, E1 and E2, and an intervening phase of inhibition, I1, are seen in the record.

## The Flexor Reflex

Certain stimuli may trigger reflex withdrawal, *flexor reflexes*. Generally, the adequate stimulus must be cutaneous and noxious. Such stimuli affect a polysynaptic network of spinal neurons, termed *flexor reflex afferents*, that program patterned withdrawal behavior.

Meinck et al.<sup>30</sup> standardized a technique for eliciting flexor reflexes. The medial plantar nerve is stimulated in the ball of the foot with a train of five shocks by using a stimulus duration at 0.1 ms and an interstimulus interval of 3–5 ms. The stimulus intensity is adjusted to the motor threshold of the flexor hallucis brevis muscle, a level that will be perceived as mildly painful. EMG is recorded from the anterior tibial muscle, rectified, and then averaged. A total of eight trains are averaged, with the stimuli repeated every 1–3 seconds. With this protocol, the normal activity is triphasic, with a large F1 response at 70 ms, a period of silence, and then a small F2 burst at approximately 150 ms.

With spinal cord lesions, exaggerated withdrawal corresponds to a large response at or beyond the latency of F2. Very high-intensity stimulation may shorten the latency of this response to a value consistent with F1. In spasticity caused by a hemispheric lesion, stimulation may trigger alternating clonic bursts in the anterior tibial and gastrocnemius muscles.

### Key Points

- Withdrawal or flexor reflexes may be recorded following electrical stimulation.
- The normal flexor reflex activity is triphasic, with a large F1 response at 70 ms, a period of silence, and then a small F2 burst at approximately 150 ms.
- With spinal cord lesions, exaggerated withdrawal corresponds to a large response at or beyond the latency of F2.

## THE SILENT PERIOD

There are two general categories of silent period. The most familiar and most thoroughly studied is elicited by a strong shock to a nerve innervating a contracting muscle. A second, less well-known form occurs in response to a cutaneous nerve not innervating the region of

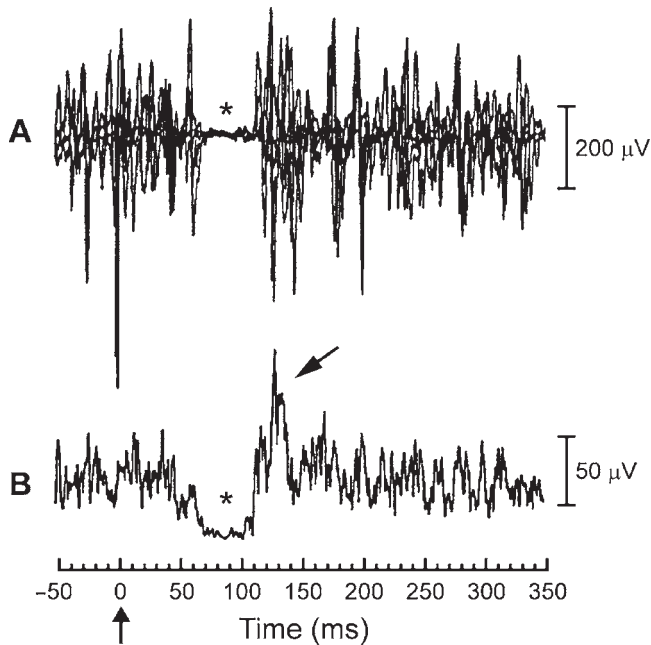
the contracting muscles and is considered a protective reflex mediated by spinal inhibitory circuits.<sup>31</sup>

If a strong shock is delivered to the nerve of a muscle that is tonically contracting, a period of relative or absolute silence begins immediately and persists for about 100 ms (Fig. 32–3). The depth of the *silent period* depends entirely on the intensity of the shock. With supramaximal shocks, which are commonly used, the silence is generally complete except for an intervening F wave. With lower stimulation intensities, the LLRs I–III described above appear.

Initially, Merton<sup>32</sup> thought the silent period resulted from the muscle twitch and the unloading of muscle spindles induced by the shock. This hypothesis became untenable with the demonstration that the silent period persists with the stimulation of a cutaneous nerve or a nonhomologous nerve or with stimulation proximal to a nerve block—all conditions in which twitch is absent.<sup>33</sup> The silent period should be viewed as a multifactorial phenomenon. With supramaximal stimulation, approximately the first 30 ms of silence results from the collision of impulses in the nerve trunk. The next period, up to approximately

60 ms, may reflect activation of recurrent collaterals of Renshaw cells. These two intervals combined are referred to as the *peripheral silent period*. The final period of silence should be viewed as a long latency inhibitory reflex often referred to as the *cortical silent period*. Recent evidence, including the study of the silent periods after cortical magnetic stimulation, raises the possibility of spinal inhibition of corticospinal inputs or of cortically mediated inhibitory reflexes.<sup>34,35</sup>

Few normative data exist about the depth and duration of the silent period; thus, this period is interpreted in an “all-or-nothing” fashion. In states of hyperexcitability of the distal nerve or muscle, the silent period may be absent because ectopic impulses arise distal to the stimulus. In tetanus, the silent period may be abbreviated or absent.<sup>36</sup> A shortened silent period or its absence has been reported in the case of a cervical cord tumor that produced arm rigidity.<sup>37</sup> Prolonged duration of the silent period has been reported in dystonia and Parkinson’s disease.<sup>38</sup> The silent period persists in patients with pure sensory neuropathy and absence of sensory nerve action potentials, raising the possibility that it provides an



**Figure 32–3.** The silent period. After a supramaximal shock, the electromyographic activity is inhibited. *A*, Peripheral silent period. *B*, Cortical silent period. Recorded signals above and averaged below. The silence is interrupted by an M wave and H reflex.

electrophysiologic assessment of the integrity of smaller, slower conducting sensory fibers.<sup>39</sup> Recent studies have suggested that the cortical silent period may be useful in identifying cortical involvement in suspected amyotrophic lateral sclerosis.<sup>40–42</sup> A number of other recent intriguing studies suggest possible clinical value of the cortical silent period in other upper motor neuron disorders, including concussion,<sup>43</sup> hereditary spastic paraplegia<sup>44</sup> and focal epilepsy,<sup>45</sup> and restless leg syndrome.<sup>46</sup>

## Cutaneous Silent Period

Strong shocks to cutaneous nerves in the arm or leg and to the trigeminal nerve inhibit ongoing muscle contraction in nearby muscles.<sup>31</sup> Latencies vary with the location of the stimulus, but are generally in the range of 50–80 ms, and last approximately 50 ms depending on the strength of contraction. They appear to be mediated by A $\delta$ , small myelinated fibers. Cutaneous silent period (CSP) does not habituate and may be followed by post-inhibitory facilitation for 50–100 ms. CSP clinical utility has not been reproducibly reported. They have not been consistently abnormal in peripheral neuropathies, but may be useful in identifying intact sensory roots after plexus trauma. They are lost in syringomyelia. There has been one report of CSP abnormality in the restless leg syndrome.<sup>46</sup>

### Key Points

- Following a strong shock delivered to the nerve of a muscle that is tonically contracting, a period of relative or absolute silence called the *silent period* begins immediately and persists for about 100 ms.
- The silent period results from a combination of peripheral, spinal cord, and cortical phenomena.
- In states of hyperexcitability of the distal nerve or muscle, the silent period may be absent because ectopic impulses arise distal to the stimulus.
- The silent period may prove to be of value in a number of upper motor neuron clinical disorders.
- The testing of the silent period should be considered in instances where hyperexcitable motor neurons are suspected but the reason is unclear.

## SUMMARY

LLRs and the silent period are EMG phenomena that reflect the complex interplay of spinal, brain stem, and cortical influences in motor control. These techniques have been applied to the study of disorders of motor control such as Parkinson's disease, Huntington's disease, and dystonia. Abnormalities of these reflexes may help to detect lesions of the central nervous system.

## REFERENCES

1. Johnson, M. T., A. N. Kipnis, M. C. Lee, and T. J. Ebner. 1993. Independent control of reflex and volitional EMG modulation during sinusoidal pursuit tracking in humans. *Experimental Brain Research* 96:347–62.
2. Hammond, P. H. 1956. The influence of prior instruction to the subject on an apparently involuntary neuromuscular response (abstract). *Journal of Physiology (London)* 132:17P–18P.
3. Marsden, C. D., P. A. Merton, and H. B. Morton. 1976. Servo action in the human thumb. *Journal of Physiology (London)* 257:1–44.
4. Goodin, D. S., M. J. Aminoff, and P. Y. Shih. 1990. Evidence that the long-latency stretch responses of the human wrist extensor muscle involve a transcerebral pathway. *Brain* 113:1075–91.
5. Capaday, C., R. Forget, R. Fraser, and Y. Lamarre. 1991. Evidence for a contribution of the motor cortex to the long-latency stretch reflex of the human thumb. *Journal of Physiology* 440:243–55.
6. Hallett, M., D. Chadwick, and C. D. Marsden. 1979. Cortical reflex myoclonus. *Neurology* 29:1107–25.
7. Kourtis, D., H. F. Kwok, N. Roach, and A. M. Wing. 2008. Praamstra P. Maintaining grip: Anticipatory and reactive EEG responses to load perturbations. *Journal of Neurophysiology* 99(2):545–53.
8. Palmer, E., and P. Ashby. 1992. Evidence that a long latency stretch reflex in humans is transcortical. *Journal of Physiology (London)* 449:429–40.
9. Palmer, E., and P. Ashby. 1992. The transcortical nature of the late reflex responses in human small hand muscle to digital nerve stimulation. *Experimental Brain Research* 91:320–6.
10. Matthews, P. B. 1991. The human stretch reflex and the motor cortex. *Trends in Neurosciences* 14:87–91.
11. Hallett, M. 1989. Long-latency reflexes. In *Disorders of movement: Clinical, pharmacological and physiological aspects*, ed. N. P. Quinn, and P. G. Jenner, 529–41. London: Academic Press.
12. Deuschl, G. 2003. Long-latency reflexes following stretch and nerve stimulation. In *Movement disorders. Handbook of clinical neurophysiology*, ed. M. Hallett, Vol. 1, 285–94. Amsterdam: Elsevier.
13. Black, I., D. Nichols, M. Pelliccio, and J. Hidler. 2007. Quantification of reflex activity in stroke survivors during an imposed multi-joint leg extension movement. *Experimental Brain Research* 183(2): 271–81.

14. Lee, Y. C., J. T. Chen, K. K. Liao, Z. A. Wu, and B. W. Soong. 2003. Prolonged cortical relay time of long latency reflex and central motor conduction in patients with spinocerebellar ataxia type 6. *Clinical Neurophysiology* 114(3):458–62.
15. Defebvre, L. 2006. Myoclonus and extrapyramidal diseases. *Neurophysiologie Clinique* 36(5–6):319–25.
16. Kanovsky, P. 2002. Dystonia: A disorder of motor programming or motor execution? *Movement Disorders* 17(6):1143–7.
17. Noth, J., K. Podoll, and H. H. Friedemann. 1985. Long-loop reflexes in small hand muscles studied in normal subjects and in patients with Huntington's disease. *Brain* 108:65–80.
18. Upton, A. R., A. J. McComas, and R. E. Sica. 1971. Potentiation of "late" responses evoked in muscles during effort. *Journal of Neurology, Neurosurgery, and Psychiatry* 34:699–711.
19. Sutton, G. G., and R. F. Mayer. 1974. Focal reflex myoclonus. *Journal of Neurology, Neurosurgery, and Psychiatry* 37:207–17.
20. Deuschl, G., K. Strahl, E. Schenck, and C. H. Lucking. 1988. The diagnostic significance of long-latency reflexes in multiple sclerosis. *Electroencephalography and Clinical Neurophysiology* 70:56–61.
21. Naumann, M., and K. Reiners. 1997. Long-latency reflexes of hand muscles in idiopathic focal dystonia and their modification by botulinum toxin. *Brain* 120:409–16.
22. Deuschl, G., C. H. Lucking, and E. Schenck. 1987. Essential tremor: Electrophysiological and pharmacological evidence for a subdivision. *Journal of Neurology, Neurosurgery, and Psychiatry* 50:1435–41.
23. Deuschl, G., C. H. Lucking, and E. Schenck. 1989. Hand muscle reflexes following electrical stimulation in choreatic movement disorders. *Journal of Neurology, Neurosurgery, and Psychiatry* 52:755–62.
24. Chen, C. C., J. T. Chen, Z. A. Wu, K. P. Kao, and K. K. Liao. 1998. Long latency responses in pure sensory stroke due to thalamic infarction. *Acta Neurologica Scandinavica* 98:41–8.
25. Caccia, M. R., A. J. McComas, A. R. Upton, and T. Blogg. 1973. Cutaneous reflexes in small muscles of the hand. *Journal of Neurology, Neurosurgery, and Psychiatry* 36:960–77.
26. Fuhr, P., and W. G. Friedli. 1987. Electrocutaneous reflexes in upper limbs—reliability and normal values in adults. *European Neurology* 27:231–8.
27. Jenner, J. R., and J. A. Stephens. 1982. Cutaneous reflex responses and their central nervous pathways studied in man. *Journal of Physiology (London)* 333:405–19.
28. Fuhr, P., T. Zeffiro, and M. Hallett. 1992. Cutaneous reflexes in Parkinson's disease. *Muscle & Nerve* 15:733–9.
29. Chen, R., P. Ashby, and A. E. Lang. 1992. Stimulus-sensitive myoclonus in akinetic-rigid syndromes. *Brain* 115:1875–88.
30. Meinck, H. M., S. Kuster, R. Benecke, and B. Conrad. 1985. The flexor reflex—influence of stimulus parameters on the reflex response. *Electroencephalography and Clinical Neurophysiology* 61:287–98.
31. Floeter, M. K. 2003. Cutaneous silent periods. *Muscle & Nerve* 28:391–401.
32. Merton, P. A. 1951. The silent period in a muscle of the human hand. *Journal of Physiology (London)* 114:183–98.
33. Leis, A. A., M. A. Ross, T. Emori, Y. Matsue, and T. Saito. 1991. The silent period produced by electrical stimulation of mixed peripheral nerves. *Muscle & Nerve* 14:1202–8.
34. Fuhr, P., R. Agostino, and M. Hallett. 1991. Spinal motor neuron excitability during the silent period after cortical stimulation. *Electroencephalography and Clinical Neurophysiology* 81:257–62.
35. Leis, A. A., I. Stetkarova, A. Beric, and D. S. Stokic. 1995. Spinal motor neuron excitability during the cutaneous silent period. *Muscle & Nerve* 18:1464–70.
36. Risk, W. S., E. P. Bosch, J. Kimura, P. A. Cancilla, K. H. Fischbeck, and R. B. Layzer. 1981. Chronic tetanus: Clinical report and histochemistry of muscle. *Muscle & Nerve* 4:363–6.
37. Weinberg, D. H., E. L. Logigian, and J. J. Kelly Jr. 1988. Cervical astrocytoma with arm rigidity: Clinical and electrophysiologic features. *Neurology* 38:1635–7.
38. Pullman, S. L., B. Ford, B. Elibol, A. Uncini, P. C. Su, and S. Fahn. 1996. Cutaneous electromyographic silent period findings in brachial dystonia. *Neurology* 46:503–8.
39. Leis, A. A., M. Kofler, and M. A. Ross. 1992. The silent period in pure sensory neuronopathy. *Muscle & Nerve* 15:1345–8.
40. Schelhaas, H. J., I. M. Arts, S. Overeem, et al. 2007. Measuring the cortical silent period can increase diagnostic confidence for amyotrophic lateral sclerosis. *Amyotrophic Lateral Sclerosis* 8(1):16–9.
41. Karandreas, N., M. Papadopoulou, P. Kokotis, A. Papapostolou, G. Tsvigoulis, and T. Zambelis. 2007. Impaired interhemispheric inhibition in amyotrophic lateral sclerosis. *Amyotrophic Lateral Sclerosis* 8(2):112–18.
42. Attarian, S., A. Verschueren, and J. Pouget. 2007. Magnetic stimulation including the triple-stimulation technique in amyotrophic lateral sclerosis. *Muscle & Nerve* 36(1):55–61.
43. De Beaumont, L., M. Lassonde, S. Leclerc, and H. Theoret. 2007. Long-term and cumulative effects of sports concussion on motor cortex inhibition. *Neurosurgery* 61(2):329–36; discussion 336–7.
44. Sartucci, F., S. Tovani, L. Murri, and L. Sagliocco. 2007. Motor and somatosensory evoked potentials in Autosomal Dominant Hereditary Spastic Paraparesis (ADHSP) linked to chromosome 2p, SPG4. *Brain Research Bulletin* 74(4):243–9.
45. Badawy, R. A., J. M. Curatolo, M. Newton, S. F. Berkovic, and R. A. Macdonell. 2007. Changes in cortical excitability differentiate generalized and focal epilepsy. *Annals of Neurology* 61(4):324–31.
46. Han, J. K., K. Oh, B. J. Kim, et al. 2007. Cutaneous silent period in patients with restless leg syndrome. *Clinical Neurophysiology* 118(8):1705–10.

*This page intentionally left blank*



# Movement Disorders

*John N. Caviness*

## **INTRODUCTION TECHNIQUES**

Surface EMG  
EEG  
EEG–EMG Polygraphy with  
Back-Averaging  
Elicited Responses

## **SURFACE EMG: NORMAL PATTERNS TREMOR**

Recording Techniques  
Abnormal Patterns

## **MYOCLONUS**

Recording Techniques  
Abnormal Patterns

## **PSYCHOGENIC JERKS STARTLE DISORDERS PERIODIC LIMB MOVEMENTS OF SLEEP**

**DYSTONIA**  
Recording Techniques  
Abnormal Patterns

## **TICS, CHOREA, AND ATHETOSIS VOLUNTARY MOVEMENT ABNORMALITIES SUMMARY**

## **INTRODUCTION**

The study of movement disorders encompasses abnormalities of motor control that result in either too little or too much movement. At one pole are akinetic-rigid syndromes, such as Parkinson's disease, and at the other are involuntary movements, such as tremor, myoclonus, dystonia, chorea, and tics. Movement disorders stem from complex and poorly understood pathophysiologic processes that occur in the central nervous system. The most valuable tool in evaluating clinical movement disorders is the

trained human eye that, together with the clinical history, provides an accurate diagnosis in most cases.

Clearly, reliance on diagnosis by visual inspection is not always sufficient. Although observation is excellent for perceiving the overall pattern of movement, it is less proficient in discerning the fine details of movement, such as timing (Which body part moved first?) and regularity (Is the movement tremulous or irregular?). At times, details such as these are critical in diagnosis. Also, experimental studies in motor control demonstrate clearly

that the brain, spinal cord, and musculoskeletal system are able to produce a specific movement with a large number of different motor patterns. As a practical example, rapid elbow flexion may result from either a brief, isolated contraction of the biceps muscle or prolonged activity of the biceps and triceps muscles. In this example, identification of the underlying motor pattern may distinguish myoclonus from dystonia.

Noninvasive clinical neurophysiology techniques provide information that complements and extends the clinical examination. Surface electromyography (EMG) is the most important of these techniques, but other useful tests include electroencephalography (EEG), EEG–EMG polygraphy with back-averaging, and elicited responses that include evoked potentials and certain other reflex responses. Multichannel EMG studies map the temporal pattern of movement with a resolution measured in milliseconds. Furthermore, the surface EMG reflects not only alpha motor neuron activity but also, by inference, specific abnormal central commands that underlie a movement disorder. Patterns of abnormal and normal findings for certain movement disorders are well described, and these characteristics can be used as supportive evidence for a more specific movement disorder diagnosis and/or origin.

### **Purpose and Role of Movement Disorder Clinical Neurophysiology**

- Additional sensitivity and accuracy to clinical assessment of movement disorders.
- Typical neurophysiology pattern confirms type of certain movement disorders.
- Identifies the source of certain movement disorders.

## **TECHNIQUES**

### **Surface EMG**

Surface EMG studies are noninvasive and are within the capability of any EMG laboratory. Surface EMG recording can be performed with any high-quality disk electrodes. We find

disposable adhesive Ag/AgCl ECG electrodes convenient because they can be applied rapidly when multiple muscles are recorded. The patient should be asked about any type of adhesive allergies that he/she has had. After the skin has been cleansed and mildly abraded, the electrodes are placed 2–3 cm apart over the motor point of the muscle and oriented parallel to the course of the muscle fibers. Special care should be given to older individuals with thin skin and those who are anticoagulated. The iliac crest provides a relatively inactive site for the ground electrode. Electrode impedances should be below 5 k $\Omega$  to get high-quality recording, but higher impedances may be acceptable if the surface EMG signal is devoid of artifact (e.g., 60 Hz).

A technical limitation of surface EMG studies is the lack of selectivity. The activity of a *single* muscle is never actually recorded because adjacent muscles inevitably contribute “cross talk” to the signal through volume conduction. This effect is minimized by use of short interelectrode distances and by recording from relatively superficial and isolated muscles, such as the biceps, deltoid, quadriceps, tibialis anterior, or first dorsal interosseus. At times, a group of muscles, such as the forearm flexors or extensors, are intentionally recorded.

The quality of the surface EMG signal must be assessed carefully before analysis. This signal represents the interference pattern of multiple motor units with high frequencies filtered out by the intervening skin and subcutaneous tissue. Deep muscles, such as the gluteus maximus or any muscle in an obese person, may produce a signal that is too degraded for analysis. The frequency spectrum of the signal contains power throughout the range between 1 and 1000 Hz, with maximal power at approximately 100 Hz. In practice, a low-frequency filter cutoff of 1–30 Hz is used to eliminate the unwanted effects of DC potential and low-frequency movement artifact. A high-frequency filter setting of 200–3 kHz passes the important high-frequency components of the signal. The amplification factor is set arbitrarily to display a maximal voluntary contraction that fills the amplifier range without blocking. After the EMG signal has been collected, it may be displayed as the raw interference pattern or digitally processed to

display a full-wave rectified signal or smoothed EMG envelope. In addition to correlating abnormal movements with EMG activity, it is important to note discharge duration, variability, and timing relationships between muscles. The amplitude of the bursts is extremely variable and rarely useful in routine clinical studies.

If a study demands highly selective recording, intramuscular electrodes must be used. Electrodes fashioned from fine wire are useful for this purpose. Pairs of wires are inserted into the selected muscle through a hypodermic needle that is then withdrawn. After the electrodes are in position, they remain stable for many hours and resist displacement by even vigorous body movement. When selective recording is needed for only short recording periods, standard concentric or monopolar needle recording may be suitable. In any situation, the improved selectivity of intramuscular recording must be balanced against the added discomfort to the patient. For some movement disorders (e.g., tremor), accelerometry is a useful addition to EMG recording for frequency measurements.

Recording samples should be taken during rest, postural activation (e.g., arms outstretched), kinetic activation (e.g., finger to nose), functional tasks (e.g., drinking from a cup, handwriting), and mental activation (e.g., counting backward), and while performing associated movements (e.g., contralateral repetitive hand movements). The condition or state(s) that are known to bring out the movement disorder should be emphasized. This may include sleep.

## EEG

EEG electrodes are recorded from the standard 10–20 positions. These same positions may be used as for routine clinical recordings, but if some positions are sacrificed in order to make room for surface EMG channels, then the frontal, central, parietal, and midline positions should be a minimum as they are usually the most active in movement disorders. EEG is very useful for correlating the state of consciousness with abnormal movement. Any EEG abnormality seen may have important diagnostic implications for

the movement disorder, but paroxysmal abnormalities (e.g., epileptiform) are particularly relevant.

## EEG–EMG Polygraphy with Back-Averaging

The neurophysiologic evaluation of movement disorders is enhanced by simultaneous recording of EEG, surface EMG, and other modalities. This allows the potential detection of specific relationships between different types of physiological activity. Reflex activation by touch, deep tendon reflex, mixed nerve stimulation (median, tibial), light, sound, and digital nerve stimulation can be examined this way, and it is useful to add a channel to monitor the stimulus production. If available, back-averaging can be performed by marking the beginning of an EMG event or stimulus. This may be done online or offline. Epochs are then defined with time included both before and after the event marker (or trigger). The averaging of these epochs reduces the signal-to-noise ratio and allows detection of time-locked relationships between waveforms of the same or different modalities. The larger number of epochs used in the calculation, the more likely a smaller waveform will be discernable. A minimum of 100 epochs to show a time-locked relationship between EEG, EMG, and other events is usually adequate. However, the result of the waveform averaging should be critically evaluated for its reproducibility, signal-to-noise ratio, and its ability to be interpreted across all electrodes being used.

## Elicited Responses

Evoked potentials and surface EMG responses to stimulation may be performed by standard techniques. The reader is referred to the chapters dealing with these topics. The choice of what type of elicited response to test for is dictated by the known abnormalities in various movement disorders. The somatosensory evoked potential (SEP) and long-latency surface EMG reflexes are the most common.

**Key Points**

- Multiple neurophysiology techniques are available to noninvasively study movement disorders.
- The particular techniques used will depend on the movement disorder being studied and the presentation of that movement disorder in that specific patient.

**SURFACE EMG: NORMAL PATTERNS**

Three normal patterns of surface EMG activity are recognized: *reflex*, *tonic*, and *ballistic* (Fig. 33–1). Reflex activity, such as the monosynaptic tendon jerk, produces brief, synchronized discharges of alpha motor neurons. The surface EMG appearance of this discharge is a short (10–30 ms) burst of activity in agonist and, at times, antagonist muscles. This reflex pattern is an involuntary response to stimulation. Indeed, most persons are unable to generate voluntarily bursts that have this short duration. However, voluntary movement produces two types of EMG patterns. When a person moves a limb slowly or holds it in a static posture, a *tonic pattern* results. This pattern consists of a continuous and steady EMG discharge, often with cocontraction of agonist and antagonist muscles. Cocontraction is a normal mechanism of motor control that increases the stiffness, or resistance, across a joint. By contrast, when one wills a very rapid movement of a joint, a *ballistic pattern* develops. An initial agonist burst of 50–100 ms duration leads the pattern, followed by an antagonist burst

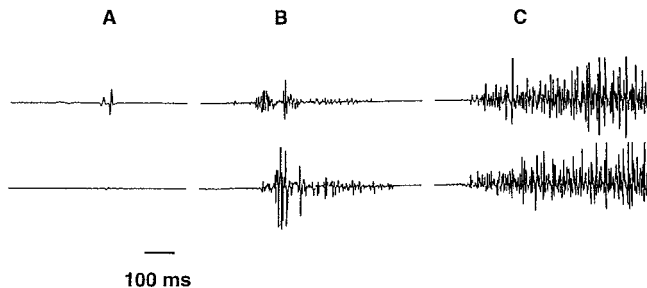
of 50–100 ms duration and a silent period in the agonist. A final agonist burst usually completes the EMG activity. The triphasic pattern appears to be fundamental to the motor control of ballistic limb movements.<sup>1</sup> The theory explaining this is that the initial agonist burst scales the size of the ballistic movement, the antagonist burst brakes the limb, and the final agonist burst determines its destination. Ballistic (or phasic) and tonic patterns are best thought of as two poles on a spectrum of voluntary movement. Most of the time, normal surface EMG activity consists of varying superimposed combinations of ballistic or phasic and tonic muscle activation at any one instant and is coordinated as needed across different muscle segments. Movement disorders reflect abnormal involuntary partial or complete alteration of these patterns

**Key Points**

- The three basic types of normal human movement are reflex, tonic, and ballistic.
- These basic types do appear in movement disorders but in abnormal ways and circumstances.

**TREMOR**

*Tremor* is an oscillation of one body part in relation to another body part that is approximately sinusoidal and rhythmic. The three sources of tremor are mechanical, reflex, and a central oscillator. All physical objects oscillate at a resonant frequency related to their inertia and stiffness. Because body parts are physical



**Figure 33–1.** The three normal surface EMG patterns: A, reflex pattern; B, triphasic pattern; and C, tonic pattern. *Upper trace*, agonist muscle; *lower trace*, antagonist muscle.

objects, they have a resonant frequency. In addition, muscles are connected to the central nervous system through peripheral nerve reflex loops, which oscillate at varying frequencies. Also, areas of the central nervous system oscillate spontaneously, possibly producing rhythmic motor activity in the related body part. The contribution of all three of these sources can contribute to the clinical phenomenon of tremor.

In tremor, surface EMG discharges reflect the oscillating positive and negative influences on the intended voluntary activation or resting state. The surface EMG of tremors records the grouping of motor unit potentials as discrete bursts of activity.<sup>2</sup> Analysis of these EMG bursts helps to establish whether a movement is truly tremulous. Disorders such as phasic dystonia may appear regular on visual inspection but be shown to be irregular when measured on an EMG recording. Conversely, a low-frequency tremor with some irregularity may appear so jerky as to be myoclonus.

## Recording Techniques

Electrodes are placed over the agonist and antagonist pairs of muscles both including and just beyond the tremor distribution. For hand tremor, forearm flexors and extensors are most active and care must be taken to eliminate cross talk between the signals by electrode positioning, because this technical error may lead to misinterpretation. Amplitude of the tremor bursts is assessed in various limb positions. Tremors are grouped into those occurring at rest and those occurring with action. *Action tremors* are further subdivided into *postural tremors* (a body part maintains a position against gravity), *isometric tremors* (muscle contraction against a stationary object), *simple kinetic tremors* (nontarget-directed voluntary movement), and *intention tremors* (at the termination of a target-directed movement).<sup>3</sup> *Task-specific tremors* are those seen during a defined activity such as handwriting. The frequency should be noted for every distribution and activation state. Another variable used in tremor analysis is the pattern of agonist–antagonist firing. One muscle may fire while the other is

silent, in an alternating or reciprocal pattern. In other tremors, the pair may fire simultaneously in a synchronous or cocontracting pattern. Occasionally, the EMG pattern may shift from one pattern to another during the period of recording. It is more common to see different patterns in different conditions, such as reciprocal during rest and more synchronous firing during muscle activation. Long-term EMG-based automated analysis may be helpful in separating parkinsonian tremor from essential tremor.<sup>4</sup>

## Abnormal Patterns

Abnormal patterns of neurophysiologic findings are seen with the various types of tremor (Fig. 33–2 and Fig. 33–3). The clinical and electrophysiologic features of the different forms of tremor are summarized in Table 33–1.

### EXAGGERATED PHYSIOLOGIC TREMOR

Even normal subjects have a fine, often imperceptible tremor when holding part of the body in a static posture. *Physiologic tremor* is primarily a mechanical tremor, but in some persons a central 6–12 Hz oscillator may have a role.<sup>5,6</sup> The mechanical portion of normal physiologic tremor shows no oscillating surface EMG discharges. However, placing weights on the body part shifts the frequency of the mechanical component lower. Under circumstances that increase catecholaminergic secretion, such as anxiety, fatigue, hypothermia, hypoglycemia, thyrotoxicosis, or pheochromocytoma, physiologic tremor increases in amplitude and becomes visible. In this state, known as *exaggerated physiologic tremor*, underlying surface EMG activity emerges through reflex activation. This may consist of a low-grade interference pattern or synchronous bursts of 50–100 ms duration and a frequency of 8–12 Hz. This pattern is often best recorded in distal upper extremity muscles, such as finger extensors and flexors.

### ESSENTIAL TREMOR

*Essential*, or *familial*, tremor is the most common movement disorder. It is usually

Table 33-1 Classification of Tremor by Localization and Electrophysiologic Features

Tremor type	Activation	Dominant frequency	Pattern of firing	Other features
Physiologic	Postural	6-12 Hz	Regular	Exacerbated anxiety, fatigue, hypothermia, hypoglycemia, thyrotoxicosis, pheochromocytoma
Essential	Postural or kinetic	4-12 Hz (5-8 Hz most common)	Regular	
Parkinsonian	Rest (may be postural after 20 seconds of activation)	4-7 Hz	Regular	
Cerebellar	Kinetic	<5 Hz	Irregular	Most prominent toward termination of movement
Holmes	Rest to postural activation or posture to kinetic movement	<4.5 Hz	Irregular	
Task-specific	Specific tasks (e.g., writing)		Irregular	
Orthostatic (shaky leg syndrome)	Standing or stretching legs	13-18 Hz	Regular	May be present in arms
Palatal	Rest	1-3 Hz	Regular	
Psychogenic	Widely variable	Widely variable	Irregular	

a bilateral, symmetrical, postural, or kinetic tremor involving the upper extremities. Additional or isolated head tremor may also occur.<sup>3</sup> The voice can also be affected. Essential tremor is thought to result from a central oscillator (an often suggested but unproven candidate involves cerebellar and brain stem pathways).<sup>6</sup> The surface EMG usually shows bursts of activity that are synchronous in agonist and antagonist muscles, with a possible frequency range of 4-12 Hz and 5-8 Hz being the most common. Of interest, the frequency of essential tremor declines with age.<sup>7</sup> When the tremor is severe, less prominent activity while the limb is at rest may be recorded.

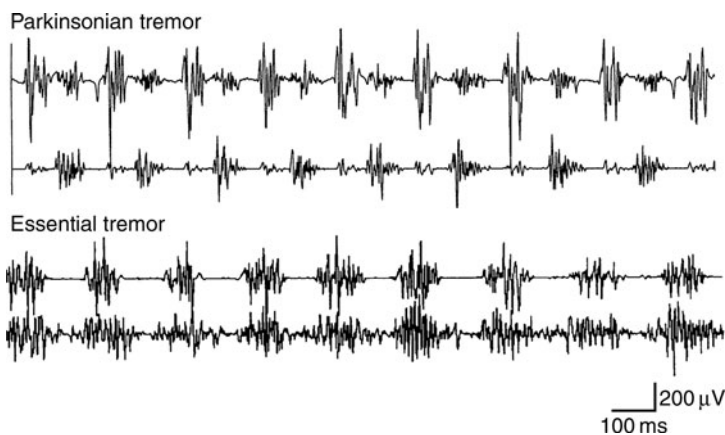
Sabra and Hallett<sup>8</sup> have reported patients with essential tremor who clearly had an alternating EMG pattern. This group of patients appeared to have a tremor that was

slower in frequency and poorly responsive to propranolol. Milanov<sup>9</sup> has reported that the alternating pattern is more common than previously believed. This dictates caution in diagnosing tremor on the basis of a single EMG characteristic. Additionally, although essential tremor is commonly thought of as a postural tremor, electrophysiologic studies have shown that the kinetic component may be more prominent than a static postural component.<sup>10</sup> The surface EMG findings in neuropathic tremor are identical to those in essential tremor.

#### PARKINSONIAN TREMOR

Tremor commonly accompanies akinetic-rigid syndromes such as Parkinson's disease.





**Figure 33-2.** Essential and parkinsonian tremor recorded from antagonistic muscles. Note that in essential tremor the muscle contractions are simultaneous, while in parkinsonian tremor they are alternating. (Courtesy J. Matsumoto.)

Clinically, parkinsonian tremors appear maximal at rest and attenuate with action. The dominant frequency is 4–7 Hz. Surface EMG studies of parkinsonian tremors demonstrate an alternating pattern of contraction that is constant through the period of recording (Fig. 33-2). Burst durations are typically in the range of 50–100 ms. The frequency of the bursts varies little through the period of the recording. The regularity of the tremor increases as the disease progresses.<sup>11</sup> Static postures initially attenuate the burst amplitudes; however, when such postures are held for 20 seconds or longer, the tremor bursts may reappear (“re-emergent tremor”). The frequency of the postural or kinetic component is usually the same as the rest component, but sometimes it can be substantially (1.5 Hz) higher. This may be the case in patients who have essential tremor alone and in those with parkinsonism.<sup>3</sup>

### CEREBELLAR TREMOR

*Cerebellar tremor* occurs with kinetic and intention limb movements. It is most prominent toward the termination of the movement. The tremor frequency is mainly less than 5 Hz, and the distribution may be distal, proximal, or both. Postural tremor may also be present. Serial dysmetria is often confused with intention tremor. In dysmetria, surface EMG studies indicate that the terminal movements are not the regular oscillations of tremor but

rather a series of inaccurate, irregular ballistic movements.

### HOLMES TREMOR

*Holmes tremor* (also known as *rubral tremor*, *midbrain tremor*, *thalamic tremor*, or *myorhythmia*) increases while going from rest to postural activation and from postural activation to kinetic or intention movement. This tremor occasionally has an irregular presentation. Holmes tremor frequency is usually less than 4.5 Hz and often associated with a recognized pathologic insult (e.g., infarct or demyelinating plaque), in which case a delayed onset (weeks to 2 years) is common.<sup>3</sup>

### TASK- AND POSITION-SPECIFIC TREMOR

Several tremors occur only with specific tasks or positions. The classic example is *primary writing tremor*. Although this tremor is predominant during writing, it often spills over into other activities such as eating or grooming. The surface EMG correlate consists of bursts of 100 ms duration that occur maximally in the pronator teres, supinator, or wrist flexors and extensors. The pattern may be synchronous or alternating. Taps to the forearm, particularly in a direction that produces supination of the forearm, may stimulate bursts of tremor. *Isolated voice tremor* is another example. It is not known whether these tremors represent a form

of essential tremor or dystonia or have another cause.<sup>3</sup>

### ORTHOSTATIC TREMOR (SHAKY LEGS SYNDROME)

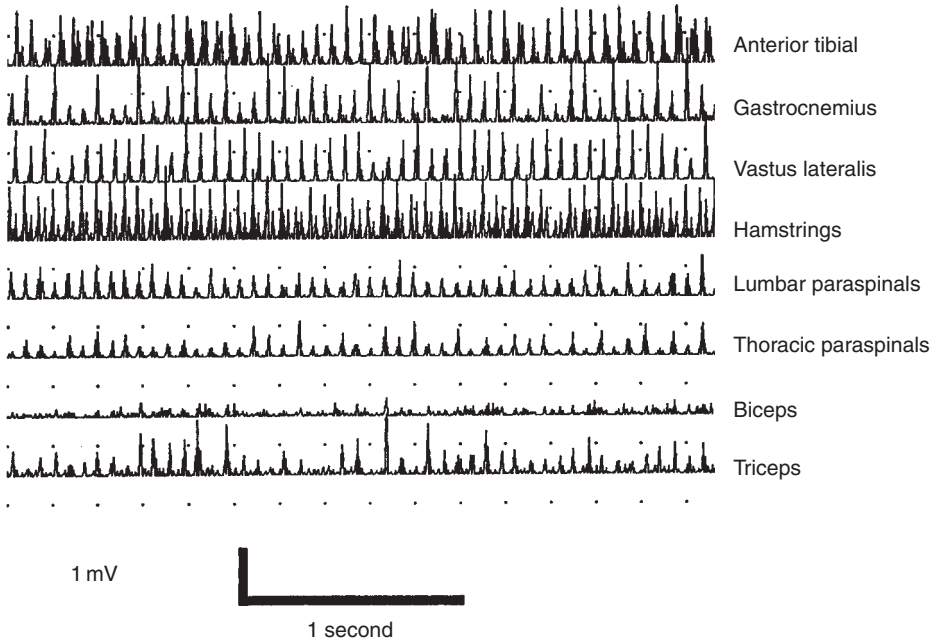
Heilman<sup>12</sup> has described a distinctive tremor, called *orthostatic tremor*, that occurs predominantly in the elderly. Patients may complain of quivering, vibration, or “shaking” in their legs shortly after they stand. This may cause a sense of instability so severe that walking becomes difficult. The surface EMG pattern is distinctive and displays high-amplitude 13–18 Hz tremor bursts (Fig. 33–3). Because of the rapid frequency, this diagnosis can be difficult to make on the basis of clinical observation. A surface EMG study is often the only way to make the definitive diagnosis. The bursts are recorded in the legs and paraspinal muscles, with the patient standing. The agonist–antagonist relationship may vary during the recording. At rest, the legs are electrically silent. Tremor discharges may be present with the legs outstretched while sitting and also may be present in the arms.

### PALATAL TREMOR

*Palatal tremor* is a rhythmic, involuntary movement that causes palatal elevation. At times, it may spread to involve tongue, neck, facial, and even limb muscles. Palatal EMG activity is detected with surface electrodes linked to the mastoid processes or placed on the anterior neck. Bursts recur at a regular frequency of approximately 1–3 Hz. Palatal tremor can stem from a symptomatic lesion, with associated olivary hypertrophy, or it can be essential in nature. Rhythmic movements of the levator veli palatini muscles cause the symptomatic palatal tremors, but the essential palatal tremors involve mainly the tensor veli palatini. Involvement of the latter muscle often causes an audible ear click to the patient. The term *palatal myoclonus* is reserved for when the movements are irregular and do not resemble a sinusoidal pattern.

### PSYCHOGENIC TREMOR

Occasionally, tremor may have a pattern that is atypical, and a conversion disorder or malingering is suspected. Surface EMG can provide supportive evidence only by demonstrating a



**Figure 33–3.** Orthostatic tremor. Surface EMG activity recorded with the patient standing and rectified for display. Tremor activity at approximately 15 Hz is recorded maximally from the leg muscles.

pattern that does not correspond to any of those described above. Psychogenic tremors tend to be paroxysmal, have inconsistent activation states, and seldom display a dominant frequency throughout a prolonged recording. Indeed, the tremor frequency and amplitude tend to vary widely with time, change of position, or distraction. However, diagnostic proof for a psychogenic or voluntary origin for a tremor cannot be offered. When such classic psychogenic features are not present, psychogenic tremors can show surface EMG patterns that overlap with those patterns discussed above, thus limiting the diagnostic utility of surface EMG for psychogenic tremors.

### Key Points

- Surface EMG discharges record bursts of motor unit potentials that reflect the oscillating positive and negative influences on the intended voluntary activation or resting state.
- Surface EMG can demonstrate or confirm regularity and agonist–antagonist relationships more clearly than visual inspection.
- Surface recording of tremor uses electrodes placed over agonist and antagonist muscles; their frequency and pattern of agonist–antagonist firing are used to classify the tremor.
- Different clinical types of tremor demonstrate characteristic frequency but there is considerable overlap.
- Exaggerated physiologic tremor consists of bursts of 50–100 ms duration at a frequency of 8–12 Hz, most often recorded in the distal upper extremity.
- Essential tremor demonstrates bursts of activity at 4–12 Hz frequency.
- Parkinsonian tremor is recorded maximally at rest and has a dominant frequency of 4–7 Hz; the burst frequency varies little during the recording.
- Cerebellar tremor is usually less than 5 Hz in frequency and is most prominent when recording toward the termination of movement.
- Holmes tremor (midbrain tremor) increases during activation of the limb and is occasionally irregular, with frequencies less than 4.5 Hz.
- Task-specific tremor occurs only in certain positions.
- Orthostatic tremor (shaky leg syndrome) demonstrates high-amplitude bursts at 13–18 Hz frequency.
- Psychogenic tremor tends to be paroxysmal, has inconsistent activation states, and rarely displays a dominant frequency throughout a prolonged recording.

## MYOCLONUS

Myoclonus is a clinical sign defined as sudden, brief, shock-like, involuntary movements caused by muscular contractions or inhibitions.<sup>13</sup> Muscular contractions produce “positive myoclonus,” whereas muscular inhibitions produce “negative myoclonus” or asterixis. Myoclonic movements have now been recognized to have many possible etiologies, anatomical sources, and pathophysiologic features.<sup>2</sup> Myoclonus may be classified by examination findings, presentation, etiology, and clinical neurophysiology testing. Important exam findings are activation state(s) and distribution. They may be *focal* (involving only a single limb or area), *multifocal* (affecting more than one body part in a random, independent fashion), *generalized* (involving all body parts simultaneously), or *segmental* (involving only muscles of a given cranial or spinal segment).

The best method to organize the possible clinical presentations and etiologies of myoclonus is by using the major clinical syndrome categories of Marsden et al. and their corresponding lists of known etiologies.<sup>14</sup> The Marsden et al. clinical syndrome categories are (1) *physiologic myoclonus* includes motor phenomena such as hiccups, hypnic jerks, and the startle response, which have the appearance of myoclonus but occur in normal subjects; (2) *essential myoclonus* designates disease in which abnormal muscle jerks are the primary feature of the illness; (3) *epileptic myoclonus* refers to myoclonus in the setting of epilepsy; and (4) *symptomatic myoclonus* represents all other disease states in which myoclonus occurs as a sign, often in the setting of diffuse neuropathology.

The goal for clinical neurophysiology study of myoclonus is to classify its origin and physiological properties<sup>15</sup> (Table 33–2). If successful, this information is valuable in the diagnosis and treatment of myoclonus. Major

**Table 33–2 Classification of Myoclonus by Localization and Electrophysiologic Features**

<b>Localization</b>	<b>Clinical features</b>	<b>Burst duration</b>	<b>EEG abnormalities</b>	<b>Time-locked cortical potentials</b>	<b>Etiologies</b>
<b>CORTICAL</b> Cortical Reflex Myoclonus	Focal, multifocal, or generalized	50 ms	Yes  Focal spike with EEG back-averaging (precedes myoclonus by 6–22 ms in upper extremity)	Yes—Precedes myoclonus by short latency  Enlarged cortical SEP waves Reflex-induced myoclonus Enhanced long-latency EMG response (40–60 ms) to electrical stimulation	Posthypoxia Lance–Adams syndrome Progressive myoclonic epilepsy syndromes Toxic and drug induced
Cortical origin myoclonus without reflex activation	Focal, multifocal, or generalized	50 ms	Yes Focal transient with EEG back-averaging	No enlarged cortical SEP waves No reflex-induced myoclonus No long-latency EMG response to electrical stimulation	Parkinson’s disease Dementia with Lewy bodies Drugs
Focal motor seizures	Focal	<100 ms	Yes Focal spike, spike-and-wave, sharp wave, rhythmic theta or delta, or PLEDs		
Myoclonus in Alzheimer’s disease	Multifocal or generalized	<100 ms	Yes, but not always time-locked	Variable enlarged cortical SEP waves Variable long-latency EMG response to electrical stimulation	

*(Continued)*

Table 33–2 (Continued)

Localization	Clinical features	Burst duration	EEG abnormalities	Time-locked cortical potentials	Etiologies
Myoclonus in Creutzfeldt–Jakob disease		<50 ms	Yes; variable correlation of sharp waves with myoclonus	Variable enlarged cortical SEP waves Variable long-latency EMG response to electrical stimulation	
Myoclonus with subacute sclerosing panencephalitis		>200 ms	Yes; high-voltage polyphasic sharp and slow wave complexes (500–2000 ms duration, every 4–15 seconds)		
Myoclonus in corticobasal degeneration		25–50 ms	No	Long-latency EMG response at 40 ms to median nerve stimulation	
Asterixis		50–200 ms (EMG silence)			
CORTICAL– SUBCORTICAL	Occurs in paroxysms at rest  Generalized, bilaterally synchronous, focal, or multifocal	Yes			Absence seizures Primary generalized myoclonic seizures
SUBCORTICAL– SUPRASEGMENTAL		Longer	No	No	
Essential myoclonus	Agonist only or agonist–antagonist cocontraction  Irregular in amplitude, duration, and timing	50–200 ms	No	No	
Reticular reflex myoclonus	Generalized jerks at rest	<50 ms	Yes; variable	No	Posthypoxia

(Continued)

Table 33–2 (Continued)

Localization	Clinical features	Burst duration	EEG abnormalities	Time-locked cortical potentials	Etiologies
	Stimulus sensitive	Simultaneous, bilaterally rostral and caudal recruitment			Uremia
Opsoclonus–myoclonus	Multifocal Predominantly induced by action	< 100 ms Occur in trains	No	No	
Propriospinal myoclonus	Trunk flexion or extension At rest or stimulus-activated	50–300 ms	No	No	
SEGMENTAL	Frequency of 0.5–3 Hz	50–500 ms	No	No	Palatal myoclonus
PERIPHERAL	Focal	Variable	No	No	Hemifacial spasm

categories of the physiological classification used here primarily refer to the neuroanatomic source of the myoclonus physiology types. Further subdivision is based on other physiological properties as well as the clinical syndrome and/or the specific disease in which the myoclonus occurs. In practical terms, the classification for a particular example of myoclonus is derived from the clinical neurophysiological findings as well as an appreciation of the clinical context in which they occur. The main physiological classification categories for myoclonus are (1) *cortical*, (2) *cortical–subcortical*, (3) *subcortical–suprasegmental*, (4) *segmental*, and (5) *peripheral*.<sup>16</sup> One should be aware that multiple myoclonus physiology types might occur in the same patient. Physiological classification can assist with distinguishing types of etiologies between and within the major clinical syndrome categories.

## Recording Techniques

Multiple clinical neurophysiology techniques should be applied to the patient with myoclonus. A routine EEG is appropriate to capture

the full pattern of any epileptogenic discharges and other EEG abnormalities. Ideally surface EMG should be combined with simultaneous EEG recording (EEG–EMG polygraphy) for correlation and EEG–EMG back-averaging. Offline trigger placement for averaging is ideal to choose epochs with typical myoclonus EMG discharges and no artifact. Online averaging (“jerk-locked averaging”) may be performed with a motion detector (e.g., accelerometer) or a rectified EMG window detector. Besides assessment of individual myoclonus EMG discharges, it is useful to inspect the average rectified myoclonus EMG discharges to determine time-locked relationships between different muscles. All clinically apparent activation states should be collected for further analysis. Evoked potentials, at least median SEPs, should be obtained. Long-latency EMG reflexes to median and/or tibial nerve stimulation should be done.

## Abnormal Patterns

Abnormal patterns of neurophysiologic findings are seen with the various types of



myoclonus. The clinical and electrophysiologic features vary according to the generator sites of the myoclonus (Table 33–2).

## CORTICAL

The cerebral cortex is the most common origin for myoclonus. The jerks are most often multifocal; but focal, segmental, and generalized myoclonus can also occur. Action myoclonus is very common in these patients and provides most of the disability. At rest, myoclonus usually will be less prominent. Myoclonus induced by reflex stimulation is common, and its characterization is important for physiological classification. A common presentation is to have myoclonus with a combination of action and reflex precipitants, and presence at rest. The vast majority of cortical myoclonus patients have one or more of the three major cortical physiology types: (1) cortical reflex myoclonus, (2) cortical origin myoclonus without reflex activation, and (3) focal motor seizures. More unusual physiological descriptions have been reported for Alzheimer's disease, Creutzfeldt–Jakob disease, subacute sclerosing panencephalitis (SSPE), corticobasal degeneration, and asterix. All of these physiological descriptions of cortical origin myoclonus will be discussed below.

### *Cortical Reflex Myoclonus*

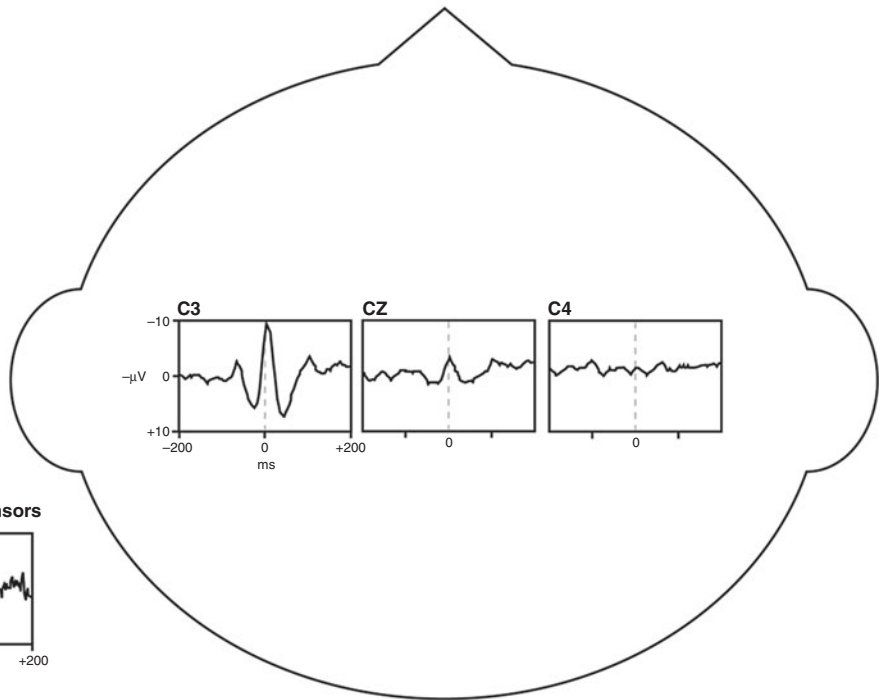
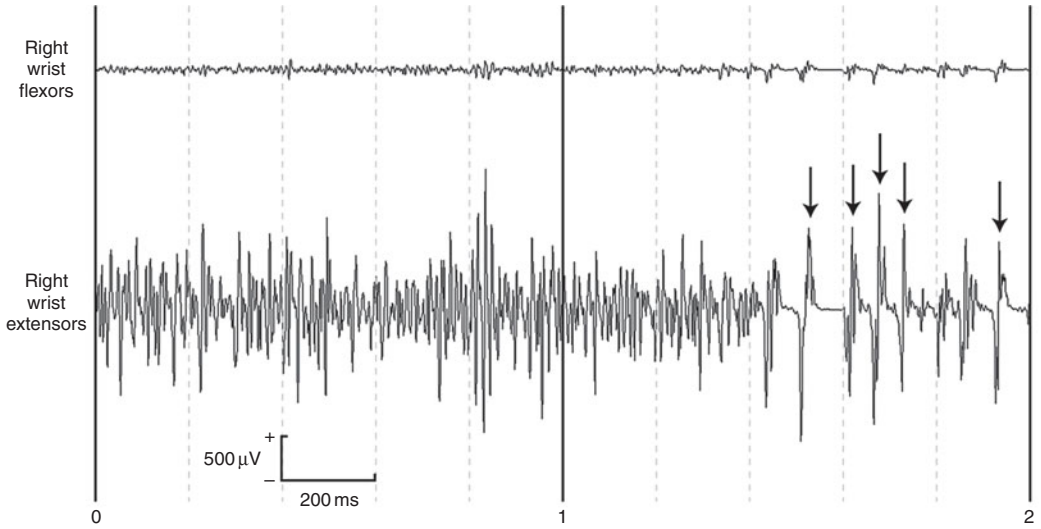
This type of cortical myoclonus physiology is the predominant type in posthypoxic myoclonus or Lance–Adams syndrome, progressive myoclonus epilepsy syndromes, toxic and drug-induced myoclonus, and many other etiologies. Cortical reflex myoclonus is defined by the demonstration of a focal time-locked cortical transient that precedes the myoclonus by a short latency (<40 ms for arm) in association with evidence for exaggerated reflex cortical phenomena. This may include one or more of the following: (1) enlarged cortical SEP waves, (2) reflex-induced myoclonus, and (3) enhanced long-latency EMG responses to electrical nerve stimulation.

Although spikes and/or sharp waves are sometimes present in the gross EEG, back-averaging of the EEG–EMG polygraph is the preferred method for demonstrating a time-locked cortical transient preceding a myoclonus EMG discharge. Although such

patients usually have reflex jerks, it is usually easier to collect many myoclonus events by muscle activation of the limb. The back-averaged transient is typically a focal, biphasic, or triphasic spike beginning with a positive deflection that precedes the onset of the myoclonic discharge by 6–22 ms in the upper extremity: the more distal muscle the myoclonus is recorded from, the longer the time interval.<sup>17</sup> The duration of the transient is 15–40 ms. The conduction of the spike to motor neuron pools is presumed to occur by corticospinal (pyramidal) pathways. The maximum of the transient is usually located over the sensorimotor cortex at the central or centro-parietal electrode according to anatomical somatotopic mapping, contralateral to the myoclonus EMG discharge (Fig. 33–4).

Enlargement of the cortical SEP P25–N33 parietal wave from median nerve stimulation is an important evidence for cortical reflex myoclonus physiology. The enhanced early cortical components of the giant SEPs may be generated by the somatosensory and primary motor cortices.<sup>18</sup> The establishment of normal values for a particular laboratory is encouraged with consistent methods and electrode derivations being used. Shibasaki et al. published an upper limit for P25–N33 amplitude at the postcentral electrode of 8.6  $\mu\text{V}$  using an ear reference, Ugawa used 10.8  $\mu\text{V}$  with Fz reference, and the normal upper limit value in our laboratory is 11.1  $\mu\text{V}$  with Fz reference.<sup>19,20</sup> Sometimes the cortical SEP waves are “giant” and deviate from the morphology and distribution seen in normal individuals. The definition of “giant” SEP is arbitrary but >20  $\mu\text{V}$  is a commonly used value. In addition to the P25–N33 wave, the parietal N20–P25 and/or frontal P22–N30 are enlarged less often.

In most cases, abnormal long-latency EMG discharges are elicited by median nerve stimulation that shows EMG discharges at 50-ms latency or greater (range 40–60) from the stimulus artifact trigger mark.<sup>17</sup> Repetitive discharges may be seen, at intervals of 20–40 ms.<sup>21</sup> At rest, in a normal individual, no response should be present. Care must be taken that the arm muscles are relaxed so as to avoid a false positive response. Brown et al. found that intrahemispheric and interhemispheric spread in a grossly somatotopic fashion from a focus



**Figure 33-4.** *Top*, EMG polygraphy of right forearm muscles showing tonic EMG followed by myoclonus EMG discharges (*arrows*). *Bottom*, EEG-EMG back-averaging of myoclonus EMG discharge. Back-averaged focal EEG transient present over left sensorimotor cortex area (electrode C3).

in one hemisphere can produce these bilateral and/or generalized jerks.<sup>22</sup> Because of the fast spread, the clinical jerking appears almost synchronous. Cortical tremor refers to relatively rhythmic distal upper extremity EMG discharges during action at approximately 9 Hz and duration around 50 ms.<sup>23</sup> Despite the phenotypic designation of “tremor,” these discharges were found to fit all the criteria of cortical reflex myoclonus physiology.

### ***Cortical Origin Myoclonus Without Reflex Activation***

The establishment of cortical reflex myoclonus as a distinct cortical physiology was an important step for the study of myoclonus mechanism. However, it has become apparent that myoclonus may have a focal time-locked cortical transient that precedes the myoclonus but is unassociated with clinical reflex myoclonus, enhanced long-latency EMG responses to electrical nerve stimulation, or enlarged cortical SEP waves. This physiology has been seen with myoclonus occurring in Parkinson's disease, dementia with Lewy bodies, hereditary diffuse Lewy body disease, drugs, and other conditions.<sup>24</sup>

### ***Focal Motor Seizures***

There are a variety of ictal EEG changes that may be seen in the contralateral motor area corresponding to a focal motor seizure manifestation. Repetitive focal spike, spike-and-wave, sharp wave, rhythmic theta or delta activity, or desynchronization may occur. In many cases, no grossly observable EEG activity is seen, and back-averaging may uncover a transient in some of those cases. In the case of epilepsy partialis continua, the above-mentioned transients will be periodic and may even occur in the pattern of periodic lateralizing epileptiform discharges (PLEDS). The EMG discharge duration is usually less than 100 ms.

### ***Alzheimer's Disease***

The myoclonus in Alzheimer's disease is usually multifocal, although it can be generalized. A few different electrophysiological patterns of myoclonus have been described in

Alzheimer's disease.<sup>25</sup> The gross EEG can show background slowing and abnormal slow waves. Focal sharp waves or sharp and slow waves may occur. Periodic or quasiperiodic sharp waves sometimes occur with similarity to Creutzfeldt–Jakob disease. The relationship of these gross EEG changes and events to myoclonus is usually not clear. The myoclonus EMG discharges are less than 100 ms, and may occur in an agonist-only pattern or with cocontraction in antagonists and other muscles. Enlargement of the cortical SEP waves and the presence of long-latency EMG responses to median nerve stimulation are variable. The most commonly reported instance is a focal contralateral central negativity with onset 20–40 ms premyoclonus EMG latency and 40–80 ms duration, but longer premyoclonus EMG latencies with longer and more widely distributed EEG waves occur.

### ***Creutzfeldt–Jakob Disease***

The myoclonus in Creutzfeldt–Jakob disease can occur in early, middle, or late stages. EEG findings often show abnormal slow and/or suppressed background and generalized periodic sharp wave discharges. The EMG duration is <50 ms and an agonist-only pattern or with cocontraction in antagonists and other muscles is observed. There is a variable correlation between the timing of the myoclonus and the sharp wave discharges on routine EEG. When back-averaging is used, a broadly distributed contralateral negative transient is seen.<sup>26</sup> This EEG correlate has 100–160 ms duration and latency to the myoclonus EMG discharge of 50–85 ms. Enlargement of the cortical SEP waves and enhanced long-latency reflexes is variable.

### ***Subacute Sclerosing Panencephalitis***

These patients can show periodic movements that appear as a jerk followed by a momentary sustained position and then gradually melt away to the static position. These movements often occur in the upper extremities. An EMG burst duration of greater than 200 ms can be seen for this “dystonic myoclonus” of SSPE. In contrast to Creutzfeldt–Jakob disease, the jerks have a consistent relationship to periodic complexes on routine EEG. These complexes

consist of high voltage (300–1500  $\mu\text{V}$ ), repetitive, polyphasic, and sharp and slow wave complexes ranging from 500 to 2000 ms in duration, usually recurring every 4–15 seconds or sometimes longer. The complex nature of the discharge makes it difficult to measure latency between the EEG discharge and the jerk EMG discharge. The complexes are typically widespread and synchronous. The SEP and long-latency EMG responses have not been adequately studied in SSPE. A slow negative potential shift has been found to precede the jerk and EEG complex.<sup>27</sup>

### ***Myoclonus of Corticobasal Degeneration and Parkinson's Disease***

Myoclonus is an important feature of corticobasal degeneration and occurs in 50% of cases. Its clinical presentation parallels that of the overall syndrome including a focal distribution in the arm (sometimes leg) associated with other focal limb manifestations that can include apraxia, rigidity, dystonia, and alien limb phenomenon. The myoclonus is prominent with muscle action and often has reflex activation to cutaneous stimuli and deep tendon reflexes of the affected limb. The EMG discharge duration for the myoclonus in corticobasal degeneration is 25–50 ms with a cocontraction pattern. The myoclonus physiology in corticobasal degeneration has distinctive features.<sup>28</sup> The EEG shows no correlate to the myoclonus EMG discharges, even when back-averaging is performed. Parietal SEP cortical waves are either normal or poorly formed, and frontal P22–N30 components are usually intact. Median nerve stimulation reveals an EMG reflex at about 40 ms, and there can be a response to digital nerve stimulation at 50 ms. This response is thought to be quite characteristic, but probably not specific, for corticobasal degeneration.

In Parkinson's disease, multichannel surface EMG recording during muscle activation has shown irregular, multifocal, brief (<50 ms) myoclonus EMG discharges. Back-averaging showed focal, short-latency, electroencephalographic transients prior to the myoclonus EMG discharge. Cortical SEP waves are not enlarged, and long-latency EMG responses

at rest are not present. The small-amplitude myoclonus arises from an abnormal discharge from the sensorimotor cortex.<sup>29</sup>

### ***Asterixis***

Negative myoclonus refers to a decrease in tonic EMG activity. The term *asterixis* is considered to be equivalent to negative myoclonus. Negative myoclonus correlates with an average EMG silence duration of 50–200 ms. Three types of EMG patterns have been described.<sup>30</sup> Type I consists of abrupt onset and offset of EMG silence during voluntary muscle activation. A type I primarily negative event that is associated with a brief, discrete burst of EMG activity that precedes the silence characterizes type II. Type III silent periods are those that follow typical positive myoclonus, especially in trains. The EMG silences of negative myoclonus usually have a multifocal distribution. The EEG correlate of type II negative myoclonus is similar to that of positive cortical myoclonus. Type I negative myoclonus does not have an EEG correlate and may have a subcortical generator.

### **CORTICAL-SUBCORTICAL**

There is strong evidence that some generalized seizure phenomena arise from paroxysmal abnormal and excessive oscillation in bidirectional connections between cortical and subcortical sites. The term *cortical-subcortical* myoclonus refers to myoclonus arising from this type of physiology and other similar phenomena. For these entities, the abnormal influence of the subcortical input is critical. Despite the subcortical involvement, the cortical discharge precedes and drives the myoclonus event. This myoclonus usually occurs in paroxysms from rest and can be associated with other seizure phenomena that may even be more clinically significant than the myoclonus itself. The myoclonus is often generalized or bilaterally synchronous, but focal or multifocal distributions occur as well. This classification includes absence and primary generalized myoclonic seizures. These electrophysiology patterns are described in other chapters of this book.

## SUBCORTICAL–SUPRASEGMENTAL

The clinical and neurophysiological characteristics of subcortical myoclonus are more variable than for those in cortical or cortical–subcortical myoclonus. The myoclonus EMG duration may be longer than that in cortical or cortical–subcortical myoclonus. Simultaneous rostral and caudal recruitment of the myoclonus in the EMG channels supports a subcortical generator. As one might expect, there is no evidence for abnormal cortical excitability (e.g., EEG spikes, enlarged cortical SEP waves) in subcortical myoclonus that is tightly correlated to the myoclonus. Assignment of a case to the subcortical category can be problematic if it is based largely on absence of evidence for abnormal cortical excitability or circumstantial findings rather than direct evidence.

### *Essential Myoclonus*

In most cases, the myoclonus EMG discharge duration is 50–200 ms. Longer discharge duration values have been described, especially in those cases with dystonia. The EMG patterns can be agonist-only or cocontracting agonist–antagonist. Often, the discharges are irregular with respect to amplitude, duration, and timing between agonist and antagonist. The SEP and long-latency EMG responses are normal. The routine EEG is normal. No focal EEG correlates have been reported, and most EEG–EMG back-averaging has been unrevealing.

### *Reticular Reflex Myoclonus*

This myoclonus appears clinically as generalized jerks that occur at rest and are stimulus sensitive. The posthypoxic state and uremia are known causes. The EMG discharge duration is less than 50 ms.<sup>31</sup> A major characteristic of the EMG discharges is a simultaneous bilateral rostral and caudal recruitment that originates from the area of the medullary reticular formation. Axial and proximal limb muscles are primarily involved. The EEG may show that epileptiform changes are associated, but they follow the first EMG activation, vary from jerk to jerk, and do not show a time-locked relationship to the myoclonus. The SEP is normal.

## *Opsoclonus–Myoclonus Syndrome*

The opsoclonus–myoclonus syndrome consists of opsoclonus, myoclonus, and variably other manifestations such as ataxia, tremor, and behavior problems. The myoclonus is usually multifocal and predominantly induced by action. The EMG discharges are less than 100 ms, often occur in trains, and can show agonist-only or agonist–antagonist cocontraction. The EEG is usually normal and if abnormalities do exist, they have no relationship to the myoclonus. Back-averaging of the myoclonus shows no EEG correlate.<sup>32</sup> The SEP cortical waves and long-latency EMG responses are normal.

### *Propriospinal Myoclonus*

This myoclonus occurs as trunk flexion or extension with axial muscle activation. Proximal limb muscles are often involved in the jerk bilaterally, but the predominant action is in the axial muscles.<sup>33</sup> These jerks can occur from rest and/or activated by stimuli such as touch, deep tendon reflex, or muscle stretch. Single or repetitive jerks may occur. The EMG discharge lasts typically 50–300 ms but sometimes longer. Both reciprocal and cocontracting agonist–antagonist relationships have been observed. A major characteristic of the EMG discharges is a simultaneous bilateral rostral and caudal recruitment originating from the area of the spinal cord origin. The activation speed of consecutive muscles is thought to be slower than for the corticospinal (pyramidal) pathway and is likely propriospinal. No EEG abnormalities in the routine recording or with back-averaging have been reported. SEPs are normal.

## SEGMENTAL

Segmental myoclonus has its generator at a particular segment or contiguous segments of the brain stem and/or spinal cord. This segmental generator produces movements at a particular segment or contiguous segments. Palatal myoclonus is the most common type of segmental myoclonus. The EMG usually shows synchronous activation of the affected muscles. The typical frequency is in the range of 0.5–3 Hz and the typical EMG



discharge duration varies widely between 50 and 500 ms. The EEG and SEP are normal.

### PERIPHERAL

Peripheral myoclonus refers to myoclonic jerks that are driven from a peripheral site. The best-documented example is hemifacial spasm. Such EMG discharges are characterized by marked duration variability from discharge to discharge. The appearance and timing of EMG discharges, which are supplied by the same nerve, are similar. In peripheral myoclonus, the spectrum of EMG discharge duration may merge continuously with those EMG discharges that are responsible for movements that are longer lasting.

### PSYCHOGENIC JERKS

Jerks that arise from a psychogenic mechanism may appear quick enough to overlap with myoclonus. Some authors would maintain that myoclonus only pertains to involuntary movements. Nevertheless, the term *psychogenic myoclonus* has gained some acceptance. Clinical neurophysiology may offer the clinician some assistance in evaluating these patients, but one must exercise caution when interpreting the results. It is considered unwise to use such techniques alone to “prove” or “rule out” a psychogenic basis for myoclonus. Results must always be used in their clinical context and the possible pitfalls should be realized. A psychogenic myoclonus EMG discharge may show the known voluntary reciprocal biphasic/triphasic agonist–antagonist/agonist pattern with the duration of each burst being 50–100 ms. Longer EMG discharges are possible in psychogenic myoclonus and the discharge pattern may have a nonstereotyped appearance. Stimulus-evoked jerks or jumps with a mean latency in excess of 100 ms suggest voluntary or psychogenic jerks.<sup>34</sup> The *beretschaftspotential* (BP) is a back-averaged negative EEG cortical potential that occurs before self-paced, voluntary phasic movements. Terada et al. found the presence of a BP preceding psychogenic myoclonus to be supportive evidence for a psychogenic etiology.<sup>35</sup> However, because recording movements from a psychogenic individual

may be technically challenging or inadequate, absence of the BP should not be used to indicate that voluntary mechanisms have been ruled out.

### STARTLE DISORDERS

The *startle reflex* is a whole body jerk that commonly occurs in response to sudden unexpected noise or touch. Characteristic EMG onset latencies to loud noise are well defined, with the orbicularis oculi invariably leading activation at 30–40 ms and the sternocleidomastoid following at 55–85 ms. Limb muscles are less consistently active, with the biceps activated at 85–100 ms and leg muscles at 100–140 ms.<sup>36</sup> Burst durations range from 50 to 400 ms. The reflex habituates rapidly. As a normal phenomenon, startle represents another form of physiologic myoclonus.

*Exaggerated startle* has numerous causes, including inflammatory brain stem lesions, anoxic injuries, psychiatric illnesses, and drug intoxication. *Hereditary hyperekplexia* is an autosomal dominant condition characterized by exaggerated startle to unexpected stimuli. A major form consisting of exaggerated startle followed by prolonged stiffness has been linked to a point mutation in the gene encoding the  $\alpha_1$  subunit of the glycine receptor.<sup>37</sup> A minor form, consisting of exaggerated startle alone, has no recognized cause. The audiogenic myoclonic jerks in hyperekplexia clearly correspond to the startle pattern described previously. However, the startle reflex is increased in magnitude and is poorly habituating in this disorder.

### PERIODIC LIMB MOVEMENTS OF SLEEP

Periodic jerks of the legs may interrupt sleep and cause insomnia or excessive daytime somnolence. Such periodic limb movements of sleep commonly accompany restless legs syndrome.<sup>38</sup> They may also appear after spinal cord trauma or vascular injury, implicating damage to descending inhibitory pathways. During the transition between drowsiness and light sleep, the movements begin their cyclic occurrence, with an average period lasting between 30 and 45 seconds. These movements



do not resemble myoclonus; thus, the previous designation of *nocturnal myoclonus* has been abandoned. The surface EMG pattern varies. Most often, the burst durations are longer than 500 ms. The earliest and most actively involved muscle is often the anterior tibial muscle. Although the jerks may appear unilateral, bilateral asynchronous EMG activation is the common occurrence.

### Key Points

- Useful neurophysiological techniques for examining myoclonus include EEG, EMG, EEG–EMG polygraphy with back-averaging, evoked potentials, and long-latency EMG reflexes.
- Main physiological classification categories for myoclonus are cortical, cortical–subcortical, subcortical, segmental, and peripheral.
- Cortical myoclonus is typically multifocal, but may be focal, segmental, or generalized.
- Cortical reflex myoclonus is defined by the demonstration of a focal time-locked cortical transient that precedes the myoclonus by a short latency (<40 ms for arm) in association with evidence for exaggerated reflex cortical phenomena, including enlarged cortical SEP waves, reflex-induced myoclonus, or enhanced long-latency EMG responses to electrical nerve stimulation.
- Enlargement of the cortical SEP P25–N33 parietal wave from median nerve stimulation is important evidence for cortical reflex myoclonus.
- In most cases of cortical reflex myoclonus, abnormal long-latency EMG discharges are elicited by median nerve stimulation, which shows EMG discharges at 50 ms latency or greater (range 40–60 ms) from the stimulus artifact trigger mark.
- In myoclonus of corticobasal degeneration, the EMG discharge duration is 25–50 ms with a cocontraction pattern and the EEG shows no correlate to the myoclonus EMG discharges.
- In essential myoclonus (subcortical–suprasegmental myoclonus), the EMG discharge duration is 50–200 ms.
- In segmental myoclonus, typical discharge frequency is in the range of 0.5–3 Hz and

the duration varies widely between 50 and 500 ms; the EEG and SEP are normal.

- The *startle reflex* demonstrates characteristic EMG onset latencies to loud noise with the orbicularis oculi invariably leading activation at 30–40 ms and the sternocleidomastoid following at 55–85 ms. Limb muscles are less consistently active, with the biceps activated at 85–100 ms and leg muscles at 100–140 ms.<sup>36</sup> Burst durations range from 50 to 400 ms.
- In periodic limb movements of sleep, the burst durations are longer than 500 ms.

## DYSTONIA

*Dystonia* is a syndrome of involuntary sustained muscle contractions that produce abnormal postures, twisting, and repetitive movements. It may be focal or generalized. The most common focal dystonia is *cervical dystonia* or *torticollis*. *Blepharospasm*, *oromandibular dystonia*, and *writers' or occupational cramps* are other common focal dystonias. *Generalized dystonia* is usually a manifestation of hereditary torsion dystonia. Generally, neurophysiologic studies are most helpful in evaluating the focal dystonias, sometimes as a prelude to therapeutic injections of botulinum toxin.

### Recording Techniques

The physiologic hallmark of dystonia is intense cocontraction of agonist and antagonist muscles, producing a marked increase in stiffness across the joint and abnormal posturing. Thus, muscles acting across the postured joint should be studied to look for simultaneous interference patterns. Intramuscular electrodes often are needed to ensure selective recordings. Whereas cocontraction is not specific for dystonia, it does rule out joint contractures or hysteria, in which abnormal limb posture is unaccompanied by EMG activity. The EMG discharges may be tonic or occur in a repetitive rhythmic or arrhythmic pattern called *phasic dystonia*. This pattern may distinguish itself from tremor by the variability of the burst durations and the frequent intrusion of tonic dystonia.

## Abnormal Patterns

### TORTICOLLIS

Deuschl and associates<sup>39</sup> have described the patterns of EMG discharge in *spasmodic torticollis*. With *rotational torticollis*, the contralateral sternocleidomastoid and the ipsilateral splenius capitis are most often active. In *retrocollis*, all posterior neck muscles are active, and in *laterocollis*, the ipsilateral splenius capitis and sternocleidomastoid muscles are active. We have found similar patterns, but variations in a particular pattern of muscle activity are common. For this reason, performing multi-channel EMG recording with intramuscular electrodes in some patients before injecting botulinum toxin may be useful (Fig. 33–5).<sup>40</sup>

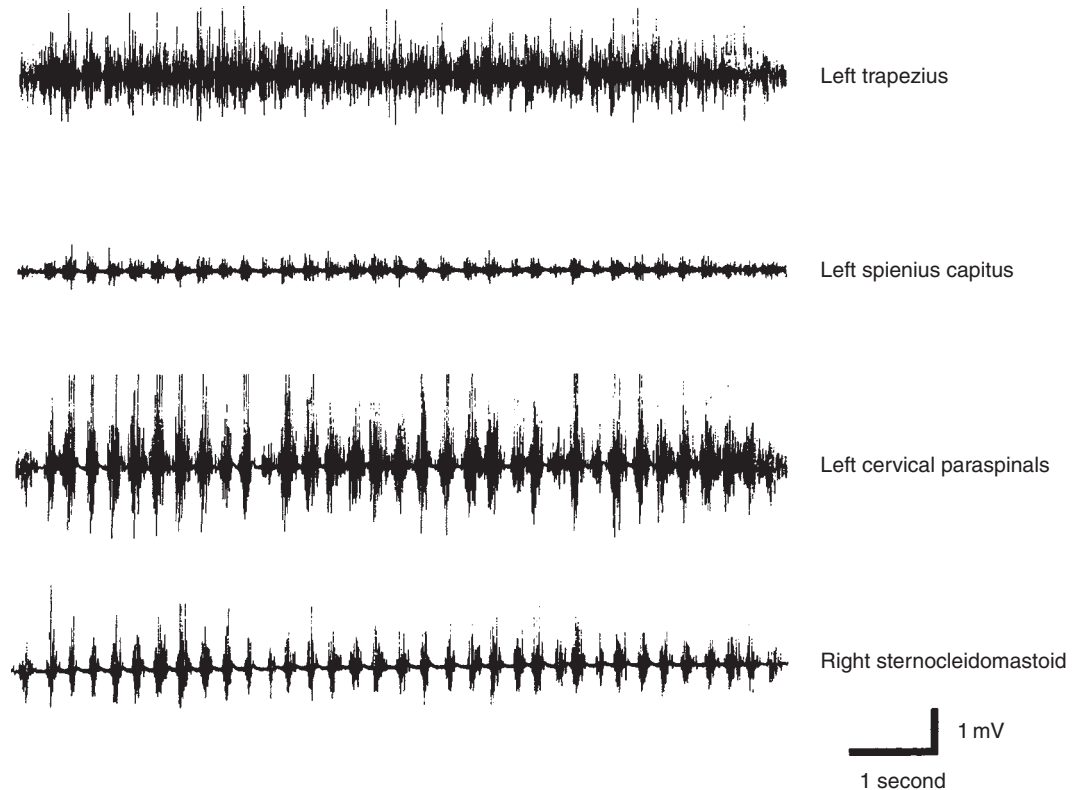
### OROMANDIBULAR DYSTONIA

In *oromandibular dystonia*, patients may be unable to eat or speak because of abnormal jaw posturing. Jaw-opening dystonia frequently

reflects dystonic activity in the lateral pterygoid and digastric muscles. Jaw-closing dystonia reflects activity in the temporalis, masseter, and medial pterygoid muscles.

### SPASMODIC DYSPHONIA

Spasmodic dysphonia may be of the adductor or abductor type. Patients with adductor spastic dysphonia present with a strained or tremulous voice caused by dystonia of the thyroarytenoid muscles. These muscles can be recorded by needle examination performed percutaneously or by direct laryngoscopy. With either method, the participation of an experienced otorhinolaryngologist is advised. In contrast, abductor spastic dysphonia is manifested as a whispering voice and the dystonic activity is in the posterior cricoarytenoid muscles, which are inaccessible to routine examination. Botulinum toxin injection is useful for these disorders and simultaneous needle EMG is recommended.



**Figure 33–5.** Dystonia. Electromyographic activity recorded with intramuscular electrodes in a patient with spasmodic torticollis. Both tonic and irregular phasic EMG bursts are present.

## WRITERS' AND OCCUPATIONAL CRAMPS

In various circumstances, repetitive skilled motions may become complicated by painful and disabling dystonia of the hand or wrist. There is no typical posture, and a combination of flexion and extension dystonia may occur. Intramuscular EMG recordings show the individual pattern of phasic and/or tonic spasms in multiple cocontracting forearm muscles.

### Key Points

- Cocontraction of agonist and antagonist muscle is characteristic but not specific for dystonia.
- Intramuscular EMG may be useful in performing botulinum toxin injections.

## TICS, CHOREA, AND ATHETOSIS

Surface EMG recording is of limited usefulness in the evaluation of tics, chorea, and athetosis. Although these involuntary movements are clinically distinct, the surface EMG patterns are nonspecific and may appear similar in all three. Burst durations can be 100–300 ms and can resemble reflex, tonic, or ballistic patterns.

### Key Points

- Surface EMG is nonspecific in tics, chorea, and athetosis.
- Burst durations in tics, chorea, and athetosis range from 100 to 300 ms.

## VOLUNTARY MOVEMENT ABNORMALITIES

Techniques are available for recording voluntary movement by surface EMG analysis. True quantitative evaluation in this realm requires additional equipment to record movement position or velocity. Qualitative evaluation is helpful occasionally but must be interpreted with caution. Such evaluation can be performed by having the patient make a short ballistic movement such as elbow flexion while recordings are made from agonist and antagonist muscles. Under most conditions when

this movement is performed as fast as possible, the triphasic pattern appears and its configuration can be examined. Abnormalities have been reported in various diseases. The ballistic movements in Parkinson's disease are characterized by low amplitude of the initial agonist burst. This results in a small-amplitude movement that the patient compensates for by making sequential small triphasic bursts. The movements of cerebellar hypermetria have been ascribed to a delayed onset of the antagonist burst<sup>41,42</sup> or a normal onset but slow rise of antagonist activity.<sup>43</sup> With pyramidal lesions, the first agonist or antagonist burst is prolonged. Finally, in patients with athetosis caused by cerebral palsy, excessive activity occurs in muscles not normally involved in the main action, and agonist and antagonist muscles often cocontract.

## SUMMARY

Surface EMG, EEG, and elicited response results provide a simple and noninvasive means of studying movement disorders. These techniques are particularly helpful in classifying involuntary movements such as tremor and myoclonus. In addition, EMG can assist with designing and performing botulinum toxin injections.

## REFERENCES

1. Hallett, M., B. T. Shahani, and R. R. Young. 1975. EMG analysis of stereotyped voluntary movements in man. *Journal of Neurology, Neurosurgery, and Psychiatry* 38:1154–62.
2. Milanov, I. 2001. Electromyographic differentiation of tremors. *Clinical Neurophysiology* 112:1626–32.
3. Deuschl, G., P. Bain, and M. Brin. 1998. Consensus statement of the Movement Disorder Society on Tremor. Ad Hoc Scientific Committee. *Movement Disorders* 13(Suppl 3):2–23.
4. Breit, S., S. Spieker, J. B. Schulz, and T. Gasser. 2008. Long-term EMG recordings differentiate between parkinsonian and essential tremor. *Journal of Neurology* 255(1):103–11.
5. Deuschl, G., P. Krack, M. Lauk, and J. Timmer. 1996. Clinical neurophysiology of tremor. *Journal of Clinical Neurophysiology* 13:110–21.
6. Hallett, M. 1998. Overview of human tremor physiology. *Movement Disorders* 13(Suppl 3):43–8.
7. Elble, R. J. 2000. Essential tremor frequency decreases with time. *Neurology* 55:1547–51.

8. Sabra, A. F., and M. Hallett. 1984. Action tremor with alternating activity in antagonist muscles. *Neurology* 34:151–6.
9. Milanov, I. 2000. Clinical and electromyographic examinations of patients with essential tremor. *The Canadian Journal of Neurological Sciences* 27: 65–70.
10. Brennan, K. C., E. C. Jurewicz, B. Ford, S. L. Pullman, and E. D. Louis. 2002. Is essential tremor predominantly a kinetic or a postural tremor? A clinical and electrophysiological study. *Movement Disorders* 17(2):313–16.
11. Vaillancourt, D. E., A. B. Slifkin, and K. M. Newell. 2001. Regularity of force tremor in Parkinson's disease. *Clinical Neurophysiology* 112:1594–603.
12. Heilman, K. M. 1984. Orthostatic tremor. *Archives of Neurology* 41:880–1.
13. Marsden, C. D., M. Hallett, and S. Fahn. 1982. The nosology and pathophysiology of myoclonus. In *Movement disorders*, ed. C. D. Marsden, and S. Fahn, 196–248. London: Butterworths.
14. Caviness, J. N., and P. Brown. 2004. Myoclonus: Current concepts and recent advances. *Lancet Neurology* 3(10):598–607.
15. Shibasaki, H., and M. Hallett. 2005. Electrophysiological studies of myoclonus. *Muscle & Nerve* 31(2):157–74.
16. Caviness, J. N. 2003. Clinical neurophysiology of myoclonus. *Movement disorders. Handbook of clinical neurophysiology*, ed. M. Hallett, Vol. 1, 521–48.
17. Shibasaki, H. 2000. Electrophysiologic studies of myoclonus. AAEI minimonograph #30. *Muscle & Nerve* 23:321–35.
18. Hitomi, T., A. Ikeda, R. Matsumoto, et al. 2006. Generators and temporal succession of giant somatosensory evoked potentials in cortical reflex myoclonus: Epicortical recording from sensorimotor cortex. *Clinical Neurophysiology* 117(7):1481–6.
19. Shibasaki, H., Y. Yamashita, and S. Tsuji. 1977. Somatosensory evoked potentials. Diagnostic criteria and abnormalities in cerebral lesions. *Journal of Neurological Sciences* 34:427–39.
20. Ugawa, Y., K. Genba, T. Shimpo, and T. Mannen. 1991. Somatosensory evoked potential recovery (SEP-R) in myoclonic patients. *Electroencephalography and Clinical Neurophysiology* 80:21–5.
21. Caviness, J. N., and M. Kurth. 1997. Cortical myoclonus in Huntington's disease associated with an enlarged somatosensory evoked potential. *Movement Disorders* 12(6):1046–51.
22. Brown, P., B. L. Day, J. C. Rothwell, P. D. Thompson, and C. D. Marsden. 1991. Intra-hemispheric and Inter-hemispheric spread of cerebral cortical myoclonic activity and its relevance to epilepsy. *Brain* 114:2333–51.
23. Ikeda, A., R. Kakigi, N. Funai, R. Neshige, Y. Kuroda, and H. Shibasaki. 1990. Cortical tremor: A variant of cortical reflex myoclonus. *Neurology* 40:1561–5.
24. Caviness, J. N., C. H. Adler, T. Beach, K. Wetjen, and R. J. Caselli. 2002. Myoclonus in Lewy body disorders. In *Myoclonus and paroxysmal dyskinesias*, ed. S. Fahn, M. Hallett, S. Frucht, and D. Truong, Advances in Neurology, Vol. 89, 23–30. New York: Lippincott Williams & Wilkins.
25. Wilkins, D. E., M. Hallett, A. Berardelli, T. Walshe, and N. Alvarez. 1984. Physiologic analysis of the myoclonus of Alzheimer's disease. *Neurology* 34:898–903.
26. Shibasaki, H., S. Motomura, Y. Yamashita, H. Shii, and Y. Kuroiwa. 1981. Periodic synchronous discharge and myoclonus in Creutzfeldt–Jakob disease: Diagnostic application of jerk-locked averaging method. *Annals of Neurology* 9:150–6.
27. Oga, T., A. Ikeda, T. Nagamine, et al. 2000. Implication of sensorimotor integration in the generation of periodic dystonic myoclonus in subacute sclerosing panencephalitis (SSPE). *Movement Disorders* 15(6):1173–83.
28. Thompson, P. D., B. L. Day, J. C. Rothwell, P. Brown, T. C. Britton, and C. D. Marsden. 1994. The myoclonus in corticobasal degeneration. Evidence for two forms of cortical reflex myoclonus. *Brain* 117:1197–207.
29. Caviness, J. N., C. H. Adler, T. G. Beach, K. L. Wetjen, and R. J. Caselli. 2002. Small-amplitude cortical myoclonus in Parkinson's disease: Physiology and clinical observations. *Movement Disorders* 17(4): 657–62.
30. Ugawa, Y., T. Shimpo, and T. Mannen. 1989. Physiological analysis of asterix: Silent period locked averaging. *Journal of Neurology, Neurosurgery, and Psychiatry* 52:89–93.
31. Hallett, M., D. Chadwick, J. Adam, and C. D. Marsden. 1977. Reticular reflex myoclonus: A physiological type of human post-hypoxic myoclonus. *Journal of Neurology, Neurosurgery, and Psychiatry* 40:253–64.
32. Gwinn, K. A., and J. N. Caviness. 1997. Electrophysiological observations in idiopathic Opsoclonus–Myoclonus syndrome. *Movement Disorders* 12(3): 438–42.
33. Brown, P., P. D. Thompson, J. C. Rothwell, B. L. Day, and C. D. Marsden. 1991. Axial myoclonus of propriospinal origin. *Brain* 114:197–214.
34. Brown, P., and P. D. Thompson. 2001. Electrophysiological aids to the diagnosis of psychogenic jerks, spasms, and tremor. *Movement Disorders* 16: 595–9.
35. Terada, K., A. Ideda, P. C. Van Ness, et al. 1995. Presence of Bereitschaftspotential preceding psychogenic myoclonus: Clinical application of jerk-locked back averaging. *Journal of Neurology, Neurosurgery, and Psychiatry* 58:745–7.
36. Wilkins, D. E., M. Hallett, and M. M. Wess. 1986. Audiogenic startle reflex of man and its relationship to startle syndromes. A review. *Brain* 109:561–73.
37. Tijssen, M. A., R. Shiang, J. van Deutekom, et al. 1995. Molecular genetic reevaluation of the Dutch hyperekplexia family. *Archives of Neurology* 52: 578–82.
38. Coleman, R. M., C. P. Pollak, and E. D. Weitzman. 1980. Periodic movements in sleep (nocturnal myoclonus): Relation to sleep disorders. *Annals of Neurology* 8:416–21.
39. Deuschl, G., F. Heinen, B. Kleedorfer, M. Wagner, C. H. Lucking, and W. Poewe. 1992. Clinical and polymyographic investigation of spasmodic torticollis. *Journal of Neurology* 239:9–15.

40. Van Gerpen, J. A., J. Y. Matsumoto, J. E. Ahlskog, D. M. Maraganore, and P. G. McManis. 2000. Utility of an EMG mapping study in treating cervical dystonia. *Muscle & Nerve* 23:1752–6.
41. Flament, D., and J. Hore. 1986. Movement and electromyographic disorders associated with cerebellar dysmetria. *Journal of Neurophysiology* 55:1221–33.
42. Gilman, S., J. Bloedel, and R. Lechtenberg. 1981. *Disorders of the cerebellum. Contemporary neurology series*, Vol. 21. Philadelphia: FA Davis Company.
43. Manto, M., E. Godaux, J. Jacqy, and J. Hildebrand. 1996. Cerebellar hypermetria associated with a selective decrease in the rate of rise of antagonist activity. *Annals of Neurology* 39:271–4.

*This page intentionally left blank*



# Vertigo and Balance

*David A. Zapala and Robert H. Brey*

## **INTRODUCTION**

Functional Anatomy and Physiology  
Clinical Features of Vestibulopathy  
and Central Compensation  
Laboratory Vestibular Test Methods

## **LABORATORY EXAMINATION: VOR-BASED MEASURES**

Recording Method  
Preparation for Testing  
Videonystagmography Test Battery  
Computerized Rotary Chair Tests  
Subjective Visual Vertical (SVV)  
Assessment

## **LABORATORY EXAMINATION: VSR-BASED MEASURES**

Vestibular Evoked Myogenic Potentials  
Computerized Dynamic  
Posturography

## **CLINICAL APPLICATIONS OF VESTIBULAR TESTING: ASSESSING SENSORINEURAL SYNDROMES OF THE LABYRINTH**

Superior Nerve Syndrome  
Superior SCC Dehiscence  
Basement Syndrome  
Posterior Syndrome  
Split Syndrome  
Global Syndrome

## **VESTIBULAR REHABILITATION SUMMARY**

## **INTRODUCTION**

Complaints of dizziness and imbalance can be caused by a bewildering array of disorders. Some disorders are easily recognized while others can remain perplexingly obscure. This chapter presents several electrophysiologic methods that might be used to investigate vestibular function. These methods include videonystagmography (VNG) or electronystagmography (ENG), rotational tests, subjective visual vertical (SVV) measurements, vestibular evoked myogenic potentials (VEMPs), and computerized dynamic posturography (CDP).

These test methods do not stand alone. To interpret test results meaningfully an appreciation of how normal central nervous system (CNS) compensation and abnormal vestibular reflex function interact during the recovery process is required. Only then can correlations between patient presentation and vestibular test results be placed in a meaningful context. This chapter summarizes how electrophysiologic vestibular test information can establish the site of lesion and reflect central compensation status. Relationships between test results and nerve-based labyrinthine syndromes are also presented.

A careful history and physical examination are by far the most important tools in the assessment of vertigo and imbalance.<sup>1-4</sup> A clear understanding of the patient's complaint, as well as mapping the onset and progression of symptoms, will go a long way in converging on a diagnosis. However, even in experienced hands there are challenges. As humans, we perceive and navigate within our environments with innate ease. This ease masks the complexity by which visual, somatosensory, and vestibular sensory information are integrated into an understanding of our location and movement in the environment. In addition, exquisite cascades of reflexive, semiautomated, and volitionally refined movements support bipedal stance and locomotion. Most of these processes require little conscious attention or effort. As a result, patients are often only able to provide vague, nonspecific descriptions of what they mean by "dizziness" or "imbalance" when things go wrong.

To simplify the differential diagnosis, most clinicians will use a set of heuristic rules to organize patient descriptions of dizziness or imbalance.<sup>2,5</sup> Complaints suggestive of vertigo (circular vection of the self or visual surround) are taken to imply an otogenic vestibular problem. Complaints of disequilibrium (unsteadiness when standing or walking) suggest a neuromuscular cause. Lightheadedness suggests a neurovascular problem. Not all complaints can be shoehorned into these categories, and even when there is a reasonable linguistic match, classification errors occur. For example, pilots, sailors, and gymnasts may not report vertiginous sensations in the face of obvious vestibular disease due to their prior training suppressing these sensations. Further, some vestibular disorders do not induce sensations of vertigo, nausea, or imbalance. Examples would include deficits from slow-growing vestibular schwannomas or disorders of the vestibular maculae. In cases where vertigo is not reported and codeveloping otologic or neurologic symptoms are lacking, heuristically based classification schemes may misdirect subsequent diagnostic inquiries.

Electrophysiologic measures of vestibular function augment the traditional history and physical examination.<sup>6,7</sup> They can identify and quantify reduced vestibular output, leading to assurance that a vestibular cause underpins the patient's complaints. However, they seldom yield a diagnosis in isolation. More

often, these tests confirm or challenge clinical hypotheses developed through the history and physical examination. There are several factors that complicate the interpretation of electrophysiologic measures of vestibular function. First, some forms of vestibulopathy produce fluctuating output from the vestibular end organ. Examples include Meniere's syndrome, migraine-associated vertigo, or perilymph fistula. Depending upon the presence and severity of symptoms at the time of study, an impaired ear may produce normal test results. Second, current test methods measure reflexes from two or possibly three of the five vestibular receptors in each labyrinth. So, a normal study cannot exclude a fluctuating or obscure vestibulopathy.

Vestibular assessment methods also differ from other electrophysiologic methods in that vestibular tests measure reflexes that are easily modified by higher forms of behavior. For example, vestibular-induced eye movements can be suppressed volitionally. Abnormal postural sway from reduced vestibulo-spinal tone is easily modified with attention to visual and proprioceptive feedback. Reliable assessment thus requires careful attention and control of psychophysical and cognitive variables to guard against inadvertent suppression of vestibular-induced reflexes. Therefore, evaluator skill is another important factor in test accuracy.

Finally, the relationship between vestibular end organ output and central vestibular processing is dynamic. With time, changes in end organ output result in adaptive changes in the way aberrant vestibular signals are interpreted within the central vestibular system. As a result, some abnormal vestibular reflexes are only observable when lesions are acute, while other reflexes may remain persistently abnormal. The ability to correlate the onset and progression of symptoms with the pattern of abnormal test results can give the examiner insight into the underlying disease process and the state of central vestibular system compensation. This is an important factor in planning medical management and vestibular rehabilitation services.

In the primary care setting, vestibular testing may not be routinely warranted. Most complaints of dizziness and imbalance will have well-recognized causes and most forms of vestibular dizziness will be self-limiting in this setting. On the other hand, in specialty settings, where patients are sent with persistent

problems after failing primary medical care, special tests may play an invaluable role. The value of recognizing the obscure vestibulopathy is that, with a few exceptions, end organ-based vestibular deficits are not life threatening and can be managed with vestibular rehabilitation, medication, and rarely surgery. Even when treatment cannot restore balance function to pre-insult levels, the psychological benefits of a comprehensive evaluation are noteworthy.

### Purpose and Role of Vestibular Testing

- To identify and quantify reduced vestibular output.
- Used to provide insight into the underlying disease process and the state of central vestibular system compensation.

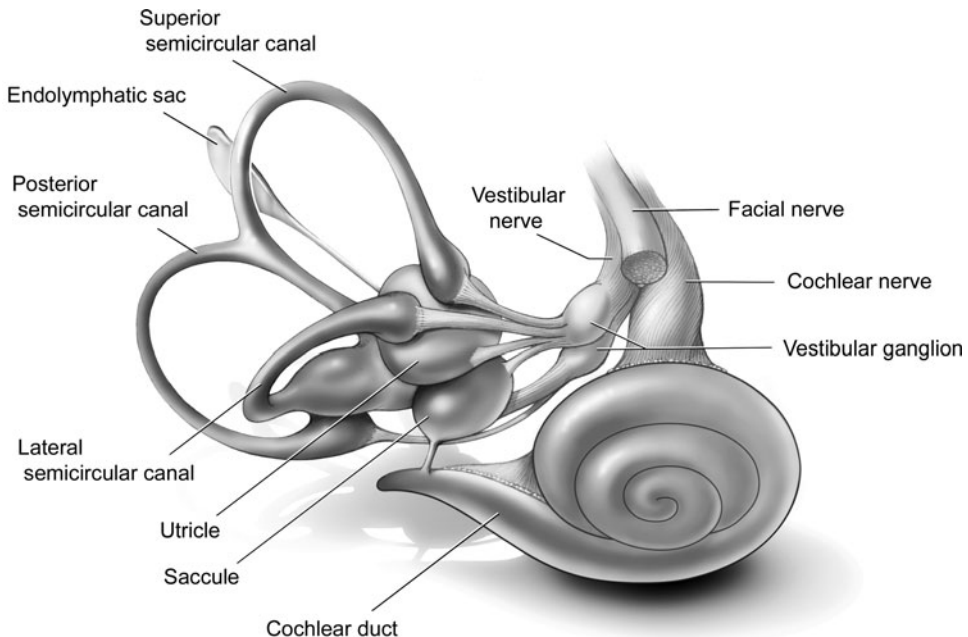
## Functional Anatomy and Physiology

The anatomy and physiology of the vestibular mechanism and certain functional relationships are important to keep in mind when evaluating the vestibular system. There are two

types of sensory organs within the labyrinth: the *semicircular canals* (SCCs) and the *otolith organs*, the *sacule and utricle* (Fig. 34–1). These organs are sensitive to three different types of head movements: *angular head movements*, *head tilts*, and *linear translations*. In response to these head movements, the vestibular system drives two primary reflexes: the vestibulo-ocular reflex (VOR) and the vestibulo-spinal reflex (VSR).

### ANGULAR HEAD MOVEMENTS AND THE VOR

*Angular head movements* occur when the head is turned about the pivot point of the cervical spine and are predominantly transduced by the SCCs. Endolymph within each SCC will demonstrate the characteristic of inertia when the head turns in the plane of a SCC. That is, the endolymph will lag behind the movement of the skull during these movements, causing the cupula within the SCC ampulla to bend. The magnitude of cupular deflection is determined by the magnitude of acceleration and the degree to which the head movement is aligned with the plane of the stimulated canal.



**Figure 34–1.** Anatomy of the membranous labyrinth and vestibulocochlear nerve branches. Note that the vestibular (Scarpa's) ganglion has superior and inferior portions, serving the superior and inferior vestibular nerve branches.

In humans, the VOR is strongly driven by angular head movements. The primary goal of the VOR is to maintain a visual targets' position on the fovea despite head movement. A secondary goal is to maintain the orientation of the horizontal meridians of the eye with the horizon. There are three SCCs oriented in three nearly orthogonal planes in each labyrinth. They are positioned to respond to any head movement about the pivot point of the cervical spine. They are also nearly coplaner with insertion planes of the ocular motor muscles, facilitating the rapid generation of compensatory VOR eye movements. Stimulation of a single SCC will reflexively provoke an eye movement in the plane of that SCC. For example, when the head is turned horizontally to the right, the VOR drives the eyes horizontally to the left to maintain visual target position on the fovea. Similarly, when the head is rolled clockwise so that the right ear is moved toward the right shoulder, the eyes will roll counterclockwise in the orbit to maintain the relationship between the horizon and the horizontal meridian of the retina. This would be described as a torsional vestibular-induced eye movement. It is important to remember that VOR-mediated eye movements are reflected in the slow phase of vestibular-induced nystagmus. However, by convention, the direction of nystagmus is described by the fast phase.

Sensory transduction within the vestibular labyrinth is accomplished by specialized hair cell systems. Underneath each cupula resides the crista, a bed of hair cells with the cilia embedded into the cupula. Within the otolithic organs, the maculae also contain hair cell beds. Hair cell systems have certain characteristics that will influence functional performance. First, hair cell systems have a *resting discharge rate*. Resting discharge rates allow hair cell systems to encode periodic or harmonic movements of the hair cell cilia accurately. Deflecting the cilia in one direction increases the nerve firing rate, while deflecting the cilia in the opposite direction decreases the firing rate. In this way, both accelerating and decelerating angular head movements (that would bend the cupula in different directions) can be encoded by changes in discharge firing rates of each ampullary nerve.

An additional characteristic of vestibular hair cell systems is that they demonstrate a

variation of *reciprocal innervation*. Each SCC is coplaner with a SCC on the contralateral side. The horizontal canals are coplaner. The right anterior and the left posterior canals are coplaner, and the left anterior and right posterior canals are coplaner. An angular head movement to the right (in any canal plane) will increase the firing rate of the right vestibular nerve and decrease the firing rate of the left vestibular nerve. That is, for any angular head movement, the leading canal will always excite the eighth nerve afferents while the lagging canal will always inhibit the eighth nerve afferents. From the perspective of the central vestibular system, differences in output of coplaner ampullary nerve afferents are interpreted as angular head movements in the direction of the leading ear.

One consequence of the resting discharge rate and reciprocal innervation organizational themes within the vestibular system is that VOR-induced eye movements are driven by changes in the output of both ears when head movements are slow. However, when angular head accelerations reach a certain critical magnitude, the nerve firing rate of the lagging ear will drop to zero spikes per second. Beyond this critical acceleration point, the leading ear alone controls the velocity of vestibular-induced eye movements. This characteristic, known as *Ewald's second law*, underpins the head thrust test (a bedside test of SCC function) and is important in understanding some of the rotational step test results.

### Key Points

- Angular head movements occur when the head is turned about the pivot point of the cervical spine.
- Three SCCs are positioned to respond to angular head movements.
- The VOR is driven primarily by angular head movements, (SCC-mediated).
- Stimulation of one SCC will provoke eye movements in the plane of that canal.
- Specialized hair cells coupled to each SCC cupula transduce angular head movements. The resting discharge rate of each hair cell allows them to encode periodic movements.
- Deflection of the cilia of the hair cells changes the firing rate in relation to

acceleration or deceleration of the head movements.

- Reciprocal innervation of the vestibular hair cell systems causes a decrease in the firing rate of one vestibular nerve when there is an increase in the firing rate of the contralateral nerve.
- When head movements are slow (low acceleration), the VOR is driven by changes in the output of both ears; when movements are fast (high acceleration), only the leading ear controls the VOR (this is known as *Ewald's second law*).

## HEAD TILTS

The vestibular labyrinth will also respond to tilting of the head away from gravitational vertical (*head tilts*). The otolith organs serve this function. Otoconia are attached to a gelatinous matrix affixed to the macula of each otolithic organ. Otoconia have a high-specific gravity relative to endolymph and, consequently, respond to the pull of gravity. Hair cell cilia in the macula are loosely attached to the gelatinous matrix. As a result, changes in head attitude will produce a change in the gravity vector acting on the otoconia. This, in turn, will produce a change in the shear force across the macula, changing the resting discharge rate of the associated nerve afferents. Differences in firing rates between ears are interpreted as a head tilt. Head tilts about the horizontal plane would primarily be encoded by the utricle. These asymmetries drive changes in VSR stimulation to the neck, spine, and large antigravity muscles. They also induce subtle changes in the VOR (see Subjective Visual Vertical Test section below).

### Key Points

- Head tilts are movements away from gravitational vertical and are served by the otolith organs.
- Changes in head attitude produce changes in the gravity effect acting on the otoconia, and change the resting discharge rate of nerve afferents.
- Difference in firing rates between ears are interpreted as head tilt.
- Head tilts about the horizontal plane are encoded by the utricle.

- Nerve firing rates asymmetries induced by head tilts drive changes in the VSR and produce subtle changes in the VOR.

## LINEAR TRANSLATIONS AND ACCELERATIONS

The ear responds to *linear translations* or *accelerations* as well. Otoconia, because of their specific gravity, will also demonstrate the characteristic of inertia. As a result, linear head movements will produce a shear force across the otolithic organs, depending on the relationship between the planes of the maculae and the direction of movement. In contrast to the nerve firing rate pattern generated by head tilts (where head tilts produce an asymmetry in nerve output), linear accelerations may provoke the same change in firing rate between sides. This signal is important in resolving ambiguous visual situations where it is difficult to determine if the head or the visual surround is moving. An example is the false sensation of movement experienced by a person sitting in an automobile when a large vehicle parked alongside begins slowly to pull forward. The visual input to the person is consistent with the sensation of the car rolling backward; the reflexive action is to step on the brakes. The absence of a vestibular signal consistent with linear acceleration helps the CNS to resolve the sensory conflict by determining that it was the larger vehicle that was moving and that the visual information was incorrect.

Vertical linear translations or accelerations are encoded primarily by the saccule and are important in navigating steps and possibly evoking protective reflexes when falling. A clinical test based on this reflex, the VEMP, has proven particularly valuable in the clinical setting.

Finally, there are a few anatomical relationships that are helpful to remember when interpreting vestibular test results. The eighth nerve separates into three main branches as it courses distally along the internal auditory canal. The branches are the superior vestibular, inferior vestibular, and cochlear eighth nerve branches. The superior vestibular nerve further branches to innervate the horizontal or “lateral” SCC ampulla, the anterior or “superior” SCC ampulla, the utricle, and a small part of the saccule (Voit's branch). This can easily be remembered by the mnemonic “LSU



on top” (the Lateral and Superior semicircular canal ampullae and Utricle are innervated by the “on top” superior vestibular nerve). The inferior vestibular nerve branch innervates the posterior SCC ampulla and the majority of the saccule. It also carries the efferent cochlear bundle. The blood supply to the vestibular labyrinth follows the innervation pattern. The anterior vestibular artery separates from the labyrinthine artery and supplies “LSU.” After separating from the anterior vestibular artery, the labyrinthine artery becomes the common cochlear artery. The common cochlear artery further divides into the main cochlear artery and the vestibulocochlear artery. The latter forms the posterior vestibular artery that supplies the posterior canal and saccule.

### Key Points

- Linear head movements produce similar forces across the otolith organs on both sides.
- Vertical linear accelerations are encoded primarily by the saccule.
- The superior vestibular nerve branch innervates the superior and horizontal SCCs, the utricle, and a small part of the saccule.
- The inferior vestibular nerve branch innervates the posterior SCC and the larger portion of the saccule.

## Clinical Features of Vestibulopathy and Central Compensation

The signs and symptoms of vestibulopathy will depend on two general factors. First, there is a relationship between the pattern of damage to sensory structures in the vestibular labyrinth and the abnormal reflex behaviors. Second, the degree to which abnormal reflex behaviors manifest is influenced by the degree of central compensation. The central vestibular pathways are by nature plastic and begin the process of compensating for changes in vestibular tone within hours of an onset of acute vestibulopathy. Further, vestibular-driven reflexive behaviors are modifiable by higher levels of behavior. As a consequence, signs and symptoms of vestibulopathy evolve over time.

It may be helpful to illustrate how compensatory influences impact vestibular test results. A prototypical example of an acute vestibulopathy is superior nerve neurolabyrinthitis. In this condition, the patient experiences a sudden onset of vertigo and vestibular ataxia that lasts for over one day, with symptoms gradually diminishing over the course of several days or weeks. There are no accompanying otologic or neurologic symptoms. There is a sudden diminishment of superior vestibular nerve resting firing rates associated with the lateral and superior SCCs (LSU distribution). This produces an asymmetry between ears within the central vestibular nuclei that is interpreted as an angular head turn toward the intact ear. Nystagmus, with the fast phase of the horizontal component beating toward the intact ear, will be evident with the eyes opened and fixated.

In the setting of an acute unilateral loss of vestibular tone, three cardinal behaviors of vestibular-induced spontaneous nystagmus can be appreciated. First, the slow component (slow phase) of the nystagmus follows the planes of the involved SCCs. In our example, the observed nystagmus will be a combination of a horizontal and a torsional nystagmus—reflecting the involved lateral (horizontal) and superior (anterior) canals. Further, the direction of the horizontal nystagmus component remains fixed regardless of eye position. This follows from the fact that the brain interprets the asymmetry in vestibular output from the ears as fixed angular rotation.

The second cardinal behavior is that the observed spontaneous nystagmus will follow Alexander’s Law. Alexander’s Law states that when gaze is directed toward the nystagmus fast phase (in the direction of the intact or “strong” ear), the horizontal nystagmus will increase in magnitude. In contrast, when the fast phase is directed toward the weak ear, the nystagmus appears less intense. While a physiological explanation of this phenomenon is beyond the scope of the present chapter, the concept can be intuitively appreciated by remembering that in normal individuals, end point nystagmus can be observed at the extreme limits of lateral gaze. This nystagmus has a fast phase that beats toward the direction of gaze. On extreme gaze to the right, there is a right-beating end point nystagmus. On extreme gaze to the left, there is a left-beating



nystagmus. This nystagmus is described as the result of “leaky” gaze-holding circuits. When there are sudden acute changes in vestibular tone (for just about any reason), gaze-holding circuits become even more “leaky.” Physiologic end point nystagmus becomes more easily provoked and interacts with the direction-fixed spontaneous vestibular nystagmus. When gaze is directed toward the fast phase, the two nystagmus signals sum. When gaze is directed away from the fast phase, the two nystagmus signals cancel each other.

Gaze nystagmus that is direction fixed and follows Alexander’s Law can be classified into 3rd degree, 2nd degree, and 1st degree. A 3rd degree Alexander’s nystagmus is present in all positions of gaze and is greater when gaze is directed toward the unaffected ear. As the CNS physiologically compensates for the deficit caused by the peripheral lesion, the nystagmus progresses to the 2nd degree (i.e., nystagmus is only observed with gaze away from the lesion and at midline) and finally to the 1st degree (i.e., nystagmus is only observed with gaze away from the side of the lesion).

Along these same lines, the torsional component of the spontaneous nystagmus will be more evident with the eyes directed away from the involved ear, perpendicular to the plane of the involved vertical canal. So with the eyes directed toward the fast phase, and away from the involved ear, the nystagmus will appear as a combination of horizontal and torsional components, all in keeping with Alexander’s Law and the planes of the involved SCCs.

The final cardinal behavior of vestibular-induced nystagmus is the effect of visual fixation on nystagmus magnitude. Vestibular-induced eye movements are easily modified by higher level signals from the gaze-holding, saccadic, and pursuit systems (among others). In the face of an acute unilateral vestibulopathy, the flocculus of the cerebellum can selectively increase the control pursuit and gaze holding circuits have on eye position, thereby suppressing the magnitude of spontaneous nystagmus with the eyes opened and fixed. However, when visual fixation is denied, vestibular nystagmus increases in magnitude. So observing that spontaneous nystagmus suppresses with visual fixation assures the observer that at least part of the central vestibular system

is intact—an expected observation in the face of a sudden unilateral loss of vestibular end organ tone.

As hours go by following the onset of superior vestibular nerve neurolabyrinthitis, the vestibular cerebellum may “clamp” the output of the vestibular system overall, in an effort to increase the influence of pursuit and gaze-holding signals on eye position. Vestibular reflexes measured in this state may be bilaterally reduced and mask the underlying asymmetry in output. As hours turn to days, spontaneous nystagmus observable with the eyes opened and fixed slowly diminishes. However, nystagmus present with visual fixation denied may persist for several months, often developing head position-dependent changes. For example, the nystagmus may be present only when the head is turned to one side or when lying down. This is termed a *positional nystagmus* and its persistence relates to the degree to which central vestibular circuits have reorganized following the initial end organ insult.

It is important to recognize that vestibular nystagmus may emanate from SCC or macular tone asymmetries. In general, central compensation changes will passively seek to diminish the effect of tonal asymmetries when the head is at rest. Spontaneous nystagmus, and to some extent positional nystagmus, will diminish accordingly (so-called *static compensation*). However, the vestibular system will also attempt to relearn how to interpret signals from the impaired vestibular end organ with head movement. This requires experience (so-called *dynamic compensation*). Movement induced sensory conflicts between the impaired and the intact ear signals, as well as conflicts among vestibular, visual, and somatosensory signals are important stimuli in the process of achieving dynamic compensation. Reorganizing neural networks to resolve these conflicts is the basis of vestibular rehabilitation.

VSRs follow a similar time course in the recovery process. Initially, superior vestibular nerve neurolabyrinthitis will provoke a tendency to stand with the center of mass shifted toward the side of the involved ear. The patient may notice a tendency to veer to the involved side. This is thought to reflect the acute loss of vestibular tone to the descending vestibulo-spinal tracts. Over the course of

days, many of these symptoms subside as volitional and then more automatic movement patterns emerge to compensate for the loss of vestibular tone.

The process of completely adjusting to changes in vestibular end organ function occurs over time. Patients may still complain of symptoms even while the overt signs of vestibulopathy have receded. The presence or absence of abnormal vestibular reflexes will depend on time between the symptom onset and the compensation state at the time of testing. Many of the electrophysiologic measures described below are designed to provoke abnormal reflex patterns that may be occult on physical examination but still problematic from a dizziness and imbalance perspective.

### Key Points

- Patterns of abnormal reflex behaviors will follow the pattern of damage to vestibular end organ structures, but are modified by central compensatory processes.
- Three cardinal behaviors of abnormal vestibular-induced eye movements: (1) the slow component of pathologic vestibular nystagmus follows the planes of the involved SCCs; (2) when gaze is directed toward the nystagmus fast phase, horizontal nystagmus will increase (Alexander's Law); and (3) vestibular-induced eye movements are modified by higher level signals from gaze-holding, saccadic, and pursuit systems.
- Gaze nystagmus that is direction fixed (Alexander's Law) is classified as 1st, 2nd, or 3rd degree. The 3rd degree is present in all positions of gaze, 2nd degree is present with gaze away from the lesion and at midline, and 1st degree is present only with gaze away from the side of the lesion.
- They lawfully reflect the planes of the involved SCCs.
- When vestibular nystagmus is observable with the eyes opened, the horizontal component will always beat in the same direction regardless of eye position and will follow Alexander's Law.
- Visual fixation suppresses vestibular-induced nystagmus.

## Laboratory Vestibular Test Methods

There are five clinically available electrophysiologic measures that assess vestibular reflex function either directly or indirectly. Three measures, ENG (or the older VNG), rotary chair tests, and measures of SVV, focus on VOR behaviors. The remaining two measures, VEMPs and CDP, focus on behaviors associated with vestibulo-spinal function or the volitional use of vestibular information for postural stability and control.

### LABORATORY EXAMINATION: VOR-BASED MEASURES

#### Recording Method

There are two recording methods currently available in clinical settings to measure eye movements: electrode-based electrooculogram recording (EOG) or infrared camera-based video-recording methods. In electrooculography, the corneoretinal potential (approximately 1 mV, with the front of the eye positive relative to the back of the eye) serves as the source signal recorded. Electrodes are placed at the outer canthi of each eye to measure the horizontal component of eye movement, and electrodes placed above and below one eye are used to measure vertical movements. A common, or ground, electrode is placed on the forehead just above the nose. As the eye moves horizontally or vertically, the corneoretinal source dipole changes its orientation relative to the recording electrodes. Changes in the field potential are measured across electrode pairs to estimate eye position. To use the EOG method, there must be a corneoretinal potential. If a patient is blind in both eyes and has no corneoretinal potential, electrooculography cannot be used to measure eye movement.

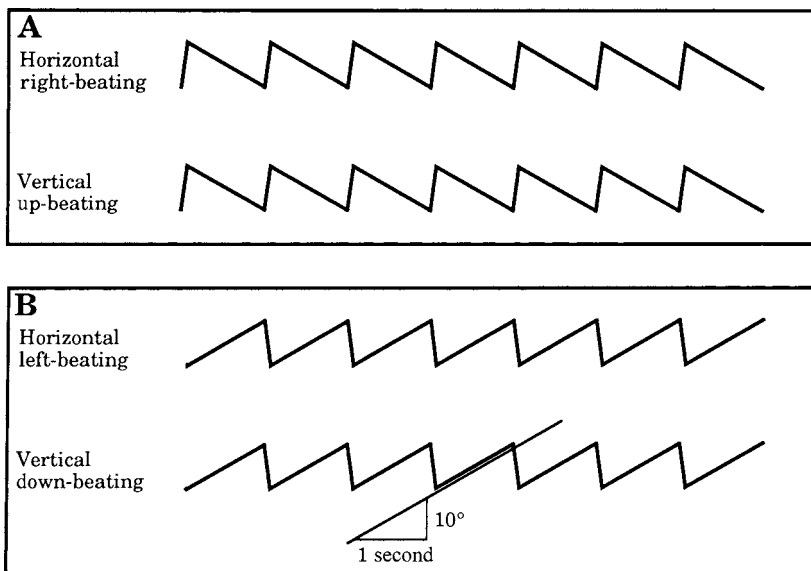
Infrared video-recording systems have quickly emerged as the preferred method of recording eye movements. The value of these systems is that eye movements can be observed and recorded for offline analysis. Additionally, eye position can be controlled, avoiding measurement errors when the eyes deviate significantly away from the central position.

Infrared video-recording systems may employ slow frame rates, limiting the recording resolution of faster eye movements. Faster digitization speeds may overcome this limitation and allow for more refined measurement of high velocity saccadic and vestibular-induced eye movements. Additionally, pattern recognition schemes are being developed to allow for the measurement of torsional eye movements by recognizing changes in the orientation of the iris muscle pattern. The ability to record torsional eye movements increases the sensitivity of video-recording methods to changes in vertical canal mediated eye movements.

Regardless of which recording system is used, certain conventions have been developed to display eye movement tracings for analysis. The conventions for plotting horizontal and vertical nystagmus over time are shown in Figure 34–2. For horizontal and vertical eye movements, “pen up” defines the movements that are up or to the right and “pen down” defines those that are down or to the left. The chart is read from left to right. Nystagmus direction is defined by the fast, or jerk, component, which is generated by the CNS. The slower component is in the opposite direction and is generated by the VOR. The speed of

the slow component is calculated in degrees per second (termed *slow component velocity* or SCV) and serves to quantify the nystagmus magnitude.

There are many types of nystagmus: pendular, rotatory (torsional), jerk (horizontal and vertical); and causes of nystagmus: vestibular, congenital, cerebellar as in rebound nystagmus, ocular motor as in internuclear ophthalmoplegia or gaze evoked. Other eye movement behaviors, such as inappropriate square waves, disconjugate eye movements, and ocular dysmetria such as saccadic over- or undershoots, may also reflect pathologic conditions. Leigh and Zee<sup>8</sup> offer an exhaustive compendium of most types of nystagmus and other eye movement abnormalities. Recording abnormal eye movement behaviors may help distinguish between the different types and causes. However, this does not emerge automatically from ENG or VNG records. Rather, it remains for the examiner to be well tutored in recognizing these eye movements and appreciating their implications. Nystagmus evoked by vestibulopathy will be limited to horizontal, vertical, or torsional “jerk” forms of nystagmus, correlating with the involved sensory organs within each labyrinth.



**Figure 34–2.** Electrooculographic recordings of horizontal and vertical nystagmus. A, Right-beating horizontal nystagmus and up-beating vertical nystagmus. B, Left-beating horizontal nystagmus and down-beating vertical nystagmus. On the latter, tracing is an example of how the velocity (slope, rise/run) of the slow component is measured as  $10^\circ/\text{second}$ .

### Key Points

- The corneoretinal potential (approximately 1 mV, with the front of the eye positive relative to the back of the eye) is the source potential recorded during electroculography.
- Electrodes are placed at the outer canthi of each eye to measure the horizontal component of eye movement, and electrodes placed above and below one eye are used to measure vertical movements.
- Changes in the field potential are measured across electrode pairs to estimate eye position.
- Infrared video-recording systems are the preferred method of recording eye movements, since eye movements can be observed and recorded for offline analysis and eye position can be controlled, avoiding measurement errors when the eyes deviate significantly away from the central position.
- By convention for horizontal and vertical eye movements, “pen up” deflections define eye movements that are rightward (horizontal vector) or upward (vertical vector) and “pen down” deflections indicate eye movements that are leftward (horizontal vector) or downward (vertical vector).
- The speed of the slow component of nystagmus is calculated in degrees per second (termed *slow component velocity* or SCV), and quantifies the nystagmus magnitude.
- Nystagmus evoked by vestibulopathy will be limited to horizontal, vertical, or torsional “jerk” forms of nystagmus, correlating with the involved sensory organs within each labyrinth.

### Preparation for Testing

A carefully documented history should rule out any preexisting condition (e.g., congenital nystagmus and use of medications or drugs) that could influence test results. Many medications, such as vestibular suppressants, sedatives, tranquilizers, antidepressants, and pain relievers, have side effects related to dizziness. When possible, these medications should be discontinued 24–48 hours before the patient

undergoes vestibular testing. Patients should refrain from smoking tobacco, because nicotine constricts blood vessels and, thus, impairs the blood supply to the vestibular mechanism. As a stimulant, caffeine can also adversely affect the vestibular reflexes. Alcohol alters the chemical balance of the perilymph and endolymph and induces positional nystagmus. Geotropic (beating toward the earth) positional nystagmus can be induced within one-half hour of alcohol ingestion and continue up to 4 hours. Ageotropic (beating away from the earth) positional nystagmus can be observed from 5 to 24 hours after alcohol is ingested. Consequently, alcohol should be avoided for at least 24 hours before testing.

Use of anticonvulsants, long-acting SSRIs, and medications for vascular regulation should not be discontinued before testing. Patients with diabetes should eat a light meal at least 2 hours before testing and should not avoid taking their insulin. Leigh and Zee<sup>8</sup> provide an in-depth discussion of the effects of drugs on eye movement.

### Key Points

- Medications, such as vestibular suppressants, sedatives, tranquilizers, short-acting antidepressants, and pain relievers, should be discontinued 24–48 hours before the patient undergoes vestibular testing.
- Patients should refrain from smoking before vestibular testing, since nicotine constricts blood vessels and impairs blood supply to the vestibular mechanism.
- Caffeine can adversely affect the vestibular reflexes.
- Alcohol alters the chemical balance of the perilymph and endolymph and induces positional nystagmus and should be avoided for at least 24 hours before testing.

### Videonystagmography Test Battery

#### *Purpose and Role of the ENG/VNG Test Battery*

- Inventory visually guided eye movements, such as saccadic, pursuit, and optokinetic-based eye movements, are used to detect visual and central eye movement deficits and ensure that the ocular motor final common pathway is intact and adequate

for interpreting vestibular-induced eye movements without artifact.

- Test for pathologic vestibular-induced nystagmus provoked by head movements or static head positions without visual fixation.
- Compare the strength of the horizontal SCC-induced VOR evoked from each ear using the bilateral, bithermal caloric test. Vestibulopathy that decreases the caloric response from one ear results in a caloric asymmetry termed a *unilateral weakness* (UW). A UW score of 25% or more usually indicates a significant asymmetry in SCC output.

### INVENTORY OF VISUALLY GUIDED EYE MOVEMENTS

Assessing visually guided eye movements (saccades, smooth pursuits, and optokinetic reflex movements) contributes to the assessment of the dizzy patient in three ways. First, from a historical perspective, measuring visually guided eye movement behaviors can detect ocular motor and supranuclear CNS disease. Improved clinical knowledge and modern electrophysiologic and imaging studies have largely supplanted the use of eye movements as primary indicators of CNS disease. Nevertheless, recording abnormal visually guided eye movements can help validate eye movement abnormalities observed or perhaps overlooked on the bedside examination.

The second contribution to assessing visually guided eye movement measurements, along with bedside ocular motor testing, is to ensure the ocular motor final common pathway is intact and adequate for interpreting vestibular-induced eye movements without artifact. Finally, in the elderly, inaccurate and visually guided eye movements can correlate with impaired visual perception, making it difficult for patients to accurately identify obstacles while attempting to ambulate through an environment.

#### **Saccadic Eye Movement Testing**

During calibration, the patient looks back and forth at targets positioned at least  $\pm 10^\circ$  off midline, which provides the examiner an opportunity to look for undershoot or overshoot dysmetria. If undershooting or

overshooting occurs consistently, it may be related to posterior fossa involvement. New computerized systems produce random visual targets [typically light-emitting diodes (LEDs)] subtending a visual arc of  $\pm 30^\circ$  on a light bar. The accuracy, latency, and velocity of the eye movements relative to the stimulating signal are calculated and compared with age- and sex-matched normal values. As a very general rule, slow saccadic velocities are associated with ocular motor final common pathway deficits. Impaired accuracy may be seen in final common pathway or cerebellar involvement. Saccadic onset latency delays, when unilateral, may imply a deficit at any level in the functional unit. There are several technical variables that influence the accuracy of these parameters, including the sampling rate used in the digitization process. Video-recording systems sampling at 30 Hz may not be adequate for reliable saccadic velocity measurements. Further, before abnormal latency and accuracy values are considered significant, visual impairments such as cataracts, retinopathy, central scotoma, or poor patient cooperation must be ruled out.

#### **Key Points**

- During saccadic eye movement testing, the patient looks back and forth at targets positioned at least  $\pm 10^\circ$  off midline, providing an opportunity to assess for undershoot or overshoot dysmetria.
- The accuracy, latency, and velocity of the eye movements relative to the stimulating signal are calculated and compared with age- and sex-matched normal values.
- Slow saccadic velocities are associated with ocular motor final common pathway deficits.
- Impaired accuracy of saccadic eye movement testing may be seen in final common pathway or cerebellar involvement.
- Saccadic onset latency delays, when unilateral, may imply a deficit at any level in the functional unit.
- Before abnormal latency and accuracy values during saccadic eye movement testing are considered significant, visual impairments such as cataracts, retinopathy, central scotoma, or poor patient cooperation must be ruled out.



### Smooth Ocular Pursuit Testing

The smooth ocular pursuit test can be conducted by having the patient hold the head still and follow a pendulum with the eyes. Newer computerized systems produce a range of frequencies, using pendular-like signals, by turning on and off adjacent LEDs on the light bar. Ocular pursuit operates well up to a frequency of 1 Hz. The computerized pursuit tests usually cover a range from 0.2 to 0.7 Hz. The test is sensitive to medication effects, poor vision, and poor patient cooperation. Several trials may be needed to ensure that the patient is trying his or her best. Pursuit performance also diminishes with age. Age-matched normal reference values are required to distinguish between normal aging effects and true pathologic pursuit. When these confounding variables are excluded, abnormal test results suggest CNS dysfunction. The most common abnormality is “cogwheeling” pursuit, in which the eyes are continually making saccadic movements to catch up with the target. Unilateral loss of pursuit or saccadic intrusions may be observed with saccadic dysmetria in unilateral cerebellar disease.

#### Key Points

- The smooth ocular pursuit test can be conducted by having the patient hold the head still and follow a pendulum or electronic pendular-like signals with the eyes.
- Smooth ocular pursuit testing is sensitive to medication effects, poor vision, and poor patient cooperation.
- Smooth ocular pursuit performance also diminishes with age.
- Unilateral loss of pursuit or saccadic intrusions may be observed with saccadic dysmetria in unilateral cerebellar disease.

### Optokinetic Nystagmus

Optokinetic nystagmus (OKN) is another test of smooth ocular pursuit or CNS function. The stimulus is usually generated as a series of light and dark vertical bars that move from right to left or left to right of the patient at 20°, 40°, or 60° per second. Ideally, the entire visual field of the patient should be filled with these stimuli in a darkened room. Less acceptable alternatives are small handheld rotating drums with black and white stripes or a series of LEDs that appear to move across a light bar. Abnormal

findings include asymmetry between right and leftbeating or an inability of the patient to increase eye speed with increased stimulus speed appropriately. Asymmetric OKN may be seen in the presence of strong spontaneous nystagmus. OKN asymmetries recorded without the presence of a positional nystagmus or caloric weakness may imply supratentorial involvement. Perceptually, normal individuals exposed to a moving full-field optokinetic stimulus experience a strong sensation of circularvection. In contrast, some individuals with closed head injury fail to experience self-movement despite normal reflexive nystagmus, suggesting a disconnection between centers associated with the perception of self-motion.

#### Key Points

- OKN tests smooth ocular pursuit or CNS function.
- OKN asymmetries recorded without the presence of a positional nystagmus or caloric weakness may imply supratentorial involvement.

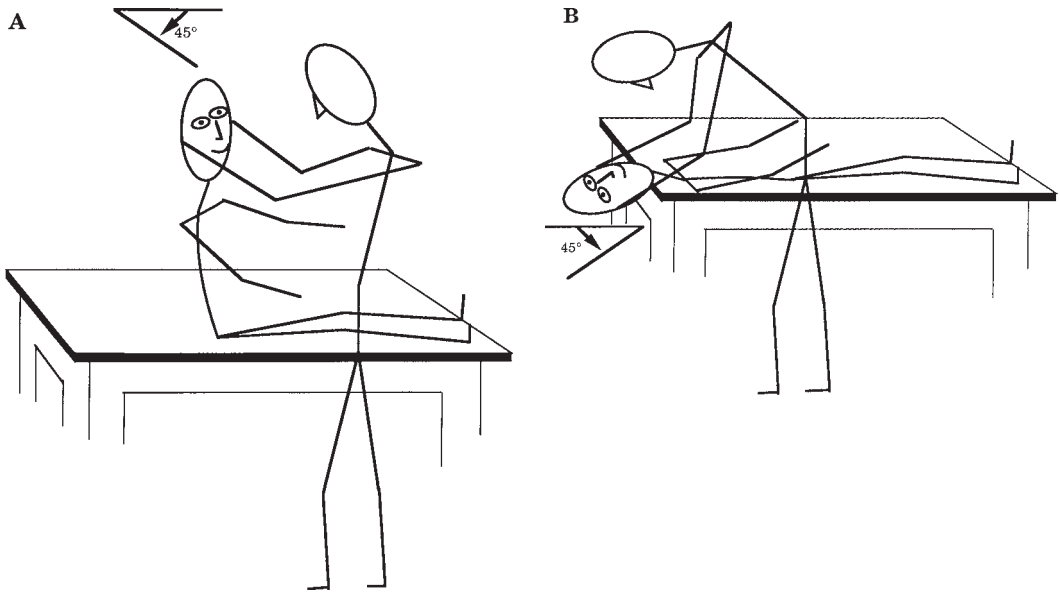
### TESTING FOR PATHOLOGIC NYSTAGMUS

#### Positioning Induced Nystagmus

Positioning induced nystagmus is nystagmus that is provoked following head movement. Benign paroxysmal positioning vertigo (BPPV) is by far the most common cause of positioning induced vertigo.<sup>9,10</sup> BPPV can be provoked from any SCC. However, the posterior canal is most commonly involved. It follows that the most common provocative maneuver is the Dix–Hallpike test, or Nylen maneuver, which moves the patient in the plane of the right (or left) posterior SCC.

To perform a Dix–Hallpike maneuver, the patient is seated with the head turned 45° to the right or the left and is then placed in the corresponding head-hanging position (with the head still turned 45° to the side). The eyes should remain open so the examiner can observe any torsional nystagmus. In the past, it was thought that the movement should be brisk. However, more comfortable movements can still provoke BPPV symptoms so long as the movement is along the plane of the involved canal. The maneuver is illustrated in Figure 34–3.





**Figure 34-3.** Dix-Hallpike maneuver (Nylén maneuver) for the head-hanging right position. *A*, In the sitting position, the patient turns the head 45° to the right with the eyes open and fixed. The patient is then put quickly into the supine position. *B*, The patient in the head-hanging right position with eyes open and fixed. Observe for nystagmus and dizziness for at least 30 seconds. The classic positive response is counterclockwise nystagmus with the head down and turned to the right and clockwise nystagmus with the head down and turned to the left. The nystagmus is reversed with sitting up but is less intense.

When positive, a brisk nystagmus will develop after a brief delay of 5–40 seconds. The nystagmus will be identical to the normal nystagmus provoked while moving into the provocative position (i.e., the eye moves in the plane of the posterior canal). The nystagmus will crescendo and then gradually diminish, typically within 10–40 seconds of onset. The provoked vertigo will duplicate the patient's symptoms. When the patient is returned to the sitting position, a second burst of nystagmus may develop. Returning the patient to the head-hanging position will often provoke a less intense response.

Epley<sup>11</sup> postulated the existence of floaters in the posterior SCC as the cause of these symptoms and proposed a physical maneuver, the canalith repositioning procedure, to move the particles out of the involved canal. Several investigators have reported excellent success rates with this procedure.<sup>12–16</sup>

Variants of BPPV involve loose particles in the horizontal or anterior SCCs. Treatment for horizontal canal BPPV involves a procedure in which a supine patient is rotated 360° to the right or left, in the direction away from

the affected ear. Herdman<sup>17</sup> has provided an excellent flowchart describing the various types of BPPV and their treatments.

EOG recording techniques have little value in the assessment of BPPV because this method cannot record torsional eye movements. However, video-based systems allow the examiner to more carefully evaluate eye movements offline. This makes detecting horizontal and anterior canal variations easier to detect.

Central positioning nystagmus is a rare abnormality associated with posterior fossa disease.<sup>18,19</sup> Positioning nystagmus may take any form, but is often vertical or oblique. Importantly, central positioning nystagmus is not associated with vertigo or dizziness and does not demonstrate visual fixation suppression. In certain lesions around the fourth ventricle, severe nausea may accompany the nystagmus.

### Key Points

- BPPV is by far the most common cause of positioning induced vertigo.
- The most common provocative maneuver, the Dix-Hallpike test, moves the patient

in the plane of the right (or left) posterior SCC.

- When the Dix–Hallpike test is positive, a brisk nystagmus will develop after a brief delay of 5–40 seconds. The nystagmus will crescendo and then gradually diminish, typically within 10–40 seconds of onset.
- Central positioning nystagmus is a rare abnormality associated with posterior fossa disease.

### Gaze Testing

Gaze testing is performed with the patient's eyes fixed on a visual target in the primary gaze position and  $\pm 30^\circ$  from midline, both horizontally and vertically. Gaze-evoked nystagmus (nystagmus that changes direction with eye position) typically implies CNS involvement. Intoxication or centrally acting medication effects will commonly cause this eye movement behavior. Often, this nystagmus will not be observed when visual fixation is denied.

Peripheral vestibulopathy may also produce abnormal gaze nystagmus with the eyes open and fixed. Importantly, this nystagmus will demonstrate the three cardinal behaviors of vestibular nystagmus mentioned above. The nystagmus will be direction-fixed, will follow Alexander's Law, and will suppress with visual fixation. Eye movement recordings enable calculation of nystagmus slow-component velocities so that the effects of eye position, visual fixation, and nystagmus direction can be objectively established.

### Key Points

- Gaze-evoked nystagmus typically implies CNS involvement.
- Peripheral vestibulopathy may also produce abnormal gaze nystagmus with the eyes open and fixed. When the observed nystagmus follows Alexander's law, suppresses with visual fixation, and corresponds with an underlying positional/spontaneous nystagmus, it is almost certainly vestibular induced.

### Positional Testing Without Fixation

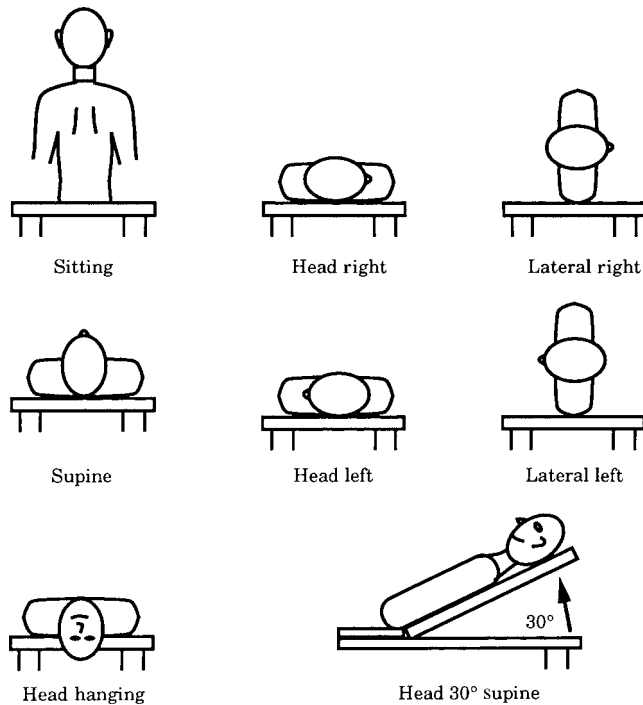
The purpose of positional testing without fixation is to measure eye movement with the patient's head held in various static positions, such as sitting, supine, supine head

right, supine head left, lateral right (no neck torsion), lateral left (no neck torsion), head hanging, and supine with the upper torso elevated by  $30^\circ$  (Fig. 34–4). The purpose for testing upper torso elevated by  $30^\circ$  is to have a reference for establishing the amount of spontaneous nystagmus present during caloric irrigation (see below). Recordings are made for 20–60 seconds. Visual fixation and volitional suppression of nystagmus are common pitfalls of the positional test.

Normal patients may demonstrate some positional nystagmus.<sup>20</sup> Typically, this nystagmus will not exceed  $6^\circ$  per second in the horizontal vector or  $9^\circ$  per second in the vertical vector in a single head position. Nystagmus that exceeds  $6^\circ$  per second in the horizontal vector is consistently present in four or more positions with an SCV greater than  $4^\circ$  per second, or nystagmus that changes direction in a single head position does not often occur in otherwise normal patients.<sup>21,22</sup>

Abnormal findings exceeding the limits described above are categorized as (1) direction-fixed or (2) direction-changing. Direction-changing can be geotropic (fast phase beats toward the floor in lateral head positions), ageotropic (fast phase beats toward the ceiling in lateral head positions), or direction-changing in a single head position. Although the findings are nonlocalizing, there are some general rules. Direction-fixed positional nystagmus is often observed in chronic unilateral hypofunction and usually beats toward the unaffected or less affected ear. With an irritative lesion such as in Meniere's syndrome, nystagmus can beat toward the diseased ear. Direction-changing nystagmus may be seen with otolith organ involvement, though not exclusively so. The intensity of positional nystagmus is also useful in monitoring physiologic compensation during the disease process, because the nystagmus diminishes as compensation occurs.

Direction-changing nystagmus in a single head position (excluding positioning induced nystagmus) is usually a sign of CNS dysfunction and is referred to as *periodic alternating nystagmus*. Periodic alternating nystagmus may change direction every two minutes or so. Persisting vertical or oblique nystagmus may also be of central origin, particularly if the nystagmus does not suppress with visual fixation.



**Figure 34-4.** Head positions used in the static positional test. The patient's eyes remain closed, but the patient must be alert.

### Key Points

- The purpose of positional testing without fixation is to measure eye movement with the patient's head held in various static positions.
- Normal patients may demonstrate some positional nystagmus, which does not exceed  $6^\circ$  per second in the horizontal vector or  $9^\circ$  per second in the vertical vector in a single head position.
- Direction-fixed positional nystagmus is often observed in chronic unilateral hypofunction and usually beats toward the unaffected or less affected ear.
- Direction-changing nystagmus in a single head position is usually a sign of CNS dysfunction and is referred to as *periodic alternating nystagmus*.

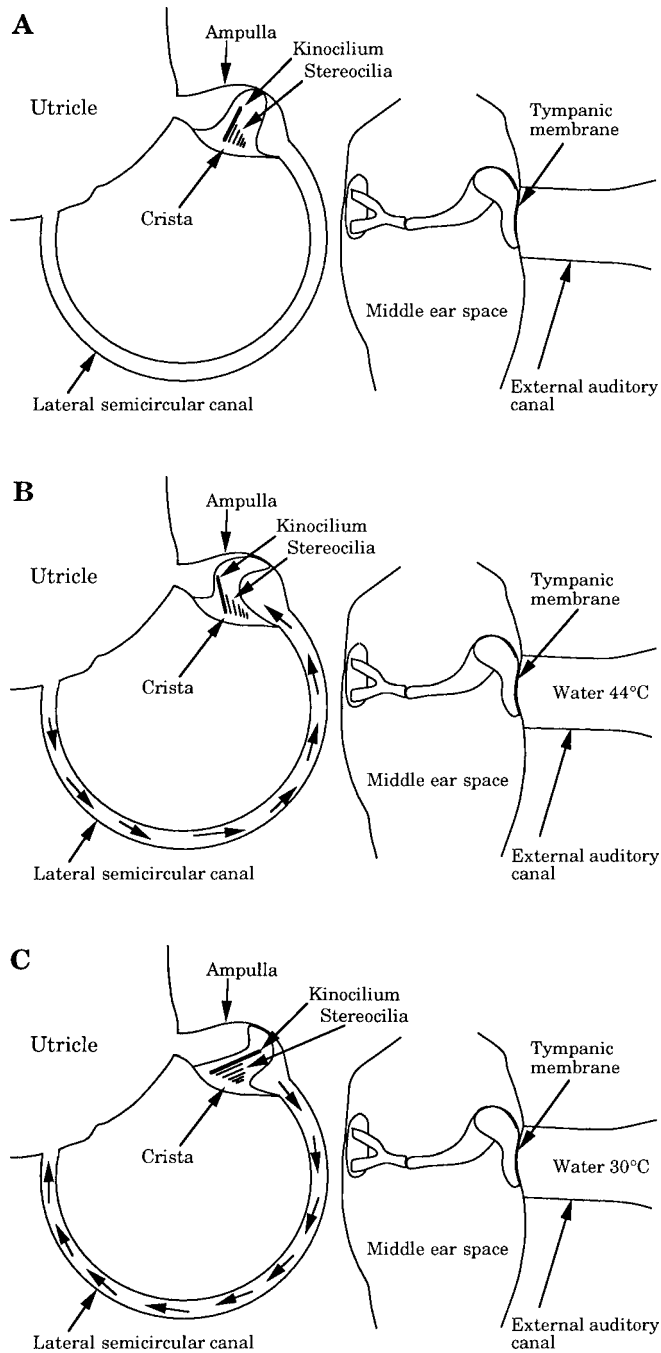
### CALORIC IRRIGATION

The caloric test is the bedrock of the VNG/ENG battery. It is one of the few tests that allow each labyrinth to be tested in isolation. Caloric irrigation is performed with the patient's head in a  $30^\circ$  supine position,

which orients the lateral SCCs vertically. The stimulus used is water ( $\pm 7^\circ\text{C}$  relative to normal body temperature) or air ( $\pm 13^\circ\text{C}$  relative to normal body temperature). The ear is irrigated with water for 30–40 seconds or with air for 60–70 seconds.

The theory behind the caloric test is that warming or cooling the bone surrounding the lateral SCC creates a convection current in the endolymph that causes utriculopetal or utriculofugal flow. The change in resting discharge rate is then registered within the vestibular nuclei, where the asymmetry in ampullary nerve output between the horizontal SCCs drives VOR-induced eye movements. Bithermal irrigations are used to induce eye movements in both directions from each ear. This minimizes the effect of underlying spontaneous nystagmus on caloric asymmetry calculations.

The left lateral SCC at rest and after warm ( $44^\circ\text{C}$ ) and cool ( $30^\circ\text{C}$ ) caloric stimulation is shown in Figure 34-5. Warm stimuli cause the nystagmus to beat toward the stimulated ear, and cool stimuli cause it to beat toward the nonstimulated ear, thus the acronym COWS (cold opposite, warm same).



**Figure 34-5.** A, Lateral semicircular canal at rest (i.e., no caloric stimulation or fluid rotation). Kinocilium and stereocilia are vertical, producing a normal resting potential in vestibular nerve. B, Stimulation with warm water (44°C) causes upward convection current (utriculopetal endolymph flow). Stereocilia bend toward kinocilium, depolarizing the dendrites at base of hair cell, thus increasing firing rate of the vestibular nerve. C, Stimulation with cool water (30°C) induces downward convection current (utriculofugal endolymph flow), causing kinocilium to bend toward stereocilia, which hyperpolarizes dendrites at base of hair cell, thus decreasing firing rate of the vestibular nerve.

The goal of the caloric test is to compare the strength of each horizontal canal in an effort to identify the weak or paretic ear. This is accomplished by the Jonkees UW formula. Unilateral weakness is determined by comparing the nystagmus generated on each side:

$$UW = \frac{(RW + RC) - (LW + LC)}{(RW + RC + LW + LC)} \times 100$$

where RW is the right warm-peak SCV, RC is the right cool-peak SCV, LW is the left warm-peak SCV, and LC is the left cool-peak SCV. The result is a percentage difference in nystagmus magnitude between ears. In most testing laboratories, a unilateral weakness of at least 25% is needed to be clinically significant. An example of a left peripheral weakness, 49% weaker on the left side, is shown in Figure 34-6.

Directional preponderance (DP) compares the magnitude of rightward- and leftward-directed nystagmus during the caloric test. It is calculated as follows:

$$DP = \frac{(RW + LC) - (LW + RC)}{(RW + RC + LW + LC)} \times 100$$

The difference between the two directions must be at least 30% to be considered significant. DP is nonlocalizing. It usually accompanies a direction-fixed positional nystagmus and, like positional nystagmus, reflects central compensation state.

Bilateral weakness is suggested when the sum of the peak nystagmus SCVs from all four irrigations is less than 28° per second. An example of this is shown in Figure 34-7. The total nystagmus generated (in degrees) is 0 + 4 + 0 + 3 = 7° per second. The caloric test is not well suited to detecting less severe forms of bilateral vestibular weakness. Test variability is such that, in some cases, it is difficult to distinguish between true bilaterally weak responses and low SCVs evoked from normal patients. Rotary chair tests are better suited to determining true bilateral vestibular weakness.

Another aspect of the caloric test is the measurement of visual fixation suppression. Shortly after the eyes reach their maximal velocity, vision is reestablished and the patient is asked to fixate on a visual target. If the patient does not suppress the nystagmus by at least

30%–40%, the result is abnormal and indicative of a CNS lesion. A summary of ENG test battery results is given in Table 34-1.<sup>23</sup>

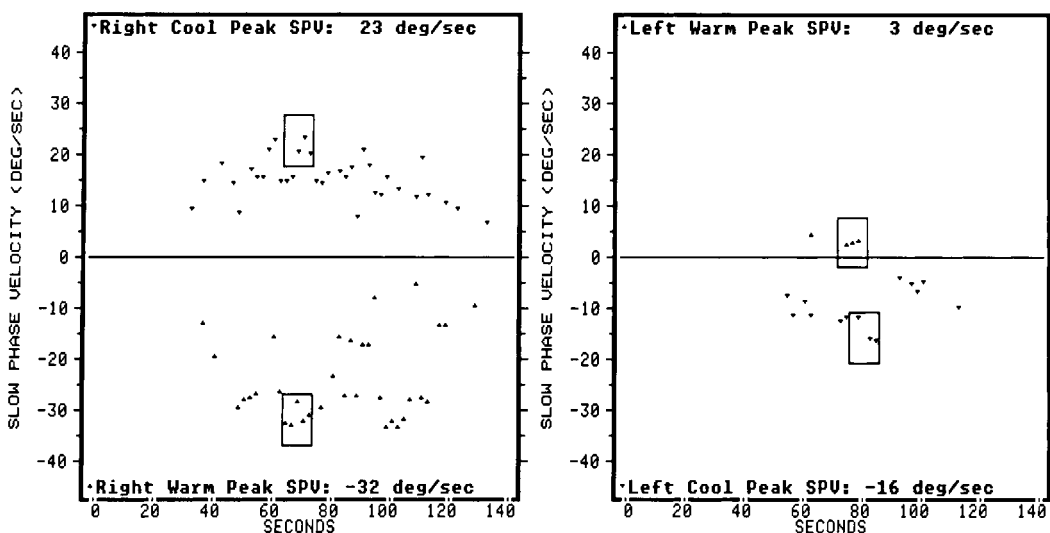
Caloric irrigation is the standard test for determining the laterality of lesions involving the horizontal canal or superior vestibular nerve branch. However, certain pitfalls must be avoided. Small variations in technique can influence the performance of the caloric test. Careful equipment calibration and laboratory-specific reference values are necessary. The patient must not be allowed to fixate visually but must remain mentally alert. Also, congenital nystagmus or any drugs or medication that could influence the results must be ruled out.

The results in patients with perforated tympanic membranes may also be misleading. If the middle or external ear is wet because of infection and drainage, a warm air stimulus initially cools rather than heats the bone and the nystagmus beats in the direction produced by a cold stimulus. This could be misinterpreted as a CNS abnormality.

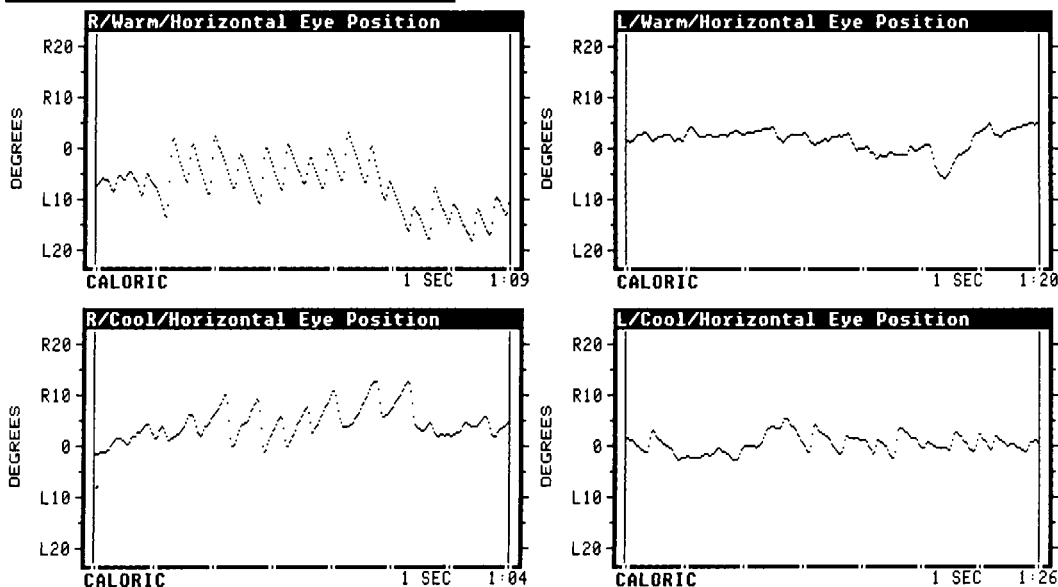
### Key Points

- Visually guided eye movement tests include measurement of saccadic, pursuit, and optokinetic-induced nystagmus. When medication effects, poor vision, and poor patient cooperation can be excluded, abnormalities may point to CNS involvement. Abnormal tests require clinical correlation to establish significance.
- Positioning nystagmus is nystagmus that develops as the result of prior movement. BPPV is the most common form and is easily treated with repositioning maneuvers.
- Positional nystagmus that is persistent and suppresses with visual fixation is commonly of peripheral origin and reflects incomplete central compensation. Positional nystagmus is likely significant when it exceeds 6° per second in the horizontal vector or 9° per second in the vertical vector in a single head position; or is greater than 4° per second and is consistently present in four or more positions.
- Positional nystagmus that changes direction in a single head position and is not associated with BPPV is likely a central, periodically alternating nystagmus.

### A. Bithermal Caloric



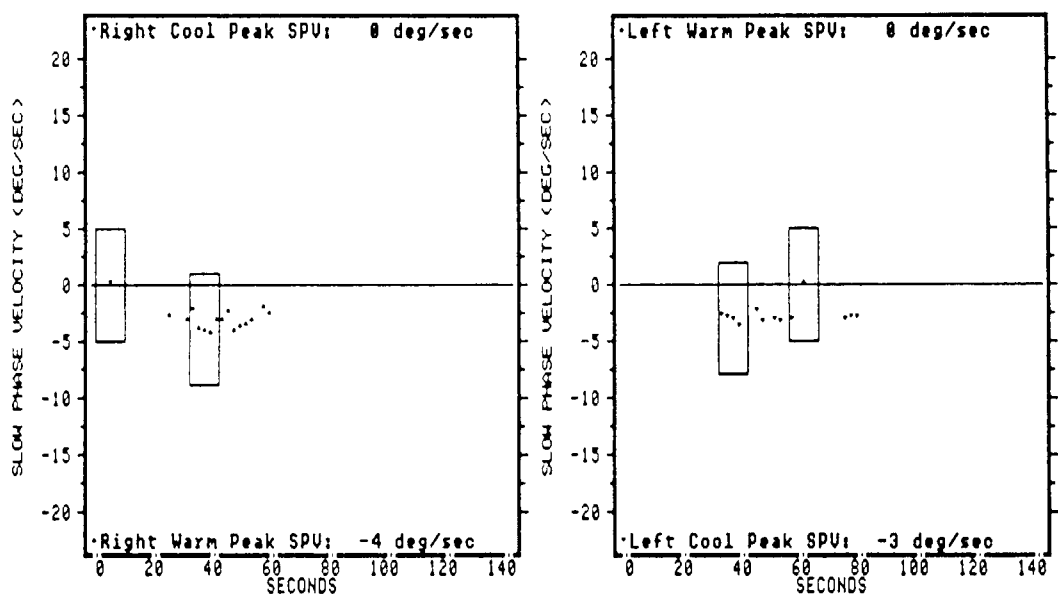
### B. CALORIC



**Figure 34-6.** Responses to caloric stimuli in a patient with left unilateral vestibular weakness. *A*, Calculated response of the nystagmus over time. The *small boxes* represent peak eye velocity values averaged for each of the four irrigations. These responses show a 49% left peripheral weakness and a 30% right-beating directional preponderance. *B*, Raw data obtained during peak eye velocities. Note the weak responses obtained by stimulating left ear. SPV, Slow phase velocity.

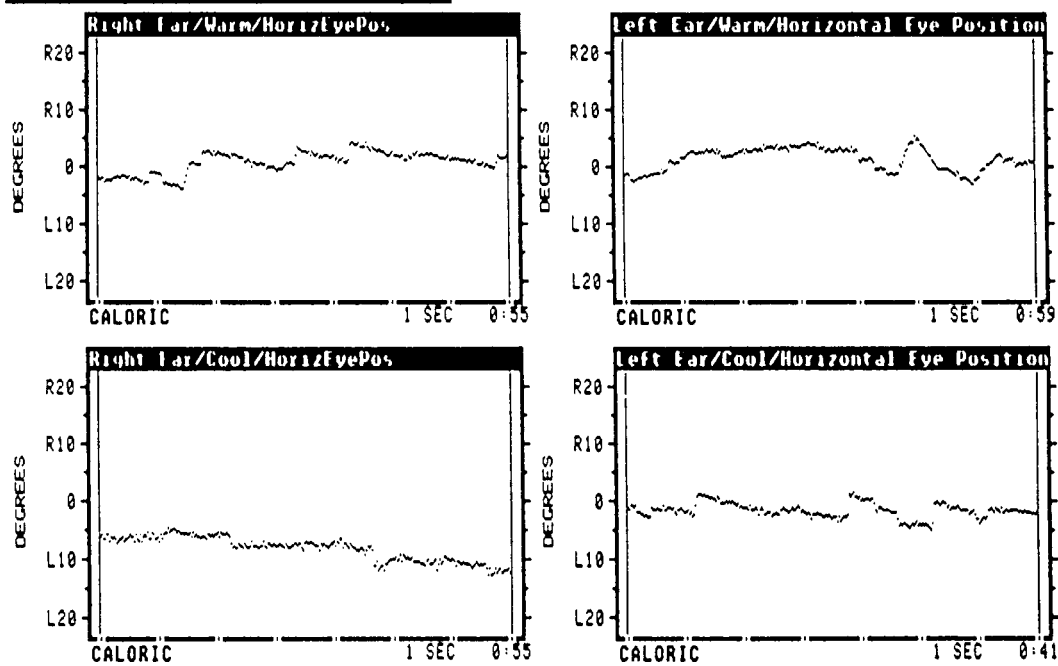


**A. Bithermal Caloric**



Caloric Weakness: 14 percent in the left ear  
 Directional Preponderance: 100 percent to the right

**B. CALORIC**



**Figure 34-7.** Responses to caloric stimuli in patient with peripheral vestibular weakness bilaterally. *A.* Calculated response of nystagmus over time. The *small boxes* represent peak eye velocity values averaged for each of the four irrigations. These responses show a total of 7° of right-beating nystagmus, which is probably caused by the positional nystagmus present whenever eyes are closed. *B.* Raw data obtained during peak eye velocities. Note weak responses with stimulation of both ears. SPV, slow phase velocity.

**Table 34–1 Electronystagmography Test Battery: Correlation of Abnormal Findings and Suspected Site of Lesion\***

Test	Type of abnormality	Suspected site of lesion
Saccade	Ipsilateral dysmetria	Cerebellopontine angle
	Bilateral dysmetria	Cerebellum
Pursuit	Decreased velocity	Throughout the central nervous system, muscle weakness or peripheral nerve palsy
	Internuclear ophthalmoplegia	Medial longitudinal fasciculus
	Break-up	Brainstem or cerebrum
Gaze	Saccadic	Cerebellum
	Direction-fixed and horizontal	Peripheral vestibular
	Direction-changing and vertical	Brainstem
	Up-beating	Brainstem or cerebellum
Failure of fixation suppression	Down-beating	Cervicomedullary junction or cerebellum
	Rotary	Vestibular nuclei/brainstem
Positional	Less than 40% decrease	Brainstem or cerebellum
	Direction-fixed	Nonlocalizing or peripheral
Dix-Hallpike	Direction-changing	Nonlocalizing or central
	Classic	Peripheral vestibular—undermost ear
Caloric	Nonclassic	Nonlocalizing
	Unilateral or bilateral weakness	Peripheral vestibular
	Directional preponderance	Nonlocalizing

\*Exceptions to the rule may occur.

From Cyr.<sup>19</sup> By permission of Allyn & Bacon.

Persisting vertical or oblique nystagmus may also be of central origin, particularly if it does not suppress with visual fixation.

- Asymmetries greater than 25% on the bilateral, bithermal caloric test are commonly associated with unilateral weakness in the ear with lower nystagmus peak SCVs.
- DP asymmetries greater than 30%, while not diagnostic, may reflect central compensation status when unilateral weakness is also detected.
- Bilateral vestibular weakness may be present when the sum of the caloric SCVs is less than 28° per second.

## Computerized Rotary Chair Tests

Computerized rotary chairs assess the VOR while the patient is turned in a precisely controlled manner. There are several test strategies that can be employed with this tool.

In some protocols, the rotary chair chamber is darkened or deliberately illuminated. The resulting compensatory eye movements developed as the chair turns reflect either VOR or visually enhanced VOR (VVOR) respectively. There are several advantages to the rotary chair test. First, for most test protocols, patients tolerate rotary chair testing better than caloric irrigation tests. Second, computer-controlled angular rotation is a more consistent stimulus than caloric irrigation, which produces more reliable data in the form of gain, phase, and symmetry measurements. Further, the controlled rotational stimulus appears to be better for monitoring changes over time than the caloric test. Third, bilateral horizontal canal weakness can be efficiently quantified. Finally, small children can be tested without difficulty. A major shortcoming is that slow acceleration rotary testing stimulates both lateral SCCs simultaneously. Techniques for isolating ear-specific VOR responses are developing, using high-acceleration chair movements (following

Ewald's second law). However, these methods are not currently in wide use. Caloric irrigation is still the primary test for evaluating each horizontal SCC independently.

### **Purpose and Role of Computerized Rotary Chair Testing**

- Slow harmonic acceleration (SHA) is useful in detecting bilateral weakness, detecting subtle VOR deficits, and testing infants or elderly patients at risk for bilateral weakness.
- With vision, SHA measures the contribution of vision to VOR-induced eye movements. Abnormalities on this task predict oscillopsia (perceived instability of the visual scene from loss of stabilizing eye movements).
- Fixation suppression tests detect central vestibular impairment.
- High-acceleration step tests may demonstrate reduced VOR gain when rotating toward the weak ear, and shortened time constants indicate vestibular deficits.

The test used most often is the low-frequency *Slow harmonic acceleration (SHA) test*, with the patient kept in total darkness. To understand SHA, it is important to recognize that normal horizontal head movements about the pivot point of the cervical spine occur at frequencies between 1 and 4 Hz. Below 1 Hz, VOR-induced eye movements will not be sufficient to keep the eye focused on a visual target. Consequently, when head movements occur at lower frequencies (slower acceleration and deceleration speeds) VOR-induced eye movements must be augmented by pursuit eye movements.

SHA testing consists of accelerating and decelerating the chair from 0° to 50° or 80° per second in a sinusoidal fashion from 0.01 to 0.64 Hz. This is below the optimal frequency range of the horizontal VOR. VOR-driven eye movements are systematically reduced in gain and demonstrate timing distortions (expressed as phase lead in degrees). When patient responses demonstrate lower than normal gain reductions, higher than normal phase leads, or tend to provoke a stronger nystagmus in one direction, vestibulopathy is very likely.

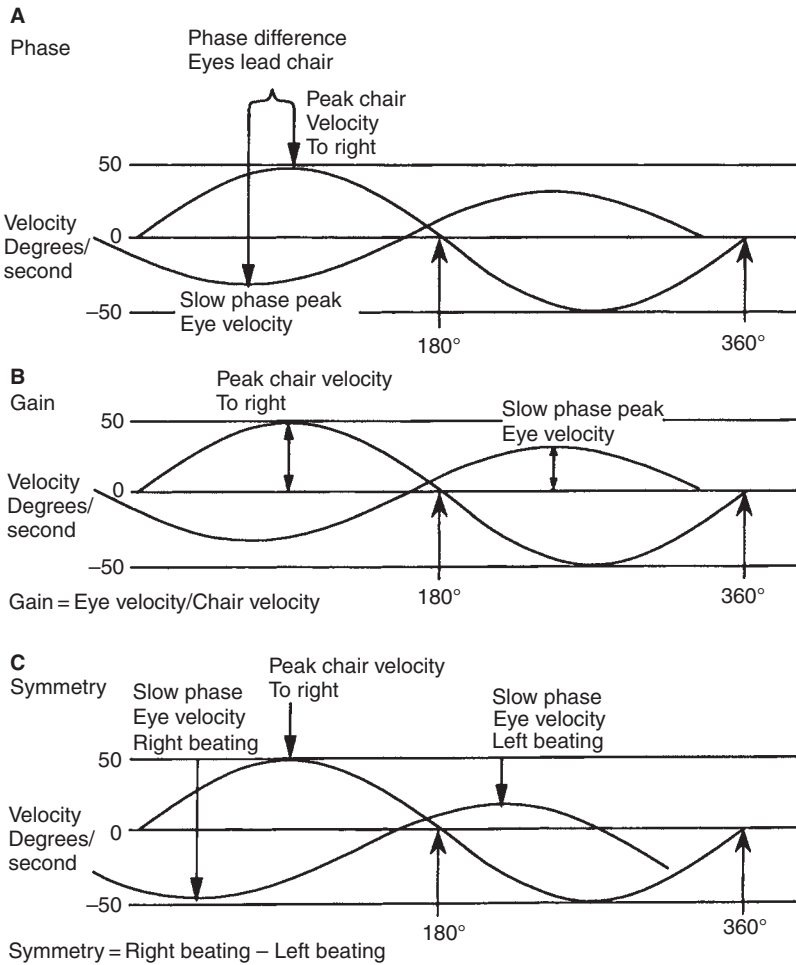
Most modern systems use an infrared camera to monitor the patient's eyes to ensure that

they are open. As the chair rotates, the computer digitizes the analog signals from the eyes and compares the eye movement with the chair rotation. The algorithms compare the velocity, phase, and gain of the two signals. At low frequencies (e.g., 0.01 Hz), normal eye velocity leads chair velocity by as much as 45°. As the chair frequency increases and approaches 0.64 Hz, the phase difference approaches zero. With the patient rotating in the dark, the gain (ratio of eye velocity to chair velocity) is low at low frequencies and increases at higher frequencies. The relationships of phase, gain, and symmetry of chair velocity and eye velocity are shown in Figure 34–8. Normal phase gain and symmetry are shown for a patient in Figure 34–9.

The data from a patient with left peripheral vestibular weakness, as indicated by a 59% caloric difference between the two ears and a 22% right-beating DP, are shown in Figure 34–10. Note that the gain is normal from 0.01 to 0.32 Hz (0.64 Hz was not tested). Phase is abnormal or borderline abnormal from 0.01 to 0.16 Hz. Asymmetry, although within normal range, is slightly below the line, indicating that right-beating vestibular nystagmus is greater than left-beating nystagmus. This patient record demonstrates the signs of central compensation for an underlying peripheral vestibular lesion. Despite the persisting left caloric weakness, there is very little abnormality noted in SHA test results due to the effects of central compensation. Asymmetries, phase leads, and gain reductions are common in acute lesions. Over time, abnormal gain and asymmetry values trend into the normal range as central compensation occurs. Phase (reflecting VOR timing relationships) can remain abnormal, particularly if there is complete loss of function on one side.

Slowly developing deficits, such as a vestibular schwannoma, may not show any abnormality at all on SHA, due to the slow growth of the mass and ample opportunity for central circuits to compensate for reductions in end organ output. Because both ears can contribute to evoked eye movements, SHA test results tend to reflect central compensation status more than reductions in peripheral vestibular output.

Patients with total bilateral vestibular weakness have poor gain at all frequencies and no response to caloric irrigation. Phase and



**Figure 34-8.** Measurement of phase (A), gain (B), and symmetry (C) using a computerized rotary chair. Sine waves represent fast Fourier analysis of the velocity of the chair and slow phase movement of the eyes, as indicated.

symmetry values are meaningless in this situation because there is no eye velocity to use for comparison. Lesser degrees of vestibular weakness may provoke near normal caloric responses, but demonstrate bilateral weakness on SHA measurements. This commonly occurs in the elderly. The caloric test, in these cases, may underestimate the role played by the vestibular system in multifactorial imbalance of the aged.

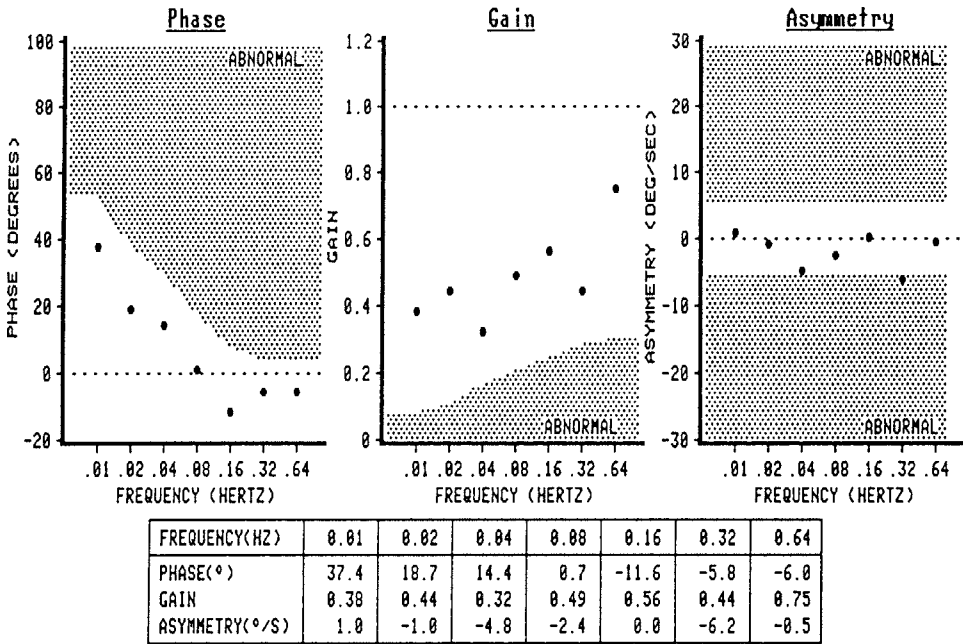
Fixation suppression of vestibular-induced eye movements can be measured with great precision during SHA testing. A visual fixation target is presented that moves at the same velocity as the chair. Normal patients are able to suppress vestibular nystagmus by gazing at the visual target. Unilateral disorders of the

vestibular cerebellum produce a loss in the ability to suppress nystagmus in one direction. Bilateral loss of fixation suppression can also occur from central vestibular deficits. As with other visually guided eye movement tests, poor vision and patient attention problems must be excluded before the possibility of CNS disease can be entertained.

The rotary chair affords the ability to investigate VVOR interactions. The patient, with eyes open, is rotated in a lighted room. Thus, visual and vestibular clues are available. In normal subjects, the test produces gain measurements that approach 1.0 and phase measurements that approach 0°. Acceptable VVOR performance requires normal vestibular and visual pursuit integration and results in stable vision

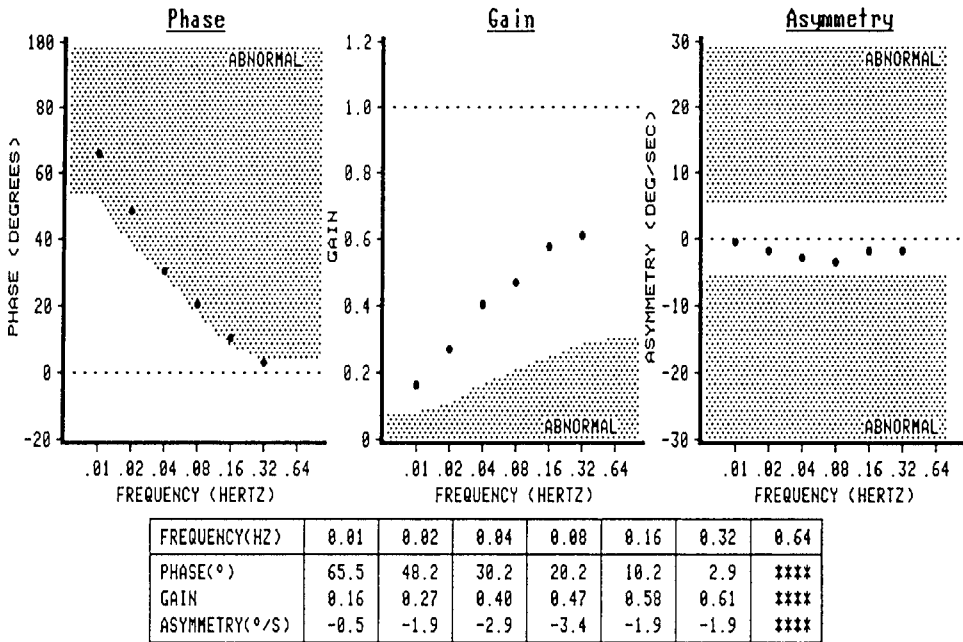
**ROTATION: Summary**

Id: \_\_\_\_\_



**Figure 34-9.** Normal rotary chair test results for phase, gain, and symmetry obtained with patient rotating in the dark. Results in shaded areas are abnormal.

**ROTATION: Summary**



**Figure 34-10.** Results of rotary chair test (conducted in darkness) in patient with right peripheral weakness. Phase is abnormal, but gain and symmetry are normal. Shaded areas are abnormal.

with fast or slow head movements. Low gain in high-frequency movements may be seen in cases of severe bilateral vestibulopathy. Deficits with low-frequency movements may be seen when pursuit is inadequate to produce stable vision. Deficits in the middle frequencies result from a combination of pursuit and vestibular weakness. Thus deficit performance on this test predicts oscillopsia with routine head movements.

The *step test* provides the information necessary to assess the time constant (i.e., the time it takes for nystagmus to decay to 37% of its maximum after stimulation has stopped). The patient is quickly accelerated from 0° to 60°, 100°, or 240° per second in 0.5 second. The chair then continues to rotate at 60°, 100°, or 240° per second for 1 minute. As the flow of the endolymphatic fluid in the SCCs approaches the velocity of the head, the nystagmus decays. Because of the elasticity of the cupula, the response time for it to bend and return to its resting state is approximately 4–7 seconds. However, the nystagmus continues for 10–30 seconds, which is attributed to central velocity storage. When the chair is stopped suddenly (0.5 second), the fluid continues to move relative to the head but in the opposite direction, thus generating nystagmus in the opposite direction. The time constant during this period is also measured. Either CNS dysfunction or the inability of the peripheral system to send the appropriate information for integration can cause abnormal findings.

There are several emerging rotational test methods that warrant mention. High-acceleration step tests may initially provoke eye movements from the leading ear. Measuring nystagmus accurately during high-acceleration movements is technically difficult. However, when refined, this may provide ear-specific asymmetry data compatible with caloric test results. Unilateral centrifugation, a rotational test where the patient is positioned so that the axis of rotation is just over one utricle, can provoke utricular-mediated VOR eye movements. Measuring these can help detect utricular disorders. These methods remain in evolution at the time of this writing.

The consistent stimulus and reliable nature of rotary chair testing make it the best choice for monitoring changes in the VOR over time. Rotary chair testing is valuable when monitoring physiologic compensation or

change in the vestibular mechanism induced by ototoxic medications. The rotary chair also provides the best environment for optokinetic testing, because most of the visual field can be filled with the moving visual stimuli.

### Key Points

- SHA methods are the test of choice for identifying bilateral vestibular weaknesses.
- Abnormal timing relationships demonstrated in phase measures are sensitive measures of vestibulopathy.
- Abnormal VVOR results indicate risk of oscillopsia.
- Fixation suppression can be measured with great precision using the SHA paradigm.
- Rotary chair tests are good for measuring changes in vestibular output over time.
- Because both horizontal SCCs contribute to VOR-induced eye movements on most rotary chair tests, the method is not optimal for identifying the side of vestibular involvement. At the same time, the test is ideal for measuring dynamic compensation status.

## Subjective Visual Vertical (SVV) Assessment

### Purpose and Role of SVV Assessment

- SVV is thought to reflect asymmetries in utricle tone. As such, this is the only measure of utricular function currently available.

Ocular tilts can be mediated in part by asymmetric utricle output. Lesions that cause reduced utricular tone on the involved side may provoke an ocular tilt reaction. In the ocular tilt reaction, the patient's head tilts toward the side of the lesion with skewed deviation and ocular torsion. The reaction may be observed in acute lesions of the peripheral or central utricular pathways. The reaction typically extinguishes quickly. However, a residual ocular torsion may persist longer than the head tilt, reflecting a residual bias difference between the two utricles. SVV tests measure how well a patient can volitionally set a projected line perfectly vertical in an otherwise darkened room.



Normal subjects are able to manipulate a vertical line within 2° of true vertical or true horizontal (subjective visual horizontal or SVH measurement) without any additional visual reference. Patients with unilateral lesions may be off by as much as 15° acutely, and often carry a residual tilt of 5°–6° following compensation. Incorporating these measurements with constant velocity rotary chair rotation may enhance the sensitivity of SVV or SVH. With constant velocity rotation, a shear force develops over the utricle, potentially increasing the asymmetry between normal and impaired sides.

It is important to understand that patient performance on SVV or SVH tests may vary across trials. Therefore, the average of several trials, using a controlled psychophysical method, should be used to capture best performance. Further, other causes of ocular tilt, including ocular motor disorders, must be excluded. When this can be accomplished, SVV and SVH measurements constitute a unique vehicle for measuring utricle function.

### **Key Points**

- Acute vestibular lesions may produce tilts in SVV measurements as high as 15°.
- Residual tilts of 5°–6° toward the weak side may be the sequela of peripheral labyrinthine impairment.
- SVV tilts may require multiple trials to establish reliable results.
- Other causes of ocular tilt need to be excluded.

## **LABORATORY EXAMINATION: VSR-BASED MEASURES**

### **Vestibular Evoked Myogenic Potentials**

VEMPs are early, biphasic field potentials that can be recorded from the muscles of the head, neck, and spine following presentation of an intense transient acoustic stimulus.<sup>24</sup> The response can be recorded using standard evoked potential methods and is commonly recorded over the sternocleidomastoid (SCM) muscles. The VEMP is thought to reflect stimulation of the saccule, which lies in close

proximity to the stapes footplate within the labyrinth. Although still under study, the most likely neural pathway underpinning the VEMP is from the saccule to the medial and/or lateral vestibular nuclei via the inferior vestibular nerve. Descending vestibulo-spinal tracks then carry the signal to the spinal accessory nuclei within the anterior horn cells of cervical spine levels C1–C6 and ultimately to the SCM muscle. There is likely more than one pathway for this reflex. VEMPs tend to be recorded ipsilaterally over neck muscles, but may be seen contralaterally when recorded from eye muscles. Nevertheless, the ability to use VEMP measurements to assess inferior vestibular nerve function has been an important addition to VOR-based tests of horizontal canal or superior vestibular nerve function. Moreover, combining caloric and VEMP test results can lead to a view of ascending VOR and descending VSR networks within the brain stem. This provides a more comprehensive assessment of central vestibular function and can aid in localization.

### **Purpose and Role of VEMPs**

- The VEMP reflects the function of the saccule, inferior vestibular nerve branch, and descending vestibular spinal pathways.

### **RECORDING METHODS**

Clinical techniques for recording VEMPs are not yet standardized. As a consequence, several techniques have been described in the literature. Careful construction of normal reference values using the specific technique applied in the laboratory is required to optimize interpretation of clinical data. Several of the variables that influence VEMP responses are reviewed below.

### **Stimuli**

VEMPs may be elicited from air-conducted (sound travels through the middle ear conductive mechanism) or bone-conducted (sound travels through the temporal bone directly to the inner ear) stimuli. So long as the evoking stimulus is intense and abrupt enough to elicit a synchronous discharge of the hair cell bed of the macula sacculae, a sharp transient change

in the muscle field potential may be detected through signal averaging. Acoustic clicks can be generated by most commercial signal averaging systems and are thus a convenient, but not necessarily optimal, stimuli. Air-conducted VEMPs are optimally evoked by tone bursts in the frequency range between 500 and 1500 Hz. The high-frequency energy contained in click stimuli will do little to evoke a VEMP, but will make the stimulus subjectively louder to the patient.

Stimulus rise time directly controls VEMP latency. Slower stimulus rise times produce longer VEMP latencies. Thus for tone bursts with a single cycle rise time, a 1000-Hz tone burst will provoke an earlier VEMP than a 500-Hz tone burst. Click stimuli, which have a near instantaneous rise time, will provoke an earlier VEMP than a 1000-Hz tone burst.

For reasons that are not clearly understood, bone-conducted stimuli tend to produce earlier VEMP responses than air-conducted stimuli. The optimal tone burst frequency for bone-conducted stimuli will be somewhat lower than for air-conducted stimuli, reflecting middle ear filter effects. A current limitation of bone-conducted stimuli is that effective stimulus intensities are difficult to produce using calibrated bone vibrators. Skull taps, and using triggering reflex hammers, may get around this limitation.

### Signal Averaging

There are two electrode montages commonly used to record a VEMP from the SCM. In the first method, the noninverting lead is placed on the upper half of the SCM muscle, with an inverted lead and ground placed on the sternum.<sup>25,26</sup> In this orientation, the first positive peak (P1 or P13 when click stimuli are used) will be plotted upward on the averaged waveform. In the second method, the noninverting lead and the ground are placed on the forehead, while the inverting lead is placed on the belly of the SCM muscle.<sup>27</sup> In this orientation, the first positive peak will be plotted downward. Beyond the polarity difference, there are subtle changes in VEMP waveform using these two methods. Clinically, these differences have not proven to be important to date. Electrode position over the SCM muscle is an important variable regardless of electrode montage employed. To decrease variability,

some authors use a large patch electrode over the SCM so that the electrode remains close to the belly of the muscle during head movements.<sup>28</sup>

The myogenic signal is amplified  $\times 5,000$ , band-pass filtered from 1–5 Hz to 250–1000 Hz, digitized, and signal-averaged. Epochs typically include a 20-ms prestimulus interval and an 80-ms poststimulus interval. Importantly, artifact rejection is turned off. Amplifier gain may need to be adjusted so that EMG activity does not saturate the amplifiers.

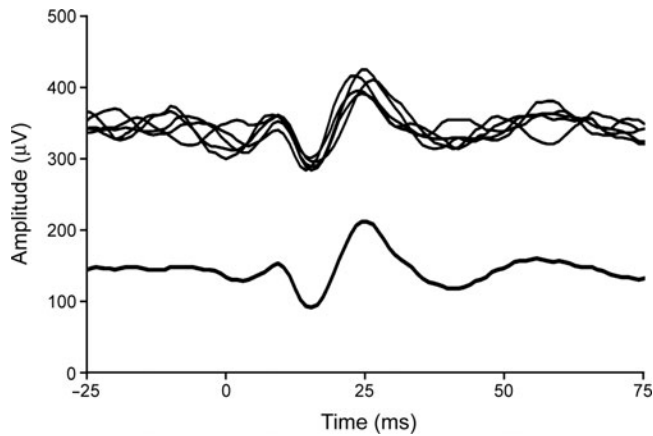
### Procedure

To obtain a VEMP, the target muscle must be contracted. There are several ways to accomplish this. In some laboratories, the patient is in the sitting position, flexing their head to contract the SCM muscle.<sup>29</sup> In our laboratory, the patient lies on an examination table with the upper torso elevated 30°. During the signal averaging process, the patient rotates his or her head 45° so that the test ear is up. The head is then lifted off the table by approximately 1 inch, causing contraction of the SCM muscle. In some laboratories, muscle contraction is controlled by online measurement of a rectified EMG signal.<sup>25</sup> Signal averaging only occurs when a rectified EMG signal falls within preset parameters. This technique may improve test accuracy. However, definitive study of these different techniques has not been accomplished at the time of this writing.

Because muscle contraction is required to observe a VEMP, muscle fatigue becomes an issue. This is particularly important in elderly patients. In our laboratory, we signal between 40 and 120 epochs per average, stopping when the biphasic VEMP amplitude is three times larger than the wavelets in the prestimulus interval. Between three and six subaverages are then combined into a superaverage for analysis purposes. An example of VEMP waveforms is shown in Figure 34–11.

### Analysis

Following the labeling conventions of Akin and Murnane,<sup>25,26</sup> the first positive polarity peak in the composite average was labeled P1 (some authors refer to this as P13), and the following negative peak was labeled N1 (also known as N23). From each composite average, P1 and



**Figure 34-11.** Example of VEMP waveforms. Five subaverages (*top*) were obtained from electrodes placed at FPz (non-inverting) and over the belly of the SCM muscle (inverting). The subaverages were averaged together and measurements were made for P1 (16.3 ms), N1 (24.9 ms), and the P1–N1 amplitude (292  $\mu\text{V}$ ). Amplitude asymmetry ratios, absolute latencies, and interaural latency differences are compared using normal limits in Table 34-3.

N1 peak latencies and the P1–N1 amplitude are measured. Amplitude and latency asymmetries between right and left sides are also compared using the following asymmetry ratio calculation:

$$\text{Asymmetry ratio}(\%) = \frac{(\text{Right P1-N1 amplitude} - \text{Left P1-N1 amplitude})}{(\text{Right P1-N1 amplitude} + \text{Left P1-N1 amplitude})} \times 100$$

This ratio is only calculated using stimulus intensities greater than 90 dBnHL to ensure a suprathreshold stimulus. Threshold, defined as the lowest stimulus intensity level at which one can reliably identify P1 and N1, is also

established for each ear, as the patient muscle strength allows.

#### NORMAL VALUES

As mentioned above, recording technique influences VEMP parameters. Table 34-2 summarizes the recording method used at the Mayo Clinic at the time of this writing. Table 34-3 shows the 95% limits for each parameter using the Mayo method. Amplitude and absolute latency distributions were logarithmically distributed. Thus the 95% limits were calculated on transformed data. Absolute amplitude measures show a great deal of

**Table 34-2 VEMP Recording Parameters—Mayo Clinic Florida Protocol**

<b>Stimulus</b>	
Frequency	500 Hz tone burst (2–0–2 rise–plateau–fall)
Rate	5.1 burst/second
Presentation	Monaural through ER-3A inserts
<b>Recording</b>	
Montage	FPz (+) to SCM muscle belly (-); ground = forehead
Filter	2–250 Hz bandpass
Amplification	$\times 5000$
<b>Averaging</b>	
Window	100 ms
Prestimulus	25 ms
Epochs/Average	40–120
Averaging Stop Rule	120 epochs or when P1–N1 amplitude is three times greater than any wave in the prestimulus interval
Superaverages	Measurements taken from superaverage (3–6 subaverages)

Table 34–3 **VEMP Normal Values—Mayo Clinic Florida Protocol**

Patient age	<30	30–39	40–49	50–59	60–69	70–79	80+	Age independent limit
<b>P1</b>								
Mean (ms)	16	16.1	16.2	16.3	16.4	16.6	16.8	
95% absolute latency limits (ms)	13.8–18.4	13.9–18.5	14.1–18.6	14.2–18.7	14.4–18.8	14.5–18.9	14.8–19.1	
95% interaural asymmetry limit (ms)								<b>2.3</b>
<b>N1</b>								
Mean (ms)								<b>24.0</b>
95% absolute latency limits (ms)								<b>20.8–27.6</b>
95% interaural asymmetry limit (ms)								<b>3.5</b>
<b>P1–N1 Amplitude</b>								
Mean ( $\mu$ V)	183	150	138	126	116	97		
95% ( $\mu$ V)	58–578	42–535	40–471	38–416	37–367	33–285		
95% interaural asymmetry limit (%)								<b>40.2</b>
<b>Threshold</b>								
Mean (dB HL)	76.6	78.3	80.1	82	83.9	85.8	87.8	70–100
95% (dB HL)	70–96	70–98	70–100	70–100	70–100	70–100	70–100	
95% interaural asymmetry limit (dB HL)								<b>11.4</b>

*Note:* 95% confidence limits for P1, N1, P1–N1 amplitude and VEMP threshold by age, base of 495 normal studies (Olsholt and Zapala, in process). Distributions were logarithmically distributed. Confidence limits were calculated based on transformed distribution estimates. The 95% interaural latency asymmetry limits represent the maximum expected latency difference between ears. The 95% interaural amplitude asymmetry (P1–N1 amplitude) is calculated using the VEMP amplitude asymmetry ratio.

variation in younger age groups, which will have implications for identifying pathologic conditions associated with large VEMP amplitudes (such as superior SCC dehiscence—see Superior SCC Dehiscence section).

### LESION EFFECTS

Hearing impairment may affect VEMP results depending on the type of hearing loss. Even subtle forms of conductive hearing loss can cause the VEMP to be absent or demonstrate reduced P1–N1 amplitude. In contrast, sensorineural hearing loss will have no effect on VEMP amplitude or latency. Lesions within the vestibular labyrinth will cause decreased VEMP P1–N1 amplitudes and elevate thresholds if saccule or inferior vestibular nerve structures are involved. Lesions affecting the superior vestibular nerve or associated labyrinthine structures will have little effect on the VEMP. Retrolabyrinthine lesions, particularly focused in the cerebellopontine angle, may increase VEMP peak latencies.

### Key Points

- VEMPs reflect the function of the saccule and inferior vestibular nerve branch of cranial nerve (CN) VIII.
- Conductive hearing loss can cause the air-conducted VEMP to be absent. It must be excluded before abnormal VEMP results can be interpreted.
- Sensorineural hearing loss (cochlear nerve branch) and lesions involving the superior vestibular nerve branch or related structures will have no effect on VEMP results.
- Abnormal VEMP results from labyrinthine lesions affect VEMP P1–N1 amplitude and VEMP threshold.
- Abnormal VEMP results from retrolabyrinthine lesions may also include peak latency delays.

## Computerized Dynamic Posturography

Balance is a complex function that requires input from three major sensory systems.

Somatosensory information is the dominant input, followed by visual and vestibular inputs. The inputs from these three systems are integrated, analyzed, and incorporated into a complex network by the CNS for maintenance of balance. For many years, physicians have used subjective methods for assessing a person's ability to maneuver and to maintain balance, with and without vision. Tests such as the Romberg and tandem gait tests are two examples.

CDP provides quantitative information on how a patient uses sensory information to maintain upright stability when standing. It also measures the performance of automated motor responses typically employed to avoid a fall when upright balance is disturbed. The quantitative information developed during CDP testing can be used to describe the types of problems patients have with balance in day-to-day activities. As such, it is helpful in determining deficit areas that might betray the presence of a disorder, or might be targeted for rehabilitation.

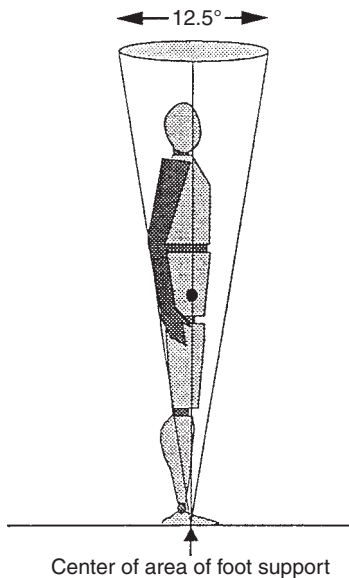
### Purpose and Role of CDP

- Quantifies the contribution of sensory information (visual, vestibular, and somatosensory) and automatic motor responses in controlling upright stance.

This test consists of two major components, each containing subtests. The first component is a test for motor control to maintain balance. The second component is a test for measuring the patient's use of sensory information as it relates to maintaining balance. The patient's anterior–posterior and lateral sway is monitored by measuring vertical force with strain gauges that are mounted underneath the two platforms on which the patient stands (one foot on each platform). By analyzing the forces developed over the platforms while the patient stands, estimates of where they maintain their center of mass over their feet (base of support) can be established. The relationship between where a patient's center of mass is held over their base of support allows for calculation of sway. Additionally, how ankle and hip movements contribute to maintaining upright stance can be estimated by measuring shear forces on the platform.

CDP protocols are designed to challenge a patient's ability to stand in the face of an unstable support surface or inaccurate sensory data. The platform can move forward or backward to produce perturbations of small, medium, or large magnitude. It can also tilt up or down, rotating at the axis below the patient's ankle. The visual surround can be made to sway in the same anterior-posterior direction as the patient (sway-referenced visual surround). The platform can also be made to tilt concurrently with the patient's anterior-posterior sway (sway-referenced platform movement). This forces the patient to ignore or to compensate for the adverse sensory stimulation.

The results of the test are compared with those from control subjects matched for age. Humans have a cone of stability of approximately  $12.5^\circ$  for anterior-posterior sway<sup>22</sup> (Fig. 34-12). Thus, a person who sways approximately  $12.5^\circ$  is at the limits of stability and is likely to fall. A fall is scored any time a patient reaches out and touches the visual surround to keep from falling or anytime he or she moves the feet to keep the center of gravity over the base of support.



**Figure 34-12.** The cone of stability is  $12.5^\circ$  and is the amount of sway against which anterior-posterior sway is judged. (From EquiTest Systems. Installing EquiTest version 4.03. NeuroCom International, Clackamas, OR. By permission of NeuroCom International.)

## MOTOR CONTROL TEST

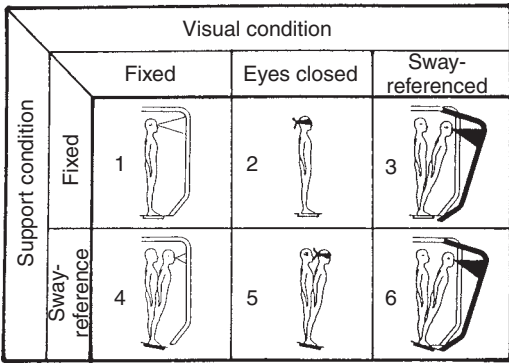
With the motor control test (MCT), the patient is presented with forward and backward platform perturbations. The stretch reflex and later occurring extra pyramidal activity work to bring the center of mass back over the patients' base of support. Loss of sensation in the lower limbs, such as would occur with peripheral neuropathy, or aberrant reflexive movements, such as would occur with lower motor neuron disease, may delay or abolish normal corrective movements. Higher level lesions, involving the brain stem, cerebellum, or cerebral motor pathways, may also produce abnormal responses, reflected in later occurring movements. Computer algorithms calculate the latency of the corrective response to each perturbation. The symmetry and amount of force and weight distribution are also measured and displayed with the MCT.

In the test for adaptation, toes up or down, the platform tilts up or down  $8^\circ$  to generate a stimulus analogous to that of walking on uneven surfaces. It is expected that patients will perform poorly on trial 1, but on trials 2-5, they should adapt and perform normally. Abnormal performance on adaptation testing can occur when ankle range-of-motion is limited, tactical and proprioceptive inputs from the lower limbs are disturbed, or when patients are severely deconditioned. Cognitive changes and movement disorders may also produce impaired performance, largely because the effect of the initial stretch reflex serves to move the patients' center of mass further off of their base of support. Volitional effort is required to counter this effect. Poor performance on this test contributes further evidence that the patient under study may not be able to coordinate ordinary recovery movements on uneven surfaces, regardless of the cause.

## SENSORY ORGANIZATION TEST

The sensory organization test (SOT) consists of six different conditions, with three trials possible for each condition. These conditions are divided into stable support surface trials (conditions 1, 2, and 3) and unstable (sway-referenced) support surface trials (conditions 4, 5, and 6). In conditions 1 and 4, the visual



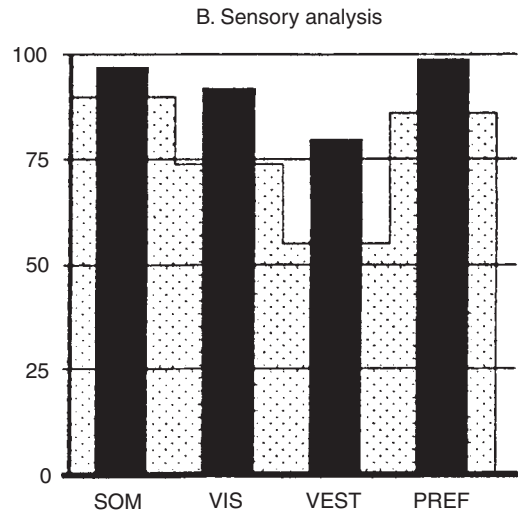
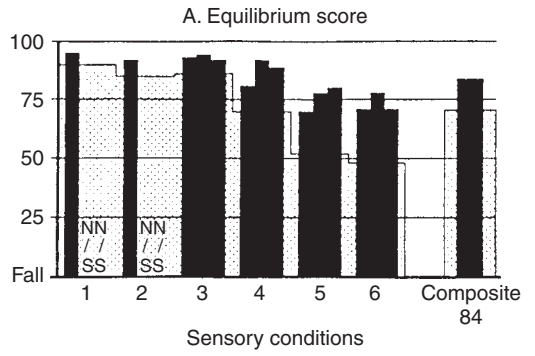


**Figure 34-13.** The six sensory conditions of the SOT. (From EquiTest Systems. Installing EquiTest version 4.03. NeuroCom International, Clackamas, OR. By permission of NeuroCom International.)

surround is stable. In conditions 2 and 5, the eyes are closed (vision denied). In conditions 3 and 6, the eyes are opened, but the visual surround is sway-referenced. Recall that sway-referenced means that the visual surround or platform is driven by the patient's anterior-posterior sway. Thus visual information is inaccurate in conditions 3 and 6, and the patient must either ignore or compensate for the inappropriate information to remain standing. These conditions are summarized in Figure 34-13.









Test results for conditions 1-6 for a normal subject are shown in Figure 34-14. Scores approaching 100 indicate little sway, whereas those near zero represent a large amount of sway (relative to the 12.5° of the cone of stability). If a patient touches the wall or moves the feet, the trial is scored as a fall (zero points). Scores falling into the shaded area are abnormal (Fig. 34-14A). From these scores, a sensory analysis is performed (Fig. 34-14B). The scores (ratios) are derived from comparisons of the various conditions, as shown in Figure 34-15. This information provides a fairly complete picture of a person's ability to maintain stability.

Abnormal results typical of patients with acute vestibular disorders are low scores on conditions 5 and 6, with an abnormal vestibular ratio. Patients who are unable to suppress inappropriate visual information function poorly on conditions 3 and 6. This has been demonstrated in patients with Alzheimer's disease. It is important to keep in mind that



**Figure 34-14.** A, Sensory organization equilibrium scores of a normal subject for the six test conditions and the composite score. The latter is the mean of 14 scores (the mean of conditions 1 and 2, and all 12 trials of conditions 3-6). N/S, no score (trial was not run). B, Normal sensory analysis scores. PREF, visual preference; SOM, somatosensory; VEST, vestibular; VIS, visual. Results in shaded areas are abnormal. (From EquiTest Systems. Installing EquiTest version 4.03. NeuroCom International, Clackamas, OR. By permission of NeuroCom International.)

performance on the SOT requires volitional movement. Poor performance thus reflects the patient's willingness or ability to use sensory information for maintaining upright stance. For example, patients with Parkinson's disease will often perform poorly on conditions 4, 5, and 6—not necessarily because they experience a sensory deficit, but rather because they have a movement ignition deficit that is challenged by the unstable platform in these conditions. Poor performance on conditions

Sensory analysis			
Ratio name	Test conditions	Ratio pair	Significance
SOM Somatosensory	 	Condition 2 Condition 1	<b>Question:</b> Does sway increase when visual cues are removed? <b>Low scores:</b> Patient makes poor use of somatosensory references.
VIS Visual	 	Condition 4 Condition 1	<b>Question:</b> Does sway increase when somatosensory cues are inaccurate? <b>Low scores:</b> Patient makes poor use of visual references.
VEST Vestibular	 	Condition 5 Condition 1	<b>Question:</b> Does sway increase when visual cues are removed and somatosensory cues are inaccurate? <b>Low scores:</b> Patient makes poor use of vestibular cues, or vestibular cues are unavailable.
PREF Visual Preference	 	Condition 3+6 Condition 2+5	<b>Question:</b> Do inaccurate visual cues result in increased sway compared to no visual cues? <b>Low scores:</b> Patient relies on visual cues even when they are inaccurate.

**Figure 34–15.** Summary of sensory analysis for six sensory conditions and the significance of their outcomes. See Figure 32–13 for abbreviations. (From EquiTest Systems. Installing EquiTest version 4.03. NeuroCom International, Clackamas, OR. By permission of NeuroCom International.)

other than 5 and 6 should alert the clinician that problems beyond the vestibular system might be contributing to imbalance or dizziness.

SOT performance is not diagnostic. There is no clear relationship between the functional performance and the presence of specific disease entities. However, the SOT does demonstrate a patient's ability to use sensory information for maintaining postural control and reflects fall risk.<sup>30,31</sup> Information from this test is helpful in identifying when patients have poor balance and can lead to appropriate rehabilitation strategies.

One of the most effective uses of CDP is testing patients who have functional abnormalities or at least functional overlays.<sup>32</sup> Because patients must cooperate to complete the test, they have ample opportunity to exaggerate their responses. Of interest, many patients with functional problems perform relatively better on the difficult tests, such as conditions 5 and 6, and poorly on the easier tests, such as

conditions 1 and 2. Results such as these are physiologically inconsistent.

### Key Points

- CDP quantifies the contribution of sensory and motor behaviors and abilities on functional balance.
- Motor control and adaptation tests quantify automatic corrective movements to bring the patient's center of mass back over the base of support following platform perturbations or tilts.
- The SOT measures the patient's ability or willingness to use sensory information for maintaining upright stance.
- CDP is particularly useful in detecting functional behaviors that cannot be consistent with organic disease.
- Although not diagnostic, CDP is helpful in identifying deficit areas that might betray the presence of a disorder, or might be targeted for the need for rehabilitation.

## CLINICAL APPLICATIONS OF VESTIBULAR TESTING: ASSESSING SENSORINEURAL SYNDROMES OF THE LABYRINTH

In patients complaining of vestibular symptoms, the test methods described above may be used to provide evidence of central compensation status. Examples include most forms of positional nystagmus, phase and asymmetry measurements on rotary chair slow harmonic acceleration, and performance on the sensory organization subtest of CDP. Other tests, such as the bilateral, bithermal caloric test, or the VEMP test, offer direct measurements of superior and inferior vestibular nerve output. When these latter tests are combined with the audiological evaluation, the function of the three main branches of CN VIII can be better assessed.

It can be profitable to group conditions based on the function of these three nerve branches: (1) the superior vestibular, (2) inferior vestibular, and (3) cochlear eighth nerve branches. Some disease processes tend to affect some branches while sparing others. Further, at least preliminarily, we have been able to show relationships between patient's subjective complaints, postural control ability, and the pattern of labyrinthine dysfunction. These syndrome classes, with the exception of the Superior Semicircular Canal Dehiscence syndrome, were developed as part of a retrospective study of 1578 consecutive patients seen at the Mayo Clinic Florida for vestibular testing between 2002 and 2004.<sup>33</sup> Patients included in this study had these syndromes as the sole explanation of their dizziness or imbalance complaints. Patients with comorbidities that could have contributed to their complaints of dizziness or imbalance were excluded. From these data, correlations between patient's complaints and test results, medical diagnosis, SOT performance, co-occurring BPPV, and subjective report of dizziness handicap (as measured on the Dizziness Handicap Inventory<sup>34</sup>) were tallied.

A second unpublished retrospective study, looking at vestibular schwannoma presentations, was performed by analyzing 1253 consecutive cases seen in 2005 through 2006.<sup>28</sup> In this second study, likelihood ratios for vestibular

schwannoma were calculated for each syndrome type. The base rate (prevalence) for vestibular schwannoma during the study interval was 1.27%.

### Superior Nerve Syndrome

The superior nerve syndrome is a common syndrome, characterized by singular impairment of structures associated with the superior vestibular nerve (the Lateral and Superior semicircular canal ampullae and the Utricle). Test results indicate a unilateral caloric weakness with normal audiological and VEMP studies. The prototypical condition for this syndrome would be vestibular neuronitis (also known as *labyrinthitis* or *superior nerve neurolabyrinthitis*—see example description in the Introduction section of this chapter). The superior nerve syndrome is strongly associated with the complaint of vertigo and subjective handicap (as measured on the dizziness handicap inventory). However, relative to other vestibular syndromes, performance on CDP SOT tends to be less impaired. Two important associations were made with this syndrome. First, this syndrome is highly correlated with subsequent development of BPPV (presumably due to utricular damage). Second, there was a very low association with vestibular schwannoma. In 1253 consecutive patients referred for auditory and vestibular testing, no cases of vestibular schwannoma were found in patients with superior nerve syndrome.

### Superior SCC Dehiscence

Minor<sup>35</sup> reported 17 cases of a dehiscence of the superior SCC identified with high-resolution computed tomography. The patients had vertigo, oscillopsia, or both when presented with intense sounds or stimuli that produced changes in middle ear or intracranial pressure. These stimuli produced torsional eye movements commensurate with stimulating the affected canal. The VEMP contributes to this diagnosis in that the P1–N1 amplitude tends to be abnormally large on the involved side and the threshold may be abnormally low (<65 dBnHL using the Mayo protocol). Although the exact mechanism for this effect

is not definitively understood, it appears that some of the pressure exerted by the stapes footplate in response to sound is shunted through the opening in the superior SCC. Along the way, the shunted pressure wave perturbs the saccule. The audiological evaluation may also assist in recognizing this condition.<sup>36</sup> There tends to be a conductive hearing loss on the involved side, with paradoxically present acoustic reflexes present. Surgical plugging of the dehiscence improves patients' symptoms in most cases.<sup>37</sup>

## Basement Syndrome

In basement syndrome, there is unilateral hearing loss and an abnormal VEMP on the same side. The implication is involvement of structures associated with the cochlear and inferior vestibular nerve branches. These nerves fill the inferior partition of the internal auditory canal and thus the designation of "basement syndrome." Vertigo is not a strong complaint in this syndrome. Rather patients tend to complain of lightheadedness, heavy headedness or vague, nondescript sensations. Dizziness Handicap Inventory scores tend to indicate less self-reported handicap than observed with syndromes involving the superior nerve. Yet there is a tendency for the group to have lower SOT scores (poorer balance). BPPV is not commonly encountered in this group.

Approximately 50% of vestibular schwannomas emanate from the inferior vestibular nerve branch. However, only one vestibular schwannoma case in 1253 patients was found to present with a basement syndrome. A second patient with vestibular schwannoma presented with an isolated abnormal VEMP latency delay. Thus, the likelihood ratio for vestibular schwannoma given a basement syndrome was low (0.54:1).

## Posterior Syndrome

Posterior syndrome occurs when there is evidence for both abnormal horizontal canal or superior vestibular nerve and saccule or inferior vestibular nerve function. VEMP and caloric responses are abnormal on the involved side. Strong complaints of vertigo and impaired

postural control as measured on SOT are associated with this syndrome. As might be anticipated, BPPV on the involved side is not associated with this condition. Vestibular schwannoma can present as a posterior syndrome, but it is apparently rare. No cases were observed in 1253 consecutive cases. One case was observed in the earlier 2003–2004 study.

## Split Syndrome

The split syndrome is characterized by an abnormal caloric weakness and co-occurring hearing loss on the same side. Episodic vertigo, as in Meniere's syndrome, was strongly associated with this pattern. Patients were typically observed between episodes. Vestibular schwannoma also presented with this group (likelihood ratio = 2.1:1). Subsequent development of BPPV was also common.

This syndrome is intriguing for several reasons. First, it is difficult to explain the syndrome based on proximity of nerve branches. Distally the superior vestibular nerve and cochlear nerve are separated by a bony shelf. At the CN VIII root, the nerve branches are in close proximity, but not any more so than the inferior vestibular nerve branch. So the sparing of the VEMP is problematic. Similarly, from a membrane point of view, the saccule sits between the cochlea and the pars superior (where the utricle and SCCs reside). Again, the saccule appears spared, despite its interposition between the cochlea and the pars superior. One possible explanation is that the VEMP is a robust response that may persist despite subcritical damage to the saccule.

The complaint of severe vertigo was common in this group. Yet, caloric testing replicated subjective complaints in less than 31% of cases. Episodic vertigo cases represented more than 50% of cases in this group. It is possible that the episodic vertigo patients experienced vertigo so severe during their episodes that the vertigo provoked by the standard caloric test was no longer provocative.

## Global Syndrome

As the name implies, this syndrome is associated with hearing loss and co-occurring

abnormal VEMP and caloric responses. This implies total involvement of CN VIII. It is rarely encountered in general practice. While many disease states were found in this group, including idiopathic, viral labyrinthitis, and Meniere's syndrome, the likelihood of a vestibular schwannoma in this group was very high (likelihood ratio=9.5:1). In general, it seems that the probability of vestibular schwannoma increases as the number of CN VIII branches involved increases. This highlights the value of the VEMP. Without the VEMP test, global and split syndromes appear identical on vestibular testing. The likelihood of vestibular schwannoma for patients who had hearing loss and caloric unilateral weakness (without considering VEMP results) was 5.0:1. So, the VEMP test helps stratify risk for retrolabyrinthine involvement. To place this into context, auditory evoked brain stem responses were estimated to have a likelihood ratio of 6.4:1 in this same group. So being classified as having a global vestibular syndrome carried greater risk for vestibular schwannoma than an abnormal evoked potential study.

Three principles are suggested so far. First, syndromes that reflect a superior vestibular nerve distribution are associated with complaints of vertigo. When inferior nerve function is present, these syndromes carry a higher probability for secondary BPPV.

Second, syndromes that reflect an inferior vestibular nerve distribution are less likely to be associated with complaints of vertigo and are only rarely associated with BPPV. There was a statistical trend for poorer performance on SOT, implying more difficulty with postural control tasks. Variability on SOT was great however, and so poor performance may not be evident in individual cases.

Third, the addition of the VEMP test improves the ability to recognize retrolabyrinthine involvement. As more branches of CN VIII show involvement, the risk of vestibular schwannoma increases. The global syndrome, where all three CN VIII branches are involved, holds the greatest risk.

The syndrome approach mentioned here holds promise for improving our ability to explain and anticipate patient complaints. Ultimately, natural course of the problematic symptoms and fall risks will likely require both an understanding of the disease process

underpinning the loss of function, and an understanding of what sensory functions are available, salvageable, and permanently lost. Formal testing will be necessary to accomplish this.

### Key Points

- Vestibular disorders can be based on the function of these three nerve branches—the superior vestibular, inferior vestibular, and cochlear eighth nerve branches.
- Audiological tests assess cochlear nerve branch function; bilateral, bithermal caloric tests assess superior vestibular nerve function and the ascending VOR pathways in the brain stem; VEMP tests assess the inferior vestibular nerve branch and descending VSR pathways in the brain stem.
- The superior nerve syndrome is a common syndrome, characterized by singular impairment of structures associated with the superior vestibular nerve (the *Lateral* and *Superior SCC* ampullae and the *Utricle*). Vertigo and subsequent BPPV are commonly associated with this syndrome.
- Dehiscence of the superior SCC causes vertigo, oscillopsia, or both when presented with intense sounds or stimuli that produced changes in middle ear or intracranial pressure.
- In basement syndrome, there is unilateral hearing loss and an abnormal VEMP on the same side. Vertigo and subsequent BPPV are not associated with this condition. Fall risk is potentially increased.
- Posterior syndrome occurs when there is evidence for abnormal horizontal canal or superior vestibular nerve and saccule or inferior vestibular nerve function. VEMP and caloric responses are abnormal on the involved side.
- The split syndrome is characterized by an abnormal caloric weakness and co-occurring hearing loss on the same side.
- Global syndrome is associated with hearing loss and co-occurring abnormal VEMP and caloric responses. This implies total involvement of CN VIII. Global syndrome groups have a higher risk of vestibular schwannoma relative to other syndrome types.



## VESTIBULAR REHABILITATION

The management of vestibular lesions can be medical, surgical, or rehabilitative. Medical treatments help with symptomatic care during acute vestibular crisis and have a role in prophylaxis. Surgery may help in those rare cases of perilymphatic fistula, superior canal dehiscence, or perhaps endolymphatic sac procedures. However, in the vast majority of cases, the CNS's own adaptive abilities will play a larger role in ameliorating troubling vestibular symptoms.

Vestibular rehabilitation has been available for many years. However, carefully developed, personalized treatments have been shown to substantially improve compensation.<sup>17,22,31</sup> These programs consist of habituation exercises, postural control exercises, general conditioning, and psychological support when needed. This relatively new area has begun to provide a mechanism for helping to treat the condition of patients who previously were told to live with their balance problem. Appropriate exercises prescribed by a physical therapist trained in vestibular rehabilitation can help speed and improve the recovery of many patients. Appreciating what structures are working, how they relate to subjective complaints and function deficits should ultimately help refine vestibular rehabilitation treatment plans even further.

## SUMMARY

This chapter has summarized five clinically available electrophysiologic measures for patients who complained of vertigo and imbalance. These measures will seldom provide a diagnosis. Careful history and physical examination, coupled with an understanding of vestibular anatomy, physiology, and pathophysiology, remain the bedrock for diagnosing problems of vertigo and imbalance. The electrophysiologic measures described in this chapter are merely extensions of the physical examination. Test data cannot be interpreted effectively without the same understanding of vestibular anatomy, physiology, and pathophysiology that underpins the initial history and physical examination.

There are several key concepts for the clinician to keep in mind when measuring

vestibular reflexes. First, there is a relationship between damaged sensory epithelia within the membranous labyrinth and abnormal reflexive behavior. However, CNS compensation will modify and often extinguish abnormal reflexive behavior on the standard physical examination. When vestibulopathy is a possibility and the physical examination is unrevealing, the electrophysiological measures described in this chapter may be informative.

ENG or VNG has been historically the most commonly employed measure of vestibular function. The bilateral, bithermal caloric test provides a direct measure of vestibular weakness involving the horizontal canal and the superior vestibular nerve branch. As such, it has localizing value. Additionally, screening for positioning induced nystagmus is helpful in detecting benign paroxysmal positional vertigo. Gaze and positional nystagmus tests help differentiate between vestibular-induced spontaneous nystagmus and gaze nystagmus from CNS involvement. Visually guided eye movements may help characterize saccadic, pursuit, or optokinetic deficits that may also have been appreciated during the physical examination.

Rotary chair testing is particularly useful in detecting bilateral vestibular weaknesses. Rotary chair test methods employ precisely controlled vestibular and visual stimuli, and are repeatable over time. This makes rotary chair protocols attractive when serial testing is required. In older patients, bilateral vestibular weakness may be missed on the standard caloric test. Rotary chair SHA testing is useful when assessing elderly and pediatric patients who may not tolerate the standard caloric test.

SVV measures offer a measure of utricular-induced ocular tilt effects. The utricle is closely associated with control of upright stance. The ability to have a direct measure of utricular function is thus an important addition to the vestibular battery. Repeated measurements using an appropriate psychophysical method may be necessary for accurate measurements of ocular tilt using this method.

VEMPs offer a measure of saccule and inferior vestibular nerve branch function. Like the caloric test, the VEMP reflects the function of each ear in isolation. It thus has localizing value.

CDP consists of the SOTs and the MCTs. These tests are not diagnostic in the sense that



they point to specific sites of lesion. Rather, they measure behaviors that underpin normal control of upright stance in the functional sense. The MCTs quantify reaction times for compensatory movements. The SOT measures a patient's ability or willingness to use visual, vestibular, and somatosensory information to remain standing. Vestibular deficits become apparent when the test situation minimizes visual and somatosensory information (SOT conditions 5 and 6). Performance deficits and other SOT conditions should alert the examiner that deficits beyond the vestibular system may be contributing to impaired balance. CDP is particularly helpful in identifying functional performance patterns that cannot be explained by organic impairment.

Patients can be meaningfully classified into vestibular syndromes based on bilateral, bithermal caloric test results, VEMP test results, and audiological evaluation results. These tests reflect superior vestibular nerve, inferior vestibular nerve, and cochlear nerve branch function. Syndromes that involve the superior vestibular nerve branch tend to provoke stronger complaints of vertigo, and a tendency for benign paroxysmal positional vertigo. Syndromes that involve the inferior vestibular nerve branch are less likely to provoke strong complaints of vertigo and have a low risk for benign paroxysmal positional vertigo. The risk for retrolabyrinthine involvement, such as vestibular schwannoma, increases with the number of CN VIII branches involved.

Vestibular rehabilitation is an important addition to medical and surgical treatments for patients with complaints of vertigo and imbalance. Understanding how vestibular reflexes are impaired helps anticipate functional deficits. Electrophysiological measures of vestibular function can help in this regard.

## REFERENCES

- Baloh, R. W. 1995. Approach to the evaluation of the dizzy patient. *Otolaryngology and Head and Neck Surgery* 112:3-7.
- Labuguen, R. H. 2006. Initial evaluation of vertigo. *American Family Physician* 73:244-51.
- Traccis, S., G. F. Zoroddu, M. T. Zecca, T. Cau, M. A. Solinas, and R. Masuri. 2004. Evaluating patients with vertigo: Bedside examination. *Neurological Science* 25(Suppl 1):S16-19.
- Walker, M. F., and D. S. Zee. 2000. Bedside vestibular examination. *Otolaryngologic Clinics of North America* 33:495-506.
- Ruckenstein, M. J. 1995. A practical approach to dizziness. Questions to bring vertigo and other causes into focus. *Postgraduate Medicine* 97:70-2, 75-8, 81.
- Baloh, R. W., and V. Honrubia. 2001. *Clinical neurophysiology of the vestibular system*, xx, 408. New York: Oxford University Press.
- Eggers, S. D., and D. S. Zee. 2003. Evaluating the dizzy patient: Bedside examination and laboratory assessment of the vestibular system. *Seminars in Neurology* 23:47-58.
- Leigh, R. J., and D. S. Zee. 2006. *The neurology of eye movements*, x, 762. New York: Oxford University Press.
- Furman, J. M., and S. P. Cass. 1999. Benign paroxysmal positional vertigo. *New England Journal of Medicine* 341:1590-6.
- Parnes, L. S., S. K. Agrawal, and J. Atlas. 2003. Diagnosis and management of benign paroxysmal positional vertigo (BPPV). *Canadian Medical Association Journal* 169:681-93.
- Epley, J. M. 1992. The canalith repositioning procedure: For treatment of benign paroxysmal positional vertigo. *Otolaryngology and Head and Neck Surgery* 107:399-404.
- Epley, J. M. 2001. Human experience with canalith repositioning maneuvers. *Annals of the New York Academy of Sciences* 942:179-91.
- Prokopakis, E. P., T. Chimona, M. Tsagournisakis, et al. 2005. Benign paroxysmal positional vertigo: 10-year experience in treating 592 patients with canalith repositioning procedure. *Laryngoscope* 115:1667-71.
- Richard, W., T. D. Brintjes, P. Oostenbrink, and R. B. van Leeuwen. 2005. Efficacy of the Epley maneuver for posterior canal BPPV: A long-term, controlled study of 81 patients. *Ear, Nose, & Throat Journal* 84:22-5.
- Steenerson, R. L., G. W. Cronin, and P. M. Marbach. 2005. Effectiveness of treatment techniques in 923 cases of benign paroxysmal positional vertigo. *Laryngoscope* 115:226-31.
- White, J., P. Savvides, N. Cherian, and J. Oas. 2005. Canalith repositioning for benign paroxysmal positional vertigo. *Otology & Neurotology* 26:704-10.
- Herdman, S. 2000. *Vestibular rehabilitation*, xxix, 597. Philadelphia: Davis.
- Brandt, T. 1990. Positional and positioning vertigo and nystagmus. *Journal of Neurological Sciences* 95:3-28.
- Shoman, N., and N. Longridge. 2007. Cerebellar vermis lesions and tumours of the fourth ventricle in patients with positional and positioning vertigo and nystagmus. *The Journal of Laryngology and Otology* 121:166-9.
- Sunami, K., R. Tochino, T. Zushi, et al. 2004. Positional and positioning nystagmus in healthy subjects under videonystagmoscopy. *Acta Otolaryngologica* 124(Suppl 554):35-7.
- Barber, H. O., and G. Wright. 1973. Positional nystagmus in normals. *Advances in Oto-Rhino-Laryngology* 19:276-83.
- Shepard, N. T., and S. A. Telian. 1996. *Telian, practical management of the balance disorder patient*, xi, 221. San Diego: Singular Publishing Group.

23. Cyr, D. G. 1991. Vestibular system assessment. In *Hearing assessment*, ed. W. F. Rintelmann, 2nd ed., 777. Austin, TX: Pro-ed.
24. Welgampola, M. S., and J. G. Colebatch. 2005. Characteristics and clinical applications of vestibular-evoked myogenic potentials. *Neurology* 64:1682–8.
25. Akin, F. W., and O. D. Murnane. 2001. Vestibular evoked myogenic potentials: Preliminary report. *Journal of the American Academy of Audiology* 12:445–52; quiz 491.
26. Akin, F. W., O. D. Murnane, and T. M. Proffitt. 2003. The effects of click and tone-burst stimulus parameters on the vestibular evoked myogenic potential (VEMP). *Journal of the American Academy of Audiology* 14:500–9.
27. Zapala, D. A., and R. H. Brey. 2004. Clinical experience with the vestibular evoked myogenic potential. *Journal of the American Academy of Audiology* 15:198–215.
28. Zapala, D. A. 2007. The VEMP: Ready for the clinic. *The Hearing Journal* 60:10–20.
29. Wang, C. T., and Y. H. Young. 2006. Comparison of the head elevation versus rotation methods in eliciting vestibular evoked myogenic potentials. *Ear & Hearing* 27:376–81.
30. Sataloff, R. T., M. J. Hawkshaw, H. Mandel, A. B. Zwislewski, J. Armour, and S. Mandel. 2005. Abnormal computerized dynamic posturography findings in dizzy patients with normal ENG results. *Ear, Nose, & Throat Journal* 84:212–14.
31. Whitney, S. L., G. F. Marchetti, and A. I. Schade. 2006. The relationship between falls history and computerized dynamic posturography in persons with balance and vestibular disorders. *Archives of Physical Medicine and Rehabilitation* 87:402–7.
32. Mallinson, A. I., and N. S. Longridge. 2005. A new set of criteria for evaluating malingering in work-related vestibular injury. *Otology & Neurotology* 26: 686–90.
33. Zapala, D. A., and K. Hibbits. 2004. Sensorineural Syndromes of the Vestibular Labyrinth. In: American Academy of Audiology's 16th Annual Convention & Expo, Salt Lake City, Utah, 2004.
34. Jacobson, G. P., and C. W. Newman. 1990. The development of the Dizziness Handicap Inventory. *Archives of Otolaryngology—Head and Neck Surgery* 116:424–7.
35. Minor, L. B. 2000. Superior canal dehiscence syndrome. *American Journal of Otology* 21:9–19.
36. Minor, L. B., J. P. Carey, P. D. Cremer, L. R. Lustig, S. O. Streubel, and M. J. Ruckenstein. 2003. Dehiscence of bone overlying the superior canal as a cause of apparent conductive hearing loss. *Otology & Neurotology* 24:270–8.
37. Banerjee, A., A. Whyte, and M. D. Atlas. 2005. Superior canal dehiscence: Review of a new condition. *Clinical Otolaryngology* 30:9–15.

SECTION 2

**ELECTROPHYSIOLOGIC  
ASSESSMENT OF NEURAL  
FUNCTION**

---

*This page intentionally left blank*

## PART F

# Autonomic Function

---

The autonomic nervous system regulates visceral function and the internal environment of the body through its effects on the heart, gut and other internal organs, peripheral blood vessels, and sweat glands (Chapter 35). Autonomic dysfunction has important implications for health and disease yet is clinically under recognized. Clinical signs of autonomic dysfunction are easily overlooked, and neural activity in the autonomic nervous system is difficult to record directly. Although sympathetic nerve function in peripheral nerves can be recorded with fine-tipped tungsten electrodes, this technique is difficult to apply clinically. Therefore, the assessment of autonomic function depends primarily on measuring the response of the autonomic nervous system to external stimuli.

The measurements of sweating (Chapters 36 and 38), cardiovascular activity and peripheral blood flow (Chapters 37 and 39), and central autonomic-mediated reflexes provide insight into the broad range of disorders that affect the central and peripheral components of the

autonomic nervous system—from the hypothalamus to the autonomic axons in the trunk and limbs. Autonomic function is not measured as frequently as it should be. With better understanding of the clinical importance of measuring autonomic function and with increasing use of newly available tests of cardiovagal function, segmental sympathetic reflexes, postural hemodynamics, and power spectral analysis, the tests and measurements of autonomic function will be of greater benefit in patient care.

Pain is mediated mainly through small nerve fibers, particularly in the autonomic nervous system. Measurements of their function can help elucidate the mechanisms underlying pain, especially peripheral pain. The emerging modalities for assessment of pain pathways include quantitative sensory tests, autonomic tests, microneurography, and laser-evoked potentials (Chapter 40). Direct recording of spontaneous electric activity in nerves by microneurography is tedious but can be particularly helpful.

*This page intentionally left blank*



# Autonomic Physiology

William P. Cheshire, Jr.

## INTRODUCTION SYMPTOMS AND DISEASES GENERAL ORGANIZATION OF THE AUTONOMIC SYSTEM

Visceral Afferents  
Visceral Efferents

## SYMPATHETIC FUNCTION

Functional Anatomy of the  
Sympathetic Outflow  
Assessment of Sympathetic  
Function in Humans

## SYMPATHETIC INNERVATION OF THE SKIN

## MUSCLE SYMPATHETIC ACTIVITY AUTONOMIC CONTROL OF HEART RATE CARDIOVASCULAR REFLEXES

Arterial Baroreflexes  
Cardiopulmonary  
Reflexes  
Venoarteriolar Reflexes  
Ergoreflexes

## MAINTENANCE OF POSTURAL NORMOTENSION SUMMARY

## INTRODUCTION

The autonomic nervous system is essential to maintaining physiologic homeostasis in health and responding to illness. Its integrative functions coordinate input from peripheral and visceral afferent nerves to orchestrate a dynamic balance among organ systems. Its adaptive functions react moment by moment to the various forms of stress the body experiences. It consists of *sympathetic* (thoracolumbar) and *parasympathetic* (craniosacral) divisions. Both divisions contain general visceral afferent and efferent fibers. The enteric nervous system, located in the wall of the gut, is considered a third division of the autonomic nervous system. The autonomic nervous system thus regulates

and coordinates such physiological functions as blood pressure and heart rate, respiration, body temperature, sweating, lacrimation, nasal secretion, pupillary size, gastrointestinal motility, urinary bladder contraction, sexual physiology, and blood flow to the skin and many organs.

## SYMPTOMS AND DISEASES

Disorders affecting the autonomic nervous system may be manifested by failure or hyperactivity of one or many of the visceral effector organs. Autonomic neuropathies that disconnect central autonomic centers and autonomic ganglia from their peripheral effectors

may result in deficits in autonomic function. Examples include orthostatic hypotension due to adrenergic failure, heat intolerance due to sudomotor failure, gastroparesis, hypotonic bladder, and erectile failure. Some autonomic neuropathies result in localized deficits, for example, Horner's syndrome, Adie's tonic pupil, and neurogenic bladder from sacral anterior horn cell involvement in poliomyelitis. Autonomic centers disconnected from inhibitory influences may give rise to episodic autonomic hyperfunction. Examples include autonomic dysreflexia and hypertonic bladder following spinal cord trauma, diencephalic syndrome following head injury, hypertensive surges of baroreflex failure following irradiation to the carotid sinuses, auriculotemporal syndrome, and catecholamine storms in pheochromocytoma.

Autonomic disturbances frequently accompany neurologic illnesses affecting motor or sensory systems or may occur in isolation. The presence of autonomic failure is sometimes clinically obvious. More frequently, accurate characterization, localization, and grading of autonomic dysfunction require a careful history to elicit subtle symptoms, a neurological examination attentive to autonomic signs, and testing in a clinical autonomic laboratory.

The differential diagnosis of autonomic failure includes the peripheral neuropathies (many of which involve autonomic fibers), central degenerative disorders, and medical disorders that impact the autonomic nervous system. Peripheral autonomic failure frequently occurs in small fiber neuropathies, particularly in diabetes mellitus and amyloidosis. Additionally, prominent autonomic dysfunction can occur in autoimmune diseases, such as autoimmune autonomic ganglionopathy associated with antibodies to the ganglionic acetylcholine receptor, Guillain-Barré syndrome, Sjögren's syndrome, Lambert-Eaton myasthenic syndrome associated with antibodies to voltage-gated calcium channels, and paraneoplastic disorders such as lung carcinoma associated with antineuronal nuclear antibody (ANNA-1 or anti-Hu). Autonomic disturbances are common also in botulism, diphtheritic neuropathy, and Chagas disease. Central neurodegenerative disorders associated with autonomic failure include multiple system atrophy (MSA), dementia with Lewy bodies, and Parkinson's disease. Isolated autonomic failure may occur acutely or subacutely (e.g., in inflammatory

or paraneoplastic pandysautonomia), or as a slowly progressive disease (pure autonomic failure).

The presence of autonomic failure has important implications for clinical management as well as for prognosis. Disruption of autonomic function can influence the long-term risks of morbidity,<sup>1,2</sup> mortality,<sup>3-5</sup> and intraoperative mortality.<sup>6,7</sup>

Autonomic testing is indicated in patients (1) with any of the aforementioned symptoms suggesting autonomic failure, (2) with peripheral neuropathies (particularly small fiber neuropathies in which nerve conduction and electromyographic findings may be normal), or (3) with parkinsonism or cerebellar dysfunction in which MSA is suspected. Unlike the easily reproducible function of somatic motor or sensory nerves, autonomic nerve function is difficult to evaluate precisely in humans. In general, evaluation of autonomic function has been restricted to noninvasive recordings of heart rate, blood pressure, blood flow, or sweat production. The interpretation of the results of these tests may be difficult, because (1) the effector organs react slowly to variations in neural input, (2) the interactions of sympathetic and parasympathetic outputs at a single target level are complex, and (3) autonomic responses are affected by pharmacologic, hormonal, local chemical, and mechanical influences.

This chapter provides an overview of some aspects of autonomic function that may help with interpreting the results of noninvasive autonomic tests commonly used clinically. Therefore, the focus is on sudomotor, cardiovascular, and adrenergic functions. Gastrointestinal, bladder, and sexual functions are not discussed.

### ***Purpose and Role of Autonomic Testing***

- Recognize the presence, distribution, and severity of autonomic dysfunction.
- Recognize patterns of autonomic failure that can be related to specific syndromes, for example,
  - Generalized autonomic failure
  - Orthostatic hypotension
  - Orthostatic intolerance
  - Reflex syncope
  - Distal small fiber neuropathy
  - Peripheral neuropathies that may have an autonomic component

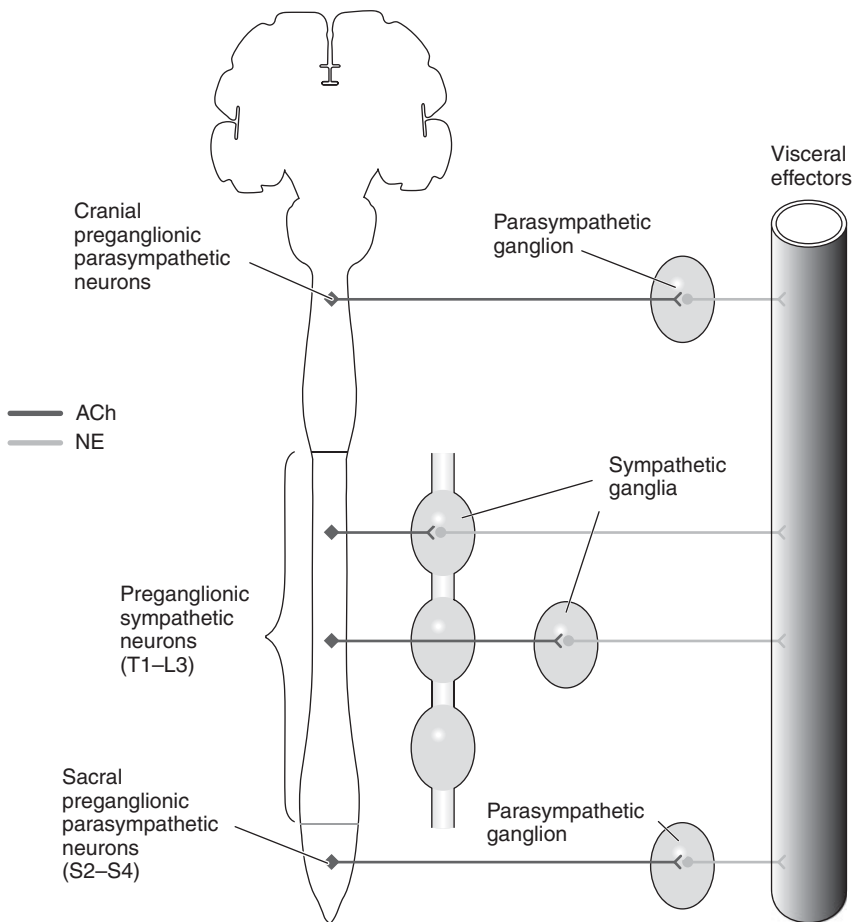
- Neurodegenerative disorders that may have an autonomic component
- Organ-specific autonomic syndromes such as gastroparesis that may have a more widespread autonomic component.
- Recognize potentially treatable autonomic disorders.
- Recognize disorders that warrant further evaluation.
- Diagnose benign autonomic disorders that may mimic life-threatening conditions.
- Quantitatively evaluate autonomic dysfunction over time
  - To define the progression or remission of autonomic disease
  - To assess the response to therapy.

## GENERAL ORGANIZATION OF THE AUTONOMIC SYSTEM

The general organization of the autonomic nervous system is composed of visceral afferent and efferent nerves (Fig. 35–1).

### Visceral Afferents

Visceral receptors generally are slowly adapting mechanoreceptors or chemoreceptors that have a low level of spontaneous activity and are innervated by small myelinated and unmyelinated fibers.<sup>8</sup> Visceral afferent signals may mediate local reflexes in peripheral organs or



**Figure 35–1.** Organization of the sympathetic and parasympathetic outputs of the autonomic nervous system. ACh, acetylcholine; NE, norepinephrine. (Permission from Mayo Clinic Medical Neurosciences, 5th ed., Mayo Clinic Scientific Press 2008.)

provide collateral input to autonomic ganglion cells. Most visceral afferent fibers enter the central nervous system at a spinal or, in the case of cranial nerves (CN), the medullary level to initiate segmental or suprasegmental viscerovisceral reflexes or to relay visceral information to higher centers.<sup>8-10</sup> Spinal sympathetic afferents mediate visceral pain and initiate segmental and suprasegmental viscerovisceral reflexes. Visceral afferents that enter at the medullary level are in the vagus (CN X) and glossopharyngeal (CN IX) nerves and synapse in the nucleus of the tractus solitarius (NTS).<sup>9,10</sup> This nucleus is critically involved in respiratory and cardiovascular reflexes through its extensive connections with neurons in the so-called *intermediate reticular zone* of the medulla.<sup>10,11</sup>

## Visceral Efferents

Sympathetic and parasympathetic autonomic outflow systems produce responses that are longer in latency and duration and more continuous and generalized than those mediated by the somatic motor system. This reflects important differences in the functional organization of autonomic and somatic efferents. Autonomic output involves a two-neuron pathway that has at least one synapse in an autonomic ganglion.<sup>11</sup> The preganglionic axons are small myelinated (type B) cholinergic fibers that emerge from neurons of the general visceral efferent column in the brain stem or spinal cord and pass through peripheral nerves to the autonomic ganglia.<sup>12</sup> Postganglionic autonomic neurons send varicose, unmyelinated (type C) axons to innervate peripheral organs. Autonomic terminals contain varicosities.

At most sympathetic neuroeffector junctions the primary postganglionic neurotransmitter is norepinephrine, which acts on the various subtypes of  $\alpha$ - and  $\beta$ -adrenergic receptors. In the sweat glands, sympathetic effects are mediated principally by acetylcholine. The primary postganglionic neurotransmitter at all parasympathetic neuroeffector junctions is acetylcholine, which acts on the various subtypes of muscarinic receptors. Whereas the main consequences of denervation in the striated muscle are paralysis and atrophy, postganglionic efferent denervation produces an exaggerated response of the target when it is exposed

to the neurotransmitter. This phenomenon, called *denervation supersensitivity*, is evidence of a lesion involving postganglionic neurons in which the remaining neuroeffector receptors are upregulated.

Activity of most autonomic effectors is modulated by dual, continuous sympathetic, and parasympathetic influences.<sup>11,12</sup> Sympathetic control originates from preganglionic neurons in segments T2–L1 of the spinal cord and predominates in blood vessels, sweat glands, and cardiac muscle. Parasympathetic outflow originates from preganglionic neurons in nuclei of CNs III, VII, IX, and X and in segments S2–S4 of the spinal cord. It predominates in control of the salivary glands, sinoatrial node, gastrointestinal tract, and bladder.<sup>11,12</sup> Sympathetic–parasympathetic interactions are not simply antagonistic but are functionally complementary. The sympathetic and parasympathetic systems may interact at several levels, including that of the central nervous system, autonomic ganglia, neuroeffector junction, and target organ.<sup>8-12</sup>

## Key Points

- The autonomic nervous system consists of sympathetic, parasympathetic, and enteric divisions.
- Most visceral afferent fibers enter the central nervous system at a spinal or medullary level to initiate segmental or suprasegmental viscerovisceral reflexes or to relay visceral information to higher centers.
- Spinal sympathetic afferents mediate visceral pain and initiate segmental and suprasegmental viscerovisceral reflexes.
- The vagus (CN X) and glossopharyngeal (CN IX) nerves synapse in the NTS,<sup>9,10</sup> which is involved in respiratory and cardiovascular reflexes.
- Sympathetic and parasympathetic autonomic outflow systems produce responses that are longer in latency and duration and more continuous and generalized than those mediated by the somatic motor system.
- Autonomic output involves a two-neuron pathway that has at least one synapse in an autonomic ganglion.
- The preganglionic axons are small myelinated (type B) cholinergic fibers that

emerge from neurons of the general visceral efferent column in the brain stem or spinal cord and pass through peripheral nerves to the autonomic ganglia.

- Postganglionic autonomic neurons send unmyelinated (type C) axons to innervate peripheral organs.
- At most sympathetic neuroeffector junctions the primary postganglionic neurotransmitter is norepinephrine.
- In the sweat glands, sympathetic effects are mediated principally by acetylcholine.
- The primary postganglionic neurotransmitter at all parasympathetic neuroeffector junctions is acetylcholine.

## SYMPATHETIC FUNCTION

### Functional Anatomy of the Sympathetic Outflow

Preganglionic sympathetic neurons have a slow, irregular, tonic activity that depends mainly on multiple segmental afferent and descending inputs.<sup>13,14</sup> Preganglionic sympathetic neurons are organized into specialized spinal sympathetic functional units that control specific target organs and are differentially influenced by input from the hypothalamus and brain stem. Sympathetic functional units include skin vasomotor, muscle vasomotor, visceromotor, pilomotor, and sudomotor units.<sup>13–15</sup> There are, for example, clear differences between the patterns of sympathetic outflow to skin and to muscle, but sympathetic activity recorded simultaneously from different muscles at rest or from skin sympathetic nerves innervating the palms and the feet are remarkably similar.<sup>14,16,17</sup>

Preganglionic sympathetic output has a segmental organization, but the segmental distribution of preganglionic fibers does not follow the dermatomal pattern of somatic nerves.<sup>13,16</sup> For example, sudomotor functional units in segments T1 and T2 innervate the head and neck, units in T3–T6 innervate the upper extremities and thoracic viscera, those in T7–T11 innervate the abdominal viscera, and ones in T12–L2 innervate the lower extremities and pelvic and perineal organs.<sup>16</sup> Preganglionic sympathetic axons exit through ventral roots

and pass through the white ramus communicans of the corresponding spinal nerve to reach the paravertebral sympathetic chain and to synapse on neurons located in the paravertebral or prevertebral ganglia.<sup>16</sup> Paravertebral ganglia innervate all tissues and organs except those in the abdomen, pelvis, and perineum.

Their postganglionic fibers destined for the trunk and limbs follow the course of spinal nerves or blood vessels or both. Spinal fibers join the peripheral spinal (somatic) nerve through the gray ramus communicans. These fibers provide vasomotor, sudomotor, and pilomotor input to the extremities and trunk. Sympathetic fibers are intermingled with somatic motor and sensory fibers, and their distribution is similar to that of the corresponding somatic nerve. Most sympathetic fibers are destined for the hand and foot and are carried mainly by the median, peroneal, and tibial nerves and, to a lesser extent, the ulnar nerve.

### SYMPATHETIC REFLEXES

Unlike somatic motor neurons, sympathetic preganglionic neurons are not monosynaptically driven by visceral, muscle, or cutaneous sensory input. These afferents converge on second-order neurons located in laminae I, V, VII, and X of the spinal cord that project to the sympathetic preganglionic neurons to initiate segmental somatosympathetic and viscerosympathetic reflexes.<sup>13</sup> Segmental reflex pathways arising from somatic or visceral afferents activate ipsilateral local interneuronal networks in laminae I, V, and VII, which may directly activate or inhibit the sympathetic preganglionic neurons. With the exception of Ia muscle spindle and Ib Golgi tendon organ afferents, activation of all other groups of primary sensory fibers arising from skin (A $\beta$ , A $\delta$ , and C), muscle (groups II, III, and IV), and viscera (groups A $\delta$  and C) can modulate preganglionic neuron activity through segmental pathways.<sup>13,14</sup> Segmental sympathetic reflexes are segmentally biased, predominantly uncrossed, and exhibit ipsilateral, function-specific, reciprocal, and nonreciprocal patterns of response. For example, nociceptive stimuli reflexively activate segmental circuitry that generates excitation of vasoconstrictor outflow to skeletal muscle and inhibition of vasoconstrictor outflow to the skin.<sup>14</sup> Unlike somatic reflexes (e.g., the flexor reflex), segmental

sympathetic reflexes do not exhibit reciprocal contralateral response patterns, but they may exhibit crossed, nonreciprocal responses. For example, during execution of the *cold pressor test*, decreases in cutaneous blood flow in an arm exposed to ice cold water are accompanied by cutaneous vasoconstriction in the contralateral forearm. All segmental spinal reflexes are subject to supraspinal modulation through several parallel pathways arising in the hypothalamus, pons, and medulla and innervating the sympathetic preganglionic neurons.<sup>9–11</sup>

## Assessment of Sympathetic Function in Humans

Sympathetic function in humans can be assessed, directly or indirectly, with various noninvasive or invasive techniques. Indirect methods include noninvasive tests of sudomotor and cardiovascular function described in Chapters 36–39; measurement of plasma norepinephrine concentration in forearm veins with the subject supine and standing;<sup>18,19</sup> assessment of splanchnic<sup>20,21</sup> and cerebral blood flow<sup>22,23</sup> using Doppler techniques; and assessment of sympathetic innervation of the heart using radioisotope methods.<sup>24,25</sup> In comparison, microneurographic technique allows direct recording of postganglionic sympathetic nerve activity in humans.<sup>16,17</sup> Nerve recordings are made with tungsten microelectrodes inserted percutaneously into a nerve, especially the median, peroneal, or tibial nerve. This technique allows multiunit recordings of two different types of outflow: skin sympathetic nerve activity and muscle sympathetic nerve activity.<sup>16,17</sup>

### Key Points

- Sympathetic outflow is organized into specialized functional units which include skin vasomotor, muscle, vasomotor, visceromotor, pilomotor, and sudomotor units.
- Preganglionic sympathetic outflow is organized segmentally and not by dermatome.
- Preganglionic sympathetic axons exit through ventral roots to reach the paravertebral sympathetic chain ganglia, which innervate all tissues and organs except

those in the abdomen, pelvis, and perineum.

- Postganglionic sympathetic fibers travel with spinal motor and sensory fibers or with arteries to provide vasomotor, sudomotor, and pilomotor innervation to the trunk and limbs.
- Most sympathetic fibers supplying the hand are carried by the median nerve.
- Most sympathetic fibers supplying the foot are carried by the peroneal and tibial nerves.
- Unlike somatic motor neurons, sympathetic preganglionic neurons are not monosynaptically driven by afferent input.
- Sympathetic reflexes are segmentally biased, predominantly uncrossed, and exhibit ipsilateral, function-specific, reciprocal and nonreciprocal patterns of response.
- Sympathetic function can be assessed noninvasively by indirect techniques, or invasively by direct microneurographic recording of postganglionic sympathetic nerve activity.

## SYMPATHETIC INNERVATION OF THE SKIN

Sympathetic vasomotor, pilomotor, and sudomotor innervation of skin effectors has primarily a thermoregulatory function.<sup>12,26,27</sup> Skin sympathetic activity is a mixture of sudomotor and vasoconstrictor impulses and may sometimes include pilomotor and vasodilator impulses. The average conduction velocity for skin sudomotor and vasomotor fibers is 1.3 m/second and 0.8 m/second, respectively.<sup>16,17</sup> The intensity of the skin sympathetic activity is determined mainly by environmental temperature and the emotional state of the subject. Decreased or increased environmental temperature can produce selective activation of the vasoconstrictor or sudomotor system, respectively, with suppression of activity in the other system. Emotional stimuli or inspiratory gasp also increases spontaneous skin sympathetic activity, but in this case the bursts are caused by simultaneous activation of sudomotor and vasomotor impulses.<sup>16,17</sup> Cutaneous arteries and veins have a prominent noradrenergic innervation that regulates both nutritive and arteriovenous skin blood flow.<sup>12,26</sup> Nutritive



skin flow is carried by capillaries and is regulated by sympathetic ( $\alpha$ - and  $\beta$ -adrenergic) and local nonadrenergic mediators. Arteriovenous skin blood flow is carried by low-resistance arteriovenous shunts, which receive abundant sympathetic vasoconstrictor input and have a key role in thermoregulation.<sup>12,26</sup> Skin vasoconstrictor neurons may coordinate their activity with vasomotor neurons in other vascular beds to maintain cardiac output, but they are not sensitive to baroreflex input.

Skin blood flow is also controlled by somatosympathetic reflexes<sup>13,14</sup> and three local axon reflexes: (1) the axon flare response, (2) the sudomotor axon reflex, and (3) the venoarteriolar reflex. The axon flare response is mediated by nociceptive C-fiber terminals.<sup>28</sup> Activation by noxious chemical or mechanical stimuli produces antidromic release of neuropeptides (substance P and others) that cause skin vasodilation directly and through stimulation of histamine release by mast cells. The sudomotor axon reflex is mediated by sympathetic sudomotor C fibers. The venoarteriolar reflex is mediated by sympathetic vasomotor axons innervating small veins and arterioles. Skin vasomotor activity has been studied clinically by using several noninvasive methods for measuring skin blood flow, including plethysmography and laser Doppler flowmetry.<sup>28</sup>

The eccrine sweat glands in humans have a major role in thermoregulation. The segmental pattern of distribution of sudomotor fibers to the trunk and limbs is irregular and varies substantially among individuals and even between the right and the left sides of an individual.<sup>12</sup> Sympathetic inputs to the sweat glands are mediated by acetylcholine, acting via  $M_3$  muscarinic receptors.

### Key Points

- Sympathetic vasomotor, pilomotor, and sudomotor innervation of skin effectors has primarily a thermoregulatory function.
- The intensity of skin sympathetic activity is determined mainly by environmental temperature and the emotional state of the subject.
- Skin blood flow is controlled by somatosympathetic reflexes and three local axon reflexes: (1) the axon flare response, (2) the sudomotor axon reflex, and (3) the venoarteriolar reflex.

- The sudomotor axon reflex is mediated by sympathetic sudomotor C fibers.
- Sympathetic inputs to the sweat glands are mediated by acetylcholine, acting via  $M_3$  muscarinic receptors.

## MUSCLE SYMPATHETIC ACTIVITY

Muscle sympathetic activity is composed of vasoconstrictor impulses that are strongly modulated by arterial baroreceptors.<sup>14,16,17</sup> Conduction velocity of the postganglionic C fibers has been estimated to be 0.7 m/second in the median nerve and 1.1 m/second in the peroneal nerve.<sup>16</sup> At rest, there is a striking similarity between muscle sympathetic activity recorded in different extremities. However, this activity in the arm and leg can be dissociated during mental stress and during forearm ischemia after isometric exercise.<sup>29</sup> Muscle sympathetic activity is important for buffering acute changes of blood pressure and decreases in response to moment-to-moment baroreceptor influence.<sup>16,17,30</sup> It has much less importance, however, for long-term control of blood pressure.<sup>17</sup> At rest, muscle sympathetic activity correlates positively with antecubital venous plasma norepinephrine levels.<sup>31</sup> Muscle sympathetic activity is also inhibited by cardiopulmonary receptors. The respiratory cycle, changes of posture, or the Valsalva maneuver may modulate the muscle sympathetic activity caused by changes in arterial pressure. However, hypercapnia, hypoxia, isometric hand-grip, emotional stress, or the cold pressor test increase muscle sympathetic activity despite unchanged or increased arterial pressure.<sup>16,17,31</sup>

### Key Points

- Muscle sympathetic activity is modulated by arterial baroreflexes.
- Arterial baroreflexes are important for buffering short-term changes in blood pressure but are relatively unimportant in regard to long-term blood pressure regulation.
- Muscle sympathetic activity is modulated by the respiratory cycle, changes of posture or intrathoracic pressure, plasma  $CO_2$  and  $O_2$  tension, muscle exertion, and emotional and thermal stress.

## AUTONOMIC CONTROL OF HEART RATE

Heart rate depends on the effects of parasympathetic and sympathetic modulation of the intrinsic firing rate of the sinus node. Parasympathetic control is provided by cardiovagal neurons in the nucleus ambiguus and dorsal motor nucleus in the medulla.<sup>12,32</sup> Sympathetic noradrenergic control derives mainly from the cervical and upper thoracic ganglia.<sup>12</sup> In humans at rest, parasympathetic tone predominates over the excitatory sympathetic  $\beta$ -adrenergic influence. Effects mediated by the vagus nerve have a shorter latency and duration than those mediated by the sympathetic nerves. Heart rate has spontaneous fluctuations, which reflect changing levels of autonomic activity modulating sinus-node discharge.<sup>33</sup>

Use of power spectral analysis of heart rate fluctuations allows a noninvasive quantitative assessment of beat-to-beat modulation of neuronal activity affecting the heart.<sup>34–36</sup> Fluctuations of heart rate at respiratory frequencies (approximately 0.15 Hz) are mediated almost exclusively by the vagus nerve.<sup>33–35</sup> Vagal influences on the heart are associated directly with respiratory activity and are minimal during inspiration and maximal at the end of inspiration and in early expiration. This is the basis of the *respiratory sinus arrhythmia*.<sup>28,33,34</sup> Spontaneous and baroreflex-induced firing of central cardiovagal neurons is inhibited during inspiration and is maximal during early expiration.<sup>31</sup> Increased tidal volume increases respiratory sinus arrhythmia, whereas increased respiratory frequency decreases it. Heart rate variability is correlated inversely with age in normal subjects at rest.<sup>28</sup>

Spontaneous lower frequency fluctuations (those less than 0.15 Hz) of heart rate are mediated by both the vagus and the sympathetic nerves and may be related to baroreflex activity, temperature regulation, and other factors. Upright posture in humans dramatically increases sympathetic nerve activity and produces a large increase in low-frequency heart rate power.<sup>33–35</sup>

### Key Points

- Heart rate depends on parasympathetic (fast) and sympathetic (slow) influences.

- The vagal influence on heart rate is strongly influenced by respiration (sinus arrhythmia), is more marked during expiration, and is absent during inspiration.
- Methods for assessing autonomic control of heart rate include (1) power spectral analysis of R–R intervals, (2) heart rate responses to periodic deep breathing, and (3) heart rate responses to the Valsalva maneuver.
- Heart rate variability declines with advancing age.

## CARDIOVASCULAR REFLEXES

### Arterial Baroreflexes

In normal subjects, control of arterial pressure depends primarily on the sympathetic innervation of the blood vessels, particularly in the splanchnic bed.<sup>36–40</sup> The number of splanchnic sympathetic preganglionic neurons progressively decreases with age, and orthostatic hypotension occurs after more than 50% of them have been lost.<sup>28</sup> Changes in sympathetic outflow are regulated by arterial baroreceptors and chemoreceptors, cardiopulmonary receptors, and receptors in skeletal muscles (i.e., ergoreceptors).<sup>36–41</sup> In addition, these reflexes are modulated by *central commands*, particularly from the amygdala, hypothalamus, and periaqueductal gray.<sup>9,10,42</sup> In humans, arterial pressure is regulated primarily by the carotid sinus and aortic baroreceptors, innervated by branches of CNs IX and X, respectively, and by cardiopulmonary mechanoreceptors, innervated by vagal and sympathetic afferents. The primary role of arterial baroreflexes is the rapid adjustment of arterial pressure around the existing mean arterial pressure.<sup>36–40</sup> The baroreceptor reflexes provide a negative feedback that buffers the magnitude of arterial pressure oscillations throughout the day.

Baroreflexes induce short-term changes in heart rate opposite in direction to the changes in arterial pressure, thus increasing heart rate variability. The carotid baroreflex has been studied by applying negative and positive pressures to the neck, which increase and decrease, respectively, carotid sinus transmural pressure.<sup>43</sup> The combined influence of carotid and aortic baroreceptors in the control of heart rate has been studied by measuring heart

rate responses to changes in arterial pressure induced by intravenous infusion of vasoconstrictor or vasodilator agents.<sup>43</sup> Despite their major influence on heart rate, the buffering effects of the carotid baroreflex depend predominantly on changes in total peripheral resistance.<sup>36–40</sup>

Baroreflex control of regional circulation is heterogeneous and largely affects resistance vessels in the splanchnic area.<sup>36–41</sup> Sympathetic vasoconstriction in the skeletal muscle is also strongly modulated by the baroreflex;<sup>16,17</sup> this control is dynamic and more suitable for buffering short-term than long-term variations of arterial pressure.<sup>37,38</sup> During orthostatic stress, baroreflex control over skeletal muscle sympathetic activity declines prior to orthostatic syncope.<sup>44</sup> During exercise, carotid baroreceptor activity is rapidly adjusted to a higher level; this allows increased arterial pressure to meet the metabolic demands of the contracting muscles.<sup>36</sup>

## Cardiopulmonary Reflexes

Cardiopulmonary receptors are innervated by vagal and sympathetic myelinated and unmyelinated afferent fibers. Atrial receptors innervated by vagal myelinated fibers are activated by atrial distention or contraction and initiate reflex tachycardia caused by selective increase of sympathetic outflow to the sinus node. Cardiopulmonary receptors with unmyelinated vagal afferents, similar to arterial baroreceptors, tonically inhibit vasomotor activity. Unlike atrial baroreceptors, cardiopulmonary receptors provide sustained rather than phasic control in sympathetic activity and vasomotor tone in the muscle and have no major effect in controlling heart rate.<sup>36–40</sup>

## Venoarteriolar Reflexes

The venoarteriolar reflex is a sympathetic postganglionic C-fiber axon reflex, with receptors in small veins and effectors in muscle arterioles. Venous pooling activates receptors in small veins of the skin, muscle, and adipose tissue; the result is vasoconstriction in the arterioles supplying these tissues. During limb dependency, this local reflex vasoconstriction may decrease blood flow by 50%. The main

function of this reflex is to increase total peripheral resistance.<sup>25</sup>

## Ergoreflexes

Static muscle contraction increases heart rate and blood pressure. The mechanisms underlying these responses involve (1) an exercise pressor reflex initiated by the activation of chemosensitive endings of small myelinated and unmyelinated afferent fibers by local metabolites in the contracting muscle and mediated by group III and IV skeletal muscle afferent fibers,<sup>45</sup> (2) a pressor reflex initiated by muscle mechanosensitive receptors,<sup>46</sup> and (3) a central command that influences descending autonomic pathways.<sup>42</sup> Cardiovascular responses to moderately intense static contraction may be produced primarily by the motor command, which is solely responsible for increased heart rate. At higher intensity, responses depend on both the motor command and the muscle chemoreflexes.<sup>36–40</sup>

### Key Points

- Control of blood pressure depends primarily on sympathetically-mediated splanchnic vascular tone.
- Cardiovascular sympathetic outflow is regulated by (1) carotid sinus, atrial, aortic, and cardiopulmonary baroreceptors, (2) central command, and (3) skeletal muscle ergoreceptors.
- The primary role of the arterial baroreflexes is the rapid adjustment of arterial pressure around the existing mean arterial pressure, predominantly via modulation of peripheral resistance in the splanchnic and skeletal muscle vascular beds.
- The vagus and glossopharyngeal nerves innervate carotid and aortic baroreceptors, whereas the vagus nerve and sympathetic myelinated and unmyelinated afferents innervate cardiopulmonary mechanoreceptors.
- Carotid sinus and cardiac atrial baroreceptors produce phasic bursts, whereas cardiopulmonary receptors produce tonic changes, to regulate sympathetic vasomotor activity.
- Venous pooling activates the venoarteriolar reflex, which is mediated by sympathetic postganglionic C fibers, resulting in

vasoconstriction in the arterioles supplying skin, muscle, and adipose tissue.

- Static muscle contraction activates ergoreflexes which increase heart rate and blood pressure via (1) chemosensitive endings of group III and IV skeletal muscle afferent fibers, (2) a pressor reflex mediated by muscle mechanosensitive receptors, and (3) a central command.

## MAINTENANCE OF POSTURAL NORMOTENSION

In healthy subjects, orthostatic stress such as active standing, head-up tilt, or application of lower body negative pressure results in pooling of venous blood in the capacitance vessels of the legs and abdomen. The bulk of venous pooling occurs within the first 10 seconds. In addition, central blood volume decreases following transcapillary filtration of fluid into the interstitial space in the dependent tissues.<sup>47</sup> These combined effects lead to a decrease in venous return to the heart, end-diastolic filling of the right ventricle, and stroke volume, resulting in approximately a 20% decrease in cardiac output.

The adaptation to orthostatic stress consists of several mechanisms. The decrease in mean arterial pressure is prevented by a compensatory vasoconstriction of the resistance and capacitance vessels of the splanchnic, renal, and muscle vascular beds. The initial adjustments to orthostatic stress are mediated by baroreflexes and cardiopulmonary reflexes. During prolonged orthostatic stress, additional adjustments are mediated by humoral mechanisms, including the arginine-vasopressin and renin-angiotensin-aldosterone systems.<sup>38,47</sup> Carotid sinus baroreceptors are of primary importance during standing, whereas cardiopulmonary receptors have a small role. When venous filling in the dependent parts increases intravenous pressure to 25 mm Hg, it activates a local axon reflex, called the *venoarteriolar reflex*, which further contributes to adaptation to orthostatic stress.

Patients with autonomic failure have disturbed neural reflex arterial vasoconstriction, and this is the primary mechanism of orthostatic hypotension. The inability to increase vascular resistance allows considerable venous pooling

to occur in the skeletal muscle, cutaneous, and splanchnic vascular beds of the dependent parts. The abdominal compartment (splanchnic circulation) and perhaps skin vasculature are the most likely sites of venous pooling. The counterregulatory mechanism that reduces pooling in the lower extremities is activation of the skeletal muscle pump. Active muscle contraction increases intramuscular pressure, which opposes the hydrostatic forces and reduces venous pooling in the legs. This may explain why some patients with orthostatic hypotension habitually fidget and contract their leg muscles when upright.<sup>48</sup> Such physical countermeasures may be taught to patients to help them compensate for orthostatic hypotension.<sup>49</sup>

### Key Points

- Orthostatic stress, such as active standing or passive head-up tilting, in the healthy subject results in (1) pooling of venous blood in capacitance vessels of the legs and abdomen within the first 10 seconds, (2) transcapillary fluid loss into extravascular tissue space, (3) decreased venous return to the heart, and (4) an approximately 20% decrease in cardiac output.
- The adaptation to orthostatic stress consists of (1) baroreflex-mediated vasoconstriction of resistance and capacitance vessels of the splanchnic, renal, and muscle vascular beds, (2) mechanical compression of lower extremity vascular beds by contracting skeletal muscle, and (3) humoral mechanisms including the arginine-vasopressin and renin-angiotensin-aldosterone systems.
- The maintenance of postural normotension depends on (1) reflex arterial vasoconstriction in the splanchnic, renal, and muscular beds, (2) cardiac output, (3) adequate plasma volume, and (4) compression of capacitance veins by lower extremity skeletal muscles.

## SUMMARY

The autonomic nervous system consists of three divisions: the sympathetic (thoracolumbar), parasympathetic (craniosacral), and enteric



nervous systems. The sympathetic and parasympathetic autonomic outflows involve a two-neuron pathway with a synapse in an autonomic ganglion. Preganglionic sympathetic neurons are organized into various functional units that control specific targets and include skin vasomotor, muscle vasomotor, visceromotor, pilomotor, and sudomotor units. Microneurographic techniques allow recording of postganglionic sympathetic nerve activity in humans. Skin sympathetic activity is a mixture of sudomotor and vasoconstrictor impulses and is regulated mainly by environmental temperature and emotional influences. Muscle sympathetic activity is composed of vasoconstrictor impulses that are strongly modulated by arterial baroreceptors. Heart rate is controlled by vagal parasympathetic and thoracic sympathetic inputs. Vagal influence on the heart rate is strongly modulated by respiration; it is more marked during expiration and is absent during inspiration. This is the basis for the so-called *respiratory sinus arrhythmia*, which is an important index of vagal innervation of the heart. Power spectral analysis of heart rate fluctuations allows noninvasive assessment of beat-to-beat modulation of neuronal activity affecting the heart. Arterial baroreflex, cardiopulmonary reflexes, venoarteriolar reflex, and ergoreflexes control sympathetic and parasympathetic influences on cardiovascular effectors. The main regulatory mechanism that prevents orthostatic hypotension is reflex arterial vasoconstriction in the splanchnic, renal, and muscular beds triggered by a decrease in transmural pressure at the level of carotid sinus baroreceptors.

## REFERENCES

- Sandroni, P., J. E. Ahlskog, R. D. Fealey, P. A. Low. 1991. Autonomic involvement in extrapyramidal and cerebellar disorders. *Clinical Autonomic Research* 1:147–55.
- Vinik, A. I., R. A. Maser, B. D. Mitchell, and R. Freeman. 2003. Diabetic autonomic neuropathy. *Diabetes Care* 26:1553–79.
- Ewing, D. J., I. W. Campbell, B. F. Clarke. 1980. Assessment of cardiovascular effects in diabetic autonomic neuropathy and prognostic implications. *Annals of Internal Medicine* 92:308–11.
- Bellavere, F., M. Ferri, C. Cardone, et al. 1984. Analysis of QT versus RR ECG interval variations in diabetic patients shows a longer QT period in subjects with autonomic neuropathy. *Diabetologia* 27:255A.
- Chambers, J. B., M. J. Sampson, D. C. Spriggins, G. Jackson. 1990. QT prolongation on the electrocardiogram in diabetic autonomic neuropathy. *Diabetic Medicine* 7:105–10.
- Knuttgen, D., D. Weidemann, M. Doehn. 1990. Diabetic autonomic neuropathy: Abnormal cardiovascular reactions under general anesthesia. *Klinische Wochenschrift* 68:1168–72.
- Burgos, L. G., T. J. Ebert, C. Asiddao, et al. 1989. Increased intraoperative cardiovascular morbidity in diabetics with autonomic neuropathy. *Anesthesiology* 70:591–7.
- Cervero, F., and R. D. Foreman. 1990. Sensory innervation of the viscera. In *Central Regulation of Autonomic Functions*, ed. A. D. Loewy, and K. M. Spyer, 104–25. New York: Oxford University Press.
- Loewy, A. D. 1990. Anatomy of the autonomic nervous system: An overview. In *Central Regulation of Autonomic Functions*, ed. A. D. Loewy, and K. M. Spyer, 3–16. New York: Oxford University Press.
- Dampney, R. A. 1994. Functional organization of central pathways regulating the cardiovascular system. *Physiological Reviews* 74:323–64.
- Jänig, W., and H.-J. Häbler. 1999. Organization of the autonomic nervous system: Structure and function. In *Handbook of clinical neurology*, Vol. 74; series 30: The autonomic nervous system. Part I. Normal functions, ed. P. J. Vinken, and G. W. Bruyn, 1–52. Amsterdam: Elsevier Science Publishers.
- Gibbins, I. 1990. Peripheral autonomic nervous system. In *The human nervous system*, ed. G. Paxinos, 93–123. San Diego: Academic Press.
- Cabot, J. B. 1996. Some principles of the spinal organization of the sympathetic preganglionic outflow. *Progress in Brain Research* 107:29–42.
- Jänig, W. 1996. Spinal cord reflex organization of sympathetic systems. *Progress in Brain Research* 107:43–77.
- Cheshire W. P. 2000. Peripheral autonomic function and dysfunction. In *The autonomic nervous system*, O. Appenzeller, section editor, *Handbook of clinical neurology*, ed. P. J. Vinken, and G. W. Bruyn, Vol. 75, 105–42. Amsterdam: Elsevier.
- Wallin, B. G., and J. Fagius. 1988. Peripheral sympathetic neural activity in conscious humans. *Annual Review of Physiology* 50:565–76.
- Wallin, B. G., and M. Elam. 1994. Insights from intraneural recordings of sympathetic nerve traffic in humans. *News in Physiological Sciences* 9:203–7.
- Garland, E. M., S. R. Raj, B. K. Black, et al. 2007. The hemodynamic and neurohumoral phenotype of postural tachycardia syndrome. *Neurology* 69(8):790–8.
- Thieben, M. J., P. Sandroni, D. M. Sletten, et al. 2007. Postural orthostatic tachycardia syndrome: The Mayo Clinic experience. *Mayo Clinic Proceedings* 82(3):308–13.
- Fujimura, J., M. Camilleri, P. A. Low, et al. 1997. Effect of perturbations and a meal on superior mesenteric artery flow in patients with orthostatic hypotension. *Journal of the Autonomic Nervous System* 67(1–2):15–23.
- Purewal, T. S., D. E. Goss, M. M. Zano, et al. 1995. The splanchnic circulation and postural hypotension in diabetic autonomic neuropathy. *Diabetic Medicine* 12(6):513–22.

22. Zhang, R., C. G. Crandall, and B. D. Levine. 2004. Cerebral hemodynamics during the Valsalva maneuver: Insights from ganglionic blockade. *Stroke* 35(4):843–7.
23. Horowitz, D. R., and H. Kaufmann. 2001. Autoregulatory cerebral vasodilation occurs during orthostatic hypotension in patients with primary autonomic failure. *Clinical Autonomic Research* 11(6): 363–7.
24. Yamashina, S., and J. Yamazaki. 2007. Neuronal imaging using SPECT. *European Journal of Nuclear Medicine and Molecular Imaging* 34(6):939–50.
25. Goldstein, D. S. 2004. Functional neuroimaging of sympathetic innervation of the heart. *Annals of the New York Academy of Sciences* 1018:231–43.
26. Johnson, J. M. 1986. Nonthermoregulatory control of human skin blood flow. *Journal of Applied Physiology* 61:1613–22.
27. Cheshire, W. P., and P. A. Low. 2007. Disorders of sweating and thermoregulation. *Continuum: Lifelong Learning in Neurology* 13(6):143–64.
28. Low, P. A. 1997. Laboratory evaluation of autonomic function. In *Clinical autonomic disorders: Evaluation and management*, ed. P. A. Low, 2nd ed., 179–208. Philadelphia: Lippincott-Raven Publishers.
29. Wallin, B. G., R. G. Victor, and A. L. Mark. 1989. Sympathetic outflow to resting muscles during static handgrip and postcontraction muscle ischemia. *The American Journal of Physiology* 256:H105–10.
30. Somers, V. K., M. E. Dyken, A. L. Mark, and F. M. Abboud. 1993. Sympathetic-nerve activity during sleep in normal subjects. *The New England Journal of Medicine* 328:303–7.
31. Eckberg, D. L., C. Nerhed, and B. G. Wallin. 1985. Respiratory modulation of muscle sympathetic and vagal cardiac outflow in man. *The Journal of Physiology (London)* 365:181–96.
32. Spyer, K. M., P. A. Brooks, and P. N. Izzo. 1994. Vagal preganglionic neurons supplying the heart. In *Vagal control of the heart: Experimental basis and clinical implications*, ed. M. N. Levy, and P. J. Schwartz, 45–64. New York: Futura Publishing Company.
33. van Ravenswaaij-Arts, C. M., L. A. Kollee, J. C. Hopman, G. B. Stoeltinga, and H. P. van Geijn. 1993. Heart rate variability. *Annals of Internal Medicine* 118:436–47.
34. Baillard, C., P. Goncalves, L. Mangin, B. Swynghedauw, and P. Mansier. 2001. Use of time frequency analysis to follow transitory modulation of the cardiac autonomic system in clinical studies. *Autonomic Neuroscience* 90:24–8.
35. Bernardi, L., C. Porta, A. Gabutti, L. Spicuzza, and P. Sleight. 2001. Modulatory effects of respiration. *Autonomic Neuroscience* 90:47–56.
36. Mancia, G., G. Grassi, A. Ferrari, and A. Zanchetti. 1985. Reflex cardiovascular regulation in humans. *Journal of Cardiovascular Pharmacology* 7(Suppl 3):S152–9.
37. Abboud, F. M. 1986. Interaction of cardiovascular reflexes in humans. In *Neural mechanisms and cardiovascular disease*, ed. B. Lown, A. Malliani, and M. Prosdocimi, 73–84. Padova, Italy: Liviana Press.
38. Cowley, A. W. Jr. 1992. Long-term control of arterial blood pressure. *Physiological Reviews* 72:231–300.
39. Joyner, M. J., and J. T. Shepherd. 1997. Autonomic regulation of circulation. In *Clinical autonomic disorders: Evaluation and management*, ed. P. A. Low, 2nd ed., 61–71. Philadelphia: Lippincott-Raven Publishers.
40. Wieling, W., and K. H. Wesseling. 1993. Importance of reflexes in circulatory adjustments to postural change. In *Cardiovascular reflex control in health and disease*, ed. R. Hainsworth, 35–65. London:WB Saunders.
41. Iellamo, F. 2001. Neural mechanisms of cardiovascular regulation during exercise. *Autonomic Neuroscience* 90:66–75.
42. Green, A. L., S. Wang, S. Purvis, et al. 2007. Identifying cardiorespiratory neurocircuitry involved in central command during exercise in humans. *The Journal of Physiology* 578:605–12.
43. Eckberg, D. L., and J. M. Fritsch. 1993. How should human baroreflexes be tested? *News in Physiological Sciences* 8:7–12.
44. Ichinose, M., M. Saito, N. Fujii, et al. 2006. Modulation of the control of muscle sympathetic nerve activity during severe orthostatic stress. *The Journal of Physiology* 576:947–58.
45. Leshnower, B. G., J. T. Potts, M. G. Garry, and J. H. Mitchell. 2001. Reflex cardiovascular responses evoked by selective activation of skeletal muscle ergoreceptors. *Journal of Applied Physiology* 90:308–16.
46. Nakamoto, T., and K. Matsukawa. 2007. Muscle mechanosensitive receptors close to the myotendinous junction of the Achilles tendon elicit a pressor reflex. *Journal of Applied Physiology* 102:2112–20.
47. Smit, A. A., J. R. Halliwill, P. A. Low, and W. Wieling. 1999. Pathophysiological basis of orthostatic hypotension in autonomic failure. *The Journal of Physiology (London)* 519:1–10.
48. Cheshire, W. P. 2000. Hypotensive akathisia: Autonomic failure associated with leg fidgeting while sitting. *Neurology* 55:1923–6.
49. Bouvette, C. M., B. R. McPhee, T. L. Opfer-Gehrking, and P. A. Low. 1996. Role of physical countermeasures in the management of orthostatic hypotension: Efficacy and biofeedback augmentation. *Mayo Clinic Proceedings* 71:847–53.



# Quantitative Sudomotor Axon Reflex and Related Tests

Phillip A. Low

**INTRODUCTION**  
**LABORATORY EVALUATION OF**  
**AUTONOMIC FUNCTION**  
**QUANTITATIVE SUDOMOTOR**  
**AXON REFLEX TEST**  
Normal Response

Abnormal Patterns  
Significance of the Test  
Applications

**IMPRINT METHODS OF SWEAT**  
**MEASUREMENT**  
**SUMMARY**

## INTRODUCTION

Typically the distal ends of the longest nerve fibers are first affected in the axonal neuropathies.<sup>5,12</sup> Small nerve fibers are often selectively involved and these are termed distal small fiber neuropathy (DSFN).<sup>5,12</sup> One method of recording C fiber function is to study the function of the postganglionic sympathetic sudomotor “C” fiber function.<sup>1,2,5,12</sup> We describe below the use of methods to measure sudomotor fiber function.

## LABORATORY EVALUATION OF AUTONOMIC FUNCTION

The *quantitative sudomotor axon reflex test* (QSART) is a routine test of autonomic function and a component of the autonomic reflex screen (Table 36–1). The autonomic reflex screen noninvasively and quantitatively evaluates sudomotor, adrenergic, and cardiovagal functions.<sup>1,2</sup> Sudomotor function is discussed in this chapter, and adrenergic and cardiovagal functions are considered in Chapter 37.

Because autonomic tests are affected substantially by many confounding variables, standardization, the recognition of pitfalls,<sup>3</sup> and patient preparation (Table 36–2) are critically important.

The indications for autonomic testing are summarized in Table 36–3. The presence of generalized autonomic failure, a major medical problem, adversely affects prognosis. It is important to quantify the deficits by system and by autonomic level. Certain benign disorders, such as chronic idiopathic anhidrosis<sup>4</sup> and benign syncope, need to be differentiated from the more serious dysautonomias. Distal small-fiber neuropathy is diagnosable with autonomic studies, and QSART is abnormal in 80% of cases,<sup>2,5,6</sup> suggesting that most patients who have distal somatic C-fiber involvement also have autonomic C-fiber impairment. This relationship is not invariable, and some patients with distal small-fiber neuropathy and abnormal epidermal skin fibers will have a normal QSART.<sup>7</sup> Sympathetically maintained pain is associated with unilateral vasomotor and sudomotor abnormalities<sup>8,9</sup> and is described in Chapter 40.<sup>10</sup>

**Table 36–1 Routine Tests of Autonomic Function**


---

The autonomic reflex screen comprises:

1. QSART distribution (4 sites)
  2. Tests of cardiovagal function
    - a. Heart rate response to deep breathing
    - b. Valsalva ratio
  3. Tests of adrenergic function
    - a. Blood pressure and heart rate response to head-up tilt
    - b. Beat-to-beat blood pressure response to Valsalva maneuver and deep breathing
- 

QSART, Quantitative sudomotor axon reflex test.

**Table 36–2 Patient Preparation for QSART**


---

No food for 3 hours before testing. The antecedent meal should be a light breakfast or lunch without coffee or tea.

Treatment with anticholinergic agents should be stopped 48 hours (preferably 5 half-lives of the drug before the study).

The patient should be comfortable and discomfort-free (e.g., bladder recently emptied).

The room and personnel should be warm and quiet.

---

**Table 36–3 Indications for Autonomic Laboratory Evaluation**


---

Strong indications

1. Suspicion of generalized autonomic failure
2. Diagnosis of benign autonomic disorders that mimic more serious dysautonomia
3. Detection of distal small-fiber neuropathy
4. Diagnosis of autonomic involvement in peripheral neuropathy
5. Pain associated with sympathetic dysfunction
6. Orthostatic intolerance, such as the postural tachycardia syndrome

Desirable indications

1. Monitoring course of autonomic failure
  2. Evaluation of response to therapy
  3. Peripheral neuropathies
  4. Syncope
  5. Amyotrophic lateral sclerosis
  6. Extrapyramidal and cerebellar degenerations
  7. Research questions
- 

The QSART is a routine test of autonomic function (Table 36–1). The commercial unit QSWEAT, sold by WR Medical, Minnesota, is modeled after the Mayo unit. A detailed evaluation of autonomic function currently comprises an evaluation of sudomotor, adrenergic, and cardiovagal function. This chapter focuses on the evaluation of postganglionic sudomotor function.

#### ***Purpose and Role of QSART and QSWEAT***

- To evaluate the integrity of the postganglionic sudomotor axon.

- To assess patients in whom there is a suspicion of an autonomic neuropathy.
- To follow the progress of patients with autonomic neuropathies.

### **QUANTITATIVE SUDOMOTOR AXON REFLEX TEST**

Many tests of sudomotor function of historical and limited clinical and research interest exist. For modern clinical neurophysiology laboratories, only the thermoregulatory sweat

test, QSART, peripheral autonomic surface potential, and sweat imprint test (SIT) require consideration. The thermoregulatory sweat test is described in Chapter 38. QSART and SIT are described in this chapter.

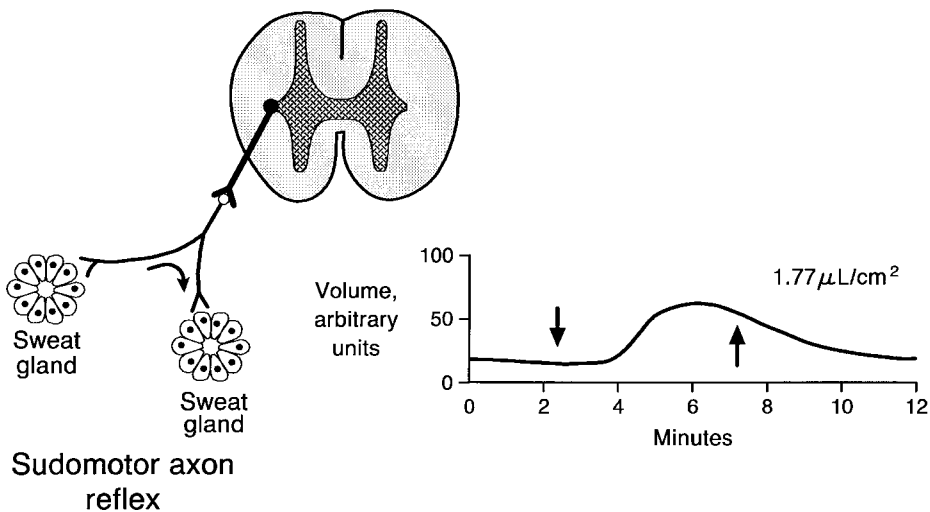
## Normal Response

The neural pathway evaluated by QSART consists of an axon reflex mediated by the postganglionic sympathetic sudomotor axon (Fig. 36-1). The axon terminal is activated by iontophoresed acetylcholine. Iontophoresis is relatively painless, but is slow and takes minutes to occur. Alternatively, the C fiber can be directly stimulated electrically, but is very painful.<sup>11</sup> The impulse first travels antidromically to a branch point, and then orthodromically to release acetylcholine from the nerve terminal. Acetylcholine traverses the neuroglandular junction and binds to muscarinic receptors on eccrine sweat glands to evoke the sweat response.

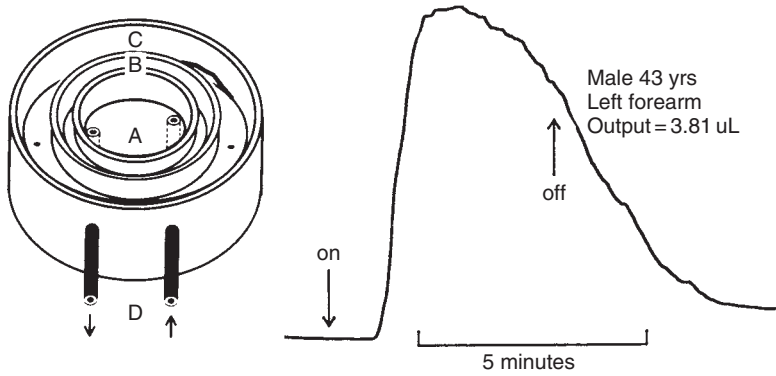
Equipment needed to perform QSART (or QSWEAT) includes the sudorometer, a multicompartmental sweat cell, a constant current generator, and some method of displaying the sweat response. Mayo builds its own sudorometer consoles; each consists of four sudorometers, thus permitting dynamic recording of sweat output from four sites

simultaneously. The commercial unit, although built very similarly, for currently inexplicable reasons generates a response that appears to be approximately 50% of the volume of the Mayo unit. A study is nearly complete that will provide a national normative database for the WR unit (WR Medical, Minneapolis, Minnesota).

The multicompartmental sweat cell (Fig. 36-2) is attached to the skin and permits iontophoresis of acetylcholine through the stimulus compartment (C) and a constant-current generator. Axon-reflex-mediated sweat response is recorded from compartment A. QSART responses are recorded from standard sites, which include the distal forearm, proximal leg, distal leg, and proximal foot. The tests are sensitive and reproducible in control subjects and in patients with neuropathy. The coefficient of variation was checked in two ways. In a group of individuals checked on two occasions the value was 14.7%. For three subjects (with low, moderate, and high sweat volumes recorded on multiple occasions) the mean coefficient of variation was 8%.<sup>12</sup> Extensive control data are available from QSART responses in 139 normal subjects (74 females and 65 males) between 10 and 83 years old. Mean sweat output was  $3.01 \mu\text{L}/\text{cm}^2$  and  $1.15 \mu\text{L}/\text{cm}^2$  for the forearm of males and females, respectively. This difference was significant ( $p < 0.001$ ). Values for the foot were



**Figure 36-1.** *Left*, Neural substrate of sudomotor axon reflex test (see text). *Right*, Representative response from a 36-year-old woman. Arrows indicate onset and cessation of iontophoresis. (From Low, P. A., T. L. Opfer-Gehrking, and M. Kihara. 1992. In vivo studies on receptor pharmacology of the human eccrine sweat gland. *Clinical Autonomic Research* 2:29-34. By permission of Lippincott Williams & Wilkins.)



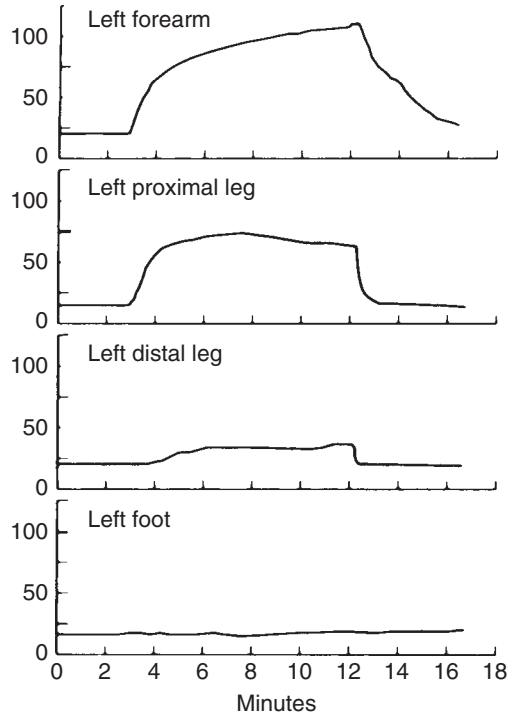
**Figure 36-2.** Quantitative sudomotor axon reflex test. *Left*, Sweat cell and, *right*, response. The sweat response in compartment A is evoked in response to iontophoresis of acetylcholine in compartment C. Compartment B is an air gap. Sweating causes a change in thermal mass of the nitrogen stream (D) that is sensed by the sudorometer and displayed (*right*). (From Low, P. A. 1992. Sudomotor function and dysfunction. In *Diseases of the nervous system*, ed. A. K. Asbury, G. M. McKhann, and W. I. McDonald, Vol. 1, 2nd ed., 479–89. Philadelphia: WB Saunders Company. By permission of Elsevier Science.)

2.65  $\mu\text{L}/\text{cm}^2$  and 1.15  $\mu\text{L}/\text{cm}^2$  for males and females, respectively. Again, the difference was statistically significant ( $p < 0.001$ ). Thus, the two groups were considered separately. For the forearm, QSART response did not regress with age. For the foot, however, there was a consistent, negative slope of QSART responses with increasing age.

**Abnormal Patterns**

Several abnormal QSART patterns are recognized. The most reliable pattern is a length-dependent pattern of QSART reduction (Fig. 36-3). Typically, the foot response is absent first and then sweating over the distal leg is lost. Sweat reduction is also accepted if the distal site is less than one-third that of the more proximal site. Sometimes the proximal site may have an excessive volume. Sometimes a response is associated with an ultrashort latency (presumably response is due to electrical and not chemical stimulation) and fails to turn off when the stimulus ceases; it is often seen in painful diabetic and other neuropathies and in florid reflex sympathetic dystrophy.

Another pattern is that of focal postganglionic denervation, as might occur with a peroneal or ulnar nerve lesion. Especially with focal abnormalities, the best approach is to combine QSART with thermoregulatory sweat test (see Chapter 38). (Preganglionic



**Figure 36-3.** Quantitative sudomotor axon reflex test distribution in a patient with distal small-fiber neuropathy. Note reduction of sweat response in the distal leg and anhidrosis over the foot. (From Low, P. A., and J. G. McLeod. 1997. Autonomic neuropathies. In *Clinical autonomic disorders: Evaluation and management*, ed. P. A. Low, 2nd ed., 463–86. Philadelphia: Lippincott-Raven Publishers. By permission of Mayo Foundation for Medical Education and Research.)

denervation can be recognized by an intact QSART response in an area that is anhidrotic on thermoregulatory sweat test.)

## Significance of the Test

*Normal test results indicate integrity of the postganglionic sympathetic sudomotor axon.* The absence of a response indicates failure of this axon, providing that iontophoresis is successful and eccrine sweat glands are present. Because the axonal segment mediating the response is likely to be short, the test probably evaluates distal axonal function. The interpretation of persistent sweat activity, manifest as a sweat response that is still at least two-thirds of maximal response by the end of the recording, is less certain, but could indicate mild neuropathy, especially if associated with an ultrashort latency. It occurs commonly in mild or painful neuropathies. Because it is unlikely that continuous activity occurs at the level of the sweat gland, the mechanism of persistent sweat activity is likely to be repetitive firing of the sympathetic axon. Damaged axons can fire spontaneously, and on stimulation, they may have more persistent activity than normal axons.

The latency is sometimes markedly reduced in painful neuropathies with persistent sweat activity. The mechanism of the very short latency (10–30 seconds) is likely augmented somatosympathetic reflexes, with a reduced threshold of polymodal C nociceptors—it often occurs with allodynia.

## Key Points

- The neural pathway of QSART is the postganglionic axon. The nerve terminal is activated by the stimulus, acetylcholine.
- The afferent and efferent pathway is the postganglionic axon (different branches) and the effector is the eccrine sweat gland.
- The test has a coefficient of variation <20%. Four sites are studied and the pattern of sweat responses is obtained.
- A normal QSART test result indicates integrity of the postganglionic sympathetic sudomotor axon.
- The absence of a QSART response indicates failure of the postganglionic sympathetic sudomotor axon, providing that iontophoresis is successful and eccrine sweat glands are present.

## Applications

QSART has been used to detect postganglionic sudomotor failure in neuropathies,<sup>12,13</sup> aging,<sup>14</sup> Lambert–Eaton myasthenic syndrome,<sup>15</sup> amyotrophic lateral sclerosis,<sup>16</sup> and preganglionic neuropathies with presumed transsynaptic degeneration.<sup>17,18</sup> In patients with distal small-fiber neuropathy, it is the most sensitive non-invasive diagnostic test available.<sup>2,5</sup> It is an important part of the autonomic reflex screen when QSART distribution is taken in conjunction with cardiovascular heart rate tests and Finapres recordings of the Valsalva maneuver and tilt.<sup>10</sup> Taken together, it helps define the distribution and severity of autonomic failure. Done under standardized conditions, the test is highly reproducible and can be utilized to follow the course of sudomotor deficit. This is useful in monitoring the course of a neuropathy and in evaluating response to therapy. Recently, the test has been used to define the threshold and duration of the local anhidrotic effect of botulinum toxin.<sup>19</sup> In studies of sympathetically maintained pain, QSART recordings are performed bilaterally and simultaneously for evidence of asymmetry of latency, volume, and morphology of the responses.<sup>8</sup>

Another application of QSART is in the detection of the site of the lesion. The QSART in combination with the thermoregulatory sweat test can be used to determine whether a lesion is preganglionic or postganglionic. A preganglionic site is deduced when anhidrosis on the thermoregulatory sweat test is associated with normal results on the QSART, and the lesion is postganglionic when both tests show anhidrosis.

For comparisons among patients of different ages and sex, these confounding variables can be managed by at least two approaches. One, the data can be expressed as normal deviates.<sup>8</sup> Two, an autonomic scoring scale can be generated that corrects for the effects of age and sex.<sup>20</sup> On this scale, severity is scored from 0 (no deficit) to 3 (maximal deficit).

## Key Points

- QSART is useful in demonstrating a length-dependent pattern of small-fiber neuropathy, where there is a progressive reduction in volume from the proximal to distal sites.

- QSART performed with thermoregulatory sweat test determines the site of the lesion. If there is anhidrosis on thermoregulatory sweat test and a normal QSART, the lesion is preganglionic in site.

## IMPRINT METHODS OF SWEAT MEASUREMENT

Several imprint methods have been used, but only the sweat imprint method is useful clinically. The subject is reviewed elsewhere.<sup>21</sup>

### PLASTIC AND SILICONE IMPRINTS

A colloidal graphite plastic method was introduced in 1952.<sup>22</sup> The plastic is dissolved in a solvent, which dries in approximately 30 seconds. The sweat droplet forms an imprint. Alternatives are silicone rubber monomers<sup>23</sup> and colloidal graphite plastic.<sup>24</sup> Harris et al.<sup>24</sup> compared bromophenol-blue, colloidal graphite plastic, and silicone monomer imprint methods and concluded that the last was the most sensitive and reliable.

Kennedy et al.<sup>25</sup> used a combination of pilocarpine iontophoresis, the Silastic imprint method, and imaging techniques to systematically study the sweat response in humans and rodents. For human studies, a 1% solution of pilocarpine is iontophoresed for 5 minutes over a 1 cm<sup>2</sup> area of skin on the dorsum of the hand and foot. The imprint material (0.5 mL base and 4 droplets of accelerator [Syringe Elasticon, Kerr Co]) is spread thinly over the skin. The material sets within 3 minutes. Counts of sweat gland density are made under a dissecting microscope and counting grid. To estimate volume, the size of the droplet can be determined with computerized imaging analysis techniques. The mean density is 311 and 281 active glands/cm<sup>2</sup> for the hand and foot, respectively, without differences for age or sex.<sup>26</sup>

This technique has been applied systematically to patients with diabetic neuropathy.<sup>25,26</sup> Counts of active sweat glands were abnormal in the hands of 24% of patients with diabetic neuropathy and in the feet of 56% of them. Of interest is that approximately one-third of patients with normal electrophysiologic tests have abnormal results on the SIT.<sup>21,27</sup>

## Key Points

- Sweat imprint methods, such as those in which sweat droplets indent a soft plastic mold, can be used to study the sweat process.

## SUMMARY

The application of noninvasive, sensitive, quantitative, and dynamic tests of sudomotor function enhances significantly our ability to quantify one aspect of the autonomic deficit. The QSART has an important role in clinical applications to better definition of the course of neuropathy, its response to treatment, and further exploration of sudomotor physiology.

## REFERENCES

1. Low, P. A. 1993. Autonomic nervous system function. *Journal of Clinical Neurophysiology* 10:14–27.
2. Low, V. A., P. Sandroni, R. D. Fealey, and P. A. Low. 2006. Detection of small-fiber neuropathy by sudomotor testing. *Muscle & Nerve* 34:57–61.
3. Low, P. A. 1993. Pitfalls in autonomic testing. In *Clinical autonomic disorders: Evaluation and management*, ed. P. A. Low, 355–65. Boston: Little, Brown and Company.
4. Low, P. A., R. D. Fealey, S. G. Sheps, W. P. Su, J. C. Trautmann, and N. L. Kuntz. 1985. Chronic idiopathic anhidrosis. *Annals of Neurology* 18:344–8.
5. Stewart, J. D., P. A. Low, and R. D. Fealey. 1992. Distal small fiber neuropathy: Results of tests of sweating and autonomic cardiovascular reflexes. *Muscle & Nerve* 15:661–5.
6. Tobin, K., M. J. Giuliani, and D. Lacomis. 1999. Comparison of different modalities for detection of small fiber neuropathy. *Clinical Neurophysiology* 110:1909–12.
7. Periquet, M. I., V. Novak, M. P. Collins, et al. 1999. Painful sensory neuropathy: Prospective evaluation using skin biopsy. *Neurology* 53:1641–7.
8. Low, P. A., and P. G. McManis. 1985. Autonomic reflex testing in sympathetic reflex dystrophy. *Neurology* 35(Suppl 1):148A.
9. Sandroni, P., P. A. Low, T. Ferrer, T. L. Opfer-Gehrking, C. L. Willner, and P. R. Wilson. 1998. Complex regional pain syndrome I (CRPS I): Prospective study and laboratory evaluation. *The Clinical Journal of Pain* 14:282–9.
10. Low, P. A. 1993. Laboratory evaluation of autonomic failure. In *Clinical autonomic disorders: Evaluation and management*, ed. P. A. Low, 169–95. Boston: Little, Brown and Company.
11. Namer, B., A. Bickel, H. Kramer, F. Birklein, and M. Schmelz. 2004. Chemically and electrically induced sweating and flare reaction. *Autonomic Neuroscience* 114:72–82.



12. Low, P. A., P. E. Caskey, R. R. Tuck, R. D. Fealey, and P. J. Dyck. 1983. Quantitative sudomotor axon reflex test in normal and neuropathic subjects. *Annals of Neurology* 14:573–80.
13. Low, P. A., B. R. Zimmerman, and P. J. Dyck. 1986. Comparison of distal sympathetic with vagal function in diabetic neuropathy. *Muscle & Nerve* 9: 592–6.
14. Low, P. A., T. L. Opfer-Gehrking, C. J. Proper, and I. Zimmerman. 1990. The effect of aging on cardiac autonomic and postganglionic sudomotor function. *Muscle & Nerve* 13:152–7.
15. McEvoy, K. M., A. J. Windebank, J. R. Daube, and P. A. Low. 1989. 3,4-Diaminopyridine in the treatment of Lambert–Eaton myasthenic syndrome. *The New England Journal of Medicine* 321:1567–71.
16. Litchy, W. J., P. A. Low, J. R. Daube, and A. J. Windebank. 1987. Autonomic abnormalities in amyotrophic lateral sclerosis. *Neurology* 37(Suppl 1):162.
17. Cohen, J., P. Low, R. Fealey, S. Sheps, and N. S. Jiang. 1987. Somatic and autonomic function in progressive autonomic failure and multiple system atrophy. *Annals of Neurology* 22:692–9.
18. Sandroni, P., J. E. Ahlskog, R. D. Fealey, and P. A. Low. 1991. Autonomic involvement in extrapyramidal and cerebellar disorders. *Clinical Autonomic Research* 1:147–55.
19. Braune, C., F. Erbguth, and F. Birklein. 2001. Dose thresholds and duration of the local anhidrotic effect of botulinum toxin injections: Measured by sudometry. *The British Journal of Dermatology* 144:111–17.
20. Low, P. A. 1993. Composite autonomic scoring scale for laboratory quantification of generalized autonomic failure. *Mayo Clinic Proceedings* 68:748–52.
21. Kennedy, W. R., and X. Navarro. 1993. Evaluation of sudomotor function by sweat imprint methods. In *Clinical autonomic disorders: Evaluation and management*, ed. P. A. Low, 253–61. Boston: Little, Brown and Company.
22. Sutarman, and Thomson M. L. 1952. A new technique for enumerating active sweat glands in man. *The Journal of Physiology* 117:51–2.
23. Sarkany, I., and P. Gaylarde. 1968. A method for demonstration of sweat gland activity. *The British Journal of Dermatology* 80:601–5.
24. Harris, D. R., B. F. Polk, and I. Willis. 1972. Evaluating sweat gland activity with imprint techniques. *The Journal of Investigative Dermatology* 58:78–84.
25. Kennedy, W. R., M. Sakuta, D. Sutherland, and F. C. Goetz. 1984. Quantitation of the sweating deficit in diabetes mellitus. *Annals of Neurology* 15:482–8.
26. Kennedy, W. R., and X. Navarro. 1989. Sympathetic sudomotor function in diabetic neuropathy. *Archives of Neurology* 46:1182–6.
27. Navarro, X., and W. R. Kennedy. 1989. Sweat gland reinnervation by sudomotor regeneration after different types of lesions and graft repairs. *Experimental Neurology* 104:229–34.

*This page intentionally left blank*

# Evaluation of Adrenergic Function

Phillip A. Low

## INTRODUCTION

### SKIN VASOMOTOR REFLEXES

Beat-to-Beat BP Response to  
the VM

Beat-to-Beat BP Response to Tilt-Up  
Venoarteriolar Reflex

Denervation Supersensitivity  
Plasma Norepinephrine  
Sustained Handgrip  
Baroreflex Indices

## SUMMARY

## INTRODUCTION

Standing up causes a transient decrease in pulse and blood pressure (BP). Baroreceptors in the carotid sinus and aortic arch are unloaded. The efferent portion of the baroreflex consists of a vagally mediated increase in heart rate and activation of sympathetic efferents, which increases total peripheral resistance. Preganglionic sympathetic fibers are cholinergic and postganglionic fibers are adrenergic. The preganglionic fiber is short and ends in a paravertebral ganglion. In comparison, the postganglionic fiber traverses the entire length of a peripheral nerve. Peripheral adrenergic function is important in the maintenance of postural normotension. It may be impaired in peripheral neuropathies and this may be manifested as alterations in acral temperature, color, or sweating. In spite of its importance, simple, accurate, and reproducible tests of peripheral adrenergic function are generally unavailable. This chapter describes methods used to determine peripheral adrenergic function and their value and

shortcomings. Microneurography is used occasionally to evaluate adrenergic function, but it is invasive and is not described here.

### *Purpose and Role of Adrenergic Function Testing*

- To test the post-ganglionic sympathetic nervous system.
- To assess for autonomic disorders that involve maintenance of blood pressure, heart rate, and sudomotor function.

## SKIN VASOMOTOR REFLEXES

The integrity of postganglionic sympathetic adrenergic fibers can be evaluated by testing skin vasoconstrictor reflexes.<sup>1</sup> Studies are performed usually on the toe or finger pads, because the sympathetic innervation in these sites is purely vasoconstrictor, whereas other sites, such as the forearm, have both vasoconstrictor and vasodilator fibers.<sup>2</sup>

Skin blood flow (SBF) is measured with a laser Doppler flowmeter or with plethysmography, and the vasoconstrictor response to an autonomic maneuver is determined. Vasoconstriction can be induced by maneuvers such as inspiratory gasp, response to standing (for the finger), contralateral cold stimulus, or the Valsalva maneuver (VM). The response can be expressed as a percentage of vasoconstriction.

The pathways of these reflexes are complex. For instance, the response to standing is mediated by the venoarteriolar reflex,<sup>3</sup> low-pressure and high-pressure baroreceptors,<sup>4,5</sup> and, to a lesser extent, by increased levels in norepinephrine,<sup>6</sup> rennin,<sup>7</sup> and vasopressin.<sup>8</sup> The advantage of these reflexes is that they have different afferents but an identical final efferent pathway. Thus, the relevant afferent pathway can be evaluated. However, this advantage is offset by a major shortcoming of tests of skin adrenergic function, that is, the marked sensitivity of skin sympathetic fibers to emotional and temperature changes,<sup>9</sup> which means there is considerable ambient fluctuation of SBF. Skin vasomotor reflexes have a coefficient of variation greater than 20% and are best regarded as semiquantitative tests. However, the tests are useful in comparing vasoconstrictor reflexes from identical sites simultaneously.

### Key Points

- Skin peripheral resistance is determined by skin vasomotor reflexes.
- Vasoconstriction can be induced by maneuvers such as inspiratory gasp, response to standing (for the finger), contralateral cold stimulus, or the Valsalva maneuver.
- The pathways are complex and methods of measurement are not very reproducible.

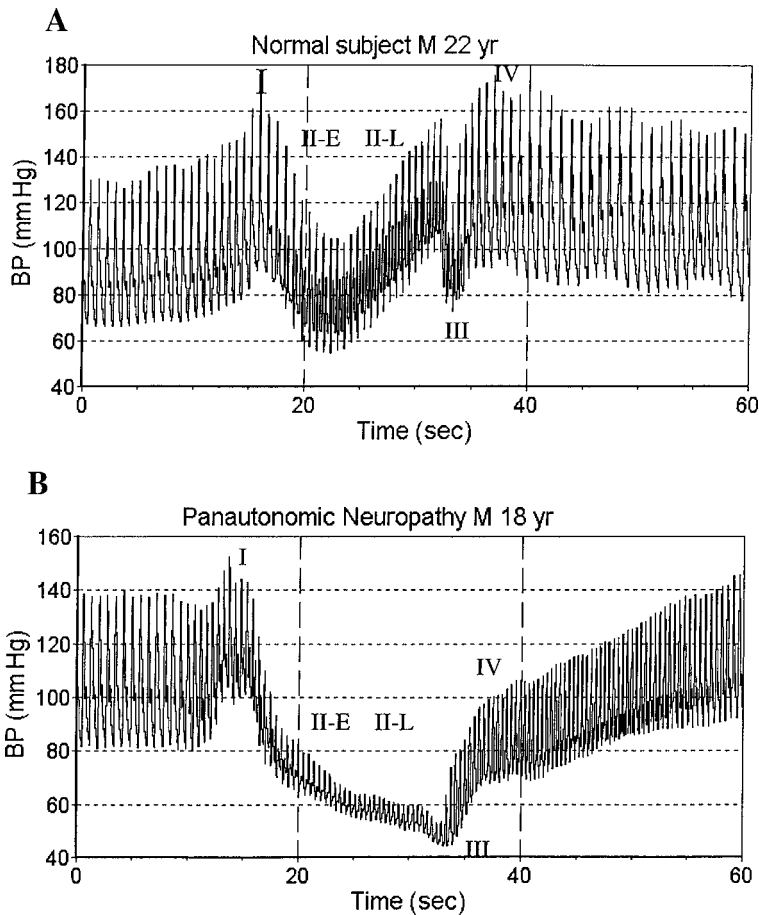
### Beat-to-Beat BP Response to the VM

The widely used tests to evaluate adrenergic function in an autonomic laboratory are beat-to-beat BP (and heart rate) responses to the VM and head-up tilt (HUT). Other tests include measurement of plasma levels of catecholamines, especially norepinephrine (supine and standing), the sustained hand-grip test, and the response to pharmacologic

agents.<sup>10</sup> These latter tests are generally insensitive (catecholamines), poorly reproducible in the clinical laboratory setting, or too invasive. The best validated tests are the BP and heart rate responses to HUT and beat-to-beat BP responses to the VM. These are the focus of this chapter.

Beat-to-beat BP responses to the VM and tilt are recorded simultaneously with the heart rate. Dynamic alterations during tilt and the VM are particularly important in detecting adrenergic failure. The VM has four main phases: I, II, III, and IV, with phase II subdivided into early (II-E) and late (II-L) phases (Fig. 37-1 and Table 37-1). The mechanisms of the VM are summarized briefly in Table 37-1.

The phases of the VM can be used to evaluate adrenergic function. This method of evaluating adrenergic function has been validated in two ways. First, pharmacologic dissection studies have demonstrated that phase II-L is primarily under peripheral  $\alpha$ -adrenergic control and is selectively blocked by phentolamine, whereas phase IV is completely blocked by propranolol, indicating that it depends on  $\beta$ -adrenoreceptors.<sup>11</sup> Second, the technique has also been validated by studies of controls and age-matched and sex-matched patient groups with graded adrenergic failure.<sup>12-14</sup> One group had generalized autonomic failure, with an orthostatic decrease in systolic BP during tilt of 30 mm Hg or greater. A second group had less orthostatic decrease in BP (less than 30 mm Hg but greater than 10 mm Hg), and a third group had well-documented peripheral autonomic failure (absence of response on the quantitative sudomotor axon reflex test) but did not have orthostatic hypotension. In contrast to controls, all the patient groups, including group 3, exhibited a significant reduction in phase II-L. An excessive decrease in BP in phase II and absence of a phase-IV overshoot were observed in the group with florid orthostatic hypotension. Intermediate changes were seen in the group with borderline orthostatic hypotension. The beat-to-beat BP changes during the VM, when coupled with BP responses to tilt, provide a significantly better evaluation of adrenergic failure than bedside recordings of BP. Patients with peripheral adrenergic failure, for example those with neuropathy involving autonomic C fibers, have an absence of phase II-L and a



**Figure 37-1.** Beat-to-beat BP responses to the VM in a control subject (A) and in a patient with panautonomic neuropathy (B). In the control subject reflex vasoconstriction, manifested as phases II-L and IV are well developed. In the patient with panautonomic neuropathy, pulse pressure is much reduced during the maneuver, phases II-L and IV are absent, and PRT is delayed.

**Table 37-1 Major Mechanisms of Phases of the VM**

Phase	Main Mechanism(s)
I & III	Compression (I) and release from compression (III) of thoracic aorta
II-E	↓ in venous return; partial compensation by vagus nerve
II-L	↑ in peripheral arteriolar tone
IV	↑ in cardiac sympathetic tone; sustained ↑ in arteriolar tone

E, early; L, late; ↑, increase; ↓, decrease.

slight increase in phase II-E. Patients with more severe and widespread autonomic failure, for example widespread involvement of limb and splanchnic adrenergic fibers, have a large phase II-E, an absence of phase II-L, and typically have delayed BP recovery time

(PRT)<sup>13,14</sup> and absent phase IV (Fig. 37-1). The gradations of alterations of the VM in different types and degrees of autonomic failure have been summarized on the basis of the experience in the Mayo Autonomic Laboratory (Table 37-2). The simplest approach is to

Table 37-2 Changes in Phases of VM with Types of Autonomic Failure

Condition	II-E	II-L	IV	Valsalva ratio
Normal	5–15 mm	To baseline	>baseline	Normal
Vagal lesion	<Normal	<Normal	Normal	<Normal
Adrenergic failure				
Peripheral	<Normal	↓ or absent; ↑ PRT	<Normal	<Normal
Generalized	↑ Fall	Absent; ↑ PRT	Absent	Reduced

↑, increase; ↓, decrease; PRT, BP recovery time.

measure PRT. A more complete evaluation related PRT to the antecedent fall in BP generating adrenergic sensitivity.<sup>14</sup> A normative database has been generated for these adrenergic indices.<sup>15</sup>

### Key Points

- Tests to evaluate adrenergic function in an autonomic laboratory are beat-to-beat BP (and heart rate) responses to the VM and HUT.
- In the clinical laboratory, an accurate and reproducible way to evaluate total peripheral resistance is to study beat-to-beat BP responses to the VM.
- The VM has four main phases: I, II, III, and IV, with phase II subdivided into early (II-E) and late (II-L) phases.
- The maneuver results in a transient fall in BP.
- The baroreflex response results in reflex vasoconstriction due to an increase in total peripheral resistance (late phase II).
- An excessive decrease in BP in phase II and absence of a phase-IV overshoot are observed in patients with florid orthostatic hypotension.
- The beat-to-beat BP changes during the VM, when coupled with BP responses to tilt, provide a significantly better evaluation of adrenergic failure than bedside recordings of BP.
- PRT increases with age. An increased PRT indicates an impairment of the adrenergic component of the baroreflex.

### Beat-to-Beat BP Response to Tilt-Up

Orthostatic BP recordings to tilt are recorded using beat-to-beat BP and verified with a

sphygmomanometer cuff with the patient supine and following tilt to 70°. It is important to perform the upright tilt procedure at a standard time after the patient lies down, because the orthostatic reduction in BP is greater after 20 minutes of preceding rest than after 1 minute; we routinely perform HUT after a minimum of 30 minutes of recumbency. Beat-to-beat recordings of systolic, mean, and diastolic BP are displayed continuously on the computer console, as is heart rate, which is derived from the electrocardiographic leads and monitor. Also, it is important to ensure that the arm is at heart level, because arm position influences the measurement of BP.

During upright tilt, normal subjects have a transient decrease in systolic, mean, and diastolic BP, followed by recovery within 1 minute.<sup>16</sup> The decrement is modest (less than 10 mm Hg, mean BP). Patients with adrenergic failure have a marked and progressive decrease in BP and pulse pressure. The heart rate response typically is attenuated, but in patients whose cardiac adrenergic innervation is spared, the response is intact and may be increased. Indices of mild adrenergic impairment include excessive oscillations of BP, an excessive decrease (more than 50%) in pulse pressure, a transient (first minute) decrease in systolic BP greater than 30 mm Hg, an excessive increment in heart rate ( $\geq 30$  beats/minute), and a failure of total systemic resistance to increase. Premonitory signs of syncope are a progressive decrease in BP (especially diastolic BP), total peripheral resistance, pulse pressure, and loss of BP (and heart rate) variability. Some of these indices are expected abnormalities in a failure of arteriolar vasoconstriction (total peripheral resistance and diastolic BP). Some are signs of increased vascular capacitance (reduction in pulse pressure and excessive increment in heart rate). Increased oscillations are indicative of intact



compensatory mechanisms (but are abnormal because they indicate a system under stress), whereas the gradual loss of variability indicates the failure of compensation.

A large autonomic database is available. The normal response varies by age and sex. To facilitate comparison, a 10-point composite autonomic severity score (CASS) of autonomic function has been developed.<sup>12</sup> The scheme allots 4 points for adrenergic and 3 points each for sudomotor and cardiovagal failure. Each score is normalized for the confounding effects of age and sex. Patients with a CASS score of 3 or less have only mild autonomic failure, those with scores of 7–10 have severe failure, and those with scores between these two ranges have moderate autonomic failure. The sensitivity and specificity of the method were assessed by evaluating CASS in four groups of patients with known degrees of autonomic failure: 18 patients with multisystem atrophy, 20 with autonomic neuropathy, 20 with Parkinson's disease, and 20 with peripheral neuropathy but no autonomic symptoms. The composite scores (mean  $\pm$  SD) for these four groups were  $8.5 \pm 1.3$ ,  $8.6 \pm 1.2$ ,  $1.5 \pm 1.1$ , and  $1.7 \pm 1.3$ , respectively. Patients with symptomatic autonomic failure had scores of 5 or more, and those without symptomatic autonomic failure had scores of 4 or less; no overlap existed among these groups.

### Key Points

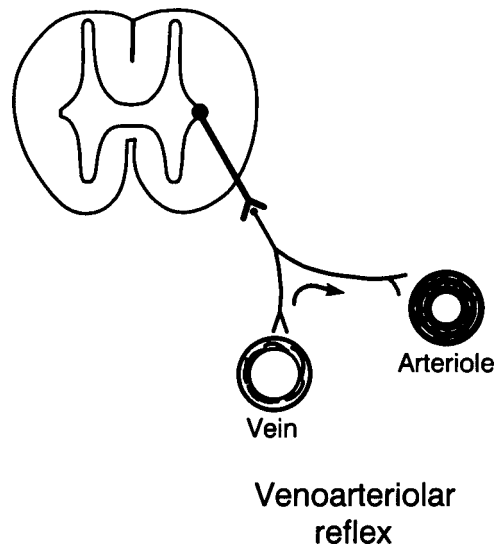
- Beat-to-beat BP recordings in response to HUT are a reliable method of studying baroreflex function.
- The normal response is affected by age and gender.
- It is important to perform the upright tilt procedure at a standard time after the patient lies down, because the orthostatic reduction in BP is greater after 20 minutes of preceding rest than after 1 minute.
- During upright tilt, normal subjects have a transient decrease in systolic, mean, and diastolic BP, followed by recovery within 1 minute.
- Patients with adrenergic failure have a marked and progressive decrease in BP and pulse pressure. The heart rate response typically is attenuated, but in

patients whose cardiac adrenergic innervation is spared, the response is intact and may be increased.

- Indices of mild adrenergic impairment include excessive oscillations of BP, an excessive decrease (more than 50%) in pulse pressure, a transient (first minute) decrease in systolic BP greater than 30 mm Hg, an excessive increment in heart rate ( $\geq 30$  beats/minute), and a failure of total systemic resistance to increase.

### Venoarteriolar Reflex

When venous transmural pressure is increased by 25 mm Hg (e.g., by lowering the limb by 40 cm), reflex arteriolar vasoconstriction occurs, reducing blood flow by 50%.<sup>3</sup> This reflex, called the *venoarteriolar reflex*, has receptors in small veins, and its neural pathway appears to be that of the sympathetic C fiber local axon reflex (Fig. 37–2).<sup>17</sup> The function of the reflex has been suggested to be to increase total peripheral resistance, compensating by up to 45% of the orthostatic decrease in cardiac



**Figure 37–2.** Neural pathway for the venoarteriolar reflex. The postganglionic axon comprises both the afferent and efferent limbs of the reflex. (From Moy, S., T. L. Opfer-Gehrking, C. J. Proper, and P. A. Low. 1989. The venoarteriolar reflex in diabetic and other neuropathies. *Neurology* 39:1490–2. By permission of the American Academy of Neurology.)

output.<sup>17,18</sup> It may also reduce the orthostatic increase in tissue fluid by adjusting the precapillary-to-postcapillary resistance ratio.

The venoarteriolar reflex was measured in the feet of patients with diabetes mellitus and was reported to be reduced in those with diabetic neuropathy.<sup>19</sup> The value of this test is its theoretical ability to examine the status of sympathetic vasoconstrictor fibers at the postganglionic level.

Moy et al.<sup>20</sup> studied the venoarteriolar reflex, quantitative sudomotor axon reflex test, and heart rate responses to deep breathing and the VM in 40 control subjects, 49 diabetic subjects, and 29 subjects with other neuropathies. The mean vasoconstrictor response was greater in the control group than the diabetic group or other neuropathy group, but the overlap among the groups was marked. The venoarteriolar reflex appeared to have lower specificity and much lower sensitivity than other tests of autonomic function. The sensitivity and specificity were considered inadequate for it to be used as a clinical test of autonomic function.

### Key Points

- The venoarteriolar reflex is an axon reflex that has receptors in small veins, and its neural pathway appears to be that of the sympathetic C fiber local axon reflex.
- The pathway is the afferent and efferent components of a postganglionic axon.
- The normal response is an increase in total peripheral resistance.
- The function of the reflex has been suggested to be to increase total peripheral resistance.
- The venoarteriolar reflex appeared to have lower specificity and much lower sensitivity than other tests of autonomic function.

## Denervation Supersensitivity

An exaggerated pressor response to the intra-arterial or intravenous application of directly acting  $\alpha$ -agonists (such as phenylephrine or norepinephrine), indicating denervation supersensitivity, may occur when there is widespread denervation of postganglionic sympathetic fibers.<sup>21–23</sup> The mechanism of denervation

supersensitivity is an increase in receptor density, affinity, efficacy of receptor–effector coupling, or other postreceptor events. These tests of adrenergic denervation supersensitivity are too invasive for routine use and are insensitive.

It would be preferable to measure acral adrenergically mediated vasoconstriction in response to the above-mentioned infusion. However, recordings of vasoconstriction of the muscle bed are indirect. Plethysmography can be performed, but recorded flow is contaminated by SBF.

### Key Points

- Denervation supersensitivity is an exaggerated BP rise in response to a drug that acts on postganglionic adrenergic receptors.
- It is due to an increase in density of these receptors that occurs secondary to postganglionic denervation.

## Plasma Norepinephrine

Plasma norepinephrine results from a spillover of norepinephrine from adrenergic postganglionic nerve terminals. The supine value is an index of net sympathetic activity<sup>24–26</sup> and is affected by the rate of norepinephrine secretion and clearance.<sup>27</sup> Plasma norepinephrine has been used to differentiate postganglionic from preganglionic failure. In a disorder in which the lesion is preganglionic, resting supine norepinephrine values are normal, but the response to standing is absent because of failure of activation. In a postganglionic lesion, the supine norepinephrine plasma values are decreased if the lesion is widespread. The disadvantage of the method is its low sensitivity, largely because 80% of released norepinephrine is taken up again by the neuron and only 20% enters venous blood. One method of enhancing clinical utility is to measure the intraneuronal metabolite dihydroxyphenylglycol (DHPG).

### Key Points

- Plasma norepinephrine measures the neurotransmitter that binds to postganglionic adrenergic receptors and increases BP.

- Plasma norepinephrine has been used to differentiate postganglionic from preganglionic failure.
- Its main limitation is that it is lacking in sensitivity.

## Sustained Handgrip

Sustained muscle contraction causes an increase in systolic and diastolic BP and heart rate. The stimulus derives from exercising muscle, the reaction is reflexive in nature, and the increase in BP is mediated by an increase in cardiac output and peripheral resistance.<sup>25</sup> The test has been adapted as a simple test of sympathetic autonomic failure.<sup>29</sup> Ewing et al.<sup>29</sup> recommend 30% maximal contraction for up to 5 minutes. Many patients have difficulty sustaining the test for 5 minutes, but 3 minutes is sufficient. The test evaluates generalized rather than peripheral adrenergic function.

### Key Points

- Sustained handgrip results in a rise in BP due to an increase in cardiac output and peripheral resistance.
- It is lacking in sensitivity and is difficult to do and standardize.

## Baroreflex Indices

Baroreflex indices evaluate the heart period (reciprocal of heart rate) responses to induced increases and decreases in BP. Phenylephrine or norepinephrine can be used to increase BP, and tilt or trinitroglycerin can be used to decrease it. One approach, adapted from the method of Korner, is to determine the range and mean gain of the heart period.<sup>21</sup> These two indices express the range of heart period in response to a moderate pressor-hypotensive stress, and the mean rate of change in heart period in response to sudden changes in BP.<sup>21</sup> Another related approach, described by Pickering et al.,<sup>30</sup> relates beat-to-beat systolic BP to heart rate. An alternative approach to stimulating baroreceptors is to use a neck chamber whose pressure can be increased or decreased.<sup>31</sup> Finally, the heart period responses to the decrease and increase in BP during the VM can be related

to changes in BP. Baroreflex gain to an increase or decrease in BP primarily evaluates the vagal responses to changes in BP. Recently, there has been considerable interest in baroreflex gain in response to spontaneous or induced changes in BP. Commonly used maneuvers include spectral analysis, the VM, and the sequence method.<sup>32</sup>

All these methods evaluate the vagal component of the baroreflex and an efficient approach is to relate the fall in BP during phase II-E to the resultant heart period. However, the adrenergic component can be selectively involved, as in certain neuropathies. Recently, we have described methodology to quantitate the adrenergic component of baroreflex sensitivity.<sup>13,14</sup> The adrenergic component of the baroreflex is reflected in phase II-L and its continuation, the PRT,<sup>13</sup> which provides a reproducible index of adrenergic baroreflex sensitivity. A more complete index can be derived by relating PRT to the preceding fall in BP.<sup>14</sup>

### Key Points

- Baroreflex indices evaluate the heart period (reciprocal of heart rate) responses to induced increases and decreases in BP.
- The baroreflex maintains a stable BP in spite of changes in position.
- There is a vagal component that changes heart rate and an adrenergic component that changes total peripheral resistance.
- The vagal component is evaluated by quantitating the change in heart period in response to a fall in BP.
- The adrenergic component can be evaluated by measuring PRT or, more completely, by dividing the antecedent fall in BP by PRT.

## SUMMARY

For noninvasive evaluation of autonomic function, tests of peripheral adrenergic function have recently been developed so that it is possible to separately evaluate the vagal and adrenergic components of baroreflex sensitivity. The vagal component is derived from the heart period response to BP change and the adrenergic component by the PRT in response to the preceding fall in BP, induced by the VM.

## REFERENCES

1. Low, P. A., C. Neumann, P. J. Dyck, R. D. Fealey, and R. R. Tuck. 1983. Evaluation of skin vasomotor reflexes by using laser Doppler velocimetry. *Mayo Clinic Proceedings* 58:583-92.
2. Roddie, I. C., J. T. Shepherd, and R. F. Whelan. 1957. A comparison of the heat elimination from the normal and nerve-blocked finger during body heating. *The Journal of Physiology (London)* 138:445-8.
3. Henriksen, O. 1991. Sympathetic reflex control of blood flow in human peripheral tissues. *Acta Physiologica Scandinavica* 603(Suppl):33-9.
4. Sundlof, G., and B. G. Wallin. 1978. Human muscle nerve sympathetic activity at rest. Relationship to blood pressure and age. *The Journal of Physiology* 274:621-37.
5. Zoller, R. P., A. L. Mark, F. M. Abboud, P. G. Schmid, and D. D. Heistad. 1972. The role of low pressure baroreceptors in reflex vasoconstrictor responses in man. *The Journal of Clinical Investigation* 51:2967-72.
6. Vendsalu, A. 1960. Studies on adrenaline and noradrenaline in human plasma. *Acta Physiologica Scandinavica* 49(Suppl 173):1-123.
7. Oparil, S., C. Vassaux, C. A. Sanders, and E. Haber. 1970. Role of renin in acute postural homeostasis. *Circulation* 41:89-95.
8. Williams, T. D., D. Da Costa, C. J. Mathias, R. Bannister, and S. L. Lightman. 1986. Pressor effect of arginine vasopressin in progressive autonomic failure. *Clinical Science* 71:173-8.
9. Burton, A. C., and R. M. Taylor. 1940. Study of adjustment of peripheral vascular tone to requirements of regulation of body temperature. *The American Journal of Physiology* 129:565-77.
10. Low, P. A. 1997. Laboratory evaluation of autonomic function. In *Clinical autonomic disorders: Evaluation and management*, ed. P. A. Low, 179-208. Philadelphia: Lippincott-Raven.
11. Sandroni, P., E. E. Benarroch, and P. A. Low. 1991. Pharmacological dissection of components of the Valsalva maneuver in adrenergic failure. *Journal of Applied Physiology* 71:1563-7.
12. Low, P. A. 1993. Composite autonomic scoring scale for laboratory quantification of generalized autonomic failure. *Mayo Clinic Proceedings* 68:748-52.
13. Vogel, E. R., P. Sandroni, and P. A. Low. 2005. Blood pressure recovery from Valsalva maneuver in patients with autonomic failure. *Neurology* 65:1533-7.
14. Schrenzenmaier, C., W. Singer, N. M. Swift, D. Sletten, J. Tanabe, and P. A. Low. 2007. Adrenergic and vagal baroreflex sensitivity in autonomic failure. *Archives of Neurology* 64:381-6.
15. Huang, C. C., P. Sandroni, D. M. Sletten, S. D. Weigand, and P. A. Low. 2007. Effect of age on adrenergic and vagal baroreflex sensitivity in normal subjects. *Muscle & Nerve* 36(5):637-42.
16. Low, P. A., J. C. Denq, T. L. Opfer-Gehrking, P. J. Dyck, P. C. O'Brien, and J. M. Slezak. 1997. Effect of age and gender on sudomotor and cardiovagal function and blood pressure response to tilt in normal subjects. *Muscle & Nerve* 20:1561-8.
17. Henriksen, O. 1977. Local sympathetic reflex mechanism in regulation of blood flow in human subcutaneous adipose tissue. *Acta Physiologica Scandinavica* 450(Suppl):1-48.
18. Henriksen, O., K. Skagen, O. Haxholdt, and V. Dyrberg. 1983. Contribution of local blood flow regulation mechanisms to the maintenance of arterial pressure in upright position during epidural blockade. *Acta Physiologica Scandinavica* 118:271-80.
19. Rayman, G., S. A. Williams, P. D. Spencer, L. H. Smaje, P. H. Wise, and J. E. Tooke. 1986. Impaired microvascular hyperaemic response to minor skin trauma in type I diabetes. *British Medical Journal (Clinical Research Edition)* 292:1295-8.
20. Moy, S., T. L. Opfer-Gehrking, C. J. Proper, and P. A. Low. 1989. The venoarteriolar reflex in diabetic and other neuropathies. *Neurology* 39:1490-2.
21. Low, P. A., J. C. Walsh, C. Y. Huang, and J. G. McLeod. 1975. The sympathetic nervous system in diabetic neuropathy. A clinical and pathological study. *Brain* 98:341-56.
22. Moorhouse, J. A., S. A. Carter, and J. Doupe. 1966. Vascular responses in diabetic peripheral neuropathy. *British Medical Journal* 1:883-8.
23. Smith, A. A., and J. Dancis. 1964. Exaggerated response to infused norepinephrine in familial dysautonomia. *The New England Journal of Medicine* 270:704-7.
24. Polinsky, R. J., I. J. Kopin, M. H. Ebert, and V. Weise. 1981. Pharmacologic distinction of different orthostatic hypotension syndromes. *Neurology* 31:1-7.
25. Wallin, B. G., G. Sundlof, B. M. Eriksson, P. Dominiak, H. Grobecker, and L. E. Lindblad. 1981. Plasma noradrenaline correlates to sympathetic muscle nerve activity in normotensive man. *Acta Physiologica Scandinavica* 111:69-73.
26. Ziegler, M. Q., C. R. Lake, and I. J. Kopin. 1977. The sympathetic nervous system defect in primary orthostatic hypotension. *The New England Journal of Medicine* 296:293-7.
27. Polinsky, R. J., D. S. Goldstein, R. T. Brown, H. R. Keiser, and I. J. Kopin. 1985. Decreased sympathetic neuronal uptake in idiopathic orthostatic hypotension. *Annals of Neurology* 18:48-53.
28. Coote, J. H., S. M. Hilton, and J. F. Perez-Gonzalez. 1971. The reflex nature of the pressor response to muscular exercise. *The Journal of Physiology* 215:789-804.
29. Ewing, D. J., J. B. Irving, F. Kerr, J. A. W. Wildsmith, and B. F. Clarke. 1974. Cardiovascular responses to sustained handgrip in normal subjects and in patients with diabetes mellitus: A test of autonomic function. *Clinical Science and Molecular Medicine* 46:295-306.
30. Pickering, T. G., B. Gribbin, E. S. Petersen, D. J. Cunningham, and P. Sleight. 1972. Effects of autonomic blockade on the baroreflex in man at rest and during exercise. *Circulation Research* 30:177-85.
31. Eckberg, D. L., M. S. Cavanaugh, A. L. Mark, and F. M. Abboud. 1975. A simplified neck suction device for activation of carotid baroreceptors. *The Journal of Laboratory and Clinical Medicine* 85:167-73.
32. Dawson, S. L., T. G. Robinson, J. H. Youde, et al. 1997. The reproducibility of cardiac baroreceptor activity assessed non-invasively by spectral sequence techniques. *Clinical Autonomic Research* 7:279-84.

# Thermoregulatory Sweat Test

Robert D. Fealey

### INTRODUCTION ROLE OF THERMOREGULATORY SWEAT TESTING: CLINICAL SYNDROMES AND PROBLEMS EVALUATED

Small Fiber Neuropathy  
Diabetic Peripheral Neuropathies  
Severity of Autonomic Failure  
Central Disorders  
Hyperhidrotic Disorders

### METHOD THERMOREGULATORY SWEAT DISTRIBUTION REPORTING RESULTS DIFFICULTIES AND PITFALLS IN INTERPRETATION SUMMARY APPENDIX: SWEAT TEST PROCEDURE

## INTRODUCTION

From a physiologic viewpoint, the thermoregulatory sweat test (TST) consists of giving a controlled heat stimulus to the body in a tolerable fashion to produce a generalized sweat response (i.e., recruiting all areas of skin capable of sweating). The TST assesses the integrity of efferent (central and peripheral) sympathetic sudomotor pathways. Central (preganglionic) structures tested include the hypothalamus, bulbospinal projections, intermediolateral cell column in the thoracic and upper lumbar spinal cord, and white rami. Peripheral (postganglionic) autonomic structures tested include the sympathetic chain ganglia and postganglionic sudomotor axons,

the M3 muscarinic cholinergic synapse, and the sweat glands. Because the entire anterior body surface is tested for both preganglionic and postganglionic lesions, the TST is well suited for screening patients with certain clinical symptoms or for demonstrating autonomic involvement in many disorders.<sup>1</sup>

### *Purpose and Role of TST*

- To assess the integrity of efferent sympathetic sudomotor pathways.
- To screen patients for small fiber peripheral neuropathy.
- To assess for autonomic involvement in patients with many neurological and medical disorders.

## ROLE OF THERMOREGULATORY SWEAT TESTING: CLINICAL SYNDROMES AND PROBLEMS EVALUATED

A comprehensive listing of clinical syndromes that can be evaluated with TST is given in Table 38–1.<sup>2</sup> Some common neurologic applications of the TST evaluation are described in the following sections.

## Small Fiber Neuropathy

Peripheral neuropathies affecting smaller diameter nerve fibers often cause the “burning feet” syndrome. Nerve conduction studies and electromyography and clinical neurologic exam are often normal in these patients, whereas tests of skin autonomic innervation are usually abnormal. The TST has been investigated in this syndrome and found to show impaired sweating of the distal limbs in 72%–74% of patients

Table 38–1 Diseases Evaluated with TST

---

<b>I. Generalized Autonomic Failure Syndromes</b>	
	Pure autonomic failure (PAF)
	Progressive autonomic failure as part of multiple system atrophy (MSA)
<b>II. Primary disorders with isolated acquired idiopathic anhidrosis</b>	
	Progressive isolated segmental anhidrosis
	Idiopathic pure sudomotor failure
	Chronic idiopathic anhidrosis
	Ross syndrome
<b>III. Primary autonomic neuropathies</b>	
	Panautonomic (acute pandysautonomia) neuropathy
	Autoimmune autonomic neuropathy (or ganglionopathy)
	Postural tachycardia syndrome (POTS) (some cases)
<b>IV. Anhidrosis associated with other neurologic disorders</b>	
	Central nervous system lesions (stroke, tumor, infection, infiltration, trauma)
	Hypothalamic lesions (heat stroke)
	Brain stem lesions (pontine and lateral medullary stroke)
	Spinal cord lesions (Traumatic spinal cord injury [SCI], multiple sclerosis)
	Cold-induced sweating syndrome
	Degenerative disorders
	Diffuse lewy-body disease, Parkinson's disease—autonomic failure
	Peripheral nerve lesions causing anhidrosis
	Hereditary sensory and autonomic neuropathy types I, II, IV
	Guillain–Barré syndrome (acute inflammatory demyelinating polyneuropathy [AIDP])
	Diabetic autonomic neuropathy
	Hereditary and primary systemic amyloidosis
	Lepromatous neuropathy
	Myasthenic syndrome
	Alcoholic neuropathy
	Fabry's disease
	Idiopathic small fiber neuropathy
	Erythromelalgia
	Sympathectomy and other surgical lesions
	Harlequin syndrome
	Postural tachycardia syndrome
	Anhidrosis due to toxins and pharmacologic agents
	Botulism, botulinum toxin injections
	Ganglionic blockers, anticholinergics, carbonic anhydrase inhibitors
	Opioids

---

(Continued)



Table 38–1 (Continued)

---

**III. Anhidrosis associated with disorders of skin and sweat glands**

Anhidrosis due to physical agents damaging skin  
Trauma, burns, pressure, scar formation, radiation therapy  
Anhidrosis due to congenital and acquired skin diseases  
Fabry and other congenital metabolic diseases  
Anhidrotic ectodermal dysplasia  
Ichthyosis  
Neutrophilic eccrine hidradenitis  
Sjogren's syndrome  
Systemic sclerosis (scleroderma)  
Incontinentia pigmenti  
Dermatomal vitiligo  
Bazex–Dupre–Christol syndrome  
Disorders affecting the sweat duct  
Miliaria  
Palmoplantar pustulosis  
Psoriasis  
Lichen planus  
Atopic dermatitis

**IV. Primary (essential) focal hyperhidrosis**

Palmoplantar, axillary, craniofacial, generalized hyperhidrosis

**V. Secondary causes of localized hyperhidrosis**

Due to cerebral infarction  
Frontal opercular infarct  
Brain stem stroke  
Associated with SCI  
Autonomic dysreflexia  
Posttraumatic Syringomyelia  
Orthostatic hypotension triggered  
Associated with other central nervous system disorders  
Arnold–Chiari type 1 malformation  
Myelopathies due to infarction, syringomyelia, tumor  
Cold-induced sweating syndrome  
Olfactory hyperhidrosis  
Associated with peripheral nervous system disorders  
Peripheral motor neuropathy with autonomic dysfunction  
Dermatomal or focal hyperhidrosis due to nerve trunk irritation  
Compensatory segmental hyperhidrosis (postsympathectomy, Ross syndrome, pure autonomic failure)  
Gustatory sweating  
Physiologic  
Idiopathic  
Postherpetic  
Post nerve injury (post surgical, diabetic autonomic neuropathy, post infectious, tumor invasion)  
Lacrimal sweating  
Harlequin syndrome  
Idiopathic, localized hyperhidrosis  
Idiopathic unilateral circumscribed hyperhidrosis  
Postmenopausal localized hyperhidrosis  
Associated with local skin disorders  
Blue rubber bleb nevi  
Glomus tumor  
Burning feet syndrome  
Granulosis rubra nasi

---

(Continued)

Table 38–1 (Continued)

---

Pretibial myxedema
POEMS syndrome
<b>VI. Secondary causes of generalized hyperhidrosis</b>
Associated with central nervous system disorders
Episodic hypothermia with hyperhidrosis (Hines–Bannick or Shapiro’s syndrome)
Posttraumatic or posthemorrhagic “diencephalic epilepsy”
Fatal familial insomnia and Parkinson’s disease
Associated with fever and chronic infection
Tuberculosis, malaria, brucellosis, endocarditis
Associated with metabolic and systemic medical diseases
Hyperthyroidism, diabetes mellitus, hypoglycemia, hypercortisolism, acromegaly
Associated with malignancy
Leukemia, lymphoma, pheochromocytoma, Castleman’s disease, carcinoids, renal cell cancer
Medication induced
Neuroleptic malignant syndrome
Serotonin syndrome, other medications
Toxic syndromes
Alcohol, opioid withdrawal, delirium tremens
Associated with central and peripheral nervous system disorders
Familial dysautonomia (Riley–Day), Morvan’s fibrillary chorea

---

SCI, spinal cord injury.

clinically diagnosed.<sup>3,4</sup> The value of the TST in characterizing the distribution of neuropathy has been emphasized in a published algorithm on the evaluation of peripheral neuropathy.<sup>5</sup> Patients can be serially evaluated via TST to document progression or recovery (Fig. 38–1, for color image, see color plates). We have recently shown that neurogenic forms of erythromelalgia have characteristic TST abnormalities in most instances.<sup>6</sup>

### Key Points

- TST identifies abnormality of small fiber function when nerve conduction studies and electromyography are normal.
- TST can be used to follow small fiber nerve involvement over time.

## Diabetic Peripheral Neuropathies

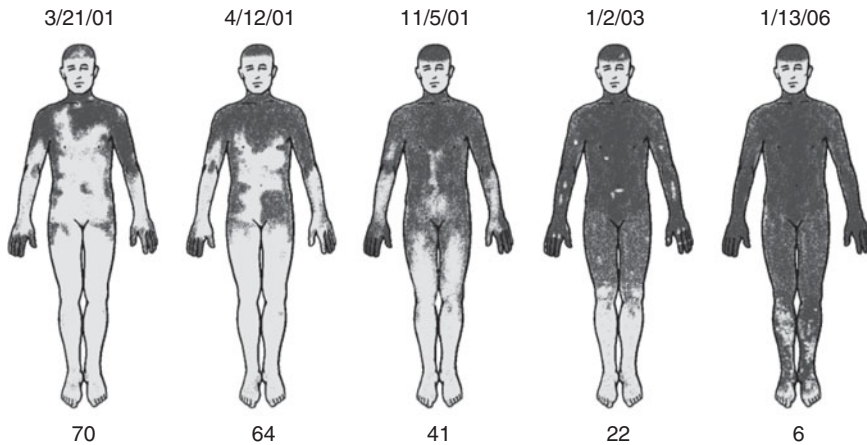
Diabetes mellitus produces distinct peripheral neurologic disorders including length-dependent axonal neuropathy, painful truncal radiculopathy, and segmental and diffuse autonomic neuropathy.<sup>7,8</sup> The ability to examine the whole anterior body surface in detail and the common involvement of sudomotor axons in diabetes makes the TST particularly well suited to the evaluation of this disorder. Most of the abnormal TST distributions described in

the section on Abnormal TST Distributions are from patients with diabetic neuropathy.

Peripheral neuropathy first produces distal sweat loss in the lower extremities and as the neuropathy advances the fingertips and the lower anterior abdomen become affected. Painful truncal radiculopathy has a distinct clinical presentation of agonizing, and at times, lancinating pain associated with cutaneous dyesthesia and a characteristic TST pattern of patchy, asymmetric anhidrosis primarily in the anterior distribution of one or several adjacent thoracic dermatomes in the distribution of the pain. Patterns relating to sympathetic chain or ganglionic involvement produce an “autosympathectomy.” Uncommonly, severe diabetic autonomic neuropathy produces global anhidrosis. The percentage of body surface anhidrosis (TST%) correlates highly with the degree of autonomic neuropathy symptoms and signs.<sup>9</sup> Other neuropathies (primary systemic amyloid,<sup>10</sup> subacute autonomic,<sup>11,12</sup> paraneoplastic, and leprosy<sup>2</sup>) with widespread, multifocal involvement are best evaluated via the TST.

### Key Points

- Proximal, distal, truncal, radiculoplexus, and autonomic ganglionic types of involvement can be evaluated with TST.



**Figure 38-1.** Recovering small fiber neuropathy. Serial TSTs in a patient with small fiber neuropathy. Extensive anhidrosis (yellow) correlated with impaired temperature perception, the latter is the only abnormality on neurological exam. Patient underwent intravenous immunoglobulin (IVIg) therapy between 3/21/01 and 11/5/01 and began to improve. Subsequent TSTs document near complete recovery of sudomotor function in a length-dependent fashion. The percentage of anhidrosis of the anterior body surface (TST%) appears below each figure providing a quantitative measure of the improvement (sweating in purple-shaded regions).

## Severity of Autonomic Failure

The TST is helpful in identifying autonomic involvement in many neurologic disorders. An important use involves the evaluation of patients presenting with an extrapyramidal syndrome. The differential diagnosis often involves separating multiple system atrophy (MSA) with its severe autonomic failure, widespread anhidrosis, and poor prognosis from Parkinson's disease with mild or no autonomic involvement on TST<sup>13-15</sup> and better prognosis and response to treatment. Often the patient with early MSA will exhibit a preganglionic, segmental sweat deficit compatible with a central lesion affecting the intermediolateral cell columns of the spinal cord.<sup>1,16</sup> Syndromes with selective sympathetic sudomotor failure include chronic idiopathic anhidrosis<sup>1,17-19</sup> and Ross syndrome,<sup>20-22</sup> which are other clinical disorders where TST can provide diagnostic information.

### Key Points

- Both Parkinson's disease with autonomic failure and MSA have highly characteristic and prevalent abnormalities on TST.
- TST is routinely used to distinguish MSA from Parkinson's disease.

- Restricted sudomotor failure syndromes like chronic idiopathic anhidrosis and Ross syndrome are ideally evaluated via TST.

## Central Disorders

Central disorders such as traumatic and inflammatory myelopathy<sup>23,44</sup> cause preganglionic TST abnormalities often showing the level of spinal cord involvement in great detail (Fig. 38-2, for color image, see color plates). The TST is often coupled with a test of postganglionic function to confirm the central involvement.

### Key Points

- Traumatic and inflammatory myelopathies, hypothalamic neuroendocrine disorders, and disorders of thermoregulation (heat stroke, Shapiro syndrome may show abnormalities on TST).

## Hyperhidrotic Disorders

Focal hyperhidrosis syndromes are routinely evaluated via TST. Many times the area of excessive sweating is unilateral and occurs in compensation to widespread loss of sweating elsewhere (e.g., in pure autonomic failure [PAF] or Ross syndrome). When excessive



**Figure 38-2.** Traumatic myelopathy. A patient with segmental anhidrosis (*yellow*) with compensatory left-sided hemihyperhidrosis (*purple*) due to a right greater than left-sided upper thoracic spinal cord injury (alizarin red indicator powder). (From Fealey, R. D., and K. Sato. 2008. Disorders of the eccrine sweat glands and sweating. In Fitzpatrick's *Dermatology in general medicine*, ed. K. Wolff, L. A. Goldsmith, S. I. Katz, B. A. Gilchrest, A. S. Paller, and D. J. Leffell, Vol. 1, 7th ed., 720-30. New York City, NY: McGraw-Hill Companies, Figure 82-2.)

sweating is confined to the palmar and plantar areas and there is normal thermoregulatory sweating elsewhere, the TST provides confirmation of a diagnosis of primary focal (essential) hyperhidrosis. More recently, we have used TST to delineate the effects of sympathectomy, a less invasive, endoscopic technique to treat hyperhidrosis of the hands<sup>24</sup> and to evaluate any patients having compensatory hyperhidrosis after such procedures.

### Key Points

- Primary focal hyperhidrosis, postsympathectomy, and perilesional compensatory hyperhidrosis are best evaluated via TST.

## METHOD

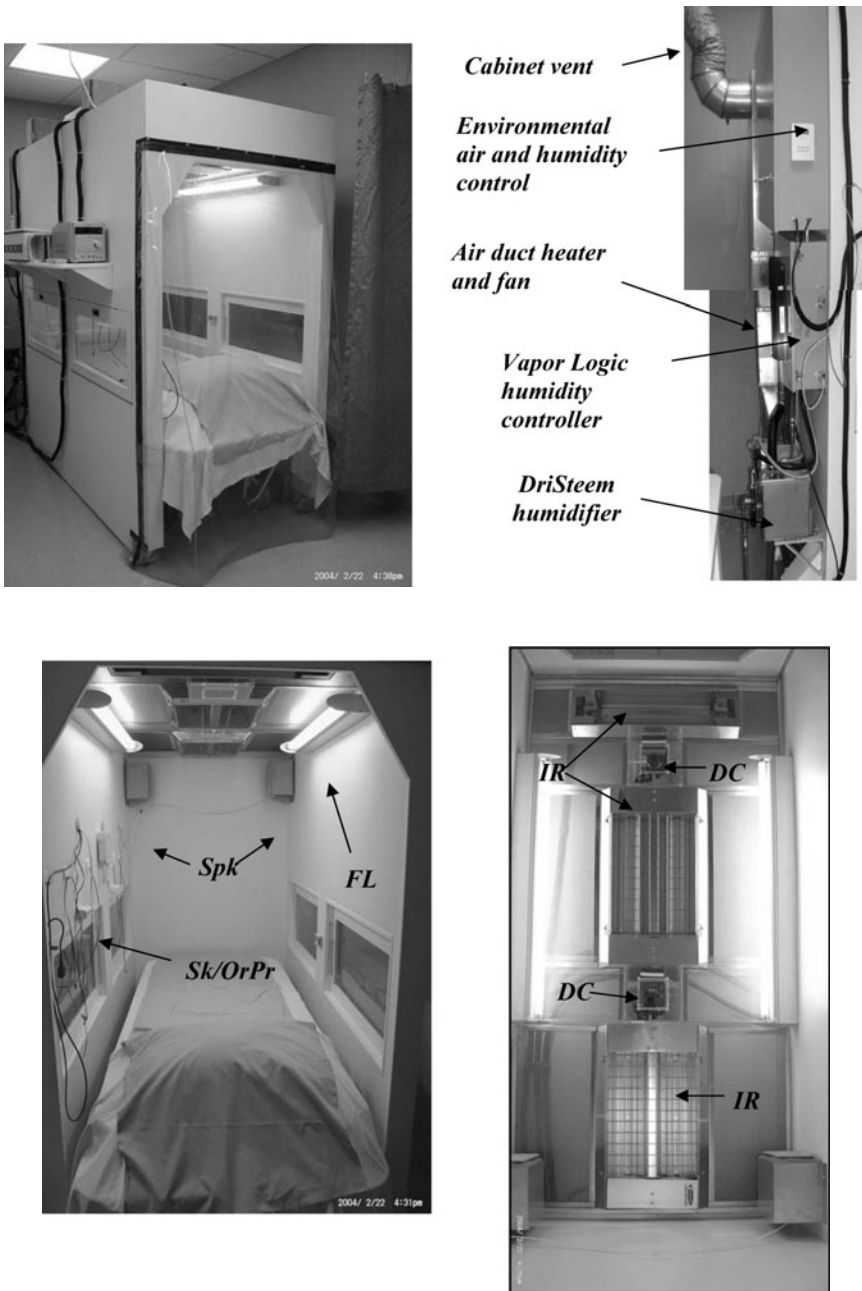
Thermoregulatory sweating is influenced by the mean and local skin temperature as well as by the central (blood/core) temperature.<sup>25</sup> A maximal sweat response occurs when both central (oral) and mean skin temperatures are increased in a moderately humid (about 35% relative humidity) environment in which some degree of sweat evaporation can occur.<sup>1,25-27</sup>

Therefore, proper technique includes controlling the ambient air temperature and humidity as well as the patient's core and skin temperature.

Several techniques, including hot baths and infrared (IR) and incandescent heat lamps, have been used for the last 50 years to produce sweating, but the most satisfactory method is to use a cabinet in which the environment is controlled and the entire body (including the head) is heated. Guttman<sup>28</sup> described such a cabinet and demonstrated the usefulness of the TST in the diagnosis and monitoring of spinal cord and peripheral nerve lesions. The TST conducted in the Mayo Clinic Thermoregulatory Laboratory is a modification of Guttman's quinizarin sweat test<sup>1</sup> and is described below.

The patient, clad only in a towel(s) to maintain modesty, is placed in a supine position on a gurney and enclosed in the cabinet (Fig. 38-3A).

The "head end" of the cabinet is a clear vinyl curtain (tented over the gurney); this arrangement allows the head to be in the heated environment yet provides the patient a clear view of the technician and outside world to minimize claustrophobia. Windowed access doors allow access and patient visibility. The rear end of the



**Figure 38-3.** Top two images: Mayo Thermoregulatory Sweat Cabinet (outside front view on *left*, rear view on *right*). Bottom two images: Inside view of Mayo Thermoregulatory Sweat Cabinet (ceiling shown on *right*). IR, infrared heaters; DC, digital camera; Sk/OrPr, skin and oral temperature probes; FL, fluorescent light; Spk, speakers.

cabinet contains the electrical and plumbing components that regulate the environmental temperature, humidity, and slow airflow rate.

Suitable parameters for achieving a generalized, maximal sweat response within 60 minutes include an ambient temperature

of 45°C–50°C and a relative humidity of 35%–40% while maintaining skin temperature between 39°C and 40°C. Components providing accurate measurement and control of skin temperature are contained in the control box.

Recently, a study using a similar magnitude of air and skin temperature and humidity and exposure duration has clearly shown that this thermal stress produces maximal thermoregulatory sweating.<sup>24,29</sup> Achieving maximal sweating is of great importance in evaluating sympathetic sudomotor function and in test reliability and reproducibility.

The major inside components of the TST cabinet are shown below in Fig. 38–3B. Within the insulated walls are three overhead IR heaters that heat the skin and are carefully regulated by skin temperature feedback control. The wide gurney, music played over rear-mounted speakers (Spk), and bright fluorescent lighting provide comfort for the patients as they rest supine with palms down. Ceiling-mounted, remotely operated digital cameras (DC) photograph the developing sweat distribution during the test and provide real-time patient monitoring.

Thermistor probes (skin and oral temperature probes [Sk/OrPr]) continuously measure skin and oral temperatures during the test. Sweating on the skin surface is best visualized by an indicator powder that is applied to the body before heating. A mixture of alizarin red, cornstarch, and sodium carbonate in a 50:100:50 gram ratio, respectively, is suitable.<sup>23</sup> It is light orange on nonsweating

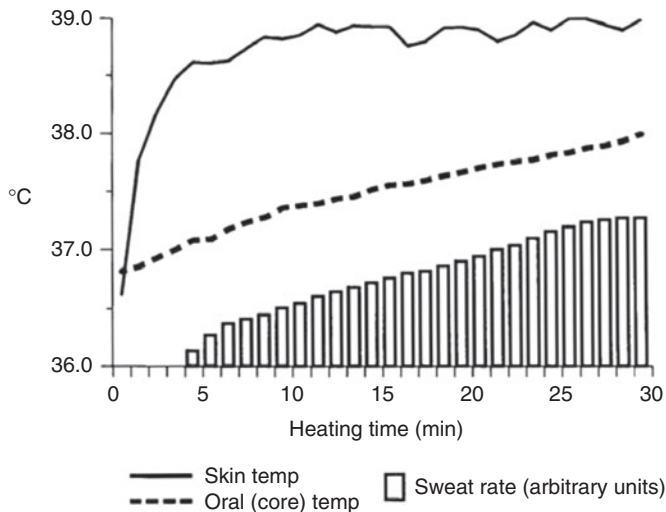
skin and turns dark purple on sweating skin. Other indicators currently used include iodinated cornstarch<sup>30</sup> and starch and iodine in solution.<sup>31</sup>

The average response of the oral temperature in 35 healthy control subjects (20–75 years old) who achieved full-body, maximal sweating during the TST was an increase of 1.2°C in 35–40 minutes (Fig. 38–4). Because all subjects had sweat profusely at an oral temperature of less than or equal to 38°C, we use this temperature as a test end point.

During 2006, the mean oral temperature increase in 1412 patients was 1.5°C, with 38°C or a 1°C increase above baseline (whichever yielded the higher temperature) as an end point. These observations indicate that the often-quoted 1°C temperature increase criterion for an adequate TST<sup>32</sup> is inadequate in patients with lower (i.e., <37°C) initial temperatures.

If generalized sweating occurs at a lower body temperature, the test can be ended before 38°C is reached.

For reasons of patient comfort and safety, we do not increase oral temperature above 38.5°C or extend the heating period beyond 65 minutes. The current procedure followed by the TST lab technician is specified in the appendix.



**Figure 38–4.** Mean skin and oral temperatures and sweat rates of 35 healthy controls during the TST. By 38°C oral temperature, all had reached a maximum sweat rate. (From Fealey, R. D. 1997. Thermoregulatory sweat test. In *Clinical autonomic disorders: Evaluation and management*, ed. P. A. Low, 2nd ed., 245–57. Philadelphia: Lippincott-Raven, Figure 2.)



### Key Points

- An enclosure (TST cabinet) with a regulated temperature and humidity is most suitable. The entire body is placed in the heated cabinet. The cabinet must accommodate a standard hospital gurney and have visibility for patient and technician communication.
- Computer-controlled heating of the skin surface via overhead IR heaters maximizes sweating and minimizes test time.
- Maintain an air temperature of 45°C–50°C, a relative humidity of 35%–40%, and skin temperature between 39°C and 40°C. Monitor core (oral or tympanic membrane) and skin temperature continuously.
- Test end point is whole body sweating or, if not fully sweating, raising core temperature to 38°C or a 1°C increase above baseline (whichever yields the higher temperature).
- An indicator powder providing high color contrast between sweating and nonsweating skin applied over most of the anterior body surface beforehand gives the best result.
- Overhead photographs of the body surface at test end document the result and provide a digital image that can be analyzed for percent anhidrosis (TST%).

### OTHER METHODS OF MEASURING SWEAT DISTRIBUTION

Sweat gland activity can be studied quantitatively by a number of other techniques including the sympathetic skin response (SSR),<sup>33,34</sup> filter paper collection, weighing and analyzing of sweat composition, the quantitative sudomotor axon reflex test (QSART),<sup>35</sup> silastic mold or iodine-impregnated paper imprint following pilocarpine stimulation,<sup>36</sup> microcannulation of the sweat duct or coil,<sup>37</sup> collection into a Macroduct® coil,<sup>38</sup> and humidity sensors within ventilated capsules. Other more sophisticated techniques utilize microdialysis membranes delivering minute quantities of transmitter substances to the dermis<sup>39</sup> or employ confocal electronmicroscopy and immunohistochemical analysis of biopsied skin stained for

peptides and proteins making up the structure and innervation of the sweat gland.

QSART measures postganglionic axon reflex sweating. The SSR measures hand and foot spinal and postganglionic sympathetic activity. Silastic mold, iodine-impregnated paper imprint, and Macroduct measure direct sweat gland activation and postganglionic innervation via pilocarpine iontophoresis. Punch biopsies can examine sweat gland and intraepidermal nerve fiber densities. These techniques are sometimes done at multiple sites to provide information on the distribution of sweating abnormalities.

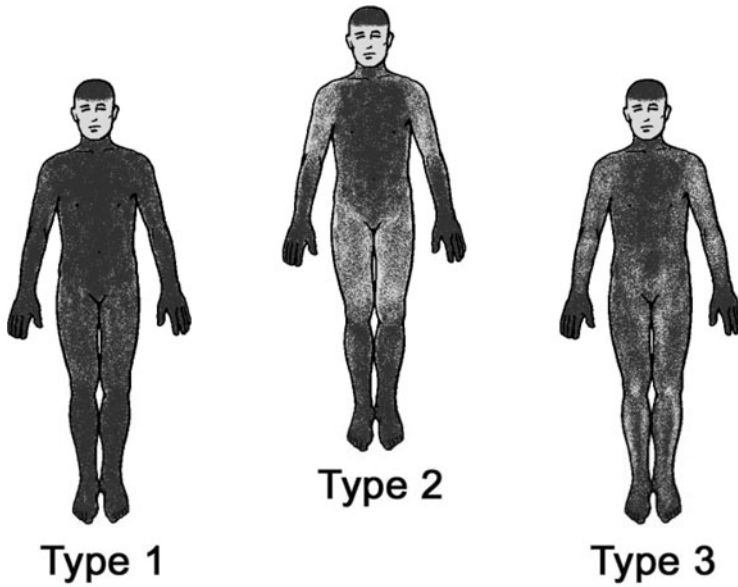
It is desirable to combine several methods for determining the integrity of the eccrine sweat response. For example, a TST can be combined with tests of the sweat gland and/or its peripheral nerve innervation to localize a sweating disorder to the peripheral or central nervous system, or a volumetric technique can be combined with a sweat droplet distribution imprint to estimate the sweat volume per active gland. The TST done first can provide direction to the optimum testing site for more focused techniques.

### Key Points

- Other techniques exist that measure sweating or sweat gland innervation at one or more focal areas of the skin. These include QSART, SSR, silastic mold and iodine-impregnated paper sweat imprint, and Macroduct sweat collection after pilocarpine stimulation, punch skin biopsy with PGP (protein gene product) 9.5 axonal staining, and membrane microdialysis.

### THERMOREGULATORY SWEAT DISTRIBUTION

*Normal distributions.* The normal variants in sweat distribution observed in the Mayo TST clinic laboratory in healthy control subjects from 20 to 75 is shown in Figure 38–5, for color image, see color plates.<sup>7</sup> Areas of “normal” anhidrosis may occur over bony prominences (e.g., the patella and clavicle) and in the inner thighs. The proximal extremities frequently show less sweating than the distal, but left–right symmetry is always the rule.



**Figure 38-5.** Normal thermoregulatory sweat distributions. Sweating areas in *purple* shading. From Low, P. A., and R. D. Fealey. *Sudomotor neuropathy*.<sup>9</sup>

Males tend to show the type 1 (heavy, generalized sweating) pattern, whereas females usually show the type 2 (heavy, generalized sweating but less in proximal extremities) or type 3 (generalized sweating but less in proximal extremities and lower abdomen) pattern. Elderly men and women tend to have types 2 and 3, and the lighter sweating areas may have a higher threshold of activation.<sup>24</sup>

**Abnormal distributions.** Six types of abnormal thermoregulatory sweat patterns or distributions have been described.<sup>7</sup> An example of each pattern is shown in Figure 38-6, for color image, see color plates.

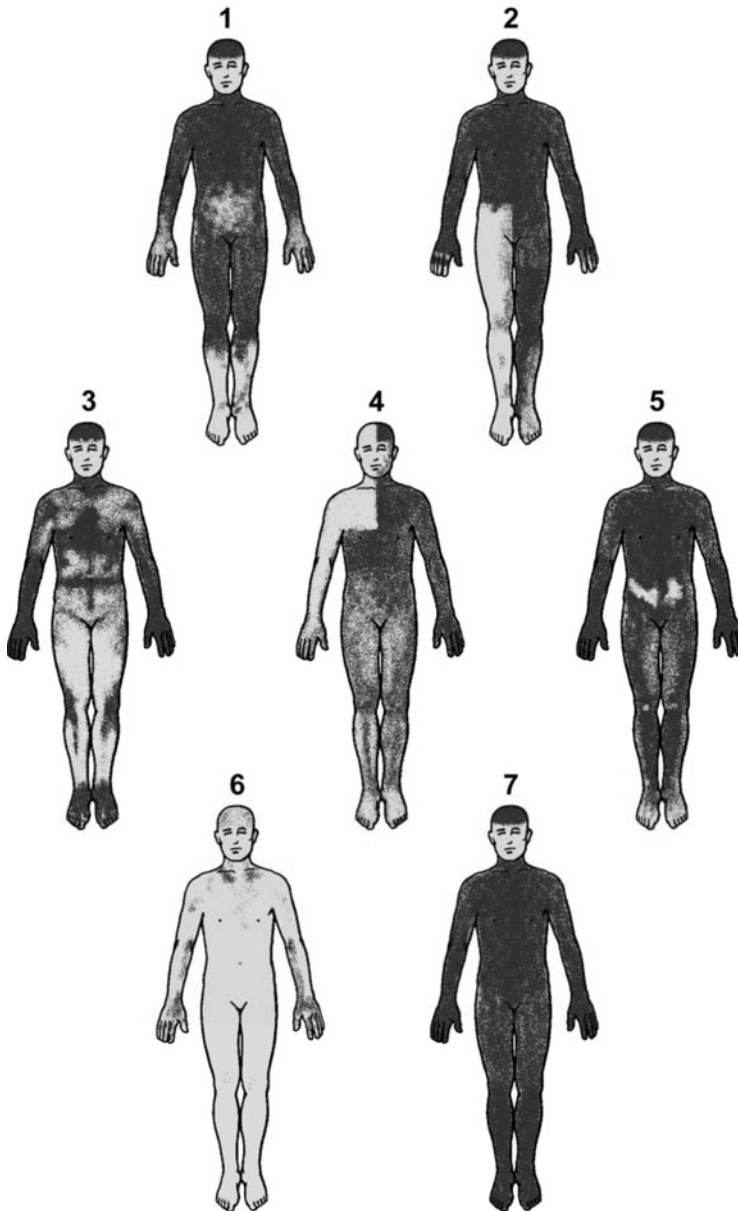
1. *Distal anhidrosis* is characterized by sweat loss in the fingers, the distal legs, feet and toes, and the lower anterior abdomen (Fig. 38-6A). When this pattern is noted, a peripheral autonomic neuropathy is highly likely.
2. *Segmental anhidrosis* involves large contiguous zones of the body surface bordered by areas of normal sweating; these usually respect sympathetic dermatomal borders or spinal cord levels (Fig. 38-6B and 38-6D). Testing the TST area of anhidrosis with a peripheral sudomotor test such as QSART is often needed to

characterize the segmental anhidrosis as central or peripheral (preganglionic vs. postganglionic).

3. *Regional anhidrosis* refers to large anhidrotic areas (but <80%) that blend gradually into sweating areas and that may or may not be contiguous; anhidrosis of the trunk alone and anhidrosis of the proximal parts of all four extremities are examples of this pattern (Fig. 38-6C).
4. *Mixed* patterns are combinations of any of the above in the same patient, for example, focal and distal patterns of anhidrosis (Fig. 38-6B, 38-6D, and 38-6E).
5. *Focal* sweat loss is confined to isolated dermatomes, peripheral nerve territories, or small localized areas of the skin (Fig. 38-6E). This pattern is usually diagnostic of a peripheral nerve branch or a focal skin disorder.
6. *Global anhidrosis*, by definition, occurs when more than 80% of the body surface is involved (Fig. 38-6F).

### Key Points

- There are six basic abnormal TST distributions—distal, segmental, focal (radicular), regional, global, and mixed.



**Figure 38-6.** Abnormal TST Distributions compared with *Type 1* normal. Examples of the most commonly encountered abnormal sweat distribution patterns: Distal (1), Segmental (2 and 4), Regional (3), Global (6), Focal (5) and Mixed (2, 4 and 5); normal image (7). Sweating areas in purple shading. (From Low, P. A., and R. D. Fealey. *Sudomotor neuropathy*.<sup>8</sup>)

- Several abnormal TST patterns provide near diagnostic information regarding the anatomical location of neuropathology.
- The use of a peripheral sudomotor test such as QSART with the TST allows the TST to distinguish between central and peripheral (preganglionic vs. postganglionic) lesions.
- Normal thermoregulatory sweat patterns can include focal loss over bony prominences and striae and show reduced sweating over the medial thighs and lateral calves.

**REPORTING RESULTS**

Data about the age, sex, identity number, clinical problem of the patient, and the date of the TST are indicated on the report (Fig. 38-7, for color image, see color plates).

The body of the report includes a *results* section showing the initial and final core temperature, the percentage of body surface anhidrosis, the type of sweat pattern, and an anatomical figure showing the distribution of the sweating or anhidrosis. This anatomical figure is generated by modifying a computer graphics body image to look like the digital camera images taken of the patient at the end of the test. This figure is used to calculate the percentage of anterior body surface anhidrosis (TST%)<sup>9,23</sup> as described below. The figure also provides a permanent record of the sweat distribution when printed on a color ink-jet printer. The figure and camera images are

reviewed by the reporting physician to ensure accuracy and give an *impression* of what the results are and then their clinical significance is made.

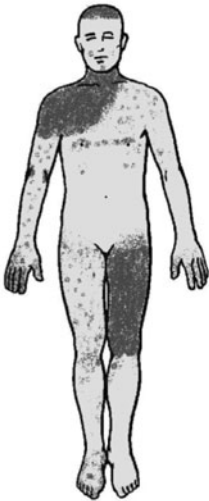
A customized computer program is used to count the number of anhidrotic pixels in the body image. This amount is divided by the total number of pixels constituting the anterior body surface drawing and multiplied by 100 to produce the percent anhidrosis. Another accurate method for deriving the TST% is to use planimetry (LASICO, Model 1252 M; resolution = 0.005 cm<sup>2</sup>). The drawn body image is scrutinized and the region(s) of anhidrosis are outlined and measured; individual areas are summated to produce a total anterior body surface estimate. The TST% provides for quantitation of the test result and can be useful in clinical studies<sup>9,14</sup> and in following the clinical course of patients with autonomic disorders<sup>40</sup> (Fig. 38-1).

***Thermoregulatory Sweat Test***

**Clinic #:**

**Name:            Desk:            Age: Sex:            Date:**

**Indication: Anhidrosis (Ross's syndrome)**



Sweating in purple (dark) shaded areas

**RESULTS**

**Oral temperature (°C): before 36.1 after 37.9**  
**Body surface anhidrosis: 74 %**  
**Distribution: SEGMENTAL**

**IMPRESSION**

**There was hyperhidrosis of the right upper trunk, right shoulder, and left thigh. The rest of the body was mostly anhidrotic except for scattered islands of sweating particularly in the right arm and leg and left thorax. Results are compatible with an acquired anhidrosis as occurs in Chronic Idiopathic Anhidrosis Ross's syndrome, Pure Autonomic Failure, and primary and secondary autonomic neuropathies.**

**Physician \_\_\_\_\_**

**Figure 38-7.** TST Report form: Example from a patient with Ross's Syndrome.

### Key Points

- The TST report should contain patient demographics, testing conditions, initial and final core temperature, the sweat distribution pattern (ideally with the percentage of anhidrosis estimated), and a physician's interpretation of the results.
- A color graphic of the sweat distribution in the report is desirable.
- Construct an electronic copy (for the medical record) and paper copy (for laboratory) of the report.

### DIFFICULTIES AND PITFALLS IN INTERPRETATION

The interpreter must be aware of the normal patterns of thermoregulatory sweating, including areas where anhidrosis may be seen normally, such as over bony prominences or the lateral calves (Fig. 38–5).

Patients who have worn pressure wraps (i.e., ace bandages and abdominal binders) within 12 hours before the test may show anhidrosis in the areas that had been covered. This is usually recognized by the straight edges of the deficit.

Severely dehydrated patients may sweat less overall,<sup>41</sup> but they generally do not have focal defects. Anticholinergic drugs, including most tricyclic antidepressants, may inhibit thermoregulatory sweating and should be stopped 48 hours before the TST is performed. Mu receptor opioid agonists (narcotic analgesics) can elevate the set point temperature for sweat onset and so may produce a false-positive result if the usual endpoint temperature is used to end the test. Retesting 24–48 hours off short-acting opioids is required for an accurate test.

The application of skin lotions such as moisturizing creams may produce a discoloration of alizarin-covered skin, making it difficult to discern areas of anhidrosis as well as normal sweating. Consequently, the use of lotions is prohibited on the day of the TST.

Anhidrosis in elderly patients may present an interpretative challenge, because the effect of aging on the autonomic nervous system may be responsible for the regional anhidrosis (most often affecting the lower abdomen and proximal extremities) that is seen in some older women who have normal neurologic examinations but report having dry skin for many years.

Whether this represents a variant of chronic idiopathic anhidrosis<sup>18</sup> or a loss of functional sweat glands or reflects the loss of preganglionic autonomic neurons known to occur with aging<sup>42</sup> is unclear. Aging is associated with declining postganglionic sympathetic sudomotor responses in the distal leg and foot as well.<sup>43</sup> In our controls aged 20–75 years (19 men and 16 women), there was no significant regression of percent anhidrosis with age, although the mean age was a relatively young 52 years.<sup>9</sup> Senile atrophy of the skin and differences in sweat gland training between young and old may also be a factor. Our current view is to interpret the anhidrosis of the elderly as abnormal and deserving of additional workup to find an etiology.

Potential problems with the TST include the untidiness and duration of the test, the possibility of skin heat injury, or skin irritation caused by the indicator powder alizarin. Contact dermatitis occurs rarely (observed frequency, 3:1000 subjects) and is readily treated with oral and topical agents. A more common but not harmful problem is the persistence of purple discoloration of small skin areas; it may take several days for the color to wash off. Because of repeated exposure to the indicator powder, technicians in our laboratory wear masks, gloves, and goggles when applying the powder to minimize inhalation, oral ingestion, or contact with the eyes. Patients are also given goggles and masks while the powder is applied under a ventilated hood that traps airborne indicator dust protecting personnel, patients, and equipment.

Technicians and patients are made aware of possible skin reactions before application and extremely sensitive individuals are not tested. Our legal department is aware of the non-FDA approved use; we accept the use of alizarin as a reasonable medical risk where no good substitute (except perhaps iodinated starch) exists and the incidence of skin reactions is very low.

Patients who are extremely claustrophobic, who indicate a history of severe contact dermatitis, or who are less than 12 years old are usually not tested.

It is anticipated that TST can be used for controlled trials to monitor progression of disease or response to treatment as long as one adheres rigorously to thermoregulatory stimulus guidelines and has a way to quantitate the results (such as the percentage of body surface



anhidrosis). As such the TST should produce reproducible data and be complementary to anatomically focused techniques of autonomic testing.

### Key Points

- Inadequate heating and low endpoint temperature are the commonest errors.
- Also common is testing with patient taking anticholinergic drugs; 48 hours off such medication is recommended.
- Do not do test if patient is febrile or has taken opioid analgesics within 4 hours of the test.
- Skin lotions and compression stockings can cause artifacts and should not be worn the day of test.

## SUMMARY

The TST assesses the integrity of central and peripheral efferent sympathetic sudomotor neural pathways. A controlled heat and humidity stimulus is given to produce a generalized sweating response in all skin areas capable of sweating. Sweating is visualized by placing an indicator powder on the skin beforehand. The entire anterior body surface can be examined and abnormalities can usually be detected at a glance.

Clinical disorders effectively evaluated by the TST, the characteristic normal and abnormal sweat distributions, the methods to reliably perform the TST, preparation of a report of the test results, and the techniques to quantify the response including the “percentage of anhidrosis” are described herein. Important parameters of the heat stimulus, the patient’s oral and skin temperature response, and pitfalls in the interpretation of the sweat test results are also described.

## APPENDIX: SWEAT TEST PROCEDURE

1. Preheat and humidify the sweat cabinet by turning it on 45–60 minutes before the test. The set points are 48°C air temperature and 37%–39% relative humidity. The overhead IR heaters can also be set to 48°C to accelerate the preparation.
2. Meet the patient and briefly describe the test; weigh the patient and then have them undress.
3. Place towel(s) on the patient to cover as little skin as feasible to maintain modesty. Place respirator mask on the patient. Remove after powdering. Put on your respirator mask, goggles, and gloves.
4. Start the ventilator hood and apply the indicator powder (alizarin red, cornstarch, and sodium carbonate).
5. Place elastic straps to hold the anterior abdomen, proximal leg, and forehead thermistor probes. Take the sterile oral probe and its sponge holder and place it in the patient’s mouth between the gum and the cheek. Turn down the overhead IR heater control setting from 48°C (step 1) to 36°C.
6. As quickly as possible, open the vinyl curtain and place the patient and gurney in the cabinet; close the curtain. Open side doors and place the skin temperature probes under the elastic straps.
7. Connect probes to thermometer input plugs. Record baseline oral and skin temperatures. Check stability of oral temperature during breathing and talking; allow 3 minutes for stabilization; begin timing the sweat test.
8. Check the cabinet temperature and humidity every 5 minutes; operating conditions have to be as follows to ensure an adequate and safe heat stimulus:
 

Air temperature	44°C–48°C
Relative humidity	35%–40%
Skin temperature	38.5°C–39.5°C
9. Try to make all observations through the closed side doors; open the curtain if necessary to wipe the patient’s forehead.
10. If the patient sweats completely (fully saturating the powder on all skin areas) before the oral temperature reaches 38.0°C, advise the physician and end the test. Otherwise, continue the test until the oral temperature is 38.0°C or 1.0°C above the initial oral temperature (whichever is greater). Do not exceed oral temperature of 38.5°C or total heating time of 65 minutes. Using the overhead digital cameras, photograph the



developing sweat distribution, obtaining additional photos for abnormalities.

11. At the end of the test, turn off heat, remove the probes, and take the patient out of the cabinet. Obtain additional digital photos of abnormal areas, chart the pattern of sweating on the report form, and call the physician to inspect the sweat distribution and prepare the report. Help the patient to shower. Keep the laboratory neat by making sure the shower curtain is inside the stall, by vacuuming any loose powder and briefly mopping floor. Wash the skin probes with soap and warm water; wash off the oral probe and put it in its pouch for sterilization.
12. Put fresh linen on gurney for next test.
13. Check to see that the patient has showered off most of the powder and help him or her to dress if necessary. Weigh the patient again. Offer electrolyte replacement drink. Place all used towels and linen in the laundry bag.
14. Enter the test data into the laboratory computer; draw the final body sweat-distribution image and calculate or measure the percentage of anhidrosis. Prepare the electronic report for patient's medical record and print a paper copy for the laboratory report file.
15. When performing a second sweat test on the same patient, ensure the same endpoint temperature and increase in oral temperature are achieved to allow comparison of resulting sweat distributions.

## REFERENCES

1. Fealey, R. D. 1997. Thermoregulatory sweat test. In *Clinical autonomic disorders*, ed. P. A. Low, 2nd ed., 245–57. Philadelphia: Lippincott-Raven.
2. Fealey, R. D., and K. Sato. 2008. Disorders of the eccrine sweat glands and sweating. In *Fitzpatrick's dermatology in general medicine*, ed. L. A. Goldsmith, K. Wolff, S. I. Katz, B. Gilchrist, A. S. Paller, and D. J. Leffell, 7th ed., 789–800. New York City, NY: McGraw-Hill Companies.
3. Low, V. A., P. Sandroni, R. D. Fealey, P. A. Low. 2006. Detection of small-fiber neuropathy by sudomotor testing. *Muscle & Nerve* 34(1):57–61.
4. Stewart, J. D., P. A. Low, and R. D. Fealey. 1992. Distal small fiber neuropathy: Results of tests of sweating and autonomic cardiovascular reflexes. *Muscle & Nerve* 15(6):661–5.
5. Dyck, P. J., I. A. Grant, and R. D. Fealey. 1996. Ten steps in characterizing and diagnosing patients with peripheral neuropathy. *Neurology* 47(1):10–17.
6. Davis, M. D., J. Genebriera, P. Sandroni, and R. D. Fealey. 2006. Thermoregulatory sweat testing in patients with erythromelalgia. *Archives of Dermatology* 142(12):1583–8.
7. Dyck, J. B., and P. J. Dyck. 1999. Diabetic polyneuropathy. In *Diabetic neuropathy*, ed. P. J. Dyck, and P. K. Thomas, 2nd ed., 255–78. Philadelphia: W. B. Saunders Company.
8. Low, P. A., and R. D. Fealey. 1999. Sudomotor neuropathy. In *Diabetic neuropathy*, ed. P. J. Dyck, and P. K. Thomas, 2nd ed., 191–9. Philadelphia: W. B. Saunders Company.
9. Fealey, R. D., P. A. Low, and J. E. Thomas. 1989. Thermoregulatory sweating abnormalities in diabetes mellitus. *Mayo Clinic Proceedings* 64(6):617–28.
10. Wang, A. K., R. D. Fealey, T. L. Gehrking, and P. A. Low. 1999. Autonomic failure in amyloidosis. *Neurology* 52(Suppl. 2):A388.
11. Suarez, G. A., R. D. Fealey, M. Camilleri, and P. A. Low. 1994. Idiopathic autonomic neuropathy: Clinical, neurophysiologic, and follow-up studies on 27 patients. *Neurology* 44(9):1675–82.
12. Vernino, S. J., Adamski, T. J., Kryzer, R. D. Fealey, and V. A. Lennon. 1998. Neuronal nicotinic ACh receptor antibody in subacute autonomic neuropathy and cancer-related syndromes. *Neurology* 50(6):1806–13.
13. Cohen, J., P. Low, R. Fealey, S. Sheps, and N. S. Jiang. 1987. Somatic and autonomic function in progressive autonomic failure and multiple system atrophy. *Annals of Neurology* 22(6):692–9.
14. Sandroni, P., J. E. Ahlskog, R. D. Fealey, and P. A. Low. 1991. Autonomic involvement in extrapyramidal and cerebellar disorders. *Clinical Autonomic Research* 1(2):147–55.
15. Fealey, R. D. 2001. Use of the thermoregulatory sweat test in the evaluation of patients with autoimmune autonomic neuropathy and early multiple system atrophy syndromes. *Japanese Journal of Perspiration Research* 8:37–40.
16. Kihara, M., J. Sugeno, and A. Takahashi. 1991. The assessment of sudomotor dysfunction in multiple system atrophy. *Clinical Autonomic Research* 1(4):297–302.
17. Faden, A. I., P. Chan, and E. Mendoza. 1982. Progressive isolated segmental anhidrosis. *Archives of Neurology* 39(3):172–5.
18. Low, P. A., R. D. Fealey, S. G. Sheps, W. P. Su, J. C. Trautmann, and N. L. Kuntz. 1985. Chronic idiopathic anhidrosis. *Annals of Neurology* 18(3):344–8.
19. Ando, Y., S. Fujii, N. Sakashita, M. Uchino, and M. Ando. 1995. Acquired idiopathic generalized anhidrosis: clinical manifestations and histochemical studies. *Journal of Neurological Sciences* 132(1):80–3.
20. Chemmanur, T., J. D. Pandian, R. S. Kadyan, and S. M. Bhatti. 2007. Anhidrosis: A clue to an underlying autonomic disorder. *Journal of Clinical Neuroscience* 14(1):94–6.
21. Nolano, M., V. Provera, and A. Perretti, et al. 2006. Ross syndrome: A rare or a misknown disorder of thermoregulation? A skin innervation study on 12 subjects. *Brain* 129(Pt 8):2119–31.

22. Ross, A. T. 1958. Progressive selective sudomotor denervation: A case with coexisting Adie's syndrome. *Neurology* 8(11):809.
23. Fealey, R. D. 1997. Autonomic dysfunction in spinal cord disease. In *Spinal cord disease basic science, diagnosis and management*, ed. E. Critchley, and A. Eisen, 219–27. London, Great Britain: Springer-Verlag.
24. Atkinson, J. L., and R. D. Fealey. 2003. Sympathotomy instead of sympathectomy for palmar hyperhidrosis: Minimizing postoperative compensatory hyperhidrosis. *Mayo Clinic Proceedings* 78(2):167–72.
25. McCaffrey, T. V., R. D. Wurster, H. K. Jacobs, D. E. Euler, and G. S. Geis. 1979. Role of skin temperature in the control of sweating. *Journal of Applied Physiology* 47(3):591–7.
26. Sugeno, J., and T. Ogawa. 1985. Characteristics of central sudomotor mechanism estimated by frequency of sweat expulsions. *Japanese Journal of Physiology* 35(5):783–94.
27. Ogawa, T., and M. Asayama. 1986. Quantitative analysis of the local effect of skin temperature on sweating. *Japanese Journal of Physiology* 36(2):417–22.
28. Guttmann, L. 1947. The management of the quinizarin sweat test (Q.S.T.). *Postgraduate Medical Journal* 23:353–66.
29. Hsieh, C., K. McNeeley, and T. C. Chelmsky. 2001. The clinical thermoregulatory sweat test induces maximal sweating. *Clinical Autonomy Research* 11(4):227–34.
30. Sato, K. T., A. Richardson, D. E. Timm, and K. Sato. 1988. One-step iodine starch method for direct visualization of sweating. *The American Journal of the Medical Sciences* 295(6):528–31.
31. Khurana, R. K. 1995. Oculocephalic sympathetic dysfunction in posttraumatic headaches. *Headache* 35(10):614–20.
32. Bannister, R., L. Ardill, and P. Fentem. 1967. Defective autonomic control of blood vessels in idiopathic orthostatic hypotension. *Brain* 90:725–46.
33. Kucera, P., Z. Goldenberg, and E. Kurca. 2004. Sympathetic skin response: Review of the method and its clinical use. *Bratislavske Lekarske Listy* 105(3):108–16.
34. Hilz, M. J., and M. Dutsch. 2006. Quantitative studies of autonomic function. *Muscle & Nerve* 33(1): 6–20.
35. Attia, M., and P. Engel. 1983. Thermoregulatory set point in patients with spinal cord injuries (spinal man). *Paraplegia* 21(4):233–48.
36. Kennedy, W. R., G. Wendelschafer-Crabb, and T. C. Brelje. 1994. Innervation and vasculature of human sweat glands: An immunohistochemistry-laser scanning confocal fluorescence microscopy study. *The Journal of Neuroscience* 14(11 Pt 2): 6825–33.
37. Sato, K., and F. Sato. 1983. Individual variations in structure and function of human eccrine sweat gland. *American Journal of Physiology* 245(2): R203–8.
38. Cole, D. E., and M. J. Boucher. 1986. Use of a new sample-collection device (Macroduct) in anion analysis of human sweat. *Clinical Chemistry* 32(7):1375–8.
39. Morgan, C. J., P. S. Friedmann, M. K. Church, and G. F. Clough. 2006. Cutaneous microdialysis as a novel means of continuously stimulating eccrine sweat glands in vivo. *The Journal of Investigative Dermatology* 126(6):1220–5.
40. Vernino, S., P. A. Low, R. D. Fealey, J. D. Stewart, G. Farrugia, and V. A. Lennon. 2000. Autoantibodies to ganglionic acetylcholine receptors in autoimmune autonomic neuropathies. *The New England Journal of Medicine* 343(12):847–55.
41. Fortney, S. M., E. R. Nadel, C. B. Wenger, and J. R. Bove. 1981. Effect of blood volume on sweating rate and body fluids in exercising humans. *Journal of Applied Physiology* 51:1594–600.
42. Low, P. A., H. Okazaki, and P. J. Dyck. 1977. Splanchnic preganglionic neurons in man. I. Morphometry of preganglionic cytons. *Acta Neuropathologica (Berlin)* 40:55–61.
43. Low, P. A. 1997. The effects of ageing on the autonomic nervous system. In *Clinical autonomic disorders*, ed. P. A. Low, 2nd ed., 161–75. Philadelphia: Lippincott-Raven Publishers.
44. Attia, M., and P. Engel. 1983. Thermoregulatory set point in patients with spinal cord injuries (spinal man). *Paraplegia* 21(4):233–48.

# Cardiovagal Reflexes

*William P. Cheshire, Jr.*

## INTRODUCTION

### HEART RATE RESPONSE TO DEEP BREATHING

Physiologic Basis

Technique

Methods of Analysis

Reproducibility

Factors Affecting the Heart Rate

    Response to Deep Breathing

Problems and Controversies

### THE VALSALVA MANEUVER

Normal Response and Physiologic Basis

Technique

The Valsalva Ratio

Vagal Baroreflex Sensitivity

Factors Affecting the Valsalva Response

Pitfalls of the Valsalva Maneuver

## CARDIOVAGAL SCORING

### POWER SPECTRUM ANALYSIS

### HEART RATE RESPONSE TO

#### STANDING

### OTHER TESTS OF CARDIOVAGAL

#### FUNCTION

### SUMMARY

## INTRODUCTION

Vagal nerve traffic cannot be recorded directly in humans. Reliable, reproducible measurement of vagal function is possible indirectly, however, through noninvasive tests of heart rate variability. The clinical relevance of heart rate variability in evaluating autonomic function was first recognized in obstetrics as a marker of fetal distress.<sup>1</sup> Although the physiologic basis of heart rate variability has been known for a long time, it has been mainly in the last two decades that cardiovascular heart rate tests have been applied clinically, thanks to the enthusiastic promotion by Ewing and associates.<sup>2</sup> Clinical tests of cardiovagal function are now widely used, although the full range of their application as well as their limitations remain underappreciated.<sup>3-5</sup>

Divergent views exist regarding what types of clinical studies constitute an adequate battery of tests of autonomic function and what are the optimal conditions for testing.<sup>2,6</sup> Nevertheless, a consensus has formed in regard to reasonable parameters for a number of basic methodologies for the evaluation of cardiovagal function that provide sensitive and reproducible results. The following description focuses on the most useful tests of cardiovagal function. Their underlying physiology, methodology, clinical utility, and shortcomings are described.

### *Purpose and Role of Cardiovascular Heart Rate Testing*

- These methodologies are used to assess the integrity of the vagal control of heart rate.

- The heart rate response to deep breathing and to the Valsalva maneuver are easily assessed markers of cardiovascular autonomic function.
- Cardiovascular failure is relevant to cardiovascular status and is frequently a marker of autonomic disease.

## HEART RATE RESPONSE TO DEEP BREATHING

### Physiologic Basis

The heart rate response to deep breathing is probably the most reliable of the cardiovascular heart rate tests, because the major afferent and efferent pathways are both vagal.<sup>7</sup> The vagus nerve provides a beat-to-beat control of the sinus node.<sup>8</sup> This is mediated by M<sub>2</sub> type muscarinic cholinergic receptors coupled to G-protein-activated inward rectifying potassium channels (GIRKs). In humans, muscarinic receptor blockade with atropine completely abolishes respiratory sinus arrhythmia.

The primary basis of respiratory sinus arrhythmia appears to be the interactions between the respiratory centers and the cardioinhibitory centers in the medulla, particularly the nucleus ambiguus.<sup>9</sup> Evidence for this is cessation of vagal efferent activity during the inspiratory phase of natural—but not artificial—ventilation, and the loss of respiratory sinus arrhythmia in some patients with brain stem lesions.<sup>10</sup> Respiratory sinus arrhythmia is modulated by input from the lungs, heart, and baroreceptors.<sup>11</sup> Pulmonary stretch receptors that mediate the Hering–Breuer respiratory reflex modulate respiratory sinus arrhythmia, although their role may be less important in humans than in experimental animals. Receptors from the right atrium initiate the vagally mediated Bainbridge reflex and a venoatrial mechanoreceptor sympathetic reflex.<sup>9</sup> Baroreflex sensitivity changes throughout deep breathing, thus modulating respiratory sinus arrhythmia.<sup>12</sup>

### Technique

For testing the heart rate response to deep breathing, care should be taken to ensure

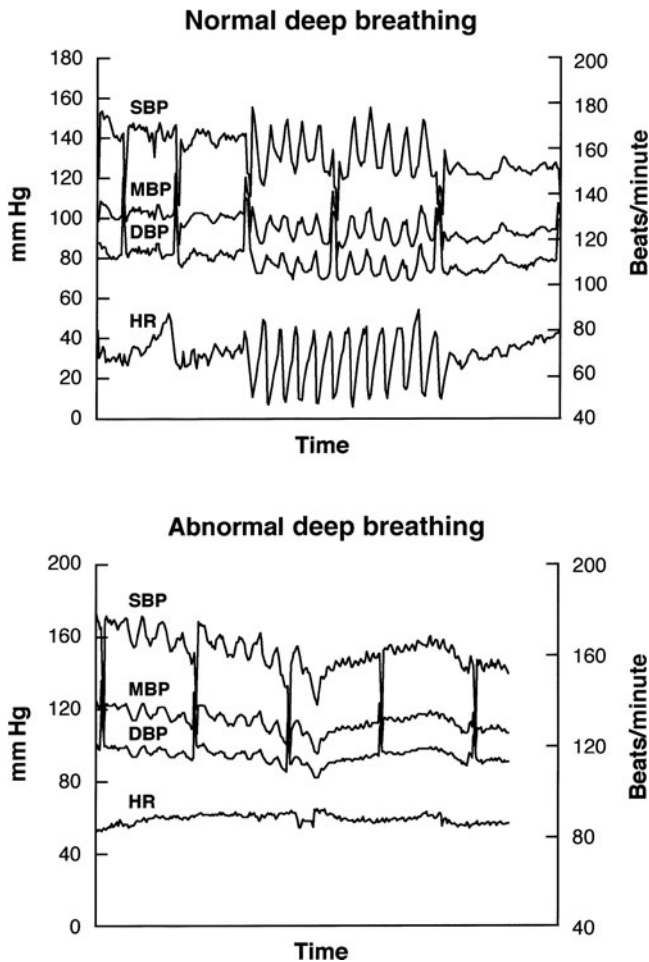
that the patient is relaxed and comfortable, because sympathetic activation diminishes the response. Medications known to inhibit respiratory sinus arrhythmia should be withheld if practical and safe to do so. The patient is tested in the supine position to maximize vagal tone.

Either of two methods of training the respiratory cycle is customarily used. The more common method is to have the subject visually follow and breathe in timing with a pattern, usually a sinusoidal oscillating bar generated by a computer. The alternative is to instruct the subject to breathe in and out as the technician gestures. The difference of the two approaches has not been studied systematically but is likely to be minor. What is most important is that the patient breathe slowly and continuously, rather than gasping or pausing, with full breaths, and at a consistent rate of 5–6 cycles per minute. A standardized deep-breathing protocol can be used without the need to factor in variations in the depth of respiration. This is because depth of breathing above a tidal volume of approximately 1.2 L causes insignificant changes in the heart rate response to deep breathing.<sup>13</sup> Bennett and associates<sup>14</sup> and Eckberg<sup>15</sup> found little or no difference in the response for different depths of respiration.

The electrocardiogram (ECG) is continuously monitored. A computer program captures each QRS complex over time and displays beat-to-beat heart rate. Most laboratories record the mean difference in R–R intervals over a series of six respiratory cycles. Some investigators have advocated measuring the heart rate response to one breath on the basis that a single deep breath is a more potent stimulus for heart rate change than repeated deep breaths.<sup>16,17</sup> Direct comparisons have shown no advantage of a single deep breath over repeated breaths.<sup>18</sup> Rather, assessments of heart rate responses to a series of breaths are more likely to be reproducible.

### Methods of Analysis

The three methods of analysis generally used are the *heart rate range*, the *heart period range*, and the *E:I ratio*.<sup>10</sup> The *E:I ratio* is the ratio of the shortest R–R interval during inspiration to the longest R–R interval during expiration. Our laboratory utilizes the heart rate range, because the effect of resting heart



**Figure 39-1.** Heart rate response to deep breathing in a normal subject (*top*) and in a patient with diabetic autonomic neuropathy (*bottom*). In each panel, the three upper tracings correspond to systolic blood pressure (SBP), mean blood pressure (MBP), and diastolic blood pressure (DBP). The bottom tracing corresponds to heart rate (HR).

rate on the range is smaller than its effect on heart period (Fig. 39-1).

Weinberg and Pfeifer<sup>19,20</sup> recommended calculation of the circular mean resultant, a method based on vector analysis, to eliminate the effects of trends in heart rate over time and to attenuate the effect of basal heart rate and ectopic beats in the calculated variability of heart rate. In this method, R-R intervals over a 5-minute interval are plotted on a circular graph in which one revolution corresponds to a single respiratory cycle. Normal heart rate variability results in a clustering of time events, whereas reduced heart rate variability results in less periodically distributed time events on the circle.

## Reproducibility

The tests have been reproducible. Typical coefficients of variation have been 11%<sup>14</sup> and 8.9%.<sup>21</sup> When combined with a second, independent test of the parasympathetic control of heart rate, the results are highly reliable in the diagnosis of cardiovascular dysfunction.<sup>22</sup>

## Factors Affecting the Heart Rate Response to Deep Breathing

Numerous factors affect the heart rate response to deep breathing. From the standpoint of



Table 39-1 Normative Data for Heart Rate Variability to Deep Breathing

Percentile	20 years	40 years	60 years	80 years
2.5	13	9	7	7
5.0	14	10	7	7
95	41	33	27	27
97.5	43	36	29	29

Normative data were obtained from 376 subjects aged 10–83 and were derived by plotting the regression of heart rate variation in beats/minute against age in years. A significant ( $p < 0.001$ ) was found in which  $y = 37.5448 * \log 10 0.9832x$ . Breakdown by gender was approximately equal.<sup>30</sup>

clinical autonomic testing, the most important of these are the effects of age and rate of forced respiration. A progressive decrease in the response with increasing age has been reported in all large studies.<sup>2,10,23–30</sup> An investigation of 557 normal subjects, evenly distributed by age and gender from 10 to 83 years old, found that the decline in heart rate responses to deep breathing with age did not regress to zero but leveled off in the older subjects, indicating that it is possible to diagnose cardiovagal failure in elderly patients in comparison to normative data<sup>30</sup> (Table 39–1).

Maximal heart rate response to deep breathing occurs at a breathing frequency of 5–6 respirations per minute in normal subjects.<sup>11,14,31,32</sup> This observation defines the basis for the standard test of deep breathing.<sup>6</sup> In patients with vagal neuropathy, the maximal heart rate response to deep breathing occurs at lower respiratory frequencies, which is of little pragmatic concern. Of greater practical importance is the selection for each subject of a respiratory rate in which the increase and decrease are additive instead of subtractive.<sup>31</sup> A clue to waveform cancellation is the observation of a large first or second response, followed by smaller responses.

The position of the subject has some effect on respiratory sinus arrhythmia. The response is larger when the subject is supine than when sitting or erect.<sup>14</sup> Unlike some other tests of autonomic function, the heart rate response to deep breathing is not greatly affected by the sex of the subject.<sup>29,30</sup> The duration of antecedent rest is not important in relaxed subjects. After 5 minutes of rest, another 25 minutes of supine rest will not alter the response. No significant differences have been found in the response whether the test is performed in the morning or in the afternoon in the same subjects.<sup>14</sup> A

number of studies have correlated cardiovagal control to depression, but the overall variance is only about 2%.<sup>33</sup>

Prolonged hyperventilation and the reduction of  $PCO_2$ , however, result in a depression in respiratory sinus arrhythmia. There is a sympathetic modulation of the heart rate response to deep breathing that is inhibited by stress and enhanced by  $\beta$ -adrenergic blockade.<sup>34–36</sup> Also, the response is impaired during severe tachycardia, in heart failure, and in deeply unconscious patients.<sup>10,32,34</sup> Medications that have been shown to reduce the heart rate response to deep breathing include muscarinic antagonists,<sup>37</sup> nicotine,<sup>38</sup> opioids,<sup>39</sup> and norepinephrine reuptake and serotonin-selective reuptake inhibitors.<sup>40,41</sup>

## Problems and Controversies

The heart rate response to deep breathing is an indirect measure of cardiovagal function. A reduced response indicates a lesion anywhere in the intricate autonomic nervous system; that is, in the afferent, central processing unit, efferent, synapse, or effector apparatus.

To further complicate interpretation, a reduced response does not unequivocally indicate cardiovagal failure. The general observation that heart rate usually increases during inspiration and decreases during expiration is an approximation of a composite set of phenomena. Both inspiration and expiration are followed by an increase, then a decrease, in heart rate but at a different rate of change, amplitude, time of appearance, and duration. Mehlsen and colleagues<sup>42</sup> suggested that the reason the maximal heart rate range in many subjects is 6 beats per minute is because they have well-defined heart rate maxima with



positive *interference* of phases. The reason subjects have a decreased heart rate range less than 7 beats per minute is because of negative *interference*.

### Key Points

- Cardiovascular heart rate tests are useful, sensitive, and reproducible tests of cardiovagal nerve function.
- The heart rate response to deep breathing is the most reliable test for evaluating vagal afferent and efferent cardiac pathways.
- Vagal beat-to-beat control of the sinus mode (respiratory sinus arrhythmia) is mediated centrally by interactions between the respiratory and the cardioinhibitory centers in the medulla, and peripherally by M<sub>2</sub> muscarinic cholinergic receptors coupled to GIRKs.
- Vagal efferent slowing of heart rate ceases during the inspiratory phase of natural, but not artificial, respiration.
- The heart rate response to deep breathing is best assessed by having the subject lie supine and take slow, continuous, full breaths at a consistent rate of 5–6 breaths per minute.
- A number of factors decrease the heart rate response to deep breathing. These include (1) advancing age, (2) anxiety, (3) tachycardia, (4) heart failure, (5) unconsciousness, and (6) medications such as muscarinic antagonists, nicotine, opioids, and norepinephrine reuptake and serotonin-selective reuptake inhibitors.

## THE VALSALVA MANEUVER

The Valsalva maneuver is a global test of reflex cardiovascular responses. It consists of an abrupt transient increase in intrathoracic and intra-abdominal pressures induced by blowing against pneumatic resistance while maintaining a predetermined pressure (*straining*).<sup>43–46</sup>

### Normal Response and Physiologic Basis

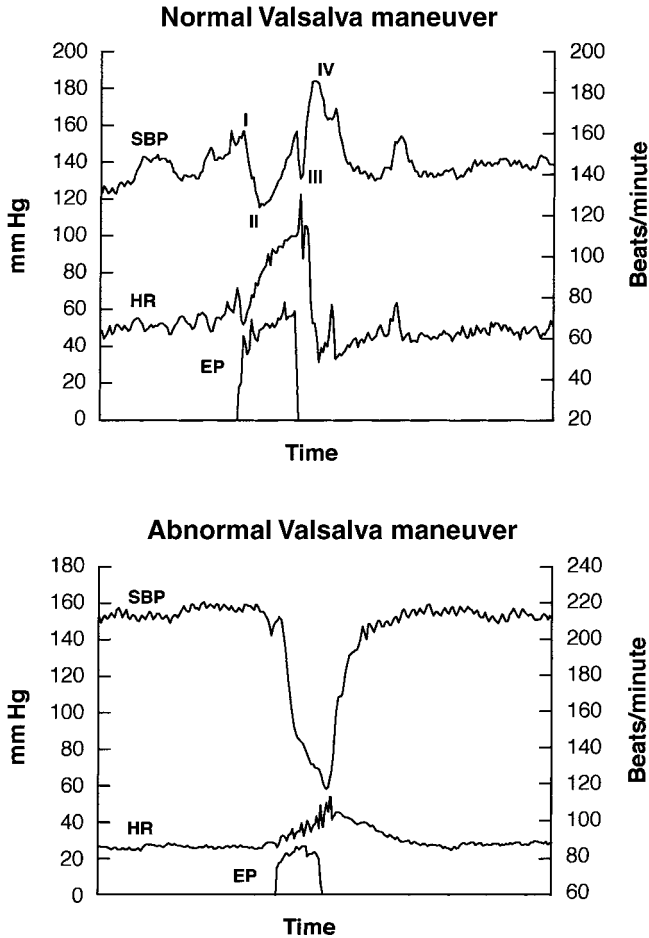
Intra-arterial recordings of arterial pressure and, more recently, noninvasive monitoring

of arterial pressure with a photoplethysmographic technique (Finapres) or tonometry (Colin Pilot or Colin 7000) have provided important information about the hemodynamic changes during the Valsalva maneuver in normal and pathologic conditions.<sup>47, 48</sup>

The responses to the Valsalva maneuver have been divided into four phases<sup>43–49</sup> (Fig. 39–2). Phase I consists of a brisk increase in systolic and diastolic arterial pressure and a decrease in heart rate immediately after the onset of the Valsalva strain and lasts approximately 4 seconds. The increase in arterial pressure during phase I reflects mechanical factors and is not associated with an increase in sympathetic activity. It persists in patients with transections of the high cervical spinal cord and in normal subjects after administration of  $\alpha_1$ -adrenergic blocking drugs.<sup>49</sup> The slowing of the heart rate is reflexive and mediated by increased parasympathetic efferent activity.<sup>50</sup>

Phase II consists of a decrease (early phase II, II<sub>e</sub>) and subsequent partial recovery (late phase II, II<sub>l</sub>) of arterial pressure and continuous increase of heart rate during straining. Continuous straining impedes venous return to the heart and results in the displacement of large amounts of blood from the thorax and abdomen to the limbs. The decrease in venous return produces a reduction in left atrial and left ventricular dimensions, left ventricular stroke volume, and cardiac output.<sup>43, 44</sup> This triggers reflex compensatory tachycardia and vasoconstriction. The tachycardia during phase II results from a prominent, early component of inhibition of cardiovagal output and is abolished with muscarinic blockade with atropine.<sup>51</sup> There is also a late contribution of increased sympathetic cardioacceleratory output that is blocked with propranolol. The progressive recovery of arterial pressure during phase II reflects a similarly progressive increase in total peripheral resistance<sup>45</sup> caused by increased sympathetic vasoconstrictor activity.<sup>52, 53</sup> Increased arterial pressure during late phase II is abolished by  $\alpha_1$ -adrenergic blockade with phentolamine.<sup>54</sup> The fall in blood pressure during phase II is more pronounced if compensatory tachycardia is prevented by atropine and propranolol and if vasoconstriction is prevented by  $\alpha_1$ -adrenergic blockade.<sup>54</sup>

Phase III consists of a sudden, brief (1–2 seconds) further decrease in arterial pressure and increase in heart rate immediately after



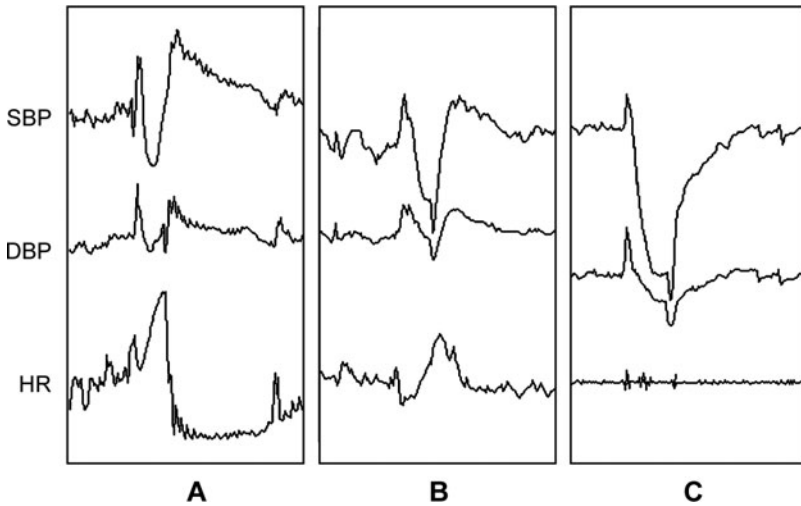
**Figure 39-2.** Changes in systolic blood pressure (SBP) and heart rate (HR) during the Valsalva maneuver in a normal subject (*top*) and in a patient with diabetic autonomic failure (*bottom*). The normal beat-to-beat SBP recording shows the typical four phases (I, II, III, IV) of the Valsalva maneuver. The abnormal Valsalva maneuver is characterized by a profound decrease in SBP in early phase II, absence of recovery in late phase II, and absence of SBP overshoot in phase IV. Note the attenuated HR responses during phases I and IV, resulting in a reduced Valsalva ratio. EP, expiratory pressure.

the release of the straining. It is essentially mechanical in nature and is the inverse of phase I.

Phase IV is characterized by increased systolic and diastolic arterial pressure above control levels, termed *overshoot*, accompanied by bradycardia relative to the control level of heart rate. In phase IV, venous return to the heart, left ventricular stroke volume, and cardiac output return nearly to baseline, whereas the arteriolar bed remains vasoconstricted because of the long time constant of sympathetic responses.<sup>49</sup> This combination results in an overshoot of arterial pressure above baseline values. Poststraining arterial pressure increases are proportional to the preceding increases

in sympathetic nerve activity. The increase in arterial pressure during phase IV can be prevented by  $\beta$ -adrenergic blockade.<sup>54</sup> Increases in both cardiac output and total peripheral resistance are important in producing the increase in arterial pressure in phase IV.

Recent pharmacologic evidence indicates that an increase in cardiac output-mediated cardioacceleration is more important than vasoconstriction in producing arterial pressure overshoot in phase IV. This overshoot is abolished by  $\beta$ -blockade with propranolol but is maintained or even exaggerated during  $\alpha$ -adrenergic blockade with phentolamine.<sup>44</sup> The increase in arterial pressure during phase IV stimulates the baroreceptors and results



**Figure 39-3.** Valsalva maneuvers in three different subjects showing beat-to-beat blood pressure (BP) and heart rate (HR) in (A) a normal response, (B) impaired late phase II response and decreased Valsalva ratio in mild autonomic failure, and (C) absent late phase II, absent phase IV, and absent HR response in severe autonomic failure.

in reflex bradycardia caused by increased parasympathetic activity, which is abolished with atropine.<sup>50,55</sup> Sympathetic inhibition after straining persists much longer than the increase in arterial pressure.

The responses during the four phases of the Valsalva maneuver depend on the variable relationships between carotid and aortic baroreceptor inputs. Pressure transients lasting only seconds may reset the relationships between the arterial pressure and the sympathetic or vagal responses.<sup>56</sup> Examples of the Valsalva maneuvers in a normal subject and subjects with mild and severe autonomic failure are shown in Figure 39-3.

## Technique

For testing the responses to the Valsalva maneuver, care should be taken, as in any other autonomic test, to ensure that the patient is well hydrated and is not taking medications known to affect blood volume, cholinergic function, or vasoreactivity. At our institution, subjects are tested in the supine position and asked to maintain a column of mercury at 40 mm Hg for 15 seconds through a bugle with an air leak (to ensure an open glottis). The responses are obtained in triplicate, and the largest response is accepted.<sup>47,54,57</sup> In some laboratories, only heart rate is monitored

continuously. Our laboratory<sup>47,54,57</sup> and many others<sup>58,59</sup> also monitor beat-to-beat arterial pressure with a noninvasive photoplethysmographic technique. The “normal” Valsalva response should be defined according to the technique used in each laboratory, because several technical variables affect the magnitude of the response.

## The Valsalva Ratio

The *Valsalva ratio* is defined as the longest R-R interval (pulse interval, in milliseconds) after the maneuver (in phase IV) divided by the shortest R-R interval during the maneuver (in phase II). In clinical settings, the Valsalva maneuver commonly has been used to calculate the Valsalva ratio. The best of three responses is accepted. In more than 96% of control subjects, this ratio exceeds 1.5.<sup>14,32,50,51,55</sup> The Valsalva ratio decreases significantly with age.<sup>29</sup>

## Vagal Baroreflex Sensitivity

The relationships between arterial pressure and heart rate during phase II and phase IV of the maneuver have been used to assess

Table 39-2 Normative Data for the Valsalva Ratio

Percentile	20 years		40 years		60 years		80 years	
	M	F	M	F	M	F	M	F
2.5	1.50	1.41	1.36	1.47	1.21	1.36	1.21	1.36
5.0	1.59	1.46	1.44	1.51	1.29	1.39	1.29	1.39
95	2.87	2.73	2.52	2.64	2.18	2.41	2.18	2.41
97.5	2.97	2.97	2.60	2.88	2.23	2.65	2.23	2.65

Normative data were obtained by plotting the regression of Valsalva ratio against age in 425 subjects of 10-83 years.<sup>30</sup>

baroreflex sensitivity.<sup>60</sup> Vagal baroreflex sensitivity, which is the change in heart rate resulting from a change in blood pressure, can be quantified by plotting each heart interval against the preceding systolic blood pressure value. The slope of the simple linear regression is a measure of baroreflex sensitivity.<sup>61</sup> One limitation of this method is that there is an unknown reflex latency between the pressure change and the change in heart period. Thus, the best of two regression slopes, one correlating blood pressure to its corresponding heart period and the other to its subsequent pulse interval, should be accepted. Vagal baroreflex sensitivity declines with age.<sup>62</sup> The adrenergic component of baroreflex sensitivity, which relates the blood pressure recovery time to the preceding decrease in blood pressure, correlates more closely than vagal baroreflex sensitivity to adrenergic failure.<sup>63</sup>

### Factors Affecting the Valsalva Response

The cardiovascular changes during the Valsalva maneuver are determined mainly by the magnitude of hemodynamic change during the forced expiratory effort, the time course and efficiency of reflex cardiovagal and sympathetic vasomotor and cardiomotor responses, and the modification of these responses by interactions with respiratory mechanisms at both central and peripheral levels. Accordingly, the responses to the Valsalva maneuver may be affected by (1) the position of the subject during the maneuver, (2) the magnitude and duration of the straining, (3) the breathing pattern before and after the maneuver, including depth and phase of respiration preceding the straining, and (4) the control of respiration

after release of the straining. Normative data on the phases of the Valsalva maneuver have been published<sup>30,57,64</sup> (Table 39-2).

### EFFECTS OF POSTURE

In subjects in the supine position, changes in arterial pressure during phases II and IV may be modest, because the large intrathoracic blood volume may buffer the reduced venous return during phase II. In the supine position, some normal subjects may show a square-wave response similar to that of patients with congestive heart failure. Changing from a supine to an inclined or upright posture increases the magnitudes of the arterial pressure decrease during phase II, the systolic blood pressure overshoot during phase IV, and the Valsalva ratio.<sup>59</sup>

### EFFECTS OF TEST DURATION

The duration of straining during the Valsalva maneuver differentially affects the vagally and sympathetically mediated responses, because of their different latencies and time constants. When the Valsalva maneuver is performed at low expiratory pressures (20 mm Hg), the magnitude of the tachycardia in phase II is independent of the duration of the test, consistent with the short latency of vagal responses. The maximal increase in arterial pressure in late phase II and phase IV correlates with the duration of the Valsalva maneuver. This may reflect the longer latency of sympathetic vasoconstrictor and cardioacceleratory responses.<sup>49</sup> A test duration of 10 seconds is effective, while 15 seconds is a practical optimum and may be sufficient to assess sympathetically mediated responses in a clinical setting.<sup>47</sup>

## EFFECTS OF EXPIRATORY PRESSURE

The magnitude of most heart rate and arterial pressure responses during phase II and phase IV correlates with the magnitude of expiratory pressure used during the Valsalva maneuver. Maximal arterial pressure and heart rate responses are obtained with expiratory pressures of 40–50 mm Hg.<sup>46,50,51,55</sup>

### PHASE OF RESPIRATION

In normal subjects, the magnitude of heart rate responses during the Valsalva maneuver is significantly lower if the expiratory strain is preceded by maximal inspiration instead of tidal inspiration.<sup>50</sup>

## Pitfalls of the Valsalva Maneuver

### PITFALLS IN PERFORMING THE VALSALVA MANEUVER

There are several precautions to keep in mind when asking patients to perform the Valsalva maneuver:<sup>46</sup>

1. The test requires patient cooperation and, thus, cannot be performed in patients who are seriously ill or who have weak respiratory, facial, or oropharyngeal muscles.
2. The maneuver should be avoided in patients with proliferative retinopathy, because of the risk of intraocular hemorrhage, and in patients with known cerebral aneurysms, because of the risk of subarachnoid hemorrhage.
3. Theoretically, the Valsalva maneuver can precipitate arrhythmias and angina and may cause syncope, particularly in elderly patients with impaired reflex mechanisms that respond to the decrease in venous return.
4. Patients with congestive heart failure, mitral stenosis, aortic stenosis, constrictive pericarditis, or atrial septal defect may have an abnormal square-wave response of arterial pressure to the Valsalva maneuver because of the increase in pulmonary blood volume, which is capable of maintaining ventricular filling during the Valsalva strain.

### PITFALLS IN INTERPRETING THE VALSALVA RATIO

There is evidence that the Valsalva ratio in normal subjects depends mainly on cardiovagal function.<sup>32,50,51,55</sup> However, the interpretation of this ratio as a test of cardiovagal function without simultaneous recordings of arterial pressure may be misleading for several reasons:

1. The Valsalva ratio correlates better with the heart rate response in phase II than with the response in phase IV.<sup>47</sup> Therefore, if sufficient tachycardia is present in phase II, the Valsalva ratio may be “normal” even in the absence of significant bradycardia in phase IV. This may occur in patients with cardiovagal impairment but intact sympathetic innervation.<sup>65</sup>
2. The Valsalva ratio also correlates with the magnitude of arterial pressure overshoot in phase IV.<sup>47</sup> The absence of bradycardia in phase IV, and thus an abnormal Valsalva ratio, may be caused not only by vagal dysfunction but also by the inability to increase arterial pressure in phase IV.
3. Both the heart rate increase in phase II and the heart rate decrease in phase IV are affected critically by the magnitude of the decrease in venous return during the Valsalva maneuver, which depends on the position of the subject and the pooling and buffering effect of thoracic vessels.<sup>59</sup>
4. Assessing the integrity of the total baroreflex arc during the Valsalva maneuver by only testing the Valsalva ratio is unreliable, because the magnitude and time course of the heart rate response may be normal despite a response of arterial pressure typical of sympathetic failure.<sup>65</sup>

The integrity of reflex sympathetic responses cannot be inferred on the basis of the Valsalva ratio. Both the magnitude of the decrease in mean arterial pressure in phase II and the overshoot of arterial pressure in phase IV have been considered indices of vasomotor function.<sup>49,54</sup> However, the magnitude of the decrease in arterial pressure in early phase II is also affected by the heart rate responses, and the overshoot of arterial pressure in phase IV may be more dependent on cardiac output.<sup>54</sup> In our laboratory, the changes in arterial

pressure during early and late phase II and phase IV are used to assess sympathetic vasomotor function.<sup>54,57</sup> Late phase II is impaired in patients with  $\alpha$ -adrenergic failure caused, for example, by dopamine- $\beta$ -hydroxylase deficiency.<sup>66,67</sup>

### Key Points

- The Valsalva maneuver consists of forced voluntary expiratory effort against resistance, which displaces blood from the thorax and abdomen into the limbs and results in a complex set of cardiovascular autonomic responses.
- The autonomic responses to the Valsalva maneuver are divided into four phases:
  - Phases I and III reflect transient mechanical effects on blood pressure of the onset and cessation of straining.
  - Phase II consists of a decrease in arterial pressure ( $II_e$ ) and a subsequent partial recovery ( $II_i$ ) caused by (1) reflex compensatory tachycardia due to inhibition of cardiovagal output and increased sympathetic cardioacceleratory output and (2) increased sympathetic vasoconstrictor activity with progressive increase in total peripheral resistance.
  - Phase IV consists of (1) reflex parasympathetically mediated bradycardia and (2) increased cardiac output-mediated cardioacceleration while the arteriolar bed remains vasoconstricted, resulting in an overshoot of blood pressure above baseline.
- The subject, tested supine, is asked to maintain a column of mercury at 40 mm for 15 seconds through a paper bugle with a small air leak (to ensure an open glottis), while beat-to-beat blood pressure and heart rate responses are continuously monitored.
- The Valsalva ratio is an index of cardiovagal function and is defined as the longest R–R interval during phase IV divided by the shortest R–R interval during phase II.
- The Valsalva ratio may be decreased (1) in older subjects, (2) if the force and duration of respiratory straining are insufficient, or (3) in sitting or standing postures.
- The Valsalva maneuver should not be performed in subjects who cannot safely

undergo an increase in intrathoracic pressure, such as patients with large cerebral aneurysms or some patients with proliferative retinopathy.

- Interpretation of the Valsalva ratio as a test of cardiovagal function may be misleading without simultaneous beat-to-beat recording of arterial pressure to ensure an adequate early phase II profile.

## CARDIOVAGAL SCORING

Low and associates have developed and validated a 10-point composite autonomic severity score (CASS), which grades autonomic failure according to the results of clinical autonomic testing while correcting for the confounding effects of age and gender. In addition to adrenergic (maximum 4 points) and sudomotor (maximum 3 points) subscores, a cardiovagal subscore (maximum 3 points) is assigned. A subscore of 1 is assigned if heart rate variability to deep breathing is mildly reduced but above 50% of the minimum value. A subscore of 2 is assigned if heart rate variability is below 50% of the minimum value. A subscore of 3 indicates that both the heart rate variability to deep breathing and the Valsalva ratio are reduced to below 50% of their minimum normative values.<sup>68</sup>

### Key Points

- The CASS is a validated index of autonomic failure that combines the results of clinical autonomic testing correcting for differences of age and gender.

## POWER SPECTRUM ANALYSIS

Autonomic data generally are evaluated in the time domain, with a focus on the changes over time in the amplitude of a response to a standardized stimulus. Spontaneous oscillations also contain key information. Frequency analysis focuses on the changes in amplitude as a function of frequency.<sup>69</sup> In recordings of the heart period (the reciprocal of heart rate), oscillations at the respiratory frequency (typically approximately 0.25 Hz) are determined by parasympathetic function; hence, its power



(amplitude) reflects the proportion of frequencies due to parasympathetic activity. A slower frequency, approximately 0.07–0.1 Hz, reflects the periodicity of the baroreflex loop. Power at this frequency reflects both sympathetic and parasympathetic functions. Similar oscillations occur in blood pressure recordings.

Several methods are available for evaluating autonomic signals in the frequency domain. Fast Fourier transform and autoregressive models are commonly used. Both of these require stationarity, a condition that is difficult to satisfy with changing autonomic signals. An alternative approach is time-frequency analysis, a method that resolves signals in both the time and the frequency domains simultaneously.

Head-up tilt results in attenuation of the respiratory frequency and augmentation of the lower frequency. An advantage of frequency analysis is its ability to evaluate sympathovagal balance. It can be expressed as the power in the low frequency in blood pressure (reflecting pure sympathetic function) over the respiratory frequency in heart period (pure parasympathetic function).<sup>70</sup>

For clinical recordings of autonomic signals, it is essential that respiration be recorded or paced, because respiration can entrain heart rate oscillations over a wide range of frequencies (from 0.01 to 0.5 Hz), and if the subject breathes slowly, respiratory rhythms will eclipse the lower frequency signals.<sup>71</sup> Either an increased tidal volume at lower respiratory rates or breath-holding can interact with spectral power at lower frequencies and greatly bias the estimation of power. Slowing of respiration can thus lead to a falsely positive increase in low-frequency power.<sup>71</sup> A minimal duration of recording for valid analysis is at least 5 minutes of good quality recording.

### Key Points

- Power spectral analysis of heart rate variability is used to evaluate cardiac autonomic function. Analysis is performed in the time domain or the frequency domain.
- High-frequency spectral power (near 0.25 Hz) reflects parasympathetic cardiovagal tone, whereas low-frequency spectral power (0.07–0.10 Hz) reflects baroreflex modulation of autonomic outflow.

- When sampling heart rate for power spectrum analysis, respiration should be recorded or paced, because respiration can entrain heart rate oscillations.

## HEART RATE RESPONSE TO STANDING

The immediate heart rate response to standing can be recorded using an ECG machine. In normal subjects, tachycardia is maximal at about the 15th beat, and relative bradycardia occurs around the 30th beat.<sup>72</sup> The 30:15 ratio (R–R interval at beat 30/R–R interval at beat 15) has been recommended as an index of cardiovagal function. Reflex tachycardia is thought to be mediated by the vagus nerve, because the response is abolished by atropine but not by propranolol.<sup>72</sup> The heart rate response to standing attenuates with age.<sup>73</sup>

The hemodynamic response to active standing is trimodal.<sup>74</sup> There is an abrupt increase in heart rate that peaks at 3 seconds, a further more gradual tachycardia that peaks at 12 seconds, and a bradycardia at 20 seconds. The initial cardioacceleration is an exercise reflex mediated by muscle contraction, resulting in the sudden inhibition of vagal tone. The second tachycardia is caused by further vagal inhibition and by reduced baroreflex activity, which is due to transient hypotension caused by a fall in peripheral vascular resistance. This transient hypotension appears to be the result of local, nonautonomically mediated vasodilation in contracting muscles, central command, and cholinergic-mediated vasodilation.<sup>75–77</sup> An overshoot in blood pressure then evokes baroreflex-mediated bradycardia. The series of autonomic responses to standing thus not only reflects the integrity of the cardiovagal system, but also depends on an intact sympathetic nervous system, local muscle reflexes, baroreflexes, and central command.

### Key Points

- The 30:15 ratio is a test of cardiovagal function in which, upon active standing, the R–R interval at beat 30 is divided by the R–R interval at beat 15 as recorded by an ECG machine.

## OTHER TESTS OF CARDIOVAGAL FUNCTION

Available tests of cardiovagal function are numerous. In a reversal of testing the heart rate response to standing, a related test measures the heart rate response to lying down. Recumbency evokes an immediate, vagally mediated decrease in the R–R interval that is maximal at the third or fourth beat. This is followed by a sympathetically mediated increase in the R–R interval at the 25th–30th beat.<sup>77–79</sup>

The heart rate response to squatting has been defined in normal subjects in comparison to its decline in diabetic autonomic neuropathy.<sup>80</sup> In this test, the subject stands still for 3 minutes, squats down for 1 minute, and then stands up during inspiration. The normal response is vagally mediated lengthening of the R–R interval during squatting, followed by sympathetically mediated shortening of the R–R interval at standing. The response declines with age.<sup>80</sup>

Coughing, which involves inspiration and an expiratory effort against a closed glottis, followed by explosive expiration as the glottis opens, generates a transient intrathoracic pressure gradient of 25–250 mm Hg. This evokes a decrease in R–R interval, which is maximal at 2–3 seconds and returns to resting value in approximately 12–14 seconds.<sup>81,82</sup> The cough-induced cardioacceleration is primarily under cholinergic control, although it is partly related to the intense contraction of abdominal and expiratory muscles.<sup>82</sup> The cough test has been applied to the evaluation of cardiac parasympathetic integrity.<sup>83</sup> Comparison to conventional tests of cardiovagal function such as the standing test and the Valsalva maneuver has shown no advantage to the cough test.<sup>84</sup>

The diving reflex is provoked by facial cooling and consists of reflex bradycardia, apnea, and vasoconstriction. The bradycardia depends on a trigeminal–cardiovagal reflex in which stimulation of the sensory branches of the trigeminal nerve evokes an efferent response in the motor nucleus of the vagus nerve.<sup>85,86</sup> A practical alternative to facial immersion in cold water (the diving test) is the application of cold compresses to the face (the cold face test), which avoids the potential for aspiration.<sup>87</sup>

Baroreflex sensitivity has also been assessed by regressing the change in heart period to a titrated decrease or increase in blood pressure

evoked by vasoactive drugs.<sup>88–90</sup> Alternatively, baroreflex sensitivity has been estimated by baroslopes generated by negative pressure applied to the carotid sinus by a finely regulated neck suction device.<sup>91,92</sup>

### Key Points

- Additional, infrequently used tests of cardiovagal function include heart rate responses to (1) lying down, (2) squatting, (3) coughing, (4) facial immersion or cooling, (5) infusion of vasoactive drugs, or (6) carotid sinus external suction.

## SUMMARY

Noninvasive cardiovascular tests are reliable and reproducible and are widely used to evaluate autonomic function in human subjects. The heart rate response to deep breathing is probably the most reliable test for assessing the integrity of the vagal afferent and efferent pathways to the heart. This is because respiratory sinus arrhythmia is a relatively pure test of cardiovagal function, whereas many other conditions, such as plasma volume, antecedent rest, and cardiac and peripheral sympathetic functions, factor into the Valsalva response. Heart rate variability to deep breathing is usually tested at a breathing frequency of 5 or 6 respirations per minute and decreases linearly with age. The Valsalva maneuver consists of a forced expiratory effort against resistance and produces mechanical (phases I and III) and reflex (phases II and IV) changes in arterial pressure and heart rate. When performed under continuous arterial pressure monitoring with a noninvasive technique, the Valsalva maneuver provides valuable information about the integrity of the cardiac parasympathetic, cardiac sympathetic, and sympathetic vasomotor outputs. The responses to the Valsalva maneuver are affected by the position of the subject and the magnitude and duration of the expiratory effort. In general, it is performed at an expiratory pressure of 40 mm Hg sustained for 15 seconds. The Valsalva ratio, the relationship between the maximal heart rate response during phase II (straining) and phase IV (after release of straining), has been considered a test of cardiac parasympathetic function. However, without simultaneous recording of

arterial pressure, this may be misleading. An exaggerated decrease in arterial pressure during phase II suggests sympathetic vasomotor failure, whereas an absence of overshoot during phase IV indicates the inability to increase cardiac output and cardiac adrenergic failure.

## REFERENCES

- Hon, E. H., and S. T. Lee. 1965. Electronic evaluation of the fetal heart rate patterns preceding fetal death: Further observations. *American Journal of Obstetrics and Gynecology* 87:814–26.
- Ewing, D. J., C. N. Martyn, R. J. Young, and B. F. Clarke. 1985. The value of cardiovascular autonomic function tests: 10 years experience in diabetes. *Diabetes Care* 8:491–8.
- van Lieshout, J. J., W. Wieling, K. H. Wesseling, and J. M. Karemaker. 1989. Pitfalls in the assessment of cardiovascular reflexes in patients with sympathetic failure but intact vagal control. *Clinical Science* 76:523–8.
- Wieling, W., and J. J. van Lieshout. 1990. The assessment of cardiovascular reflex activity: Standardization is needed. *Diabetologia* 33:182–3.
- Low, P. A. 1997. Pitfalls in autonomic testing. In *Clinical autonomic disorders: Evaluation and management*, ed. P. A. Low, 2nd ed., 391–401. Philadelphia: Lippincott-Raven Publishers.
- Low, P. A., and M. A. Pfeifer. 1997. Standardization of autonomic function. In *Clinical autonomic disorders: Evaluation and management*, ed. P. A. Low, 2nd ed., 287–95. Philadelphia: Lippincott-Raven Publishers.
- Katona, P. G., and F. Jih. 1975. Respiratory sinus arrhythmia: Noninvasive measure of parasympathetic cardiac control. *Journal of Applied Physiology* 39:801–5.
- Jalife, J., and D. C. Michaels. 1994. Neural control of sinoatrial pacemaker activity. In *Vagal control of the heart: Experimental basis and clinical implications*, ed. M. N. Levy, and P. J. Schwartz, 173–205. New York: Futura Publishing Company.
- Spyer, K. M. 1999. Central nervous control of the cardiovascular system. In *Autonomic failure: A textbook of clinical disorders of the autonomic nervous system*, ed. C. J. Mathias, and R. Bannister, 4th ed., 45–55. New York: Oxford University Press.
- Vallbona, C., D. Cardus, W. A. Spencer, and H. E. Hoff. 1965. Patterns of sinus arrhythmia in patients with lesions of the central nervous system. *The American Journal of Cardiology* 16:379–89.
- Saul, J. P., and R. J. Cohen. 1994. Respiratory sinus arrhythmia. In *Vagal control of the heart: Experimental basis and clinical implications*, ed. M. N. Levy, and P. J. Schwartz, 511–36. New York: Futura Publishing Company.
- Eckberg, D. L., Y. T. Kifle, and V. L. Roberts. 1980. Phase relationship between normal human respiration and baroreflex responsiveness. *The Journal of Physiology (London)* 304:489–502.
- Freyschuss, U., and A. Melcher. 1975. Sinus arrhythmia in man: Influence of tidal volume and oesophageal pressure. *Scandinavian Journal of Clinical and Laboratory Investigation* 35:487–96.
- Bennett, T., P. H. Fentem, D. Fitton, J. R. Hampton, D. J. Hosking, and P. A. Riggott. 1977. Assessment of vagal control of the heart in diabetes. Measures of R–R interval variation under different conditions. *British Heart Journal* 39:25–8.
- Eckberg, D. L. 1983. Human sinus arrhythmia as an index of vagal cardiac outflow. *Journal of Applied Physiology* 54:961–6.
- O'Brien, I. A., P. O'Hare, and R. J. Corral. 1986. Heart rate variability in healthy subjects: Effect of age and the derivation of normal ranges for tests of autonomic function. *British Heart Journal* 55:348–54.
- Bennett, T., I. K. Farquhar, D. J. Hosking, and J. R. Hampton. 1978. Assessment of methods for estimating autonomic nervous control of the heart in patients with diabetes mellitus. *Diabetes* 27:1167–74.
- Espi, F., D. J. Ewing, and B. F. Clarke. 1982. Testing for heart rate variation in diabetes: Single or repeated deep breaths? *Acta Diabetologica Latina* 19:177–81.
- Weinberg, C. R., and M. A. Pfeifer. 1984. An improved method for measuring heart-rate variability: Assessment of cardiac autonomic function. *Biometrics* 40:855–61.
- Genovely, H., and M. A. Pfeifer. 1988. RR-variation: The autonomic test of choice in diabetes. *Diabetes/Metabolism Reviews* 4:255–71.
- Smith, S. A. 1982. Reduced sinus arrhythmia in diabetic autonomic neuropathy: Diagnostic value of an age-related normal range. *British Medical Journal* 285:1599–601.
- Wieling, W. 1983. Reduced sinus arrhythmia in diabetic autonomic neuropathy. *British Medical Journal* 286:1285.
- Bergstrom, B., B. Lilja, K. Rosberg, and G. Sundkvist. 1986. Autonomic nerve function tests. Reference values in healthy subjects. *Clinical Physiology* 6:523–8.
- Ingall, T. J. 1986. Autonomic nervous system function in ageing and in diseases of the peripheral nervous system. Thesis, University of Sydney.
- Kajiser, L., and C. Sachs. 1985. Autonomic cardiovascular responses in old age. *Clinical Physiology* 5:347–57.
- Masaoka, S., A. Lev-Ran, L. R. Hill, G. Vakil, and E. H. Hon. 1985. Heart rate variability in diabetes: Relationship to age and duration of the disease. *Diabetes Care* 8:64–8.
- Wieling, W., J. F. van Brederode, L. G. de Rijk, C. Borst, and A. J. Dunning. 1982. Reflex control of heart rate in normal subjects in relation to age: A data base for cardiac vagal neuropathy. *Diabetologia* 22: 163–6.
- Clark, C. V., and R. Mapstone. 1986. Age-adjusted normal tolerance limits for cardiovascular autonomic function assessment in the elderly. *Age and Ageing* 15:221–9.
- Low, P. A., T. L. Opfer-Gehrking, C. J. Proper, and I. Zimmerman. 1990. The effect of aging on cardiac autonomic and postganglionic sudomotor function. *Muscle & Nerve* 13:152–7.
- Low, P. A., J. C. Denq, T. L. Opfer-Gehrking, P. J. Dyck, P. C. O'Brien, and J. M. Slezak. 1997. Effect of age and gender on sudomotor and cardiovascular function

- and blood pressure response to tilt in normal subjects. *Muscle & Nerve* 20:1561–8.
31. Angelone, A., and N. A. Coulter, Jr. 1964. Respiratory sinus arrhythmia: A frequency dependent phenomenon. *Journal of Applied Physiology* 19:479–82.
  32. Pfeifer, M. A., D. Cook, J. Brodsky, et al. 1982. Quantitative evaluation of cardiac parasympathetic activity in normal and diabetic man. *Diabetes* 31:339–45.
  33. Rottenberg, J. 2007. Cardiac vagal control in depression: A critical analysis. *Biological Psychology* 74:200–11.
  34. Coker, R., A. Koziell, C. Oliver, and S. E. Smith. 1984. Does the sympathetic nervous system influence sinus arrhythmia in man? Evidence from combined autonomic blockade. *The Journal of Physiology (London)* 356:459–64.
  35. Pitzalis, M. V., F. Mastropasqua, F. Massari, et al. 1998. Beta-blocker effects on respiratory sinus arrhythmia and baroreflex gain in normal subjects. *Chest* 114:185–91.
  36. Elghozi, J. L., and C. Julien. 2007. Sympathetic control of short-term heart rate variability and its pharmacological modulation. *Fundamental & Clinical Pharmacology* 21:337–47.
  37. Lacroix, D., R. Logier, S. Kacet, et al. 1992. Effects of consecutive administration of central and peripheral anticholinergic agents on respiratory sinus arrhythmia in normal subjects. *Journal of the Autonomic Nervous System* 39:211–17.
  38. Wang, J., X. Wang, M. Irnaten, et al. 2003. Endogenous acetylcholine and nicotine activation enhances GABAergic and glycinergic inputs to cardiac vagal neurons. *Journal of Neurophysiology* 89:2473–81.
  39. Loula, P., V. Jäntti, and A. Yli-Hankala. 1997. Respiratory sinus arrhythmia during anaesthesia: Assessment of respiration related beat-to-beat heart rate variability analysis methods. *International Journal of Clinical Monitoring and Computing* 14:241–9.
  40. Davidson, J., L. Watkins, M. Owens, et al. 2005. Effects of paroxetine and venlafaxine XR on heart rate variability in depression. *Journal of Clinical Psychopharmacology* 25:480–4.
  41. Low, P. A., and T. L. Opfer-Gehrking. 1992. Differential effects of amitriptyline on sudomotor, cardiovagal, and adrenergic function in human subjects. *Muscle & Nerve* 15:1340–4.
  42. Mehlsen, J., K. Pagh, J. S. Nielsen, L. Sestoft, and S. L. Nielsen. 1987. Heart rate response to breathing: Dependency upon breathing pattern. *Clinical Physiology* 7:115–24.
  43. Booth, R. W., J. M. Ryan, H. C. Mellet, E. Swiss, and E. Neth. 1962. Hemodynamic changes associated with the Valsalva maneuver in normal men and women. *The Journal of Laboratory and Clinical Medicine* 59:275–85.
  44. Brooker, J. Z., E. L. Alderman, and D. C. Harrison. 1974. Alterations in left ventricular volumes induced by Valsalva manoeuvre. *British Heart Journal* 36:713–18.
  45. Sharpey-Schafer, E. P. 1955. Effects of Valsalva's manoeuvre on the normal and failing circulation. *British Medical Journal* 1:693–5.
  46. Nishimura, R. A., and A. J. Tajik. 1986. The Valsalva maneuver and response revisited. *Mayo Clinic Proceedings* 61:211–17.
  47. Benarroch, E. E., T. L. Opfer-Gehrking, and P. A. Low. 1991. Use of the photoplethysmographic technique to analyze the Valsalva maneuver in normal man. *Muscle & Nerve* 14:1165–72.
  48. Imholz, B. P., G. A. van Montfrans, J. J. Settels, G. M. van der Hoeven, J. M. Karemaker, and W. Wieling. 1988. Continuous non-invasive blood pressure monitoring: Reliability of Finapres device during the Valsalva manoeuvre. *Cardiovascular Research* 22:390–7.
  49. Korner, P. I., A. M. Tonkin, and J. B. Uther. 1976. Reflex and mechanical circulatory effects of graded Valsalva maneuvers in normal man. *Journal of Applied Physiology* 40:434–40.
  50. Eckberg, D. L. 1980. Parasympathetic cardiovascular control in human disease: A critical review of methods and results. *The American Journal of Physiology* 239:H581–93.
  51. Leon, D. F., J. A. Shaver, and J. J. Leonard. 1970. Reflex heart rate control in man. *American Heart Journal* 80:729–39.
  52. Delius, W., K. E. Hagbarth, A. Hongell, and B. G. Wallin. 1972. Manoeuvres affecting sympathetic outflow in human muscle nerves. *Acta Physiologica Scandinavica* 84:82–94.
  53. Wallin, B. G., and D. L. Eckberg. 1982. Sympathetic transients caused by abrupt alterations of carotid baroreceptor activity in humans. *The American Journal of Physiology* 242:H185–90.
  54. Sandroni, P., E. E. Benarroch, and P. A. Low. 1991. Pharmacological dissection of components of the Valsalva maneuver in adrenergic failure. *Journal of Applied Physiology* 71:1563–7.
  55. Levin, A. B. 1966. A simple test of cardiac function based upon the heart rate changes induced by the Valsalva maneuver. *The American Journal of Cardiology* 18:90–9.
  56. Smith, M. L., L. A. Beightol, J. M. Fritsch-Yelle, K. A. Ellenbogen, T. R. Porter, and D. L. Eckberg. 1996. Valsalva's maneuver revisited: A quantitative method yielding insights into human autonomic control. *The American Journal of Physiology* 271:H1240–9.
  57. Deng, J. C., P. C. O'Brien, and P. A. Low. 1998. Normative data on phases of the Valsalva maneuver. *Journal of Clinical Neurophysiology* 15:535–40.
  58. Parati, G., R. Casadei, A. Groppelli, M. Di Rienzo, and G. Mancia. 1989. Comparison of finger and intra-arterial blood pressure monitoring at rest and during laboratory testing. *Hypertension* 13:647–55.
  59. Ten Harkel, A. D., J. J. Van Lieshout, E. J. Van Lieshout, and W. Wieling. 1990. Assessment of cardiovascular reflexes: Influence of posture and period of preceding rest. *Journal of Applied Physiology* 68:147–53.
  60. Kautzner, J., J. E. Hartikainen, A. J. Camm, and M. Malik. 1996. Arterial baroreflex sensitivity assessed from phase IV of the Valsalva maneuver. *The American Journal of Cardiology* 78:575–9.
  61. Trimarco, B., M. Volpe, B. Ricciardelli, et al. 1983. Valsalva maneuver in the assessment of baroreflex responsiveness in borderline hypertensives. *Cardiology* 70:6–14.



62. Huang, C. C., P. Sandroni, D. M. Sletten, et al. 2007. Effect of age on adrenergic and vagal baroreflex sensitivity in normal subjects. *Muscle & Nerve* 36:637–42.
63. Schrezenmaier, C., W. Singer, N. M. Swift, et al. 2007. Adrenergic and vagal baroreflex sensitivity in autonomic failure. *Archives of Neurology* 64:381–6.
64. Faulkner, M. S., D. Hathaway, and B. Tolley. 2003. Cardiovascular autonomic function in healthy adolescents. *Heart & Lung* 32:10–22.
65. Opfer-Gehrking, T. L., and P. A. Low. 1993. Impaired respiratory sinus arrhythmia with paradoxically normal Valsalva ratio indicates combined cardiovascular and peripheral adrenergic failure. *Clinical Autonomic Research* 3:169–73.
66. Biaggioni, I., D. S. Goldstein, T. Atkinson, and D. Robertson. 1990. Dopamine-beta-hydroxylase deficiency in humans. *Neurology* 40:370–3.
67. Cheshire, W. P., D. W. Dickson, K. F. Nahm, et al. 2006. Dopamine beta-hydroxylase deficiency involves the central autonomic network. *Acta Neuropathologica (Berlin)* 112:227–9.
68. Low, P. A. 1997. Laboratory evaluation of autonomic function. In *Clinical autonomic disorders: Evaluation and management*, ed. P. A. Low, 2nd ed., 191–2. Philadelphia: Lippincott-Raven Publishers.
69. Novak, V., P. Novak, and P. A. Low. 1997. Time-frequency analysis of cardiovascular function and its clinical applications. In *Clinical autonomic disorders: Evaluation and management*, ed. P. A. Low, 2nd ed., 323–48. Philadelphia: Lippincott-Raven Publishers.
70. Novak, V., P. Novak, T. L. Opfer-Gehrking, and P. A. Low. 1996. Postural tachycardia syndrome: Time frequency mapping. *Journal of Autonomic Nervous System* 61:313–20.
71. Novak, V., P. Novak, J. de Champlain, et al. 1993. Influence of respiration on heart rate and blood pressure fluctuations. *Journal of Applied Physiology* 74: 617–26.
72. Ewing, D. J., I. W. Campbell, A. Murray, J. M. Neilson, and B. F. Clarke. 1978. Immediate heart-rate response to standing: Simple test for autonomic neuropathy in diabetes. *British Medical Journal* 1:145–7.
73. Cybulski, G., and W. Niewiadomski. 2003. Influence of age on the immediate heart rate response to the active orthostatic test. *Journal of Physiology and Pharmacology* 54:65–80.
74. Borst, C., W. Wieling, J. F. van Brederode, A. Hond, L. G. de Rijk, and A. J. Dunning. 1982. Mechanisms of initial heart rate response to postural change. *The American Journal of Physiology* 243:H676–81.
75. Wieling, W., M. P. Harms, A. D. ten Harkel, et al. 1996. Circulatory response evoked by a 3 s bout of dynamic leg exercise in humans. *Journal of Physiology* 494:601–11.
76. Goodwin, G. M., D. I. McCloskey, and J. H. Mitchell. 1972. Cardiovascular and respiratory responses to changes in central command during isometric exercise at constant muscle tension. *Journal of Physiology* 226:173–90.
77. Sanders, J. S., A. L. Mark, and D. W. Ferguson. 1989. Evidence for cholinergically mediated vasodilatation at the beginning of isometric exercise in humans. *Circulation* 79:815–24.
78. Bellavere, F., and D. J. Ewing. 1982. Autonomic control of the immediate heart rate response to lying down. *Clinical Science* 62:57–64.
79. Bellavere, F., C. Cardone, M. Ferri, et al. 1987. Standing to lying heart rate variation. A new simple test in the diagnosis of diabetic autonomic neuropathy. *Diabetic Medicine* 4:41–3.
80. Marfella, R., D. Giugliano, G. di Maro, R. Acampora, R. Giunta, and F. D'Onofrio. 1994. The squatting test. A useful tool to assess both parasympathetic and sympathetic involvement of the cardiovascular autonomic neuropathy in diabetes. *Diabetes* 43: 607–12.
81. Wei, J. Y., J. W. Rowe, A. D. Kestenbaum, and S. Ben-Haim. 1983. Post-cough heart rate response: Influence of age, sex, and basal blood pressure. *The American Journal of Physiology* 245:R18–24.
82. Cardone, C., F. Bellavere, M. Ferri, and D. Fedele. 1987. Autonomic mechanisms in the heart rate response to coughing. *Clinical Science* 72:55–60.
83. Cardone, C., P. Pausco, G. Marchetti, et al. 1990. Cough test to assess cardiovascular autonomic reflexes in diabetes. *Diabetes Care* 13:719–24.
84. van Lieshout, E. J., J. J. van Lieshout, A. D. ten Harkel, and W. Wieling. 1989. Cardiovascular responses to coughing: Its value in the assessment of autonomic nervous control. *Clinical Science (London)* 77: 305–10.
85. Khurana, R. K., S. Watabiki, J. R. Hebel, R. Toro, and E. Nelson. 1980. Cold face test in the assessment of trigeminal-brain stem-vagal function in humans. *Annals of Neurology* 7:144–9.
86. Schaller, B. 2004. Trigemino-cardiac reflex: A clinical phenomenon or a new physiological entity? *Journal of Neurology* 251:658–65.
87. Khurana, R. K., and R. Wu. 2006. The cold face test: A non-baroreflex mediated test of cardiac vagal function. *Clinical Autonomic Research* 16:202–7.
88. Kingwell, B. A., G. A. McPherson, and P. I. Korner. 1991. Assessment of gain of tachycardia and bradycardia responses of cardiac baroreflex. *The American Journal of Physiology* 260:H1254–63.
89. Korner, P. I., M. J. West, J. Shaw, and J. B. Uther. 1974. "Steady-state" properties of the baroreceptor-heart rate reflex in essential hypertension in man. *Clinical and Experimental Pharmacology & Physiology* 1:65–76.
90. Korner, P. I., J. Shaw, M. J. West, and J. R. Oliver. 1972. Central nervous system control of baroreceptor reflexes in the rabbit. *Circulation Research* 31: 637–52.
91. Ebert, T. J., J. J. Hayes, J. Ceschi, et al. 1984. Repetitive ramped neck suction: A quantitative test of human baroreceptor function. *The American Journal of Physiology* 247:H1013–17.
92. Kardos, A., H. Rau, M. W. Greenlee, et al. 1995. Comparison of two mechanical carotid baroreceptor stimulation techniques. *Acta Physiologica Hungarica* 83:121–33.

*This page intentionally left blank*



# Electrophysiology of Pain

*Rose M. Dotson and Paola Sandroni*

**INTRODUCTION**  
**QUANTITATIVE SENSORY TEST**  
**AUTONOMIC TESTS**  
**MICRONEUROGRAPHY**

**LASER EVOKED POTENTIALS**  
**CONTACT HEAT EVOKED**  
**POTENTIALS**  
**SUMMARY**

## INTRODUCTION

The diagnosis and treatment of neuropathic pain are a challenge for physicians caring for patients who have medical conditions causing this type of pain. The incompletely understood complex mechanisms of neuropathic pain contribute to the difficulty. Another major obstacle has been finding a test to objectively demonstrate and quantify a physiologic disruption in sensory function that may be the cause of the pain. For many years, those involved in the study of pain have attempted to quantify the pain experience solely by bedside psychophysical evaluations and the subjective reports of patients. Tests of large-fiber function, including vibrometry, sensory nerve conduction studies, and routine somatosensory evoked potentials, have been used to document large myelinated fiber sensory abnormalities that might also involve small diameter axons of the nociceptive system. The first step was to develop neurophysiologic techniques to assess the function of the peripheral and central components of pain pathways in normal subjects. The next step was to refine the techniques and to gather normal data. These techniques can be applied to patients with altered sensory function, specifically those with neuropathic pain.

The tests are objective or semiobjective physiologic measures that correlate with abnormal function in the nociceptive system and document a lesion that potentially could result in pain. They allow clinicians to assess neuropathic pain by quantifying responses to neurophysiologic tests and using the results to develop a better understanding of the underlying pathophysiologic mechanisms of the pain.

This chapter reviews various neurophysiologic techniques used to study the function and dysfunction of the nociceptive system in humans, including quantitative sensory tests (QSTs), autonomic tests, microneurography (MCNG), laser evoked potentials (LEPs) and contact heat evoked potential stimulator (CHEPS). The review outlines the physiologic basis of and methods for performing these techniques, some applications of the tests in patients with pain, and some of the potential pitfalls in the use of these tests. Details of the techniques for performing autonomic tests are given in Chapters 35–39.

### ***Purpose and Role of Available Techniques to Evaluate Pain Pathways***

- QST is a neuropsychophysiologic technique: it complements the neurological

examination and neurophysiologic testing by providing a quantification of the subjective sensory experience.

- Autonomic testing assesses the function of small fibers: although the small fibers conveying pain are somatic, not autonomic, they are often similarly affected by the pathologic process, and autonomic function can be used as a surrogate measure.
- MCNG is a time-consuming, albeit accurate, direct way to assess single fiber function. It has no clinical role at this point, but is widely used in research.
- LEPs and CHEPS are the equivalent of somatosensory evoked potentials for small fibers. LEPs have limited clinical use. CHEPS are promising as a routine test, but their role still needs to be proven.

## QUANTITATIVE SENSORY TEST

The QST is useful for assessing myelinated and unmyelinated sensory fibers in the periphery and in nociceptive pathways of the central nervous system in persons with neurogenic pain.<sup>1</sup> The test uses controlled thermal stimulation of the skin to allow examiners to reproducibly quantify sensory nerve function of nociceptive pathways. It relies on the subjective report of the patient that he or she perceives the stimulus. The QST quantifies sensory nerve function by allowing the examiner to determine the intensity of stimulus required for perception and, at times, to correlate this with the patient's report of the type and intensity of sensation. The test must use one stimulus type at a time, with precisely defined physical characteristics and intensity. The apparatus must have a program that allows the examiner to deliver stimuli to the skin of the patient using appropriate algorithms. This ensures that the test provides an accurate, consistent, and semiobjective assessment of sensory function.

The most useful and efficient algorithm for determining pain thresholds—that is, the intensity at which at least 50% of the stimuli are perceived as painful—is the *method of limits*. In addition, this algorithm allows the examiner to obtain reliable results with delivery of the least number of potentially unpleasant stimuli. This is important because repetitive

stimulation of a primary afferent can produce sensitization. The method of limits exposes the patient to a stimulus of changing intensity after he or she has been instructed to signal the first perception of pain or temperature sensation, called the *appearance threshold*. Thresholds may also be approached from above threshold level, with the patient reporting the cessation of sensation, called the *disappearance threshold*. This algorithm is as sensitive and reproducible as other less time-efficient methods, for example, forced-choice testing, which may give lower absolute values but do not provide more accurate data.<sup>2-4</sup>

*Magnitude estimation*, an algorithm that uses a visual analog scale to rate sensation perceived when a suprathreshold stimulus is applied, is useful in evaluating pain.<sup>5-7</sup> Dyck et al.<sup>8</sup> developed a method called the *4, 2, and 1 stepping algorithm* that incorporates magnitude estimation with the addition of null stimuli randomly interposed between pyramidal and flat-topped pyramidal stimuli. The testing starts at an intermediate level of stimulus intensity, uses 25 steps to reach maximal intensity, and uses the visual analogue scale that allows patients to rate the pain intensity. This method of testing produces results that are well correlated with the standard forced-choice algorithm.<sup>8,9</sup>

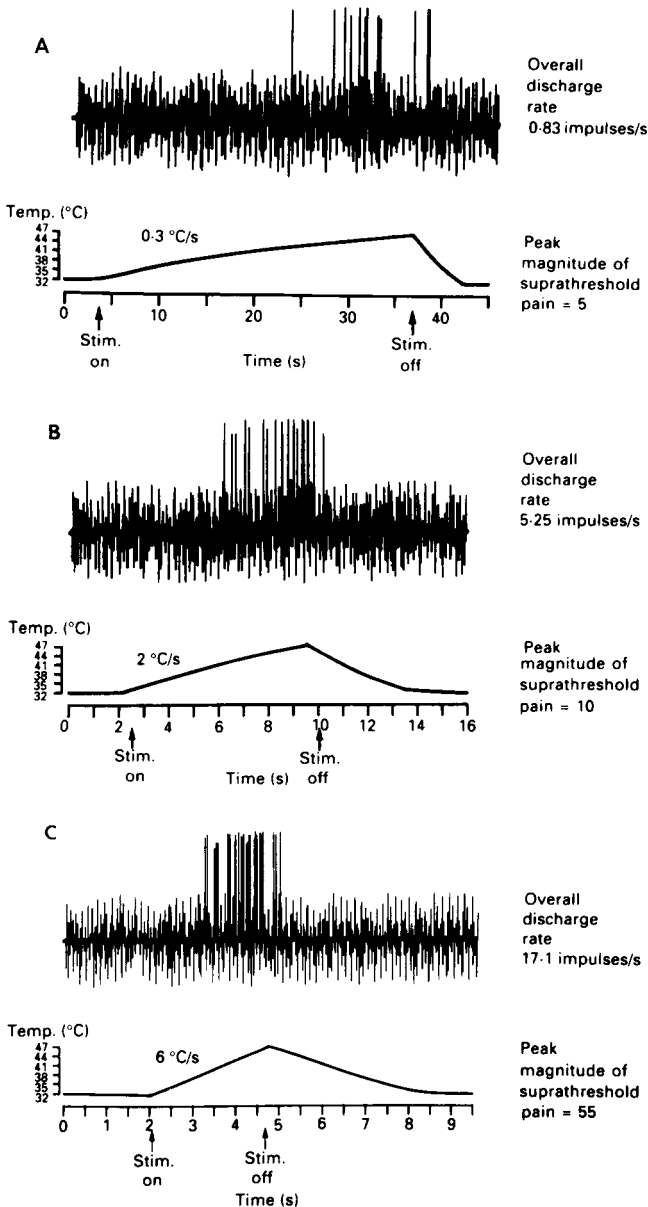
The examiner can observe abnormal patterns that correspond to pathophysiologic changes in the sensory nervous system, central or peripheral. There are also clues to nonphysiologic or psychogenic abnormal patterns with erratic results that are not reproducible.

QST systems provide a temperature stimulus by means of a contact Peltier-type thermode, with a surface area of 3–13 cm,<sup>2</sup> that is applied to the skin to warm or cool the area under the thermode. A thermocouple is placed at the skin–thermode interface to monitor the temperature of the stimulus. The thermode is set initially at the adaptation or holding temperature of 30°C–34°C, within the range of temperature at which only a transient thermal sensation is caused by placing the probe on the skin.<sup>10</sup> The examiner operates the apparatus to cause temperature changes within certain limits, usually 0°C–50°C, that are set to prevent burning the patient's skin. The rate of temperature change should be standardized to ensure the validity of normal data. The findings from a study using psychophysical measures

and MCNG to record C nociceptor activity in response to noxious heat stimuli delivered with a QST apparatus to the skin of normal human volunteers are shown in Figure 40-1. This study showed that both the magnitude of pain perceived by the subjects and the frequency of C nociceptor discharges in response to the stimulus increased with faster rates of temperature increase.<sup>11</sup> Therefore, the examiner should conduct the QST using a consistent

temperature ramp for gathering normal data and testing patients.

The patient indicates when the first sensation occurs in response to cooling or warming the stimulus probe attached to the skin. The sensation (stimulus perception or pain) that occurs in response to a cold or hot stimulus is indicated by the patient, who either tells the examiner or presses a button to halt the stimulus and to reset the thermode temperature to the



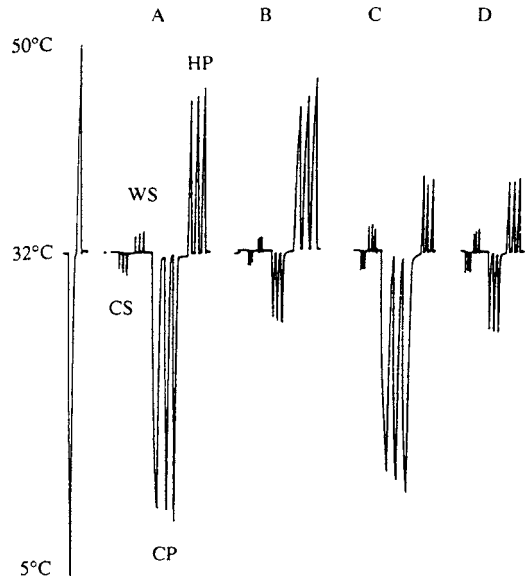
**Figure 40-1.** A-C, Discharge of a single C nociceptor in response to heat stimulus ramps between 32°C and 47°C, at three rates of temperature rise. Note different time bases for each of the three graphs. Discharge rate recorded and peak magnitude estimate of evoked pain are given. (From Yarnitsky, D., D. A. Simone, R. M. Dotson, M. A. Cline, and J. L. Ochoa. 1992. Single C nociceptor responses and psychophysical parameters of evoked pain: Effect of rate of rise of heat stimuli in humans. *The Journal of Physiology* 450:581-92. By permission of the Physiological Society.)

holding level. The QST apparatus records the stimulus temperature at which the patient indicated perception of a change in temperature or pain. The test apparatus includes standardized thermode size, stimulation sites, rate of change in stimulus temperature, interstimulus intervals, and pretest skin temperature.

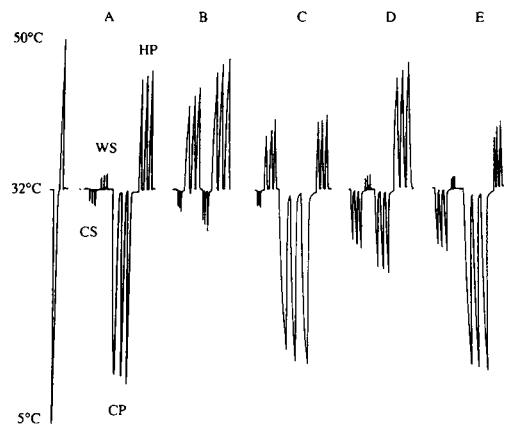
Tests are performed in normal volunteers and in patients who have pain, to provide standardized normal values and valid comparisons. In addition, comparison of the results obtained on painful areas of skin with that obtained from the same site on the uninvolved side allows the examiner to determine whether unilateral cold or heat hyperalgesia or allodynia is present. The interpretation of results should consider that cold hypalgesia may occur in normal subjects as well as in patients with pain. Heat hypalgesia alone is rare and difficult to document because of the setting of an upper temperature limit of 50°C to prevent injury. The normal ranges of pain thresholds obtained using the method of limits are 44°C–47°C for a hot stimulus and 9°C–12°C for a cold stimulus.<sup>12</sup>

The QST evaluates the entire peripheral and central portions of the sensory system that participate in the transmission and perception of painful hot or cold stimuli. Thermal stimulation directly activates the receptor in the skin, and the receptor in turn activates the axon innervating it. In the peripheral nervous system, the primary afferent fibers that convey these messages to the central nervous system are C and A $\delta$  nociceptors. The central nociceptive system consists of the spinothalamic tract, cerebral cortex, antinociceptive areas of the brain stem, and probably the hypothalamus, amygdala, and limbic cortex.<sup>13</sup>

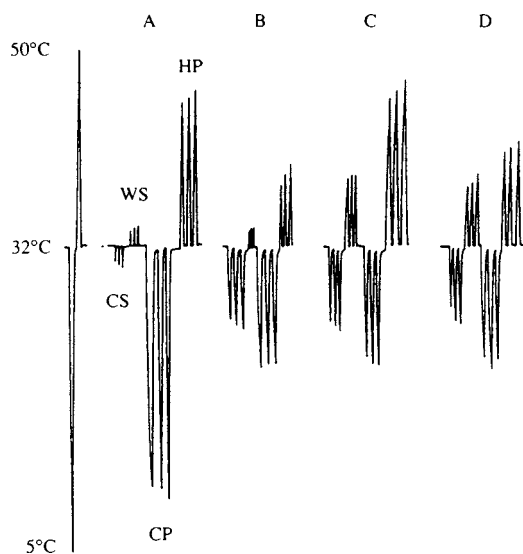
Decreased (hyperalgesia or allodynia) or increased (hypalgesia) thresholds for the perception of a cold or hot stimulus may occur in various combinations, as demonstrated by Verdugo and Ochoa<sup>12</sup> in patients with somatosensory disorders (Figs. 40–2 to 40–4). In some patients with pain, the somatosensory abnormality is hyperalgesia selectively in response to a cold or a hot stimulus. Ochoa and Yarnitsky<sup>14</sup> described patients with neuropathy who had cold skin, reduced ability to perceive cool stimuli, and cold hyperalgesia. These patients had evidence of small myelinated A $\delta$ -fiber neuropathy with sparing of unmyelinated C fibers.



**Figure 40–2.** Pure cold pain and/or heat pain hyperalgesia. A, Normal pattern; B, Pure cold pain hyperalgesia (30 patients); C, Pure heat hyperalgesia (26 patients); D, Combined cold pain and heat pain hyperalgesia (5 patients). CP, cold pain; CS, cold sensation; HP, heat pain; WS, warm sensation. (From Verdugo, R., and J. L. Ochoa. 1992. Quantitative somatosensory thermotest. A key method for functional evaluation of small calibre afferent channels. *Brain* 115:893–913. By permission of Oxford University Press.)



**Figure 40–3.** Thermal hypesthesia combined with thermal pain hyperalgesia. A, Normal pattern; B, Warm hypesthesia associated with cold pain hyperalgesia (6 patients); C, Warm hypesthesia associated with heat pain hyperalgesia (1 patient); D, Cold hypesthesia associated with cold pain hyperalgesia (4 patients); E, Cold hypesthesia associated with heat pain hyperalgesia (17 patients). CP, cold pain; CS, cold sensation; HP, heat pain; WS, warm sensation. (From Verdugo, R., and J. L. Ochoa. 1992. Quantitative somatosensory thermotest. A key method for functional evaluation of small calibre afferent channels. *Brain* 115:893–913. By permission of Oxford University Press.)



**Figure 40-4.** Thermal hypesthesia combined with thermal pain hyperalgesia (continuation of Fig. 40-3). A, Normal pattern; B, Cold hypesthesia associated with cold and heat pain hyperalgesia (5 patients); C, Cold and warm hypesthesia associated with cold pain hyperalgesia (1 patient); D, Cold and warm hypesthesia associated with cold and heat pain hyperalgesia (1 patient). CP, cold pain; CS, cold sensation; HP, heat pain; WS, warm sensation. (From Verdugo, R., and J. L. Ochoa. 1992. Quantitative somatosensory thermotest. A key method for functional evaluation of small calibre afferent channels. *Brain* 115:893-913. By permission of Oxford University Press.)

Many clinical reports indicate that patients with complex regional pain syndrome (CRPS), or reflex sympathetic dystrophy (RSD), frequently report cold hyperalgesia on the QST or bedside examination. In fact, a comprehensive QST evaluation of patients with this clinical diagnosis by means of the QST showed that they may have cold hyperalgesia, heat hyperalgesia, or both. These abnormalities can be quantified and followed clinically with the QST to show response to treatment.<sup>12,15</sup>

Heat hyperalgesia with spontaneous burning pain occurs in erythromelalgia or capsaicin-treated skin. The QST pattern in these instances is one of decreased threshold for pain to hot, but not to cold, stimuli. The spontaneous burning pain and mechanical hyperalgesia in these patients can be lessened by decreasing skin temperature, but the pain remains during compression-ischemia A-fiber nerve block. This experimental finding indicates that C fibers mediate these sensory changes of primary hyperalgesia within the

actual area of injury in patients or in the area where capsaicin is applied directly to the skin of normal subjects.<sup>16</sup> A study in human subjects that used QST and MCNG to identify sensitized C nociceptors in the peripheral nerve innervating an area of skin where the patient experienced spontaneous burning pain and heat hyperalgesia showed that the neural discharge of the abnormal, sensitized C nociceptors correlated with the perceived magnitude of pain as measured by the visual analog scale<sup>17</sup> (Figs. 40-5 and 40-6). The QST is useful in determining the pattern and degree of abnormality, in following the clinical course, and in documenting the response to treatment.<sup>15,18</sup>

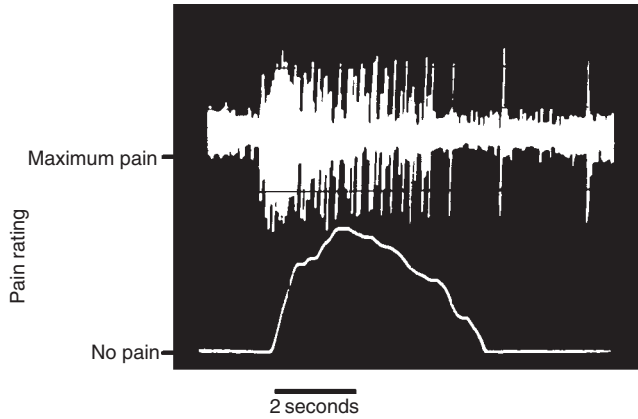
QST measurements can document and quantify hypesthesia, hyperesthesia, hypalgesia, and hyperalgesia. Thus, the clinician has a reproducible measurement of nerve dysfunction that can be attributed to a particular type of primary afferent nerve fiber that may be involved in pain production if the lesion is in the periphery. However, the QST does not differentiate central from peripheral dysfunction, because the abnormalities found are not specifically localized and may be located in the nociceptive pathway at any level of the neuraxis. This test can be used to make the initial assessment, to follow the clinical course, and to determine the response to medications and other forms of intervention.<sup>19,20</sup>

### Key Points

- QST is a neuropsychophysiologic test.
- All sensory fibers are tested; thus, it can detect the degree of large vs. small fiber dysfunction.
- Patient's cooperation is necessary for an accurate assessment: malingerers can usually be detected by the inconsistencies, thanks to the paradigm used.
- Elevated thresholds (i.e., hypoesthesia) as well as allodynia can be detected.

## AUTONOMIC TESTS

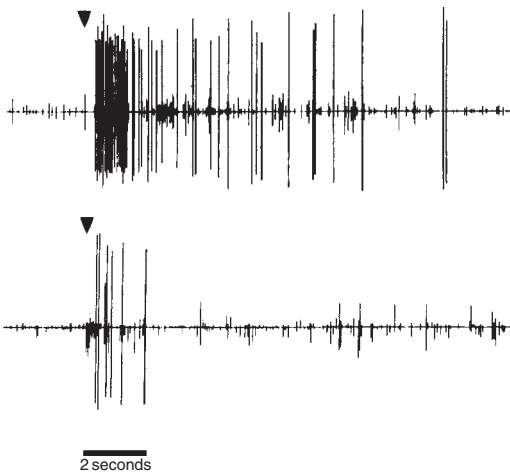
Patients with neurogenic pain and features indicating involvement of the sympathetic nervous system, either sudomotor or vasomotor, have a poorly understood pain symptom complex known as *complex regional pain*



**Figure 40-5.** Correlation between neural discharge of an identified sensitized C polymodal nociceptor with receptive field in symptomatic skin (*upper trace*) and simultaneous temporal profile of pain magnitude (*lower trace*) in response to gentle stroking of the receptive field. (From Cline, M. A., J. Ochoa, and H. E. Torebjörk. 1989. Chronic hyperalgesia and skin warming caused by sensitized C nociceptors. *Brain* 112:621–47. By permission of Oxford University Press.)

*syndrome* (CRPS) or *reflex sympathetic dystrophy* (RSD).<sup>21,22</sup> Visual inspection and patients' reports of alterations in sweating and skin temperature of involved body areas implicate the sympathetic nervous system. The multiple pathophysiologic mechanisms that may result in this clinical pattern are not completely known. There are several possibilities

regarding the exact role of the sympathetic efferents in this context, and this may vary from patient to patient or even within the same patient. These efferents may be the passive or the reactive arc of a somatosympathetic reflex response to noxious input. Also, denervated sympathetic end organs in case of nerve injury may cause the clinical symptoms or signs of autonomic nervous system involvement in neuropathic pain. Roberts<sup>23</sup> proposed that sympathetic efferents normally have an active role in helping to maintain low-threshold mechanoreceptor input to sensitized central nociceptors. Another hypothesis is that nociceptor activity is maintained by sympathetic efferent activity, thereby causing spontaneous or stimulus-induced sympathetically maintained pain. Indirect evidence supports the idea that there is sympathetic activation of nociceptors in humans with the clinical features of CRPS.<sup>24</sup> However, data from animal research indicate that, in peripheral nerve injury, sympathetic efferent activity causes excitation of cutaneous nociceptors.<sup>25–28</sup>



**Figure 40-6.** Response of an identified C polymodal unit in symptomatic skin (*upper trace*) compared with that from opposite nonpainful hand (*lower trace*). The mechanical stimulus (stroking with a blunt wooden stick) was applied to the receptive fields, at a time marked by arrowheads. Note the prolonged after-discharge for the C unit in symptomatic skin. (From Cline, M. A., J. Ochoa, and H. E. Torebjörk. 1989. Chronic hyperalgesia and skin warming caused by sensitized C nociceptors. *Brain* 112:621–47. By permission of Oxford University Press.)

The quantitative sudomotor axon reflex test (QSART), discussed in Chapter 36, is a sensitive test with an approximately 20% coefficient of variation. Thus, this test gives reproducible results in normal subjects and in patients with neuropathy. Furthermore, there is no significant side-to-side difference in normal subjects. This allows clinicians to compare the results in patients to normative values and to determine side-to-side differences in a patient with a unilateral painful condition to obtain useful



information about sympathetic dysfunction or sympathetic involvement in neuropathic pain states that fit the definition of CRPS.<sup>29–31</sup>

Patterns of QSART response that occur in limbs affected by painful peripheral neuropathies and CRPS are excessive or persistent sweat responses with reduced latencies or, in some cases, decreased sweat volumes.<sup>29–31</sup> An abnormal QSART pattern in a patient complaining of pain provides an objective measure indicating a pathophysiologic change in the involved limb that may occur with, but is not necessarily a causative factor for, the neuropathic pain.

Measurements of resting sweat output are helpful in conjunction with QSART to show sudomotor abnormalities in patients with the clinical features of CRPS. These patients tend to have increased resting sweat output on the involved limb compared with the normal side.<sup>30,31</sup>

The sympathetic skin response (SSR) evaluates sympathetic sudomotor function through somatosympathetic reflexes.<sup>32</sup> Some reports have documented SSR abnormalities in sudomotor function in patients with CRPS.<sup>33,34</sup> Because of inherent difficulties in producing quantifiable and reproducible data with the SSR technique, it is not a useful neurophysiologic tool for the assessment of neuropathic pain.

Skin temperature measurements with a surface thermistor or infrared thermography can compare multiple sites on the skin of the involved extremity with the corresponding areas on the asymptomatic extremity. Because patients with neuropathic pain or CRPS may have alterations in skin temperature in conjunction with sensory aberrations, these measurements permit examiners to document clinically useful abnormal temperature patterns or asymmetries caused by various pathophysiologic mechanisms.<sup>30</sup> Patients with lesions causing deafferentation pain and vasomotor denervation may have relatively warm skin on the involved side because of vasodilatation. Later in the course of the condition, denervation supersensitivity results in vasoconstriction caused by upregulation of adrenoreceptors on blood vessels that begin to respond more vigorously to circulating catecholamines. Thus, the skin on the involved side becomes cooler than that on the normal side. Maneuvers that usually result in reflex warming of the

skin, such as warming another part of the body or sympathetic blockade of the affected area, do not cause warming of that area of skin.

Patients with sensitized C nociceptors, erythromelalgia, or topically applied capsaicin secrete vasodilating substances antidromically from active nociceptors, and as a result, the skin is warm in the areas with pain and hyperalgesia.<sup>16,35,36</sup> This can be reproduced in normal human volunteers by performing MCNG with intraneural microstimulation at intensities that produce a painful sensation. Initially, the pain may cause vasoconstriction that is readily apparent on infrared thermography as cooling of the skin. Continued activity in the primary nociceptors with microstimulation causes vasodilatation and warming of the skin that sympathetic reactivation can override to produce cool skin. This may provide a pathophysiologic explanation for the variability in the temperature of the painful area of skin compared with that of the normal skin in patients with neuropathic pain.<sup>37</sup>

### Key Points

- Autonomic studies evaluate cardiovagal, adrenergic, and postganglionic sudomotor function: in doing so, they assess autonomic, but not somatic, small-fiber function.
- The tests are noninvasive but require patient's preparation and cooperation.
- The battery is complementary to other gastrointestinal, urologic, and cardiologic assessments of autonomic functions.
- A specific set of tests, focused on vasomotor and sudomotor functions, can be useful in the diagnosis of CRPS, albeit not very specific.
- The tests are reproducible and can be used to monitor disease evolution and treatment response.

## MICRONEUROGRAPHY

In MCNG, semimicroelectrodes with a tip diameter of 1–15  $\mu\text{m}$  are inserted percutaneously into an accessible peripheral nerve to record the activity in a single axon, in a portion of a fascicle, or in an entire nerve fascicle.<sup>35</sup> MCNG is useful for uncovering the physiologic mechanisms of neuropathic pain.<sup>39</sup> It is

a time-consuming test that requires a highly motivated and observant patient for successful acquisition of useful data. The electrode is connected via a preamplifier to an amplifier with attached audiomonitors and an oscilloscope to permit the examiner to monitor the neural activity of a peripheral nerve innervating an involved area of skin. The recording of skin and muscle sympathetic activity,  $A\beta$  low-threshold mechanoreceptors, and  $A\delta$  and C nociceptor afferent activity can provide pathophysiologic information about the mechanisms of different types of neuropathic pain.

As noted above, MCNG has documented the occurrence of sensitized C nociceptors in a patient with erythromelalgia-type pain.<sup>17</sup> Torebjork et al.<sup>40</sup> used MCNG to provide evidence that an injury or the application of capsaicin to the skin causes central sensitization in the area of secondary hyperalgesia outside the actual area of capsaicin injection or topical application. Ongoing nociceptive input appears to help maintain this sensitization.<sup>39</sup>

With MCNG, investigators have identified three previously undescribed types of human C nociceptors that respond only to mechanical, heat, or chemical stimuli.<sup>41</sup> Some of these units were sensitized to heating or mechanical stimuli after chemical stimulation with mustard oil, capsaicin, or tonic pressure.<sup>42,43</sup> These likely have a role in the primary hyperalgesia that occurs with chemical irritation or inflammation and in the secondary hyperalgesia caused by central sensitization.

Animal experiments have shown that sympathetic activation of primary afferents occurs with direct stimulation of sympathetic nerves.<sup>23</sup> This was not found in MCNG studies of human subjects and patients with the clinical features of CRPS in whom reflex activation of sympathetic efferents did not activate low-threshold mechanoreceptors.<sup>44</sup> In animals, the activity of sympathetic efferents results in neural activity in low-threshold mechanoreceptors in even the normal state; sympathetic efferents have a similar effect on nociceptors only after nerve injury.<sup>26-28</sup> Although patients with CRPS symptoms have allodynia on neurologic examination, activity in single isolated low-threshold mechanoreceptors produced by intraneural microstimulation at frequencies up to 30 Hz did not cause pain.<sup>45</sup> This suggests that temporal and spatial summation may be necessary for spontaneous or stimulus-induced

pain to occur with activation of low-threshold mechanoreceptors in the presence of central nociceptor sensitization.

MCNG may be used to unravel the complex story of pain and the sympathetic nervous system in humans by directly recording sympathetic efferent activity. With MCNG, Casale and Elam<sup>46</sup> demonstrated normal activity in a sympathetic efferent fiber in a nerve innervating a painful area of skin of a patient with the clinical symptom complex of CRPS. Our observations in several such patients are consistent with this finding.

### Key Points

- MCNG monitors directly the level of activity of single nerve fibers by intraneural recording.
- Once identified, fibers can be tested by applying specific stimuli to induce a response (such as a sensory stimulation for a somatic fiber or inducing hypotension if recording from a sympathetic fiber).
- The technique is tedious and time-consuming, and requires a very cooperative subject.
- Technical limitations have limited its use to research studies; it has no clinical application at this time.

## LASER EVOKED POTENTIALS

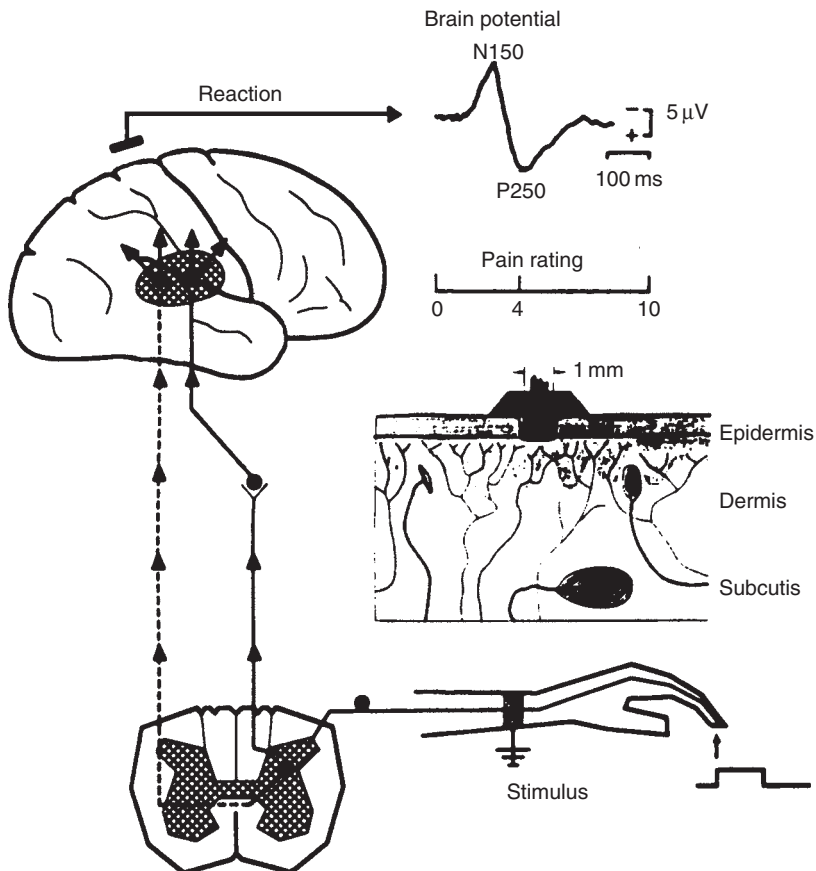
LEPs provide a noninvasive, easily tolerated means of directly assessing function of the central and peripheral portions of the nociceptive system.<sup>47</sup> Carmon et al.<sup>48</sup> first showed that stimulation of normal human skin with short-duration infrared CO<sub>2</sub> laser pulses produced a near-field cerebral potential at the vertex. Amplitudes of the cerebral response usually correlate well with the intensity of perceived pain reported by patients in response to the stimulus and with the intensity of the applied stimulus.<sup>49</sup> Wu et al.<sup>50</sup> recently reported on two patients with hyperalgesia (caused by central pain in one and peripheral neuropathic pain in the other) in whom the LEP responses were delayed, desynchronized, and attenuated.

Heat pain-producing lasers, as opposed to transcutaneous electrical stimulation of peripheral nerves traditionally used for somatosensory evoked potentials, can induce pain

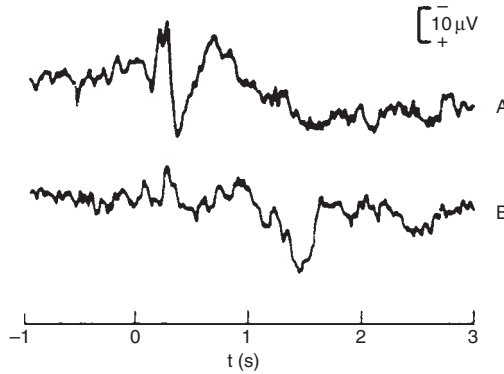
with minimal influence on other sensations (Fig. 40-7). Only minimal habituation, adaptation, or tissue damage tends to occur even with repeated applications of the laser stimulus. Although some laboratories use intracutaneous electric shock to obtain pain somatosensory evoked potentials, most laboratories perform LEPs. The laser does not contact the skin directly as it produces an invisible, inaudible, short-duration (20 ms) radiant heat pulse. The very superficial layers of skin (20–50  $\mu\text{m}$ ) are able to absorb this pulse because of its long wavelength ( $\text{CO}_2$  laser, 10.6  $\mu\text{m}$ ; and thulium YAG laser, 1.8–2.01  $\mu\text{m}$ ).<sup>48,51–54</sup> This type of stimulus produces a rapid increase in

skin surface temperature (50°C per second) and selectively activates the smallest diameter nerve terminals of thinly myelinated A $\delta$  and unmyelinated C fibers.<sup>46,50,51</sup> Laser stimulus intensity is best characterized as stimulus energy per unit area, and the average pain threshold in young healthy adults is 10 mJ/mm<sup>2</sup>.<sup>55</sup>

LEPs have larger amplitudes than routine somatosensory evoked potentials and require averaging of only 25–40 responses (Fig. 40-8). The components of LEPs include late and ultralate waveforms with a maximal amplitude over the vertex at Cz (according to the International 10–20 System). Laser activation of



**Figure 40-7.** The measurement of pain-related cerebral potentials. Pain-inducing stimuli, such as intracutaneous shock (lower right) or laser heat pulse, specifically activate nociceptive afferents, which conduct information in anterolateral and dorsal spinal tracts to the thalamus and, from there, to the cerebral cortex. Sensation is estimated on an analogue scale, with values of 4 and more denoting increasing pain. Stimulus-induced brain potentials appear in the surface EEG and are visible after averaging more than 40 stimulus repetitions. The negativity (upward deflection) at 150 ms (N150) after stimulus onset and the positivity at 250 ms (P250) are late components of the evoked potential that reflect the painfulness of the stimulus applied. (From Bromm, B. 1995. Consciousness, pain, and cortical activity. *Advances in Pain Research and Therapy* 22:35–59. By permission of Lippincott Williams & Wilkins.)



**Figure 40-8.** Late and ultralate LEPs in a healthy subject. Vertex vs. linked earlobes (negativity upward). Stimulation of the back of the hand elicited a late positivity at about 400 ms (A). Preferential A-fiber block by pressure to the radial nerve at the wrist strongly attenuated the late LEP and an ultralate potential appeared (B), indicating that the latter was mediated by preserved C-fiber input. (From Treede, R.-D., J. Lorenz, K. Kunze, and B. Bromm. 1995. Assessment of nociceptive pathways with laser-evoked potentials in normal subjects and patients. *Advances in Pain Research Therapy* 22:377-92. By permission of Lippincott Williams & Wilkins.)

A $\delta$  fibers that have conduction velocities of 4–30 m/second in humans<sup>38</sup> causes first pain, with a latency of approximately 500 ms corresponding with the late LEP. The typical waveform obtained with stimulation of the skin on the dorsum of the hand has middle latency negative peaks (N1, N170), a negative peak (N2) at a latency of  $250 \pm 20$  ms (mean  $\pm$  SD), and a positive peak (P2) at  $390 \pm 30$  ms. N2 is maximal at Cz, with extension into the central leads, but P2 is maximal at Cz and Pz. The level of attention, arousal, and distraction influences these potentials, especially Pz, and these factors must be taken into account when performing the test.<sup>48,53,56</sup>

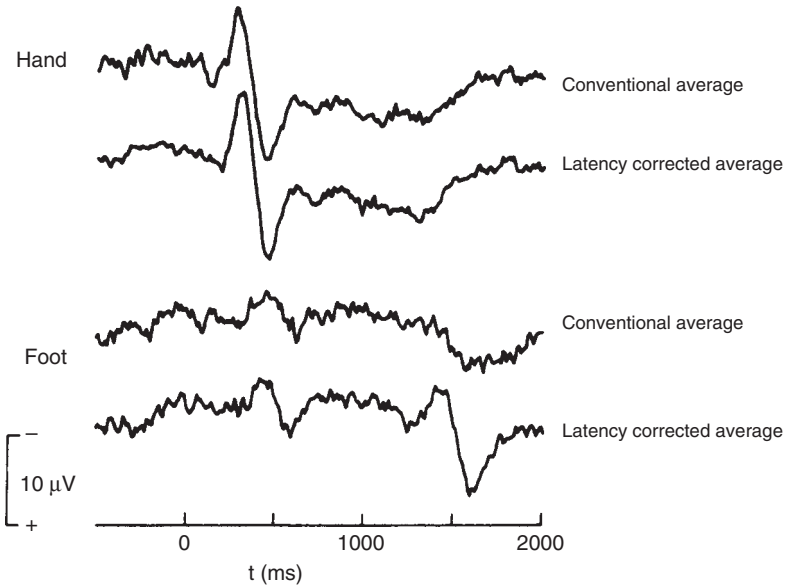
Activation of C fibers (conduction velocity, 0.4–1.8 m/second in humans) results in the ultralate components of LEPs. This response has a positive peak maximal at the vertex and a latency of about 1400 ms. It is unreliable in recordings unless preferential A-fiber block suppresses the late component.<sup>53</sup> The ultralate wave is easily obtained if the late component is absent because of disease selectively affecting A $\delta$  and not C fibers.

Scalp topography and waveforms of the late and ultralate LEPs are similar, suggesting that they have the same cerebral generators.<sup>57</sup> Spatiotemporal source analysis likely indicates that N2 is generated by activity mainly bilaterally in secondary somatosensory cortex. A deep dipole in the midline corresponding to the location of the anterior cingulate gyrus is primarily responsible for the

P2 component. Contralateral primary and secondary somatosensory cortex activity appears to be the generator of the middle latency (N1) component.

LEPs are useful clinically to evaluate objectively the peripheral and central nociceptive pathways in patients with neuropathic pain and disturbances of pain perception, such as hypalgesia, hyperalgesia, allodynia, and spontaneous pain.<sup>58-60</sup> Some of these patients have abnormal summation, or *wind-up*, consisting of the perception of continuous burning pain instead of the normal individual sharp-pricking painful sensations when a repetitive 1-Hz pinprick stimulus is applied to the skin. LEPs indicated the involvement of A $\beta$  and A $\delta$  fibers in a patient with polyneuropathy, muscle weakness, impaired sensation (cold, position, and vibratory), absence of conventional tibial nerve somatosensory evoked potentials, and large myelinated fiber loss on sural nerve biopsy.<sup>53</sup> In this patient, LEPs showed small late responses, evidence for impaired A $\delta$  function, and large ultralate responses, with a peak latency of approximately 1600 ms, which is evidence for preserved function of C fibers (Fig. 40-9).

In a case of polyneuropathy in which the nerve conduction distance between the hand and the foot was 0.8 m, the late and ultralate LEP responses corresponded to conduction velocities of 16 m/second and 1.2 m/second, respectively<sup>53</sup> (Fig. 40-10). This study confirmed that A $\delta$  peripheral afferents are responsible for transmission of the late component

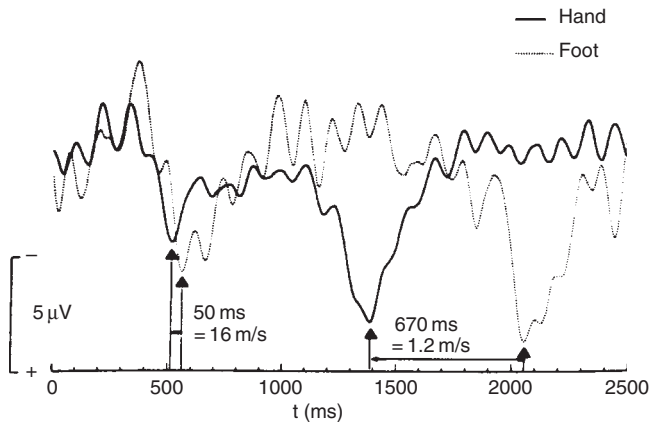


Subject H.G., 67 years. polyneuropathy. laser EP

**Figure 40-9.** Late and ultralate LEPs in a 67-year-old man with polyneuropathy. *Top traces:* Following stimulation of the right hand, a normal  $A\delta$ -fiber-related late potential was recorded. *Bottom traces:* Following stimulation of the left foot, the late potential was markedly decreased in amplitude and a C-fiber-related ultralate potential was documented. The heat-pain threshold for laser stimuli was unremarkable in both areas, but a pronounced temporal summation occurred with stimulation of the foot. (From Treede, R.-D., J. Lorenz, K. Kunze, and B. Bromm. 1995. Assessment of nociceptive pathways with laser-evoked potentials in normal subjects and patients. *Advances in Pain Research Therapy* 22:377-92. By permission of Lippincott Williams & Wilkins.)

and C-fiber activation for the ultralate component. This patient had marked wind-up, despite hypalgesia in response to a single pin-prick stimulus, and there was unmasking of the ultralate component of the LEP. This

unmasking appears to provide a cortical correlate for disinhibition of C-fiber responses to noxious heat that occurs in persons who display wind-up when A fibers are impaired.<sup>53</sup> Therefore, this technique can be useful in the



**Figure 40-10.** Late and ultralate LEPs in a 25-year-old man with hereditary motor and sensory neuropathy type I. The latency differences between hand and foot stimulation indicate that late LEPs are mediated by  $A\delta$  fibers and ultralate LEPs by C fibers. (From Treede, R.-D., J. Lorenz, K. Kunze, and B. Bromm. 1995. Assessment of nociceptive pathways with laser-evoked potentials in normal subjects and patients. *Advances in Pain Research Therapy* 22:377-92. By permission of Lippincott Williams & Wilkins.)

evaluation of nociceptive pathways in general. Also, it can help document A $\delta$ -fiber impairment with sparing of C-fiber function. The selective loss of small unmyelinated fibers can only be documented when A fibers are blocked or impaired, because activity in C fibers produces the highly variable ultralate LEP response.<sup>53</sup>

### Key Points

- LEPs have been the first technique described to test pain pathways, trying to emulate what somatosensory evoked potentials are for large fiber sensory modalities.
- Albeit promising, the potential risk of superficial burns and the intrinsic difficulties of the technique have made it unsuitable for clinical use.

## CONTACT HEAT EVOKED POTENTIALS

LEPs have not achieved wide use in clinical practice due to intrinsic technical difficulties (requiring skilled personnel to calibrate and operate the expensive equipment) and pitfalls, which include the fact that they are not a natural stimulus and can cause skin burns and hyperpigmentation. Contact heat is a natural stimulus, but previously could not be used as a suitable stimulus for evoked potentials due to its slow rise time. In recent years, heat-foil technology has been developed that can elicit CHEPS as it has a rapid rising time of 50° C/second.<sup>61</sup> Peak temperature is reached 360 ms after the offset of the 300-ms duration stimulus. The stimuli are delivered at random intervals, mean = 10 seconds. Forty trials are averaged and recordings are performed as per routine somatosensory evoked potential. The largest activation occurs at the vertex area. To generate well-formed waveforms, the stimulus intensity has to be able to induce at least moderate pain in the subjects, with a VAS rating of 6 or higher (Fig. 40–11). This is generally achieved with peak temperatures in the range of 50° C. Four peaks become visible then: N450 (at T3), N550 (at Cz), P750 (at Cz), and P1000 (at Pz). This stimulus appears to activate both A $\delta$  and C fibers; it sometimes can induce

two types of sensations: a first sharp pain followed by a second, duller type pain. The calculated conduction velocities for the first peak (N550) would fit A $\delta$  fibers (10 m/second) and can be generated at temperatures of 45 C. The later components (around 1000 ms) would be the result of C-fiber activation (velocities estimated at 2–3 m/second) and are visible only with higher peak temperatures around 52 C. Reproducibility and reliability of CHEPS are comparable to those of LEPs.

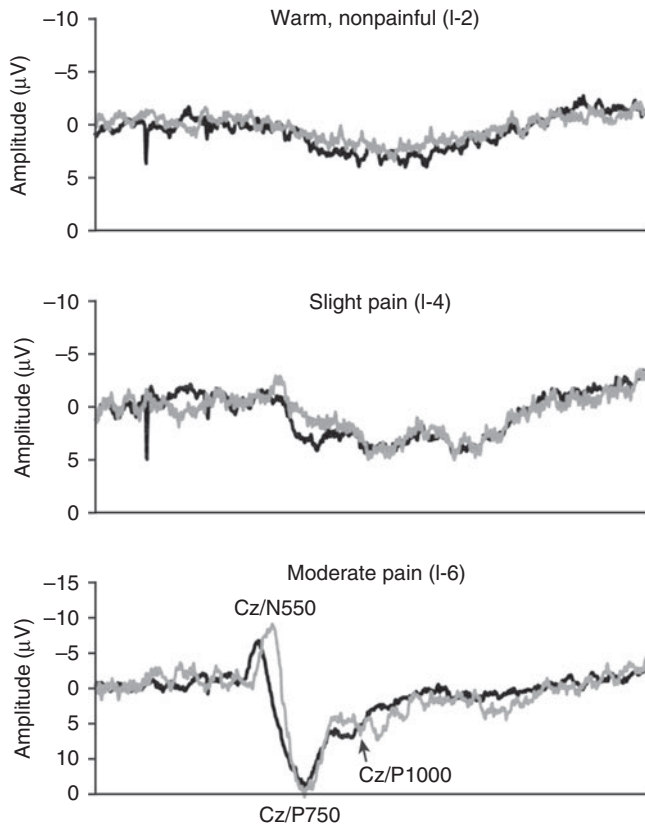
Varying the attentional target toward different properties of the stimulus did not cause any significant change in CHEPS response amplitudes and latencies, suggesting that CHEPS represent a reliable functional measure of the nociceptive pathways.<sup>62</sup>

CHEPS amplitudes correlate negatively with age. Amplitudes and latencies of CHEPS correlate with verbal pain scores: the higher the rating, the shorter the N1 latency and the higher the N1–P1 amplitude.<sup>63</sup>

In a study performed on patients with symptoms of sensory neuropathy compared to controls, CHEPS were compared to other methods used to evaluate small fibers—the histamine-induced skin flare response, intraepidermal fibers (IEF) count, and quantitative sensory testing. Amplitudes of A $\delta$  evoked potentials were reduced in patients, who also showed reduced leg skin flare responses and reduced IEF compared to controls. The reduction in flare response and fiber count correlated with the potential amplitude. The authors concluded CHEPS provide a clinically practical, noninvasive, and objective measure, and can be a useful additional tool for the assessment of sensory small-fiber neuropathy.<sup>64</sup> More recently, two children with congenital insensitivity to pain were tested: they had normal flare response but absent cortical heat evoked potentials, suggesting an abnormality in more proximal or central pain pathways.<sup>65</sup>

In a recent study to evaluate trigeminal small-fiber function, Truini et al. found contact heat stimuli at 51° C evoked vertex potentials consisting of an NP complex similar to that elicited by laser pulses, though with a latency some 100 ms longer. Perioral stimulation yielded higher pain intensity ratings, shorter latency, and larger amplitude CHEPS than supraorbital stimulation. Contact heat stimuli at 53° C evoked a blink-like response in the relaxed orbicularis oculi muscle and a silent





**Figure 40-11.** Contact heat evoked potentials. Vertex waveforms in relation to stimulus heat energy levels (I-2, I-4, I-6), resulting in increasing pain sensation on verbal rating score. Amplitude increase correlated to increase of energy levels, and the results also demonstrated the consistency and reproducibility between Study-I (*dark*) and Study-II (*grey*). Prominent vertex components are marked: Cz/N550, Cz/P750, and Cz/P1000 at I-6 (moderate pain level). (From Chen, A. C. N., D. M. Niddam, and L. Arendt-Nielsen. 2001. Contact heat evoked potentials as a valid mean to study nociceptive pathways in human subjects. *Neuroscience Letters* 316:79–82. By permission of Elsevier.)

period in the contracted masseter muscle. In patients with facial neuropathic pain, the CHEPS abnormalities paralleled those seen with LEPs.<sup>66</sup>

A dipolar model explaining the scalp CHEPS distribution is very similar to that previously described to explain the topography of evoked potentials to radiant heat stimulation by laser pulses.<sup>67</sup> Since laser stimuli activate the nociceptive fibers, the strong similarity of the cerebral dipoles activated by contact heat stimuli and by laser pulses suggests that only nociceptive inputs are involved in the scalp painful CHEPS building. Therefore, CHEPS recording can reliably assess nociceptive pathways, similarly to LEPs.

Recent evidence shows that CHEPS evoked response amplitudes correlate negatively with

age and the initial negative latency correlates with gender, with shorter latencies noted in females. Pain intensity per the verbal rating scale (VRS) was decreased with aging and higher in females than males. Higher VRS responses correlated positively with higher CHEPS amplitude and a shorter latency of the first negative peak. Thus, age-related changes in thermal pain perception and CHEPS should be considered when using this modality of testing somatosensory function.<sup>63</sup>

### Key Points

- CHEPS may be the new generation equivalent of LEPs, easier to use with virtually no risks.

- Preliminary data show they could be a valuable objective tool to assess A $\delta$ - and C-fiber pain pathways.
- As some degree of pain has to be induced to generate an adequate cortical potential, patient's cooperation is a must.

## SUMMARY

Pain is a subjective experience in which the patient's emotional state has a major role, contributing to the challenge pain clinicians have in quantifying and objectively evaluating this common complaint. The multiplicity and complexity of the neural mechanisms that produce chronic pain make the clinician's task even more challenging. During the last 20 years, research in the assessment of the nociceptive and autonomic systems has provided useful tools for the diagnosis, treatment, and scientific investigation of neuropathic pain. QSTs provide an accurate, reproducible assessment of the sensory response to well-delineated controlled stimuli for evaluating the function of small myelinated and unmyelinated fibers. These tests can be useful for documenting sensory disturbances that may occur in patients with neuropathy who experience hypalgesia, hyperalgesia, or allodynia. The inclusion of autonomic tests in the evaluation of some patients with neuropathic pain may provide objective evidence of increased sympathetic tone, heightened somatosympathetic reflexes, or sympathetic denervation. This information may help the clinician to diagnose more accurately the particular type of pain syndrome the patient has so that the treatment may be better directed at the underlying mechanism. MCNG, primarily a research tool, is a powerful method for directly studying primary afferent and sympathetic efferent neural activity in patients with pain caused by lesions of the nervous system. LEPs allow clinicians and researchers to investigate objectively function of the peripheral and central nociceptive pathways in patients with neuropathic pain.

## Key Points

- Pain is a subjective experience. Only the subject suffering from it can quantify it.
- Neuropsychophysiologic studies can aid the quantification of pain experience.

- Neurophysiologic studies can evaluate the integrity and/or dysfunction of the neuroanatomic substrate of pain, and may indirectly provide insight into the pathophysiology of pain.

## REFERENCES

1. Greenspan, J. D. 2001. Quantitative assessment of neuropathic pain. *Current Pain and Headache Reports* 5:107–13.
2. Claus, D., M. J. Hilz, and B. Neundorfer. 1990. Thermal discrimination thresholds: A comparison of different methods. *Acta Neurologica Scandinavica* 81:533–40.
3. Dyck, P. J., J. L. Karnes, D. A. Gillen, P. C. O'Brien, I. R. Zimmerman, and D. M. Johnson. 1990. Comparison of algorithms of testing for use in automated evaluation of sensation. *Neurology* 40:1607–13.
4. Peripheral Neuropathy Association. 1993. Quantitative sensory testing: A consensus report from the Peripheral Neuropathy Association. *Neurology* 43:1050–2.
5. Price, D. D., P. A. McGrath, A. Rafii, and B. Buckingham. 1983. The validation of visual analogue scales as ratio scale measures for chronic and experimental pain. *Pain* 17:45–56.
6. Price, D. D. 1988. *Psychological and neural mechanisms of pain*, 18–49. New York: Raven Press.
7. Gruener, G., and P. J. Dyck. 1994. Quantitative sensory testing: Methodology, applications, and future directions. *Journal of Clinical Neurophysiology* 11:568–83.
8. Dyck, P. J., P. C. O'Brien, J. L. Kosanke, D. A. Gillen, and J. L. Karnes. 1993. A 4, 2, and 1 stepping algorithm for quick and accurate estimation of cutaneous sensation threshold. *Neurology* 43:1508–12.
9. Dyck, P. J., I. Zimmerman, D. A. Gillen, D. Johnson, J. L. Karnes, and P. C. O'Brien. 1993. Cool, warm, and heat-pain detection thresholds: Testing methods and inferences about anatomic distribution of receptors. *Neurology* 43:1500–8.
10. Darian-Smith, I. 1984. Thermal sensibility. In *Handbook of physiology: A critical, comprehensive presentation of physiological knowledge and concepts*, Vol. 3, The nervous system, ed. J. M. Brookhart, and V. B. Mountcastle, 879–913. Bethesda: American Physiological Society.
11. Yarnitsky, D., D. A. Simone, R. M. Dotson, M. A. Cline, and J. L. Ochoa. 1992. Single C nociceptor responses and psychophysical parameters of evoked pain: Effect of rate of rise of heat stimuli in humans. *The Journal of Physiology* 450:581–92.
12. Verdugo, R., and J. L. Ochoa. 1992. Quantitative somatosensory thermotest. A key method for functional evaluation of small calibre afferent channels. *Brain* 115:893–913.
13. Willis, W. D., Jr. 1995. From nociceptor to cortical activity. *Advances in Pain Research and Therapy* 22:1–19.
14. Ochoa, J. L., and D. Yarnitsky. 1994. The triple cold syndrome. Cold hyperalgesia, cold hypoaesthesia

- and cold skin in peripheral nerve disease. *Brain* 117:185–97.
15. Wahren, L. K., and E. Torebjork. 1992. Quantitative sensory tests in patients with neuralgia 11–25 years after injury. *Pain* 48:237–44.
  16. Culp, W. J., J. Ochoa, M. Cline, and R. Dotson. 1989. Heat and mechanical hyperalgesia induced by capsaicin. Cross modality threshold modulation in human C nociceptors. *Brain* 112:1317–31.
  17. Cline, M. A., J. Ochoa, and H. E. Torebjork. 1989. Chronic hyperalgesia and skin warming caused by sensitized C nociceptors. *Brain* 112:621–47.
  18. Wahren, L. K., E. Torebjork, and B. Nystrom. 1991. Quantitative sensory testing before and after regional guanethidine block in patients with neuralgia in the hand. *Pain* 46:23–30.
  19. Nygaard, O. P., R. Kloster, T. Solberg, and S. I. Mellgren. 2000. Recovery of function in adjacent nerve roots after surgery for lumbar disc herniation: Use of quantitative sensory testing in the exploration of different populations of nerve fibers. *Journal of Spinal Disorders* 13:427–31.
  20. Attal, N., V. Gaude, L. Brasseur, et al. 2000. Intravenous lidocaine in central pain: A double-blind, placebo-controlled, psychophysical study. *Neurology* 54:564–74.
  21. Dotson, R. M. 1993. Causalgia—reflex sympathetic dystrophy—sympathetically maintained pain: Myth and reality. *Muscle & Nerve* 16:1049–55.
  22. Stanton-Hicks, M., W. Janig, S. Hassenbusch, J. D. Haddox, R. Boas, and P. Wilson. 1995. Reflex sympathetic dystrophy: Changing concepts and taxonomy. *Pain* 63:127–33.
  23. Roberts, W. J. 1986. A hypothesis on the physiological basis for causalgia and related pains. *Pain* 24:297–311.
  24. Campbell, J. N., R. A. Meyer, and S. N. Raja. 1992. Is nociceptor activation by alpha-1 adrenoreceptors the culprit in sympathetically maintained pain? *American Pain Society Journal* 1:3–11.
  25. Levine, J. D., Y. O. Taiwo, S. D. Collins, and J. K. Tam. 1986. Noradrenaline hyperalgesia is mediated through interaction with sympathetic postganglionic neurone terminals rather than activation of primary afferent nociceptors. *Nature* 323:158–60.
  26. Sato, J., and E. R. Perl. 1991. Adrenergic excitation of cutaneous pain receptors induced by peripheral nerve injury. *Science* 251:1608–10.
  27. Sato, J., S. Suzuki, T. Iseki, and T. Kumazawa. 1993. Adrenergic excitation of cutaneous nociceptors in chronically inflamed rats. *Neuroscience Letters* 164:225–8.
  28. Gold, M. S., D. M. White, S. C. Ahlgren, M. Guo, and J. D. Levine. 1994. Catecholamine-induced mechanical sensitization of cutaneous nociceptors in the rat. *Neuroscience Letters* 175:166–70.
  29. Low, P. A. 1993. Autonomic nervous system function. *Journal of Clinical Neurophysiology* 10:14–27.
  30. Chelmsky, T. C., P. A. Low, J. M. Naessens, P. R. Wilson, P. C. Amadio, and P. C. O'Brien. 1995. Value of autonomic testing in reflex sympathetic dystrophy. *Mayo Clinic Proceedings* 70:1029–40.
  31. Sandroni, P., P. A. Low, T. Ferrer, T. L. Opfer-Gehrking, C. L. Willner, and P. R. Wilson. 1998. Complex regional pain syndrome I (CRPS I): Prospective study and laboratory evaluation. *The Clinical Journal of Pain* 14:282–9.
  32. Shahani, B. T., J. J. Halperin, P. Boulu, and J. Cohen. 1984. Sympathetic skin response—A method of assessing unmyelinated axon dysfunction in peripheral neuropathies. *Journal of Neurology, Neurosurgery, and Psychiatry* 47:536–42.
  33. Cronin, K. D., R. L. Kirsner, and V. P. Fitzroy. 1982. Diagnosis of reflex sympathetic dysfunction. Use of the skin potential response. *Anaesthesia* 37:848–52.
  34. Rommel, O., M. Tegenthoff, U. Pern, M. Strumpf, M. Zenz, and J. P. Malin. 1995. Sympathetic skin response in patients with reflex sympathetic dystrophy. *Clinical Autonomic Research* 5:205–10.
  35. Ochoa, J. 1986. The newly recognized painful ABC syndrome: Thermographic aspects. *Thermology* 2:65–107.
  36. Ochoa, J., M. Cline, W. Comstock, et al. 1987. Painful syndrome newly recognized: Polymodal hyperalgesia with cross modality threshold modulation and rubor (abstract). *Abstracts—Society for Neuroscience* 13:189.
  37. Ochoa, J. L., D. Yarnitsky, P. Marchettini, R. Dotson, and M. Cline. 1993. Interactions between sympathetic vasoconstrictor outflow and C nociceptor-induced antinociceptive vasodilatation. *Pain* 54:191–6.
  38. Vallbo, A. B., K. E. Hagbarth, H. E. Torebjork, and B. G. Wallin. 1979. Somatosensory, proprioceptive, and sympathetic activity in human peripheral nerves. *Physiological Reviews* 59:919–57.
  39. Torebjork, E. 1993. Human microneurography and intraneural microstimulation in the study of neuropathic pain. *Muscle & Nerve* 16:1063–5.
  40. Torebjork, H. E., L. E. Lundberg, and R. H. LaMotte. 1992. Central changes in processing of mechanoreceptive input in capsaicin-induced secondary hyperalgesia in humans. *The Journal of Physiology* 448:765–80.
  41. Schmidt, R., M. Schmelz, C. Forster, M. Ringkamp, E. Torebjork, and H. Handwerker. 1995. Novel classes of responsive and unresponsive C nociceptors in human skin. *Journal of Neuroscience* 15:333–41.
  42. Schmidt, R., M. Schmelz, H. E. Torebjork, and H. O. Handwerker. 2000. Mechano-insensitive nociceptors encode pain evoked by tonic pressure to human skin. *Neuroscience* 98:793–800.
  43. Schmelz, M., R. Schmid, H. O. Handwerker, and H. E. Torebjork. 2000. Encoding of burning pain from capsaicin-treated human skin in two categories of unmyelinated nerve fibres. *Brain* 123:560–71.
  44. Dotson, R., J. Ochoa, M. Cline, W. Roberts, D. Yarnitsky, and D. Simone. 1990. Sympathetic effects on human low threshold mechanoreceptors (abstract). *Abstracts—Society for Neuroscience* 16:1280.
  45. Dotson, R., J. Ochoa, M. Cline, P. Marchettini, and D. Yarnitsky. 1992. Intraneural microstimulation of low threshold mechanoreceptors in patients with causalgia/RSD/SMP (abstract). *Abstracts—Society of Neuroscience* 18:290.
  46. Casale, R., and M. Elam. 1992. Normal sympathetic nerve activity in a reflex sympathetic dystrophy with marked skin vasoconstriction. *Journal of the Autonomic Nervous System* 41:215–19.
  47. Rossi, P., M. Serrao, G. Amabile, L. Parisi, F. Pierelli, and G. Pozzessere. 2000. A simple method for estimating conduction velocity of the spinothalamic

- tract in healthy humans. *Clinical Neurophysiology* 111:1907–15.
48. Carmon, A., J. Mor, and J. Goldberg. 1976. Evoked cerebral responses to noxious thermal stimuli in humans. *Experimental Brain Research* 25:103–7.
  49. Beydoun, A., T. J. Morrow, J. F. Shen, and K. L. Casey. 1993. Variability of laser-evoked potentials: Attention, arousal and lateralized differences. *Electroencephalography and Clinical Neurophysiology* 88: 173–81.
  50. Wu, Q., L. Garcia-Larrea, P. Mertens, A. Beschet, M. Sindou, and F. Mauguiere. 1999. Hyperalgesia with reduced laser evoked potentials in neuropathic pain. *Pain* 80:209–14.
  51. Bromm, B. 1995. Consciousness, pain, and cortical activity. *Advances in Pain Research and Therapy* 22:35–59.
  52. Kazarians, H., E. Scharein, and B. Bromm. 1995. Laser evoked brain potentials in response to painful trigeminal nerve activation. *The International Journal of Neuroscience* 81:111–22.
  53. Treede, R.-D., J. Lorenz, K. Kunze, and B. Bromm. 1995. Assessment of nociceptive pathways with laser-evoked potentials in normal subjects and patients. *Advances in Pain Research Therapy* 22: 377–92.
  54. Spiegel, J., C. Hansen, and R. D. Treede. 2000. Clinical evaluation criteria for the assessment of impaired pain sensitivity by thulium-laser evoked potentials. *Clinical Neurophysiology* 111:725–35.
  55. Gibson, S. J., S. A. LeVasseur, and R. D. Helme. 1991. Cerebral event-related responses induced by CO<sub>2</sub> laser stimulation in subjects suffering from cervicobrachial syndrome. *Pain* 47:173–82.
  56. Tarkka, I. M., and R. D. Treede. 1993. Equivalent electrical source analysis of pain-related somatosensory evoked potentials elicited by a CO<sub>2</sub> laser. *Journal of Clinical Neurophysiology* 10: 513–19.
  57. Treede, R. D., and B. Bromm. 1988. Reliability and validity of ultra-late cerebral potentials in response to C-fibre activation in man. In *Proceedings of the Vth World Congress on Pain*, ed. R. Dubner, G. F. Gebhart, and M. R. Bond, 567–73. Amsterdam: Elsevier.
  58. Antonini, G., F. Gragnani, A. Romaniello, et al. 2000. Sensory involvement in spinal-bulbar muscular atrophy (Kennedy's disease). *Muscle & Nerve* 23:252–8.
  59. Agostino, R., G. Cruccu, A. Romaniello, P. Innocenti, M. Inghilleri, and M. Manfredi. 2000. Dysfunction of small myelinated afferents in diabetic polyneuropathy, as assessed by laser evoked potentials. *Clinical Neurophysiology* 111:270–6.
  60. Agostino, R., G. Cruccu, G. D. Iannetti, et al. 2000. Trigeminal small-fibre dysfunction in patients with diabetes mellitus: A study with laser evoked potentials and corneal reflex. *Clinical Neurophysiology* 111:2264–7.
  61. Chen, A. C. N., D. M. Niddam, and L. Arendt-Nielsen. 2001. Contact heat evoked potentials as a valid mean to study nociceptive pathways in human subjects. *Neuroscience Letters* 316:79–82.
  62. Le Pera, D., M. Valeriani, D. Niddam, A. C. Chen, and L. Arendt-Nielsen. 2002. Contact heat evoked potentials to painful and non-painful stimuli: Effect of attention towards stimulus properties. *Brain Topography* 15:115–23.
  63. Chao, C. C., S. T. Hsieh, M. J. Chiu, M. T. Tseng, and Y. C. Chang. 2007. Effects of aging on contact heat-evoked potentials: The physiological assessment of thermal perception. *Muscle & Nerve* 36(1):30–8.
  64. Atherton, D. D., P. Facer, K. M. Roberts et al. 2007. Use of the novel contact heat evoked potential stimulator (CHEPS) for the assessment of small fibre neuropathy: Correlations with skin flare responses and intra-epidermal nerve fibre counts. *BMC Neurology* 7(1):21.
  65. Facer, P., D. D. Atherton, K. M. Roberts, et al. 2007. A new syndrome of congenital insensitivity to pain diagnosed by skin biopsy and contact heat evoked potentials. PNS Meeting.
  66. Truini, A., F. Galeotti, E. Pennisi, F. Casa, A. Bisciotta, and G. Cruccu. 2007. Trigeminal small-fibre function assessed with contact heat evoked potentials in humans. *Pain* 132(1–2):102–7.
  67. Valeriani, M., D. Le Pera, D. Niddam, A. C. Chen, and L. Arendt-Nielsen. 2002. Dipolar modelling of the scalp evoked potentials to painful contact heat stimulation of the human skin. *Neuroscience Letters* 318:44–8.

SECTION 2

**ELECTROPHYSIOLOGIC  
ASSESSMENT OF NEURAL  
FUNCTION**

---

*This page intentionally left blank*



## PART G

# Sleep and Consciousness

---

The steadily increasing recognition of the frequency and severity of sleep disorders has markedly increased the demand for physiologic assessment of sleep. The development of electrophysiologic tools for the assessment of sleep has helped define the normal and altered physiology of sleep. Sleep disorders include inadequate, excessive, and disordered sleep. The latter includes excessive or abnormal movements during sleep. The recording of the surface muscle electromyogram during these movements while monitoring blood pressure, pulse, and respiration, as described in this section, can help physicians identify, characterize, and define the type and severity of sleep disorder (Chapter 41).

Electrophysiologic assessment of sleep disorders is a superb example of the importance of combining the methods of clinical neurophysiology for assessing the condition of a patient. The combination of newly defined patterns of surface electromyographic recordings, electroencephalographic recordings, and measurements of autonomic function is a critical part of the assessment of sleep disorders. New advances in sleep studies include unattended polysomnography, split-night recordings, excess daytime sleepiness evaluation, and the interpretation of electro-oculography and multiple sleep latency testing in the parasomnias.

*This page intentionally left blank*

# Assessment of Sleep and Sleep Disorders

*Michael H. Silber, Cameron D. Harris, and Peter J. Hauri*

## **INTRODUCTION**

### **TECHNIQUES USED IN STUDYING SLEEP**

Polysomnography  
Multiple Sleep Latency Test  
Maintenance of Wakefulness Test  
Actigraphy  
Portable Monitoring

### **STAGING OF SLEEP**

Sleep Stages  
Arousals  
Body Position  
Summary Statistics for Sleep Variables

### **ASSESSING RESPIRATION DURING SLEEP**

Definitions  
Airflow  
Respiratory Effort  
Snoring Sounds

Blood Gases  
Cardiac Rhythm  
Summary Statistics for Respiratory Variables

### **ASSESSING MOVEMENTS IN SLEEP**

Periodic Limb Movements  
REM Sleep Without Atonia  
Bruxism

### **ASSESSING OTHER PHYSIOLOGIC VARIABLES**

Core Temperature  
Esophageal pH Measurements

### **PERFORMANCE OF A SLEEP STUDY ASSESSING SLEEP DISORDERS**

Disorders of Excessive Somnolence  
Parasomnias

### **SUMMARY**

## **INTRODUCTION**

Soon after the human electroencephalogram (EEG) was discovered in 1929, researchers began recording brain electrical activity during sleep. In 1937, Loomis described and classified non-rapid eye movement (NREM) sleep, and in 1953 rapid eye movement (REM) sleep was discovered by Aserinsky and Kleitman. In the

1960s seminal discoveries were made delineating the disturbances in sleep physiology in narcolepsy and obstructive sleep apnea. The clinical evaluation of sleep and its disorders began in the early 1970s, eventually leading to the development of the medical specialty of Sleep Medicine. The number of clinical sleep laboratories, most within comprehensive sleep centers, continues to increase. The goal

of this chapter is to review the techniques used to study sleep and discuss the physiologic parameters recorded and the use of these methodologies in elucidating sleep disorders.

### ***Purpose and Role of Polysomnography***

- Indicated for the diagnosis of sleep-related breathing disorders and the initiation of therapy with positive airway pressure.
- Indicated for patients with neuromuscular disease and symptoms of sleep disorders not diagnosed by history alone.
- Not indicated for the diagnosis of narcolepsy and idiopathic hypersomnia.
- Indicated for the elucidation of parasomnias that are potentially injurious, unusual, or atypical, or do not respond to conventional therapy, or when the distinction from a seizure disorder is difficult despite standard EEG.
- Indicated for the diagnosis of suspected periodic limb movement disorder.

### ***Purpose and Role of the Multiple Sleep Latency Test***

- The multiple sleep latency test (MSLT) is a validated objective measure of the ability to fall asleep.
- Indicated as part of the evaluation of patients with suspected narcolepsy or idiopathic hypersomnia.

### ***Purpose and Role of the Maintenance of Wakefulness Test***

- The maintenance of wakefulness test (MWT) is a validated objective measure of the ability to stay awake.
- Indicated to assess a person's ability to remain awake when failure to do so may constitute a personal or public safety risk.
- May be indicated in patients with excessive sleepiness to assess response to treatment.

### ***Purpose and Role of Actigraphy***

- Indicated to assist in the diagnosis of circadian rhythm disturbances, including delayed sleep phase syndrome.
- Indicated to characterize circadian rhythms and sleep disturbances in patients with insomnia.

- Indicated as a way to determine circadian patterns and daily sleep time in patients with hypersomnia and may be useful prior to an MSLT.

### ***Purpose and Role of Portable Monitoring***

- Indicated to diagnose suspected OSA in patients unable to be studied in a sleep laboratory, for example, because they are not ambulatory or medically unstable.
- Indicated for follow-up of previously diagnosed OSA to assess response to therapy.
- May be used as an alternative to polysomnography to diagnose OSA in patients with a high pre-test probability of moderate to severe OSA in the absence of co-morbidities and as part of a comprehensive clinical sleep evaluation.

## **TECHNIQUES USED IN STUDYING SLEEP**

### **Polysomnography**

Polysomnograms are recorded during the normal sleeping hours of a patient. Patients come to the sleep laboratory 1–2 hours before their usual bedtime. After the electrodes and sensors have been applied, patients may watch television or read until they are ready to go to sleep. They sleep 6–8 hours before either awakening spontaneously or being awakened by a technician. The goal of polysomnography is to quantify the amount of time spent in various stages of sleep during the night and to document clinically relevant events that disrupt sleep, such as cardiopulmonary abnormalities or abnormal motor activity.

The basic format of a comprehensive polysomnogram is standardized. The required minimum montage<sup>1</sup> includes (1) continuous monitoring of at least three channels of an EEG, (2) two channels of an electro-oculogram (EOG), (3) three channels of respiratory data (markers of airflow, respiratory effort, and oxyhemoglobin saturation), (4) electrocardiographic (ECG) recording, and (5) electromyographic (EMG) of the chin and anterior tibial muscles. Other variables may be monitored as

clinically indicated, including snoring, position of the sleeper, additional EEG, surface EMG recordings from all four limbs, esophageal pressure, and esophageal pH. The patient's nighttime behavior should also be observed and recorded during polysomnography.

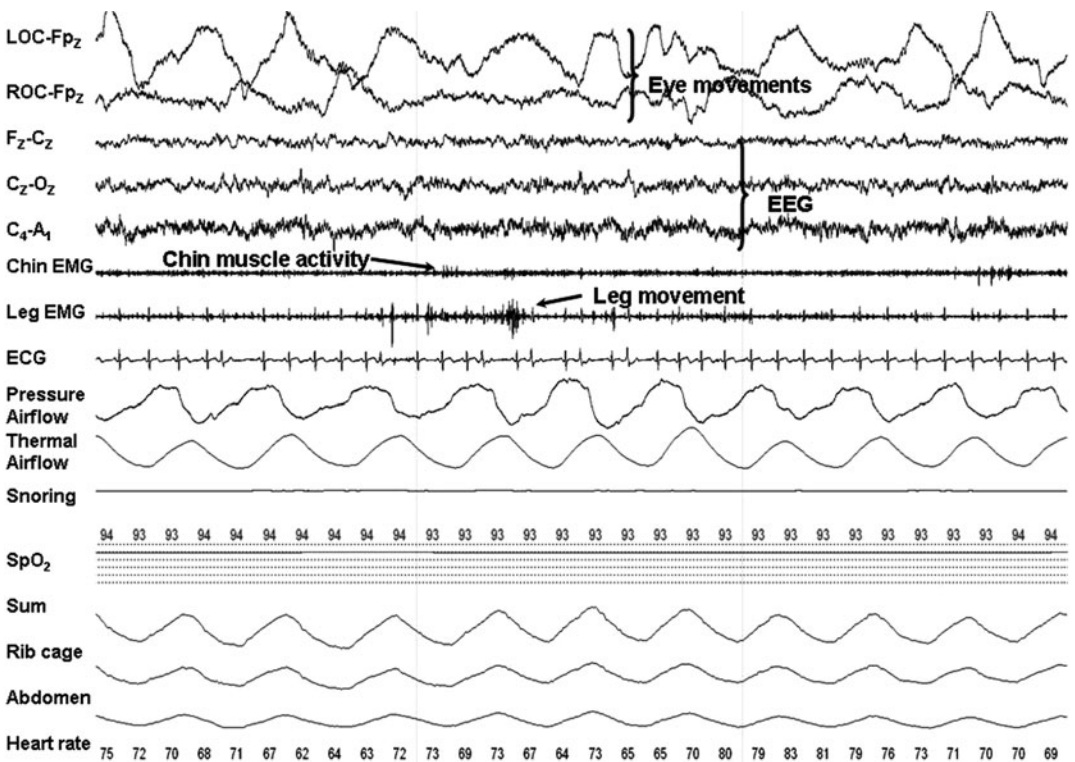
Polysomnograms are recorded with digital systems that allow review at variable screen widths. A 30-second screen window is most frequently used, but longer windows (60–180 seconds) may aid in evaluating respiratory or other periodic events and a shorter window (10 seconds), in assessing EEG abnormalities. Digital systems allow 16–32 channels of data to be recorded.

Polysomnograms are usually interpreted visually. Even though sleep stages and other polysomnographic variables are scored by the computer,<sup>2</sup> visual inspection of the raw data is still necessary. The interpretation of many nocturnal events requires clinical skill (e.g., other

sleep disorders may masquerade as sleep-disordered breathing), and some patients may have an abnormal sleep structure that is not easily scored by the machine. The analysis of polysomnograms of neonates and infants requires special experience and skill because, for these groups, EEG stages are defined differently, and respiratory and other behaviors during sleep are unique.

An excerpt from a typical polysomnogram is shown in Figure 41–1, and a typical summary of a polysomnographic recording (in this case, from a patient who complained of excessive sleepiness) is shown in Figure 41–2. The usual placement of electrodes and sensors and the amplification variables typically used for a polysomnogram are summarized in Table 41–1.

Current standards approved by the American Academy of Sleep Medicine (AASM)<sup>1</sup> allow laboratories to choose between two different



**Figure 41–1.** Typical polysomnogram montage, including channels for eye movement, EEG, chin and leg EMG, air-flow, snoring sounds, oxyhemoglobin saturation, and respiratory effort. Abdomen, abdominal breathing effort by inductive plethysmograph; Airflow, nasal pressure, and oronasal thermocouple; ECG, electrocardiogram; EMG, electromyogram; LOC, left outer canthus; Rib cage, thoracic breathing effort by inductive plethysmograph; ROC, right outer canthus; sonogram, sound recording; SpO<sub>2</sub>, oxyhemoglobin saturation by pulse oximetry; Sum, electronic summation of rib cage and abdominal movements.

**Polysomnography Report**

Date of Study: 9/5/2007

Age: 59

Sex: Male

Scored by: CH

<b>Variables Recorded:</b> EEG, EOG, tibial and submental EMG, ECG, thermocouple and nasal pressure transducer, inductive plethysmograph, sonograph, pulse oximetry	<b>Special Circumstances</b> Diagnostic Study
---	--

**Sleep Architecture**  
Start Time: 9/5/2007 23:13:42 PM  
End Time: 9/6/2007 6:40:12 AM

Minute	%TST
Time in Bed (TIB)	443.5
Time out of bed	4.0
Sleep Effic. (TST/TIB)	82 %
Initial sleep latency	7.0
Initial REM latency	65.5
Wake after sleep onset	81.0
Stage N1	30.0 8 %
Stage N2	163.0 45 %
Stage N3	79.5 22 %
Stage R	91 25 %
Total sleep time (TST)	363.5

**Disordered Breathing (DB) Profile**  
Frequency/Sleep Hr

	NREM	REM	TST	NREM	REM	TST
Central Apnea	0	0	0	-	-	-
Obstructive/Mixed	0	0	0	-	-	-
Hypopnea	5	27	11	15	20	18
Apnea/Hypopnea	5	27	11	15	20	18

**Effect of Body Position**

Sleep Time	Apnea/Hypopnea index		Snore Rating	
	Back	Off Back	Back	Off Back
NREM	47.5	225.0	NREM 19	2
REM	0.0	91.0	REM 0	27
%Sleep Time			30	20
Grade (0-4)			2	1

**Arousal Profile**

	Arousal Index (#/hr)	Movement Related (%)	Breathing Related (%)
Total	19	3	58

**Periodic Movements Index**  
Movements/Sleep Hour: 2  
Percent with Arousals: 30%

**Oxygen Saturation (SpO<sub>2</sub> %)**  
Awake Baseline: 94  
Range: NREM 90-95 REM 80-95

%	>= 90	80 - 89	70 - 79	60 - 69	< 60
TST	95	5	0	0	0

Mean Saturation: 92

**Cardiac rhythm abnormalities:**  
None

**EEG abnormalities:**  
None

**Technical Comments:**

**SUMMARY:** The sleep study showed normal sleep latency and normal sleep architecture. Eleven hypopneas per hour were recorded in the supine position and during REM sleep in the lateral position. Oxyhemoglobin saturation fell to a minimum of 80%. Sleep efficiency was low at 82%. Of 19 arousals per hour, 58% were breathing related.

**CLINICAL INTERPRETATION:** The study shows the presence of mild non-positional obstructive sleep apnea resulting in oxyhemoglobin desaturation and disturbance in sleep efficiency and continuity.

**Figure 41-2.** A typical polysomnogram report. NREM, non-REM sleep; REM, rapid eye movement sleep.

EEG montages, a recommended and an alternative version. The recommended montage consists of F4-M1, C4-M1, and O1-M1, while the alternative montage consists of Fz-Cz, Cz-Oz, and C4-M1. The recommended montage uses referential derivations, allowing the site of origin of signals to be determined by their maximal amplitude. The alternative montage provides both referential and bipolar representation of sleep activity, with the midline electrodes being less prone to contamination by EMG artifact than a mastoid reference. Similarly, recommended and alternative EOG montages are permitted (Fig. 41-3). The advantage of the recommended montage is that all eye movements in any direction are represented by signals of the opposite phase, making differentiation from EEG and artifact

simple. However, low-amplitude vertical and oblique eye movements may be missed, and it is not possible to differentiate eye movement direction. In contrast, the alternative montage, which is used in our laboratory, displays most eye movements, representing vertical eye movements as in-phase and horizontal movements as out-of-phase deflections. This is helpful in the differentiation of rapid eye movements of REM sleep (most commonly horizontal) from blinks of wakefulness (resulting in vertical movements), especially in REM sleep without atonia. The chin EMG is recorded with surface electrodes placed above and below the inferior edge of the mandible. The 10-Hz low-frequency filter setting used in the EMG derivations reduces movement artifact.



Table 41-1 Typical Settings for a Polysomnogram

Signal	Sensor type and placement	Sensitivity	LFF, Hz	HFF, Hz
EOG*	Electrodes placed 1 cm lateral and 1 cm inferior to outer canthi referenced to Fpz	5–7.5 $\mu$ V/mm	0.3	35
EEG*	Electrodes placed at Fz, Cz, Oz, C3, C4, M1, and M2	5–7.5 $\mu$ V/mm	0.3	35 <sup>†</sup>
Chin EMG	Electrodes placed in the midline 1 cm above inferior edge of mandible and 2 cm below inferior edge to the right and to the left of the midline	2 $\mu$ V/mm	10	100
Leg EMG	Electrodes placed over belly of anterior tibialis muscle of each leg	2 $\mu$ V/mm	10	100
ECG	Electrodes placed on right shoulder and left hip	50 mV/mm	0.3	70
Oxygen saturation	Light absorbance sensor placed on earlobe or finger	100 mV/cm <sup>‡</sup>	DC	5
Airflow	Thermocouple placed in front of both nares and the mouth, connected in series to provide one signal	Transducer-dependent <sup>‡</sup>	0.1	15
	Nasal pressure transducer	Transducer-dependent	0.1	15
Breathing effort	Inductors (elastic bands with embedded wires) placed around the chest, just under the axillae, and around the abdomen at the level of the navel	Patient-dependent <sup>‡</sup>	DC	15
Snoring	Microphone placed in contact with the skin slightly superior and lateral to thyroid cartilage	Transducer-dependent <sup>‡</sup>	10	100

LFF, low-frequency filter; HFF, high-frequency filter.

\*These are the derivations used in our laboratory (AASM alternative derivations). See the text for the AASM recommended derivations.

<sup>†</sup> The HFF can be set at 70 Hz if more detailed EEG analysis is desired.

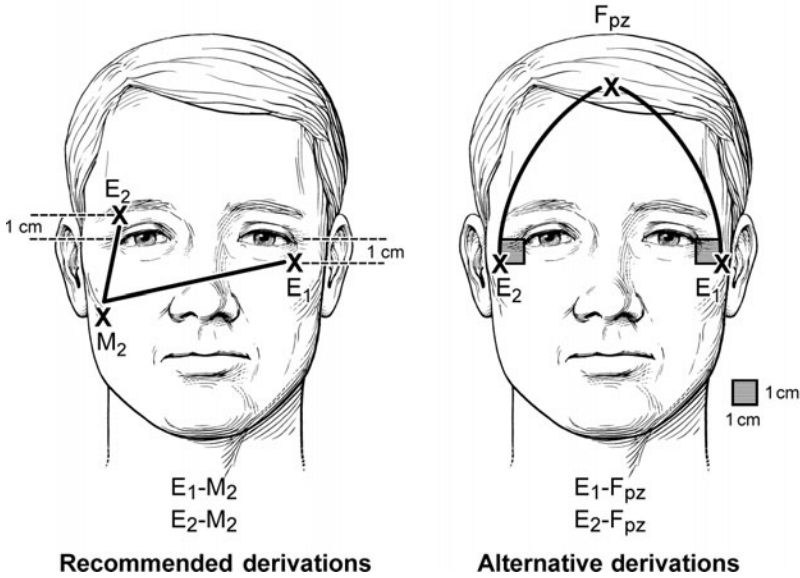
<sup>‡</sup> Optimum sensitivity may depend on manufacturer or equipment used, or recording conditions.

DC, direct current; ECG, electrocardiogram; EEG, electroencephalogram; EMG, electromyogram; EOG, electrooculogram.

Polysomnographic studies are indicated for the following purposes:<sup>3</sup>

1. Assessment of sleep-disordered breathing, including suspected, obstructive, or central sleep apnea. Polysomnography is also indicated for titration of positive airway pressure (PAP) in patients with diagnosed sleep-disordered breathing. Polysomnography is not routinely indicated for nocturnal hypoxemia in the

presence of chronic lung disease unless sleep-related upper airway obstruction is also suspected. The mere presence of snoring, obesity, systemic hypertension, or nocturnal cardiac arrhythmia without other symptoms is not an indication for polysomnography. However, patients with heart failure, coronary artery, or cerebrovascular disease or significant arrhythmias should be questioned about symptoms of sleep apnea



**Figure 41-3.** AASM recommended and alternative derivations for recording eye movements (EOG). In the recommended derivations, E1 and E2 are placed 1 cm below and 1 cm above the outer canthus of the left and right eyes. The reference electrode is placed on the right mastoid. In the alternative derivations, E1 and E2 are placed 1 cm below and 1 cm lateral to the outer canthus of the left and right eyes. The reference electrode is Fpz.

and polysomnography performed if they are present. Patients with neuromuscular disorders and sleep-related symptoms should undergo polysomnography if a sleep disorder cannot be confidently diagnosed by history.

2. Assessment of excessive daytime somnolence (suspected narcolepsy or idiopathic hypersomnia). This assessment requires polysomnography and a subsequent MSLT.
3. Assessment of parasomnias. An extended polysomnographic montage using additional EEG and EMG channels and time-synchronized audiovisual recording is indicated for sleep-related violent or potentially injurious behavior, or behavior that is highly disturbing to the sleep of others. Such a study is also indicated for sleep behaviors that are unusual or atypical because of age at onset, frequency or duration of occurrence, or the specifics of the particular motor pattern in question. Paroxysmal arousals thought to be possible nocturnal seizures are a further indication, when the results of standard EEG are inconclusive. Polysomnography is not routinely

indicated for typical, uncomplicated, and noninjurious parasomnias that can easily be diagnosed on the basis of the medical history or for patients with known nocturnal seizures but no other sleep complaints.

4. Assessment of periodic limb movements of sleep (PLMS). Polysomnography is indicated when PLMS are suspected to be the cause of insomnia or excessive daytime sleepiness, especially in the absence of restless legs syndrome. The frequency of PLMS and their effect on sleep continuity and architecture need to be determined. Polysomnography is not indicated for the diagnosis of restless legs syndrome.

Polysomnography is not indicated for the routine evaluation of transient or chronic insomnia. However, it may be indicated if sleep-disordered breathing or PLMS are thought to comprise a significant component of the insomnia, if the initial diagnosis is uncertain, or if behavioral or pharmacologic treatment has been unsuccessful. In rare cases, polysomnography may be performed if

a sleep-state misperception syndrome is suspected. Such a syndrome is defined as a complaint of insomnia or excessive sleepiness that occurs without any objective evidence of sleep disturbance. In this case, the polysomnogram would demonstrate normal sleep latency, a normal number of arousals, and normal sleep duration.

## Multiple Sleep Latency Test

The MSLT<sup>4</sup> consists of four or five 20-minute rest periods spaced 2 hours apart. The test is conducted with the patient lying in bed in a dark room and is almost always recorded on the day following a night with polysomnography. The goal of the test is to quantify physiologic sleepiness during waking hours and to determine the occurrence of REM sleep near sleep onset. For this test, patients are asked to remain in the laboratory for the entire day. They may read, watch television, or engage in other quiet activities, but they must not sleep or exercise between scheduled naps. Recordings performed during the MSLT are simpler than those performed during polysomnography and typically only EEG, EOG, submental EMG, and ECG data are recorded. For each nap, sleep latency and the occurrence of REM sleep are noted. For the MSLT, sleep latency is defined as the time between “lights out” and the beginning of the first epoch of any stage of sleep. If no sleep occurs during the first 20 minutes in bed, the rest period is discontinued and the sleep latency is recorded as 20 minutes. After sleep onset has occurred, patients are allowed to sleep for 15 minutes to determine whether they will enter REM sleep. Accurate interpretation of the results depends on fulfillment of certain preconditions. First, adequate amounts of sleep must be obtained for 1–2 weeks before the study to ensure that the patient is not voluntarily sleep deprived. This is assessed by having the patient complete a sleep log and often wear a wrist actigraph, a device that monitors motor activity of an arm and allows periods of rest and activity to be differentiated. At least 6, or preferably 7, hours of sleep, as measured by the polysomnogram, should be obtained during the night before the MSLT. Although it might be imagined that a laboratory sleep study the preceding night might affect the MSLT

latencies by disrupting sleep, no differences in latencies have been found after nights of home vs. laboratory polysomnography.<sup>5</sup> Second, all treatment with psychotropic drugs that can safely be discontinued should be stopped at least 2 weeks before the study.

A mean sleep latency over four or five nap opportunities is calculated. If one of the sleep latencies is an outlier (e.g., 3-, 4-, 5-, 4-, and 18-minute latencies), it may be more accurate to use the median than the mean sleep latency.<sup>6</sup> A value of fewer than 5 minutes generally indicates excessive daytime sleepiness, and a value greater than 10 minutes falls within the statistically normal range. Values between 5 and 10 minutes should be regarded as representing a continuum, with lower values indicating greater sleepiness than higher values.<sup>7</sup> Most patients with narcolepsy will have mean sleep latencies <8 minutes.<sup>8</sup> The presence of REM sleep occurring within 15 minutes of sleep onset (sleep onset REM [SOREM]) in any of the nap opportunities is also recorded. The presence of SOREMs in two or more naps, or in one nap and the preceding overnight polysomnographic study, is considered abnormal.<sup>4</sup> Although this finding is regarded as the neurophysiologic marker of narcolepsy, it is not specific and other causes need to be considered. These include abrupt withdrawal of REM-suppressant medication (e.g., most stimulants and antidepressants), moderate or severe OSA syndrome,<sup>9</sup> or sleep deprivation. If the sleepy patient has no history of cataplexy, the results of the polysomnography are normal, and the MSLT shows a pathologically short mean sleep latency with fewer than two SOREMs, the likely diagnosis is idiopathic hypersomnia.<sup>8</sup>

## Maintenance of Wakefulness Test

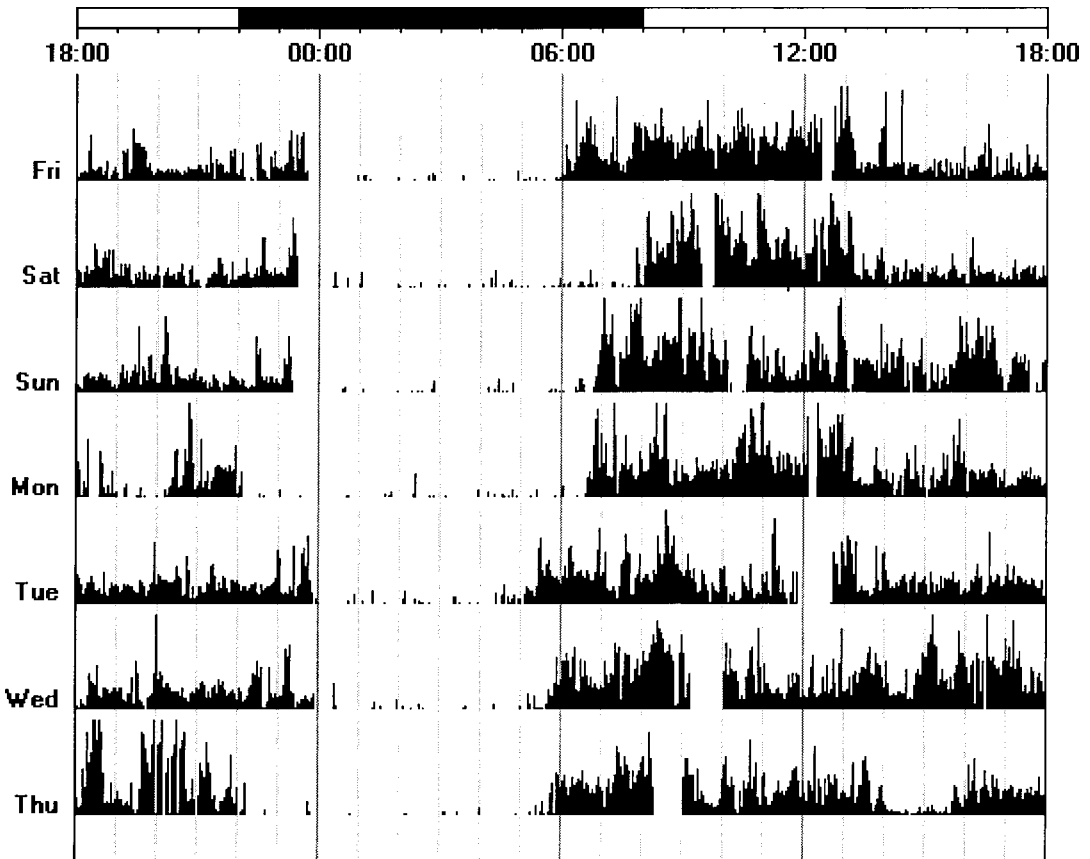
A less frequently used variant of the MSLT is the *maintenance of wakefulness test*.<sup>4</sup> This is not a test for sleepiness but measures the ability of the patient to remain awake. It should not be used to diagnose sleep disorders, but sometimes it is helpful in assessing the response to stimulants or a patient's fitness to drive or to fly an airplane. Conditions are the same except that the patient sits in a comfortable recliner or bed with the back and head supported by a bed rest in a dimly lit room (7.5-W night light)

and is asked to try remain awake rather than to sleep. The patient may not use extraordinary methods to remain awake, such as slapping the face or singing. Each trial lasts until unequivocal sleep occurs, defined as three consecutive epochs of stage N1 sleep or one epoch of any other stage, or after 40 minutes if no sleep occurs. Sleep latency is measured from test onset until the start of the first epoch scored as sleep. Normal mean sleep latency for this protocol<sup>7,10</sup> is 30.4 minutes, but the data are not normally distributed with 42% of all subjects remaining awake for 40 minutes on all four tests. The 15th percentile falls between 16 and 25 minutes, depending on the exact definition used for sleep onset. A recent study<sup>11</sup> determining the ability of the MWT to predict simulated driving performance in patients with OSA suggested that mean latencies of

19 or less correlated with driving impairment. A reasonable practical guide is to consider latencies greater than 20 minutes as indicative of adequate alertness.

## Actigraphy

A small, watch-like device is worn by the patient on the wrist of the nondominant hand, usually for an entire week (Fig. 41-4). This device counts and stores in its memory the number of wrist movements that occur for each 1-minute epoch. Periods of relative absence of such movements are interpreted as sleep and periods of high activity as wakefulness. Actigraphy is a valid way of assessing sleep patterns in normal subjects and in patients with some sleep disorders.<sup>12</sup> In particular, there



**Figure 41-4.** Wrist actigraphy data recorded from 18:00 (6:00 PM) Friday through 18:00 the following Friday. The height of each vertical black line is proportional to the level of activity for a 1-minute epoch. Areas where the lines are very short or absent represent periods of immobility and probable sleep.

is good correlation between total sleep time measured by actigraphy and polysomnography. Actigraphy, in general, shows a closer agreement with polysomnography than with sleep logs.

Actigraphy is indicated for the following purposes:

1. To assist in the diagnosis of circadian rhythm disorders, including delayed sleep phase disorder, advanced sleep phase disorder, and shift work sleep disorder.
2. To characterize the sleep patterns in patients with insomnia, including insomnia with depression.
3. To characterize the circadian pattern and daily sleep time in patients with hypersomnia, especially prior to performing an MSLT.

Actigraphy may be helpful in monitoring treatment of patients with circadian rhythm disorders or insomnia. It may be used in older populations as well as in infants and children.

## Portable Monitoring

Portable monitoring incorporates a range of techniques used for assessing OSA including overnight oximetry, partial cardiorespiratory studies, and fully portable polysomnography with monitoring of EEG, EOG, and EMG. It is usually performed in the home without a technician in attendance. Overnight oximetry may be a useful screening technique in some patients but should not be used as a definitive diagnostic method. Although the presence of unequivocal repetitive desaturations in an oximetric tracing strongly suggests sleep-disordered breathing, normal findings on oximetry do not rule out sleep apnea. Patients, especially younger ones, may have sleep apneas serious enough to cause repeated arousals from sleep without causing significant oxyhemoglobin desaturation. Alternatively, the patient may not have slept much during the night when oximetry was performed or may have positional sleep apnea and happened to sleep only on the side during the study. Portable monitors used to diagnose OSA should at a minimum record oximetry, airflow, and respiratory effort, although EEG, EOG,

and EMG may add useful additional information, including determination of sleep stage and total sleep time. If portable monitoring is used, it is essential that it be part of the comprehensive clinical assessment of patients by knowledgeable physicians and that the studies be interpreted by sleep specialists with access to the raw data.

The role of portable monitoring for the diagnosis of OSA remains controversial. The American Academy of Sleep Medicine has reviewed this practice and has suggested that under certain, carefully defined conditions, unattended portable recording for the assessment of OSA may be acceptable<sup>13</sup>. These include suspected OSA in patients unable to be studied in a sleep laboratory, for example, because they are not ambulatory or medically unstable, follow up of previously diagnosed OSA to assess response to therapy, and as an alternative to polysomnography to diagnose OSA in patients with a high pre-test probability of moderate to severe OSA in the absence of co-morbidities and as part of a comprehensive clinical sleep evaluation. It is not currently recommended for the routine diagnosis of OSA.<sup>14</sup> Portable monitoring has a higher frequency of false positives and negatives than conventional polysomnography and it is by no means clear that widespread use of the procedure would result in more cost-effective therapy. However, two recent studies<sup>15,16</sup> have suggested that diagnosis of OSA by portable monitoring in selected patients carefully followed in academic sleep centers by experienced sleep specialists may result in similar clinical outcomes after treatment compared with patients diagnosed by laboratory polysomnography. Further larger outcome-based research studies are in progress.

### Key Points

- The goal of polysomnography is to document clinical events that disrupt sleep, including respiratory and movement disorders.
- Multiple physiologic sensors are used in polysomnography, including EEG, EOG, EMG, respiratory monitoring, and ECG.
- There are standard derivations for recording EEG, EOG, and EMG in polysomnography.
- The MSLT, an objective measure of the ability to fall asleep, must be performed

under carefully controlled conditions for the results to be valid.

- The MWT measures a person's ability to remain awake and must be interpreted with thorough understanding of normative data.
- Actigraphy is indicated for the assessment of sleep patterns in circadian rhythm disorders, insomnia, and hypersomnia.
- Portable monitoring is not currently recommended for the routine diagnosis of OSA. If used, the results must be interpreted by a sleep specialist and used as part of the comprehensive management of the patient.

## STAGING OF SLEEP

As early as 1937, it was recognized that what is now called NREM sleep showed different electrophysiological phenomena at variable times during the night with slow eye movements, sleep spindles, and increasing rhythmic slow activity. After the discovery of REM sleep in 1953, classifications of sleep stages matured, culminating in the 1968 manual, edited by Alan Rechtschaffen and Anthony Kales.<sup>17</sup> This classification remained the standard for scoring sleep in humans until the American Academy of Sleep Medicine commissioned the development of a new manual in 2004. Three years of

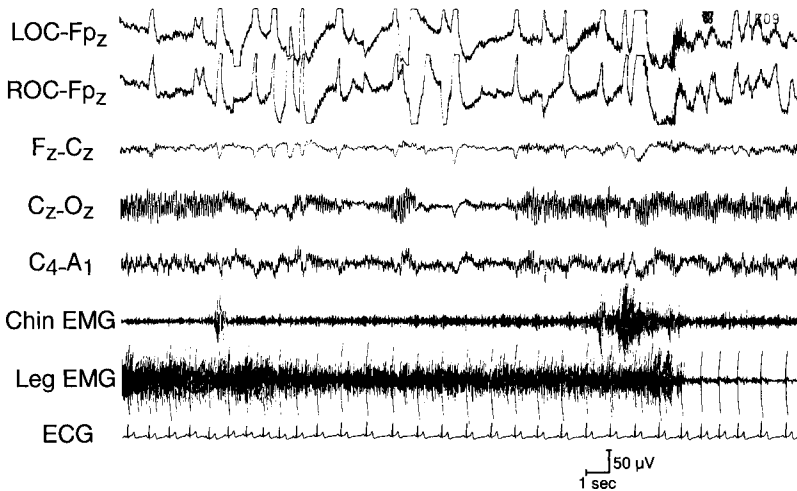
work, involving eight task forces and approximately 80 experts, culminated in the 2007 publication of the *AASM Manual for the Scoring of Sleep and Associated Events: Rules, Terminology and Technical Specifications*<sup>1</sup> and seven review articles explaining the evidence and rationale behind the new rules.<sup>18</sup>

## Sleep Stages

Sleep is scored in arbitrary 30-second periods, known as *epochs*. For each epoch, a stage is assigned that comprises the greatest portion of that epoch. Sleep is divided into NREM sleep (subdivided into three stages: N1, N2, and N3) and REM sleep.

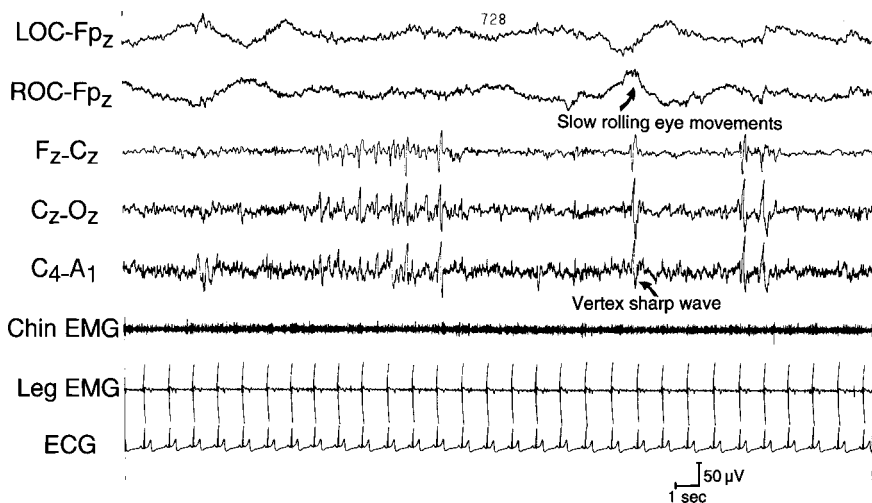
Wakefulness (*Stage W*) is scored if there is activity in the 8–13 Hz (alpha) range over the occipital region with eye closure, attenuating with eye opening, during the majority of a 30-second epoch (Fig. 41–5). If alpha rhythm is not discernable, stage W can also be scored in the presence of eye blinks, reading eye movements or rapid eye movements in association with normal or high chin muscle tone.

*Stage N1* is defined by a relatively low-amplitude mixed-frequency EEG predominantly in the 4–7 Hz range. There are typically slow, usually horizontal, eye movements and often decreased tone on the chin EMG (Fig. 41–6). Vertex sharp waves (<0.5-second duration, maximal over the central region) may



**Figure 41–5.** Wakefulness (stage W). Note the prominent alpha rhythm, rapid eye movements, and high EMG activity in the chin and legs.



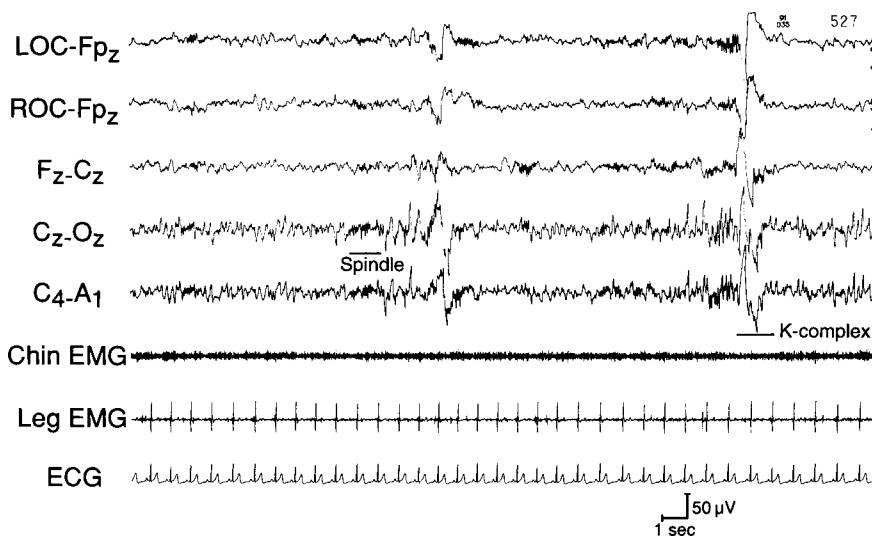


**Figure 41-6.** Stage N1 sleep. Note the vertex sharp waves, the slow rolling eye movements, and the absence of alpha rhythm.

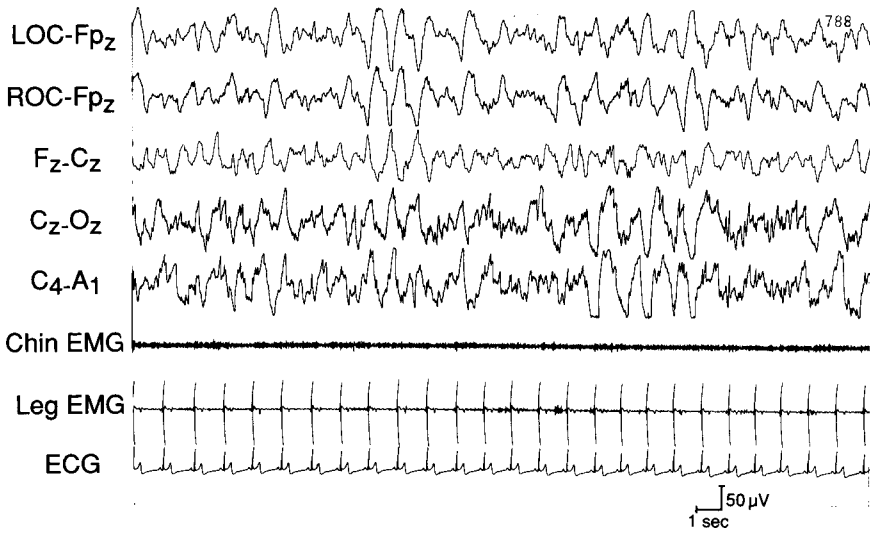
be seen. It may be difficult to distinguish stage W from stage N1 in the approximately 10% of subjects who do not generate alpha rhythm during eye closure in wakefulness. In these subjects, stage N1 should be scored when the earliest of the following phenomena occurs: slow eye movements, vertex sharp waves, or slowing of the background EEG by at least 1 Hz.

Stage N2 is characterized by the appearance of sleep spindles (trains of 11–16 Hz activity, most commonly 12–14 Hz, maximal over the central region lasting  $\geq 0.5$  second) or K

complexes (diphasic sharp waves, initially negative followed by a positive component, maximal over the frontal region lasting  $\geq 0.5$  second) (Fig. 41-7). K complexes may occur spontaneously or be evoked by intrinsic or extrinsic sensory stimuli. In patients with conditions such as obstructive sleep apnea, light sleep may be highly fragmented by K complexes followed by runs of alpha rhythm at the termination of apneas. K complexes associated with arousals in the absence of sleep spindles or spontaneous K complexes are insufficient to justify a change from stage N1 to stage N2 sleep.<sup>19</sup> Because



**Figure 41-7.** Stage N2 sleep. Note sleep spindles and K complexes that characterize stage N2 sleep.



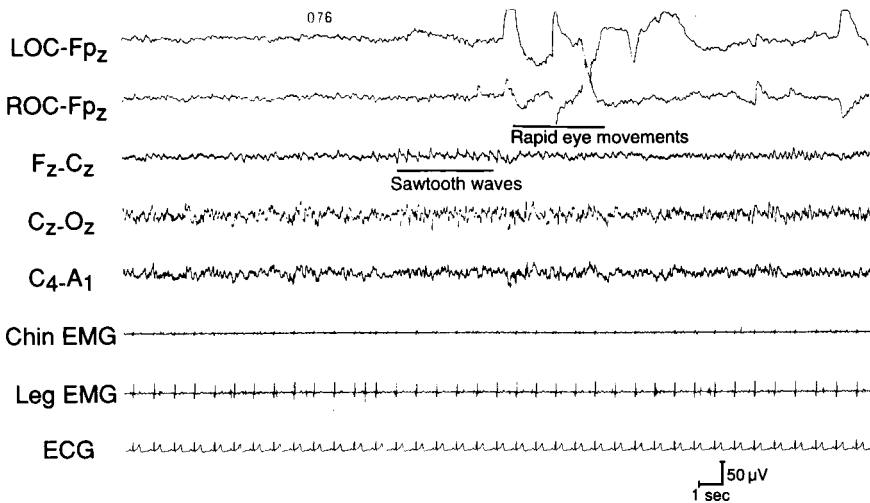
**Figure 41-8.** Stage N3 sleep. More than 20% of the epoch contains 0.5–2 Hz activity of amplitude greater than 75  $\mu$ V.

sleep spindles and K complexes are discrete and intermittent, intervals of low-amplitude mixed-frequency activity between K complexes or spindles are still scored as stage N2 unless there is evidence of a transition to stages W, N3, or R, an arousal or a major body movement followed by slow eye movements.

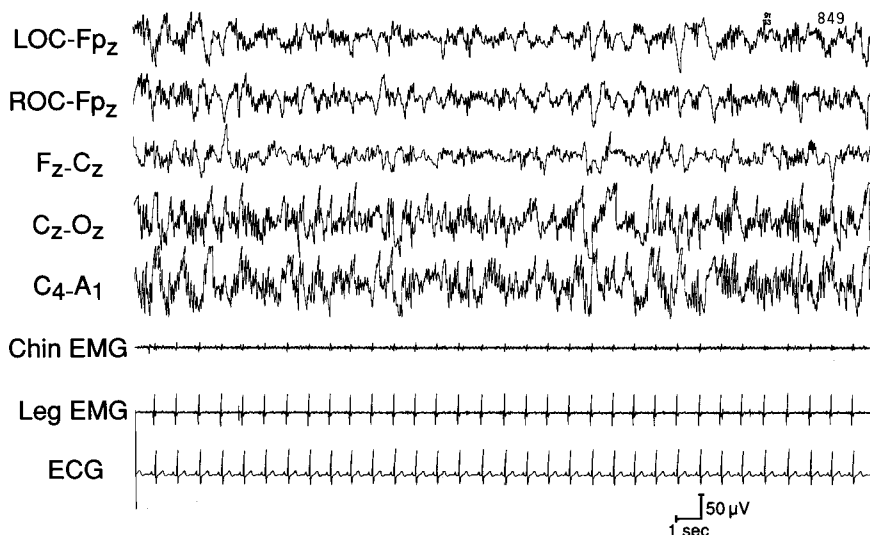
*Stages N3 sleep* (also known as *slow-wave sleep*) is a combination of the Rechtschaffen and Kales stages 3 and 4 (Fig. 41-8). The defining criteria are high-amplitude slow waves (at least 75  $\mu$ V peak-to-peak measured over the frontal region, 0.5–2 Hz frequency) comprising

at least 20% of the epoch. Sleep spindles may persist in stage N3 sleep.

REM sleep (*Stage R*) is defined by a relatively low-amplitude, mixed-frequency EEG, similar to that seen in stage N1, in combination with low chin EMG tone and episodic bursts of rapid eye movements (Fig. 41-9). Sawtooth waves (sharply contoured or triangular, often serrated, 2–6 Hz waves over the central region, frequently preceding bursts of rapid eye movements) may be seen in REM sleep. Transient muscle activity, previously referred to as *phasic muscle twitches*, consists of short irregular



**Figure 41-9.** REM sleep (stage R). REM sleep is characterized by rapid eye movements, low chin muscle tone on EMG, and an EEG pattern similar to that seen in stage N1 sleep. Sawtooth waves may also be seen.



**Figure 41–10.** Alpha intrusions into non-rapid eye movement sleep. This polysomnogram of a 50-year-old woman with a complaint of chronic fatigue illustrates intrusion of diffuse alpha activity into slow-wave sleep.

bursts of EMG activity, usually <0.25 second duration, superimposed on low EMG tone. The presence of sawtooth waves or transient muscle activity is strongly supportive of stage R sleep and may be helpful if scoring is in doubt.

Major body movements do not define a sleep stage but occur when movement and muscle artifact obscure more than half the EEG of an epoch. They usually occur in the setting of an arousal, so if alpha rhythm is discernable at all during the epoch or in the preceding or following epochs, the epoch with the movement should be scored as stage W. Otherwise the epoch is assigned the same stage as the epoch that follows it.

## Arousals

*Arousals* are defined as abrupt shifts in EEG frequency to the alpha, theta, or fast beta (>16 Hz) frequency bands. The subject must be asleep for at least 10 seconds before the arousal, and the EEG frequency shift must last for a minimum of 3 seconds. Arousals scored in REM sleep must also show increased chin EMG activity lasting at least 1 second. Scoring these arousals is important for an assessment of sleep quality: the more arousals there are, the worse one's perception is of how well one has slept and the sleepier one is during the subsequent day.<sup>20</sup>

*Alpha intrusion* should be distinguished from arousals. It is characterized by alpha

activity superimposed on the normal activity of NREM sleep (Fig. 41–10). This phenomenon, also called *alpha-delta sleep*,<sup>21</sup> is often associated with chronic pain (e.g., in fibromyalgia or rheumatoid arthritis), but it also may occur in patients who have no known medical disorder.

## Body Position

*Body position* may affect the severity of disordered breathing. It is always scored in clinical polysomnograms. This is done either with a special position indicator worn by the patient or by observing the patient through a closed circuit video monitor. If the patient does not spontaneously sleep part of the time on the back and part of the time on the side during the recording, he or she is usually awakened and asked to sleep in the other position to assess respiration in both positions.

## Summary Statistics for Sleep Variables

After all epochs have been scored, summary statistics are computed (Fig. 41–2). They include the following:<sup>3</sup>

1. *Total recording time* is from “lights out” to “lights on” in the morning for the last time.

2. *Total sleep time* includes all epochs scored as stages N1, N2, N3, or REM sleep.
3. *Sleep efficiency* is computed as the ratio of total sleep time to total recording time, expressed as a percentage.
4. *Sleep latency* is the lights out time to the start of the first epoch of any stage of sleep.
5. *Wake after sleep onset* is defined as the time in stage W during total recording time, excluding sleep latency.
6. *Sleep onset* is the start of the first epoch scored as other than stage W (usually stage N1).
7. *REM latency* is the time from sleep onset until the start of the first epoch scored as stage R. REM latency decreases with age (Table 41–2). Initial REM latency considerably shorter than that expected for a patient's age is nonspecific, but may suggest consideration for diagnoses of major depression, sleep deprivation, narcolepsy, or withdrawal of REM-suppressing medications. If narcolepsy is suspected, an MSLT is essential.
8. Time in each stage of sleep and percentage of total sleep time spent in each stage should be recorded.
9. *Arousal index* counts the number of arousals per sleep hour. The arousal indices considered normal depend on the scoring criteria used and may also vary from laboratory to laboratory. A study of arousals in normal subjects<sup>22</sup> revealed a mean of 4 per hour using the original Rechtschaffen and Kales definition<sup>17</sup> and a mean of 20 per hour using the American Sleep Disorders Association criteria,<sup>23</sup> which are very similar to the new AASM arousal criteria described earlier.<sup>1</sup> In our laboratory, we consider 15 or fewer arousals per hour to be normal.

To interpret arousal indices, it is important to know how many of the arousals and awakenings are caused by disordered breathing or by periodic limb movements. Arousals that do not meet the criteria for hypopneas may be associated with subtle increases in upper airway resistance. Markedly increased arousal indices unassociated with periodic limb movements or disordered breathing are often seen in patients with pain or other medical disorders or in those with psychological distress, especially anxiety.

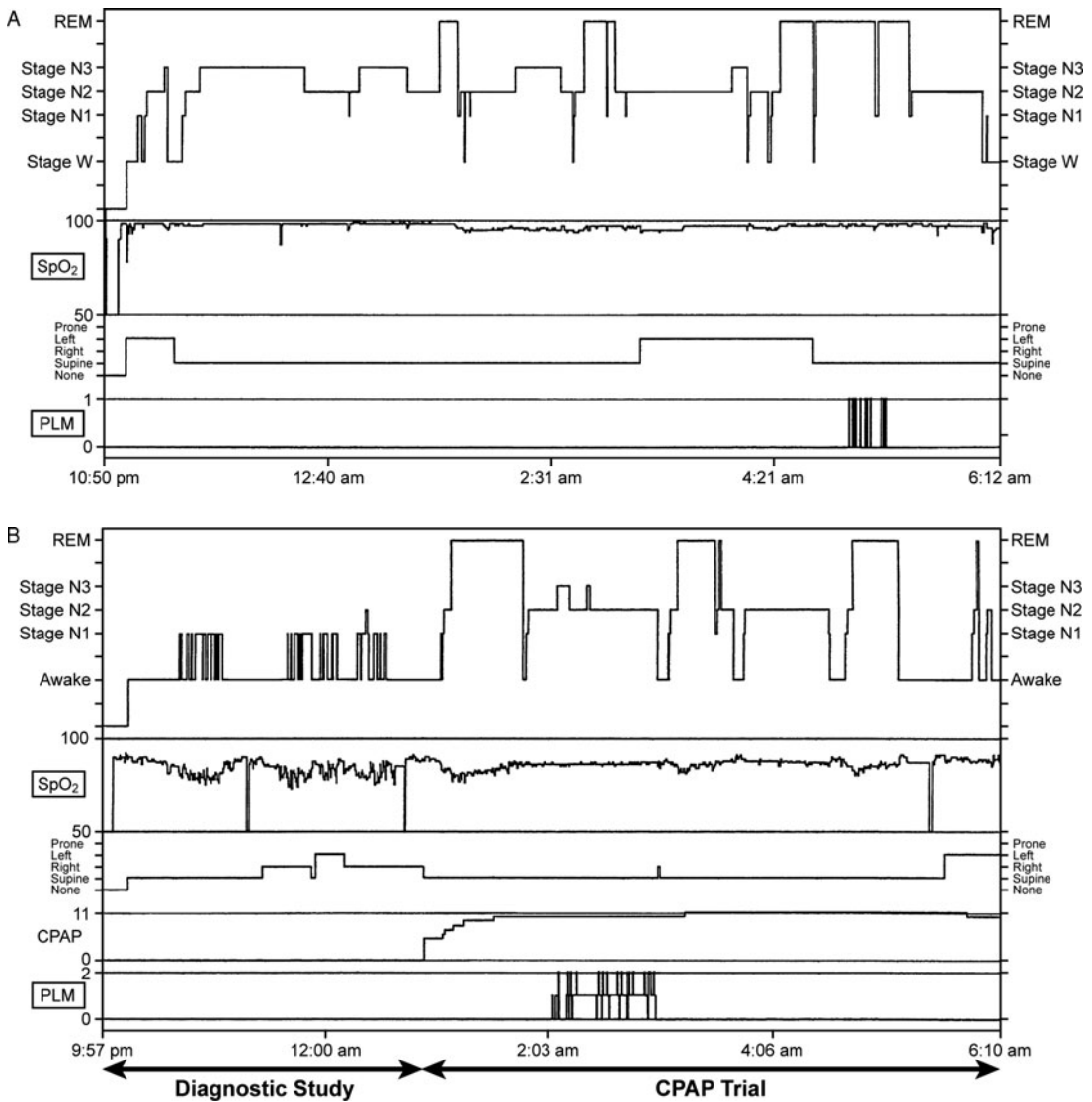
Interpretation of the various sleep scores and indices requires clinical judgment and should be made conservatively. Studies have shown that the patient's sleep in the laboratory on the first night may be atypically poor (*first-night effect*).<sup>24</sup> Alternatively, some insomniacs sleep especially well on the first night in the laboratory (*reverse first-night effect*).<sup>25</sup> Because the first night spent in the laboratory is frequently atypical, research studies often use a minimum of two laboratory nights to assess sleep and discard the first as adaptation. Economically, however, this is not feasible for clinical studies. Therefore, clinical studies are rarely performed to assess sleep architecture alone but usually to assess factors that disrupt sleep, such as breathing or movement disorders.

A comparison between the objectively recorded sleep variables as discussed in this chapter and the patients' self-reports of their sleep (obtained by their answers to a questionnaire the following morning) may yield clinical insight, especially if there is a large discrepancy in total sleep time. Such a discrepancy may be explained by (1) a high arousal index or alpha intrusions into sleep or (2) sleep-state misperception, a form of insomnia in which polysomnography reveals

**Table 41–2 Normal Lower Bounds for REM Latency (Mayo Sleep Disorders Center data)**

Age (years)	Initial REM Latency (minutes)
15–24	70
25–34	60
35–44	45
45–60	35
>60	30

REM, rapid eye movement sleep.



**Figure 41-11.** Sleep histogram of, *A*, a 19-year-old woman with no history of a sleep disorder and, *B*, a 58-year-old man with severe obstructive sleep apnea. The man had severely fragmented sleep during the diagnostic study, with marked rebound of rapid eye movement sleep during the CPAP trial. PLM, periodic limb movements of sleep; CPAP, air pressure (cm H<sub>2</sub>O) of continuous positive airway pressure system.

normal sleep while the patient complains of severely restricted sleep time. Development of sleep over an entire night is best represented by results of a sleep histogram (Fig. 41-11). This can indicate whether the sleep disturbances (e.g., disordered breathing and periodic limb movements) are evenly distributed over the entire sleep period or are associated with specific sleep stages, times of the night, or body positions. They can also show whether excessive wakefulness occurs early or

late (possibly suggesting influences of the circadian rhythm or psychiatric factors).

**Key Points**

- *The AASM Manual for the Scoring of Sleep and Associated Events* provides rules for the scoring of sleep stages, arousals, and other physiologic parameters during polysomnography.

- Sleep is divided into NREM (stages N1, N2, and N3) sleep and REM (stage R) sleep, each with specific scoring criteria.
- Arousals are sudden shifts in EEG frequency (usually to alpha) lasting at least 3 seconds, following at least 10 seconds sleep and, when occurring in REM sleep, are associated with increased chin tone.

## ASSESSING RESPIRATION DURING SLEEP

Most polysomnographic studies are performed to assess disordered breathing during sleep. The basic information obtained from polysomnography about disordered breathing includes the frequency and type of breathing disturbances, how severely oxyhemoglobin saturation is affected, and whether or not there is an associated cardiac arrhythmias. It is also of clinical relevance to determine if there is a difference in the degree of disordered breathing related to body position or sleep stage.

### Definitions

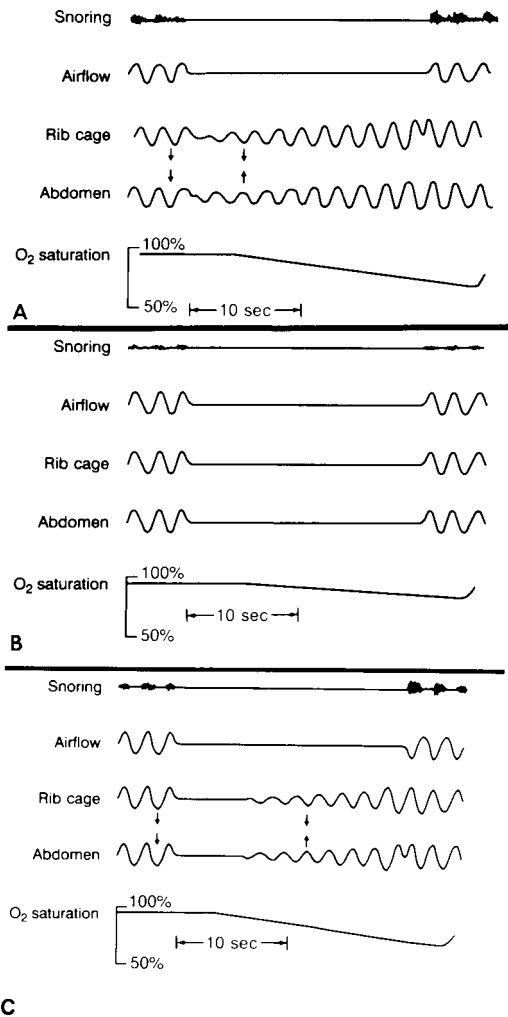
Disordered-breathing events associated with sleep are classified as apneas, hypopneas, or respiratory effort-related arousals (RERAs).<sup>1</sup> Apnea is defined as complete cessation of airflow, and hypopnea is a partial decrease in airflow. In theory, apnea and hypopnea are distinct, but the difference in their clinical relevance is slight, and reliable discrimination of the two types of events may be technically difficult. An *apnea* is defined as  $\geq 90\%$  drop in airflow amplitude measured by a thermal sensor lasting at least 10 seconds. There are two acceptable rules for defining a *hypopnea*. The recommended AASM rule requires  $\geq 30\%$  drop in airflow measured by a nasal pressure transducer lasting at least 10 seconds and associated with  $\geq 4\%$  oxyhemoglobin desaturation. The alternative rule requires  $\geq 50\%$  drop in airflow measured by a nasal pressure transducer lasting at least 10 seconds associated with  $\geq 3\%$  oxyhemoglobin desaturation or an arousal. The alternative definition is favored for epidemiological research, but most clinicians use the recommended rule. A *respiratory effort-related arousal* requires a sequence of breaths lasting at least 10 seconds

with increasing respiratory effort leading to an arousal but not fulfilling criteria for an apnea or hypopnea. Traditionally, respiratory effort is monitored using esophageal pressure but this technique is rarely used today. Decreased nasal pressure signal amplitude with flattening of the inspiratory component (“flow limitation”) and desynchrony of the abdominal and chest inductance plethysmography signals are acceptable surrogate markers, while a sequence of increasing amplitude snores may be helpful collaborative information.

It is also necessary to determine if an apnea or hypopnea is obstructive or central. *Obstructive apnea* is defined as a cessation of airflow in the presence of measurable, often gradually increasing, respiratory effort. During obstructive apnea, paradoxical breathing is often observed, that is, the chest expands as the abdomen contracts, but this is not essential for diagnosis (Fig. 41–12A). *Central apnea* shows a cessation of airflow coupled with a lack of respiratory effort (Fig. 41–12B). Sleep-onset central apnea may be relatively benign; it often simply indicates anxious overbreathing during wakefulness, with normalization during sleep. Periodic central apnea, or Cheyne–Stokes breathing, during sleep suggests either poor cardiac output (longer circulation time between lung and blood gas sensors in the carotid body) or problems with neuronal control of respiration. Apnea events with an initial central component followed by an obstructive component are called *mixed apneas* (Fig. 41–12C).

To evaluate disordered breathing events, a polysomnographic montage includes airflow evaluated by both a nasal pressure transducer and an oronasal thermal sensor, breathing effort, snoring intensity, a continuous measure of oxyhemoglobin saturation, and cardiac rhythm. As mentioned above, the body position of the sleeper also has to be assessed. If continuous positive airway pressure (CPAP) is considered as a treatment for disordered breathing during sleep, polysomnography is used to determine the minimal CPAP pressure that eliminates all disordered breathing (including snoring) in all sleep stages and in all positions. Therapeutic trials in the laboratory help the patient to adapt to wearing the mask while sleeping under professional supervision. During the CPAP trial, pressure must be monitored either by continuous recording on the polygraph or by careful written notation of pressure changes.





**C**  
**Figure 41-12.** Types of sleep apnea. *A*, Obstructive apnea is characterized by complete cessation of airflow, paradoxical movement of the rib cage and abdomen, and oxyhemoglobin desaturation. *B*, Central apnea has simultaneous cessation of airflow and respiratory effort, and oxyhemoglobin desaturation. *C*, Mixed apnea—an initial central apnea followed by a later obstructive component. (From Kaplan, J. 1991. Diagnosis and therapy of sleep-disordered breathing. In *Respiratory care: A guide to clinical practice*, ed. G. G. Burton, J. E. Hodgkin, and J. J. Ward, 3rd ed., 279–87. Philadelphia: JB Lippincott Company. By permission of Lippincott Williams & Wilkins.)

## Airflow

The reference standard for measurement of airflow is a pneumotachometer, a device that requires a snug-fitting mask over the face of the subject. Pneumotachometers provide an accurate quantitative measurement of airflow,

but the constrictive mask is uncomfortable and tends to disturb sleep. Its use is limited to research applications. The first method for detecting airflow during clinical polysomnography is the use of thermal sensors (thermocouples or thermistors) placed in the airstream at each nostril and the mouth.<sup>26</sup> Thermal sensors detect the temperature change between inspired and expired air. Although this does not quantitatively measure how much air is flowing, changes in signal amplitude indicate relative increases or decreases in airflow. The second method measures changes in airway pressure with a cannula placed in the nostrils and connected to a pressure transducer.<sup>26</sup> Thermal sensors are more sensitive to small volumes of airflow than nasal pressure transducers and therefore should be used to be certain that an apnea, rather than a hypopnea, is present. In contrast, the nasal pressure signal is more sensitive to minor changes in airflow or increases in upper airway resistance and thus should be used to define the presence of hypopneas or RERAs. As discussed earlier, both the sensors are required in routine polysomnograms. When CPAP is used during polysomnography, thermal sensors do not function well. Most CPAP systems designed for laboratory use provide analog signals for pressure and airflow. These signals can be interfaced with the polygraph to allow continuous monitoring of airflow during the CPAP trial.

## Respiratory Effort

The purpose of the respiratory pump muscles is to create a pressure gradient between the thoracic cavity and the atmosphere. The resulting pressure variations can be measured accurately by placing a transnasopharyngeal balloon-tipped, transducer-tipped, or water-filled catheter into the esophagus. Although this technique is the reference standard for measuring respiratory effort, it is invasive and can be an unpleasant experience and, thus, is not used routinely. Esophageal pressure may be used in rare circumstances to definitively distinguish central from obstructive apneas and to identify RERAs.

The recommended method to detect respiratory effort is inductance plethysmography, a noninvasive technique for detecting respiratory effort based on measuring changes

in the dimensions of the thoracic cavity.<sup>27</sup> Motion of the diaphragm changes the volume of the abdominal cavity, and motion of the rib cage changes the volume of the thoracic cavity. The inductance plethysmograph has wires embedded in elastic bands that are placed around the chest and abdomen to sense changes in the cross-sectional area of each of these two cavities. An electrical summation of the signals from rib cage and abdomen provides a rough estimate of overall tidal volume. The signals may be calibrated or uncalibrated; however, calibrated signals should be used to distinguish obstructive from central hypopneas.

An alternative method for measuring breathing effort is the monitoring of EMG activity in intercostal muscles. Because intercostal activity is inhibited during REM sleep, electrodes are placed over the sixth or seventh intercostal space in an attempt to also record diaphragmatic EMG. This technique should only be utilized if inductance plethysmography becomes unreliable.

## Snoring Sounds

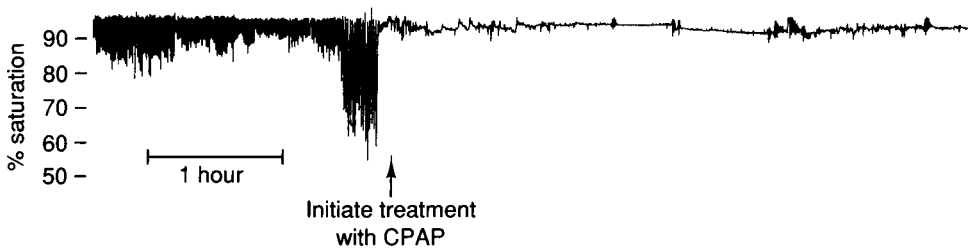
In many sleep laboratories, a small microphone is attached to the throat of the patient or mounted on the headboard or suspended above the bed. The output of the device may be filtered and recorded directly on the polygraph or processed through an integrator or sound level meter before recording. Digital systems allow for audio recording of the actual sound for later review, a technique especially helpful for distinguishing snoring from stridor. The recorded signal may be supplemented with the

technician's personal judgment, using a grading scale for loudness of snoring in four steps: (1) barely audible, (2) audible at the bedside, (3) audible from the open door to the bedroom, and (4) audible through the closed door.

## Blood Gases

Continuous monitoring of oxyhemoglobin saturation is mandatory because it provides information about the consequences of respiratory dysfunction.<sup>1</sup> Monitoring of oxyhemoglobin saturation is performed easily with a pulse oximeter, a device that measures the light absorption of two wavelengths of red light passed through a capillary bed, such as that of the earlobe or the nail bed of a finger. The wavelengths used match the peak absorption factors of oxyhemoglobin and deoxyhemoglobin. The oximeter then calculates the ratio of oxyhemoglobin to total hemoglobin and translates it into a digital display and an analog voltage that is written out on the polygraph. Because of lung-ear or lung-digit circulation time, the nadir of the oxyhemoglobin saturation graph usually follows the termination of the respiratory event (by 7–9 seconds when the sensor is on the ear). A review of the compressed signal over the course of the night can allow easy identification of periods of maximal respiratory dysfunction and their relationship to sleep stage and body position (Fig. 41–13).

If CO<sub>2</sub> retention is of concern in a patient, end-tidal (capnography) or transcutaneous PCO<sub>2</sub> may be recorded. The PCO<sub>2</sub> of air sampled from the airway at end-expiration (end-tidal) approximates alveolar PCO<sub>2</sub>. Transcutaneous PCO<sub>2</sub> uses a skin surface electrode to



**Figure 41–13.** Oximetry strip chart recording. The repetitive desaturations occurring in the early portion of the tracing are caused by obstructive apneas. Initiation of CPAP eliminates the apnea during the later portion of the recording.

measure the  $\text{PCO}_2$  in tissue underlying the skin. Both the techniques provide data about trends in arterial  $\text{PCO}_2$  but should be supplemented with blood gas analysis of arterial blood samples for accurate diagnosis of alveolar hypoventilation.

## Cardiac Rhythm

The ECG is recorded to detect changes in the cardiac rhythm related to disordered breathing during sleep. A single lead II is derived from electrodes placed on the torso or the right arm and left leg.<sup>28</sup> Additional leads can be placed if clinically indicated.

## Summary Statistics for Respiratory Variables

The following respiratory variables are typically reported on the polysomnographic summary sheet:

1. The number of central, obstructive, or mixed apneas and the number of hypopneas should be recorded. The *apnea hypopnea index* (AHI) indicates the combined number of apneas and hypopneas per sleep hour. This is usually reported for total sleep time, NREM and REM sleep time, and sleep time in the supine vs. other positions. AHI is the standard indicator of severity for obstructive sleep apnea. Fewer than 5 events per hour is considered normal, 5–15 events per hour is considered mild, 15–30 is moderate, and more than 30 is severe, although degree of oxyhemoglobin desaturation and associated arousals should also be taken into account.
2. The number of RERAs and the RERA index (number of RERAs per hour of sleep) should be recorded.
3. Mean and minimum oxyhemoglobin saturation values during wakefulness, REM sleep, and NREM sleep are usually given or a range is indicated. Optional measures include the percentage of time during sleep that the patient spends with oxygen saturation above 80% or 90%, and

the number of events per sleep hour with 3% or 4% oxyhemoglobin desaturations. The occurrence of Cheyne–Stokes breathing or hypoventilation should be specified.

4. Snoring is often reported on a scale from 1 to 4 (see the section on Snoring Sounds).

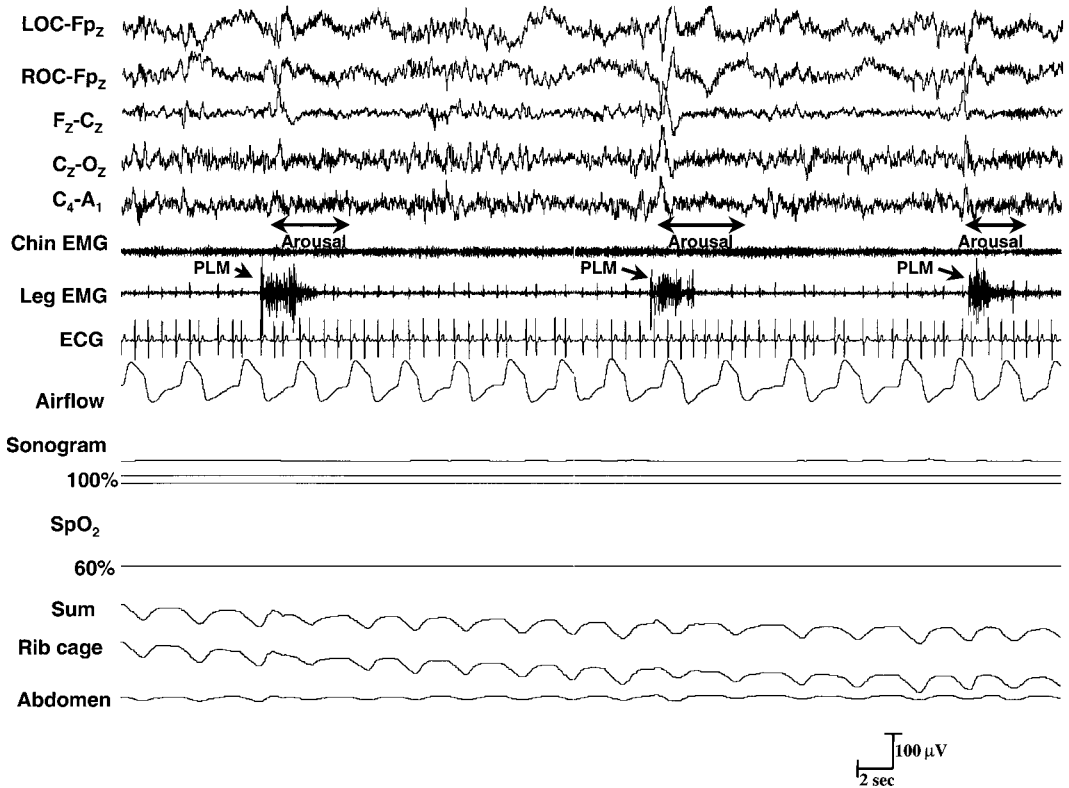
## Key Points

- Respiratory events during sleep are classified into apneas (obstructive, central, and mixed), hypopneas, and RERAs.
- Airflow is monitored by both a nasal pressure transducer and a thermal sensor; the former is used to define hypopneas and RERAs and the latter to define apneas.
- Respiratory effort is most commonly monitored by inductance plethysmography and occasionally by intercostal and diaphragmatic EMG.
- Other respiratory sensors include pulse oximeters and microphones to record snoring.
- The ECG should be recorded using standard or modified lead II.

## ASSESSING MOVEMENTS IN SLEEP

### Periodic Limb Movements

PLMS, usually of the legs but rarely the arms, may occur at regular intervals during sleep. They are recorded with surface electrodes applied over the anterior tibialis muscle of both legs. Either one channel of EMG is recorded from both legs or two channels are recorded, one per leg. The latter arrangement eliminates much of the ECG artifact that is typical in a one-channel recording from both legs. PLMS are scored only if at least four occur in sequence, with a duration of 0.5–10 seconds each and an interval of 5–90 seconds between the onsets of consecutive movements (Fig. 41–14).<sup>1</sup> Each movement must have a minimum amplitude of  $8\mu\text{V}$ , measured as a change in EMG amplitude over the resting



**Figure 41–14.** Periodic limb movements of sleep (PLMS). Bursts of anterior tibial surface EMG occurring at approximately 20-second intervals are accompanied by arousals lasting 3 seconds or longer.

EMG.<sup>29</sup> Bilateral leg movements separated by less than 5 seconds between movement onsets are counted as single movements. Periodic limb movements show flexions of hip, knee, and ankle joints together with extension of the toes, similar to a withdrawal response. Periodic limb movements need to be distinguished from gross body movements, which also show EMG artifact in the ECG and EEG leads, and from body movements associated with arousal from sleep apnea.

PLMS occur in many normal, especially older, sleepers but may also occur in several disorders, including *restless legs syndrome* (RLS). Generally, polysomnography is not indicated for the diagnosis of RLS, which is made on the basis of the history because the presence of PLMS is neither sufficiently specific nor sensitive. When limb movements are not associated with arousals, their significance in causing daytime sleepiness is uncertain. In many cases, PLMS may be an epiphenomenon accompanying other disorders such

as narcolepsy or idiopathic hypersomnia and may not in themselves cause symptoms.<sup>30</sup> However, if a high percentage of the movements cause the sleeper to awaken, PLMS can potentially contribute to excessive daytime somnolence, although care should be taken to first rule out other causes of sleepiness.

Periodic limb movements can also be recorded during wakefulness, especially in patients with RLS. Their presence during periods of wakefulness on a polysomnogram can be helpful diagnostically, and their presence can be formally quantitated by the *suggested immobilization test* for RLS. In this test, the patient is asked to lie down in the early evening but to remain awake and not to move the legs voluntarily. Anterior tibial EMG is recorded, and the periodic limb movement index over 30–60 minutes is calculated. More than 40 PLMS per hour have both a sensitivity and specificity of 81% for the diagnosis of RLS.<sup>31</sup> The test is often uncomfortable because patients with RLS need to move their legs

to relieve the discomfort and thus is rarely performed.

A periodic limb movement index (i.e., the number of periodic limb movements per sleep hour) is reported, followed by a periodic limb movement arousal index. This is the number of periodic limb movements per sleep hour that led to arousal. Movements occurring within 0.5 second before or after an apnea or hypopnea should not be counted.<sup>1</sup>

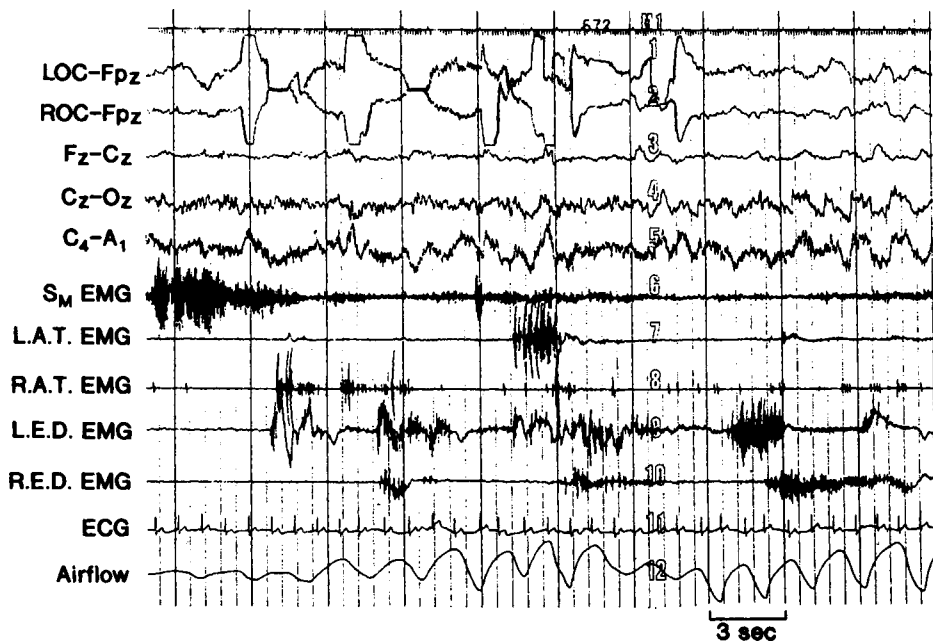
## REM Sleep Without Atonia

*REM sleep without atonia* is scored when both the EEG and the EOG suggest REM sleep but the chin or anterior tibial EMG does not show the expected muscle atonia. This usually takes the form of a marked increase in transient muscle activity (“phasic twitches”), but sometimes sustained tonic muscle activity is present. Transient muscle activity can be quantitated by dividing each 30-second epoch into ten 3-second mini-epochs. If at least five

of the mini-epochs contain transient muscle activity, this is considered excessive.<sup>1</sup> Experience and judgment are needed to determine whether muscle tone is excessive during REM sleep over the course of an entire night, as adequate normative data are not available. REM sleep without atonia is the neurophysiologic marker of REM sleep behavior disorder (RBD) (see the section on Assessing Sleep Disorders). In RBD, the technician in addition often observes vigorous twitching, quasi-purposeful movements such as punching in the air, and vocalization during REM sleep (Fig. 41–15).

## Bruxism

Bruxism can be recognized by a sequence of three or more brief elevations in chin EMG lasting 0.25–2 seconds each or sustained elevation lasting more than 2 seconds.<sup>1</sup> Audio and visual recordings are essential in confirming the diagnosis.



**Figure 41–15.** REM sleep without muscle atonia. The montage is modified to record EMG activity from all four limbs from an older man with Parkinson’s disease. Note frequent bursts of activity in the limb and submental EMG leads. Typically, the movements associated with this activity are related to dream content. L.A.T. = left anterior tibial; R.A.T. = right anterior tibial; L.E.D. = left extensor digitorum (arm); R.E.D. = right extensor digitorum (arm) (From Daube, J. R., G. D. Cascino, R. M. Dotson, M. H. Silber, and B. F. Westmoreland. 1998. *Continuum: Lifelong learning in neurology [Clinical Neurophysiology]*, Vol. 4, Part A, 169. Baltimore: Lippincott Williams & Wilkins. By permission of the American Academy of Neurology.)



**Key Points**

- Periodic limb movements are defined as trains of at least four anterior tibial EMG bursts, each of amplitude at least  $8\mu\text{V}$  above baseline and lasting 0.5–10 seconds, with a time of 5–90 seconds between the start of consecutive movements.
- PLMS are common in restless legs syndrome, but are nonspecific and are often asymptomatic.
- REM sleep without atonia is the neurophysiologic substrate of RBD.
- Bruxism can be recognized by a characteristic appearance of elevations in the chin EMG in association with audiovisual recordings.

**ASSESSING OTHER PHYSIOLOGIC VARIABLES****Core Temperature**

Monitoring core temperature may provide information about the phase and amplitude of the circadian cycle. Theoretically, this may be helpful in the diagnosis of circadian rhythm disorders, but in practice it is used only as a research technique.

**Esophageal pH Measurements**

Many patients experience reflux of stomach contents into the esophagus during sleep. Clearing of this material from the esophagus is markedly delayed during sleep. In specialized laboratories, esophageal pH may be measured to confirm a diagnosis of gastroesophageal reflux and to determine any relationship between episodes of reflux and arousals.

**PERFORMANCE OF A SLEEP STUDY**

Before evaluation, patients are usually sent questionnaires about sleep and a sleep log to be filled out for a minimum of 1 week. A sleep disorder specialist, ideally board certified in Sleep Medicine, then interviews the patient. If

indicated, polysomnography with or without a subsequent MSLT is then scheduled.

On the appointed night, patients come to the sleep center at about 7 PM. First, they fill out a questionnaire about their activity during the past day, about their intake of medicine, coffee, and alcohol, and about emotional issues that might disrupt sleep. A technician applies the electrodes and sensors necessary for the polysomnographic study. Patients then watch television or read until they are ready to go to bed. After the patients are connected to the polysomnograph, biocalibrations are made (patients are asked to move and blink their eyes, move their legs, grit their teeth, breathe exclusively through either the nose or the mouth, and perform an isovolume maneuver to maximize the recording of paradoxical breathing). Patients stay in bed for a minimum of 6 hours after “lights out” (often longer) except for short trips to the bathroom. A technician monitors the recording throughout the night, observes the patients through video monitoring, and notes on the record a patient’s position and any potentially significant events (e.g., patient vocalization, environmental noise that arouses the patient, and loudness of snoring).

If a diagnosis of OSA syndrome is made early in the night, the second half of the night may be used for a therapeutic trial of nasal CPAP. The AASM recommends that such “split-night” studies be restricted to patients with apnea-hypopnea indices greater than 40 (or greater than 20 if apneas are long with major desaturations) in the first half of the night.<sup>3</sup> However, economic pressures have forced an increasing number of sleep laboratories to perform “split-night” studies routinely if disordered breathing of lesser severity is detected in the first half of the study. No differences in medium and long-term CPAP use have been found in patients titrated with a split-night protocol compared with those undergoing a full-night CPAP study.<sup>32</sup>

In the morning, patients fill out another questionnaire about their perception of the quality of their sleep in the laboratory. A technician then scores the recordings and computes various indices. After the sleep specialist has reviewed the record, a follow-up conference with the patient is scheduled to discuss the results, to make a final diagnosis, and to initiate treatment if indicated.



### Key Points

- Polysomnography should be performed by a sleep specialist as part of a comprehensive clinical assessment of patients with suspected sleep disorders.
- Split-night polysomnograms may be cost-effective for the diagnosis and initiation of treatment for OSA, especially in patients with moderate to severe disease.

## ASSESSING SLEEP DISORDERS

### Disorders of Excessive Somnolence

*Excessive daytime somnolence* is defined as the tendency to fall asleep very easily. The ability to fall asleep quickly differentiates excessive daytime somnolence from chronic fatigue, malaise, or low-grade depression, in which patients may be exhausted and lie in bed for most of the day but are usually unable to fall asleep quickly when asked to do so. Excessive daytime somnolence may be caused by an extrinsic or intrinsic cause. The most common extrinsic cause is voluntary sleep deprivation (*insufficient sleep syndrome*), often found in people who work two jobs or have other reasons for not allowing themselves enough time in bed. If insufficient sleep syndrome is suspected, it is often useful to ask patients with excessive daytime somnolence to stay in bed 1 hour longer for an entire week, regardless of how long they have stayed in bed until that time, and observe whether excessive daytime somnolence wanes. Other extrinsic causes include the use of sedating medications, alcohol or recreational drugs, shift work, or environmental noise (including the snoring of a spouse).<sup>33</sup>

The most common intrinsic cause of excessive sleepiness is obstructive sleep apnea. Other causes include central sleep apnea, narcolepsy, idiopathic hypersomnia, disorders of circadian rhythm such as delayed sleep phase disorder, and PLMS (if these are associated with a high percentage of arousals).<sup>8</sup> Polysomnography (with or without a subsequent MSLT) is needed to diagnose most intrinsic causes (circadian rhythm disorders are exceptions). Initially, polysomnography is performed, usually after the patient completes a

sleep log or wears an actigraph for a week. If a cause, such as sleep apnea, is found, the MSLT scheduled for the following day is canceled and the problem is treated. If the polysomnogram is normal and nighttime sleep is adequate (6 or 7 hours), MSLT is performed. Interpretation of the MSLT is discussed earlier.

### Parasomnias

*Parasomnias* are undesirable, mainly motor, phenomena that occur during sleep. They include disorders of arousal (e.g., sleepwalking and sleep terrors), REM-associated parasomnias (e.g., RBD and nightmare disorder), and other parasomnias (e.g., sleep-related groaning and sleep-related eating disorder).<sup>8</sup> The indications for studying parasomnias are discussed earlier under Polysomnography. The laboratory assessment of parasomnias requires more sophisticated recording systems and additional interpretive abilities than routine polysomnography.<sup>34</sup> Additional polygraphic channels are needed, including one or more channels for recording arm EMG (usually over the extensor digitorum muscles) and additional EEG channels (preferably 16), to rule out seizures that can mimic parasomnias (Fig. 41–16). Digital recording systems with a 10-second screen size and high-resolution, time-synchronized videotape recording under infrared light are essential. Physicians interpreting parasomnia studies should be familiar with both routine polysomnographic interpretation and ictal EEG patterns.

*Disorders of arousal* (sleepwalking, sleep terrors, or confusional arousals) are characterized by sudden arousals from slow-wave sleep, followed by abnormal motor behavior. They are most common in children but may commence or persist in adulthood. Although the conditions are usually benign, occasionally patients may suffer or inflict severe injuries. The polysomnogram shows a rapid, usually unprovoked arousal from slow-wave sleep. This is sometimes preceded by a series of hypersynchronous delta waves without epileptiform activity, seen in the scoring channel in 47% of events.<sup>35</sup> The actual event is usually obscured by movement artifact, but the record may show tachycardia and varied EEG patterns, including rhythmic delta activity, irregular mixed frequency activities (predominantly delta and



**Figure 41-16.** Parasomnia recording using an expanded EEG montage, illustrating arousal parasomnia. There is a sudden partial arousal from stage N3 non-rapid eye movement sleep without epileptiform activity. Note that the arousal is preceded by a series of hypersynchronous delta waves and that some slow activity continues throughout the arousal. In this 9-year-old boy, the episodes of sleep terror were precipitated by stridor (visible as deflections on the sonogram channel) as a result of vocal cord paresis following surgery for a posterior fossa medulloblastoma. LOC, left outer canthus; ROC, right outer canthus; sonograph, recording of upper airway sound. (From Daube, J. R., G. D. Cascino, R. M. Dotson, M. H. Silber, and B. F. Westmoreland. 1998. *Continuum: Lifelong learning in neurology [Clinical Neurophysiology]*, Vol. 4, Part A, 166. Baltimore: Lippincott Williams & Wilkins. By permission of the American Academy of Neurology.)

theta), or alpha rhythm. Compared with normal age-matched controls, the polysomnogram of patients with disorders of arousal shows a higher percentage of slow-wave sleep, more frequent arousals from slow-wave sleep, and a more even distribution of slow-wave sleep through the night.<sup>36</sup> Although these findings shed interesting light on the pathogenesis of the disorder, they are not specific enough to be of diagnostic help. The polysomnographic appearances of sleep terrors, sleepwalking, and confusional arousals are identical, and video recording is essential to delineate fully the nature of the event. Even if a typical episode is not recorded the night of the study, careful review of the tracing often reveals the presence of minor confusional arousals.

*REM sleep behavior disorder* is characterized by an abnormal persistence of muscle tone during REM sleep with dream enactment behavior.<sup>37</sup> This usually takes the form of arm flailing and kicking with vocalizations. If the patient is awakened, a violent dream is often recalled. Injuries to the patient and bed partner are common. The condition occurs most frequently in older men and is often associated with neurodegenerative disease such as Parkinson's disease, dementia with Lewy bodies, or MSA (synucleinopathies). The polysomnogram shows abnormally increased transient muscle activity in REM sleep and occasionally a persistent tonic EMG. Even if no gross movements are recorded the night of the study, muscle tone during REM

sleep usually remains high and can be recognized. It is essential to record an additional upper-extremity EMG channel, because not all skeletal muscles are involved in any one patient.

### Key Points

- Excessive somnolence may be caused by insufficient sleep syndrome, environmental sleep disorder, hypersomnia induced by drugs, sleep apnea, narcolepsy, idiopathic hypersomnia, and circadian rhythm disorders.
- The elucidation of excessive somnolence needs a careful history and the judicious use of sleep studies such as actigraphy, polysomnography, and the MSLT.
- Polysomnography to elucidate the parasomnias must include additional EEG and EMG derivations and time-synchronized audiovisual monitoring. Interpretation must be performed by physicians trained to recognize electroencephalographic seizures as well as polygraphic manifestations of sleep disorders.
- Even if characteristic events do not occur the night of the study, the diagnosis of REM sleep behavior disorder can be made by identifying increased muscle tone in REM sleep, and often the diagnosis of a disorder of arousal can be made by identifying minor confusional arousals.

### SUMMARY

This chapter reviews the techniques that are available to study sleep and disorders that may occur during sleep. Multiple physiologic parameters can be assessed using one or a combination of polysomnography, multiple sleep latency or maintenance of wakefulness tests, actigraphy, and portable monitoring. The use of these tests is helpful to not only identify different stages of sleep, but to assess sleep disorders, such as abnormal movements in sleep and disorders manifesting with excess somnolence. The field of Sleep Medicine and the associated sleep neurophysiology continues to grow and expand our understanding of sleep-related disorders.

### REFERENCES

1. Iber, C., S. Ancoli-Israel, A. Chesson, et al. 2007. *The AASM Manual for the Scoring of Sleep and Associated Events: Rules, Terminology and Technical Specifications*, 1st ed. Westchester, IL: American Academy of Sleep Medicine.
2. Hirshkowitz, M., and C. A. Moore. 1994. Issues in computerized polysomnography. *Sleep* 17:105–12.
3. Kushida, C. A., M. R. Littner, T. I. Morgenthaler, et al. 2005. Practice parameters for the indications for polysomnography and related procedures: An update for 2005. *Sleep* 28:499–521.
4. Standards of Practice Committee of the American Academy of Sleep Medicine. 2005. Practice parameters for clinical use of the multiple sleep wakefulness test and the maintenance of wakefulness test. *Sleep* 28:113–21.
5. Kingshott, R. N., and N. J. Douglas. 2000. The effect of in-laboratory polysomnography on sleep and objective daytime sleepiness. *Sleep* 23:1109–13.
6. Benbadis, S. R., M. C. Perry, B. R. Wolgamuth, et al. 1995. Mean versus median for the multiple sleep latency test. *Sleep* 18:342–5.
7. Arand, D., M. Bonnet, T. Hurwitz, et al. 2005. The clinical use of the MSLT and MWT. *Sleep* 28:123–44.
8. American Academy of Sleep Medicine. 2005. *The International Classification of Sleep Disorders: Diagnostic and Coding Manual*, 2nd ed. Westchester, IL: American Academy of Sleep Medicine.
9. Aldrich, M. S., R. D. Chervin, and B. A. Malow. 1997. Value of the multiple sleep latency test (MSLT) for the diagnosis of narcolepsy. *Sleep* 20:620–9.
10. Doghramji, K., M. M. Mitler, R. B. Sangal, et al. 1997. A normative study of the maintenance of wakefulness test (MWT). *Electroencephalography and Clinical Neurophysiology* 103:554–62.
11. Sagaspe, P., J. Taillard, G. Chaumet, et al. 2007. Maintenance of wakefulness test as a predictor of driving performance in patients with untreated obstructive sleep apnea. *Sleep* 30:327–30.
12. Morgenthaler, T. I., C. Alessi, L. Friedman, et al. 2007. Practice parameters for the use of actigraphy in the assessment of sleep and sleep disorders: An update for 2007. *Sleep* 30:519–29.
13. Collop, N. A., W. M. Anderson, B. Boehlicke, et al. 2007. Clinical guidelines for the use of unattended portable monitors in the diagnosis of obstructive sleep apnea in adult patients. *Journal of Clinical Sleep Medicine* 3:737–747.
14. Chesson, A. L., R. B. Berry, and A. Pack. 2003. Practice parameters for the use of portable monitoring devices in the investigation of suspected obstructive sleep apnea in adults. A joint project sponsored by the American Academy of Sleep medicine, the American Thoracic Society and the American College of Chest Physicians. *Sleep* 26:907–13.
15. Mulgrew, A. T., N. Fox, N. T. Ayas, and C. F. Ryan. 2007. Diagnosis and initial management of obstructive sleep apnea without polysomnography: A randomized validation study. *Annals of Internal Medicine* 146:157–66.

16. Whitelaw, W. A., R. F. Brant, and W. W. Flemons. 2005. Clinical usefulness of home oximetry compared with polysomnography for assessment of sleep apnea. *American Journal of Respiratory and Critical Care Medicine* 171:188–93.
17. Rechtschaffen, A., and A. Kales. 1968. *A manual of standardized terminology, techniques, and scoring system for sleep stages of human subjects*. Bethesda, MD: National Institute of Neurological Disease and Blindness.
18. Iber, C., S. Ancoli-Israel, M. Chambers, and S. F. Quan. 2007. The new sleep scoring manual—The evidence behind the rules. *Journal of Clinical Sleep Medicine* 3:107.
19. Silber, M. H., S. Ancoli-Israel, and M. H. Bonnet. 2007. The visual scoring of sleep in adults. *Journal of Clinical Sleep Medicine* 3:121–31.
20. Bonnet, M. H. 1986. Performance and sleepiness as a function of frequency and placement of sleep disruption. *Psychophysiology* 23:263–71.
21. Hauri, P., and D. R. Hawkins. 1973. Alpha-delta sleep. *Electroencephalography and Clinical Neurophysiology* 34:233–7.
22. Mathur, R., and N. J. Douglas. 1995. Frequency of EEG arousals from nocturnal sleep in normal subjects. *Sleep* 18:330–3.
23. Sleep Disorders Atlas Task Force of the American Sleep Disorders Association. 1992. EEG arousals: Scoring rules and examples. *Sleep* 15:173–84.
24. Agnew, H. W. J. 1966. The first night effect: An EEG study of sleep. *Psychophysiology* 2:263–6.
25. Hauri, P. J., and E. M. Olmstead. 1989. Reverse first night effect in insomnia. *Sleep* 12:97–105.
26. Redline, S., R. Budhiraja, V. Kapur, et al. 2007. The scoring of respiratory events in sleep: Reliability and validity. *Journal of Clinical Sleep Medicine* 3: 169–200.
27. Staats, B. A., H. W. Bonekat, C. D. Harris, and K. P. Offord. 1984. Chest wall motion in sleep apnea. *The American Review of Respiratory Disease* 130: 59–63.
28. Caples, S. M., C. L. Rosen, W. K. Shen, et al. 2007. The scoring of cardiac events during sleep. *Journal of Clinical Sleep Medicine* 3:147–54.
29. Walters, A. S., G. Lavigne, W. Hening, et al. 2007. The scoring of movements in sleep. *Journal of Clinical Sleep Medicine* 3:155–67.
30. Montplaisir, J., M. Michaud, R. Denesle, and A. Gosselin. 2000. Periodic leg movements are not more prevalent in insomnia or hypersomnia but are specifically associated with sleep disorders involving a dopaminergic mechanism. *Sleep Medicine* 1: 163–7.
31. Montplaisir, J., S. Boucher, A. Nicolas, et al. 1998. Immobilization tests and periodic leg movements in sleep for the diagnosis of restless leg syndrome. *Movement Disorders* 13:324–9.
32. McArdle, N., A. Grove, G. Devereaux, et al. 2000. Split-night versus full-night studies for sleep apnoea/hypnoea syndrome. *The European Respiratory Journal* 15:670–5.
33. Beninati, W., C. D. Harris, D. L. Herold, and J. W. Shepard. 1999. The effect of snoring and obstructive sleep apnea on the sleep quality of bed partners. *Mayo Clinic Proceedings* 74:955–8.
34. Aldrich, M. S., and B. Jahnke. 1991. Diagnostic value of video-EEG polysomnography. *Neurology* 41:1060–6.
35. Schenck, C. H., J. A. Pareja, A. L. Patterson, and M. W. Mahowald. 1998. Analysis of polysomnographic events surrounding 252 slow-wave sleep arousals in thirty-eight adults with injurious sleepwalking and sleep terrors. *Journal of Clinical Neurophysiology* 15: 159–66.
36. Espa, F., B. Ondze, P. Deglise, et al. 2000. Sleep architecture, slow wave activity, and sleep spindles in adult patients with sleepwalking and sleep terrors. *Clinical Neurophysiology* 111:929–39.
37. Olson, E. J., B. F. Boeve, and M. H. Silber. 2000. Rapid eye movement sleep behavior disorder: Demographic, clinical and laboratory findings in 93 cases. *Brain* 123:331–9.

SECTION 2

**ELECTROPHYSIOLOGIC  
ASSESSMENT OF NEURAL  
FUNCTION**

---

*This page intentionally left blank*



# Intraoperative Monitoring

---

The central and peripheral nervous systems are at risk for damage during surgical procedures, particularly vascular, orthopedic, and neurosurgical procedures. Although some types of damage may be expected because of the nature of the procedure, other types can occur unexpectedly. In either case, damage may be reversible if the surgeon is made aware of the change and takes appropriate action. Standard clinical tools cannot assess neural function during surgical procedures. Therefore, surgeons have had relatively little information on which to base decisions about modifying the procedure in response to impending damage to neural tissue.

Most electrophysiologic measurements described in this book can be made intraoperatively to monitor neural function. Electroencephalography can be used to monitor the status of cortical function; somatosensory evoked potentials, to monitor sensory pathways in the periphery, spinal cord, and brain; auditory evoked potentials, to monitor peripheral and central auditory pathways; nerve conduction studies and electromyography, to monitor peripheral nerve damage; and motor evoked potentials, to monitor descending motor pathways in the brain stem and spinal cord. Each of these techniques has been modified, so it can be used in the operating room for a wide variety of surgical procedures. These monitoring techniques provide helpful guidance to the surgeon during the procedure and have reduced morbidity associated with certain procedures. The optimal monitoring methods vary

with the level and type of surgical procedure: supratentorial (Chapter 42), posterior fossa (Chapter 43), spinal column (Chapter 44), and peripheral nerve (Chapter 45).

As surgeons have become more familiar with the benefits of intraoperative monitoring of neural function, the demand for it has increased. This change is reflected in the expanded discussion in this edition of the compound muscle action potentials, motor evoked potentials, electromyographic recordings, carotid stump, and compressed spectral array, and in the revision of the discussion on intraoperative monitoring during nerve entrapment procedures. As post-traumatic brachial plexus reconstruction methods have developed, there has been an increasing call for neurophysiologic monitoring during the surgery. With increased experience with intraoperative monitoring, more specific criteria have been developed to prevent damage.

Continuous electrophysiologic monitoring can be helpful in the intensive care unit. Patients in an intensive care unit either have a major neurologic disease or are at risk of having one develop as a complication of another disorder. Electrophysiologic techniques can be used to monitor neural function in this setting just as they can be in the operating room to identify early or otherwise unrecognizable neural damage. The chapters in this section illustrate the applications of electrophysiologic techniques both in the operating room and in the intensive care unit.

*This page intentionally left blank*

# Cerebral Function Monitoring

Elson L. So and Frank W. Sharbrough

INTRODUCTION  
TECHNICAL FACTORS IN  
INTRAOPERATIVE EEG  
MONITORING  
EFFECTS OF ANESTHESIA ON  
ELECTROENCEPHALOGRAPHY  
SYMMETRICAL EEG PATTERNS  
DURING ANESTHESIA  
PREOPERATIVE FOCAL  
ABNORMALITIES SEEN WITH  
ANESTHESIA  
CLINICAL APPLICATIONS  
EEG CHANGES DURING  
CAROTID ENDARTERECTOMY

SEP RECORDING DURING  
CAROTID ENDARTERECTOMY  
OTHER MONITORING  
TECHNIQUES DURING  
CAROTID ENDARTERECTOMY  
EEG MONITORING DURING  
CARDIAC SURGERY  
BISPECTRAL ANALYSIS OF EEG  
FOR MONITORING DEPTH OF  
ANESTHESIA  
EEG MONITORING FOR  
EPILEPSY SURGERY  
SUMMARY

## INTRODUCTION

Among the first applications of intraoperative recording of cerebral electrical activity were corticography and, later, acute depth studies during epilepsy surgery. More recently, scalp electroencephalographic (EEG) recordings (with or without special computer processing) have been used routinely in many medical centers to monitor cerebral electrical activity during endarterectomy<sup>1</sup> and cardiac bypass operations.<sup>2</sup> EEG monitoring during the latter procedure is limited by the effect of hypothermia, which often suppresses EEG activity,<sup>3</sup> making it ineffective as a monitoring tool for ischemia. EEG monitoring for cardiac surgery is further limited because easily correctable

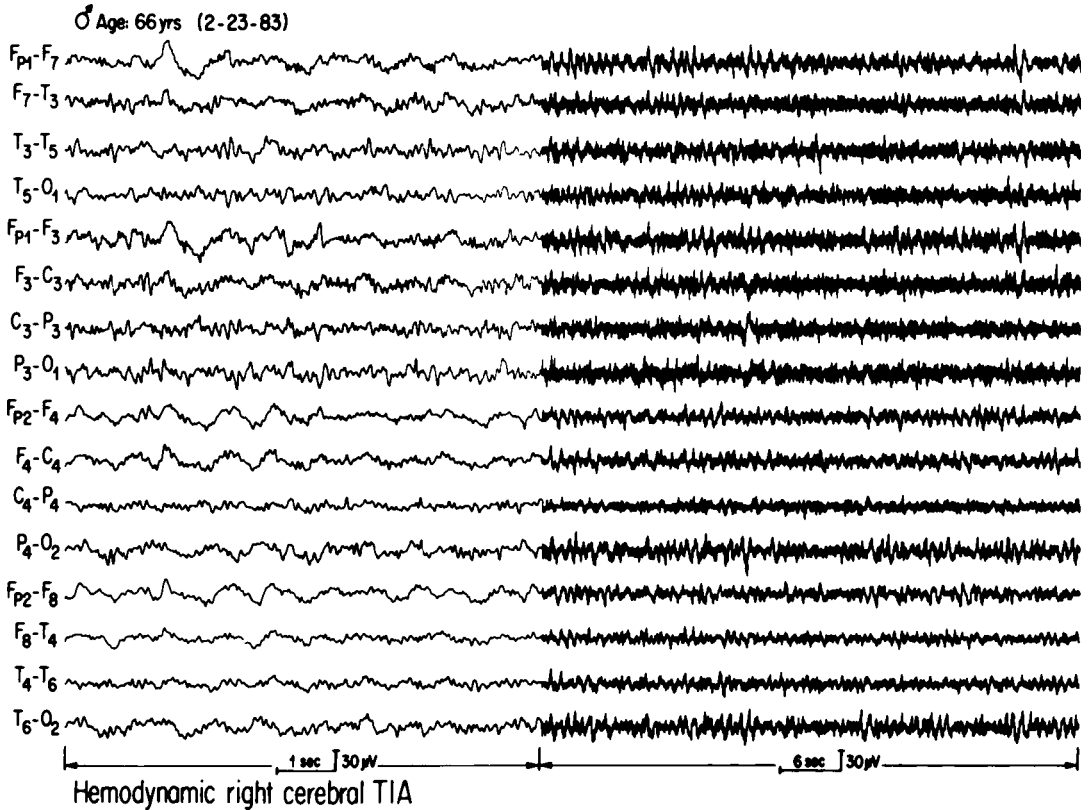
causes of ischemia occur less commonly than during operations on the carotid artery.

### *Purpose and Role of Cerebral Function Monitoring*

- To monitor cerebral electrical activity during carotid endarterectomy and cardiac bypass surgery.

## TECHNICAL FACTORS IN INTRAOPERATIVE EEG MONITORING

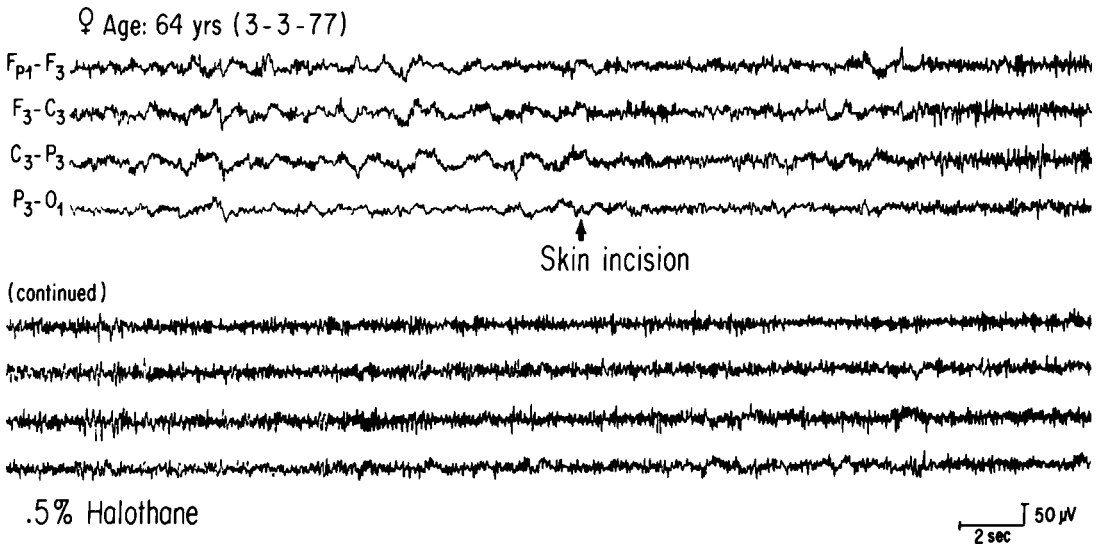
To ensure reliable EEG recordings during intraoperative monitoring, it is important to pay special attention to technical factors:<sup>4</sup>



**Figure 42-1.** EEG with isoflurane anesthesia. *Left*, EEG recorded with routine paper speed (30 mm/second). Common patterns of anesthetic—ARF alpha pattern, ATS pattern, and PAS pattern—are seen in the left hemisphere. In the right hemisphere, there is an increase in the amount of irregular slowing, especially in temporal distribution, and reduction in the normal ARF alpha pattern. *Right*, The same changes can be appreciated qualitatively even at a reduced paper speed of 5 mm/second (one-sixth the usual paper speed). Note that this patient has a focal abnormality while under anesthesia, even though the patient had had only a right cerebral transient ischemic attack (TIA) without residual deficit. (From Daube, J. R., C. M. Harper, W. J. Litchy, and F. W. Sharbrough. 1990. Intraoperative monitoring. In *Current practice of clinical electroencephalography*, ed. D. D. Daly, and T. A. Pedley, 2nd ed., 743. New York: Raven Press. By permission of Mayo Foundation for Medical Education and Research.)

application of electrodes with collodion for stability, an adequate number of electrodes (at least 8 and preferably 16 channels), filtering of background noise with a 60-Hz notch filter, use of adequate sensitivity, and proper grounding for patient safety. The timescale used to display EEG data is a particularly important technical factor, because a large amount of data are generated during intraoperative EEG monitoring, and it must be compressed without essential data being lost. Computer processing with spectral analysis presented as a compressed spectral array has been used for this purpose.<sup>5</sup> There are reports that suggest that computerized quantitative analysis of EEG may complement visual analysis in detecting the EEG changes.<sup>6,7</sup> However, data can be compressed visually without using spectral analysis simply

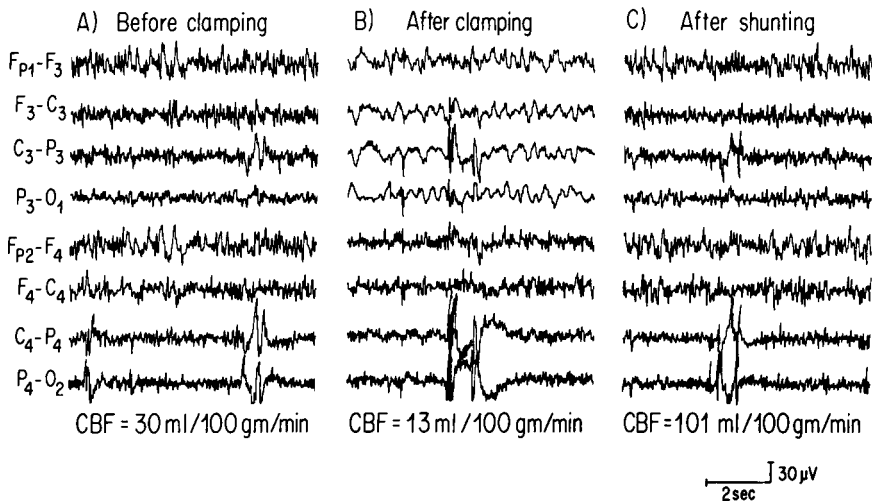
by altering the timescale in digital EEG recordings; for example, slowing the paper speed initially to a rate of 15 mm/second, which is half the speed used in standard EEG recordings<sup>8</sup> (Figs. 42-1 to 42-4). Even a longer timescale display, corresponding to a paper speed of 5 mm/second (one-sixth of that used in standard recordings), is adequate for detecting important EEG changes of ischemia during intraoperative clamping (Fig. 42-5). If unusual EEG changes are suspected while a slower timescale is being used, returning to the regular timescale or paper speed of 30 mm/second will permit prompt identification of abnormal patterns (Fig. 42-1). Moreover, EEG changes may be detected early by displaying both ongoing EEG and baseline EEG using a split-screen view for visual comparison.



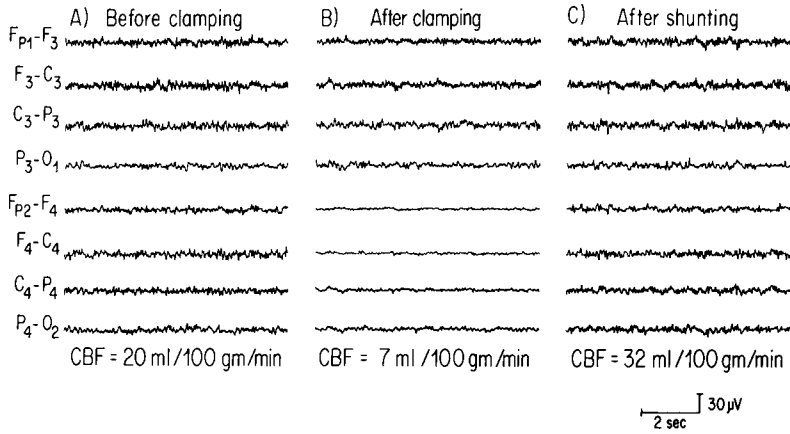
**Figure 42-2.** The effect of painful stimulation (skin incision) on the EEG during levels of anesthesia below minimal alveolar concentration; such stimulation tends to reduce the amount of slow activity and to accentuate the amount of fast activity seen with a given concentration of anesthetic agent. Paper speed is 15 mm/second (half the usual speed). (From Daube, J. R., C. M. Harper, W. J. Litchy, and F. W. Sharbrough. 1990. Intraoperative monitoring. In *Current practice of clinical electroencephalography*, ed. D. D. Daly, and T. A. Pedley, 2nd ed., 742. New York: Raven Press. By permission of Mayo Foundation for Medical Education and Research.)

Therefore, it is essential that EEG recording commence before anesthetics are administered, and recorded subsequently on a continuous basis. At our institution, the EEG monitoring is continued until the patient has recovered sufficiently from anesthetic effect to respond to

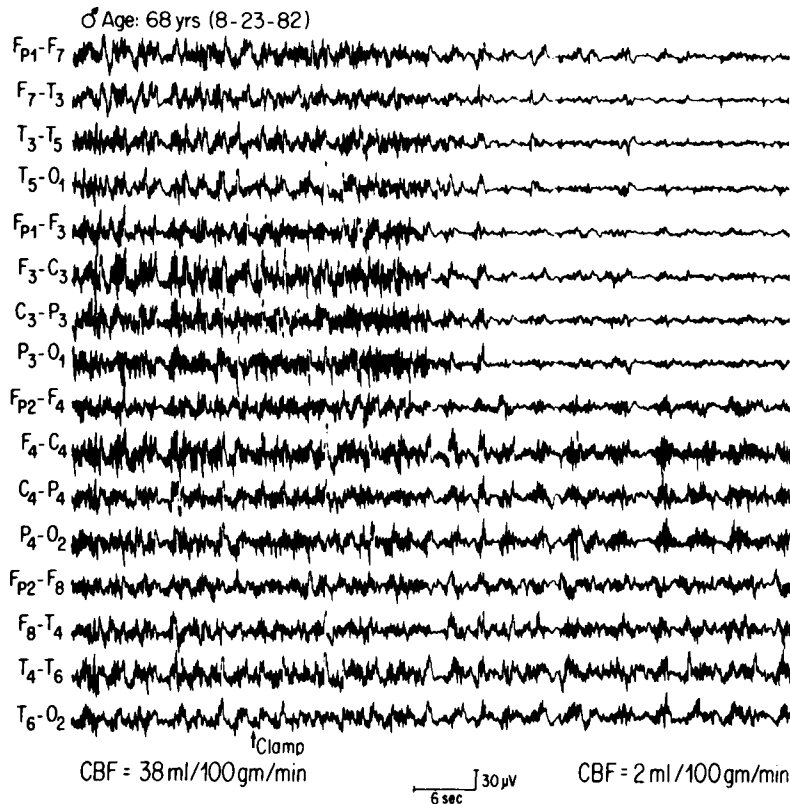
simple commands for checking motor strength. If the electrophysiologist is not present in the operating room, technical provisions should be made to permit reliable and immediate review of the digital recording at a site readily accessible to the electrophysiologist.



**Figure 42-3.** A-C, EEG of a 54-year-old man undergoing left carotid endarterectomy. The EEG result demonstrates the type of reduction in the faster anesthetic components and the retention of rhythmic slowing that occurs with less severe decrease in cerebral blood flow (CBF) below the critical level. This change is easy to identify despite significant artifact affecting the posterior electrodes. Paper speed is 15 mm/second (half the usual paper speed). (From Daube, J. R., C. M. Harper, W. J. Litchy, and F. W. Sharbrough. 1990. Intraoperative monitoring. In *Current practice of clinical electroencephalography*, ed. D. D. Daly, and T. A. Pedley, 2nd ed., 742. New York: Raven Press. By permission of Mayo Foundation for Medical Education and Research.)



**Figure 42-4.** A-C, EEG of a 74-year-old man undergoing right carotid endarterectomy. The EEG in B demonstrates the more severe type of EEG "suppression" that occurs in association with a more severe decrease in cerebral blood flow below the critical level. Paper speed is 15 mm/second (half the usual paper speed). (From Daube, J. R., C. M. Harper, W. J. Litchy, and F. W. Sharbrough. 1990. Intraoperative monitoring. In *Current practice of clinical electroencephalography*, ed. D. D. Daly, and T. A. Pedley, 2nd ed., 743. New York: Raven Press. By permission of Mayo Foundation for Medical Education and Research.)



**Figure 42-5.** EEG of a 68-year-old man undergoing left carotid endarterectomy. The EEG shows the type of dramatic, rapid attenuation of all components often associated with cerebral blood flow of less than 6 or 7 mL/100 g per minute. Paper speed is 5 mm/second (one-sixth the usual paper speed). (From Daube, J. R., C. M. Harper, W. J. Litchy, and F. W. Sharbrough. 1990. Intraoperative monitoring. In *Current practice of clinical electroencephalography*, ed. D. D. Daly, and T. A. Pedley, 2nd ed., 744. New York: Raven Press. By permission of Mayo Foundation for Medical Education and Research.)



### Key Points

- EEG data during carotid endarterectomy must be compressed and displayed at settings that will permit review of large amount of data.
- If the electrophysiologist is not present in the operating room, technical provisions should be made to permit reliable and immediate review of the digital recording at a site readily accessible to the electrophysiologist.
- EEG recording should commence before anesthetics are administered, and recorded subsequently on a continuous basis.
- EEG monitoring should be continued until the patient has recovered sufficiently from anesthetic effect to respond to simple commands for checking motor strength.

## EFFECTS OF ANESTHESIA ON ELECTROENCEPHALOGRAPHY SYMMETRICAL EEG PATTERNS DURING ANESTHESIA

Although much has been written about the effects of different anesthetic agents on the EEG during anesthesia, most of these agents produce similar EEG patterns when used at concentrations below their minimal alveolar concentration, which is the level necessary to prevent movement in response to a painful stimulus in approximately 50% of patients. Common anesthetic agents, including thiopental, halothane, enflurane, isoflurane, and nitrous oxide, produce certain EEG changes that are related to the degree and timing of anesthesia.

*Subanesthetic Concentrations.* Subanesthetic concentrations characteristically produce maximal beta activity in the anterior midline. This pattern is most commonly seen with thiopental but may occur less prominently with halothane, enflurane, isoflurane, and 50% nitrous oxide activity.<sup>9</sup>

*Rapid Induction.* Rapid surgical inductions performed with thiopental are accompanied by the following characteristic sequence of changes: the subanesthetic pattern of beta activity rapidly becomes widespread, increases

in amplitude, and slows in frequency toward the alpha range.<sup>10</sup> During this phase, the faster rhythm may be intermixed with bursts of high-amplitude, frontal-intermittent, rhythmic delta activity, the *FIRDA pattern*. With a slower rate of induction with nonbarbiturate inhalation agents, there is less tendency toward intermittent rhythmic bursting.

*Light steady-state anesthesia.* When a light level of steady-state anesthesia is reached, a characteristic anterior maximum, rhythmic fast (ARF) pattern, usually in the lower beta- or alpha-frequency range, is seen. This pattern is present with most agents, including halothane, enflurane, isoflurane, and even thiopental (see Fig. 42-1). The frequency of this pattern tends to slow with increasing concentrations of the agent. This anesthetic ARF pattern is strikingly similar to postanoxic, widespread, anterior maximum alpha-coma pattern. The origin of the postanoxic ARF pattern is uncertain. However, evidence suggests that the anesthetic ARF pattern, usually in the alpha-frequency range, is a drug-induced beta-variant pattern,<sup>10</sup> which with anesthesia becomes more widespread, higher in amplitude, and slower in frequency—from the upper to the lower beta range and finally into the alpha or even theta range. In humans, the anesthetic ARF pattern tends to be more continuous than normal sleep spindles.

In addition to the alpha-frequency ARF anesthetic pattern, there are often anterior maximum, triangular, slow (ATS) waves, which commonly are diphasic and have a sharply contoured, initially negative phase that is followed by a more rounded positive phase (Fig. 42-1). These ATS waves characteristically have a duration of less than 1 second and may occur either as a single transient or in brief trains. When preceded by a waxing ARF alpha pattern, they may produce a “mitten-like” pattern.<sup>9</sup> In addition to the ATS waves, more posterior, arrhythmic, slow (PAS) waves, which are often of lower amplitude, may become prominent. Duration of these individual polymorphic slow waves is usually longer than 1 second. The maximum of this activity is often difficult to identify clearly, but it is always more posterior and may be more prominent over the temporal regions (Fig. 42-1). This pattern is least obvious with halothane, more obvious with enflurane, and most prominent with

isoflurane. Strictly, nitrous oxide alone is not potent enough to be an anesthetic agent at atmospheric pressure; nonetheless, it potentiates the effects of other inhalation agents. During “balanced anesthesia” with 50% nitrous oxide in combination with another agent, the PAS pattern tends to be more prominent than when only a single agent is used.

### Key Points

- Most of anesthetic agents produce similar EEG patterns when used at concentrations below their minimal alveolar concentration.
- Recognizable EEG patterns during general anesthetic effect include ARF, ATS, and the PAS.
- Subanesthetic concentrations characteristically produce maximal beta activity in the anterior midline.
- With rapid induction, the beta-frequency activity may be intermixed with bursts of high-amplitude, frontal-intermittent, rhythmic delta activity, the *FIRDA pattern*.
- With a slower rate of induction with non-barbiturate inhalation agents, there is less tendency toward intermittent rhythmic bursting.
- With light steady-state anesthesia, a characteristic ARF pattern is seen.

## PREOPERATIVE FOCAL ABNORMALITIES SEEN WITH ANESTHESIA

Most patients undergoing endarterectomy show a symmetrical baseline pattern of the type described above. However, depending on patient selection, 30%–40% of patients may have a focal abnormality of varying severity.<sup>11</sup> In general, a preoperative focal anesthetic EEG abnormality correlates with a preoperative waking EEG abnormality. Occasionally, in exceptional patients, anesthesia activates an abnormality that was either not apparent or less apparent during the waking trace.<sup>12</sup> However, anesthesia may obscure an abnormality that was present during the waking trace and may also activate an abnormality that is minimal or not apparent during the waking state, as in the case of an anterior hemispheric insult

that does not affect the normal symmetrical alpha pattern. Despite such a normal symmetrical alpha pattern, the anesthetic record may show a major decrease in the ARF pattern and an increase in the irregular slowing in the anterior distribution. In these patients, the drug-induced beta activity seen during the pre-anesthetic state is nearly always decreased on the side of a reduced anesthetic ARF pattern, which is further evidence that the anesthetic alpha-frequency ARF pattern is related more directly to drug-induced beta activity than to the normal waking alpha rhythm.

This focal abnormality seen with anesthesia consists of a unilateral decrease in the amplitude of the ARF anesthetic pattern by more than 30%–40%. This commonly is associated with increased wave length and amplitude of persistent polymorphic slowing on the side of the decreased amplitude. The latter generally can be distinguished from the usual PAS pattern during anesthesia because it has a longer wave length and is more irregular and higher in amplitude on the pathologic side.

In most patients, focal baseline EEG abnormality correlates with preoperative deficits. However, a small percentage of patients with such baseline abnormalities have experienced only transient ischemic attacks, presumably caused by a hemodynamic mechanism. These patients usually have normal findings on computed tomography, with an ipsilateral decrease in retinal artery pressure and a low-baseline cerebral blood flow thought sufficient to cause EEG abnormalities in the absence of residual neurologic signs or computed tomographic abnormalities<sup>6</sup> (Fig. 42–1).

The anesthetic EEG also tends to activate an abnormality when intermittent rhythmic slow waves are present in the temporal region on the side of ischemia. This intermittent abnormality is often converted into a more obvious and persistent focal slowing along with reduction in the ARF pattern during anesthesia. A more posterior lesion, which produces significant abnormality in the alpha pattern, may leave the anesthetic ARF pattern symmetrical, without obvious focal slowing. In such a case, preanesthetic beta activity is also usually symmetrical.

The nonlocalizing FIRDA pattern or more persistent generalized slowing is easily recognized as abnormal during the waking state, but it cannot be identified as abnormal during

anesthesia because these patterns commonly occur in most patients at some stage of anesthesia, whether or not they have had symptoms of a central nervous system lesion.

### **Key Points**

- As many as 30%–40% of patients may have a focal abnormality of varying severity on the preoperative baseline EEG.
- Anesthesia may obscure an abnormality that was present during the waking trace and may also activate an abnormality that is minimal or not apparent during the waking state.
- If there is preoperative unilateral anterior hemispheric insult, the anesthetic record may show a major decrease in the ARF pattern and an increase in the irregular slowing in the region.
- Drug-induced beta activity seen during the preanesthetic state is nearly always decreased on the side of a reduced anesthetic ARF pattern.
- When intermittent rhythmic slow waves are present in the temporal region on the side of ischemia, the intermittent slow waves are often converted by anesthesia to a more obvious and persistent focal slowing along with reduction in the ARF pattern.

## **CLINICAL APPLICATIONS**

Intraoperative monitoring is useful only if it can accurately and promptly forewarn surgeons of the occurrence of cerebral complications in time for corrective measures to be instituted. The greatest susceptibility to cerebral ischemic injury occurs when the carotid artery is cross-clamped just before it is incised. To avoid this potential complication, some surgeons have routinely placed a shunt from the common carotid artery to the internal carotid artery to bypass the site of the clamp. However, the rate of embolic stroke with routine placement of a shunt is nearly 10 times greater than that with selective use of a shunt.<sup>13</sup> Thus, reliable and accurate techniques of intraoperative monitoring are needed to select patients who require a shunt to decrease the risk of cerebral ischemic injury during carotid cross-clamping.

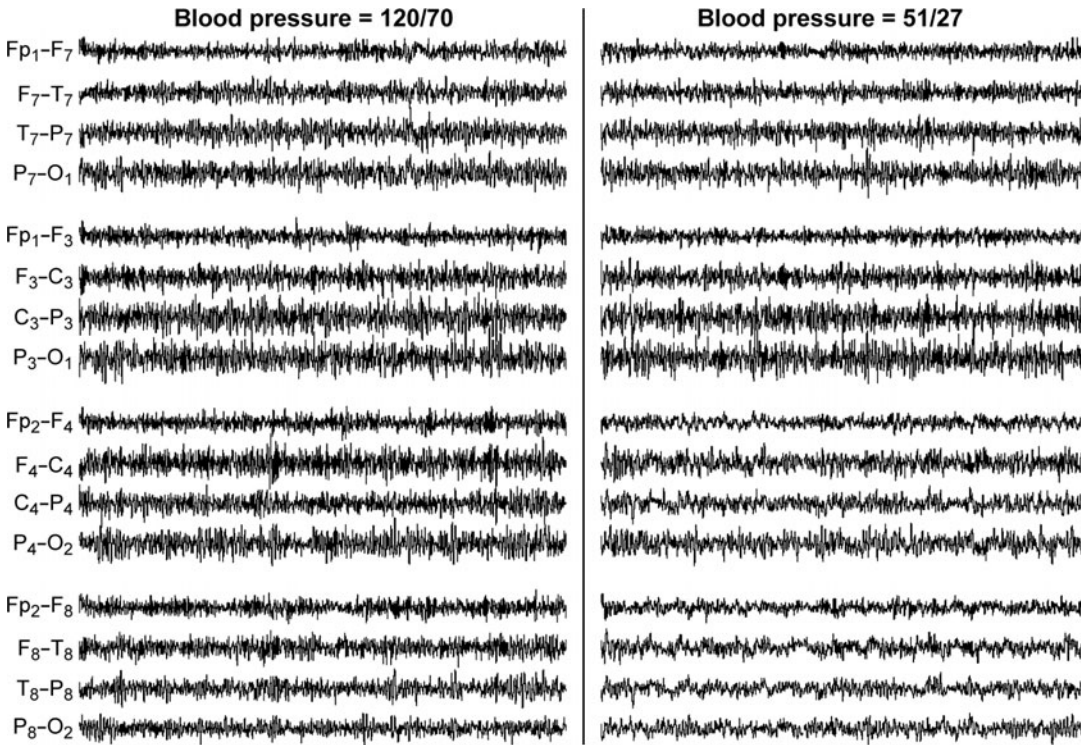
Intraoperative monitoring techniques can be divided into those that detect cerebral dysfunction (EEG, somatosensory evoked potentials (SEPs), and neurologic examination) and those that measure the integrity of cerebral perfusion (carotid stump pressure, transcranial Doppler, and cerebral blood flow measurements). McCarthy and colleagues<sup>14</sup> have confirmed that when a major EEG change occurs during carotid cross-clamping, the risk of stroke is higher than when there is no change (4.5% vs. 1.4%). Selective shunt placement in patients with major EEG changes significantly decreases the rate of stroke.<sup>15</sup> The rate of intraoperative stroke when no monitoring is used is six times higher than that when EEG monitoring is used to select patients for shunt placement.<sup>16</sup>

### **Key Points**

- The greatest susceptibility to cerebral ischemic injury occurs when the carotid artery is cross-clamped just before it is incised.
- When a major EEG change occurs during carotid cross-clamping, the risk of stroke is higher than when there is no change.
- Selective shunt placement in patients with major EEG changes significantly decreases the rate of stroke.
- The rate of intraoperative stroke when no monitoring is used is six times higher than that when EEG monitoring is used to select patients for shunt placement.

## **EEG CHANGES DURING CAROTID ENDARTERECTOMY**

EEG changes commonly occur with carotid artery clamping—some change occurs in approximately 25% of patients. These changes almost always occur within 20–30 seconds after clamping and are associated with decreased cerebral blood flow below a critical level, which varies with the anesthetic agent. With halothane, the critical level is between 15 and 18 mL/100 g per minute; it is slightly lower with enflurane and isoflurane.<sup>17</sup> The reasons for these differences are uncertain. Roughly, the severity and rapidity of the onset of EEG change vary in direct proportion to the degree



**Figure 42-6.** EEG of a 75-year-old man undergoing right carotid endarterectomy. *Left side* of the figure shows no asymmetry at baseline following anesthesia administration but before carotid clamping. *Right side* of the figure shows right hemisphere slowing when blood pressure dropped to 51/27 without carotid clamping.

of lowering of blood flow below the critical level. Minor changes consist of a 25%–50% decrease in the faster components and an increase in amplitude and wave length of slower components (Fig. 42-3). Changes that occur with more severe decreases in blood flow (in the range of 6 or 7 mL/100 g per minute or less) are associated with an even greater reduction of anesthetic faster components, along with decreased amplitude of the slower components, producing a lower amplitude and featureless EEG on the side of clamping (Figs. 42-4 and 42-5). Although up to 25% of EEGs may show some change, only 1%–3% show the more severe degree of change.

Focal transient changes that occur at times other than during clamping can be seen in up to 10% of patients. In most, this is caused by transient asymmetrical effects of changing levels of anesthesia on a preexisting focal abnormality and is of no consequence.<sup>17</sup> Embolization can occur in association with shunting. Some EEG changes likely are caused by the

reversible effects of embolization from the operative site. However, in approximately 1% of patients undergoing endarterectomy, a focal EEG change develops intraoperatively that is not associated with carotid artery clamping and persists throughout the procedure; ultimately, it is associated with a new neurologic deficit in the immediate postoperative period. These changes almost always prove to be caused by embolization. Another cause of EEG change during carotid endarterectomy is hypotension that occurs with or without bradycardia (Fig. 42-6).

### Key Points

- EEG changes associated with decreased cerebral blood flow below a critical level almost always occur within 20–30 seconds after clamping.
- Although up to 25% of EEGs may show some change, only 1%–3% show the more severe degree of change.



- Severe EEG change consists of marked reduction of theta- and alpha-frequency waves, along with markedly decreased amplitude of delta waves, producing a low amplitude and featureless EEG on the side of clamping (Figs. 42–4 and 42–5).
- Focal transient changes that occur at times other than during clamping can be seen in up to 10% of patients. In most, this is caused by transient asymmetrical effects of changing levels of anesthesia on a preexisting focal abnormality and is of no consequence.

## SEP RECORDING DURING CAROTID ENDARTERECTOMY

Intraoperative changes in an SEP recording are measured and quantified more easily than EEG changes. Moreover, SEPs are less likely to be influenced by factors such as anesthetic effects, preoperative cerebral abnormalities, and recording artifacts. Nonetheless, a major drawback is that, after carotid cross-clamping, SEP changes are not detected as promptly as EEG changes, because it often takes a minute or longer to complete the averaging and analysis of SEP signals,<sup>18</sup> but nearly all EEG changes occur within 20–30 seconds after cross-clamping. A study that compared the two techniques concluded that they are complementary.<sup>19</sup>

## OTHER MONITORING TECHNIQUES DURING CAROTID ENDARTERECTOMY

Intraoperative neurologic examination has been advocated as a method of determining intolerance to carotid cross-clamping. However, the method cannot be used in nearly 25% of the patients who prefer or require general anesthesia.<sup>20</sup> Although intraoperative neurologic examination has not been shown to be superior to EEG monitoring in decreasing stroke rate, the combination of the two techniques reportedly can reduce the need for shunt placement.<sup>21</sup> In a retrospective study of 314 patients who were awake during carotid endarterectomy and were monitored by neurological examination, 32 developed

neurological deficits during carotid clamping, but only 19 (60%) had ischemic EEG changes. None of the 314 patients developed a postoperative stroke.<sup>22</sup>

A method of monitoring the integrity of vascular flow during carotid surgery is intracarotid injection of xenon.<sup>4</sup> The determination of cerebral blood flow with this technique is clearly influenced by the PaCO<sub>2</sub> level and requires that xenon be delivered directly to the internal carotid artery while the external carotid artery is clamped. Blood flow is usually determined only three or four times intraoperatively: before clamping, immediately after clamping, immediately after placing a shunt (if one is used), and at the end of the procedure. Blood flow measurement is complementary to EEG findings. Focal EEG changes as a result of ischemia caused by decreased perfusion pressure distal to a clamped carotid artery are always associated with low blood flow, as measured with the xenon technique. An unexpected EEG change that persists and is associated with “normal blood flow” is essentially pathognomonic of embolization. The presence of normal blood flow after embolization is explained on the basis of the so-called look-through phenomenon.<sup>23</sup> A simplified interpretation of this phenomenon is as follows: if the ischemia is a result of embolic occlusion of one-half of the blood vessels to a region (with the other one-half being patent), injection of xenon produces a normal or, at times, an increased flow and washout of xenon through the patent blood vessels. Totally occluded vessels receive no xenon and thus do not contribute to the overall measurement of flow.

Carotid stump pressure determination is a measurement of the back pressure of flow at the distal carotid stump after cross-clamping. Although low carotid stump pressure values are more likely to be associated with clinically important EEG changes<sup>24</sup> and higher stroke rates,<sup>14</sup> the specificity of carotid stump pressure measurement is only approximately 60%–80%.<sup>14,15,24</sup> Also, carotid stump pressure measurement is not as reliable as xenon blood flow measurement.<sup>25</sup> Studies that compared EEG with carotid stump pressure monitoring suggested that EEG monitoring is more accurate,<sup>15</sup> and the use of carotid stump pressure measurement alone may result in a high rate of unnecessary shunts.<sup>24</sup>

Transcranial Doppler (TCD) insonates the temporal bone window to measure blood flow velocity at the middle cerebral artery ipsilateral to the carotid cross-clamping. A review of the method concluded that it complements EEG monitoring, probably because the two techniques measure different potential effects of carotid cross-clamping.<sup>26</sup> An advantage of TCD is that it can detect abnormalities of intracranial emboli from carotid debris and hyperperfusion patterns after carotid repair.<sup>27</sup> TCD has also been reported to be useful in identifying patients who are at risk of developing neurological symptoms during the postsurgical recovery period.<sup>25</sup> However, a study that compared both carotid stump pressure and TCD with neurologic monitoring showed that neither could reliably predict the need for shunt. The positive predictive value for either was relatively low and could result in unnecessary use of a shunt.<sup>29</sup>

Near-infrared spectrophotometry (NIRS) is a noninvasive optical method for continuously measuring cerebral oxygenation. Its measurement is relatively unaffected by anesthetic effect, altered cerebral metabolism, or markedly decreased perfusion pressure. Techniques have been developed to isolate the intracranial component from the extracranial component of NIRS signals, but further investigations are needed to determine whether NIRS could independently indicate the need for shunt placement during carotid endarterectomy.<sup>30,31</sup>

### Key Points

- An unexpected EEG change that persists and is associated with “normal blood flow” is essentially pathognomonic of embolization.
- The combination of intraoperative neurologic examination and EEG monitoring can reportedly reduce the need for shunt placement.
- Studies that compared EEG with carotid stump pressure monitoring suggest that EEG monitoring is more accurate and the use of carotid stump pressure measurement alone may result in a high rate of unnecessary shunt.
- An advantage of TCD is that it can detect abnormalities of intracranial emboli from carotid debris and hyperperfusion patterns after carotid repair.

## EEG MONITORING DURING CARDIAC SURGERY

EEG monitoring has not been used widely during cardiac surgery because the profound hypothermia that is induced intraoperatively suppresses most of the EEG activities needed for monitoring. Diffuse EEG changes are difficult to distinguish from global ischemia even when the hypothermia is mild or when PaCO<sub>2</sub> is high. To address the limitations of EEG monitoring in cardiac surgery, a recent review proposed that EEG monitoring be used concomitantly with TCD and NIRS.<sup>2</sup>

## BISPECTRAL ANALYSIS OF EEG FOR MONITORING DEPTH OF ANESTHESIA

EEG monitoring had been attempted for guiding depth of anesthetic sedation in order to avoid patient recall and awareness during and immediately after surgery. However, the limited frequency and amplitude domain information of unprocessed EEG is inadequate for providing additional information regarding anesthetic depth. With the advent of readily available and powerful mathematical computing, EEG signals can now be processed with high-level statistics during surgery to yield a single number index derived from multivariate analysis of several EEG signal characteristics. This derived index based on the most commonly employed mathematical algorithm is called the *bispectral index* (BIS).<sup>32</sup> A number of BIS studies have yielded encouraging but inconclusive results, until the recent randomized blinded study of BIS compared against the standard of end-tidal anesthetic gas (ETAG) for decreasing anesthesia awareness.<sup>33</sup> Two of the 967 BIS patients and two of the 974 ETAG patients in this study reported anesthesia awareness. The study provided the strongest evidence that BIS does not contribute further to the current practice of determining depth of anesthesia for avoiding anesthetic awareness.

## EEG MONITORING FOR EPILEPSY SURGERY

The principles and techniques in EEG monitoring for epilepsy surgery are different than



those for carotid endarterectomy or cardiac surgery (see Chapter 15). Whereas EEG monitoring during extracerebral surgeries on the cardiovascular system is mainly for the purpose of detecting and avoiding impending adverse effects of these surgeries on the brain, EEG monitoring in epilepsy surgery has the primary goal of guiding the location and maximizing the extent of brain tissue resection while minimizing the risk of invading cortical areas that are critical for functions such as language or motor skills.

## SUMMARY

Intraoperative electrophysiologic monitoring of cerebral function during cardiovascular surgery requires a thorough knowledge of the effect of anesthetic agents on electrophysiologic signals. Although there are variations among anesthetic agents and their effects on the EEG, most of the agents produce similar changes that can be recognized and distinguished from the effects of ischemia. Success of the monitoring also depends heavily on the technical aspects of recording, such as the timescale of the EEG display and adjustment of the anesthetic agent used.

Currently, intraoperative EEG monitoring is used mostly during carotid surgery because of its favorable sensitivity and specificity in promptly detecting cerebral intolerance to carotid cross-clamping. Recent studies have continued to demonstrate convincingly the usefulness of intraoperative monitoring in decreasing the risk of stroke in carotid endarterectomy. For the most part, the advent of non-EEG monitoring techniques has not replaced EEG monitoring. Many recent studies have shown that these non-EEG monitoring techniques complement EEG monitoring, largely because the aspects of intraoperative cerebral hypoperfusion or ischemia that these tests measure are different from those that EEG measures. To date, studies that have compared the different modalities used in intraoperative monitoring have lacked the scientific rigor of randomized controlled studies.

## REFERENCES

1. Sharbrough, F. W., J. M. Messick Jr., and T. M. Sundt Jr. 1973. Correlation of continuous electroencephalograms with cerebral blood flow measurements during carotid endarterectomy. *Stroke* 4:674–83.
2. Edmonds, H. L. Jr., R. A. Rodriguez, S. M. Audenaert, E. H. Austin III, S. B. Pollock Jr., and B. L. Ganzel. 1996. The role of neuromonitoring in cardiovascular surgery. *Journal of Cardiothoracic and Vascular Anesthesia* 10:15–23.
3. Quasha, A. L., F. W. Sharbrough, T. A. Schweller, and J. H. Tinker. 1979. Hypothermia plus thiopental: Synergistic EEG suppression (abstract). *Anesthesiology* 51(Suppl):S20.
4. Sundt, T. M. Jr., F. W. Sharbrough, J. C. Trautmann, and G. A. Gronert. 1975. Monitoring techniques for carotid endarterectomy. *Clinical Neurosurgery* 22:199–213.
5. Chiappa, K. H., S. R. Burke, and R. R. Young. 1979. Results of electroencephalographic monitoring during 367 carotid endarterectomies. Use of a dedicated minicomputer. *Stroke* 10:381–8.
6. Visser, G. H., G. H. Wieneke, and A. C. van Huffelen. 1999. Carotid endarterectomy monitoring: Patterns of spectral EEG changes due to carotid artery clamping. *Clinical Neurophysiology* 110:286–94.
7. Minicucci, F., M. Cursi, C. Fornara, et al. 2000. Computer-assisted EEG monitoring during carotid endarterectomy. *Journal of Clinical Neurophysiology* 17:101–7.
8. Yanagihara, T., and D. W. Klass. 1979. Discrepancy between CT scan and EEG in hemodynamic stroke of the carotid system. *Transactions of the American Neurological Association* 104:141–4.
9. Stockard, J., and R. Bickford. 1975. The neurophysiology of anaesthesia. *Monographs on Anesthesiology* 2:3–46.
10. Sharbrough, F. W. 1982. Nonspecific abnormal EEG patterns. In *Electroencephalography: Basic principles, clinical applications and related fields*, ed. E. Niedermeyer, and F. Lopes da Silva, 135–54. Baltimore-Munich: Urban & Schwarzenberg.
11. Sundt, T. M. Jr., F. W. Sharbrough, R. E. Anderson, and J. D. Michenfelder. 1974. Cerebral blood flow measurements and electroencephalograms during carotid endarterectomy. *Journal of Neurosurgery* 41:310–20.
12. Hansotia, P. L., F. W. Sharbrough, and J. Berendes. 1975. Activation of focal delta abnormality with methohexital and other anesthetic agents (abstract). *Electroencephalography and Clinical Neurophysiology* 38:554.
13. Salvian, A. J., D. C. Taylor, Y. N. Hsiang, et al. 1997. Selective shunting with EEG monitoring is safer than routine shunting for carotid endarterectomy. *Cardiovascular Surgery* 5:481–5.
14. McCarthy, W. J., A. E. Park, E. Koushanpour, W. H. Pearce, and J. S. Yao. 1996. Carotid endarterectomy. Lessons from intraoperative monitoring—A decade of experience. *Annals of Surgery* 224:297–305.
15. Lacroix, H., G. Van Gertruyden, J. Van Hemelrijck, A. Nevelsteen, and R. Suy. 1996. The value of carotid stump pressure and EEG monitoring in predicting carotid cross-clamping intolerance. *Acta Chirurgica Belgica* 96:269–72.
16. Plestis, K. A., P. Loubser, E. M. Mizrahi, G. Kantis, Z. D. Jiang, and J. F. Howell. 1997. Continuous electroencephalographic monitoring and selective shunting reduces neurologic morbidity rates in

- carotid endarterectomy. *Journal of Vascular Surgery* 25:620–8.
17. Sundt, T. M. Jr., F. W. Sharbrough, D. G. Piepgras, T. P. Kearns, J. M. Messick Jr, and W. M. O'Fallon. 1981. Correlation of cerebral blood flow and electroencephalographic changes during carotid endarterectomy: With results of surgery and hemodynamics of cerebral ischemia. *Mayo Clinic Proceedings* 56:533–43.
  18. Guerit, J. M., C. Witdoeck, M. de Tourchaninoff, et al. 1997. Somatosensory evoked potential monitoring in carotid surgery. I. Relationships between qualitative SEP alterations and intraoperative events. *Electroencephalography and Clinical Neurophysiology* 104:459–69.
  19. Fiori, L., and G. Parenti. 1995. Electrophysiological monitoring for selective shunting during carotid endarterectomy. *Journal of Neurosurgical Anesthesiology* 7:168–73.
  20. Stoughton, J., R. L. Nath, and W. M. Abbott. 1998. Comparison of simultaneous electroencephalographic and mental status monitoring during carotid endarterectomy with regional anesthesia. *Journal of Vascular Surgery* 28:1014–21.
  21. Fiiorani, P., E. Sbarigia, F. Speziale, et al. 1997. General anaesthesia versus cervical block and perioperative complications in carotid artery surgery. *European Journal of Vascular and Endovascular Surgery* 13:37–42.
  22. Hans, S., and O. Jareunpoon. 2007. Prospective evaluation of electroencephalography, carotid stump pressure, and neurologic changes during 314 carotid endarterectomies performed in awake patients. *Journal of Vascular Surgery* 45:511–55.
  23. Donley, R. F., T. M. Sundt, R. E. Anderson, and F. W. Sharbrough. 1975. Blood flow measurements and the “look through” artifact in focal cerebral ischemia. *Stroke* 6:121–31.
  24. Harada, R. N., A. J. Comerota, G. M. Good, H. A. Hashemi, and J. F. Hulihan. 1995. Stump pressure, electroencephalographic changes, and the contralateral carotid artery: Another look at selective shunting. *American Journal of Surgery* 170: 148–53.
  25. McKay, R. D., T. M. Sundt, J. D. Michenfelder, et al. 1976. Internal carotid artery stump pressure and cerebral blood flow during carotid endarterectomy: Modification by halothane, enflurane, and innovar. *Anesthesiology* 45:390–9.
  26. Ackerstaff, R., and F. Moll. 1998. Use of EEG and TCD for assessment of brain function during operations on carotid artery. In *Peri-Operative monitoring in carotid surgery*, ed. S. Horsch, and K. Ktenidis, 110–20. Darmstadt: Steinkopf Verlag.
  27. Fiori, L., G. Parenti, and F. Marconi. 1997. Combined transcranial Doppler and electrophysiologic monitoring for carotid endarterectomy. *Journal of Neurosurgical Anesthesiology* 9:11–6.
  28. Nielsen, M. Y., H. H. Sillesen, L. G. Jorgensen, and T. V. Schroeder. 2002. The haemodynamic effect of carotid endarterectomy. *European Journal of Vascular and Endovascular Surgery* 24(1):53–8.
  29. Belardi, P., G. Lucertini, and D. Ermirio. 2003. Stump pressure and transcranial Doppler for predicting shunting in carotid endarterectomy. *European Journal of Vascular and Endovascular Surgery* 25(2):164–7.
  30. Al-Rawi, P. G., P. Smielewski, and P. J. Kirkpatrick. 2001. Evaluation of a near-infrared spectrometer (NIRO 300) for the detection of intracranial oxygenation changes in the adult head. *Stroke* 32(11):2492–500.
  31. de Letter, J. A., H. T. Sie, B. M. Thomas, et al. 1998. Near-infrared reflected spectroscopy and electroencephalography during carotid endarterectomy—In search of a new shunt criterion. *Neurological Research* 20(Suppl 1):S23–7.
  32. Bard, J. W. 2001. The BIS monitor: A review and technology assessment. *AANA Journal* 69(6):477–83.
  33. Avidan, M. S., L. Zhang, B. A. Burnside, et al. 2008. Anesthesia awareness and the bispectral index. *NEJM*: 1097–108.

# Brain Stem and Cranial Nerve Monitoring

Brian A. Crum

## INTRODUCTION

### METHODS

Electromyography  
Nerve conduction studies  
Evoked potentials

### APPLICATIONS

Middle Cranial Fossa  
Posterior Cranial Fossa  
Head and Neck Surgery

### SUMMARY

## INTRODUCTION

Cranial nerves can be injured during surgical procedures performed in the middle and posterior cranial fossae as well as in the head and neck region. Damage results from compression, stretch, abrasion, or ischemia of the nerve. If axonal disruption occurs, recovery is limited resulting in significant clinical deficits (i.e., facial paralysis or deafness). Cranial nerve function can be monitored during anesthesia by recording spontaneous or stimulus-evoked electrical activity directly from the nerve or the cranial muscles. Activity in other pathways in the brain stem can be monitored by following changes in evoked potentials of various sensory and motor pathways. These methods can detect damage to either the intra-axial or the extra-axial portion of cranial nerves (Table 43–1). This monitoring is also useful for real-time localization of cranial nerves

during an operation when normal anatomy is altered, making accurate identification of nerves difficult. Finally, information from intraoperative cranial nerve monitoring may lead to an altered surgical plan to preserve neurological function at a time when clinical assessment is not possible.

### *Purpose and Role of Brain Stem and Cranial Nerve Monitoring*

- Utilize electrophysiological studies, for example, BAEP, SEP, EMG, and CMAP to monitor neural structures during surgery.
- Determine neural integrity and potential damage at a time when clinical assessment is not possible.
- Assist surgical decisions based on presence, absence, or quality of electrophysiological signals.

Table 43-1 Cranial Nerve Modality Used for Monitoring

II	Flash VEPs
III, IV, VI	Extraocular muscle needle EMG
V	Masseter EMG, NAP from first division
VII	Facial muscle EMG, CMAP, Lateral Spread Response
VIII	BAEPs, NAP
IX	Soft palate EMG
X	Cricothyroid and vocalis EMG
XI	Trapezius EMG
XII	Hypoglossal EMG

## METHODS

### Electromyography

Special small-diameter flexible wire electrodes can be used to record motor unit activity from within muscles. These electrodes are less traumatic to local tissue and are more easily secured than the standard monopolar or concentric needle electrodes. Currently, subcutaneously placed EEG electrodes are utilized in our laboratory for muscle recordings. Electrodes placed in muscle record various spontaneous and stimulus-evoked activity arising from individual muscle fibers or motor units. Movement and electric artifacts, fibrillation and fasciculation potentials, and random motor unit potential (MUP) activity related to inadequate anesthesia are regularly recorded from muscle intraoperatively. Electric stimulation of the innervating nerve produces a response by activation of MUPs, and those in the area immediately surrounding the electrode are recorded. Mechanical irritation (abrasion, stretch, or compression), saline irrigation, and ischemia produce high-frequency bursts of MUPs, called *neurotonic discharges* that have a characteristic sound and

appearance.<sup>1</sup> Neurotonic discharges provide surgeons immediate feedback about nerve location and potential injury to nerves in the surgical field. Neurotonic discharges can be recorded in situations that require neuromuscular blockade by titrating the dose of the neuromuscular blocking agent such that a motor response is obtained with an amplitude of at least 25% of the baseline amplitude.<sup>2,3</sup>

Neurotonic discharges have various forms, but all of them consist of MUPs that fire in a rapid and irregular manner (Fig. 43-1). The bursts, or trains, of MUPs fire at frequencies of 30–100 Hz. At times, multiple discharges firing asynchronously and independently are recorded from a single muscle. Neurotonic discharges are often precipitated by mechanical stimulation of the axonal membrane of peripheral nerves. They are sensitive indicators of nerve irritation and occur in virtually all monitored patients.<sup>4,5</sup> Sharp transection of a nerve may not produce neurotonic discharges,<sup>6</sup> and damaged nerves are less likely to produce neurotonic discharges than healthy nerves. In addition, irrigation of a nerve with saline frequently produces long trains of neurotonic discharges lasting 2–60 seconds. Therefore, the density and

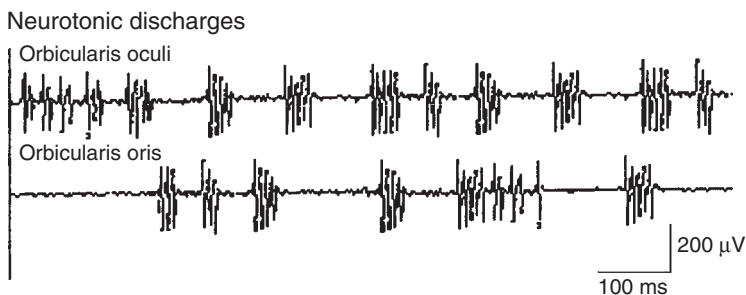


Figure 43-1. Neurotonic discharges recorded from facial nerve innervated muscles during posterior fossa surgery.

frequency of neurotonic discharges recorded during surgery correlates only roughly with the severity of postoperative neurologic deficit.<sup>7</sup> They do, however, correlate with activity of close proximity to the nerve.

Intraoperative electromyography (EMG) is performed with the same sweep speed and filter settings as standard diagnostic needle EMG. Sensitivities are 50–200  $\mu\text{V}/\text{division}$ , filter settings are 30–20,000 Hz, and sweep speed is from 10 to 100 ms/division. Recordings are possible from almost any cranial muscle, including extraocular and facial muscles, muscles of mastication and tongue, and pharyngeal and laryngeal muscles. The activity from multiple muscles is often monitored simultaneously with a multichannel recording instrument. As with standard EMG, auditory signals are very important in the analysis of the origin and relationship of the potentials to intraoperative events.

### Key Points

- EMG records motor unit action potentials from muscle.
- Neurotonic discharges are signals of possible nerve damage.
- Neurotonic discharges are short or long bursts of rapidly firing motor units.
- EMG and NCS assist the surgeon in localizing a nerve in the operative field.

### Nerve conduction studies

Two types of nerve conduction studies (NCS) can be performed on cranial nerves intraoperatively. Compound muscle action potentials (CMAPs) represent activity in motor axons and muscle fibers. Whenever possible, CMAPs recorded from the skin surface overlying the motor point are used because they give more quantifiable information about the total number of functioning motor axons in the nerve than CMAPs recorded from intramuscular electrodes. The optimal surface electrodes are 5-mm disks (similar to those used in routine NCS) that are applied firmly to the skin with collodion or tape. CMAP recordings are made with filter settings of 2 Hz–20 kHz, sweep speeds of 1–10 ms/division, and sensitivities of 100  $\mu\text{V}$ –5 mV/division.

Nerve action potentials (NAPs) are recorded directly from mixed or sensory nerves in the surgical field or subcutaneously. Although NAPs are lower in amplitude and more difficult to record than CMAPs, they may provide useful information when sensory nerves are involved or when CMAPs cannot be recorded. The amplitude of the CMAP or NAP is proportional to the number of axons conducting the response. Therefore, when a goal of monitoring is to determine the number of intact axons, the amplitude or area of the response can be measured and compared with values recorded earlier intraoperatively or with preoperative baseline measurements. The use of neuromuscular blocking agents will reduce the amplitude of the CMAP, but not the NAP. The use of these agents must be kept in mind when using CMAP monitoring, though, this type of monitoring can still be accomplished. The IOM team must be aware of the degree of blockade (measured as a reduction in CMAP amplitude from the first shock to the fourth in a train of stimuli) and any changes that occur during monitoring.

Several different stimulators are used to activate peripheral nerve axons intraoperatively. Handheld stimulators of various sizes and configurations that can be gas-sterilized are commercially available. Stimulators that are insulated to the very tip of the electrode have fewer problems with current shunting, but they may also produce subthreshold stimuli if they are not applied properly to the surface of the nerve. Other stimulators have a hooked configuration that allows a nerve or fascicles within a nerve to be separated from surrounding tissue. This reduces artifact from the stimulus or surrounding muscles and allows the nerve elements of interest to be stimulated selectively. Bipolar stimulators have the cathode and anode attached to the same handle and within several centimeters of each other. This provides a localized stimulus that reduces the risk of current spread to adjacent nerves. The disadvantage of the bipolar stimulator is that activation may be inadequate if the nerve is distant or there is too much fluid in the surgical field. Monopolar stimulators use a single handheld cathode placed on the nerve, with a separate anode placed some distance away, usually a needle in the edge of the surgical field or a distant surface electrode. Monopolar stimulation reduces the chance of inadequate



stimulation, but increases the likelihood of current spread to other nerves and shock artifact.

The size of the stimulating electrodes varies depending on the nerve stimulated. Small cranial nerves require stimulator tips as small as 1 mm, and larger peripheral nerves may require 2–3 mm electrodes to provide adequate stimuli. If a surgical forceps is modified for use as a bipolar stimulator, the surgeon can dissect tissue with the stimulator.

### Key Points

- NCS can be performed by recording CMAPs over muscle or by recording direct NAPs over nerve.
- CMAPs can provide quantifiable information about the status of motor axons.
- Direct nerve stimulation and selection of equipment pose technical challenges that depend on several factors, for example, size and depth of the nerve, and amount of nerve exposed.

## Evoked potentials

### VISUAL EVOKED POTENTIALS

Visual evoked potentials (VEPs) reflect electric activity in optic pathways in response to photic stimulation of the retina. The most reproducible response is recorded as a broad positivity over the occipital head region approximately 100 ms after the stimulus. This *P100* waveform represents electrical activity in the occipital cortex. It is well defined in all awake patients when a pattern-reversal illuminated stimulus is given to the retina. VEPs can also be recorded in anesthetized patients with a strobe flash stimulus applied through the closed eyelid or by way of specially designed contact lenses. However, flash-evoked VEPs are greatly attenuated by general anesthesia and, thus, have limited use intraoperatively.<sup>8</sup>

### Key Points

- VEPs are not used intraoperatively due to their susceptibility to anesthesia.

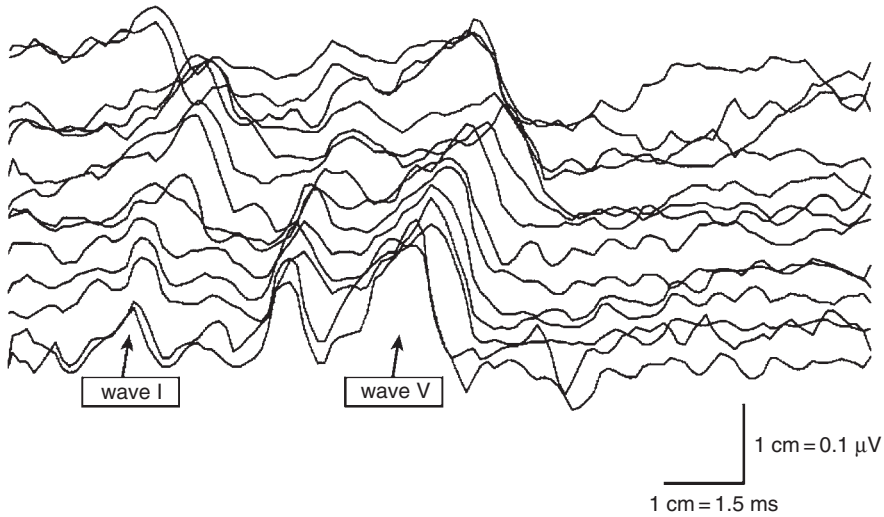
### AUDITORY EVOKED POTENTIALS

Auditory evoked potentials reflect electric activity in the auditory nerve and brain stem in response to cochlear stimulation. Brain stem auditory evoked potentials (BAEPs) are recorded from surface electrodes placed either in the external ear canal or on the ear pinna and referenced to the vertex. Five distinct waveforms can be recorded: wave I originates from the lateral auditory nerve and wave II is from the medial auditory nerve. Wave III comes from depolarization in the cochlear nucleus and waves IV and V come from bilateral activation in the lateral lemniscus and inferior olive. The electrocochleogram can be recorded from a needle electrode placed through the tympanic membrane into the wall of the middle ear cavity. The first major negative waveform (N1) of the electrocochleogram represents activity in the lateral portion of the auditory nerve and is analogous to wave I of the BAEP. Auditory NAPs can also be recorded from a small cotton-wick electrode placed directly on the nerve in the cerebellopontine angle at surgery. Auditory evoked potentials are not affected significantly by general anesthetics.

BAEPs appear to be the best technique for most surgical procedures, because they pose fewer technical problems, can be used during the entire surgical procedure, monitor the entire auditory system, and correlate well with postoperative hearing status.<sup>9–11</sup> The electrocochleogram is better defined in patients with acoustic neuromas, but technical difficulties are common and only the lateral portion of the auditory nerve located in the auditory canal of the temporal bone is monitored. Recording of auditory NAPs provides immediate feedback, but technical problems are common and the technique can be used only when the auditory nerve is exposed in the surgical field. If they can be reliably recorded, they show better preservation of hearing.<sup>11</sup>

Sudden changes in the latency and amplitude of BAEPs occur when the nerve is transected or avulsed or the internal auditory artery is damaged leading to nerve ischemia.<sup>12</sup> Recovery after sudden loss of BAEPs is unusual, but correlation of the change with intraoperative events may help prevent hearing loss in future cases. More commonly, there are gradual changes in BAEPs reflecting excessive traction on or manipulation of





**Figure 43-2.** BAEP recorded through surgery. The initial response is at the bottom and last at the top of the figure. Gradual prolongation of waves I and V and the I-V interpeak latency all of which improve by the conclusion of the monitoring. Sensitivity  $0.1 \mu\text{V}/\text{cm}$ , time base  $1.5 \text{ ms}/\text{cm}$ .

the nerve and often resolve with adjustment of retractors or modification of the surgical approach (Fig. 43-2). Cooling of the auditory nerve during surgical exposure will also lead to mild increase in the latencies of wave II to wave V.

### Key Points

- BAEPs are relatively simple and useful for monitoring peripheral and central auditory pathways.
- BAEPs are not affected by general anesthesia.
- Sudden loss of the BAEP suggests irreversible damage to the nerve, often by ischemia in the internal auditory artery distribution.
- More commonly, the latency of wave V of the BAEP is prolonged during surgery and this improves by the end of surgery.

### SOMATOSENSORY EVOKED POTENTIALS AND MOTOR EVOKED POTENTIALS

Median, ulnar, and tibial somatosensory evoked potentials (SEPs) can be used to monitor activity in the medial lemniscus in the brain stem. Most often median SEPs are utilized. Changes may occur only when sensory pathways are involved or when damage to the brain stem is

extensive. Monitoring of motor evoked potentials (MEPs) may enhance the sensitivity of brain stem monitoring by detecting early compromise of pyramidal tract neurons, though this is a minor risk in most surgeries. Previously, use of MEPs to monitor brain stem function was limited by sensitivity to anesthetics.<sup>13</sup> Currently, however, anesthesia regimens can be used to eliminate this effect (intravenous narcotics, benzodiazepines, fentanyl, ketamine). The main limitation of MEPs is the short distance between cranial nerves and their muscles to the cortex which introduces significant stimulus artifact.

### Key Points

- SEPs and MEPs can monitor motor and sensory pathways during surgery in which the brain stem is at risk.

## APPLICATIONS

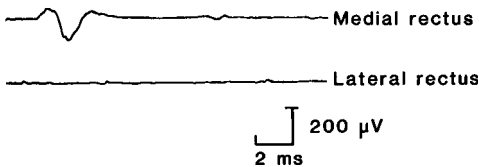
### Middle Cranial Fossa

VEPs have been used to monitor the visual system during removal of tumors in the region of the pituitary and hypothalamus and during operations on vascular lesions that may affect the optic nerves, chiasm, or tracts. Because of

the sensitivity to general anesthetics, variability in latency and amplitude of the response, and the poor correlation with postoperative visual function, visual evoked responses are not a reliable monitor of the function of the visual pathway during surgery.<sup>8</sup>

Tumors and vascular lesions of the orbit, sella, sphenoid or cavernous sinus, and petrous portion of the temporal bone can damage cranial nerves directly or distort normal anatomical relationships, making it difficult to distinguish between normal and abnormal nervous system structures. Types of cases that may benefit from monitoring include surgery for tumors such as meningiomas, lymphomas, carcinomas, pituitary tumors, and vascular lesions such as carotid or ophthalmic aneurysms. The oculomotor, trochlear, and abducens nerves can be monitored with EMG or CMAPs.<sup>14</sup> Wire electrodes are placed in the extraocular muscles after the patient is anesthetized. This is more easily accomplished in muscles supplied by the oculomotor and abducens nerves. Neurotonic discharges are recorded in the appropriate muscle when its nerve is mechanically stimulated in the surgical field. The surgeon may also use a handheld stimulator to identify selected cranial nerves by recording a CMAP in the appropriate target muscle.<sup>15</sup>

#### Stimulate: Oculomotor nerve



**Figure 43-3.** CMAPs from extraocular muscles obtained by direct electric stimulation of the oculomotor nerve in the surgical field in the region of the cavernous sinus.

(Fig. 43-3). An NAP can be recorded directly from the ophthalmic division of the trigeminal nerve with a small cotton-wick electrode.<sup>16</sup>

#### Key Points

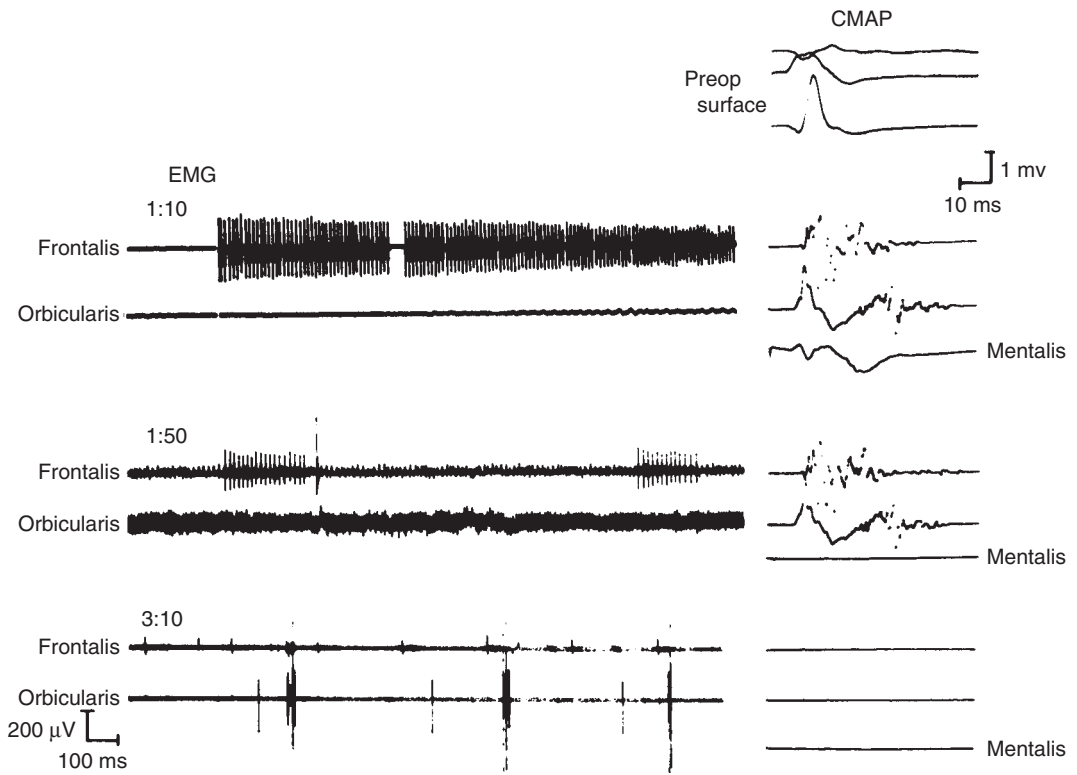
- For middle cranial fossa surgery, IOM with EMG of oculomotor and abducens innervated muscles is most common.

### Posterior Cranial Fossa

The trigeminal, abducens, facial, auditory, vestibular, glossopharyngeal, vagus, spinal accessory, and hypoglossal nerves can be injured during posterior fossa surgery. The abducens is monitored for resection of tumors of the floor of the fourth ventricle. The trigeminal, facial, and auditory nerves are most at risk during acoustic neuroma resection or microvascular decompression or neurectomy for trigeminal neuralgia, hemifacial spasm, or vertigo (Table 43-2). The brain stem may be compressed by cerebellopontine mass lesions larger than 3 cm in diameter. The facial nerve and the motor division of the trigeminal nerve are monitored with electrodes placed in muscles of facial expression and mastication, respectively. Mechanical stimulation produces neurotonic discharges in the respective muscles. Electric stimulation in the operative field can be used to identify the various nerves in the cerebellopontine angle. The amplitude of CMAPs recorded over the nasalis or mentalis muscles correlates with the number of functioning axons in the nerve<sup>15</sup> (Fig. 43-4). Preservation of the facial CMAP at the end of the operation when stimulating the proximal portion of the facial nerve, just after leaving the brain stem, predicts good recovery of facial nerve function within 1 year postoperatively.<sup>7</sup>

**Table 43-2 Most Common Surgical Procedures and Their Monitoring Plans**

Acoustic neuroma	Facial and trigeminal muscle EMG, facial CMAP, BAEPs
Hemifacial spasm	Facial and trigeminal muscle EMG, Lateral Spread Response
Trigeminal nerve microvascular decompression	Facial and trigeminal EMG, BAEPs
Parotid surgery	Facial EMG
Thyroid or parathyroid surgery	Laryngeal EMG



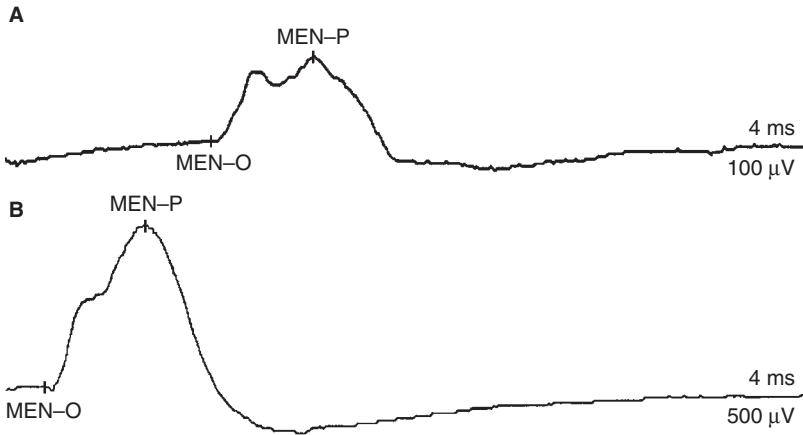
**Figure 43-4.** Monitoring of EMG potentials and facial CMAPs intraoperatively for acoustic neuroma in a 55-year-old woman. Examples of neurotonic discharges observed at various times intraoperatively and gradual loss of facial CMAPs indicate iatrogenic injury of the facial nerve. (From Daube, J. R., and C. M. Harper. 1989. Surgical monitoring of cranial and peripheral nerves. In *Neuromonitoring in surgery*, ed. J. E. Desmedt, 118. Amsterdam: Elsevier Science Publishers. By permission of the publisher.)

This monitoring can still be accomplished successfully with up to 50% neuromuscular blockade.<sup>18</sup> Stimulus intensity required to obtain an evoked response from facial innervated muscles can be predictive of outcome; a stimulus intensity of 0.05 mA or less predicts normal facial nerve functioning postoperatively.<sup>19</sup> The ratio of the amplitude obtained with proximal facial nerve stimulation to that obtained with distal facial nerve stimulation can also be used for prediction of facial nerve functioning after acoustic neuroma surgery<sup>20</sup> (Fig. 43-5).

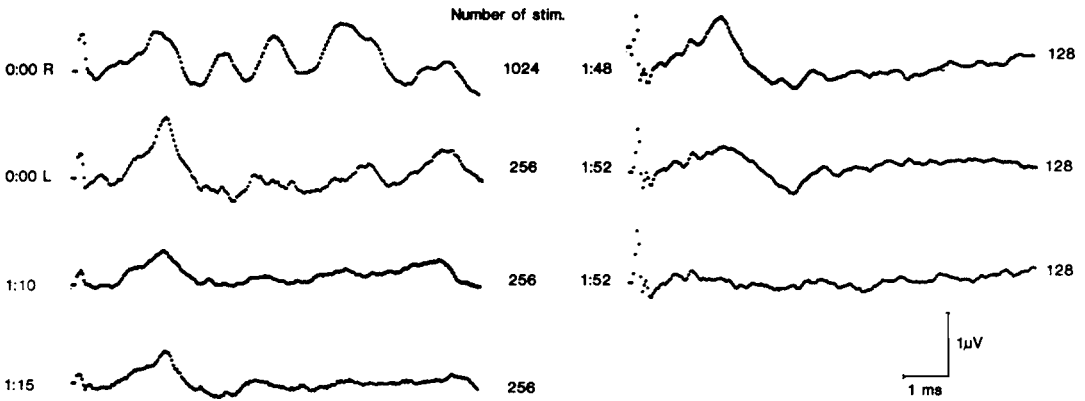
BAEPs can be monitored simultaneously with EMG and CMAPs.<sup>10</sup> Changes in BAEPs correlate well with the postoperative level of hearing.<sup>10,12,21</sup> Gradual changes are often reversible by altering the surgical approach or by moving retractors.<sup>22,23</sup> Sudden loss of BAEPs is usually irreversible<sup>12</sup> (Fig. 43-6). Changes that correlate with postoperative function help determine the mechanism of

nerve injury, thereby improving future surgical results. When brain stem compression is present, monitoring SEPs or MEPs may also be useful.

The lateral spread response (LSR) is an electrophysiological finding in patients with hemifacial spasm, and can be used in IOM for this condition. The LSR is defined as being able to evoke a CMAP from muscles of one facial nerve branch by stimulation of a different branch (Fig. 43-7). This is tested by recording over orbicularis oculi, for example, and stimulating the mandibular branch percutaneously. This is a common finding in hemifacial spasm and the disappearance of the LSR during surgery is a strong predictor of elimination of the hemifacial spasm postoperatively (Fig. 43-8). The persistence of the LSR, however, does not preclude a good result from surgery as most of these patients still experience resolution, just not at such a high rate.<sup>24</sup>



**Figure 43-5.** Facial CMAP at the conclusion of acoustic neuroma surgery. The proximal response (A) is approximately 10% of the distal response (B). Sensitivity 100  $\mu$ V/division, time base 4 ms/division for (A). Sensitivity 500  $\mu$ V/division, time base 4 ms/division for (B). Patient had significant postoperative facial weakness.



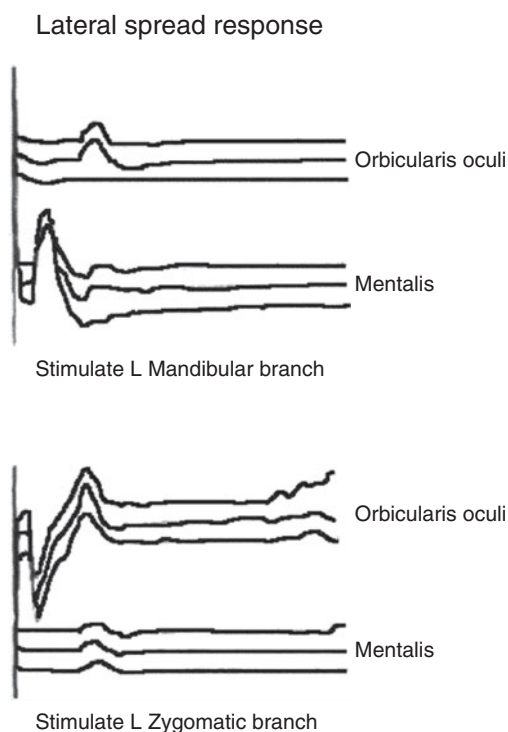
**Figure 43-6.** Monitoring of BAEPs during operation for acoustic neuroma. The sudden loss of the response (at 1:52) correlated with inadvertent coagulation of the internal auditory artery. (From Harper, C. M., and J. R. Daube. 1989. Surgical monitoring with evoked potentials: The Mayo Clinic experience. In *Neuromonitoring in surgery*, ed. J. E. Desmedt, 281. Amsterdam: Elsevier Science Publishers. By permission of the publisher.)

Surgeries of the jugular foramen, foramen magnum, and clivus may also place the facial, auditory, glossopharyngeal, vagal, spinal accessory, and hypoglossal nerves at risk. Facial nerve and auditory monitoring is as mentioned above. Needle EMG electrodes can be placed in the soft palate for monitoring of glossopharyngeal nerve function. The cricothyroid is used for the external laryngeal nerve and the vocalis for recurrent laryngeal nerve monitoring. Electrodes in trapezius allow monitoring of spinal accessory nerve. Electric stimulation can be used to distinguish between rootlets of the glossopharyngeal and vagus nerves in patients undergoing neurectomy for glossopharyngeal neuralgia.<sup>25,26</sup> EMG monitoring of the

hypoglossal nerve (with electrodes placed in the tongue), in addition to monitoring of the vagus and spinal accessory nerves, is useful during operations to remove chordomas, meningiomas, and other lesions in the region of the clivus and foramen magnum.

**Key Points**

- Cranial nerves V and VII through XII can be helpful in monitoring of posterior fossa surgery.
- The most common procedures are for acoustic neuroma resection and microvascular decompression for trigeminal neuralgia or hemifacial spasm.

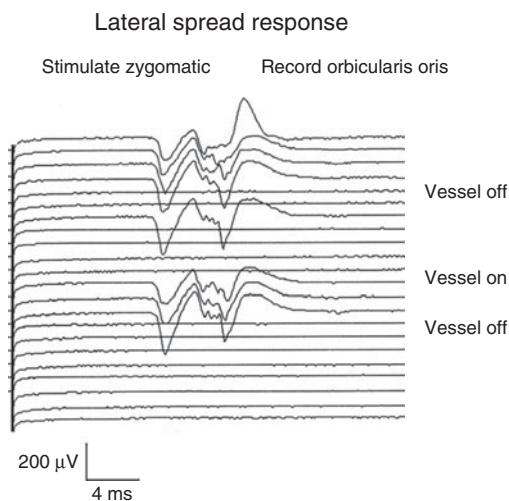


**Figure 43-7.** Stimulation of the mandibular branch should only lead to an evoked response in mentalis and stimulation of the zygomatic branch should only activate orbicularis oculi. In hemifacial spasm there is a “spread” of activation to muscles supplied by other branches of the facial nerve when one branch is stimulated.

- The facial nerve is monitored by free-running EMG (watching for neurotonic discharges) and facial nerve CMAP amplitude or threshold.
- BAEPs are used to improve hearing preservation.
- The LSR can be helpful in hemifacial spasm surgery, though preservation of this response does not preclude an excellent surgical outcome.
- For skull base surgery, EMG of appropriate muscles helps the surgeon identify specific cranial nerves and avoid damage to these nerves.

## Head and Neck Surgery

Operations for neoplasms of the parotid gland may injure one or more branches of the facial



**Figure 43-8.** The LSR disappears when the blood vessel is lifted off the facial nerve and returns when the vessel is in contact with the facial nerve.

nerve that course through the gland. Each branch can be monitored selectively by placing wire electrodes in the frontalis (temporal branch), orbicularis oculi (zygomatic), orbicularis oris (buccal), and mentalis (mandibular) muscles (Table 43-2). Mechanical irritation of the nerve produces neurotonic discharges in the target muscle. Electric stimulation in the surgical field can locate and, therefore, prevent damage to branches of the facial nerve. EMG monitoring has been shown to decrease the risk of facial nerve injury during parotidectomy.<sup>27,28</sup>

The recurrent branch of the laryngeal nerve can be injured during carotid endarterectomy,<sup>29</sup> anterior cervical discectomy,<sup>30</sup> or resection of thyroid tumors.<sup>31</sup> Wire electrodes can be placed by direct laryngoscopy into the vocalis muscle for monitoring the recurrent laryngeal nerve. Monitoring has been shown to decrease the frequency of vocal cord paralysis associated with these procedures.<sup>28</sup>

The spinal accessory nerve is at risk during neck dissections and lymph node biopsies. Needles can be placed into the trapezius muscle for intraoperative monitoring, both for neurotonic discharges and for assistance with nerve localization. This has proven useful in reducing the risk of injury to this nerve in neck surgeries.<sup>32</sup>

### Key Points

- EMG monitoring can help to protect the facial, laryngeal, and spinal accessory nerves during extracranial head and neck surgery.

### SUMMARY

Various modalities are available for monitoring the function of the cranial nerves and brain stem during intracranial or extracranial head and neck operations. After consideration of the surgical risks, a multimodality approach can be tailored to the needs of each patient. Close communication between the IOM team and the surgical team is vital in order to obtain appropriate electrophysiological information and provide useful feedback at a time when clinical detection of nerve injury is impossible. IOM has been shown to decrease the incidence of cranial nerve injury during posterior fossa surgery.

### REFERENCES

1. Harner, S. G., J. R. Daube, and M. J. Ebersold. 1986. Electrophysiologic monitoring of facial nerve during temporal bone surgery. *Laryngoscope* 96:65–9.
2. Blair, E. A., E. Teeple Jr., R. M. Sutherland, T. Shih, and D. Chen. 1994. Effect of neuromuscular blockade on facial nerve monitoring. *The American Journal of Otolaryngology* 15:161–7.
3. Brauer, M., D. Knuettgen, R. Quester, and M. Doehn. 1996. Electromyographic facial nerve monitoring during resection for acoustic neurinoma under moderate to profound levels of peripheral neuromuscular blockade. *European Journal of Anaesthesiology* 13:612–15.
4. Romstock, J., C. Strauss, and R. Fahlbusch. 2000. Continuous electromyography monitoring of motor cranial nerves during cerebellopontine angle surgery. *Journal of Neurosurgery* 93:586–93.
5. Kombos, T., O. Suess, B. C. Kern, T. Funk, T. Pietila, and M. Brock. 2000. Can continuous intraoperative facial electromyography predict facial nerve function following cerebellopontine angle surgery? *Neurologia Medico-Chirurgica (Tokyo)* 40:501–5.
6. Nelson, K. R., and H. C. Vasconez. 1995. Nerve transection without neurotonic discharges during intraoperative electromyographic monitoring. *Muscle & Nerve* 18: 236–8.
7. Harner, S. G., J. R. Daube, M. J. Ebersold, and C. W. Beatty. 1987. Improved preservation of facial nerve function with use of electrical monitoring during removal of acoustic neuromas. *Mayo Clinic Proceedings* 62:92–102.
8. Raudzens, P. A. 1982. Intraoperative monitoring of evoked potentials. *Annals of New York Academy of Sciences* 388:308–26.
9. Radtke, R. A., C. W. Erwin, R. Wilkins, and M. Rozear. 1987. Intraoperative brain stem auditory evoked potentials (BAEPs): Significant decrease in postoperative auditory deficit (abstract). *Neurology* 37(Suppl 1):219.
10. Harper, C. M., S. G. Harner, D. H. Slavit, et al. 1992. Effect of BAEP monitoring on hearing preservation during acoustic neuroma resection. *Neurology* 42:1551–3.
11. Jackson, L. E., and J. B. Roberson Jr. 2000. Acoustic neuroma surgery: Use of cochlear nerve action potential monitoring for hearing preservation. *The American Journal of Otolaryngology* 21:249–59.
12. Neu, M., C. Strauss, J. Romstock, B. Bischoff, and R. Fahlbusch. 1999. The prognostic value of intraoperative BAEP patterns in acoustic neuroma surgery. *Clinical Neurophysiology* 110:1935–41.
13. Zentner, J. 1989. Noninvasive motor evoked potential monitoring during neurosurgical operations on the spinal cord. *Neurosurgery* 24:709–12.
14. Schlake, H. P., R. Goldbrunner, C. Milewski, et al. 1999. Technical developments in intra-operative monitoring for the preservation of cranial motor nerves and hearing in skull base surgery. *Neurological Research* 21:11–24.
15. Sekiya, T., T. Hatayama, N. Shimamura, and S. Suzuki. 2000. Intraoperative electrophysiological monitoring of oculomotor nuclei and their intramedullary tracts during midbrain tumor surgery. *Neurosurgery* 47:1170–6.
16. Stechison, M. T., A. Moller, and T. J. Lovely. 1996. Intraoperative mapping of the trigeminal nerve root: Technique and application in the surgical management of facial pain. *Neurosurgery* 38:76–81.
17. Goldbrunner, R. H., H. P. Schlake, C. Milewski, J. C. Tonn, J. Helms, and K. Roosen. 2000. Quantitative parameters of intraoperative electromyography predict facial nerve outcomes for vestibular schwannoma surgery. *Neurosurgery* 46:1140–6.
18. Lennon, R. L., M. P. Hosking, J. R. Daube, and J. O. Welna. 1992. Effect of partial neuromuscular blockade on intraoperative electromyography in patients undergoing resection of acoustic neuromas. *Anesthesia and Analgesia* 75(5):729–33.
19. Neff, B. A., J. Ting, S. L. Dickinson, and D. B. Welling. 2005. Facial nerve monitoring parameters as a predictor of postoperative facial nerve outcomes after vestibular schwannoma resection. *Otology & Neurotology* 26(4):728–32.
20. Isaacson, B., P. R. Kileny, H. El-Kashlan, and A. K. Gadre. 2003. Intraoperative monitoring and facial nerve outcomes after vestibular schwannoma resection. *Otology & Neurotology* 24(5):812–17.
21. Wazen, J. J. 1994. Intraoperative monitoring of auditory function: Experimental observations and new applications. *Laryngoscope* 104:446–55.
22. Hatayama, T., and A. R. Moller. 1998. Correlation between latency and amplitude of peak V in the brain stem auditory evoked potentials: Intraoperative recordings in microvascular decompression operations. *Acta Neurochirurgica* 140:681–7.
23. Matthies, C., and M. Samii. 1997. Management of vestibular schwannomas (acoustic neuromas): The



- value of neurophysiology for intraoperative monitoring of auditory function in 200 cases. *Neurosurgery* 40:459–66.
24. Kong, D. S., K. Park, B. G. Shin, J. A. Lee, and D. O. Eum. 2007. Prognostic value of the lateral spread response for intraoperative electromyography monitoring of the facial musculature during microvascular decompression for hemifacial spasm. *Journal of Neurosurgery* 106(3):384–7.
  25. Taha, J. M., J. M. Tew Jr., R. W. Keith, and T. D. Payner. 1994. Intraoperative monitoring of the vagus nerve during intracranial glossopharyngeal and upper vagal rhizotomy: Technical note. *Neurosurgery* 35:775–7.
  26. Taha, J. M., and J. M. Tew Jr. 1995. Long-term results of surgical treatment of idiopathic neuralgias of the glossopharyngeal and vagal nerves. *Neurosurgery* 36:926–30.
  27. Terrell, J. E., P. R. Kileny, C. Yian, et al. 1997. Clinical outcome of continuous facial nerve monitoring during primary parotidectomy. *Archives of Otolaryngology—Head and Neck Surgery* 123:1081–7.
  28. Brennan, J., E. J. Moore, and K. J. Shuler. 2001. Prospective analysis of the efficacy of continuous intraoperative nerve monitoring during thyroidectomy, parathyroidectomy, and parotidectomy. *Otolaryngology and Head and Neck Surgery* 124: 537–43.
  29. Markand, O. N., R. S. Dilley, S. S. Moorthy, and C. Warren Jr. 1984. Monitoring of somatosensory evoked responses during carotid endarterectomy. *Archives of Neurology* 41:375–8.
  30. Jellish, W. S., R. L. Jensen, D. E. Anderson, and J. F. Shea. 1999. Intraoperative electromyographic assessment of recurrent laryngeal nerve stress and pharyngeal injury during anterior cervical spine surgery with Caspar instrumentation. *Journal of Neurosurgery* 91(Suppl 2):170–4.
  31. Timon, C. I., and M. Rafferty. 1999. Nerve monitoring in thyroid surgery: Is it worthwhile? *Clinical Otolaryngology* 24:487–90.
  32. Midwinter, K., and D. Willatt. 2002. Accessory nerve monitoring and stimulation during neck surgery. *The Journal of Laryngology and Otology* 116(4):272–4.

*This page intentionally left blank*

# Spinal Cord Monitoring

*Jeffrey A. Strommen*

**INTRODUCTION  
GENERAL PRINCIPLES OF  
INTRAOPERATIVE MONITORING  
EQUIPMENT AND ELECTRICAL SAFETY  
MONITORING METHODS—  
SOMATOSENSORY EVOKED  
POTENTIALS**

Stimulation Techniques  
Recording Techniques  
Physiologic and Technical Issues  
Application and Interpretation of  
SEP Changes

**MOTOR EVOKED POTENTIALS**

Stimulation Techniques  
Recording Techniques  
Physiologic/Technical Considerations  
Applications and Interpretation of  
MEP Changes

**ELECTROMYOGRAPHY AND  
NERVE CONDUCTION STUDIES**

Recording Techniques  
Physiologic and Technical Effects  
Applications and Interpretation of  
Findings

**TYPES OF SPINAL SURGERIES**

Primary Spine Disease  
Cervical Spine Disease  
Thoracic Spine Disease and  
Scoliosis Surgery  
Lumbosacral Spine Disease  
Primary Neural Disease  
Dorsal Rhizotomy  
Cauda Equina and Tethered Cord  
Vascular Diseases

**SUMMARY**

## INTRODUCTION

The integrity of neural structures including the brain stem, spinal cord, and peripheral nerves can be effectively monitored with multimodal techniques during a wide variety of surgeries. These techniques are utilized with the goal of preserving function and preventing injury to vital neural structures at a time when clinical examination is not possible. The primary goal of intraoperative monitoring is to prevent new neurologic deficits by identifying impairment

sufficiently early to allow prompt correction of the cause. Selection of the appropriate modalities is customized to the patient dependent on the clinical status and the structures felt to be at potential risk. In spinal procedures, this generally involves monitoring the central somatosensory pathway with somatosensory evoked potentials (SEPs), corticospinal pathways with motor evoked potentials (MEPs), and the spinal root with electromyography (EMG) or compound muscle action potentials (CMAPs).

Neurophysiologic monitoring in the operating room (OR) setting can be challenging given the significant electrical interference encountered as well as the effect of physiologic variables including temperature, anesthetics, and hypotension, and variable responses with pre-existing damage to neurologic structures. This chapter will review the techniques and applications of neurophysiologic monitoring of multiple modalities during spinal surgery. These methods have evolved and will continue to change with time and advancing technology in both monitoring and surgical methods.

### ***Purpose and Role of Intraoperative Spinal Cord Monitoring***

- Prevent new neurologic deficits by identifying impairment sufficiently early to allow prompt correction of the cause.
- Monitor spinal cord sensory pathways with SEPs, corticospinal pathways with MEPs, and spinal nerves with EMG and CMAP.

## **GENERAL PRINCIPLES OF INTRAOPERATIVE MONITORING**

The ideal monitoring system is a mechanism that provides the surgeon rapid feedback of nerve or spinal cord function with reliable, easily interpreted data while not interfering with the surgical procedure. If this feedback is provided in a rapid and reliable fashion, the surgeon can take appropriate action to prevent or reverse the potential neurologic injury. For example, some situations such as compression of the spinal cord may be reflected by a gradual or subtle change in the recorded potentials. Since these changes are typically reversible and revert to baseline when the alteration is reversed, monitoring is best accomplished by demonstrating normal function early in a procedure and testing it repeatedly in search for changes that signal impending damage. The monitoring system must be able to monitor multiple structures and the same structure with multiple techniques to provide the rapid and accurate feedback to the surgeon in a relatively hostile electrical environment.

Electrophysiologic testing early in a procedure will distinguish those functions that

remain intact under anesthesia from those that may be altered as a result of normal variations, patient age, underlying disease, or other factors. Monitoring can thus provide reassurance to the surgeon of intact neural function during the course of an operation, allowing greater intervention than would have been contemplated without monitoring.

Reversible alterations in recordings occur when a manipulation results in a nondestructive change in neural function that can be recognized by monitoring the function continuously. Examples include irritation of neural tissue or mild local compression. Early recognition of these alterations allows surgeons to modify their procedures to reduce the likelihood of a persistent deficit.

Destructive manipulation, such as when tissue is severed, is also readily recognized, but not reversible. In these instances, the changes may occur rapidly and irreversibly. Monitoring provides immediate evidence not only of the damage, but also of the severity of the damage. Recognition of irreversible changes can also be useful by teaching the surgeon about the mechanism of injury and helping to predict the nature and severity of the postoperative deficit.

Selective recordings can localize the damage within the neural structures at risk by demonstrating which nerves or tracts are still functional and which are not. The neural structures and their associated causative risks during spine surgery include the following:

- Spinal cord—ischemia, slow compression, stretching, and direct trauma.
- Nerve roots and spinal nerve—stretching, blunt trauma, pinching, and ischemia.
- Cauda equina—stretching, blunt trauma, pinching, and ischemia.

Damage may occur at one or more levels of the spine; thus optimally, each level at risk should be monitored. The modalities and variables of monitoring change with the level. The level most commonly monitored is the thoracic level.

Monitoring is of benefit in many surgical procedures on the spine.<sup>1-3</sup> Immediately postoperatively, persistent neurologic deficit develops in less than 0.5% of patients who undergo corrective operations for scoliosis or other surgical procedures on the spine, but this deficit can be devastating. Of the complications that

occur, one-half are complete paraplegia and one-half are incomplete paraplegia, with one-third of the patients having no recovery of function.<sup>4</sup> With surgical monitoring, some patients can be considered surgical candidates who otherwise might not be because of the risk of an adverse outcome.

There is inherent limitation with any monitoring system. False-positive results are not infrequent and likely reflect either a subclinical lesion or more likely technical factors that have artificially affected the potentials. Identifying changes requires that a well-defined set of baseline values be obtained during the initial, low-risk portions of the surgery. The variations due to extraneous factors must be identified so that the surgeon can be assured that alterations of responses are related to the surgical procedure and not to changes in blood pressure, artifacts, anesthesia, or other factors. False-negative results, where the patient experiences neurologic deficit without an identifiable change in the recordings, occur much less frequently. In most cases, this is likely related to the involvement of critical structures that were not directly monitored during the procedure. An example of this would be paralysis after spine surgery when the SEP remained stable but MEPs were not monitored. This can also occur when monitoring is discontinued prematurely. As previously stated, some abnormalities may be seen immediately after an injury while others, particularly those indicative of mild nerve compression, may not become manifest for up to an hour after the step in the procedure that caused the injury. Monitoring must therefore continue throughout the operative procedure, even after a so-called *critical period* in the operation has passed.

Intraoperative monitoring differs from routine electrodiagnostic studies in several ways, both from a technical standpoint and in regard to interpretation. The most prominent factor is related to a hostile electrical environment when devices such as cautery, 60-Hz artifact, respirators, or warmers may attenuate or completely obliterate the response. The appearance and reproducibility of potentials recorded intraoperatively are affected greatly by the type and level of anesthesia, blood pressure, temperature, and other physiologic variables. The underlying disease process itself will likely also have affected the baseline responses. Due to these factors, rather than utilizing absolute

values or normal control values, the patient will generally serve as his or her own control with a change in values during the procedure being indicative of potential neurologic injury. One must therefore establish reliable baseline recordings before critical portions of the procedure as well as monitor all potential confounding factors so the surgeon can be informed of a true potential change due to surgical manipulation.

### **Key Points**

- Monitoring methods must be able to provide rapid and reliable feedback on both sudden and gradual changes.
- Multimodal monitoring of structures at risk is required to avoid false-negative results.
- Monitoring requires assessment both at baseline and throughout the surgical procedure.
- Avoidance of false-positive changes requires monitoring and accounting for:
  - Physiologic variables—anesthesia, neuromuscular block, temperature, muscle activity, and blood pressure.
  - Electrical interference—60-cycle, noisy or dislodged electrodes and cautery.

## **EQUIPMENT AND ELECTRICAL SAFETY**

Two International Federation of Clinical Neurophysiology publications provide specific recommendations for assuring quality and safety during surgical monitoring.<sup>5,6</sup> The equipment used for surgical monitoring is typically the same as that used in outpatient testing with some modifications. Evoked potential equipment should include capabilities for adding, subtracting, storing, smoothing, automatic artifact rejection, and simultaneous display of multiple traces from several channels. EMG equipment should allow audio presentation as well as visual, and should have automatic artifact rejection to minimize operative interference, particularly that due to cautery. The common mode rejection ratio should be at least 85 dB, for elimination of 50- or 60-Hz line interference, which is a common problem in the OR.

All equipment should conform to OR safety specifications and careful attention must be

paid to electrical safety when using equipment purchased commercially or made *in house*. Monitoring equipment must not be able to allow a current of more than 100 mA to pass through the patient if there is a failure of equipment grounding. This is measured as the chassis leakage current across a functioning ground plug. For electrically sensitive patients, such as those with catheters leading to the heart or great vessels, the limit should be 10 mA. These current limits are substantially larger than would occur under normal operating circumstances with properly functioning equipment. The most common danger is from improper and malfunctioning grounding. A patient should be electrically grounded at only one site, usually a large ground plate. That ground is used for the diathermy and for similar routine OR equipment. All OR machinery should be properly grounded; in that case a second patient ground is unnecessary. Current neurophysiology equipment should have optical isolation of each patient contact, preventing conduction of inadvertent electrical currents between the patient and the equipment. An optically isolated isoground is used with many such pieces of equipment. In general, this can be used safely in the OR, even on a patient who has a true ground plate already in place. In such a patient, any ground current will travel out the true ground plate, without substantial leakage current traveling through the isoground circuit. The neurophysiologist needs to take the responsibility for assuring that the leakage current of equipment is tested and safe. At most hospitals, biomedical engineers are available to check equipment for proper grounding on the main power cord and for leakage current along any connection to the patient.

### Key Points

- Equipment requirements for optimal recognition of changes include
  - Auditory and visual signal display.
  - Automatic artifact rejection.
  - Simultaneous, eight-channel, multi-modality recording and display.
  - Sequential stimulation and recording on single sweep traces.
- Monitoring equipment safety requirement—100 mA current limit through the patient in the event of equipment or grounding failure.

## MONITORING METHODS—SOMATOSENSORY EVOKED POTENTIALS

SEPs have become an accepted method of monitoring spinal cord function during a wide variety of surgical procedures on the spinal cord. Although they are most commonly used during correction of scoliosis, any spine surgery may warrant SEP monitoring if there is risk of cord damage. These include monitoring during surgery for cervical spondylosis and for intramedullary and extramedullary spinal cord lesions such as tumors and vascular malformations. As shown in animal models, ischemia or compression of the spinal cord prolongs, reduces, and then obliterates SEP in proportion to the amount of damage. A large multicenter study of scoliosis surgery showed that the incidence of postoperative neurologic deficits was 0.46% with SEP monitoring and 1.04% without SEP monitoring.<sup>7</sup>

Optimal use of intraoperative SEP requires a number of specific decisions about methods of stimulation and recording. These vary with the level of the nervous system to be monitored, the structures at risk, the type of surgery being performed, the extent of preoperative deficit, and the choice of anesthetic.

### Stimulation Techniques

Similar to SEP performed in the outpatient setting, stimulation of a peripheral nerve is used to generate the responses. Stimulation may be performed on any of the major peripheral nerves and can be either unilateral or bilateral. Commonly stimulated nerves include the tibial nerve at the ankle, peroneal nerve at the knee, and median or ulnar nerves at the wrist. Unilateral stimulation of nerves whose fibers are most at risk or which are most likely to show a change is preferred, although occasionally the presence of a preoperative deficit or a particular anesthetic agent may attenuate SEP voltage sufficiently that bilateral stimulation is needed. Bilateral stimulation, however, can mask asymmetric changes in the SEP that would be easily revealed by unilateral stimulation.

Surface electrodes embedded in a plastic strip or platinum EEG needle electrodes may be used for stimulation and should be fixed firmly over the nerve. Stimulus intensity



must be supramaximal for large sensory fibers. Levels that lead to a muscle twitch in distal muscles are used and should be determined prior to neuromuscular blockade. When reliable responses cannot be obtained from more distal stimulation sites in the leg, stimulation of the sciatic nerve in the proximal thigh or cauda equina may be successful.

Rates of stimulation may affect the elicited responses. Rapid stimulation rates are optimal in order to decrease the time needed to obtain a response. Although SEP can be recorded with stimulation rates of 5 Hz or even 10 Hz in most awake patients, under anesthesia the scalp SEP fatigues at rates greater than 3 Hz. It may be necessary to stimulate at rates as low as 0.5 or 1.0 Hz in children and adolescents, especially at deeper levels of anesthesia.

Direct stimulation in the operative field gives direct activation of ascending and descending SEP. It is often not easy to be certain whether such potentials are motor or sensory, since cord stimulation may activate either or both. Direct cord stimulation methods typically utilize subarachnoid, epidural, spinous process, and intraspinal ligament stimulation and recording. Epidural electrodes inserted between the spine and the dural sac obtains large readily recorded potentials. Similar recordings have been made of descending activity by stimulating and recording the stimuli from the spinal cord directly.

### Key Points

- Nerves stimulated should be selected to maximize recognition of damage to pathways at risk and to obtain reliable SEP.
  - Tibial nerve at the ankle (peroneal nerve at the knee) or more proximal.
  - Ulnar nerve (median nerve) at the wrist or more proximal.
  - Unilateral (bilateral).
  - Other peripheral nerves based on structures at risk, including direct stimulation of nerves in the operative field.
- Stimulation intensities should be sufficient to elicit a muscle twitch in appropriate muscles.

## Recording Techniques

Recording the responses during intraoperative SEP monitoring is performed using standard

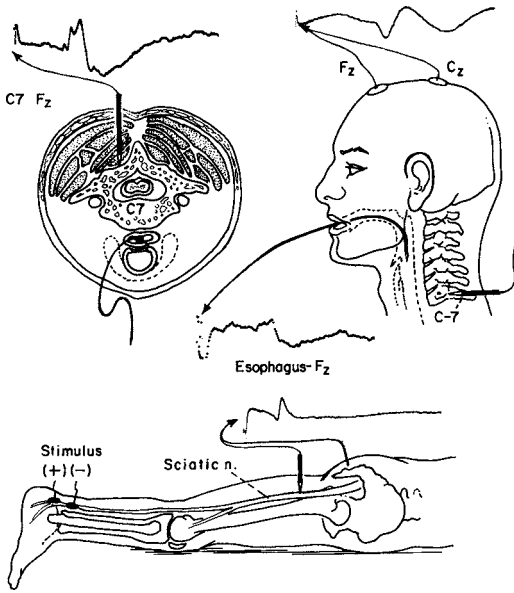
surface electrodes on the scalp, similar to those used for laboratory SEP recording, or subdermal needle electrodes. Surface electrodes must be firmly attached with collodion and filled with conductive gel to ensure stability and low impedance throughout long surgical procedures. Subdermal needle electrodes are being more frequently utilized and have better impedances. Electrodes are placed at standard sites on the scalp and along the peripheral nerve and spine.

For scalp recording, electrodes are placed at Cz–Fz for tibial responses and C3' or C4'–Fz for median and ulnar responses. Larger, more reliable tibial SEP may be seen with C3–C4 recordings than with the standard Cz–Fz recordings, and should always be tested to ensure that the optimal potential is selected.

For recording the potentials at the cord level, needle electrodes are placed adjacent to the peripheral nerve or lamina. Percutaneous needle electrodes of 30–75 mm placed directly on the lamina outside the surgical field or in the intraspinal ligament at any spinal level in the surgical field can record well-defined, reliable potentials. Esophageal or nasopharyngeal electrodes at the cervical levels are necessary to record cervical cord potentials outside the surgical field in cervical spine surgery. Either of these can provide a good stable recording anterior to the spinal cord.

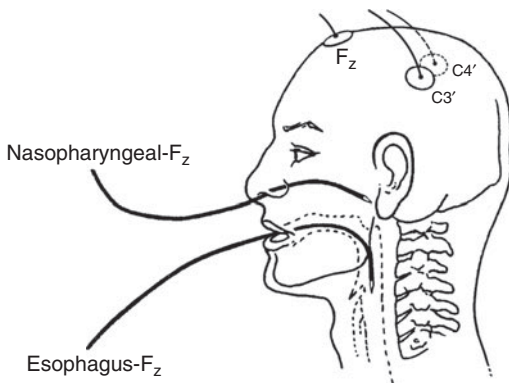
Epidural recordings can be made at any level in the operating field with multilead cable electrodes, strip electrodes, fine wires, or needles in the intraspinal ligament. Small wick electrodes or plastic embedded platinum electrodes are used to record directly from the spinal cord or epidural space, and from the surface of the cortex. For each of these active electrodes an appropriate reference must be chosen. Nearby reference electrodes reduce noise, but distant electrodes enhance signal amplitude. In general, active and reference electrodes should be of the same material and firmly affixed to minimize noise.

In addition to recording from the scalp and the cord, recordings should be made from peripheral sites along the sensory pathways to ensure adequate stimulus input. Adherence to this important principle will minimize the incidence of false-positive changes and make troubleshooting for technical errors more efficient. Figures 44–1 and 44–2 demonstrate technically reliable approaches utilized for SEP monitoring during spinal surgeries.



**Figure 44-1.** Standard placement of electrodes for monitoring SEPs during thoracolumbar spine surgery. The sciatic response is recorded with a needle electrode near the nerve. Cervical responses are recorded from an electrode on the lamina of the spine of C7 and from an esophageal electrode. Scalp responses are recorded from standard vertex electrodes. (From Daube, J. R., C. M. Harper, W. J. Litchy, and F. W. Sharbrough. 1990. Intraoperative monitoring. In *Current practice of clinical electroencephalography*, ed. D. D. Daly, and T. A. Pedley, 2nd ed., 747. New York: Raven Press. By permission of Lippincott Williams & Wilkins.)

Recordings made in the surgical field can be performed in cases where the spine is open and the dura mater exposed. These recordings



**Figure 44-2.** Electrode placement for standard median or ulnar SEPs during cervical spine surgery. The cortical response is best recorded at C3'–C4'; cervical potentials are recorded via either a nasopharyngeal or an esophageal electrode.

give larger responses but are associated with more technical problems during the surgical procedure, such as mechanical artifact. Such recordings require more technical expertise for obtaining satisfactory results and require that the surgeon be familiar with and cooperative with the recording procedure.

As with routine SEP, the low-amplitude responses obtained with SEP requires averaging multiple responses. The number of stimuli averaged should be just enough to obtain reliable recordings in order to give the surgeon feedback as rapid as possible. However, when averaging large numbers of stimuli, a transient or gradual change in the evoked potential may be obscured. As with other evoked potentials, stable baseline studies must be obtained prior to critical stages and then followed continuously when these structures are at risk.

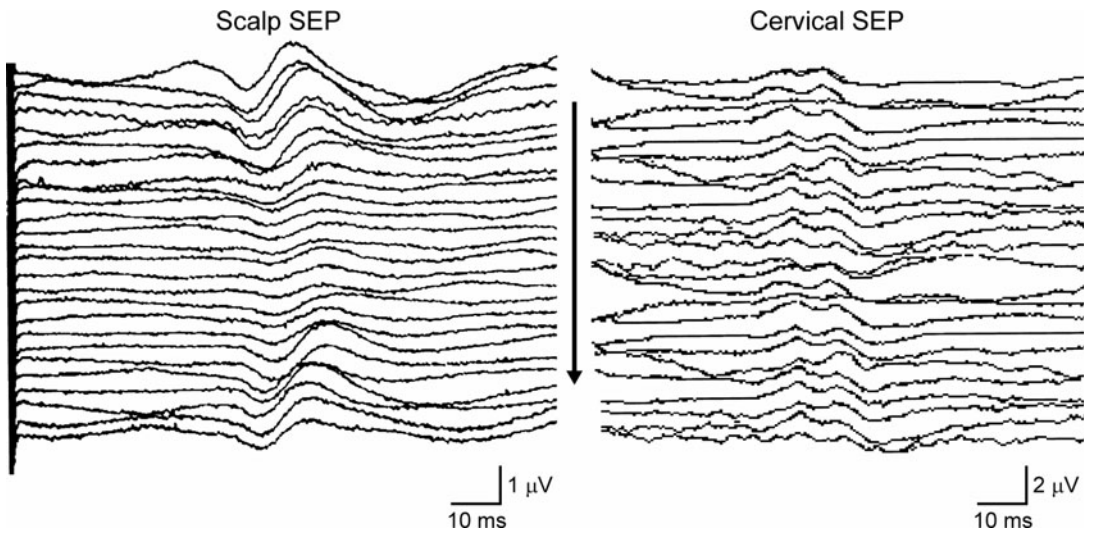
Signal amplification and filter settings are similar to those used for diagnostic SEP recordings, although at times the gain must be reduced or the bandpass restricted because of the high noise environment. Amplification of 5–10  $\mu\text{V}/\text{cm}$ , sweep speeds of 2–10  $\text{ms}/\text{cm}$ , low-frequency filters (LFF) of 30–100 Hz, and high-frequency filters (HFF) of 2000–3000 Hz are generally satisfactory.

### Key Points

- Electrodes must be firmly attached.
- Leg sensory pathway requires testing both C3–C4 and C3 and C4 to Fz recordings at the beginning to determine which provides the most reliable recording.
- Sensitivities and sweep speed settings should be adequate to best identify the SEP (0.5–10  $\mu\text{V}/\text{cm}$  and 2–10  $\text{ms}/\text{cm}$ ).
- Filter settings that best eliminate artifact with a minimum of reduction of the SEP (low of 30–100 Hz and high of 2000–3000 Hz) are required.
- Stable baseline recordings should be obtained after the patient is anesthetized, but before the critical period of surgery.

### Physiologic and Technical Issues

**Noise.** Electrical noise is the most common technical problem encountered during intraoperative monitoring. Early in the procedure, every effort must be made to identify and



**Figure 44-3.** Series of averages of 200 SEP displayed as a stack of sweeps reading sequentially from top (arrow). *Left*, Loss of scalp amplitude due to depth of anesthesia. *Right*, Preserved cervical response throughout the surgery.

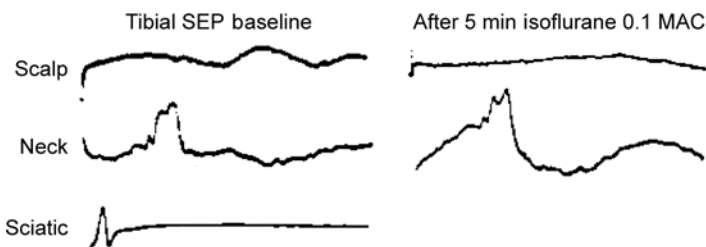
eliminate all sources of noise, especially 60 cycle. Maximizing the signal to noise ratio is an ongoing challenge in the electrically hostile environment of the OR but with proper electrode placement, impedance matching, and filtering, reproducible recordings can generally be obtained with 250 stimuli. The recording system should suppress input during cautery and reject high-amplitude artifact.

**Muscle Activity.** EMG activity from surrounding muscle can also produce unwanted artifact if neuromuscular activity is not blocked. EMG activity may be so prominent as to obscure SEP. This most commonly occurs when the level of anesthesia is low.

**Anesthesia.** Anesthesia reduces the cortical SEP recorded from the scalp and to a much lesser extent SEP recorded elsewhere<sup>8</sup>

(Figs. 44-3 and 44-4). Since the reduction in amplitude is directly related to depth of anesthesia, the level of anesthesia should be kept as light as possible. This is especially true in the presence of disease and in children and adolescents. The anesthetic effect varies with the agent used: it is least with fentanyl and nitrous oxide (NO), more with isoflurane and enflurane, and greatest with halothane. Both propofol and midazolam provide stable median N20 and tibial P40 latencies and amplitudes for SEP monitoring of cord function during spine surgery.<sup>9,10</sup> There may be some increase in latency and decrease in amplitude immediately after induction.

Newer agents including desflurane and sevoflurane lead to similar reduction of amplitudes and the addition of NO to these agents leads to marked reduction.<sup>11</sup> The primary



**Figure 44-4.** Effect of anesthesia on tibial (cervical cord stimulation) scalp SEP during scoliosis surgery on a 10-year-old boy. *Left*, Baseline recordings before inhalational anesthetic. *Right*, Loss of the scalp SEP with preservation of the cervical response after a short period of inhalational anesthetic illustrating the effect of inhalational anesthetics on the anterior horn cell pool in children and adolescents.

effect of anesthesia on the scalp SEP is a gradual prolongation of the latency and reduction in the amplitude. These effects increase the longer the period of anesthesia. Rarely, the scalp response is enhanced after the induction of anesthesia. In a small proportion of cases, predominantly in children and adolescents, the response is lost immediately after the induction of anesthesia. Premedication has little effect on the SEP.

Since the anesthetic sensitivity of spinal cord evoked potentials is less than scalp recordings, a combination of spinal and scalp recordings provides the advantages of determining if changes in responses may be related to level of anesthesia. The percutaneous electrodes on the lamina allow continued recording of spinal potentials when reproducible scalp potentials cannot be obtained. Although in most spine surgeries, a reduction of scalp amplitude with preservation of the cervical spine potential would suggest anesthetic effects; this is not necessarily true in upper cord or brainstem procedures where the cervical response will be maintained despite a clinically significant insult. Occasionally, because of a patient's preoperative neurologic deficit, scalp potentials cannot be recorded. In many of these patients, SEP may be recorded at the neck.

**Blood Pressure.** In addition to the level of anesthesia, blood pressure alterations may prolong the latency and reduce the amplitude of SEP, especially if the mean blood pressure is less than 70 mm Hg.

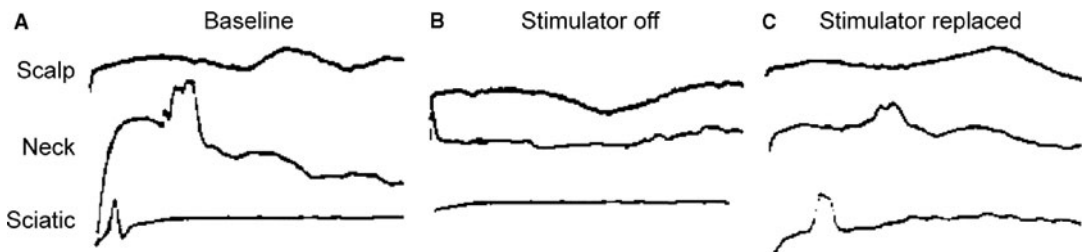
**Variability of Responses.** A frequent problem during surgical monitoring is SEP variability on sequential recordings. SEPs may change for many reasons other than surgical damage to the sensory pathway. During cervical surgery with the patient in the sitting position, a marked

reduction in SEP can occur because of the accumulation of subdural air. This change is recognized readily by comparing the standard vertex electrode recording with that of electrodes placed just above the ear, where there is less subdural air.

Differentiating changes caused by technical factors from those caused by pathway damage requires that the alteration in the amplitude or latency be consistent at both the neck and scalp recording sites and the peripheral response be intact. Accuracy of monitoring can be improved with appropriate use of peripheral recordings, including monitoring arm SEP over Erb's point with median or ulnar nerve stimulation and monitoring leg SEP from the sciatic nerve at the gluteal fold or the N22 lumbar potential from T12–L1. If there is damage to the central pathways during the procedure leading to loss of the spine and scalp responses, the peripheral response should still be present. If the peripheral response is also absent there is either a peripheral process or more likely malfunctioning of the stimulator (Fig. 44–5).

### Key Points

- Multiple levels of the peripheral and central somatosensory pathways should be monitored to localize sites of technical problems or damage.
- Inhalation agents are the most common physiologic cause for cortical SEP reduction.
  - Simultaneous spinal cord recordings that are not affected are needed to best recognize inhalation agent effects.
- Extraneous sources of false positives and false negatives must be controlled.
  - External and equipment noise should be eliminated early.
  - Cautery suppression should be available.



**Figure 44–5.** Peripheral stimulation failure during spine surgery. A, Intact scalp, neck, and sciatic recordings. B, Abrupt loss of all response due to mechanical displacement of the stimulator at the ankle. C, SEP return with reestablishment of stimulation.

- Inhalational anesthetics should be as light as possible.
- Blood pressure reduction can reduce SEP amplitudes.
- SEP variation during baseline recordings defines later limits.

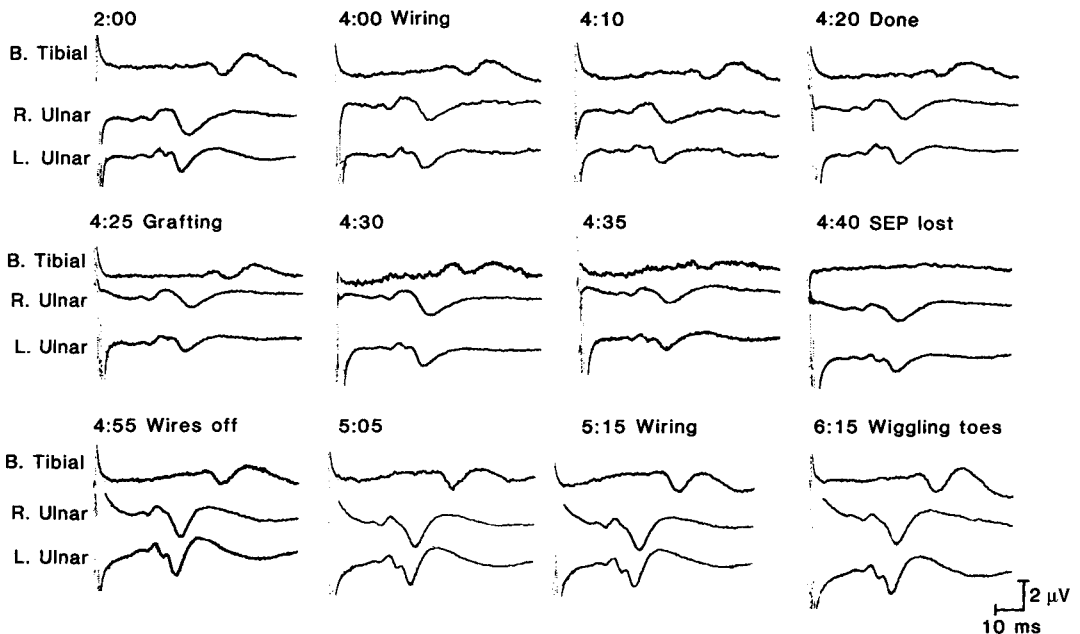
## Application and Interpretation of SEP Changes

Ideally, the ordinary background variability of the potentials recorded during intraoperative SEP is no more than 30% in amplitude and 1.0 ms in latency. While a 50% fall in amplitude from baseline and a 5% change in latency, if the concentration of anesthetic and other physiologic factors have remained stable, are generally guidelines for high likelihood of damage,<sup>12</sup> no absolute change in amplitude can be considered evidence of spinal cord damage. Subcortical potentials are less likely to be affected by anesthesia and provide a means to interpret the significance of cortical changes. Because of this, the neurophysiologist must be aware

of not only the anesthetic levels and physiologic variables, but must be in communication with the surgeon at all times since mild changes during critical portions of the procedure may reflect significant neural compromise.

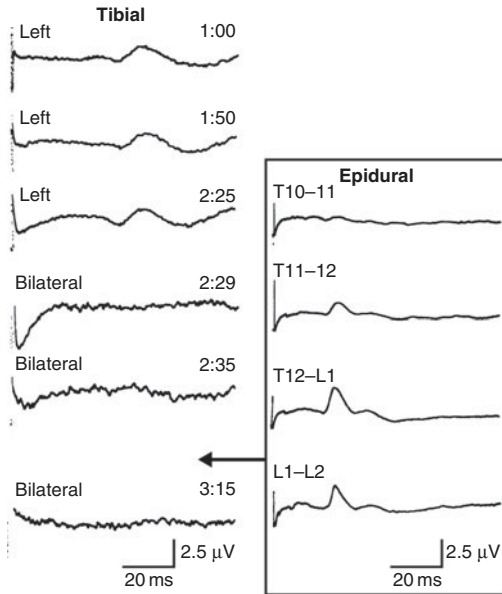
Small, consistent signal changes from two sites of stimulation provide evidence of compression before more major changes appear. Infrequent and unusual nonsurgical causes of rapid changes in SEP must always be considered before concluding that the operation is the cause. These causes may be any of the physiologic changes in temperature, blood pressure, or subdural air.

Several patterns of change in SEP have been observed that correlate with postoperative neurologic function. The change may be late or gradual, emphasizing the importance of continuing the monitoring until the patient is awake. Gradual changes in SEP may be caused by retraction, compressive hematoma, or by ischemia of the spinal cord or peripheral nerves (Fig. 44-6). Less frequently, SEP change abruptly, usually in relation to an acute contusion of the spinal cord or vascular infarct. When the loss of SEP is abrupt, the site of



**Figure 44-6.** Gradual loss of SEPs during stabilization procedure for cervical spine fracture in a 60-year-old man. Responses were lost within a few minutes after wiring C5-C7, but they returned quickly after the wires were removed. The patient awoke with no deficit. B, bilateral; L, left; R, right. (From Daube, J. R., C. M. Harper, W. J. Litchy, and F. W. Sharbrough. 1990. Intraoperative monitoring. In *Current practice of clinical electroencephalography*, ed. D. D. Daly, and T. A. Pedley, 2nd ed., 765. New York: Raven Press. By permission of Lippincott Williams & Wilkins.)





**Figure 44-7.** Tibial SEPs during thoracic spine surgery. Note the relatively sudden loss of scalp potentials, unrelated to anesthesia, at 2:29. An epidural recording electrode inserted as shown on the right recorded the tibial spinal cord SEP. The SEP was not recordable above T11. The patient awoke with paraplegia likely due to spinal cord infarct. (From Harper, C. M., and J. R. Daube. 1989. Surgical monitoring with evoked potentials: The Mayo Clinic experience. In *Neuromonitoring in surgery*, ed. J. E. Desmedt. Amsterdam: Elsevier. By permission of the publisher.)

injury should be localized by recording with epidural or direct spinal electrodes, followed by careful inspection of the involved level for hematoma or other potentially reversible causes of spinal cord injury (Fig. 44-7). If the loss of SEP is abrupt and not reversible, paraplegia is likely to occur. Improvement in the amplitude of SEP intraoperatively is usually associated with improved neurologic status postoperatively. Postoperative motor deficits without associated changes in SEP intraoperatively are infrequent but well documented.<sup>13</sup> The motor deficits may occur as part of the anterior spinal artery syndrome or they may be caused by direct injury to the ventral spinal cord, ventral horn cells, or nerve roots.

### Key Points

- Recognition of spinal cord damage requires:
  - SEP amplitude loss beyond that seen during baseline recordings.

- Intact peripheral response with loss of both neck and scalp SEP.
- No possible technical or physiologic causes.
- An amplitude reduction of greater than 50% or a latency prolongation greater than baseline variation (generally a 5% latency increase) is considered abnormal.

## MOTOR EVOKED POTENTIALS

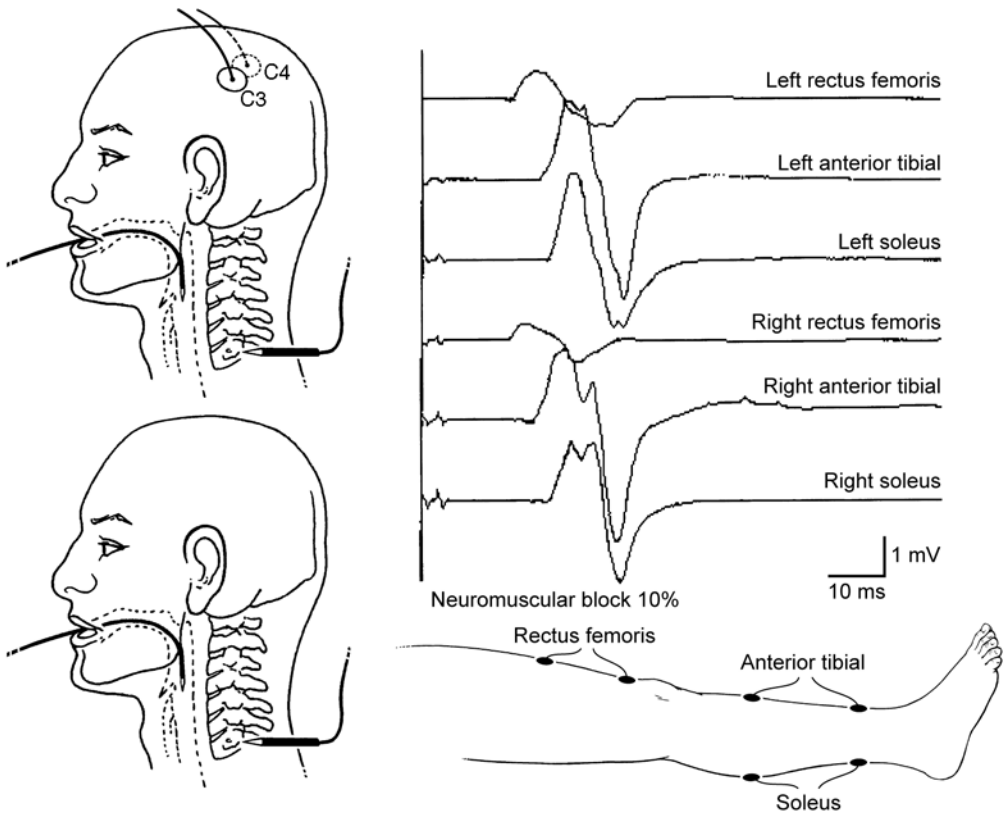
Historically, emphasis has been placed on SEP monitoring during spine surgery with the assumption that a significant neurologic injury that results in motor deficit would be sufficient enough to also involve the recorded sensory pathways. In reality, an injury sparing the posterior columns, whether due to compression or vascular insult, will not significantly affect the somatosensory pathways yet can result in devastating motor deficits. A complimentary method of recording the MEP is available to monitor the integrity of the corticospinal tract. A variety of methods of stimulation and recording have been reported over the years. This section will focus on the more commonly used methods with only brief comments on other options.

## Stimulation Techniques

Motor evoked potentials are reliably obtained intraoperatively with direct stimulation of the spinal cord or cerebral hemispheres. MEPs can be elicited with either electric or magnetic stimulation. In an anesthetized patient, magnetic stimulation has no advantage over electric stimulation and has major disadvantages: the coil is cumbersome and hard to immobilize relative to the skull, the apparatus is expensive (particularly if trains of stimuli are to be given), and magnetic MEPs are more sensitive than electric MEPs to anesthetic agents.<sup>14</sup> Therefore, electrical stimulation is the most common method utilized.

Transcranial electrical stimulation is performed by stimulation via subdermal electrodes whereas spinal cord stimulation can be performed using direct epidural, laminar needle, nasopharyngeal or esophageal electrodes. In the past, spinal cord stimulation was





**Figure 44-8.** Electrically induced MEPs can be evoked with stimulation between C3 and C4 on the scalp, or between a nasopharyngeal and a laminar electrode. The former is more commonly used. Recordings are made from surface electrodes of multiple leg muscles bilaterally.

easier to perform; however, with recent technologic advances transcortical electrical stimulation (TCES) has become the technique most frequently utilized.

The stimulation technique for MEP has been described in Chapter 25. In summary, with TCES anodal stimulation is given with a short duration (0.05 ms), rapid rise time stimulus using subcutaneously placed EEG electrodes at C3 and C4 (Fig. 44-8). Several (2-5) stimuli with an interstimulus interval of 1-4 ms are given with intensity of 200-800 V. These parameters are varied until a reproducible response can be recorded in all the muscles examined. The polarity of the simulation is also switched to assure maximal anodal stimulation. Contraindications to TCES include the presence of a pacemaker, infusion pumps, cochlear implants, or a history of epilepsy, seizures, skull fracture or defect, major head trauma, stroke, other intracranial disease, or aneurysm clips and other retained metal fragments.

Spinal cord stimulation can be accomplished with a nasopharyngeal/esophageal active and laminar needle electrode. Other options are stimulation in the operative field with interspinous or epidural electrodes in the surgical field using a distant anode in the subcutaneous tissue, but are more technically difficult.

### Key Points

- TCES of MEPs requires optimization of a number of choices:
  - Contraindications to TCES must be considered for each patient.
  - Stimulating electrodes at C3 and C4 should have each electrode tested as anode to identify lowest threshold for activation.
  - Stimulus parameters:
    - Two stimuli are sometimes satisfactory, but 3-5 may be needed.

- Inter-stimulus intervals of 3 ms are usually satisfactory, but longer or shorter intervals can be tried to enhance responses.
- Stimulus intensities of 200–800 V may be needed.
- Cervical cord stimulation can be used if cranial stimulation is contraindicated:
  - Stimulation between a percutaneous needle electrode on a cervical lamina and a nasopharyngeal electrode are most efficient and reliable.
  - Paired pulses with a 3-ms interval can evoke potentials under 110 V.

## Recording Techniques

Motor evoked potentials can be recorded directly from the spinal cord as a cord-evoked potential, from a peripheral nerve as a nerve action potential, or from muscle as a CMAP.

### SPINAL CORD RECORDING

Stimulation of the spinal cord, even at threshold, activates both motor and sensory fibers. Therefore, the MEPs recorded from the spinal cord in response to direct spinal cord stimulation (cord-to-cord) are a mixture of potentials in ascending and descending pathways, and this mixture may be less sensitive to spinal insult than monitoring of selective pathways.

Recordings may be made within the surgical field, and these are most useful for operations on the spinal cord (e.g., tumors or arteriovenous malformations). Epidural bipolar cardiac pacing electrodes with an inter-electrode separation of 2–3 cm are suitable for recording descending MEP (the same electrode can be used to record SEP directly from the spinal cord or to stimulate the spinal cord). The directly recorded potentials can help to localize the area of damage or record responses that are too small to be obtained with other methods.

Responses recorded from the spinal cord during transcranial MEP monitoring have the advantage of being relatively immune to the effects of anesthetic agents, and not affected by muscle activity since full neuromuscular blockade will not affect the responses. In addition, SEPs can be recorded reliably in the same sweeps if the cerebral cortex and peripheral nerve are stimulated simultaneously. MEP may

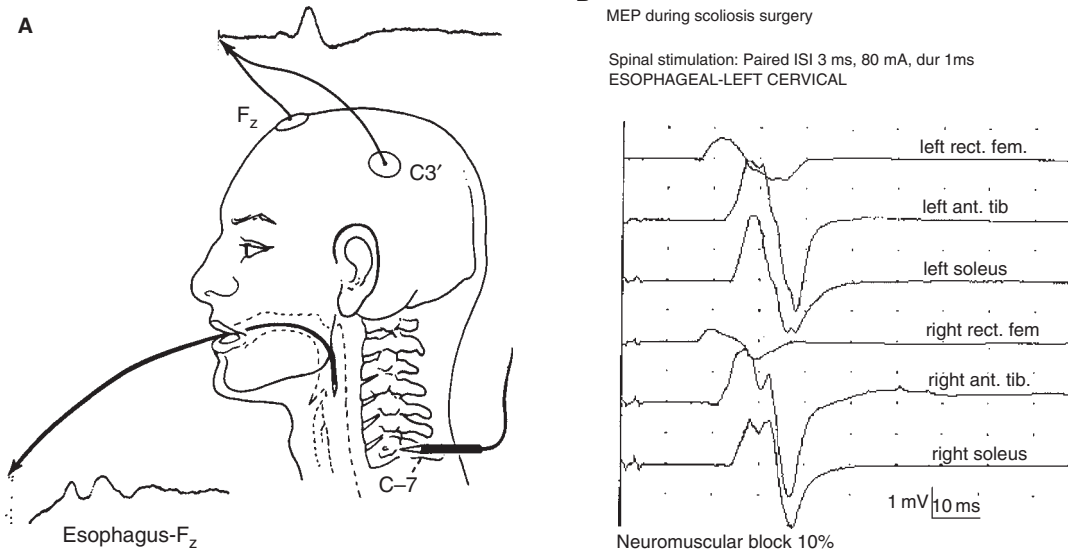
also be recorded in patients with a preexisting neural deficit and an abnormality in the corticospinal tracts may be identified promptly. The disadvantages of spinal cord recordings are that they are feasible only when epidural leads can be inserted, which usually requires a posterior approach to the spinal cord; they do not identify the side responsible for any deterioration in the recorded volleys and they are not as reliably recorded from the lumbar cord.

### PERIPHERAL NERVE RECORDINGS

Nerve action potentials can be recorded in the region of the sciatic or tibial nerve in response to stimulation of the cerebral cortex or the spinal cord, but they are less well defined with cortical stimulation. Due to the small responses, 100 or more responses need to be averaged. If inhalation anesthesia is used, the neurogenic MEP obtained with spinal cord stimulation may reflect activity primarily of posterior column axons, because spinal motor neuron activity is reduced. With the neuromuscular block that typically is used, a significant component of the neurogenic potential may be the end plate potential from surrounding muscle as well as potentials from the motor and sensory fibers in the peripheral nerve.

### MUSCLE RECORDINGS

CMAPs are the potentials that are most commonly recorded during MEP monitoring. CMAPs may be recorded with surface electrodes placed over the muscle in response to stimulation of either the cerebral cortex or the spinal cord, but the potentials are different for the two modes of stimulation. Narcotic anesthesia is necessary for CMAPs to be elicited, and even then the CMAPs produced by single stimuli to the motor cortex are too variable for monitoring motor function reliably. Pairs or trains of stimuli, especially to the spinal cord, produce enough temporal summation of excitatory input to activate most motor neurons. Large, stable CMAPs can be recorded, but this often requires partial neuromuscular block to control movement (Fig. 44–9). The level of neuromuscular block is monitored best with recording of CMAPs in response to peripheral nerve stimulation along with the CMAPs from central stimulation.



**Figure 44-9.** MEPs elicited by stimulation of the spinal cord with paired stimuli applied between a laminar needle and esophageal electrodes. **A**, Esophageal stimulating or recording electrode location with tibial SEP shown from the scalp and esophageal electrodes. **B**, MEP from esophageal stimulation recorded as surface CMAPs from leg muscles bilaterally, with partial neuromuscular block. Ant. tib., anterior tibialis; rect. fem., rectus femoris.

Compound muscle action potentials are recorded best from multiple muscles in both legs. A major advantage of the technique is that monitoring can be adapted by choosing muscles to suit the specific clinical need. For example, muscles innervated by specific nerve roots when the operation is low spinal or segmental or when a nerve root is known to be at risk. The signal-to-noise ratio for CMAPs is sufficient for single trials to be recorded without averaging. Although the reproducibility of evoked CMAPs is good, it may not be as high as that of MEP in epidural recordings.

The major advantages of MEP monitoring with CMAPs are that unilateral dysfunction can be identified, evoked potentials with spinal cord stimulation are resistant to anesthesia, there is no intrusion into the operative field, CMAPs evoked with spinal stimulation can be recorded simultaneously with SEP, cortically evoked potentials can be adapted for virtually all spinal and cerebral operations, and CMAP recording is equally useful for operations on the low spinal cord, cauda equina, or nerve root. Disadvantages include variability in the CMAPs evoked with spinal stimulation with the level of neuromuscular blockade, unable to perform with spinal stimulation during cervical spine surgery, and cortically evoked CMAPs intrinsically are more variable and

more sensitive to anesthesia than spinal evoked CMAPs.

### Key Points

- MEP recordings can be made from spinal cord, peripheral nerve, or muscle.
  - CMAP from muscle are easiest to perform and show only a limited variability from shock to shock.
    - Surface, subcutaneous, or intramuscular electrodes can be used.
    - Sufficient depth of recording is needed to assure a response.
  - Peripheral nerve MEP recordings are of unique value only in determining the presence of viable motor axon in a nerve root during traumatic brachial plexus reconstruction.
  - Direct, intraoperative, spinal cord MEP recordings
    - Can localize pathology along the spinal cord but
    - Cannot distinguish unilateral from bilateral abnormalities.
- Neuromuscular blocking agents are needed to minimize limb and body movement during surgery.
  - Continuous monitoring with repetitive stimulation can distinguish loss of

potential from a change in neuromuscular block, from one due to change in central anesthetic level.

## Physiologic/Technical Considerations

*Anesthesia.* The primary factor affecting the MEPs is anesthetic agents. These agents can suppress the response at multiple sites but particularly those that involve synaptic transmission. Specifically these are the cortex, anterior horn cell, and neuromuscular junction.<sup>15</sup> Halogenated inhalation agents easily abolish MEPs by blockade at either the cortex or the anterior horn cell. This appears to be more prominent with transcranial magnetic stimulation. If used at all, the concentration of these agents need to remain very low (<0.5%). There are no reports of the effect of propofol or midazolam on MEP.

*Muscle Activity and Neuromuscular Blockade.* Since the responses obtained during recording the CMAPs over the muscles are motor responses, the use of neuromuscular blocking agents will suppress or eliminate these responses. Therefore, either no blockade or very controlled neuromuscular blockade up to 50% may be used when monitoring the CMAP. Since there is little or no neuromuscular blockade, there will generally be some movement with transcortical stimulation and the surgeon should be notified before the stimulus is applied.

*Blood pressure and Temperature.* Temperature also may have a mild effect in that there may be a gradual increase in stimulation threshold.

### Key Points

- MEPs are exquisitely sensitive to inhalational agents.
  - Baseline surgical recordings are needed initially without inhalation agents.
  - Levels of anesthetic should be changed only slowly and should be present.
- Neuromuscular junction block should be monitored throughout to identify amplitude reduction due to a change in level.

## Applications and Interpretation of MEP Changes

The threshold values of MEP changes that warn of imminent neurologic damage vary in the literature. Given the significant variability of the response due to physiologic and technical factors many laboratories utilize an all-or-none response. Therefore, if a response was present and disappears during a critical stage of the procedure there is high likelihood of neural damage assuming that technical or anesthetic effects are excluded. Some authors have used a value of 80% reduction of one out of six lower extremity muscles showing a sensitivity of 95%.<sup>16</sup> When relatively strict criteria such as this are used, there is a clear increase in false-positive responses with this same study showing a specificity of 91%. Changes in latency of spinal cord or muscle responses have not been useful intraoperatively.

The development of reproducible MEP techniques has advanced the ability to monitor the motor tracts during spinal procedures. As previously mentioned it has been assumed that if the SEPs are stable during a procedure, the motor tracts should be spared. Although this is true in most instances, cases of paralysis in the setting of normal SEP can occur. By utilizing multimodal monitoring of both motor and sensory pathways the risk of catastrophic paralysis can be reduced.

The utility of transcranial electrical stimulation during surgery has been evaluated by a number of investigators. Although the success rate for establishing reliable MEP during high-risk surgical procedures has been hindered in the past by lack of equipment and appropriate protocols, a recent study found that MEP could be successfully monitored in 94.8% of cases for upper extremities and 66.6% of lower extremities.<sup>17</sup> In this same study it was noted that extremes of age (<7 or >64) and presence of a spinal cord lesion reduced the success of obtaining reliable responses.

In a series of reports, Levy et al.<sup>18,19</sup> described their experience with MEP monitoring during a variety of neurosurgical procedures. They used a modification of the bipolar technique with the anode placed on the hard palate in some patients and direct cortical stimulation with anode and cathode placed via a burr hole in others. Responses were recorded either from the spinal cord or

from the peripheral nerve. They reported a good correlation between changes in the MEP and postoperative motor function. In over 100 cases there were no patients with normal MEP who developed new motor deficits.

Zentner et al.<sup>20</sup> reported their experience with MEP monitoring in 50 neurosurgical operations on the spinal cord. The bipolar technique of Merton and Morton was used with CMAPs recorded over thenar and anterior tibial muscles at latencies of 20 ms and 30 ms respectively. Using a change in amplitude of 50% as a limit of significance, they found a false-positive rate of 20% with no false negatives. Of the 4 patients with new motor deficits postoperatively, the MEP disappeared in one and was reduced in amplitude by 60–85% in three. Kitagawa et al.<sup>21</sup> reported a similar experience with 20 patients undergoing cervical spine surgery. The three patients with new postoperative deficits all had at least a 50% reduction in the averaged spinal MEP recorded from the epidural space below the level of surgery.

Owen et al. have recorded MEP following spinal stimulation in 300 patients undergoing a variety of neurosurgical, orthopedic, and vascular surgical procedures.<sup>22</sup> Ketamine or narcotic-NO anesthesia were used in the majority. NO concentrations greater than 60% or the use of halogenated anesthetics greatly reduced the amplitude of the MEP. Using a drop in amplitude of 60% or greater as a significant change in the MEP, there were 18 patients early in their experience that had false-positive MEP. These were attributed to technical difficulties that with experience could be easily recognized and corrected. All seven of the patients with new postoperative deficits had significant changes in the MEP amplitude intraoperatively. SEP were said to be *preserved* in all seven patients with motor deficits. Two additional patients had new sensory deficits with changes in the SEP but not in the MEP recorded intraoperatively.

### Key Points

- MEP can be elicited with either transcranial (magnetic or electrical) or spinal electrical stimulation.
  - In the operative setting electrical stimulation is more effective and reliable than magnetic.

- Inhalation of anesthetic agents can abolish responses; thus, very low levels of inhalation of anesthetic agents with supplemental narcotic anesthesia and partial neuromuscular blockade allows for optimal recordings.

## ELECTROMYOGRAPHY AND NERVE CONDUCTION STUDIES

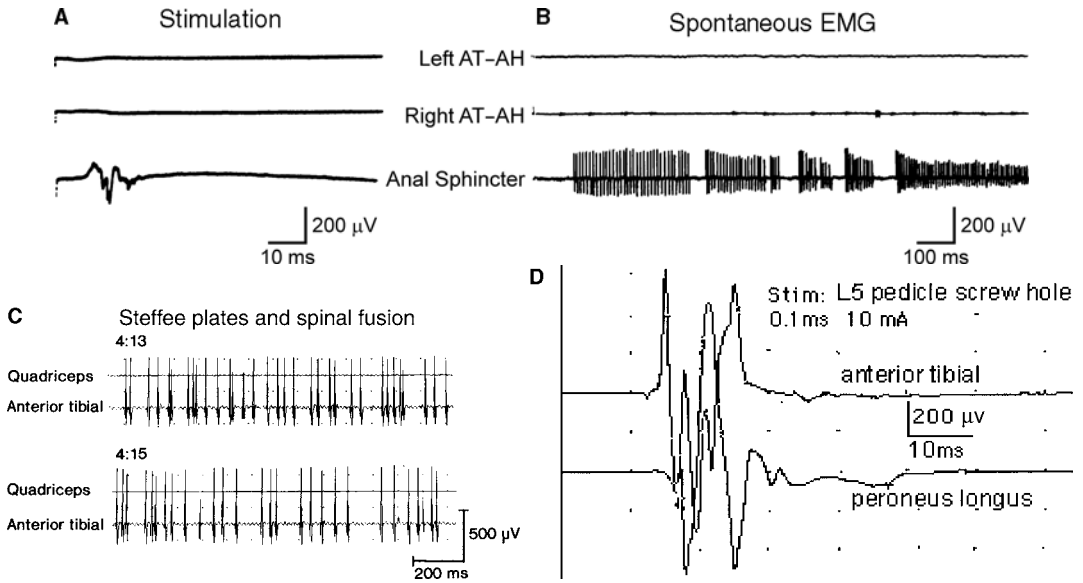
Damage to cervical or lumbosacral nerve roots or motor neurons may occur during surgical procedures on the spine. For example, anterior horn cells can be damaged during dissection of intraspinal tumors or by ischemia caused by compression or traction. Radiculopathies caused by local compression or traction of a root are an occasional complication of scoliosis surgery. In cases where roots or nerves are at risk, monitoring with a combination of nerve conduction studies (NCS) and EMG recording for the presence of neurotonic discharges in limb muscles innervated by the affected motor neurons or axons can warn of potential damage caused by manipulation, traction, or ischemia of nerve roots and can minimize risk to these structures (Fig. 44–10B).<sup>23,24</sup>

In the intraoperative setting, the primary potentials of interest with EMG recordings are neurotonic discharges and motor unit potentials. Neurotonic discharges are distinctive discharges of a motor unit that appear as rapid, irregular bursts lasting several milliseconds or prolonged trains lasting up to 1 minute. Neurotonic potentials occur in response to mechanical, thermal, or metabolic irritation of the nerve that innervates a muscle whereas motor unit potentials reflect reflex activity of anterior horn cells.<sup>25</sup> Each discharge may contain 1–10 individual motor unit potentials which discharge at frequencies of 50–200 Hz.<sup>26,27</sup> They are distinguished from motor unit potentials by this burst pattern as well as the relationship to thermal, mechanical, or metabolic irritation of the nerve membrane. By contrast, motor unit potential will have a semi-rhythmic pattern, which may arise with either irritation to the motor axon or voluntary activity due to incomplete muscle relaxation.

### Key Points

- Peripheral nerve and muscle monitoring uses EMG and NCS.





**Figure 44-10.** Three examples of monitoring with EMG and NCS during lumbar surgery. *A*, CMAPs evoked in the anal sphincter by direct stimulation of tissue in the surgical field identified the tissue as axons in the L2–L4 nerve roots (lipomeningocele resection). *B*, Neurotonic discharges in the anal sphincter during lipomeningocele dissection warned the surgeon of irritation of the L2–L4 axons. *C*, Motor unit potential firing during lumbar fusion warned the surgeon of irritation of dorsal root axons. *D*, CMAPs evoked in L5-innervated muscles by a stimulating electrode in a pedicle screw hole with less than 10 mA current warned the surgeon that the pedicle screw was close enough to the dorsal root to irritate it or damage it.

- EMG recordings look for two patterns:
  - MEPs indicating inadequate anesthesia.
  - Neurotonic discharges indicating irritation or damage to axons.
- NCS have two purposes during surgery:
  - Quantitatively define the severity of preexisting and new damage.
  - Localize the site of the damage.

## Recording Techniques

### EMG RECORDING

EMG activity can be recorded with a variety of electrodes. Recording with surface electrodes is inadequate since they cannot record activity deep in a muscle nor can they clearly identify the specific responsible muscle. EEG needles placed subcutaneously are commonly used and in those situations where a deeper muscle is required, fine nichrome wires can be inserted with a hollow bore needle. Standard monopolar or concentric needle electrodes can reliably record EMG activity but have limitation related to being bulky and difficult to keep in place and out of the way of the surgeon

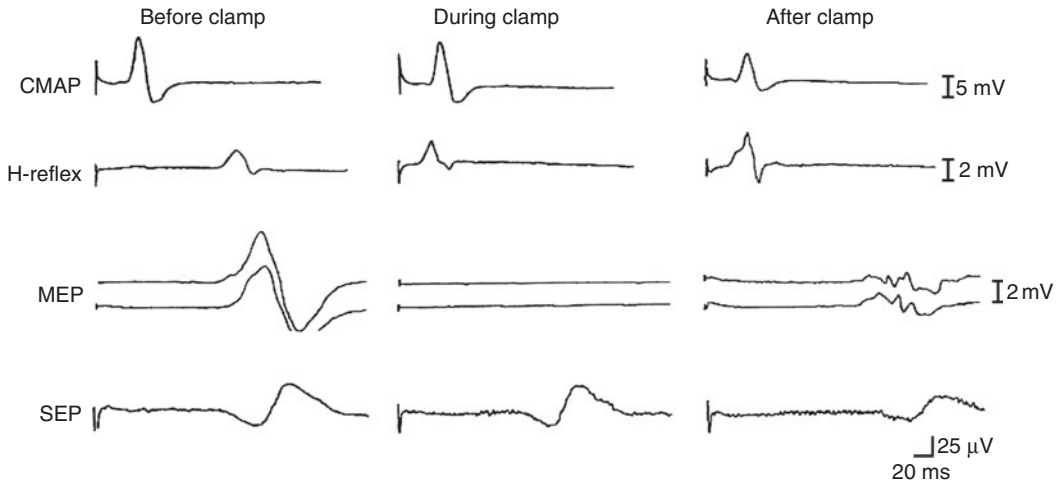
and anesthesiologist. Recordings can be made from any somatic muscle and the selection of muscles depends on the structures at most risk. For example, monitoring of L3–S3 innervated muscles in the leg, including the anal sphincter, would be helpful in operations for myelomeningocele (Fig. 44-10*A* and 44-10*B*). Also, intramuscular recordings of motor unit potential firing caused by a reflex response can detect irritation of the sensory axons in the dorsal root (Fig. 44-10*C*).

The EMG recordings are made with standard gains of 100–500  $\mu\text{V}$ , LFF of 20–30 Hz, HFF of 20 kHz, and sweep speed of 10–200 ms/division. EMG recordings from multiple muscles can be presented simultaneously over a loudspeaker as well as on a digital or analog display and the activity of interest can be printed or stored for later review.

### CMAP RECORDING

Direct stimulation of nerves in the surgical field can provide information about the location and integrity of the nerves.<sup>25</sup> If the normal anatomy is distorted, recording the





**Figure 44-11.** The relative value of different monitoring methods (see text) in detecting spinal cord ischemia is shown by the marked loss of the MEP with much less change in the other modalities that occurs when the aorta is clamped for TAA.

muscle response to stimulation can help distinguish among nerve roots and differentiate the roots from nonneural structures. NCS record CMAPs produced by local stimulation of individual nerves (Fig. 44-10A). Recordings of the CMAPs can be made with surface, subcutaneous, or intramuscular electrodes.

Stimulation of the nerves or roots may be applied with a variety of stimulators, including monopolar, bipolar, or forceps electrodes. Pedicle screw or drill stimulation is also utilized to assure proper placement. This technique involves direct stimulation of the pedicle screw or screw hole with recording of CMAPs in the appropriate limb muscles with either subcutaneous or intramuscular needle electrodes. If there has been breaching of the pedicle wall, CMAPs will be recorded with relatively low levels of stimulation (Fig. 44-10D). Various studies have determined this risk of root trauma secondary to misplaced pedicle screws to be present with threshold stimulus intensities less than 6–10 mA.<sup>29,30</sup> This technique has also been utilized with placement of iliosacral screws during pelvic ring fracture repair.<sup>31</sup>

## Physiologic and Technical Effects

**Neuromuscular blockade and Anesthesia.** Neuromuscular blockade will significantly attenuate the EMG and CMAP activity and should be avoided as much as possible. Alternative

inhalation agents or narcotic anesthesia is preferred although neurotonic discharges can be recorded if short-acting, nondepolarizing neuromuscular blocking agents are titrated to produce a 50% reduction of the baseline motor action potentials. Although such a level of muscle relaxation increases the possibility of unwanted movement during the operation, movements of the patient can be prevented with adequate levels of narcotic or inhalation anesthesia. At times additional agents such as fentanyl or midazolam must be administered to reduce background muscle contractions and associated motor unit potentials. If partial neuromuscular blockade is used, a continuous monitor of the degree of blockage should be used.

## Applications and Interpretation of Findings

Recording of EMG activity is a simple technique that provides a means for rapid feedback to the surgeon to warn of potential nerve trauma. The presence of these discharges warns the surgeon that a nerve is being affected by surgical activity, and absence of these discharges can usually reassure the surgeon that the nerve remains unaffected. This technique has use in spinal surgeries when the roots are felt to be at risk during decompression procedures. Cervical or lumbar decompression in those with severe

spondylosis, tumors, or infectious processes that place the roots at significant risk, especially in those myotomes with preexisting neurologic deficit, are typical indications for this monitoring strategy.

Additionally, these techniques can be used for nerve localization when the tissue is not clearly identified due to altered anatomy from a tumor that displaces or encases the nerve.

### **Key Points**

- Neurotonic discharges represent mechanical irritation of the nerve.
  - Their recognition can minimize nerve root damage during exploration, decompression, or pedicle screw placement.
  - Intramuscular nichrome wires may be used for deeper muscles but short monopolar or intramuscular EEG needles are generally adequate.
  - These responses are not affected by inhalation agents but neuromuscular blockage should be minimized.

## **TYPES OF SPINAL SURGERIES**

Electrophysiologic monitoring can be beneficial in many surgical procedures in infants, children, and adults by reducing the extent and duration of damage. The surgeon should decide whether monitoring is needed because he or she can best judge the risk of neural damage and the structures at risk. The anesthesiologist selects the optimal anesthesia, and, after discussion with the surgeon and anesthesiologist, the clinical neurophysiologist selects the optimal monitoring methods. The spine surgery procedures commonly monitored include scoliosis, kyphoscoliosis, cervical spondylosis and stenosis, lumbar spondylosis and stenosis, spine trauma, rheumatoid arthritis, spine tumor, and herniated disk.

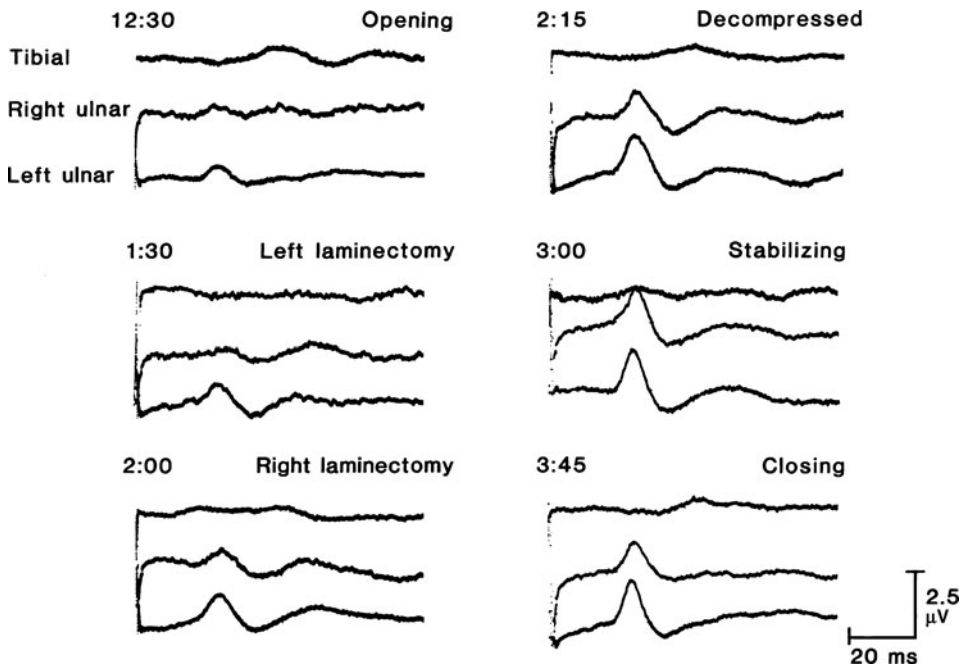
### **Primary Spine Disease**

The optimal methods of monitoring differ from patient to patient depending on the age of the patient, preoperative deficit, type of surgery, spinal level of surgery, anesthetic agents used, and other individual patient factors regardless of the spinal level of the operation. The most

important factors to consider are the age of the patient, the surgical risk, and the spinal level of surgery.

Three major factors must be considered when monitoring is performed in patients younger than 21 years; each of these factors presents a unique challenge to the clinical neurophysiologist. First, infants and small children usually require different stimulating and recording electrodes and great care in electrode placement. Second, scalp SEP averaging is more difficult in children, especially younger ones, because the amplitude of slow-wave activity is much higher when the child is anesthetized. Because of this, slower rates of stimulation, a larger number of averaged stimuli, or a lower level of anesthesia (or a combination of these) are often required. In all children, recordings from the cervical cord are ideal to demonstrate that the spinal cord is intact, even if the scalp response is not clearly recognizable. Third, in some children and adolescents, the scalp response is lost early during anesthesia, presumably an idiosyncratic reaction to the anesthetic agent. In these cases, a cervical cord recording from a nasopharyngeal, esophageal, or laminar needle electrode is necessary to monitor spinal cord function.

Surgical risk varies according to the amount of spinal cord deformity, the severity of preoperative deficit, the size and type of lesion to be excised, bony stability, previous operations, and other medical disorders. The surgical risk may be low enough that intraoperative monitoring of neural function is not necessary. Also, monitoring may not provide any benefit because the deficit is complete and cannot be made worse or the structure has to be sacrificed to complete the operation. In many cases SEPs alone may be adequate but increasingly the addition of MEPs has been indicated given more complex spine surgeries and intraspinal processes. For each level of spine surgery, the risk to each neural structure should be assessed separately. If the risk is primarily to nerve roots rather than the spinal cord, spinal cord monitoring may not be needed. In those settings EMG alone may be indicated. For example, in most lumbar decompression surgeries there is little benefit to monitoring SEP as these procedures occur below the level of the spinal cord and carry the largest risk to the nerve roots. Needle or fine wire EMG recording of multiple bilateral myotomes would be more important in



**Figure 44-12.** Gradual improvement of SEP amplitude and latency during spinal cord decompression for rheumatoid arthritis. The patient's neurologic deficit improved postoperatively. (From Daube, J. R., C. M. Harper, W. J. Litchy, and F. W. Sharbrough. 1990. Intraoperative monitoring. In *Current practice of clinical electroencephalography*, ed. D. D. Daly, and T. A. Pedley, 2nd ed., 766. New York: Raven Press. By permission of Lippincott Williams & Wilkins.)

this setting. This is particularly true when there is a fusion procedure that may involve screw placement. If there is encroachment upon the root, neurotonic discharges will generally be detected and the surgeon will assess to position and move or remove the screw or the device. Stimulation of the screw hole or pedicle screw may also be beneficial in this situation to assure the pedicle wall has not been breached.

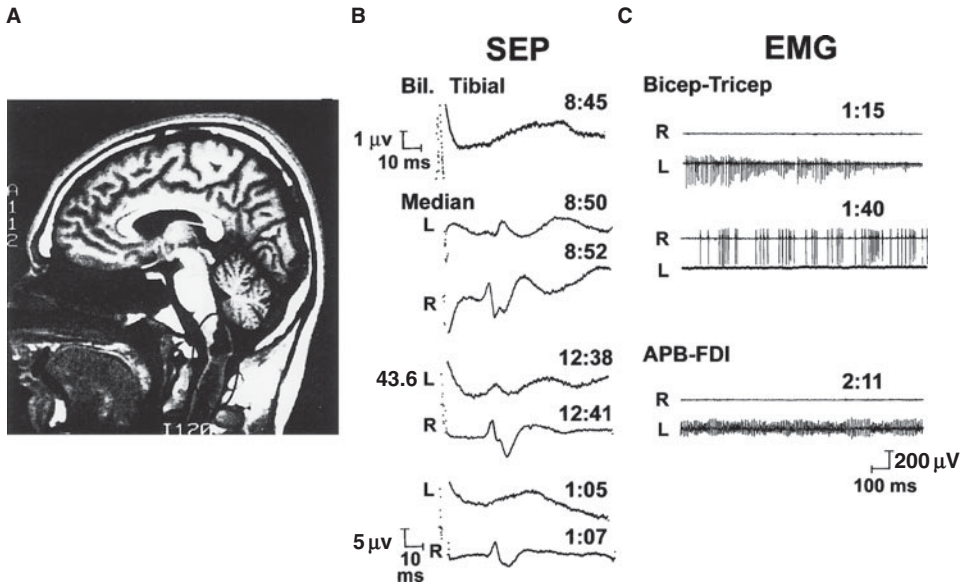
At the thoracic and cervical level, adjacent vertebrae commonly are wired together to obtain the stabilization needed for bone healing and fusion. The risk to neural structures can occur at any time during the procedure, but the risk is particularly high during fixation. In this setting both SEP and MEP monitoring is generally indicated. SEPs are recorded throughout these procedures and MEPs at critical times when the spinal cord is at risk. As there is no or little neuromuscular blockade in this setting, the surgeon needs to be informed as there may be some movement of the patient. For standard decompression surgeries of the cervical or thoracic spine when there is no significant neurologic deficit, the risk of a catastrophic event is low and in this setting SEPs may be adequate. In this setting the anesthetic regimen can

include low-level inhalation agents as well as neuromuscular blockade.

Although the major purpose of SEP monitoring is to help recognize subclinical changes that could herald new postoperative neural deficit, SEP occasionally show improvement when the procedure reduces spinal cord compression or ischemia (or both). This is often seen with cervical stabilization in patients with cervical rheumatoid arthritis (Fig. 44-12).

### Key Points

- The specific type of spine surgery and structures at risk define the modality and location of neurophysiologic monitoring.
  - Preservation of spinal cord function is optimized by monitoring TCES leg MEP along with arm and leg SEP.
  - Recordings both proximal and distal to the segment of spinal cord at risk will minimize false-negative recording.
- Continuous assessment of potential sources of error, as well as consideration of possible false-positive and false-negative response alteration, is necessary during monitoring of spine cases.



**Figure 44-13.** Simultaneous recording of SEPs from the scalp and arm and EMG recordings during an operation on a cervical cord tumor with syrinx. **A**, Magnetic resonance image of the syrinx (oval). **B**, Tibial SEP were absent from the onset of recording. The left median SEP was lost at 1:00 PM. The only postoperative deficit was loss of proprioceptive sensation in the left arm. **C**, Neurotonic discharges warned the surgeon of irritation of the local root or anterior horn cells.

## Cervical Spine Disease

Monitoring during cervical spine surgery requires initially determining which neural structures are at risk and the level of risk. The major concern for most patients having an operation at the C1–C4 level is myelopathy. Preoperative neurologic deficit, a multi-level operation, upper cervical surgery, and instrumentation increase the risk. Monitoring of tibial and median SEP is generally sufficient unless the spinal cord is already compromised, in which case MEP monitoring may also be needed. The combination of MEP and SEP monitoring will again provide critical information about the sensory and motor pathways and in cases of either spinal cord tumors or severe spondylotic myelopathy, the combined method may be preferred. This is especially true during an anterior approach where the motor pathways may be at greater risk. In a study of 427 cervical procedures Hili-brand et al. found sensitivity and specificity of 100% when monitoring myogenic MEP with a threshold value of 60% loss. Of 12 patients that showed a significant reduction or loss of MEP, 10 were reported correctable with return to normal values and no postoperative clinical deficit whereas 2 remained absent and with clinical deficit. Of the two with deficit, only

one showed substantial change in the SEP responses.<sup>32</sup> Although this study reported sensitivity of SEP recording at only 25%, larger studies performing only SEP monitoring have reported sensitivity of 77% and specificity of 100% in cervical spine corpectomy.<sup>33</sup> If the cervical spine is unstable, monitoring should begin before anesthesia, because positioning the head after the patient has been anesthetized may compromise the spinal cord. Monitoring of nerve roots with EMG should be considered for patients having spine surgery at the C5–T1 level if there is significant preoperative radiculopathy or if the roots or spinal nerves may be compromised during the operation (Fig. 44-13).

### Key Points

- Surgery for cervical spine pathology is optimized to detect both central and peripheral damage by
  - EMG recordings for neurotonic discharges in myotomes at risk particularly if there is preexisting radiculopathy.
  - TCES MEP through the cord segment at risk to both arm and leg muscles if there is clinical evidence of cord compromise.

- Arm and leg SEP provide the greatest coverage: ulnar SEP if the cord damage extends below C7; median SEP if above that level.
- Bilateral tibial SEP with stimulation at the knee, hip, or cauda equina may be needed for patients with preexisting neurologic deficit.

## Thoracic Spine Disease and Scoliosis Surgery

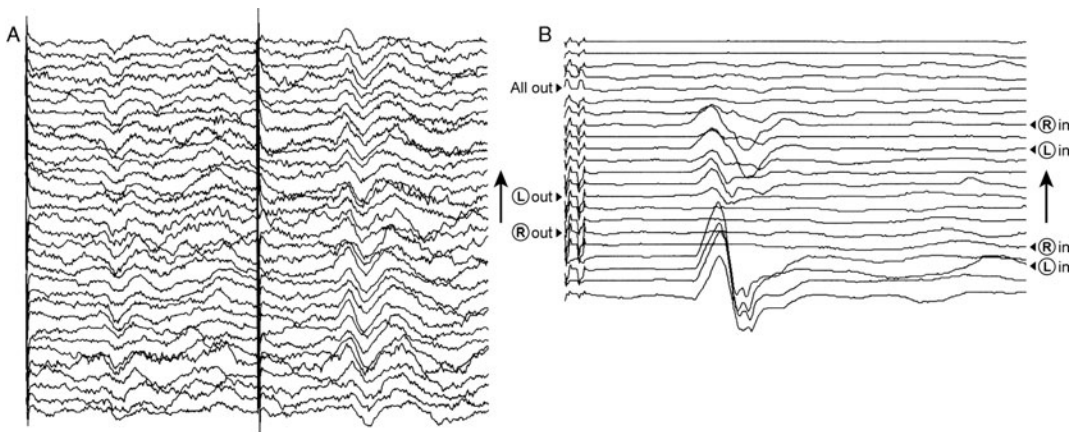
Somatosensory evoked potential monitoring is sufficient for most patients undergoing thoracic spine surgery.<sup>34</sup> However, because motor function may be lost despite intact SEP, a combination of MEP and SEP monitoring has been recommended as the “standard of care” for scoliosis surgery.<sup>35</sup> In some academic medical centers, MEP monitoring can easily be applied and is used routinely.<sup>36</sup> However, anesthetic and technical considerations make MEP monitoring more difficult to apply in many settings. In these cases, MEP monitoring should be considered if there is marked deformity, preoperative deficit, anterior vertebrectomy, or other evidence of considerable risk to the spinal cord.<sup>37</sup>

The possible loss of sensory function alone is sufficient reason to monitor SEP even if MEP monitoring is available.<sup>38</sup> The utility of combined monitoring of MEP and SEP during spinal correction surgery has been reported

by several investigators. Pelosi et al.<sup>39</sup> reported on 126 spinal operation where both SEP and MEP were successfully recorded in 82% of cases. In this series they report four patients who had either no change in SEP or full recovery of SEP who postoperatively had significant lower limb weakness. In contrast, no new postoperative motor deficits occurred in patients who had either no change in MEP or MEP that returned to baseline at completion of the surgery. In seven patients only MEP changes occurred and in three others the MEP changes preceded SEP changes by several minutes. Figure 44–14 shows a case where during scoliosis repair there was relatively minimal change in SEP but loss of MEP with postoperative motor deficit.

### Key Points

- Monitoring modalities should be selected based on the risk of spinal cord damage in individual patients.
  - When the greater complexity of MEP monitoring make them more difficult to monitor, SEP can be quite satisfactory.
  - Marked spine deformity, structural compression of the spinal cord, and clinical evidence of myelopathy all warrant MEP monitoring.
  - Sensory deficits warrant SEP monitoring, even if MEP monitoring is available.



**Figure 44–14.** A, Right and left tibial SEPs recorded over the scalp remained relatively stable despite loss of MEPs recorded over the soleus. B, Loss of soleus MEP with electric stimulation of the cervical spinal cord after rod placement. Temporary return with rod removal, but lost again with replacement. When rods were permanently removed, the patient awoke with incomplete paraplegia which gradually cleared over a few months.



## Lumbosacral Spine Disease

Often with surgery at the lumbosacral level, spinal nerves are at greater risk than the spinal cord itself. Because SEP are less effective than EMG in identifying nerve root damage, EMG monitoring is often an important part of monitoring during procedures at the lumbosacral level.<sup>40</sup> As these procedures often involve fusion, compound muscle action recordings with drill or pedicle screw stimulation are often used to assure proper placement.

### Key Points

- EMG provides optimal monitoring for the spinal nerves that are at greater risk.
- SEP and MEP provide additional value only if there is evidence of preexisting lumbosacral cord damage.
- Stimulation of pedicle screws for hardware placement provides warning of proximity to nerve roots that may be damaged.

## Primary Neural Disease

Operations on tumors of the spinal cord, particularly intramedullary tumors, are high-risk procedures that can easily lead to further spinal cord damage. Intraoperative monitoring can warn the surgeon of this damage which may lead to modification of the procedure. MEP and SEP monitoring maximize the possibility of recognizing significant change.<sup>41</sup> Some groups have found that monitoring during intramedullary cord surgery decreases the frequency of major complications.<sup>42-44</sup>

### Key Points

- Direct spinal cord surgery warrants both SEP and MEP monitoring.

## Dorsal Rhizotomy

In patients with spasticity, especially children with cerebral palsy, improvement in the spasticity and function reportedly has been obtained by cutting a proportion of the fibers in the L2–S1 dorsal roots, but the reports are anecdotal.<sup>45</sup> Although this procedure had been known for many years, only recently has Staudt

et al.<sup>46</sup> reported electrophysiologic monitoring in these patients. Two to five fascicles are dissected apart in each dorsal root and stimulated with single stimuli and trains of stimuli to elicit a reflex. The character of the responses bilaterally in L2- to S2-innervated limb muscles is assessed to determine the contribution of each fascicle to the spasticity. It is critical to identify the motor root to avoid increased weakness from sectioning motor axons. The motor and sensory roots are distinguished readily by measuring the threshold to single stimuli. Despite many reports on the benefits of dorsal rhizotomy, no controlled study has demonstrated that electrophysiologic testing provides a better outcome than blindly sectioning 30%–50% of the roots that innervate spastic muscles.

### Key Points

- Section of lumbosacral dorsal rootlets has been reported to decrease spasticity.
- Monitoring the reflex motor response to stimulation of individual sensory root fascicles could theoretically allow section of those with the greatest contribution to spasticity.
  - High-frequency stimulation is applied briefly.
  - Identification of more abnormal rootlets depends on identifying spread of the reflex response beyond the root stimulated, increasing response with continued stimulation, and continuation of the reflex after the stimulus stops.
- Success of the stimulation is highly dependent on anesthetic levels that do not suppress all reflex responses.

## Cauda Equina and Tethered Cord

Surgical procedures below the spine of L1 pose a risk to the cauda equina rather than to the spinal cord. The overlap of multiple roots innervating individual dermatomes makes SEP monitoring insensitive to nerve root damage in the cauda equina. Therefore, monitoring cauda equina function relies heavily on a combination of EMG and NCS. The presence and distribution of evoked responses in limb and anal sphincter muscles with direct stimulation of tissue in the area of the cauda equina allow neural



tissue and specific roots to be identified. Continuous EMG monitoring of the same muscles can warn the surgeon of impending damage. For example, neurotonic discharges indicate that a ventral root is mechanically irritated and motor unit potential firing indicates that a dorsal root is irritated.<sup>25</sup> The most difficult operations to perform in the region of the cauda equina are those for congenital abnormalities.

Several congenital abnormalities of the lumbosacral cord and cauda equina can result in progressive neurologic deficit referred to as *tethered cord syndrome*.<sup>47</sup> The primary purpose of electrophysiologic monitoring is to preserve neural tissue by identifying it and distinguishing it from other tissue that will be dissected or sectioned. Continuous EMG monitoring from multiple limb and sphincter muscles is the most effective method for doing this by identifying mechanical irritation of neural tissue during dissection and immediately warning the surgeon of possible damage (Fig. 44–10). Direct stimulation of unidentified tissue elements will quickly identify it as neural tissue if a CMAP is evoked in a limb or sphincter muscle. In a recent study utilizing SEP and EMG monitoring of 44 consecutive adults undergoing surgery of tethered cord, SEP had a high specificity but low sensitivity whereas EMG had a sensitivity of 100% but a low specificity of 19%.<sup>48</sup>

### Key Points

- Cauda equina and sacral cord surgical monitoring relies on
  - EMG of L3- to S3-innervated muscles to record neurotonic discharges.
  - Direct stimulation to identify individual nerve roots.
  - SEP to identify low spinal cord compromise.

### Vascular Diseases

In addition to its well-known use during cerebral aneurysm, carotid artery, and other cerebral vascular operations, electrophysiologic monitoring is used during two procedures: thoracoabdominal aortic aneurysm and vascular malformation operations. These surgeries put the spinal cord at risk for loss of blood supply and paraplegia. Direct surgical

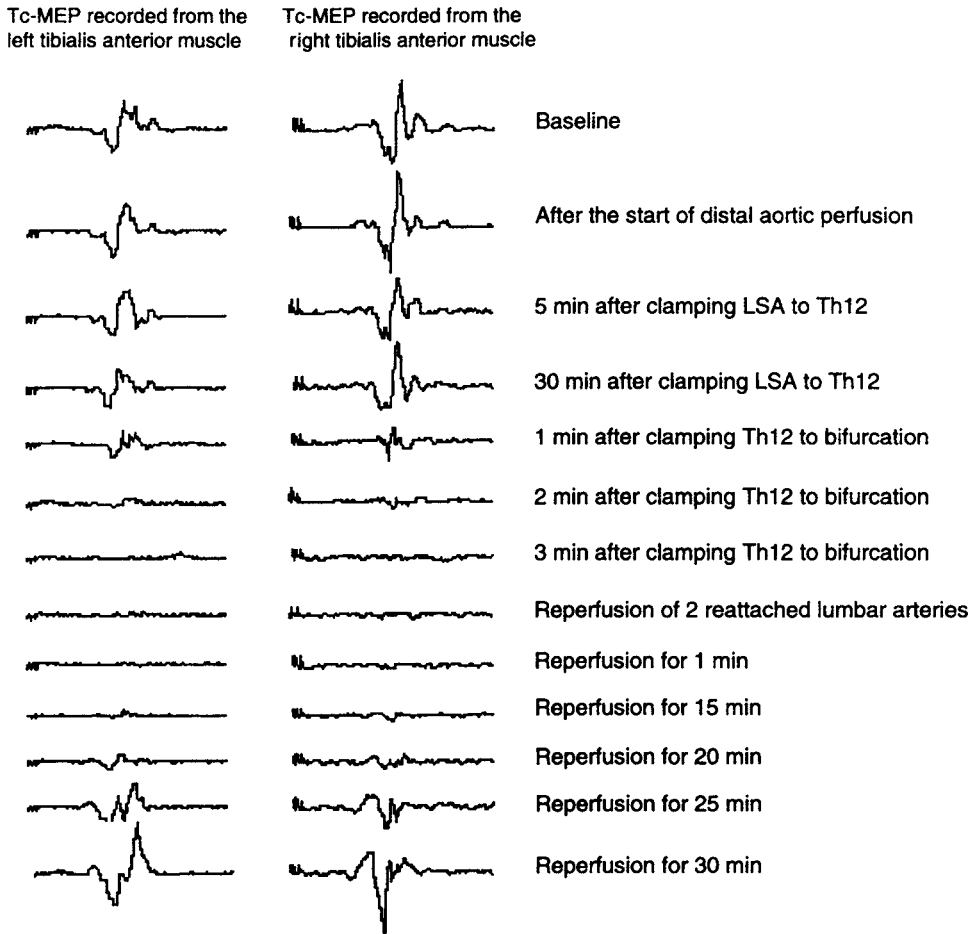
ablation of arteriovenous malformations can be monitored with SEP or MEP if the surgeon deems the risk sufficient. Monitoring with SEP or MEP during temporary occlusion of the major feeder vessels of an arteriovenous malformation can indicate the risk of ablating the vessel by embolization. The difficulty of performing MEP monitoring has precluded its use during embolization of an arteriovenous malformation.

Monitoring is important in thoracoabdominal aortic aneurysm surgery because the risk of paraplegia is as high as 15%. To decrease this rate, the surgical procedure has been modified, including spinal cord cooling, cerebrospinal fluid drainage, premedication, cross-clamping at short distances to minimize the segment of spinal cord exposed to ischemia, femoral bypass, and measurement of spinal cord blood flow.

For each of these, the combined functional measures of SEP, MEP, and H reflexes (Fig. 44–11) allow distinguishing the effects of ischemia at the cortical (blood pressure or carotid occlusion), peripheral nerve (femoral artery clamping), entire spinal cord (aorta clamping), and segmental spinal cord (segmental spinal artery occlusion) levels.<sup>49</sup> Initial studies of the benefit of revascularization using SEP as a guide were less successful than more recent studies using MEP.<sup>50,51</sup> The rapid alterations that can occur with occlusion and revascularization are shown in Figure 44–15. MEPs and H reflexes recorded from peripheral muscles are better indicators of dangerous ischemia, because the motor neurons and synapses in the anterior horn are more sensitive to ischemia than the motor pathways in the spinal cord.<sup>52</sup>

### Key Points

- The spinal cord is at risk of ischemia during vascular malformation surgery and for thoracoabdominal aneurysm surgery.
- Monitoring can rapidly identify the occurrence of dangerous ischemia that will result in permanent cord damage if not repaired quickly.
  - MEP and H-reflex monitoring showed loss of function within minutes that if not reversed resulted in postoperative paralysis.



**Figure 44–15.** A loss of left and right anterior tibial MEPs, with electric stimulation of the cerebral cortex (transcranial [Tc]-MEP), immediately after the aorta was clamped at level Th12 during thoracoabdominal aneurysm. (From Jacobs, M. J. H. M., P. de Haan, S. A. Meylaerts, B. A. de Mol, and C. J. Kalkman. 2000. Benefits of monitoring motor-evoked potentials during thoracoabdominal aortic aneurysm repair: Technique of choice to assess spinal cord ischemia? In *Perspectives in vascular surgery*, ed. P. Głowiczki, and J. Goldstone, Vol. 12, 1–16. New York: Thieme Medical Publishers. By permission of the publisher.)

- SEP was less effective in identifying these changes.
- Leg ischemia from femoral occlusion results in a much slower loss of both MEP and SEP peripherally.

## SUMMARY

Continuous electrophysiologic monitoring of spinal cord or spinal nerve (or both) function intraoperatively can minimize potential damage that may occur during spine surgery. SEPs are easiest to use for monitoring function and have had the widest application. Unless spinal

cord injury is caused by a vascular insult, with purely motor damage, SEP monitoring can identify the damage early enough to alert the surgeon. The addition of MEP monitoring further protects the motor pathways that may be at risk during some spinal procedure. Neurotonic discharges recorded from peripheral muscle are sensitive to nerve root irritation and, thus, can help surgeons recognize when and where damage may be occurring. These techniques appear reliable and with experience the neurophysiologist can acquire the skills to perform and correctly interpret these studies thus enhancing the neurologic and functional outcomes during the often complex procedures.

## REFERENCES

1. Daube, J. R. 1999. Intraoperative monitoring reduces complications and is therefore useful. *Muscle & Nerve* 22:1151-3.
2. Guerit, J. M. 1998. Neuromonitoring in the operating room: Why, when, and how to monitor? *Electroencephalography and Clinical Neurophysiology* 106:1-21.
3. Herdmann, J., V. Deletis, H. L. Edmonds Jr., and N. Morota. 1996. Spinal cord and nerve root monitoring in spine surgery and related procedures. *Spine* 21:879-85.
4. MacEwen, G. D., W. P. Bunnell, and K. Sriram. 1975. Acute neurological complications in the treatment of scoliosis. A report of the Scoliosis Research Society. *The Journal of Bone and Joint Surgery (American)* 57:404-8.
5. Burke, D., M. R. Nuwer, J. Daube, et al. 1999. Intraoperative monitoring. The International Federation of Clinical Neurophysiology. *Electroencephalography and Clinical Neurophysiology* 52(Suppl):133-48.
6. Nuwer, M. R., J. R. Daube, C. Fischer, J. Schramm, and C. D. Yingling. 1993. Neuromonitoring during surgery. *Electroencephalography and Clinical Neurophysiology* 87:263-76.
7. Nuwer, M. R., E. G. Dawson, L. G. Carlson, L. E. Kanim, and J. E. Sherman. 1995. Somatosensory evoked potential spinal cord monitoring reduces neurologic deficits after scoliosis surgery: Results of a large multicenter survey. *Electroencephalography and Clinical Neurophysiology* 96:6-11.
8. Sloan, T. 1998. Anesthetic effects on electrophysiologic recordings. *Journal of Clinical Neurophysiology* 15(3):217-26.
9. Lauer, K., C. Munshi., and S. Larson. 1994. The effect of midazolam on median nerve somatosensory evoked potentials. *Journal of Clinical Monitoring* 10(3):181-4.
10. Laureau, E., B. Marciniak, A. Hebrard, B. Herbaux., and J. D. Guieu. 2004. Comparative study of propofol and midazolam effects on somatosensory evoked potentials during surgical treatment of scoliosis. *Neurosurgery* 45(1):69-74.
11. Banoub, M., J. E. Tetzlaff, and A. Schubert. 2003. Pharmacologic and physiologic influences affecting sensory evoked potentials. *Anesthesiology* 99(3):716-37.
12. Nuwer, M. R. 1999. Spinal cord monitoring. *Muscle & Nerve* 22:1620-30.
13. Lesser, R. P., P. Raudzens, H. Lüders, et al. 1986. Postoperative neurological deficits may occur despite unchanged intraoperative somatosensory evoked potentials. *Annals of Neurology* 19:22-5.
14. Burke, D., and R. G. Hicks. 1998. Surgical monitoring of motor pathways. *Journal of Clinical Neurophysiology* 15:194-205.
15. Sloan, T. B., and E. J. Heyer. 2002. Anesthesia for intraoperative neurophysiologic monitoring of the spinal cord. *Journal of Clinical Neurophysiology* 19(5):430-43.
16. Langeloo, D., M. A. Lelivelt, H. L. Journee, R. Slapendel, and M. de Kleuver. 2003. Transcranial electrical motor-evoked potential monitoring during surgery for spinal deformity. A study of 145 patients. *Spine* 28(10):1043-50.
17. Chen, X., D. Sterio, X. Ming, et al. 2007. Success rate of motor evoked potentials for intraoperative neurophysiologic monitoring: Effects of age lesion location and preoperative neurological deficits. *Journal of Clinical Neurophysiology* 24(3):281-5.
18. Levy, W., D. York, M. McCaffrey, and F. Tanzer. 1984. Motor evoked potentials from transcranial stimulation of the motor cortex in humans. *Neurosurgery* 15:214-27.
19. Levy, W. 1987. Clinical experience with motor and cerebellar evoked potential monitoring. *Neurosurgery* 20:169-82.
20. Zentner, J. 1989. Noninvasive motor evoked potential monitoring during neurosurgical operations on the spinal cord. *Neurosurgery* 24:709-12.
21. Kitagawa, H., T. Itog, H. Takano, et al. 1989. Motor evoked potentials monitoring during upper cervical spine surgery. *Spine* 14:1078-83.
22. Owen, J., K. Bridwell, R. Grubb, et al. 1991. The clinical application of neurogenic motor evoked potentials to monitor spinal cord function during surgery. *Spine* 16:S384-90.
23. Holland, N. R. 1998. Intraoperative electromyography during thoracolumbar spinal surgery. *Spine* 23:1915-22.
24. Harper, C. M. Jr., J. R. Daube, W. J. Litchy, and R. A. Klassen. 1988. Lumbar radiculopathy after spinal fusion for scoliosis. *Muscle & Nerve* 11:386-91.
25. Obi, T., M. Mochizuki, K. Isobe, K. Mizoguchi, M. Takatsu, and Y. Nishimura. 1999. Mechanically elicited nerve root discharge: Mechanical irritation and waveform. *Acta Neurologica Scandinavica* 100:185-8.
26. Daube, J., and C. Harper. 1989. Surgical monitoring of cranial and peripheral nerves. In *Neuromonitoring in surgery*, ed. J. E. Desmedt, Vol. 1, 115-38. New York: Elsevier.
27. Harper, C., and J. Daube. 1998. Facial nerve electromyography and other cranial nerve monitoring. *Journal of Clinical Neurophysiology* 15(3):206-16.
28. Kothbauer, K., U. D. Schmid, R. W. Seiler, and W. Eisner. 1994. Intraoperative motor and sensory monitoring of the cauda equina. *Neurosurgery* 34:702-7.
29. Calancie, B., P. Madsen, and N. Lebowhl. 1994. Stimulus-evoked EMG monitoring during transpedicular lumbosacral spine instrumentation. Initial clinical results. *Spine* 19(24):2780-6.
30. Maguire, J., S. Wallace, R. Madiga, R. Leppanen, and V. Draper. 1995. Evaluation of intrapedicular screw position using intraoperative evoked electromyography. *Spine* 20(9):1068-74.
31. Moed, B. R., B. K. Ahmad, J. G. Craig, G. P. Jacobson, and M. J. Anders. 1998. Intraoperative monitoring with stimulus-evoked electromyography during placement of iliosacral screws. An initial clinical study. *The Journal of Bone and Joint Surgery American* 80:537-46.
32. Hilibrand, A. S., D. M. Schwartz, V. Sethuraman, A. R. Vaccaro, and T. J. Albert. 2004. Comparison of transcranial electric motor and somatosensory evoked potential monitoring during cervical spine surgery. *The Journal of Bone and Joint Surgery (American)* 86(6):1248-53.
33. Khan, M. H., P. N. Smith, J. R. Balzer, et al. 2006. Intraoperative somatosensory evoked potential

- monitoring during cervical spine corpectomy surgery. Experience with 508 cases. *Spine* 31(4):E105–13.
34. Nuwer, M. R. 1998. Spinal cord monitoring with somatosensory techniques. *Journal of Clinical Neurophysiology* 15:183–93.
  35. Padberg, A. M., T. J. Wilson-Holden, L. G. Lenke, and K. H. Bridwell. 1998. Somatosensory- and motor-evoked potential monitoring without a wake-up test during idiopathic scoliosis surgery. An accepted standard of care. *Spine* 23:1392–400.
  36. Burke, D., R. Hicks, J. Stephen, I. Woodforth, and M. Crawford. 1992. Assessment of corticospinal and somatosensory conduction simultaneously during scoliosis surgery. *Electroencephalography and Clinical Neurophysiology* 85:388–96.
  37. Deutsch, H., M. Arginteanu, K. Manhart, et al. 2000. Somatosensory evoked potential monitoring in anterior thoracic vertebrectomy. *Journal of Neurosurgery* 92(Suppl):155–61.
  38. Lorenzini, N. A., and J. H. Schneider. 1996. Temporary loss of intraoperative motor-evoked potential and permanent loss of somatosensory-evoked potentials associated with a postoperative sensory deficit. *Journal of Neurosurgery and Anesthesiology* 8: 142–7.
  39. Pelosi, L., J. Lamb, M. Grevitt, S. M. H. Mehdiyan, J. K. Webb, and L. D. Blumhardt. 2002. Combined monitoring of motor and somatosensory evoked potentials in orthopaedic spine surgery. *Clinical Neurophysiology* 113:1082–91.
  40. Weiss, D. S. 2001. Spinal cord and nerve root monitoring during surgical treatment of lumbar stenosis. *Clinical Orthopaedics* 384:82–100.
  41. Nagle, K. J., R. G. Emerson, D. C. Adams, et al. 1996. Intraoperative monitoring of motor evoked potentials: A review of 116 cases. *Neurology* 47: 999–1004.
  42. Jones, S. J., R. Harrison, K. F. Koh, N. Mendoza, and H. A. Crookard. 1996. Motor evoked potential monitoring during spinal surgery: Responses of distal limb muscles to transcranial cortical stimulation with pulse trains. *Electroencephalography and Clinical Neurophysiology* 100:375–83.
  43. Kothbauer, K., V. Deletis, and F. J. Epstein. 1997. Intraoperative spinal cord monitoring for intramedullary surgery: An essential adjunct. *Pediatric Neurosurgery* 26:247–54.
  44. Tamaki, T. 1998. Intraoperative spinal cord monitoring—Clinical overview. In *Spinal cord monitoring: Basic principles, regeneration, pathophysiology, and clinical aspects*, ed. E. Stålberg, H. S. Sharma, and Y. Olsson, 509–20. Wien/New York: Springer-Verlag.
  45. Gul, S. M., P. Steinbok, and K. McLeod. 1999. Long-term outcome after selective posterior rhizotomy in children with spastic cerebral palsy. *Pediatric Neurosurgery* 31:84–95.
  46. Staudt, L. A., M. R. Nuwer, and W. J. Peacock. 1995. Intraoperative monitoring during selective posterior rhizotomy: Technique and patient outcome. *Electroencephalography and Clinical Neurophysiology* 97:296–309.
  47. McQuillan, P. M., and N. Newberg. 1995. Intraoperative electromyography. In *Primer of intraoperative neurophysiologic monitoring*, ed. G. B. Russell, and L. D. Rodichok, 171–87. Boston: Butterworth-Heinemann.
  48. Paradiso, G., G. Y. Lee, R. Sarjeant, L. Hoang, E. M. Massicotte, and M. G. Fehlings. 2006. Multimodal intraoperative neurophysiologic monitoring findings during surgery for adult tethered cord syndrome: Analysis of a series of 44 patients with long-term follow-up. *Spine* 31(18):2095–102.
  49. Sueda, T., K. Okada, M. Watari, K. Orihashi, H. Shikata, and Y. Matsuura. 2000. Evaluation of motor- and sensory-evoked potentials for spinal cord monitoring during thoracoabdominal aortic aneurysm surgery. *The Japanese Journal of Thoracic and Cardiovascular Surgery* 48:60–5.
  50. Galla, J. D., M. A. Ergin, S. L. Lansman, et al. 1999. Use of somatosensory evoked potentials for thoracic and thoracoabdominal aortic resections. *The Annals of Thoracic Surgery* 67:1947–52.
  51. Jacobs, M. J. H. M., P. de Haan, S. A. Meylaerts, B. A. de Mol, and C. J. Kalkman. 2000. Benefits of monitoring motor-evoked potentials during thoracoabdominal aortic aneurysm repair: Technique of choice to assess spinal cord ischemia? In *Perspectives in vascular surgery*, ed. P. Gloviczki, and J. Goldstone, Vol. 12, 1–16. New York: Thieme Medical Publishers.
  52. Shine, T. S., B. A. Harrison, M. L. De Ruyter, et al. 2008. Motor and somatosensory evoked potentials: Their role in predicting spinal cord ischemia in patients undergoing thoracoabdominal aortic aneurysm repair with regional lumbar epidural cooling. *Anesthesiology* 108(4): 580–7.

# Peripheral Nervous System Monitoring

C. Michel Harper, Jr.

## INTRODUCTION

### METHODS

Nerve Conduction Studies  
Electromyography  
Somatosensory Evoked Potentials  
and Motor Evoked Potentials

## APPLICATIONS

Entrapment Neuropathies  
Repair of Traumatic Peripheral  
Nerve Injury  
Prevention of Injury during  
Peripheral Nerve Surgery

## SUMMARY

## INTRODUCTION

Electrophysiological peripheral nervous system monitoring is performed during surgery for entrapment neuropathies, nerve trauma, and primary or metastatic neoplasms that involve peripheral nerves. Monitoring helps locate and preserve peripheral nerve function, particularly in situations where normal anatomy is distorted by pathology. In cases of nerve repair, information obtained from intraoperative electrophysiological studies supplements preoperative studies providing more precise data regarding the location and severity of lesions as well as the status of natural repair mechanisms. This information helps guide therapeutic decision-making with regard to decompression, neurolysis,

grafting, or neurotization of nerves. With minor modifications, standard techniques of electrodiagnosis such as nerve conduction studies (NCS), electromyography (EMG), and somatosensory evoked potentials (SEPs) are used to monitor the peripheral nerves during surgery. Appropriate monitoring protocols can be designed for each patient after the findings of the preoperative neurological examination, NCS, EMG, and surgical goals are reviewed.

### *Purpose and Role of Peripheral Nerve Monitoring*

- Supplements information gained from preoperative electrodiagnostic studies.
- Helps locate nerves when pathology distorts normal anatomy.

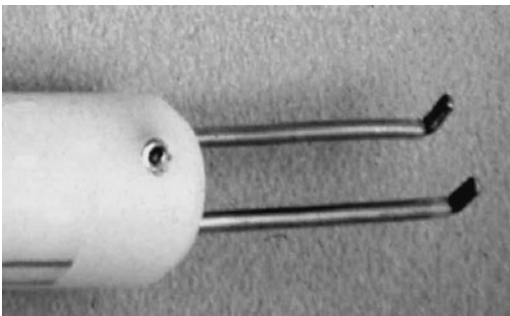


- Assesses the number, location, severity of lesions, and status of natural repair.
- Guides surgical decision-making.

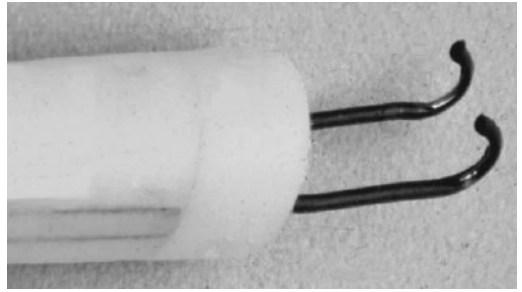
## METHODS

### Nerve Conduction Studies

Intraoperative NCS are similar in principle and technique to those used for standard electrodiagnostic studies.<sup>1</sup> Mixed motor and sensory nerves or sensory cutaneous nerves are stimulated with a hand-held bipolar electrical stimulator placed directly onto the nerve within the surgical field (Fig. 45-1). The size of the stimulator is matched to the size of nerve. Larger stimulators similar to those used in routine NCS are used to stimulate large nerve trunks that are isolated from other nerves. Hooked stimulating electrodes can be used to elevate nerves from the surrounding tissue when better stimulus isolation is required (Fig. 45-2). Small electrodes are used when individual or small groups of fascicles are stimulated. Occasionally, monopolar stimulation is used if there is insufficient exposure to apply a bipolar stimulator to the nerve. Intraoperative stimulation requires careful consideration of the location and strength of stimulus. The normal nerve is activated with as little current as 1–5 mA of 0.5 ms duration.<sup>2</sup> Over-stimulation produces unintended stimulation of the surrounding nerves or stimulus spread along the course of the nerve (leading to inaccurate calculation of latency



**Figure 45-1.** Bipolar stimulating electrode used for direct stimulation of nerves exposed at surgery. The anode and cathode are separated by a distance of 10 mm.



**Figure 45-2.** Hooked electrode that can be used for stimulation or recording from nerves exposed at surgery. The recording surface is exposed along the concavity of the hook. The electrodes are set 10 mm apart.

and conduction velocity). Stimulus threshold should be monitored closely as diseased nerves have higher thresholds than normal nerves.<sup>3</sup> Orientation of the stimulator is also important. Bipolar stimulation produces a more focal distribution of current than monopolar stimulation and is therefore preferred for intraoperative stimulation of most peripheral nerves. The cathode and anode should be aligned with the long axis of the nerve and the cathode should be proximal to the desired direction of the current. Peripheral nerve ischemia produces transient conduction block in affected nerves. To prevent this from affecting electrophysiologic recordings, tourniquet should be avoided or removed at least 30 minutes before the anticipated time of recording.

Compound muscle action potentials (CMAPs) are recorded from surface or subcutaneous needle electrodes placed over distal muscles. Compound nerve action potentials (NAPs) are recorded from large mixed nerves with a hand-held bipolar recorder placed directly on the nerve or from small cutaneous nerves with needle electrodes placed next to the nerve.<sup>2</sup> CMAP recordings are larger, less contaminated with artifact, and exclusively monitor the function of motor axons.

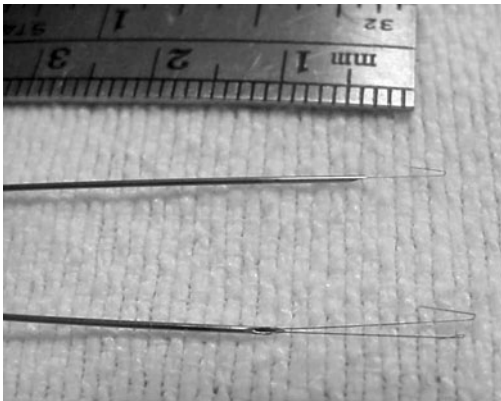
NAP recordings are technically more difficult to perform and typically require averaging of 8–10 potentials.<sup>2,4</sup> A distance of 5–8 cm between stimulating and recording electrodes is typically required to record a reliable NAP free from excessive stimulus artifact. Temperature of exposed peripheral nerves is typically lower than normal but cannot be controlled during intraoperative studies. Although low



temperatures prolong absolute latencies and increase durations and amplitudes of NAPs recorded during surgery, this rarely alters the reliability of these techniques. NAPs are more sensitive than CMAPs in localizing abnormalities along nerves and better able to detect early axonal regeneration through an area of nerve injury long before regeneration is reflected in CMAP recordings.<sup>5</sup> The presence of CMAPs or NAPs indicates that some axons are in continuity; amplitude and area of the response are proportional to the number of functioning axons. Focal slowing of conduction velocity, conduction block, or increased threshold of stimulation localizes pathology along the nerve with 1–2 cm accuracy.<sup>6–8</sup>

## Electromyography

EMG activity can be recorded during surgery with small monopolar needles or small intramuscular wire electrodes (Fig. 45–3).<sup>2,7</sup> The wires are introduced percutaneously with a hollow needle, which is then withdrawn leaving the wire in place. When intramuscular electrodes are used, electrical stimulation of the nerve produces a polyphasic EMG response that, although difficult to quantify, is less likely than surface electrodes to record nonspecific activity from adjacent muscles. Mechanical irritation of the nerve produces a high-frequency discharge of motor unit



**Figure 45–3.** Nichrome intramuscular wires used for intramuscular EMG recordings. The wire sits inside the core of a small hypodermic needle. The needle is used to insert the wire into the muscle. The wires remain in place after the needle is withdrawn.

potentials (neurotonic discharge) that can be easily distinguished from artifact and other motor unit potential activity in EMG recordings.<sup>6</sup> Neurotonic discharges are used to locate nerves within the surgical field and to warn of the potential for nerve injury should the irritation continue.<sup>9</sup>

## Somatosensory Evoked Potentials and Motor Evoked Potentials

SEPs and MEPs are typically used to study conduction in central nervous system and are also used in peripheral nerve monitoring during surgery. The intraoperative SEP techniques are virtually identical to those used in the electrodiagnostic laboratory. Averaged potentials are recorded from surface electrodes over the cervical spine and scalp following direct electrical stimulation of peripheral nerve elements in the surgical field. The presence of a response indicates continuity of sensory axons between the spinal cord and the site of peripheral nerve stimulation. For MEP, transcranial electrical stimulation is used to activate the motor cortex. This is best performed with a specially designed, commercially available constant voltage stimulator that delivers a short-duration stimulus with rapid rise time in a train of 3–4 stimuli at 2–3 ms intervals.<sup>2,7</sup> Stimulus intensities range from 500–800 V. MEP recordings are made from hook electrodes applied directly to surgically exposed nerves or from muscles. Stimulus artifact is common but can be eliminated by averaging 4–6 stimuli of alternating polarity. When NAPs are recorded directly from the nerve, neuromuscular blockade is required to eliminate the possibility of recording artifact from muscles in the region of the recording electrodes.

### Key Points

- With minor modifications, standard electrodiagnostic techniques (NCS, EMG, SEP, MEP) are easily applied to operative setting.
- Intraoperative NCS require specially designed sterile stimulating and recording electrodes.

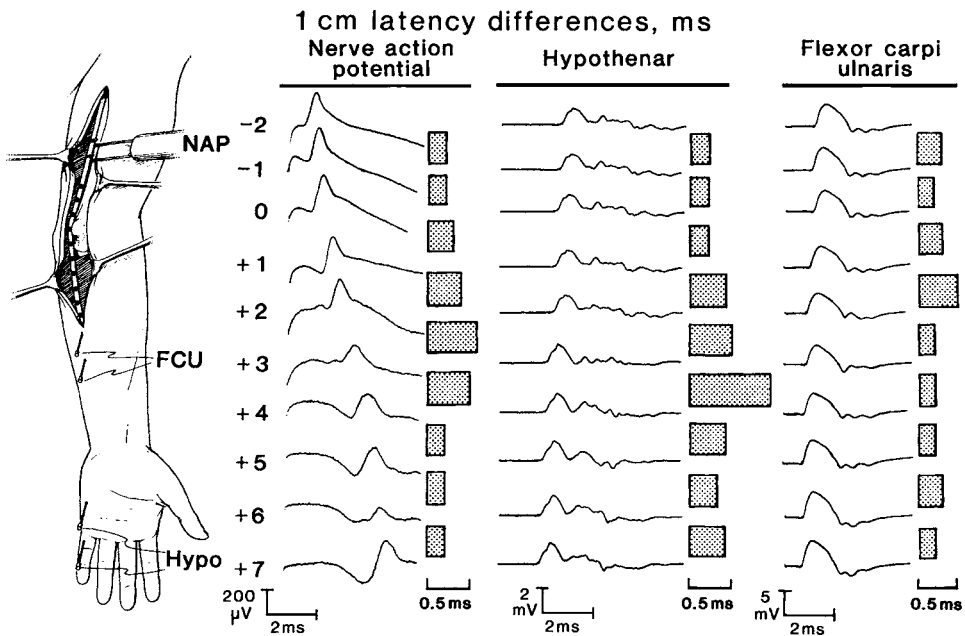
- MEP recordings are performed with a specially designed constant voltage transcortical stimulator.
- Stimulus artifact can be managed with good technique, averaging, and alternating stimulus polarity.

## APPLICATIONS

### Entrapment Neuropathies

NCS are utilized in selected cases to improve localization during surgery for various entrapment neuropathies,<sup>6-8</sup> including ulnar neuropathy at the elbow and wrist, median neuropathy in the forearm, radial neuropathy in the arm or forearm, peroneal neuropathy at the knee, and sciatic neuropathy in the buttock. Little additional information is added by doing intraoperative NCS in cases where preoperative studies demonstrate focal conduction block or slowing over a 2–3 cm segment of nerve. However, when the site of entrapment

is unclear, NCS performed during surgery can frequently add valuable localizing information. This typically occurs when the site of entrapment is deep or in an unusual location (e.g., median and radial nerves in forearm and sciatic nerve in buttock) or when the lesion is predominantly axonal (e.g., ulnar neuropathy at the elbow and peroneal neuropathy at the knee). In the absence of conduction block, there is no change in CMAP amplitude between proximal and distal stimulation sites. Despite the lack of obvious conduction block on CMAP recordings, a segmental change in NAP amplitude or a focal slowing of conduction is frequently observed even in purely axonal lesions (Fig. 45–4). To demonstrate this, a bipolar hooked nerve electrode is placed proximal to the lesion for NAP recording and stimulating electrodes are applied distal to the segment being tested. Proximal placement of the recording electrode eliminates movement artifact and CMAPs caused by contraction of adjacent muscles. The stimulator is moved from distal to proximal in successive 1–2 cm segments. The lesion is identified by a change in amplitude and slowed conduction of the



**Figure 45–4.** Intraoperative recording of CMAPs and NAPs during ulnar nerve exploration and stimulation at 1-cm intervals. The “0” point indicates the location of the medial epicondyle. The greatest change in latency and amplitude occurred over a 3-cm segment spanning the origin of the cubital tunnel. FCU, flexor carpi ulnaris; Hypo, hypothenar. (From Daube, J. R., and C. M. Harper. 1989. Surgical monitoring of cranial and peripheral nerves. In *Neuromonitoring in surgery*, ed. J. E. Desmedt, 115–51. Amsterdam: Elsevier. By permission of Elsevier Science Publishers.)

NAP over the short nerve segment. NAPs may provide useful information before regeneration has had a chance to reach the muscle, a time when CMAPs are absent.

Localization by clinical signs and preoperative NCS and EMG is adequate in the majority of cases of entrapment neuropathy.<sup>1,2,6,8</sup> Carpal tunnel release and most cases of ulnar transposition do not benefit from intraoperative NCS. However, complicated cases of ulnar or median neuropathy, or radial, femoral, sciatic, tibial, and peroneal neuropathies are often monitored because of inherent difficulties in defining the number and location of lesions with preoperative studies in these cases.<sup>8,10-12</sup> Conduction block and focal slowing are easier to detect and localize accurately when the nerve is exposed. In addition, over-stimulation is easier to detect and correct intraoperatively and areas of increased threshold help identify damaged nerve segments. The sensitivity and accuracy of intraoperative NCS may help the surgeon choose the most appropriate treatment. These principles are illustrated in Figure 45-4, which summarizes the findings of intraoperative NCS during a case of ulnar nerve exploration. Preoperative NCS revealed localized slowing with increased CMAP dispersion, approximately 3 cm distal to the medial epicondyle. CMAPs were recorded intraoperatively over the abductor digiti minimi and flexor carpi ulnaris muscles and NAPs were recorded from the proximal ulnar nerve. There were changes in amplitude and latency of both CMAPs and NAPs over a 3-cm segment at the origin of the cubital tunnel. There were no areas of slowing proximal or distal to this point, so a cubital tunnel release was performed. A similar strategy for improved localization is applicable to any nerve that can be exposed at suspected sites of entrapment.

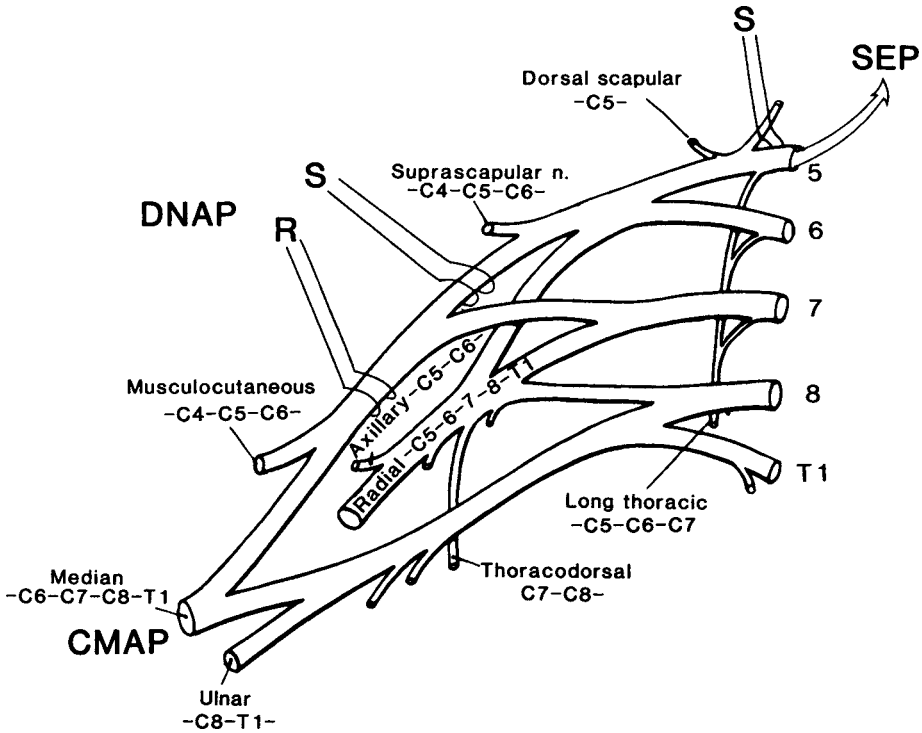
## Repair of Traumatic Peripheral Nerve Injury

Intraoperative monitoring is particularly useful when multiple, deep, proximal nerves are injured and when multiple potential mechanisms of injury are involved (traction, contusion, ischemia, etc.). The primary purpose of monitoring in this setting is to localize the injured segment(s) and assess the

status of axonal continuity across the injured area.

The utility of these techniques is best illustrated by examining their role in the surgical repair of traumatic injuries to the brachial plexus.<sup>2,7,13</sup> The complexity of brachial plexus anatomy, multiplicity and severity of injury to its elements, and frequent occurrence of nerve root avulsion make lesions of this structure particularly difficult to evaluate and treat.<sup>2,7,13,14</sup> The presence or absence of nerve root avulsion is one of the most important factors in determining prognosis and the need for surgical intervention in brachial plexus injuries. If root avulsion is present, then repair of postganglionic elements innervated by the avulsed root will be of no benefit. The clinical examination, NCS, needle EMG, and myelography are used preoperatively to assess the integrity of the cervical nerve roots.<sup>2,7</sup> The combination of Horner's syndrome, denervation of paraspinal and other proximal muscles, preserved sensory nerve action potentials (SNAPs), and the presence of a meningocele on myelography in the setting of a paralyzed anesthetic limb strongly suggests the presence of multiple root avulsions. However, any one of these findings in isolation is less predictive. Examples of false-positive and false-negative myelograms have been reported.<sup>13,14</sup> Because the posterior primary ramus of a given nerve root innervates paraspinal muscles at multiple levels, the distribution of fibrillation potentials may overestimate the number of roots involved. In addition, the presence of a postganglionic lesion with diminished SNAP may mask an associated lesion involving preganglionic segments. The predictive value of preoperative SEP in detecting root continuity as well as the presence of mixed pre- and postganglionic lesions has been disappointing.<sup>15</sup>

These uncertainties can usually be resolved by performing NCS, and SEP and MEP recordings during surgery.<sup>15-19</sup> Partial lesions are incomplete and associated with residual motor and/or sensory axonal continuity. Intraoperative recordings help determine the location and severity of partial lesions in brachial plexopathy. Using direct stimulation of plexus elements exposed at surgery, the fascicles of interest are isolated allowing more precise segmental localization of partial lesions. In partial lesions, CMAPs, NAPs, and SEPs all produce recordable responses across and distal to the



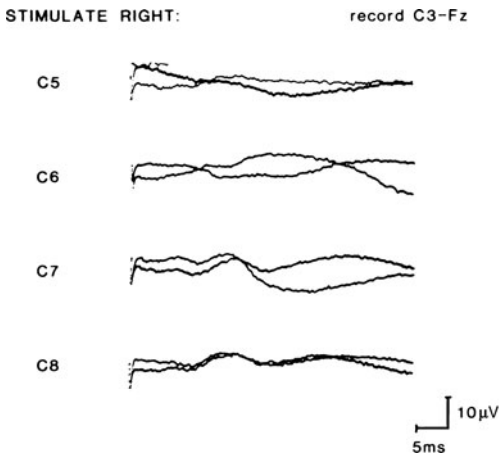
**Figure 45-5.** Electrophysiologic techniques for monitoring brachial plexopathy. (*Upper right*) SEPs recorded over scalp during root stimulation. (*Center*) NAPs recorded directly (DNAP) from short segments of the plexus. (*Lower left*) CMAPs recorded from distal muscles during selective stimulation of plexus elements. S, stimulating electrodes; R, recording electrodes. (From Daube, J. R., and C. M. Harper. 1989. *Surgical monitoring of cranial and peripheral nerves*. In *Neuromonitoring in surgery*, ed. J. E. Desmedt, 115-51. Amsterdam: Elsevier. By permission of Elsevier Science Publishers.)

injured segment (Figs. 45-5, 45-6, and 45-7). The size of the response is proportional to the number of functioning axons. Most partial lesions are left alone or treated with external neurolysis (removal of scar tissue). Complete lesions are associated with total axonal interruption at the time of injury. When brachial plexus surgery is carried out several months postinjury, complete lesions can be subdivided into those that show signs of regeneration across the injured segment and those that do not.

First and most importantly, SEPs<sup>16-19</sup> and MEPs<sup>2,7,15</sup> are used to determine the presence or absence of nerve root avulsion. A well-defined SEP recorded from the brain or spinal cord after direct stimulation of the exposed nerve root indicates central continuity of the dorsal root while the absence of a response confirms the presence of root avulsion at that level (Fig. 45-6). In most cases, this indicates a high likelihood of ventral root continuity as well. However, recording of an NAP from

plexus elements following transcranial electrical stimulation (i.e., MEP) provides more direct evidence of ventral root continuity (Fig. 45-8). NAPs recorded after peripheral nerve stimulation can also be used to assess root integrity indirectly but the proper interpretation of NAP in the setting of root avulsion requires experience and is not always definitive. Total absence of the NAP while stimulating the root and recording it 4 cm distal along the spinal nerve or proximal trunk suggests root avulsion, but a very proximal postganglionic lesion could also produce this finding. Also, in root avulsion, if the postganglionic element is intact, a well-defined NAP will be recorded from preserved postganglionic sensory fibers.

Once nerve root continuity is confirmed, intraoperative NCS and SEPs can be used to assess the integrity of more distal elements of the brachial plexus. Detecting conduction block or focal slowing of conduction velocity over short segments in either CMAP or NAP recordings sometimes localizes lesions.



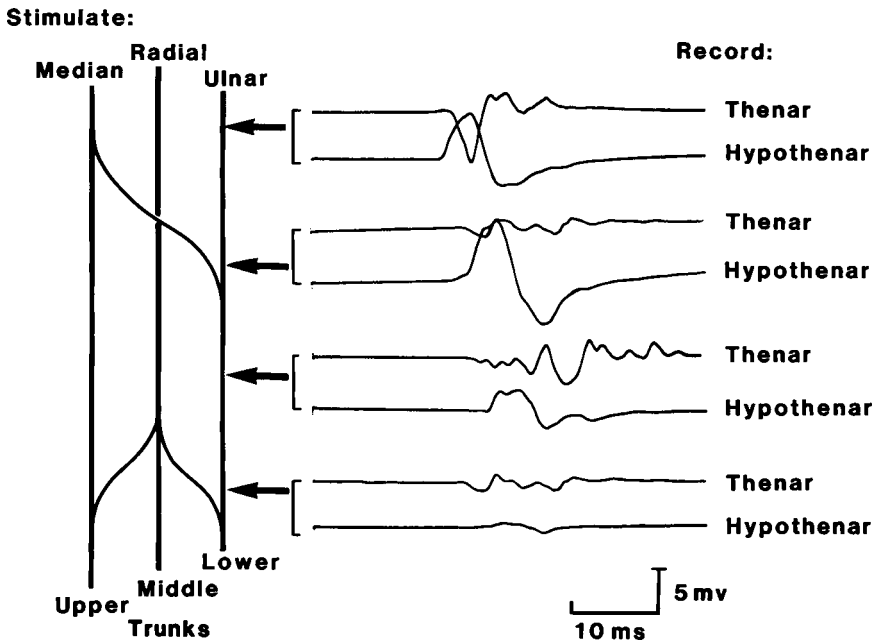
**Figure 45-6.** Intraoperative recording of SEPs over scalp with stimulation of cervical nerve roots directly in surgical field. Well-defined responses were seen with stimulation of the C-7 and C-8 roots. No response was obtained with stimulation of C-5 or C-6 roots, indicating avulsion of the root at these levels. (From Daube, J. R., and C. M. Harper. 1989. *Surgical monitoring of cranial and peripheral nerves*. In *Neuromonitoring in surgery*, ed. J. E. Desmedt, 115-51. Amsterdam: Elsevier. By permission of Elsevier Science Publishers.)

NAP and SEP recordings are better suited than CMAP recordings in detecting early regeneration since reinnervation at this stage

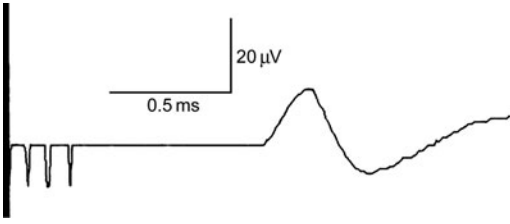
typically has yet to reach a target muscle (Fig. 45-9). When regeneration is detected, the segment is left alone or neurolysis is performed. If the NAP and/or SEP are absent, then grafting is performed, as long as proximal nerve root continuity is confirmed. Recording the NAP from individual nerve fascicles has been reported to help guide partial fascicular repair in the setting of incomplete lesions.<sup>12,13</sup> Technical difficulties related to the size of the electrodes, occurrence of shock artifact, and avoidance of current spread to adjacent fascicles have limited the widespread use of fascicular recordings.

### Prevention of Injury during Peripheral Nerve Surgery

As with the cranial nerves, the peripheral nerves that innervate the trunk and extremity muscles are susceptible to mechanical or ischemic injury during a variety of surgical procedures. EMG and SEP monitoring have been utilized in an attempt to prevent injury to the phrenic nerve<sup>20</sup> and brachial plexus during



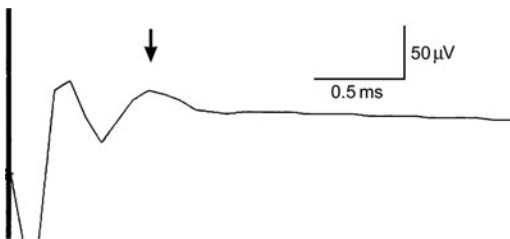
**Figure 45-7.** Intraoperative NCS showing conduction block along medial cord of brachial plexus. (From Daube, J. R., and C. M. Harper. 1989. *Surgical monitoring of cranial and peripheral nerves*. In *Neuromonitoring in surgery*, ed. J. E. Desmedt, 115-51. Amsterdam: Elsevier. By permission of Elsevier Science Publishers.)



**Figure 45-8.** Transcranial motor evoked potential (MEP) recorded directly from the C5 nerve root during surgical repair of traumatic brachial plexopathy. The NAP is recorded with hook electrodes applied to the C5 root. It represents an averaged response to six trains of transcranial electrical stimuli (4 pulses per train at 3 ms intervals). The well-defined MEP indicates that the C5 motor root is intact.

cardiac and other major surgical procedures.<sup>21</sup> During these procedures, EMG monitoring for neurotonic discharges helps localize and warn of potential injury to the nerve, while direct electrical stimulation with a handheld stimulator is used to identify viable nerves or fascicles. SEPs can detect early conduction block associated with compression or ischemia of limb nerves caused by improper positioning of limbs during surgery. Orthopedic procedures that involve disarticulation or extensive manipulation of the limbs are often monitored. EMG and/or SEP monitoring have been reported as a means to help detect and prevent injury to the axillary and musculocutaneous nerves during shoulder surgery, and to the femoral, obturator, and sciatic nerves during high-risk hip surgery.<sup>22</sup>

EMG monitoring may also be useful during the resection of primary or metastatic peripheral nerve neoplasms.<sup>14</sup> In this setting, the goal is to resect the tumor with as little damage to normal nerve fascicles as possible. During dissection, individual or groups of fascicles are



**Figure 45-9.** NAP recorded directly from the middle trunk of the brachial plexus during surgical repair of traumatic brachial plexopathy. A well-defined NAP (arrow) indicates axonal continuity across the suspected area of injury.

stimulated mechanically or electrically while monitoring EMG activity in distal muscles. An attempt is made to preserve fascicles that produce a distal EMG response while those that do not are sacrificed.

### Key Points

- Intraoperative NCS improve localization during surgery for selected entrapment neuropathies (axonal lesions or entrapment in deep or proximal locations).
- In brachial plexus repair, SEPs and MEPs accurately assess the presence of partial or complete nerve root avulsion.
- NAP recordings over short segments assess the presence of axonal continuity and early regeneration across lesions affecting peripheral nerve elements.
- Intraoperative NCS help identify nerves and functioning fascicles within nerves during tumor resection or other pathological conditions that distort normal anatomy.

### SUMMARY

Electrophysiological monitoring of the peripheral nervous system provides useful information that supplements and complements preoperative assessment. Monitoring improves localization and understanding of the underlying pathophysiology of peripheral nerve lesions leading to more rational treatment decisions and potentially improved outcomes. Monitoring is accomplished by adaptation of routine electrodiagnostic techniques (i.e., nerve conduction studies, evoked potentials, and electromyography) with special attention to technical factors including electrical and movement artifact. These techniques have been successfully applied during surgery for entrapment neuropathies, traumatic nerve injury and repair, and during procedures that risk peripheral nerve injury.

### REFERENCES

1. Brown, W. F., and J. Veitch. 1994. AAEM minimonograph #42: Intraoperative monitoring of peripheral and cranial nerves. *Muscle & Nerve* 17:371-7.
2. Crum, B. A., and J. A. Strommen. 2007. Peripheral nerve stimulation and monitoring during operative procedures. *Muscle & Nerve* 35:159-710.



3. Mandpe, A. H., A. Mikulec, and R. K. Jackler. 1998. Comparison of response amplitude versus stimulation threshold in predicting early postoperative facial nerve function after acoustic neuroma resection. *The American Journal of Otolaryngology* 19:112–17.
4. Tiel, R. L., L. T. Happel Jr., and D. G. Kline. 1996. Nerve action potential recording method and equipment. *Neurosurgery* 39:103–8.
5. Oberle, J. W., G. Antoniadis, S. A. Rath, and H. P. Richter. 1997. Value of nerve action potentials in the surgical management of traumatic nerve lesions. *Neurosurgery* 41:1337–42.
6. Daube, J. R., and C. M. Harper. 1989. Surgical monitoring of cranial and peripheral nerves. In *Neuromonitoring in surgery*, ed. J. E. Desmedt, 115–51. Amsterdam: Elsevier.
7. Harper, C. M. 2005. Preoperative and intraoperative electrophysiologic assessment of brachial plexus injuries. *Hand Clinics* 21:39–46.
8. Campbell, W. W., S. K. Sahni, R. M. Pridgeon, G. Riaz, and R. T. Leshner. 1988. Intraoperative electroneurography: Management of ulnar neuropathy at the elbow. *Muscle & Nerve* 11:75–81.
9. Harper, C. M. 2004. Intraoperative cranial nerve monitoring. *Muscle & Nerve* 29:339–51.
10. Kline, D. G., D. Kim, R. Midha, et al. 1999. Management and results of sciatic nerve injuries: A 24-year experience. *Journal of Neurosurgery* 90:806–7.
11. Kim, D. H., and D. G. Kline. 1996. Management and results of peroneal nerve lesions. *Neurosurgery* 39(2):312–9.
12. Gruen, J. P., W. Mitchell, and D. G. Kline. 1998. Resection and graft repair for localized hypertrophic neuropathy. *Neurosurgery* 43:78–83.
13. Kline, D. G., E. R. Hackett, and L. H. Happel. 1986. Surgery for lesions of the brachial plexus. *Archives of Neurology* 43:170–81.
14. Spinner, R. J., and D. G. Kline. 2000. Surgery for peripheral nerve and brachial plexus injuries or other nerve lesions. *Muscle & Nerve* 23:680–95.
15. Turkof, E., H. Millesi, R. Turkof, et al. 1997. Intraoperative electroneurodiagnostics (transcranial electrical motor evoked potentials) to evaluate the functional status of anterior spinal roots and spinal nerves during brachial plexus surgery. *Plastic and Reconstructive Surgery* 99:1632–41.
16. Yiannikas, C., B. T. Shahani, and R. R. Young. 1983. The investigation of traumatic lesions of the brachial plexus by electromyography and short latency somatosensory potentials evoked by stimulation of multiple peripheral nerves. *Journal of Neurology, Neurosurgery, and Psychiatry* 46:1014–21.
17. Landi, A., S. A. Copeland, C. D. Wynn-Parry, et al. 1980. The role of somatosensory evoked potentials and nerve conduction studies in the surgical management of brachial plexus injuries. *The Journal of Bone and Joint Surgery (British)* 62:492–7.
18. Sugioka, H., N. Tsuyana, T. Hara, et al. 1982. Investigation of brachial plexus injuries by intra-operative cortical somatosensory evoked potentials. *Archives of Orthopaedic and Trauma Surgery* 99:143.
19. Mahla, M. E., D. M. Long, J. McKennett, C. Green, and R. W. McPherson. 1984. Detection of brachial plexus dysfunction by somatosensory evoked potential monitoring—a report of two cases. *Anesthesiology* 60:248–52.
20. Mazzoni, M., C. Solinas, E. Sisillo, et al. 1996. Intraoperative phrenic nerve monitoring in cardiac surgery. *Chest* 109:1455–60.
21. Seal, D., J. Balaton, S. G. Coupland, et al. 1998. Somatosensory evoked potential monitoring during cardiac surgery: An examination of brachial plexus dysfunction. *Journal of Cardiothoracic and Vascular Anesthesia* 12:129–30.
22. Helfet, D. L., N. Anand, A. L. Malkani, et al. 1997. Intraoperative monitoring of motor pathways during operative fixation of acute acetabular fractures. *Journal of Orthopaedic Trauma* 11:2–6.

*This page intentionally left blank*

## SECTION 3

# APPLICATIONS OF CLINICAL NEUROPHYSIOLOGY: ASSESSING SYMPTOM COMPLEXES AND DISEASE ENTITIES

---

The many electrophysiologic assessment and techniques of clinical neurophysiology described in earlier chapters outline the wide range of measurements that can be made in patients with suspected disease of the central or peripheral nervous system. Each of the techniques are applied either to assist clinicians in assessing disease of the central or peripheral nervous system or, less commonly, in monitoring changes in neural function. These techniques can be used to monitor neural function in observing progression of disease or improvement in a patient's condition with specific treatment. They are also used in the intensive care unit and operating room to identify progressive neural damage. Each approach has advantages and shortcomings. The clinical neurophysiologic testing technique that is most appropriate for a patient depends on the clinical problem. Often, some combination of techniques best provides the necessary data. The focus of the following chapters is the application of clinical neurophysiologic techniques in assessing clinical problems.

The selection of a technique first requires taking a medical history and examining the patient and then formulating a differential diagnosis. This differential diagnosis may include many possible disorders, but for practical purposes, disorders that are most likely are considered first in selecting a diagnostic technique. Findings of the clinical history and

examination must also be considered in selecting individual components of the techniques, for example, which nerves to test with nerve conduction studies in a patient with suspected peripheral nerve disease. Neurologic symptoms will suggest whether one or more neural systems are involved. Confirmatory signs on examination provide more certainty about the involvement of a particular neural system. Clinical neurophysiologic testing can often provide further confirmation if needed. The symptoms that suggest disorders of specific systems include paralysis, weakness, tremor, other extraneous movements, and posture abnormalities (motor system); sensory loss, paresthesia, pain, and impairment of vision, hearing, or balance (sensory system); or perspiration abnormalities, fatigue, vascular changes, pain, and emotional disorders (internal control system and autonomic disorders).

Symptoms or signs involving movement are strong evidence that disease affects the motor system at some level of the nervous system. If there is atrophy, loss of power, jerking, shaking, stiffness, or any of the many manifestations of disease of the motor system, clinical neurophysiologic testing with one of the following modalities that assesses the motor system should be considered. *Motor nerve conduction studies* can be critically important in identifying disease of the peripheral motor pathways in the plexus, peripheral nerve, neuromuscular

junction, or muscle. Amplitudes of evoked responses can help define the severity of the disease process and the presence of conduction block. Conduction slowing can define the precise location of the damage. *Repetitive stimulation* can separate functional fatigue from defects of neuromuscular transmission caused by disease at the neuromuscular junction. *Needle EMG* can identify and characterize peripheral nerve and muscle diseases. *Multichannel surface electromyographic (EMG) recordings* from widespread muscle groups can often characterize the presence or absence of a motor system disorder in patients with symptoms of disorders of movement such as tremors, jerks, and twitches. These symptoms cannot always be classified clearly by clinical observation, but quantitative measurements can sometimes define them more precisely.

Complaints of numbness, tingling, localized pain, loss of vision, hearing impairment, and poor balance suggest involvement of sensory systems. Clinical neurophysiologic testing can assist in identifying and characterizing the disease involving the sensory system at any level of the nervous system. The following tests should be considered for patients with sensory symptoms. *Somatosensory evoked potentials (SEPs)* can help determine the presence of impairment along the sensory pathways, particularly if there is an identifiable sensory loss. *Sensory nerve conduction studies* can localize disease in peripheral nerves. Slowing of sensory nerve action potentials may distinguish between primarily axonal and demyelinating disorders. *Visual evoked potentials* and *auditory evoked potentials (AEPs)* can help localize the site of abnormality and characterize the type of abnormality, even without visual or hearing impairment.

Electrophysiologic techniques can help in the localization of a disease to a specific level of the nervous system. A variety of techniques can localize disease to and within the *supratentorial level*. Electroencephalography is one of the most helpful techniques for distinguishing among supratentorial diseases because of its ability to identify localized areas of cerebral involvement caused by either an epileptogenic or a destructive process. Electroencephalography can also help distinguish between subcortical and cortical diseases. Evoked potentials can be used to distinguish subcortical from cortical involvement. SEPs may increase or

decrease in size in cortical disease and be reduced or delayed in subcortical processes such as multiple sclerosis. Visual evoked potentials are able to distinguish disease in the optic nerves and tracts from that in the cerebral cortex. Multichannel movement recordings can assist in determining the origin of disorders with tremor, jerking, and twitching and may be identified as *cortical* or *basal ganglionic* by the character of the pattern of firing and distribution on these recordings.

Localization at the *posterior fossa level* can be assisted with several techniques. AEPs and auditory testing can specifically identify involvement of the peripheral auditory pathways and distinguish it from involvement of auditory pathways at the level of the pons or midbrain. AEPs also can distinguish the nature of these disorders. Posturography can identify the presence of a peripheral vestibular disorder and distinguish it from central disease of the vestibular pathways. Tibial and median SEPs recorded from the scalp with recordings at the neck can identify involvement at the posterior fossa level. Blink reflexes and facial nerve conduction studies can identify involvement of cranial nerves V and VII and distinguish their involvement from diseases of the midbrain or pons. Needle EMG of cranial muscles can provide evidence of damage to brain stem motor neurons or peripheral motor pathways in primary neurogenic processes, myasthenia gravis, or primary myopathies. Patients with bulbar symptoms can often be separated into those with an upper motor neuron–pseudobulbar disorder and those with lower motor neuron involvement in amyotrophic lateral sclerosis or myasthenia gravis.

The *spinal cord level* can be assessed with SEPs, nerve conduction studies and needle EMG, and autonomic testing. SEPs recorded with median, ulnar, or tibial nerve stimulation can distinguish involvement of the peripheral and spinal nerves from direct spinal cord damage and separate lumbar and thoracic cord lesions from cervical cord lesions. Occasionally, SEPs are able to determine the nature of the disorder, especially demyelinating disorders. On nerve conduction studies, F waves, patterns of amplitude changes with motor and sensory conduction studies, and H reflexes can sometimes identify involvement of specific levels of the spinal cord. Paraspinal fibrillation potentials on needle EMG provide evidence of lower

motor neuron involvement at the spinal cord level; they can also help define distribution of lower motor neuron loss along the spinal cord. For example, in amyotrophic lateral sclerosis, EMG may demonstrate evidence of subclinical involvement at the thoracic level. Autonomic function testing in primary spinal cord disease, particularly localized disease with trauma, inflammatory disease, or ischemia, will show localized changes at a specific segmental level.

Localization at the *peripheral level* is assisted by nerve conduction studies, needle EMG, and sometimes autonomic testing. Motor and sensory nerve conduction studies identify localized areas of damage to individual nerves. Repetitive stimulation identifies and characterizes disorders of the neuromuscular junction. Needle EMG localizes lesions in cases in which nerve conduction studies are not successful, either because the damage is primarily axonal or the nerves are not accessible for stimulation

and recording. EMG can also assist in distinguishing primary neurogenic disease from neuromuscular junction and muscle diseases. Autonomic function tests separate peripheral sympathetic and parasympathetic disorders from spinal cord disease and involvement of central autonomic pathways. Patterns of distribution of temperature change, alteration in sweating, and vascular reflexes are combined to provide this information.

The approach to particular groups of clinical problems, with suggestions on the approach to patients, is reviewed in Chapters 46 and 47, focusing on the use of electroencephalography, electromyography, and nerve conduction studies. These suggestions will not be entirely correct for any individual patient because assessment depends on the unique history and physical examination findings of each patient, but provide a guideline for consideration of specific studies.

*This page intentionally left blank*



# Assessing Central Nervous System Symptoms

*Elson L. So*

- INTRODUCTION**
- ASSESSMENT OF MOTOR SYMPTOMS OF CENTRAL ORIGIN**
- ASSESSMENT OF SENSORY SYMPTOMS OF CENTRAL ORIGIN**
- ASSESSING IMPAIRMENT OF CONSCIOUSNESS AND COGNITION**
- ASSESSING IMPAIRMENT OF VISCERAL FUNCTION AND SLEEP**
- IDENTIFYING DISEASE TYPES**
- PROGNOSIS**
- ASSESSING CLINICAL DISORDERS WITH EEG**

- Electroencephalographic Evaluation of Impaired Consciousness or Delirium
- Electroencephalographic Evaluation of Cognitive Dysfunction
- Electroencephalographic Evaluation of Seizures and Other Paroxysmal Disorders
- EEG in the Intensive Care Unit
- Intraoperative EEG
- EEG in the Newborn
- EEG in the Epilepsy Monitoring Unit

## **SUMMARY**

## **INTRODUCTION**

Clinical history and neurological examinations form the foundation of assessing central nervous system (CNS) disorders. In many instances, laboratory tests are needed to affirm diagnosis and guide treatment. Imaging tests alone are often inadequate for these purposes, and neurophysiologic tests are needed to understand the mechanisms underlying CNS symptoms and to establish the neurological diagnosis. Moreover, neurophysiological procedures are more widely available and useful

than imaging tests in monitoring the ongoing effects of surgical procedures.

This chapter will provide an overview of the application of clinical neurophysiology in central nervous system disorders.

## **ASSESSMENT OF MOTOR SYMPTOMS OF CENTRAL ORIGIN**

Symptoms or signs involving movement are strong evidence that disease affects the motor

system at some level of the nervous system. Electroencephalography (EEG) should be considered if the motor symptom or deficit may be caused by disease at the cortical level, either a seizure or a destructive process (e.g., tumor or infarct). EEG is of limited value in assessing movement disorders, except when an epileptic mechanism is under consideration. Transcranial motor evoked potentials (MEPs) test the entire motor pathway from the cerebral cortex (where the motor system is activated by a magnetic or electric pulse) to muscle (where the response is recorded). MEPs are most useful in distinguishing primary motor system disease from functional or psychiatric disease. For example, a patient with hysterical paralysis of the legs can be evaluated with this technique.

## ASSESSMENT OF SENSORY SYMPTOMS OF CENTRAL ORIGIN

Complaints of numbness, tingling, localized pain, loss of vision, hearing impairment, and poor balance suggest involvement of sensory systems. Clinical neurophysiologic testing can assist in identifying and characterizing the disease involving the sensory system at any level of the nervous system. The following tests should be considered for patients with sensory symptoms:

- EEG can help identify sensory symptoms arising at the cortical level. For example, unilateral paresthesia caused by a seizure discharge or a local destructive lesion may be associated with focal spikes or slowing.
- Somatosensory evoked potentials (SEPs) can help determine the presence of impairment along the sensory pathways, particularly if there is an identifiable sensory loss.
- Visual evoked potentials and auditory evoked potentials (AEPs) can help localize the site of abnormality and characterize the type of abnormality, even without visual or hearing impairment.

## ASSESSING IMPAIRMENT OF CONSCIOUSNESS AND COGNITION

Episodic or continuous confusion, unconsciousness, and disorders of sleep can be evaluated and characterized with the following electrophysiologic tests:

- EEG, often critical in defining the nature of an impairment of consciousness, can distinguish seizure disorders from metabolic disturbances, focal lesions with increased pressure, hysterical disorders, and sleep disorders.
- Polysomnography provides a precise assessment and characterization of sleep disorders, often assisting in defining their specific nature and, thereby, appropriate treatment modalities.
- SEPs and brain stem auditory evoked potentials (BAEPs) can determine whether central sensory pathways from the level of the brain stem to the cerebral cortex are intact and functioning normally. This helps define the status of patients in coma. Severity of impairment of SEPs after head trauma is helpful in judging prognosis.

EEG is the most precise laboratory technique available for assessing cortical function. Disorders of cognition with impairment of mentation, language, and memory are caused primarily by disorders at the level of the cerebral cortex. Only clinical testing of thinking and memory can provide more information than EEG. Characteristic EEG abnormalities can help define the nature of the disorders that produce impaired mentation, including Alzheimer's disease, chronic infection, ischemic vascular disease, subdural hematoma, and frontal lobe mass lesions.

## ASSESSING IMPAIRMENT OF VISCERAL FUNCTION AND SLEEP

Impairment of visceral function, including autonomic disorders, syncope, and disorders of the reproductive organs, can be assessed with two groups of electrophysiologic tests: autonomic function testing and polysomnography.

- Autonomic function testing can assess peripheral sympathetic function in vascular disease or peripheral nerve disease. It can also assess central vascular control mechanisms that may be altered in autonomic diseases such as multisystem atrophy.
- Polysomnography assesses sleep disorders by measuring both EEG activity and associated autonomic function. Disorders of the autonomic nervous system may be manifested on polysomnography. Polysomnography is particularly valuable in central disorders of the internal regulatory system, but it can also be helpful in assessing impotence and sleep apnea.

## IDENTIFYING DISEASE TYPES

Clinical neurophysiology can facilitate identification of specific diseases. Electrophysiologic testing can sometimes supplement the initial classification of a disease as vascular, inflammatory, degenerative, or neoplastic, but it does so in different ways for different tests. In many instances, only a broad category of disease can be suggested, but in others, specific diseases can be identified. These are described in detail in the chapters on each of the techniques. The following are some examples.

- EEG can distinguish epileptogenic from destructive lesions, but rarely can it categorize the changes as neoplastic, inflammatory, infectious, or degenerative. At times, specific clinical entities can be suggested, such as the Lennox–Gastaut syndrome, hepatic encephalopathy, and hypsarrhythmia of infancy.
- Evoked potentials rarely provide evidence of a specific clinical entity. Marked increase in latency is usually evidence of a demyelinating process in patients with multiple sclerosis. Evoked potentials are useful particularly in identifying areas of subclinical involvement to confirm the presence of multiple lesions in multiple sclerosis.
- Polysomnography testing can identify sleep apnea and some forms of sleep impairment such as periodic movements of sleep.

## PROGNOSIS

Although several clinical neurophysiologic procedures can define the severity of a disease process, the procedures vary in their ability to characterize the stage of evolution of the disease or to provide prognostic information. EEG is the most established and widely used laboratory procedure that provides nonstructural—but objective—evidence of the severity and progression of cerebral disorders. However, except for a few disorders, the association between an abnormal EEG finding and disease severity varies among patients, partly because of the variability in the manner and the severity with which the cerebral symptoms present for similar stages of the disorder. A key principle in using EEG is that serial EEG recordings must be obtained to optimize the value of this test in assessing disease progression and prognosis in each person.

The physiologic and pathologic mechanisms that underlie normal and abnormal EEG are not as well understood as those in peripheral nerve and muscle disorders. One reason is that brain specimens of living patients are not as readily available for study and correlation with EEG findings. Nonetheless, EEG is used to evaluate nearly all diseases affecting the brain. It remains the best tool for assessing severity and prognosticating the outcome of many categories of cerebral dysfunction, including toxic, metabolic, infectious, vascular, degenerative, traumatic, and seizure disorders.

## ASSESSING CLINICAL DISORDERS WITH EEG

As indicated by the discussion above, clinical neurophysiologic testing cannot be applied in a routine fashion. For each patient, testing should be designed to answer the clinical question posed by the patient's problem. This requires giving careful thought to the selection of the testing procedures. The ensuing sections discuss the practical approach in using EEG to assess central nervous system disorders.

Unlike other clinical neurophysiologic tests, EEG is used frequently and regularly for patients of all age groups and with various

conditions. Therefore, the following information about the patient and recording conditions must be obtained and documented with each EEG procedure: (1) age (including gestational age in neonates), (2) clinical history, (3) reason for the procedure, (4) medications, (5) time of last meal, (6) number of hours of previous night's sleep, (7) time of last occurrence of symptom, (8) current level of consciousness and alertness, and (9) previous EEG records.

The following are the general technical considerations when recording or reviewing an EEG:

- Recording environment must be comfortable for the patient and without any distraction if possible.
  - Document the patient's behavior, especially when there is an EEG discharge.
- Document potential or known source of artifacts.
  - Monitor respiratory movements and oximeter readings if necessary.
  - Stimulate the patient to elicit the most alert state and its corresponding EEG appearance.
- Record effect of eye opening and eye closure on the EEG.
- Use additional electrodes when appropriate to enhance detection and localization of abnormal activities.
  - Adjust sensitivity or gain settings and frequency filters to display properly waveforms of different amplitude range. (With analog recording, pages of different settings may be necessary.)
  - Avoid setting low linear frequency filter at greater than 1.0 Hz. (Analog recording should include pages with recording at 0.5 Hz.)
  - Minimize distortion of both benign sharp transients and abnormal sharp waves by minimizing use of low-pass filter (high linear frequency filter) below 70 Hz.
- Expanding the timescale (increasing draw speed) enhances the appearance of fast frequency waveforms.
- Expanding the timescale (increasing draw speed) facilitates the appreciation of phase relationship between waveforms in different channels.
- Compressing the timescale (reducing the draw speed) emphasizes the display of alpha and beta activities and may mask underlying delta and theta waveforms. Reducing the setting of the low-pass filter (i.e., from high linear frequency filter setting of 70 Hz to 15 Hz) could alleviate the masking of slower waveforms and reveal generalized or focal slowing.
- Review waveforms of interest in different montages, at least in one bipolar montage and one referential or Laplacian montage.
- Review waveforms of interest with a montage that covers sufficiently all regions of both hemispheres, before focusing on montages that cover selected brain regions.
- Display the electrocardiographic monitor at proper amplitude so that complexes will be easily visualized yet not interfere with EEG tracings.
- Increasing the time base (increasing draw speed) unmask high-frequency waveforms that are hidden by digital under-sampling of the EEG data.
- Reducing the low-pass filter (high linear frequency filter) corrects the digital aliasing effect of distorting high-frequency waves into slower waveforms.

A segment of the recording should show EEG activity when the patient is most alert. This is important because many patients become drowsy or sleepy during the EEG procedure. The EEG activities associated with drowsiness are difficult to differentiate from abnormal background slowing of a mild degree. Drowsy and sleep EEG activities can also mask background abnormality of generalized or focal slowing. The patient should be stimulated verbally or physically during the recording to determine the highest level of arousal that the patient is capable of achieving, especially when the EEG is performed to evaluate impaired consciousness.

The best approach to discussing the use of EEG in evaluating neurologic disorders is a symptom-oriented approach. The discussion should also include the recording of EEGs in special environments such as the operating room and intensive care units. Preceding chapters have already presented the abnormal EEG features or patterns of specific cerebral disorders.

## Electroencephalographic Evaluation of Impaired Consciousness or Delirium

Impairment of consciousness is one of the most frequent clinical manifestations of acute neurologic illnesses. Electrophysiologic recording is the only laboratory method that objectively assesses the severity of disturbance in cerebral function. This property of electrophysiologic recording makes it valuable as a method for objectively following the progress of the patient's condition to supplement clinical observation. In general, the severity of EEG abnormality parallels the observed depth of mental obtundation.

Several abnormal EEG patterns indicate the severity and the prognosis of the patient's condition (e.g., burst-suppression pattern, spindle coma pattern, alpha coma pattern). Moreover, a number of abnormal EEG patterns suggest strongly the probable cause or mechanism underlying the mental obtundation (e.g., triphasic waves, seizure discharges, periodic lateralized epileptiform discharges [PLEDs]). Not uncommonly, an EEG shows objective signs of cerebral dysfunction before other test results are positive or available (e.g., slowing or PLEDs in infectious, ischemic, traumatic, metabolic, or toxic disorders). The following should be considered when performing or reviewing EEGs for evaluation of mental obtundation:

- When prolonged recording is not contemplated, use of electrode cap may be appropriate in a patient who is not restless.
- Use compressed timescale (slow draw speed) and increase the time constant if subtle focal slowing or asymmetries are suspected.
- Compressing the timescale emphasizes the display of alpha and beta activities and may mask underlying delta and theta waveforms. Reducing the setting of the low-pass filter (i.e., from high linear frequency filter setting of 70 Hz to 15 Hz) alleviates this masking of slower waveforms so that generalized or focal slowing becomes apparent. Verbally stimulate the patient, and observe and document any behavioral or EEG response. Use physical stimulation if necessary.

Beware that stimulation may not be advisable in patients with increased intracranial pressure or unstable cardiovascular status.

- When there is spontaneous or unexpected change in the baseline EEG, look for potential stimulus of the change in the recording environment, such as suctioning or repositioning the patient.
  - Observe the patient continually for abnormal movements.
  - Monitor respiratory movements and oximeter readings if necessary.
- Record effect of eye opening and eye closure on the EEG.
  - When paroxysmal or periodic EEG patterns occur or the background of the EEG changes spontaneously, observe and document any corresponding change in motor or behavioral activity.
  - Use extraocular eye leads to help resolve the nature of frontal waveforms that are difficult to distinguish from eye movement artifacts.
- Reposition the head if ambiguous waveforms occur in the cranial region that rests against the examination table.
- Consider recording sleep activity to activate spikes and sharp waves in patients with mild to moderate mental obtundation, unless the recording already shows abnormalities highly suggestive of the underlying cause or mechanism of delirium.
- Consider serial EEGs to help monitor the course of the patient's disorder.
- In making the diagnosis of electrocerebral inactivity, adhere to the recommendations of the American Clinical Neurophysiology Society.

## Electroencephalographic Evaluation of Cognitive Dysfunction

Cognitive dysfunction is another frequent neurologic complaint and presenting symptom. Whereas neuropsychologic testing directly measures the symptom of cognitive deficit, EEG indirectly evaluates the severity of the



cognitive dysfunction. However, the information provided by EEG is independent of the patient's cognitive effort and performance at the time of the recording. Thus, EEG findings can complement the clinical assessment of cognitive disorders by detecting objective evidence of cerebral dysfunction. Furthermore, memory impairment or forgetfulness is frequently a symptom of anxiety and depression. The public's awareness of Alzheimer's disease has resulted in more patients becoming concerned about the significance of their own symptoms of forgetfulness. Abnormal EEG findings help determine the organic nature of the complaint. However, normal EEG findings in combination with normal clinical and laboratory results can be reassuring. Although normal EEG findings do not completely exclude an organic cause of cognitive disorder, an abnormal wake EEG background eliminates psychologic disorder as the only explanation of cognitive dysfunction.

The correlation between the severities of EEG abnormality and cognitive dysfunction is not as good as that between EEG and mental obtundation. This is particularly true for subcortical dementias. Despite this, a few cognitive disorders have characteristic EEG patterns. Conditions characterized by rapid cognitive decline in adults often require consideration of Creutzfeldt-Jakob disease. Because brain biopsy is often avoided in these patients, the characteristic pattern of periodic sharp waves may be the only supportive laboratory evidence available.

Some specific causes of childhood dementia or progressive encephalopathy can be suggested by characteristic abnormal EEG patterns. Examples are the patterns of periodic waveforms in patients with metabolic encephalopathy, subacute sclerosing panencephalitis (SSPE), or abnormal storage diseases. Epileptic encephalopathy can also be suggested by the detection of frequent clinical or subclinical seizures or widespread epileptiform discharges. Because formal neuropsychologic testing may be difficult to perform during early childhood, EEG may be especially useful as an objective tool in the serial assessment of cognitive function.

## Electroencephalographic Evaluation of Seizures and Other Paroxysmal Disorders

Epileptic seizure episodes result from the abnormal and excessive discharge of neurons. Thus, EEG is commonly used to detect abnormal interictal and ictal electric discharges that are highly associated with epileptic seizure disorders. Interictal abnormalities that have the best association with epileptic seizure disorders are spikes, sharp wave discharges, and temporal intermittent rhythmic delta activity (TIRDA). These interictal epileptiform discharges (IEDs) occur in only 40% of the initial EEGs of patients with seizures and in approximately 1% of persons without epilepsy. Nonetheless, their presence strongly supports a diagnosis of seizure disorder when other appropriate clinical or laboratory data are present. Furthermore, focal or generalized EEG slowing may reveal an underlying structural or functional derangement associated with the seizure disorder.

EEG helps in determining the specific seizure type or epilepsy syndrome. The classifications of epileptic seizures and epilepsy syndromes are based on both the clinical information and the type of EEG abnormality. The location and distribution of IEDs or ictal discharges help determine the seizure type and the epilepsy syndrome. At the minimum, the distinction between focal and generalized discharges contributes importantly to the initial step of seizure diagnosis, that is, establishing whether the disorder is focal or primary generalized. This is an essential step in seizure management, because selecting the antiepileptic drug appropriate for treatment depends largely on distinguishing between these two main seizure types. Although some antiepileptic drugs are effective for both seizure types, many are effective in controlling one type and not the other. Knowledge of the location and distribution of IEDs and ictal discharges is also essential in localizing the surgical focus and selecting candidates for epilepsy surgery.

Certain interictal EEG discharge patterns are characteristic of specific epilepsy syndromes. In the appropriate clinical setting, the hypsarrhythmia pattern is specific for infantile spasms, whereas centrotemporal discharges



induced by sleep are highly suggestive of the syndrome of benign rolandic epilepsy (benign epilepsy with centrotemporal spikes). The diagnosis of the epilepsy syndrome determines the clinical management and prognosis of many seizure disorders. Many epilepsy syndromes are age-dependent in onset and remission, and the likelihood of spontaneous remission is good. In comparison, some syndromes typically are intractable to drug treatment. Also, certain epilepsy syndromes are highly associated with an underlying structural abnormality.

The presence or absence of IEDs can serve as a prognostic factor in assessing the risk of seizure recurrence. Following the first unprovoked seizure, the presence of IEDs is associated with a higher risk of seizure recurrence. Many studies also support the finding that if the current EEG shows IEDs in seizure-free patients who discontinue taking antiepileptic medication, seizures are more likely to recur.

The following should be considered when evaluating patients for epileptic seizure disorders and other paroxysmal events:

- Obtain a sleep recording as well as a wake recording, unless the wake recording has already disclosed IED activity that is sufficient for clinical management.
- Consider partial sleep deprivation before the EEG procedure, especially if a previous EEG did not show epileptiform abnormalities.
- Schedule sleep-deprived patients for EEG to be performed the following morning and not the afternoon.
- If the patient still is unable to fall asleep during the procedure despite sleep deprivation, consider administering chloral hydrate to promote sleep. (Precautions of conscious sedation should be exercised, particularly for children. Instruct the patient not to drive for the rest of the day if a sedative is given.)
- Use anterior temporal electrodes to enhance the probability of recording temporal IEDs.
- Perform photic stimulation and hyperventilation unless contraindicated medically.
- Use precipitating measures for patients whose spells have known precipitants.
- Consider supplementing the “routine” EEG recording with simultaneous video recording if the patient is experiencing daily spells.
- Minimize distortion of sharp transients and paroxysmal activities by minimizing the use of low-pass filter (high linear frequency filter) of less than 70 Hz.
- Use of the timescale or draw speed of 30 mm/second is generally suitable for detecting sharp transients and paroxysmal activities. Lower speed may interfere with the visual detection of low or medium amplitude sharp transients and paroxysmal activities.
- Expanding the timescale (increasing draw speed) helps in assessing phase relationship between sharp waves in different channels. Use additional electrodes when appropriate to enhance detection and localization of sharp transients and paroxysmal activities.
- Use one channel for the electrocardiographic monitor and another channel for oximeter monitoring.
- When the capture of paroxysmal events is still indicated despite having performed the EEG with the above measures, consider ambulatory EEG recording or prolonged monitoring in the epilepsy monitoring unit.

## EEG in the Intensive Care Unit

Recording EEGs in the intensive care unit presents special challenges. Several devices and pieces of equipment in the intensive care unit can introduce artifacts into the EEG recording and make EEG recording difficult, such as electrocardiographic and blood pressure monitors, indwelling catheters, respirators, intravenous pumps, surgical drains, and positive leg pressure devices. Placing electrodes on the patient and recording the EEG may interfere with nursing care and vice versa. Generally, the patients in intensive care who have an EEG study have altered mentation or are experiencing seizures and other paroxysmal events. Thus, recommendations made

above for EEG recording for specific clinical situations should be followed when applicable (i.e., recording the EEG of a patient in coma or with seizures). Additional recommendations for making EEG recordings in the intensive care unit are the following:

- Ensure electrical safety (see Chapter 2). Avoid introducing the patient into the path of a ground loop or double ground, especially a patient with an indwelling cardiovascular catheter.
- Apply electrodes cautiously, and adjust the application accordingly when there are traumatic or surgical wounds at the craniocervical regions, or in patients with cervical spine injuries.
- Observe infection control measures.
- Observe closely for artifacts. Determine and document their origin.
- Document the time and the amount of administration of medications that have CNS effects.
- If artifacts from other equipment interfere excessively with the EEG recording, inquire whether the equipment responsible for the artifacts can be turned off or removed temporarily.
- Modify and document electrode placements if head dressings or wounds interfere with standard electrode placements.
- Consider prolonged recording or intermittent recording to monitor the clinical course of the patient.
- For prolonged monitoring, conduct daily safety and integrity checks of the recording system.
- Consider simultaneous video-EEG recording for evaluating the nature of behavioral or EEG events, and for recognizing sources of EEG artifacts.

## Intraoperative EEG

Electroencephalographic monitoring of the cerebral cortex is performed most often during carotid endarterectomy and epilepsy surgery. Recording in the operating room setting presents challenges similar to those of recording in the intensive care unit. Intraoperative EEG has additional constraints, such as anesthetic agents and limited ability to physically adjust the patient or the equipment. The

recording must be interpreted immediately to provide the information necessary to guide the surgical procedure. Because intraoperative recordings are essentially prolonged monitoring that extends over hours, digital EEG should be used. Digital recording allows prompt retrieval of segments of the recording for side-by-side comparison to assess the course of the patient and the effect of surgical intervention.

## EEG in the Newborn

Frequently, EEG is performed in a full-term or premature newborn for evaluation of suspected abnormal movements and apneic episodes. Clinical manifestations of seizures in the newborn differ from those in older children and adults. Many of the seizure behaviors in the newborn are subtle, and many also mimic normal physiologic events. In the newborn, apnea is much more frequently an epileptic manifestation than it is in older patients. However, apnea in the newborn is also commonly a manifestation of cerebral injury or severe prematurity. For these reasons, EEG is frequently used to detect objective abnormalities that help in determining the mechanism or the nature of the clinical manifestations in the newborn. Recording EEG in the newborn presents unique challenges and requires special skills. Considerable skill is needed in applying electrodes on a small head, especially in premature neonates. The scalp of the newborn is more delicate than that of an older child or adult. Extracerebral monitors such as those for eye movements, respiration, and muscle activity are needed to help define the wake and sleep states in the newborn. Many EEGs of premature newborns are performed in the neonatal intensive care unit. Thus, the requirements and constraints discussed in the preceding section about recording in the intensive care unit setting also apply. In addition, the following should be considered:

- Assure the parents or caregiver about the nature of the study.
- If possible, perform the recording during or right after feeding.
- Use miniature cup electrodes for recording the EEG, surface EMG, eye movements, and electrocardiogram; use piezoelectric transducers or impedance pneumographs for recording respiration.

- In the newborn, oximeter recordings can identify seizures that result in oxygen desaturation.
- Use a nasal thermistor for recording airflow and simultaneous respiratory piezoelectric transducers or impedance pneumographs if apnea is suspected.
- Make certain that the setting is well ventilated if using collodion or acetone. Do not use either of these substances inside an isolette.
- Use a heat lamp, and monitor body temperature if the newborn is removed from the isolette for applying electrodes.
- Note if there is scalp edema, which may affect the EEG recording.
- Use the newborn montage, with fewer electrodes.
- Use the appropriate frequency filter settings and gain to optimize recordings.
- Perform part of the recording with a montage that includes the midline or central regions.
- Adjust or prop the patient's head to minimize electrocardiographic and ballistocardiographic or other movement artifacts.

## EEG in the Epilepsy Monitoring Unit

Video-EEG monitoring has become a major procedure in clinical neurophysiology (see Chapter 11). Currently, epilepsy monitoring is conducted in many hospitals and clinics. The monitoring can be done in a dedicated facility with fixed equipment or in other locations with mobile recording equipment. The advent of digital EEG and video has made it easier to store and access data for review. The correlation between EEG activity and clinical behavior of the patient is enhanced by the simultaneous display of video and EEG data. The recording can be retrieved and reviewed at remote locations as needed if the equipment used for recording, storing, and reviewing data are linked in a network.

Successful use of video-EEG monitoring depends on both technical and nontechnical factors. Epilepsy monitoring is performed best as part of a comprehensive program of patient evaluation and management. Essential participants in the program include nurses,

occupational therapists, psychologists or psychiatrists, and social work personnel. The need for their services should be individualized according to the medical, psychologic, and social conditions of each patient. The following should also be considered when conducting epilepsy monitoring:

- Counsel patients and guardians about the nature and the requirements of the procedure, including the need to push the event button when symptoms occur.
- Ensure a safe monitoring environment. Minimize or strategically locate equipment and furniture. Protect the patient from hard surfaces or protruding fixtures. Use padding if necessary.
- The patient should be accompanied when ambulating if spontaneous or activated seizures are likely to occur. Have selected patients wear helmets.
- Make sure the electrode connections are stable and the patient is in view throughout the monitoring. Use a high-resolution color camera during the daytime and an infrared camera at night to obtain the best video image.
- Facilitate the occurrence of seizures or symptoms by activating procedures if necessary (e.g., withdrawal of antiepileptic drug therapy, sleep deprivation, photic stimulation, hyperventilation, or psychologic suggestion).
- Provide continuous visual monitoring unless the type of spell or seizure is not likely to cause injury. Be aware that patients with epilepsy are at risk for the development of prolonged convulsive seizures after antiepileptic drug treatment has been withdrawn.
- For each patient, provide a plan for preventing or interrupting prolonged seizures or spells. This may include having venous access with a heparin lock. Certified equipment and qualified personnel must be immediately available for cardiorespiratory resuscitation.
- Except for brief seizures such as absence or myoclonic seizures, evaluate the patient when each seizure occurs, noting the time of occurrence.
- Ictal and postictal neurologic evaluations should include tests for alertness,

orientation, comprehension, language, and motor function.

- Document the time and the amount of administration of antiseizure medications or other medications that have CNS effects.
- Conduct daily safety and integrity checks of the recording system.
- Encourage assisted physical activity to minimize complications of long-term bed rest.
- Adjust settings of spike or seizure detection programs according to patient's sleep-wake state and physical activity to optimize detection of events.
  - Secure the leads of intracranial electrodes to minimize pulling or movement.
  - Verify that the connection of intracranial electrode leads to the jackbox is correct.

At our institution, the connections are verified by two technologists each time it is made, and they document their verification by signing on the daily technologist worksheet.

## SUMMARY

The major value and primary application of clinical neurophysiology is in the assessment and characterization of neurologic disease. Selection of appropriate studies for the problem of an individual patient requires a careful clinical evaluation to determine possible causes of the patient's symptoms. The nature of the symptoms and the conclusions of the clinical evaluation are the best guides to appropriate use of clinical neurophysiologic testing.

The approach to testing can be assisted by deciding which structures are likely to be involved. EEG, autonomic function testing, and polysomnography provide distinct assessment of disturbances of consciousness, cognition, visceral function, and sleep. The level of the nervous system that is likely to be involved by the disease process can also guide selection of the neurophysiologic methods that will be most helpful in sorting out the clinical problem. Disorders of the cerebral hemisphere are best characterized electrically by EEG, SEPs, polysomnography, and movement recordings.

# Application of Clinical Neurophysiology: Assessing Peripheral Neuromuscular Symptom Complexes

*Devon I. Rubin and Jasper R. Daube*

## **CLINICAL NEUROPHYSIOLOGY IN THE ASSESSMENT OF PERIPHERAL NERVOUS SYSTEM DISORDERS**

Confirming a Clinical Diagnosis  
Excluding Alternate Diagnoses  
Localizing the Disease  
Identifying Disease in Patients Who  
Are Difficult to Examine Clinically  
Identifying Subclinical Disease  
Characterizing Disease  
Pathophysiology  
Defining Disease Severity  
Defining Stage and Evolution of  
Disease  
Determining Prognosis  
Identifying Disease Types

## **ASSESSING CLINICAL DISORDERS: ASSESSMENT WITH EMG AND NCS RADICULOPATHIES**

Cervical and Lumbosacral Radiculopathies  
Thoracic Radiculopathies

## **COMMON FOCAL MONONEUROPATHIES**

Carpal Tunnel Syndrome  
Ulnar Neuropathy  
Peroneal Neuropathy

## **PERIPHERAL NEUROPATHY**

Defining Pathophysiology of  
Peripheral Neuropathies  
(Axonal vs. Demyelinating)  
Axonal Neuropathies  
Demyelinating Neuropathies

## **BRACHIAL PLEXOPATHY**

Trunk Lesions  
Cord Lesions

## **GENERALIZED WEAKNESS MYOPATHY**

**MYALGIAS, MUSCLE STIFFNESS,  
AND EPISODIC MUSCLE  
WEAKNESS**

## **NMJ DISORDERS**

**POLYRADICULOPATHY  
MOTOR NEURON DISEASE  
FACIAL WEAKNESS**

## **ANOMALOUS INNERVATION**

Martin-Gruber Anastomosis  
Riche–Cannieu Anastomosis—“All  
Ulnar Hand”  
Accessory Peroneal Nerve

**UNEXPECTED FINDINGS ON  
NERVE CONDUCTION  
STUDIES: CAUSE AND ACTION  
SUMMARY**

## CLINICAL NEUROPHYSIOLOGY IN THE ASSESSMENT OF PERIPHERAL NERVOUS SYSTEM DISORDERS

When a patient comes to a physician with specific complaints, the assessment of neurologic disease begins with generating a hypothesis about the location and type of disease based on the patient's symptoms, history, and the results of the neurologic examination. A hypothesis is formulated on the neural system(s) involved, the level of involvement, the type of disease, and the prognosis. If there is sufficient certainty that the hypothesis is correct, electrophysiologic testing may not be needed. However, in many instances, precise anatomic localization may be difficult and more than one system may be involved. Neurophysiologic testing can assist in confirming the suspected localization. In the peripheral nervous system, a disease can be localized to the spinal cord, brain stem, spinal root, plexus, peripheral nerve, neuromuscular junction (NMJ), or muscle, and may involve any combination of the motor system, sensory system, or autonomic nervous system. The neurophysiologic tests used to confirm the localization and the systems involved are selected based on the patients' symptoms. In addition to localization, clinical neurophysiology can help define a number of important features of the underlying problem.

### Confirming a Clinical Diagnosis

The most common application of clinical neurophysiology is to confirm a suspected clinical diagnosis. Uncertainty about the diagnosis usually reflects an atypical or incomplete symptom complex, incomplete or mixed findings that do not all fit with the suspected disorder, a relatively mild stage of the disease with a minimum of symptoms and signs, or unexpected findings that are not consistent with the diagnosis. For example, a patient with a recent history of mild, symmetric proximal arm and leg weakness may be clinically suspected of having a myopathy, such as polymyositis. The findings on electrodiagnostic testing can help to confirm an underlying muscle disease.

### Excluding Alternate Diagnoses

Clinical neurophysiology can be of value when a specific disease is suspected, but other diseases with similar findings have to be excluded. For example, a patient with hand numbness and arm pain may have clinical features suggestive of carpal tunnel syndrome (CTS) although a C6 radiculopathy might also be a possibility; nerve conduction studies (NCS) and needle electromyography (EMG) can be used to help exclude the latter.

### Localizing the Disease

Clinical neurophysiology may help localize the disease with a precision not possible clinically. Localization may be general, such as identifying a disorder at the NMJ in a patient with generalized weakness. Additionally, localization may be focal and precise along a nerve, such as when short segmental stimulation studies ("inching") on NCS identify compression at the aponeurosis of the flexor carpi ulnaris muscle as the cause of an ulnar neuropathy.

### Identifying Disease in Patients Who Are Difficult to Examine Clinically

In situations in which the physician cannot obtain an adequate clinical history or perform an adequate neurologic examination, clinical neurophysiology may provide the information needed to make a diagnosis. These situations include patients who are in the intensive care unit, have dementia or psychiatric disease, or may not be able to cooperate. A language barrier may interfere with taking a medical history and performing a neurologic examination. When traumatic injuries such as fractures or postoperative immobilization preclude thorough neurologic examination, clinical neurophysiology may be able to assess function and provide essential information.

### Identifying Subclinical Disease

Several electrophysiologic techniques can be used to identify subclinical disease by detecting



an abnormality that either is below threshold for clinical identification or has no clinical accompaniments. Examples include slowing of conduction in a hereditary neuropathy with no deficit, fibrillation potentials in a radiculopathy with no clinical deficit and widespread fibrillation potentials from ALS with deficit in only one arm.

## Characterizing Disease Pathophysiology

In clinical situations in which the physician is able to localize a disorder to the peripheral nervous system, clinical neurophysiology may be needed to characterize the disease. In disorders of the peripheral nerve, the combination of findings on NCS and needle examination can help to classify the problem with major implications for identifying the underlying etiology and determining prognosis.

In disorders of the peripheral nerve, several mechanisms may define the underlying pathophysiology:

**Conduction block.** In a neuropraxic nerve lesion due to focal demyelination or a focal region of inexcitability of the nerve, a localized block of conduction of the action potentials occurs along some or all of the axons. The proportion of fibers that are blocked in a nerve directly correlates with the amount of clinical deficit. With complete block, there is no voluntary movement of the muscle innervated by the affected nerve, whereas with partial block, there is some degree of weakness. Nerve function proximal and distal to the conduction block can be entirely normal. Conduction block may be caused by either metabolic or structural changes. Conduction block caused by local anesthetics, anoxia, and some toxins may improve over minutes to hours and may not be associated with histologic alteration. Conduction block caused by distortion or loss of myelin persists for days to weeks, because it requires remodeling of the histologic abnormality. Conduction block caused by either of these mechanisms may not improve if the offending mechanism is not eliminated.

**Partial demyelination.** Slowing of conduction is usually caused by myelin changes and, thus, requires weeks to months for improvement

to occur if the underlying cause can be eliminated. In contrast to conduction block, slowing of conduction alone may be associated with little or no clinical deficit.

**Axonal degeneration.** Axonal disruption or degeneration is associated with a loss of axons through Wallerian degeneration. Therefore, recovery of function depends on reinnervation. Reinnervation can occur rapidly, within days to weeks, if the number of axons lost is not great and the remaining axons can provide reinnervation by local collateral sprouting. Reinnervation is much slower, over months to years, if it requires sprouting and growth of the damaged axons.

Electrophysiologic changes in muscle, as identified during needle EMG, associated with nerve damage depend primarily on whether the degeneration is Wallerian. Slowing of conduction is not associated with measurable changes on needle EMG or in estimates of the number of motor units. Conduction block is associated with reduced recruitment of motor unit potentials (MUPs) on needle EMG and reduced estimates of the number of motor units proximal to the site of damage. Wallerian degeneration produces reduced recruitment of MUPs, reduced estimates of the number of motor units, and muscle changes associated with denervation and reinnervation.

Denervation of muscle results in a loss of the trophic factors that maintain normal membrane function. With the loss of innervation, a muscle fiber discharges spontaneously and the associated discharges are *fibrillation potentials*. Fibrillation potentials develop 1–3 weeks after acute denervation. Delay in their appearance varies with species and muscle characteristics. In humans, the delay depends most on the length of axon attached to the muscle fiber. If axonal destruction occurs close to a muscle fiber, fibrillation potential develops more quickly than if the damage is more proximal (i.e., the shorter the segment of axon attached to the muscle, the more quickly Wallerian degeneration occurs). The corollary is that muscles closer to the lesion show fibrillation potentials sooner than muscles more distant to the damage.

The reinnervation of muscle is associated with a defined sequence of changes in the estimate of the number of motor units and in MUPs. If reinnervation is by collateral

sprouting, the estimate of the number of motor units remains low and increases only in proportion to the number of axons that regenerate and reach the muscle. With initial reinnervation, MUPs consist of activity in only a small number of muscle fibers, with poor synchrony of firing and unstable NMJs. Therefore, potentials are low amplitude, polyphasic, and unstable. These have been called *nascent MUPs*. As reinnervation proceeds to include more muscle fibers with better synchrony of firing, MUPs become higher in amplitude, longer in duration, less polyphasic, and more stable. Therefore, late after reinnervation, MUPs are of long duration and high amplitude. Reinnervation is usually completed by less than the normal number of axons; thus, recruitment is decreased because there are fewer motor units. These changes are summarized in Tables 47-1, 47-2, and 47-3. Both conduction block and axonal disruption can have different time courses, depending on the underlying mechanism and the number of axons involved. The changes over time in compound muscle action potentials (CMAPs) and the results of needle EMG examination after a localized nerve injury are shown in Tables 47-1, 47-2, and 47-3.

### Defining Disease Severity

Clinical assessment usually can define the severity of a disease as *mild*, *moderate*, *severe*, or *with total loss of function*. Clinical neurophysiology can quantitate the severity with reproducible measures of the extent of abnormality that can then be followed over time. Quantitation can assist in making decisions about the best treatment and prognosis, especially the likelihood of improvement. As an example, NCS can define a 30% block, rather than axonal loss, as the cause of weakness in a peroneal neuropathy. Such quantitation provides evidence that the process is relatively mild and a good recovery can be expected.

### Defining Stage and Evolution of Disease

Selecting a treatment for the cause of symptoms requires identifying the underlying disease and its stage. It is not sufficient to know that a patient's symptoms are caused by a localized lesion in the midthoracic

**Table 47-1 Compound Muscle Action Potential Amplitude after Peripheral Nerve Injury\***

	Amplitude		
	0-5 Days	After 5 days	During recovery
<i>Conduction block</i>			
Proximal stimulation	Low	Low	Increases
Distal stimulation	Normal	Normal	Normal
<i>Axonal disruption</i>			
Proximal stimulation	Low	Low	Increases
Distal stimulation	Normal	Low	Increases

\* Supramaximal stimulation.

**Table 47-2 Results of Needle Examination after Peripheral Nerve Injury**

	0-15 Days	After 15 days	During recovery
<i>Conduction block</i>			
Fibrillation potentials	None	None	None
Motor unit potentials	↓ number	↓ number	↑ number
<i>Axonal disruption</i>			
Fibrillation potentials	None	Present	Reduced
Motor unit potentials	↓ number	↓ number	Nascent

↓, decrease; ↑, increase.

**Table 47–3 Interpretation of Electromyographic Findings after Peripheral Nerve Injury**

<b>Finding</b>	<b>Interpretation</b>
<i>0–5 Days</i>	
Motor unit potentials present	Nerve intact, functional axons
Fibrillation potentials present	Old lesion
Low-amplitude compound action potential	Old lesion
<i>5–15 Days</i>	
Compound action potential, distal only	Conduction block
Low-amplitude compound action potential	Axonal disruption
Motor unit potentials present	Nerve intact
<i>After 15 days</i>	
Compound action potential, distal only	Conduction block
Motor unit potentials present	Nerve intact
Fibrillation potentials	Axonal disruption
<i>Recovery</i>	
Increasing compound action potential	Block clearing
Decreasing number of fibrillation potentials	Reinnervation
Nascent motor unit potentials	Reinnervation

spinal cord without knowing the nature of the lesion. Thoracic cord disease caused by a herniated disk, intraspinal tumor, arteriovenous malformation, multiple sclerosis, or vitamin B12 deficiency is treated differently. Clinical neurophysiology can help define prognosis by classifying changes as acute, subacute, chronic, or residual from an old process. Whether the disease is rapid, intermediate, slow, stable, or improving produces different clinical neurophysiologic findings. An *acute process* develops within seconds to a few days. A *subacute disorder* evolves over a few days to weeks and a *chronic disorder*, over months to years. In *progressive diseases*, there is increasing damage and impairment of function. Improvement occurs when the disease process subsides and neural mechanisms of repair can begin to reduce the severity of damage. In a *stable process*, damage has occurred but remains unchanged, because either the rate of neural reparative processes is able to keep pace with the rate of neural damage in a chronic continuous disorder or the disease process has subsided entirely but the damage cannot be repaired. This usually is referred to as a *residual of the disease*.

### Determining Prognosis

Although several clinical neurophysiologic procedures can define the severity of a disease

process, the procedures vary in their ability to characterize the stage of evolution of the disease or to provide prognostic information. Compared with other neurophysiologic techniques, EMG and NCS are more consistent for detecting abnormalities that typify the stage of development of an underlying neurologic disorder. Clinically valuable prognostic information can be gained from EMG and NCS in many peripheral nerve disorders. Identification of disease type with EMG is well known, but changes in EMG findings with time are less familiar. Recognition of different stages in the evolution of a disease depends on understanding the pathophysiologic changes that occur in nerve and muscle. The three types of nerve damage—conduction block, slowing of conduction, and axonal destruction—evolve over very different time courses. Secondary changes in muscle with each of these evolve over time courses that vary with severity of disease.

### Identifying Disease Types

Clinical neurophysiology can facilitate identification of specific diseases. Electrophysiologic testing can sometimes supplement the initial classification of a disease as vascular, inflammatory, degenerative, or neoplastic, but it does so in different ways for different tests. In many instances, only a broad category of disease can be suggested, but in others, specific diseases

can be identified. These are described in detail in the chapters on each of the techniques. The following are some examples.

- NCS help distinguish demyelinating disease from axonal disease. Marked slowing and dispersion are evidence of a demyelinating neuropathy, which may be caused by either an inherited or an acquired disorder.
- Repetitive nerve stimulation (RNS) can demonstrate specific patterns of abnormalities seen in myasthenia gravis (MG) and distinguish them from Lambert-Eaton myasthenic syndrome.
- Occasionally, EMG can assist in identifying specific disorders by characteristic findings such as fibrillation potentials and short duration MUP with polymyositis or radiation damage with myokymia.
- Autonomic function testing can provide evidence of specific disorders such as multisystem atrophy or reflex sympathetic dystrophy.

Physicians and clinical neurophysiologists must be aware of the potential applications of clinical neurophysiology and make full use of them. The focus of this section is on considerations important in deciding whether one or more clinical neurophysiologic techniques are warranted for a particular clinical problem and on applications of testing and interpretation of findings in different types of neuromuscular disorders.

## ASSESSING CLINICAL DISORDERS: ASSESSMENT WITH EMG AND NCS

Since the types and locations of neuromuscular disorders are relatively well defined, algorithms and approaches to testing a patient with a suspected specific disorder can be developed. The algorithms must take into account findings obtained during the test in order to determine the amount and types of testing that should be performed. They are *suggestions* for EMG and NCS in neuromuscular disorders and nearly always need to be modified according to the particular problem and findings in individual

cases. The following sections outline the utility of electrophysiologic tests, discuss typical findings, and review general guidelines and approaches for different types of neuromuscular problems. Protocols and algorithms to guide the assessment of these problems are included in the accompanying CD.

## RADICULOPATHIES

The diagnostic value of EMG in assessing patients with a suspected radiculopathy includes answering the questions: (1) Is there evidence of radiculopathy? (2) Which nerve root is involved in the radiculopathy? (3) How severe is the neural damage caused by the radiculopathy? (4) Is the radiculopathy of recent onset, is it ongoing, or is it a residual of an old lesion? (5) Is there evidence of other peripheral nerve disease? EMG does not define the cause of the radiculopathy, and the findings on testing may be similar whether the radiculopathy is caused by a disk, tumor, or diabetes mellitus. Because disorders of the nerve roots produce changes only if the nerve fibers are damaged, EMG can never exclude the presence of a radiculopathy and EMG findings may be normal even when the radiculopathy causes severe pain.

## Cervical and Lumbosacral Radiculopathies

NCS may be of assistance in the evaluation of cervical and lumbosacral radiculopathies, but have limitations. They are most useful for identifying or excluding other peripheral nerve disorders, such as mononeuropathies or plexopathies, that may clinically mimic radiculopathies. The most sensitive and important method used to evaluate radiculopathies is needle EMG. Identifying abnormalities on the needle examination confined to muscles innervated by a common nerve root, and particularly involving the paraspinal muscles, helps to confirm a radiculopathy. Furthermore, the specific spontaneous waveforms and MUP changes assist in identifying the temporal profile of the radiculopathy and in the determination of whether there is ongoing denervation ("active" radiculopathy). The utility and limitations of

each type of electrophysiologic tests are discussed below.

**Motor NCS.** The most commonly performed motor NCS are the median and ulnar in the arm and the peroneal and tibial in the leg. The most common abnormality that may be seen with radiculopathies in motor NCS is a reduction in CMAP amplitudes, generally with mild or no slowing in the conduction velocities depending on the severity of axonal loss. The degree of amplitude reduction correlates with the degree of axonal loss from Wallerian degeneration. However, these routine motor NCS are limited in that they only assess the C8–T1 roots and L5–S1 roots. Therefore, in patients with suspected radiculopathies in other roots, routine NCS will be normal. Motor NCS of other nerves can be performed, such as femoral (rectus femoris) for an L3–4 radiculopathy, radial (extensor digitorum communis [EDC] recording) for C7–8 radiculopathy, and musculocutaneous (biceps) for C5–6 radiculopathy. However, given the large size of the muscle being recorded in these NCS, abnormalities will generally not be seen unless the radiculopathy is very severe. Furthermore, in radiculopathies that primarily involve the dorsal root and cause pain and sensory loss but no motor involvement, motor NCS will not demonstrate any abnormalities.

**F waves and H reflexes.** Late responses, such as F waves and H reflexes, can measure proximal conduction through the nerve roots. Similar to standard motor NCS, ulnar and median F waves assess conduction through the C8–T1 root; peroneal and tibial F waves through the L5–S1 roots. The H reflex is most commonly recorded from the soleus muscle and assesses the S1 root. Occasionally, the C6–7 root can be assessed if the median H reflex is recorded from the flexor carpi radialis (FCR). Prolongation of the latencies of F waves indicates proximal slowing in the motor fibers, while prolongation of the H-reflex latencies indicates proximal slowing in the motor or sensory fibers. In a small proportion of patients with lesions of the C7, C8, L5, or S1 nerve root, particularly those with recent damage, the F waves or H reflexes may be abnormal when other measurements are normal. It must be recalled that F waves and H-reflex latencies are generally most prolonged in a patient who has a

marked loss of axons and can be residual of an old radiculopathy.

**Sensory NCS.** Sensory nerve action potentials (SNAPs) should be normal in nerve root disease, since root diseases typically involve the root proximal to the dorsal root ganglion. As a result, SNAPs help in differentiating radiculopathies from more peripheral diseases. The choice of sensory NCS should reflect the distribution of sensory symptoms. Commonly performed sensory studies include the median and ulnar antidromic, radial, sural, or superficial peroneal.

**Needle EMG.** The most useful method for identifying radiculopathy is needle EMG. Since EMG changes evolve over time, the age of the lesion can be judged from both the distribution and the type of abnormality. The severity of damage can be estimated by the amount of motor fiber degeneration (fibrillation potentials and MUP changes). Well-defined fibrillation potentials are not seen until 3 weeks after nerve damage. Examination of the paraspinals is particularly important, since changes in paraspinal muscles localize the process proximal to the plexus. Proximal and paraspinal muscles are the earliest to show fibrillation potentials (evidence of axonal destruction) and also the earliest to show improvement. Unfortunately, persistent abnormalities in paraspinal muscles due to local muscle trauma following neck or back surgery preclude postoperative testing and interpretation of abnormalities in these muscles. The peripheral distribution of an abnormality defines the root involved. EMG is particularly valuable in differentiating relatively recent nerve damage with abundant fibrillations (especially in proximal muscles) from the residual of an old disease with scanty fibrillation potentials (mainly in distal muscles).

## Thoracic Radiculopathies

There are limited electrophysiologic studies that can be reliably used to evaluate for a thoracic radiculopathy. NCS are generally not helpful, since there are no reliable techniques used to stimulate or record from the intercostal nerves. The exception is T1 radiculopathies, in which the median motor amplitude may be



low if there is sufficient axonal loss. Needle examination of the thoracic paraspinal muscles as well as the rectus abdominis or external oblique abdominal muscles may demonstrate findings in thoracic radiculopathies.

## COMMON FOCAL MONONEUROPATHIES

Electrophysiologic changes on NCS in mononeuropathies vary with the rapidity of development, the duration and severity of damage, and the underlying pathologic condition. Localized narrowing of axons or paranodal or internodal demyelination caused by a chronic compressive lesion produces localized slowing of conduction. Narrowing of axons distal to chronic compression results in slowing of conduction along the entire length of the nerve. Telescoping of axons with intussusception of one internode into another produces distortion and obliteration of the nodes of Ranvier and, thus, results in a conduction block. Moderate segmental demyelination and local metabolic alterations are often associated with conduction block. With stimulation proximal to the site of damage, the conduction block is manifested as lower amplitude evoked responses. In an acute lesion with disruption of the axons, the segment of nerve distal to the lesion may continue to function normally for up to 5 days; then, as the axons undergo Wallerian degeneration, they cease to conduct and the amplitude of the evoked response diminishes and finally disappears. One week after an acute injury, the amplitude of the evoked response is a rough gauge of the number of intact viable axons. Interpretations of the duration and severity of nerve injury after focal neuropathies and radiculopathies can be made on the basis of an analysis of the combination of these changes. Examples of these interpretations are given in Tables 47-1, 47-2, and 47-3.

### Carpal Tunnel Syndrome

In patients with hand numbness and suspected CTS, electrodiagnostic testing is useful in confirming the localization to the median nerve at the wrist and defining the severity of the lesion. Sensory and motor NCS are the most useful studies to assess for median

mononeuropathies. While needle EMG cannot precisely localize the problem to the region of the carpal tunnel, it is also important to help define the degree of denervation in the thenar muscles, as well as to exclude other superimposed disorders, such as proximal median neuropathies or cervical radiculopathies.

*Motor NCS.* The median motor NCS will often be normal in patients with mild CTS; however, with more severe or long-standing nerve compression, the motor fibers may be affected. In most instances, the median nerve recorded from the abductor pollicis brevis (APB) will demonstrate prolongation of the latency with stimulation at the wrist. Occasionally, slowing of the median motor conduction velocity (CV) in the forearm may occur. With severe CTS in which axonal loss has occurred, the CMAP amplitude will be reduced. In cases where no response can be recorded from the APB, median and ulnar nerve stimulation while recording from the second lumbrical and palmar interosseus may demonstrate prolongation of the median-lumbrical latency.

*Sensory NCS.* Sensory NCS are the most sensitive and earliest affected in CTS. Prolongation of the distal latency (DL) followed by reduction in the SNAP amplitudes occurs with increased severity of disease. Stimulation and recording over the shortest segment of nerve, such as with orthodromic palmar studies, increases the sensitivity of the study compared to stimulation and recording over longer nerve segments. Additionally, in very mild CTS, comparison of the median nerve latency with either the ulnar or the radial nerve latencies recorded over the same distance of nerve segment may be the only abnormality.

*Needle EMG.* Needle examination of the APB or opponens pollicis provides evidence of axonal damage when conduction studies are still normal. Fibrillation potentials correlate with the degree of axonal loss and long-duration MUPs indicate chronicity of the syndrome. Examination of proximal median and other nonmedian nerve innervated muscles is useful to exclude other nerve disorders.

The abnormalities on NCS and needle EMG may improve following treatment, such as surgical decompression. However, the findings



may not always resolve completely and some degree of abnormalities may persist indefinitely.

## Ulnar Neuropathy

Similar to CTS, NCS provide important information in localizing a disorder to the ulnar nerve. In patients with hand weakness and sensory loss in the 4th or 5th digit, electrodiagnostic testing is utilized to confirm an ulnar neuropathy and exclude C8 radiculopathies or lower trunk/medial cord plexopathies. The confirmation of an ulnar neuropathy at the elbow often relies on the identification of conduction slowing across the elbow (compared to forearm nerve segments), conduction block across the elbow, or needle examination findings limited to muscles supplied by the ulnar nerve. In most instances, the ulnar neuropathy will be localized to the region of the medial epicondyle or the cubital tunnel. Rarely, ulnar neuropathies will occur at the wrist or in the hand.

**Motor NCS.** The ulnar motor nerve conduction study is the most useful test to precisely localize the site of ulnar nerve compression. Recording is most often performed from the abductor digiti minimi (ADM); however, in patients with greater weakness in the first dorsal interosseus (FDI), recording should also be made from this muscle. Well-defined criteria to identify an ulnar neuropathy at the elbow have been published,<sup>1</sup> and include slowing of CV across the elbow of  $>10$  m/second compared to the forearm CV, reduction in the CMAP of  $>20\%$  with elbow stimulation compared to the wrist stimulation (in the absence of a median–ulnar anastomosis), or focal conduction block identified with short segment stimulation across the elbow. In more severe ulnar neuropathies, the CMAP amplitude may be reduced. In longstanding ulnar neuropathies, slowing will be present along the entire nerve distal to the site of the damage. In patients with only intrinsic ulnar hand muscle weakness, and with a normal ulnar motor response recorded from the ADM, recording from the FDI should be performed and compared to the unaffected side to assess for a lesion involving the deep branch of the ulnar nerve in the hand. In addition, performance of the median motor NCS is useful

to exclude a C8–T1 radiculopathy or lower trunk plexopathy. Mild slowing along the entire length of the ulnar nerve occurs with a moderately severe C8 or lower trunk damage and loss of faster conducting axons.

**Sensory NCS.** Similar to the ulnar motor NCS, the ulnar sensory NCS may demonstrate slowing of CV or reduction in amplitude. In fact, the sensory NCS are often affected earlier and more severely than the motor conduction. Conduction block is difficult to identify on sensory conduction studies, but may occasionally be identified with stimulation above and below the elbow when compared to the unaffected side. In ulnar neuropathies at the wrist, the dorsal ulnar cutaneous NCS should be spared even when the ulnar antidromic study is involved. If a lower trunk plexopathy is considered and the ulnar sensory NCS is abnormal, medial antibrachial studies may be useful and will be abnormal in lower trunk plexopathies.

**Needle EMG.** Needle EMG is used to assist in localizing the lesion and determine the chronicity and degree of axonal loss. In ulnar neuropathies at the elbow, abnormal findings are most severe in the FDI and ADM, but forearm muscle abnormalities will confirm proximal damage if conduction studies are non-localizing. Examination of nonulnar innervated muscles is important to exclude alternative localizations, such as low cervical radiculopathies or plexopathies.

## Peroneal Neuropathy

The electrodiagnostic confirmation of peroneal neuropathy relies on identification of conduction block or slowing along only the peroneal nerve. This usually involves the common peroneal nerve at the fibular head. Isolated involvement of the superficial or deep peroneal nerve can occur. NCS will demonstrate focal slowing or conduction block in lesions characterized by focal demyelination, and amplitude reduction when axonal loss occurs. When a focal demyelinating lesion is identified with routine studies, short segment (“inching”) studies can be performed, as in the ulnar nerve, to attempt to more precisely localize the lesion.

**Motor NCS.** The peroneal motor NCS, recording from either extensor digitorum brevis or anterior tibialis muscles, are used to identify focal demyelination. When >20% amplitude reduction is present with knee stimulation compared to ankle stimulation, stimulation at the fibular head should be performed. In peroneal neuropathies characterized by axonal loss, CMAP amplitude reduction is typically seen. Tibial NCS should also be performed to assess for a sciatic nerve lesion or lumbosacral plexopathy. With a long-standing peroneal neuropathy at the knee, slowing will be present along the entire length of the nerve distal to the knee.

**Sensory NCS.** The superficial sensory nerve is the only peroneal sensory nerve that can be studied. In most peroneal neuropathies, this sensory nerve is affected early and more severely than motor fibers. However, in lesions characterized by focal demyelination, the superficial peroneal sensory response may be preserved since the conduction block occurs proximal to the segment of the nerve studied. Also, in patients with isolated involvement of the deep peroneal nerve, the superficial peroneal sensory response will also be normal.

**Needle EMG.** Needle EMG is important to confirm a peroneal neuropathy, localize the lesion along the peroneal nerve when precise localization cannot be made with conduction studies, and define the severity. Muscles supplied by both the deep and the superficial branches of the peroneal nerve should be examined. When distal peroneal muscles are abnormal, examination of the short head of the biceps (the most proximal muscle innervated by the peroneal nerve) is important to identify the proximal extent of the lesion. Additionally, other L5 muscles not innervated by the peroneal nerve should be studied to exclude L5 radiculopathy or lumbosacral plexopathy.

## PERIPHERAL NEUROPATHY

Electrodiagnostic testing is important to confirm the presence of a disorder involving the peripheral nerves diffusely, and distinguish a “length-dependent” or distal predominant

peripheral neuropathy from a polyradiculopathy, multiple lumbosacral radiculopathies, or from spinal cord or nonorganic disease. It also has utility in providing information regarding underlying pathology and classification of neuropathies, such as differentiation of a predominant demyelinating vs. axonal neuropathy, identifying involvement of motor and sensory fibers, and determining chronicity of the disease. Distinguishing these characteristics may assist in identifying the potential etiologies of neuropathy. Most neuropathies are characterized by a “length-dependent” pattern of nerve involvement, and the findings are most evident in the most distal nerves and muscles. In axonal neuropathies, motor and sensory NCS amplitudes are often decreased or absent, with relative sparing of the conduction velocities and distal latencies. However, with sufficient loss of large, fast conducting axons, a mild degree of conduction slowing may occur. In contrast, in predominantly demyelinating neuropathies, significant CV slowing and prolongation of the latencies, out of proportion to amplitude reduction, are prominent features. The findings of increased temporal dispersion or conduction block are characteristic of segmental demyelination and suggest an autoimmune, or inflammatory etiology.

In most cases, the etiology of the neuropathy cannot be determined by electrophysiologic testing. Most toxic, metabolic, or nutritional neuropathies are predominantly axonal neuropathies. Occasionally, clues to the underlying etiology are noted by the pattern of findings, such as the finding of a mixed axonal and demyelinating, length-dependent neuropathy along with paraspinal fibrillation potentials in diabetes or bilateral CTS superimposed on a largely axonal neuropathy in amyloidosis. With many nerves and muscles available to test, the most appropriate ones must be selected. For example, plantar nerves show earlier abnormalities in neuropathy than more proximal sensory nerves.

NCS are the most direct measure of the functionality of the nerve, and abnormalities reflect the severity of the neuropathy, the underlying pathology, and the duration of the symptoms. In most “length-dependent” sensorimotor peripheral neuropathies, certain typical patterns of findings are commonly seen.

- Sensory NCS are often affected earlier and more severely than motor NCS.
- Lower extremity NCS are affected earlier and more severely than upper extremity NCS.
- NCS abnormalities affect nerves of similar length to a similar degree (e.g., peroneal = tibial, median = ulnar).

Although not all peripheral neuropathies demonstrate these features, caution should be taken in making the diagnosis of a “length-dependent peripheral neuropathy” when variations of these findings are seen. For example, with some exceptions, patients who have predominantly upper extremity symptoms with abnormal NCS in the arms and normal lower extremity NCS are more likely to have another process, such as median or ulnar neuropathies. Patients who demonstrate significant asymmetry in findings are more likely to have a radiculopathy, polyradiculopathy, mononeuritis multiplex, or focal mononeuropathy. Patients who have unequal involvement of similar length nerves may have another process such as a radiculopathy or mononeuropathy. For example, a peroneal CMAP amplitude of 0.2 mV with a tibial CMAP amplitude of 12 mV would raise the possibility of a peroneal neuropathy or L5 radiculopathy.

Normal findings on electrophysiologic testing do not exclude peripheral neuropathy. The results of NCS and EMG are often normal with only small-fiber involvement in diabetic, amyloid, or some hereditary sensory neuropathies. Alternatively, EMG may provide evidence of nerve damage before it is evident clinically, such as in patients with complaints of vague or nonspecific pain or those with diabetes.

The evaluation of patients with a suspected generalized neuropathy includes motor and sensory NCS and needle EMG. Each of these studies provides important information related to peripheral neuropathy.

**Motor NCS.** The most commonly performed motor NCS are those that are the most distal and likely to be involved early in a neuropathy, such as the peroneal (EDB) and tibial (abductor hallucis [AH]). If the responses to both of these are absent or markedly low, a peroneal motor NCS recording from the anterior tibialis or a median or ulnar motor NCS may

be useful to determine the underlying pathophysiology. The degree of amplitude reduction correlates with the degree of axonal loss. Careful observation of the waveforms to assess for abnormal dispersion or conduction block in demyelinating neuropathies is important. Since motor NCS reflect the integrity of the motor nerve fibers as well as the neuromuscular junction (NMJ) and muscle, interpretation of abnormalities on motor NCS must be made in the context of other findings on NCS and needle examination. Several general points are important to consider in the interpretation of motor NCS in the evaluation of peripheral neuropathy:

- The amplitude and area of the recorded CMAP reflect the number and integrity of the axons, while the DL and CV reflect both the integrity of myelin sheath and the number of large conduction axons.
- Loss of substantial number of large diameter axons may lead to a slowing of the CV (and mimic “demyelination”). Therefore, electrophysiologic criteria for demyelination should be met (discussed later) before a “demyelinating” neuropathy is diagnosed.
- The waveform morphology is as important as the absolute numerical data of each motor conduction study since temporal dispersion and focal conduction block, which are indicators of segmental demyelination, cannot be identified without scrutiny of the waveforms.
- Standard motor NCS measure the conduction in distal segments of the nerves, recorded from distal muscles. Since in most sensorimotor peripheral neuropathies the distal nerves are affected more than the proximal nerves, abnormalities in routine motor NCS would be expected. The proximal segment of the nerve is less frequently affected and can be assessed with proximal nerve stimulation (e.g., at Erb’s point) or with late reflexes, such as the F waves. When the proximal nerve segments are abnormal, a disorder such as a polyradiculopathy is more likely than a peripheral neuropathy.

Disorders that produce abnormalities only on motor NCS while sparing sensory conduction are less common than sensorimotor peripheral

**Table 47–4 Disorders Producing Low Motor CMAP Amplitudes without Sensory Involvement**

Diffuse, symmetric motor neuropathies	Acute inflammatory demyelinating polyradiculopathy (AIDP) Chronic inflammatory demyelinating polyradiculopathy (CIDP) Paraproteinemia (e.g., monoclonal gammopathy of undetermined significance) Spinal muscular atrophy GM1-associated motor neuropathy Lead intoxication
Diffuse or focal, asymmetric motor neuropathies	Amyotrophic lateral sclerosis  Multifocal motor neuropathy with conduction block Monomelic amyotrophy (Sobue, Hirayama syndrome)
Nonneurogenic disorders with low CMAP amplitudes	Distal myopathies (Inclusion body myositis, distal dystrophies) Lambert–Eaton myasthenic syndrome

neuropathies. Etiologies of motor predominant neuropathies or other disorders involving only motor NCS to be considered are listed in Table 47–4.

*F waves.* F-wave latencies provide a measure of proximal conduction and, in some disorders, may show early abnormality. F estimates provide a simple, convenient method to determine the proximal–distal distribution of conduction slowing. The F estimate is calculated from the limb length, peripheral CV, and DL, thus predicting the F latency on the assumption that the CV is the same along the entire length of the nerve. If the F latency is the same as the F estimate, conduction is the same along the entire length, be it normal or slow (the latter suggests a polyradiculoneuropathy). If the F latency is less than the F estimate, then conduction is faster proximally as would be expected with a peripheral neuropathy. If the F latency is longer than the F estimate, then conduction is slower proximally, as would be expected with a polyradiculopathy.

*Sensory NCS.* Sensory nerves are more susceptible to metabolic or toxic insults than motor nerves and are therefore affected prior to and more severely than motor nerves in most types of neuropathy; this is similar to

what is seen clinically with patients' complaints of sensory symptoms and objective sensory loss prior to development of weakness. In the American Association of Neuromuscular and Electrodiagnostic Medicine (AANEM) consensus statement on identification of peripheral neuropathy, an abnormal sural sensory response along with an abnormality in at least one other nerve is considered the minimal degree of abnormality necessary to support an electrodiagnosis of a distal sensorimotor peripheral neuropathy.<sup>2</sup> In more severe cases, upper extremity sensory NCS are also affected. Several important issues are necessary to consider with respect to sensory NCS in the evaluation of peripheral neuropathy.

- **Normal sensory responses do not necessarily exclude a peripheral neuropathy.** A relatively preserved sural sensory response may not be “normal.” The amplitude may be significantly lower than the patient's normal value (e.g., a sural amplitude of 10  $\mu$ V may fall within the normal laboratory range although it would be 50% reduced in a patient who had a sural amplitude of 22  $\mu$ V two years prior). Alternatively, the underlying process may be affecting predominantly small sensory fibers, which are not reliably assessed with routine NCS. Finally, preservation

of the sensory responses in the context of true sensory loss may indicate that the pathology is proximal to the dorsal root ganglion, such as diffuse involvement of the nerve roots in a polyradiculopathy.

- **Diffusely abnormal sensory NCS do not necessarily confirm a generalized peripheral neuropathy.** Technical factors, such as low skin temperature, can cause diffuse slowing of conduction velocities or prolongation of the distal latencies, mimicking a peripheral neuropathy.

- **Lower extremity sensory NCS are less reliable in the older population.** There are a limited number of sensory NCS that can be reliably performed in the lower extremity (sural, superficial peroneal, medial plantar). A percentage of “normal” individuals over 55–60 years do not have recordable lower extremity SNAPs. When these are absent in older patients, the electromyographer cannot reliably determine whether sensory fibers are affected.

Several disorders may produce a severe sensory neuropathy or neuronopathy (Table 47–5). In these cases, diffusely abnormal or absent sensory responses on NCS occur with normal motor NCS and normal needle examination.

*Needle EMG.* Needle EMG is used to assess the degree of axonal loss as well as the chronicity of the neuropathy. In length-dependent neuropathies, abnormalities

are most severe in the distal lower extremity muscles, such as the abductor hallucis or peroneus tertius. When proximal muscles are affected, other processes such as motor neuron disease, polyradiculopathy, or multiple mononeuropathies would be considered. Fibrillation potentials are often seen in axonal neuropathies, although in very slowly progressive neuropathies, slow, continuous reinnervation may reduce the degree of fibrillation potentials. The chronicity of the neuropathy can be judged from the types of abnormalities in voluntary MUPs. In primarily demyelinating neuropathies, the abnormalities on needle EMG may be minimal.

### Defining Pathophysiology of Peripheral Neuropathies (Axonal vs. Demyelinating)

One of the most important roles of electrodiagnostic testing is to provide information about the pathophysiology of the neuropathy, which may be helpful in narrowing the list of potential etiologies and assisting the referring physician in the subsequent evaluation for the cause. Although predominantly demyelinating neuropathies are less common, identification of demyelination can lead to a more focused differential diagnosis, a higher potential for response to treatment, and an overall better prognosis for recovery. Specific findings and criteria are used to determine whether the process is predominantly axonal or demyelinating. Consideration of these criteria is important for appropriate interpretation of the study. In many instances, the findings may suggest a combination of axonal loss and demyelination.

Table 47–5 **Sensory Neuronopathies or Ganglionopathies**

---

Sjogren's syndrome
Vitamin B6 toxicity
Vitamin B12 deficiency
Vitamin E deficiency
<i>Cis</i> -platinum
HIV
HTLV-1
Paraneoplastic sensory neuronopathy
Syphilis
Lyme
Spinocerebellar ataxias
Friedrich's ataxia

---

### Axonal Neuropathies

The majority of patients evaluated for suspected peripheral neuropathy will demonstrate features of axonal loss. The primary pathology of axonal loss or degeneration is manifest on NCS as a reduction in the SNAP and CMAP amplitudes. In addition to amplitude reduction, a mild degree of motor and sensory CV slowing and prolongation of the distal latencies is often present as a result of either secondary demyelination or loss of the



larger, faster conducting axons. However, the degree of slowing is mild and generally less than 30% of normal. When there is a significant loss of axons, slowing of up to 50% of the lower limit of normal may be seen solely due to axonal loss. In contrast to demyelinating neuropathies, conduction block and increased temporal dispersion are not seen in axonal neuropathies.

The electrophysiologic features of axonal neuropathies are as follows:

- CMAP or SNAP amplitude less than 70% of normal (with CV greater than 70% of lower limit of normal) or amplitudes less than 50% with any degree of CV slowing.
- Distal latencies less than 130% of normal.
- No dispersion or block.
- Normal F waves and blink reflexes.
- Needle EMG—Fibrillation potentials in distal greater than proximal muscles variable).
- Needle EMG—long-duration, high-amplitude MUP (in chronic disease).

Axonal neuropathies are due to a vast number of etiologies, some of which are listed in Table 47–6.

## Demyelinating Neuropathies

Demyelinating neuropathies are pathologically characterized by primary or predominant loss

of myelin. This can occur in a uniform and diffuse manner such as in Charcot–Marie–Tooth type I, or in a segmental and patchy manner such as in chronic inflammatory demyelinating polyradiculopathy (CIDP) (Table 47–7).

A number of different electrophysiologic criteria for demyelination have been proposed over the years utilizing different combinations and degrees of CV slowing, prolongation of DL, prolongation of F-wave latencies, the presence of conduction block or temporal dispersion, and the number of nerves that are required to demonstrate the abnormalities.<sup>3–8</sup> These criteria should be used when making a diagnosis of a “demyelinating neuropathy,” rather than interpreting the study as a demyelinating neuropathy when only *slightly* slowed CV or prolonged distal latencies are present. Characteristic features of demyelinating neuropathies include the following:

**CV slowing**—The degree of CV slowing required to indicate a predominantly demyelinating neuropathy varies among the published criteria, but is generally taken as less than 70%–80% of the lower limit of normal. Several criteria take the CMAP amplitude into consideration when using the criteria. As noted previously, loss of large, faster conducting axons will produce a mild degree of CV slowing. Therefore, if there is evidence of axonal loss (as identified by low CMAP amplitudes), the degree of CV slowing to indicate concomitant primary demyelination should be less than 50% of LLN. Using these criteria, according to Mayo

Table 47–6 Examples of Etiologies of Axonal Sensorimotor Peripheral Neuropathies

Metabolic	Diabetes, hypothyroid, chronic liver disease, chronic renal failure, critical illness
Vitamin deficiency	B12, thiamine, copper, zinc
Vasculitis (connective tissue disease)	Periarteritis nodosa, SLE, rheumatoid arthritis, cryoglobulinemia
Toxins	Arsenic, thallium, lead
Medications	Metronidazole, phenytoin, hydroxychloroquine, colchicine, vincristine, taxol, simvastatin, cyclosporine
Inherited	Hereditary motor sensory neuropathy type II
Paraprotein associated	MGUS, myeloma, amyloid
Infectious	Syphilis, CMV, HIV



Table 47-7 **Predominantly Demyelinating Neuropathies***Acquired (segmental demyelination)\**

- Acute inflammatory demyelinating polyradiculopathy (AIDP)
- Chronic inflammatory demyelinating polyradiculopathy (CIDP)
- Paraprotein-associated neuropathy
  - Monoclonal gammopathy
  - Osteosclerotic myeloma
  - Waldenstrom's macroglobulinemia
- Diphtheria
- Medications and toxins (perhexiline, amiodarone, toluene)
- Hereditary neuropathy with liability to pressure palsies

*Hereditary (uniform demyelination)*

- Hereditary motor sensory neuropathy type I (CMT)
- Hereditary motor sensory neuropathy type III (Dejerine Sottas)
- Congenital hypomyelinating neuropathy
- Leukodystrophies
  - Metachromatic
  - Globoid cell (Krabbe's)
  - Adrenomyeloneuropathy\*
  - Cerebrotendinous xanthomatosis
  - Congenital hypomyelinating neuropathy
- Pelizeus–Merzbacher disease\*
- Refsum's disease\*

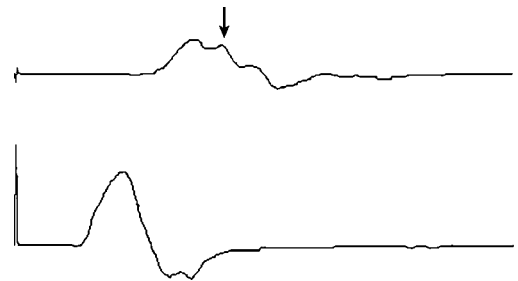
\* May demonstrate multifocal conduction slowing.

EMG laboratory normative data, evidence for demyelination in commonly performed motor NCS requires conduction velocities in the following ranges:

	Normal CMAP amplitude	Low CMAP amplitude
<b>Peroneal</b>	<29–33 m/second	<21 m/second
<b>Tibial</b>	<28–32 m/second	<20 m/second
<b>Median</b>	<34–38 m/second	<24 m/second
<b>Ulnar</b>	<36–41 m/second	<25 m/second

**DL prolongation**—The DL must be prolonged to  $\geq 125\%$ – $150\%$  of upper limit of normal.

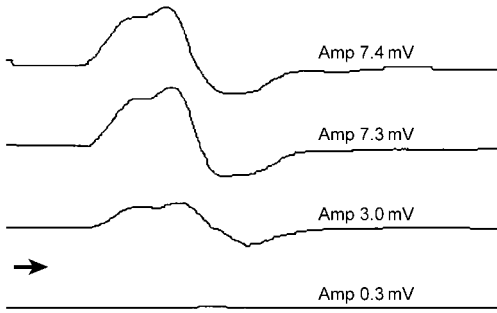
**Abnormal temporal dispersion**—Abnormal temporal dispersion is defined as a reduction in CMAP amplitude at a proximal site of stimulation compared to a distal site, along with an increase in the duration of the CMAP by  $>15\%$ – $30\%$ . The finding of abnormal temporal dispersion is characteristic of demyelinating neuropathies and indicates an increase in the range and variability in the conduction times of axons within a nerve due to segmental or multifocal demyelination. This



**Figure 47-1.** Abnormal temporal dispersion in the median nerve in CIDP.

finding suggests an acquired etiology when it occurs in more than one nerve. This is often visualized as a “ratchety” or “serrated” waveform, rather than a smooth negative peak (Fig. 47-1).

**Conduction block**—Conduction block is defined as failure of an axon to conduct an action potential and is another characteristic feature of focal demyelination. In a normal motor nerve, all of the axons within the nerve conduct an action potential along the nerve at a relatively equal rate. When the action potentials of all of the axons within a nerve are blocked (*complete conduction block*), stimulation proximal to the block will produce no response when recorded over a distal muscle, whereas



**Figure 47-2.** Radial motor nerve “inching” conduction study demonstrating focal conduction block.

stimulation distal to the block will produce a normal response since the distal portion of the nerve remains intact (Fig. 47-2). If only some of the axons within a nerve are blocked (*partial conduction block*), the CMAP to proximal stimulation will be significantly lower in amplitude

and area than with distal stimulation. The criteria for defining conduction block vary from between 20% and 60% reduction in CMAP amplitude and area from distal to proximal sites of stimulation<sup>9</sup> (Table 47-8). These percentages depend on the nerve being studied and the distance between the two stimulation sites—the shorter the distance between the two sites of stimulation, the lower the required reduction in amplitude or area. For example, stimulation at the ankle and knee sites along the peroneal nerve may demonstrate a 15% reduction in amplitude and area and still be considered normal. However, in the same nerve, a 15% reduction in amplitude and area over a 2-cm segment across the fibular head would be considered abnormal. Careful attention to technical factors is important when interpreting conduction block. Submaximal stimulation at the proximal site where the

**Table 47-8 Electrodiagnostic Criteria for Partial Conduction Block and Percent Reduction in Amplitude or Area**

	Defining criteria	Percent reduction in amplitude or area	
Definite	CMAP area difference (proximal to distal) greater than 50%, regardless of distance or CMAP duration (except for tibial nerve study)	Median, ulnar	>50% or 40%
	CMAP area difference (proximal to distal) greater than 30%, less than 15% difference in CMAP duration, regardless of distance	Peroneal, tibial	>60% or 50%
	CMAP area difference (proximal to distal) greater than 20% over distances of 10 cm or less, regardless of CMAP duration		
	CMAP area difference (proximal to distal) greater than 10% over a distance of 2 cm, regardless of CMAP duration		
Probable (with no temporal dispersion)		Median, ulnar	40%–50% or 30%–40%
Probable (with temporal dispersion)		Median, ulnar	>50% or 40%
		Peroneal, tibial	>60% or 50%
Possible	CMAP area difference (proximal to distal) greater than 30%, regardless of distance or CMAP duration		

nerve may be deeper (e.g., the tibial nerve at the knee or the brachial plexus at Erb's point) may mimic conduction block.

*Prolonged F-wave latencies or blink reflex latencies*—Prolongation of the F-wave latencies is an indicator of proximal demyelination. In some immune-mediated neuropathies, such as acute inflammatory demyelinating polyradiculopathy (AIDP) and CIDP, proximal segments of the nerves and nerve roots may be affected early in the course of the disease. The criteria of degree of prolongation above normal vary from prolongation of >120%–150% of upper limit of normal.

## BRACHIAL PLEXOPATHY

In patients with suspected brachial plexopathy, electrodiagnostic studies play an important role in helping to confirm the clinical suspicion of brachial plexus involvement, localize the site(s) of involvement within the plexus, exclude alternative sites of localization (e.g., lower trunk vs. C8 root vs. ulnar nerve), identify subclinical plexus involvement (e.g., in neuralgic amyotrophy), define the severity and determine the degree of reinnervation (e.g., traumatic plexopathy), and occasionally define the etiology (e.g., neoplastic vs. radiation plexopathy). An organized approach in the use of NCS and needle examination is crucial to diagnose and localize lesions of the brachial plexus. Extensive and uncommon NCS and a liberal needle examination may be required to assess each major component of the plexus.

NCS are commonly performed as a first step in the electrodiagnostic evaluation. The selection of studies to be performed depends on the index of suspicion of a plexus lesion as well as the presumed localization based on the clinical history and examination.

*Motor NCS.* Motor NCS are useful in their ability to assess the integrity of the motor axons coursing through different segments of the plexus and by their ability to stimulate the trunks at the supraclavicular fossa (Erb's point). In most plexopathies, CMAP amplitude reduction is a more common finding than slowing of the CV. Since lesions of the root, plexus, or individual nerves all may produce Wallerian degeneration of axons distal to the anterior

horn cells in the spinal cord, the appropriate CMAP amplitudes may be reduced with injuries at each of these sites, and abnormalities in motor amplitudes alone do not confirm a plexopathy. In some instances, segmental conduction slowing or conduction block through the plexus may occur. "Routine" upper limb NCS (median and ulnar motor) evaluate only the lower trunk or medial cord of the plexus, and therefore other, less commonly performed, motor NCS may be necessary when involvement of other segments of the plexus is suspected.

*Sensory NCS.* SNAP abnormalities occur early in the course of plexopathies, usually prior to abnormalities on motor NCS. Abnormalities in sensory nerve responses indicate a process distal to the dorsal root ganglia, whereas normal sensory responses raise the likelihood of a preganglionic process such as a cervical radiculopathy. In plexopathies, a reduction or absence of SNAP amplitude is most commonly seen. Comparison of the findings in the affected sensory nerve to the same nerve on the unaffected side, even in studies where the results are within the absolute normal laboratory limits, is important to identify relative reductions in amplitude and, generally, a 50% side-to-side reduction in amplitude is abnormal.

*Needle EMG.* Needle EMG is the most efficient method of evaluating the different components of the brachial plexus. The decision on muscles to be examined requires the use of localization from the clinical examination and findings on NCS. The optimal strategy in performing the needle examination is to test muscles supplied by each major peripheral nerve and each major spinal root, and then to "narrow" the localization by examining two or more muscles supplied by each cord and trunk, finding the "common link." If all of the muscles involved can be localized to a single nerve or single root, caution should be taken in making the diagnosis of "brachial plexopathy." The clinical examination is important in defining which muscles should be examined, as muscles that are clinically involved should be tested during the needle examination. The proximal extent of the damage must be defined by the examination of proximal muscles (infraspinatus, rhomboids, serratus anterior, and occasionally the diaphragm)

and cervical paraspinals. Examination of the unaffected side may be helpful in identifying subclinical involvement, such as often occurs in neuralgic amyotrophy. The findings on needle examination reflect the temporal profile and the underlying pathophysiology of plexus injury. In patients with acute or early involvement, or plexopathies characterized predominantly by neuropractic lesions, the only or predominant findings may be reduced recruitment. In patients in whom substantial axonal loss has developed and who are examined more than 3 weeks following the insult, fibrillation potentials and MUP changes (increased polyphasia and long-duration MUPs) are seen. In some circumstances, unusual spontaneous discharges may support an underlying etiology, such as the presence of myokymic discharges in patients with radiation-induced plexopathy.

**Trunk Lesions**

*Upper trunk.* Routine motor NCS do not assess the upper trunk segments. Motor conduction studies that may demonstrate abnormalities when significant axonal loss occurs include the axillary (deltoid), musculocutaneous (biceps), and suprascapular (infraspinatus). In rare instances, or when studied early in the course of the onset of symptoms, conduction block between proximal and distal stimulation points along these nerves may be seen. Sensory NCS that may show abnormalities include the lateral

antebrachial cutaneous, median antidromic (thumb), dorsal radial sensory, and median antidromic (index). The most common muscles affected on the needle examination include deltoid, teres major (axillary nerve); brachioradialis (BR), extensor carpi radialis (ECR) (radial nerve); biceps, brachialis (musculocutaneous nerve); and PT, FCR (median nerve). Abnormalities may also occur in the infraspinatus and supraspinatus (suprascapular nerve) depending on whether the injury occurred proximal to the takeoff of the suprascapular nerve from the upper trunk (Table 47–9).

*Middle trunk.* NCS assessing the middle trunk are limited. The radial (EDC) motor studies may be affected in some instances. The most reliable median sensory NCS is the median antidromic (middle finger), although the median antidromic (index) is affected in 80% of lesions and the radial sensory is affected in 40%. Needle examination may demonstrate abnormalities in the triceps, anconeus, and EDC (radial nerve); and PT and FCR (median nerve). Suggested studies to evaluate for middle trunk plexopathies are listed in Table 47–10.

*Lower trunk.* Routine NCS are most useful in evaluating the lower trunk lesions. These include median motor (APB), ulnar motor (ADM or FDI), ulnar antidromic (5th), and medial antebrachial cutaneous. Needle examination demonstrates abnormalities in all ulnar-innervated muscles: APB, flexor pollicis longus (FPL), and pronator quadratus (PQ)

**Table 47–9 Upper Trunk Assessment**

<b>Nerve conduction studies</b>	<b>Needle examination</b>
Sensory	Supraspinatus
Median—Thumb	Infraspinatus
Median—Index	Deltoid
Radial (dorsum)	(Teres minor)
Lateral antebrachial cutaneous	Biceps
Ulnar—5th*	Brachioradialis
	Supinator
Motor	Pronator teres
Axillary	
Musculocutaneous	Rhomboid major*
Suprascapular	Triceps*
Median (APB)*	FDI*
Ulnar (ADM)*	Upper cervical PSP*

\* Expected to be normal.

Table 47–10 Middle Trunk Assessment

Nerve conduction studies	Needle examination
Sensory	Pronator teres
Median—Index	Flexor carpi radialis
Median—Middle	Triceps
Radial	
Median—Thumb*	Deltoid*
Ulnar—5th*	Biceps*
	Brachioradialis*
Motor	FDI*
Radial	Midcervical PSP*
Median (APB)*	
Ulnar (ADM)*	

\* Expected to be normal.

Table 47–11 Lower Trunk Assessment

Nerve conduction studies	Needle examination
Sensory	First dorsal interosseus
Ulnar—5 <sup>th</sup>	Abductor pollicis brevis
Medial antebrachial	Flexor pollicis longus
Median—Index*	Extensor indicis proprius
Radial*	Flexor carpi ulnaris
	Flexor digitorum profundus
Motor	
Median (APB)	Deltoid*
Ulnar (ADM)	Biceps*
	Pronator teres*
	Triceps*
	Midcervical PSP*

\* Expected to be normal.

(median nerve); and extensor indicis proprius (EIP) and extensor pollicis brevis (EPB) (radial nerve) (Table 47–11).

## Cord Lesions

*Posterior cord.* NCS used to evaluate the posterior cord include the axillary (deltoid), radial (EDC), and radial sensory. Needle examination abnormalities occur in deltoid, teres minor (axillary nerve), and radial innervated muscles (BR, triceps, ECR, supinator, EDC, EIP, etc). In looking at the list of muscles involved, it is evident that muscles supplied by all roots (C5–T1) and all trunks may show abnormalities in posterior cord lesions (Table 47–12).

*Lateral cord.* NCS that may be useful include musculocutaneous (biceps) and lateral

antebrachial cutaneous, both of which may be abnormal in lateral cord lesions. Needle examination abnormalities occur in the biceps and brachialis (musculocutaneous nerve), and PT and FCR (median nerve). Sparing of the axillary nerve-innervated muscles (deltoid, teres minor), suprascapular-innervated muscles (infraspinatus, supraspinatus), and upper trunk or radial nerve-innervated muscles (brachioradialis, supinator) helps to distinguish lesions of the lateral cord from the upper trunk or posterior cord (Table 47–13).

*Medial cord.* NCS are helpful in assessing median cord lesions, including median motor (APB), ulnar motor (ADM or FDI), ulnar antidromic (5th), and medial antebrachial cutaneous. Needle examination abnormalities occur in all ulnar-innervated muscles

Table 47–12 Posterior Cord Assessment

Nerve conduction studies	Needle examination
Sensory	Deltoid
Radial	Teres minor
Median—Index*	Brachioradialis
Ulnar—5th*	Supinator
Motor	Triceps
Radial	Extensor carpi radialis
Axillary	Extensor digitorum communis
Median (APB)*	Extensor indicis proprius
Ulnar (ADM)*	Biceps*
	Pronator teres*
	FDI*
	Mid cervical PSP*

\* Expected to be normal.

Table 47–13 Lateral Cord Assessment

Nerve conduction studies	Needle examination
Sensory	Biceps
Median—Thumb	Pronator teres
Median—Index	Flexor carpi radialis
Median—Middle	
Lateral antebrachial	Brachioradialis*
Radial (dorsum)*	Deltoid*
Ulnar—5th*	Rhomboid major*
	Triceps*
Motor	FDI*
Musculocutaneous	Upper cervical PSP*
Median (APB)*	
Ulnar (ADM)*	

\* Expected to be normal.

and several median-innervated muscles (APB, FPL, opponens pollicis). The sparing of muscles supplied by the C8–T1 root, but the posterior cord or radial nerve (EIP, EPB) localized the lesion to the lower trunk. Another important point is that the NCS in lower trunk and medial cord lesions will be identical with the exception of the radial (EIP) (Table 47–14).

Tables 47–15 and 47–16 may assist in the interpretation of the findings on NCS and needle examination, and may help to find the “common link” in localizing to the appropriate site of the plexus.

One of the factors contributing to the difficulty in the electrodiagnostic evaluation and interpretation of findings in brachial

plexopathies is the complex anatomy and sometimes the patchy nature of involvement of different elements of the plexus in many circumstances. Completely isolated involvement of a single trunk or cord is less common than *predominant* involvement of one site with less severe involvement of other sites. Therefore, electrodiagnostic testing should study components that may not be involved, in addition to those that are clinically involved. Since a brachial plexopathy may involve any of the many nerves of the upper extremity, the evaluation of a brachial plexopathy is best modified on the basis of the clinical deficit and suspected site of involvement. The following are the suggested approaches that may be used to evaluate lesions at different sites of the plexus.



**Table 47–14 Medial Cord Assessment**

<b>Nerve conduction studies</b>	<b>Needle examination</b>
Sensory	First dorsal interosseus
Ulnar—5th	Abductor pollicis brevis
Medial antebrachial	Flexor pollicis longus
Median—Index*	Extensor indicis proprius
Radial*	Flexor carpi ulnaris
	Flexor digitorum profundus
Motor	
Median (APB)	Deltoid*
Ulnar (ADM)	Biceps*
	Pronator teres*
	Triceps*
	Midcervical PSP*

\* Expected to be normal.

**Table 47–15 Segments of the Brachial Plexus Assessed by Specific NCS**

	<b>Upper trunk (C5–6)</b>	<b>Middle trunk (C6–7–8)</b>	<b>Lower trunk (C8–T1)</b>
Lateral cord	Lateral antebrachial cutaneous Median sensory (thumb) Median sensory (index)	Median sensory (index) Median sensory (middle)	
Posterior cord	Radial sensory Axillary motor	Radial sensory Radial motor (EDC)	
Medial cord			Ulnar sensory (5th digit) Dorsal ulnar cutaneous sensory Medial antebrachial sensory Median motor (ABP) Ulnar motor (ADM, FDI)

**Table 47–16 Muscle Innervation According to Trunk, Cord, and Nerve**

	<b>Upper trunk (C5–6)</b>	<b>Middle trunk (C6–7–8)</b>	<b>Lower trunk (C8–T1)</b>
Lateral cord	Biceps (MC) Brachialis (MC)	Pronator teres (M) FCR (M)	
Posterior cord	Brachioradialis (R) Supinator (R) Deltoid (Ax) Teres minor (Ax) Triceps (R)	Triceps (R) Anconeus (R) Extensor carpi radialis (R) Extensor digiti communis (R) Extensor carpi ulnaris (R)	Extensor indicis proprius (R) Extensor carpi ulnaris (R)
Medial cord			Abductor pollicis brevis (M) First dorsal interosseus (U) Abductor digiti minimi (U) Flexor carpi ulnaris (U) Flexor digitorum profundus (U) Flexor pollicis longus (M)

SSc, suprascapular nerve; MC, musculocutaneous nerve; Ax, axillary nerve; R, radial nerve; M, median nerve; U, ulnar nerve.

*Differentiating root from plexus lesions.* It is often difficult to completely differentiate between processes involving the roots from the trunks of the plexus. The sparing of SNAPs in clinically affected areas of sensory loss and the identification of abnormalities on needle EMG in cervical paraspinals are indicative of a process involving the roots. Several other findings may be useful:

- *C5–6 vs. upper trunk*—The pattern of findings on needle examination may be similar, although the presence of abnormalities in the rhomboids or serratus anterior implicates a process proximal to the trunks. Sensory nerve conduction abnormalities in the lateral antebrachial cutaneous or median nerves occur in upper trunk plexopathies but not radiculopathies.
- *C7 vs. middle trunk*—Distinguishing between lesions at these sites is difficult. Fortunately, isolated middle trunk plexopathies are extremely rare. Low-amplitude radial or median sensory responses on NCS may occur with middle trunk plexopathies. Needle examination findings in the serratus anterior and cervical paraspinals indicate a root lesion.
- *C8–T1 vs. lower trunk*—Lesions of the C8 and T1 roots affect the ulnar and median motor NCS but do not affect the ulnar or medial antebrachial cutaneous sensory NCS. Needle examination demonstrates abnormalities in the intrinsic hand muscles and medial forearm muscles in both localizations.

Electrophysiological testing is also used in the preoperative assessment of patients who have had traumatic injury of the brachial plexus. The Mayo Clinic brachial plexus outpatient protocol that is performed in all patients who are plexus or spinal accessory surgery candidates includes a thorough performance of NCS. The protocol is described in Table 47–17.

## GENERALIZED WEAKNESS

Generalized weakness is a common complaint. Patients with weakness are often referred for electrophysiologic testing to assess for a number of possible neuromuscular disorders

that may account for the symptoms. In most cases, generalized weakness is not caused by a neuromuscular disease. However, disorders that should be considered include myopathies, NMJ disorders, polyradiculopathies, or motor neuron diseases. The presence of true, objective weakness raises the possibility of a disorder at one of these levels, and the distribution of objective weakness helps to determine the type and extent of testing that is performed. NCS are important not only to obtain objective evidence of a disorder of the motor nerves or muscles, but to assess for diseases of the NMJ. Needle examination of distal and proximal muscles can help to identify the type of underlying disorder and more precisely determine the localization.

*Motor NCS.* In patients with weakness, motor NCS may demonstrate a number of abnormalities that assist in localizing the process along the peripheral neuroaxis. In motor neuron diseases or polyradiculopathies, low CMAP amplitudes may be present. Focal demyelination, as evidenced by increased temporal dispersion or conduction block, in motor nerves may be seen in acquired demyelinating polyradiculopathies such as CIDP or in multifocal motor neuropathy with conduction block. In disorders of neuromuscular transmission, routine motor NCS may be normal or low amplitude (especially in Lambert–Eaton myasthenic syndrome). Since myopathies typically involve proximal muscles and standard motor NCS are recorded from distal muscles, routine CMAP amplitudes will often be normal in primary myopathies.

*F waves.* F waves may demonstrate prolongation in patients with weakness due to polyradiculopathies, particularly early in the course when other abnormalities on conduction studies may not be evident.

*Repetitive nerve stimulation studies.* The performance of repetitive stimulation studies should be considered in all patients who complain of generalized weakness, as they will occasionally identify an unsuspected NMJ disorder. The extent of testing depends on the level of suspicion of an NMJ disorder; if high, several distal and proximal nerve–muscle combinations should be performed. In patients in whom motor CMAP amplitudes are low and Lambert–Eaton myasthenic syndrome is

Table 47-17 Mayo Clinic Brachial Plexus Outpatient EMG Protocol

	Common approach	Other considerations
Motor NCS	Median (APB) Ulnar (ADM) Radial (EDC) Musculocutaneous Spinal accessory	<b>Standard NCS are needed in each nerve with weakness or sensory loss in its distribution.</b>
Sensory NCS	Median (antidromic) Ulnar (antidromic) Radial Lateral antebrachial cutaneous	Consider doing sensory and/or motor studies on opposite side for comparison if findings are borderline or where otherwise appropriate.
Needle EMG	Cervical paraspinal (two levels) Biceps (both heads) Triceps (lateral and medial heads) First dorsal interosseous  If there is weakness in upper trunk distribution, test additional C5 & C6 muscles  Rhomboid , infraspinatus, deltoid, brachioradialis, lateral brachialis, medial brachialis  If there is weakness in middle trunk distribution, test additional C7 muscles  Pronator teres, extensor carpi radialis If there is weakness in lower trunk distribution, test additional C8 muscles  Extensor carpi ulnaris, flexor carpi ulnaris, flexor pollicis longus	

considered, repetitive stimulation should be performed before and after 10 seconds of exercise to assess for facilitation.

*Sensory NCS.* These are useful to perform in patients complaining of weakness, even if they have no sensory complaints, in order to assess for subclinical sensory involvement. If abnormal, a disorder of the peripheral nerves would become more likely than diseases primarily affecting muscle, NMJ, or anterior horn cells. However, some disorders, such as amyloidosis or sarcoidosis, may affect nerve and muscle (neuromyopathies).

*Needle EMG.* Needle examination can determine the underlying pathology, when weak muscles are examined. In a weak muscle, voluntary MUPs will be of short duration, low amplitude, and polyphasic if due to a myopathy; varying in amplitude if due to an NMJ disease; or demonstrate reduced recruitment and

possibly long duration if due to a neurogenic disorder.

## MYOPATHY

There are a variety of techniques available to study the muscle, including motor and sensory NCS, repetitive stimulation, and needle EMG. Electrodiagnostic testing is an important step in the evaluation of patients with suspected myopathies and can help to (1) confirm a clinically suspected myopathy; (2) exclude other disorders that may mimic myopathies, such as polyradiculopathies, motor neuron disease, or NMJ disorders; (3) provide clues to the etiology of the myopathy; (4) assist in the selection of a muscle for biopsy; and (5) assess response to treatment. Early in the course of a myopathy, the findings on NCS and needle EMG may be patchy or subtle, requiring

persistence and thoroughness in widespread sampling of muscles. EMG is also limited in its ability to distinguish between different etiologies. Although the electrodiagnostic findings reflect the underlying muscle fiber pathology and physiology, in many disorders similar pathologic changes may be occurring within the muscle and the findings are not specific for individual diseases. Furthermore, in some types of myopathies, electrodiagnostic studies demonstrate no abnormalities at all, which confounds the overall assessment of the patient's disorder.

The findings in certain myopathies, such as inflammatory myopathies, also evolve over time, beginning with small MUPs and quickly developing fibrillation potentials and polyphasic MUPs. The regenerating muscle fibers and fibers that have lost their innervation because of nerve terminal damage, segmental necrosis, or fiber splitting produce a number of fibrillation potentials that roughly parallel the degree of disease severity. As the disease subsides, fibrillation potentials become less prominent and MUPs have a more normal size. The number of muscle fibers in some motor units increases, resulting in larger than normal MUPs late in the disorder.

NCS are an integral part of the electrodiagnostic evaluation of patients with suspected myopathies, even though in most patients the results are normal. NCS assess either nerve function in isolation or the combination of

nerve and muscle function, and are much more sensitive to change in neuropathic disorders. However, in some myopathies, non-specific abnormalities may occasionally be seen.

**Motor NCS.** Loss of a sufficient number of axons in neurogenic disorders may rapidly lead to reduction in the recorded CMAP amplitude; however, a substantial *direct* loss of muscle fibers will less significantly reduce the CMAP amplitude. It is estimated that over 50% of muscle fiber loss in a muscle is necessary to produce reduction in the CMAP amplitude. Conduction velocities, distal latencies, and F-wave latencies are typically normal and unaffected in muscle diseases, unless concomitant nerve dysfunction is present. The muscle fiber CV may be slowed in some myopathies, although this requires specialized technique of direct muscle stimulation to identify.

In most myopathies, standard motor NCS (e.g., median, ulnar, peroneal, and tibial) are usually normal, since these study the distal nerve or muscle sites and the majority of myopathies affect predominantly proximal muscles. Myopathies with distal muscle weakness are more likely to demonstrate low CMAP amplitudes (Table 47–18). Proximal NCS may demonstrate low CMAP amplitudes in more severe myopathies.

The major utility of motor NCS is to exclude alternative etiologies that may be confused

**Table 47–18 Myopathies with Low CMAP Amplitudes on Distal NCS**

---

Muscular dystrophies
Myotonic dystrophy
Faciocapulohumeral dystrophy
Emery–Dreifuss muscular dystrophy
Distal muscular dystrophies
Welander, Miyoshi, Markesberry–Griggs
Inflammatory myopathy
Inclusion body myositis
Severe polymyositis
Metabolic myopathy
Debrancher enzyme deficiency
Acid maltase deficiency
Congenital myopathy
Nemaline myopathy
Central core myopathy
Centronuclear myopathy
Myofibrillary myopathy (desmin)

---

clinically with myopathies, such as motor neuron disease, multifocal motor neuropathy with conduction block, or NMJ disorders.

**Repetitive nerve stimulation.** RNS is useful to exclude NMJ disorders and should be normal in myopathies. In patients with suspected weakness due to myopathy, baseline 2-Hz repetitive stimulation in one or two nerve/muscle groups should be performed. In some myotonic disorders with a disturbance of sarcolemma function, such as myotonic dystrophy, myotonia congenita, and paramyotonia congenita, RNS may demonstrate decrement at low or high rates of stimulation at baseline, which repairs immediately following exercise and worsens after several minutes, similar to MG. In these disorders, however, the CMAP amplitude is typically reduced immediately after the exercise.

**Sensory NCS.** Sensory NCS are routinely normal in myopathies. In cases where the SNAP amplitudes are reduced, disorders producing both myopathy and neuropathy (“neuromyopathy”) should be considered (Table 47–19). However, two separate processes could also account for the combination of findings, especially in patients with underlying medical diseases that are known to produce peripheral neuropathy, such as diabetes.

**Needle EMG.** Needle EMG is a way of efficiently sampling multiple muscles in a widespread distribution and extrapolating the underlying pathologic changes that may be occurring within the muscle fibers. The findings on needle examination often correlate with the pathologic changes on muscle biopsy, thereby assisting in the selection of an appropriate muscle for biopsy. The combination of spontaneous activity and MUP changes reflects the underlying pathologic reactions occurring in the muscle fibers.

**Fibrillation potentials.** In myopathic disorders characterized by fiber necrosis, fibers splitting, or intracellular vacuole formation, fragments of muscle fibers are separated from the innervation terminal nerve twig. This “functional denervation” leads to the development of fibrillations in those separated segments. Fibrillation potentials in myopathies often demonstrate features that are different from those in neurogenic disorders. They may be of low amplitude, have a slower firing rate, are more often positive waveform, and may occur in a patchy distribution within a muscle. Myopathies that occur with fibrillation potentials are listed in the table (Table 47–20).

**Myotonic discharges.** Myotonic discharges are seen in disorders where instability of

Table 47–19 Disorders Causing Myopathy and Neuropathy

<b>Connective tissue disorders</b>	<b>Infiltrative disorders</b>
SLE	Amyloidosis
Rheumatoid arthritis	Sarcoidosis
Mixed connective tissue disease	
Sjogren's	
Polyarteritis nodosa	
<b>Endocrine disorders</b>	<b>Infectious diseases</b>
Acromegaly	HIV
Addison's	Toxoplasmosis
Hyperthyroid	
Hypothyroid	
<b>Metabolic myopathies</b>	<b>Medications</b>
Acid maltase deficiency	Vincristine
Debrancher enzyme deficiency	Chloroquine
	Colchicine
	Cyclosporin
<b>Congenital myopathies</b>	<b>Alcohol</b>
Myofibrillary (desmin)	
Mitochondrial disorders	

Table 47–20 Myopathies Associated with Fibrillation Potentials

Inflammatory	Congenital myopathies
Polymyositis	Myofibrillary (desmin)
Dermatomyositis	Nemaline
Inclusion body myositis	Centronuclear
Dystrophies	Metabolic myopathies
Dystrophinopathies (Duchenne's, Becker's)	Acid maltase deficiency
Sarcoglycanopathies	Debrancher enzyme deficiency
Limb-girdle muscular dystrophy	
Fascioscapulohumeral dystrophy	
Distal dystrophies	
Myotonic dystrophy	
Toxic myopathy	Critical illness myopathy
Cholesterol lowering agent myopathy (CLAM)	
Acute alcohol myopathy	
Colchicine	Disorders producing rhabdomyolysis
Azidothymidine (AZT)	Trauma
Cyclosporin	Drugs (heroin, phencyclidine)
Emetine	Prolonged coma
Penicillamine	
Infiltrative	Infectious
Amyloid	Trichinosis
Sarcoidosis	Viral myositis
	HIV myopathy

muscle fiber membrane, due to defective sodium or chloride channels, produces repetitive spontaneous firing of muscle fiber action potentials. The identification of myotonic discharges is useful in narrowing the differential diagnosis; however, there are no specific features of myotonic discharges that allow distinction between the different

myotonic disorders. Infrequent myotonic discharges may be seen in a variety of myopathies (Table 47–21) and even briefly in long-standing neurogenic disorders. However, profuse and prominent myotonic discharges are only seen in a few types of disorders, particularly the myotonic dystrophies and channelopathies.

Table 47–21 Myopathies Associated with Myotonic Discharges

*Prominent*

- Myotonic dystrophy (DM1)
- Proximal myotonic myopathy (PROMM, DM2)
- Myotonia congenita
- Paramyotonia congenita
- Hyperkalemic periodic paralysis
- Schwartz–Jampel syndrome

*Infrequent*

- Acid maltase deficiency
- Polymyositis
- Dermatomyositis
- Inclusion body myositis
- Toxic myopathies
  - Cholesterol lowering agents
  - Chloroquine
  - Cyclosporin
- Amyloid myopathy



*Motor unit potentials.* In myopathic diseases, random loss, atrophy, or variation of size of muscle fibers in a motor unit leads to short-duration, low-amplitude, and polyphasic MUPs. The total number of motor units within a muscle is usually unchanged in myopathies; however, loss of individual fibers within motor units leads to less force production from each motor unit. Therefore, more motor units than normal must be recruited to generate a force. The initial firing frequency of the motor units is normal, but more motor units fire with low effort (rapid recruitment). Rapid recruitment makes assessment of individual MUPs difficult, since multiple potentials fire at low effort. In severe or end-stage myopathies, loss of all muscle fibers constituting entire motor units may produce reduced recruitment, which can sometimes be mistaken for a neurogenic process.

A number of myopathies may be characterized pathologically by muscle fiber atrophy or dysfunction of structural components, without fiber destruction. In these cases, while clinical weakness may be present and changes in MUP morphology may occur, fibrillation potentials and other spontaneous discharges are notably absent. Furthermore, short-duration MUPs can be seen in severe or long-standing NMJ disorders, which can mimic myopathies.

Long-duration MUPs may also be seen with any chronic or long-standing myopathy. This finding often leads to a misdiagnosis of a neurogenic disorder, such as amyotrophic lateral sclerosis (ALS), as identification of the shorter duration, lower amplitude MUP may be masked by the superimposed larger units. In this situation, quantitative MUP analysis may result in normal mean values of amplitude and duration of the recorded MUP. Several explanations have been proposed for the origin of long-duration polyphasic MUPs, including (1) reinnervation of regenerating muscle fibers with slowed conduction in immature nerve terminals, (2) increased scatter of the endplate zone, (3) slowed conduction in regenerating muscle fibers, and (4) hypertrophy of regenerated muscle fibers. In

myopathies where the pathologic process affects the muscle contractile apparatus or muscle membrane, muscle fiber necrosis, regeneration, and motor unit remodeling often will not occur, and therefore the findings on needle examination are normal. Alternatively, some disorders will only affect type II muscle fibers, which are not assessed adequately by routine EMG. Myopathies that may demonstrate a normal EMG include steroid-induced myopathies, some congenital myopathies, metabolic myopathies, endocrine myopathies, and some sarcoglycanopathies.

## MYALGIAS, MUSCLE STIFFNESS, AND EPISODIC MUSCLE WEAKNESS

Many different central and peripheral disorders may present with muscle stiffness. Central processes such as rigidity and spasticity are best assessed clinically, because EMG test results are normal. The evaluation of peripheral disorders is based on the character of the symptoms. If the major complaint is *episodic weakness*, with or without muscle stiffness, the patient should be tested for periodic paralysis. If the major complaint is *episodic myalgia* without true muscle stiffness, the patient should be tested for a myopathy. A muscle biopsy or ischemic forearm exercise or lactate test (or both) is helpful if myalgia or contractures develop with exercise. If the major complaint is *muscle stiffness*, consider doing the needle examination first to confirm the presence and nature of spontaneous activity. If myotonic discharges are found, NCS may help define their source.

## NMJ DISORDERS

Electrophysiologic testing is an important step in the evaluation of patients with suspected NMJ disorders. While in some cases the clinical presentation of patients with diseases such as MG or Lambert–Eaton myasthenic syndrome is classic, leaving little doubt about the diagnosis, in many instances patients present with vague or mild weakness, or symptoms that

are difficult to easily localize to the NMJ. For example, a patient who presents with a feeling of generalized weakness may have a disorder involving the muscle (myopathy), peripheral nerves (polyradiculopathy), anterior horn cells (ALS), or even no neuromuscular disease. In these cases, electrophysiologic testing can help to localize the disease to the NMJ or identify another mimicking disease. Furthermore, when a disease of the NMJ is identified, EMG can help to define whether the disorder affects the presynaptic (Lambert–Eaton myasthenic syndrome) or postsynaptic junction (MG), can help to define the severity of the disease, and in some instances can be used to follow the patient to objectively assess response to treatment. The approach to the patient with a suspected NMJ disease depends on the index of clinical suspicion for an NMJ disorder. In patients in whom an NMJ disease is strongly suspected, testing may be more comprehensive, particularly when the clinical features are relatively mild, than in those in whom there is a low suspicion.

Several types of electrophysiologic studies are important in assessing the NMJ, each of which provides important and often complementary information that is used to determine the underlying disease:

*Routine motor NCS (assessing the CMAP amplitudes):* Routine motor NCS are important to perform prior to repetitive stimulation studies. In most cases of postsynaptic NMJ disorders, such as myasthenia gravis, the CMAP amplitudes are normal on routine motor NCS. However, in severe cases of myasthenia gravis, the CMAP amplitudes may be low as a result of severe blockade of neuromuscular transmission. In contrast, in presynaptic NMJ disorders, such as Lambert–Eaton myasthenic syndrome or botulism, the CMAP amplitudes on motor NCS are typically low. Following exercise or electrical stimulation at rapid rates (e.g., >20 Hz), the CMAP amplitudes increase (*facilitate*). In LEMS, facilitation occurs rapidly following brief (10 seconds) exercise or electrical stimulation; in botulism, facilitation may occur only after longer (e.g. 1–2 minutes) of exercise or electrical stimulation.

*Repetitive nerve stimulation.* RNS is a reliable and important technique used to assess

for NMJ disorders. The diagnosis of a defect of neuromuscular transmission is supported by identification of a reproducible decrement of 10% or more in the CMAP amplitude and area following RNS at 2–5 Hz, ideally in two or more nerves.<sup>10,11</sup> The sensitivity of RNS depends on the distribution of clinically affected muscles and disease severity.<sup>12,13</sup> In patients with generalized MG, bulbar and proximal muscles are usually more affected clinically than distal muscles and the diagnostic yield of RNS is typically higher in proximal nerves compared to distal nerves, such as musculocutaneous or biceps, axillary or deltoid, and spinal accessory or trapezius.<sup>10–12</sup> Despite the higher sensitivity, RNS of proximal nerve–muscle combinations is technically more difficult to obtain reliable and consistent results due to instability of baseline as a result of more limb and stimulator movement. Proximal stimulation may also be more uncomfortable for the patient. As a result, a standard protocol in many laboratories begins initially with RNS on a distal nerve–muscle combination, such as the ulnar or peroneal nerves, followed by proximal or cranial nerves.

The choice of the nerve–muscle combinations for RNS ultimately depends on the distribution of clinical weakness. A common approach consists of ulnar (ADM) or peroneal (AT) if symptoms are worse in the legs, spinal accessory (trapezius), and facial. If these nerves do not demonstrate significant decrement and there is a high clinical suspicion, one should strongly consider performing RNS on other nerves, such as radial (EIP or anconeus), musculocutaneous (biceps), axillary (deltoid), or trigeminal (masseter).

Performing repetitive stimulation at different rates can provide important information about the type of NMJ disorder and can assist in determining whether the disorder involves the presynaptic or postsynaptic junction. *However, it is important to understand that both a severe postsynaptic NMJ disorder and a presynaptic disorder may demonstrate similar findings with slow and fast rates of stimulation.* Stimulation at slow rates (2–5 Hz) will maximize the degree of decrement by maximizing the release of immediately available stores of acetylcholine. Decrement at these slow rates of stimulation may be seen with both presynaptic and postsynaptic junction disorders.

Cholinesterase inhibitors can repair abnormalities on RNS and lessen the severity of findings on single fiber electromyography (SFEMG). Pyridostigmine should be discontinued 6 hours (long acting form 12 hours) prior to performing an electrodiagnostic study. Immunosuppressive therapy may also render a patient seronegative and improve abnormalities on electrodiagnostic testing, although mild changes on SFEMG usually persist.

*Needle EMG.* While decrement on RNS is strongly supportive of an NMJ disorder, it is not specific and decrements (even greater than 10%) may be seen in other disorders, such as progressing neurogenic diseases or muscle channelopathies. As a result, the findings on NCS alone are not completely sufficient to confirm the diagnosis. Needle EMG provides important complementary information about the underlying disorder. In NMJ diseases, the most prominent finding on needle EMG is MUP variation. MUP durations and amplitudes are typically normal in mild cases, but may be short or low in more severe cases. Long-duration or highly polyphasic MUPs should not be seen in NMJ disorders; if they are identified, another disease, such as motor neuron disease or a superimposed neurogenic process, should be considered.

*Single fiber EMG.* SFEMG is very sensitive (100% abnormal if a clinically involved muscle is examined), but is nonspecific. Abnormalities of increased jitter and blocking are frequently observed in myopathies and neurogenic disorders associated with denervation. SFEMG is usually reserved for patients with normal findings on standard NCS (including RNS) and concentric needle EMG. It is most useful in making the diagnosis of MG in very mild cases or excluding it in cases with atypical features or chronic fatigue. SFEMG is time-consuming, requires a cooperative patient, and is abnormal in any disease associated with a mild disorder of NMT.

## POLYRADICULOPATHY

Disorders involving multiple nerve roots, with or without distal peripheral nerve involvement, may clinically present similar to length-dependent peripheral neuropathy. The electrodiagnostic findings may demonstrate similar

findings as are seen in length-dependent peripheral neuropathies, sometimes leading to misinterpretation of the electrodiagnostic study. By definition, the pathology in polyradiculopathies is located at the root level. In some cases, the dorsal root ganglion or a more distal component of the nerve may also be involved (“polyradiculoneuropathy”). Clinical symptoms include sensory loss (often distal predominant), weakness, and areflexia. Weakness is often diffuse, patchy, and symmetric or asymmetric, and involves proximal muscles to the same degree or more than distal muscles.

The electrophysiologic features of polyradiculopathies may be similar to those of peripheral neuropathies. The key distinguishing features are the identification of abnormalities in proximal nerve segments (ideally roots) and the identification of neurogenic abnormalities in proximal muscles in addition to distal muscles.

*Motor NCS.* Motor NCS may demonstrate low CMAP amplitudes, particularly in axonal polyradiculopathies. Careful assessment for abnormal temporal dispersion, particularly in proximal segments of the nerve, is important when assessing for demyelinating polyradiculopathies such as CIDP. This may require stimulation in proximal nerve segments such as Erb's point.

*Sensory NCS.* Sensory NCS may be entirely normal if the process involves the preganglionic root. However, many disorders may involve the dorsal root ganglia or even peripheral portions of the nerves, thereby leading to low amplitude or absent SNAPs.

*F waves.* F waves are particularly important in assessing polyradiculopathies. F-wave latencies may be prolonged, particularly if there is demyelination in the proximal portions of the roots or nerves. In more severe cases, F waves may be absent.

*Needle EMG.* The NCS findings (apart from F waves) in polyradiculopathies may be similar to that in length-dependent peripheral neuropathies. Needle EMG can efficiently assess proximal components of the nerves and roots, and are important to define the anatomic distribution of involvement. In contrast to length-dependent peripheral neuropathies, fibrillation potentials and long-duration MUPs are found

in proximal upper (and possibly lower) extremity muscles, especially in the paraspinals. Mild or early polyradiculopathies may only involve the roots, with changes seen only in the paraspinals.

**MOTOR NEURON DISEASE**

Electrodiagnostic studies are important in suspected motor neuron diseases to localize the problem to the anterior horn cells or motor nerves, exclude other mimicking disorders such as myopathies or polyradiculopathies, and to assess for temporal profile and progression of the disease.

*Motor NCS.* Motor NCS may be normal or of low amplitude in motor neuron diseases. Assessment for focal motor conduction block or abnormal temporal dispersion is particularly important to identify and, when present, may indicate a disorder such as multifocal motor neuropathy with conduction block or a demyelinating polyradiculopathy.

*Sensory NCS.* Sensory NCS are typically normal in pure motor neuron diseases. However, minor abnormalities, such as slightly low amplitudes, may be occasionally seen in ALS. Furthermore, in disorders such as spinobulbar muscular atrophy (Kennedy’s disease), SNAP amplitudes are commonly low.

*Needle EMG.* Gradual loss of anterior horn cells in motor neuron disease produces changes in the EMG findings during the course of the disease (Table 47–22). These changes allow electromyographers to assess the evolution of the disease as well as its severity. In the initial stages of the disease, before clinical weakness is evident, collateral sprouting of viable motor neuron axons maintains innervation of all muscle fibers; thus, few if any fibrillation potentials are evident. However, the loss of MUPs can be recognized. Later, MUP size increases with innervation of greater numbers of muscle fibers. If a significant amount of collateral sprouting has occurred, some MUPs vary in configuration. As these changes progress to the stage where reinnervation cannot keep pace with denervation,

Table 47–22 Evolution of Electromyographic (EMG) Changes in Motor Neuron Disease

	Subacute active	Chronic active	Inactive or residual
<b>Motor NCS</b>			
CMAP amplitude	Normal, unless severe	Low (if severe)	Low (if severe)
Conduction velocity	Normal	Up to 30% slowed (if severe)	Up to 30% slowed (if severe)
Distal latency	Normal	Up to 30% prolonged (if severe)	Up to 30% prolonged (if severe)
Repetitive stimulation	Mild decrement in some	Mild decrement in some	Normal
<b>Needle EMG</b>			
Fibrillation potentials	Many	Many	Few, small
Fasciculation potentials	Frequent in mildly affected, absent in severely affected	Frequent in mildly affected, absent in severely affected	Rare or absent
Complex repetitive discharges	None	Rare	Occasional
Motor unit potentials	Reduced recruitment, long duration, high amplitude May be unstable	Reduced recruitment, long duration, high amplitude May be unstable	Reduced recruitment, long duration, high amplitude

fibrillation potentials become prominent. During this time, larger numbers of regenerating fibers are present and intermittent blocking of the components of an MUP, *motor unit potential variation*, becomes more evident. The potentials become increasingly polyphasic, with satellite potentials. This combination of polyphasic and varying MUPs is evidence of a severe, progressing disorder. At times, it is accompanied by a decrement on slow repetitive stimulation.

The diagnosis of definite amyotrophic lateral sclerosis requires upper motor neuron and lower motor neuron signs at three levels of the nervous system. Other lower motor neuron syndromes may have similar EMG findings, including spinal muscular atrophy, residuals of poliomyelitis, hexosaminidase A deficiency, multifocal motor neuropathy, pure motor inflammatory neuropathy, demyelinating neuropathy, lead neuropathy, porphyria, Fazio-Londe disease (cranial), focal motor neuron disease (Sobue's), arteriovenous malformation of the cord, syrinx, and paraneoplastic syndromes such as lymphoma or radiation.

## FACIAL WEAKNESS

NCS and needle EMG can be used to evaluate patients with unilateral or bilateral facial weakness. Electrophysiologic studies are helpful to localize the process to the facial nerve and, in some instances, determine the site of injury along the nerve. Additionally, testing can help to identify subclinical involvement of other cranial nerves or assess for a more generalized neuromuscular disorder causing facial weakness. Finally, testing is useful for prognostication. In particular, comparison of the facial motor amplitude on the involved side with that on the unaffected side in a unilateral facial neuropathy can be used to determine prognosis.

## ANOMALOUS INNERVATION

Variations in peripheral nerve anatomy are common and are important to recognize by the electrodiagnostician. Failure to recognize anomalous anatomy may lead to erroneous

diagnoses when in fact the study may be normal. The most commonly encountered anomalous variations are the median-to-ulnar anastomoses ("Martin-Gruber anastomosis", "median-to-ulnar crossover") and accessory peroneal nerve.

## Martin-Gruber Anastomosis

The Martin-Gruber anastomosis (MGA) is a common variation that occurs in 15%–31% of individuals and is bilateral in up to 68% of individuals. In this variation, a communication exists between the median and the ulnar nerve fibers in the forearm, whereby fibers that are destined to supply ulnar-innervated muscles course through the median nerve in the upper arm and upper forearm, and "cross over" to the ulnar nerve in the forearm before innervating the destined muscles. The fibers may branch off the median nerve proper or the anterior interosseus branch. Sensory fibers are not involved. In rare instances, proximal MGA may occur with origin of the crossing over fibers located at an above elbow site, thereby resembling an ulnar neuropathy at the elbow.<sup>14</sup>

The muscles supplied by the crossing over fibers vary among individuals and include one or more of the following: (1) first dorsal interosseus, (2) abductor digiti minimi, and (3) adductor pollicis or flexor pollicis brevis. In approximately half of individuals with MGA, only one muscle is innervated by the crossing over fibers (FDI > adductor pollicis > ADM).<sup>15–18</sup> Three types of MGA occur, all of which produce a different pattern on routine median and ulnar motor NCS.

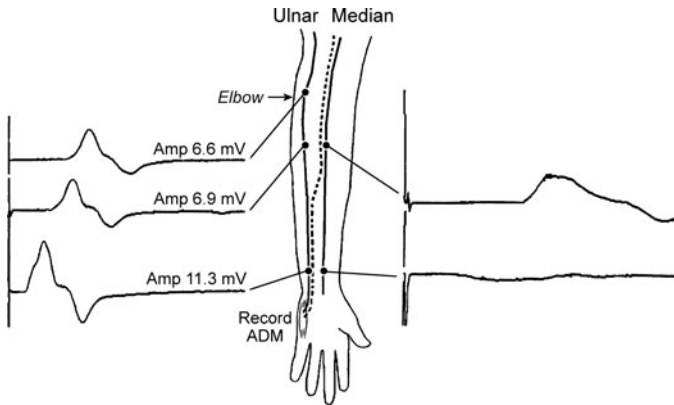
### TYPE I MGA. CROSSOVER FIBERS SUPPLY HYPOTHENAR MUSCLES (ADM)—FALSELY "ABNORMAL" ULNAR NCS

In type I MGA, the crossing over fibers supply the ADM through the crossover. Therefore, during a routine ulnar motor NCS recording from the ADM, stimulation of the ulnar nerve at the elbow does not include the crossing over fibers to the ADM, whereas stimulation at the wrist includes these fibers. The result is often a drop in CMAP amplitude and area (sometimes more than 20%) between the wrist and the elbow, simulating a focal conduction block such



Table 47–23 Findings of a Type I Martin-Gruber anastomosis

- 
- a) Ulnar nerve stimulation (recorded from ADM)
    - a. CMAP with above elbow (AE) stimulation > 20% lower than wrist (Wr) stimulation
    - b. CMAP with below elbow (BE) stimulation > 20% lower than wrist stimulation (AE = BE)
  - b) Median nerve stimulation (recorded from APB)
    - a. Normal results. CMAP with above elbow stimulation slightly lower than wrist stimulation
  - c) Median nerve stimulation (recorded from ADM)
    - a. Initial negative CMAP obtained with elbow stimulation (normal individuals will not have any response)
    - b. No response with wrist stimulation
- 



**Figure 47–3.** Type I Martin-Gruber anastomosis. Ulnar nerve stimulation recording from the ADM (*left traces*) demonstrating CMAP amplitude drop between wrist and below elbow stimulation sites. Stimulation of the median nerve demonstrates a response from the ADM with elbow stimulation from the crossing fibers, but not with wrist stimulation (*right traces*).

as in an ulnar neuropathy. Below elbow stimulation will yield a similar result as above elbow stimulation since the fibers have not crossed over yet (Table 47–23).

Type I MGA can be confirmed by stimulating the median nerve at the wrist and elbow while still recording over the ADM. With a crossover, a CMAP response with an initial negative deflection will occur with elbow stimulation but no response will occur with wrist stimulation (Fig. 47–3).

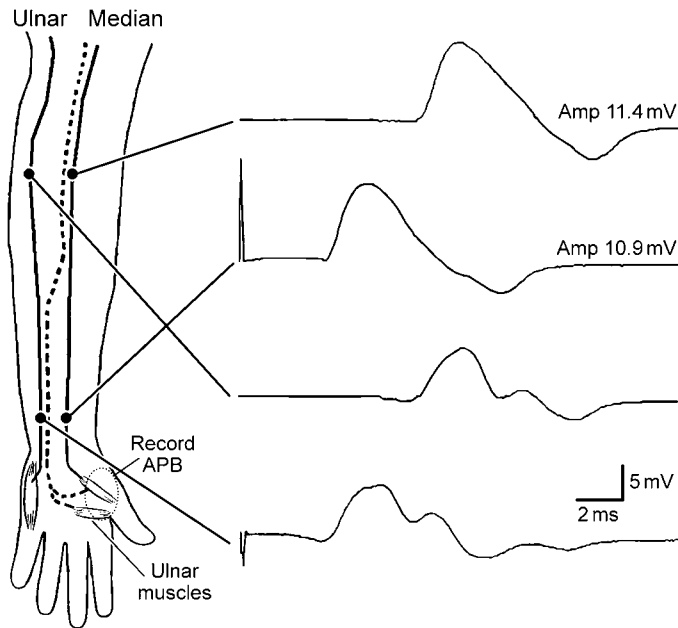
**TYPE II MGA. CROSSOVER FIBERS SUPPLY THENAR-REGION MUSCLES (ADDUCTOR POLLICIS, FLEXOR POLLICIS BREVIS, OR FIRST DORSAL INTEROSSEUS)—FALSELY “ABNORMAL” MEDIAN NCS**

In type II MGA, crossing over fibers supply ulnar muscles adjacent to the thenar eminence. The result is that median nerve stimulation

at the elbow, in addition to stimulating all true median-innervated muscles, will also stimulate muscles in the thenar region supplied by the crossing over fibers. This produces a higher CMAP amplitude than would normally be produced due to the additive muscle action potentials of the adductor pollicis, flexor pollicis brevis, and/or FDI. When the median nerve is stimulated at the wrist distal to the site of the crossover, the fibers to these muscles are not depolarized (Fig. 47–4) (Table 47–24).

In contrast to type I MGA, type II MGA is difficult to confirm, since volume conduction from ulnar muscles in the thenar region will always produce a CMAP response with ulnar nerve stimulation at the elbow and wrist sites, even in individuals without MGA. In some cases, a much higher response with ulnar wrist stimulation than elbow stimulation supports a type II MGA. In addition, a similar pattern of findings can be seen with overstimulation of the median nerve at the elbow or





**Figure 47-4.** Type II Martin-Gruber anastomosis. With median nerve stimulation recording from the APB, the elbow CMAP amplitude (*upper trace*) is higher than the wrist CMAP (*second trace*). Stimulation of the ulnar nerve while recording from the APB (traces 3 and 4) demonstrates the volume-conducted response from ulnar muscles near the thenar eminence.

#### Table 47-24 Findings of a Type II Martin-Gruber anastomosis

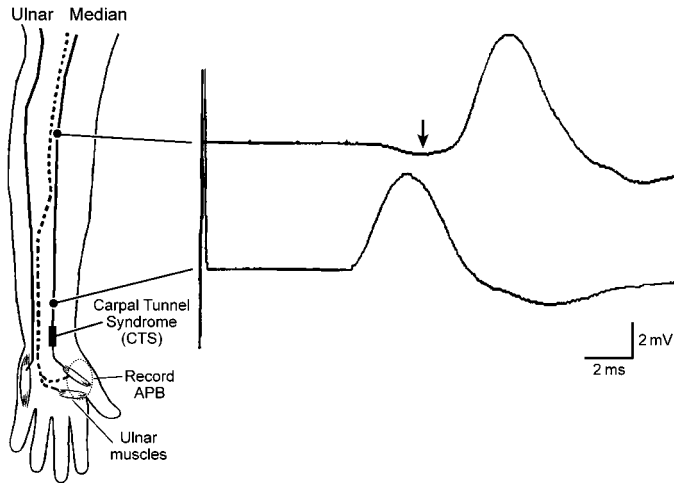
- 
- a) Median nerve stimulation (recorded from the APB)
    - a. Higher CMAP amplitude with above elbow stimulation than wrist stimulation
    - b. Change in CMAP morphology between the above elbow and the wrist stimulation sites
  - b) Ulnar nerve stimulation (recorded from the ADM)
    - a. Normal results. CMAP with above elbow stimulation is slightly lower than wrist stimulation
  - c) Ulnar nerve stimulation (recorded from the APB)
    - a. CMAP recorded at wrist and above elbow stimulations, with larger amplitude at wrist stimulation
    - b. Possible initially negative CMAP with above elbow stimulation (this is not always seen)
    - c. CMAP recorded at wrist stimulation, with initially positive takeoff
- 

understimulation at the wrist in individuals without MGA.

#### TYPE II MGA IN CARPAL TUNNEL SYNDROME

A distinctive pattern is seen in up to 20% of individuals with a type II MGA and a median neuropathy at the wrist ("carpal tunnel syndrome").<sup>19,20</sup> In this situation, an *initial positive deflection* is seen in the CMAP waveform with median nerve stimulation at the elbow, whereas with wrist stimulation no initial positivity occurs (Fig. 47-5). The absence of

an initial positivity at both sites of stimulation indicates that the problem is not due to inappropriate placement of the active (G1) electrode over the endplate region. The reason for this finding is that, with elbow stimulation, there is focal slowing or partial conduction block at the wrist of the true median fibers innervating the median muscles in the thenar eminence (e.g., APB, opponens pollicis). However, the crossing over fibers that supply other adjacent muscles in the thenar region (such as the adductor pollicis or flexor pollicis brevis) do not course under the transverse carpal ligament and therefore have slightly faster CV.



**Figure 47-5.** Type II Martin-Gruber anastomosis with superimposed CTS. The positive deflection with elbow stimulation reflects CMAP originating from the adductor pollicis and deep head of flexor pollicis brevis that are supplied through the crossing over fibers. The CMAP recorded from the APB is slowed at the site of compression at the wrist, thereby unmasking this volume-conducted response.

Since these muscles are at a distance away from the G1 electrode and depolarize slightly sooner than the median-innervated thenar muscles, they are recorded as a volume-conducted response (positive deflection).

In fact, this volume-conducted response from the ulnar-innervated crossed over fibers occurs in all individuals with type II MGA; however, because the median fibers (in the absence of CTS) conduct slightly faster than the crossing over fibers, the positive deflection is “hidden” in the major negative CMAP and is not seen. The finding of a positive deflection with elbow stimulation has been rarely described in patients with CTS with otherwise normal conduction studies.<sup>20</sup>

**TYPE III MGA. (COMBINATION OF TYPES I AND II)**

Type III MGA is simply a combination of types I and II. Table 47-25 describes the findings seen on routine median and ulnar motor NCS.

**Riche-Cannieu Anastomosis—“All Ulnar Hand”**

The Riche-Cannieu anastomosis is an uncommon anatomic variation, but one that very often leads to misinterpretation of findings. While this anastomosis has been identified in approximately 19% of hands in cadaveric studies, it

**Table 47-25 Findings of Type III Martin-Gruber anastomosis**

- 
- a) Ulnar NCS (recorded from the ADM)
    - a. CMAP with above elbow (AE) stimulation > 20% lower than wrist (Wr) stimulation
    - b. CMAP with below elbow (BE) stimulation > 20% lower than wrist stimulation (AE = BE)
  - b) Median NCS (recorded from the APB)
    - a. Higher CMAP amplitude with AE stimulation than wrist stimulation
    - b. Change in CMAP morphology between the AE and the wrist stimulation sites
  - c) Median NCS (recorded from the ADM)
    - a. Initial negative response obtained with elbow stimulation
    - b. No response with wrist stimulation
-

is seen in a very small percentage of patients undergoing NCS.<sup>21</sup> In this anastomosis, the thenar muscles and therefore all of the hand muscles are supplied by the ulnar nerve. In most cases, the deep branch of the ulnar nerve, which normally lies deep in the palm of the hand, courses over to innervate the thenar muscles. In the purest form, all hand muscles are innervated by the ulnar nerve.<sup>22</sup> Therefore, on median motor NCS no response is obtained in the APB with median nerve stimulation at the elbow or wrist.

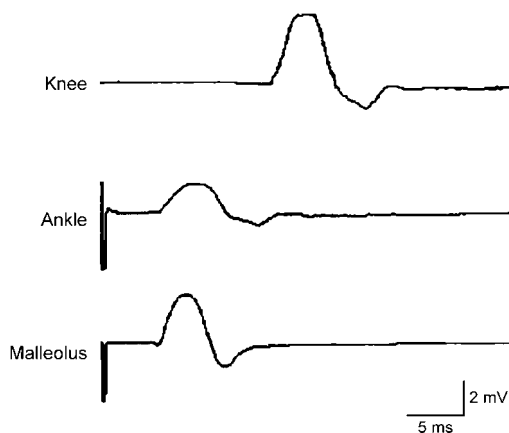
Clues to the presence of this anastomosis are normal muscle bulk and strength and normal findings on needle examination in the thenar muscles, despite an absent CMAP on median motor conduction studies. In a “partial” Riche–Cannieu anastomosis, there is some median nerve supply to the thenar muscles, although the ulnar nerve supplies the majority of muscles or fibers. In this case, a present but low CMAP amplitude will occur with median nerve stimulation.

In most cases, the Riche–Cannieu anastomosis is not clinically significant. However, several cases have been described where needle examination abnormalities were seen in the APB with an ulnar nerve lesion or abnormalities in the ADM with CTS.<sup>23,24</sup> Without knowledge of this anomaly, these findings could be misinterpreted.

The Riche–Cannieu anastomosis is confirmed by the presence of a normal CMAP response, with an initially negative deflection, with stimulation of the ulnar nerve and recording from the APB. Caution must be made in interpreting this finding, as a response will always be obtained due to volume conduction from neighboring ulnar-innervated muscles. Additionally, if there is a true median nerve lesion, with significant atrophy of the thenar muscles, a much higher response may occur with ulnar nerve stimulation, indicating the need for a careful clinical examination prior to or during the study.

### Accessory Peroneal Nerve

In most individuals, the EDB is supplied by a branch of the deep peroneal nerve. In up to 28% of the population, the axons supplying the EDB travel within the superficial peroneal



**Figure 47-6.** Accessory peroneal nerve. Higher peroneal CMAP amplitude with knee stimulation compared to ankle stimulation. Stimulation behind the lateral malleolus produces a CMAP.

nerve and course around the lateral malleolus before innervating the EDB.<sup>25,26</sup> This anatomic anomaly is termed an *accessory deep peroneal nerve* or *accessory peroneal nerve*. The accessory peroneal nerve may innervate fibers of the EDB to a variable degree. In most cases, only a percentage of fibers (usually the lateral fibers) are supplied by the accessory branch, with the medial fibers supplied directly by the deep peroneal nerve. However, in some cases, the accessory peroneal nerve supplies the entire muscle (Fig. 47-6) (Table 47-26).

In most situations, this finding is of no clinical significance. However, in lesions of the deep peroneal nerve, clinical and electrophysiologic sparing of the toe extensors could occur in the presence of an accessory peroneal nerve. Also, in laboratories where the peroneal nerve is stimulated at the ankle before the knee, caution should be made when a low CMAP amplitude is obtained, which could be misinterpreted as the result of underlying pathology, and stimulation at the knee should always be performed.

### UNEXPECTED FINDINGS ON NERVE CONDUCTION STUDIES: CAUSE AND ACTION

During the electrodiagnostic evaluation of most patients, the examining physician usually

Table 47–26 Findings of an Accessory Peroneal Nerve

- 
- a. Higher CMAP amplitude with stimulation at the knee and fibular head than with stimulation at the ankle. (This finding can also be seen with understimulation at the ankle or overstimulation at the knee.)
- b. Stimulation behind the lateral malleolus produces an initially negative CMAP, recorded from the EDB.
- c. CMAP amplitude recorded from lateral malleolus stimulation typically equals the difference between the knee and the ankle CMAP amplitudes.
- 

has a general hypothesis of what the underlying disease may be. Therefore, certain findings are often expected to be found or not found during NCS and needle examination. However, the expected findings are not always seen, which may be due to a different localization or disease than what was initially expected. However, technical and other physiologic factors may also result in unexpected findings on testing. It is important for the electromyographer to be able to recognize and rectify any technical problems during a study.

## SUMMARY

The major value and primary application of clinical neurophysiology is in the assessment and characterization of neurologic disease. Selection of appropriate studies for the problem of an individual patient requires a careful clinical evaluation to determine possible causes of the patient's symptoms. The nature of the symptoms and the conclusions of the clinical evaluation are the best guides to appropriate use of clinical neurophysiologic testing.

The approach to testing can be assisted by deciding which structures are likely to be involved. For example, motor and sensory symptoms are best assessed using the different methods of motor and sensory NCS. Electroencephalography, autonomic function testing, and polysomnography provide distinct assessment of disturbances of consciousness, cognition, visceral function, and sleep. The level of the nervous system that is likely to be involved by the disease process can also guide selection of the neurophysiologic methods that will be most helpful in sorting out the clinical problem. Disorders of the cerebral hemisphere are best characterized electrically by electroencephalography, somatosensory evoked potentials, polysomnography, and movement recordings. Lesions in the posterior fossa may benefit from the addition

of cranial conduction studies and brain stem auditory evoked potentials. Spinal cord disease produces alterations in EMG, NCS, and somatosensory evoked potentials. Peripheral diseases show changes on NCS, EMG, and autonomic function testing.

The multiplicity of different neurophysiologic measures that can be applied in peripheral disorders is sometimes assisted by applying guideline protocols based on the patient's clinical findings and what is found during testing. Although a clinical neurophysiologic assessment rarely provides evidence for a specific diagnosis, it can provide valuable information about the severity, progression, and prognosis of the disease.

## REFERENCES

1. AAEM Quality Assurance Committee. 1999. Literature review of the usefulness of nerve conduction studies and electromyography in the evaluation of patients with ulnar neuropathy at the elbow. *Muscle & Nerve* 22:S408–11.
2. England, J. D., G. S. Gronseth, G. Franklin, et al. 2005. Distal symmetrical polyneuropathy: Definition for clinical research. *Muscle & Nerve* 31:113–23.
3. American Academy of Neurology. 1991. Research criteria for diagnosis of chronic inflammatory demyelinating polyneuropathy (CIDP). Report from an Ad Hoc Subcommittee of the American Academy of Neurology CIDP Task Force. *Neurology* 41:617–18.
4. Bromberg, M. B. 1991. Comparison of electrodiagnostic criteria for primary demyelination in chronic polyneuropathy. *Muscle & Nerve* 14:968–76.
5. Albers, J. W., and J. J. Kelly. 1989. Acquired inflammatory demyelinating polyneuropathies: Clinical and electrodiagnostic features. *Muscle & Nerve* 12:435–51.
6. Thaisetthawatkul, P., E. L. Logigian, and D. N. Herrmann. 2002. Dispersion of the distal compound muscle action potential as a diagnostic criterion for chronic inflammatory demyelinating polyneuropathy. *Neurology* 59:1526–32.
7. Van den Bergh, P. Y. K., and F. Pieret. 2004. Electrodiagnostic criteria for acute and chronic inflammatory demyelinating polyradiculoneuropathy. *Muscle & Nerve* 29:565–74.

8. Lewis, R. A., A. J. Sumner, and M. E. Shy. 2000. Electrophysiological features of inherited demyelinating neuropathies: A reappraisal in the era of molecular diagnosis. *Muscle & Nerve* 23:1472–87.
9. Olney, R. K. 1999. American Association of Electrodiagnostic Medicine. Consensus criteria for the diagnosis of partial conduction block. *Muscle & Nerve* 22:S225–9.
10. Martinez, A. C., M. T. Ferrer, E. D. Tejedor, M. C. Perez Conde, B. Anciones, and A. Frank. 1982. Diagnostic yield of single fiber electromyography and other electrophysiological techniques in myasthenia gravis. *Electromyography and Clinical Neurophysiology* 22:377–93.
11. Ozdemir, C., and R. R. Young. 1976. The results to be expected from electrical testing in the diagnosis of myasthenia gravis. *Annals of the New York Academy of Sciences* 274:203–22.
12. Oh, S. J., N. Eslami, T. Nishirhira, et al. 1982. Electrophysiological and clinical correlation in myasthenia gravis. *Annals of Neurology* 12:348–54.
13. Oh, S. J., D. E. Kim, R. Kuruoglu, R. J. Bradley, and D. Dwyer. 1992. Diagnostic sensitivity of the laboratory tests in myasthenia gravis. *Muscle & Nerve* 15:720–4.
14. Whitaker, C. H., and K. J. Felice. 2004. Apparent conduction block in patients with ulnar neuropathy at the elbow and proximal Martin-Gruber anastomosis. *Muscle & Nerve* 30:808–11.
15. Wilbourn, A. J., and E. H. Lambert. 1976. The forearm median-to-ulnar nerve communication: Electrodiagnostic aspects. *Neurology* 26:368.
16. Sun, S. F., and E. W. Streib. 1983. Martin-Gruber anastomosis: Electromyographic studies: Part II. *Electromyography and Clinical Neurophysiology* 23:271–85.
17. Kimura, I., and D. R. Ayyar. 1984. The hand neural communication between the ulnar and median nerves: Electrophysiological detection. *Electromyography and Clinical Neurophysiology* 24:409–14.
18. Kimura, J., M. J. Murphy, and D. J. Varda. 1976. Electrophysiological study of anomalous innervation of intrinsic hand muscles. *Archives of Neurology* 33:842–4.
19. Gutmann, L. 1977. Median-ulnar nerve communications and carpal tunnel syndrome. *Journal of Neurology, Neurosurgery, and Psychiatry* 40:982–6.
20. Gutmann, L., A. Gutierrez, and J. E. Riggs. 1986. The contribution of median to ulnar communication in diagnosis of mild carpal tunnel syndrome. *Muscle & Nerve* 9:319–21.
21. Rowntree, T. 1949. Anomalous innervation of the hand muscles. *The Journal of Bone and Joint Surgery* 31-B:505–10.
22. Sachs, G. M., E. M. Raynor, and J. M. Shefner. 1995. The all ulnar motor hand without forearm anastomosis. *Muscle & Nerve* 18:309–13.
23. Dimitru, D., N. E. Walsh, and C. F. Weber. 1988. Electrophysiologic study of the Riche-Cannieu anomaly. *Electromyography and Clinical Neurophysiology* 28:27–31.
24. Seradge, H., and E. Seradge. 1990. Median innervated hypothenar muscle: Anomalous branch of median nerve in carpal tunnel syndrome. *The Journal of Hand Surgery* 15A:356–9.
25. Gutmann, L. 1993. AAEM minimonograph #2: Important anomalous innervations of the extremities. *Muscle & Nerve* 16:339–47.
26. Lambert, E. H. 1969. The accessory deep peroneal nerve: A common variation in innervation of extensor digitorum brevis. *Neurology* 19:1169–76.

*This page intentionally left blank*



# Glossary of Electrophysiologic Terms\*

**A Wave:** A *compound muscle action potential* that follows the *M wave*, evoked consistently from a muscle by submaximal electric stimuli and frequently abolished by *supramaximal stimuli*. Its *amplitude* is similar to that of an *F wave*, but the *latency* is more constant. Usually occurs before the *F wave*, but may occur afterwards. Thought to be due to extra *discharges* in the nerve, *ephapses*, or axonal branching. This term is preferred over *axon reflex*, *axon wave*, or *axon response*. Compare with the *F wave*.

**Absolute Refractory Period:** See *refractory period*.

**Accommodation:** In neuronal physiology, a rise in the *threshold* transmembrane *depolarization* required to initiate a *spike*, when depolarization is slow or a subthreshold depolarization is maintained. In the older literature, the observation that the final intensity of current applied in a slowly rising fashion to stimulate a nerve was greater than the intensity of a pulse of current required to stimulate the same nerve. The latter may largely be an *artifact* of the nerve sheath and bears little relation to true accommodation as measured intracellularly.

**Accommodation Curve:** See *strength-duration curve*.

**Acoustic Myography:** The recording and analysis of sounds produced by the contracting muscle. The muscle *contraction* may be produced by stimulation of the nerve supply to the muscle or by volitional *activation* of the muscle.

**Action Potential (AP):** The brief regenerative electric *potential* that propagates along a single axon or muscle fiber membrane. An all-or-none phenomenon; whenever the

*stimulus* is at or above *threshold*, the action potential generated has a constant size and configuration. See also *compound action potential* and *motor unit action potential*.

**Activation:** (1) In physiology, a general term for the initiation of a process. (2) The process of *motor unit action potential* firing. The force of muscle *contraction* is determined by the number of *motor units* and their *firing rate*.

**Activation Procedure:** A technique used to detect defects of neuromuscular transmission during *repetitive nerve stimulation* testing. Most commonly a sustained voluntary *contraction* is performed to elicit *facilitation* or *postactivation depression*. See also *tetanic contraction*.

**Active Electrode:** Synonymous with *exploring electrode*. See *recording electrode*.

**Acute Inflammatory Neuropathy:** An acute, monophasic *polyneuropathy*. Characterized by a time course of progression to maximum deficit within 4 weeks of onset of symptoms. Most common clinical presentation is an ascending sensory-motor *neuropathy*. Electrodiagnostic studies most commonly reveal evidence for *demyelination*, but *axonal degeneration* also occurs. Distinguish from *chronic inflammatory demyelinating polyradiculoneuropathy (CIDP)*. See also *Guillain-Barré syndrome*.

**Adaptation:** A decline in the *frequency* of the *spike discharge* as typically recorded from sensory axons in response to a maintained *stimulus*.

**ADEMG:** Abbreviation for *automatic decomposition electromyography*.

**AEP:** Abbreviation for *auditory-evoked potential*.

---

\* Reproduced by permission of the American Association of Electrodiagnostic Medicine.

**Afterdischarge:** (1) The continuation of *action potentials* in a neuron, axon, or muscle fiber following the termination of an applied *stimulus*. (2) The continuation of firing of *muscle action potentials* after cessation of voluntary *activation*, for example in *myotonia*.

**Afterpotential:** The membrane *potential* between the end of the *spike* and the time when the membrane potential is restored to its resting value. The membrane during this period may be depolarized or hyperpolarized at different times.

**Akinesia:** Lack or marked *delay* of intended movement, often observed in patients with Parkinson's disease. Often used synonymously with *bradykinesia*.

**Amplitude:** With reference to an *action potential*, the maximum *voltage* difference between two points, usually *baseline-to-peak* or *peak-to-peak*. By convention, the amplitude of *potentials* which have an initial negative deflection from the baseline, such as the *compound muscle action potential* and the *antidromic sensory nerve action potential* are measured from baseline to the most negative peak. In contrast, the amplitude of a *compound sensory nerve action potential*, *motor unit potential*, *fibrillation potential*, *positive sharp wave*, *fasciculation potential*, and most other action potentials is measured from the most positive peak to the most negative peak.

**Amplitude Decay:** The percent change in the *amplitude* of the *M wave* or the *compound sensory nerve action potential* between two different stimulation points along the nerve.  $\text{Decay} = 100 \cdot (\text{amplitude}_{\text{distal}} - \text{amplitude}_{\text{proximal}}) / \text{amplitude}_{\text{distal}}$ . Useful in the evaluation of *conduction block*. Abnormal decay without increased *temporal dispersion* may indicate a conduction block.

**Anodal Block:** A local block of nerve conduction caused by membrane *hyperpolarization* under a stimulating *anode*. Does not occur in routine clinical studies, since it is possible for the anode to routinely result in nerve *depolarization* if sufficient current intensities are used.

**Anode:** The positive terminal of an electric current source. See *stimulating electrode*.

**Antidromic:** Propagation of a nerve impulse in the direction opposite to physiologic conduction; for example, conduction along

*motor nerve* fibers away from the muscle and conduction along sensory fibers away from the spinal cord. Contrast with *orthodromic*.

**AP:** Abbreviation for *action potential*.

**Artifact (also Artefact):** A *voltage* change generated by a biologic or nonbiologic source other than the ones of interest. The *stimulus artifact* (or *shock artifact*) represents cutaneous spread of stimulating current to the *recording electrode* and the *delay* in return to *baseline* which is dependent on the ability of filters to respond to high voltage. Stimulus artifacts may precede or overlap the activity of interest. *Movement artifact* refers to a change in the recorded activity caused by movement of the recording electrodes.

**Asterixis:** A quick involuntary movement caused by a brief lapse in tonic muscle *activation*. It can be appreciated only during voluntary movement. Is usually irregular, but can be rhythmic and confused with action *tremor*.

**Ataxia:** Clumsiness of movement. Specific features include *dysmetria* (incorrect distance moved) and *dysdiadochokinesis* (irregularity of attempted rhythmic movements). Most commonly due to a disorder of the cerebellum or proprioceptive sensory system. Referred to, respectively, as cerebellar ataxia or sensory ataxia.

**Auditory Evoked Potential (AEP):** Electric *waveforms* of biologic origin elicited in response to sound stimuli. Classified by their *latency* as short-latency *brain stem auditory evoked potential (BAEP)* with a latency of up to 10 ms, middle latency with a latency of 10–50 ms, and long latency with a latency of over 50 ms. See *brain stem auditory evoked potential*.

**Automatic Decomposition EMG (ADEMG):** Computerized method for extracting individual *motor unit action potentials* from an *interference pattern*.

**Averager:** See *signal averager*.

**Averaging:** A method for extracting time-locked *potentials* from random background *noise* by sequentially adding traces and dividing by the total number of traces.

**Axon Reflex:** Use of term discouraged as it is incorrect. No *reflex* is thought to be involved. See preferred term, *A wave*.

**Axon Response:** See preferred term, *A wave*.

**Axon Wave:** See *A wave*.

**Axonal Degeneration:** Degeneration of the segment of a nerve distal to the cell body with preferential distal pathology.

**Axonotmesis:** Nerve injury characterized by axon and myelin sheath disruption with supporting connective tissue preservation, resulting in *axonal degeneration* distal to the injury site. Compare *neurapraxia* and *neurotmesis*.

**Backaveraging:** *Averaging* a signal which occurs in a time epoch preceding a triggering event. Often used to extract a time-locked EEG signal preceding voluntary or involuntary movement, usually triggered by the onset of the *EMG* activity of the movement. An example is the *Bereitschaftspotential*.

**Backfiring:** *Discharge* of an *antidromically* activated motor neuron.

**BAEP:** Abbreviation for *brain stem auditory evoked potential*.

**BAER:** Abbreviation for *brain stem auditory evoked response*. See preferred term, *brain stem auditory evoked potential*.

**Baseline:** (1) The *potential* recorded from a biologic system while the system is at rest. (2) A flat trace on the recording instrument; an equivalent term, *isoelectric line*, may be used.

**Benign Fasciculation Potential:** A *firing pattern* of *fasciculation potentials* occurring in association with a clinical syndrome of *fasciculations* in an individual with a non-progressive neuromuscular disorder. Use of term discouraged.

**BER:** Abbreviation for *brain stem auditory evoked responses*. See preferred term, *brain stem auditory evoked potentials*.

**Bereitschaftspotential (BP):** A component of the *movement-related cortical potential*. The slowly rising negativity in the EEG preceding voluntary movement. The German term means "readiness potential." Has two *phases* called BP1 and BP2 or BP and NS9 (negative slope). See *backaveraging*.

**Biphasic Action Potential:** An *action potential* with one *baseline* crossing, producing two *phases*.

**Biphasic End Plate Activity:** See *end plate activity (biphasic)*.

**Bipolar Needle Electrode:** *Recording electrode* that measures *voltage* between two insulated wires cemented side-by-side in a steel cannula. The bare tips of the electrodes

are flush with the level of the cannula which may serve as a ground.

**Bipolar Stimulating Electrode:** See *stimulating electrode*.

**Bizarre High-Frequency Discharge:** See preferred term, *complex repetitive discharge*.

**Bizarre Repetitive Discharge:** See preferred term, *complex repetitive discharge*.

**Bizarre Repetitive Potential:** See preferred term, *complex repetitive discharge*.

**Blink Reflex:** See *blink responses*.

**Blink Responses:** *Compound muscle action potentials* evoked from orbicularis oculi muscles as a result of brief electric or mechanical *stimuli* applied to the cutaneous area innervated by the supraorbital (or less commonly, the infraorbital) branch of the trigeminal nerve. Typically, there is an early compound muscle action potential (*R1 wave*) ipsilateral to the stimulation site with a *latency* of about 10 ms and a bilateral late compound muscle action potential (*R2 wave*) with a *latency* of approximately 30 ms. Generally, only the R2 wave is associated with a visible *contraction* of the muscle. The configuration, *amplitude*, *duration*, and *latency* of the two components, along with the sites of recording and stimulation, should be specified. The R1 and R2 waves are oligosynaptic and polysynaptic brain stem *reflexes*, respectively. Together they are called the *blink reflex*. The afferent arc is provided by the sensory branches of the trigeminal nerve and the efferent arc is provided by facial nerve motor fibers.

**Blocking:** Term used in *single fiber electromyography* to describe dropout of one or more components of the *potential* during sequential firings. If more than one component drops out simultaneously it is described as concomitant blocking. Usually seen when *jitter* values exceed 80–100  $\mu$ s. A sign of abnormal neuromuscular transmission, which may be due to primary *neuromuscular transmission disorders*, such as *myasthenia gravis* and other myasthenic syndromes. Also seen as a result of degeneration and reinnervation in *neuropathies* or *myopathies*. Concomitant blocking may be generated by a split muscle fiber or failure of conduction at an axon branch serving several muscle fibers.

**BP:** Abbreviation for *Bereitschaftspotential*.

**Brachial Plexus:** An anatomical structure which is formed by the spinal roots from C5 to T1, traverses the shoulder region, and culminates in the named peripheral nerves in the arm. It is composed of roots, trunks, divisions, cords, and terminal nerves.

**Bradykinesia:** Slowness of movement, often observed in patients with Parkinson's disease. Often used synonymously with *akinesia*.

**Brain Stem Auditory Evoked Potential (BAEP):** Electric *waveforms* of biologic origin elicited in response to sound stimuli. Normally consists of a sequence of up to seven waves, designated I to VII, which occur during the first 10 ms after the onset of the *stimulus* and have positive polarity at the vertex of the head.

**Brain Stem Auditory Evoked Response (BAER, BER):** See preferred term, *brain stem auditory evoked potentials*.

**BSAP:** Abbreviation for brief, small, abundant potentials (see *BSAPP*). Use of term is discouraged.

**BSAPP:** Abbreviation for brief, small, abundant, polyphasic *potentials*. Used to describe a *recruitment pattern* of brief *duration*, small *amplitude*, overly abundant, polyphasic *motor unit action potentials*, with respect to the amount of force generated; usually a minimal *contraction*. Use of term discouraged. Quantitative measurements of motor unit action potential duration, amplitude, numbers of *phases*, and *recruitment frequency* are preferred. See *motor unit action potential*.

**C Reflex:** An abnormal *reflex response* representing the electrophysiologic correlate of sensory evoked *myoclonus*. The term "C" was chosen to indicate that the reflex might be mediated in the cerebral cortex. This is sometimes, but not always, true.

**c/s (also cps):** Abbreviation for *cycles per second*. See preferred term, *hertz (Hz)*.

**Carpal Tunnel Syndrome:** A *mononeuropathy* affecting the median nerve at the wrist. As the nerve passes through the carpal tunnel, a space bounded dorsally by the bones of the wrist, laterally by the forearm flexor tendons, and volarly by the transverse carpal ligament, it is subject to compression by any of these structures. Repetitive hand and wrist movement is thought to contribute to the compression.

**Cathode:** The negative terminal of an electric current source. See *stimulating electrode*.

**Center Frequency:** The mean or median *frequency* of a *waveform* decomposed by *frequency analysis*. Employed in the study of muscle *fatigue*.

**Central Electromyography:** Use of electrodiagnostic recording techniques to study *reflexes* and the control of movement by the spinal cord and brain. See *electrodiagnosis*.

**Central Motor Conduction:** The time taken for conduction of *action potentials* in the central nervous system from motor cortex to alpha motoneurons in the spinal cord or brain stem. Calculated from the *latencies* of the *motor evoked potentials* produced by *transcranial magnetic stimulation* or *transcranial electrical stimulation*, subtracting the time for peripheral conduction.

**Chorea:** Clinical term used to describe irregular, random, brief, abrupt, involuntary movements of the head or limbs due to a disorder of the basal ganglia. Most commonly observed in patients with Huntington's disease and Sydenham's chorea.

**Chronaxie (also Chronaxy):** See *strength-duration curve*.

**Chronic Inflammatory Demyelinating Poly-radiculoneuropathy (CIDP):** A *polyneuropathy* or *polyradiculoneuropathy* characterized by generalized *demyelination* of the peripheral nervous system. In most cases there is also a component of *axonal degeneration*. Some cases are associated with a monoclonal gammopathy of undetermined significance (MGUS). Distinguish from *acute inflammatory neuropathy*.

**Clinical Electromyography:** Term used commonly to describe the scientific methods of recording and analysis of biologic electrical *potentials* from human peripheral nerve and muscle. See preferred term, *electrodiagnostic medicine*.

**CMAP:** Abbreviation for *compound muscle action potential*.

**Coaxial Needle Electrode:** See synonym, *concentric needle electrode*.

**Collision:** When used with reference to *nerve conduction studies*, the interaction of two *action potentials* propagated toward each other from opposite directions on the same nerve fiber so that the *refractory periods* of the two potentials prevent propagation past each other.



**Complex Motor Unit Action Potential:** A *motor unit action potential* that is polyphasic or serrated. See preferred terms, *polyphasic action potential* or *serrated action potential*.

**Complex Repetitive Discharge:** A type of *spontaneous* activity. Consists of a regularly repeating series of complex polyphasic or serrated *potentials* that begin abruptly after *needle electrode* movement or spontaneously. The potentials have a uniform shape, *amplitude*, and *discharge frequency* ranging from 5 to 100 Hz. The discharge typically terminates abruptly. May be seen in both myopathic and neurogenic disorders, usually chronic. Thought to be due to ephaptic excitation of adjacent muscle fibers in a cyclic fashion. This term is preferred to *bizarre high-frequency discharge*, *bizarre repetitive discharge*, *bizarre repetitive potential*, *pseudomyotonic discharge*, and *synchronized fibrillation*. See also *ephapse* and *ephaptic transmission*.

**Compound Action Potential:** A *potential* or *waveform* resulting from the summation of multiple individual axon or *muscle fiber action potentials*. See *compound mixed nerve action potential*, *compound motor nerve action potential*, *compound nerve action potential*, *compound sensory nerve action potential*, and *compound muscle action potential*.

**Compound Mixed Nerve Action Potential:** A *compound nerve action potential* recorded from a *mixed nerve* when an electric *stimulus* is applied to a segment of the nerve that contains both afferent and efferent fibers. The *amplitude*, *latency*, *duration*, and *phases* should be noted.

**Compound Motor Nerve Action Potential (Compound Motor NAP):** A *compound nerve action potential* recorded from efferent fibers of a *motor nerve* or a motor branch of a *mixed nerve*. Elicited by stimulation of a motor nerve, a motor branch of a mixed nerve, or a ventral nerve root. The *amplitude*, *latency*, *duration*, and number of *phases* should be noted. Distinguish from *compound muscle action potential*.

**Compound Muscle Action Potential (CMAP):** The summation of nearly synchronous *muscle fiber action potentials* recorded from a muscle, commonly produced by stimulation of the nerve supplying the muscle either directly or indirectly. *Baseline-to-peak*

*amplitude*, *duration*, and *latency* of the negative *phase* should be noted, along with details of the method of stimulation and recording. Use of specific named *potentials* is recommended, for example, *M wave*, *F wave*, *H wave*, *T wave*, *A wave*, and *R1* or *R2 wave* (*blink responses*).

**Compound Nerve Action Potential (Compound NAP):** The summation of nearly synchronous *nerve fiber action potentials* recorded from a nerve trunk, commonly produced by stimulation of the nerve directly or indirectly. Details of the method of stimulation and recording should be specified, together with the fiber type (*sensory*, *motor*, or *mixed nerve*).

**Compound Sensory Nerve Action Potential (Compound SNAP):** A *compound nerve action potential* recorded from the afferent fibers of a *sensory nerve*, a sensory branch of a *mixed nerve* or in response to stimulation of a sensory nerve or a dorsal nerve root. May also be elicited when an adequate *stimulus* is applied synchronously to sensory receptors. The *amplitude*, *latency*, *duration*, and configuration should be noted. Generally, the amplitude is measured as the maximum peak-to-peak *voltage* when there is an initial positive deflection or from *baseline-to-peak* when there is an initial negative deflection. The latency is measured as either the time to the initial deflection or the negative peak, and the duration as the interval from the first deflection of the *waveform* from the baseline to its final return to the baseline. Also referred to by the less preferred terms *sensory response*, *sensory potential*, or *SNAP*.

**Concentric Needle Electrode:** *Recording electrode* that measures an electric *potential* difference between a centrally insulated wire and the cannula of the needle through which it runs.

**Conditioning Stimulus:** See *paired stimuli*.

**Conduction Block:** Failure of an *action potential* to propagate past a particular point in the nervous system whereas conduction is possible below the point of the block. Documented by demonstration of a reduction in the area of a *compound muscle action potential* greater than that normally seen with stimulation at two different points on a nerve trunk; anatomic variations of nerve pathways and technical factors related to nerve

stimulation must be excluded as the cause of the reduction in area.

**Conduction Distance:** The length of nerve or muscle over which conduction is determined, customarily measured in centimeters or millimeters.

**Conduction Time:** See *conduction velocity*.

**Conduction Velocity (CV):** Speed of propagation of an *action potential* along a nerve or muscle fiber. The nerve fibers studied (motor, sensory, autonomic, or *mixed nerve*) should be specified. For a nerve trunk, the maximum conduction velocity is calculated from the *latency* of the *evoked potential* (muscle or nerve) at maximal or supramaximal intensity of stimulation at two different points. The distance between the two points (*conduction distance*) is divided by the difference between the corresponding latencies (*conduction time*). The calculated result is the conduction velocity of the fastest fibers and is usually expressed as meters per second (m/s). As commonly used, refers to the *maximum conduction velocity*. By specialized techniques, the conduction velocity of other fibers can also be determined and should be specified, for example, *minimum conduction velocity*.

**Congenital Myasthenia:** A heterogeneous group of genetic disorders of the neuromuscular junction manifest by muscle weakness and *fatigue*.

**Contraction:** A voluntary or involuntary reversible muscle shortening that may or may not be accompanied by *action potentials* from muscle. Contrast the term *contracture*.

**Contraction Fasciculation:** Clinical term for visible twitching of a muscle with weak voluntary or postural *contraction* which has the appearance of a *fasciculation*. More likely to occur in neuromuscular disorders in which the *motor unit* territory is enlarged and the tissue covering the muscle is thin, but may also be observed in normal individuals.

**Contracture:** (1) Fixed resistance to stretch of a shortened muscle due to fibrous connective tissue changes and loss of sarcomeres in the muscle. Limited movement of a joint may be due to muscle contracture or to fibrous connective tissue changes in the joint. Contrast with *contraction*, which is a rapidly reversible painless shortening of the muscle. (2) The prolonged, painful, electrically silent, and involuntary state of

temporary muscle shortening seen in some *myopathies* (e.g., muscle phosphorylase deficiency).

**Coupled Discharge:** See preferred term, *satellite potential*.

**cps (also c/s):** Abbreviation for *cycles per second*. See preferred term, *hertz (Hz)*.

**Cramp Discharge:** Involuntary repetitive firing of *motor unit action potentials* at a high frequency (up to 150 Hz) in a large area of a muscle usually associated with painful muscle *contraction*. Both *discharge frequency* and number of motor unit action potentials activated increase gradually during development and subside gradually with cessation. See *muscle cramp*.

**Cross Talk:** (1) A general term for abnormal communication between excitable membranes. See *ephapse* and *ephaptic transmission*. (2) Term used in *kinesiologic EMG* for signals picked up from adjacent muscles.

**Crossed Leg Palsy:** Synonym for *peroneal neuropathy at the knee*.

**Cubital Tunnel Syndrome:** A *mononeuropathy* involving the ulnar nerve in the region of the elbow. An *entrapment neuropathy* caused by compression of the nerve as it passes through the aponeurosis (the cubital tunnel) of the two heads of the flexor carpi ulnaris approximately 1.5–3.5 cm distal to the medial epicondyle of the elbow. The mechanism of entrapment is presumably narrowing of the cubital tunnel during elbow flexion. See also *tardy ulnar palsy* and *ulnar neuropathy at the elbow*.

**Cutaneous Reflex:** A *reflex* produced by cutaneous stimulation. There are several *phases* to cutaneous reflexes, and, if the muscle has a background *contraction*, the phases can be seen to be inhibitory as well as excitatory.

**CV:** Abbreviation for *conduction velocity*.

**Cycles Per Second (c/s, cps):** Unit of frequency. See preferred term *hertz (Hz)*.

**Decomposition EMG:** Synonym for *automatic decomposition EMG*.

**Decremental Response:** See preferred term, *decrementing response*.

**Decrementing Response:** A reproducible decline in the *amplitude* and/or area of the *M wave* of successive *responses* to *repetitive nerve stimulation*. The rate of stimulation and the total number of stimuli should be specified. Decrementing responses with disorders of neuromuscular transmission



are most reliably seen with slow rates (2–5 Hz) of nerve stimulation. A decrementing response with *repetitive nerve stimulation* commonly occurs in disorders of neuromuscular transmission, but can also be seen in some *neuropathies*, *myopathies*, and *motor neuron disease*. An *artifact* resembling a decrementing response can result from movement of the *stimulating* or *recording electrodes* during *repetitive nerve stimulation* (see *pseudodecrement*). Contrast with *incrementing response*.

**Delay:** (1) The time between the beginning of the horizontal sweep of the oscilloscope and the onset of an applied *stimulus*. (2) A synonym for an information storage device (*delay line*) used to display events occurring before a trigger signal.

**Delay Line:** An information storage device used to display events which occur before a trigger signal. A method for displaying a *waveform* at the same point on a sweep from a free-running *electromyogram*.

**Demyelination:** Disease process affecting the myelin sheath of central or peripheral nerve fibers, manifested by *conduction velocity* slowing, *conduction block*, or both.

**Denervation Potential:** Sometimes used as a synonym for *fibrillation potential*. Use of this term is discouraged, since fibrillation potentials can occur in the absence of denervation. See preferred term, *fibrillation potential*.

**Depolarization:** A change in the existing membrane *potential* to a less negative value. Depolarizing an excitable cell from its resting level to *threshold* typically generated an *action potential*.

**Depolarization Block:** Failure of an excitable cell to respond to a *stimulus* due to preexisting *depolarization* of the cell membrane.

**Depth Electrodes:** *Electrodes* which are inserted into the substance of the brain for electrophysiological recording. Most often inserted using stereotactic techniques.

**Dermatome Somatosensory Evoked Potential (DESP):** Scalp-recorded *waveforms* generated from repeated stimulation of a specific dermatome. Different from typical *somatosensory evoked potentials* which are recorded in response to stimulation of a named peripheral nerve.

**Discharge:** The firing of one or more excitable elements (neurons, axons, or muscle fibers); as conventionally used, refers to all-or-none

*potentials* only. Synonymous with *action potential*.

**Discharge Frequency:** The rate at which a *potential* discharges repetitively. When potentials occur in groups, the rate of recurrence of the group and rate of repetition of the individual components in the groups should be specified. See also *firing rate*.

**Discrete Activity:** See *interference pattern*.

**Distal Latency:** The interval between the delivery of a *stimulus* to the most distal point of stimulation on a nerve and the onset of a *response*. A measure of the conduction properties of the distal-most portion of motor or sensory nerves. See *motor latency* and *sensory latency*.

**Double Discharge:** Two sequential firings of a *motor unit action potential* of the same form and nearly the same *amplitude*, occurring consistently in the same relationship to one another at intervals of 2–20 ms. See also *multiple discharge* and *triple discharge*.

**Doublet:** Synonym for the preferred term, *double discharge*.

**DSEP:** Abbreviation for *dermatome somatosensory evoked potential*.

**Duration:** The time during which something exists or acts. (1) The interval from the beginning of the first deflection from the *baseline* to its final return to the baseline of an *action potential* or *waveform*, unless otherwise specified. If only part of the waveform is measured, the points of the measurement should be specified. For example, the duration of the *M wave* may be measured as the negative *phase* duration and refers to the interval from the deflection of the first negative phase from the baseline to its return to the baseline. (2) The interval of the applied current or *voltage* of a single electric *stimulus*. (3) The interval from the beginning to the end of a series of recurring stimuli or action potentials.

**Dynamic EMG:** See *kinesiologic EMG*.

**Dyskinesia:** An abnormal involuntary movement of a *choreic* or *dystonic* type. The term is nonspecific and is often used in association with a modifier that describes its etiology, for example, tardive dyskinesia or L-DOPA dyskinesia.

**Dystonia:** A disorder characterized by involuntary movements caused by sustained muscle *contraction*, producing prolonged movements or abnormal postures.

**E-1:** Synonymous with *input terminal 1*. See *recording electrode*.

**E-2:** Synonymous with *input terminal 2*. See *recording electrode*.

**E:I Ratio:** In autonomic testing, the ratio of the longest electrocardiographic R–R interval during expiration to the shortest during inspiration. Primarily a measure of parasympathetic control of heart rate.

**Early Recruitment:** A *recruitment pattern* which occurs in association with a reduction in the number of muscle fibers per *motor unit* or when the force generated by the fibers is reduced. At low levels of muscle contraction more *motor unit action potentials* are recorded than expected, and a *full interference pattern* may be recorded at relatively low levels of muscle contraction. Most often encountered in *myopathy*.

**Earth Electrode:** Synonymous with *ground electrode*.

**EDX:** Abbreviation for *electrodiagnosis*. Can also be used for *electrodiagnostic and electrodiagnostic medicine*.

**Electric Inactivity:** See preferred term, *electric silence*.

**Electric Silence:** The absence of measurable electric activity due to biologic or nonbiologic sources. The sensitivity and signal-to-noise level of the recording system should be specified.

**Electrocorticography:** Electrophysiologic recording directly from the surface of the brain. In the intraoperative setting, recordings are made of ongoing spontaneous electroencephalogram activity, or *potentials* evoked by stimulation of peripheral sensory pathways.

**Electrode:** A conducting device used to record an electric *potential* (*recording electrode*) or to deliver an electric current (*stimulating electrode*). In addition to the *ground electrode* used in clinical recordings, two electrodes are always required either to record an electric potential or to deliver a *stimulus*. See *ground electrode*, *recording electrode*, and *stimulating electrode*. Also see specific *needle electrode* configurations: *monopolar*, *unipolar*, *concentric*, *bifilar recording*, *bipolar stimulating*, *multilead*, *single fiber*, and *macro-EMG needle electrodes*.

**Electrodiagnosis (EDX):** The scientific methods of recording and analyzing biologic

electrical *potentials* from the central, peripheral, and autonomic nervous systems and muscles. See also *clinical electromyography*, *electromyography*, *electroneurography*, *electroneuromyography*, *evoked potentials*, *electrodiagnostic medicine*, *electrodiagnostic medicine consultation*, and *electrodiagnostic medicine consultant*.

**Electrodiagnostic Medicine:** A specific area of medical practice in which a physician integrates information obtained from the clinical history, observations from physical examination, and scientific data acquired by recording electrical *potentials* from the nervous system and muscle to diagnose, or diagnose and treat, diseases of the central, peripheral, and autonomic nervous systems, neuromuscular junctions, and muscle. See also *electrodiagnosis*, *electrodiagnostic medicine consultation*, and *electrodiagnostic medicine consultant*.

**Electrodiagnostic Medicine Consultant:** A physician specially trained to obtain a medical history, perform a physical examination, and to record and analyze data acquired by recording electrical *potentials* from the nervous system and muscle to diagnose and/or treat diseases of the central, peripheral, and autonomic nervous systems, neuromuscular junction, and muscle. See also *electrodiagnosis*, *electrodiagnostic medicine*, and *electrodiagnostic medicine consultation*.

**Electrodiagnostic Medicine Consultation:** The medical evaluation in which a specially trained physician (*electrodiagnostic medicine consultant*) obtains a medical history, performs a physical examination, and integrates scientific data acquired by recording electrical *potentials* from the nervous system and muscle to diagnose and/or treat diseases of the central, peripheral, and autonomic nervous systems, neuromuscular junction, and muscle. See also *electrodiagnosis*, *electrodiagnostic medicine*, and *electrodiagnostic medicine consultant*.

**Electromyogram:** The record obtained by *electromyography*.

**Electromyograph:** Equipment used to activate, record, process, and display electrical *potentials* for the purpose of evaluating the function of the central, peripheral, and autonomic nervous systems, neuromuscular junction, and muscles.

**Electromyographer:** See preferred term, *electrodiagnostic medicine consultant*.

**Electromyography (EMG):** Strictly defined, the recording and study of *insertion, spontaneous, and voluntary activity* of muscle with a *recording electrode* (either a *needle electrode* for invasive EMG or a *surface electrode* for kinesiological studies). The term is also commonly used to refer to an *electrodiagnostic medicine consultation*, but its use in this context is discouraged.

**Electroneurography (ENG):** The recording and study of the *action potentials* of peripheral nerve. Synonymous with *nerve conduction studies*.

**Electroneuromyography (ENMG):** The combined studies of *electromyography* and *electroneurography*. Synonymous with *clinical electromyography*. See preferred term *electrodiagnostic medicine consultation*.

**EMG:** Abbreviation for *electromyography*.

**End Plate Activity:** Spontaneous electric activity recorded with a *needle electrode* close to muscle end plates. These *potentials* may have several different morphologies.

1. Monophasic: Low-amplitude (10–20  $\mu\text{V}$ ), short-duration (0.5–1.0 ms), negative potentials occurring in a dense, steady pattern, the exact *frequency* of which cannot be defined. These nonpropagated potentials are probably *miniature end plate potentials* recorded extracellularly. Referred to as *end plate noise* or *sea-shell sound* (*sea shell roar* or *noise*).
2. Biphasic: Moderate-amplitude (100–300  $\mu\text{V}$ ), short-duration (2–4 ms), initially negative *spike potentials* occurring irregularly in short bursts with a high frequency (50–100 Hz). These propagated potentials are generated by muscle fibers excited by activity in nerve terminals. These potentials have been referred to as biphasic spike potentials, *end plate spikes*, and, incorrectly, *nerve potentials*. May also have a biphasic initially positive morphology.
3. Triphasic: Similar to biphasic potentials, but the *waveforms* have three *phases* with an initial positive deflection. Fire in an irregular fashion; contrast with *fibrillation potential*.

**End Plate Noise:** See *end plate activity* (*monophasic*).

**End Plate Potential (EPP):** The graded non-propagated membrane potential induced in

the postsynaptic membrane of a muscle fiber by release of acetylcholine from the presynaptic axon terminal in response to an *action potential*.

**End Plate Spike:** See *end plate activity* (*biphasic*).

**End Plate Zone:** The region in a muscle where neuromuscular junctions are concentrated.

**ENG:** Abbreviation for *electroneurography*.

**ENMG:** Abbreviation for *electroneuromyography*.

**Entrapment Neuropathy:** A *mononeuropathy* caused by compression of nerve as it passes through an area of anatomical narrowing.

**Ephapse:** A point of abnormal communication where an *action potential* in one muscle fiber or axon can cause *depolarization* of an adjacent muscle fiber or axon to generate an action potential.

**Ephaptic Transmission:** The generation of a *nerve fiber action potential* from one muscle fiber or axon to another through an *ephapse*. Postulated to be the basis for *complex repetitive discharges*, *myokymic discharges*, and *hemifacial spasm*.

**EPSP:** Abbreviation for *excitatory postsynaptic potential*.

**Erb's Point:** The site at the anterolateral base of the neck where percutaneous nerve stimulation activates the axons comprising the upper trunk of the *brachial plexus*.

**Erb's Point Stimulation:** Percutaneous *supraclavicular nerve stimulation* during which the upper trunk of the *brachial plexus* is activated. See the more general and preferred term, *supraclavicular nerve stimulation*.

**Evoked Potential:** Electric *waveform* elicited by and temporally related to a *stimulus*, most commonly an electric stimulus delivered to a sensory receptor or nerve, or applied directly to a discrete area of the brain, spinal cord, or muscle. See *auditory evoked potential*, *brain stem auditory evoked potential*, *spinal evoked potential*, *somatosensory evoked potential*, *visual evoked potential*, *compound muscle action potential*, and *compound sensory nerve action potential*.

**Evoked Potential Studies:** Recording and analysis of electric *waveforms* of biologic origin elicited in response to electrical, magnetic, or physiological *stimuli*. Stimuli are applied to specific motor or sensory

receptors, and the resulting waveforms are recorded along their anatomic pathways in the peripheral and central nervous system. A single motor or sensory modality is typically tested in a study, and the modality studied is used to define the type of study performed. See *auditory evoked potentials*, *brain stem auditory evoked potentials*, *visual evoked potentials*, and *somatosensory evoked potentials*.

**Evoked Response:** Tautology. Use of term discouraged. See preferred term, *evoked potential*.

**Excitability:** Capacity to be activated by or react to a *stimulus*.

**Excitatory Postsynaptic Potential (EPSP):** A local, graded *depolarization* of a neuron in response to *activation* by a nerve terminal. Contrast with *inhibitory postsynaptic potential*.

**Exploring Electrode:** Synonymous with *active electrode*. See *recording electrode*.

**F Reflex:** An incorrect term for *F wave*.

**F Response:** Synonymous with *F wave*. See preferred term, *F wave*.

**F Wave:** An *action potential* evoked intermittently from a muscle by a supramaximal electric *stimulus* to the nerve due to *antidromic activation* of motor neurons. When compared with the maximal *amplitude* of the *M wave*, it is smaller (1%–5% of the *M wave*) and has a variable configuration. Its *latency* is longer than the *M wave* and is variable. It can be evoked in many muscles of the upper and lower extremities, and the latency is longer with more distal sites of stimulation. Named “F” wave by Magladery and McDougal in 1950, because it was first recorded from foot muscles. Compare with the *H wave* and the *A wave*. One of the *late responses*.

**Facial Neuropathy:** Clinical diagnosis of facial weakness or paralysis due to pathology affecting the seventh cranial nerve (facial nerve). Bell’s palsy refers to a facial *neuropathy* due to inflammation of the facial nerve.

**Facilitation:** An increase in an electrically measured *response* following identical *stimuli*. Occurs in a variety of circumstances: (1) Improvement of neuromuscular transmission resulting in *activation* of previously inactive muscle fibers. May be identified in several ways: *Incrementing response*—a

reproducible increase in the *amplitude* and area of successive *M waves* during *repetitive nerve stimulation*. *Postactivation* or *posttetanic facilitation*—Nerve stimulation studies performed within a few seconds after a brief period (2–60 seconds) of nerve stimulation producing *tetanus* or after a strong voluntary *contraction* may show changes in the configuration of the *M wave(s)* compared to the results of identical studies of the rested muscle as follows: (a) *repair of the decrement*—a diminution of the *decrementing response* with slow rates (2–5 Hz) of repetitive nerve stimulation; (b) *increment after exercise*—an increase in the amplitude and area of the *M wave* elicited by a single supramaximal stimulus. Distinguish from *pseudofacilitation*, which occurs in normal individuals in response to repetitive nerve stimulation at high rates (20–50 Hz) or after strong volitional contraction. It probably reflects a reduction in the *temporal dispersion* of the summation of a constant number of *muscle fiber action potentials* and is characterized by an increase in the amplitude of the successive *M waves* with a corresponding decrease in their *duration*. There is no net change in the area of the negative *phase* of successive *M waves*. (2) An increase in the amplitude of the *motor evoked potential* as a result of background muscle activation.

**Far-Field:** A region of electrical *potential* where the isopotential *voltage* lines associated with a current source change slowly over a short distance. Some use the term far-field potential to designate a potential that does not change in *latency*, *amplitude*, or polarity over infinite distances; alternative designations include “boundary potential” and “junctional potential.” The terms *near-field* and *far-field* are arbitrary designations as there are no agreed-upon criteria defining where the near-field ends and the far-field begins. Compare with *near-field*.

**Fasciculation:** The random, spontaneous twitching of a group of muscle fibers belonging to a single *motor unit*. The twitch may produce movement of the overlying skin (if in limb or trunk muscles) or mucous membrane (if in the tongue). If the motor unit is sufficiently large, an associated joint movement may be observed. The electric activity associated with the twitch is termed a *fasciculation potential*. See also *myokymia*.



Historically, the term *fibrillation* was used incorrectly to describe fine twitching of muscle fibers visible through the skin or mucous membranes. This usage is no longer accepted.

**Fasciculation Potential:** The electric activity associated with a *fasciculation* which has the configuration of a *motor unit activation potential* but which occurs spontaneously. Most commonly occur sporadically and are termed "single fasciculation potentials." Occasionally the potentials occur as a *grouped discharge* and are termed a "brief repetitive discharge." The repetitive firing of adjacent fasciculation potentials, when numerous, may produce an undulating movement of muscle (see *myokymia*). Use of the terms *benign fasciculation* and *malignant fasciculation* is discouraged. Instead, the configuration of the *potentials*, peak-to-peak *amplitude*, *duration*, number of *phases*, stability of configuration, and *frequency* of occurrence, should be specified.

**Fatigue:** A state of depressed responsiveness resulting from activity. Muscle fatigue is a reduction in *contraction* force following repeated voluntary contraction or electric stimulation.

**Fiber Density:** (1) Anatomically, a measure of the number of muscle or nerve fibers per unit area. (2) In *single fiber electromyography*, the mean number of *muscle fiber action potentials* fulfilling *amplitude* and *rise time* criteria belonging to one *motor unit* within the recording area of a *single fiber needle electrode* encountered during a systematic search in a weakly, voluntarily contracting muscle. See also *single fiber electromyography* and *single fiber needle electrode*.

**Fibrillation:** The spontaneous *contractions* of individual muscle fibers which are not visible through the skin. This term has been used loosely in *electromyography* for the preferred term, *fibrillation potential*.

**Fibrillation Potential:** The *action potential* of a single muscle fiber occurring spontaneously or after movement of a *needle electrode*. Usually fires at a constant rate. Consists of biphasic or triphasic *spikes* of short *duration* (usually less than 5 ms) with an initial positive *phase* and a peak-to-peak *amplitude* of less than 1 mV. May also have a biphasic, initially negative phase when recorded at the site of initiation. It has

an associated high-pitched regular sound described as "rain on a tin roof." In addition to this classic form, *positive sharp waves* may also be recorded from fibrillating muscle fibers when the potential arises from an area immediately adjacent to the needle electrode.

**Firing Pattern:** Qualitative and quantitative descriptions of the sequence of *discharge* of electric *waveforms* recorded from muscle or nerve.

**Firing Rate:** *Frequency* of repetition of a *potential*. The relationship of the frequency to the occurrence of other potentials and the force of muscle *contraction* may be described. See also *discharge frequency*.

**Flexor Reflex:** A *reflex* produced by a noxious cutaneous *stimulus*, or a train of electrical stimuli, that activates the flexor muscles of a limb and thus acts to withdraw it from the stimulus. In humans, it is well characterized only in the lower extremity.

**Frequency:** Number of complete cycles of a repetitive *waveform* in 1 second. Measured in *hertz (Hz)* or *cycles per second (cps or c/s)*.

**Frequency Analysis:** Determination of the range of *frequencies* composing a *waveform*, with a measurement of the absolute or relative *amplitude* of each component frequency.

**Full Interference Pattern:** See *interference pattern*.

**Full Wave Rectified EMG:** The absolute value of a *raw EMG* signal. Involves inverting all the *waveforms* below the *isopotential line* and displaying them with opposite polarity above the line. A technique used to analyze *kinesiologic EMG* signals.

**Functional Refractory Period:** See *refractory period*.

**G1, G2:** Abbreviation for *grid 1* and *grid 2*.

**Generator:** In *volume conduction* theory, the source of electrical activity, such as an *action potential*. See *far-field* and *near-field*.

**"Giant" Motor Unit Action Potential:** Use of term discouraged. Refers to a *motor unit action potential* with a peak-to-peak *amplitude* and *duration* much greater than the range found in corresponding muscles in normal subjects of similar age. Quantitative measurements of amplitude and duration are preferable.

**Giant Somatosensory Evoked Potential:** Enlarged *somatosensory evoked potentials*

seen as a characteristic of cortical *reflex myoclonus* and reflecting cortical hyperexcitability.

**Grid 1:** Synonymous with *G1, input terminal 1 (E-1)*, or *active* or *exploring electrode*. Use of the term *Grid 1* is discouraged. See *recording electrode*.

**Grid 2:** Synonymous with *G2, input terminal 2 (E-2)*, or *reference electrode*. Use of the term *Grid 2* is discouraged. See *recording electrode*.

**Ground Electrode:** A connection from the patient to earth. Used as a common return for an electric circuit and as an arbitrary zero *potential* reference point.

**Grouped Discharge:** Term used historically to describe three phenomena: (1) irregular, voluntary grouping of *motor unit action potentials* as seen in a tremulous muscular *contraction*, (2) involuntary grouping of motor unit action potentials as seen in *myokymia*, (3) general term to describe repeated firing of motor unit action potentials. See preferred term, *repetitive discharge*.

**Guillain-Barré Syndrome:** Eponym for *acute inflammatory neuropathy*. Also referred to as Landry-Guillain-Barré syndrome or Landry-Guillain-Barré-Strohl syndrome.

**H Reflex:** Abbreviation for Hoffmann reflex. See *H wave*.

**H Response:** See preferred term, *H wave*.

**H Wave:** A *compound muscle action potential* with a consistent *latency* recorded from muscles after stimulation of the nerve. Regularly found in adults only in a limited group of physiologic extensors, particularly the calf muscles. Compared to the *M wave* of the same muscle, has a longer latency and thus is one of the *late responses* (see *A* and *F wave*). Most reliably elicited with a *stimulus* of long *duration* (500–1000  $\mu$ s). A stimulus intensity sufficient to elicit a maximal amplitude *M wave* reduces or abolishes the *H wave*. Thought to be due to a *spinal reflex*, with electric stimulation of afferent fibers in the *mixed nerve* and *activation* of motor neurons to the muscle mainly through a monosynaptic connection in the spinal cord. The latency is longer with more distal sites of stimulation. The reflex and *wave* are named in honor of Hoffmann's description (1918). Compare the *F wave* and *A wave*.

**Habituation:** Decrease in size of a *reflex motor response* to an afferent *stimulus* when the latter is repeated, especially at regular and recurring short intervals.

**Hemifacial Spasm:** Clinical condition characterized by frequent, repetitive, unilateral, involuntary *contractions* of the facial muscles. Electrodiagnostic studies demonstrate brief *discharges* of groups of *motor unit action potentials* occurring simultaneously in several facial muscles. Occasionally high-frequency discharges occur.

**Hertz (Hz):** Unit of *frequency*. Synonymous with *cycles per second*.

**Hoffmann Reflex:** See *H wave*.

**Hyperekplexia:** Clinical condition characterized by exaggerated *startle reflexes*. Startle reflexes can be exaggerated by being more extreme than expected (larger *amplitude* or more widespread) or by lack of normal *habituation* to repeated similar *stimuli*. Can be either genetic or acquired.

**Hyperpolarization:** A change in the existing membrane *potential* to a more negative value.

**Hypertonia:** See *tone*.

**Hypotonia:** See *tone*.

**Hz:** Abbreviation for *hertz*.

**Impulse Blocking:** See *blocking*.

**Inching:** A *nerve conduction study* technique consisting of applying stimuli at multiple short distance increments along the course of a nerve. This technique is used to localize an area of focal slowing or *conduction block*.

**Incomplete Activation:** *Motor unit action potentials* firing, on requested maximal effort, in decreased numbers at their normal physiological rates, within the basal firing range of 5–10 Hz. Causes include *upper motor neuron syndrome*, pain on muscle *contraction*, hysteria/conversion reaction, and malingering. Contrast with *reduced recruitment*.

**Increased Insertion Activity:** See *insertion activity*.

**Increment After Exercise:** See *facilitation*.

**Incremental Response:** See preferred term, *incrementing response*.

**Incrementing Response:** A reproducible increase in *amplitude* and/or area of successive *M waves* to *repetitive nerve stimulation*. The rate of stimulation and the number of *stimuli* should be specified. Commonly seen in two situations. First, in normal



subjects the configuration of the M wave may change in response to repetitive nerve stimulation so that the amplitude progressively increases as the *duration* decreases, leaving the area of the M wave unchanged. This phenomenon is termed *pseudofacilitation*. Second, in *neuromuscular transmission disorders*, the configuration of the M wave may change with repetitive nerve stimulation so that the amplitude and the area of the M wave progressively increase. This phenomenon is termed *facilitation*. Contrast with *decrementing response*.

**Indifferent Electrode:** Synonymous with *reference electrode*. Use of term discouraged. See *recording electrode*.

**Infraclavicular Plexus:** Segments of the *brachial plexus* inferior to the divisions; includes the three cords and the terminal peripheral nerves. This clinically descriptive term is based on the fact that the clavicle overlies the divisions of the brachial plexus when the arm is in the anatomic position next to the body.

**Inhibitory Postsynaptic Potential (IPSP):** A local graded *hyperpolarization* of a neuron in response to *activation* at a synapse by a nerve terminal. Contrast with *excitatory postsynaptic potential*.

**Injury Potential:** (1) The *potential* difference between a normal region of the surface of a nerve or muscle and a membrane region that has been injured; also called a “demarkation,” or “killed end” potential. Approximates the potential across the membrane because the injured surface has nearly the same potential as the interior of the cell. (2) In *electrodiagnostic medicine*, the term is also used to refer to the electrical activity associated with *needle electrode* insertion into muscle. See preferred terms *fibrillation potential*, *insertion activity*, and *positive sharp wave*.

**Input Terminal 1:** The input terminal of a differential amplifier at which negativity, relative to the other input terminal, produces an upward deflection. Synonymous with *active* or *exploring electrode*, *E-1*, or less preferred term, *grid 1*. See *recording electrode*.

**Input Terminal 2:** The input of a differential amplifier at which negativity, relative to the other input terminal, produces a downward deflection. Synonymous with *reference*

*electrode*, *E-2*, or less preferred term, *grid 2*. See *recording electrode*.

**Insertion Activity:** Electric activity caused by insertion or movement of a *needle electrode* within a muscle. The amount of the activity may be described as normal, reduced, or increased (prolonged), with a description of the *waveform* and repetition rate. See also *fibrillation potential* and *positive sharp wave*.

**Integrated EMG:** Mathematical integration of the *full wave rectified EMG* signal. Reflects the cumulative EMG activity of a muscle over time. See also *linear envelope EMG*.

**Interdischarge Interval:** Time between consecutive *discharges* of the same *potential*. Measurements should be made between the corresponding points on each *waveform*.

**Interference:** Unwanted electric activity recorded from the surrounding environment.

**Interference Pattern:** Electric activity recorded from a muscle with a *needle electrode* during maximal voluntary effort. A full interference pattern implies that no individual *motor unit action potentials* can be clearly identified. A reduced interference pattern (intermediate pattern) is one in which some of the individual motor unit action potentials may be identified while others are not due to superimposition of *waveforms*. The term *discrete activity* is used to describe the electric activity recorded when each of several different motor unit action potentials can be identified in an ongoing recording due to limited superimposition of waveforms. The term *single unit pattern* is used to describe a single motor unit action potential, firing at a rapid rate (should be specified) during maximum voluntary effort. The force of *contraction* associated with the interference pattern should be specified. See also *early recruitment*, *recruitment pattern*, and *reduced recruitment pattern*.

**Interference Pattern Analysis:** Quantitative analysis of the *interference pattern*. This can be done either in the *frequency* domain using fast Fourier transformation (FFT) or in the time domain. Can be done using a fixed load (e.g., 2 kg) at a given proportional strength (e.g., 30% of maximum) or at random strengths. The following are measured in the time domain: (1) the number of *turns*

per second and (2) the *amplitude*, defined as the mean amplitude between peaks.

**Intermediate Interference Pattern:** See *interference pattern*.

**International 10–20 System:** A system of *electrode* placement on the scalp in which electrodes are placed either 10% or 20% of the total distance on a line on the skull between the nasion and inion in the sagittal plane and between the right and left preauricular points in the coronal plane.

**Interpeak Interval:** Difference between the peak *latencies* of two components of a *waveform*.

**Interpotential Interval:** Time between two different *potentials*. Measurement should be made between the corresponding parts of each *waveform*.

**Intraoperative Monitoring:** The use of electrophysiological stimulating and recording techniques in an operating room setting. The term is usually applied to techniques which are used to detect injury to nervous tissue during surgery or to guide the surgical procedure.

**Involuntary Activity:** *Motor unit action potentials* that are not under volitional control. The condition under which they occur should be described, for example, spontaneous or *reflex potentials*. If elicited by a *stimulus*, its nature should be described. Contrast with *spontaneous activity*.

**IPSP:** Abbreviation for *inhibitory postsynaptic potential*.

**Irregular Potential:** See preferred term, *serrated action potential*.

**Isoelectric Line:** In electrophysiologic recording, the display of zero *potential* difference between the two input terminals of the recording apparatus. See *baseline*.

**Iterative Discharge:** See preferred term, *repetitive discharge*.

**Jiggle:** Shape variability of *motor unit action potentials* recorded with a conventional *EMG needle electrode*. A small amount occurs normally. In conditions of disturbed neuromuscular transmission, including early reinnervation and myasthenic disorders, the variability can be sufficiently large to be easily detectable by eye. Quantitative methods for estimating this variability are not yet widely available.

**Jitter:** The variability of consecutive *discharges* of the *interpotential interval* between

two *muscle fiber action potentials* belonging to the same *motor unit*. Usually expressed quantitatively as the mean value of the difference between the interpotential intervals of successive discharges (the *mean consecutive difference, MCD*). Under certain conditions, it is expressed as the mean value of the difference between interpotential intervals arranged in the order of decreasing interdischarge intervals (the *mean sorted difference, MSD*). See *single fiber electromyography*.

**Jolly Test:** A technique named after Friedrich Jolly, who applied an electric current to excite a *motor nerve* repetitively while recording the force of muscle *contraction*. Use of the term is discouraged. Inappropriately used to describe the technique of *repetitive nerve stimulation*.

**Kinematics:** Technique for description of body movement without regard to the underlying forces. See *kinesiologic EMG*.

**Kinesiologic EMG:** The muscle electrical activity recorded during movement. Gives information about the timing of muscle activity and its relative intensity. Either *surface electrodes* or intramuscular fine *wire electrodes* are used. Synonymous with *dynamic EMG*.

**Kinesiology:** The study of movement. See *kinesiologic EMG*.

**Kinetics:** The internal and external forces affecting the moving body. See *kinesiologic EMG*.

**Late Component (of a Motor Unit Action Potential):** See preferred term, *satellite potential*.

**Late Response:** A general term used to describe an *evoked potential* in *motor nerve conduction studies* having a longer *latency* than the *M wave*. Examples include *A wave*, *F wave*, and *H wave*.

**Latency:** Interval between a *stimulus* and a *response*. The *onset latency* is the interval between the onset of a stimulus and the onset of the *evoked potential*. The *peak latency* is the interval between the onset of a stimulus and a specified peak of the evoked potential.

**Latency of Activation:** The time required for an electric *stimulus* to depolarize a nerve fiber (or bundle of fibers as in a nerve trunk) beyond *threshold* and to initiate an *action potential* in the fiber(s). This time is usually of the order of 0.1 ms or less. An equivalent

term, now rarely used, is the “utilization time.”

**Latent Period:** See preferred term, *latency*.

**Linear Envelope EMG:** Moving average of the *full wave rectified EMG*. Obtained by low-pass filtering the full wave rectified EMG. See also *integrated EMG*.

**Linked Potential:** See preferred term, *satellite potential*.

**Lipoatrophy:** Pathologic loss of subcutaneous fat and connective tissues overlying muscle which mimics the clinical appearance of atrophy of the underlying muscle.

**Long-Latency Reflex:** A *reflex* with many synapses (polysynaptic) or a long pathway (long-loop) so that the time to its occurrence is greater than the time of occurrence of *short-latency reflexes*. See also *long-loop reflex*.

**Long-Loop Reflex:** A *reflex* thought to have a circuit that extends above the spinal segment of the sensory input and motor output. May involve the cerebral cortex. Should be differentiated from reflexes arising from stimulation and recording within a single segment or adjacent spinal segments (i.e., a segmental reflex). See also *long-latency reflex*.

**M Response:** See preferred term, *M wave*.

**M Wave:** A *compound muscle action potential* evoked from a muscle by an electric *stimulus* to its *motor nerve*. By convention, the M wave elicited by a supramaximal *stimulus* is used for motor *nerve conduction studies*. Ideally, the *recording electrodes* should be placed so that the initial deflection of the *evoked potential* from the *baseline* is negative. Common measurements include *latency*, *amplitude*, and *duration*. Also referred to as the *motor response*. Normally, the configuration is biphasic and stable with repeated stimuli at slow rates (1–5 Hz). See *repetitive nerve stimulation*.

**Macro Motor Unit Action Potential:** The average electric activity of that part of an anatomic *motor unit* that is within the recording range of a *macro-EMG electrode*. Characterized by consistent appearance when the small recording surface of the macro-EMG electrode is positioned to record *action potentials* from one muscle fiber. The following characteristics can be specified quantitatively: (1) maximal peak-to-peak *amplitude*, (2) area contained under the *waveform*, and (3) number of *phases*.

**Macro MUAP:** Abbreviation for *macro motor unit action potential*.

**Macroelectromyography (Macro-EMG):** General term referring to the technique and conditions that approximate recording of all *muscle fiber action potentials* arising from the same *motor unit*. See *macro motor unit action potential*.

**Macro-EMG:** Abbreviation for *macroelectromyography*.

**Macro-EMG Needle Electrode:** A modified *single fiber electromyography* electrode insulated to within 15 mm from the tip and with a small recording surface (25  $\mu\text{m}$  in diameter) 7.5 mm from the tip.

**Malignant Fasciculation:** Used to describe large, polyphasic *fasciculation potentials* firing at a slow rate. This pattern has been seen in progressive *motor neuron disease*, but the relationship is not exclusive. Use of this term is discouraged. See *fasciculation potential*.

**Maximal Stimulus:** See *stimulus*.

**Maximum Conduction Velocity:** See *conduction velocity*.

**MCD:** Abbreviation for *mean consecutive difference*. See *jitter*.

**Mean Consecutive Difference (MCD):** See *jitter*.

**Mean Sorted Difference (MSD):** See *jitter*.

**Membrane Instability:** Tendency of a cell membrane to depolarize spontaneously in response to mechanical irritation or following voluntary *activation*. May be used to describe the occurrence of spontaneous single *muscle fiber action potentials* such as *fibrillation potentials* during *needle electrode examination*.

**MEP:** Abbreviation for *motor evoked potential*.

**MEPP:** Abbreviation for *miniature end plate potential*.

**Microneurography:** The technique of recording peripheral nerve *action potentials* in humans by means of intraneural *electrodes*.

**Miniature End Plate Potential (MEPP):** The postsynaptic muscle fiber *potentials* produced through the spontaneous release of individual acetylcholine quanta from the presynaptic axon terminal. As recorded with *monopolar* or *concentric needle electrodes* inserted in the end plate region, MEPPs are monophasic, negative, short *duration* (less than 5 ms), and generally less than 20  $\mu\text{V}$  in *amplitude*.

**Minimum Conduction Velocity:** The *nerve conduction velocity* measured from slowly conducting nerve fibers. Special techniques are needed to produce this measurement in *motor* or *sensory nerves*.

**Mixed Nerve:** A nerve composed of both motor and sensory axons.

**MNCV:** Abbreviation for *motor nerve conduction velocity*. See *conduction velocity*.

**Mononeuritis Multiplex:** A disorder characterized by axonal injury and/or *demyelination* affecting nerve fibers in multiple nerves (multiple *mononeuropathies*). Usually occurs in an asymmetric anatomic distribution and in a temporal sequence which is not patterned or symmetric.

**Mononeuropathy Multiplex:** A disorder characterized by axonal injury and/or *demyelination* affecting nerve fibers exclusively along the course of one named nerve.

**Monophasic Action Potential:** An *action potential* with the *waveform* entirely on one side of the *baseline*.

**Monophasic End Plate Activity:** See *end plate activity (monophasic)*.

**Monopolar Needle Electrode:** A solid wire *electrode* coated with Teflon™, except at the tip. Despite the term monopolar, a separate surface or subcutaneous reference electrode is required for recording electric signals. May also be used as a *cathode* in *nerve conduction studies* with another electrode serving as an *anode*.

**Motor Evoked Potential (MEP):** A *compound muscle action potential* produced by either *transcranial magnetic stimulation* or *transcranial electrical stimulation*.

**Motor Latency:** Interval between the onset of a *stimulus* and the onset of the resultant *compound muscle action potential (M wave)*. The term may be qualified, as *proximal motor latency* or *distal motor latency*, depending on the relative position of the stimulus.

**Motor Nerve:** A nerve containing axons which innervate extrafusal and intrafusal muscle fibers. These nerves also contain sensory afferent fibers from muscle and other deep structures.

**Motor Nerve Conduction Velocity (MNCV):** The speed of propagation of *action potentials* along a *motor nerve*. See *conduction velocity*.

**Motor Neuron Disease:** A clinical condition characterized by degeneration of *motor nerve* cells in the brain, brain stem, and spinal cord. The location of degeneration determines the clinical presentation. Primary lateral sclerosis occurs when degeneration affects mainly corticospinal tract motor fibers. Spinal muscular atrophy occurs when degeneration affects lower motor neurons. Amyotrophic lateral sclerosis occurs when degeneration affects both corticospinal tracts and lower motor neurons.

**Motor Point:** The site over a muscle where its *contraction* may be elicited by a minimal intensity short-duration electric *stimulus*.

**Motor Response:** (1) The *compound muscle action potential (M wave)* recorded over a muscle in response to stimulation of the nerve to the muscle. (2) The muscle twitch or *contraction* elicited by stimulation of the nerve to a muscle. (3) The muscle twitch elicited by the *muscle stretch reflex*.

**Motor Unit:** The anatomic element consisting of an anterior horn cell, its axon, the neuromuscular junctions, and all of the muscle fibers innervated by the axon.

**Motor Unit Action Potential (MUAP):** The *compound action potential* of a single *motor unit* whose muscle fibers lie within the recording range of an *electrode*. With voluntary muscle *contraction*, it is characterized by its consistent appearance and relationship to the force of the contraction. The following measures may be specified, quantitatively if possible, after the *recording electrode* is placed randomly within the muscle:

1. Configuration
  - (a) *Amplitude*, peak-to-peak ( $\mu\text{V}$  or mV).
  - (b) *Duration*, total (ms).
  - (c) Number of *phases* (monophasic, biphasic, triphasic, tetraphasic, and polyphasic).
  - (d) Polarity of each phase (negative, positive).
  - (e) Number of *turns*.
  - (f) Variation of shape (*jiggle*), if any, with consecutive *discharges*.
  - (g) Presence of *satellite (linked) potentials*, if any.
  - (h) *Spike* duration, including satellites.



2. *Recruitment* characteristics

- (a) *Threshold of activation* (first recruited, low threshold, high threshold).
- (b) *Onset frequency*.
- (c) *Recruitment frequency* (Hz) or *recruitment interval* (ms) of individual potentials.

Descriptive terms implying diagnostic significance are not recommended, for example, *myopathic*, *neuropathic*, *regeneration*, *nascent*, *giant*, *BSAP*, and *BSAPP*. See *polyphasic action potential* and *serrated action potential*.

**Motor Unit Fraction:** See *scanning EMG*.

**Motor Unit Number Counting:** See the preferred term *motor unit number estimate* (*MUNE*).

**Motor Unit Number Estimate (MUNE):**

A quantitative technique for determining the number of functioning *motor units* in a muscle. A variety of methods, including *spike-triggered averaging*, *incremental motor nerve stimulation*, *F-wave* measurement, or a Poisson statistical technique can be used. Synonyms can include *motor unit number estimation* and *motor unit number estimating*.

**Motor Unit Number Estimating (MUNE):**

See *motor unit number estimate* (*MUNE*).

**Motor Unit Number Estimation (MUNE):**

See *motor unit number estimate* (*MUNE*).

**Motor Unit Potential (MUP):** See synonym, *motor unit action potential*.

**Motor Unit Territory:** The area of a muscle cross section within which the muscle fibers belonging to an individual *motor unit* are distributed.

**Movement Artifact:** See *artifact*.

**Movement-Related Cortical Potential:**

Electroencephalogram activity associated with (before and after) a voluntary movement. There are several components including the *Bereitschaftspotential* before the movement and the motor potential at about the time of the movement. See also *Bereitschaftspotential*.

**MSD:** Abbreviation for *mean sorted difference*. See *jitter*.

**MUAP:** Abbreviation for *motor unit action potential*.

**Multi MUP Analysis:** A *template matching*, *decomposition EMG* method used for *MUAP* analysis.

**Multielectrode:** See *multilead electrode*.

**Multifocal Motor Neuropathy:** A disease characterized by selective focal block of *motor nerve* conduction in multiple nerves. *Motor nerve conduction studies* may permit identification and localization of the segments of nerve affected by the underlying pathology.

**Multilead Electrode:** Three or more insulated wires inserted through apertures in a common metal cannula with their bared tips flush with the cannula's outer circumference. The arrangement of the bare tips relative to the axis of the cannula and the distance between each tip should be specified. See *electrode*.

**Multiple Discharge:** Four or more *motor unit action potentials* of the same form and nearly the same *amplitude* occurring consistently in the same relationship to one another and generated by the same axon. See *double* and *triple discharge*.

**Multiplet:** See *multiple discharge*.

**MUNE:** Abbreviation for *motor unit number estimate*, *motor unit number estimation*, and *motor unit number estimating*.

**MUP:** Abbreviation for *motor unit potential*. See preferred term, *motor unit action potential*.

**Muscle Action Potential:** Term commonly used to refer to a *compound muscle action potential*.

**Muscle Atrophy:** Decrease in size of a muscle that may be due to disease of nerve or muscle, or *todisuse*.

**Muscle Cramp:** An involuntary, painful muscle *contraction* associated with electrical activity. *Cramp discharges* are most common, but other types of *repetitive discharges* can also be seen.

**Muscle Fiber Action Potential:** *Action potential* recorded from a single muscle fiber.

**Muscle Fiber Conduction Velocity:** The speed of propagation of a single *muscle fiber action potential*, usually expressed as meters per second. Usually less than most *nerve conduction velocities*, varies with the rate of *discharge* of the muscle fiber, and requires special techniques for measurement.

**Muscle Hypertrophy:** Increase in the size of a muscle due to an increase in the size of the muscle fibers or replacement or displacement of muscle fibers by other tissues. The latter is also referred to by the term

*pseudohypertrophy*, because the muscle is enlarged but weak. Muscle fibers increase in size as a physiologic response to repetitive and forceful voluntary contraction or as a pathologic response to involuntary electric activity in a muscle, for example, *myotonic discharges* or *complex repetitive discharges*.

**Muscle Stretch Reflex:** Activation of a muscle which follows stretch of the muscle, for example, by percussion of a muscle tendon. See *stretch reflex* and *T wave*.

**Muscle Tone:** See *tone*.

**Myasthenia Gravis:** A disease characterized by muscle weakness which increases with repetitive muscle activation. Most commonly, an autoimmune disease caused by the presence of antibodies to the acetylcholine receptors at the neuromuscular junction.

**Myoclonus:** A quick jerk of a body part produced by a brief muscle contraction typically originating from activity in the central nervous system. Based on the anatomic location of the pathology, may be classified as spinal, segmental, brain stem, or cortical.

**Myoedema:** Focal muscle contraction produced by muscle percussion. Not associated with propagated electric activity. May be seen in hypothyroidism (myxedema) and chronic malnutrition.

**Myokymia:** Continuous quivering or undulating movement of surface and overlying skin and mucous membrane associated with spontaneous, repetitive discharge of motor unit action potentials. See *myokymic discharge*, *fasciculation*, and *fasciculation potential*.

**Myokymic Discharge:** A form of involuntary activity in which motor unit action potentials fire repetitively and may be associated with clinical myokymia. Two firing patterns have been described: (1) Commonly, the discharge is a brief, repetitive firing of single motor unit action potentials for a short period (up to a few seconds) at a uniform rate (2–60 Hz) followed by a short period (up to a few seconds) of silence, with repetition of the same sequence for a particular potential at regular intervals. (2) Rarely, the potential recurs continuously at a fairly uniform firing rate (1–5 Hz). Myokymic discharges are a subclass of grouped discharges and repetitive discharges. See also *ephapse* and *ephaptic transmission*.

**Myopathic Motor Unit Potential:** Low-amplitude, short-duration, polyphasic motor unit action potentials. Use of term discouraged. It incorrectly implies specific diagnostic significance of a motor unit action potential configuration. See *motor unit action potential*.

**Myopathic Recruitment:** Used to describe an increase in the number and firing rate of motor unit action potentials compared with normal for the strength of muscle contraction. Use of term discouraged.

**Myopathy:** Disorder affecting the structure and/or function of muscle fibers. Etiologies include hereditary, congenital, mitochondrial, inflammatory, metabolic, infectious, neoplastic, vascular, and traumatic diseases. Most, but not all of these disorders, show abnormalities on needle electromyography.

**Myotonia:** Delayed relaxation of a muscle after voluntary contraction or percussion. Associated with propagated electric activity, such as *myotonic discharges*, *complex repetitive discharges*, or *neuromyotonic discharges*.

**Myotonic Discharge:** Repetitive discharge which occurs at rates of 20–80 Hz. There are two types: (1) biphasic (positive–negative) spike potentials less than 5 ms in duration resembling fibrillation potentials. (2) positive waves of 5–20 ms duration resembling positive sharp waves. Both potential forms are recorded after needle electrode insertion, after voluntary muscle contraction, or after muscle percussion and are due to independent, repetitive discharges of single muscle fibers. The amplitude and frequency of the potentials must both wax and wane. This change produces a characteristic musical sound in the audio output of the electromyograph due to the corresponding change in pitch, which has been likened to the sound of a “dive bomber.” Contrast with *waning discharge*.

**Myotonic Potential:** See preferred term, *myotonic discharge*.

**NAP:** Abbreviation for *nerve action potential*. See *compound nerve action potential*.

**Nascent Motor Unit Potential:** From the Latin nascens, “to be born.” Refers to very low-amplitude, short-duration, highly polyphasic motor unit action potentials observed during early states of reinnervation. Use of term is discouraged, as it incorrectly



- implies diagnostic significance of a motor unit action potential configuration. See *motor unit action potential*.
- NCS:** Abbreviation for *nerve conduction study*.
- NCV:** Abbreviation for *nerve conduction velocity*. See *conduction velocity*.
- Near-Field:** A region of electrical activity where the isopotential *voltage* lines associated with a current source change rapidly over a short distance. The terms *near-field* and *far-field* are arbitrary designations, as there are no agreed-upon criteria defining where the near-field ends and the far-field begins. Compare with *far-field*.
- Needle Electrode:** An electrical device used for recording or stimulating that is positioned near the tissue of interest by penetration of the skin. See specific electrodes: *bifilar (bipolar) needle recording electrode*, *concentric needle electrode*, *macro-EMG needle electrode*, *monopolar needle electrode*, *multilead electrode*, *single fiber needle electrode*, and *stimulating electrode*.
- Nerve Action Potential (NAP):** Strictly defined, refers to an *action potential* recorded from a single nerve fiber. The term is commonly used to refer to the *compound nerve action potential*. See *compound nerve action potential*.
- Nerve Conduction Study (NCS):** Recording and analysis of electric *waveforms* of biologic origin elicited in response to electric or physiologic *stimuli*. The waveforms are *compound sensory nerve action potentials*, *compound muscle action potentials*, or *mixed nerve action potentials*. The compound muscle action potentials are generally referred to by letters which have historical origin: *M wave*, *F wave*, *H wave*, *T wave*, *A wave*, and *R1, R2 waves*. It is possible under standardized conditions to establish normal ranges for *amplitude*, *duration*, and *latency* of the waveforms and to calculate the maximum *conduction velocity* of *sensory* and *motor nerves*. The term generally refers to studies of waveforms generated in the peripheral nervous system, whereas *evoked potential studies* refers to studies of waveforms generated in both the peripheral and central nervous systems. Synonymous with *electroneurography*.
- Nerve Conduction Velocity (NCV):** The speed of *action potential* propagation along a nerve fiber or nerve trunk. Generally assumed to refer to the maximum speed of propagation unless otherwise specified. See *conduction velocity*.
- Nerve Fiber Action Potential:** *Action potential* recorded from a single axon.
- Nerve Potential:** Equivalent to *nerve action potential*. Also commonly, but inaccurately, used to refer to the biphasic form of *end plate activity* observed during *needle electrode* examination of muscle. The latter use is incorrect, because muscle fibers, not nerve fibers, are the source of these *potentials*.
- Nerve Trunk Action Potential:** See preferred term, *compound nerve action potential*.
- Neurapraxia:** Clinical term used to describe the reversible motor and sensory deficits produced by focal compressive or traction lesions of large myelinated nerve fibers. It is due to *conduction block*, most often caused by focal *demyelination*, but, when very short-lived, presumably caused by focal ischemia. The axon is not injured at the lesion site. Compare with *axonotmesis* and *neurotmesis*.
- Neuromuscular Transmission Disorder:** Clinical disorder associated with pathology affecting the structure and function of the neuromuscular junction and interfering with synaptic transmission at that site. Specific diseases include *myasthenia gravis*, Lambert–Eaton myasthenic syndrome, and botulism.
- Neuromyopathy:** Clinical disorder associated with pathology affecting both nerve and muscle fibers.
- Neuromyotonia:** Clinical syndrome of continuous muscle fiber activity manifested as continuous muscle rippling and stiffness. It may be associated with delayed relaxation following voluntary muscle *contraction*. The accompanying electric activity may be intermittent or continuous. Terms used to describe related clinical syndromes are continuous muscle fiber activity syndrome, Isaac syndrome, Isaac–Merton syndrome, quantal squander syndrome, generalized *myokymia*, pseudomyotonia, normocalcemic *tetany*, and neurotonia. Distinguish from *myotonia*.
- Neuromyotonic Discharge:** Bursts of *motor unit action potentials* that fire at high rates (150–300 Hz) for a few seconds, often starting or stopping abruptly. The *amplitude* of

the *waveforms* typically wanes. *Discharges* may occur spontaneously or be initiated by *needle electrode* movement, voluntary effort, ischemia, or percussion of a nerve. The activity originates in motor axons. Distinguish from *myotonic discharges* and *complex repetitive discharges*. One type of electrical activity recorded in patients who have clinical *neuromyotonia*.

**Neuropathic Motor Unit Potential:** Abnormally high-*amplitude*, long-*duration*, polyphasic *motor unit action potential*. Use of term discouraged. Incorrectly implies a specific diagnostic significance of a motor unit action potential configuration. See *motor unit action potential*.

**Neuropathic Recruitment:** A *recruitment* pattern characterized by a decreased number of *motor unit action potentials* firing at a rapid rate. Use of term discouraged. See preferred terms, *reduced interference pattern*, *discrete activity*, and *single unit pattern*.

**Neuropathy:** Disorder of the peripheral nerves. May be classified by the anatomical structure of the nerve most affected by the disease: the cell body (neuronopathy), the axon (axonopathy), or the myelin sheath (demyelinating neuropathy). May selectively affect *motor* or *sensory nerves* or both simultaneously. The etiology may be hereditary, metabolic, inflammatory, toxic, or unknown.

**Neurotmesis:** Partial or complete nerve severance including the axons, associated myelin sheaths, and supporting connective tissues, resulting in *axonal degeneration* distal to the injury site. Compare with *axonotmesis* and *neurapraxia*.

**Neurotonic Discharges:** Repetitive *motor unit action potentials* recorded from intramuscular *electrodes* during *intraoperative monitoring*. Thought to arise from irritation or injury of nerves supplying the muscle from which the recording is made.

**Noise:** Electric activity not related to the signal of interest. In *electrodiagnostic medicine*, *waveforms* generated by *electrodes*, cables, amplifier, or storage media and unrelated to potentials of biologic origin. The term has also been used loosely to refer to one form of *end plate activity*.

**Onset Frequency:** The lowest stable *firing rate* for a single *motor unit action potential* that can be voluntarily maintained by a subject.

**Order of Activation:** The sequence of appearance of different *motor unit action potentials* with increasing strength of voluntary *contraction*. See *recruitment*.

**Orthodromic:** Propagation of a nerve impulse in the same direction as physiologic conduction; for example, conduction along *motor nerve* fibers toward the muscle and conduction along *sensory nerve* fibers toward the spinal cord. Contrast with *antidromic*.

**Paired Stimuli:** Two consecutive stimuli delivered in a time-locked fashion. The time interval between the two stimuli and the intensity of each *stimulus* can be varied but should be specified. The first stimulus is called the *conditioning stimulus* and the second stimulus is the *test stimulus*. The conditioning stimulus may modify tissue *excitability*, which is then evaluated by the *response* to the test stimulus.

**Parasite Potential:** See preferred term, *satellite potential*.

**Peak Latency:** Interval between the onset of a *stimulus* and a specified peak of an evoked *waveform*.

**Peroneal Neuropathy at the Knee:** A *mononeuropathy* involving the common peroneal nerve as it passes around the head of the fibula. The presumed mechanism is compression of the nerve against the fibula. See also *crossed leg palsy*.

**Phase:** That portion of a *waveform* between the departure from and the return to the *baseline*.

**Plexopathy:** Axonal and/or demyelinating disorder affecting the nerve fibers exclusive to the cervical, brachial, lumbar, or sacral rearrangement of spinal nerve roots into peripheral nerves.

**Polarization:** The presence of an electric *potential* difference usually across an excitable cell membrane.

**Polyneuropathy:** Axonal and/or demyelinating disorder affecting nerve fibers, usually in a symmetrical fashion. The distal segments of the longer nerves in the lower extremities are usually the most severely affected. May be classified as sensory, motor, or sensorimotor depending on the function of nerve fibers affected.

**Polyphasic Action Potential:** An *action potential* with four or more *baseline* crossings, producing five or more *phases*. See *phase*. Contrast with *serrated action potential*.

**Polyradiculoneuropathy:** See *radiculopathy*.

**Positive Sharp Wave:** A biphasic, positive then negative *action potential* of a single muscle fiber. It is initiated by *needle electrode* movement (insertional or unsustained positive sharp wave) or occurs spontaneously. Typically *discharge* in a uniform, regular pattern at a rate of 1–50 Hz; the *discharge frequency* may decrease slightly just before cessation of discharge. The initial positive deflection is rapid (<1 ms), its *duration* is usually less than 5 ms, and the *amplitude* is up to 1 mV. The negative *phase* is of low amplitude, and its duration is 10–100 ms. A sequence of positive sharp waves is commonly referred to as a *train of positive sharp waves*. Assumed to be recorded from a damaged area of a muscle fiber. This configuration may result from the position of the needle electrode which is believed to be adjacent to the depolarized segment of a muscle fiber injured by the electrode. Note that the positive sharp *waveform* is not specific for muscle fiber damage. May occur in association with *fibrillation potentials* and are thought by some to be equivalent discharges. *Motor unit action potentials* and potentials in *myotonic discharges* may have the configuration of positive sharp waves.

**Positive Wave:** Loosely defined, the term refers to a *positive sharp wave*. See preferred term *positive sharp wave*.

**Postactivation:** The period following voluntary *activation* of a nerve or muscle. Contrast with *posttetanic*.

**Postactivation Depression:** A reduction in the *amplitude* and area of the *M wave(s)* in response to a single *stimulus* or *train of stimuli* which occurs within a few minutes following a 10–60 second strong voluntary *contraction*. *Postactivation exhaustion* refers to the cellular mechanisms responsible for the observed phenomenon of postactivation depression. Also used to describe reduction of the *M wave* following a *tetanus*, which should more logically be termed *posttetanic depression*.

**Postactivation Exhaustion:** A reduction in the safety factor (margin) of neuromuscular transmission after sustained *activation* at the neuromuscular junction. The changes in the configuration of the *M wave* due to postactivation exhaustion are referred to as *postactivation depression*.

**Postactivation Facilitation:** See *facilitation*.

**Postactivation Potentiation:** An increase in the force of *contraction* (mechanical *response*) after a strong voluntary contraction. Contrast *postactivation facilitation*.

**Posttetanic:** The period following *tetanus*. Contrast with *postactivation*.

**Posttetanic Depression:** See *postactivation depression*.

**Posttetanic Facilitation:** See *facilitation*, *posttetanic*.

**Posttetanic Potentiation:** (1) The incrementing mechanical *response* of muscle during and after *repetitive nerve stimulation*. (2) In central nervous system physiology, enhancement of *excitability* or *reflex* outflow of neuronal systems following a long period of high-frequency stimulation. See *facilitation* and *potentiation*.

**Potential:** (1) A difference in charges, measurable in volts, that exists between two points. Most biologically produced potentials arise from the difference in charge between two sides of a cell membrane. (2) A term for a physiologically recorded *waveform*.

**Potentiation:** Physiologically, the enhancement of a *response*. The convention used in this glossary is to use the term *potentiation* to describe the incrementing mechanical response of muscle elicited by *repetitive nerve stimulation*, for example, *posttetanic potentiation*, whereas the term *facilitation* is used to describe the incrementing electrical response elicited by *repetitive nerve stimulation*, for example, *postactivation facilitation*.

**Prolonged Insertion Activity:** See *insertion activity*.

**Propagation Velocity of a Muscle Fiber:** The speed of transmission of a *muscle fiber action potential*.

**Pseudodecrement:** An *artifact* produced by movement of the *stimulating* or *recording electrodes* during *repetitive nerve stimulation*. The *amplitude* and area of the *M wave* can vary in a way that resembles a *decrementing response*; however, the *responses* are generally irregular and not reproducible.

**Pseudofacilitation:** See *facilitation*.

**Pseudohypertrophy:** See *muscle hypertrophy*.

**Pseudomyotonic Discharge:** Formerly used to describe *complex repetitive discharges*. Use of term discouraged.

**Pseudopolyphasic Action Potential:** Use of term discouraged. See preferred term, *serated action potential*.

**QEMG:** Abbreviation for *quantitative electromyography*.

**QSART:** Abbreviation for *quantitative sudomotor axon reflex test*.

**QST:** Abbreviation for *quantitative sensory testing*.

**Quantitative Electromyography (QEMG):** A systematic method for measuring the recordings made by an intramuscular *needle electrode*. Measurements include *motor unit action potential* characteristics such as *amplitude*, *duration*, and *phases*, or *interference pattern* characteristics. See *turns and amplitude analysis*.

**Quantitative Sensory Testing (QST):** An instrumented method for measuring cutaneous sensation.

**Quantitative Sudomotor Axon Reflex Test (QSART):** Test of postganglionic sympathetic sudomotor axons function by measuring sweat output following *activation* of axon terminals by local application of acetylcholine. *Antidromic* transmission of the impulse from the nerve terminals reaches a branch point, then travels *orthodromically* to release acetylcholine from the nerve terminals, inducing a sweating *response*. In small fiber *polyneuropathy*, the response may be reduced or absent. In painful *neuropathies*, and in *reflex sympathetic dystrophy*, the response may be excessive and persistent or reduced.

**R1, R2 Waves:** See *blink responses*.

**Radiculopathy:** Axonal and/or demyelinating disorder affecting the nerve fibers exclusive to one spinal nerve root or spinal nerve. May affect the anterior (motor) or posterior (sensory) spinal nerve roots, or both, at one spinal cord segment level. The resulting clinical syndrome may include pain, sensory loss, paresthesia, weakness, *fasciculations*, and *muscle atrophy*. If more than one spinal root is involved, the term *polyradiculopathy* may be used as a descriptor.

**Raster:** A method for display of a free-running sweep in *electromyography*. Sweeps are offset vertically so that each successive sweep is displayed below the one preceding it.

**Raw EMG:** Unprocessed *EMG* signal recorded with surface or intramuscular *electrodes*.

**Reciprocal Inhibition:** Inhibition of a motor neuron pool secondary to the *activation* of the motor neuron pool of its antagonist. It is one of several important spinal mechanisms of motor control that help to make movements smoother and utilize less energy. There are multiple mechanisms for reciprocal inhibition, including one mediated by the Ia inhibitory interneuron that activates Ia afferents and disynaptically inhibits the muscle that is the antagonist to the source of the Ia afferents.

**Recording Electrode:** Device used to record electric *potential* difference. All electric recordings require two *electrodes*. The electrode close to the source of the activity to be recorded is called the *active* or *exploring electrode*, and the other recording electrode is called the *reference electrode*. Active electrode is synonymous with *input terminal 1*, or *E-1* (or older terms whose use is discouraged, i.e., *grid 1* and *G1*). Reference electrode is synonymous with *input terminal 2*, or *E-2* (or older terms whose use is discouraged, i.e., *grid 2* and *G2*). In some recordings it is not certain which electrode is closer to the source of the biologic activity, for example, recording with a *bifilar needle recording electrode*, or when attempting to define *far-field* potentials. In this situation, it is convenient to refer to one electrode as input electrode 1, or *E-1*, and the other as input electrode 2, or *E-2*. By present convention, a potential difference that is negative at the active electrode (input terminal 1, *E-1*) relative to the reference electrode (input terminal 2, *E-2*) causes an upward deflection on the display screen. The term "monopolar recording" is not recommended, because all recordings require two electrodes; however, it is commonly used to describe the use of one type of intramuscular *needle electrode*. A similar combination of needle electrodes has been used to record nerve activity and also has been referred to as "monopolar recording."

**Recruitment:** The successive *activation* of the same and additional *motor units* with increasing strength of voluntary muscle *contraction*. See *motor unit action potential*.

**Recruitment Frequency:** *Firing rate* of a *motor unit action potential (MUAP)* when a different MUAP first appears during gradually increasing voluntary muscle *contraction*.



This parameter is essential to assessment of *recruitment pattern*.

**Recruitment Interval:** The *interdischarge interval* between two consecutive *discharges* of a *motor unit action potential (MUAP)* when a different MUAP first appears during gradually increasing voluntary muscle *contraction*. The reciprocal of the recruitment interval is the *recruitment frequency*. See also *interdischarge interval*.

**Recruitment Pattern:** A qualitative and/or quantitative description of the sequence of appearance of *motor unit action potentials* during increasing voluntary muscle *contraction*. The *recruitment frequency* and *recruitment interval* are two quantitative measures commonly used. See *interference pattern*, *early recruitment*, and *reduced recruitment* for qualitative terms commonly used.

**Recurrent Inhibition:** Decreased probability of firing of a motor neuron pool mediated by Renshaw cells. Renshaw cells are activated by recurrent collaterals from the axons of alpha-motoneurons. Such inhibition influences the same cells that originate the excitatory impulses and their neighbors.

**Reduced Insertion Activity:** See *insertion activity*.

**Reduced Interference Pattern:** See *interference pattern*.

**Reduced Recruitment Pattern:** A descriptive term for the *interference pattern* when the number of *motor units* available to generate a muscle *contraction* are reduced. One cause for a *reduced interference pattern*. See *interference pattern* and *recruitment pattern*.

**Reference Electrode:** See *recording electrode*.

**Reflex:** A stereotyped *motor response* elicited by a sensory *stimulus* and a *response*. Its anatomic pathway consists of an afferent, *sensory* input to the central nervous system, at least one synaptic connection, and an efferent output to an effector organ. The response is most commonly *motor*, but reflexes involving autonomic effector organs also occur. Examples include the *H reflex* and the *sudomotor reflex*. See *H wave* and *quantitative sudomotor axon reflex test*.

**Refractory Period:** General term for the time following an *action potential* when an excitable membrane cannot be stimulated to

produce another action potential. The *absolute refractory period* is the time following an action potential during which no *stimulus*, however strong, evokes a further *response*. The *relative refractory period* is the time following an action potential during which a stimulus must be abnormally large to evoke a second response. The *functional refractory period* is the time following an action potential during which a second action potential cannot yet excite the given region.

**Refractory Period of Transmission:** Interval following an *action potential* during which a nerve cannot conduct a second one. Distinguish from *refractory period*, as commonly used, which deals with the ability of a *stimulus* to produce an action potential.

**Regeneration Motor Unit Potential:** Use of term discouraged. See *motor unit action potential*.

**Relative Refractory Period:** See *refractory period*.

**Repair of the Decrement:** See *facilitation*.

**Repetitive Discharge:** General term for the recurrence of an *action potential* with the same or nearly identical form. May refer to recurring potentials recorded in muscle at rest, during voluntary *contraction*, or in response to a single nerve *stimulus*. See *double discharge*, *triple discharge*, *multiple discharge*, *myokymic discharge*, *complex repetitive discharge*, *neuromyotonic discharge*, and *cramp discharge*.

**Repetitive Nerve Stimulation:** The technique of repeated *supramaximal stimulation* of a nerve while recording successive *M waves* from a muscle innervated by the nerve. Commonly used to assess the integrity of neuromuscular transmission. The number of *stimuli* and the *frequency* of stimulation should be specified. *Activation procedures* performed as a part of the test should be specified, for example, sustained voluntary *contraction* or contraction induced by nerve stimulation. If the test includes an activation procedure, the time elapsed after its completion should also be specified. For a description of specific patterns of *responses*, see *incrementing response*, *decrementing response*, *facilitation*, and *postactivation depression*.

**Repolarization:** A return in membrane *potential* from a depolarized state toward the normal resting level.

**Residual Latency:** The calculated time difference between the measured *distal latency* of a *motor nerve* and the expected latency, calculated by dividing the distance between the stimulating *cathode* and the active *recording electrode* by the maximum *conduction velocity* measured in a more proximal segment of the nerve. It is due in part to neuromuscular transmission time and to slowing of conduction velocity in terminal axons due to decreasing diameter and the presence of unmyelinated segments.

**Response:** An activity elicited by a *stimulus*.

**Resting Membrane Potential:** *Voltage* across the membrane of an excitable cell in the absence of a *stimulus*. See *polarization*.

**Rheobase:** See *strength–duration curve*.

**Rigidity:** A velocity-independent increase in *muscle tone* and stiffness with full range of joint motion as interpreted by the clinical examiner from the physical examination. Often associated with simultaneous low-grade *contraction* of agonist and antagonist muscles. Like muscle *spasticity*, the involuntary *motor unit action potential* activity increases with activity or passive stretch. Does not seem to change with the velocity of stretch, and, on passive stretch, the increased tone has a “lead pipe” or constant quality. It is a cardinal feature of central nervous system disorders affecting the basal ganglia. Contrast with *spasticity*.

**Rise Time:** The interval from the onset of a polarity change of a *potential* to its peak. The method of measurement should be specified.

**Satellite Potential:** A small *action potential* separated from the main *motor unit action potential* by an isoelectric interval which fires in a time-locked relationship to the main action potential. It usually follows, but may precede, the main action potential. Less preferred terms include *late component*, *parasite potential*, *linked potential*, and *coupled discharge*.

**Scanning EMG:** A technique by which a *needle electrode* is advanced in defined steps through muscle while a separate *SFEMG* electrode is used to trigger both the display sweep and the advancement device. Provides temporal and spatial information about the *motor unit*. Distinct maxima in the recorded activity are considered to be generated by muscle fibers innervated by a

common branch of an axon. These groups of fibers form a *motor unit fraction*.

**Sea Shell Sound (Sea Shell Roar or Noise):** Use of term discouraged. See *end plate activity* and *monophasic*.

**Sensory Latency:** Interval between the onset of a *stimulus* and the onset of the negative deflection of the *compound sensory nerve action potential*. This term has been used loosely to refer to the *sensory peak latency*. May be qualified as proximal sensory latency or distal sensory latency, depending on the relative position of the stimulus.

**Sensory Nerve:** A nerve containing only sensory fibers, composed mainly of axons innervating cutaneous receptors.

**Sensory Nerve Action Potential (SNAP):** See *compound sensory nerve action potential*.

**Sensory Nerve Conduction Velocity:** The speed of propagation of *action potentials* along a *sensory nerve*.

**Sensory Peak Latency:** Interval between the onset of a *stimulus* and the peak of the negative *phase* of the *compound sensory nerve action potential*. Contrast with *sensory latency*.

**Sensory Potential:** Synonym for the more precise term, *compound sensory nerve action potential*.

**Sensory Response:** Synonym for the more precise term, *compound sensory nerve action potential*.

**SEP:** Abbreviation for *somatosensory evoked potential*.

**Serrated Action Potential:** A *waveform* with several changes in direction (*turns*) which do not cross the *baseline*. Most often used to describe a *motor unit action potential*. The term is preferred to *complex motor unit action potential* and *pseudopolyphasic action potential*. See also *turn* and *polyphasic action potential*.

**SFEMG:** Abbreviation for *single fiber electromyography*.

**Shock Artifact:** See *artifact*.

**Short-Latency Reflex:** A *reflex* with one (monosynaptic) or few (oligosynaptic) synapses. Used in contrast to *long-latency reflex*.

**Short-Latency Somatosensory Evoked Potential (SSEP):** That portion of the *waveforms* of a *somatosensory evoked potential* normally occurring within 25 ms after stimulation of the median nerve in the upper



extremity at the wrist, 40 ms after stimulation of the common peroneal nerve in the lower extremity at the knee, and 50 ms after stimulation of the posterior tibial nerve at the ankle.

**Signal Averager:** A digital device that improves the signal-to-noise ratio of an electrophysiological recording by adding successive time-locked recordings to preceding traces and computing the average value of each data point. A signal acquired by this method is described as an “averaged” *waveform*.

**Silent Period:** A pause in the electric activity of a muscle that may be produced by many different *stimuli*. Stimuli used commonly in clinical neurophysiology include rapid unloading of a muscle, electrical stimulation of a peripheral nerve, or *transcranial magnetic stimulation*.

**Single Fiber Electromyography (SFEMG):** The technique and conditions that permit recording of single *muscle fiber action potentials*. See *single fiber needle electrode*, *blocking*, and *jitter*.

**Single Fiber EMG:** See *single fiber electromyography*.

**Single Fiber Needle Electrode:** A *needle electrode* with a small recording surface (usually 25  $\mu\text{m}$  in diameter) which permits the recording of single *muscle fiber action potentials* between the recording surface and the cannula. See *single fiber electromyography*.

**Single Unit Pattern:** See *interference pattern*.

**SNAP:** Abbreviation for *sensory nerve action potential*. See *compound sensory nerve action potential*.

**Snap, Crackle, and Pop:** A benign type of *increased insertion activity* that follows, after a very brief period of electrical silence, the normal *insertion activity* generated by *needle electrode* movement. It consists of trains of *potentials* that vary in length; however, they can persist for a few seconds. Each train consists of a series of up to 10 or more potentials in which the individual components fire at irregular intervals. The potentials consistently vary in *amplitude*, *duration*, and configuration. Individual potentials may be mono-, bi-, tri-, or multiphasic in appearance; they often have a positive *waveform*. The variation on sequential

firings produces a distinctive sound, hence the name. Seen most often in those with mesomorphic builds, especially young adult males. Found most often in lower extremity muscles, especially the medial gastrocnemius.

**Somatosensory Evoked Potential (SEP):** Electric *waveforms* of biologic origin elicited by electric stimulation or physiologic *activation* of peripheral *sensory nerves* and recorded from peripheral and central nervous system structures. Normally is a complex *waveform* with several components which are specified by polarity and average *peak latency*. The polarity and latency of individual components depend upon (1) subject variables, such as age, gender, and body habitus, (2) *stimulus* characteristics, such as intensity and rate of stimulation, and (3) recording parameters, such as amplifier time constants, *electrode* placement, and electrode combinations. See *short-latency somatosensory evoked potentials*.

**Spasticity:** A velocity-dependent increase in *muscle tone* due to a disease process that interrupts the suprasegmental tracts to the alpha motor neurons, gamma motor neurons, or segmental spinal neurons. May be elicited and interpreted by the clinical examiner during the physical examination by brisk passive movement of a limb at the joint. Almost uniformly accompanied by hyperreflexia, a Babinski sign, and other signs of upper motor neuron pathology, including clonus and the clasp-knife phenomenon. The clasp-knife phenomenon is a rapid decrease of tone following a period of increased tone during passive rotation of the joint. The pathophysiology is not certain and may include more than dysfunction of the corticospinal tracts.

**Spike:** (1) A short-lived (1–3 ms), all-or-none *waveform* that arises when an excitable membrane reaches *threshold*. (2) The electric record of a nerve or muscle impulse.

**Spinal Evoked Potential:** Electric *waveforms* of biologic origin recorded over the spine in response to electric stimulation or physiologic *activation* of peripheral sensory fibers. See preferred term, *somatosensory evoked potential*.

**Spontaneous Activity:** Electric activity recorded from muscle at rest after *insertion activity* has subsided and when there is not

voluntary *contraction* or an external *stimulus*. Compare with *involuntary activity*.

**SSEP:** Abbreviation for *short-latency somatosensory evoked potential*.

**Staircase Phenomenon:** The progressive increase in muscle *contraction* force observed in response to continued low rates of muscle *activation*.

**Startle (Reflex):** A *response* produced by an unanticipated *stimulus* that leads to alerting and protective movements such as eye lid closure and flexion of the limbs. Auditory stimuli are typically most efficacious.

**Stiff-man Syndrome:** A disorder characterized by continuous muscle *contraction* giving rise to severe stiffness. Axial muscles are typically affected most severely. Patients have difficulty moving. Walking and voluntary movements are slow. Sensory stimulation often induces severe spasms. *Electromyography* demonstrates continuous activity of *motor unit action potentials* in a normal pattern that cannot be silenced by contraction of the antagonist muscle. It is often associated with circulating antibodies to glutamic acid decarboxylase (GAD), and the resulting deficiency of GABA may play a role in its pathophysiology. Since women are affected in equal or greater numbers than men, the term *stiff-person syndrome* may be preferable.

**Stiff-person Syndrome:** Synonym for *stiff-man syndrome*.

**Stigmatic Electrode:** A term of historic interest. Used by Sherrington for *active* or *exploring electrode*.

**Stimulated SFEMG:** See preferred term *stimulation SFEMG*.

**Stimulating Electrode:** Device used to deliver electric current. All electric stimulation requires two *electrodes*; the negative terminal is termed the *cathode*, and the positive terminal is the *anode*. By convention, the stimulating electrodes are called *bipolar* if they are encased or attached together and are called *monopolar* if they are not. Electric stimulation for *nerve conduction studies* generally requires application of the cathode in the vicinity of the neural tissue to produce *depolarization*.

**Stimulation Single Fiber Electromyography (Stimulation SFEMG):** Use of electrical stimulation instead of voluntary *activation* of *motor units* for the analysis of

*single fiber electromyography*. The method is used in patients who are unable to produce a steady voluntary muscle *contraction*. The stimulation can be delivered to intramuscular axons, nerve trunks, or muscle fibers.

**Stimulus:** Any external agent, state, or change that is capable of influencing the activity of a cell, tissue, or organism. In clinical *nerve conduction studies*, an electric stimulus is applied to a nerve. It may be described in absolute terms or with respect to the *evoked potential* of the nerve or muscle. In absolute terms, it is defined by a *duration* (ms), a *waveform* (square, exponential, linear, etc.), and a strength or intensity measured in *voltage* (V) or current (mA). With respect to the evoked potential, the stimulus may be graded as *subthreshold*, *threshold*, *submaximal*, *maximal*, or *supramaximal*. A threshold stimulus is one just sufficient to produce a detectable *response*. Stimuli less than the threshold stimulus are termed subthreshold. The maximal stimulus is the stimulus intensity after which a further increase in intensity causes no increase in the *amplitude* of the evoked potential. Stimuli of intensity below this level but above threshold are submaximal. Stimuli of intensity greater than the maximal stimulus are termed supramaximal. Ordinarily, supramaximal stimuli are used for nerve conduction studies. By convention, an electric stimulus of approximately 20% greater voltage/current than required for the maximal stimulus is used for supramaximal stimulation. The *frequency*, number, and duration of a series of stimuli should be specified.

**Stimulus Artifact:** See *artifact*.

**Strength–Duration Curve:** Graphic presentation of the relationship between the intensity (Y axis) and various *durations* (X axis) of the *threshold* electric *stimulus* of a nerve or muscle. The *rheobase* is the intensity of an electric current of infinite duration necessary to produce a minimal *action potential*. The *chronaxie* is the time required for an electric current twice the rheobase to elicit the first visible action potential. Measurement of the strength–duration curve is not a common practice in modern *electrodiagnostic medicine*.

**Stretch Reflex:** A *reflex* produced by passive lengthening of a muscle. The principal sensory *stimuli* come from group Ia and

group II muscle spindle afferents. It consists of several *phases*. The earliest component is monosynaptic and is also called the myotatic reflex, or tendon reflex. There are also long-latency stretch reflexes. See also *muscle stretch reflex* and *T wave*.

**Submaximal Stimulus:** See *stimulus*.

**Subnormal Period:** A time interval that immediately follows the *supernormal period* of nerve which is characterized by reduced *excitability* compared to the resting state. Its *duration* is variable and is related to the *refractory period*.

**Subthreshold Stimulus:** See *stimulus*.

**Supernormal Period:** A time interval that immediately follows the *refractory period* which corresponds to a very brief period of partial *depolarization*. It is characterized by increased nerve *excitability* and is followed by the *subnormal period*.

**Supraclavicular Plexus:** That portion of the *brachial plexus* which is located superior to the clavicle.

**Supraclavicular Stimulation:** Percutaneous nerve stimulation at the base of the neck which activates the upper, middle, and/or lower trunks of the *brachial plexus*. This term is preferred to *Erb's point stimulation*.

**Supramaximal Stimulus:** See *stimulus*.

**Surface Electrode:** Conducting device for stimulating or recording placed on the skin surface. The material (metal, fabric, etc.), configuration (disk, ring, etc.), size, and separation should be specified. See *electrode (ground, recording, stimulating)*.

**Sympathetic Skin Response:** Electrical *potential* resulting from electrodermal activity in sweat glands in response to both direct and *reflex* peripheral or sympathetic trunk stimulation of autonomic activity.

**Synkinesis:** Involuntary movement made by muscles distant from those activated voluntarily. It is commonly seen during recovery after *facial neuropathy*. It is due to aberrant reinnervation and/or *ephaptic transmission*.

**T Wave:** A *compound muscle action potential* evoked from a muscle by rapid stretch of its tendon, as part of the *muscle stretch reflex*.

**Tardy Ulnar Palsy:** A type of *mononeuropathy* involving the ulnar nerve at the elbow. The nerve becomes compressed or entrapped due to deformity of the elbow from a previous injury. See also *cubital*

*tunnel syndrome* and *ulnar neuropathy at the elbow*.

**Template Matching:** An automated method used in *quantitative electromyography* for selecting *motor unit action potentials* for measurement by extracting only *potentials* which resemble an initially identified potential.

**Temporal Dispersion:** Relative desynchronization of components of a *compound muscle action potential* due to different rates of conduction of each synchronously evoked component from the stimulation point to the *recording electrode*. It may be due to normal variability in individual axon *conduction velocities*, especially when assessed over a long nerve segment, or to disorders that affect myelination of nerve fibers.

**Terminal Latency:** Synonymous with preferred term, *distal latency*. See *motor latency* and *sensory latency*.

**TES:** Abbreviation for *transcranial electrical stimulation*.

**Test Stimulus:** See *paired stimuli*.

**Tetanic Contraction:** The *contraction* produced in a muscle through repetitive maximal direct or indirect stimulation at a sufficiently high *frequency* to produce a smooth summation of successive maximum twitches. The term may also be applied to maximum voluntary contractions in which the firing frequencies of most or all of the component *motor units* are sufficiently high that successive twitches of individual motor units fuse smoothly. Their combined tensions produce a steady, smooth, maximum contraction of the whole muscle.

**Tetanus:** (1) The continuous *contraction* of muscle caused by repetitive stimulation or *discharge* of nerve or muscle. Contrast with *tetany*. (2) A clinical disorder caused by circulating tetanus toxin. Signs and symptoms are caused by loss of inhibition in the central nervous system and are characterized by muscle spasms, hyperreflexia, seizures, respiratory spasms, and paralysis.

**Tetany:** A clinical syndrome manifested by muscle twitching, cramps, and carpal and pedal spasm. These clinical signs are manifestations of peripheral and central nervous system nerve irritability from several causes. In these conditions, *repetitive discharges (double discharge, triple discharge, multiple discharge)* occur frequently with voluntary

activation of motor unit action potentials or may appear as *spontaneous activity*. This activity is enhanced by systemic alkalosis or local ischemia.

**Tetraphasic Action Potential:** *Action potential* with three *baseline* crossings, producing four *phases*.

**Thermography:** A technique for measuring infrared emission from portions of the body surface. The degree of emission depends upon the amount of heat produced by the region that is studied. Its use in the diagnosis of *radiculopathy*, peripheral nerve injury, and disorders of the autonomic nervous system is controversial.

**Thermoregulatory Sweat Test:** A technique for assessing the integrity of the central and peripheral efferent sympathetic pathways. It consists of measuring the sweat distribution using an indicator powder while applying a controlled heat *stimulus* to raise body temperature sufficient to induce sweating.

**Thoracic Outlet Syndrome:** An *entrapment neuropathy* caused by compression of the neurovascular bundle as it traverses the shoulder region. Compression arises from acquired or congenital anatomic variations in the shoulder region. Symptoms can be related to compression of vascular structures, portions of the *brachial plexus*, or both.

**Threshold:** The level at which a clear and abrupt transition occurs from one state to another. The term is generally used to refer to the *voltage* level at which an *action potential* is initiated in a single axon or muscle fiber or a group of axons or muscle fibers.

**Threshold Stimulus:** See *stimulus*.

**Tic:** Clinical term used to describe a sudden, brief, stereotyped, repetitive movement. When associated with vocalizations, may be the primary manifestation of Tourette syndrome.

**Tilt Table Test:** A test of autonomic function that is performed by measuring blood pressure and heart rate before and a specified period of time after head-up tilt. The *duration* of recording and amount of tilt should be specified.

**TMS:** Abbreviation for *transcranial magnetic stimulation*.

**Tone:** The resistance to passive stretch of a joint. When the resistance is high, this is called *hypertonia*, and when the resistance

is low, this is called *hypotonia*. Two types of hypertonia are *rigidity* and *spasticity*.

**Train of Positive Sharp Waves:** See *positive sharp wave*.

**Train of Stimuli:** A group of *stimuli*. The *duration* of the group or the number of stimuli as well as the stimulation *frequency* should be specified.

**Transcranial Electrical Stimulation (TES):** Stimulation of the cortex of the brain through the intact skull and scalp by means of a brief, very high *voltage*, electrical *stimulus*. *Activation* is more likely under the *anode* rather than the *cathode*. Because it is painful, this technique has largely been replaced by *transcranial magnetic stimulation*.

**Transcranial Magnetic Stimulation (TMS):** Stimulation of the cortex of the brain through the intact skull and scalp by means of a brief magnetic *stimulus*. In practice, a brief pulse of strong current is passed through a coil of wire in order to produce a time-varying magnetic field in the order of 1–2 Tesla. Contrast with *transcranial electrical stimulation*.

**Tremor:** Rhythmical, involuntary oscillatory movement of a body part.

**Triphasic Action Potential:** *Action potential* with two *baseline* crossings, producing three *phases*.

**Triple Discharge:** Three *motor unit action potentials* of the same form and nearly the same *amplitude*, occurring consistently in the same relationship to one another and generated by the same axon. The interval between the second and third *action potentials* often exceeds that between the first two, and both are usually in the range of 2–20 ms. See also *double discharge* and *multiple discharge*.

**Triplet:** Synonym for the preferred term, *triple discharge*.

**Turn:** Point of change in polarity of a *waveform* and the magnitude of the *voltage* change following the turning point. It is not necessary that the voltage change pass through the *baseline*. The minimal excursion required to constitute a change should be specified.

**Turns and Amplitude Analysis:** See preferred term *interference pattern analysis*. Refers to the interference pattern analysis developed by Robin Willison in the 1960s.



**Ulnar Neuropathy at the Elbow:** A *mononeuropathy* involving the ulnar nerve in the region of the elbow. At least two sites of *entrapment neuropathy* have been recognized. The nerve may be entrapped or compressed as it passes through the retrocondylar groove at the elbow. Alternatively, it may be entrapped just distal to the elbow as it passes through the cubital tunnel. Anatomic variations or deformities of the elbow may contribute to nerve injury. See also *cubital tunnel syndrome* and *tardy ulnar palsy*.

**Unipolar Needle Electrode:** See synonym, *monopolar needle recording electrode*.

**Upper Motor Neuron Syndrome:** A clinical condition resulting from a pathological process affecting descending motor pathways including the corticospinal tract or its cells of origin. Signs and symptoms include weakness, *spasticity*, and slow and clumsy motor performance. On *electromyographic* examination of weak muscles, there is slow *motor unit action potential* firing at maximal effort.

**Utilization Time:** See preferred term, *latency of activation*.

**Valsalva Maneuver:** A forcible exhalation against the closed glottis which creates an abrupt, transient elevation of intrathoracic and intra-abdominal pressure. This results in a characteristic pattern of heart rate and blood pressure changes that can be used to quantify autonomic function. See *Valsalva ratio*.

**Valsalva Ratio:** The ratio of the fastest heart rate occurring at the end of a forced exhalation against a closed glottis (*phase II* of the *Valsalva maneuver*), and the slowest heart rate within 30 seconds after the forced exhalation (*phase IV*). In patients with disorders of the autonomic nervous system, the ratio may be reduced.

**VEP:** Abbreviation for *visual evoked potential*.

**VER:** Abbreviation for *visual evoked response*. See *visual evoked potential*.

**Visual Evoked Potential (VEP):** Electric *waveforms* of biologic origin recorded over the cerebrum and elicited in response to visual stimuli. They are classified by *stimulus* rate as transient or steady state, and they can be further divided by stimulus presentation mode. The normal transient VEP to checkerboard pattern reversal or shift has a major positive occipital peak at about 100 ms (P100), often preceded by a negative peak

(N75). The precise range of normal values for the *latency* and *amplitude* of P100 depends on several factors: (1) subject variables, such as age, gender, and visual acuity, (2) stimulus characteristics, such as type of stimulator, full-field or half-field stimulation, check size, contrast and luminance, and (3) recording parameters, such as placement and combination of *recording electrodes*.

**Visual Evoked Response (VER):** Synonym for preferred term, *visual evoked potential*.

**Volitional Activity:** Synonymous with *voluntary activity*.

**Voltage:** *Potential* difference between two recording sites usually expressed in volts (V) or millivolts (mV).

**Volume Conduction:** Spread of current from a *potential* source through a conducting medium, such as body tissues.

**Voluntary Activity:** In *electromyography*, the electric activity recorded from a muscle with consciously controlled *contraction*. The effort made to contract the muscle may be specified relative to that of a corresponding normal muscle, for example, minimal, moderate, or maximal. If the recording remains isoelectric during the attempted contraction and equipment malfunction has been excluded, it can be concluded that there is no voluntary activity.

**Wake-up Test:** A procedure used most commonly in spinal surgery. During critical portions of an operation in which the spinal cord is at risk for injury, the level of general anesthesia is allowed to decrease to the point where the patient can respond to commands. The patient is then asked to move hands and feet, and a movement in response to commands indicates the spinal cord is intact. This procedure is used routinely in some centers. *Somatosensory evoked potential* monitoring has supplanted its use in most centers, except sometimes in the situation where they indicate the possibility of spinal cord injury.

**Wallerian Degeneration:** Degeneration of the segment of an axon distal to nerve injury that destroys its continuity.

**Waning Discharge:** A *repetitive discharge* that gradually decreases in *frequency* or *amplitude* before cessation. Contrast with *myotonic discharge*.

**Wave:** A transient change in *voltage* represented as a line of differing directions over time.

**Waveform:** The shape of a *wave*. The term is often used synonymously with *wave*.

**Wire Electrodes:** Thin wires that are insulated except for the tips, which are bared. The wire is inserted into muscle with a

needle. After the needle is withdrawn, the wire remains in place. Wire electrodes are superior to *surface electrodes* for *kinesiologic EMG*, because they are less affected by *cross talk* from adjacent muscles. They also record selectively from the muscle into which they are inserted.



# Index

Note: In this index, figures are indicated by “f” and tables by “t”

- A waves. *See* Axon reflexes
- Abductor digiti minimi (ADM), 809, 832
- Abductor pollicis brevis (APB), 808
- Absence seizures, 141, 176f
- Absolute latencies of BAEP waves, 307
- Accommodation, 82, 82f
- Acetylcholine, 371
- Acoustic neuroma, 289f, 289–90
- Acoustic reflex, 298–99, 299t, 300f
  - CN VIII *vs.* cochlear findings, 299t, 299–300
  - decay, 299
  - disorders of brain stem, 300–301
  - disorders of CN VII, 299t, 300
- Acoustic reflex tests, 295
  - purpose and role, 296
- Actigraphy, 704f, 704–5
  - indications, 705
  - purpose and role, 698
- Action potentials, 82
  - excitability, 84–86, 85f
  - ionic basis, 83–84, 84f
  - vs.* local potentials, 80t
  - patterns of activity, 87–88
  - propagation, 86–87
  - threshold, 82–83
- Action tremors, 555
- Active reference electrodes, 45
- Active sleep, 168
- Active sources (of bioelectric potentials), 33
- Active transport, 70–71
- Active zones, 90
- Acute inflammatory demyelinating polyradiculoneuropathy (AIDP). *See* Guillain-Barré syndrome
- Acute process, 805
- Adenosine triphosphate (ATP), 70, 93–94, 95f
- Adrenergic function, 637. *See also* Skin vasomotor reflexes
- After-hyperpolarization, 84, 88
- Afterpotential, 84
- Airflow and sleep, 713
- Alexander's Law, 580, 581
- Aliasing, 59
- Allodynia, 680
- Alpha activity, 124
- Alpha–delta sleep, 707
- Alpha-frequency coma pattern, 163
- Alpha intrusion, 709
- Alpha rhythm, 124, 124f
- Alpha variants, 130
- Altered reactivity, 153
- Alternating current EMF, 12, 12f
- Alternating (polarities), 287
- Alternation, 503
- Alzheimer's disease, 565
- Ambulatory electroencephalography (AEEG), 187
  - clinical applications, 189–91
  - indications, 187–88
  - purpose and role, 187
  - technology, 188–89
- Amplification, 17–18
- Amplifiers, 16–18, 478
  - differential, 18f, 18–19, 19f
- Amplitude, 458
- Amyotrophic lateral sclerosis (ALS), 255, 275f, 431, 504f, 506f
  - and nerve conduction variables, 352t
- Amyotrophy, neuralgic, 363
- Analog signals, 56
- Analog-to-digital conversion, 57–59. *See also* Digitization
- Analog-to-digital converter (ADC), 56–58
  - scheme of a 4-bit, 57f
- Anesthesia, 316, 728f
  - bispectral analysis of EEG for monitoring depth of, 736
  - light steady-state, 731–32
  - motor evoked potentials and, 760
  - preoperative abnormalities seen with, 732–33
  - somatosensory evoked potentials and, 757f, 757–58
  - symmetrical EEG patterns during, 731–32
- Angular head movements, 577–79
- Anhidrosis, 646t, 654. *See also* Thermoregulatory sweat test
- Anodal block, 245, 332. *See also* Hyperpolarization
- Anomalous innervation, 831
- Anoxia, 276
- Anterior horn cell disorders, 489–90
- Anterior maximum, rhythmic fast (ARF) pattern, 731–32
- Anterior maximum, triangular, slow (ATS) waves, 731
- Anterior temporal and frontal spikes, 138
- Anterior visual pathway lesions, 317–21
- Anticoagulation, needle exams and, 409–10
- Antidromic (sensory) technique, 243, 244f, 253
- Apnea hypopnea index (AHI), 715
- Apneas, 712. *See also* Obstructive sleep apnea
  - mixed, 712
- Appearance threshold, 678
- Arm-diaphragm synkinesis, 437
- Arousal, disorders of, 719
- Arousal index, 710
- Arousals, 7097
- Arrhythmia. *See also* Hypsarrhythmia; Positive, arrhythmic, slow (PAS) waves
  - respiratory sinus, 624, 627
- Arterial baroreflexes. *See* Baroreflexes
- Arteriovenous malformations, 155

- Artifacts, 111, 123–24  
 common forms, 112t  
 electric, 267  
 nonphysiologic, 111–13, 113f  
 physiologic, 111
- Artifactual waveforms, 111–13
- Asterixis, 566
- Asymmetric reactivity, 153
- Asymmetry, 153, 170
- Athetosis, 571
- Atonia, REM sleep without, 717, 717f
- Atypical spike and wave discharges, 142–43
- Audiogram, 296–98, 297f, 303  
 applications, 299t, 303  
 purpose and role, 296
- Auditory acuity, 287
- Auditory anatomy and physiology, 282f, 283
- Auditory brain stem response (ABR), 309
- Auditory evoked potentials (AEPs), 788
- Auditory neuropathy/dys-synchrony, 302
- Auditory pathways, 100. *See also* Brain stem auditory evoked potentials  
 neuroanatomy, 282f, 283
- Auditory pattern recognition, 414
- Autocorrelation analysis, 63–64, 207f
- Autocorrelation function (ACF), 64
- Autoimmune myasthenia gravis. *See* Myasthenia gravis
- Automated analysis of single MUPs, 464
- Automated decomposition EMG (ADEMG), 464–65
- Automated methods of analysis of spontaneous activity, 472
- Autonomic axons. *See* Axons
- Autonomic control of heart rate, 624
- Autonomic failure, severity of, 649
- Autonomic laboratory evaluation, indications for, 630t
- Autonomic nervous system, 617. *See also* Sympathetic function  
 general organization, 619f, 619–21  
 symptoms and diseases, 617–19
- Autonomic testing, 618, 630t  
 purpose and role, 618–19
- Autonomic tests, 681–83
- Averaging, 246–47, 261–62. *See also under* Quantitative MUNE  
 back, 62, 553  
 digital, 60–62  
 forward, 62  
 jerk-locked, 230  
 signal, 600
- Averaging MUNE, spike-triggered, 498–500, 499f
- Axonal degeneration, 803
- Axonal neuropathies, 350–52, 351t, 813–14
- Axonal sensorimotor peripheral neuropathies, etiologies of, 814t
- Axon reflexes, 99f, 342–43. *See also* Quantitative sudomotor axon reflex test
- Axons, 97
- Back averaging, 62, 553
- Balance, 573–75, 607–8
- Ballistic pattern, 554
- Baroreflexes, arterial, 624–25
- Baroreflex indices, 643
- Baroreflex sensitivity, 667–68, 672
- Basal ganglia, 517, 788,
- Base (transistor), 17
- Basement syndrome, 608
- Behavioral events, nonepileptic  
 PVEEG and, 196–97
- Behavior disorder, REM sleep, 720
- Bending energy, 207
- Benign epileptiform transients of sleep (BETS), 132–33
- Benign paroxysmal positioning vertigo (BPPV), 586, 587, 607
- Benign rolandic epilepsy of childhood (BREC), 139–40
- Benign sporadic sleep spikes (BSSS), 132–33  
 characteristics, 134t
- Benign temporal slow wave transients, 126–27
- Bereitschaftspotential (BP), 229, 230, 568  
 early *vs.* late, 230
- Beta activity, 124–25, 125f
- Beta-frequency coma pattern, 163
- Bilateral periodic lateralized epileptiform discharges (BiPLEDs), 140
- Biphasic potentials, 41
- Biphasic waveforms, 48
- Bipolar potentials, 39
- Bispectral index (BIS), 736
- Bizarre repetitive potentials. *See* Complex repetitive discharges
- Bleeding disorders, needle exams and, 409–10
- Blepharospasm, 569
- Blink reflex, 530  
 applications, 531–35  
 methods of eliciting, 530–31, 531f  
 neuroanatomy, 530, 530f
- Blink reflex latencies, 817
- Blink reflex responses, factors affecting, 535
- Blocking, 477, 481–82
- Blood gases, 714–15
- Blood pressure (BP), 637, 643  
 intraoperative, 758, 764
- Blood pressure recovery time (PRT), 639–40
- Body position, 709
- Bottom tracing, 242f, 467f
- Botulism, 255, 381, 488
- Bouton, terminal, 370
- Brachial plexopathy, 817–23, 821t, 822
- Brain abscess, 180
- Brain death, 164–65, 276, 292
- Brain stem, 99, 276. *See also* Intraoperative monitoring, of cranial nerves  
 disorders, 300–301
- Brain stem auditory evoked potentials (BAEPs), 44, 100, 281–82, 284f, 285f, 292–93, 310  
 anatomical localization and, 283f  
 applications, 288–92, 308–9  
 electrodes, 306  
 factors affecting BAEP response, 286–87  
 generators of, 283  
 interpretation, 287, 306–8  
 intraoperative, 739–40, 745, 745f  
 methods, 284–86  
 recording, 284–86  
 stimulation, 284  
 purpose and role of  
 in central disorders, 283  
 in peripheral acoustic disorders, 305  
 stimuli, 306

- Brain stem auditory evoked response (BAER). *See* Brain stem auditory evoked potentials
- Brain stem auditory pathways. *See also* Auditory pathways neuroanatomy, 282f, 283
- Brain stem lesions, 274  
intrinsic, 291–92
- Brain stimulation, deep, 31–32
- Breach rhythm, 130, 131f, 132
- Breathing, deep. *See under* Heart rate response
- Breathing arm or hand, 437
- Bruxism, 717
- Buildup (EEG), 120, 122
- Burst patterns of EMG waveforms, 415
- Burst suppression, 148, 149f
- Burst-suppression pattern, 163, 163f, 170
- C reflex, 545
- Calcium, role of extracellular, 78
- Calcium channels, voltage-gated, 74, 74f
- Calcium spike, low-threshold, 88
- Caloric irrigation, 588, 589–93, 589–93f
- Capacitance, 7
- Capacitative properties, 41
- Capacitors, 7  
rules for seats of, 8
- Cardiac rhythm, 715
- Cardiac surgery, 736
- Cardiopulmonary receptors, 625
- Cardiovascular function, tests of, 672. *See also* Heart rate response; Valsalva maneuver
- Cardiovascular scoring, 670
- Cardiovascular heart rate testing. *See also* Heart rate response  
purpose and role, 661–62
- Cardiovascular reflexes, 624–26. *See also* Valsalva maneuver
- Carotid endarterectomy  
EEG changes during, 728f, 729f, 733–35  
monitoring techniques during, 735–36  
SSEP recording during, 735
- Carotid stump pressure measurement, 735
- Carpal tunnel syndrome (CTS), 253–54, 335, 808–9  
defining the severity of, 358t  
Martin-Gruber anastomosis in, 833–34  
NCS abnormalities in, 358t, 358–59
- Cathode–anode relationship, 332–33
- Cauda equina, 772–73
- Cell membrane, 69–76
- Central apnea, 712
- Central commands, 624
- Central conduction time (CCT), 392
- Central disorders, 649. *See also* Central nervous system (CNS) symptoms
- Central nervous system (CNS) excitability, H reflex and, 526
- Central nervous system (CNS) symptoms, 648  
assessing, 791–92  
with EEG, 793–800  
identifying disease types, 793  
localization of disease, 792–93  
prognosis, 793
- Central-temporal spikes, 176, 177f
- Cerebellar tremor, 557
- Cerebral cortex, 100–101
- Cerebral infarction, EEG and, 154
- Cervical dystonia, 569
- Cervical radiculopathy, 806–7
- Cervical spine disease, 770–71
- Cervical spondylitic myelopathy, 271, 272f
- Chiasmatic lesions, 317–18
- Childhood  
benign rolandic epilepsy of, 139–40  
slow lambdas of, 175
- Children. *See also under* EEG  
drowsiness, 173–74  
epileptiform abnormalities, 176–78  
somatosensory evoked potentials, 276  
tumors, 181
- Chorea, 571
- Chronic disorder, 805
- Chronic inflammatory demyelinating polyradiculopathy (CIDP), 354–55, 539f, 814, 816f
- Chrono-dispersion, 340
- Circuit analysis, 7–9
- Circuits. *See also specific types of circuits*  
containing inductors and capacitors, 10–14  
ideal, 10
- Click sensation level, 284
- Closed fields, 35
- Closely spaced potentials, 39
- Cognition, assessing impairment of, 792, 797
- “Cogwheeling” pursuit, 586
- Coherence function, 207
- Coils, 7. *See also* Inductors
- Cold hyperalgesia, 680, 680f, 681f
- Collector (transistor), 17
- Coma patterns, 162f, 162–64  
BAEPS, 292
- Coma, prognosis in, 275–76
- Combined sensory index (CSI), 357–59
- Common mode, 18
- Common mode rejection ratio (CMRR), 19
- Complex MUPs, 459, 479
- Complex regional pain syndrome (CRPS), 681–83
- Complex repetitive discharges (CRDs), 414, 429–30, 830f  
disorders associated with, 429–30, 430t
- Composite autonomic severity score (CASS), 670
- Compound muscle action potentials (CMAPs), 327–28, 363, 381, 496  
axon reflexes (A waves), 342–43
- CMAP changes in disease  
mechanisms of conduction in myelinated fibers, 345  
mechanisms of slow conduction in disease, 345–46  
pathophysiology, 344
- disorders producing low motor CMAP without sensory involvement, 812t
- F waves, 338, 341–42, 341t  
latency, 338–40f, 340–42, 341t  
measurements, 340–41  
recording, 338–39  
repeater, 352  
stimulation, 339–40
- general clinical applications, 328  
intraoperative, 741, 745f, 747, 763–64, 766–67, 778–79
- measurements, 334  
amplitude and area, 334, 496  
conduction velocity, 335–36, 336f  
duration, 334, 335f  
latency, 334–35

- Compound muscle action potentials (CMAPs)  
 (*Continued*)  
 normal values in CMAP recordings, 337–38  
 potential errors in, 336–37  
 peripheral nerve disorders and, 346–63  
 physiologic variables affecting  
 age, 343–34  
 temperature, 343  
 recording  
 location of recording electrode, 330f, 330–32, 331f  
 type of recording electrode, 329t, 329–30  
 stimulating electrode  
 position of, 332–34  
 type of, 332
- Computer-assisted quantitation of MUPs, 462–64, 463f  
 Computerized dynamic posturography (CDP), 603–6  
 purpose and role, 603
- Computerized rotary chair tests, 594–95, 594–98  
 purpose and role, 595
- Condensation, 287
- Conductance changes during action potentials, 83f, 83–84
- Conduction block, 346–48, 347f, 803, 815–16  
 complete, 815  
 partial, 816, 816t
- Conduction slowing, 346–49
- Conduction velocity (CV), 247, 248f, 335–36, 336f, 808,  
 809, 814
- Conductive hearing losses, 297, 305
- Conductivity, 41
- Conductors, 6
- Congenital abnormalities, 173
- Congenital myasthenia, 381
- Congenital myasthenic syndromes, 488
- Consciousness, assessing impairment of, 792, 795
- Contact heat evoked potential stimulator (CHEPS),  
 540–41, 688–89
- Continuous positive airway pressure (CPAP), 711f, 712,  
 713, 714f
- Continuous waves, 109–10  
 measurable variables of, 109t
- Contraction fasciculations, 431
- Contralateral preponderance of negativity (CPN), 230
- Cortex, cerebral, 100–101
- Cortically generated potentials. *See also*  
 Movement-related cortical potentials  
 in volume conductors, 34–35
- Cortical malformations, 172
- Cortical origin myoclonus. *See also* Myoclonus  
 without reflex activation, 565
- Cortical projection techniques, 210
- Cortical reflex myoclonus, 544, 545f, 563–65
- Cortical silent period, 547
- Cortical stimulation, therapeutic, 31–32
- Corticobasal degeneration, myoclonus of, 566
- Cough test, 672
- Coupling discharges, 459. *See also* Satellite potentials
- Cramp discharges, 435–36, 436f  
 disorders associated with, 436t
- Cramp fasciculation, 435
- Cranial fossa, intraoperative monitoring of, 743–44, 745f,  
 746–47
- Cranial nerve (CN) VII, disorders of, 300
- Cranial nerve (CN) VIII, 299t, 299–300, 305
- Cranial nerve (CN) VIII tumors, 308f, 308–9, 309f, 310f
- Cranial nerves (CN), 620
- Cranial reflexes, 529, 541. *See also specific reflexes*  
 purpose and role, 529
- Creutzfeldt–Jakob disease (CJD), 160–61, 161f, 565
- Critical period (surgery), 753
- Cross-correlation analysis, 206
- Cross-spectral analysis, 207
- Cumulative amplitude, 468
- Current density, 6
- Current sources, 38–41
- Cutaneous nerve stimulation SEPs, 266
- Cutaneous silent period (CSP), 548
- Deafness, 296
- Decomposition-based quantitative EMG (DQEMG)  
 MUNE, 500, 501f
- Decomposition quantitative EMG (DQEMG), 408, 464,  
 470f, 500
- Deep brain stimulation, 31–32
- Degenerative disorders, 179. *See also specific disorders*
- Delay (SFEMG), 478
- Delirium, EEG evaluation of, 795
- Delta activity, 125
- Demyelinating disease, 271–73, 290–91, 345–46, 394. *See*  
*also* Multiple sclerosis
- Demyelinating neuropathies, 814–17. *See also*  
 Inflammatory demyelinating polyradiculopathy  
 inherited, 353t  
 predominantly, 815t  
 segmental, 352t, 352–53. *See also specific disorders*  
 focal neuropathies, 355–62
- Demyelination, 242  
 partial, 803
- Denervation supersensitivity, 642
- Depolarization, 86
- Depolarization blockade, 94
- Dermatomal SEPs, 266
- Diabetic peripheral neuropathies, 648
- Diagnosis. *See also under* Disease  
 confirming a clinical diagnosis, 802  
 differential, 802
- Dielectric constant, 41
- Differential diagnosis, 802
- Diffusion pressure, 71
- Digital averaging, 60–62  
 operation of an averager, 60f
- Digital clinical neurophysiology, 54
- Digital computers, utility of, 53
- Digital electroencephalography (EEG), 54–56  
 inter-reader agreement in classification of EEG  
 records, 56t
- Digital filtering, example of, 64f
- Digital filters  
 characteristics, 63  
 types of, 62–63
- Digital recording technology  
 capabilities, 54  
 disadvantages, 54
- Digital signal processing  
 time and frequency domain analysis, 63–67  
 uses, 59–60
- Digital systems, construction of, 56
- Digitization, 56–59  
 principles, 56–57
- Diodes, 16–17
- Dipoles, 38, 39f, 50, 51

- Dipole source localization, 46–47, 211–12
- Direct current (DC) circuit, 12
- Directional preponderance (DP), 591
- Direction-changing nystagmus, 588
- Direction-fixed positional nystagmus, 588
- Disappearance threshold, 678
- Discharge (event), 107
- Discrete firing, 419
- Disease
  - defining stage and evolution of, 804–5
  - identifying. *See also* Diagnosis
    - in patients who are difficult to examine, 802
  - identifying subclinical, 802–3
  - localizing, 792, 802
- Disease pathophysiology, characterizing, 803–4
- Disease severity, defining, 804
- Disease types, identifying, 805–6
- Display times of common signals, 110t
- Distal anhidrosis, 654
- Distal latency (DL), 808
  - prolongation of, 815
- Distal motor latency (DML), 335
- Distant potentials, 39
- Distant reference, 39, 41, 45, 46f
- Distortion product evoked otoacoustic emissions (DPOAEs), 301, 302f
- Diving reflex, 672
- Dix–Hallpike test, 586, 587f
- Doping, 16
- Dorsal column entry (DCV), 264
- Dorsal rhizotomy, 772
- Drowsiness. *See also under* EEG
  - in children, 173–74
- Drugs and EEG, 171
- Drug withdrawal, 171
- Duration, 456–57, 477, 482
- Dying-back neuropathies, 346
- Dynamic compensation, 581
- Dysgenetic disorders, 172
- Dystonia, 445, 569–71
  - recording techniques, 569
- “Dystonic myoclonus” of SSPE, 565
- EEG (electroencephalography), 18, 117, 119, 136, 151, 165. *See also specific topics*
  - abnormalities, 175–83. *See also* EEG manifestations of diffuse disorders
    - focal intracranial processes causing, 154–59
    - types of, 152–54
  - activation procedures, 120, 122–23, 123f
  - artifacts, 123–24
  - assessing clinical CNS disorders with, 793–800
  - benign variants, 175
    - during drowsiness and sleep, 127, 132–34, 135f, 136, 173–75
    - during wakefulness, 130, 131f, 132
  - dipole source localization in, 46–47
  - display of EEG activity, 119–20
  - evaluation for suspected brain death, 164–65
  - of infants and children, 175–83
    - conditions giving rise to abnormal EEG patterns, 171–73, 178–82
    - developmental changes during infancy, childhood, and adolescence, 173
      - drowsiness and, 173–74
      - neonatal EEG patterns, 168–73
  - movement disorders and, 553
  - normal EEG activity of adults
    - awake state, 124–26
    - older adults, 126–27, 129–30
    - sleep state, 127–30
  - volume conduction and EEG applications, 45–46
  - volume conductor resistive-capacitive (RC) properties and, 41
  - waveforms and, 103
- EEG analysis, quantitative methods of, 203, 212. *See also* EEG special studies; Fourier (spectral) analysis
  - cortical projection techniques, 210
  - cross-correlation analysis, 206
  - cross-spectral analysis, 207
  - interpolation, 207–8
  - montage reformatting, 205–6
  - multivariate statistical methods and topographic analysis, 209–10
  - source dipole localization, 210–11
  - spike, sharp-wave, high-frequency oscillation and seizure detection, 204–5
  - topographic displays (mapping), 208–9, 209f
- EEG-EMG polygraphy with back-averaging, 553
- EEG manifestations of diffuse disorders, 159–64
  - coma patterns, 162–64
  - generalized periodic patterns, 160–62
  - specific patterns, 160
- EEG special studies. *See also* EEG analysis
  - purpose and role, 203
- Effusion, subdural, 180–81
- E:I ratio, 662
- Electric artifact, 267
- Electric charges and force, 5–6, 8
- Electric current, 6–7
  - physiologic effect, 23, 24f
  - requirements for it to flow through body, 22–23
- Electric potential. *See* Electrical potentials
- Electric power distribution systems, 21–22
- Electric safety. *See also* Electric stimulation safety
  - principles and implementation, 27–30
  - procedures for technicians, 30
  - rules, 29–30
- Electric shock, 22–23
  - in hospitals, 24–25
  - risk of
    - factors increasing, 24–25
    - factors reducing, 23
- Electric stimulation safety, 30–32. *See also* Electric safety
- Electrical potentials, 6. *See also specific topics*
  - calculating in infinite homogeneous media, 50
  - in nonhomogeneous media, 50–51
  - sources, 34–36
  - spatial distribution, 39, 40f, 41
- Electrical pressure, 71
- Electrical surface stimulator, handheld, 332
- Electricity, basic principles and definitions in, 5–7
- Electrocerebral inactivity (ECI), 164f, 164–65
- Electrocorticography (ECoG), 223, 224f, 225
- Electrodecremental pattern, 143
- Electroencephalogram (EEG), 119, 120–23f. *See also* EEG
  - recording the, 119
- Electroencephalographic analysis. *See* EEG analysis

- Electromagnetic tomography, low resolution, 211
- Electromagnets, 7. *See also* Inductors
- Electromotive force (EMF), seat of, 6  
rules for, 8
- Electronystagmography (ENG). *See* ENG/VNG test  
battery
- Electrooculogram recording (EOG), 582, 583f
- Electrophysiologic generators, 97–101
- Electroretinogram, 100
- EMF. *See* Electromotive force; Evoked magnetic fields
- EMG (electromyography), 18. *See also* Needle EMG;  
*specific topics*  
intraoperative, 740, 779. *See also under* Intraoperative  
spinal cord monitoring  
semiquantitative, 415, 452  
volume conductor resistive-capacitive (RC) properties  
and, 41–42
- EMG potentials, origin of, 415–17
- EMG waveforms, 103  
burst patterns, 415  
origin, 417
- Emitter (transistor), 17
- Empyemas, subdural, 180–81
- Encephalitis, 179–80. *See also* Panencephalitis  
herpes simplex, 158–59, 180
- End plate activity, 407, 417–18
- End plate noise, 407, 417
- End plate potential (EPP), 371. *See also* Miniature end  
plate potentials
- End plate spikes, 98
- End plate zone, 453
- End-tidal anesthetic (ETAG), 736
- Energy failure, 93–94
- ENG/VNG test battery, 589, 594t  
purpose and role, 584–85
- Entrapment neuropathies, 780–81
- Ephaptic activation, 485
- Epilepsy monitoring unit (EMU), video-EEG monitoring  
in, 217–18, 221, 799–800
- Epilepsy, surgical evaluation of, 225. *See also under*  
Seizures  
background, 215–16  
preoperative video-EEG monitoring, 218–19  
presurgical evaluation with continuous or chronic  
intracranial monitoring, 219  
depth wire electrodes, 219–21  
subdural electrode monitoring, 221–22  
presurgical selection and evaluation  
clinical evaluation, 216  
imaging studies, 216–17  
intracarotid amobarbital (ICA), 217f, 217–18  
purpose and role of EEG in, 216
- Epilepsy surgery. *See also* Epilepsy, surgical evaluation of  
and quality of life (QOL), 215, 216
- Epileptic myoclonus, 559
- Epileptic vs. nonepileptic events, PVEEG and, 195–96
- Epileptiform abnormalities in children, 176–78
- Epileptiform activity, 153, 170  
definitions and overview, 137–38  
with a potential seizure association, 148, 170, 171f
- Epileptiform discharges. *See also* Periodic lateralized  
epileptiform discharges  
ictal, 145, 147  
interictal, 796–97  
specific focal, 138–40
- Epileptiform patterns, generalized, 141–45
- Epileptiform transients of sleep, benign, 132–33
- Episodic myalgia, 827
- Episodic weakness, 827
- Epochs, 706
- Equilibrium potential, 71–72
- Equipment ground, 25
- Equipment grounding, 27–28  
tests for, 28–29
- Equipotential grounding system, 26
- Equipotential lines, 38, 39f
- Ergoreflexes, 625
- Esophageal pH measurements, 718
- Essential myoclonus, 559, 567
- Essential tremor, 555–56, 557f
- Event recording, waveforms and, 106–8
- Event-related potentials, 232–33
- Evoked magnetic fields (EMFs), 47
- Evoked otoacoustic emissions (EOAEs), 295–96, 301–3  
purpose and role, 296
- Evoked potentials. *See also specific topics*  
digital averaging devices for, 60–62  
intraoperative, 742–43
- Ewald's second law, 578
- Exaggerated physiologic tremor, 555
- Exaggerated startle, 568
- Excessive daytime somnolence, 719
- Excitatory postsynaptic potential (EPSP), 34–35, 92
- Exponential change, 414–15
- Extrapyramidal disease, 535
- F waves, 506, 521t, 807, 817, 829. *See also under*  
Compound muscle action potentials
- Facial nerve lesions, 532f, 532–33
- Facial nerve response, 740f  
lateral spread, 535–36, 536f
- Facial synkinesis, 437  
assessment, 533, 533f, 535–36
- Facial weakness, 831
- Facilitation, 372  
postactivation, 374
- False double, 485
- Familial tremor, 555–56
- Far-field potential (FFP), 43, 261, 284
- Fasciculation, cramp, 435
- Fasciculation potentials, 430–31  
disorders associated with, 431t
- Fast alpha variant, 130
- Fast spike-and-wave, 134
- Feedback data flow, 63
- Feed-forward data flow, 63
- Fiber density, 422, 453, 475, 479
- Fibrillation potentials, 416, 425–28, 426f, 427f, 803, 826  
diseases associated with, 427t
- Filter circuits, 14f, 14–16
- Filters  
high-pass, 14f, 14–15  
low-pass, 15–16
- Finite impulse response (FIR), 63
- FIRDA (frontal intermittent rhythmic delta activity)  
pattern, 152, 731
- First dorsal interosseus (FDI), 809
- First-night effect, 710
- Flat disc electrodes, 332
- Flexor carpi radialis technique, 522



- Flexor reflex afferents, 546  
 Flexor reflexes, 546  
 Focal cerebral lesions, 159  
 Focal delta slowing, 180, 180f  
 Focal intracranial lesions, EEG in, 154  
   purpose and role of, 154  
 Focal intracranial processes causing EEG abnormalities, 154–59  
 Focal motor seizures, 565  
 Focal myoclonus, 559  
 Force, 5–6, 8  
 Forward averaging, 62  
 Forward biasing, 16–17  
 Forward problem, 47  
 Fossa  
   cranial, 743–44, 745f, 744–47  
   posterior, 534, 745f, 744–47  
 4, 2, and 1 stepping algorithm, 678  
 Fourier (spectral) analysis, 64–66, 203–4  
 Frequency of signals, 103–6, 105f, 110t  
 Frequent stimulus, 233  
 Friedreich's ataxia, 274, 274f  
 Frontal intermittent rhythmic delta activity (FIRDA)  
   pattern, 152, 731  
 Frontal lobe seizures, 198  
 Frontal spikes, 138  
 Full recruitment, 419  
 Fundamental frequency, 64  
 F-wave measurements, 503f, 506, 507f
- Ganglionopathies, 813t  
 Gastrocnemius technique, 522  
 Gaze nystagmus, 581–82  
 Gaze testing, 588  
 Gender differences, 286–87, 315–16  
 Generalized dystonia, 558  
 Generalized myoclonus, 559  
 Generalized slow spike-and-wave, 176, 177f  
 Generalized spike-and-wave, 3-Hz, 176  
 Generators  
   electrophysiologic, 97–101  
   and origin of SEPs, 258  
 Glial cells, role of, 78  
 Glioma, brain stem, 291f  
 Global anhidrosis, 654  
 Global syndrome, 608–9  
 G-protein-coupled receptors, 91, 93  
 Gray matter disease, 179  
 Great auricular sensory nerve conduction studies, 540  
 Ground, 22, 25  
 Ground potential, 19  
 Guillain-Barré syndrome (AIDP), 269, 270f, 343, 353–54
- H reflex(es), 517, 524, 807  
   clinical applications, 524–26  
   *vs.* F wave, 521t  
   factors affecting the presence or amplitude of, 521t  
   pediatric, 524  
   physiologic basis, 519–21, 520f  
   purpose and role, 519  
   technique, 521–24  
 Handheld electrical surface stimulator, 332  
 Hard of hearing, 296  
 Harmonics, 64  
 Head and neck surgery, intraoperative monitoring during, 747
- Head tilts, 579. *See also* Head-up tilt  
 Head trauma, 181, 275–76  
   and EEG, 157, 157f  
 Head-up tilt (HUT), 638. *See also* Head tilts  
 Hearing impairment, 296, 305. *See also* Brain stem  
   auditory evoked potentials  
 Hearing level (HL), 296. *See also* Brain stem auditory  
   evoked potentials  
 Heart period range, 662–63  
 Heart rate range, 662  
 Heart rate response, 662. *See also* Cardiovascular function  
   to deep breathing  
   factors affecting, 663–64  
   methods of analysis, 662–63, 663f  
   normative data, 664t  
   physiologic basis, 662  
   problems and controversies, 664–65  
   reproducibility, 663  
   technique, 662  
   to standing, 671  
 Heat hyperalgesia, 680, 680f, 681f  
 Hemiconvulsions, hemiplegia, and epilepsy syndrome  
   (HHE), 181  
 Hemifacial spasm, assessment of, 535–36, 536f  
 Hemiplegia, 181  
 Hemorrhage  
   cerebral, 276  
   intracerebral, 155  
   intraventricular, 171  
 Hereditary hyperekplexia, 568  
 Hereditary neuropathy with liability to pressure palsies  
   (HNPP), 349  
 Herpes simplex encephalitis, 158–59, 180  
 Hertz, 103. *See also* Frequency of signals  
 High-frequency potentials, 429  
 High safety factor, 372  
 Hmax/Mmax (ratio of maximal H-reflex to M-response  
   amplitude), 526  
 Hoffman reflexes. *See* H reflex(es)  
 Holes, 16  
 Holmes tremor, 557  
 Homogeneous sphere model, 51  
 Horn cell disorders, anterior, 489–90  
 Hot line, 21  
 H-reflex latency, normal values for, 524t  
 Hydrocephalus, 181–82, 182f  
 Hyperalgesia, 680, 680f, 681f  
 Hyperhidrotic disorders, 645–46t, 647–48  
 Hyperpolarization, 84, 88, 332. *See also* Anodal block  
 Hyperventilation, 120, 122, 123f, 173, 176f  
 Hypopnea, 712  
 Hypsarrhythmia, 143–44, 144f, 176, 176f
- Ictal discharges, 145, 147, 148, 149f  
 Imbalance. *See* Balance  
 Immittance unit, 298, 298f  
 Immobilization, 373  
 Immobilization test, suggested, 716  
 Impedance, calculation of, 13–14  
 Implanted electrical devices, stimulating near, 30  
 Imprint methods of sweat measurement, 634  
 Inactive reference electrodes, 45, 331  
 Inching, 349, 816f  
 Inductance, 7  
 Inductive-capacitive (LC) circuits, 10–11, 11f

- Inductive-resistive-capacitive circuits, 11–12
- Inductors, 7  
rules for seats of, 8
- Infants, 798–99. *See also under* EEG  
conditions giving rise to abnormal EEG patterns in, 171–73
- Infection precautions in needle exams, 410
- Infectious diseases, 171
- Infinite impulse response (IIR), 63
- Inflammatory demyelinating polyradiculopathy. *See also* Guillain-Barré syndrome  
chronic, 354–55, 534f, 814, 815t
- Inflammatory disorders, 158
- Inhibitory postsynaptic potential (IPSP), 34, 35, 92  
deep vs. superficial, 35
- Innervation, 422  
anomalous, 831–35
- Innervation ratio, 453
- Insertional activity, 407, 424–25, 425f
- Instrument ground, 25
- Insufficient sleep syndrome, 719
- Intensive care unit (ICU)  
EEG of, 797–98  
SEPs recorded in, 276–77
- Intention tremors, 555
- Interaural latency differences, 307
- Interference, 113, 665. *See also* Artifacts  
common forms of, 112t
- Interference pattern analysis (IPA), 408  
amplitude analysis, 469–71, 470f  
analysis, 468  
method, 467–68  
utility, 468
- Interference patterns, 107, 408, 467, 495  
properties, 467
- Interictal discharges, 138–40, 796
- Interictal epileptiform discharges (IEDs), 796
- Intermittent waveforms, 103
- Interpeak intervals, 307–8
- Interpolation, 207–8
- Interval analysis, 63
- Intracarotid amobarbital (ICA), 217f, 217–18
- Intracerebral hemorrhage, EEG and, 155
- Intracranial monitoring. *See under* Epilepsy, surgical  
evaluation of
- Intracranial processes, focal, 154–59
- Intraepidermal fibers (IEF), 688
- Intraoperative EEG monitoring, 737, 798  
during cardiac surgery, 736  
EEG changes during carotid endarterectomy, 729f, 730f, 733–35  
for epilepsy surgery, 736–37  
technical factors in, 727–31, 729f, 730
- Intraoperative monitoring (IOM), 292, 393–94, 725, 737.  
*See also* Anesthesia  
clinical applications, 733  
of cranial nerves, 739, 748  
applications, 743–44, 744f, 746–47  
cranial nerve modalities used, 740t  
methods, 740–43  
monitoring plans of common surgical procedures, 744t
- Intraoperative nerve conduction studies (NCSs), 741–42
- Intraoperative peripheral nervous system monitoring, 777–78  
applications, 780–81  
methods, 778–80  
SEPs and MEPs, 779–80  
prevention of injury during surgery, 783–84  
purpose and role, 777–78
- Intraoperative spinal cord monitoring, 751–52, 774. *See also* Spinal surgeries  
EMG and nerve conduction studies, 765–68, 766f  
applications and interpretation of findings, 767–68  
physiologic and technical effects, 767  
recording techniques, 766–67  
general principles, 752–53  
motor evoked potentials (MEPs)  
application and interpretation of MEP changes, 764–63  
physiologic/technical considerations, 764  
recording techniques, 762–64, 763f  
stimulation techniques, 760–62  
purpose and role, 752  
somatosensory evoked potentials (SEPs), 754  
application and interpretation of SEP changes, 759f, 759–60, 760f  
physiologic and technical issues, 756–59  
recording techniques, 755–56, 756f  
stimulation techniques, 754–55
- Intraventricular hemorrhage, 171
- Inverse problem, 47, 210
- Inward current flow, 34
- Ion channel blockade, 94, 96
- Ion channels, 72–75, 90–91  
categories of, 73–75  
examples of, 74t
- Isoelectric EEG, 170
- Isoflurane anesthesia, 728f
- Isolated acquired idiopathic anhidrosis, 646t
- Isolated voice tremor, 557
- Isolation transformers, 26, 27f
- Isometric tremors, 555
- Jaw jerk  
applications, 537–38  
methods of eliciting, 537  
neuroanatomy, 537
- Jerk-locked averaging, 230
- Jerks, 788  
psychogenic, 568
- Jiggle, 481
- Jitter, 476–77, 479–81, 484f, 484–86, 485f
- Junctional folds, 370
- K-complex, 128
- Kinetic tremors, simple, 555
- Kirchhoff's first law, 8
- Kirchhoff's second law, 8–9
- Labyrinthitis, 607
- Lambda wave, 126, 127f
- Lambert-Eaton myasthenic syndrome, 378f, 380, 381, 488
- Landau-Kleffner syndrome, 182, 183f
- Laser evoked potentials (LEPs), 684–88
- Lateral cord, 819, 820t
- Lateral spread response (LSR), 363, 535–36, 536f, 745–47, 747f
- Laterocollis, 570
- Leakage current, 24f, 26f, 27f  
origin, 25  
tests for, 28–29

- Leakage current reaching patients, 25  
 methods to reduce, 25–27
- Learning set, 66
- Lennox-Gastaut syndrome, 177f
- Lesions  
 brain stem, 274, 291–92  
 chiasmatic, 317–18  
 facial nerve, 532f, 532–33  
 focal cerebral, 159  
 focal intracranial, 154  
 posterior fossa, 534  
 prechiasmatic, 317–18  
 retrochiasmatic, 321–22  
 root *vs.* plexus, 822  
 spinal cord, 273–74  
 supratentorial, 274  
 trigeminal nerve, 531–32, 532f  
 trunk, 818–19, 821t, 822  
 vascular, 181  
 visual pathway, 317–22  
 visual system, 317–22
- Lesions effects of VEMPs, 603
- Leukodystrophy, metachromatic, 179f
- Liability to pressure palsies, 349
- Ligand-gated receptors, 90–91
- Limits, method of, 678
- Linear change, 414
- Linear conductors, 6
- Linear display (digital EEG), 55
- Linear translations and accelerations, 579–80
- Linked potentials, 441, 459. *See also* Satellite potentials
- Local potentials, 78–79, 80f  
 characteristics, 79–82  
 ionic basis, 76t, 79  
 temporal course, 81f
- Localization  
 of disease, 788–89, 802  
 paradoxical, 266, 314
- Localizing nerve with stimulator (sliding), 333
- Long latency reflexes (LLRs), 543–44, 548  
 cutaneous reflexes, 546  
 flexor reflex, 546  
 to mixed nerve stimulation, 545–46  
 purpose and role, 543  
 to stretch, 544–45
- Low resolution electromagnetic tomography (LORETA), 211
- Lower motor neurons (LMNs), 453
- Lower tracing, 254f
- LSU, 579–80
- Lumbosacral radiculopathy, 806–7
- Lumbosacral spine disease, 772
- Lymphedema, needle exams and, 412
- M wave, 334, 339f
- Magnetic fields. *See also* Electromagnets  
 evoked, 47
- Magnetic stimulation, 332
- Magnetoencephalogram (MEG), 47
- Magnetoencephalography (MEG), 211–12
- Magnitude estimation, 678
- Maintenance of wakefulness test (MWT), 703–4  
 purpose and role, 698
- Mapping, topographic. *See* Topographic displays
- Martin-Gruber anastomosis (MGA), 831  
 type I, 831, 832t, 832f, 834–35  
 type II, 832–34, 833f, 833t, 834f  
 in carpal tunnel syndrome, 833–34  
 type III, 834t, 834–35
- Masseter inhibitory reflex (MIR), 538  
 applications, 539–40  
 methods of eliciting, 538–39
- Masseter reflex. *See* Jaw jerk
- Maximal voluntary contraction (MVC), 467
- Mayo Clinic, v  
 brachial plexus outpatient EMG protocol, 823t  
 Thermoregulatory Laboratory, 650, 651f
- Mean amplitude, 465
- Mean consecutive difference (MCD), 478, 480–81
- Mean interspike interval, 482
- Mean sorted difference (MSD), 480
- Medial cord, 819, 821t
- Median and ulnar mixed nerve SEPs, 263–65
- Median nerve action potentials, 42f
- Median neuropathies, 357–59, 359f
- Membrane potentials. *See also* Cell membrane; Resting potential  
 characteristics of different, 73t  
 generated by diffusion across semipermeable membrane, 77f  
 variables that determine, 72f
- Meningitis, 179
- Mental retardation, 177f
- Meralgia paresthetica, 270f
- Metabolic disorders, 171
- Metabolism, inborn errors of, 171–72
- Metachromatic leukodystrophy, 179f
- Microneurography (MCNG), 683–84
- Midbrain tremor, 557
- Middle cranial fossa, intraoperative monitoring of, 743–44
- Migraine headache, 159, 183, 183f
- Miniature end plate potentials (MEPP), 98, 371, 417
- Mitten patterns, 136
- Mononeuropathies  
 common, 253–55  
 common focal, 808–10
- Monopolar electrode, 423
- Monopoles, 38, 39f, 50
- Montage reformatting, 55, 205–6
- Motor control test (MCT), 604
- Motor evoked potentials (MEPs), 325, 385–86, 396  
 anesthesia and, 764  
 applications, 393–95  
 contraindications and risks, 395  
 intraoperative, 741, 779–80. *See also under*  
 Intraoperative spinal cord monitoring  
 pharmacology, 392–93  
 purpose and role, 386  
 technique  
 measurements, 392  
 recording, 390, 392  
 stimulation, 386–87, 387f  
 technical aspects of electrical stimulation, 387–89  
 technical aspects of magnetic stimulation, 389–90
- Motor nerve conduction studies. *See* Nerve conduction studies
- Motor neuron diseases, 255–56, 274–75, 830–31  
 evolution of EMG changes in, 830t
- Motor neurons, lower, 453

- Motor potential (MP), 229, 230
- Motor symptoms of central origin, assessment of, 791–92
- Motor unit action potential. *See* Motor unit potentials
- Motor unit fractions, 459
- Motor unit number estimates (MUNEs), 421, 493–94. *See also* Quantitative MUNE
- from all-or-none increments in CMAP, 500–1, 501f, 503–4
  - from multiple all-or-none increments at one stimulation point, 501, 502f, 503–4
  - purpose and role, 493
  - by standard EMG, 495
  - by standard motor NCS, 496–97
  - statistical (STAT), 506–9, 509f, 510f
- Motor unit potential (MUP) variation, 831
- vs.* stability, 459–60
- Motor unit potentials (MUPs), 36, 406–8, 416, 418, 494, 740. *See also* Needle EMG; Quantitative EMG
- area, 457–58
  - automated analysis of single, 464
  - characteristics, 453–54
  - commonly measured variables, 457f
  - complexity, 459, 479
  - doublets and multiplets, 444, 444f
  - disorders associated with, 444t
  - long-duration, 438–40f, 441
  - disorders associated with, 439t
  - manual analysis, 462
  - measurement, 408–9
  - mixed patterns (long- and short-duration), 442
  - myopathy and, 827
  - phases, 440–42, 458–59
  - properties
    - evaluated using standard electrodes, 456–60
    - measurable only with special electrodes, 460–62
  - recruitment, 418
  - short-duration, 439–40
  - disorders associated with, 440t
  - terminal component, 457, 458
  - varying/unstable, 442–44
  - disorders associated with, 443t
- Motor units, 401, 494
- Motor unit territory, 453
- proportion functioning distal to the block, 496
- Movement abnormalities, voluntary, 571
- Movement-associated potentials, 62
- Movement disorders, clinical neurophysiology of, 552, 568. *See also* Myoclonus; *specific disorders*
- abnormal patterns, 570–71
  - elicited responses, 553–54
  - normal patterns, 554
  - purpose and role, 552
  - techniques, 552–53
- Movement-related cortical potentials (MRCPs), 229
- abnormalities in disease, 231–32
  - contingent negative variation, 232
  - individual variation, 231
  - normal waveforms, 230–31, 231f
  - purpose and role, 229
  - technique, 230
- M-response amplitude, 526
- Multichannel surface EMG recordings, 788
- Multifocal motor neuropathy (MMN) with conduction block, 355
- Multifocal myoclonus, 559
- Multimodality evoked potential (MMEP), 275–76
- Multi-motor unit action potential analysis (multi-MUAP analysis), 465–66
- Multiplanar and multiple sphere models, 51
- Multiple sclerosis (MS)
- BAEPs and, 288f, 290f, 290–91
  - blink reflex and, 535
  - somatosensory evoked potentials and, 272–73
  - visual evoked potentials in, 318–20, 320f
- Multiple sleep latency test (MSLT), 703, 718
- purpose and role, 698
- Multiple system atrophy (MSA), 649
- Multipoint stimulation (MPS), 504–6, 505f, 506f
- Multivariate statistical methods, 209–10
- Mu rhythm, 126, 126f
- Muscle activity, intraoperative, 757, 764
- Muscle artifact, 267
- Muscle end plate potentials, 98
- Muscle relaxation, importance of, 262f
- Muscles, 98. *See also* Compound muscle action potentials; Needle EMG
- data collection from contracting, 407–8
  - data collection of resting, 407
  - peri-pleural, 410
  - primary disorders of, 488–89
- Muscle stiffness, 827
- Myalgias, 827
- Myasthenia, 381
- familial infantile, 381
- Myasthenia gravis, 380, 486–88
- Myasthenic syndromes, congenital, 381, 488
- Myelinated fibers. *See also* Demyelinating disease
- mechanisms of conduction in, 345
- Myelopathy, 320f, 650f
- cervical spondylitic, 271, 272f
- Myoclonus, 274, 275f, 559–62
- abnormal patterns, 562–63
  - classification by localization and electrophysiologic features, 560–63t
  - cortical, 544, 545f, 563–65
  - cortical-subcortical, 566
  - palatal, 558
  - peripheral, 568
  - recording techniques, 562
  - segmental, 559, 567–68
  - subcortical-suprasegmental, 567
- Myokymic discharges, 432–33, 432f
- disorders associated with, 433t
- Myopathic diseases, 493
- Myopathy(ies), 255, 823–27
- associated with fibrillation potentials, 826t
  - associated with myotonic discharges, 826t
  - disorders causing, 825t
  - with low CMAP amplitudes on distal NCS, 824t
- Myorhythmia, 557
- Myotonic discharges, 428–29, 429t, 826. *See also* Neuromyotonic discharges
- diseases associated with, 429t
- Myotonic disorders, 381
- Nascent MUPs, 440, 804
- Near-field potentials (NFPs), 43, 261, 284
- Near-infrared spectrophotometry (NIRS), 736
- Neck surgery, intraoperative monitoring during, 747

- Needle electrodes, 332, 477f, 477–78  
types used in quantitative EMG, 454f, 454–55
- Needle EMG (electromyography), 404, 445–47. *See also specific disorders*
- abnormal electrical activity
    - disorders of central control, 445
    - voluntary MUPs, 437–44
  - abnormal recruitment, 437–38
  - abnormal spontaneous electric activity, 424
    - complex repetitive discharges, 429–30, 430t
    - cramp potentials, 435–36, 436f, 436t
    - fasciculation potentials, 430–31, 431t
    - fibrillation potentials, 425–28, 426f, 427t, 427f
    - insertional activity, 424–25, 425f
    - myokymic discharges, 432–33, 432f, 433t
    - myotonic discharges, 428–29, 429t
    - neuromyotonic discharges, 433–35, 434t
    - synkinesis, 436–37
  - clinical evaluation, 405
  - conducting needle examination, 405
    - data collection of contracting muscles, 407–8
    - data collection of resting muscles, 407
    - muscle selection, 405–6
    - needle insertion, 406
    - needle movement, 406
    - preparing patient, 405
    - recording display during examination, 407
  - knowledge base of, 404–5
  - needle size, 411, 411t
  - normal EMG activity
    - duration and amplitude, 423
    - firing rate and recruitment of MUPs, 418–19, 420f, 421
    - MUP configuration, 421f, 421–22, 422f
    - normal spontaneous activity, 417–18
    - normal voluntary activity, 418
    - phases, 423
    - stability, 423
  - origin of EMG potentials, 415–17
  - pattern recognition, 414f, 414–15
  - patterns of abnormalities, 445, 445f, 446t
  - potential complications during examination, 409–14
  - purpose and role, 404
  - recording display during examination, 407
  - semiquantitative EMG, 415
  - steps in evaluation process, 405
  - technique, 405
- Needle EMG applications of volume conduction, 49
- Needle stimulator position, 333–34
- Negative afterpotential, 84
- Negative slope (NS), 230
- Neonatal EEG patterns
  - abnormal, 169–73
  - normal, 168–69
- Neonatal screening, evoked otoacoustic emissions tests
  - for, 301–2
- Nernst equation, 71
- Nerve action potentials (NAPs), 741, 742, 778
- Nerve conduction studies (NCSs). *See also specific topics*
- digital averaging devices for, 60–62
  - intraoperative, 741–42, 778–81
  - motor, 787–88
    - purpose and role of, 328–29
  - NCS applications of volume conduction, 48
  - sensory, 787. *See also* Sensory nerve action potentials
    - great auricular, 540
    - unexpected findings, 835–36
    - volume conductor resistive-capacitive (RC) properties and, 41–42
- Nerve conduction variables. *See also specific variables*
- changes after focal nerve injury, 352, 352t
- Nerve stimulation
  - in SEPs, 258–60, 259f
  - unilateral vs. bilateral, 259–60
- Neuralgic amyotrophy, 363
- Neurochemical transmitters
  - biosynthesis, storage, release, and reuptake, 89–99
  - postsynaptic effects, 90–91
- Neurocutaneous disorders, 172
- Neurogenic blocking, 485f, 485–86
- Neurogenic disorders, 490. *See also specific disorders*
- primary, 489
- Neurogenic motor evoked potential (MEP), 390
- Neurolabyrinthitis, 581, 607
- Neuroma, acoustic, 289f, 289–90
- Neuromodulation, 93
  - vs. classic neurotransmission, 91t
- Neuromuscular blockade and motor evoked potentials
  - and, 764
- Neuromuscular junction (NMJ), 823–24
  - anatomy and physiology, 370f, 370–72
  - disorders, 255, 828–29
- Neuromuscular transmission, primary disorders of, 486. *See also specific disorders*
- Neuromyotonic discharges (neuromyotonia), 433f, 433–35, 434f
  - disorders associated with, 434t
- Neuronal excitability, 75–76
- Neuronopathies, sensory, 813t
- Neurons, current flow near
  - caused by synaptic activation, 34–35, 35f
- Neuropathies. *See also* Demyelinating neuropathies; Peripheral neuropathies; *specific neuropathies*
- axonal, 351–52, 352t, 813–14, 814t
  - disorders causing, 825t
  - focal, 355–62
    - evaluation of, 349–50
    - median, 357–59, 359f
    - primary autonomic, 646t
- Neurophysiology, 96, 836
  - clinical correlations, 93–96
- Neurotonic discharges, 434, 435f, 740–41, 740f
- Neurotransmission. *See also* Neurochemical transmitters
  - classic, 92
  - vs. neuromodulation, 91t
- Newborn, EEG in the, 798–799
- Nocturnal myoclonus, 569
- Nodes, 8
- Noise, 248–49. *See also* Signal-to-noise ratio
  - electrical, during intraoperative monitoring, 756–57
  - end plate, 407, 417
- Non-rapid eye movement (NREM) sleep, 697–98, 706, 709f
- Norepinephrine, plasma, 642–43
- Normal cloud, 470
- Normal deviates, 338
- Normotension, maintenance postural, 626
- NREM sleep, 697–98, 706, 709f
- N-type semiconductor, 16



- Nylen maneuver, 586, 587f  
 Nystagmus  
   positioning induced, 586–88  
   testing for pathologic, 586–89  
   types of, 583. *See also specific types*
- O waves, 175  
 Obese patients, 410–11  
 Obstructive sleep apnea (OSA), 697–98, 707–8, 711f, 715, 719  
 Occipital intermittent rhythmic delta activity (OIRDA), 152, 178  
 Occipital spikes and seizures, 176–78, 178f  
 Occupational cramp, 569, 571  
 Oculomotor nerve, stimulation of, 744f  
 Oddball stimulus, 233  
 Oddball technique, 233  
 Ohms, 7  
 Ohm's law, 7  
 OIRDA. *See* Occipital intermittent rhythmic delta activity, 152, 178  
 Onset latency, 247, 248f  
 Open fields, 35  
 Operating room (OR). *See also* Intraoperative monitoring  
   equipment and electrical safety, 753–54  
 Opsoclonus-myoclonus syndrome, 567  
 Optic neuritis, acute, 319  
 Optic pathways, 100  
 Optokinetic nystagmus (OKN), 586  
 Oromandibular dystonia, 569, 570  
 Orthodromic technique, 243, 244f, 245, 253–54  
 Orthostatic technique, 253–54. *See also* Orthodromic technique  
 Orthostatic tremor, 558, 558f  
 Otoacoustic emissions, evoked, 295–96, 301f, 301–3  
 Otoacoustic emissions tests, evoked, 301–2  
 Otoconia, 579  
 Outward current flow, 34  
 Overshoot, 666
- P300, 233  
 Pacemakers  
   examining patients with, 410  
   stimulating near, 30  
 Pachygyria, 172f  
 Pain hyperalgesia, thermal, 680f, 681f  
 Pain pathways, techniques to evaluate. *See also specific techniques*  
   purpose and role, 677–78  
 Pain syndrome, complex regional, 681  
 Pain tolerance, low, 411  
 Palatal tremor, 558  
 Palmar latency, 357  
 Palmar technique, 253–54  
 Panencephalitis, subacute sclerosing, 161, 162f, 180, 565–66  
 Paradoxical localization, 266, 314  
 Parallel potentials, 39, 41  
 Paramyotonia, 381  
 Parasite potentials, 459. *See also* Satellite potentials  
 Parasomnias, 719–21, 720f  
 Parkinsonian tremor, 556, 557f  
 Parkinson's disease (PD)  
   movement-related potentials in, 231–32  
   myoclonus of, 566  
 Paroxysm, 176f  
 Paroxysmal disorders, EEG evaluation of, 796–97  
 Paroxysmal positioning vertigo, benign, 586, 587, 607  
 Paroxysmal rhythmic fast activity, 143  
 Parsonage-Turner syndrome, 363  
 Partial conduction block, 816, 816f  
 Passive sources (of bioelectric potentials), 33, 34  
 Pathophysiologic mechanisms, 93  
 Patient ground, 25  
 Pattern recognition, 66, 414  
 Pattern recognition algorithm, developing a, 66  
 Peak latency, 247  
 Peak ratio, 468  
 People with epilepsy (PWE), 215. *See also* Epilepsy,  
   surgical evaluation of  
 Periodic alternating nystagmus, 588  
 Periodic discharges, 148, 149f  
 Periodic lateralized epileptiform discharges (PLEDs),  
   140, 141f, 153, 157f, 170  
   herpes simplex encephalitis and, 158–59  
 Periodic limb movements of sleep (PLMS), 568, 702,  
   714–17, 716f  
 Periodic paralysis, 382, 382f  
 Periodic patterns, 153–54  
 Peripheral nerve damage, diffuse, 350–52  
 Peripheral nerve disorders. *See also* Peripheral nervous  
   system disorders; *specific disorders*  
   CMAP findings in, 346–52  
 Peripheral nerve injury  
   CMAP after, 356t, 804t  
   duration of deficit after, 347t  
   EMG interpretations after, 357t  
   needle examination findings after, 356t, 804t  
   repair, 781–83  
 Peripheral nerve stimulation methods, 497–98. *See also*  
   *specific methods*  
 Peripheral nerves, 97–98  
 Peripheral nervous system, monitoring. *See* Intraoperative  
   peripheral nervous system monitoring  
 Peripheral nervous system disorders. *See also* Peripheral  
   nerve disorders; *specific disorders*  
   clinical neurophysiology in assessment of, 802–6  
   assessment with EMG and NCS, 806  
 Peripheral neuromuscular disorders, abnormal NCS  
   patterns in, 348t  
 Peripheral neuropathies, 350–52, 351t, 489, 533–34,  
   810–13. *See also specific neuropathies*  
   defining pathophysiology, 813  
 Peripheral silent period, 547  
 Peripheral stimulation failure during spine surgery, 758f  
 Peri-pleural muscles, examining, 410  
 Permeability of membranes, 72  
 Peroneal motor conduction study, 507f  
 Peroneal nerve, accessory, 835f, 835, 836t  
 Peroneal neuropathies, 362, 361f, 809–10  
 Perpendicular potentials, 39, 41  
 Persistent low voltage, 170  
 Persistent slowing, 171  
 Phantom spike-and-wave, 134  
 Phase cancellation, 242, 347  
 Phase relation, 110  
 Phase spectrum, 207  
 Phases of MUP, 440–42, 456–57  
 Phasic dystonia, 569  
 Phasic muscle twitches, 708–9  
 Photic driving, 123



- Photic responses, 130, 173  
 Photic stimulation, 122–23  
 Photoconvulsive response, 144, 145f  
 Photomyogenic response, 123  
 Photoparoxysmal response, 123  
 Physiologic myoclonus, 559  
 Physiologic tremor, 554  
   exaggerated, 555  
 Plasma norepinephrine, 642–43  
 Plastic imprints, 634  
 Plexopathy, 252–53  
   brachial, 817–22, 821t, 822  
 Polyneuropathy, 686, 687f  
 Polyphasic MUPs, 423, 440–42, 459  
 Polyradiculopathy, 829–30. *See also* Inflammatory demyelinating polyradiculopathy  
 Polysomnography, 698–701, 699f, 700f, 701–703, 792  
   purpose and role, 698  
   typical settings, 701t  
 Poor activation, 419  
 Pores of membranes, 73  
 Portable monitoring, 705–6  
   purpose and role, 698  
 Positional nystagmus, 581  
 Positional testing without fixation, 588–89  
 Positioning induced nystagmus, 586–88  
 Positive, arrhythmic, slow (PAS) waves, 731, 732  
 Positive afterpotential, 84  
 Positive occipital sharp transients of sleep (POSTS), 127–29, 129f  
 Positive rolandic sharp waves, 170  
 Positive spike bursts, 14 and 6 Hz, 132, 175  
 Positive waveform, 425–26, 426f  
 Positron emission tomography (PET), 217  
 Postactivation facilitation, 374  
 Posterior cord, 819, 820t  
 Posterior cranial fossa, intraoperative monitoring of, 745f, 744–47  
 Posterior fossa lesions, 534  
 Posterior fossa level, localization of disease at, 788  
 Posterior slow waves of youth, 175  
 Posterior syndrome, 608  
 Posterior visual pathway lesions, 321–22  
 Postexercise exhaustion, 380  
 Postictal slowing, 183  
 POSTS. *See* Positive occipital sharp transients of sleep  
 Postsynaptic effects of neurotransmitters, 90–91  
 Postsynaptic potentials, 92, 92t, 101  
   inhibitory, 34–35, 92  
 Postural normotension, maintenance, 626  
 Postural tremors, 555  
 Posture and Valsalva response, 668  
 Posturography. *See* Computerized dynamic posturography  
 Potential. *See* Electrical potentials  
 Power, electrical, 6  
 Power spectrum, 65, 471  
 Power-spectrum analysis, 471–72, 670–71  
 Prechiasmatic lesions, 318  
 Preganglionic sympathetic neurons, 621  
 Premovement positivity (PMP), 229, 230  
 Pressure palsies, liability to, 349  
 Presynaptic inhibition, 90, 91f  
 Probability distribution, moments of, 66  
 Prognosis, determining, 805  
 Progressive diseases, 805  
 Projected rhythm, 152  
 Prolonged video electroencephalography (PVEEG), 193–94, 199  
   clinical application, 195–99  
   equipment, 194–95  
 Propagating generators  
   effect of volume conduction on potential components due to, 44  
   stationary potentials produced by, 44  
 Propriospinal myoclonus, 567  
 Proximal conduction, H reflex used to measure, 524–25  
 Proximal myotonic myopathy, 428  
 Pseudofacilitation, 376  
 Pseudohypacusis, 302–3  
 Pseudomyotonic discharges, 429  
 Psychogenic jerks, 568  
 Psychogenic seizures, 196–97  
 Psychogenic tremor, 558  
 Psychomotor-variant pattern, 132  
 P-type semiconductor, 16  
 Pupillary size, 315  
 Pure-tone and speech audiometric testing, 296, 297f  
  
 QSWEAT, 630  
   purpose and role, 630  
 Quadrupoles, 38, 39f, 50  
 Quantitative analysis  
   of single MUPs, 462  
   of user selected MUP, computer-assisted, 462–64, 463f  
 Quantitative EMG (QEMG), 408, 451–53, 469, 473. *See also* Motor unit potentials; Semiquantitative EMG  
   decomposition-based, 466  
   purpose and role, 453  
   recording equipment characteristics, 454–55, 456f  
 Quantitative MUNE, 497, 509. *See also* Motor unit number estimates  
   clinical applications, 510  
   surface averaging of needle EMG MUPs, 498–500  
   underlying assumptions, 497–98  
 Quantitative sensory test (QST), 678–81  
 Quantitative sudomotor axon reflex test (QSART), 629–30, 631f, 632f, 682–83  
   abnormal patterns, 632–33  
   applications, 633–34  
   normal response, 631–32  
   patient preparation, 630t  
   purpose and role, 630  
   significance, 633  
 Quantization (digitization), 57  
 Quantization parameters, effect of, 58f  
 Quantum, 370  
 Quantum size (ADC resolution), 57  
 Quiet sleep, 168  
  
 Radial motor nerve, 816f  
 Radiculopathies, 252, 271, 363, 806–8  
 Rapid eye movement (REM) sleep. *See* REM sleep  
 Rapid firing, 419  
 Rapid recruitment, 419, 421, 438  
 Rapid surgical induction, 731  
 Rare stimulus, 233  
 Rarefaction, 287  
 Rasmussen encephalitis, 180  
 Rate of rise, 107  
 Reactance, calculation of, 13

- Reactivity  
   altered, 153  
   asymmetric, 153  
 Reciprocal innervation, 578  
 Recruitment, 418. *See also under* Needle EMG (electromyography)  
   defined, 495  
   rapid, 419, 421, 438  
 Recruitment analysis, 495–96  
 Recruitment pattern, 437  
 Rectification, 17  
 Reduced numbers, 419  
 Reduced recruitment, 419, 437  
 Re-emergent tremor, 557  
 Reflex sympathetic dystrophy (RSD), 681  
 Reflex withdrawal, 546  
 Reflexes, 517, 554. *See also specific reflexes*  
   cardiopulmonary, 625  
   startle, 568  
 Refractory period, 85  
 Regional anhidrosis, 654  
 Relative refractory period, 85  
 REM (rapid eye movement) sleep, 130, 703, 706, 706f  
   without muscle atonia, 717, 717f  
 REM latency, 710  
   normal lower bounds for, 710t  
 REM sleep behavior disorder, 720–21  
 Repeater F waves, 352  
 Repetitive nerve stimulation (RNS), 369, 383, 788, 825, 828–29  
   clinical correlations, 380–83  
   rapid rates of stimulation, 378–79  
   technique, 372–77  
 Repetitive nerve stimulation (RNS) studies, 822–23  
   criteria of abnormality, 377–78  
   purpose and role, 370  
   selection of nerve-muscle combinations, 379t, 379–80  
 Repetitive transient waveforms, 62  
 Residual latency (RL), 335  
 Residual of disease, 805  
 Resistance, 6  
 Resistive-capacitive (RC) circuits, 9  
   time constant, 9–10  
 Resistive-capacitive (RC) properties in volume conductors, 41–42  
 Resistive-inductive (RL) circuits and time constant, 10  
 Resistivity, 41  
 Resistors, 7, 17  
   rules for seats of, 8  
 Resonance, 13  
 Respiration, phases of, 669  
 Respiratory effort and sleep, 712, 13  
 Respiratory effort-related arousals (RERAs), 712  
 Respiratory sinus arrhythmia, 624, 627  
 Respiratory synkinesis, 436–37, 437f  
 Respiratory variables, 715  
 Resting discharge rate, 578  
 Resting potential, 76–78  
 Restless leg syndrome (RLS), 716  
 Reticular reflex myoclonus, 567  
 Retrochiasmatic lesions, 321–22  
 Retrocollis, 570  
 Reverse biasing, 17  
 Reverse first-night effect, 710  
 Rhythmic temporal theta bursts of drowsiness, 132, 132f  
 Riche-Cannieu anastomosis, 834–35  
 Rigidity, 445  
 Rise time, 107, 415, 423, 458  
 Rolandic epilepsy of childhood, benign, 139–40  
 Rolandic sharp waves, positive, 170  
 Root-mean-square (rms) potentials or currents, 12  
 Rotary chair test, 594, 596f, 598. *See also* Computerized rotary chair tests  
 Rotational torticollis, 570  
 Rubral tremor, 557  
  
 Saccadic eye movement testing, 585  
 Safety factor, 371, 372. *See also* Electric safety  
 Saltatory conduction, 87, 87f  
 Sampling (digitization), 58–59  
 Satellite potentials, 423, 441–42, 458  
 Scoliosis surgery, 771  
 Sedation, 316  
 Sedative medications, 267  
 Segmental anhidrosis, 654  
 Seizures  
   absence, 141, 176f  
   classification of types of, 197–98  
   detection, 204–5  
   EEG evaluation of, 798–99  
   EEG recorded during a, 206f  
   psychogenic, 196–97  
   PVEEG and surgical evaluation, 198–99  
   routine EEG in surgical evaluation, 218  
 Semicircular canals (SCCs), 577, 578  
   superior SCC dehiscence, 607–8  
 Semiconductors, 16, 17f  
 Semiquantitation, 414  
 Semiquantitative EMG, 415, 452  
   steps in, 415  
 Semirhythmic patterns, 414, 418  
 Sensorineural disorders, 305  
 Sensorineural hearing loss, 297  
 Sensorineural syndromes of the labyrinth, assessing, 607–9  
 Sensory axons. *See* Axons  
 Sensory evoked potentials, 237. *See also* Somatosensory evoked potentials  
 Sensory nerve action potential (SNAP) studies  
   findings in diseases, 252–56  
   methods, 243, 245  
   planning, 251–52  
 Sensory nerve action potentials (SNAPs), 36, 61f, 239–40, 256  
   abnormal, 241–43  
   averaging, 246–47  
   clinical importance, 243, 245  
   intraoperative, 781  
   measurements, 247–48  
   nerve stimulation, 245–46  
   normal, 240–41  
   pathophysiology, 240–43, 245–47  
   purpose and role, 240  
   recording the potential, 246  
   technical factors, 248  
     distance between recording electrode and nerve, 249–50, 251f  
     interelectrode distance, 250–51  
     measurement, 250  
     noise and shock artifact, 248–49

- recording and stimulating distance, 249
  - submaximal stimulation, 249
  - temperature, 249, 250f
- Sensory neuropathies, 813t
- Sensory organization test (SOT), 604–6, 605f, 606f
- Sensory receptors, special, 100
- Sensory symptoms of central origin, assessment of, 792
- Serrated MUPs, 459
- Shaky legs syndrome, 558, 558f
- Sharp wave, 137, 138f
- Sharpness criteria, 204
- Shock artifact from stimulator location, 333
- Short segmental stimulation. *See* Inching
- Shut-eye waves, 175
- Signal analysis, types of, 65f
- Signal display, 110–11
- Signal-to-noise ratio, 60–61, 113, 248
- Silent period, 543, 546–48, 547f
  - cutaneous, 548
  - purpose and role, 543
- Silicone imprints, 634
- Simple kinetic tremors, 555
- Single fiber EMG (SFEMG), 455, 475–77, 488
  - clinical applications, 484–88
  - NMJ disorders and, 827–29
  - pitfalls
    - damaged fiber, 485, 485f
    - false trigger, 483–84, 484f
    - general, 483
    - incorrect measurement position, 484
    - neurogenic blocking, 485f, 485
    - split fiber or ephaptic activation, 485
    - unique to stimulated SFEMG, 485–86
    - unstable trigger, 483
  - purpose and role, 475
  - stimulated, 478–79
  - technique, 477
    - hardware, 477–78
    - measurement, 479–83
    - method of activation, 478–79
    - software, 478
  - voluntary, 478
- Single peak, 39
- Single potential, 109
  - measurable variables of, 109t
- Single-photon emission computed tomography (SPECT), 199, 216
- Sink, 34
- Skin, sympathetic innervation of the, 622–23
- Skin blood flow (SBF), 638
- Skin problems, 647t
  - needle exams and, 410
- Skin response, sympathetic, 653, 683
- Skin vasomotor reflexes, 637–43
- Sleep. *See also under* EEG
  - active *vs.* quiet, 168
  - assessing impairment of, 792
  - assessing movements in, 715–18
  - assessing respiration during, 712–15
  - benign epileptiform transients of, 132–33
  - EEG and, 123, 127–30, 132–34, 135f, 136, 173–75, 697
  - NREM, 697, 706, 709f
  - periodic limb movements of, 568–69, 702, 715–17, 716f
  - positive occipital sharp transients of, 127–29, 129f
  - REM (rapid eye movement) sleep, 130, 700, 706, 706f, 708, 708f, 720
  - staging, 706–12
  - Sleep apnea. *See also* Obstructive sleep apnea
    - types of, 712, 713f
  - Sleep deprivation, voluntary, 719
  - Sleep disorders. *See also* Obstructive sleep apnea
    - assessing, 719–21
  - Sleep efficiency, 710
  - Sleep latency, 710
  - Sleep onset, 710
  - Sleep onset REM (SOREM), 703
  - Sleep spikes, benign sporadic, 132–33, 134t
  - Sleep spindles, 127–28, 128f
  - Sleep stages, 706–9
  - Sleep studies, performance of, 718–19
  - Sleep time, total, 710
  - Sleep variables, 709–12
  - Sliding, 333
  - Slow alpha variant, 130
  - Slow component velocity (SCV), 583
  - Slow firing, 419
  - Slow fused transients, 175
  - Slow harmonic acceleration (SHA), 595, 598
  - Slow lambdas of childhood, 175
  - Slow-wave abnormalities, 152, 160
  - Small fiber neuropathy, 646–648
  - Small sharp spikes (SSS), 132–33
  - Smooth ocular pursuit testing, 586
  - Snoring sounds, 714
  - Sodium pump, 78
  - Soleus technique, 522, 523f
  - Somatosensory evoked potentials (SEPs), 36, 43–44, 257–58, 277, 788
    - anesthesia and, 757f, 757–58
    - clinical applications, 269
      - disorders of CNS, 271–76
      - disorders of peripheral nervous system, 269–71
      - SEP findings in brain death, 276
      - SEPs recorded in ICU, 276–77
    - factors that affect amplitude and latencies of evoked response, 266–68
    - in infants and children, 276
    - interpretation of, 266
    - intraoperative, 741, 778. *See also under* Intraoperative spinal cord monitoring
    - localization
      - amplitude reduction, 268
      - latency prolongation, 268
    - nerve stimulation variables and, 258–60
    - neuroanatomic sites of origin of, 258
    - purpose and role, 258
    - recording
      - averaging, 261–62
      - methods and montages, 260t, 260–61
      - peak nomenclature, 262–66
      - volume conduction and near- and far-field potentials, 261
  - Somnolence, disorders of excessive, 719
  - Spasm, 568
    - hemifacial, 535–36, 536f
  - Spasmodic dysphonia, 570
  - Spasmodic torticollis, 570
  - Spasticity, 445
  - Spatial gradient, 43

- Spatial summation of local potentials, 81f, 82
- Spectral analysis. *See* Fourier (spectral) analysis
- Speech-recognition thresholds, 297
- Spike (event), 107
- Spike and slow wave complex, 137
- Spike and wave, 134, 148f, 176, 177f
- 3-Hz, 141, 142f
  - 6-Hz, 134, 135f
  - wicket, 127, 134, 135f, 136
- Spike discharge, 137, 138f
- Spike duration, 458
- Spike form, 425, 426f
- Spike-triggered averaging (STA) MUNE, 498–500, 499f
- Spinal and bulbar muscular atrophy (SBMA), 255
- Spinal cord, 99, 779
- Spinal cord injury, 394–95
- Spinal cord lesions, 273–74
- Spinal cord level, localization of disease at, 788–89
- Spinal cord tumors, 273
- Spinal surgeries. *See also* Intraoperative spinal cord monitoring
- types of, 768–74
- Spindle coma pattern, 163
- Spine disease
- cervical, 770–71
  - lumbosacral, 772
  - primary, 768–69
  - primary neural disease, 772
  - thoracic, 771
- Split fiber, 485
- Split syndrome, 608
- Spondees, 297
- Spontaneous activity. *See also under* Needle EMG (electromyography)
- automated methods of analysis of, 472
- Sputtering, 435
- Squatting, heart rate response to, 672
- Stable process, 805
- Stacked ABR (auditory brain stem response), 309
- Staggering. *See* X-shifted fashion
- Stållberg, E., 486
- Standard stimulus, 233
- Startle disorders, 568
- Static compensation, 581
- Static positional test, 588, 589f
- Stationary (evoked) potentials, 44, 45f
- Stationary waves, 261
- Statistical analysis, 66
- Statistical methods, multivariate, 209–10
- Statistical (STAT) MUNE, 506–8, 509f, 510f
- Steady state, 77–78
- Step test, 595
- Stiff-man syndrome, 445
- Stimulus intensity, 287
- Stimulus polarity, 287
- Stimulus rate, 287
- Stimulus-induced rhythmic, periodic or ictal discharges (SIRPIDS), 148, 149f
- Straining, 665
- Stretch reflex, 544–45
- Stroke, 276, 394
- Structural generators, 97–101
- Subacute disorder, 805
- Subacute sclerosing panencephalitis (SSPE), 161, 162f, 180, 565–66
- Subanesthetic concentrations, 731
- Subclinical rhythmic electrographic discharge of adults (SREDA), 130, 131f
- characteristics, 131t
- Subdural effusion and empyemas, 180–81
- Subdural hematoma, 158
- Subjective visual vertical (SVV) assessment, 598–99
- purpose and role, 598
- Subtraction ictal-interictal SPECT coregistered on magnetic resonance images (SISCOM), 199
- Sudomotor axon reflex, 99f
- Suggested immobilization test, 716
- Superconducting quantum interference device (SQUID), 47, 211
- Superimposition, 376, 376f
- Superior nerve neuritis, 607
- Superior nerve syndrome, 607
- Superior SCC dehiscence, 607–8
- Suppression, 153
- Supratentorial lesions, 274
- Supratentorial level, 788
- localization of disease at, 788
- Surface EMG, 552–53
- Surface EMG activity, normal patterns of, 554, 554f
- Surface-recorded motor unit potential (SMUP), 494, 497
- determining the size of, 498
- Surgery. *See* Intraoperative monitoring
- Surgical evaluation, PVEEG and, 198–99
- Sustained handgrip, 643
- Sweat distribution. *See also* Thermoregulatory sweat distribution
- non-Mayo methods of measuring, 653
- Sweat glands, 98–99, 647t
- Sweat loss, focal, 654
- Sweat measurement. *See also* Thermoregulatory sweat test
- imprint methods of, 634
- Sympathetic activity, muscle, 623
- Sympathetic function, 621–22
- assessment of, 622
- Sympathetic innervation of the skin, 622–23
- Sympathetic outflow, functional anatomy of, 621
- Sympathetic reflexes, 621–22
- Sympathetic skin response (SSR), 653, 683
- Symptomatic myoclonus, 559
- Synapses, electrical, 93
- Synaptic cleft, 88
- Synaptic transmission, 88, 89, 89f. *See also* Neurochemical transmitters
- abnormalities in, 95f
  - characteristics, 88–89
- Synaptic vesicles, 90
- Synkinesis, 436–37, 437f. *See also* Facial synkinesis
- Syringomyelia, 273
- Tailored resection, 223
- Task-specific tremors, 559
- Temperature, 249, 250f, 343, 718, 764
- Temporal dispersion, abnormal, 815, 815f
- Temporal intermittent rhythmic delta activity (TIRDA), 145, 145f, 157f
- Temporal spikes, 138, 139f
- Temporal summation of local potentials, 81, 81f
- Terminal bouton, 370
- Terminal component (MUP), 457, 458

- Terminal negative afterpotential, 458  
Terminal-two electrode, 331. *See also* Inactive reference electrodes  
Tetanic stimulation, 371  
Tethered cord syndrome, 773  
Thalamic tremor, 557  
Thermal hypesthesia, 680–81f  
Thermal pain hyperalgesia, 680, 680f, 681f  
Thermoregulatory sweat distribution, 653–55  
  abnormal distributions, 654, 655f  
  normal distributions, 653–54, 654f  
Thermoregulatory sweat test (TST), 645, 656  
  clinical syndromes and problems evaluated, 646–48t, 648–50  
  difficulties and pitfalls in interpretation, 657–80  
  method, 650–53  
  procedure, 658–59  
  purpose and role, 645  
  reporting results, 656f, 656–57  
Theta activity, 125  
Thickness (MUP), 458  
Thoracic outlet syndrome, 270, 363  
Thoracic radiculopathies, 807–8  
Thoracic spine disease, 771  
Threshold, 498  
  for excitation, 83  
Tibial mixed nerve SEPs, 265–66  
Tibial nerve stimulation, 259f  
Tibial scalp potentials, 274f  
Tics, 571  
Tilt-up. *See also* Head-up tilt  
  beat-to-beat BP response to, 640–41  
Time constant (TC), 9–11  
Tonic pattern, 554  
Top tracing, 242f, 467f  
Topographic analysis, EEG, 209–10  
Topographic displays (mapping), 208–9, 209f  
Torticollis, 569, 570  
Tracé alternant pattern, 168  
Transcortical electrical stimulation (TCES), 761  
Transcortical (reflex) loop, 544  
Transcranial Doppler (TCD), 733  
Transcranial electric stimulation (TES), 385–87, 387f, 389  
Transcranial electrical magnetic stimulation, 31  
Transcranial magnetic stimulation (TMS), 385, 386, 388f, 389  
Transient abnormalities, 183  
Transient disorders, 159  
Transient evoked otoacoustic emissions (TEOAEs), 301, 301f  
Transistors, 16–19  
Transmembrane ion gradients, 69–70, 70f  
Traveling evoked potentials, 44, 45f  
Traveling waves, 261  
Tremor, 445, 445f, 554  
  abnormal patterns, 555  
  cerebellar, 557  
  classification by localization and electrophysiologic features, 556t  
  essential, 555–56  
  exaggerated physiologic, 555  
  Holmes, 557  
  orthostatic, 558, 558f  
  palatal, 558  
  Parkinsonian, 556–57, 557f  
  psychogenic, 558–59  
  recording techniques, 555  
  task- and position-specific, 557–58  
Trigeminal contact heat evoked potential stimulator (CHEPS) method, 539–41  
Trigeminal nerve lesions, 531–32, 532f  
Trigger, amplitude, 478  
Triphasic wave patterns, 161–62, 554  
Triphasic waveforms, 47  
Triplets, 444, 444f  
Trunk  
  lower, 818, 819t, 822  
  middle, 818, 819t, 822  
  muscle innervation according to, 821t  
  upper, 818, 818t, 822  
Trunk lesions, 818–19, 821t, 822  
  root *vs.* plexus lesions, 822  
Tuberous sclerosis, 172f  
Tumors, 155–56. *See also* Cranial nerve (CN) VIII tumors  
  brain stem, 292f  
  in children, 181  
Turns, 458–59  
Turns/amplitude ratio, 468  
Twitching. *See* Jerks; Tremor  
  
Ulnar nerve, 263–65, 381, 381f, 835  
Ulnar neuropathies, 254–55, 359, 360f, 361, 809  
Unilateral weakness (UW), 585  
Unstable MUPs, 442, 443t, 444  
Upper tracing, 254f  
  
V waves, 128, 129f  
Vagal baroreflex sensitivity, 667–68  
Valsalva maneuver (VM), 638, 662  
  beat-to-beat BP response to, 638–40, 639f  
  normal response and physiologic basis, 665–67, 666f  
  phases, 638–40t  
  pitfalls in performing, 669  
  technique, 667  
Valsalva ratio, 667  
  pitfalls in interpreting, 669–70  
Valsalva response, factors affecting, 668–69  
Varying MUPs, 442, 443t, 444  
Vascular diseases, surgery for, 773  
Vascular lesions, 181  
Velocity recovery function, 480–81  
Venoarteriolar reflexes, 99f, 623, 625, 641–42  
  neural pathway, 641f  
Vertex sharp transients (V waves), 128, 129f  
Vertigo, 576, 607–8  
  benign paroxysmal positioning, 586, 587, 607  
Vestibular evoked myogenic potentials (VEMPs), 599–603, 607–9  
  example of VEMP waveforms, 601f  
  lesions effects, 603  
  normal values, 601, 602t  
  purpose and role, 599  
  recording methods, 599  
  analysis, 600–1  
  procedure, 600  
  signal averaging, 600  
  stimuli, 599  
Vestibular hair cell systems, 578  
Vestibular mechanisms, functional anatomy and physiology of, 577–80  
Vestibular nystagmus, 581–82

- Vestibular rehabilitation, 610
- Vestibular test methods, laboratory, 582
- Vestibular testing, 576–77  
 clinical applications, 607–9  
 purpose and role, 577
- Vestibulo-ocular reflex (VOR), 577, 578, 594  
 laboratory examination  
 preparation for testing, 584  
 recording method, 582–84  
 videonystagmography test battery, 584–94
- Vestibulopathy, clinical features of, 580–82
- Vestibulo-spinal reflex (VSR), 577, 581–82  
 VSR-based measures, 599–603
- Videonystagmography (VNG). *See* ENG/VNG test battery
- Visceral afferents, 619–20
- Visceral efferents, 620
- Visceral function, assessing impairment of, 792
- Visual acuity, 315
- Visual evoked potentials (VEPs), 311, 312, 322, 788  
 factors affecting VEP response, 314–16  
 interpretation, 317  
 intraoperative, 742  
 localization of visual system lesions, 317–22  
 purpose and role, 312  
 recording, 314  
 stimulation, 312, 314
- Visual pathways, central  
 neuroanatomy, 312, 313f
- Visual system anatomy and physiology, 312, 313f
- Visually enhanced VOR (VVOR), 594, 596
- Visually guided eye movements, inventory of, 585–86
- Voice tremor, isolated, 557
- Voltage-gated cation channels, 73–75
- Voltage(s)  
 of common signals, 110t  
 persistent low, 170
- Volume conduction, 34  
 principles of, 33–34  
 applications of, 43–49
- Volume conduction theory, 41–43
- Volume conductors, 33–34  
 distant recordings in, 42–43  
 electric properties, 37f, 37–38, 41–43  
 nerve action potential from nerves on, 36f  
 potentials in  
 cortically generated, 34–35  
 peripherally generated, 35–36
- Wake after sleep, 710
- Wakefulness, 706, 706f
- Warm-up phenomenon, 429
- Waveforms. *See also specific topics*  
 alteration of, 108  
 physiologic, 108–11  
 artifactual, 111–13  
 continuous, 103–6, 109–10  
 event recording and, 106–8
- Weakness  
 episodic, 827–28  
 facial, 831  
 generalized, 822–24  
 unilateral, 585
- West's syndrome, 143
- White matter disease, 179
- Wicket spikes/wicket waves, 127, 134, 135f, 136
- Wind-up, 686
- Word recognition, 297–98
- Writers' cramp, 569, 571
- Writing tremor, primary, 557
- X-shifted fashion, display in, 375, 376f